



JANUARY 2000

Volume 68 No 1

Amateur Radio

- ★ Converting Computer Power Supplies
- ★ Another Inductance Meter
- ★ Small HF Loop Antennas
- ★ “anti-ARDF” — APRS



**Taking it all to the great outdoors —
the Field Day season in full swing**

- ★ Musen FL2000B revamped
- ★ The ACT 3.5



WIA Yearbook 2000

Callbook Listings
Frequency Listings
Band Plans
Repeater Lists
Beacon Lists
Satellite Lists
Licence Conditions
Examiner Lists
Special Interest Groups
Public Relations Notes
Radio and TV Freqs.
and much, much more !

**2000 is a great year
to have an up-to-date
call book.
This YEARBOOK
edition
contains all of the
content you have
come to expect of
the WIA callbook
as well as some
new items.**

It is more than a callbook, it's a Yearbook, the WIA Yearbook!

**The "WIA Yearbook 2000" is now available from
Divisional Bookshops and selected outlets.**



Amateur Radio

Volume 68
Number 1
January 2000

The Journal of the Wireless
Institute of Australia

ISSN 0002-6859

Editorial

Editor: Colwyn Low VK5UE

Technical Editor: Peter Gibson* VK3AZL

Publications Committee Members

Ron Fisher VK3OM
Don Jackson VK3DBB
Evan Jarman VK3ANI
Bill Rice VK3ABP
Gil Sones VK3AUI

Advertising

Mrs June Fox,
Tel: (03) 9528 5962

Hamads

"Hamads" Newsletters Unlimited
29 Tanner Street, Richmond VIC 3121
Fax: (03) 9428 4242
e-mail: news1@webtime.com.au

Office

10/229 Balaclava Road
Caulfield, Victoria
Telephone (03) 9528 5962
Facsimile (03) 9523 8191
Business Hours 9:30am to 3:00pm weekdays

Postal

P.O. Box 2175
CAULFIELD JUNCTION
VICTORIA 3161
AUSTRALIA
e-mail: armag@hotkey.net.au

Production

Newsletters Unlimited (03) 9428 3458

Printer

Streamline Press, Melbourne (03) 9417 2766

Postal Service

IMS (03) 9291 5888

Production Deadlines

Advertising booking and articles for
publication 10th of proceeding month.

Hamads and advertising material deadline
18th day of proceeding month

The contents of Amateur Radio are Copyright
Wireless Institute of Australia
C 2000

General

Channel 35 available for another year	3
Book Review: 'Pioneers of Radar'	25
<i>Ben Furby VK2XNZ</i>	
Amateur Radio Annual Index	48

Technical

The ACT 3.5	6
<i>Peter Parker VK3YE</i>	
Converting Computer Power Supplies	11
<i>Keith Alder VK2AXN</i>	
Yaesu Musen FL2000B revamped	12
<i>N E Mattick VK2QF</i>	
Yet Another Inductance Meter!	20
<i>John Hassell VK6JAH</i>	
An Experimenter's Power Supply with Current Limit	22
<i>Drew Diamond VK3XU</i>	
Modifying a Linear Power Supply to Charge Gel Batteries	26
<i>Warren Stirling VK3XSW</i>	
Small HF Loop Antennas — Technical Abstracts	30
<i>Gil Sones VK3AUI</i>	

Columns

Advertisers' Index	56	Hamads	54
ALARA	19	HF Predictions	52
AMSAT Australia	41	Over to You	47
ARDF	43	Repeater Link	39
Club News	18	Spotlight on SWLing	38
Contests	33	Technical Abstracts	36
WIA Division News		Try This	32
VK1 Notes	45	VHF/UHF - An Expanding World	35
VK2 Notes	44	WIA Comment	4
VK4 Notes	45	WIA News	4
VK6 Notes	46	WIA Division Directory	56
VK7 Notes	46	WIA Federal Directory	2
Editor's Comment	2		

Our cover this month

Montage of Field Day photos

Clockwise from top: Steve VK5AIM, John Moyle Contest 1999; Terry Grummer VK6TRG, WA VHF Group Field Day; Colwyn VK5UE, Field Day 1997 Wongalere; Property VK7JGD, John Moyle Field Day 1997

Contributions to Amateur Radio

Amateur Radio is a forum for WIA members' amateur radio experiments, experiences opinions and news. Manuscripts with drawings and or photos are always welcome and will be considered for publication. Articles on disc or email are especially welcome. The WIA cannot be responsible for loss or damage to any material. A pamphlet, How to write for Amateur Radio is available from the Federal Office on receipt of a stamped self-addressed envelope.

Back Issues

Back issues are available directly from the WIA Federal Office (until stocks are exhausted, at \$4.00 each (including postage within Australia) to members.

Photostat copies

When back issues are no longer available, photocopies of articles are available to members at \$2.50 each (plus an additional \$2 for each additional issue in which the article appears).

Disclaimer

The opinions expressed in this publication do not necessarily reflect the official view of the WIA and the WIA cannot be held responsible for incorrect information published.

Amateur Radio Service

A radiocommunication service for the purpose of self-training, intercommunication and technical investigation carried out by amateurs; that is, by duly authorised persons interested in radio technique solely with a personal aim and without pecuniary interest.

Wireless Institute of Australia

The world's first and oldest
National Radio Society
Founded 1910

Representing
The Australian Amateur Radio Service

Member of the
International Amateur Radio Union

Registered Federal Office of the WIA

10/229 Belaclava Road
Caulfield North Vic 3181

Tel: (03) 9526 5962 Fax (03) 9523 8191
<http://www.wia.org.au>

All mail to
PO Box 2175 Caulfield Junction VIC 3181

Business hours: 9.30am-3pm weekdays

Acting Federal Secretary

Peter Naish VK2BPN

Federal Office staff

Juna Fox Bookkeeper
Rita Trebilco VK3IF Examinations Officer

Council

President	Peter Naish	VK2BPN
VK1 Federal Councillor	Glenn Dunstan	VK1XX
VK2 Federal Councillor	Michael Corbin	VK2YC
VK3 Federal Councillor	Brenda Edmonds	VK3KT
VK4 Federal Councillor	Ross Marren	VK4AMJ
VK5 Federal Councillor	David Box	VK5OV
VK6 Federal Councillor	Wil McGhie	VK8UU
VK7 Federal Councillor	Phil Corby	VK7ZAX

Executive

Peter Naish	VK2BPN
Tony Farrow	VK2TJF
John Loftus	VK4EMM
Wally Howse	VK6KZ

Federal Coordinators

AMSAT	Graham Ratcliff	VK5AGR
ARDF	Jack Bramham	VK3WWW
Awards	John Kelleher	VK3DP
Contests	Ian Godsil	VK3DID
Education	Brenda Edmonds	VK3KT
FTAC	John Martin	VK3KWA
Historian	John Edmonds	VK3AFU
IARU	Grant Willis	VK5ZWI
Intruder Watch	Gordon Loveday	VK4KAL
ITU Conference and study group	David Wardlaw	VK3ADW
Public Relations	David Thompson	VK2NH
QSL Manager (vke, vko)	Nail Penfold	VK6NE
Videotapes	Don Bland	VK4TVD

ACA Liaison Team

Peter Naish	VK2BPN
Glenn Dunstan	VK1XX
Michael Corbin	VK2YC
Wally Howse	VK6KZ
Canberra Liaison Officer	
Richard Jenkins	VK1RJ

EDITORS COMMENT

What's new in Amateur Radio?

Welcome to January 2000.

A New Year and a new editor. I am Colwyn Low VK5UE. I have edited the WIA SA Division Newsletter for three years.

A LITTLE BACKGROUND, I came to Amateur Radio and electronics at High School and University. I held the call G13MCZ and worked from the University Amateur Radio Club station for a few years before moving to a school in County Fermanagh. There I made use of my Morse qualification and worked Top Band CW for about four years. On migrating to South Australia and WRE Salisbury I obtained the call VK5UE and went dormant for some years. I took part in Elizabeth Amateur Radio Club John Moyle Field Days and JOTA. The Field Day stations were big and needed a 25kVA generator!!

So now "What is new in Amateur Radio"? The US FCC have set in place a major revision of licencing from April 2000: three classes of licence (Technician, General and Amateur Extra) and a 5wpm Morse test. This will anger some people, but we have to accept reality and have qualifications appropriate to to-day. I can assure you Morse will be heard on Amateur Bands for many years to come because Morse is the appropriate mode for some activities. QRP and VHF/UHF distance records will continue to use CW. Further, you can communicate with Morse

abbreviations when you have no knowledge of the other Amateur's native language. Sure digital modes and computers will be used by many, but so will SSB and FM and PSM etc.

The big problems we as Amateurs have to-day are populating our extensive frequency allocations and keeping our exclusive allocations. These require us to be active on the air and to promote Amateur radio to friends and contacts, to youth groups, to schools and to Adult Education groups. Note Redcliffe ARC University of the Third Age Amateur Classes.

Then there is WICEN. The WICEN support of the Emergency Services keeps Amateur radio in touch with Government Authorities. Its exercises in providing communications to Car Rallies, Canoeing events, Yacht races etc is important to keep Amateur Radio in the Public eye.

Finally we have all to remember that it is the volunteers who keep the WIA going. We could not afford to pay staff to do all that is necessary to keep Amateur Radio alive in Australia. Those who knock the WIA have not yet made a practical suggestion on what should replace it. The WIA may need continual reform but better modify what works than start research for a prototype, which will not be ready for a decade.

Colwyn, Editor.

The

CLUB NEWS

pages are your pages

for news of your activities, or to publicise your events

Send information to

The Editor *Amateur Radio*

PO Box 2175 CAULFIELD JUNCTION VIC 3181

email armag@hotkey.net.au Fax (03) 9523 8191

Channel 35 available for another year

The following is the text of a letter from the Australian Communications Authority to WIA Federal President Peter Naish VK2BPN, regarding the extension of the UHF television Channel 35 "drop-through" to the Amateur Radio Service.

File Reference: X96/918 & X95/1391

Mr Peter Naish
Federal President
Wireless Institute of Australia
PO Box 2175
CAULFIELD JUNCTION VIC 3161

Dear Mr Naish

AUSTRALIAN BROADCASTING AUTHORITY DROP-THROUGH FOR UHF TELEVISION CHANNEL 35 (575 - 582 MHz)

I refer to my 7 September 1998 letter advising that the Australian Broadcasting Authority (ABA) had indicated that the drop-through for UHF television channel 35 would not be extended as UHF television channel 35 would be required for digital television in the near future.

Recently, the Australian Communications Authority received formal advice from the ABA that it has reconsidered the continued use of UHF television channel 35 for Amateur television services. Under section 34 of the [italics on] Broadcasting Services Act 1992 [italics off], the current drop-through period for UHF television channel 35 (575 - 582 MHz) has been extended at four (of the current five) sites until 31 December 2000. The decision by the ABA is based on licensees accepting interference from digital television test transmissions, and that neither they nor their viewers will claim protection from such interference. (An appropriate special condition will be attached to licences is, and when, they are renewed.)

The four sites for which the drop-through has been extended are:

**Lane Cove, New South Wales;
Springwood, New South Wales;
Spring Hill, Queensland; and
O'Halloran Hill, South Australia.**

Services at these sites must operate wholly within the drop-through band for channel 35 (575 - 582 MHz), must accept interference from digital television and must not claim protection from such interference, and must cease operation by midnight on 31 December 2000.

The current drop-through for Olinda, Victoria, cannot be extended as the ABA has allotted channel 35 for use by digital services in Melbourne under the Digital Channel Plan. Therefore, the Amateur television service at Olinda must cease operation by midnight on 31 December 1999.

It should be noted that the extension of the drop-through does not apply to licensees who have changed operating frequency to a frequency other than channel 35 (to the amateur bands for example).

Yours sincerely

Alan Jordan
Manager
Radiocommunications Licensing Policy Team
Radiofrequency Planning Group
7 December 1999

**Federal President, Peter Naish
VK2BPN.**

We enter this new year on a very positive note, beginning to see the benefits of some important decisions made during the past couple of years. Our relationships both internally and externally are once again working well.

Our house journal, *Amateur Radio*, is a key element of our services to you, the members of WIA. With the retirement of our long serving Editor, Bill Rice, at the end of last year we now have a new man on the job.

Colwyn Low has agreed to take on the responsibility for editing and managing the magazine at least for the next few months. Please welcome him to the WIA Editor position and give him all the support that this important task requires.

While on the subject of *Amateur Radio*, I am hopeful that recent improvements which we have put in place will enable us to deliver it to you in a more timely manner. I am confident that this publication will be of high quality and maintain its topical nature.

The WIA ACA Liaison Committee met with ACA in Canberra during December and progressed a number of key matters. A full report on these will be included in next month's issue of this journal but I can say that the WIA and ACA have reached preliminary agreement on several points that will bring benefit to the amateur radio service in Australia.

Our discussions included amateur access to spectrum in the LF Band, possible future return to co-primary status of frequencies in the six metre band, clarification on some licencing arrangements in regard to reservation of suffixes in the WIA-WIZ group and use of higher power output for special purposes, linking of repeaters plus a number of other issues.

As is usual, the outcome from these discussions will take a while before any actual benefits can become effective. There are still a number of hurdles to be overcome, some administrative but others of a political nature within ACA and the communications ministry.

However, your committee was pleased with the positive reaction by ACA to our requests and the overall trend to success. During 2000 we will be able to finalise a number of matters on your behalf.

Peter Naish, VK2BPN
WIA Federal President.

WIA News Prepared, researched and compiled by
David Thompson VK2NH
Federal Public Relations Coordinator.

Y2K – Why the Fuss?

Writing this in early December 1999, I can only hope that that is the question we were all asking in early January 2000. Despite all the remedial work and planning carried out to minimise the effects, there will have been many unexpected manifestations of the misnamed "Millennium" Bug

Perhaps now it's time to look forward to the 21st century (whether or not you think it has already begun!) and think about ways we Amateurs can all move forward and embrace the Information Age.

WIA Yearbook 2000 Now Available

At long last, the *WIA Yearbook 2000* is now available from your Divisional bookshop. The change of name reflects the expanded content of the yearbook, which has nearly doubled in size, and now contains much material new to this edition. As well as the latest Amateur call signs, repeater and beacon listings, and reference data, the *Yearbook* now includes new articles and features of interest to shortwave listeners, Cbers, radio astronomy fans, other special interest groups. The *Yearbook* should also be available through the usual retail outlets.

Amateur Television – UHF Channel 35 Lives On!

As most ATV enthusiasts are aware the 50cm band was officially withdrawn from Amateur use in 1989, but that the Australian Broadcasting Authority has allowed Amateurs to continue using UHF TV channel 35 on a "drop-through" basis until the channel was required by local broadcasters.

The "drop-through" was scheduled to end for good in December 1999, but has been extended for another 12 months, following representations from ATV repeater licensees in several parts of Australia.

Full details were not available at time of writing, but it is known that the Brisbane ATV repeater VK4RTV has been given

permission to remain on '35 subject to interference which may result from SBS Digital Television tests. The other four existing ATV repeaters have also been given permission to remain on channel 35 with similar conditions.

Channel 35 is potentially a most valuable resource for introducing Amateur Radio to the general community. In Sydney, many non-Amateurs watch the regular Amateur transmissions on VK2RTV – even visitors staying at some city hotels tune can watch these transmissions.

ACA updates Amateur Operating Procedures

The Australian Communications Authority has updated its *Amateur Operating Procedures* booklet on its web site. The updated document can be accessed at <http://www.aca.gov.au/publications/info/regs.htm>

Another document, *Disclosure of Personal Information* has also been revised. This may be of interest to anyone concerned about their station location being publicised on the Internet. The document is located at <http://www.aca.gov.au/publications/info/privacy.htm> (Since the database of radiocommunications licencees was first published a couple of years ago, the New South Wales Division of the WIA has offered its members the use of a post office box for licence renewals, for a nominal fee. It is this address that appears on the web site rather than the station's physical address.)

Finally, for readers who might still use the Citizens Bands, the updated CB Class licence information is at <http://www.aca.gov.au/publications/info/cbrcl.htm>

How Healthy is your Club?

Following on from some vigorous discussion on the packet network about the future of Amateur Radio, Lee de Vries VK3PK is gathering information about trends in club membership numbers.

Lee has asked that secretaries and treasurers of Amateur Radio clubs contact him with statistics about club membership levels.

If you would like to assist Lee in his study, please contact Lee at his callbook address.

New 10m beacon in Victoria

Still in VK3, Mark Harrison VK3BYY (m.harrison@medoto.unimelb.edu.au) has announced a new beacon for the ten metre band.

VK3RMH is now operational on 28.2565 MHz, from a site about 25km northeast of Melbourne (grid square QF22JH). Its power output is 20 Watts ID and carrier with a 2 Watt carrier step.

The antenna is a half-wave vertical on North side of the site's tower (directing North)

The beacon's Morse identification cycles through two messages, each followed by a 20 Watt carrier and 2 Watt carrier for 5 seconds each.

The ID messages read: "VK3RMH MELB QF22JH 20/2W VERT" and "VK3RMH AT HOTMAIL.COM QSL"

Signal reports may be sent via Internet email to vk3rmh@hotmail.com, or to m.harrison@medoto.unimelb.edu.au, to whom further enquiries may be directed.

The beacon has been established by the North East Radio Group, Inc., whose address is P.O. Box 270, Greensborough, Victoria, 3002.

From the Internet rec.radio.amateur.misc newsgroup

VKG Insecurity

Plans to install a high security digital radio network have been put on hold and police may have to rely on their existing analog system for the Olympics.

The head of the police communications group, acting Chief Superintendent Dan Dillon, has recommended that the service put off a decision on the supplier of equipment for a new \$27 million network.

But there are serious concerns about the capacity and security of the aging network after hackers gained access last year and broadcast threats to police in Sydney.

A digital system would be more secure and efficient and reduce congestion by allowing for the creation of more radio channels.

(VK4BAT) via QNEWS Improved Communications for Sydney-Hobart Yacht Race

In an effort to avoid the tragic loss of life that struck the 1999 Sydney to Hobart Yacht race, competitors in this year's event had the benefit of greatly improved communications.

Last year's race was marked by severe storms in Bass Strait, which necessitated a

number of rescue operations in very difficult conditions. Six competitors lost their lives during the event.

Each boat in this year's event was fitted with Satcom-C satellite transceivers, providing real-time position information for every vessel. As well as making the job of the rescue services easier, the systems allowed fans to track the progress of their favourites on the race web site. The Satcom-C radios also allowed competitors to receive up-to-date weather information, essential in the rapidly-changing conditions that characterise the race.

The real-time position reporting was an improvement over previous years, when positions were reported only twice daily via voice radio links to the organisers.

The position reporting system also allowed rapid identification of vessels in trouble much more easily than last year, when many boats had simultaneously activated their Emergency Position Indicating Radio Beacons (EPIRBs), which carry no vessel identifying information.

On top of this, many of the individuals on board were encouraged to carry personal EPIRBs, allowing them to be located more easily if washed overboard.

Finally, all vessels carried a special waterproof VHF handheld, and monitored a special race channel around the clock for emergency traffic.

Adapted from a story in Wired News, via Ham Radio Newsline

NASA's Bandwidth Squeeze

NASA's Deep Space Network is facing increasing bandwidth problems, trying to stay in communication with more than 40 active space missions from its earth stations in California, Canberra, and Madrid.

In the words of Jet Propulsion Laboratory spokesman, John Watson, "There's just 24 hours in a day and only so many antennas."

Payload restrictions on each spacecraft limit the size, weight, and power consumption of onboard communications equipment, and that has implications for the bandwidth of signals transmitted by each spacecraft.

The bandwidth challenges have inspired engineers to be smarter about how they communicate with the spacecraft; newer space probes are being designed to be more autonomous, requiring fewer commands from Earth.

NASA's space communications centre on the 2GHz S-Band, and the X-Band around 8 GHz, but now engineers are considering moving up to the Ka-Band at 32 GHz.

JPL was experimenting with Ka-Band data communications on the Mars Polar

Lander and Cassini missions, but unfortunately the Polar Lander was lost in early December 1999. NASA does not expect to make regular use of the Ka-Band until at least 2005, as there are a number of technical challenges to overcome, such as accurately tracking the signals.

After Ka-Band will probably be light waves; successful preliminary tests have already been carried out on one Japanese spacecraft.

Adapted from a story in Wired News, via Ham Radio Newsline

Amateur Radio crosses Korean DMZ

The first-ever amateur radio communications between North and South Korea took place November 22. Amateur radio operator Yi Tong-kyu was surprised when he checked his communications record on the afternoon of 21 November. He discovered the country code P5, which signifies that the source was North Korea. He thought it was a trick to pretend to be from North Korea and ignored it, but he saw P5 again on the 22nd.

Yi succeeded to communicate and found that the sender was someone presumed to be a Japanese visiting North Korea. They communicated for about just a minute, but it was the first radio communications between the North and South since national division.

Yi Tong-kyu said the government has approved communications with foreigners [in North Korea], and it was the first of its kind since the approval.

Martti Laine, OH2BH, operated as P51BH for a couple of hours on 21 April 1999, making 263 QSO's on 20 metres CW and SSB and 15 metres SSB. Martti built the Ham facility in North Hamgyong Province in May. The signals were from that facility.

The law in force only approves communications with foreigners residing in North Korea, but this first successful North South communications make locals hopeful communications barriers with North Korea would gradually diminish.

(Source:- Seoul KBS-1 Television Network in Korean/ RSGB in United Kingdom) via QNEWS

ar

WIAQ new members November 1999

Frank Tieppo VK4CBT of Windsor
Klaus Merretz VK4HCC of Toowoomba
Gary Coutts VK4GAZ of Southport
Gary Mehlert VK4FT of Mt Warren Park

The ACT 3.5

A five-watt direct conversion CW transceiver for 80 metres

by Peter Parker VK3YE

12/8 Walnut Street, Carnegie, Victoria, 3163
E-mail: parker@alphalink.org.au

Are you looking for a simple 80 metre CW rig for portable operating or for the monthly 80 metre QRP scrambles? One that covers the whole 80 metre CW segment, delivers the QRP power limit, yet is fairly simple to build? If so, the ACT-3.5 might be just what you're looking for.

THE ACT 3.5 TUNES between 3.500 and 3.550 MHz and puts out five watts. It features a simple direct conversion receiver, a sidetone and relay-controlled transmit-receive switching. An LED shows when the key is down and a meter gives a relative indication of transmitted RF output. Unlike many simple QRP rigs, it features reverse-polarity protection.

The completed transceiver is pictured in Photo 1. The case is small enough for portable operating, yet is large enough for easy construction. It could be made smaller if the constructor elects to build only the transmitter and uses it in conjunction with an HF communications receiver.

Circuit description

Fig 1 shows the block diagram for the ACT 3.5. A 3.58 MHz ceramic resonator oscillator pulled down to the CW segment provides the local oscillator signal required by both the transmitter and the direct conversion receiver. A two transistor buffer from *Solid State Design for the Radio Amateur* provides isolation between the oscillator and the Driver/PA stages during transmit. The driver and PA stages are similar to those used in many transmitter

circuits by Drew Diamond VK3XU and provides up to 5 watts on 80 metres. A two-stage pi-network attenuates any harmonics before the transmitted signal is sent to the antenna via the transmit/receive relay. The use of voltage regulation in the supply line to the oscillator assists in keeping the transmitted frequency stable.

The receiver is a very basic direct conversion NE602 type, not unlike that used in Drew Diamond's *Little Mate* transceiver. Economies have been made in the circuitry surrounding the 741 op-amp and the use of a BC548 instead of an LM386 for the final audio amplifier stage. Despite the lower gain, the received volume is still sufficient if medium to high impedance headphones (eg 600 ohm) are used.

When the key is pressed several things

happen. The collector voltage of the PNP keying transistor increases to approximately 12 volts. This voltage provides bias to the power amplifier stage, powers the sidetone, lights the Transmit LED and energises the relay. This causes 12 volts to be applied to the drain of the power amplifier and the antenna to be connected to the transmitter section. Releasing the key causes the LED to extinguish, relay to release, voltage to be removed from the PA stage and the antenna to be switched to the receiver module.

The sidetone is an optional extra.

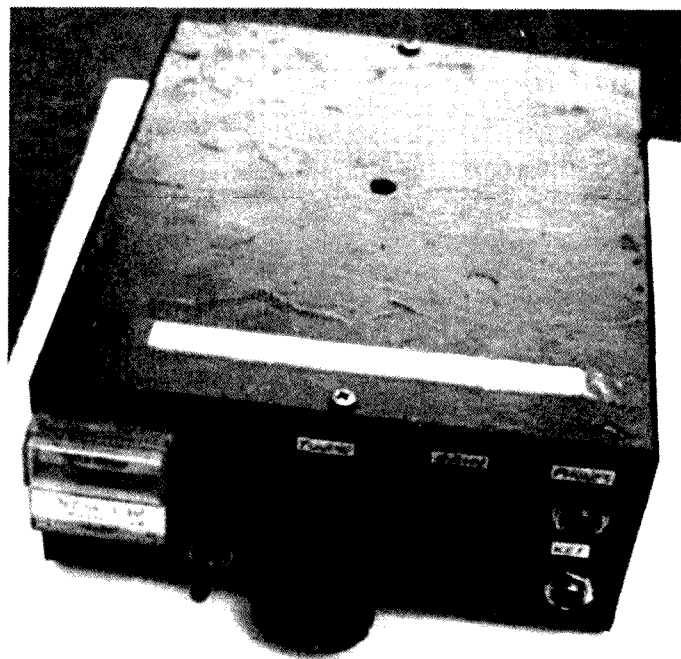


Photo 1: Completed ACT 3.5 Transceiver

However its inclusion makes operating more pleasant. The design used in the prototype again came from Solid State Design. It provides sufficient volume to allow its output to be fed directly to the headphones without additional audio amplification being required.

The meter on the front panel is a legacy of the previous project built inside the case. Removing it would have left a large and ugly hole that would be difficult to cover up, so it was decided to leave the meter and make use of it instead. An RF choke, diode and sensor wire near the pi-network provide a cheap but effective indicator of relative transmitted RF. This embellishment can be omitted if all you want is a 'bare bones' transceiver.

Construction

Use a metal box to house the transceiver. The prototype measured 6x17x14 cm and comfortably accommodates all stages. The ACT 3.5 pictured follows the conventional practice of having the antenna socket on the rear and the controls, switches and sockets on the front panel. However, if you often operate from remote spots and use the rig on the ground, you may consider mounting all dials, meters controls and sockets on the top lid so they can be easily be seen by the operator without bending down.

The ACT 3.5 circuitry comprises six modules. These are:

- i. Ceramic resonator oscillator/buffer/driver board
- ii. Transmitter power amplifier/low pass filter board
- iii. Power/keying/relay board
- iv. Receiver board
- v. Sidetone board
- vi. Relative output meter

Most modules are built in 'dead bug' style on pieces of printed circuit boards that form sub-chassis inside the case. The Receiver and Power/keying/relay stages are constructed on pieces of blank matrix board. The two components used for the relative output meter are mounted on the back of the meter movement.

1. Ceramic resonator oscillator/buffer/driver board

This module provides the 3.5 MHz signal required by both the transmitter and receiver and sufficient RF drive to the power amplifier.

The selection of tuning capacitor and vernier drive plays a key role in determining whether operating the rig will be a pleasure or a chore. The author was fortunate to obtain an air-spaced tuning capacitor with

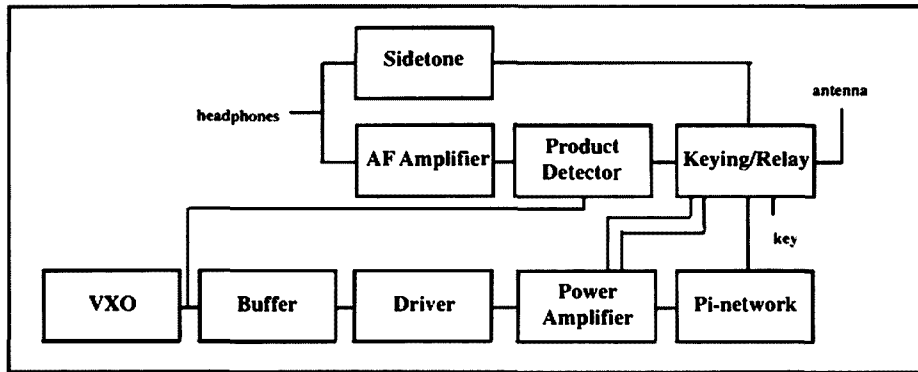


Figure 1: Block diagram ACT 3.5

an inbuilt 3:1 vernier reduction drive. This provided good bandspread across the most used CW frequencies. If your capacitor has no bandspread, it is definitely worth your while to invest in an external vernier reduction drive such as that stocked by Dick Smith's (catalogue P-7170).

As to the choice of the variable capacitor itself, an air-spaced unit is preferred as it provides better frequency stability and usually has a spindle long enough to fit a vernier drive. However, the author has used the commercially-available plastic dielectric variable capacitors with other 80 metre ceramic resonator transceivers and has found them reasonably satisfactory.

The printed circuit board material used to mount the oscillator/buffer/driver stages is bolted to the back of the variable capacitor inside the box. Leads should be kept short to minimise stray capacitances and maximise frequency swing.

Build the VXO and buffer first. Check that 8 volts is present on the collector of the BC548 and try to locate the carrier generated on a nearby 3.5 MHz receiver. Vary the tuning capacitor to see what frequencies can be covered. If there is coverage below 3.500 MHz, reduce the value of the 100pF capacitor between collector and earth until all of the tuning range falls within 80 metres. If high frequency coverage (above 3.540 MHz) is lacking, adjust any trimmers on the variable capacitor to near minimum capacitance. It is quite normal for the tuning of variable ceramic resonator oscillators to be non-linear - the bottom 10 kHz of the band will take up most of the rotation on the variable capacitor. Note that there are variations between different makes of

ceramic resonators - the orange/brown type from Vorlac requires less capacitance to cover a given frequency than do the blue RS type used in the prototype.

Once satisfied with the tuning range and frequency stability of the variable ceramic resonator oscillator, construct the driver. Do not forget the ferrite bead on the base of the driver transistor - this reduces the risk of self-oscillation. When the driver is added the signal in the receiver should be considerably stronger when the collector of the 2N3053 is touched with a finger.

2. Transmitter power amplifier and pi-network

As mentioned before, this module is almost a straight lift from many of Drew

text continues on page 10

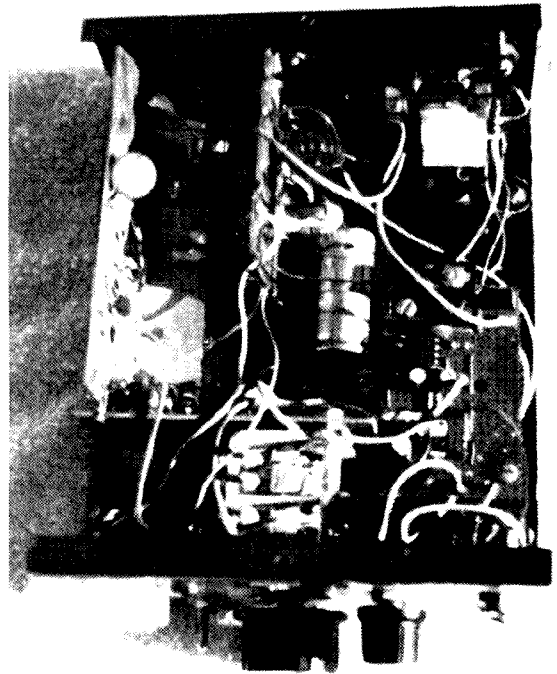


Photo 2: Inside of ACT 3.5. Clockwise from variable capacitor: VXO/Buffer/Driver, sidetone, PA, Pi-network, Power/Keying/Relay, receiver.

ACT 3.5 Transceiver diagrams

ACT 3.5
TRANSMITTER
.VK3YE

FIGURE TWO

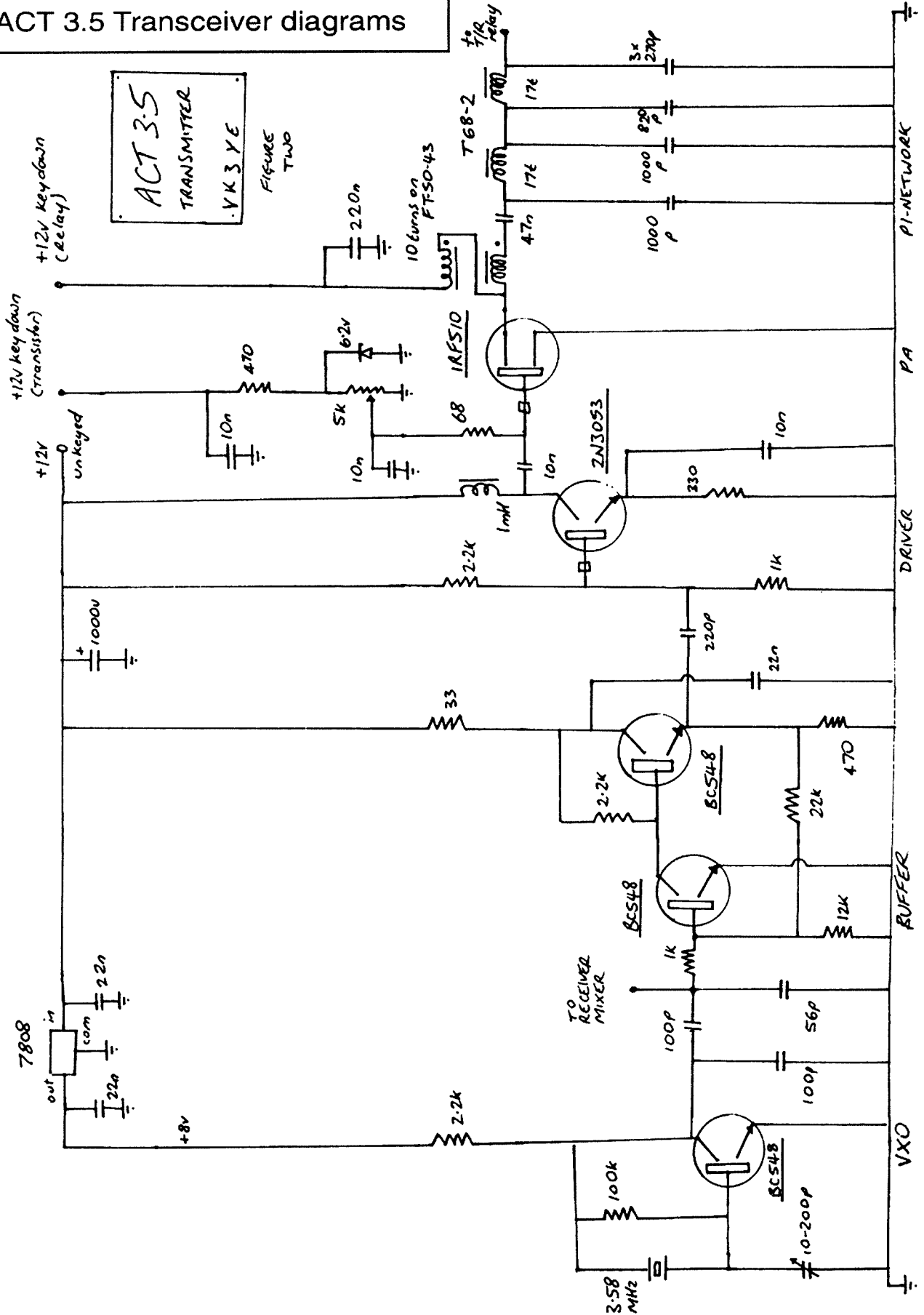
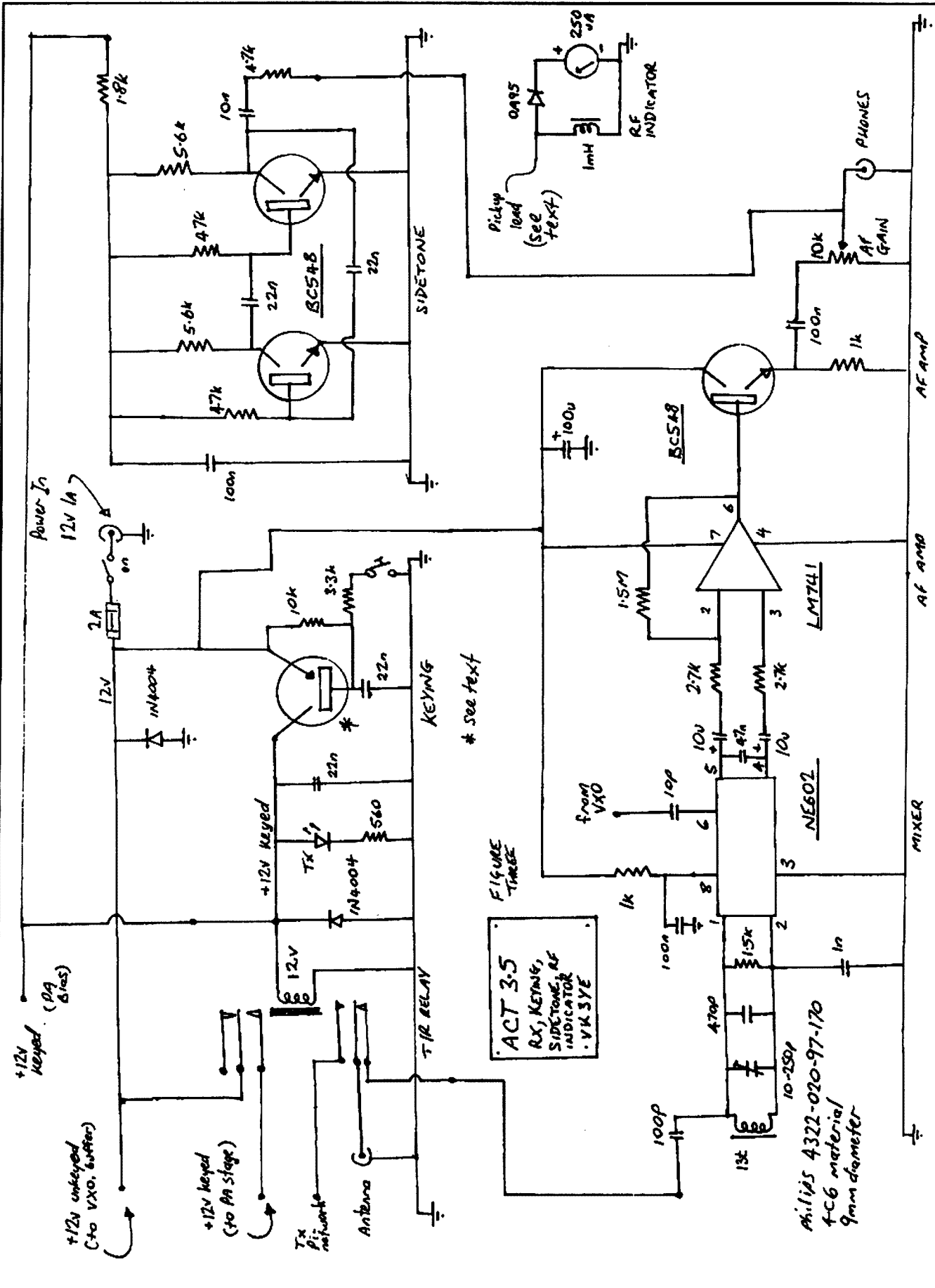


Figure 3a: Transmitter stages of ACT 3.5



* See text

FIGURE THREE

ACT 3.5
RX, KEYING, SIDETONE, RF INDICATOR, VKSYE

Phillips 4322-020-97-170
4-C6 material
9mm diameter

Figure 3b: Receiver, keying, sidetone, RF indicator stages of ACT 3.5

Diamond's recent transmitter projects. Important things to watch for include the polarity of the zener diode and the toroid windings, the need for a heatsink on the IRF510, and the setting of the 5k trimpot. The pi-network in the prototype used salvaged silver mica capacitors. If these are not available use polystyrene capacitors - these are less lossy than ceramics at RF. Again connections around this stage should be kept short to minimise stray capacitance. Amidon T-68-2 toroids were used in the pi-network because they were on hand. However T-50-2 toroids are more common in QRP transmitter circuits. If using T-50-2 toroids, wind 21 turns onto the toroid instead of the 17 specified.

To test, connect a 50 ohm dummy load and RF power meter (0 to 20 watt range suggested) to the output of the pi-network. Apply power to ceramic resonator oscillator/buffer/driver board and the two PA connections that will eventually go to the keying/relay board.

Touch the tops of the driver and PA transistors to check that they are not uncomfortably hot. Slowly advance the 5k trimpot to increase indicated power on the

meter to 4-5 watts. This occurred in the prototype when the trimpot was about 75 percent of its travel away from earth.

3. Power/keying/relay board

This is one of the simplest stages in the transceiver, but plays a large part in making the rig smooth to operate. It consists of a relay switched by a medium-power PNP transistor. This is not specified on the diagram - the one used in the prototype was an unknown junkbox type. However, a BD140 or TIP32 should be suitable. The main things to watch are the connections to the relay contacts - any errors here could result in the rig behaving very strangely indeed. The polarity of the diode across the relay is also critical.

Testing this stage consists of pressing the key and observing whether the LED lights and the relay pulls in.

4. Receiver board

This board is not needed if all you require is a transmitter. Again it borrows heavily from the *Little Mate*. Because of the use of ICs, all parts are mounted on a piece of unclad perforated circuit board.

A single, high-Q tuned circuit provides front-end selectivity for the NE602 mixer stage. This stage beats the incoming signal with the local oscillator to produce an audio output. Some top-cut is provided by the 47nF capacitor across pins 4 and 5. The audio is then amplified by the 741 and BC548 stages. Gain is sufficient even for QRP signals, but there isn't much to spare - the AF gain control is usually set at maximum and left there except when signals are strong. Audio from the sidetone is coupled directly to the high impedance headphones.

A number of hard to obtain components are used in the receiver section. These include the NE602, the 10-250 pF compression trimmer and the 9 mm toroid. The toroid is a 9mm diameter, Philips 4322-020-97-170, 4c6 material type. Information on obtaining these is given later.

Adjustment of the trimmer capacitor is critical to receiver performance. Because the tuned circuit is sharp, poor adjustment will mean low sensitivity. However, bandwidth is sufficient to provide acceptable performance across the transceiver's entire tuning range.

5. Sidetone

This is a two transistor design borrowed from *Solid State Design*. It is only needed if you are building the full transceiver. The unit in the prototype was built dead-bug style on a piece of unetched printed circuit board material. Because a sufficient number of components used have one

connection earthed, no stand-offs, insulators or pads were required to support the other components.

6. Relative output meter

As mentioned before, the transceiver includes a meter for relative RF output. Like the meter in the Heath HW8, it has no function on receive. The meter circuit is built after all other transmitter stages have been constructed. The two components required are soldered to the back of the meter. There is no direct connection between the relative RF meter circuit and the rest of the transmitter. Instead the meter uses a pickup wire which is loosely coupled to the RF-carrying wire between the PA stage and the pi-network. This end of the pickup wire is then soldered to ground. Experiment with the amount of coupling if the meter needle shoots off the end of the scale or barely moves.

Availability of parts

About 95 percent of the components used in this transceiver are available from regular parts suppliers such as Dick Smith Electronics. The CW Operators QRP Club stocks most of the more specialised parts, such as the IRF510, NE602, toroids and the variable capacitor. The large trimmer capacitor used in the receiver front-end is commonly found in old HF communications equipment. The 3.58 MHz ceramic resonator used was a blue coloured type from RS Components. Vorlac in Melbourne also stocks ceramic resonators, but they may require component value changes in the oscillator circuit to provide the correct tuning range. The author has a number of ceramic resonators available on receipt of a SASE to constructors wishing to build this or similar projects.

Operation

Using the transceiver is similar to any other rig except there is no automatic frequency offset. This means that the set needs to be adjusted to zero beat with the incoming signal every time you finish your transmission. Similarly when calling CQ, the frequency needs to be adjusted about 800 Hz to be assured of hearing any replies.

Results

Stations throughout south-east Australia have been worked with this transceiver. A number of contacts to ZL have also been made with this transceiver. One of these was with a 1.5 metre square magnetic loop antenna used indoors during a contest. All reports on the quality of the transmitted signal have been complimentary.

**Got a product to
sell to radio
amateurs?**

***This
space is
for you!***

Contact

**Mrs June Fox,
WIA Federal office
Tel: (03) 9528 5962**

***for details of our
competitive rates***

**Amateur
Radio**

gets hams talking!

Converting Computer Power Supplies

— an easy way

Keith Alder VK2AXN

THERE HAVE BEEN ARTICLES in several journals recently (1,2) describing how to convert computer switch-mode power supplies to provide 13.8 volt at up to 20 amp to power amateur equipment.

After several unsuccessful attempts to reproduce their results, including a couple of spectacular electronic disasters, I concluded that most of my problems were caused by pushing the units beyond their capacity.

Most of the readily available (and cheap) ex-computer supplies, from the 286 -386 types of computer, are rated at up to 200 watt — not a starter for the desired output. But even a 240 watt unit expired when converted to 13.8 volt and operated at 15 amp.

The conversion wasn't an easy job, requiring tracing of the control circuit and modification of the printed circuit board and the high frequency transformer. I found this difficult because none of the supplies I acquired conformed to the circuits published in the literature, particularly in the control and overload sections.

It occurred to me that a better method would be to use two power supplies suitably coupled together to provide the required output. Power handling capacity should be adequate and conversion much simpler.

So I obtained two identical 200 watt units and modified as follows:

The waveform generator in these supplies is usually a 16-pin chip, TL494 or equivalent, which produces the 30kHz (approx.) square wave drive for the chopper transistors. Pin 1 controls the waveform for regulation of the output voltage. My modification is simply to disconnect the

resistor connecting pin 1 to the 5 volt output, at the 5 volt end, and connect in series a 10k trimpot. Adjustment of this enables the output voltage to be increased (in my supplies) to 7.1 volt before the supply trips.

By adjusting two such supplies each to 6.9 volt and connecting them in series it is possible to obtain 13.8 volts at (nominally!) 20 amp.

Connecting two in series requires that one supply has its earth-to-case connection disconnected. This is simple — just cut the PCB track at the one corner where it earths the supply via one of the mounting screws.

Then the two can be bolted together and connected in series. I left one cooling fan in place but reversed it to blow rather than suck; also I added an ammeter and a voltmeter at the end vacated by the second fan.

Regulation can be improved by drawing a standing current (in my case, 2 amp) through a heavy 3 ohm resistor added to each PCB but this does reduce slightly the maximum current for external load. However please note that despite the nameplate rating of the +5 volt output at 20 amp on these supplies, I do not believe they are designed for this continuously and I do not recommend trying it!

However my supply happily endures peak loads of up to 17 amps for SSB use with my TS 430S without a flicker of voltage variation, and can provide 15 amp continuously without distress.

Four further points are important: -

- 1) Pushing up the output from 5 to 6.9 volt causes the nominal +12 volt output to rise also, to about 16.5 volt. I have not bothered to change anything



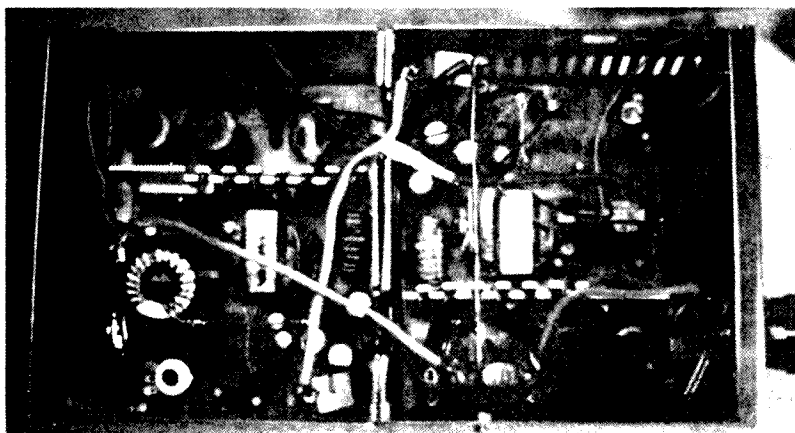
related to this, although it may be getting close to the limit for the 12 volt circuit filter capacitors. Nothing has gone wrong after a couple of months of daily use.

I did not remove any components at all from the +12V, -12V, or -5V circuits because in previous tries at conversion of single units I found that some of these components were relevant to the control and overload systems and I failed miserably to trace the circuitry!

- 2) The increase in the +12 volt line means that the fan will run faster and be noisier. In my case I put a 25 ohm resistor in series with the fan.
- 3) There was some harmonic interference from the approx. 30 kHz chopper audible on 40 metres but not on higher frequency bands — I cured this by extra filtering of the output using two extra toroids (from previously destroyed units!) in series, with 0.01 microfarad capacitors each side to earth.
- 4) MOST IMPORTANT! These supplies are probably the most lethal bit of equipment any amateur is likely to handle. Take care! Some of the PCB circuitry is at 340 volt DC with hefty capacity behind it, and is also connected directly to the mains. This applies to all of it up to and including the HF transformer. The DC output is fully isolated and quite safe. But handling the boards out on the bench is hazardous — best to make the simple modifications, re-install in the cases, and adjust with a long insulated tool.

References: -

- 1) Phil Harman, Radio and Communications, November & December 1998.
- 2) Leo Simpson, Silicon Chip, December 1998.



Yaesu Musen FL2000B *revamped*

by **N E Mattick VK2QF**
"Blackwillow"
Hargraves NSW 2850

VK2QF has extended the life of his Yaesu FL 2000B Linear Amplifier with considerable ingenuity. However, constructors are warned that potentially lethal high voltages are employed in this amplifier and only experienced people should tackle this project

HAVING USED the old "FL2000B" amplifier on the ten metre band for 50Mhz dx liaison for some years in its original form until one day a heater failed and went across to the plate inside valve 1 giving a healthy spark and "all lights out" around the place. Needless to say some sort of service was due, especially since the HT had been shorted! Replacements for the 572B's were not considered due to their prohibitive price and poor survival. So some alternatives were seriously considered.

An initial "lash up" trial of two wartime 813 Pentodes was a failure due to low gain and excess plate stray capacitance placing the plate circuit beyond resonance on the ten and fifteen metre bands, (more on this topic later).

Not perturbed by this failure I continued to concentrate on a solution that proved to

be utterly successful in the end.

The parameters for the project were the following;

- Low IMD.
- Durability.
- A valve that would operate in any position.
- Low cost and recycling of otherwise discarded equipment.
- Minimal noise commensurate with adequate performance and heat removal,
- Parts must be on hand and or be made readily within a basic workshop,
- No physical changes to the appearance of the cabinet or front panel was allowed,

- High gain and equal performance across the range of bands that the amplifier was designed for, (in fact 10db of gain was realised meaning a Kenwood TS 570s as a driver will run a signal 3Db down on the legal limit Singlesideband signal),
- The basic design of cathode driven circuitry was to remain therefore any selected valve must either be a triode or more importantly be capable of triode (GROUNDED GRID CONNECTION), this was met by the chosen valve.

It is not intended to give a comprehensive description of the project as it is assumed that the builder will have sufficient experience to carry out the modifications to fruition. Furthermore this work only applies to the YAESU MUSEN FL2000B amplifier, just how this unit is different from later models eg, FL2100(B) is not known by the author, so should any builder decide

CATHODE TUNING CHART.

VSWR	INPUT INDUCTOR	INPUT C	OUTPUT C
1.4:1	Less one turn L202 = 15t > 80 mx	320 pf	150 pf
1.2:1	Less one turn L203 = 10t > 40 mx	400 pf	150 pf
1.2:1	Remove slug L204 = standard > 20 mx	250 pf	125 pf
1.2:1	Remove slug L205 = standard > 15 mx	110 pf	115 pf
1.2:1	Less one turn L206 = 4t > 10 mx	100 pf	140 pf

Note: 15 and 10 metre bands have variable capacitors to optimise loading. All fixed capacitors are SILVERED MICA types

Figure 1

TANK COIL CHART.

10 mx	4 turns from plate end
15 mx	8 turns from plate end
20 mx	12 turns from plate end
40 mx	20 turns from plate end
80 mx	29 turns from plate end

Figure 2

to modify one of these it remains their responsibility to adapt any differences in the basic design and circuit.

It is also necessary to highlight at the outset all inherent dangers when working with mains powered equipment let alone the HIGH TENSION voltages encountered in this amplifier as designed by YAESU MUSEN. This HIGH TENSION voltage is 2,400 volts which it needs to be made clear that contact with this is definitely lethal, so unless those who may attempt this

work are experienced at working with these voltages it is recommended by the author that the work be done under the supervision of an experienced technician. *It is worth noting at this juncture that the author never "powered up", "worked on" or "modified" the amplifier without its full shields and covers fitted, during each phase of development, also the mains supply wiring is controlled by an "ELCD" or earth leakage circuit detector.*

To modify the amplifier the constructor will need the following;

- 1) 8352 / 4CX1000K tetrode in known good electrical condition, these seem to sell for approximately \$100 at hamfests. (It is possible that a similar result could be obtained with alternative valves, eg; 4CX1000A and 4CX1500B as they are electrically and mechanically similar).
- 2) Metal lathe.
- 3) 10 mm PTFE or perspex rod.
- 4) 90 mm stormwater pipe.
- 5) 65 mm alloy bar stock.
- 6) 8 x 220uF 400v or better miniature electrolytic capacitors
- 7) Air spaced capacitor 100pf to better than plate capacitor ratings of air gap.
- 8) 600pF to 1000pF 30Kv or better coupling capacitor.
- 9) 1 x 65ohm 20w resistor.
- 10) Sundry miscellaneous hardware, pcb,

relays and signal components.

- 11) Miniature blower to deliver a minimum 40cfm of air at 13mm Hg water column.

The simplicity of the project is the relinquishment of the need for the SK820 BREECHLOCK socket. These sockets are unprocurable and cost more than the valve at retail prices. Grid grounding and mounting are accomplished in one operation with both the Screen and Control grids being clamped together in a simple alloy split ring made from bar stock.

The three rings that compose this clamp are as follows;

- Screen ring, width 3mm,
- G1G2 ring which is a snug fit into the lands between these two sets of radial terminals,
- Base ring of 3mm which is under the G1 terminals.

These are cut in half and bolted every 120° over the valve ceramic body. A thread is cut into the top or screen alloy ring and bolts which have three simple flat mounting lugs which reach out beyond the perimeter of the 70mm diameter hole that must be made in the wall of the former Grid compartment vertical chassis. As the tolerance of the valves varies it is up to the individual constructor to ensure that sufficient clearance is provided for thermal expansion of the valve when in use, therefore as a guide the author used 0.5mm

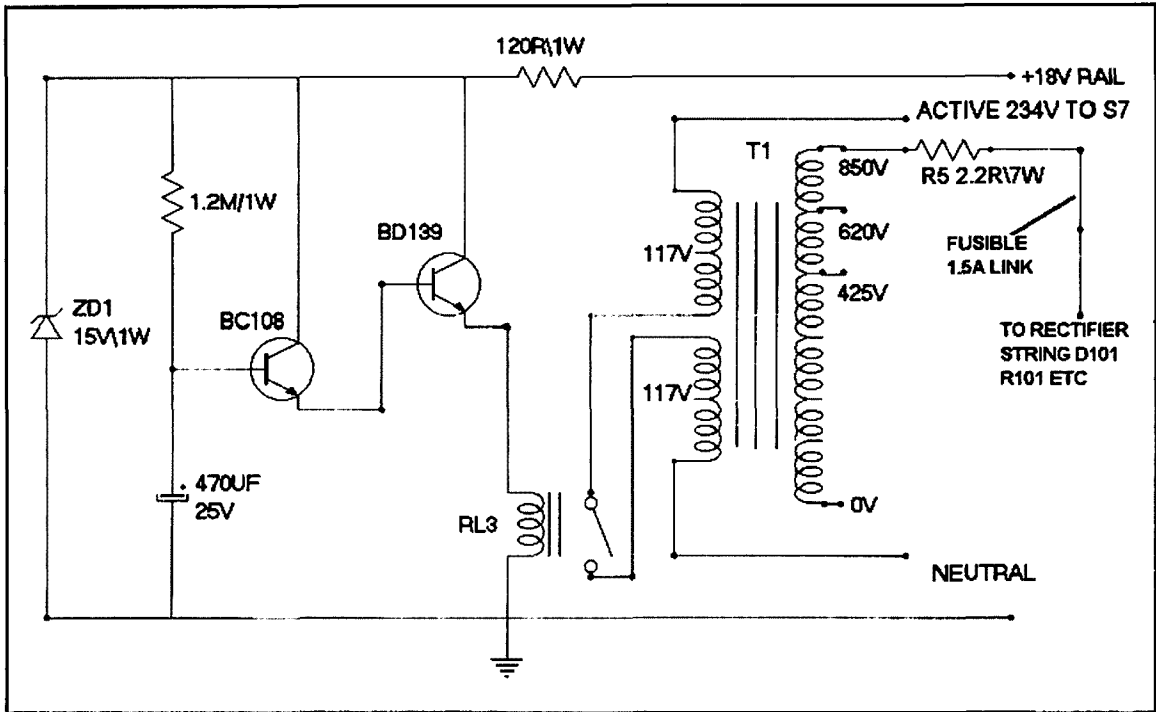


Figure 3. Timer Circuit

oversize for the alloy mounting rings based on the mean cylindrical measurement of the prototype 8352.

The 8352 is relocated to centralise the anode radiator in the plate compartment away from the original valve one mounting position.

The cathode compartment is largely unmodified except for;

L202 - L206 as per the chart Fig 1.

S2 is relocated away from the the terminals of the 8352.

All unused holes in the compartment are fully sealed against RF and air leaks to maximise system performance, (silicon sealant is ideal for sealing the air leaks with bolts and washers for the smaller unused chassis holes).

The L2 bifilar choke is connected by leads directly soldered to the Heater and Heater Cathode terminals of the 8352, do not omit C205 as performance will be degraded.

A new rear panel is folded to suit the blower outlet and this will be quite up to the individual circumstances to determine it's dimensions.

In the plate compartment some extensive development work must be done. To ensure adequate cooling for the 8352 and the fully mounted blower must be tested to ensure adequate back pressure drop across the plate radiator.

A simple chimney is fashioned from 90mm stormwater pipe, this product must

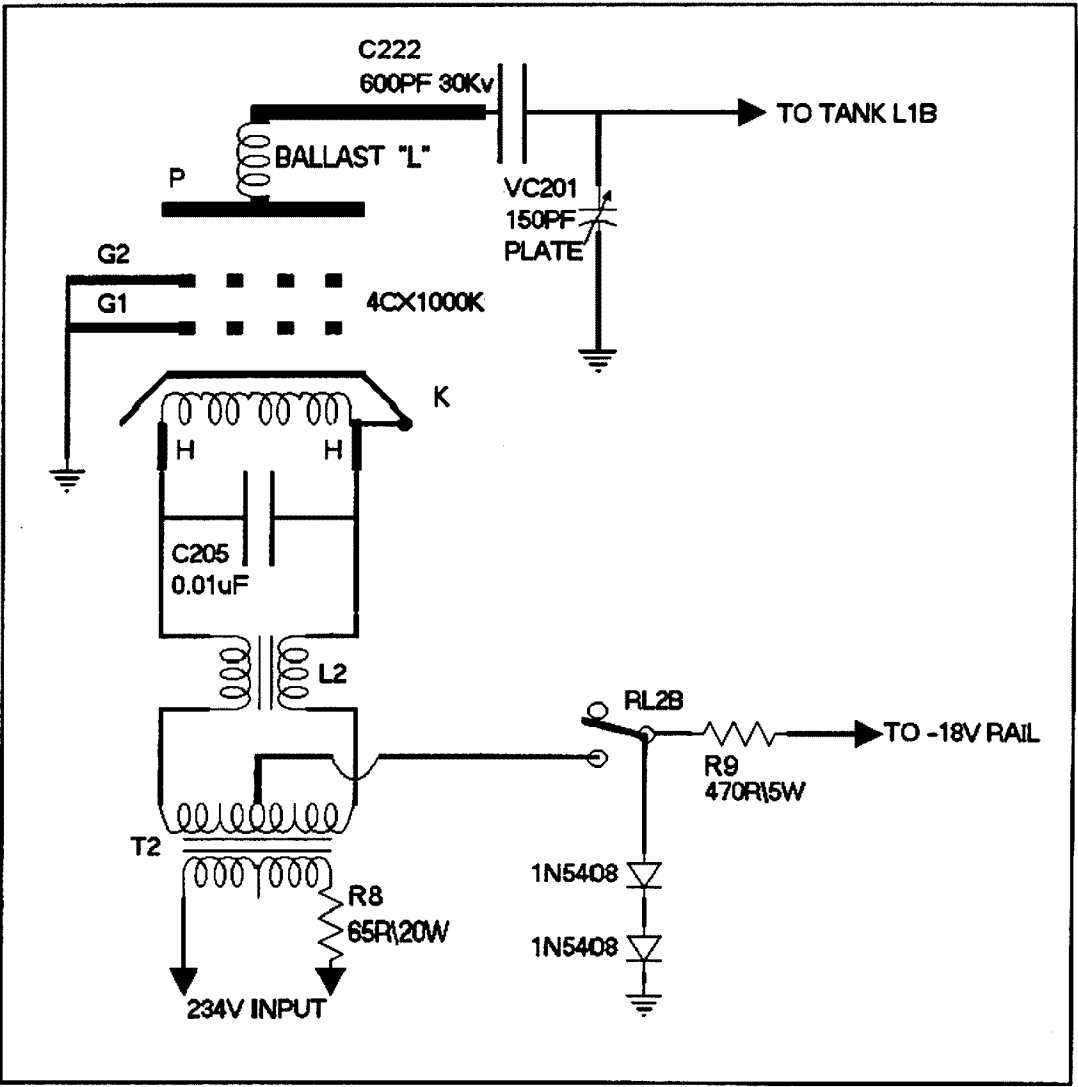


Figure 4. Main PA circuit

Other plate compartment mod's are...

The connecting shaft from S1 to S2 was replaced by a machined length of perspex as the original caused arcing (when the amplifier was driven) in the S1 universal coupling.

The tank coil is removed, cleaned with acetic acid (Vinegar) and re-tapped as per Fig 2.

All lines around the directional coupler are replaced with 6mm teflon coaxial cable, this will improve stability and circuit losses.

C224 usually fails in normal use and must be replaced by a 100 pf air spaced capacitor mounted in the bottom side of the plate compartment, this capacitor must be of equal or better voltage rating than that of the plate capacitor VC201. On the subject of VC201 it has a 50mm long earth strap which is a source of MF parasitics in these amplifiers so replace it with a piece of braid from the stator to the adjacent solder lug on the front panel.

On the topic of the standby condition of the amplifier it was considered important to have

be given the "DIELECTRIC TEST" in the xyl's microwave oven before placing it in service. To test a sample piece of pipe place it in a microwave oven along with a suitable small dish of water to act as a dummy load, give the oven a series of short runs and test for any temperature rise in the sample. As a guide it is felt that the cream or white colour pipes give the best dielectric properties and in the authors case no heat could be detected at all with what was used as the chimney for 8352.

Once the 8352 is mounted and the chimney is fitted it is essential to assess the capacity of the blower to deliver sufficient air to cool the valve under all conditions. The miniature blower in use on the prototype is rated to deliver 100cfm into an unrestricted outlet. In practice it is delivering much less but critically it's pressure differential was measured at 13mm hg water column in the cathode compartment using a simple PVC tube sealed to the chassis. Although VARIAN

specify 25cfm at 5mm water column it is safer to err on the side of oversupply.

The plate compartment is also modified ref fig 4.

L207 is repositioned and L208 / L209 are discarded. This is because the stray plate capacitance of the 8352 in this chassis situation causes the tank circuit to be beyond resonance on the upper HF bands of ten and fifteen metres. The solution to this is to place a 7 turn 20mm diameter (14 b+s wire gauge) ballast inductor from plate to L207 (see fig 4 "Ballast L").

C222 is prone to failure in these amplifiers and should not be left in circuit as to do so would be dangerous, a serious replacement must be found and the author used a 600pf 30Kv coupling capacitor. A common value for these capacitors is 1000pf, this value is the original circuit design and either would be suitable provided the voltage rating is correct, around 10Kv upwards.

minimum heat dissipation around the shack, especially since this is a rather large valve in a small chassis. Unlike the original circuit the 8352 cathode is floating on receive. So the author hunted around for a design that filled the need here (ref 1). This ARRL design (a two valve passive grid 600w linear amplifier with floating cathode) was experimentally tried during run-up of the 8352 on the "bench". No problems have been encountered with this idea, measurement of the cathode voltage in standby shows 6.0v only, this is quite acceptable "self bias" and the unit does not emit any noise that will interfere with the incoming receive signal.

The bias circuit for the amplifier has on transmit RL2B close to two 3amp (1N5408) diodes at the centre tap of the heater winding, this is biased by a 470 ohm resistor (ref fig 4 R9) from the minus 18 volt relay rail. It was found necessary due to the high "Gm" ("Mutual transconductance") of the 8352 to "push" minus 2 volts onto the

cathode for a standing current of 50 mA via the 470 ohm resistor, bearing in mind this will vary from valve to valve also. In transmit under drive this rises to plus three volts of operational dc bias. It is in this transmit condition that another important condition must be tested in the later stage, that of the stability of the whole amplifier when all tuning controls are rotated through their ranges on all bands. No instabilities were encountered at all on any band when the unit was at transmit (no drive) drawing it's 50 mA idle current.

It is next essential to assure a 3 minute heater run up delay timer which after switch on delays by a predetermined time constant of r/c as per Fig 3 (this circuit is powered by rectifying via D1 and filtering C1 the 13 volt winding in the original heater transformer T2). This timer controls RL3 which closes the circuit of T1 to the AC supply thus enabling HIGH TENSION voltages.

With a cathode driven amplifier it is imperative that HIGH TENSION voltage is present whenever there is a possibility of drive being applied. To avoid destroying the 8352 a HIGH TENSION sensing circuit Fig 5, comprising Q1 / Q2 and RL2C which isolates the PTT line in the absence of HIGH TENSION voltage. This circuit is turned on by a 10M ohm sensing resistor from the junction of R110 and R109 in the rectifier string. Relay 2 must be a high speed type to ensure good semi-break in characteristics.

Also in Fig 5 is the DC control circuitry for the blower motor. Builders will have to adapt their own circumstances to suit in this area. The prototype blower was highly modified. Initially it's AC motor was removed and a substitute 3000 rpm high torque DC unit with bronze bearings was modified to take ball races, (most costly minor parts in the whole project!). This

motor is totally shielded against noise leakage for maximum receiver performance. Power for the DC motor is via an external "shack" supply of 13.8v. It is recommended that the same supply is used to power the exciter "rig" so that as a safety measure should it fail (the 13.8v supply) the amplifier cannot be keyed. At power on, rectification of the 13v winding on T2, triggers Q5 thereby ensuring air is delivered whenever heater volts is applied. A transmit blower boost (to air supply) is via a pair of contacts in the cathode relay (RL2A), this has the benefit of low audible noise on receive and maximum air delivery during transmission periods. Blower speed on standby is controlled by RV1.

This circuit also encompasses one more essential feature for protection of the 8352 and this is an after cool rundown timer Q3 / Q4. When the amplifier is turned off after heavy work it is possible to leave the 8352

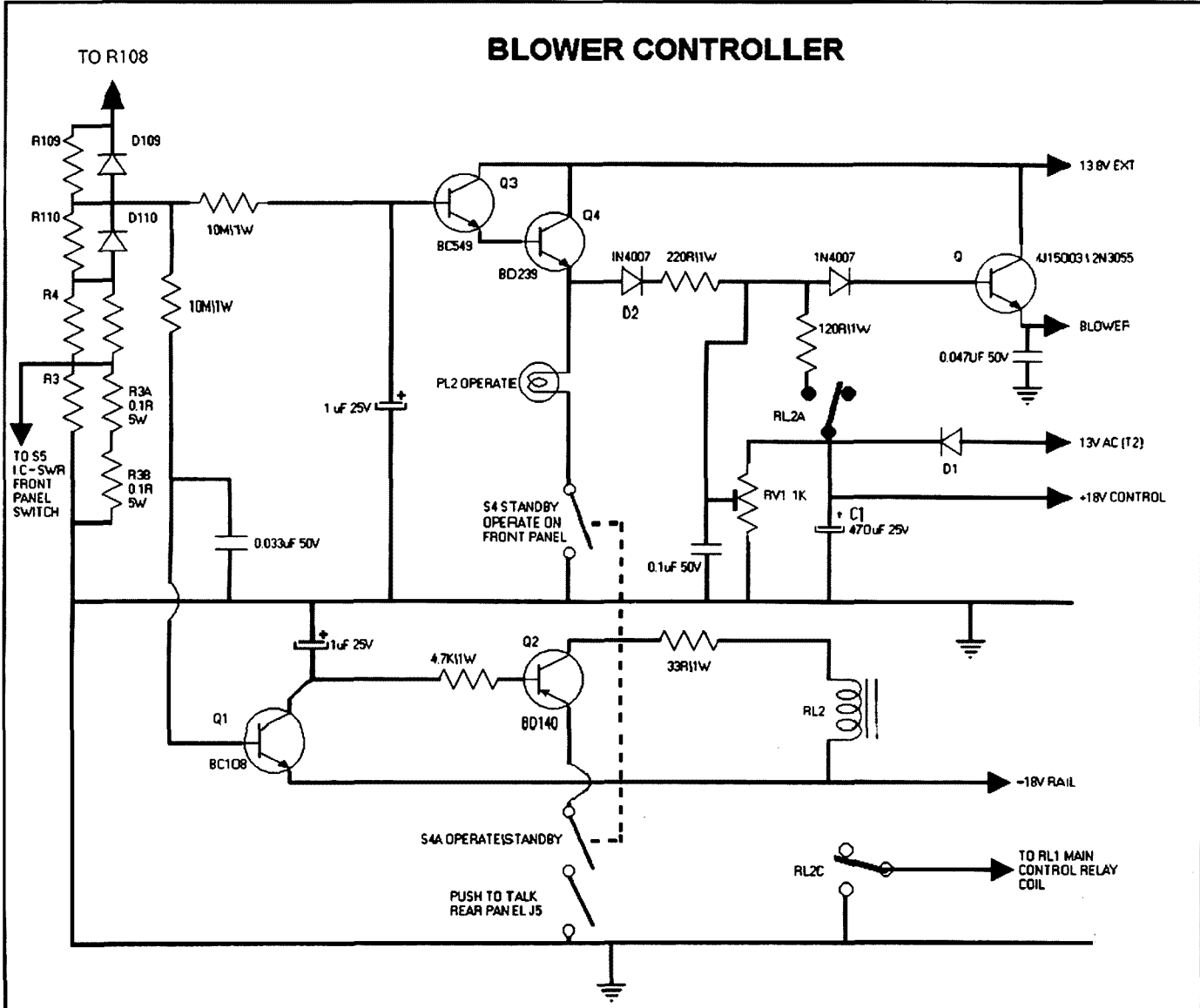


Figure 5. Blower Controller

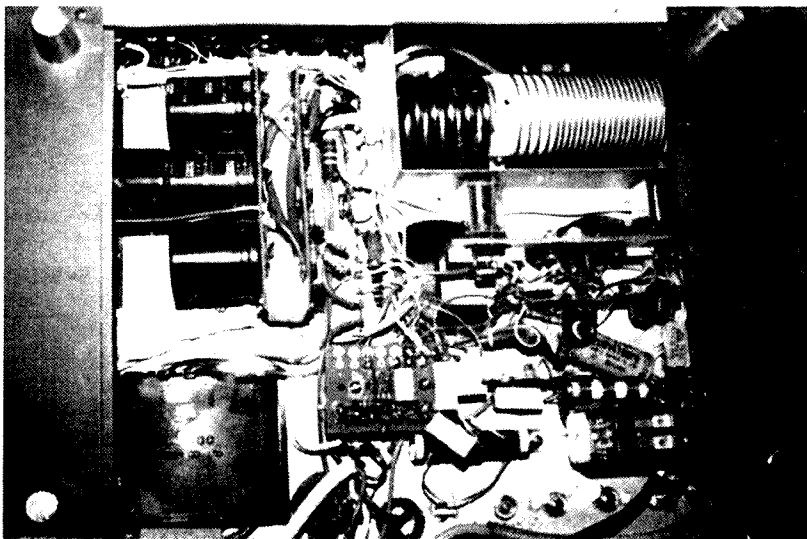


Photo 1: Power Supply and control systems

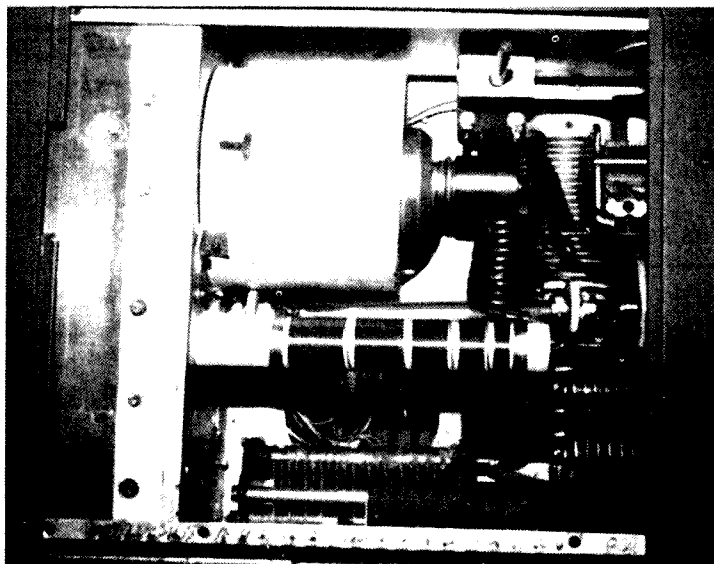


Photo 2. Output section — general layout

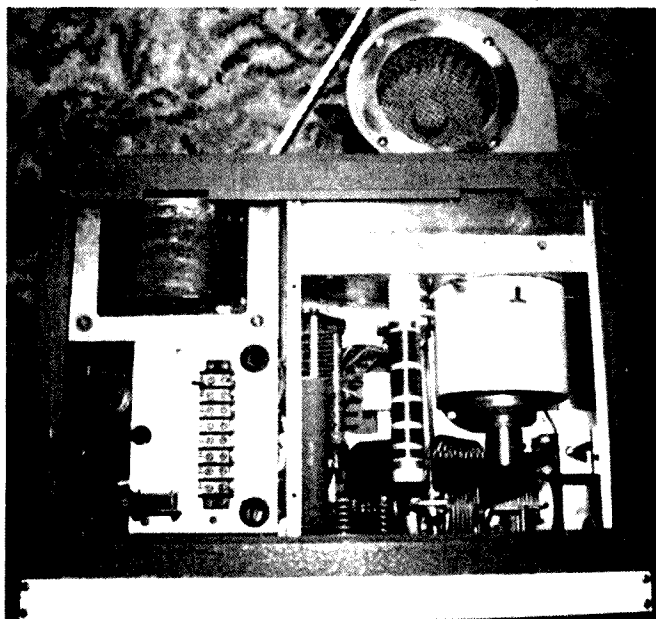


Photo 3. Amplifier — general layout (Blower)

overheated so rather than having to wait with the equipment whilst it aftercools for two minutes this is taken care of. The circuit senses HIGH TENSION voltage via a 10M ohm resistor at the cold end of the rectifier string (junction of R110 / R109) and continues powering the blower motor (via Q3, Q4, D2 and Q5) as the HT voltages bleed away.

Also in the power supply area attention must be given to the voltage doubler. The original capacitors must be replaced with suitable units to provide a total capacity of 25uF or better. By substituting 8 220uF miniature capacitors a total of 27.5uF was achieved. The need for this modification cannot be stressed too highly as performance will be severely degraded and IMD (intermodulation distortion) will increase if this area is not upgraded.

Other PSU changes are R4 the bias resistor (ref fig 5), is deleted and tapped in half to act as a surge limiting resistor. Two 0.1 ohm 5w resistors (ref fig 5 R3A & R3B) are placed in parallel with R3 thus doubling the plate meter scale to FSD of 1,200 mA. A 2.2 ohm 7 watt surge (ref fig 3 R5) limiting resistor is placed in the T1 HIGH TENSION tapping point, this goes to a fusible link as a safety precaution.

The hazard sheet from Varian specifies a tolerance for the heater voltage of six volts \pm 5%. To ensure that it is correct remote leads were attached to the terminals of the 8352 and with air applied, the whole system was run so that the voltage could be read. T1 / T2 (both original units) are fully tapped out in their primary circuits to the 234v position giving them the best settings to run the 8352, even so the heater voltage from T2 is in excess so a 65 ohm 20 watt resistor (ref fig 4 R8) was needed in the primary circuit to correct this critical voltage.

Tuning and Testing

Once the constructor is totally confident all the modifications are complete a small amount of drive should be applied to the circuit and the alignment process begun. Setting of the input inductors is essential, this is best done with reference to the chart of modifications in Fig 1 and the Yaesu owners manual.

As a guide peak all tuning controls and measure the reflected power in the exciter line. Assess the necessary changes to be made either to the appropriate inductor or capacitors that are modified in the input circuit.

Since developing the amplifier it has had many hours of "ON AIR" use, mainly for semi break-in CW contesting where it has performed faultlessly. Whilst no "Lab" attempt has been made to assess the IMD

performance of the 8352 it appears using the equipment available that it is either the same or better than original.

One more point to bear in mind is that this amplifier had in its original condition the ability to exceed the legal power limit for the Amateur service in Australia. The "revamp" described in this article also has the potential to exceed the power limit and constructors must ensure that the Regulations are complied with.

So there it is a faulty piece of equipment returned to vastly better use, now is the time to rebuild whilst the "SOLAR WINTER" is on and be prepared for bigger and better "DX" in cycle 23.

References

1: ARRL handbook for 1976, page 184 "A 160 Meter Amplifier".

ar

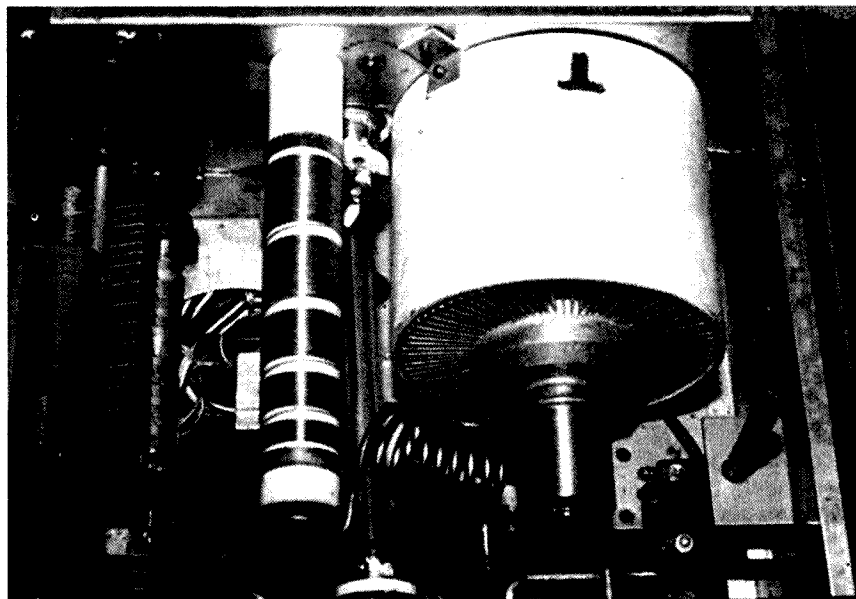


Photo 4. Output stage — tube detail

G. & C. COMMUNICATIONS

Graham Brennan VK3 KCS
19 Arleon Crescent, Cranbourne 3977

KENWOOD

GVL Electrophone

uniden®

We specialise in Australia-wide mail order

(03) 5996 3298

e-mail: gccom@netspace.net.au

www.netspace.net.au/~gccom

Fax (03) 5995 0184

All major credit cards welcome

An active amateur offering professional service, advice and product.

*Support
the Advertisers
who support*

**Amateur
Radio**

CLUB NEWS

The Central Coast Field Day

– the biggest Amateur Radio event in the Southern Hemisphere

The Central Coast Amateur Radio Club will again be holding Australia's largest amateur radio event **The CENTRAL COAST FIELD DAY** on **Sunday 27 February 2000** at the **WYONG RACECOURSE, Howarth St, Wyong**. Gates will open at 8.30 am in wet or fine weather and displays are under cover. This is one of the longest running events in the Australian amateur radio calendar and the year 2000 field day will be the 43rd consecutive year of this popular and growing event.

As usual a large contingent of well-known suppliers of electronic equipment, components and books will be attending. These companies will have their latest products on display and many traders will have items on sale at very special Field Day prices.

The ever popular "Flea Market" attracts a large number of people who trade an enormous amount of surplus electronic equipment to eager buyers from trestles, their trucks, trailers or from the boot of their car. The flea market just gets bigger every year.

The organisers are keeping the format for the Field Day in line with the changing face

of amateur radio. In recent years seminars on a wide range of topical subjects ranging from packet radio to satellite communications have been a popular attraction. This year an even bigger program of interesting lectures and equipment displays is being arranged.

FIELD DAY ATTRACTIONS WILL INCLUDE ...

- ALARA Stand, Flea Market
- Disposals, Various Amateur Television Groups
- WIA Historian Stand, Packet Radio Displays
- QSL Bureau, Fox Hunts
- Seminars, Technical Lectures and Workshops, Historical radio displays
- VK2 Education Service Stand, WICEN Display
- Trade Displays and Sales, Satellite Television Receiving demos.
- Complimentary Reptile Park Tickets for the family,

ADMISSION ... Adults \$10.00 ...
Children under 12 Free ... Seniors Card

\$5.00 ... Pensioner \$5.00 ... Students \$5.00.

A special group concession is available on application.

Trading and all programmed activities will commence at 8.30 am.

INFORMATION ... On the Wyong Racecourse venue, Group Concessions, Trade Displays, Flea Market,

Disposals, Programs or any other Field Day information can be obtained by writing to:

CCARC Field Day Organising Team
PO Box 346, Woy Woy, 2256 NSW
Phone 02 4340 2500

Packet: VK2AFY@VK2EHQ, email: bobfitz@ozemail.com.au, Home Page <http://www.ccarc.org.au/>

Further information is available on the Field Day section of our club's web site www.ccarc.org.au or by phoning me on 02 4389 9206.

Companies, persons, groups or clubs wishing to set up a traders table or display at the Field Day should contact the Field Day Organising Team before 31st January, 2000.

Bob Fitzgerald, VK2XRF

Adelaide Hills Amateur Radio Society Notes

AHARS has just held it's annual Buy and Sell. It was possibly more successful than last year as the dates of the Classic Adelaide Car Rally were avoided. Last year so many of the AHARS members were assisting with radio communication for the Rally that attendance at the Buy and Sell was down.

As a fore-runner to the Buy and Sell the ESC (Equipment Supply Committee) were invited to address the November meeting. This was a very interesting and informative meeting and certainly will have increased sales of parts and kits on the day as well as made members aware of the range of kits and interests the ESC carries.

We were also interested to hear how many changes in emphasis there have been over the years. ESC was formed almost 40 years ago when there were still many components and complete units available as surplus from the war years. David VK5KK very clearly knew his stock and the history of the group through those years

Then, valves and valve value components made up the bulk of the parts held by the ESC, now it is ICs and other small items that fill the drawers.

A catalogue of some of the kits and components available are published from time to time but the ESC is also always available directly through P.O. Box 789 Salisbury. 5108 SA. Please allow a little time for processing.

Redcliffe Radio and Communications Group Course

The U3A Redcliffe Radio and Communications group is now taking enrolments for the year 2000 AOCF Radio Course which commences on Tuesday February 1.

This is a very popular course among retirees and shift workers as the classes are held on Tuesday mornings from 10.00am till 12 noon with some weekends. Numbers are limited to twelve, plus correspondence students.

The course gives full coverage that includes workshop and "on air" practice, technical theory, morse code (not compulsory) and regulations at AOCF level, and finishes up in November with the examinations.

There are no class fees except the U3A registration which is very reasonable. A recommended textbooks list is available with syllabus.

Further information and course syllabus can be obtained by contacting Kevin VK4AKi on 07 3880 1112 or url: <http://www.qsl.net/vk4aki>

ALARA

Christine Taylor VK5CTY
ALARA Publicity Officer

16 Fairmont Avenue, Black Forest SA 5035
Packet: VK5CTY@VK5TTY

“DX before dishes” in 2000

The ALARA Contest

This was not quite as successful as we would like either because propagation just didn't seem to be in our favour or too many people had other things to do that day. Fewer contacts than usual seem to be made during the day, perhaps because the date clashed with other commitments. On 80 metres, though, a lot of callsigns were heard.

Some overseas YLs and OMs contacts were heard and a few more people around the World have now heard of ALARA and understand what the letters stand for. That is a positive outcome for us all.

Anyway, we hope you enjoyed the contacts you did have and hopefully you have all sent in your logs or the Contest manager will be very cross!!.

Don't forget, you can claim for the ALARA Award if you used the contest to accumulate the required YL stations. The details of this award are listed in the November issue. Do give the Awards Manager some work to do, she claims that she needs it.

The Masters' Games

As we told you a few months ago Maria VK5BMT offered her services as a volunteer for the Masters' Games held this time in Adelaide.

Guess where she was used? Yes, they put her in the central radio room where she was delighted to be able to use her special skills. She was the distribution point for all the information from and to all the venues. She kept track of where people were and was able to save a few headaches because she actually knew when some one was unavailable or perhaps was on their way to a different venue.

All the changes, all the results and all the requests came though Maria's ears and hands.

William, the man in charge, said he had never had such an efficient radio operator. As William has been in charge of the overall operation of the last two Masters' Games, that is high praise.

Well done Maria for showing 'outsiders' one of the faces of amateur radio.

Incidentally, Maria says she enjoyed every minute of it and would do it again tomorrow.

The New Century

Well, how did you fair with Y2K? How many New Years' resolutions did you make — and how many have you already broken?

I hope one of the resolutions was “DX before dishes” The sunspot cycle is at it's peak this year so let us all make the most of it.

One group that is planning to make the most of the sunspots is the YL International SSB'ers, Inc. They are calling for a one month reunion (particularly of those who are 'Old Timers' with membership numbers below 10,000) during the month of February on 14.332mhz.

They are calling the event “YL' 2K Homecoming”.

Why not participate? It sounds most interesting.

This information was sent to me by Dave VK1GD but originated from Dick KA3DCQ who had the idea of a 'Homecoming' to celebrate the high sunspot number year, in 1992. That effort was very successful. Hopefully this one will be equally successfully. Why not give it a go?

There is a website maintained by Jim VE1JIM at <http://www.qsl.net/yl-issb>.

This group has a VK-ZL group with Dave ZL1AMN as control. It is around 02.30 Zulu each Saturday that you are likely to hear Dave and others. Other times, other areas are accessed. For this information why not try the website listed above or contact Dick himself on ka3cdq@chesapeake.net or Rhonda at hamsrus@afcon.net

Flo Reitzel KU7F is the usual YL control in the US.

As is the usual arrangement, new members are sponsored by existing members e.g. June VK4SJ and her OM were sponsored by Larry W5VTM.

Once a year a large (140 page) Newsletter called “The Voice” is sent to members with smaller ones monthly. An annual QSO party is held and a number of local dinner gatherings. The group also fund a \$500 scholarship each year.

The motto of the group is “We believe in the dignity of Man” and their aim is to “Build Friendships among all the People of the World and to the Service to our Fellowman, wherever they may be through Amateur Radio”

If you are a SSB DXer YL or OM you could be interested to participate. If you are not interested yourself you might like to pass the information on to others to help to swell the numbers.

Ahars Buy and Sell

As usual the VK5 YLs provided food and drink for the annual talkfest that is officially the AHARS Buy and Sell event. This is definitely the place to meet other amateurs either for the first time or because you usually do meet them each year as you wander among the stalls looking for “just the thing”.

As we all know, one person's junk is another's treasure. A few items do reappear on a different table the next year, but most are put to good use by the new owner.

Jean VK5TSX and Tina VK5TMC were the organisers this year but they were helped on the day by Meg VK5YG, Jenny VK5ANW, Marilyn VK3DMS and Christine VK5CTY.

Photographs of Brisbane were on show and souvenirs were for sale.

ar

Action for the month

Tell a non-member
what the WIA does
for all amateurs in
Australia



Yet another Inductance Meter

John Hassell VK6JAH

THE DESCRIPTION OF an RF inductance meter by Lloyd Butler in the June 1997 edition of AR convinced me I needed something similar to sort out the collection of RF chokes and coils I have gathered together over the years.

Lloyd's inductance meter covers 0.1 μ H to 3mH in four ranges using a switched RF oscillator to excite a tuned circuit made up of the unknown inductor and a calibrated variable capacitor. RF current in the tuned circuit is detected and measured by a rectifier and meter. The variable capacitor is calibrated in inductance so that when resonance is indicated by the meter the value of the unknown inductor can be read from the capacitor's dial.

The main problem encountered by Lloyd was to make the oscillator work on four widely different frequencies. His final design uses some rather complicated switching to achieve a result and I wondered if a single frequency oscillator with a digital divider would be simpler and easier to get going. The other difficulty I saw was finding a 50 μ A meter for the detector circuit. These are now rare on the surplus market and expensive if purchased new. In AR for May 1997, Drew Diamond described his "Nano-L" inductance bridge. He used a transistor and LED combination as the resonance indicator and this looks a cheap and simple substitute for a meter. He also used a TTL crystal oscillator module as his RF source which would be the ideal beginning of a digital divider chain to generate the frequencies needed for a multi-range instrument.

Circuit Details

I followed Lloyd Butler's idea of a switched range oscillator but used TTL logic to generate the required frequencies. I start with a 16 MHz oscillator module, then divide the signal down with a 74161 binary divider which gives outputs on 8 MHz, 4 MHz, 2 MHz and 1 MHz. Two further divisions are made using a 7474 dual D flip-flop to give outputs on 500 kHz and 250 kHz. Not all these frequencies may be needed as it will depend if the tuning range of the variable capacitor used gives excessive overlap of the dial scales, in which case some frequencies may be omitted during calibration.

Rotary switch S1 selects the wanted frequency and feeds it via a 0.1 μ F capacitor to the 20k drive potentiometer. This switch is a single pole 12 position type with an adjustable index ring which allows the desired number of positions to be set. I set the switch initially to 7 positions to select all the frequencies from 16 MHz to 250 kHz. If some frequencies are not needed it is easy to reset the index ring later. The 2.2k pull up resistor ensures the TTL output swings almost to the +5V rail.

The 20K drive potentiometer sets the level of signal to the tuned circuit formed by the variable capacitor and the unknown inductance. The tuning capacitor I used is a dual 400pF per section type wired in parallel to give a capacitance range of about 30-800 pF. The two 33pF capacitors coupling the signal into and out of the tuned circuit are a compromise. If they are made smaller in value they block too much signal on the lower frequency ranges, if they are too large they load down the tuned circuit at higher frequencies.

The detector and LED indicator circuit is straight from Drew Diamond's "Nano-L" design and works very well. At resonance, peak RF voltage is developed across the tuned circuit. This is rectified by the detector diodes which provide bias current to turn on the transistor and light the LED. Be sure to use

germanium

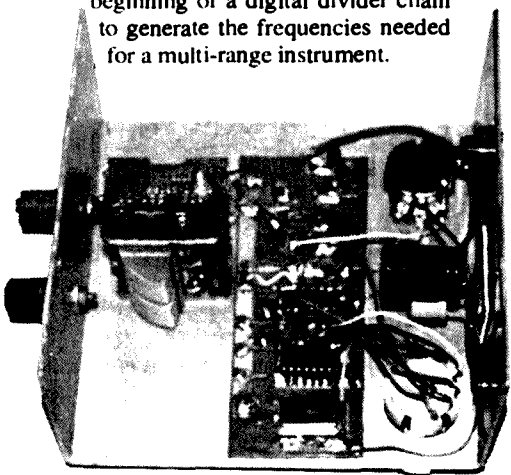
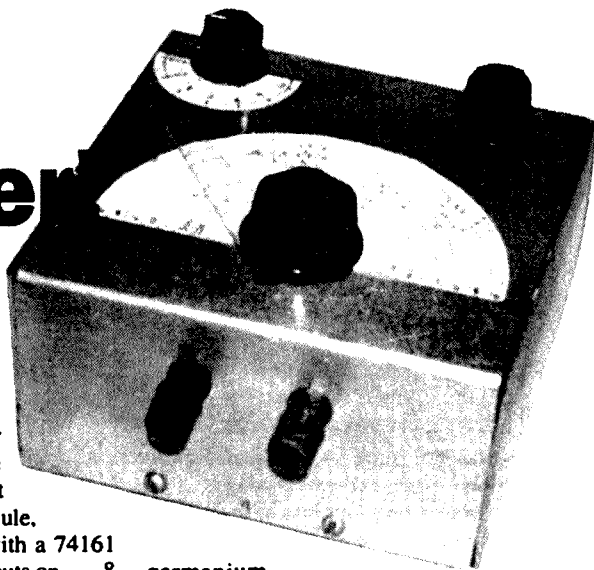
diodes in the detector as silicon diodes have too much forward voltage drop. I used 1N60 diodes but 0A91 or 0A95 types are also suitable. Any small signal npn transistor can be used to drive the LED. I had a 2N2222 on hand but a BC109 or 2N3904 works just as well.

Power requirements for the inductance meter is 5 volt at about 130 milliamp using standard TTL. I powered my unit from a 9V 150 mA DC plug pack and used a 7805 regulator to give the required 5 volts. Battery power could be used but it would be a good idea to go for LS series TTL to lower current demand. A 78L05 100mA regulator would then be adequate.

Construction

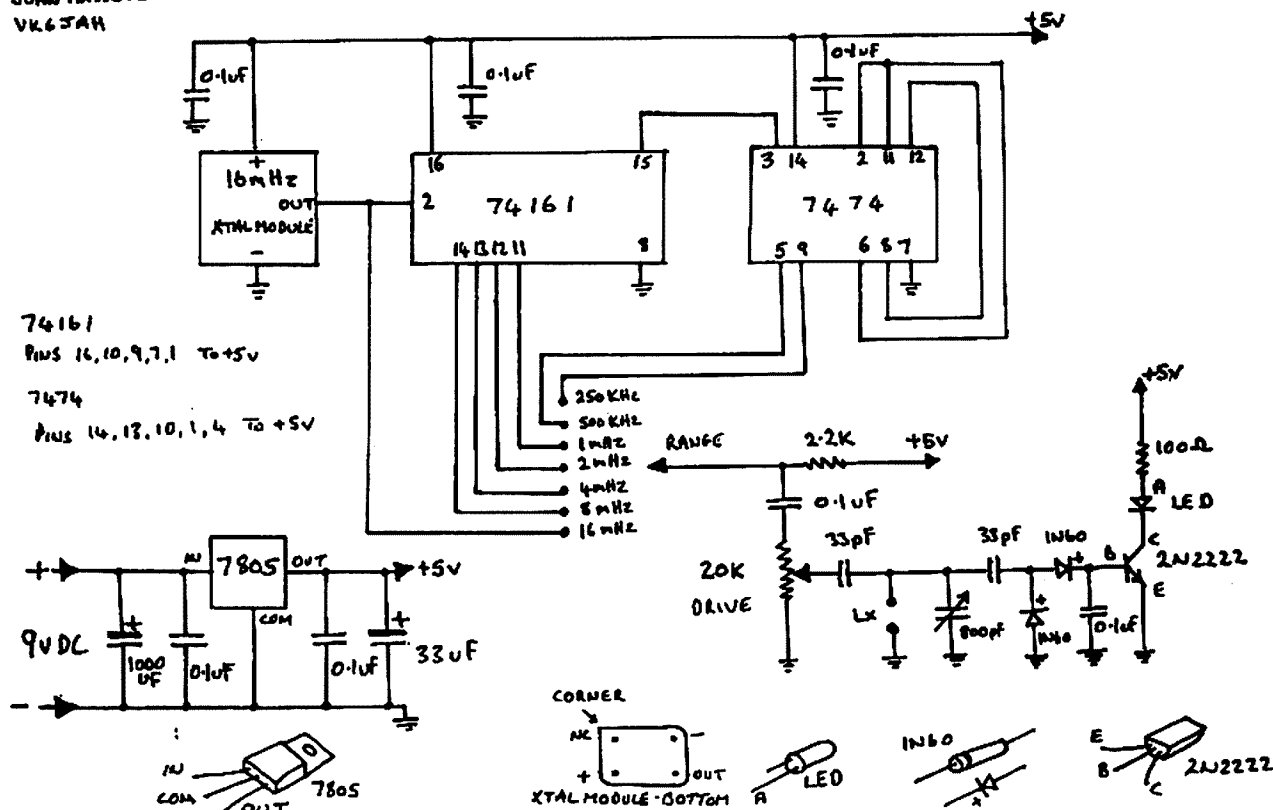
The inductance meter was built into a home-made 140mm x 140mm x 70mm aluminium box. The box is made by bending up two U shaped pieces of aluminium so that one piece forms the base and two sides and the other piece the top and the two other sides. The two parts of the box are held together with small pieces of aluminium angle and self-tapping screws. All the major component parts are mounted on the under-surface of the top part of the box.

The circuit was constructed "Paddy Board" style on a 110mm x 40mm strip of copper-clad board which was glued into position. I mounted the integrated circuits on small substrate boards glued to the main board but "dead bug" style mounting would work just as well. The 7805 regulator with its associated filter capacitors was mounted on a small separate board. This board was glued to the side of the box and the tab of the 7805 bolted to the aluminium for heat sinking. I used a dab of glue from a hot glue gun to hold down the main board and the solder pads. This allows minor adjustments of pad position to be made with the touch of



INDUCTANCE METER

JOHN HASSELL
VK6JAH



a hot soldering iron and easy removal of the pad if there is a change in design.

Mount the tuning capacitor so that the solder lugs for the fixed plates are as close as possible to the "hot" terminal for the unknown inductor. I used two solder lugs on the "hot" terminal and soldered them to each of the fixed plate lugs on the dual gang capacitor making a very short parallel connection. The "cold" terminal is bolted directly to the aluminium box side. A 50mm cursor was cut from a scrap of thin perspex and glued to the knob mounted on the capacitor shaft.

Make sure when you position the potentiometer, LED indicator and rotary switch, that you leave room for the swing of the cursor.

Wiring should be kept short and direct and the 0.1uF by-pass capacitor on each integrated circuit's +5v line should be soldered directly between the pin and earth. Remember that with TTL all unused control and input pins must go somewhere usually to +5v. The load input pins 3-6 on the 74161 can be left floating.

Operation and Calibration

With an unknown inductor connected, select a range and set the dial so that the

variable capacitor is at minimum mesh. Set the drive potentiometer so that the LED is just extinguished. Swing the dial and watch the LED for a "blink". If there is no indication of resonance, select another range and try again. When an indication is seen, back off the drive a little and try to find the peak brightness of the LED by rocking the dial back and forth and then read off the inductance value from the dial scale. Always try to use the minimum amount of drive as this will give the sharpest indication and suppress any spurious resonances.

I calibrated the unit using known inductors that I had on hand. The large electronic parts retailers such as DSE and Jaycar sell RF chokes in a range from 1uH through to 10mH for around \$1 each, so it is not expensive to purchase a selection to provide calibration points for each range. Remember that inductors can be connected in series and parallel in the same way as resistors to give other values.

I drew up a paper scale and glued it in position. Initially mark the inductance values on the scale in pencil so that any mistakes can be easily corrected, then ink them in later. A coat of clear varnish makes the scale more durable, just check it does not dissolve the ink!

Parts

The variable capacitor I used came from an older style transistor radio and is the metal framed type. Avoid the plastic ones. The crystal oscillator module came from Vorlac Industries and cost 50 cent. Check their web page for this and lots of other interesting surplus bargains. (www.vorlac.com.au). Remember it does not have to be exactly 16MHz. Anything around that frequency will be fine. All other parts are available from the usual electronic suppliers.

Final Thoughts

Here is a simple inductance meter which is cheap, easy to build and easy to get going. Being crystal controlled the calibration should be very stable. The only part that may be hard to find is a suitable tuning capacitor. Check out the local garage sales for old transistor radios. Dead ones go very cheap!

References

1. An RF Inductance Meter - Butler, Amateur Radio June 1997
2. Nano-L Inductance Bridge for Small Coils - Diamond, Amateur Radio May 1997
3. TTL Cookbook - Lancaster, Howard W Sams & Co. 1975

An Experimenter's *power supply* with Current-Limit

Drew Diamond, VK3XU

45 Gatters Rd
Wonga Park 3115.

Regulated, variable voltage power supplies find use in all aspects of radio and electronics work- and there never seems to be enough of them. It is some years since we offered plans for a bench power supply for the experimenter (see Ref. 1). That model was fitted with just one current limit of nominally 2 A. But there are times, especially during development or troubleshooting, when, in order to reduce the likelihood of damage, a limit on the current capacity is very desirable. Current-limit/constant-current mode is also a handy feature when charging Ni-Cd and small lead-acid batteries.

POWER SUPPLIES which offer continuously variable current-limit appear in electronics journals from time to time. However, that feature perforce makes the design rather complex. The circuit is considerably simplified if switched, rather than continuously variable current-limit suits the intended applications.

Typical electronics and radio projects generally require a supply of 6, 9, 12 or 15 Vdc at up to perhaps 1 A, so it may be (fairly safely) assumed that a maximum of 1 A would suit most experimental work, and that a voltage range of 3 to 20 V would power the greater portion of contemporary electronic devices. Hence the range provided for this model, which has the following measured characteristics:

Performance

Voltage Range:	3 to 20 Vdc.
Current Range:	100 mA, 500 mA and 1A.
Load Regulation:	Within +/-10 mV from no-load to rated load.
Line Regulation:	Within +/-5 mV for +/- 10% change in mains.
Ripple and Noise:	Less than 10 mV p- p at full load.
Output Protection:	Short-circuit and limited reverse polarity.

Circuit

The circuit is quite conventional, and employs the popular, and readily available LM723 as regulator. The internally

generated 7.2 V reference at pin 6 is dropped to 2.3 V, and applied to the error amp. non-inverting input at pin 5, thus setting the minimum voltage output at about 2.8 V (it cannot be made to go to zero without a considerable amount of extra circuitry). Error signal, from the voltage divider comprised of 560 ohm - 5 K pot - 680 ohm sensing resistors connected between (+) and (-) output terminals (or "binding-posts") is applied to the inverting input at pin 4. As the '723 can only supply 100 mA on its own, the output current at pin 10 drives a 2N3055 power transistor as series pass regulator.

The voltage applied between pins 2 and 3 controls the current availability. When the positive voltage at pin 2 (with respect to pin 3) approaches 0.54, the supply will go into constant-current mode, thus limiting the current to that value. Current sampling is obtained from a series string of low value resistors of 0.55 - 0.55 - 4.7 ohms. Switch S1 is wired so that current limits of 100 mA, 500 mA and 1 A may be selected. If a short-circuit load is accidentally applied, no damage is done, because the supply will instantly go into constant-current mode at the set limit.

Transformer secondary voltage is 22 Vac each side of centre tap which, after full-wave two-diode rectification and smoothing provides an un-regulated voltage of about 31 Vdc. A 1 K bleed resistor is connected across the 4700 uF smoothing capacitor in order to discharge the capacitor when mains is removed.

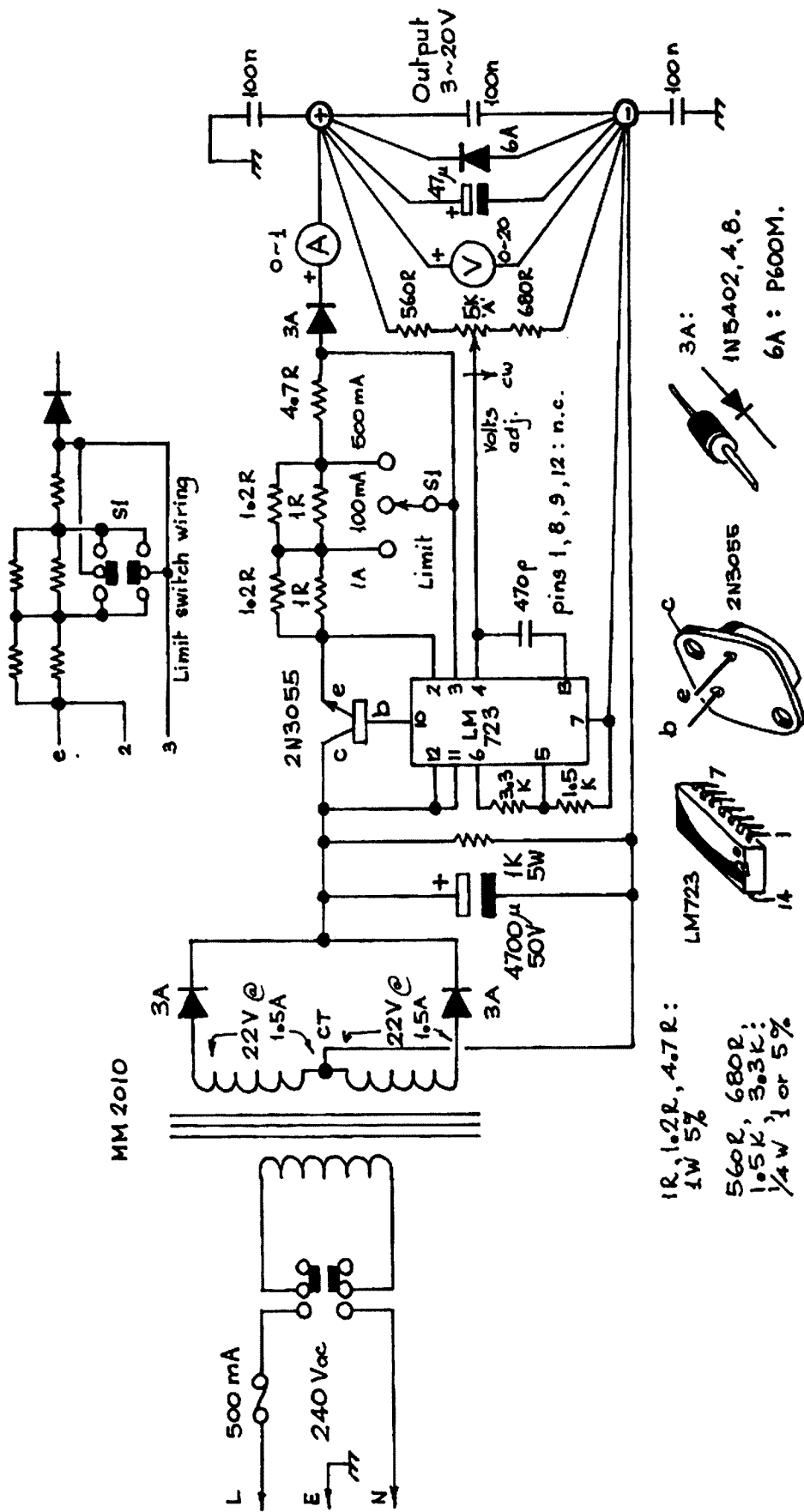
High frequency stability is obtained by

inclusion of a 470 pF capacitor between pin 4 and HF comp. pin 13. Stability is further improved with the addition of a 47 uF capacitor connected between (+) and (-) output terminals. The '723 is reportedly prone to malfunction when transmitting near, or from a '723 type supply. Connection of 100 nF ceramic or monolithic capacitors from each output terminal to chassis, and another between, and right at the terminals effectively prevents RF signals from entering the regulator input.

When using such a supply, for all kinds of jobs, there is the possibility of wrong polarity being accidentally applied (when battery charging for instance). A 6 Amp diode is reverse connected across the output terminals to absorb energy from inductive loads which may "kick-back" a reverse potential, and to provide protection from wrong polarity. Should a strong source (a set of charged Ni-Cd's for example) remain wrongly connected for more than a few seconds, the diode will overheat, and short-circuit the output- the only damage being the destruction of an easily replaced diode as a slap on the wrist for being so careless. A 3 Amp diode is connected in series with the (+) lead in order to prevent external voltage sources from reaching the regulator should mains supply be removed.

Construction

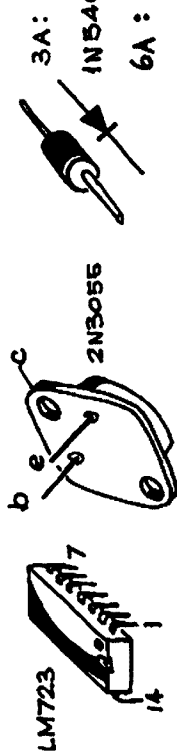
Because of their great utility, power supplies can get rather knocked about in service, so a fairly solid metal cabinet is suggested. A metal box will also provide added immunity



1R, 1.2R, 4.7R:
1W 5%

560R, 680R:
1/4W 1 or 5%

Caps > 35V w/kg.



Experimenter's Power Supply
—VK3XU—

Figure 1



Photo 1. Experimenter's Power Supply

from RF fields. The home-made aluminium enclosure shown in Photo 1 measures 150 x 150 x 180 mm WDH. Photo 2 shows a suggested chassis and panel arrangement. Chassis and cover are 1.5 mm sheet, and front and back panels are 4 mm sheet (check out the "off-cuts" bin at you local al. merchant). Any box that you prefer, squat or tall, will serve.

In order to dissipate excess heat generated by the 2N3055 under some load conditions (the worst normal load is 3 V at 1 A, the worst abnormal load is a prolonged short-circuit), the 2N3055 must be fitted to a 2 degree C/ W (or better) heatsink which in turn is mounted upon the rear panel. Mine uses a Jaycar HH8566. A Dick Smith H 3485 would also serve. After drilling the holes for the '3055, countersink each hole a little to remove burrs. Include a silicon-impregnated TO3 washer and bushes when installing the '3055.

During development of this supply, my experimental "lash-up" consisted of the individual parts wired up on the bench, with components tacked-on as required, and the circuit worked properly like that; so it may reasonably be assumed that just about any wiring method that you prefer will work satisfactorily. Photo 3 shows my own

preferred approach to building one-off projects, which uses "paddyboards" (see Ref. 2) upon a main board measuring 100 x 70 mm. The '723 is accommodated in a 14-pin machine I.C. socket. Each of the 14 pins has a 20 mm 0.6 mm dia. (approximately) tinned wire soldered to it, which in turn are soldered to each of the 14 lands of a substrate measuring 35 x 25 mm. Or a Dick Smith H-5600 or 5601 PCB, fitted with a 14-pin socket would also serve. The I.C. substrate is soldered or super-glued copper side up upon the main board.

The output should "float". That is, neither (+) or (-) rail should be connected to chassis. This dodge helps to reduce hum loops in audio work, prevents polarity problems when connecting to other equipment, and allows other supplies to be connected in series with this one to obtain higher voltages when needed. Therefore, the circuit board and all other parts must be effectively insulated from chassis using insulated spacers and/or washers.

Check with your multimeter from time to time during assembly that no "stray" grounds have occurred—especially after fitting the '3055.

To obtain good voltage regulation, the sense resistors should connect right at the output terminals, as shown on the circuit. There are rather a lot of connections to these terminals, so it would be prudent to forget about ordinary solder tags, and make up extra large tags from brass sheet, or use a 65 x 15 mm piece of circuit board, divided with a hack-saw cut, and fitted under the terminal nuts, as shown in Photo 3.

The current-limit switch S1 is a miniature toggle DPDT "centre-off" type. To reduce contact resistance, the contacts should be wired in parallel, as depicted on the

circuit. All mains connections must be adequately covered, using heat-shrink tube or similar, to prevent accidental contact. Rather than use components which are "adequate", I have "over-specified" on the transformer (1.5A instead of 1 A), diodes and two or three of the other parts. The small additional cost is justified in terms of significantly improved reliability. If a front panel "on" indicator is required, wire an LED in series with a 4.7 K 1/2 or 1 W resistor across the 4700 uF cap. The short lead of the LED connects to the (-) rail.

Operation

Visually check all wiring connections and component polarities. Test for very high resistance for each output terminal to chassis to confirm that no stray grounds have occurred. Remove the '723 from its socket. Switch on, and measure the dc voltage across the 4700 uF capacitor, which should be about 31 V. Switch off, wait for the cap. to discharge, then install the '723 and switch on again. It should be possible to smoothly adjust the output from about 2.8 to 20 or 21 V.

Obtain a range of wire-wound resistors and check that the current-limit works properly. For instance, at 10 V, a 10 ohm resistor will draw 1 A. If you try to output a higher voltage, the voltmeter should remain at 10 V and the ammeter at 1 A (or perhaps just a little more for both). Similar for the 100 mA (100 ohms) and 500 mA (20 ohms). Test the full regulated capacity by connecting 20 ohms at 20 V; the supply

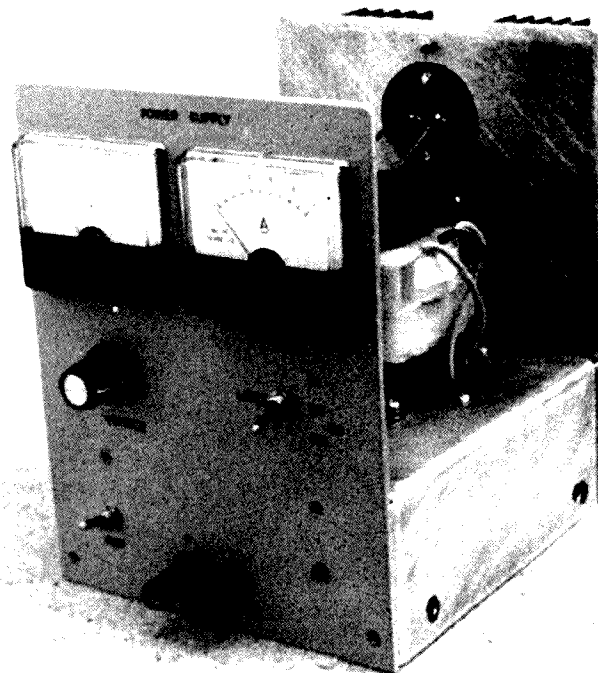


Photo 2. Chassis and heatsink

should deliver 1 A with no perceptible fall in voltage. With the current-limit proven, test the short-circuit protection, if desired, by bridging the output terminals.

When battery charging, set the current limit to the nearest recommended rating. If in doubt, a general "rule of thumb" for Ni-Cd's is about 1/10th the Ah capacity of the battery. Adjust the supply 2 or 3 V higher than the nominal battery voltage (say 9 V for a 7.2 V battery). Connection of (+) to (+), (-) to (-) will cause the supply voltmeter to indicate the actual battery voltage, and the ammeter will show the constant charging current. As the battery charges, the voltage should gradually rise to a value slightly higher than the nominal battery voltage.

Parts

The transformer in the prototype is a type JT180, Cat. MM-2010 from Jaycar. If you choose a tapped 30 V / 2 A transformer, use the 24 V tap and a full-wave bridge rectifier. 1 W carbon, and 5 W wire resistors may be ordered from Altronics and Jaycar. All the remaining components are available from the usual electronics merchants, such as Altronics, Dick Smiths, Electronics World and Jaycar.

References and Further Reading:

1. "HFC Regulated Variable Voltage Power Supply"; Diamond, AR May '93.
2. "'Paddyboard' Circuit Construction"; Diamond, AR, Feb. '95.
3. The Art of Electronics, 2nd Edition ; Horowitz & Hill, Cambridge University Press (see Ch 6 for an excellent theory and prac. essay on power supply design).

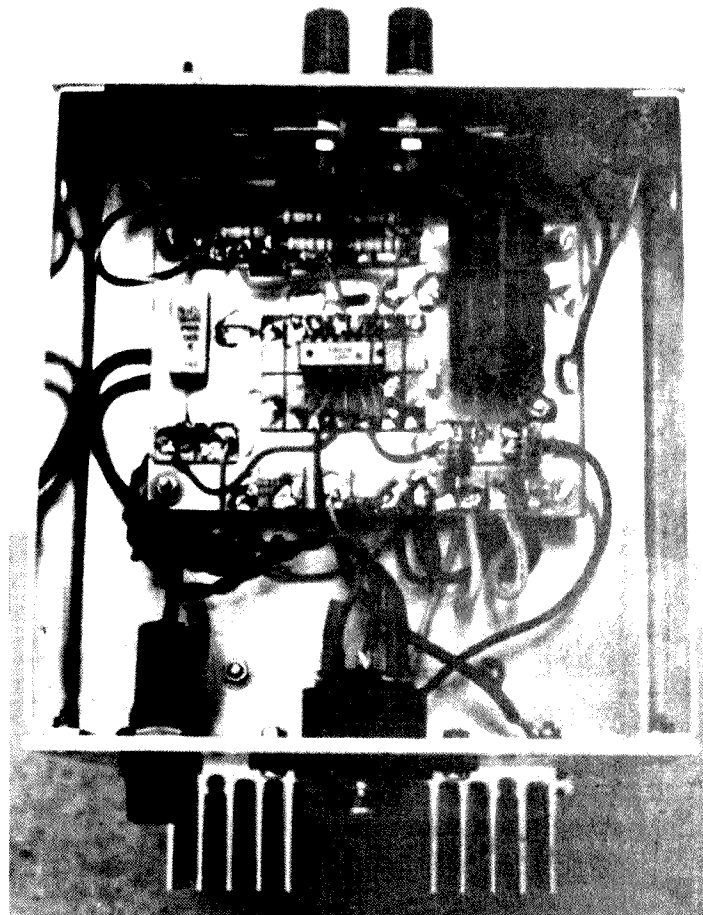


Photo 3. Under Chassis view

ar

Book Review

Pioneers of Radar, by Colin Latham and Anne Stubbs
Sutton Publishing 1999, ISBN 0-7509-2120-X

More than an exercise in nostalgia

by Ben Furby VK2XNZ

THE TIME: 1935 to 1945. **Situation:** Radar is vital to Britain's war effort against the Germans, who from September 1939 have been dropping magnetic mines and later bombs on Britain. Physics graduates, machinists, stores experts and others have been hastily assembled to get radar equipment out of laboratories and into field service, at ground stations, aircraft and ships.

This book, a 263 page collection of the varied-length reminiscences of 59 contributors, is more than an exercise in nostalgia. Many of these contributors became famous in electronics engineering and science then, and later. They are not all scientists, but include machinists, photographers and stores people. Among a scattering of Australasians gathered by

the brains search net was Professor (later Sir) Mark Oliphant at Birmingham, who led the team that evolved the magnetron, the key to powerful, UHF radars.

Plenty of amusing incidents ensure this book is not a dreary catalogue of individual experiences. These often related to pressure and speed to get equipment up and running yesterday. The one I specially liked was the scientist who had to increase the band of frequencies covered by a wide band transmitter mounted in aircraft. He merely mounted a metal plate next to the tuning capacitor ("condenser"?), and the vibration transmitted by the plane's reciprocating engines happily varied the capacitance rapidly and achieved the wanted effect. German precision engineering, eat your heart out.

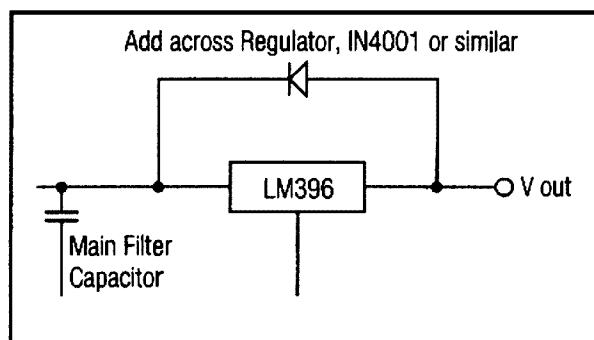
Scattered among hams in Australasia, the UK and the USA, are some of the survivors of those men and women in the services who operated radars during that war. You find them aplenty at the reunions of ex-World War II radar people that are still taking place. It appears that old radar operators never die: their traces just glow less brightly until they fade and disappear off the screen (and from the reunions). This book will have plenty of material to revive those memories and fuel more reminiscences at the reunions. The plentiful photos help jog memories, too. It's also a record of the pre-computer design era, when options were long and painfully evaluated, and shows how much drudgery the computer has taken out of design

ar

Modifying a Linear Power Supply to charge Gel Batteries

by Warren Stirling, VK3XSW

This project requires a linear (not a switchmode) power supply regulated for 13.8v dc and capable of supplying at least 4 amps over it's normal load current on a continuous basis. The modification adds a current limited, but not temperature compensated, output suitable for charging gell batteries in the 16 to 80ah capacity range.



IN THE EVENT of mains failure the battery is directly connected in parallel with the load and when mains power returns the battery is reconnected to a current limited output. This means that the battery will take longer to charge but extends the battery service life by limiting charge current surges.

The parts required are:

- 1 x 1 ohm 20 watt resistor
- 1 x 1k2 1/4 watt resistor
- 1 x 470uF, 35v electrolytic capacitor
- 1 x 1N4001 diode
- 1 x relay, 10A DC (min) rated contacts, two changeover contact sets (dpdt) with a 24v DC coil, nominal coil resistance of 460 ohms

Circuit Operation:

When mains power is present the nominal voltage across the main filter capacitor of the power supply is 24v DC. The relay operates on application of this DC voltage via the normally closed output of one of the contact sets directly to ground.

The 470uF capacitor provides enough power to keep the relay operating (by

discharging directly into the relay coil) so that the relay completes the changeover to the hold path which is via the 1k2 resistor to ground. Operating the contact set removes the short across the 1 ohm resistor so that the power supply output (13.8v DC nominal) is current limited by the 1 ohm resistor (about 3.5a DC into a dead flat battery).

In this configuration the relay will drop out when the voltage across the power supply main filter capacitor reaches approximately 18v DC. When the relay drops out the battery is connected directly across the load, via the relay contacts that now short out the 1 ohm current limiting resistor, while the power supply is still maintaining a regulated voltage to the load (albeit only for the time the filter capacitor in the power supply can maintain the load current in the absence of the mains input).

The relay works in this configuration because the current required to establish the magnetic field that moves the relay armature (operate current) is higher than the current required to maintain the magnetic field when it is established (hold current). In the prototype these two current values were measured at 52mA operate and 11 mA hold.

The relay in the prototype operated at 21v DC applied, but dropped out just below 5v DC. The theory is the 1k2 resistor drops 13.2v DC (coil hold current of 11mA x 1200 ohms), the relay needs 5v DC across the coil to stay operated therefore the relay will drop out at approx 18v DC.

While the relay in the prototype is specified as a 24v DC coil relay, the contact set changed over with 21v DC applied to the coil. The 3 volt difference between these two readings is the increase in the coils magnetic field required to apply tension to the contact set so that the resistance of the contact set in minimal, in other words while the contact set changed over at 21v DC applied, the mechanical tension applied to the contact set is low, so the resistance of the contact set is high, increasing the mechanical tension of the contact set reduces its resistance.

Determining The Relay Characteristics:

A variable voltage DC power supply and a multimeter are required to determine the relay characteristics.

Assuming a relay with a nominal 24v DC coil:

1. Measure the relay coil resistance and note it. Set the variable voltage DC power supply to 24v DC and connect it to the relay via the multimeter which has been set to measure about 500mA max.
2. Apply power and make sure the relay operates reliably. Note the current through the relay coil, this is the operate current.
3. Slowly decrease the power supply voltage until the relay drops out. Do this several times and note the current at the point just BEFORE the relay reliably drops out, this is I(hold), the hold current. Multiply I(hold) by the relay coil resistance to find V(hold), the minimum voltage at which the relay will stay operated.

Better results are obtained using the hold current than the hold voltage as relays are inherently current operated devices. While this is a DC circuit and Ohms Law would dictate no difference using the hold current or the hold voltage to determine the value of the hold current resistor I have found using the hold current approach yields more repeatable results.

4. Measure the voltage across the main filter capacitor of the linear power supply to be modified.

In the prototype the relay coil resistance is 460 ohms, the operate current is 52mA, the hold the hold current is 11mA, (thus the hold voltage is 5v) and the main filter capacitor voltage is 24v.

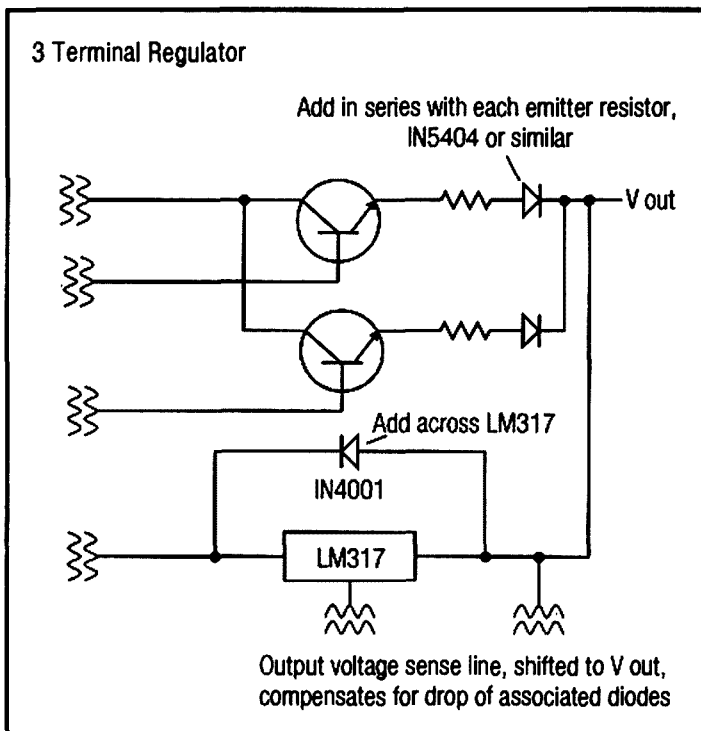
To determine the value of the relay hold current resistor use the following formula:
 $R(\text{hold}) = [V(\text{filter capacitor}) - V(\text{hold})] / I(\text{hold})$.

Note: R is in ohms, V is in volts and I is in amperes.

In the prototype this gives a value of 1.73K ohms. I used 1.2K ohms which increases the hold current from 11mA to 16mA, just to make sure the relay stays operated; after all 11mA is the MINIMUM value of the hold current and doesn't allow for drops in the filter capacitor voltage due to high load currents, mains fluctuations etc.

Modifying A Linear Power Supply To Survive A Battery As Its Load:

This is easily done where the regulator in the power supply is a single 3 terminal device such as the LM396K as is slightly



more complicated where the regulator is a block consisting of a control element driving series pass transistors, the most common example of this is the LM317K driving 2N3055 transistors via another transistor.

In both cases the normally reverse biased diodes need only be 1 amp devices while the normally forward biased devices need to be at least 5 amp devices, depending on the number of pass transistors and the total load current.


Notes:

The choice of relay, its characteristics and the value of the current limit resistor will determine the relay drop out voltage but it

MUST be higher than about 17 volts so that the battery is connected while the power supply regulator is operating (13.8v DC output and approx 4v drop across the linear regulator). This minimises the voltage spike that will occur when the battery is switched directly across the load.

The power supply MUST be able to survive a battery across its output in the absence of mains power. Most linear power supplies can be modified to do this. The ability of the power supply to be started with a load of approximately (4 amps + its normal load current) is also a requirement (allowing for the power supply to start with a dead flat battery across the output while powering its normal load).

ar



Situation Vacant

Cartoonist/Illustrator

(fee paying position)

We obviously need a cartoonist/illustrator for the pages of AR. We seek an artist economical of line, quick on the draw, knowledgeable about amateur radio and with a slightly wicked sense of humour. Location is unimportant but you must be contactable by fax or preferably email. You must be able to work undirected from galley proofs.

How to apply

Pick several stories from this edition of AR, do a cartoon or illustration and fax/email it, with your details and charges, to

Newsletters Unlimited
 Fax (03) 9428 4242 or
 newsl@webtime.com.au
 (We also may use you for other publications)

DON'T MISS THE ACTION!

2-Way Coax Switch

A heavy-duty, 2-way coax switch suitable for amateur, CB or commercial applications. It is well constructed with a die-cast case and can handle up to 2kW PEP or 1kW CW at 30MHz with less than 0.2dB insertion loss. SO-239 sockets.

D 5200



\$29⁹⁵
SAVE \$10

1kW HF Antenna Balun

Designed as a centre support for wire dipole or yagi antennas, this 'T' shaped 1:1 balun has 52 ohm unbalanced input and 52 ohm balanced output. An SO-239 socket is mounted into the base of the balun for easy coax connection. RF input power handling is 1kW PEP maximum, and insertion loss is less than 1dB. It can handle the entire HF band of 3-30MHz. RAK model BL-50A. Made in Japan.

D 5310



\$49⁹⁵
SAVE \$20

VX-5R 6m/2m/70cm Deluxe Hand-Held

Tiny yet incredibly rugged, the VX-5R provides 6m, 2m and 70cm amateur band operation with 5W output as standard (4.5W on 70cm), made possible by a unique PA design and a super high capacity 7.2v 1100mA/H Lithium-ion battery. Plus, ultra-wide coverage VHF and UHF as well as AM medium-wave and shortwave reception facilities are provided, along with a large backlit dot-matrix LCD screen. All this in a die-cast aluminium enclosure just 58 x 87 x 28mm WHD (w/o knobs or antenna)!

Features

- Tx: 50-54, 144-148, 430-450MHz
- RX: 0.5-1.8MHz, 1.8-16MHz, 47-729MHz, 800-999MHz (cellular blocked)
- Full feature keypad. CTCSS encode/decode, digital code squelch
- Comprehensive menu system
- Over 200 memories
- 8 digit alpha-numeric memory labelling
- 5 battery saving systems, plus Tx/Rx usage monitor
- Spectra-Scope™ for monitoring adjacent channel activity
- Comes with FNB-58LI Lithium-ion battery, flexible antenna and AC adaptor/charger

D 3670



2 YEAR WARRANTY

\$699
YAESU

VX-5R Accessories

CSC-73 Carry Case	D 3671	\$26.95
CD-15 Fast Desk Charger	D 3672	\$49.95
FBA-23 Dry-Cell Battery Case	D 3673	\$49.95

Yaesu FT-90R 2m/70cm micro mobile

Another engineering breakthrough from Yaesu – a tiny dual-band mobile rig with high power output, a remoteable front panel, and a rugged receiver front-end. The FT-90R provides 50W RF output on the 2m band as well as 35W output on the 70cm band, a solid diecast casing with microprocessor controlled cooling fan for reliable operation, and a large back-lit LCD screen, all in a package measuring just 100mm x 30mm x 138mm.

Also includes:

- Wide dynamic range receiver for reduced pager breakthrough
 - Huge receiver coverage – 100-230, 300-530, 810-999.975MHz (Cellular blocked)
 - 180 memories and a variety of scanning functions
 - Built-in CTCSS encode/decode, battery voltage metering
 - Designed for 1200 and 9600 baud Packet operation
 - Tiny remoteable front panel (requires optional YSK-90 separation kit)
- Includes MH-42 hand mic, DC power lead, and easy to follow instructions.

D 3312

YSK-90 Front Panel Separation Kit

D 3317 **\$129⁹⁵**

\$850

YAESU



2 YEAR WARRANTY

FOR ALL YOUR COMMUNICATION NEEDS

FT-50RD 2m/70cm Handheld

The Yaesu FT-50RD is an amazingly compact 2m/70cm amateur band handheld transceiver which provides MIL-STD 810 shock and vibration resistance, super wideband receiver coverage, simple menu settings for most functions, and compatibility with the optional Yaesu ADMS-IE software/interface package for PC programming of many functions.

Other features include:

- Tx 144-148MHz, 430-450MHz
- Rx 76-200, 300-540, 590-999MHz (cellular blocked)
- FTT-12 keypad provides Digital Voice Recording, CTCSS/DCS scanning, and CTCSS encode/decode
- 2m/70cm RF output: 2.5, 1.0, 0.1W standard, up to 5W with 9.6V battery or 12V DC socket
- "Omni-glow" LCD screen for easier night-time viewing
- 112 memory channels with 4 character alpha naming
- Dual watch allows monitoring of sub-band activity
- Direct FM modulation for better audio quality
- 5 battery saving systems (includes Rx and Tx Save)
- Comes with FNB-40 slimline 6V 650mA/H Nicad battery pack, flexible 2m/70cm antenna and modified M-9626 AC plugpack adaptor for Nicad charging

D 3660



2 YEAR WARRANTY

~~\$199~~
SAVE \$70

LATEST 2000 RELEASES

WIA Callbook

Wide range of information for Australian Amateurs plus useful callsign and address listings.

B 2344

NEW

~~\$17.95~~

ARRL Handbook

77th edition of this famous publication. Incredibly wide range of information for operators and constructors.

B 2237

NEW

~~\$59.95~~



VHF/UHF Power/SWR Meter

A high-quality SWR/power meter suitable for Amateur, UHF CB and commercial applications. Durable Japanese construction assures you of maximum reliability. With an all-metal case, large meter display, 140-525MHz coverage with less than 0.3dB insertion loss, and 4W, 20W and 200W power scales. Revex model VV540.

D 1370

~~\$150~~
SAVE \$35

FT-2500M 2m Heavy-Duty Transceiver

Built tough to take the rough stuff, the Yaesu FT-2500M meets US MIL-STD 810C for shock and vibration so it'll provide years of reliable mobile operation. Its easy-to-operate front panel design, rubber coated knobs, and large Omni-Glow display are teamed up with a one-piece diecast chassis to set the FT-2500M apart from other 2m mobiles. For improved front-end performance, Yaesu's exclusive 3-stage Advanced Track Tuning feature and dual-FET mixer reduce overloads from strong signals while providing excellent sensitivity and wide-band receive operation.

Also includes:

- 31 tuneable memories
- 7 selectable tuning steps
- MH-26 hand mic, mobile mounting bracket & DC power lead.
- In-built CTCSS encoder
- Various scanning modes

Specifications:

Frequency range: Tx 144-148MHz, Rx 140-174MHz
 Output power: 50W, 25W, 5W
 Sensitivity: better than 0.2uV for 12dB SINAD
 Image rejection: better than 70dB
 Max audio output: 2.0W into 8 ohms (10% THD)
 Dimensions: 160 x 50 x 180mm (W.H.D.)

D 3632

2 YEAR WARRANTY



YAESU

LOW PRICE

~~\$599~~
\$499

PHONE FAX AND MAIL ORDERS

PHONE: WITHIN AUSTRALIA: 1300 366 644
(Local call charge)

FAX: (02) 9395 1155 within Australia and
(+612) 9395 1155 from outside Australia

MAIL: DICK SMITH ELECTRONICS, Direct Link, Reply Paid 160,
PO Box 321, North Ryde NSW 1670 (No stamp required)



Visit our web site at
<http://www.dse.com.au>

DICK SMITH ELECTRONICS

That's where you go!

Yaesu transceivers and accessories stocked in selected stores only. Other stores can place orders on a deposit-paid basis.

Excludes packaging and postage. All major credit cards accepted.
14 Day Money Back Guaranteed if NOT completely satisfied. (Software excluded)

TECHNICAL ABSTRACTS

Gil Sones VK3AUI
30 Moore Street Box Hill South Vic 3128

Small HF Loop Antennas

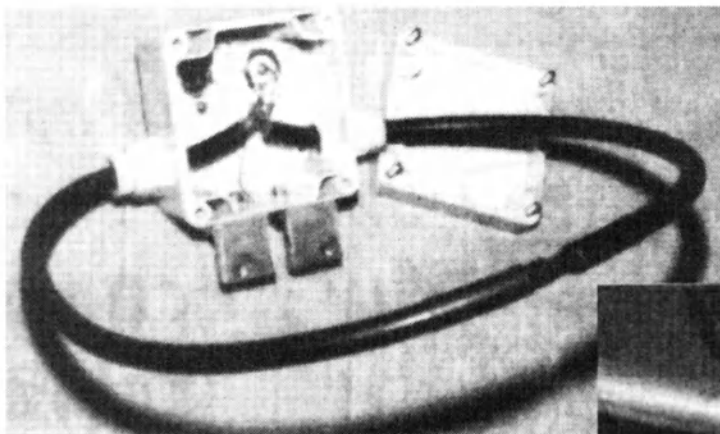
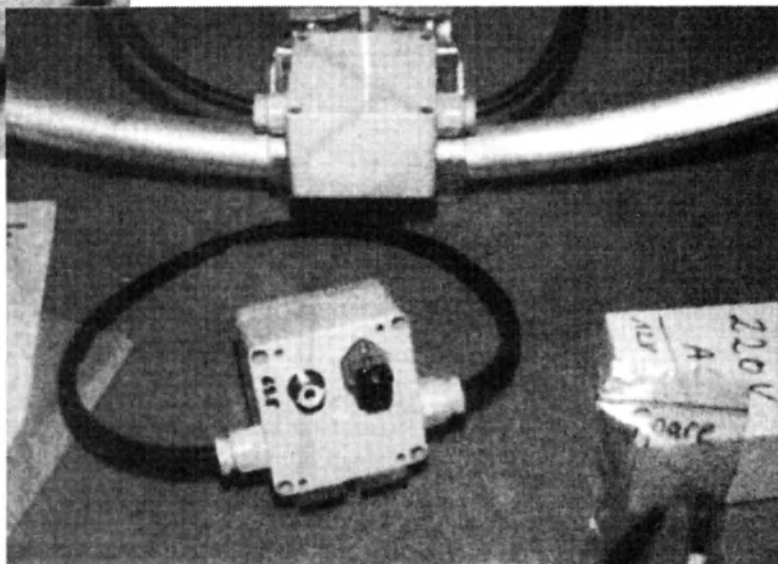


Fig 1. Original Loop of Patterson and the AMA Loop.



Loop antennas which are small with respect to the wavelength have been available from a number of sources. In the USA the AEA and MFJ products are well known and have been available in Australia. The German AMA series may be less well known but does offer a range of loops. The loops are often only a metre or so in diameter but there are versions which are two and three metres in diameter. The compact size of these antennas makes them attractive in many applications. They do have some limitations along with most small antennas.

IN THE JAPANESE magazine CQ Ham Radio September 1999 a survey of the small loop antenna was conducted by JG1UNE. A lot of information was presented but much of this is in Japanese. However there was some information which is of interest to those contemplating such an antenna.

The small loop first came to notice in an article in the magazine Electronics 21st August 1967 in an article by K Patterson describing some work on an army antenna. This was followed in QST May 1968 with an article by L McCoy. In the 1980's some articles appeared in CQ DL and Ted Hart W5JQR published an article in QST June 1986. In 1993 J Belrose VE2CV published an article in QST November 1993 which provided some details of his work with some loops.

There are a number of problems with transmitting small loops. They present some difficulties in efficient matching and their efficiency is low. The tuning components are highly stressed with high RF voltages

and high circulating currents which can lead to losses and flashovers particularly if any more than modest powers are involved.

The bandwidth of the antenna is small and this must be so if any efficiency is being achieved in the structure and the matching.

The original loop described by Patterson in 1967 and the AMA loop of Chris Kaeflerlein DK5CZ and Hans Wurtz DL2FA are shown in Fig 1. These differ in the tuning and matching. The earlier design used an arrangement of capacitors for the tuning and matching. This put quite stringent requirements on the capacitors and their connections if efficiency was to be achieved. The later design uses a coupling loop for matching and a separate tuning capacitor. The matching is easier and the tuning capacitor connections are simpler. The tuning capacitor must still cope with high RF voltages and large circulating currents. The Q is high and the bandwidth is quite narrow.

Table 1.

Type AMA	Diam m	Band m	dBd	dBi	Q	VSWR2 2:1 BW +/- KHz
4	3.4	160	-10.17	-8.02	3436	2
		80	-3.13	-0.98	2485	5.3
		40	-0.17	1.44	542	14
8	1.7	80	-9.44	-7.92	3969	2.1
		40	-2.49	-0.34	2459	4.3
		30	-1.08	1.07	1133	12
		20	-0.62	1.53	472	17
10 10D	1.3	40	-4.18	-2.03	3483	4.1
		30	-1.8	0.35	2001	9
		20	-0.89	1.26	927	10
		17	-0.6	1.55	457	17
		15	-0.52	1.63	299	18
13	0.8	80	-18.00	-15.85	3635	2
		40	-8.82	-6.67	4469	3.2
		30	-4.63	-2.48	3906	6
		20	-2.23	-0.08	2549	10
		17	-1.23	0.92	1483	17
		15	-0.91	1.24	1023	18

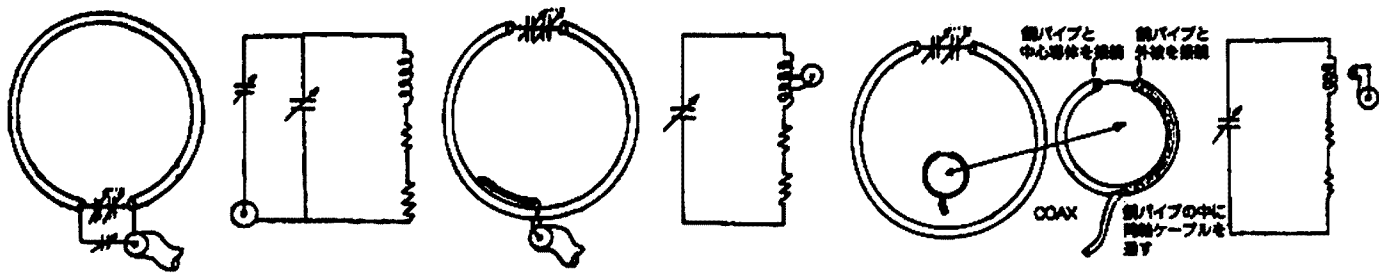


Fig 2. Three Loop Arrangements from W5QJR.

In Fig 2 which is the work of Ted W5QJR three different tuning and matching systems are shown. A plot of bandwidth against frequency for three loop sizes is shown in Fig 3. This is from the work of Jack VE2CV. The narrow bandwidth can be seen and the advantage of larger loop sizes at the lower frequencies is also shown.

The gain of four sizes of AMA loops is shown in Fig 4. The gains are largely negative where the loop has a circumference much less than the wavelength. A full wave loop is used in the Quad antenna. The gain is given in dBi which is dB relative to an isotropic radiator. A dipole has a gain of 2.15 dB relative to an isotropic radiator. Remember that short whip antennas also have negative gain due to losses.

The performance of some AMA loops is given in Table 1. These loops are made in Germany. Information can be obtained from Dipl. Ing. Christian Kaeferlein, D-64285 DARMSTADT Weinbergstrasse 5 Germany (FRG). Tel +49-6151-61271. E-mail: kaeferlein-elektronik@t-online.de.

The AEA and MFJ loops have been available at times in Australia and you should try local distributors.

RF Voltage Probe

A useful piece of equipment when working on RF circuits is an RF voltage probe. This enables RF voltages to be measured and displayed on an ordinary multimeter or digital voltmeter. An analogue meter is useful as it will allow easy peaking of circuits. However a digital meter will do particularly if it has a bar graph facility.

A simple and effective RF Voltage Probe appeared in the Technical Topics column of Pat Hawker G3VA in Rad Com October 1999. The item came from John A Share G3OKA.

The circuit and the simple circuit board are shown in Fig 5. The component leads

continued next page

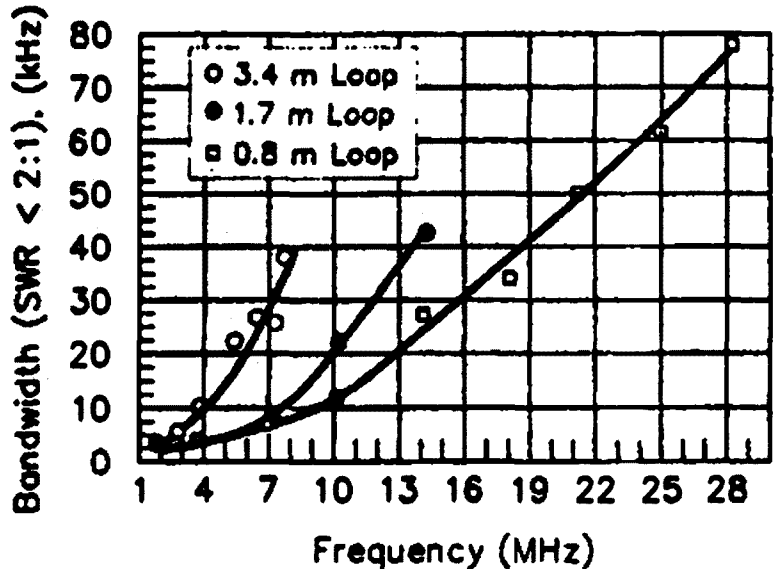


Fig 3. Loop Bandwidth with frequency from VE2CV.

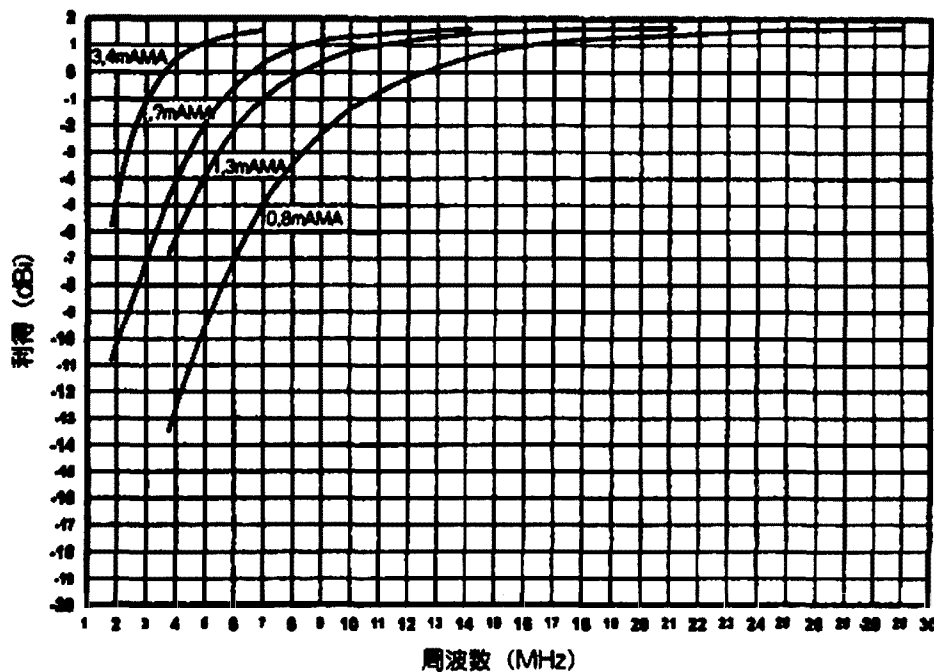


Fig 4. Gain in dBi of AMA loops.

TECHNICAL ABSTRACTS

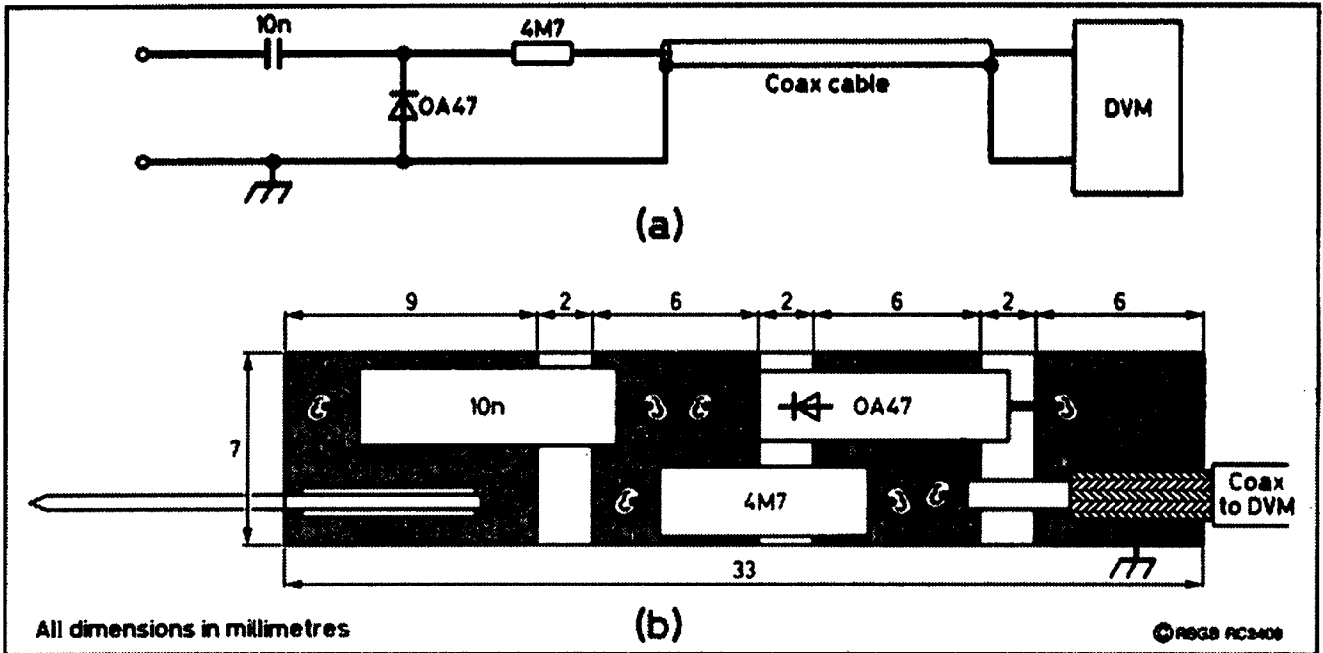


Fig 5. RF Voltmeter Probe.

continued from previous page

should be kept very short to gain the best VHF performance. The circuit board in the original was a piece of single sided laminate with the pads separated using a craft knife.

The circuit board was 7mm by 32mm and the circuit was covered with some heat shrink tubing. The diode used was an OA47 but a general purpose Germanium diode would be suitable. The voltage

characteristic of a Silicon diode is not ideal for this circuit.

June Fox WIA Federal Office is holding the Magazines with the original diagrams etc.

ar

Try This

Make LIPDs work for you

by Wally Watkins VK4DO

Living and maintaining a 2.6ha property has its problems while at the same time trying to monitor an Amateur band when away from the shack.

The answer is a LIPD. The November 98 "Silicon chip" magazine had an article entitled *An FM transmitter for musicians* and is available in kit form.

By leaving the microphone out and connecting the receiver output to the line-in terminals, your new LIPD will bring to life the Amateur band of your choice. Using a

quarter wave vertical, the signal is Q5 anywhere on the property. A small FM receiver is quite adequate.

The kit is easy to build and if you find a clear spot between 88 and 89 MHz the stability is very good. Even inside the house, monitoring while watching TV etc, is no problem.

ar

CONTESTS

Ian Godsil VK3DID,
57 Nepean Highway, Aspendale, 3195

Contest Calendar January 2000 - March 2000

Jan 1/2	Original QRP Contest		
Jan 7-9	Japan International Low Band DX Contest	(CW)	(Dec 99)
Jan 15/16	Summer VHF-UHF Field Day Contest	(CW/SSB)	(Dec 99)
Jan 16	Ross Hull Contest - Final Day		
Jan 16	HA DX CW Contest		
Jan 28-30	CQ WW 160m DX Contest	(CW)	
Jan 29/30	REF CW Contest		(Jan 00)
Feb 5/6	Ten-Ten Winter Party	(SSB)	
Feb 12/13	WW RTTY WPX Contest		
Feb 12	Asia-Pacific Spint	(CW)	(Jan 00)
Feb 19/20	ARRL International DX Contest	(CW)	(Jan 00)
Feb 26/27	RSGB 7 MHZ Contest	(CW)	(Jan 00)
Feb 26/27	REF SSB Contest		(Jan 00)
Feb 26/27	Jock White Field Day NZ	(CW/SSB)	(Jan 00)
Feb 27	High Speed Club CW Contest		
Mar 4/5	ARRL International DX Contest	(SSB)	(Jan 00)
Mar 11/12	RSGB Commonwealth Contest	(CW)	
Mar 18/19	Russian DX Contest	(CW/SSB)	
Mar 25/26	CQ WW WPX Contest	(SSB)	

Thanks this month to UA9CDC F6HJO ARRL NZART JE1JKL VK5OV

SPECIAL NOTE: Please check the Calendar for correct dates of Ross Hull and VHF-UHF Field Days. All dates correct in published Rules.

GREETINGS TO EVERYONE and I hope that the New Year will be a good one for you.

Things are rather quiet on the contesting scene at present, but those really interested can still find some activity almost every weekend.

I particularly ask your support again for the Ross Hull and VHF-UHF Field Day contests. Possibly they will be over when you read this, but even so I trust that you have them in your diaries.

Next on the local scene will be the John Moyle Field Day in March. Here is another excellent opportunity to try VHF - after all, it was the flavour of the month in November/December with some Divisions promoting Awards for operating on the higher frequencies!

Please take the opportunities of quieter times to check through your equipment. Lately there has been an increase in QRP activity on some bands, so perhaps you could give these operators a call and help them on their way.

For some reason the REF Contest details did not appear in December, so I list them here.

73 and good contesting. Ian VK3DID
<vk3did@eudoramail.com>

RESULTS REF CONTEST 1999 CW Section (Call/callscore)

VK2AYD	MO	10175
VK4TT	MO	546

RESULT RUSSIAN DX CONTEST 1999 (Call/band/modescore)

VK4TT	14	SSB	20340
-------	----	-----	-------

RESULTS 1999 AUSTRALASIAN SPRINTS from David VK5OV, Contest Manager

CW (Call/score)

VK2QF	23**	VK3DID/QRP	17*
VK2RJ	19	VK3YE/QRP	10
VK8AV	15		

Phone (Call/score)

VK3IO	43*	VK4JAE/7	24*
VK3DID/QRP	25	VK7JGD	23
VK5PO	46**	VK8AV	16*
VK5NOS	29	ZL3GL	11*
VK5KH	26		
VK5UE	24	SWL Ian McGovern	49*
VK5OV	19		
VK5RV	17		

CONTESTS

continued

REF CONTEST 2000

CW: January 29 - 30

SSB: February 26 - 27

0600z Sat - 1800z Sun

OBJECT: is for foreign stations to work as many French stations as possible once per band.

BANDS: 80m - 10m (no WARC).

CATEGORIES: Single operator; Multi-operator single tx; SWL.

EXCHANGE RS(T) plus serial number. French stations will send RS(T) plus department number.

SCORE: one point for stations in own continent, three points for DX stations.

MULTIPLIERS on each band will be departments, 00 and 99. **FINAL SCORE** is total QSO points X sum of multipliers.

SEND LOGS by 14 March (CW) and 14 APRIL (SSB) to:

REF Contest, BP 7429, 37074 TOURS CEDEX (FRANCE)

ARRL INTERNATIONAL DX CONTEST

CW: 19-20 February

SSB: 4 - 5 March

0000z Saturday - 2400z Sunday

OBJECT: to work as many W/VE stations in as many states and provinces as possible.

BANDS: 160m - 10m (no WARC).

CATEGORIES: Single operator all bands QRP (max. five watts o/p), low power (max 150 watts o/p) or high power (more than 150 watts o/p); single operator single band. [Note: use of spotting nets prohibited in this category.] Single operator assisted; multi-operator single tx, two tx or multi-tx. 10 minutes rule applies to single and two tx.

EXCHANGE: RS(T) plus three-digit number for o/p power. W/VE stations will send RS(T) plus state or province.

SCORE: three points per W/VE QSO.

MULTIPLIER: total number of US states and Canadian Provinces worked per band.

FINAL SCORE is total QSO points X total multipliers.

LOGS must show all information, with multipliers marked at first time of working. Logs with more than 500 entries should include a dupe sheet.

SEND LOGS to: ARRL Contest Branch, 225 Main Street, Newington, CT 06111, USA. Entries may be on paper; on official entry forms; on 3.5 disk in ASCII format; or via e-mail to: <contest@arrl.org>

SUMMARY SHEET with signed disclaimer should accompany each entry.

RSGB 7MHZ CONTEST

26 - 27 February

1500z Sat - 0900 Sun

BAND: 40 metres.

MODE: CW.

CATEGORIES: single operator, multi-operator single tx, SWL.

EXCHANGE: RST plus serial number. UK stations will send RST plus county code.

SCORE 30 points for QSO with UK stations.

MULTIPLIER: each UK county worked.

FINAL SCORE is total QSO points X total multipliers.

SEND LOGS to: Steve Knowles G3UFY, 77 Benson Manor Road, Thornton Heath, Surrey, CR7 7AF, England, by 8 April.

JOCK WHITE FIELD DAY (NZART)

26 - 27 February

0200z - 1100z then 1700z - 2400z Saturday

0000z - 0200z Sunday

OBJECT: VKs to work as many ZL field day stations as possible.

BANDS: 80/40m.

MODES: CW/SSB.

EXCHANGE RS(T) plus serial number. ZLs will send RS(T), serial number and branch number. Stations may be worked once on each mode and band once per hour (total 18 hours).

SCORE: three points per phone QSO, five points per CW QSO.

FINAL SCORE is total QSO points X total number of different branches worked.

SEND LOGS to: Stan White ZL2ST, 19 Rossport Street, Johnsonville, Wellington, NZ, by 24 March, 2000.

ASIA-PACIFIC SPRINT

CW: 12 February

SSB: 10 June

CW: 21 October

1230z - 1430z

BANDS: 40/20m

MAX. POWER: 150w o/p.

CATEGORY: single operator single tx. **EXCHANGE:** RS(T) plus serial number beginning 001. Stations may be worked only once per band.

MULTIPLIER: prefixes per WPX rules once only, not once per band.

FINAL SCORE: total QSOs X multipliers. QSY at least one kHz after each QSO (CW) or 6 kHz (SSB).

SEND LOGS on paper or disk in ASCII format to: James Brooks, 26 Jalan Asas, Singapore 678787 within 7 days. Logs may be sent by e-mail to: <jamesb@pacific.net.sg> within three days.

Mid South Coast Amateur Radio Club Inc NETS

Each Wednesday

*3.617 MHz at 1930 hrs and
146.700 MHz at 2030hrs on our
repeater VK2RMU*

*These nets are run under the club's
callsign VK2HQ*

*Amateur Radio apologises that this information
was omitted from the NETS list in October AR.*

VHF AN UHF EXPANDING WORLD

David K Minchin VK5KK

PO Box 789 Salisbury South Australia 5108

E-mail: technolt@arcom.com.au Web page: <http://www.ozemail.com.au/~technolt>

Fax: +61 8 8234 6396 Phone 0414 808060 (before 2130 EST please)

All times are UTC

Well .. We made it !!

THIS COLUMN MARKS the passing of more than one milestone. Put bluntly, Eric is a hard act to follow! While I have written or compiled a few of the columns over that last 20 years, readers may have to bear with me as I find the groove!

Little is to change. One of the column's main functions is that of reporting what is happening on the VHF and above bands, in various parts of VK. Overseas information is included, where there is some parallel with our own situation.

The printed media has not been the fastest way of communicating since the beginning of our hobby! With the pressure of deadlines, a good 4 weeks can lapse between writing and delivery. This does put some strict guidelines on what goes into the column.

In talking with Eric, during the changeover, some light appeared on what is most important in the column. Magazines do tend to stick around as reference material for a fair part of the active life of an Amateur. Because of this an important role of the column is simply to record a large amount of operating information for future dissection and perhaps posterity.

If you have something of interest, drop me a line. Email is the preferred method as I spend a deal of time in other states. Fax and snail mail are also alternatives.

Six metres into Broome, W.Aust

The Cycle is upon us! If you were planning a move to the northern parts of VK for the next few years to work 6 metre DX, you should already be there! Bill Webber, VK6JQ, Broome (PH12c), has sent in the following report. Bill writes...

Six metres is alive and well again. I have enclosed a list of those heard and worked in Europe up to 25th of November, also Pakistan in Zone 21 and Tajistan in Zone 17.

Those in bold are new countries for me. Up to the beginning of October I had only worked 47 countries in total with only 44 confirmed. My new total is 61 at the end of October with still 44 only confirmed.

VR2XMT said he worked I, OD, 4X, JY and either 9A2 or 9H on 24 October.

This opening (season) has resulted in 92 contacts with 82 stations in 31 Countries (Not including EY8 and AP2 worked 10/10 and 15/10 ... 5KK) over 13 days between 24th OCT. and 18th of Nov. Of the 31 Countries, 14 are new countries on 6 Metres.

The following is an extract from Bill's Log listing stations worked for this equinox as well as some other stations heard. All contacts (mostly on CW) were made using a TS600 - 10 watts to 6-element yagi up 12 metres.

10-10 0653 EY8CQ 579, 0702 EY8MM 559

15-10 0910 AP2WAP 559

16-10 0750 AP2WAP 559

18-10 0747 AP2WAP 539.

24-10 0852 IT9RZR 519 heard, 0903 Z32ZM 539, 0903 IS0QDV 539, 1015 UR2LCV 419 heard, 1122 UR2LCV 419 heard, 1143 SV5BYR 559, 1213 9H1BT 419 heard

25-10 0838 SP2SGZ 52 heard, 0921 SP5XMU 51 heard, 0942 SP6CPH 559, 1000 OM1TW 319 heard, 1005 OM1TLS 559, 1012 SP6ASD 559, 1053 DL6AMI 529 heard, 1056 I0WTD 579, 1100 I07XIV 539, 1104 I0W9CRE 52 heard, 1106 U07JM 539, 1113 EH3ADW 539, 1122 I07MCJ 559, 1128 LZ1JH 529, 1137 9H1EL 549, 1145 SV1DH 599, 1149 SV1AHX 529 heard

26-10 0853 F8OP 529, 0921 HB9QQ 569

27-10 0944 HB9QQ 519 heard, 0946 HB9QQ 579, 0952 HB9QQ 55, 0955 SP4MPI 419 heard, 1000 F4PAN 519, 1013 F1IXQ 53 heard, 1017 I0WIDIM 52 heard, 1019 OE6BMG 419 heard, 1026 F1IXQ 59 heard, 1038 IZ0COK 52 heard, 1048 I8LPR 319 heard, 1132 EH7AGW 319 heard, 1147 EH3ADW 319 heard, 1157 F8VQ 319 heard.

28-10 0718 4X1RF 319 heard, 0731 SM4DHN 529, 0753 SM3EQY 52, 0807 SV1DH 529 heard, 0809 SM0AJU 599, 0843 OZ7DX 51 heard,

0851 SM7BYU 529, 0903 ON4GG 539, 0913 PA0LSB 579, 0916 PA0HIP 589, 0920 ON4AOI 579, 0935 ON4CBA 579, 0940 DK9KX 569, 0946 DJ5JK 549, 0956 DL6AMI 549, 1001S SP4MPB 529, 1007 EH3AR 529, 1014 EH3ADW 539, 1042 CT1EET 52 heard, 1108 F5OVQ 419 heard

29-10 0744 EY8MM 31 heard, 0832 EY8MM 41 heard, 0924 AP2WAP 529 heard, 0946 AP2WAP 529 heard, 1005 F1IXQ 569 heard

31-10 0804 OH2BC 529 heard, 0824 SM7FJE 549, 0828 YU7FU 419 heard,

0835 ER5WU 539, 0858 YU1EU 539, 0918 DL7QY 599, 0925 DL3IAE 569,

0938 DL3RBH 559, 0946 SP2NJE 319 heard.

1-11 0734 SP2NJE 549, 0739 OE2UKL 559, 0746 DL7AV 599, 0753 OE5UAL 57, 0811 SP2NA 529 heard, 0837 SP5EWY 539, 0845 ON1TL 56 heard

2-11 0807 DJ5CL 519 heard, 0809 DF3CB 529 heard, 0858 OM1TL 419 heard, 1044 SP5MPB 319 heard, SM7FJE 519 heard

3-11 0751 UR5W? 219 heard, 0752 F8OP 539, 0758 I02GSO 529, 0813 OH2BC 559, 0820 OH2BC worked 7J6CCU. 0835 OH1TN 539, 0947 YL3AG 559 heard, 0956 DL3DXX 559, 1009 SP5BAK 529

4-11 0841 SM7AED 219 heard only

5-11 0746 OH2BC heard working 9M6JU, 0811 SM6CIU heard working 9M6JU,

0814 PA0HIP 419 heard, 0922 SM7FJE 529 heard

6-11 0732 JY9NX 539, 0825 OM1TL 589, 0840 OM1BM 519 heard, 0857 OM4FF 539, 0904 US5CCO 56, 0907 I04ORY 559 heard, 0917 EH7KW 519 heard, 0926 OE3OKS 519 heard, 1009 Y02IS 529, 1017 Y02DM 539

8-11 0726 U07JM 519 heard, 0732

UR5LZ 519, 0737 OH2BC 599, 0739 Y02IS 599, 0745 OH2BC 589, 0747 ES1CW 559, 0752 5B4FL 539, 0801US4CCD wked VK4APE on SSB, 0816 YL3AG 589, 0856 SP6ASD wked VK2BA, 0858 OZ7DX 56, 0905 HB9QQ 529 heard, 0958 UR5LX 539, 1003 F1MXE 539, 1054 CT1EEB 539.

9-11 0750 US5CCO 319 heard

10-11 0748 IK1YWB 219 heard, 0846 9A8A 529, 0853 S57ACE 539, 0854 9A3HZ 549, 0902 9A7V 579, 0914 S53X 569, 0920 9A1EZA 539, 0926 YT1AU 539, 1004 FIIXQ 569, 1034 EH3ADW 519

12-11 0946 EH3ADW 519 heard

14-11 0721 YU1EU 529, 0738 YU7FU 529, 0743 EY8MM wked VR2LC, 0818 OM3ZDM 579, 0834 OM1BM 569, 0844 OK2BGW 529, 0857 S59A 589, 0908 PA7MH 529, 0915 DK2PH 559, 0935 ON9CFB 539, 0944 DL8YHR 529, 0957 LZ2HM 559, 1001 LZ1KDP 549, 1012 LZ1OP 569, 1030 DL6AMI 529

18-11 1033 PA0HIP 219 heard, 1038 F5HA 529, 1044 ON5SE 519 heard, 1047 F6FRR 529, 1113 JY9NX heard wking VR2LC, 1126 LZ1HM 319 last signal heard from Europe.

Phew! I might stand corrected but is the contact with SP6CPH the first VK to Poland QSO? (Nothing like putting your nose out in the first issue!).

Six metres... Still more!

This equinox just past has resulted in a number of international contacts from VK2,4,6,8. A number of W - VK contacts have occurred and been reported in previous columns the following covers some of the other areas. The southern states will all be praying for a good autumn equinox!

17/10, David Vitek, Parkholme SA reported on MUF variations through October Showing peaks from 0415 - 0510 with 49.750 plus 746, 755, 758 offsets and JA7 & JA8 into Adelaide around the same time. MUF to USA path barely above 35 MHz through the whole period till November with Asian MUF rising to 40 MHz on occasion. Looks like VK5 has a way to go yet!

31/10 VK4FNQ worked YU7FU, YUIEO & YO4AUL as well as F5JKK, Overseas, Europe had its first extensive South American opening on 12/10 perhaps the best since 2/11/1991...G4UPS 6 Metre Information.

11/11, John VK4KK, Brisbane noted an opening to Italy commencing around 0754. Des VK4DMI was the first to hear the Italian stations and alerted John. VK4KK worked IZ5EME, IK5YJY and IW0GPN, all around 5x5. Main signals to alert for

European openings are the video to be found on 48.238, 48.250 and 48.280 with the first the main one. Several others in the Brisbane area also worked. Brisbane boys also recently worked TI5 and HP2 one morning. 11/11, Don VK6HK, Perth, also worked into Europe around 1000, no further details than that F, DL, ON, OZ, PA, SP was worked from the Perth area.

2/12, Rex VK7MO reports ... *6 Metres was open to JA from VK7 from 0330 to 0420 UTC.*

Emil Pocock, W3EP reports ... *Surely some of the most exotic and exciting DX news of the month came from Asia, thanks especially to Hatsuo Yoshida, JA1VOK. He reports that JR6DGU, JR6HI, 7J6CCU, and others in the Ryukyus (the southern most of the Japanese islands) continued to lead their way. Their catches for the month included 5R8GJ (Madagascar), 7Q7RM (Malawi), 9USD Burundi, AP3WAP (Pakistan), EY8MM (Tajikistan), and UU7JM (Ukraine). JR6HI heard 2D8VHF/b on October 6 around 0100.*

Japanese in most of the rest of the remaining call areas had to make do with S21ZE (Bangladesh), 9VIUV (Singapore), BV2DP (China), FOØKOJ, A35SO, and ZP5CW (Paraguay). Other Asian stations made incredible contacts. BV2DP worked VQ9DX (Chagos), VK8MS, and KHØ/JK3HLP (Marianas), along with many Japanese, on October 1. VR2XMT (Hong Kong) logged PYØFM, AP2WAP, EY8MM, FRIGZ, 5R8GJ, 9VIUV, SV5BYR, 4X1RF, OD5SX, JY9NX, SV1DH, and two 9H (Malta) during the month.

In addition to Japan and Hong Kong, EY8MM worked 5B4FL (Cyprus), JY9NX, 4S7 (Sri Lanka), 9M2TO (West Malaysia), and DU (Philippines) on October 8 and 9. S21ZE ran 434 JAs in all call areas save JA8, BV, VR2, HL, KHØ, and V7 between October 14 and 18. Finally, YJØDX (Vanuatu) made a long-path contact with TZ6VV (Mali) on October 30 at 2121. There was a lone report of a US contact with East Asia. Erik Dean, N6XP (DM06), made an unusual southerly skewed-path contact with JA9CGR on October 18 at 0142

YO4AUL logged a series of notable contacts with VK4ABW, VK4BW, and VK4FNQ... thanks to W3EP & QST.

VHF-UHF Pioneer Paul M. Wilson, W4HHK, Silent Key

The following bulletin was received from the ARRL via W1AW

VHF-UHF pioneer Paul Wilson, W4HHK, of Collierville, Tennessee, died November 29. He was 75.

A stalwart in the 144-MHz and Microwave Standings, Wilson remained active right up until his health deteriorated earlier this year. In early July, he completed his VUCC on 10 GHz. He celebrated his

75th birthday in September by making his first contact on 24 GHz. "Paul's life should inspire every amateur to strive to always try something new in Amateur Radio, regardless of age or health," said ARRL Vice President Joel Harrison, W5ZN—a friend of Wilson's. "He has definitely been an example for me."

Wilson got his ham ticket in 1941 at the age of 16. While still in high school, he began experimenting on the old 2-1/2 meter band (112 MHz). After World War II, he rekindled his interest in VHF and UHF, becoming a major figure on the then-new 2-meter band.

During the 1950s, he got involved in meteor scatter propagation. In 1954, W4HHK and Tommy Thomas, W2UK in New Jersey sent and received reports via 2-meter meteor scatter over a 950-mile (1520 km) path—a first! W4HHK and W2UK won the ARRL Technical Merit Award for 1955.

Wilson took on the challenge of Earth-Moon-Earth propagation as well, and in 1961 he began work on an 18-foot dish. He was among those making their first 70-cm EME contacts in July 1965. From that frontier, he moved on to attempt 2304 MHz moonbounce, and he won the ARRL Technical Merit Award for 1969 for his work on that band. In 1970, W4HHK and W3GKP claimed a new record—the first 2304-MHz EME contact.

In 1972, Wilson used his 18-foot dish to monitor the Apollo X command module on 2.2 GHz as the astronauts orbited the moon. He received a NASA confirmation of his reports in the form of a photograph signed by all the astronauts on the mission.

Noted VHF-UHFer Al Ward, W5LUA, called Wilson "a true VHF pioneer and said he would be missed. "Paul's signal on 2304 EME was like a beacon station, and his presence will be missed by all who have worked him in the last 29 years off the moon," Ward said.

Wilson retired in 1980 after 30 years as an engineer for TV station WMC in Memphis. His wife "DB"—to whom he was married for 54 years—is W4UDQ. His son, Steven, is N4HHK.

A staunch League supporter and ARRL Technical Adviser, Wilson was frequently in the pages of QST over the years—both as an author and as a subject. In his December 1999 QST "It Seems to Us . . ." editorial, ARRL Executive Vice President David Sumner, K1ZZ, singled out Wilson as an Amateur Radio hero for his pioneering accomplishments.

The Central States VHF Society awarded Wilson its Chambers Award in 1986 for "his continuing technical contributions to UHF, especially EME on 13cm."

... QST de W1AW

Esperance 2 metre Beacon
Wally, VK6KZ writes ... *Bill (VK6AS) put the beacon back on air on Friday 12 November with the new antenna and new coax. Hasn't been heard here - yet - but conditions to Esperance only fair last couple of days....* VK6KZ Wally also indicated that the Albany beacon is on the air but has still not been heard in Perth. It certainly has not been heard in VK3/5 for well over a year now! There are some discussions about the possibility of moving the beacon to Mt. Barker, 50Km north of Albany.

Summer VHF-UHF Field Day 2000

John Martin VK3KWA, contest manager, reminds us that the next Summer VHF-UHF Field Day will take place on January 15 and 16, 2000. The contest rules are the same as for the 1999 Spring Field Day. Please note the couple of minor changes that were discussed in more detail on page 48 of October 1999 "Amateur Radio".

The next Field Day should provide plenty of opportunities. It will take place over the last weekend of the Ross Hull Contest, so there will be extra home stations there to work. And if you live in Tasmania or anywhere within reach of it, remember that any Field Day contacts can be counted for the new George Bass Diploma offered by WIA Victoria.

Duration: VK6 only: 0400 UTC Saturday January 15 to 0400 UTC Sunday January 16, 2000. All other call areas: 0100 UTC Saturday to 0100 UTC Sunday.

The Contest is split into the usual Four Sections

A: Portable station, single operator, 24 hrs.

B: Portable station, single operator, any 6 consecutive hours.

C: Portable station, multiple operator, 24 hrs.

D: Home station, 24 hrs.

Single operator stations may enter both Section A and Section B.

If the winner of Section A has also entered Section B, his log will be excluded from Section B.

Logs must be received by Monday, February 14, 2000. Early logs would be appreciated. Logs may be posted to: WIA VHF-UHF Field Day Manager, 3 Vernal Avenue, Mitcham, Vic 3132. Logs may also be e-mailed (in ASCII text form ONLY) to jmartin@xcel.net.au.

Second Weekend ARRL EME Contest

Mike, VK2FLR was active during the 27/28th of November "Second Weekend" ARRL EME Contest. Mike made contact

with the following stations W0HP, OZ1HNE, DL5MAE, DL7MAT, I3DLI, SM2BYA, PA2CHR, DK3BU, IK1MTZ, K6MYC, VE3KH, DJ6FU, DL5MN, DJ7OF.

Mike writes ... *Missed N2WK, 9A4FW, (heard me but I couldn't hear them), F6BSJ (couldn't quite get the correct call), G3ZIG (loud here Roger, but you were not responding to my report), EA3DXU (not strong and ran out of time).*

Did not hear VE2JWH, VE1ZJ, W0PT, PE1LWT, IZ5EME, WB4JEM, and GD4IOM.

High local noise in my North American window on the first pass made copy almost impossible; much better on the second pass, but still no luck with the Canadian Maritimes - not enough moon elevation here to get out of the local noise field.

Polarity seemed to be moving rapidly all weekend, giving me brief periods of pile-up conditions. My apologies to those who called without a reply.

I will be open for skeds for the next couple of weeks, outside 1700-2200 UTC, ... VK2FLR

TROPO DX from VK3 - VK7

The events of the 29th and 30th of November showed some extraordinary Tropospheric conditions from VK3 - VK7. The following reports summarize the opening.

Barry, VK3BJM writes ... *Conditions were satisfactory (!) again last night over Bass Strait. I missed Sunday nights' activity (finishing installing new deep-cycle battery in the vehicle), so I was pleased to be on last night.*

At about 1015z (29/11/99) David, VK7DC, in Burnie (QE28), appeared on 144.1.

Having QSY'ed to 144.12, he was subsequently worked to death by VK3's XPD, KEG, BJM, TMP, CAT, AXH, KAI/p, WRE/p, YB, WR, GK, KAS, GRL, JEG, YE/p, AFW, KLO, KWA/p, DUT, JED/p, HY, DUQ, AL, CAT/m, BFW, KAB, XLD, and BRZ. 27 stations in one sitting.

Not content with that, David was persuaded to hook up his 70cm station, on which band he was worked by VK3's BJM, TMP, AFW, XPD, KAI/p, WRE/p, HY, DUT, KAB, BDL, BRZ, AL, and XLD.

David was using an IC-202 into a 12el yagi on 2m; I missed what David was using on 70cm, but I believe he was using a bay of 4 yagis, antenna-wise. Most reports were 5x9 + a lot, on both bands. Several QRP stations made contacts on 2m, VK3's YE/p (2.5w), JED/p (1w in S/wave held horizontal), and KWA/pedestrian mobile, IC-202 with 1/4 wave whip.

Max, VK7KY appeared later on and was worked by VK3's BRZ, XLD and BJM, on 144.12. ... VK3BJM

Ron VK3AFW writes ... *Peter, VK7ZPB, on Flinders Is. was also worked by VK3AFW, VK3KLO and VK3BDL on 6m, 2m and 70 cm SSB last night (29/11/99). He was worked by several others on 2m. VK7RAE beacons on these three bands were all good copy last night. Signals were down this morning. Andrew, VK7XR, was just 5x9 on 2m. ... VK3AFW*

2 Metre TEP USA to South America

22/11 Ed WP4O ... worked CX9AF, CX9DX, CX1DIO, LW9EVS, LU7DJZ, LU9EUE and LU9AS all on 144 MHz with signals ranging from 53 to 59 plus 10db.

Microwaves and Above

This little segment will find its legs over the next few months. It has been a pet area of mine since 1976, and perhaps has been my main, perhaps only area of activity for the last 10 years!

We are now seeing pockets of activity growing in all mainland states with perhaps 10 Ghz being the most popular. Each month I will report on the various activities across the Country as well as some help for newcomers on where to look to get started. Over the next few months I will be gathering a "Microwave Activity List" for each state. If you want your details on the list, please send in call sign plus band(s) and etc equipment details.

In Closing

Gareth, VK1ANF has just returned from Vietnam ... *Just a brief note to say that I've just returned from several weeks in Hanoi, Vietnam, and noticed a number of taxis there with Kenwood 2 metre FM transceivers fitted. It's my understanding they use the transceivers to talk to their base. The frequencies I saw used were 147.350 and 147.450 MHz, and could explain some of the strange things we hear down under on 2 metres at certain times of the year ... VK1ANF*

That's it for this month. A lot of 6 Metre information after the Spring Equinox, with some luck the 2M and above bands will be more in focus over the summer months.

Lastly, Eric VK5LP has sent in a couple of items that are perhaps appropriate for this part of the column...

1. The Cure for boredom is curiosity.
There is no cure for curiosity!
2. Middle age is when you know all the answers and nobody ever asks you the questions.
73's David VK5KK

SPOTLIGHT ON SWLING

by **Robin L. Harwood VK7RH**
5 Helen Street, Newstead Tasmania 7250
(03) 6344 2324
E-mail: robroy@tassle.net.au

Welcome to the New Millennium!

Yes the year 2000 has finally rolled around and the Third Millenium has been born yet technically speaking the 21st. Century does not start until midnight on the 31st of December of this year. Commercial interests have hoodwinked us into thinking the 20th Century has finished, yet the local newspaper published details of New Year's celebrations in December 1899, mentioning that the celebrations 12 months hence would see the birth of a new century.

OF COURSE, BY NOW we will know if the Y2K millenium bug will cause the havoc and inconvenience predicted by some. Many agencies have been planning for any contingencies that may arise and have been primarily relying on HF communications, in case the satellite communications are down or disabled. They have been using voice or analogue systems instead of data.

I know that the American Federal Emergency Management Agency (FEMA) will be running several nets around 5.2 MHz and between 10.3 to 10.5 MHz during the final week of December and beyond into

January. The Canadians will also have an emergency Y2K communications network in case of any difficulties probably inter-linking with the FEMA network. The US Coastguard even requested the assistance of some radio amateurs over the same period, in case there were communication difficulties.

It is difficult anticipating what changes will happen over this year and into the 21st.Century. I expect some stations will undertake experimental digital broadcasts over HF. However there is no agreement over what standards are going to be employed because the Americans and Europeans have non-compatible systems, which is a disincentive to the mass production of suitable receivers or decoders. The use of SSB is to be phased in by 2015, yet more efficient technologies are being rapidly developed which could render SSB redundant. I do expect that a uniform digital system could emerge and quickly be implemented, yet analogue modes will continue because developments will be slower in some regions, such as south Asia or in Africa.

The increasing trend is for many international broadcasters to stream their output on to the Internet on various digital platforms such as Real Audio or MP3. This already has led the decline of broadcasts targeting Europe, North and South America and parts of Asia. However the number of simultaneous contacts over the Internet are limited by bandwidth at present to the hundreds, compared to the countless millions who readily access signals over either domestic or international radio. Also audio streaming over the Net, although possessing superior fidelity, can often drop out due to net congestion and insufficient bandwidth capacity.

Several meetings are held prior to the two major periods, coinciding with the adjustment of summer and winter times.

These are held to help broadcasters coordinate frequency planning, thus minimizing clashes. In reality this coordination process has been restricted to regional areas such as Europe and North America, with the inevitable clashes.

Early in November, Radio Netherlands in Hilversum found that their Bonaire transmissions to Australasia on 9820 kHz were being interfered by two stations. One was religious broadcaster, KTWR in Guam and the other was in China and both were broadcasting in Chinese. To complicate matters, a rather wayward Vietnamese sender also drifted on to the channel, causing a severe heterodyne. After being alerted by Australian and NZ listeners to this unsatisfactory state of affairs, Radio Netherlands shifted to 9790 kHz. This is a clear channel. Ironically, both the wayward Vietnamese and one of the Chinese speaking stations also have been quiet since the move. I also have noted another bad frequency clash between China Radio International and Radio Tashkent in Uzbekistan both targeting identical areas in English, on an adjacent channel.

I have been observing low-powered unofficial broadcasting stations. late at night between 3.7 and 3.8 MHz. Their frequency stability varies with the modulation, although nominally on AM. Their audio quality often is very poor. Tune around 1200 UTC on a good night when the summer atmospheric conditions are not too bad and you will easily hear them, despite their erratic status.

All the best for 2000 and hope that you will not have any glitches to your system.

Keep listening and 73-
Robin L. Harwood

ar

Have you tried

**DXing, microwaves,
CW, high speed data,
ATV, operating portable,
slow scan TV, QRP,
contesting,
homebrewing,
AM, UHF,
packet radio,
foxhunting,
building repeaters,
JOTA,
160 metres
or
publicising amateur
radio?**

**Write about it and send it
to *Amateur Radio* - the
magazine which covers
more facets of amateur
radio than any other.**

REPEATER LINK

Will McGhie VK6UU

21 Waterloo Cr. Lesmurdie 6076

will2@omen.net.au

rslt VK6UU@VK6BBR

Problems with pirates on 10 metre band

Feedback

Robert McKnight VK2MT took the time to E-mail me his comments regarding the operation of the Wollongong 10 metre repeater. Robert's comments were prompted by a reference made by Jack, VK2GJH, in a recent article in Repeater Link. Robert also promised an article about the trials of maintaining a repeater for a later article in Repeater Link.

VK2MT

Regarding Jack's (VK2GJH) comments about the perceived performance of our 29.620 Repeater, VK2RUW in Wollongong: I have to wonder what repeater he actually WAS accessing on 29.620MHz. Our repeater has largely been off air for the past year, apart from a few hours. This has been due to the large amount of pirate activity from the North. To see all the effort largely wasted due to this pirate activity is difficult to accept. For your information some history of the 10 metre repeater VK2RUW.

During the last Solar Cycle, our Club built our original 10m repeater. It was based on a modified Cybernet AM CB with Handheld UHF Tamaphones used for the link between the receive and transmit sites. It also ran a "Legs Lincoln" Amplifier. It was primitive, but it worked well. When that Cycle died away, our Club decided that as a long-term project, we would re-build and improve (based on previous experience) the 10metre Repeater in readiness for the next Solar Cycle. We procured 2 G-Band 828s (rare as hen's teeth), modified them, swapped receiver boards with a U-bander (toprovide site linking), built voice idents and DTMF controller, all inpreparation for this current Solar Cycle.

Now that the Solar Cycle has arrived,

what do we hear on 29.520MHz the moment there is a slight lift in conditions – endless chitter chatter from our north. I have been using both the 10 and 11m bands since 1976, through a few solar cycles and I've never heard the pirate activity this bad. What can we do about? Not much, the horse has well and truly bolted. Intruder Watch may be able to help with the other HF Bands, but the huge amount of pirates on our 10m band is staggering. These countries don't care less about any complaints from down-under.

For your interest, Australia is not alone in this pirate problem. I have had some very interesting repeater contacts and E-mail with Roger W1OJ who runs a 29.620 repeater in Boston. We compared notes about many things regarding repeaters. For instance, Roger's repeater runs 1kW output at 100% duty cycle! The system runs 2 receivers with GaAs FET pre-amps at both sites; the best received signal is selected at the transmitter site– not a bad system!

The Boston repeater is plagued with pirate stations on their receiver inputs, but their problems emanate from South America, from taxi drivers & resort islands etc. Interestingly, each of our relevant pirate problems originates from the opposite side of the equator, an obviously easy path for 10m signals.

As I said earlier, the current pirate problem is the worst I've ever heard it. We've been looking forward to this coming solar cycle for ages to get our new 10 metre repeater "pumping" with activity, but now it's here, it's looking like being a dead loss, for repeater operators anyway. Obviously, individual 10 metre users can tune around till they find a free frequency, but repeater inputs aren't quite so frequency flexible.

What's the answer? I guess "populate or perish" may help. The more of us on 10

metres, maybe the less of them. Hopefully they'll just move elsewhere, maybe onto 11 metres. But as there is so many more 11 metre operators than 10 metre Amateurs, it will need a big increase on our behalf to convince the pirates to move off the relatively quiet 10m band.

Another answer is putting CTCSS on our 10m repeater receivers to stop the non-legitimate users, but this will of course effectively stop 95% of the legitimate users as well.

The only way I can see of getting some interference-free enjoyment from this Solar Cycle, is for us all to hop on a central frequency such as 29.120MHz and link our 2m and 70cm repeaters via 10 metre Gateways. If all the Gateways ran both CTCSS encode and decode, to protect our local users from listening to the pirate activity, they would only ever hear the other Gateways and of course any individual HF users who have CTCSS encode on their rigs.

The idea of a number of Gateways in Australia all operating on the same frequency is a great idea. If each VK call area had such a system, all on the same frequency, and linked when propagation allowed, just think of the fun that could be had

Setting up a simplex Gateway is that much simpler compared to a duplex repeater. This is not to say we don't still encourage the building and using of 10 metres repeaters in Australia, but numerous Gateways would certainly be a step in the right direction for getting more users onto 10 metres and hopefully start to push the pirates away.

What to do?

Thank you Robert for the information on the Wollongong 10 metre repeater and the pirate problems on 10 metres. Just what can

REPEATER LINK

continued

we do to make life difficult for the pirate activity on our 10-metre band? Difficult from the point of view of making the band less attractive for pirates. The pirates are here to stay as far as I believe. There is just so much activity that we could not change the situation at all. However perhaps we can salvage some use of the 10-metre band.

In terms of the FM segments on 10 metres, gateway linking offers one small avenue for operation that could make life difficult for pirate activity. As Robert suggested, link VHF/UHF repeaters via 10

metres, and encode the 10 metre links with CTCSS. This greatly limits the effect pirate activity has on the 10 metre linking frequency. 10metres is put to one type of use that is a lot of innovative amateur radio fun, increases activity and hopefully makes life just that little bit more difficult for the illegal operators.

Not Legal

The pirate activity on 10 metres is not legal and neither is linking on 10 metres. Until we change this regulation it is not

legal to link repeaters via 10 metres.

How we change this regulation is a frustrating time consuming effort. Having been involved over many years to try and bring about real change in repeater regulations in Australia, all I can say, is there any young keen amateur willing to put in many hours of bureaucratic back and forth? Be prepared for a long tussle over probably many years. If so let me know and I will pass on what I have learnt, perhaps mistakenly learnt, over the years, for what it may be worth.

2000 technology: friend or foe?

When I started to write this month's article I hit the "save as" icon and I typed in the name "jan-00". This is the first time I have used the 00 to represent the year 2000. Having passed my 50th birthday and having been involved in amateur radio since my early twenties, this is an interesting time to reflect on what changes I have seen in this 30 years.

TECHNOLOGY IS the number one change. We operate amateur equipment that was not even thought of, or could be thought of some 30 years ago. Valves still dominated the amateur radio scene 30 years ago. Guessing the future of amateur radio in terms of the technology is impossible, but digital would appear to be the future.

The declining lack of amateur numbers is one area that we would not have predicted 30 years ago. It was always assumed that our numbers would steadily rise. In fact one reason for having an amateur exam was to restrict numbers, as we all assumed that one day there would just not be enough spectrum space, particularly on our HF bands. We sure got that one wrong. And the surprising point is that technology killed off our numbers. It gave us better radios, but it also gave young people more options in the technology field, and many of these prospective young amateurs moved into computers, the Internet and many other technological activities, but not amateur radio.

Regulations are the number one little change over the past 30 years. Attitudes have changed somewhat but we are still tied by Government regulators, and I believe to our disadvantage. However I will say the

regulatory body, the ACA has changed greatly over the past 30 years. With reduced staff numbers and a more customer focussed direction, the regulator is hardly recognizable from 30 years ago. There is big money and community expectation in spectrum, and the ACA have a big job keeping up with technology and community and business needs.

Amateur radio is way down the list, and as a hobby activity amateur radio can expect little more. But as we have been shunted down the list of importance, what should have changed is the amount and complexity of amateur regulations. We should be self-regulating but we are not. Self-regulation has been talked about but that is all. We are still completely over-regulated and I see little reason to believe it will change. It can

This is rather strange that a technological hobby be threatened in some way by its very technology.

actually eventuate that in an attempt to reduce regulation, we actually end up with more. Until a real attempt is made to reduce the complexity of regulation in the amateur service, amateur radio will suffer. Voice repeaters regulations reflect this situation and we seem largely powerless to bring about change, real change, not just increase the number of allowed repeaters from 3 to

4, but real change, meaning no limit.

In conclusion the year 2000 is just another year. But it is an interesting number that provides a point of reference and thought about amateur radio past and present. I have seen incredible changes in technology, but in some ways to the detriment of amateur radio. This is rather strange that a technological hobby be threatened in some way by its very technology. Being able to talk to someone across town or on the other side of the World has no where near the awe it did 30 years ago. People of all ages, and in particular the young, do it at the click of a mouse button on the Internet. What will amateur radio be like in 30 years from now? Will we still have the same limiting voice repeater regulations we have today? Voice repeaters started in Australia a little over 30 years ago, will there still be voice repeaters, as we know them 30 years from now?

These are some of my thoughts for the year 2000 and amateur radio.

ar

**Amateur
Radio**
Supporting the
community



RMB 1627 Milawa Vic. 3678 Email: vk3jt@amsat.org

Currently Operational Amateur Radio Satellites

THIS LIST is compiled from a variety of sources with a high reliance on AMSAT News Service bulletins as well as personal operating experience and information gleaned from discussions on the AMSAT-VK net and the AMSAT-NA bulletin board on the Internet. It is as comprehensive and up to date as copy deadline dates will allow. A good source of up to the minute information is the AMSAT world-wide-web site. Due to the dynamic nature of the amateur radio satellite scene, readers are urged to check all information against this source, particularly if tooling-up for new satellites, modes or frequencies. The list is updated in this column twice each year in January and in July. Its purpose is to assist those who may not have access to more immediate sources of information.

RS-13

Uplink 21.260 to 21.300 MHz CW/SSB
 Uplink 145.960 to 146.000 MHz CW/SSB
 Downlink 29.460 to 29.500 MHz CW/SSB
 Downlink 145.960 to 146.000 MHz CW/SSB
 Beacon 29.458 MHz
 Robot Uplink 145.840 MHz
 Robot Downlink 29.504 MHz
 Operational, in mode-KA with a 10-metre downlink and a 15-metre and 2-metre uplink.

For some months the RS-13 transponder has been acting in an unpredictable fashion. Early in December the situation improved and at last reports it had returned to normal operation.

RS-15

Uplink 145.858 to 145.898 MHz CW/SSB
 Downlink 29.354 to 29.394 MHz CW/SSB
 Beacon 29.352 MHz (intermittent)
 SSB meeting frequency 29.380 MHz (unofficial)
 Semi-operational, mode-A, using a 2-metre uplink and a 10-metre downlink.

AO-10

Uplink 435.030 to 435.180 MHz CW/LSB

Downlink 145.975 to 145.825 MHz CW/USB

Beacon 145.810 MHz (unmodulated carrier)

Semi-operational, mode-B.

AO-10 has been locked into a 70-cm uplink and a 2-metre downlink for several years and can be used when the beacon signal is NOT FM-ing. Signal throughput can be very strong when the satellite is close in, but it can be frustrating to battle the deep fades and low signal strength when it is out around apogee.

AO-27

Uplink 145.850 MHz FM
 Downlink 436.795 MHz FM
 Operational, mode J.

AO-27 uses a method called Timed Eclipse Power Regulation (TEPR) to regulate the on-board batteries. In simple terms, TEPR times how long the satellite has been in an eclipse (or in the sun) and decides what subsystems to turn on or off. I have still not received any reports of AO-27 being turned on over Australia.

National co-ordinator:

Graham Ratcliff VK5AGR
 Email: vk5agr@amsat.org

AMSAT Australia net:

The AMSAT-Australia net is held on 60 or 40 meters LSB (Lower Side Band) each Sunday evening (except over the Christmas/New Year period). During the winter months in South Australia (end of March until the end of October) the net is on 3.685 MHz +/- QRM with an official start time 10.00 UTC with early check-ins at 09.45 UTC.

During the summer months when daylight saving is in operation in South Australia (end of October until end of March) the net is on 7.068 MHz +/- QRM with an official start time of 09.00 UTC with early check-ins at 08.45 UTC. The times and frequencies have been chosen as the best compromise for an Australia-wide net taking into consideration seasonal propagation changes and the various state summer time variations.

AMSAT Australia newsletter and software service:

The newsletter is published monthly by Graham VK5AGR. Subscription is \$30 for Australia, \$35 for New Zealand and \$40 for other countries by AIRMAIL. It is payable to AMSAT Australia addressed as follows:

AMSAT Australia
 GPO Box 2141
 Adelaide SA 5001

Keplerian Elements.

Current keps are available from the Internet by accessing the AMSAT FTP site, ftp.amsat.org and following the sub-directories to "KEPS".

FO-20

Uplink 145.900 to 146.000 MHz CW/LSB
 Downlink 435.800 to 435.900 MHz CW/USB

Operational. FO-20 is in mode JA continuously.

FO-29

Voice/CW Mode JA
 Uplink 145.900 to 146.000 MHz CW/LSB
 Downlink 435.800 to 435.900 MHz CW/USB

Semi-operational, rotated with digital mode and digi-talker.

Digital Mode JD

Uplink 145.850 145.870 145.910 MHz FM
 Downlink 435.910 MHz FM 9600 baud
 BPSK

Digitaltalker 435.910 MHz

Semi-operational, rotated with analog mode and digi-talker. The transponder schedule is likely to change with too short notice to print any meaningful data here.

KO-23

Uplink 145.900 MHz FM 9600 baud FSK
Downlink 435.175 MHz FM

Non-operational at the time of writing. This could change at any time however as we have enjoyed periods of re-activation by the control stations as battery conditions allow.

KO-25

Uplink 145.980 MHz FM 9600 baud FSK
Downlink 436.500 MHz FM

Operational and carrying the main load of 9600 baud BBS traffic.

UO-22

Uplink 145.900or145.975 MHz FM
9600baud FSK
Downlink 435.120 MHz FM

Operational and carrying the main load of satgate traffic with quite a lot of BBS traffic as well since KO-23 has been unreliable.

UO-11

Downlink 145.825 MHz FM, 1200 baud
AFSK
Mode-S Beacon 2401.500 MHz

Operational.

The operating schedule is unchanged.

ASCII status (210 seconds)
ASCII bulletin (60 seconds)
BINARY SEU record (30 seconds)
ASCII TLM frames (90 seconds)
ASCII WOD whole-orbit-data (120 seconds)

ASCII bulletin (60 seconds)
BINARY ENG data (30 seconds)
The ASCII bulletin is currently a static message, detailing modes and frequencies of all active amateur radio satellites.

AO-16

Uplink 145.90 145.92 145.94 145.86 MHz
FM using 1200 baud Manchester FSK
Downlink 437.0513 MHz SSB RC-BPSK
1200 baud PSK
Mode-S Beacon 2401.1428 MHz

Operational but the beacon is sometimes turned off.

AO-16 has operated continuously for over 1,800 days since its last software reload.

LO-19

Uplink 145.84 145.86 145.88 145.90 MHz
FM using 1200 baud Manchester FSK
Downlink 437.125 MHz SSB RC-BPSK
1200 baud PSK

Currently semi-operational. No BBS service. The digipeater is active.

TO-31

Uplink 145.925 MHz 9600 baud FSK
Downlink 436.925 MHz 9600 baud FSK

Operational

ProcMail V2.00G has been released by G7UPN. This software permits the processing of image files from TO-31. It has been posted to the AMSAT-NA FTP site.

PO-34

New technology satellite using spread-spectrum techniques. It has not yet been fully commissioned.

SO-35

Semi-operational to a published schedule, usually a month ahead. SunSat has been in mode-B using an uplink of 436.291 MHz (+/- doppler) and a 145.825 MHz downlink. Many stations can be heard at week-ends working via SunSat. Although some mobile and hand-held portable contacts have been made, those who do best are stations equipped with auto-track antennas and auto-doppler compensation. The doppler compensation is particularly important on the 70cm uplink.

UO-36

Downlinks
437.025 MHz
437.400 MHz

UO-36 carries a number of imaging payloads, digital store-and-forward communications and mode L/S transponders. The satellite is not currently available for general uplink transmissions. S-band high speed downlink commissioning continues at rates between 128kb/s and 1Mb/s. The S-band downlink frequency has not been announced. The VK5HI/TMSAT viewer shareware is available on the AMSAT-NA web site.

IO-26

Uplink 145.875 145.900 145.925 145.950
MHz FM 1200 baud
Downlink 435.822 MHz SSB
Semi-operational, digipeater function is 'on'.

GO-32

Downlink 435.225 MHz using HDLC
telemetry.
GO-32 is still undergoing tests prior to being opened for general use.

MIR Space Station

Ham radio activity aboard the Mir space station came to a close on August 28, 1999 as the crew returned to Earth, leaving the station unmanned. The date for re-manning of MIR keeps slipping forward and the reports as to re-activation of the amateur radio equipment also seem to change from time to time. Keep watching as the current reports indicate that there may be a short period of activity around May before MIR is sent down into the Pacific Ocean.

Using InstantTrack (version 1) into the new Millennium.

The version 1 edition of the InstantTrack program had for a long time been assumed to be incompatible with dates from 2000 onwards. In fact the program itself is quite compatible. A problem does arise however when loading kep elements with "00" in the year field and NASA had for some time signaled its intention to adopt that date format into the new millennium. A rather clever way out of this situation emerged late in 1999. John, F6HCC produced a utility program based on a "kep-converter" utility that had been around for some time. The kep converter, called 2LIN2KEP.BAS was originally written in basic by G3RWL. It took a set of kep elements in NASA format and converted them into AMSAT format. Some folks, indeed some software preferred this verbose format where all the individual elements could be read as text so their real values were much more apparent than in NASA format. John's clever idea was to take this utility and include some code, which would add 100 to the year field. In this way InstantTrack would read the year as progressing from 19-ninety-nine to 19-one-hundred which of course is in effect 2000. Most people will have caught up with this utility by now but if you want a copy, contact Graham vk5agr at the AMSAT-VK address above. Please send either a formatted 1.44 Mb floppy and return postage or sufficient donation to cover copying and return mailing. The utility is called 2L2ITKE.EXE. At the time of writing we are all still eagerly awaiting the new version 1.5 of InstantTrack which will include a new range of features and of course will be 2000 compatible.

Amateur Radio Pico-Satellites launch delay

The October launch date for JAWSAT stretched out to December and at the time of writing stands at late January. When launched, JAWSAT will separate into two smaller packages, ASUSAT and OPAL. Then two amateur radio pico-satellites will separate from OPAL to become StenSat and MSAT-1. These incredibly small devices are about the size of a packet TNC and could easily point the way to the future of low-cost amateur satellite packages. Those stations equipped for the 9600 baud digital birds will be able to take part in the ASUSAT experiment by copying telemetry from the new satellite after launch and sending it to the control teams for analysis. This entire project is a joint effort involving 3 American universities.

ar



Ron Graham VK4BRG
PO Box 323 Sarina Qld 4737

ARDF or anti-ARDF?...That is the question.

OVER THE LAST FEW MONTHS I have been experimenting with what could be considered anti-ARDF. Instead of having to find the location of a hidden transmitter, this system "tells" the location of its associated transmitter. This system is called Automatic Position Reporting System (APRS). Amateurs are using it, principally, to indicate the position of their home station or their mobile. Commercial usage is abundant with some examples being indicating the position of emergency vehicles, tracking valuable cargo and stolen vehicles, monitoring the positions of marine buoys, in the later generation of emergency beacons (thus enabling them to be found more quickly), even in the loco's hauling sugar cane in this area, etc.

What is APRS?

APRS is a system that automatically transmits, at pre-determined intervals, a (generally moving) object's position. That position may be received by an APRS equipped station, which on its computer screen is displaying a map of the area of interest. The transmitting station's position is indicated on that map together with information to identify that particular station. Naturally, the system can display the position of a large number of transmitting stations (objects) at the one time.

Thus one should be able to relate how APRS is used in the applications mentioned above, plus, hopefully envisage some other applications that could benefit the amateur radio fraternity.

Personnel on the moving object (or vehicle) may, with normally a lap top computer, also view a map showing their own position and the positions of the other participating stations. This is another application in addition to the home based central location.

Equipment needed

Transmitting Station

The position is normally derived from a GPS receiver. That digital positional information (normally in NMEA format) is fed into an interface unit which converts it into audio tones .. actually standard 1200 baud AX25 packet. The audio is fed into a suitable transmitter and the information

broadcast as unconnected UI packet information to all stations.

Thus one needs a suitable GPS, interface unit and transmitter.

Receiving Station

This consists of a suitable receiver feeding audio into a standard packet TNC. The digital signal from the TNC is fed to a computer that is running an APRS programme. That program accesses the map of interest and is capable of manipulating maps in various ways. Zoom in/out, read off bearings and distances between selected points etc. It also converts the data from the TNC into positional and identifying information that appears on the map.

Here, one needs a suitable receiver, TNC and APRS programme running on a computer.

Of course, there are many ways that APRS can be set up and with different equipment involved. For example, the interface unit, mentioned as a transmitting requirement, could be replaced with a dual port computer: one port for the GPS and the other for the radio.

Amateur Applications?

I suppose we should put our heads together to try and determine further suitable applications for APRS : particularly those that could further our cause with public related activities. Possibly, these could be divided into:

- a) Sport related : such as marathons, car rallies, horse endurance events, boating etc.
- b) Emergency related : such as WICEN and SES involvement.

The present "state of the art" amateur APRS tracking equipment is that it is still reasonably large, heavy and power hungry. This, in my opinion, limits the applications to equipment installed in various vehicles where the above criteria are acceptable. This needn't limit applications with say marathon/horse endurance type events, for example, as the equipment could be placed in participating vehicles or at checkpoints.

As equipment is further miniaturised, and this is really just a matter of costs, APRS tracking equipment will be able to be carried by persons participating in various events. Quite low power transmitters would be used, so digipeaters would need to be placed in the

area to relay the data to a central point.

Benefits

Having sporting or emergency type events covered by APRS with participant's positions being nicely displayed on a map should appeal to organizers. It should be worth a lot of PR, allowing them to explain (and actually show others) what is happening. With participants positions being shown on a map, it is just so much easier to have an overview of the situation.

Maps

Naturally, a map of the area of interest, at a suitable scale, is required. Some maps are currently available and some types of paper maps may be scanned and used. More and more parts of this country and cities are becoming available on CD's, though as these are commercial enterprises, prices are often high.

More Information

Darryl, VK2TDS, has promoted APRS in Australia and New Zealand by giving talks at a number of clubs. He has a CD available for a nominal cost of \$10. The CD contains heaps of general APRS information, APRS programmes, Australian maps etc. Darryl may be contacted at PO Box 169, Ingleburn, 2565.

I have cloned a device that is popular in the US where it is called PIC-E. That TAPR device was, I think, derived from their MIC-E (microphone encoder). Both those devices and my clone form the necessary interface between a GPS and a transceiver.

Recently, there became available a number of surplus US\$20 GPS receivers. Unfortunately the source is now depleted, but quite a few found their way into amateurs hands. This prompted me to re-design my PC board to accommodate that receiver and a necessary data conversion chip. So this integrated unit only needs a transceiver to form an APRS tracking unit.

It is planned to try and fit the above unit into the popular Philips FM-828 transceiver and thus end up with a completely integrated APRS tracker with reasonable power output. It would only need the GPS antenna, a 2 metre antenna and a 12 volt power source to form that complete tracker.



Divisional Notes

VK2 Notes

by Pat Leeper VK2JPA

patleep@bigpond.com

This has been another successful year for the VK2 Division with 97 new members for the year, including 11 applications to be tabled at the December meeting (not yet held at time of writing).

An innovation taken up by the Division has been the VK2DQ Internet theory course which is being supervised by Barry White VK2AAB. This is in addition to the Correspondence course and both of these would now seem to cover all fields. Let's hope it brings more amateurs to our hobby — we need them! Many youngsters are apparently already finding the Internet boring and may be ready to go on to other interests — keep pushing Amateur Radio to them!

It has been decided the special Olympic Games call sign be activated for special days this year, and for a period of 4 weeks prior to the Olympic Games and 5 weeks after the Paralympics. The prefix during the actual Games' period is expected to be AX.

Council is looking into costs of posting QSL cards as the recent postal price hike has hit this service to the members. It may be necessary to make a small charge on outgoing cards. Further information will be made available as it comes to hand.

In General Business, Council discussed the impact on HF transmissions of the proposed high speed data over telephone lines to be used for Internet access. Each transmission method can corrupt the other as telephone lines are unshielded. If this is allowed to be used here, HF radio could be on the way out. This matter needs to be brought up with the A.C.A.

There will be no Council meeting in January.

Members are reminded that the Annual General Meeting of the VK2 Division will be held on Saturday 15th April at Amateur Radio House Parramatta. Nominations for Council and Motions on Notice close on Saturday 4th March at 12 noon at the office at Amateur Radio House, 109 Wigram Street, Parramatta.

The first examinations for 2000 will be on Sunday 20th February, with applications closing on Thursday 10th February. Applications forms are available from the VK2 office.

The Affiliated Clubs Conference was held on 13th November with a good roll-up. There were eighteen clubs represented by 1 or 2 delegates, along with the VK2 Councillors, Peter Naish VK2BPN (Federal President), Tony Farrow VK2TJF (Federal Director and WICEN delegate), Glenn Dunstan VK1XX (VK1 Federal Councillor), and Guest Speakers including Bill Vlies (ACA), Col Christiansen VK2BCC (ACA), Peter Jensen VK2AQJ. After Peter Naish VK2BPN had addressed the meeting, a number of subjects were discussed, including the Y2K problem and the effect of the GST. Peter said the Y2K compliancy will be ready when needed, and a GST component will be added to the Federal portion of membership fees from 1st January 2000. As each Division is autonomous, each will have to assess the impact of that on their portion of the membership fees.

Peter asked for more articles for AR, especially in the experimental areas of VLF and microwave bands to show the results of the experimentation that is going on there.

Peter Jensen VK2AQJ gave a talk on his recent trip to the U.K., mentioning that they are facing much the same problems as we have here — ageing membership, falling numbers, encroachment by the Internet. However, he found that one of the clubs he visited has gained young members by concentrating on the digital side of Amateur Radio, with computers, modems and radios. He also spoke on the new mode of PSK31 which is very popular in the U.K.

There was discussion on a possible special 2-metre repeater for use by visiting amateurs during the Games, which would have to be outside the local repeater allocation to cater for overseas handhelds. Handhelds, either local or overseas, will not be able to be taken onto Olympic sites as all equipment must be authorised. If a handheld is taken on-site and causes interference, it will be confiscated.

In-band and off-air linking was also discussed, and this needs a professional proposal to be drawn up before it can be placed before the ACA.

Bill Vlies answered questions on various subjects. One interesting answer he gave to a question on pager interference was — the only thing amateurs can do is come up with the technology to beat it!

There was much more general discussion and this can be read in the minutes that are sent out to the affiliated clubs following the conference. All present had an enjoyable and interesting day and many hoped to be back for the next one.

This will be on Saturday 6th May 2000, so mark it down in your new diary.

That's all for this month from the VK2 Division.



The Affiliated Clubs Conference

VK1 Notes

By Peter Kloppenburg VK1CPK

Forward Bias

As most of us are aware by now, A Novice course is starting on February 2, 2000 at the Hughes Community Centre, Wisdom St, Hughes. Course duration is 24 weeks.

At appropriate times during the course, excursions will be arranged to hamshacks of established amateurs (Mentors or in AR terms "Elmers") for practical demonstrations of radio equipment and on-air operations. These excursions will take place on weekends coincident with good propagation conditions. Some practical

demonstrations will also be conducted during class hours using simple test equipment and electronic components such as voltmeters, batteries, light emitting diodes, and resistors among others. Another study component is **Regulations**. These rules of on-air operations are non-technical and can therefore be learned at home. However, parts of the regulations will be dealt with during classes, to better familiarise students with the terminology used in the world of amateur radio

operations. **Morse** tuition will be offered if one of our fellow amateurs offers half an hour of his time to bring students up to speed. An information Evening was held at the Community Centre on October 24, that successfully provided prospective students with details of the course. Another such evening is scheduled for January 26 at the same place. By the time of the Annual General Meeting (AGM), the Novice course should be in full swing. Are you coming to the AGM? If you do, you get a free cuppa, an annual report from the President, and a view towards the future of Amateur Radio. In addition to all this, you'll get an opportunity to join the committee and make it happen.

The next General Meeting will be held at Room 2, Griffin Centre, Civic, Canberra, on January 24, 2000. See you there.

VK4 Notes

QNEWS

by Alistair Elrick VK4FTL
WIAQ Councillor and QTC Editor

Amateur Radio Sunday Funday 2000

Caboulture Super Club will host this event and the date will be February 20. (That's the weekend prior to Gosford Field Day). Contests, Rag Chewing, Fun and Food will be the order of the day. Funday organiser, VK4BB Brian Beamish, says he's looking forward to working with the Caboulture President Mark, VK4VG and his team at this, the second annual Amateur Radio Sunday Funday.

Camping facilities at the local Scout site for \$3 per person per night has been arranged. The site offers room for many tents, caravans and camper trailers, as well as a 13-bed dormitory style accommodation building and a large hall with full cooking facilities. All conveniences toilets and showers etc are available also, all within an easy 10 minute drive from the Funday site.

The FUNDAY 2000 site has shelter and toilets, with a playing area for children, and there is no shortage of parking. Maybe your club would like to provide a demo or input into the day? If so contact Brian VK4BBS. It's a Fun Day so do plan to come along on the 20th February and enjoy. As last year a Gold Coin donation from those attending, with all money raised going to the Royal Flying Doctor Service.

(Brian VK4BBS Funday Organiser)

QTC Magazine

Now available as a direct e-mail feed. Subscribe from the instructions on our website; remember to also send an e-mail to

VK4JPH to give your call, e-mail address and your membership details.

Recently Peter VK4JPH and a 'friend' brought the WIAQ front page up to date, with several improvements. Peter no doubt has learned a great deal from this 'friend' reputedly a professional web designer.

Summerland AR Club (VK2)

Phil VK2YGF from the Summerland AR Club made a rebroadcast of QNEWS using the RealAudio files from the WIAQ web site. It was reported as very good quality audio with no sign of metallic or echo effects. A great way to get your feed of Qnews for broadcast anytime to suit the local requirements. The SARC web page is at <http://www.nor.com.au/community/sarc/sarc.htm> or look on page 926 on the national packet teletext system of your BBS.

University Of The Third Age

But I hear you ask what is this U3A?

Well it was founded by Olive McKee in 1987 and has members on the Redcliffe Peninsula and surrounding areas, and a sub-branch in Caboulture.

A person of the Third Age is in retirement or has completed the responsibilities of parenthood. The Third Age is the part in one's adult life when one has the time to devote to interests other than earning a living and raising a family. In other words, there are no age limitations. Since all teaching is voluntary, costs of courses can be kept to an absolute minimum.

Contact the University of the 3rd. Age (U3A) via the Redcliffe Radio & Communications Group to learn all aspects of Amateur Radio.

AOCP classes are on Tuesdays 10.00 AM - 12 noon.

Just phone Kevin VK4AKI on 3880 1112 or kevjon @ bit.net.au

Townsville to the Azores - on Six Metres!

With the current solar cycle lurching headlong to its peak around the middle of next year, six metres - "the magic band" - is putting its best DX performance for a decade.

VK4ABW in Townsville worked CU7DRY in the Azores, off North West Africa, earlier this week - a distance of 17,806 km, according to the figuring of Neville, VK2QF. Not a bad effort, but still about 2000 km shy of the 6m DX record held by Mike, VK2FLR.

New Harmonic

We were all pleased to learn of an additional harmonic in the household of Laurie VK4BLE the WIAQ QSL Bureau Manager. Wife Alison VK4HAD gave birth to a little girl, Stephanie Kate on 30-11 99, a sister to Emily and Daniel. Well done and congratulations from all the Amateur fraternity.

Well this is the first AR edition for the year 2000 and I hope all survived the celebrations. Think about your Division of the Wireless Institute of Australia and what you can contribute for the benefit of your fellow members, by actively participating in the Councils and their support activities.

73's from Alistair

VK6 Notes

Chris VK6BIK

chrismor@avon.net.au

member of the WIA since 1929, was to be recommended to the next AGM to be granted Honorary Life Membership of the Division in recognition of 70 continuous years as a member of the Division. **Broadcast:** Tony VK6TS asked whether the monthly on-air meeting should continue. It was agreed that it was worthwhile to do so. The next net will be at 2000 hours (changed from 1930) on Tuesday 18th January 2000. **QSL Bureau:** Neil VK6NE reported the rise in postage rates had placed Bureau operations at a critical phase. While VK6 operations were holding their own, it may be necessary to adopt a National Bureau only at some future time, if the QSL Bureau system is to remain viable. **General Business:** Cliff VK6LZ advised Council that the proposal for commercial redevelopment of the Tick Hill repeater site had been dropped. The Morse survey was discussed. Will VK6UU will examine the results and provide some statistics for a future meeting. Dave 6IW advised that he anticipated that he would not wish to carry on in the office of Membership Secretary after the 2000 AGM.

Please note that as I will be away in Africa during January, there will be no Notes for the Feb issue, unless a volunteer steps forward. Also, I am seriously considering a move to the East Coast, and will be going over to VK4 to check things out soon. I have enjoyed compiling the monthly notes (and, some would rightly say, ramblings), but we may be looking for a new correspondent from Feb 2000. If you would like to give it a go, please contact the Secretary, Christine VK6ZLZ.

Happy New Year, I hope the Y2K bug didn't bite, and 73 from Toodyay, Chris VK6BIK

evening was when Joe Gelston, VK7JG hauls in two trout from the St. Patrick's River which winds through the park. One was a beauty but Joe was miffed when we made him send the other tiddley back to its Mummy.

The Division is in the process of looking for another Home Page address as our present one has upped his charges. As soon as we can we will notify the Federal Home page - in the meantime if you want news from the Island State go in through the link on the Federal page.

Just a note to remind all our members that the annual meetings are fast approaching and we must be looking for Councilors for the next 12 months. I have already intimated that I feel that after three years it's time for a presidential change and so I will be stepping down as President at those meetings.

Cheers for now. Ron Churcher, VK7RN.

ar

VK6RMS (147.250 rx) on Mt. Saddleback at Boddington the most reliable access point from my qth in Toodyay (distance about 150 kms). I am pleased to report that another experimenter who has come to weak-signal sideband work late in life, Conn VK6PM (Toodyay), has been working Bill VK6AS (Esperance) on 2m CW and SSB. Conn uses a small 8 element yagi at a height of 23 ft, no pre-amp, and just 10 watts - so this is quite an achievement for a modest station as the distance between stations is 580 km. Of course, Bill's outstanding 2m installation (hopefully there will have been a pic of this published somewhere in the last issue), would have been doing much of the work, but it does show what can be done without depending entirely on ducting.

CW Survey - Final Results (obtained on 10/12/99 from the internet)

CW Retention/Abolition survey. YES (i.e. keep cw as an exam requirement, even if at reduced speed) = 125; NO (i.e. don't keep) = 147. So victory for the NO's, and surely a clear mandate from VK6 amateurs for the WIA to proceed accordingly in it's dealings with the ACA and other regulatory bodies? (see also item below under General Business).

From the Minutes (Dec. Council Meeting). Some items of interest:

Membership: Dave VK6IW had received five new applications for membership. They are: David Lloyd VK6AOM, Glen Thurston VK6ZGT, Patricia Dicks VK6QL, Luigi lemi VK6YEH, and Peter Harvord VK6BRN. All were warmly welcomed to the Division (Dave 6IW/Eddie 6ZSE). "Mac" Maguire VK6MG aged 95 and a

And so forward to a new era in amateur radio with the approaching launch of the Phase 3D satellite. Out with the old, in with the new! I predict that this more "user friendly" satellite will, over a couple of years, decisively shift the emphasis in amateur radio to the higher bands, and bring more younger people into the hobby. We shall see.

Cockatoo'ed in Toodyay. To the relief perhaps of some, the tower is down, I'm off the air completely, and will struggle to get back, especially as I am contemplating moving interstate early in the new year. The large (chook size) white parrots have slam-dunked my entire antenna array (HF, 6m, 2m, 70cm), chewing through my defenses of retic plastic pipe to get at the co-axe cable and antenna feed points, baluns etc.. I woke up early one morning due to the screeching and squabbling noises to find about a hundred of these destructive monsters fighting over the juiciest co-axe! There are many advantages for Ham radio when living in the country (eg: room for antenna farms, use of linears, quietness, etc..), but also obviously some major disadvantages as well. If planning a move to the country, choose your location wisely!

Operating. I was struck recently by the apparent fact that most of the hams working at the leading edge (vhf/uhf/microwave) of amateur technology, are pensioners! Who will replace them when they fall off the perch? Hence my hopes for P3D. The country linked-repeater system centered on VK6RUF has started to open solidly again, with good propagation extending it's usefulness into outlying areas. I find

VK7 Notes

by Ron Churcher, VK7RN.

VK7AAW at Forcett near Hobart is always well attended. Incidentally Bill reckons he's got the only 4 letter suffix in Australia (Get it??).

The Christmas dinner at Ulverstone for the Northwest branch saw the annually presented "Joan Fudge award" won this year by Terry Ives, VK7ZTI, our treasurer. This award is a fine perpetual trophy in honor of a lovely lady - our first female amateur from this area and our secretary for some years. It recognises outstanding service for the branch.

A fine misty rain, which set in about an hour after the barbecue fires were lit, failed to dampen the spirits of the northern branch members at their Myrtle Park year-end barbecue. The big excitement of the

By the time you read this all the rip-roaring rush and tear about of the Christmas Season will be gone and most of us will have sat back and asked ourselves, "Why do we do it every year?" At any rate I hope that your festivities were all that you would want them to be.

Let me first on behalf of the Tasmanian Division wish our new editor, Colwyn Low a happy time in the job and thank Bob Harper for his work during his time as editor, not forgetting our old friend Bill Rice as well. We have some good people in amateur radio.

December was a pretty lively time in Tasmanian amateur radio circles with the end of the year functions. The "sewing circle" barbecue at the QTH of Bill Donald

OVER TO YOU

RF Radiation Hazard

VK3ZED's 'haste and anger' (AR, Over to You, November 1999) suggests a rather naive knowledge of RF power, antenna gain and associated power density or field strength, particularly of microwaves.

His scoffing of the heating potential of microwave RF power focussed with a parabolic dish antenna suggests a poor understanding of the achievable concentration of RF field strength compared with the same source of power radiated omnidirectionally. The hazard to human tissue (and pigeons!) of remaining, for even short periods of time, within the RF field of the main beam of a radiating microwave dish antenna is not easily perceived by those unfamiliar with microwaves. The vulnerability of soft tissue such as the brain and eyes cannot be underestimated.

I would have thought that the simple school physics demonstration of sunlight through a magnifying glass is evidence of how gain (optical, in this case) can be

applied to electromagnetic waves to increase their power density to potentially dangerous levels. The gain is certainly effective...and the results real!!

Phil Smith VK1GZ

More Info on "Kestrel"

I have read small articles in this and last month's magazines about the yacht "Kestrel".

If you want further information about Noel Toohey and his yacht there is a net which was formed by that gentleman and a few of his friends many years ago called not surprisingly "The Kestrel Net".

It is held on 3.600 at around 09.00 Zulu and I think it is still going, although some of the members have become silent keys. Some of the regulars are VK2AYG, VK2UI and VK2GWE.

I believe the former owner of my callsign was also a member. I used to be on the net some 10 years ago and they used to contact Noel from time to time on his way around the Pacific.

Kevin Mulcahy VK2CE

Future of VNG

The news items in pages 3 and 34 of October AR concerning the Standard Time and Frequency station is a timely warning from Ron VK3AFW. After reading this item I would like to add my own warning on this matter and a warning to all Amateur Operators in general, along strong political lines. We all want amateur radio to continue and grow in spite of the Internet etc.

To accomplish this we must all become a strong political lobby, despite personal opinions. The neutrality tightrope is obsolete. Conservative governments are the servants of the big end of town. Their expressed concern for people is a veneer, while 'non-conservatives' have been political pariahs since the early 1970s.

Both major political parties have engaged in asset stripping of the people. Downsizing and privatising have been and are an absolute disaster, sending the cost of goods and services sky high. It is therefore necessary for all of us to campaign and lobby all politicians to have this or a future government buy up, buy back or buy out the contract concerning Station VNG!

Station VNG can be and must be a fully

publicly owned asset. Sir, having been a political analyst for many years, I very strongly urge you to put these views before all Amateur Operators, to write or fax all politicians and the VNG User's Consortium. Your local member will buckle under the weight of hundreds of letters and faxes etc. While sitting at the keyboard would be a good time to also make your feelings and voice heard loud and clear that all of the amateur bands and frequencies can and must be preserved for your use only and positively NOT for private vested interests.

The radio frequency spectrum is a natural God-given asset of the people. It is wide enough for all to use, but absolutely nobody has any right to monopolise any section of the spectrum. Therefore, to maintain our hobby, do not sit on your hands, but let us all start lobbying and campaigning for Station VNG and our hobby in general

M M Gell VK5ZLC

3/18 Brighton Road Glenelg SA 5045

This letter reflects the views of its author only, and not necessarily those of the WIA. Institute policy is expressed only in official WIA Council statements.

Andrews

Communications Systems

(EST. 1976 - ACN 001 968 752)



ALINCO

AUSTRALIA'S FIRST AUTHORISED
FACTORY DIRECT IMPORTER
MASSIVE SHIPMENTS EVERY MONTH

FULL 3-YEAR WARRANTY ON
ALINCO and ICOM
WE SELL MOST BRANDS

BALUNS, VERTICALS, YAGIS, P/S,
ICOM-KENWOOD-JRC-AOR-EMOTATOR-
MFJ-DIAMOND-TIMEWAVE-KANTRONICS
-THP - GARMIN - TERLIN - UNIDEN - ETC
DX-1600 HF LINEARS FROM \$ 3.799

**HUGE RANGE OF ELECTRONICS,
ICOM and ALINCO Radios.**

Over 22 Years of
Professional Sales and Service.
Instant Repairs Fridays
HF Transceivers & Linears Wanted

(02) 9636 9060 or (02) 9688 4301

SHOP 8, 41 BATHURST ST, GREYSTANES,
N.S.W. 2145. FAX (02) 9688 1995

For All Your Requirements

AUTHORISED DEALER

ICOM

KENWOOD

AMATEUR COMMERCIAL

COMMUNICATIONS



14 Mary Street
Hazlemere

Western Australia 6055
Telephone: (08) 9274 1118

Facsimile: (08) 9250 3734

E-mail: tower@eon.net.au

www: http://www.tower.visionimage.com.au

Amateur Radio

ANNUAL

CATEGORY

Author

Issue Page

ADMINISTRATION

Dr David Wardlaw, VK3ADW elected IARU Vice Pres.
DX Window Compromise
LIPDs
Low Powered Devices in the band 433.05 to 434.79 MHz
Questionnaire : Amateur Radio
Radiation Regulation
The 1999 WIA AGM
WIA and ACA Co-operate in Olympic Training
WIA Queensland Incorporation completed
WIA submits Response to Radio Comms. Act (1992) Discussion paper
11th IARU Region 3 Conference Year 2000 Australia

WIA News	Oct	6
WIA News	Dec	3
Peter Naish VK2BPN	Jun	7
ACA	May	4
Bob Harper VK4KNH	Sep	48
Peter Naish VK2BPN	Feb	3
Ian Hunt VK5QX	Jun	4
	Nov	3
WIA News	Oct	4
	Mar	3
WIA News	Oct	6

ANTENNAS, TOWERS, LINES, etc.

A Current Indicator for Open - Wire Transmission Lines
A Note about the DL6WU Yagi
A Tower of Strength
An Automatic Beam Pointer
An Inconspicuous Antenna
Boom Corrections to Element Lengths
End Fed Antenna
Feedline Verticals
Fox Hunting DF Twin Antenna
High Sea Antennas
Low Profile Radio Operator
Return Loss bridge (RLB)
Screwdriver Antenna
Shielded Balanced Feed Line
Skeleton Slot Revisited
Stacked Yagis, Phasing and Matching
Twin Band Antenna

Drew Diamond VK3XU	Jan	15
Ian Cxowan VK1BG	Apr	20
Kevin Peacock VK4VKD	May	12
Barry White VK2AAB	Jun	20
Tom Walker VK4BTW	Dec	11
Guy Fletcher VK2KU	Mar	11
Technical Abstracts	Jul	32
Technical Abstracts	Dec	36
Technical Abstracts	Oct	30
Mark Dowdridge VK4MFX	Dec	22
Peter Parker VK3YE	Apr	34
Ron Sanders VK2WB	Oct	24
Technical Abstracts	Jul	33
Technical Abstracts	Nov	41
Technical Abstracts	Dec	36
Gordon McDonald VK2ZAB	Nov	22
Technical Abstracts	Aug	33

AWARDS

CQ Magazine Awards
List of 18 Miscellaneous International Awards

	Dec	46
	Oct	42

BOOK REVIEWS

The RSGB Guide to EMC

Bill Rice VK3ABP	Apr	23
------------------	-----	----

COMPUTERS AND PROGRAMS

Amateur Radio on the Web
Computers in the Amateur Shack
Your PC and Y2K
Y2K - It's Elementary Dear Watson

Bob Harper VK4KNH	May	14
Peter Parker VK3YE	Feb	38
Roy D. Welch W0SL	Mar	40
Alan Shawsmith VK4SS	Aug	18

CONTESTS

ALARA Contest Rules 1999
An Introduction to Contesting
Harry Angle Memorial Sprint
Harry Angle Memorial Sprint 1999 Results
John Moyle Field Day Contest Rules March 1999

Ian Godsil VK3DID	Sep	47
Novice Notes	Aug	47
	Mar	49
	Aug	42
	Feb	48

INDEX

1999

CATEGORY

Results of the John Moyle Field Day Contest 1999
 RD 1998 Contest Results
 RD Contest Amended Results 1998
 Spring VHF-UHF Field Day 1998 : Results
 Summer VHF-UHF Field Day 1999 : Results
 Jack Files Sprint results
 VHF – UHF Field Days
 VK7 Division wins 1999 Remembrance Day Contest
 50th Annual Ross Hull Memorial VHF-UHF Contest Rules
 1999 Remembrance Day Contest Rules

Author

Issue Page

Oct 45
 Feb 44
 Oct 46
 Feb 46
 May 47
 Mar 48
 Dec 49
 Nov 4
 Oct 47
 Aug 13
 Alec Petkovic VK6APK

DIGITAL COMMUNICATIONS

Repeaters on the Internet

Repeater Link Jun 41

EQUIPMENT REVIEWS

Icom IC-Q7A

Paul McMahon VK3DIP Aug 25

HISTORY

After fifty years – I can still remember
 Commemoration of the First Wireless Message
 End of an ERA
 Guglielmo Marconi, Pioneer of Radio
 Harry Angel VK4HA
 How it Began – RTTY in VK-Land
 Monitoring Station of Yesteryear
 On Video – WIA Federal Video Tape Library
 One metre days
 Preserving Our Pictorial History
 Remember the First Time
 Signing Off – Technology Replaces Morse Code
 The End of an Amateur Radio Era
 The Great Ross Hull
 Vern Kerr. Honour in Memory of a Radio Pioneer
 WWII RAAF Site Memorial
 50 People we should thank.

Eric Jamieson VK5LP Mar 21
 ALARA Dec 14
 Christine Taylor VK5CTY Sep 20
 OE1WHC Sep 12
 Mar Cover
 Eric Ferguson VK3KF (SK) Sep 34
 John Wright L21068 Jul 51
 Don Bland VK4TVD Jul 39
 VHF-VHF Jun 36
 Will McGhiem VK6UU Mar 25
 Sam Wright VK6YN Jan 21
 Annette Codispoti Jun 18
 Peter Naish VK2BPN Dec 16
 Eric Jamieson VK5LP Dec 17
 R.C.Tulloch VK4BF Sep 16
 WIA News Jul 3
 Oct 12

MISCELLANEOUS TECHNICAL

A HF Complex Impedance Analyser
 A twin meter SWR Bridge
 Adapting the Astatic D-104 Microphone
 All is not old that Glitters
 An Automatic Tracker for Tuned Circuits
 An Inductive Variometer
 An L & T-Match Design Chart
 An RF Resistance Bridge
 ARDF Converter
 Auto Antenna Switch for Icom Tranceivers
 Black-Black-Black (Burnt Resistor)
 Balanced Video
 Broadband Level meter
 Ceramic 7 MHz Preselector

Ralph Holland VK1BRH Jun 26
 Drew Diamond VK3XU May 21
 Technical Abstracts Nov 40
 Mike Krochmal VK3KRO Jul 15
 Joe Rotenberg VK3BBN Sep 30
 Technical Abstracts Jul 33
 Graham Thornton VK3IY Jul 17
 Drew Diamond VK3XU Jul 24
 Ron Graham VK4BR Sep 44
 Technical Abstracts Feb 26
 Technical Abstracts Sep 31
 Technical Abstracts Dec 36
 Technical Abstracts Mar 30
 Technical Abstracts May 32

CATEGORY

Compact Mobile Tuner
 Component bending Jig
 CTSS Tone Detector
 E-field Meter
 Electret Microphone without a battery
 Exploring Rechargeable Batteries
 General Purpose Amplifier/Mike Tester/Power supply
 High performance Regenerative Receiver
 Improvements to a Signal Generator Model Q-131/SG-9200
 Logarithmic Detector for Panadaptor
 Magnetic Dial Scales
 Make PCB's with your Computer
 Mike Impedance Matcher
 Mini Sky Needle
 Narrow Band Voice Transmission
 RF Low Pass Filters
 RF Current Probe
 Second Harmonic Optimised Low Pass Filter
 Soft Starting (Mains Supply)
 Telescopic Mast for an Amateur on the Move
 Test Connections
 Touch Sensitive Key
 The Car Battery as a Low Cost Power Source
 The Great Crystal Set Competition
 TV locked Frequency Standard
 Update on 160 metre Bandpass Filter
 Using Film Canisters
 Where on earth are you ? Grid Squares
 Why 50 ohms ?
 Workshop Time

Author

Technical Abstracts
 Technical Abstracts
 Warren Stirling VK3KSW
 Technical Abstracts
 John Lindstad VK2WF
 Peter Parker VK3YE
 Drew Diamond VK3XU
 Technical Abstracts
 Drew Diamond VK3XU
 Technical Abstracts
 Technical Abstracts
 Joe Rotenberg VK3BBN
 Bob Harper VK4KNH
 Technical Abstracts
 Lloyd butler VK5BR
 Ron Saunders VK2WB
 Technical Abstracts
 Technical Abstracts
 Technical Abstracts
 Graham B Jackson VK3GBJ
 Technical Abstracts
 Technical Abstracts
 Ian Cowan VK1BG
 Christine Taylor VK5CTY
 Technical Abstracts
 Keith Gooly VK5OQ
 Technical Abstracts
 Bob Harper VK4KNH
 Bob Harper VK4KNH
 Terry Sexton

Issue Page

May 30
 Jan 25
 May 24
 Aug 32
 Nov 36
 Dec 33
 Jun 23
 Mar 31
 Apr 6
 Apr 19
 Feb 26
 Apr 10
 Jul 30
 Jun 33
 Jan 18
 Feb 18
 Jun 33
 Jun 34
 Mar 32
 Feb 16
 Sep 31
 May 31
 Feb 22
 Jan 6
 Apr 18
 Sep 30
 Feb 26
 Nov 19
 Jun 10
 Mar 16

OPERATING

Amateur Television for JOTA
 Australian LF Band Gains International Reputation
 Beware Burundi (DXCC recognition)
 Demonstrating Amateur radio in a School
 DXCC Listings Dec 1998
 I'm in Ham Radio because I love it !
 "It hit me like a ton of bricks" LIPDs
 JOTA (World Wide Jamboree on the Air)
 JOTA Callsigns in Queensland
 Low Frequency Reception
 LIPDs
 Preparing for JOTA
 Promoting the Hobby
 PSK31 - Digital RTTY
 QSLing for VK5MIR voice contacts
 Special Event Planning for Amateur Radio
 Spectrum Arrangements for the Amateur 80 Metre DX Window
 The Classic Adelaide Car Rally
 The John Moyle Field Day Competition
 The Need for Morse Code. Another View point
 What use would you be in a catastrophe

Barry Cleworth VK5BQ
 Jim Linton VK3PC
 Graeme Scott VK2KE
 Ian VK5XE
 Rob Seaman VK6TRC
 Robert Milne VK78ZAL
 Will McGie VK6UU
 Christine Taylor VK5CTY
 Richard Mumane VK2SKY
 Fred Johnson ZL2IAMJ
 Ian Hunt VK5QX
 Bob Harper VK4KNH
 WIA News
 Christine Taylor VK5CTY
 Bob Harper VK4KNH
 G3WGV
 Chris Hill VK6KCH

Sep 17
 Apr 24
 Apr 44
 Jan 20
 Feb 50
 Sep 5
 Sep 45
 Oct 16
 Oct 19
 Aug 30
 Sep 43
 Oct 13
 Sep 5
 Sep 33
 Apr 31
 Jun 48
 Sep 4
 Jul 12
 Feb 6
 Apr 25
 Jan 8

PEOPLE

A Regulator Reflects
 Alan M. Dorhoff K2EEK, Editor CQ Dead
 Andy Thomas VK5MIR - South Australian Cosmonaut

Rob Gurr VK5RG
 Christine Taylor VK5CTY

Apr 24
 Aug 30
 Jun 15

CATEGORY	Author	Issue	Page
APRS enters SUN-Herald City to Surf	Daryl Smith VK2TDS	May	18
Australia Day Honours VK4ZXZ, VK4RX, VK4XZ	Bob Harper VK4KNH	Mar	6
David Minchin VK5KK	Eric Jamieson VK5LP	Sep	41
Paul Lieb KH6HME – VHF-UHF Pioneer	VHF – UHF	Jul	35
Radio Reminiscences	Jim Davis VK7OW	May	20
Ralph Traeger Memorial	Ian Hunt VK5QX	Feb	42
Robert Harwood. This Radio Star is Alive and Kicking	Mandy Smith	Sep	23
The End of an Amateur Radio Era	Peter Naish VK2BPN	Dec	16
The Great Ross Hull	Eric Jamieson VK5LP	Dec	17
VK5s go to Dayton Hamvention '99 – USA	Grant Willis VK5ZWI	Aug	20
VK5AMD – A Remarkable YL		Nov	16
50 People we should thank		Oct	12

PLACES

A surprise in Bali	Richard Cortis VK2XRC	Oct	20
ALARAMEET Brisbane 1999		Nov	11
St Brandon DX_Pedition	Stephen Pall	Jan	9

PROPAGATION

Ionospheric Update (Solar Cycle 23 update)	Evan Jarman VK3ANI	Feb	51
Ionospheric Update (Solar Activity)	Evan Jarman VK3ANI	May	51
Ionospheric Update	Evan Jarman VK2ANI	Aug	51
Ionospheric Update	Evan Jarman VK3ANI	Nov	51

RECEIVERS

An Attenuation Set for Receiver Sensitivity Measurements	Drew Diamond VK3XU	Aug	22
Biaural Direct-conversion receiver	Drew Diamond VK3XU	Sep	24
The 'Moorabbin' a Simple Regenerative AM Receiver	Peter Parker VK3YE	Nov	32
Receive SSB on your FM Receiver	Peter Parker VK1PK	Mar	18
Receiver Calibrator and transmitter Monitor	Technical Abstracts	Jan	23

REPEATERS AND BEACONS

Letter re 29MHz Repeaters	Repeater Link	Oct	38
Teletext – The Silent Revolution	Gerard VK2DAA	Nov	37

TEST EQUIPMENT

A Spectrum/Attenuation Measuring Set	Drew Diamond VK3XU	Dec	24
An Inductance Meter for Radio Coils	Drew Diamond VK3XU	Feb	12
An RF Attenuator	Keith Gooly VK5OQ	Nov	30
HF-MT Dummy Load	Ross Fraiser VK2KVV	Feb	20
K2 Transceiver	Adrian Hatherley VK3LK	Oct	21
Return Loss Bridge (RLB)	Ron Saunders VK2WB	Oct	24
160 meter Band Pass Filter	Keith Gooley VK5OQ	Feb	14

TRANSMITTERS

A Homebrew 813 Linear Amplifier Part 1	C. J. Bourke VK4YE	Mar	7
A Homebrew 813 Linear Amplifier Part 2	C. J. Bourke VK4YE	Apl	12
A Simple QRP Transmitter	Pounding Brass	May	33
An AM/CW Transmitter for 1.8,3.5 and 7 MHz	Drew Diamond VK3XU	Dec	30

WRITING ARTICLES

How to write for Amateur Radio	John Nieman	Jan	26
Taking Photos for Amateur Radio	Bob Harper VK4KHN	Apr	22

by Evan Jarman VK3ANI

34 Alandale Court, Blackburn Vic 3130

These graphs show the predicted diurnal variation of key frequencies for the nominated circuits.

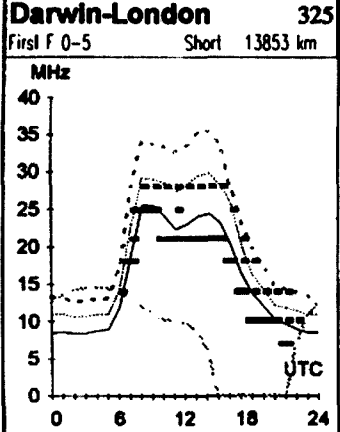
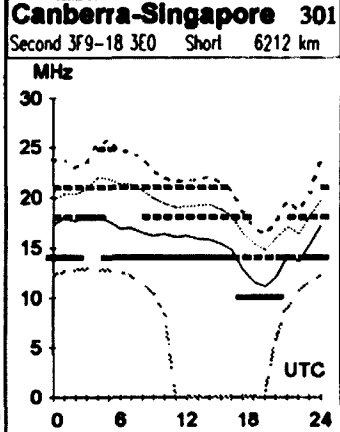
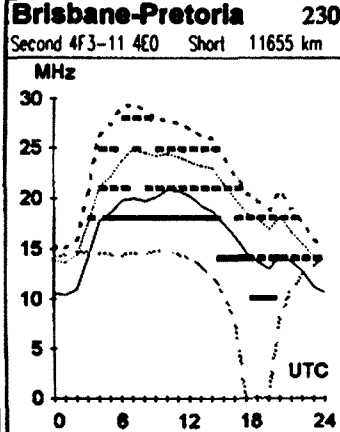
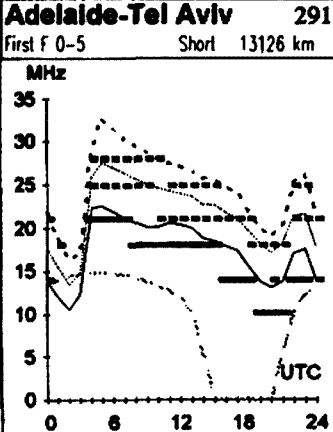
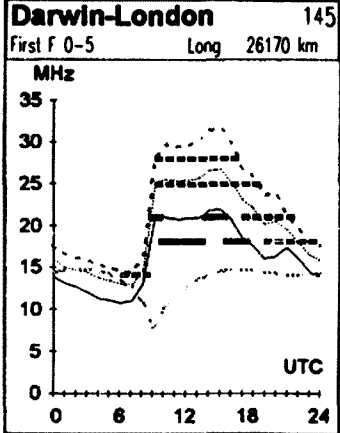
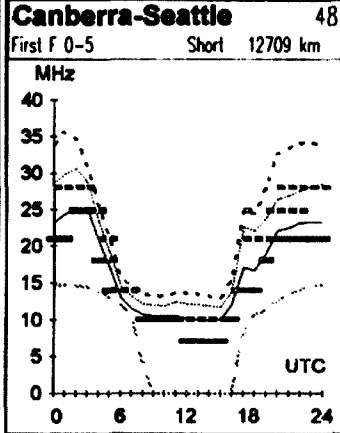
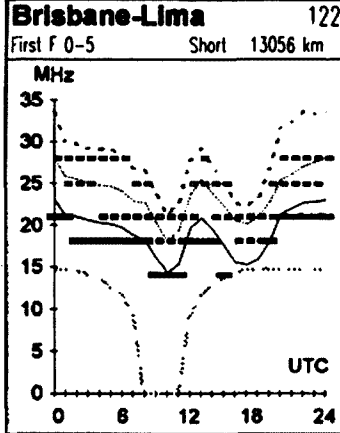
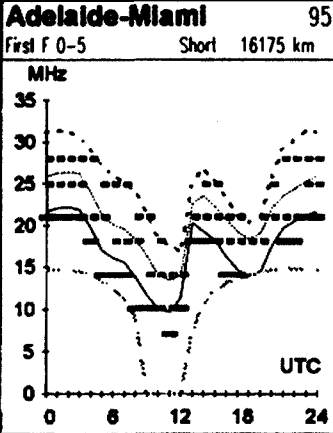
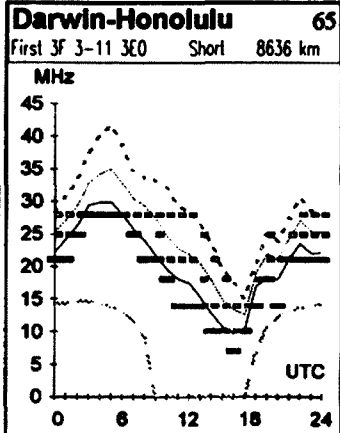
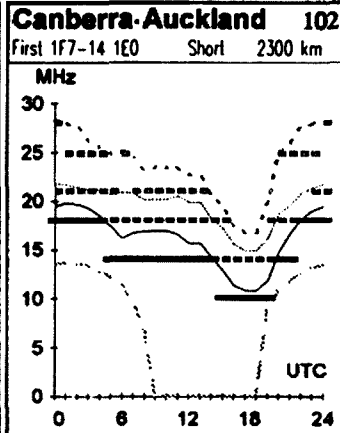
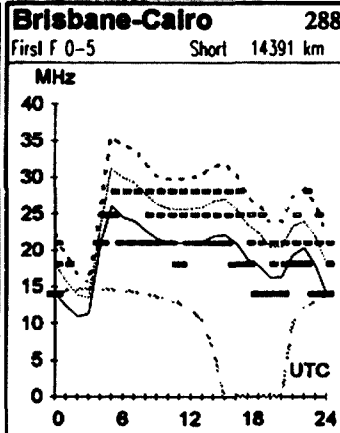
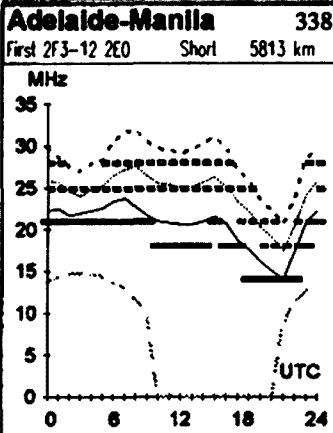
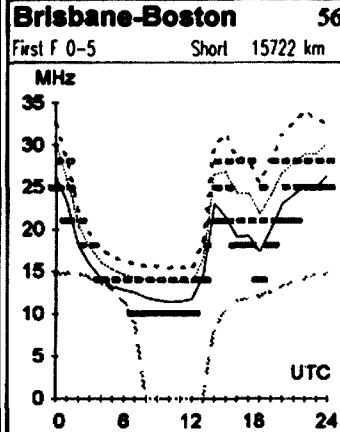
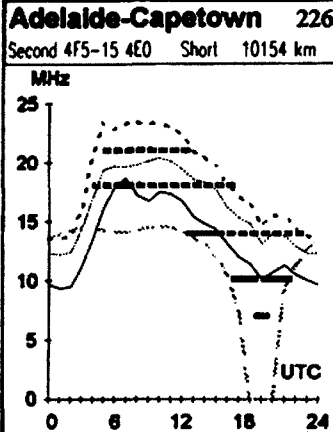
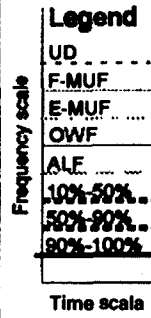
These frequencies as identified in the legend are:-

- Upper Decile (F-layer)
- F-layer Maximum Useable Frequency
- E-layer Maximum Useable Frequency
- Optimum Working Frequency (F-layer)
- Absorption Limiting Frequency (D region)

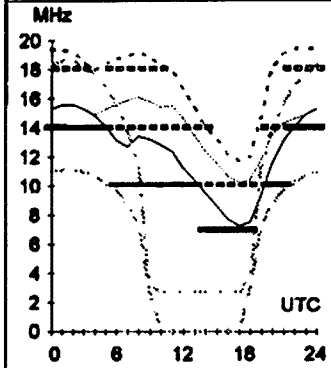
Shown hourly are the highest frequency amateur bands in ranges between these key frequencies; when useable. The path, propagation mode and Australian terminal bearing are also given for each circuit.

These predictions were made with the Ionospheric Prediction Service program: ASAPS version 4.

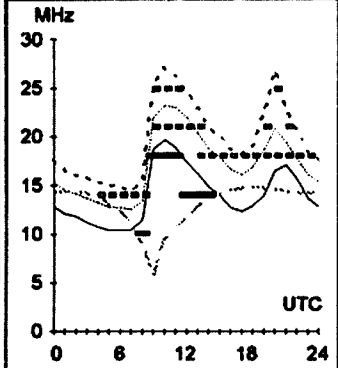
January 2000
T Index: 136



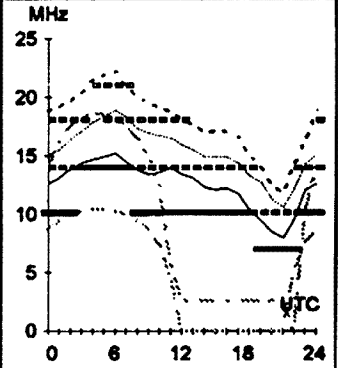
Hobart-Invercargill 111
 First 1F13-23 Short 1708 km



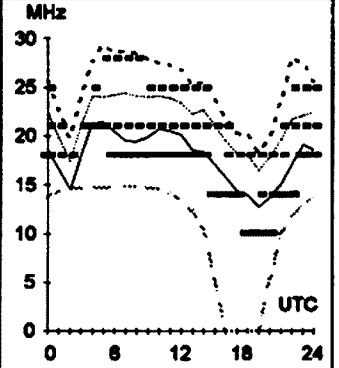
Melbourne-London 131
 First F 0-5 Long 23118 km



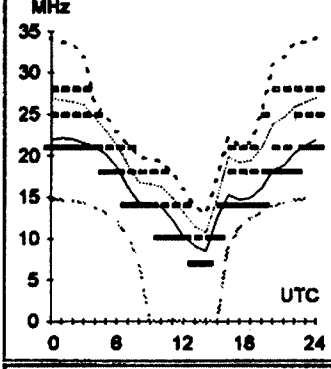
Perth-Jakarta 340
 Second 2F15-27 2E3 Short 3017 km



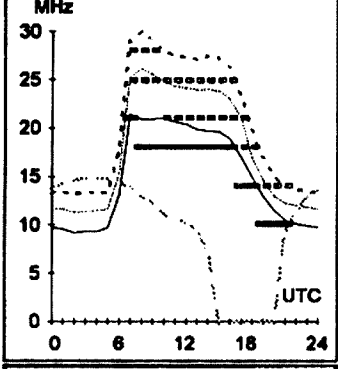
Sydney-Nairobi 255
 First F 0-5 Short 12147 km



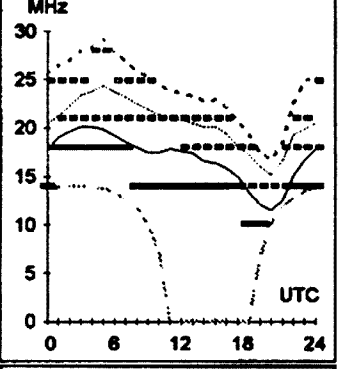
Hobart-Los Angeles 66
 First F 0-5 Short 12820 km



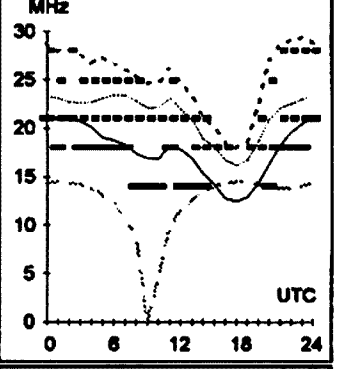
Melbourne-London 311
 First F 0-5 Short 16906 km



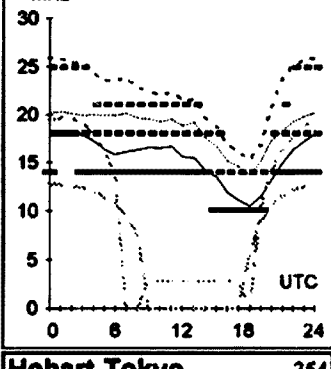
Perth-Kiribati 72
 Second 3F7-15 3E0 Short 7014 km



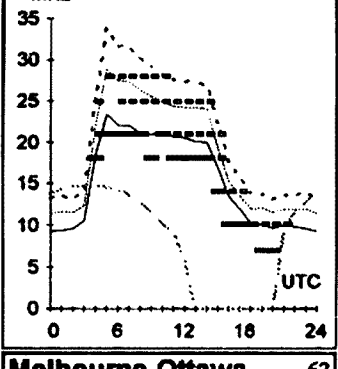
Sydney-Santiago 145
 Second 4F4-10 4E0 Short 11347 km



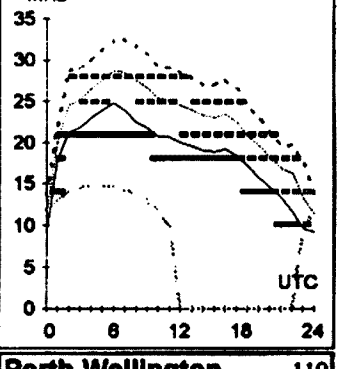
Hobart-Suva 56
 First 2F10-17 2E0 Short 4011 km



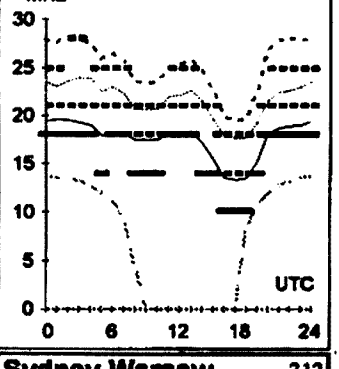
Melbourne-Moscow 316
 First F 0-5 Short 14428 km



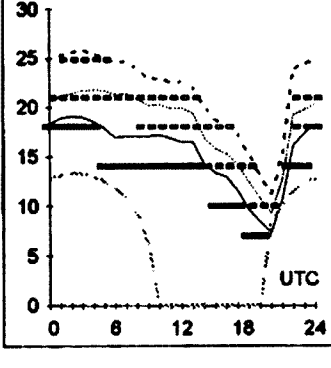
Perth-New Delhi 325
 Second 3F5-13 3E0 Short 7872 km



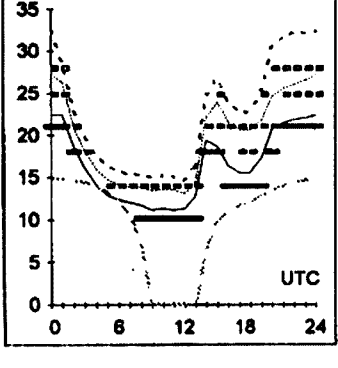
Sydney-Samoa 71
 First 2F8-15 2E0 Short 4462 km



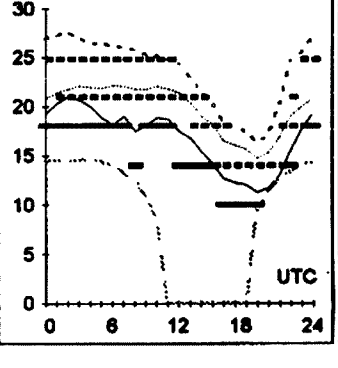
Hobart-Tokyo 354
 Second 4F8-16 4E0 Short 8770 km



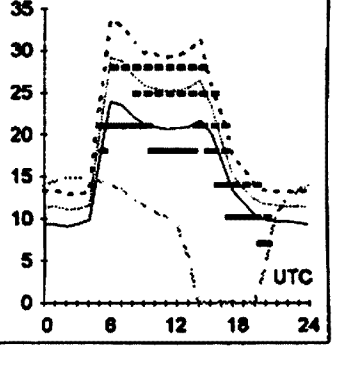
Melbourne-Ottawa 63
 First F 0-5 Short 16567 km



Perth-Wellington 119
 First 2F5-12 2E0 Short 5255 km



Sydney-Warsaw 313
 First F 0-5 Short 15589 km



HAMADS

- Hamads may be submitted on the form on the reverse of your current Amateur Radio address flysheet. Please print carefully, especially where case or numerals are critical.
- Please submit separate forms for For Sale and Wanted items, and be sure to include your name, address and telephone number (including STD code) if you do not use the flysheet.
- Eight lines (forty words) per issue free to all WIA members, ninth and tenth lines for name and address. Commercial rates apply for non-members.
- Deceased estates Hamads will be published in full, even if the ad is not fully radio equipment.
- WIA policy recommends that the serial number of all equipment for sale should be included.
- QTHR means the address is correct in the current WIA Call Book.
- Ordinary Hamads from members who are deemed to be in general electronics retail and wholesale distributive trades should be certified as referring only to private articles not being re-sold for merchandising purposes.
- Commercial advertising (Trade Hamads) are pre-payable at \$25.00 for four lines (twenty words), plus \$2.25 per line (or part thereof), with a minimum charge of \$25.00. Cheques are to be made out to: WIA Hamads.
- Copy should be typed or in block letters, and be received by the deadlines shown on page 1 of each issue of Amateur Radio, at:

Postal: *Newsletters Unlimited, 29 Turner Street, Richmond, 3121*

Fax: *03 9428 4242* E-mail: *newsl@webtime.com.au*

Please only send your Hamad once

Please send Hamads by mail OR fax OR email (much preferred).

Please do not send by more than one method for any one ad or issue, it is confusing.

- **FACTOR I/II TNC/MODEM.** e.g. PK232MBX with firmware later than Aug 91. (Consider PK232MBX that is upgradable). e.g. KAMPLUS e.g. PTC II/IIe. e.g. Homebrew? or w.h.u. Capable of working from 12v d.c. Marine Mobile so no phone. Tel. Ken, VK4JR, for QSP, (07) 3293 0083. Email: vk2ezq@amsat.org (set transmission to "plain text format"). Packet: vk2ezq@vk5rq.#syp.#sa.aus.oc. I will tel/email/arrange sched. Can you work h.f.? 73 de Ted, VK2EZQ.

FOR SALE VIC

- **Signal Generator HP 60BE 10-480 MHz +7(13) to -125 dBm, Precision Attenuator, including handbook \$150 ono. Marconi 801 D/8/S 10-480 MHz +4, -130 dBm Precision Attenuator \$120 ono. Both good condition. David VK3XLD QTHR 03 5282 4440. Can deliver to Melbourne area.**
- **Icom IC707, as new, in box, \$975. Max VK3GMM (03) 5985 2671.**
- **Antennas TH6 good condition \$450. 5 Element Werner Wolf on 10Mx \$150, and FT7 HF mobile Ser# 8K120186 \$250. Phone VK3XBG Tom on (03) 5174 6904 or write QTHR.**

FOR SALE - NSW

- **Yaesu FT-101Z HF TXCVR S/N 9C020308. G.C. Spare PA valves. Built in fan. DC-DC converter \$250.00 Kenwood TR-2400 2m FM TXCVR S/N 0115038. Leather case, spkr mic, AC charger, car charger. G.C. \$120.00 Kenwood AT-200 antenna tuner S/N 840855 \$120.00. Dipole antenna kit 80, 40, 20, 10m, never used. \$50.00. VK2KRQ John (02) 4369 0458 12A Rickard Road Empire Bay NSW**
- **Rotator Kenpro Model KR400 and control box, completely overhauled, \$100. George VK2AHJ (02) 9878 2278**
- **Eimac 4CX1000 Valve, breech lock socket, chimney and cathode choke \$200. BWD 881 Power Scope CRO, unused with all probes, \$500. Ray VK2FW QTHR (02) 6365 3410**
- **Yaesu FT50R 2m/70cm, hand held with leather case, large battery, hardly used, original packing, \$350. Have two. David VK2BDT (02) 4821 5036**
- **Power supply 240vAC to 14vDC, 15 amps, regulated. Panel meters 0-20vDC, 0-20 amps DC. Fused primary and secondary DC outlet polarised socket, \$240. Phone 02 6550 0764. VK2EJU**
- **Hilltop DX site, 360° take off. Two 18 metre towers with antennae, 1.8 MHz to 432 MHz, plus four bedroom brick veneer and tile home, ducted evap. cooling, off peak heating, covered outdoor area with BBQ. Contact VK2ASI, PO Box 205 Tamworth 2340. Phone (02) 6765 7947 AH.**
- **Trico Digital Multi Meter Model D703, large readout, 240 volts \$50. Leader Signal Generator**

Model LSG11, \$45. M Haylor VK2OW, 19 Mill St Riverstone 2765.

● **BOOK: "Radiotelegraph and Radiotelephone Codes, Prowords and Abbreviations." 2nd Edition. \$16 posted Australia. 90 Pages. Q,X,Z Codes, 97 Phonetic, 20 Morse Codes. Phillips, Myer, 10,11,12,13 Codes. Much other info. Internet - <http://www.nor.com.au/community/sarc/phonetic.htm>. VK2JWA, John W.Alcom. QTHR. 02-66215217 jalcom@nor.com.au**

● **INTERNET Connect from Port Macquarie to the Gold Coast from 80c per hour. Summerland Amateur Radio Club. For info - <http://www.nor.com.au/community/sarc/sarc.htm> Harry VK2XIO, QTHR, cascom@nor.com.au PO Box 293, Lismore, 2480. Ph (02) 6629 8198**

WANTED NSW

- **ICOM IC-1275A Transceiver and IC-R7100 Receiver in good condition. Also Bird 43 wattmeter plugins: 5C, 5E, 25E, 250E, 2.5K, 25K. Guy VK2KU (02) 4751 6726 any time**
- **Manual/Circuit (copy OK) for Amplifier Radio Frequency Aperiodic 1.5 - 30 Mc/s 5820-66-010-8448. The unit was built by PYE (AUST) in 1960. Data needed for display leaflet at Wyong Field Day. Expenses gladly refunded. Ian O'Toole VK2ZIO QTHR (02) 9680 2112 (A.H.) d2012pn1@ozemail.com.au**

WANTED VIC

- **Yaesu FT757GX (or II) in good condition preferably with service manual and power supply. Contact Graham VK3DPC QTHR 041 77 22 400 or email: graham@zendata.com.au**
- **Copper Wire. I need about 35 metres of 14 or 16 swg hard-drawn copper wire for an antenna project. Can anyone help with the wire or with a source of supply? Bill VK3HX QTHR (03) 9807 9172**

FOR SALE QLD

- **Yaesu FT26 2m handheld txcvr with 12v battery pack. Runs 5w SNo 1N171265, \$200 complete with charger and car adaptor. Very good condition. Battery pack is new. Ph (07) 3408 0206 VK4LV QTHR.**
- **Icom All Band HF Transceiver Model 720A. MFJ Versa manual HF Tuner, Home Brew 20 Amp Power Supply. \$500 the lot. Contact Brian VK4BOW. Ph (07) 4786 4800. Fax (07) 4786 4808 Email: bungee@tpg.com.au**
- **Yaesu FT-7576 X II, Yaesu FT-102, Yaesu FT-212RH, Yaesu FT-227R, Yaesu SP-102, Tuners Tokyo-Labs HC-500, Emtron EAT-300, Receiver Lafayette HA350, Antennas 10-15 CE42 Duoband (new), 10-15-20 TH3 Junior, 10-15-20 Tet-Emuron HB43DX, 10-15-20 D-4305, Tower 10 metre + with winch rotator, assorted items. First reasonable offer accepted. Phil VK4FPM Hervey Bay 4655 (07) 4124 1384**

- **Oscilloscope D61** \$100, AORSM 1-14 \$420, 8-13 \$30 each, earphones HI-Z STC \$15, \$20, Beeston \$25, Brown \$20, Megger Junior handcrank 500v \$50, Radiotron Designers Handbook \$50, Reich electron tubes \$25, Eastman vacuum tubes \$25, Ericsson/Trimax transformers 600/150 to 100k/25k, 600/150, 20k/5k, 40k, ea. \$5. VK4APD Ph (07) 3397 3751.

- **Kenwood TS922 Linear Amplifier.** Excellent condition, \$1500. VK4IK QTHR (07) 5465 6053

- **Kenwood TS-520S VGC** with mike and spare 6146 tubes, \$300. Paul VK4DJ (07) 4778 6031

- **KAM+ TNC** brand new. Top of the range. Connections never been wired up. All complete with cables, plugs, manuals. Plus Host Master 11+ software, serial no 11K20-11157. New retail price listed at \$799 plus software. Sell the lot incl software \$600. Call June VK4SJ (07) 5492 9205, email: beau@optusnet.com.au.

FOR SALE SA

- **Yaesu FT890 HF txcvr** inbuilt ATU, Terlin Outbacker Perth plus antenna with bonnet mount \$1575. John VK5WBJ (08) 8277 0225

FOR SALE WA

- **Microwave Link Racon** Micropass 23GHz Digital 2mbps (E1) c/w orderwire and engineering channel. Full duplex operation. Shelf life only. Mint condition. \$2500 Karl VK6YKD Ph (08) 9319 1130.

- **PK232MBX TNC Multimode**, ex. cond., handbook and software \$250 ono. **Kenwood remote VFO AT230** for TS830S tx/rx, mint cond. \$300. Alan VK6PG QTHR (08) 9275 3348, email: vk6pg@tpg.com.au

- **One Hygain Long John No 375** five element 10 metre beam, **one Hygain Long John No 376** five element 15 metre beam, both for \$150. Condition fair. On ground. Buyer to disassemble and take away. Cy VK6IK QTHR Phone (08) 9291 9128

WANTED TAS

- **8873 Conduction cooled Triode.** Phone Joe VK7JG (03) 6327 2256 Fax (03) 6327 1787 QTHR

- **Kenwood DG-5 Digital Display** for TS520S or photocopy of schematic and manual. 6M SSB Transverter to suit TS-520S. Justin VK7ZTW QTHR (03) 62231351
justin@hmjgc.fam.aust.com

MISCELLANEOUS

- **Free to good home, WWII equipment.** Colonial Radio corp receiver type BC454-B,

missing IF cans. AWA AT5 Oscillator Section H/F type J7750. G.L Moore VK3FFX QTHR Ph (03) 9531 9301

- **I am an amateur radio operator in the Fiji Islands.** I have a small rig capable of 20w only. Therefore I wish to buy a second hand transceiver at 100-150w. I shall be most grateful if you could send me some info on the above. Ruvendra Prasad 3D2RP, PO Box 756, Nadi, Fiji Islands

TRADE ADS

- The "One Man Tower" by VK4VKD, brand new, never assembled, as it came from the factory, 10m high, \$1000, • Hy Gain Beam, 10-15-20m, Explorer 14, \$200, • Targa Beam, 10-15-20m, 3 El. \$120, • Antenna rotator, CREATE, model RC5B-3 \$300, • 23cm Yagi Group, Comet Japan, 4x52 Ele. , with matching network, \$600,

- 12cm Yagi, 40 elem., Tonna, brand new, \$150, • 70cm/2m Cross Yagi System for sat-comm. \$150, • Kenwood TS 50, \$900, • Kenwood TS 440S, looks bad, but works OK. \$500, • 2 3 c m Lin Amp, TLA 1270-100, 100 Watt out, from SSB Electronic Germany, \$ 1,500, • 70cm Lin Amp, TLA 432-100, 100 Watt out, \$500,

- 70cm Lin Amp, TLA 432-200, 200 Watt out, \$1000, • Pactor Controller SCS, PTC-2, \$1,100, • Icom IC 127IE, 23cm All mode TRX, \$ 1000, • Icom IC 275H, 100 Watt 2m All mode, \$ 800, • LT 6 S, 50 MHz Transverter, SSB Electronic, new, \$700, • TWE Mobile-HF-Amplifier MA 500, 600 Watt, \$700, • Metron Mobile-HF-Amplifier MA 1000, \$900, • Mikrofon Icom SM 8, \$100, • Diamond SWR Meter SX 1000, 4 Bands, 1,8 - 1300 Mc, new, \$200, • MFJ 249 Antenna Tester, battery bracket defect, \$100,

- Lots of Pre-amps from SSB Electronic, for 12cm, 23cm, 70cm - 2m - 6m
• -also Converters etc., pse ask.
Walter in Perth, VK6BCP, (08) 9341 2054, e-mail: vk6bcp@arrl.net

- **AMIDON FERROMAGNETIC CORES:** For all RF applications. Send business size SASE for data/price to RJ & US Imports, PO Box 431, Kiama NSW 2533 (no enquiries at office please ... 14 Boanyo Ave Kiama).

<www.cyberelectric.net.au/~rjandusimports>
Agencies at: Assoc TV Service, Hobart; Truscotts Electronic World, Melbourne and Mildura; Alpha Tango Products, Perth; Haven Electronics, Nowra

- **WEATHER FAX programs** for IBM XT/ATs
*** "RADFAXZ" \$35.00, is a high resolution short-wave weather fax, Morse and RTTY receiving program. Suitable for CGA, EGA, VGA and Hercules cards (state which). Needs SSB HF radio and RADFAX decoder. *** "SATFAX" \$45.00, is a NOAA, Meteor and GMS weather satellite picture receiving program. Needs EGA or VGA & WEATHER FAX PC card, + 137 MHz Receiver. *** "MAXISAT" \$75.00 is similar to SATFAX but needs 2 MB of expanded memory (EMS 3.6 or 4.0) and 1024 x 768 SVGA card. All programs are on 5.25" or 3.5" disks (state which) plus documentation, add \$3.00 postage. ONLY from M. Delahunty, 42 Villers St, New Farm QLD 4005. Ph 07 358 2785.

<http://www.hamsearch.com>
a not-for-profit site that is a search engine for hams

PLEASE BE KIND TO OUR TYPIST

Our Hamad typist is not an expert in your field.

Please write legibly on your form, in capitals and lowercase, and use legitimate abbreviations.

This saves excessive corrections by the proofreader, and reduces the chance of errors being published, which inconveniences everyone.

TRADERS

If you have a product or service to sell to amateur radio operators, then

A DISPLAY AD

in
Amateur Radio

is for you

Even if your product or service is not radio orientated, if the profile of the readership is close to your client base profile, you should consider this niche market.

Call
Mrs June Fox
Tel: (03) 9528 5962
for our competitive rates

WIA Division Directory

The WIA consists of seven autonomous State Divisions. Each member of the WIA is a member of a Division, usually in their residential State or Territory, and each Division looks after amateur radio affairs within its area.

Division	Address Officers	News Broadcasts	Note: All times are local. All frequencies MHz.	Fees
VK1 ACT Division GPO Box 600 Canberra ACT 2601	President Gilbert Hughes Secretary John Woolner Treasurer Les Davey	VK1GH VK1ET VK1LD	VK1WI: 3.570 LSB, 146.950 FM each Sunday evening from 8.00pm local time. The broadcast text is available on packet, on Internet <i>aus.radio.amateur.misc</i> news group, and on the VK1 Home Page http://www.vk1.wia.ampr.org	(F) \$72.00 (G) (S) \$58.00 (X) \$44.00
VK2NSW Division 109 Wigram St Parramatta NSW (Office hours Mon-Fri 1100-1400) (PO Box 1066, Parramatta 2124) Phone 02 9689 2417 Freecall 1800 817 644 Fax 02 9633 1525	President Michael Corbln Secretary Eric Fossey Treasurer Eric Van De Weyer Web: http://marconi.mpce.mq.edu.au/wia e-mail: vk2wi@ozemail.com.au	VK2YC VK2EYF VK2KUR	From VK2WI 1.845, 3.595, 7.146*, 10.125, 14.160, 24.950, 28.320, 29.120, 52.120, 52.525, 144.150, 147.000, 438.525, 1281.750 (* morning only) with relays to some of 18.120, 21.170, 584.750 ATV sound. Many country regions relay on 2 m or 70 cm repeaters. Sunday at 1000 and 1930. Highlights included in VK2AWX Newcastle news, Monday 1930 on 3.593 plus 10 m, 2 m, 70 cm, 23 cm. The broadcast text is available on the Internet newsgroup <i>aus.radio.amateur.misc</i> , and on packet radio.	(F) \$89.00 (G) (S) \$58.00 (X) \$41.00
VK3 Victorian Division 40G Victory Boulevard Ashburton VIC 3147 (Office hours Tue & Thur 0830-1530) Phone 03 9885 9261 Fax 03 9885 9298	President Jim Linton CEO Barry Wilton Secretary Peter Mill Web: http://www.tbsa.com.au/~wivvic/ e-mail: vk3wi@rint.com.au	VK3PC VK3XV VK3APO	VK3BWI broadcasts on the 1st and 3rd Sunday of the month at 8.00pm. Primary frequencies, 3.615 LSB, 7.085 LSB, and FM(R)s VK3RML 146.700, VK3RMM 147.250, VK3RWG 147.225, and 70 cm FM(R)s VK3ROU 438.225, and VK3RMU 438.075. Major news under call VK3WI on Victorian packet BBS and WIA VIC Web Site.	(F) \$75.00 (G) (S) \$61.00 (X) \$47.00
VK4 Queensland Division GPO Box 638 Brisbane QLD 4001 Phone 07 5496 4714	President Colin Gladstone Secretary Peter Harding Treasurer Alistair Elrick e-mail: wiaq@brsbanes.dialix.com.au Web: http://www.wiaq.powenip.com.au	VK4ACG VK4JPH VK4FTL	VK4WIA: 1.825 MHz SSB, 3.605 MHz SSB, 7.118 MHz SSB, 14.342 MHz SSB, 21.175 MHz, 28.400 MHz SSB, 29.220 MHz FM, 53.725 MHz FM, 147.000 MHz FM, 438.500 MHz (Brisbane only), and regional VHF/UHF repeaters at 0900 hrs EAST Sunday. Repeated on 3.605 MHz SSB & 147.000 MHz FM at 1930 hrs EAST Monday. Broadcast news in text form on packet under WIAQ@VKNET.	(F) \$85.00 (G) (S) \$72.00 (X) \$55.00
VK5 South Australian Division (GPO Box 1234 Adelaide SA 5001) Phone 08 8294 2992	President Jim McLachlan Secretary David Minchin Treasurer John Butler	VK5NB VK5KK VK5NX	VK5WI: 1827 kHz AM, 3.550 MHz LSB, 7.095 AM, 14.175 USB, 28.470 USB, 53.100 FM, 147.000 FM Adelaide, 146.700 FM Mid North, 146.800 FM Mildura, 146.825 FM Barossa Valley, 146.900 FM South East, 146.925 FM Central North, 147.825 FM Gawler, 438.425 FM Barossa Valley, 438.475 FM Adelaide North, ATV Ch 35 579.250 Adelaide. (NT) 3.555 USB, 7.065 USB, 10.125 USB, 146.700 FM, 0900 hrs Sunday, 3.585 MHz and 146.675 MHz FM Adelaide, 1930 hrs Monday.	(F) \$77.00 (G) (S) \$63.00 (X) \$49.00
VK6 West Australian Division PO Box 10 West Perth WA 6872 Phone 08 9351 8873	Acting Pres. Cliff Bastin Secretary Christine Bastin Treasurer Bruce Hedland-Thomas Web: http://www.faroc.com.au/~vk6wia/ e-mail: vk6wia@faroc.com.au	VK6LZ VK6ZLZ VK6OO	VK6WIA: 146.700 FM(R) Perth at 0930hrs Sunday relayed on 1.825, 3.560, 7.075, 14.116, 14.175, 21.185, 29.680 FM, 50.150 and 438.525 MHz, country relays 3.582, 147.200 (R) Cataby, 147.350 (R) Busselton and 146.900 (R) Mt William (Bunbury). Broadcast repeated on 146.700 at 1900 hrs Sunday relayed on 1.865, 3.563 and 438.525 MHz : country relays on 146.350 and 146.900 MHz.	(F) \$89.00 (G) (S) \$59.00 (X) \$38.00
VK7 Tasmanian Division PO Box 271 Riverside TAS 7250 Phone 03 6425 2923 Fax 03 6425 2923	President Ron Churcher Secretary Tony Bedelph Treasurer John Bates Web: http://www.wia.tasnet.net	VK7RN VK7AX VK7RT	VK7WI: 146.700 MHz FM (VK7RHT) at 0930 hrs Sunday relayed on 147.000 (VK7RAA), 146.725 (VK7RNE), 146.625 (VK7RMD), 3.570, 7.090, 14.130, 52.100, 144.150 (Hobart), repeated Tues 3.590 at 1930 hrs.	(F) \$88.00 (G) (S) \$75.00 (X) \$55.00
VK8 Northern Territory (part of the VK5 Division and relays broadcasts from VK5 as shown, received on 14 or 28 MHz).				

Membership Grades

Full (F) Pension (G) Needy (G) Student (S) Non receipt of AR (X)
Three-year membership available to (F) (G) (X) grades at fee x 3 times.

ADVERTISERS INDEX

Andrews	47	Tower.....	47
Dick Smith	OBC, 28,29	WIA NSW Division	IBC
G. & C. Communications.....	17		

TRADE PRACTICES ACT

It is impossible for us to ensure that the advertisements submitted for publication comply with the Trade Practices Act 1974. Therefore, advertisers and advertising agents will appreciate the absolute need for themselves to ensure that the provisions of the Act are strictly complied with.

VICTORIAN CONSUMER AFFAIRS ACT

All advertisers are advised that advertisements containing only a PO Box number as the address cannot be accepted without the addition of the business address of the box-holder or seller of the goods.

W.I.A. (N.S.W. Division) BOOKSHOP

The following items are normally available for sale in the N.S.W. Division Bookshop. No price shown indicates out of stock - stock received regularly from USA and UK, so please call for availability. We can arrange special orders for items not normally held in stock - just give us a call.

Order by telephone quoting credit card details, or by mail enclosing cheque, money order or credit cards details to -

W.I.A. (N.S.W. Division), P.O. Box 1066, Parramatta. NSW 2124

Tel: (02) 9689 2417 or Fax (02) 9633 1525

Discounts are available on most items to W.I.A. Members - please check before ordering. Post/packing extra where applicable

	Retail Price		Retail Price
Antennas:			
Antennas & Techniques for Low Band DXing - J. Devoldere ON4UN	37.00	QRP & DX	
ARRL Antenna Book	50.00	Introducing QRP - D Pascoe G0BPS	24.00
Antenna Compendium volume 1	20.00	QRP Power	19.00
Antenna Compendium volume 2	25.00	W1FB's QRP Notebook Doug DeMaw W1FB	19.00
Antenna Compendium volume 3	25.00	Dxing On The Edge - J Briggs K1ZM	46.00
Antenna Compendium volume 4 (including software)		The Complete DXer 2nd Ed - B Locher W9KNI	19.00
Antenna Compendium volume 5 (including software)			10.00
W1FB's Antennaok Notebook - Doug DeMaw W1FB	21.00	Packet:	
Practical Wire Antennas - J D Heys G3BDQ	33.00	Your Packet Companion - Steve Ford WB8IMY	21.00
Physical Design Yagi antennas - David B Leeson W6QHS	32.00	Packet - Speed, More Speed & Applications	24.00
Practical Antenna Handbook 2nd Edition Carr	98.00	Getting On Track with APRS	24.00
Antenna Impedance Matching - Wilfred N Caron	31.00	RSGB Pocket Guide -Your First Packet Station - S Jelly G0WSJ	17.00
RSGB HF Antenna Collection - Edited by Erwin David G4LQI	41.00	Packet Radio Primer	29.00
HF Antennas for All Locations - Les Moxon G6XN	49.00	Practical Packet Radio - Stan Horzepa WA1LOU	29.00
Practical Antennas for Novices - John Heys G3BDQ	22.00	RF & Interference:	
Antenna Experimenter's Guide - Peter Dodd G3LDO	57.00	RF Exposure & You	22.00
W6SAI's HF Antenna Handbook - Bill Orr W6SAI	32.00	Television Interference Manual - 2nd Edition - RSGB	12.00
Cubical Quad Antennas - Bill Orr & Stuart Cowan	31.00	Radio Frequency Interference Handbook (Aust)	25.00
Vertical Antennas - Bill Orr & Stuart Cowan	31.00	Radio Frequency Interference - How to Find it & Fix it - ARRL	28.00
Simple Low-Cost Wire Antennas - Bill Orr & Stuart Cowan	26.00	Education:	
Simple Low-Cost Wire Antennas - Bill Orr & Stuart Cowan	26.00	Novice Operators Theory Handbook & Study Guide	30.00
More ... Out of Thin Air	24.00	As above with Exams (Correspondence Course)	49.00
Lew McCoy on Antennas	26.00	AOCB Bridging Correspondence Course	49.00
The Radio Amateurs Antenna Handbook - Bill Orr & Stuart Cowan	29.00	Radio Theory Handbook for Amateur Operators - 3rd Ed. Swainston	55.00
Antennas for VHF & UHF	17.00	Amateur Radio Operating Manual - 3rd Edition - RSGB	31.00
VHF-UHF-Microwaves-Satellites:		ARRL Operating Manual	41.00
VHF Amateur Radio Bill Orr & Stuart Cowan	30.00	Ham Radio Made Easy - Steve Ford WB8IMY	29.00
Radio Auroras - Charlie Newton G2FKZ	20.00	W1FB's Help For New Hams - Doug DeMaw	21.00
RSGB Microwave Handbook Vol 1		Understanding Basic Electronics - L D Wolfgang WR1B	37.00
RSGB Microwave Handbook Vol 2		Historical:	
RSGB Microwave Handbook Vol 3		Traeger The Pedal Radio Man - Fred McKay	15.00
Space Radio Handbook - John Branegan GM4IHJ	40.00	In Marconi's Footsteps - Early Radio - P Jensen VK2AQJ	49.95
Spread Spectrum Sourcebook		200 Meters & Down - The Story of Amateur Radio - C DeSoto - ARRL	14.00
Radio Amateurs Satellite Handbook	34.00	Miscellaneous:	
ARRL Satellite Anthology	20.00	Test Equipment for the Radio Amateur - C Smith G4FZH	30.00
UHF/Microwave Experimenter's Manual	36.00	W1FB's Design Notebook - Doug DeMaw W1FB	21.00
UHF/Microwave Projects Manual volume 1		The L F Experimenters Source Book	26.00
UHF/Microwave Projects Manual volume 2	26.00	Your HF Digital Companion - Steve Ford WB8IMY	25.00
Weather Satellite Handbook	31.00	Your Mobile Companion - Roger Burch WF4N	25.00
VHF/UHF Handbook	59.00	The Modern Amateur's Mobile Handbook - D Ingram K4TJWJ	25.00
VHF/UHF DX Book	66.00	Personal Computers in the Ham Shack - P Danzer & R Rozny	29.00
Introduction to Satellite Communications - F A Wilson	20.00	The Internet & World Wide Web Explained	19.00
Handbooks & Projects:		Radiotelegraph & Radiotelephone Codes, Prowords & Abbreviations	12.00
ARRL Handbook 2000 (Avail Feb)		Shortwave Listening for Beginners - A L McCormick	30.00
RSGB RadCom Handbook (Avail Feb)		Passport to World Band Radio - Shortwave Guide	44.00
ARRL Electronics Data Book	32.00	The Best of the New Ham Companion	19.00
RSGB Radio Data Handbook 6th Edition	37.00	Technical Topics Scrapbook volume 1	32.00
The New Shortwave Propagation Handbook	32.00	Technical Topics Scrapbook volume 2	38.00
Your Guide to Propagation (RSGB)	22.00	Transmitter Hunting Radio Direction Finding Simplified	37.00
Hints & Kinks for the Radio Amateur	21.00	Members Only Items:	
Practical Transmitters for Novices	34.00	Metal lapel badges (WIA logo)	4.00
Practical Receivers for Beginners	40.00	Car Stickers (WIA Logo)	1.50
Solid State Design	22.00	QSL Cards -	25 for \$3.00 + 45 cents postage 100 for \$10.00 + \$2.00 postage.
Building & Using Balun and Ununs	32.00		
How to Design & Make your own PCBs	14.00		
More Advanced Power Supply Projects			
Log Books & Call Books:			
WIA Log Book (Portrait Print)	5.00		
ARRL Log Book (Landscape Print)	9.00		
2000 Australian Amateur Callbook	17.95		
Souvenir Key Rings -Metal with WIA Logo (avail Dec/Jan)	7.50		

PRICES SUBJECT TO CHANGE WITHOUT NOTICE

FT-847 EARTH STATION



Only one transceiver gives you all-mode operation on the HF, 6m, 2m, and 70cm bands with full satellite capability...

the new Yaesu FT-847 "Earth Station"

Ready for action on SSB, CW, AM, FM and Digital modes, the FT-847's compact size makes it ideal for a variety of portable/mobile applications as well as for serious base station operation. You get a solid 100W output on the HF and 6m bands, 50W output on both 2m and 70cm, dual fan cooling and a rugged diecast chassis. Plus, the ultra-quiet HEMT receive pre-amp on 2m and 70cm contributes to the FT-847's industry best sensitivity figures. Advanced Digital Signal Processing (DSP) circuitry enhances received signal/noise ratio for easier copy of signals under marginal conditions through the use of 16 selectable noise reduction algorithms, while the Bandpass and Auto-notch filters aid the IF based Shift and Noise Blanker circuits in reducing interference on crowded bands.

The FT-847 is ready for satellite operation, with crossband full duplex operation, normal and inverted VFO tracking of the satellite uplink/downlink, as well as 12 special satellite memories with alpha-numeric tags. Also provided is a low-noise Direct Digital Synthesiser (DDS) that provides tuning steps as small as 0.1Hz, plus there's an adjustable DSP bandpass filter as narrow as 25Hz for exceptional weak-signal CW performance. You can also install optional Collins® mechanical filters in both the transmit and receive chain for enhanced SSB operation, as well as a 500Hz Collins® filter in the receiver side for CW. An RF-style speech processor with adjustable frequency shift voice tailoring is also provided to add punch to your SSB transmissions.

The FT-847 is ready for data modes, with a rear panel Data In/Out socket and a Packet socket for 1200/9600 baud

VHF/UHF operation. Other features include extended receive operation (37-76, 108-174, and 420-512MHz), a high-speed computer control interface, 10-key keypad for band/frequency entry, and a Shuttle-Jog tuning ring for fast QSY. Also included are encode/decode CTCSS and DCS operation, selectable channelised steps for FM operation, FM narrow/wide modes for 29MHz use, and a large LCD screen with adjustable backlighting.

Each transceiver is supplied with a hand-mic, DC power lead and a comprehensive instruction manual. Call us for a copy of Yaesu's 6 page colour brochure to learn more about this incredible value "Earth Station" transceiver.

D 3425

2 YEAR WARRANTY
YAESU

\$3250

**HURRY! Beat the January price rise.
BUY NOW AND SAVE.**

DICK SMITH
ELECTRONICS

That's where you go!



FEBRUARY 2000

Volume 68, No 2

Amateur Radio

'Spicy' circuits

Circuit simulation using Spice or Pspice

- ✱ An experimental Low Frequency Band Transmitter
- ✱ 40w Mosfet HF Linear Amplifier
- ✱ An On-Air Czech
- ✱ MORE 'SPICE' — The Spouses' Day Out



Inset: HOME BREW YAGI ANTENNA ARRAY
(more cover details page 1)

COVER: PHOTO: ART IN AMATEUR RADIO

Quo Vadis Morse II?

plus

ALARA

WIA, Divisional & Club News & regular columns



WIA Yearbook 2000

Callbook Listings

Frequency Listings

Band Plans

Repeater Lists

Beacon Lists

Satellite Lists

Licence Conditions

Examiner Lists

Special Interest Groups

Public Relations Notes

Radio and TV Freqs.

and much, much more !

2000 is a great year to have an up-to-date call book.

This YEARBOOK edition contains all of the content you have come to expect of the **WIA callbook as well as some new items.**

It is more than a callbook, it's a Yearbook, the WIA Yearbook!

The "WIA Yearbook 2000" is now available from Divisional Bookshops and selected outlets.



Amateur Radio

Volume 68
Number 2
February 2000

The Journal of the Wireless
Institute of Australia

ISSN 0002-6859

Editorial

Editor: Colwyn Low VK5UE

Technical Editor: Peter Gibson* VK3AZL

Publications Committee Members

Ron Fisher VK3OM
Don Jackson VK3DBB
Evan Jarman VK3ANI
Bill Rice VK3ABP
Gil Sones VK3AUI

Advertising

Mrs June Fox,
Tel: (03) 9528 5962

Hamads

"Hamads" Newsletters Unlimited
29 Tanner Street, Richmond VIC 3121
Fax: (03) 9428 4242
e-mail: news@webtime.com.au

Office

10/229 Balacalva Road
Caulfield, Victoria
Telephone (03) 9528 5962
Facsimile (03) 9523 8191
Business Hours 9:30am to 3:00pm weekdays

Postal

P.O. Box 2175
CAULFIELD JUNCTION
VICTORIA 3161
AUSTRALIA
e-mail: armag@hotkey.net.au

Production

Newsletters Unlimited (03) 9428 3458

Printer

Streamline Press, Melbourne (03) 9417 2766

Postal Service

IMS (03) 9291 5888

Production Deadlines

Advertising booking and articles for
publication 10th of proceeding month.

Hamads and advertising material deadline
18th day of proceeding month

The contents of Amateur Radio are Copyright
Wireless Institute of Australia
C 2000

General

Taking Tea with the Ladies. The Gippsland Technical Symposium Spouses' Tour 12
Pauline Corrigan VK3XBG's YL

Quo Vadis Morse II? 19
Ian Godsil VK3DID

Talking Radio. Highlights of the WIA/ACA Liaison meeting 30

Technical

Circuit Simulation using Spice or PSpice 6
Phil Rice VK3BHR

40W MOSFET HF Linear Amplifier 14
Drew Diamond VK3XU

An Experimental Low Frequency Band Transmitter 20
Lloyd Butler VK5BR

New Finals for FT-101 (Technical Abstracts) 32
Gil Sones VK3AUI

PTT Sound (Technical Abstracts) 33
Gil Sones VK3AUI

Columns

Advertisers' Index 56

ALARA 13

AMSAT Australia 34

Awards 39

Club News 5

Contests 40

WIA Division News

VK1 Notes 10

VK2 Notes 10

VK3 Notes 10

VK4 Notes 11

VK6 Notes 11

VK7 Notes 12

Editor's Comment 2

Hamads 54

HF Predictions 52

Ionospheric Update 51

Novice Notes 46

Repeater Link 50

Spotlight on SWLing 44

Technical Abstracts 32

VHF/UHF - An Expanding World 36

WIA Comment 3

WIA News 3

WIA Division Directory 56

WIA Federal Directory 2

Our cover this month

Main Photo: 'ART IN AMATEUR RADIO'

Michael Corbin's VK2YC Home QTH Array, picturesque against the setting sun

Inset: VHF Yagi Antenna Array of Bill Hockley VK6AS, of Esperance, WA

*Comprises 8X 16 element home brew Yagis for a total of 128 elements.
Boom length is 9.2m (4.4λ). E stack 14'1". H stack 13'4 1/2"*

Gain is 22DBD. Used for Troppo and EME. Has both Azimuth and Elevation Capability

Contributions to Amateur Radio

Amateur Radio is a forum for WIA members' amateur radio experiments, experiences opinions and news. Manuscripts with drawings and or photos are always welcome and will be considered for publication. Articles on disc or email are especially welcome. The WIA cannot be responsible for loss or damage to any material. A pamphlet, How to write for Amateur Radio is available from the Federal Office on receipt of a stamped self-addressed envelope.

Back Issues

Back issues are available directly from the WIA Federal Office (until stocks are exhausted, at \$4.00 each (including postage within Australia) to members.

Photostat copies

When back issues are no longer available, photocopies of articles are available to members at \$2.50 each (plus an additional \$2 for each additional issue in which the article appears).

Disclaimer

The opinions expressed in this publication do not necessarily reflect the official view of the WIA and the WIA cannot be held responsible for incorrect information published.

Amateur Radio Service

A radiocommunication service for the purpose of self-training, intercommunication and technical investigation carried out by amateurs; that is, by duly authorised persons interested in radio technique solely with a personal aim and without pecuniary interest.

Wireless Institute of Australia

The world's first and oldest
National Radio Society
Founded 1910

Representing
The Australian Amateur Radio Service

Member of the
International Amateur Radio Union

Registered Federal Office of the WIA
10/229 Balaclava Road
Caulfield North Vic 3161
Tel: (03) 9528 5962 Fax (03) 9523 8191
<http://www.wia.org.au>

All mail to
PO Box 2175 Caulfield Junction VIC 3161

Business hours: 9.30am-3pm weekdays

Acting Federal Secretary

Peter Naish VK2BPN

Federal Office staff

June Fox Bookkeeper
Rita Trebilco VK3IF Examinations Officer

Council

President	Peter Naish	VK2BPN
VK1 Federal Councillor	Glenn Dunstan	VK1XX
VK2 Federal Councillor	Michael Corbin	VK2YC
VK3 Federal Councillor	Brenda Edmonds	VK3KT
VK4 Federal Councillor	Ross Marren	VK4AMJ
VK5 Federal Councillor	David Box	VK5OV
VK6 Federal Councillor	Willi McGhie	VK6UU
VK7 Federal Councillor	Phil Corby	VK7ZAX

Executive

Peter Naish VK2BPN
Tony Farrow VK2TJF
John Loftus VK4EMM
Wally Howse VK6KZ

Federal Coordinators

AMSAT	Graham Ratcliff	VK5AGR
ARDF	Jack Bramham	VK3WWW
Awards	John Kelleher	VK3DP
Contests	Ian Godsil	VK3DID
Education	Brenda Edmonds	VK3KT
FTAC	John Martin	VK3KWA
Historian	John Edmonds	VK3AFU
IARU	Grant Willis	VK5ZWI
Intruder Watch	Gordon Lovsday	VK4KAL
ITU Conference and study group	David Wardlaw	VK3ADW
Public Relations	David Thompson	VK2NH
QSL Manager (VKA, VKO)	Neil Penfold	VK6NE
Videotapes	Don Bland	VK4TVD

ACA Liaison Team

Peter Naish VK2BPN
Glenn Dunstan VK1XX
Michael Corbin VK2YC
Wally Howse VK6KZ
Canberra Liaison Officer
Richard Jenkins VK1RJ

Post woes

JANUARY AR got out a little earlier than December but it seems that there is a week between delivery in Melbourne and the outer fringes of the country. My personal copy arrived 18th January. So even if we try to get the issue posted in Melbourne on the Wednesday before the first Friday of the Month of issue, some of us will not see it until the second Friday.

Morse: on the way out?

The ARRL decision to reduce Morse code testing to 5 wpm only will go a long way to making HF bands available to more amateurs and aspiring amateurs. It will also, I think, mean that a Morse code test to get any form of Amateur licence is on the way out. We now have to ensure that our examinations are relevant to licencing people with knowledge and skills required to operate an Amateur Radio Station effectively. People, who are able to set up the station, operate it for effective communication and are courteous to others and do not spoil the enjoyment of other users of our bands.

You, too, can be published

Now as you are all very aware the WIA requires lots of voluntary input to keep our hobby viable. This magazine also runs on a lot of voluntary help. In is our "In House Journal" that is why it contains WIA and Divisional Notes as well as technical and general articles. There are people who write about what they are doing both experimentally and generally, but they cannot write articles for every issue of AR. Everything that is a little novel or just helps us operate better is worth sharing with others through the magazine. Can someone have their arm twisted to write about "Digital Modes on the HF Bands" and "Amateur TV" for starters? If you think these topics are irrelevant then please write an article on something that is.

While I am looking for articles of all sorts I would particularly like some photographs of Amateur activities. Photos of people using equipment or at Conventions or like this month's cover, major home brew equipment are also needed for the cover. There is a limit to

the local items of Amateur interest that I have access to for photography. The most important things about the photographs are sharp focus and good contrast. Pictures should have the subject in an uncluttered background. I have some photos at present, where it is very hard to distinguish whip aerials against vegetation, brickwork or utility poles and wires.

Congratulations!

There are two awards presented by the Amateur Radio Publications Committee each year, the **Higginbotham Award** for general service to Amateur Radio, not necessarily the magazine and the **Technical Award** for the best technical article in the previous year's magazine.

The 1999 awards have been made as follows

1. **The Higginbotham Award to Eric Jamieson, VK5LP.**

Eric has produced the 'VHF-UHF, An Expanding World' column in Amateur Radio Magazine for some 30 years. The award recognises his dedication, and skill in collecting the information and presenting it in a readable form for all amateurs.

2. **Technical Award to Guy Fletcher, VK2KU**

for his article "Boom Corrections to Element Lengths of Yagis at 144, 432 and 1296 MHz", published in the March 1999 issue on page 11

Action for the month: John Moyle Field Day

Think about it, and then do something about participating. It is surprising what a few whips on a roof rack or gutter or magnet mounted can do on the right bands at the right time of day.

Y2K – (Hopefully) the Last Word

The world didn't end, nor were there any decent computer-induced catastrophes to report. The lights stayed on (unless you happened to be unlucky enough to live in Gambia); a few military satellites lost their carefully harvested spy data; several nuclear power plants suffered minor malfunctions, without compromising anyone's safety (they said), a few airport radar systems, dialysis machines, and plastic card eaters spat the dummy, but for the most part, life has carried on.

There were few communication problems to report (as of 9th January as I write this). From my vantage point overlooking Sydney harbour, the only technical problem I noticed was that my GSM cellphone reported "no signal" – hardly surprising given a million or so people nearby at least some of whom felt the need to tell someone how good the fireworks looked. In contrast, landlines appeared to be okay (at least there was a dialtone). Had the phone system been totally incapacitated, I'm not sure that Amateur Radio would have helped, unless the accursed pagers that plague two metres were to fall silent as well!

Many were disappointed, not least of which the journalist hoping for juicy stories to fill their papers. Others have

complained that it was all a con, still others pleased that the money spent fixing defective software was spent well. (I fall into this last category, having seen the devastating effects of the bug when testing some fixes back in 1998.) Anyway, it seems to be all over bar the shouting, at least until 29th February...

Radio Amateurs were active in many parts of the world, having been requested to monitor the situation and to provide backup communications should the need arise. In Australia, the only official Amateur involvement reported so far was in VK3, where WICEN Victoria was on standby to provide emergency communications; for details of VK3 WICENs extensive preparations, see their web page at <http://www.vic.wicen.org.au/>.

continued next page



Comment

Federal President, Peter Naish
VK2BPN.

Morse proficiency: necessary or obsolete?

The hottest topic of the month is again The Morse Code. Or rather, the need to demonstrate a proficiency in sending and receiving Morse code before one is allowed to operate on the HF Bands.

As most of you know by now, the FCC in the USA has changed the rules to reduce the number of licence grades to just three, with a maximum speed requirement of 5 WPM for those licences which permit HF band operation. This closely followed a change in the UK where their licencing authority has introduced a HF licence with a 5 WPM examination. Clearly, the move has begun overseas to phase down the long-standing requirement for stringent Morse code proficiency.

With this movement it is inevitable, that here in Australia, we should be looking seriously at our situation regarding Morse code. The WIA is taking a leading position and there has already been dialogue with ACA to sound out the feeling of our regulators. As expected, they are well aware of the world movements. They have expressed a wish to work closely with WIA to review the Australian licence requirements and implement any changes, which may be appropriate. The WIA Federal Council through its ACA Liaison Committee is preparing, as a matter of urgency, its strategy in regard to 5-WPM code speed. This is expected to reflect the current strong opinion from Australian amateurs generally that a reduction in the speed of the Morse code examination should be made as soon as possible.

The complete abolition of the need to pass a Morse code examination before being granted HF Band privileges is still

some way off. The ITU treaty, that establishes the Amateur Radio service, may not be varied for a number of years yet. It is however high on the list of subjects for discussion within the IARU, the body that represents amateur radio in the international arena. The IARU, together with member organisations such as WIA, will be working closely with ITU delegates to ensure that popular views in regard to Morse code are presented at forthcoming WRC meetings. This is one issue that concerns all Australian amateurs, whatever their interests and whether WIA members or not. It is good that we can work together for our mutual benefit.

A final comment - Morse code is alive and well, as anybody who takes the time to listen on the HF bands will find. It is the preferred mode of operation of many amateurs worldwide. Much of the most exotic DX is best available on CW. However, with the demise of Morse code in commercial and government telecommunications, there is now little logic in mandating a need to demonstrate Morse code proficiency as a prerequisite to HF Band amateur radio operation. The argument is not for or against Morse code, but for or against Morse code examinations. My personal opinion is that the abolition of Morse code examinations is only a matter of time.

During the next week or so I will be in a better position to bring you news of the WIA's activities in respect of this very important matter,

FCC restructures US Amateur Licences

Three license classes, one code speed (5 wpm)

The FCC has issued its long-awaited Report and Order on amateur licensing restructuring. The bottom line is that starting April 15, 2000, there will be three license classes—Technician, General, and Amateur Extra—and a single Morse code requirement—5 WPM.

"We believe that an individual's ability to demonstrate increased Morse code proficiency is not necessarily indicative of that individual's ability to contribute to the advancement of the radio art," the FCC said.

Besides drastically streamlining the Amateur Radio licensing process, the FCC said its actions would "eliminate unnecessary requirements that may discourage or limit individuals from becoming trained operators, technicians, and electronic experts."

Although no new Novice and Advanced licenses will be issued after the effective date of the Report and Order, the FCC does not plan to automatically upgrade any existing license privileges. The ARRL had proposed a one-time, across-the-board upgrading of current Novice and Tech Plus licensees to General class, but the FCC declined to adopt the idea. This means that current licensees will retain their current operating privileges, including access to various modes and subbands, and will be able to renew their licenses indefinitely.

Starting April 15, 2000, individuals who qualified for the Technician class license prior to March 21, 1987, will be able to upgrade to General class by providing documentary proof to a Volunteer Examiner

Coordinator, paying an application fee, and completing FCC Form 605.

The FCC's decision not to automatically upgrade Novice and Tech Plus licensees means the current Novice/Tech Plus HF subbands will remain and not be "refarmed" to higher class licensees as the ARRL had proposed. The FCC said it did not refarm these subbands because there was "no consensus" within the amateur community as to what to do with them. The FCC decided to lump Technician and Tech Plus licensees into a single licensee database, all designated as "Technician" licensees. Those who can document having passed the 5 WPM Morse code examination will continue to have the current Tech Plus HF privileges. The FCC said it may request documentation from a licensee or VEC to verify whether a licensee has passed a telegraphy examination.

The FCC action also authorizes Advanced Class hams to prepare and administer General class examinations, and eliminates Radio Amateur Civil Emergency Service (RACES) station licenses. RACES will remain, however.

Under the new licensing scheme, there will be four examination elements. Element

1 will be the 5 WPM Morse code exam. Element 2 will be a 35-question Technician exam; Element 3 will be a 35-question General exam; and Element 4 will be a 50-question Amateur Extra exam. The FCC has left it in the hands of the National Conference of VECs Question Pool Committee to determine the specific mix and makeup of written examination questions.

Elimination of the 13 and 20 WPM Morse requirements means an end to physician certification waivers for applicants claiming an inability to pass the Morse code examination due to physical handicap.

The FCC disagreed with the League's suggestion that it undertake a restructuring of operating privileges along with licensing restructuring. The Commission said it wanted to "reach a consensus" regarding new technologies before it tried to restructure amateur operating privileges and frequencies.

A copy of the entire Report and Order (FCC 99-412) is available at <http://www.arrl.org/announce/regulatory/wt98-143ro.pdf> or at http://www.fcc.gov/Daily_Releases/Daily_Business/1999/db991230/fcc99412.txt

(from ARRL Bulletin 96, 30 December 1999)
/EX

Catch an Intruder in 2000

Tom Walker VK4BTW the VK4 Coordinator, extends an open invitation to all Amateurs who value our Spectrum Space to file reports on non-Amateur activities heard on ANY of our Bands.

To that end there is an Intruder Watch Net held weekly on Fridays at 0700 UTC, on 3.578 MHz +/- QRM. Here is an ideal place to exchange information and ideas regarding experiences in logging and dealing with intruders. Feel free to join in; you will be most welcome, it's a good place to start if you wish to help in this Service.

Contact by Packet :- VK4BTW @ VK4WIP.#IPS.QLD.AUS.OC or by Post:

Reply Paid No. 73

T.A. Walker

13 Bothwell St.

TOOWOOMBA Qld. 4350

TAPR Releases Draft APRS Protocol Specification

The APRS (Automatic Position Reporting System) Working Group has completed the second public draft of the APRS Protocol Specification.

This document covers the core functionality of APRS Protocol Version 1.0 as it works today. This is the base-level specification that all implementations should comply with. It was adopted unanimously by Working Group members, who include the authors of APRS-DOS, WinAPRS, MacAPRS, X-APRS, PocketAPRS, APRS+SA, javAPRS, and APRServe, and the developers of the Mic-E and Pic-E products.

The Specification now includes packet format diagrams, the APRS symbol tables, full details of the Mic-E encoded format, the compressed latitude/longitude position format, plus weather report and telemetry

formats. Above all, the Specification contains many examples of how APRS data is formatted to make it easier to understand.

The APRS Protocol Specification draft now is available as an Adobe PDF file at <http://www.tapr.org/tapr/html/Faprswg.html>. Comments, criticisms and suggestions for improvement are invited, and the document includes details on how to file comments.

The APRS Working Group will issue the final approved version of the Specification as soon as possible after it considers all comments

(John Ackermann, N8UR, in the ARRL Letter 18.48, dated 10 December 1999)

United Kingdom: Amateur Radio and the Internet

Ian Abel G3ZHI reports that since the UK's regularity body, RA's earlier announcement that radio amateurs will be able to connect to the Internet, these facilities have now been agreed following consultation with the Radio Society of Great Britain (RSGB). The initial phase of experimentation will allow

1. Linking of repeaters to non-amateur networks

2. Linking of Mailboxes, existing SysOps will be able to apply for an extension to their Mailbox Notice of Variation to allow connection to non-amateur networks.

3. Remote Control of Repeaters

The RA locally in Nottingham has allowed on a temporary and experimental basis a local simplex link between Internet

Iphone chat group and 437.5MHz output.

So if you hear or see Aidey G7WFM's callsign in Iphone or on your Repeater call him!

This is one of the first such experiments following the RA's announcement recently to allow Internet access between radio amateurs worldwide via Internet.

g3zhi/g4njh via QNEWS

ar

CLUB NEWS

News from the Moorabbin & District Radio Club

Peter Parker VK3YE, Publicity Officer
parkerp@alphalink.com.au (03) 9569 6751

MDRC interviewed on 3RPH

More people now know about the MDRC and amateur radio thanks to an interview on community radio station 3RPH. The interview was first broadcast on Sunday December 19 and was repeated on Monday December 20.

The 13-minute interview was part of 3RPH's 'Feedback' show - a program on developments in radio communications and broadcasting. It covered past and present activities of the MDRC. The interview was

conducted by Laurie Walters VK3DPD, the program's producer.

3RPH is a community radio station run by the Vision Australia Foundation - a non-profit support group for blind people. The station is run almost entirely by some 400 volunteers. Volunteers do research, collate material to be read out, do on-air readings and carry out interviews. If you'd like to offer yourself for a few hours a week, phone the station on 9864 9333.

Hobby Show

A date has been set for the next St Kilda Hobby Show. The show will be held on Saturday February 26 between 11am and 7pm. The venue will be the same as last time - the Army hall, 8 Chapel Street, St Kilda.

The MDRC ran an amateur radio station at the first Hobby Show, held last November. The photograph shows our exhibit at the show. We plan to be there again this month, and hope that other amateur clubs will also be present. Information on the show appears at

URL: <http://www.skyboom.com/original/hbbyshow.html>

Radio on Rails Results

Results for October's Radio on Rails have been released and appear below:

Section A - Transmitting Mobile

1. VK3JED 91
2. VK3YE 85
3. VK3KBD 19

Section B - Receiving Mobile

1. Craig White 22

Section C - Transmitting Home

1. VK3TYR 30
2. VK3CAT 28
3. VK3GK 12
4. VK3JWT 10

Section D - Receiving Home

1. Craig White 7

Winning stations and placegetters should have received certificates by the time they read this. Thanks to those who participated and made Radio on Rails a success. The rules seemed to work well, and no changes are proposed. The next event is planned for early April - more details next month.



MDRC's stall at November's St Kilda Hobby Show. In the picture are Craig (SWL) and Keith VK3JNB.



October 1999 Radio on Rails participants. L to R - Tony VK3JED, Peter VK3YE, Darryl VK3HEM, Craig (SWL), Paul VK3ALE, Terry VK3KBD.

News from AHARS

THE ADELAIDE HILLS AMATEUR RADIO SOCIETY MEMBERS have been invited to join the South Coast Radio Club for a barbecue on Jan19th. That should be an interesting evening as it also includes a talk about the visit to the Dayton Hamfest made by four intrepid VK5 amateurs in 1999.

We are fortunate to have Rob VK5RG as our Program organiser again this coming year so we can look forward to a year of interesting, mostly technical lectures if previous years are any indication. Rob has many contacts with people doing interesting things.

In February, to follow the AGM we have Graham VK5ZFZ talking about loudspeakers, which should open a few eyes. We all use loudspeakers but few of us know the ins and outs of their versatility and how to repair them when they misbehave.

Circuit Simulation using Spice or PSpice

by Phil Rice VK3BHR
Lot 601K Durston's Rd.
Maiden Gully Vic. 3551

When designing a new RF circuit, it is often useful to build a prototype. This can become a bit tedious when iteratively refining a design. An alternative is to simulate the circuit on a computer so you know what you are practically aiming at.

There are a number of circuit simulation programs available, the latest of which offer integrated schematic capture and component databases.

PSpice was one of these (the company that produced it, Microsim, has been bought out and PSpice is no longer produced). Evaluation versions of PSpice suitable for nearly any PC or compatible (or Macintosh too) can be found on the Internet.

To make this information as widely useful as possible (we don't all have the latest Pentium boxes) I will avoid the latest graphic window dressing (circuit capture from schematics) and concentrate on text input of the circuit. I feel this isn't a backward step as PSpice circuit descriptions are easy to put together. Each component is described by a name, connection points (nodes) and value or a model description.

PSpice is capable of a number of types of simulation (nonlinear dc, nonlinear transient, and linear AC analyses) on circuits containing resistors, capacitors, inductors, mutual inductors, independent voltage and current sources, four types of dependent sources, transmission lines, and the four most common semiconductor devices: diodes, BJT's, JFET's, and MOSFET's.

Linear AC analyses will be the most useful, so that's the one we will look at in a bit of detail. PSpice will do a nonlinear DC analysis when analysing a semiconductor circuit (to find the quiescent conditions), so you get that for free.

To begin, you need a circuit diagram (Figure 1). Number the points of interconnection (the nodes). Ground must be node zero and you can't have more than 64 nodes in the evaluation version of PSpice.

Next, name all the components (Figure 1 again) but see Table I for the rules. For each component you need

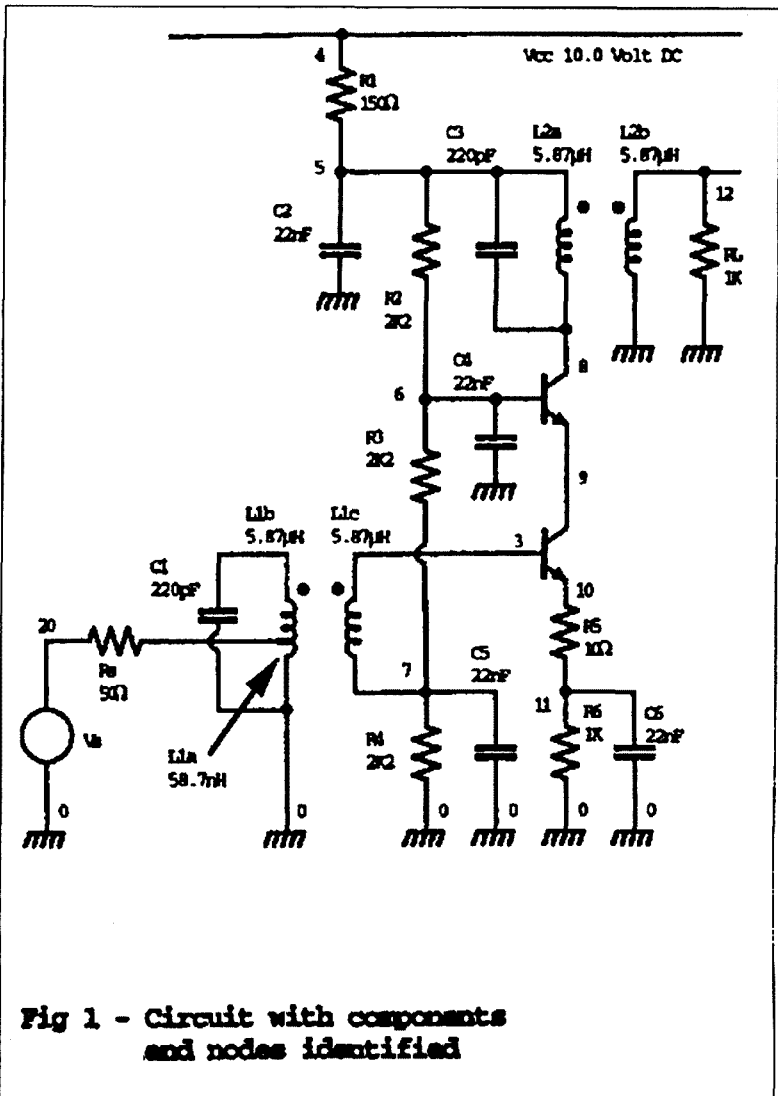


Fig 1 - Circuit with components and nodes identified

Intermediate frequency cascode amplifier

Vcc 4 0 DC 10.0V

* Simulate signal source

Vs 20 0 AC 1.0V

Rs 20 1 50.0

* Bias resistors

R1 4 5 150.0

R2 5 6 2200.0

R3 6 7 2200.0

R4 7 0 2200.0

R5 10 11 10.0

R6 11 0 1000.0

* Input tuned circuit

* Turns ratio

* L1a:L1b:L1c = 1:10:10

* "Tight coupling"

C1 2 0 220.0pF

L1a 1 0 0.0587uH

L1b 2 0 5.87uH

L1c 3 7 5.87uH

K1ab L1a L1b 0.9

K1bc L1b L1c 0.9

* Bypass capacitors

C2 5 0 22.0nF

C4 6 0 22.0nF

C5 7 0 22.0nF

C6 11 0 22.0nF

* Cascode transistors

Q1 9 3 10 PN2222A

Q2 8 6 9 PN2222A

* Output tuned circuit

* Turns ratio

* L2a:L2b = 1:1

* "Tight coupling"

C3 5 8 220.0pF

L2a 5 8 5.87uH

L2b 12 0 5.87uH

K2ab L2a L2b 0.75

* "Load" simulates effect of

* next stage

RL 12 0 1000.0

.ac lin 51 4.00MegHz 4.50MegHz

.print ac vdb(12)

.probe

```
.model PN2222A NPN( Is=14.34f
+ Xti=3 Eg=1.11 Vaf=74.0 Bf=256
+ Ne=1.307 Ise=14.34f Ikf=.2847
+ Xtb=1.5 Br=6.0 Nc=2 Isc=0
+ Ikr=0 Cjc=7.3p Mjc=.3416
+ Vjc=.75 Fc=.5 Cje=22.0p
+ Mje=.377 Vje=.75 Tr=46.9n
+ Tf=410p Itf=.6 Vtf=1.7
+ Xtf=3 Rc=1 Rb=10)
```

.end

Fig 2 - SPICE input file

one statement consisting of the name, node numbers and value (or for semiconductors, a model name). Figure 2 is the PSpice input file for the circuit of Figure 1. Component values include the most common abbreviations for multipliers. Any extra parts of the value are treated as comments - ie. ignored, so you can for example use μF , pF etc. and it will work OK. PSpice will use the very first statement as a title on its output listing, so if you forget the title statement, PSpice will steal the first component from your circuit and then complain about its absence.

For each type of semiconductor, you will need a "dot Model" statement. Unless you are trying to do accurate modelling, the default statements given in table 1 will be OK. Sometimes more accurate models can be got from semiconductor manufacturer's Internet Web pages. The PN2222 model of Figure 2 will do for most "general purpose small signal" NPN silicon transistors.

Finally, you need some control statements to set the frequency range for the linear AC analyses and to specify the required output.

Figure 3 is an example of part of the text output available from PSpice (edited

severely to fit). There's a lot more information in the listing.

Figure 4 is a graph produced by the "Probe" program that accompanies PSpice. To generate data for this program to graph, just include the statement "dot probe" in your PSpice input file (see Figure 2). Probe is a menu driven program and fairly easy to use. When it asks you to "Enter variables or expressions ..." you can enter variable names as for the "dot plot" or "dot print"

continued next page

<p>CheckList</p> <ol style="list-style-type: none"> 1. Draw circuit 2. Name components 3. Number nodes 4. Component statements 5. Device models 6. Control statements <p>Component values:</p> <p>Numbers may be integer, floating point, or scientific with or without a scale factor of:</p> <p>T=1E12 G=1E9 MEG=1E6 K=1E3 M=1E-3 U=1E-6 N=1E-9 P=1E-12 F=1E-15 MIL=25.4E-6</p> <p>Letters which are not scale factors are generally ignored.</p> <p>Basic components:</p> <p>Rooooox NI N2 VALUE Cooooox N+ N- VALUE Looooox N+ N- VALUE</p>	<p>Diodes</p> <p>DXXXXXX N+ N- MNAME .MODEL MNAME D IS=1.0E-13 RS=1 CJO=3.3pf</p> <p>NAME PARAMETER DEFAULT TYPICAL</p> <p>RS Ohmic resistance 0 10 CJO Zero bias junction capacitance 0 2pf IS Saturation current 1.0E-14 1.0E-14</p> <p>Transistors</p> <p>QXXXXXX NC NB NE MNAME .MODEL MOD1 NFN BF=80 BR=0.02 IS=1.0E-16 CJC=0.1pf</p> <p>NAME PARAMETER DEFAULT TYPICAL</p> <p>BF Forward beta 100 200 BR Reverse beta 1 0.1 RB Base ohmic resistance 0 100 RC Collector ohmic resistance 0 10 RE Emitter ohmic resistance 0 1 CJE Zero bias B-E junction capacitance 0 2pf CJC Zero bias B-C junction capacitance 0 1pf IS Saturation current 1.0E-14 1.0E-14</p> <p>A silicon device is assumed unless otherwise specified.</p>
<p>Coupled Inductors</p> <p>Kooooox L1L2L3 VALUE</p> <p>VALUE is the coefficient of coupling between L1L2L3 and L4L5L6. 0 < VALUE <= 1.0</p> <p>Using the 'dot' convention, place a 'dot' on the first node of each inductor.</p> <p>Remember L=NPN</p> <p>If you have a turns ratio of 4:1 the inductor values will have a 16:1 ratio.</p> <p>Independent Sources</p> <p>VXXXXXX N+ N- DC value AC value IYYYYYY N+ N- DC value AC value</p> <p>N+ and N- are the positive and negative nodes, respectively. Sources need not be grounded.</p> <p>Positive current is assumed to flow from positive node, through the source, to the negative node. A current source of positive value, will force current to flow from the N+ node, through the source into the N- node.</p> <p>Voltage sources, in addition to being used for circuit excitation, are the 'ameters' for SPICE, that is, zero valued voltage sources may be inserted into the circuit for the purpose of measuring current. They will have no effect on circuit operation since they represent short-circuits.</p>	<p>The parameters are optional. The .MODEL statement can be as short as: .MODEL MNAME D</p> <p>Which is a rough approximation to a "small signal" diode.</p> <p>The parameters are optional. The .MODEL statement can be as short as: .MODEL MNAME NFN or RNP</p> <p>Which is a rough approximation to a "small signal" transistor</p>
<p>AC Statement</p> <p>.AC DEC ND FSTART FSTOP .AC OCT ND FSTART FSTOP .AC LIN NP FSTART FSTOP</p> <p>DEC stands for decade variation, and ND is the number of points per decade. OCT stands for octave variation, and NO is the number of points per octave. LIN stands for linear variation, and NP is the number of points.</p> <p>If this statement is included in the file, SPICE will perform an ac analysis of the circuit over the specified frequency range. In order for this analysis to be meaningful, at least one independent source must have been specified with an ac value.</p> <p>.PRINT or .PLOT Statement</p> <p>.PRINT or .PLOT AC or DC Variable_List</p> <p>eg. .PRINT AC VM(4,2) VR(7) VP(8,3) .PLOT DC V(2) I(VSRC) V(23,17)</p> <p>This statement produces a tabular listing or graph of one to eight output variables.</p> <p>V(N1,N2) specifies the voltage difference between nodes N1 and N2. If N2 is omitted, ground (0) is assumed.</p> <p>For the ac analysis, five additional Outputs can be accessed by replacing the letter V by: VR - real part, VI - imaginary part, VM - magnitude, VP - phase, VDB = 20*log10(magnitude) I(VXXXXXXX) specifies the current flowing in the independent voltage source named VXXXXXXX. Positive current flows from the positive node, through the source, to the negative node. For the ac analysis, the corresponding replacements for the letter I may be made in the same way as described for voltage Outputs.</p>	<p>The parameters are optional. The .MODEL statement can be as short as: .MODEL MNAME D</p> <p>Which is a rough approximation to a "small signal" diode.</p> <p>The parameters are optional. The .MODEL statement can be as short as: .MODEL MNAME NFN or RNP</p> <p>Which is a rough approximation to a "small signal" transistor</p>
<p>AC Statement</p> <p>.AC DEC ND FSTART FSTOP .AC OCT ND FSTART FSTOP .AC LIN NP FSTART FSTOP</p> <p>DEC stands for decade variation, and ND is the number of points per decade. OCT stands for octave variation, and NO is the number of points per octave. LIN stands for linear variation, and NP is the number of points.</p> <p>If this statement is included in the file, SPICE will perform an ac analysis of the circuit over the specified frequency range. In order for this analysis to be meaningful, at least one independent source must have been specified with an ac value.</p> <p>.PRINT or .PLOT Statement</p> <p>.PRINT or .PLOT AC or DC Variable_List</p> <p>eg. .PRINT AC VM(4,2) VR(7) VP(8,3) .PLOT DC V(2) I(VSRC) V(23,17)</p> <p>This statement produces a tabular listing or graph of one to eight output variables.</p> <p>V(N1,N2) specifies the voltage difference between nodes N1 and N2. If N2 is omitted, ground (0) is assumed.</p> <p>For the ac analysis, five additional Outputs can be accessed by replacing the letter V by: VR - real part, VI - imaginary part, VM - magnitude, VP - phase, VDB = 20*log10(magnitude) I(VXXXXXXX) specifies the current flowing in the independent voltage source named VXXXXXXX. Positive current flows from the positive node, through the source, to the negative node. For the ac analysis, the corresponding replacements for the letter I may be made in the same way as described for voltage Outputs.</p>	<p>The parameters are optional. The .MODEL statement can be as short as: .MODEL MNAME D</p> <p>Which is a rough approximation to a "small signal" diode.</p> <p>The parameters are optional. The .MODEL statement can be as short as: .MODEL MNAME NFN or RNP</p> <p>Which is a rough approximation to a "small signal" transistor</p>

Table 1

Intermediate frequency cascode amplifier

**** SMALL SIGNAL BIAS SOLUTION TEMPERATURE = 27.000 DEG C

NODE	VOLTAGE	NODE	VOLTAGE	NODE	VOLTAGE	NODE	VOLTAGE
(1)	0.0000	(2)	0.0000	(3)	3.1098	(4)	10.0000
(5)	9.4253	(6)	6.2517	(7)	3.1098	(8)	9.4253
(9)	5.5841	(10)	2.4418	(11)	2.4176	(12)	0.0000
(20)	0.0000						

.....

FREQ	VDB(12)
4.000E+06	3.928E+01
4.010E+06	4.001E+01
4.020E+06	4.074E+01
4.030E+06	4.144E+01
4.040E+06	4.211E+01
4.050E+06	4.273E+01
4.060E+06	4.328E+01
4.070E+06	4.374E+01
4.080E+06	4.410E+01
4.090E+06	4.435E+01
4.100E+06	4.449E+01
4.110E+06	4.454E+01

Fig 3 - part of SPICE output listing.

continued from previous page

statements. You can even enter simple equations using these variables.

Conclusion

The accuracy of the simulation depends on how well the "PSpice Circuit" matches reality. It's difficult to accurately model semiconductors at high frequencies, so don't try to model power amplifiers. For passive circuits such as filters and tuned circuits, it seems easy to get a good simulation of reality. I find it easier to experiment with circuits using PSpice, than to build the "real thing".

ar

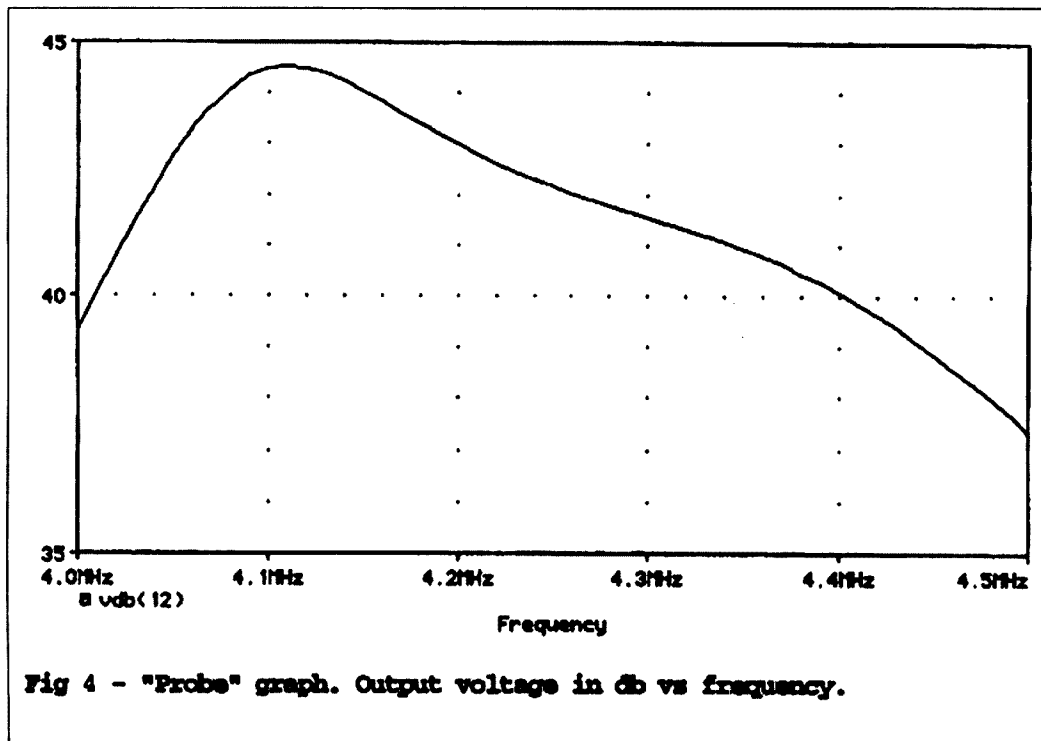


Fig 4 - "Probe" graph. Output voltage in db vs frequency.



Divisional Notes

VK1 Notes

Peter Kloppenburg VK1CPK

Forward Bias

As most of the members are aware, the Annual General Meeting (AGM) will be held on February 28, 2000 at the Griffin Centre, Civic, Canberra City. On that occasion committee members report on what happened during the previous year in their respective portfolios and their view towards the future.

During the proceedings, members of the committee will stand down and a new committee will be selected for the coming year. There are nine positions on the committee; President, two Vice-Presidents, Treasurer, Secretary, Immediate Past President, and three ordinary committee members.

Just as with State and Federal Governments, a number of functions will to

be taken care of by individual members of the committee. They include Membership officer, WICEN coordinator, Education officer, Federal WIA Representative, Public relations officer, QSL Manager, Deceased Estate officer, Surplus Sales officer, Welcome officer, Broadcast officer, and Intruder Watch officer.

A really efficient division is supported by its members performing additional functions such as Slow Morse coaching, JOTA liaison, ALARA liaison, Contests and Awards officer, Seminars, Forums & Workshops coordinator, Novice Course coaching, A.R. Forward Bias writing, and Web Master of the Division's web site.

In line with other Divisions, the ACT has

now appointed a Chairman for the ACT Technical Advice Committee, also known as ATAC. Any member who specialises in a particular field of communications or other field affecting Amateur Radio could become a member of this sub-committee. ATAC fulfills a number of functions such as bandplanning, EMC & Interference advice, Repeater & Beacon application approvals, and Licencing advice, etc, etc.

Many of these functions can be performed by members having an average range of experience in Amateur Radio. Obviously, the elected committee cannot do everything itself, but needs the active support of the members. If you feel you want to take up any of the functions mentioned above and help yourself and the Division, contact the President, Gilbert Hughes on (02) 6254 3266. Nomination forms for election to the committee are available from the Secretary, Peter Kloppenburg on (02) 6231 1790, or at the AGM.

VK2 Notes

Pat Leeper VK2JPA

patleep@bigpond.com

Members are reminded that the Annual General Meeting of the VK2 Division will be held on Saturday 15th April at Amateur Radio House, 109 Wigram Street, Parramatta. Nominations for Council and Motions on Notice will close on Saturday 4th March at 12 noon at the office at Amateur Radio House, Parramatta. Nomination forms for Council will be available from the office.

The first examinations for 2000 will be

held on Sunday 20th February, with applications closing on Thursday 10th February. Application forms are available from the VK2 office.

The next Affiliated Clubs Conference will be on Saturday 6th May 2000, and follows a very successful conference held November last.

The December meeting of the Council was very much a "housekeeping" meeting as to be expected at the close of the year.

For those who use the video library, the Council has ordered a set of the ARRL videotapes. When these arrive, they will become available for loan to affiliated clubs and individual members. Some of these are historical in nature, with at least one including Ross Hull when he worked for the ARRL, and others are of various amateur activities up to the present day.

The VK2 Division will be represented at the Central Coast Amateur Radio Club Field Day at Wyong again this year with the bookshop and deceased estate items. Come along and see the range of publications — the bookshop has something for everyone with amateur radio interests.

VK3 Notes

From: WIA Victoria vk3wi@rint.com.au

Harmonise the code licence standard – WIA Victoria

The Morse code proficiency test speed for Australian amateur radio licence qualifications should be 5 words per minute, says WIA Victoria, in response to the "winds of change" in Europe, North America and Africa.

WIA Victoria said that past surveys have shown that its members (and WIA members nationally) supported retention of the Morse code licence requirement, although support has declined steadily.

WIA Victoria President, Jim Linton VK3PC, said that Morse code as a mandatory licence requirement has been the most consistently debated topic in our

hobby for five decades. The WIA Victoria, after considering a clear international trend during the past two years, and the views of its members in the last survey, is now supporting 5 words per minutes as the standard for all HF licences.

"It makes no sense for Australia to maintain its 10 words per minute standard when the United States has opted for five, and other nations or radio societies are considering similar measures," he said.

He was referring to a series of announcements over the past 18 months, the latest being by the US Federal Communications Commission in December 1999, that

from April 2000, 5wpm will be the only code test speed for licences in the United States.

The Radio Society of Great Britain (RSGB) announced its policy in May 1998 that the code requirement be abolished, but as an interim measure 5 words per minute be an option for access to the HF bands by British radio amateurs. The RSGB has since achieved the introduction of a HF licence making 100W pep privileges available to those who qualify at 5 wpm. South Africa and Sweden are also among those proposing the lowering the code requirement to 5 words per minute.

While the International Radio Regulation S25.5 is a convention requiring a Morse code proficiency for operation below 30MHz, it does not specify a speed. Removal of S25.5 will require a decision at a World Radio Conference

VK4 Notes — QNEWS

By Alistair Elrick VK4FTL
WIAQ Councillor and QTC Editor

Amateur Radio Funday 2000

The Funday 2000 on Sunday 20th February (the weekend before Gosford Field day) is shaping up to be a very entertaining event. Brian Beamish VK4BBS is hoping attendees have those Crystal sets up and running and the foxhunters ready to fire up. The site at Centenary Lakes Park on Morayfield Road (UBD Map 57 Q-2) is ideal for FUNDAY 2000. It has shelters, toilets, playing area for children and lots of parking. Caboolture Station is a comfortable 10 minutes walk away. Why not go train mobile?

It starts 10.30am, finishing around 3-3.30pm. The Caboolture Club President Mark VK4VG and his team have been burning the midnight oil to make this day a success; so bring the family. You will not be disappointed. The local Council required a \$300 security deposit on the area which Caboolture have kindly offered to cover.

There are camping facilities for \$3 per person per night at the local Scout Camp on Caboolture River Road, an easy 10-minute drive from the Funday site. There is room for tents, caravans and camper trailers plus a 13-bed dormitory and a large hall with full cooking facilities. The site has all conveniences, toilets and showers. There is a BBQ on Saturday night for campers: sausages, hamburgers & steaks plus salads, bread and tea & coffee for \$5.00 per person. BYO any other drinks including beer or wine. Breakfast Sunday is \$2.00 per person — notify Brian VK4BBS before 4pm on

Saturday 19th February. Contact him via the WIAQ Office, Email, fax or phone.

What's at the Funday?

Free Electric BBQ's (BYO Drinks and Eats). Play area for the kiddies. Pleasant Walks, Fox Hunts, Club Station (on air). Crystal Set competitions. Pipe Band, Dancers and a singer plus more. Eyeball contacts.

As last year, all attending will be asked to donate a gold coin, or more, for the Royal Flying Doctor Service.

Now get those Crystal sets up and running! An aerial and earth will be provided to enable the Judges to evaluate the Xtal sets:

1. The Most Unique Working Crystal set
2. The Most Humorous Working Crystal Set
3. The Best Short-wave receiving Crystal set
4. The Best Crystal set built by a 13 year old or younger
5. Peoples Choice, where YOU get to pick YOUR favourite.

The WIA Bookshop will have a display but there will be no sales. This is a get-together and display event only for promotion and advancement of Amateur Radio. Clubs or Groups are invited to put on a small demonstration or club display. See you there!

The new WIAQ Inc

A chapter of the VK4 Division will close on 24th January with the wind up of the old WIAQ as a Company. The AGM of the new WIAQ Inc. will be held on 25th March, the new chapter continuing into 2000 and

beyond. It is hoped that there will be sufficient nominations for 2000-2001 Council so all positions can be filled. Note that the Council nominations need not only come from SE Qld area resident members. Telephone conferencing will continue to involve all sections of the Division.

While the VK3 10m beacon on 28.2565 MHz is fully operational from 30 km NE of Melbourne and VK4RTL beacon in Townsville on 28.270 MHz has been refurbished and putting out 5 Watts, they can possibly not be heard consistently at each other's location. Nevertheless good 10m contacts have been made between VK3 and VK4 during the early part of this summer. The local Brisbane 10m repeater on 29.660 MHz, which is linked to the Southside 2m repeater on 147.075 MHz, has been very well utilised when openings are on to VK3 and VK5. The local activity on the 2m side will pass to the 10m repeater so it does have the effect of a beacon. But it is always worth a CQ call to see if the band is open, even if you can't hear the Beacons.

Remember, if your Club or Group has an event coming up, contact QNEWS or QTC to publicise it. Give at least 2 month's notice to QTC because of lead-time on publication. One month is required for QNEWS, so it can be repeated over several broadcasts, closer to the event date. This is open to all sources.

QNEWS

Email: qnews @ powerup.com.au or
Packet: QNEWS @VK4WIA.BNE.QLD.AUS.OC
QTC

Email: qtc@wiaq.powerup.com.au
or by Post to PO Box 638 GPO Brisbane
Qld 4001 and mark the envelope attn
QNEWS or QTC.

73's from Alistair

VK6 Notes

Notice of the Annual General Meeting for 2000

It is hereby notified that the Annual General Meeting of the Wireless Institute of Australia (Western Australian Division Incorporated) will be held from 10am on Saturday 15th April 2000 prior to the 3rd Gathering of Clubs followed by a social afternoon. Non-members welcome.

The venue for these events will be the R.S.L. Hall on the corner of Fred Bell Parade and Playfield Street, East Victoria Park.

The agenda will be:

1. Consideration of the Council's annual report
2. Consideration of the financial report
3. Consideration of other reports
4. Election of office-bearers (President, Vice President and seven other Councillors)

5. Election of two Auditors
6. Appointment of a Patron
7. General business which has been duly notified.

Notices of Motion for the AGM must be received by the Secretary not less than 42 days prior to the meeting (ie by 4th March 2000), and must be signed by at least three members.

The Secretary's postal address is WIA WA Div. PO Box 10 West Perth WA 6872.

Nominations of candidates for election to Council must be received by the Secretary, in writing, not less than 42 days prior to the meeting (ie by 4th March 2000), with an intimation that the candidate is willing to act.

A candidate may submit a statement, not

exceeding 200 words, outlining his or her experience and case for election. Each nomination shall be signed by two members proposing the candidate. Candidates must possess a current licence.

Any financial member who is entitled to vote may appoint a proxy, who must also be a financial member who is entitled to vote, to speak and vote on his or her behalf. Written notice of such proxy must be received by the Secretary prior to the meeting, and be in the following form:

"I (*full name*), a member of the Institute, hereby appoint (*full name*), also a member of the Institute, to act for me as my proxy, and in my name do all things which I myself being present could do at the meeting of the Institute held on the 15th April 2000.

Signed:

Witness:

Date: "

VK7 Notes

End of Year in NW VK7

The VK7 end of year activities were well attended. The accompanying photographs were taken at the Tasmanian Division (North-West Branch) Annual Christmas Dinner. The occasion was used to present the Joan Fudge Memorial Award for service to the Division to the Treasurer Terry Ives, VK7 ZTI. This was reported in the January 2000 VK7 Notes. Joan Fudge was a very good Branch Secretary in the early 80's. She died of cancer and the Division decided to remember her with this Service Award.

Thanks to all of you.

ar



The VK7 Branch President, Robert McCullough, VK7MGW presenting the Joan Fudge Memorial Award for service to the Branch in 1999 to VK7 Treasurer Terry Ives, VK7ZTI. Refer January AR 2000



Two Launceston (Northern Branch) visitors, Terry Brundle, VK7U, and XYL Silvia.



Three Old Lags, Bob Cropper, VK7BY, Syd Medford, VK7SF and Ken Hancock, VK7KH.



VK7 State and Branch Secretary (also FTAC) Tony Bedelph, VK7AX flanked by XYL Rosemary and Max Hardstaff, VK7KY.



VK7 JOTA co-ordinator, Kirby Cunningham, VK7KC and XYL Gai, VK7NGC

Taking Tea with the Ladies

(and any gentlemen who care to come along)

Gippsland Technical Symposium July 1999, Spouses' Tour

Pauline Corrigan VK3XBG's YL

I would like to let the wives know about our Spouses' Tour held on 10 and 11 July while the men were busy learning technical stuff.

It started last year, and two came back this year, Ruth from Oakleigh and Sigrid from Canberra. There were nine in all.

Saturday

We started with a drive to Yarragon, where we browsed through the antique stores and gift shops. We had lunch at the Yarragon Hotel before driving to Jindivik to buy some smoked meat from the smoke house. This is also a great place for afternoon tea.

The countryside here is magnificent. From there we went to Neerim South to the cheese factory for afternoon tea, and to buy a selection of cheeses. Then I had to head back to Churchill to go to work at 6pm. The weather was fantastic.

Sunday

We went to Morwell Sunday market for a browse. The weather was a bit overcast and



by the time we were ready to go, the rain had started. We drove to Traralgon to go to the cheese factory, but it was closed. We checked the Traralgon antique shops before heading back to Churchill for a barbecue lunch with the men.

Next year

We will be going to a winery up in the hills where we will get to taste some fine wines and sample some of the best Black Forest cake I've ever tasted. The spouses have also asked if I will open up my home as I own approximately 3,500 clocks besides the other antique junk I collect. This will be happening, though I think this is worse than

going to an antique fair. We will have lunch while you're browsing, ladies, but I don't sell my junk. So less travel next year, but plenty to whet your appetite still. I would really appreciate an idea of numbers though, as our winemaker is 78, and I also may have to hire a bus, depending on numbers attending.

Thank you to all who attended — Nicola, Port Fairy; Aileen, Burwood; Phyl, Tassie; Jenny, Upper Beaconsfield; Bev, Hansonville; Ruth, Oakleigh; Sigrid, Canberra; 'June'. Hope you can come next time.

ar

ALARA

Christine Taylor VK5CTY
ALARA Publicity Officer
16 Fairmont Avenue, Black Forest SA 5035
Packet: VK5CTY@VK5TTY
email: geensee@picknowl.com.au

The New Year is here!



Did you have any millennium bug problems?
How about this story from the New Scientist 18th Dec 1999:

One of the showcases of Britain's millennium celebrations is the London Eye, the huge Ferris wheel dominating the Thames close by the Houses of Parliament. Some may disagree, but Feedback thinks it is a dramatic structure entirely in keeping with its millennial role.

Or is it? Bookings for trips on the wheel can already be made on the Web, so a colleague of reader Alan Harding tried to buy tickets for 29 February 2000.

But she found that this date was not available.

After a long series of phone calls, she got through to a human operator, who had to confess that the software was unaware that 2000 is a leap year.

Should we be amused that the millennium wheel's booking software isn't Y2K compliant - or should we be worried?"

New Year's Eve or The Start of the New Millennium?

Were you involved in the WICEN nets? We were part of it up at our country block. Fortunately it was not necessary to do anything more than be available. Perhaps the politicians and technicians got it right after all.

Whether you think we have now moved into the third millennium or whether you are still "twelve months short of a millennium", the rollover to the year 2000 was watched with bated breath all around the world.

Did you check out your computer? Did you have your computer on as the numbers changed? Did you fill a jerrycan with petrol? Did you fill your pantry

shelves? Did you get a hard copy of your bank statement? Lots of people did any or all of those things. If so you were all good Boy Scouts or should that be Girl Guides?!!

Now to other matters:

Don't ever complain about having to learn Morse Code!!

Kay Robertson ZL2BRW (now, sadly, a silent key) suffered from multiple sclerosis which eventually caused her to become blind and paralysed. It was while she was in bed that she became interested in ham radio. She studied for and passed the theory and regulations with help from local amateurs, but until she had gained her Morse accreditation she could not talk to overseas amateurs.

Because the disease eventually made it impossible for her to write, She learned to repeat messages sent in code, orally. That is the way she had to do her exam - and she passed it, too!

So next time you feel like moaning about having to do Morse, stop and think about Kay.

(Reprinted from June 99 WARO Bulletin)

Some Christmas Stories

These are from the Monday night ALARA Net.

The unseasonable weather - in the South it was much too cold for Christmas and the New Year, in the North and West it was too wet. I suspect that the weather bureaux told

us all that it was quite average for the month but we don't think of it by the month, only by the date. Certainly, in VK5 we had several very hot days immediately before Christmas so they would have brought the AVERAGE up to normal, but not the date.

The Christmas card stories: Two cards sent to the same person. Cards sent by both partners to the same address. The card that came from someone you had left off your list. The special homemade cards sent to special people or the handmade cards from your children or grandchildren.

But probably the story that takes the cake is this one. A card came from someone she had forgotten so she immediately wrote out a card for them and went out to post it. When she got home from the post box she discovered that the newly written card was still on the table. She had posted the card she had received.

Have you got stories like these? Probably.

The varied topics of interest on the Monday Nets is quite amazing. Why don't you join in? If you are shy, just remember we have all felt just as strange as you do because we all joined in for the first time, sometime.

YLs are welcome, of course, but OMs are also welcomed once we have had a couple of rounds to ourselves.

We start at 1000Zulu during Daylight Saving months and at 1030Zulu in the winter months on or about 3.580MHz.

Remember, when you have obtained 10 YL contacts (from 5 states) you can apply for the ALARA Award (OM and YL operators are eligible). If you want proper contacts for this, just ask us and we will stay after the Net closes to give you a formal signal report.

ar

40W MOSFET HF Linear Amplifier

Drew Diamond, VK3XU
45 Gatters Rd., Wonga Park, 3115.

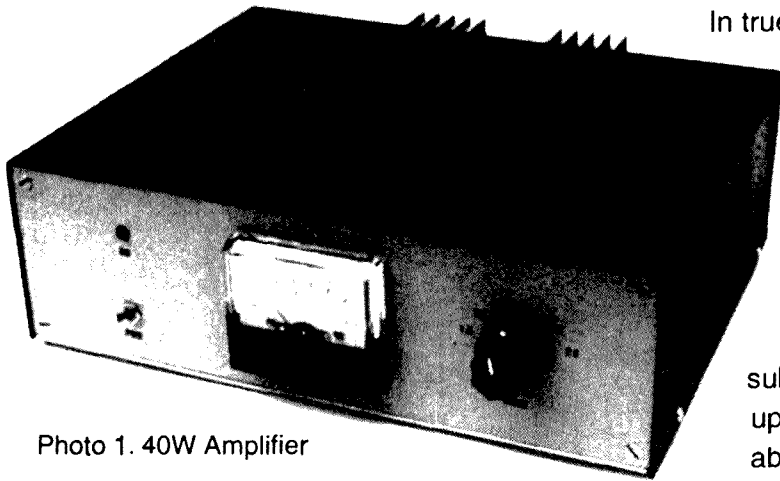


Photo 1. 40W Amplifier

In true amateur tradition, experimenters continue to develop medium-power RF amplifiers using cheap and commonly available power MOSFETs, generally those in the IRF type number series, intended for power supply and switch service. The IRF510 was identified very early as a likely device applicable to HF linear amplifier work. But published designs could only provide substantial amounts of power, about 20 to 50 W, up to perhaps 14 MHz (see Refs. 4 - 9). Beyond about 14 MHz, output was significantly reduced.

THE MAIN PROBLEM with these MOSFETs is their rather large gate-source capacitance (150 pF for the IRF510), which makes driving the highly capacitive gate an increasingly difficult job as frequency is raised. One radioman, Rod Green, VK6KRG, cracked the problem early by cleverly absorbing this unavoidable capacitance into the gate input network (Refs. 1, 2 and 3), thus obtaining useful gain for his single-ended IRF510 amplifier at 21 MHz.

For a while it seemed that we had pushed the IRF series to their limit, then Jim Wyckoff, AA3X, provided details of his 30 W 3.5 MHz amplifier (Ref. 9), which apparently gave spur to renewed efforts by other experimenters. One of these, Mike Kossor, WA2EBY, published details of his circuit in the March issue of QST (Ref. 10), which gives full 1.8 - 28 MHz coverage. As far as I know, Mike's design is a notable improvement on all previous broadband amplifiers using IRF devices. Until the advent of his pattern, most circuits were of similar configuration (Refs. 4 to 9), where, apart from terminating the gate-gate input of the push-pull pair with some low impedance, no attempt was made to absorb the gate-source capacitance.

Having been shown the way, the following amplifier was built. As some components are not easily available here, adaptations have had to be made to suit parts availability. Despite one or two compromises as a result of parts difficulties, figures very similar to the QST model have been obtained:

Performance

Output Power:	At least 40 W, 50 W on some bands.
Input Power:	Nominally 2 W.
Gain:	About 13 dB.
Frequency Range:	Amateur bands from 1.8 to 28 MHz.
Spectral Purity:	With the suggested filter; all harmonics at least -40 dB.
Duty Cycle:	50 %.
Load Tolerance:	Withstands high SWR for reasonable periods.
Power Supply:	Nominally 30 Vdc at up to 3 A.

In CW and SSB service, linearity, as observed on an oscilloscope is shown to be very good- SSB has nicely rounded peaks and good zero crossover characteristics. Checked on a receiver, no significant splatter or clicks occur provided that the amplifier is not over-driven.

Circuit

A pair of IRF510 devices are connected in push-pull class B configuration, as shown in Fig. 1. A 3 dB attenuator (6 dB return loss) is inserted at the input in order to absorb much the reactive nature of the gate to gate impedance, and thus provide a more resistive load for the driving exciter. Broadband transformer T1 converts the unbalanced input to a balanced drive for the gates of the MOSFETs.

Two effectively series-connected 27 ohm resistors terminates the gate to gate input. Each 27 ohm resistor has a 390 nH peaking coil in series which, at the high HF end (broadly around 21 MHz) resonates with the 150 pF input of each gate, thus effectively reducing the effect of this capacitance at the HF end of the amplifier's response.

For class B operation, the enhancement-mode MOSFETs are biased just to the point of conducting drain current. The 5 K potentiometer is connected across a 5.1 V zener derived source to provide a stable bias voltage.

Drain current is supplied via broadband choke coil T2, connected such that it is effectively a high impedance between the drains. Fortuitously, the drain to drain

continued next page

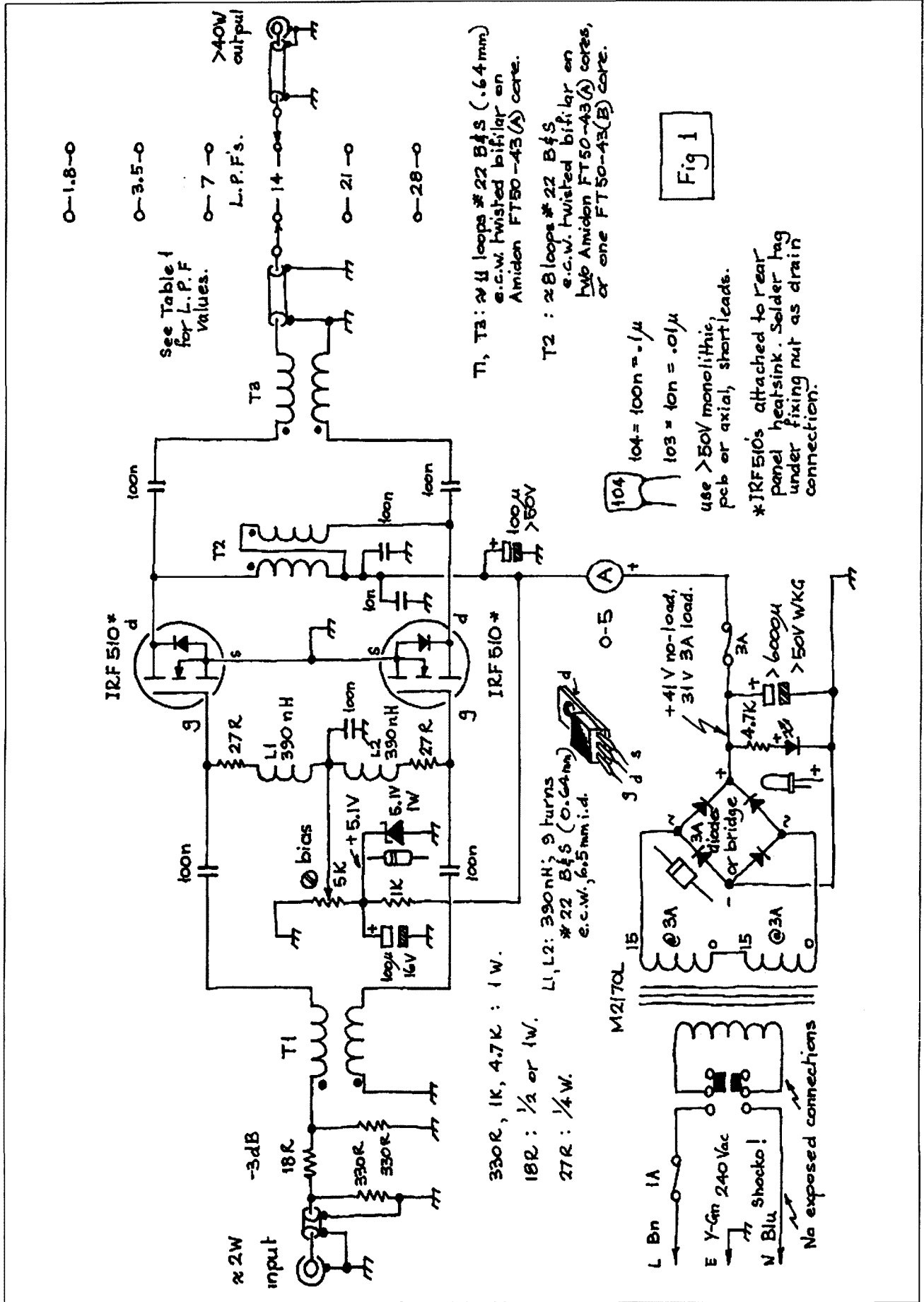


Figure 1

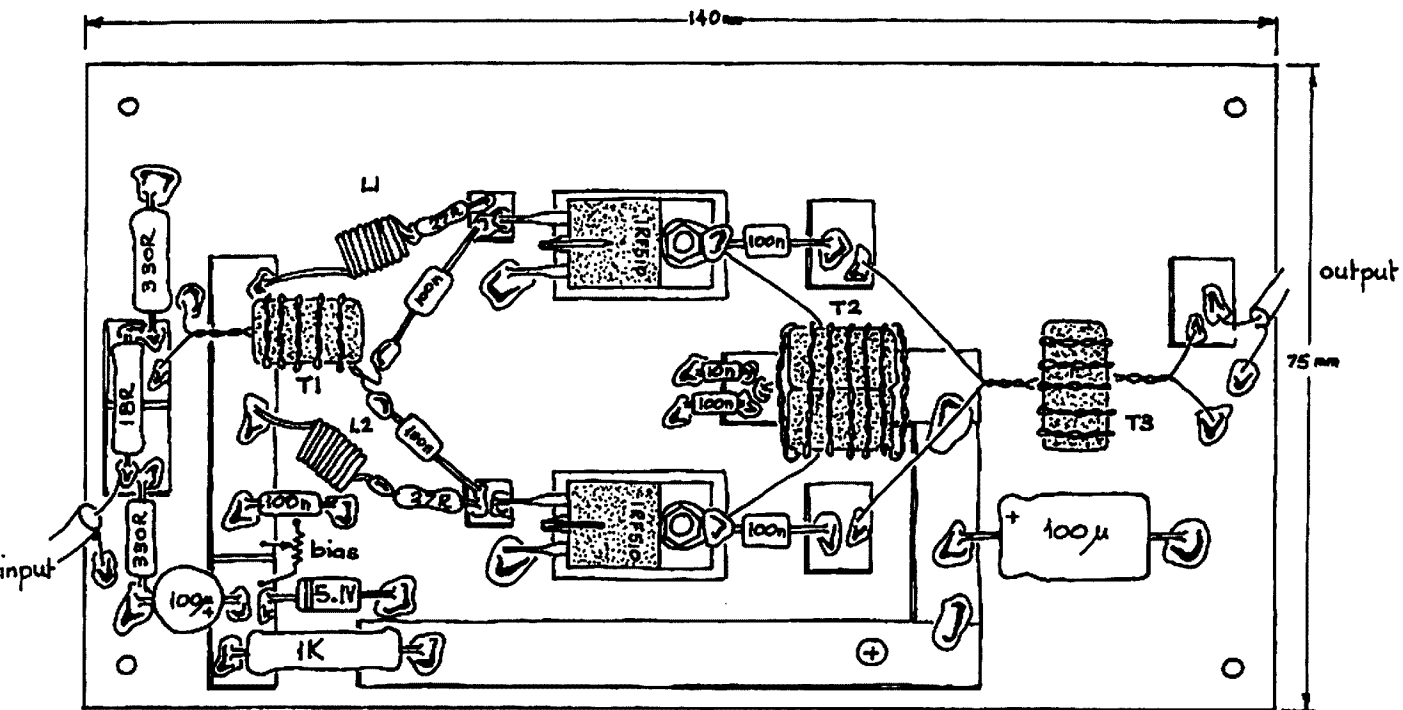


Figure 2. Amplifier "Paddyboard" Layout

continued from previous page

impedance is near 50 ohms, so that a 1 : 1 broadband transformer T3, identical to T1, is all that is necessary to couple the balanced drains to the unbalanced load.

Significant amounts of harmonic energy can be generated by this configuration, so it is mandatory that the output signal be put through a low-pass filter to reduce these harmonics to a suitably small level. It is generally agreed that harmonics should be

at least 40 dB below the main signal (i.e. for a 50 W signal, the harmonic is less than 0.5 mW). An ordinary 5 or 7-element low-pass filter may not provide this degree of attenuation. Therefore, for this project, "improved second-harmonic optimised filters", designed and described by Ed Wetherhold, W3NQN (Ref. 11) are specified here. Interestingly, provision of a low-pass filter for each band always substantially increases the real output power obtained on that band.

A "stiffly" regulated power supply was found not to be necessary. Supply requirement of nominally +30 Vdc at up to 3 A (maximum load) is provided by a mains step-down transformer which supplies 30 Vac. After full-wave rectification and smoothing, a voltage of about 31 Vdc is obtained when the amplifier is drawing 3A. A fuse is connected in series with the (+) rail to cut supply should a fault occur.

Construction

Photos 1 and 2 show a suggested enclosure which measures 250 x 195 x 78 mm WD. Front and rear panels are of 4 mm thick al. sheet, which are connected front to back with 12 mm square al. rod. The bottom panel and cover are of 1.5 mm al. sheet (check the off-cuts bin at your local al. merchant). This arrangement allows easy service access to the rear-mounted amplifier board, both during and after assembly. The cover has 49 x 6.5mm vent holes drilled in the top, and 17 holes in each side.

The amplifier board, which measures 140 x 75 mm, may be double or single-sided p.c. material. The components are mounted "paddyboard" style (see Ref. 12). Component layout is shown in the plan view Fig. 2.

Broadband transformers T1, T2 and T3 are made as follows. Take two straight 300 mm lengths of 0.64 mm enamelled copper wire (e.c.w.). Lay them parallel, then fix one end of the pair in a vice. Twist the free ends together, then fix that end in a drill chuck. Whilst keeping the wires taut, turn the drill until you have about 3 twists per 10 mm. Firmly pull the drill to set the twist, then remove the pair. For T1 and T3, carefully wind the pair onto an Amidon FT50-43 (A) core- 11 loops should fit nicely. Trim the leads to about 20 mm each. T2 is wound similarly, this time using a two core stack, or one FT50-43 (B) core- about 8 loops. The

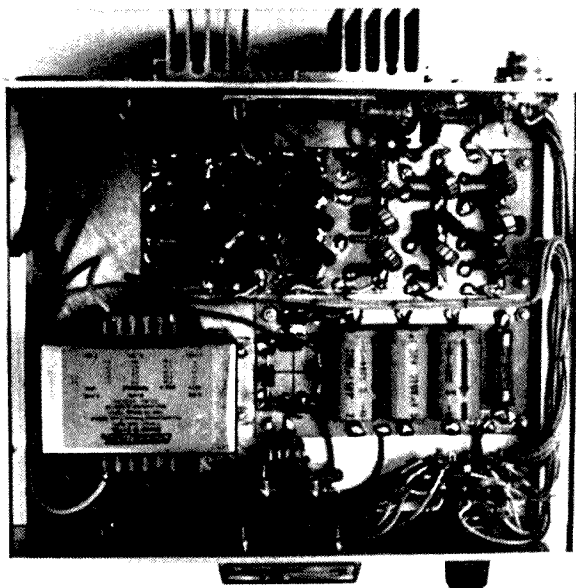


Photo 2. Internal view

end of one winding must be connected to the start of the other, which becomes the (+) 31 V connection. Winding starts are shown on the circuit with a dot.

Heatsinking for the IRF510's is essential. The amp. board is attached to the rear panel as shown in Photo 3. 60 x 6 mm cut-outs in the amp. board allow the MOSFETs to be attached to the rear panel, which acts as partial heatsink. Use TO220 silicone-impregnated insulating washers at the interface between each device and rear panel. A solder tag under the device fixing nut provides the drain connection. Additional dissipation capacity is had by fitting a Jaycar HH8566 (or similar) 72 x 110 mm heatsink to the rear panel. Provide holes in the heatsink assembly to permit easy fitting of the MOSFETs, which should be installed after the amp. board and heatsink have been fixed to the rear panel. Remember to check that your soldering iron tip is properly earthed before soldering the MOSFETs into circuit (these devices- in my experience, do not appear to be super-sensitive to static damage, but you should observe normal anti-static precautions).

The wiring of the low-pass filters is fairly critical. As they are 50 ohm input and output devices, the best plan is to use a 2-pole, 6

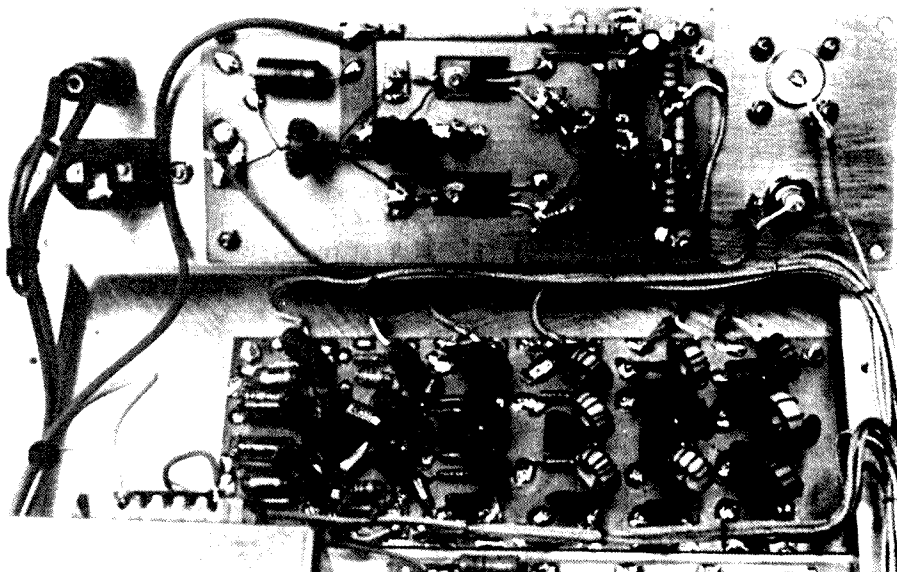


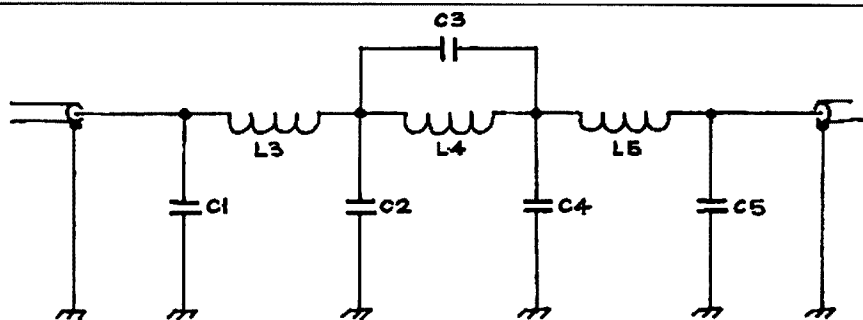
Photo 3. Amplifier and filter boards (rear panel folded down for clarity)

(or more) position wafer switch for band changing, and miniature 50 ohm coax for the interconnections. The braid should be grounded at each end of its run, so that there are no interruptions to the continuity of the outer conductor. The clicker-plate would make a handy point to solder the braids

around the wafer switch. The impedance of ordinary shielded wire is close to 50 ohms, and makes a reasonable substitute.

Table 1 shows the values required for each LPF. If you only need certain bands, then simply make a filter for each band

continued next page



Band MHz	C1, C5 PF	C2, C4 PF	C3 PF	L3, L5 μ H	L2 μ H
1.8	1500 + 150	2200 + 350	330 47	5.2 28t occupy 3/4 T68-2 core.	4.7 25t occupy 3/8 T68-2 core.
3.5	470 + 390	1200 + 40	150 47	2.7 21t occupy 3/8 T50-2 core.	2.4 20t occupy 3/8 T50-2 core.
7.0	330 + 100	330 + 350	100	1.2 14t occupy 3/8 T50-2 core.	1.2 14t occupy 3/4 T50-2 core.
14	220	330	47	0.67 10t occupy 1/2 T50-6 core	0.6 10t occupy 3/8 T50-6 core
21	150	220	33	0.45 8t occupy 1/2 T50-6 core	0.4 8t occupy 3/8 T50-6 core.
28	100	82 + 82	27	0.33 7t occupy 1/2 T50-6 core	0.3 7t occupy 3/8 T50-6 core.

All coils wound with #22 B&S (0.64mm) e.c.w. T68-2 is a red core, \approx 0.68" dia., T50-2 is a red core \approx 0.5" dia., T50-6 is yellow, 0.5" dia.

Table 1. Low-pass Filters

continued from previous page

required. Details are not shown for 10.1, 18 or 24 MHz. See Ref. 11 if you need these bands also. Ordinary 0.5" T50-2 and -6 Amidon cores were found to be quite adequate to the 50 W power level, except those for the 1.8 MHz filter; 0.5" cores saturated and became hot. So I have specified 0.68" (T68-2) cores for top-band.

Photo's 2 and 3 show how the filters are made and wired. The filter board measures 170 x 75 mm. There are six "paddyboard" strips each 60 x 6 mm which are divided evenly into four segments, to which are soldered the filter components for each band. Ideally, the filter capacitors should be silvered mica types- use these if available. However, styrofoam/polystyrene are quite suitable, more readily available and cheaper than mica's. And if you can't get styro's, then ceramics will do- but not the little 50 V ones generally available. To withstand a load SWR of more than 2, the capacitors must be 100 V, and preferably 500 V.

If you already have a power supply which can deliver 30 Vdc at 3 A, then an internal supply is not required (incidentally, the amp. will work quite well from a 13.8 Vdc supply- expect about 15 W). However, for convenience, and to avoid tying up a general-purpose supply, a dedicated internal 30 Vdc supply is recommended. The transformer, type M2170L, rated 30 Vac at 3.3 A, which has top mounted secondary terminals, and "flying leads" for mains, was purchased from Altronics. But any similarly rated transformer should do. The power supply diodes, three 2200 uF/50 V smoothing capacitors, 3AG fuse holder and

4.7 K/1 W LED dropper/bleeder resistor are mounted paddyboard style on a board which measures 120 x 60 mm. To prevent accidental contact, use heat-shrink tube (or similar) to cover all exposed mains wiring connections.

As there are numerous requirements for antenna changeover (from transmit to receive) depending upon transmitter, or transceiver type, just how this job is done must be left to individual builders. Ref. 10 has details of an elegant solution to the problem, and may well suit your set-up.

Operation

Visually check all wiring, component locations, and polarities where applicable. Remove the 3 amp fuse. With your multimeter on ohms, check, by measuring resistance to ground; that the drain tabs have not punctured the silicone washers (but note the protection diode internal to the '510).

Apply mains power. The LED should glow. Measure the voltage across the smoothing capacitors- should be about 41 Vdc. Switch off, then install the fuse. Connect a suitable dummy load or 50 ohm power meter to the amplifier's output. Set the bias pot slider to the "earthy" end of its travel (minimum bias voltage). Switch on. There should be little current indicated on the ammeter. Carefully adjust the 5 K bias trimpot so that drain current just begins to show on the meter. Set it for about 200 or 300 mA (0.3 A).

You will need an "exciter" capable of 2 or 3 watts output power to drive the amplifier. Switch in the amplifier's LPF appropriate to the band in use. Apply an

input signal from the exciter, adjusting the drive upwards from zero if possible. You should observe a smooth rise in drain current, and a corresponding rise in output power. At 2 W input, the drain current should be about 3 A, and output power should be about 40 or 50 W.

In actual "on-air" operation, the load SWR ought to be kept below 2, but no damage should result from operating into a moderately high SWR load for short periods. After a long transmission, the no-signal drain current may creep up to perhaps 0.5 A, but should drop back after a cooling period.

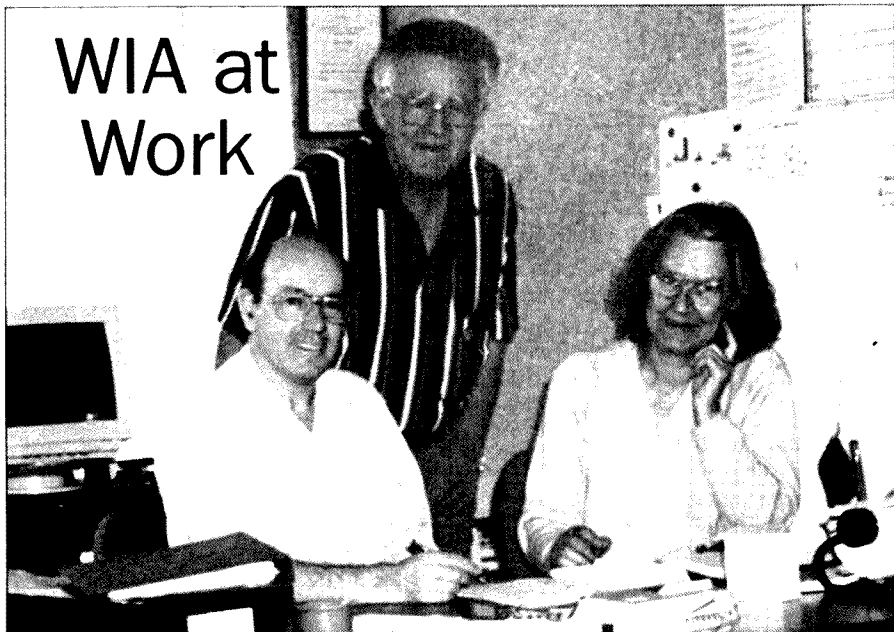
Parts

The standard components are available from the well known electronics suppliers, such as Altronics, Dick Smiths and Jaycar. Additionally, Electronic World (03 9723 3860) can supply the IRF510's, Amidon cores and styro capacitors. See Hamads in this journal for other Amidon suppliers. Rockby Electronics (03 9562 8559) have some mica capacitors and many of the standard parts.

References and Further Reading:

1. "21 MHz QRP 'Maxi' RF Power Amplifier", R. Green, VK6KRG, Low-Key (journal of the VK QRP Club) #3, Sept. '84.
2. "How to Design RF Power Amps", R. Green, Low-Key #4, Dec. '84.
3. "Forrestfield" 21 MHz Transmitter; R. Green; Low Key #27, Sept. '90.
4. "MOSFET Power Amplifier for 1.8 - 10.1 MHz", Diamond, AR Oct. '88.
5. "Power FET Switches as RF Amplifiers", D. DeMaw, W1FB, QST Apr. '89.
6. "Power Amplifier using MOSFETs", L. Butler, VK5BR, AR Nov. '89.
7. MOSFET Amp. in Tech. Correspondence, Hayward and Damm, QST Nov. '89.
8. "25 W MOSFET Linear Amplifier", Diamond, AR Jan. '91.
9. "1 W in, 30 W Out with Power MOSFETs", J. Wyckof, AA3X, QST Jan. '93.
10. "Broadband HF Amplifier Using Low-Cost Power MOSFETs", M. Kossor, WA2EBY, QST Mar-Apr. '99.
11. "Second-Harmonic Optimised Low-Pass Filters", E. Wetherhold, W3NQN, QST Feb. '99.
12. "Paddyboard Circuit Construction", Diamond, AR Feb. '95.

WIA at Work



From left: John Loftus, Wally Howse and June Fox during a Directors' Internal audit of the Federal office, September, 1999

Quo Vadis Morse II?

Over the last 20 years I have heard many people say, "I couldn't do that" (learn Morse). Why? These people are no different from their parents or grandparents who learnt things like Morse if it were part of their job

Ian Godsil VK3DID

Phone: 0408-123-557

E-mail: <contests@radiomag.com>

A FEW WEEKS AGO I had a phone call from a chap I had known well many years ago. We lost touch, except for a card at Christmas.

I did know that in those days he was a pirate on several Amateur Bands. By his own admission he "enjoyed a good chat" and "40 metres was the best band".

The purpose of the call was to enquire whether Morse had been dropped from the VK licence, as he had an opportunity to buy a complete Ham station at very modest price.

This saddened me, as he obviously had an interest and was not without some ability — he ran a farm and learnt to sail and fly. Yet he apparently wanted a world-wide citizen's band. The interest was there, but not the WILL to learn the code, even if he did not intend to use it.

Over the last 20 years I have heard many people say "I couldn't do that" (learn Morse). Why? These people are no different from their parents or grandparents who learnt things like Morse if it were part of their job, without squealing. They got to and did it!

More recently Morse (or CW as we prefer to call it) has passed from general commercial usage and many countries are grappling with decisions as to whether it should stay a requirement for HF Amateur licensing.

Historically Samuel Morse hit on a wonderful way of getting information from one place to another — a way that was proven reliable and efficient. Whole countries came within reach of people. Ships and planes in far places had greater chance of being in touch with the world and, most importantly, of being aided in the event of trouble.

Our Q Code grew from the use of Morse and over the years techniques for sending and receiving were improved. Fine and rightly so, but we cannot live just on history.

Present Usage

1. In our part of the world, CW has gone from the Maritime, Aeronautical and Armed Services, except for a handful

of stations in China and some other continents. (I personally miss the listening practice, but there are other ways to make up the loss. See? Again WILL — DETERMINATION.)

2. Here in VK we are very fortunate to continue the "CW Net" — a long-running Net on 7025 kHz every Sunday morning at 1000 hours Eastern clock time (2300z Saturday during Summer Time and 0000z Sunday in normal time).

This Net will not only give opportunities for as many QSOs as you want, but makes most efficient use of band space.

The Net Controller pairs off stations on a nominated frequency. When the QSO is over, those stations can either go QRT or re-sign with the Controller and get another QSO. If you think that CW is dead in VK, try listening to 40 metres on a Sunday morning. You will also hear how nets can be made much more interesting and efficiently run.

3. **QRP (Low Power Operation)** is a good way to try Morse and simple set construction. Most operation is on 80 metres at night, which makes copy a bit difficult because of band conditions in Summer; but there are some chaps around on 40, 30 and 20 metres. I have operated 12 metres with good success in recent years.

There would be more operators experimenting with modern construction techniques for QRP CW today than any other area of Amateur Radio. Morse is certainly not dead for them!

I have even heard of a well-known Ham who is planning an add-on box for a 2 metres rig to send CW, so that younger operators can practise. CW is certainly not dead for him, neither is his desire to help others to get ahead.

You may like to have a look at the QRP Club's Home Page at

<http://www.users.on.net/zietz/qrp/club.htm>

4. **Collectors** pop up in almost every hobby and there are those who collect hand keys, paddles, sounders, etc. Have you ever seriously read the "Pounding Brass" column in 'Amateur Radio'?

5. Today, **computers** can generate Morse — and do it very well provided that the machine is talking to another computer. Most humans do not have an innately good sense of rhythm; but that did not stop all sorts of people from becoming good Morse operators.

One of the most interesting experiments I ever did was to compare computer-generated Morse at 99 wpm with RTTY using the same equipment, path, frequency and operators. The Morse came out in front.

Computers are heavily used in contesting today for a variety of functions, particularly log-keeping, but including Morse generation.

Whither?

As our title asks, "What of the future of Morse Code?"

My own feeling is that it will never completely die out. It will be the Amateur Service that keeps it alive, because I feel that there will always be an Amateur somewhere who feels the urge to tinker with the Code — even if it is by computerized means.

The only rider I would add to the above is that Morse may teeter for a while should there come the world-wide removal of the Amateur Service; but even then I still feel that there will be pockets of it that will survive somewhere.

But much more importantly, what is your attitude? What will you do? Will you support the WIA by providing your opinions so that it will know how to represent us all? Will you support the QRP Operators' Club in its aims? Or will you be a victim of complacency? "I'm all right, Jack." "They'll fix it." "I don't care."

The future of CW (and indeed of Amateur Radio) rests fairly and squarely with US — ALL OF US. If you enjoy your hobby, please USE IT; but at the very least let's start having some serious discussion on the topic.

An Experimental Low Frequency Band Transmitter

Lloyd Butler VK5BR

Early in 1997, with the help of Harry Krause (VK5HK) I took some steps to experiment with test transmission in the Low Frequency (LF) region of the radio frequency spectrum. The plan was to transmit from the QTH of VK5HK which is the old coastal radio site (previously VIA). The site has an ideal vertical antenna tower for the purpose and Harry was happy for this to be used for the tests in conjunction with other facilities he has on site. I discussed the previously in my article on the LF bridge (*Amateur Radio* October 1998 – reference 1).

AMATEUR LF BANDS have been approved and are already in use in various countries around the world such as the United Kingdom, New Zealand and countries in Europe. ARRL have applied for approval in the USA and the WIA have made approaches to the authorities in Australia. In the absence of an amateur licence approval we did consider a scientific licence as granted to several other experimenters in Victoria and Tasmania, but the licence fee has been increased and operating conditions looked a bit restrictive.

All in all, I guess we just let the project ride, hoping that WIA would succeed in their bid to get an LF band allocation. However, I did build a transmitter ready to send out the test signals. So far it has done no more damage than heat up my dummy

load but I thought it was high time its design was committed to the documentation which follows.

The transmitter has been designed to operate within the frequency range of 160 to 200 kHz, essentially to correspond with out nearest LF active country New Zealand which has a band approval of 160 to 190 kHz. (If Australia gets approval outside the range, say 135-138 kHz as in the UK, then I guess the transmitter range will have to be modified).

The transmitter power amplifier can deliver 70 Watts of RF power via a 25 Ohm 220 khz LP filter into a 25 Ohm resistive load (The power output could be increased to 100 Watts if the output circuit were changed to suit an 18 Ohm load).

It was proposed to operate the transmitter

to air in a keyed continuous wave (or CW) mode from an auto-keyed pre-programmed Morse ident signal. Provision has been made to key from either audio tone or direct DC control. The RF power amplifier operated in a linear mode and hence the transmitter circuit could also be arranged to accept a speech modulated RF signal such as AM or SSB instead of the continuous RF signal now taken from a VFO.

The transmitter was constructed almost completely from components I had available around the radio shack. (I think the only component I had need to buy from the electronics store was a thermistor). Because of this you may see examples of where the component count is higher than it need be, such as using three transformers to get 50VAC when one would have done. My philosophy – why spend \$50 (or more) when I can find a way to do the job for nothing out of the component junk-box.

The RF Circuit

The circuit of the RF Power Amplifier, RF Driver and keyer system is shown in figure 1.

The RF Power Amplifier uses a pair of HEXFET IRF430 transistors (V1,V2) operating in a linear mode, push-pull class B. The design of the circuit is based on one which I had previously submitted and which was published in *Amateur Radio*, November 1989 (ref 2). For more detail on the characteristics of the HEXFET transistors and the circuit design, I refer you to that article.

Using the output transformer as shown, the amplifier can deliver 70 Watts into 20 Ohms (or 100 Watts into 18 Ohms) with an efficiency around 60%. (The remaining 40% is of course heating of the transistors). The transistors are mounted on 6 inches

Photo 1: LF Transmitter — RF Unit and VFO

continued on page 25

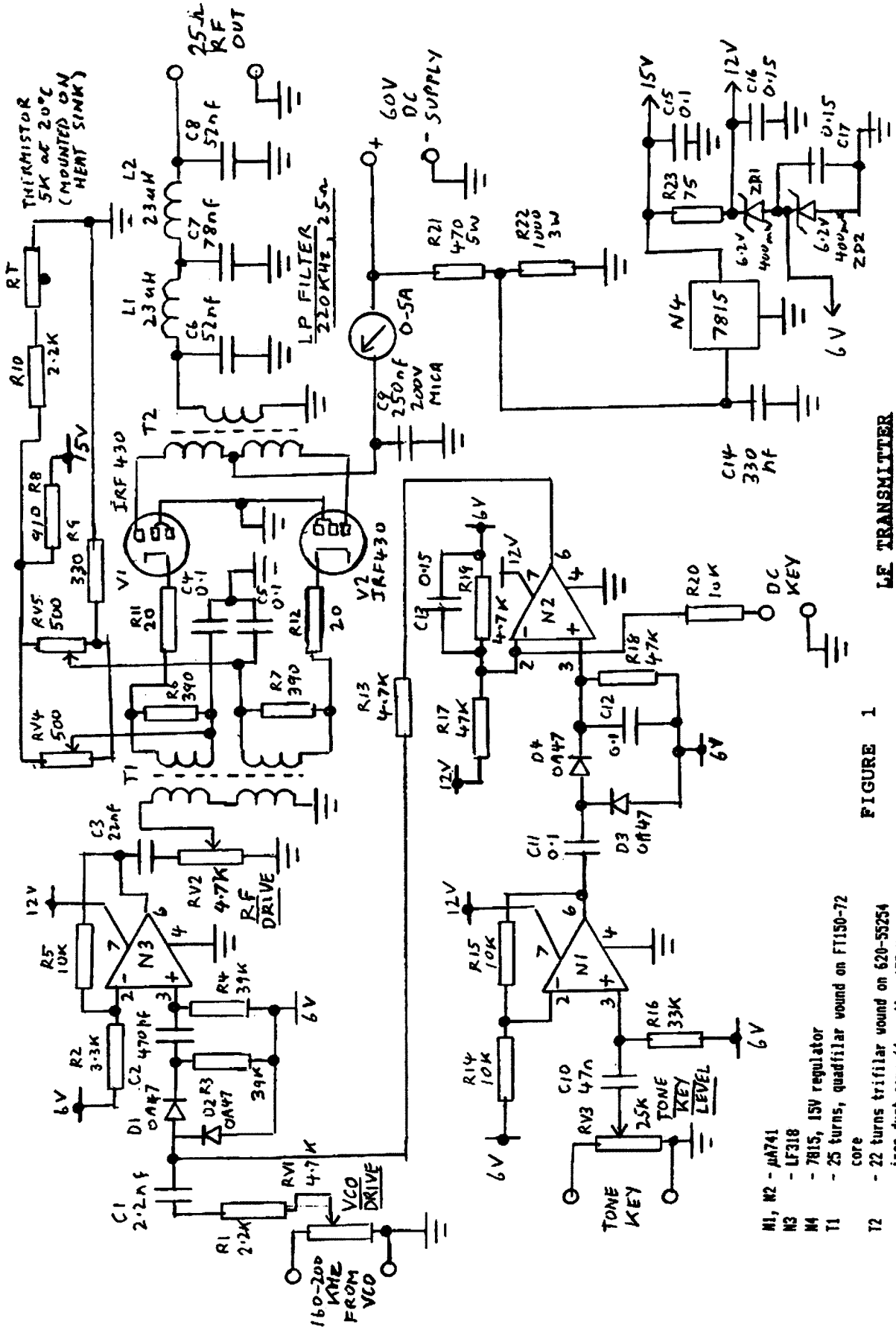


FIGURE 1
 LF TRANSMITTER
 KEYSER CIRCUIT, RF DRIVER & POWER AMPLIFIER CIRCUITS

- M1, M2 - AM741
- N3 - LF318
- M4 - 7815, 15V regulator
- T1 - 25 turns, quadfilair wound on FT150-72 core
- T2 - 22 turns trifilar wound on 620-55254 iron dust core (4aa, A1 = 175ah/1000T)
- L1, L2 - 26 turns on FC394 T130-3 core

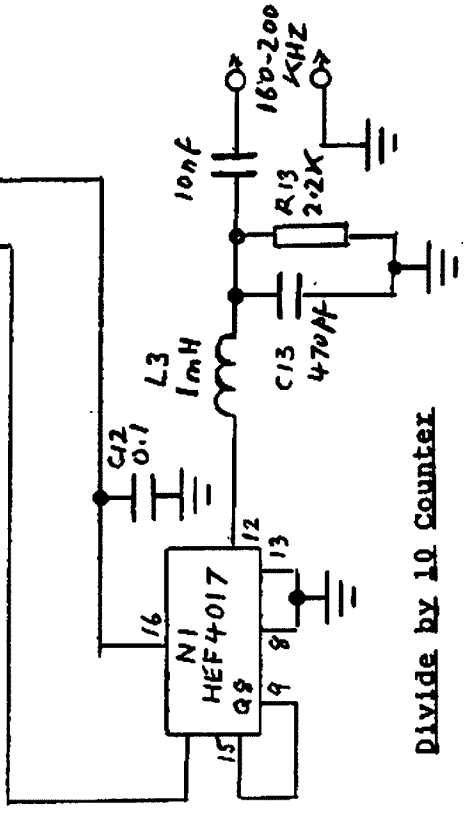
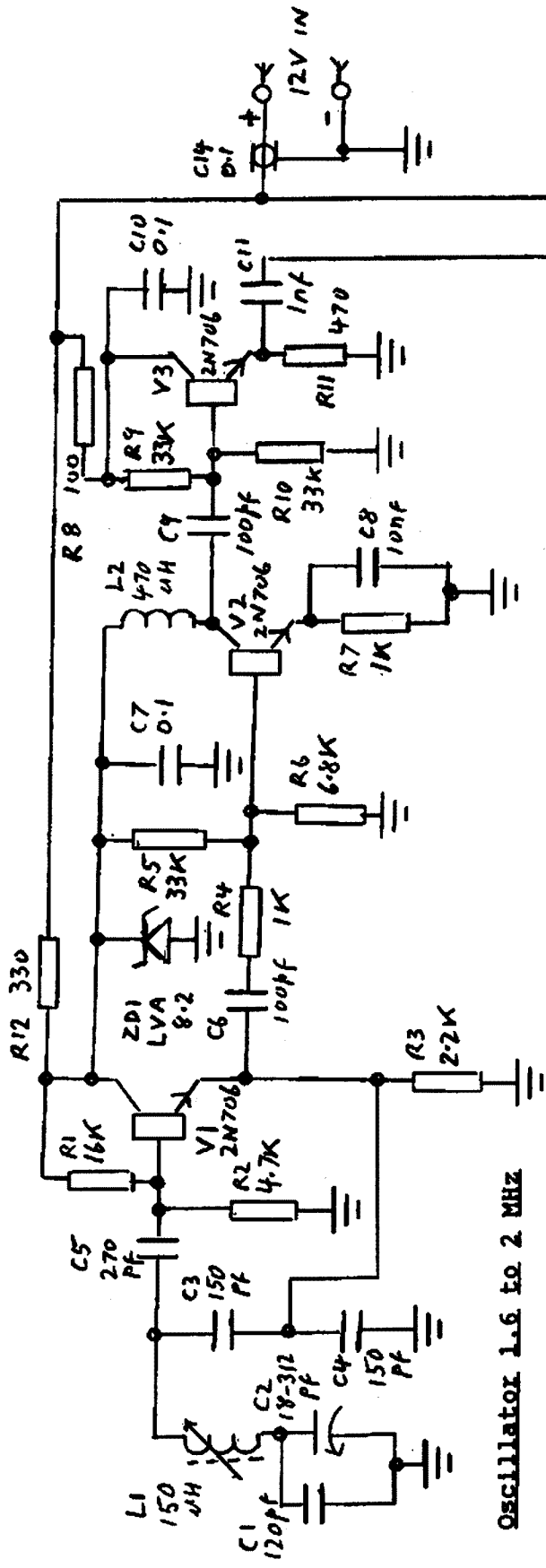


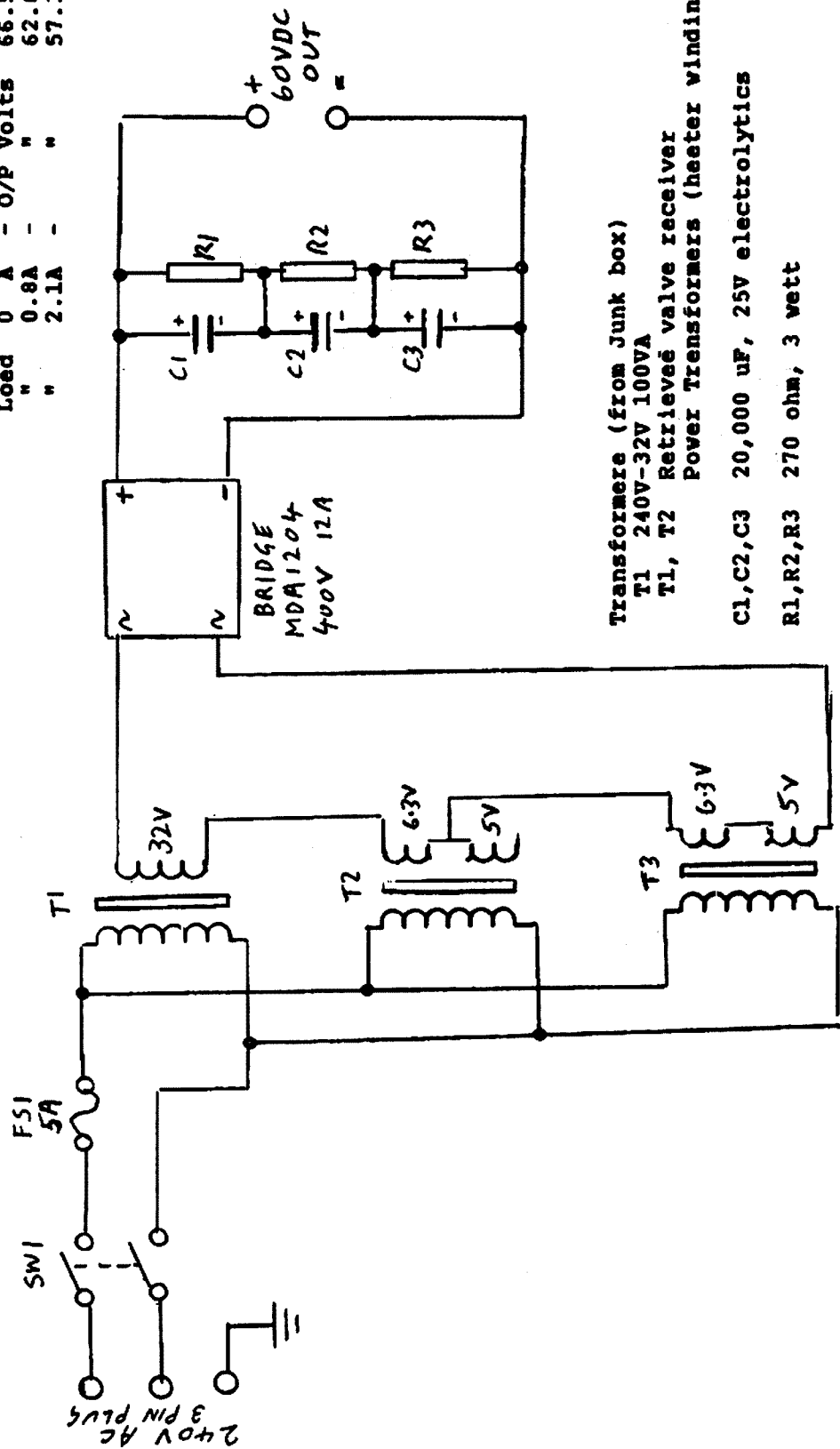
FIGURE 2

LE TRANSMITTER

160 = 200 KHZ VARIABLE FREQUENCY OSCILLATOR (VFO)

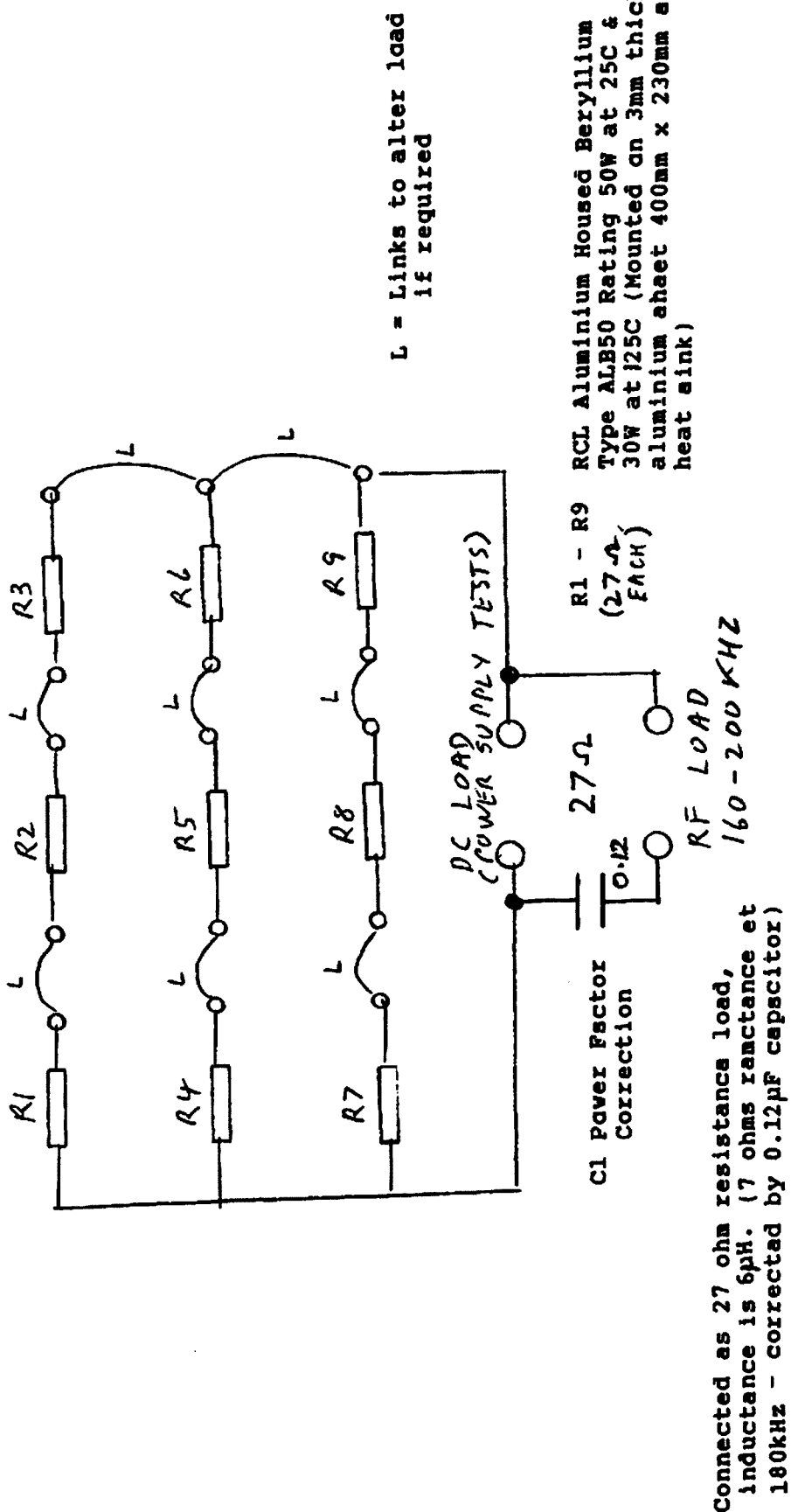
Regulation Tests

Load	A	O/P Volts
0	-	66.5V
"	0.8A	62.6V
"	2.1A	57.3A



- Transformers (from Junk box)
 T1 240V-32V 100VA
 T1, T2 Retrieved valve receiver
 Power Transformers (heater windings used)
- C1, C2, C3 20,000 uF, 25V electrolytics
 R1, R2, R3 270 ohm, 3 watt

FIGURE 3 LE TRANSMITTER
 50 VOLT 3 AMP POWER SUPPLY



L - Links to alter load if required

RCL Aluminium Housed Beryllium Type ALB50 Rating 50W at 25C & 30W at 125C (Mounted on 3mm thick aluminium sheet 400mm x 230mm as heat sink)

R1 - R9 (27 ohms EACH)

RF LOAD 160-200 KHZ

C1 Power Factor Correction

Connected as 27 ohm resistance load, inductance is 6pH. (7 ohms reactance at 180kHz - corrected by 0.12µF capacitor)

FIGURE 4

LE TRANSMITTER

DUMMY POWER LOAD RESISTANCE (DC & RF)

continued from page 20

(150mm) of Minifin heatsink via beryllium insulating washers. With natural convection, the thermal resistance of the Minifin is around 1 degree Celsius per Watt and the washers 0.1 degrees Celsius per Watt. As such, the temperature rise at the transistor case could be around 56 degrees for an anticipated heat dissipation of up to 40 Watts (continuous signal). This should hold the transistors within their temperature tolerance, but just to make sure, I bolted some extra aluminium fin material to the two sides of the Minifin. In practice operating at 70 Watts of continuous output, the transistors run at quite a moderate temperature as felt by the hand. (Of course, in keyer operation the average output power and heat dissipation is even much less).

Static drain current (no signal) is set to 150 mA per transistor (300 mA total) with trim pots RV4 and RV5 which control the forward bias voltage). Thermistor Rt is mounted in direct thermal contact with the heat sink and connected in the gate bias circuit. This reduces bias as the temperature rises to hold static drain current reasonably constant with temperature rise the need for this was explained in Reference 2. As full power of 70 Watts loaded into 25 Ohms, total drain current rises to around 2 Amperes.

The RF output is fed via a 5th order Chebychev 220 kHz low pass filter designed for the 25 Ohm load. Theoretical attenuation at the first octave in this type of filter is in the order of 55 dB and harmonic radiation could be expected to be more than 70 dB below carrier level.

The nominal drain supply for the output transistors is 60 volts DC. This is dropped down to 15V via regulator N4 for the gate bias supply. The 15V is further reduced, using zener diodes ZD1 and ZD2, to provide 12V and 6V supply liner for the RF driver and keyer stages: N3, N1 and N2. The 12V is also fed out to the VFO which is built in a separate shielded box to that containing the transmitter, driver and keying circuits.

Carrier on/off for keying in controller by the gates D1 and D2. For gate closed, D1 is reverse biased and D2 conducts to loop the RF line from the VFO. For gate open, D2 is reverse biased and open and D1 conducts to connect the VFO to the input of stage N3. Stage N2 provides the switching voltage in turn controller either by opening or closing the DC key line of keyer tone. The DC keying is applied via the inverting input of N2. Keyed tone is fed via stage N1 to rectifier circuit D3 and D4 which develops a DC voltage to control N2 output via its non inverting input.

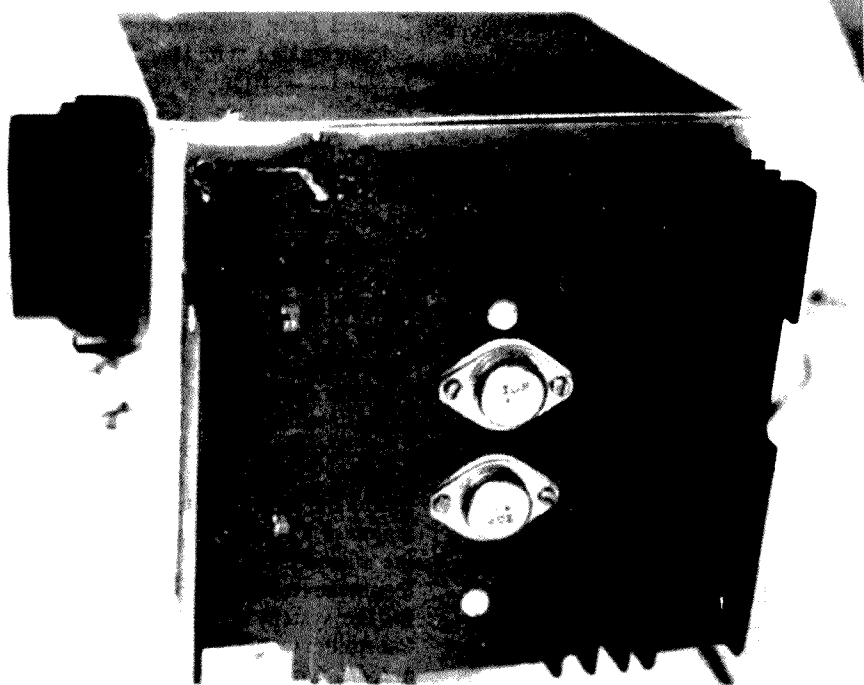


Photo 2: LF Transmitter
Rexfet Power Transistors mounted on heat sink

The Variable Frequency Oscillator (VFO)

The VFO provides output tunable between the range of 160 to 200 kHz. The circuit diagram is shown in figure 2. The tunable oscillator V1 operates at 10 times the base band frequency (ie 1.6 to 2 MHz) rather than at the base band frequency itself of 160 to 200 kHz. The 10 times arrangement is done for two reasons:-

- (1) It is more convenient to provide a small tuning capacitor to cover the range of 1.6 to 2 MHz than is the larger variable capacitor needed to tune the LF band.
- (2) By operating the VFO at a remotely different frequency, there is less chance of any instability problem due to feedback from the high power output of the transmitter into the VFO.

The card containing the variable oscillator V1 and buffer stages (V2 & V3) was already assembled as I had used that card for several projects before. I simply had to adjust the tuning range, calibrate the dial and add the divide by 10 stage N1. Frequency selection is controlled by variable capacitor C2 which is coupled to a vernier drive dial.

The output of N2 is a square wave and this is shaped to sine wave form by filter L2-C13. Output voltage from the filter approached 15Vpp. This is too high for the

input of the keying gate and RF driver and its level is reduced by potentiometer RV1 (Fig 1).

60V Power Supply

The circuit of the 60 Volt power supply is shown in figure 3. This is a simple unregulated supply using a transformed secondary voltage of about 50. The output is rectified by a bridge package and filtered by a large parallel capacitor.

I didn't have quite the right transformer, so I used a heavy duty 30 volt transformer which I did have and built up the voltage to 50 by series connection of the heater filament supply secondaries of two retrieved valve power supply transformers.

Another item I did not have was a very large capacitor with a voltage rating exceeding the peak DC output voltage. I did have some 20,000 μ F electrolytic capacitors rated at 25V so I connected three of these in series to provide 6700 μ F at 75V. The three power transformers and three large capacitors made up a lot of bulk and weight and the whole supply was mounted on a discarded valve receiver chassis which had been stripped of previous components.

With this simple type of power supply, there is quite a bit of voltage swing between the key up and key down states. For the proposed CW operation this is of little concern. On the other hand, if the transmitter were to be used in an SSB mode, some compression of the modulated signal

continued next page

continued from previous page

could be expected at the signal envelope increases in amplitude with speech lever upward swing. For this mode, improved regulation in the power supply might be desirable.

The Dummy Load

Having selected 20 Ohms as the operational load, a dummy load close to 20 Ohms was needed for test purposes. Fortunately, at LF it is possible to use some types of power resistor which would otherwise be unsuitable for higher frequencies because of their inductance and distributed capacity. I made up a load using nine 27 Ohm aluminium housed beryllium resistors in a series/parallel connection and mounted them on an aluminium sheet, 420mm by 230mm by 3mm thick, for a heat sink. The arrangement, shown in figure 4, can dissipate 300 to 400 Watts depending on resistor case temperature. With 70 Watts of power from the transmitter, there is barely a temperature rise.

Load resistance values other than 27 Ohms are arranged by altering connection links between the individual resistors. The inductance in series with 27 Ohms resistance is close to 6 μ H which represents only 7 Ohms reactance at 180 kHz. This reactance is essentially cancelled by the power factor correcting capacitor of 0.12 μ F in series.

Apart from its function as a RF test load, the dummy load (without series capacitor) was also put to use to carry out DC load tests on the power supply.

Transmission Line and Antenna Matching

As these low frequencies, unless one has a large canyon to hand and antenna, the effective antenna length is very much smaller than a quarter wavelength. Hence, radiation resistance is very low (often somewhat less than an Ohm) and the antenna must be loaded with quite a large inductor which inherently has loss resistance quite high compared to the value of radiation resistance. Added to this is the installation earth loss resistance. All in all, unless the antenna is of massive proportions, most of the power delivered is consumed as loss in the inductor and loss in the earth system.

My initial thoughts were that we would be unlikely to get a total Load resistance (radiation plus loss) below 25 Ohms. That is the reason I selected 25 Ohms for the load circuit of the transmitter, expecting to feed the antenna directly from the transmitter.

Further to that, Harry was able to provide a big inductor coil which could be adjusted

up to 1.2 mH and had a Q of around 300. I figured from measurements and some calculation that, at mid band frequency (180 kHz), his vertical tower would have a radiation resistance of around 0.5 Ohm and a capacitance of around 850pF. I decided that, loaded with his inductor, we would have a loss resistance in the inductor of 3.5 Ohms and I made a guess that his extensive earth system would have a loss resistance within one Ohm. Hence, out total load would look like a resistance of 5 Ohms and radiation efficiency would be 10% (For 70 watts of transmitter power we would radiate 7 watts).

Rather than operate the transmitter right at the antenna, it was decided that it would be more convenient to locate the transmitted in Harry's radio shack (the old VIA control room) and feed the antenna via a 225 metre length of 75 Ohm coax already in place to the antenna. (At these frequencies, power loss in the coax would be small). A proposal for the system is shown in figure 5. The transmitter would be coupled to the coax via a 25/75 Ohm transformer mounted at the transmitter. An L match at the antenna would match the coax to the antenna low resistance circuit. A shunt capacitor of around 43 nano Farad would be needed and the 1.2 mH coil would be adjusted to provide the series reactance for the L match plus the inductive reactance to load the antenna (ie. to cancel its capacitive reactive component).

Well, the operational installation has never been put into practice but we did formulate the plan. Also considered was the possibility of transmitting from my home. However, with the limited antenna I could provide, radiation resistance would be a mere fraction of an Ohm and radiated power would be but a fraction of a Watt.

RF Capacitors

One problem I encountered with this project was finding suitable capacitors to operate at high power in the RF transmission circuit. At these low frequencies, capacitance values are quite high and not only do they have to withstand the peak RF voltage, they also have to pass quite high reactive current. As I explained in a previous article (*Amateur Radio* January 1995, ref 3), RF current through loss resistance in the capacitor causes heating (ie. power lost) and if heating is excessive it can damage the capacitor.

For the three LP filter capacitors C6, C7 & C8 in figure 1, the best I could do was to make up the required values with 600V polyester tubular capacitors. At nominal values of 52 and 78, nano Farads, peak current for 70 Watts output is in the order of 4 to 4 Amperes. These capacitors were hardly designed to stand this sort of

treatment and it is not surprising that, in a sustained carrier condition, they run warm. It is a worry that they might not withstand prolonged operation and I would like to replace them with more suitable mica or high power disc ceramics.

Another problem capacitor is the 42 nano Farad one proposed as part of the L matching network (figure 5). A suitable type of capacitor with high current rating would also have been needed for this application.

A third capacitor to mention is bypass capacitor C9 as the centre of T2 in figure 1. This point is virtually RF cold but the capacitor does have to conduct any out of balance current between V1 & V2. For this job, I had a nice 250 nano Farad 200V mica available.

Summary

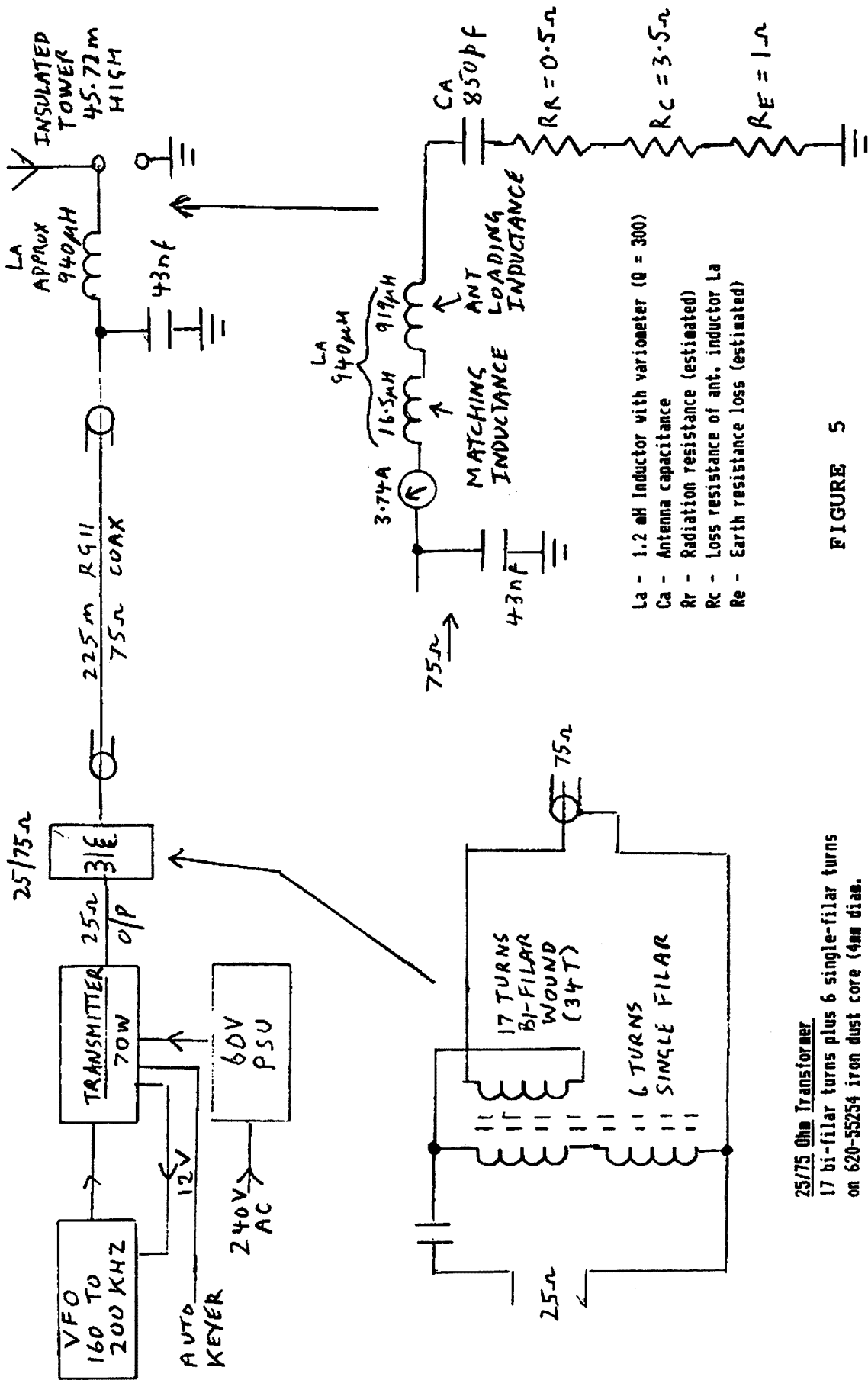
Described is an LF transmitter assembled essentially from components accumulated in the amateur radio shack. Also described are details of a plan we had to use the transmitter to send out test signals from the old Coastal Radio Site VIA (Now the home and amateur radio station of Harry VK5HK).

In its present form, the transmitter can operate within the range of 160 to 200 kHz at a power of 70 Watts keyed in a CW mode) At the time of writing, we wait the success of the WIA in seeking a LF band segment for licensed amateurs. If they do succeed and the approved band is outside this transmitter frequency range (say 138 kHz as in UK rather than 160-190 as in NZ) then I will have to change the VFO frequency range and the cut-off frequency of the LP filter at the output.

I guess every frequency band offers its own design problems. As LF it is not lead length or stray capacitance but more about larger inductors and finding suitable capacitors. Above all it is about how to radiate some useful power from an antenna limited in size compared to a wavelength. Also to get on the air below 200 kHz, it is a case of either build a special transmitter or modify one made for higher frequencies. So it's home-brew just like the good old days!

References

- 1 Lloyd Butler VK5BR – A LF Antenna Bridge – *Amateur Radio*, October 1998
- 2 Lloyd Butler VK5BR – RF Power Linear Amplification using the IRF MOSFET – *Amateur Radio* November 1989
- 3 Lloyd Butler VK5BR – Capacitors at High RF Power *Amateur Radio* January 1995



- La - 1.2 mH Inductor with variometer (Q = 300)
- Ca - Antenna capacitance
- Rr - Radiation resistance (estimated)
- Rc - Loss resistance of ant. inductor La
- Re - Earth resistance loss (estimated)

FIGURE 5

LF TRANSMITTER

25/75 Ohm Transformer
 17 bi-filar turns plus 6 single-filar turns
 on 620-55254 iron dust core (4mm dia.)
 AI = 175mH/1000T

PROPOSED ARRANGEMENT TO FEED & LOAD VERTICAL ANTENNA TOWER

DON'T MISS THE ACTION!

VX-5R 6m/2m/70cm Deluxe Hand-Held

Tiny yet incredibly rugged, the VX-5R provides 6m, 2m and 70cm amateur band operation with 5W output as standard (4.5W on 70cm), made possible by a unique PA design and a super high capacity 7.2v 1100mA/H Lithium-ion battery. Plus, ultra-wide coverage VHF and UHF as well as AM medium-wave and shortwave reception facilities are provided, along with a large backlit dot-matrix LCD screen. All this in a diecast aluminium enclosure just 58 x 87 x 28mm WHD (w/o knobs or antenna)!

Features

- Tx: 50-54, 144-148, 430-450MHz
- RX: 0.5-1.8MHz, 1.8-16MHz, 47-729MHz, 800-999MHz (cellular blocked)
- Full feature keypad, CTCSS encode/decode, digital code squelch
- Comprehensive menu system
- Over 200 memories
- 8 digit alpha-numeric memory labelling
- 5 battery saving systems, plus Tx/Rx usage monitor
- Spectra-Scope™ for monitoring adjacent channel activity
- Comes with FNB-58LI Lithium-ion battery, flexible antenna and AC adaptor/charger

D 3670

VX-5R Accessories

CSC-73 Carry Case	D 3671	\$26.95
CD-15 Fast Desk Charger	D 3672	\$49.95
FBA-23 Dry-Cell Battery Case	D 3673	\$49.95

YAESU

\$699

2 YEAR WARRANTY



FT-50RD 2m/70cm Handheld

The Yaesu FT-50RD is an amazingly compact 2m/70cm amateur band handheld transceiver which provides MIL-STD 810 shock and vibration resistance, super wideband receiver coverage, simple menu settings for most functions, and compatibility with the optional Yaesu ADMS-IE software/interface package for PC programming of many functions.

Other features include:

- Tx 144-148MHz, 430-450MHz
- Rx 76-200, 300-540, 590-999MHz (cellular blocked)
- FTT-12 keypad provides Digital Voice Recording, CTCSS/DCS scanning, and CTCSS encode/decode
- 2m/70cm RF output: 2.5, 1.0, 0.1W standard, up to 5W with 9.6V battery or 12V DC socket
- "Omni-glow" LCD screen for easier night-time viewing
- 112 memory channels with 4 character alpha naming
- Dual watch allows monitoring of sub-band activity
- Direct FM modulation for better audio quality
- 5 battery saving systems (includes Rx and Tx Save)
- Comes with FNB-40 slimline 6V 650mA/H Nicad battery pack, flexible 2m/70cm antenna and modified M-9626 AC plugpack adaptor for Nicad charging

D 3660

YAESU

\$499

SAVE \$70

2 YEAR WARRANTY



Yaesu FT-90R 2m/70cm micro mobile

Another engineering breakthrough from Yaesu – a tiny dual-band mobile rig with high power output, a remoteable front panel, and a rugged receiver front-end.

The FT-90R provides 50W RF output on the 2m band as well as 35W output on the 70cm band, a solid diecast casing with microprocessor controlled cooling fan for reliable operation, and a large back-lit LCD screen, all in a package measuring just 100mm x 30mm x 138mm.

Also includes:

- Wide dynamic range receiver for reduced pager breakthrough
- Huge receiver coverage – 100-230, 300-530, 810-999.975MHz (Cellular blocked)
- 180 memories and a variety of scanning functions
- Built-in CTCSS encode/decode, battery voltage metering
- Designed for 1200 and 9600 baud Packet operation
- Tiny remoteable front panel (requires optional YSK-90 separation kit)

Includes MH-42 hand mic, DC power lead, and easy to follow instructions.

D 3312

YAESU

\$899

2 YEAR WARRANTY



YSK-90 Front Panel Separation Kit

D 3317

\$129⁹⁵

FOR ALL YOUR COMMUNICATION NEEDS

6m 1/2 Wave Base Antenna

A rugged Australian-made vertical antenna designed to cover the 51 to 54MHz range, with minimum SWR around 53MHz. Built using high tensile T81 grade aluminium, it's just 2.9m long with a sealed base section and 100WV minimum power rating. Complete with mounting hardware.

D 4825

D&G Antennas



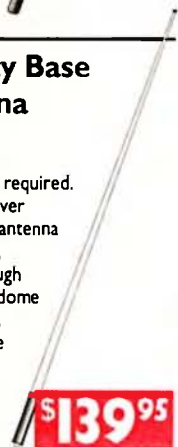
\$69⁹⁵

2m Heavy Duty Base Station Antenna

For use where long-range omni-directional 2m band (144-148MHz) coverage is required. This 3.4m long 1/2 wave over 1/2 wave colinear vertical antenna provides approx. 5dB gain, and is housed in a very tough single-section fibreglass radome for all-weather protection. The strong aluminium base section is fitted with an N-type socket in its base for coax cable connection.

D 4822

BENELEC



\$139⁹⁵

FT-2500M 2m Heavy-Duty Transceiver

Built tough to take the rough stuff, the Yaesu FT-2500M meets US MIL-STD 810C for shock and vibration so it'll provide years of reliable mobile operation. Its easy-to-operate front panel design, rubber coated knobs, and large Omni-Glow display are teamed up with a one-piece diecast chassis to set the FT-2500M apart from other 2m mobiles. For improved front-end performance, Yaesu's exclusive 3-stage Advanced Track Tuning feature and dual-FET mixer reduce overloads from strong signals while providing excellent sensitivity and wide-band receive operation.

Also includes:

- 31 tuneable memories
- 7 selectable tuning steps
- Various scanning modes
- In-built CTCSS encoder
- MH-26 hand mic, mobile mounting bracket & DC power lead.

Specifications:

Frequency range: Tx 144-148MHz, Rx 140-174MHz
 Output power: 50W, 25W, 5W
 Sensitivity: better than 0.2uV for 12dB SINAD
 Image rejection: better than 70dB
 Max audio output: 2.0W into 8 ohms (10% THD)
 Dimensions: 160 x 50 x 180mm (W.H.D.)

D 3632



YAESU

\$499
LOW PRICE

2 YEAR WARRANTY

LATEST 2000 RELEASES

WIA Callbook

Wide range of information for Australian Amateurs plus usual callsign and address listings.
 B 2344

NEW \$17⁹⁵

ARRL Handbook

77th edition of this famous publication. Incredibly wide range of information for operators and constructors.
 B 2237

NEW \$59⁹⁵

Yaesu FT-840 HF Mobile

An ideal first rig for home or vehicle use, the economical Yaesu FT-840 covers all HF bands from 160-10m with 100W PEP output, and provides continuous receiver coverage from 100kHz to 30MHz.

The FT-840 provides:

- SSB/CW/AM operation (FM optional)
- 100 memory channels, two independent VFOs per band
- Large back-lit LCD screen, uncluttered front panel
- Effective noise blanker
- Variable mic gain and RF power controls
- SSB speech processor for greater audio punch

- IF Shift & CW Reverse to fight interference
- Dual Direct Digital Synthesizers for cleaner TX/RX operation
- Compact case size of just 238 x 93 x 243mm (W.H.D.)

D 3275

YAESU

\$1675

FM module suit FT-840 D 2932 \$109.95 2 YEAR WARRANTY



PHONE FAX AND MAIL ORDERS

PHONE: WITHIN AUSTRALIA: 1300 366 644
 (Local call charge)

FAX: (02) 9395 1155 within Australia and
 (+612) 9395 1155 from outside Australia

MAIL: DICK SMITH ELECTRONICS, Direct Link, Reply Paid 160,
 PO Box 321, North Ryde NSW 1670 (No stamp required)

Excludes packaging and postage. All major credit cards accepted.
 14 Day Money Back Guaranteed if NOT completely satisfied. (Software excluded)



Visit our web site at
<http://www.dse.com.au>

DICK SMITH ELECTRONICS

That's where you go!

Yaesu transceivers and accessories stocked in selected stores only. Other stores can place orders on a deposit-paid basis.

Talking Radio

Highlights of the WIA/ACA Liaison meeting

The WIA met with the Australian Communications Authority in December 1999. Representing the WIA/ACA-Liaison Committee were Peter Naish, WIA Federal President and Committee Chairman; Wally Howse, WIA Director; Michael Corbin, WIA NSW State President; Glenn Dunstan, WIA Councillor for ACT; and Richard Jenkins, WIA Canberra liaison officer.

Issues discussed:

Olympic Games - possible use of Amateur 6cm band

The Sydney Olympic Broadcasting Organisation (SOBO) proposes to circle a plane over Sydney to act as a backup method of communications. Technical details yet to be specified; it is expected to be a 5 watt service radiating from the undercarriage of the aircraft.

There are concerns from overseas associates, North America and Europe particularly, that this proposal could compromise the amateur satellite service, with the expected launch of an amateur satellite in the second quarter of 2000.

The WIA suggested that SOBO use part of the band away from the amateur satellite service. The ACA agreed that this was a good suggestion and it was what SOBO intended at this time.

Status report on 80 metre DX Window progress

Glenn Dunstan will coordinate a small team of WIA members to progress this matter and liaise with the ACA and users around the 80m DX window.

There are now mechanisms in place preventing any new assignments being made in the band. An implementation plan has been endorsed by the Radiocommunications Steering Committee (RSC). The ACA to approach users during January/February 2000, and inform them of the decision; the WIA will in turn shall contact users with their own follow up letter.

Discussion on the provision of more primary spectrum allocations for the amateur radio service to compensate for spectrum losses elsewhere. Desire by the WIA to gain access

nationally to the full six-metre band of 50 - 54 MHz.

The WIA sought permanent allocation of the 50-54 MHz band if and when the ABA return the spectrum to radiocommunications. Currently Amateurs are secondary to broadcasting from 50-52MHz, and primary in the 52-54MHz segment. Other allocations may be lost to other users, namely 2.3 GHz to pay-TV and 3.5 GHz to spectrum auction. The WIA is pushing for primary allocations within the microwave bands to compensate for previous losses.

The ACA commented that secondary allocations should be viewed as an extra opportunity and not viewed as lost primary allocation. Over the last few decades it has been noted that amateurs have done a lot of work within secondary allocations but focus should remain on primary allocations for mainstream activities. Any future allocations would need to be in line with Region 3. The future of broadcasting in the 50-52 MHz segment is unknown at this stage.

WIA request for a review of licensing arrangements in the LF Band

It is still the ACA's intent to progress this to more reflect amateur usage of this band. It is hoped that an amateur callsign may be allocated to a Scientific licence, however it is unsure how much work this will entail or whether current structures can accommodate this. The issue of bandwidth of operation will also be looked at.

The Radiocommunication Licensing Policy Team (RLPT) will update the WIA during first quarter of 2000.

EME Permits, "inconsistency" clause required

Amendments to Licence Conditions Determination (LCD) for amateur licences will include a generic condition that will be applied to all licences. This condition will allow the ACA to vary an amateur's licence by special condition to give more power. The inconsistency clause allows a special condition to be written that is inconsistent with the LCD. The special condition will override conditions in the LCD to accommodate high power Earth Moon Earth requests. Other criteria may still apply to each request with Wally Howse (WIA) asking for EMR issues to be addressed rather than elevation.

This revised LCD is currently with ACA Legal and is expected to be presented to ACA Authority for final approval at their first meeting for 2000, expected mid-January. Once approval has been given, this change will be gazetted the following week.

Examinations - reply to WIA's request for a firm date for the introduction of the proposed revised examination arrangements and ACA commitment for an extension of present arrangement to enable adequate financial and resource budgeting by WIA.

There is a possibility of one organisation being able to conduct both amateur and marine exams, however they must have the necessary skills to provide this service.

The ACA would like organisations to run the exams in their own right and issue the certificates of proficiency. Allowing competition is part of the ACA's principle, but the low volume of exams is an important factor. While it is recognised that there may be some problems with this approach it does warrant further investigation.

The WIA asked for a firm commitment to continue the current arrangements until 31 December 2000. Such a commitment would allow the ACA to include in its tendering process, an indication that the successful tenderer would take over responsibility for exams from 1 January 2001. The ACA undertook to consider this.

WIA examination invigilators

The WIA is looking at rationalising the somewhat outdated list of invigilators; there appears to be quite a number of invigilators who have not conducted an exam for quite some time and are now clearly not available. The current objective of the WIA is to terminate the appointment of all invigilators and seek nominations for new invigilators. The WIA will set criteria for their invigilators in an attempt to improve the service for the people sitting the exams, the WIA and the ACA.

Review of licence fee schedule and a five year licence

During the last WIA/ACA meeting it was recorded that "the renewal administrative charge was now \$19 not \$20 per transmitter". This was incorrect as the renewal fee is only \$9. Where a licensee elects to pay up front for a multi-year amateur licence, the amount payable will be the unrounded annual licence fee multiplied by the term of the licence, less a discount on the administrative component. The discount will be \$9 or the total administrative component of the licence fee (whichever is lower) for each annual renewal that would have been made over the period of the licence. ie one year = \$50, 2 years = \$91, 3 years = \$132, 4 years = \$173, 5 years = \$214. This was confirmed in copies of page 47 of the Apparatus Licence Fee Schedule which were handed to meeting attendees.

The WIA asked what impact the Goods and Services Tax (GST) would have on licence fees. It is unknown at this stage what the effect will be and the ACA will inform the WIA of the decision when it comes to hand.

ACA review of the principle of a HF Gateway facility.

Initial approaches have raised a concern of unqualified amateurs accessing bands not applicable to their licence class. Linking VHF/UHF repeaters is known to be successful with few if any breaches of requirements. The meeting agreed that the licensee of such a service would probably need to be a repeater group rather than an

individual. With advanced technology now available, the ACA will now reconsider this issue.

Reservation of callsign suffix group WIA-WIZ for special purposes including Wireless Institute Civil Emergency Network (WICEN).

The callsigns WIA-WIZ are reserved for use by the WIA, including WICEN. Anyone who wishes to operate a device under such a callsign should apply for a licence.

A licensee under section 117 of the *Radiocommunications Act 1992*, may by written instrument authorise other persons to operate a radiocommunications device under the licence. However, any licensee who authorises another person must keep a copy of the authorisation in Australia; and retain the copy for at least one year after the authorisation ceases to be in force.

A licensee may apply for exemption from licence fees. Exemptions are made under regulation 5 of the *Radiocommunications Taxes Collection Regulations* and under the *Radiocommunications (Charges) Determination No. 1 of 1997* and any application should meet the criteria set out in these.

In summary,

- The callsign suffixes WIA-WIZ are reserved by the ACA for issue to the WIA;
- WIA or WICEN may apply to use these callsigns;
- Records must be kept in relation to third party operations;
- Eligible applicants may be granted fee exemption if they meet the criteria.

Linked repeaters, removal of restrictions on in-band linking

The ACA advised that there is an obsolete reference in the Amateur Licence Information Paper that only three amateur repeaters may be cross-linked. This reference is superseded by the Amateur LCD where there are no requirements on in band linking. The ACA will remove the reference from the Amateur Licence Information Paper.

Amateur use of Channel 35

The ACA received advice from the ABA that the drop through for amateur TV services has been extended in four of the five locations, O'Halloran Hill (SA), Springwood (NSW), Spring Hill (QLD) and Lane Cove (NSW), until 31 December 2000. The only exception is Olinda (VIC)

which is required for use by digital services in Melbourne under the ABA's Digital Channel Plan (DCP) for Victoria.

Correspondence received from amateur concerning WIA lack of consultation

The ACA received correspondence from an amateur who is concerned about a perceived lack of consultation by the WIA on matters such as the 80m DX window and the LF band. The WIA had consulted with the members that used the 80m DX window on a daily basis who would be considered as experts in this area, and they were happy that the WIA wished to align with the European band plan. The WIA had included references to its proposals on the 80m DX window through its News Broadcasts and on its Federal Web page so that all members could comment in addition to the keen operators in this band.

Internet Linking of Repeaters

Peter Naish asked for the ACA's view on a trial program set up by the UK's Radiocommunications Agency allowing for amateur repeaters to be linked via the Internet. Current policy does not allow for such an application. Mutual concern that unqualified people could get access to repeaters not just in Australia but overseas. The concerns are similar to those raised for HF gateways.

Use of Morse Code

The WIA raised an information point that there is an increasing body of WIA members and radio enthusiasts in general who are debating the need for qualification to send and receive Morse code in order to obtain a HF Amateur licence. Resulting from that increasing interest among WIA members, the WIA, through its State Divisions, was conducting a survey on Morse code to come up with a concise view on what the Australian radio amateur wishes to do about the matter. The WIA is happy to provide the ACA with the results of this survey.

The ACA responded that it expected that the issue will be addressed at WARC 2003. The ACA, although receiving a number of form letters requesting changes to the requirements for Morse code, does not propose any unilateral changes. The existing arrangements are the basis for a number of reciprocal agreements. The ACA would like to see amateurs worldwide put forward a consolidated position on Morse code which can be resolved at WARC 2003.

TECHNICAL ABSTRACTS

Gil Sones VK3AUI

30 Moore Street, Box Hill South Vic 3128

New Finals for FT101

The FT101 series of transceivers from Yaesu were very popular but the price of replacement final valves has risen as the market for valves has shrunk. Most of the FT101 series used 6JS6 series valves intended for TV horizontal deflection service. These were a cheap alternative but have now risen in price as the TV replacement market has all but disappeared. Also the originals were usually from a small group of manufacturers whose products had been found empirically to be good for RF service. The supply nowadays may require some expensive experimentation for RF service as the internal structure of the valves may differ. They may work in a TV set but may be less successful in a transceiver.

Other manufacturers used the 6146B and its variants which were designed for RF service. Over the time since manufacture of three transceiver these valves whilst expensive have not risen dramatically in price. Being characterised for RF service they can be sourced from alternative suppliers. There have been articles in magazines describing how to substitute 6146's for 6JS6's in an FT101. The original article appeared in Radio ZS August 1998 and then in QST May 1999 with an update in QST September 1999. The article was the work of Roger Davis ZS1J and the QST articles were reprints in the Hints and Kinks column of Bob Schetgen KU7G.

Also in the article a common fault with the FT101 series was mentioned which should be attended to regardless of the finals used. The 80 pF capacitor between the grids of the final valves and the driver tube plate (12BY7A) which is C13 has been known to break down in a number of cases leading to the destruction of the final valves. The replacement of the capacitor is recommended but if a replacement is impossible to obtain the finals can be protected by placing an 0.01 mF HV disc in series. This will prevent the application of positive voltage on the grids which can lead to the demise of the valves and in some cases the demise of the power supply.

The modification is shown in Fig 1. To commence unsolder the components and wiring to the 12 pin sockets used by the 6JS6's. This means the components R14(100 Ohm), L4/R9, C16, R12, the blue heater wire, and the inner of the black coax, and also the decoupling capacitors. The 12

pin sockets should then be removed and replaced with 8 pin octal sockets. The keyway of the octal should face to the chassis centre as shown in Fig 1A. Wire the sockets according to Fig 1A.

The decoupling capacitors which have been left off the pictorial for clarity should be connected between the points marked with an asterisk and the nearest convenient chassis grounding point. They are shown on the circuit in Fig 1B.

The 6146 type requires a different screen voltage to the 6JS6 and so the orange wire between R14 and C35 (a feedthrough) needs to be moved to a different feedthrough capacitor C30. This is the 300 Volt line for

the 12BY7A driver. You may need to adjust the 6146 screen voltage further with a series zener diode as this nominal voltage does appear too high but this was not mentioned in the original article.

In the original article the neutralising was modified by replacing C125 (100 pF) with a 2 pF capacitor. C125 is connected between the top of the plate choke and the variable neutralising capacitor. However in the latest article an alternative and superior modification to the neutralising circuit was given. The improved modification was to leave C125 untouched and to connect an additional 2000 pF 1KV capacitor across C11 the 200 pF bypass capacitor for the cold

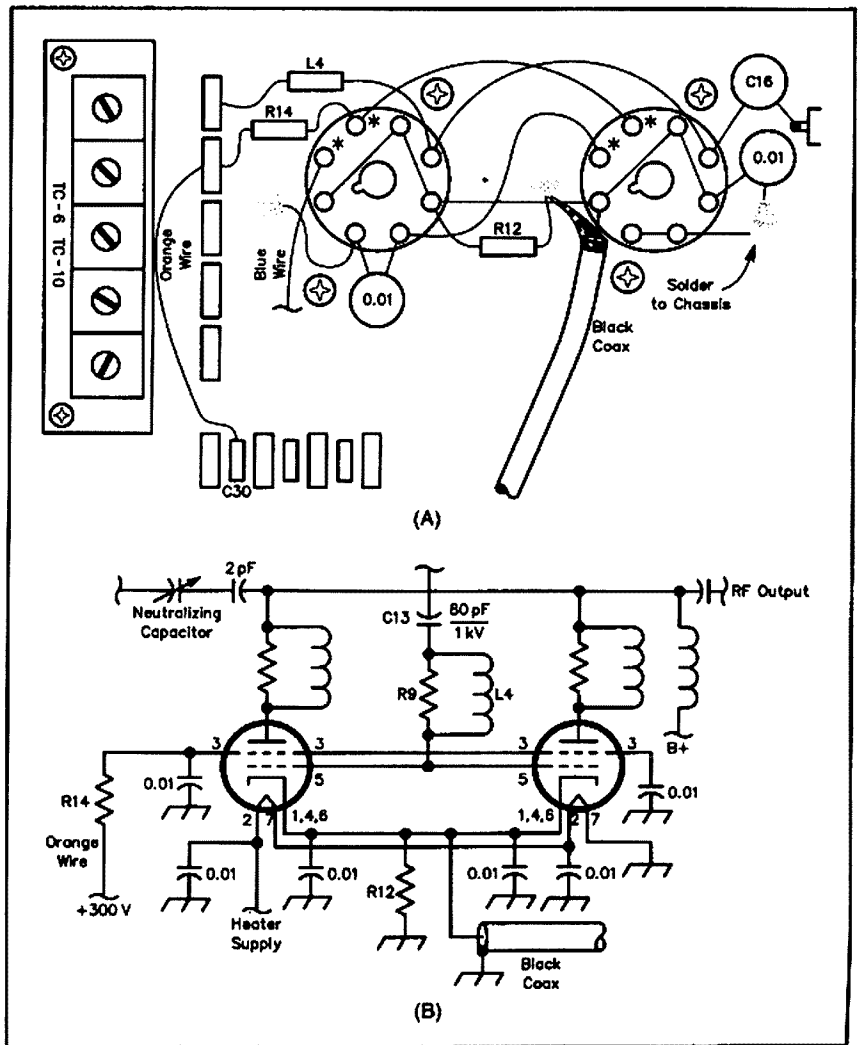


Fig 1 (A) Pictorial of FT101 PA wiring. (B) FT101 Final schematic. * indicates 0.01 mF decoupling connection point.

end of the 12BY7 plate tuned circuit. This not only modifies the neutralising but also by improving bypassing of the driver tuned circuit provides greater drive.

To compensate for the different grid capacitance of the new finals a 20 pF trimmer should be connected across T103. The trimmer board with trimmer capacitors TC6 to TC10 will need to be temporarily moved aside to fit and adjust this trimmer.

Before testing the final bias supply pot

should be adjusted fully counter clockwise. This is on board PB-1314. This should be adjusted for 60 mA plate current in SSB mode with no audio.

The trimmer capacitor across T103 is adjusted with the other trimmer board temporarily moved aside. The preselector should be set to the beginning of the 28 MHz mark and the trimmer adjusted for maximum drive. The trimmer board may then be fastened back in position. The trimmers

should be treated with caution during this adjustment as they have high voltage on them. The alignment should be checked as detailed in the handbook and the neutralisation adjustment made as per the handbook. There may be some interaction between the adjustment of the new trimmer and the handbook alignment but it should be minimal. The neutralisation should proceed normally and should be a simple procedure.

PTT Sound

There are many programs available to allow you to run modes such as CW, RTTY, AMTOR, FACTOR, PSK31, SSTV, FAX, Hellschreiber etc using the sound card in a PC.

One source of such programs on the internet is <http://www.muenster.de/~welp/sb.htm>. A suitable interface card between the computer and the transceiver appeared in QST November 1999. The article by Salvador Esteban EB3NC had originally appeared in CQ Radio Amateur Spanish Edition August 1998. While you may be able to get away without an interface card it does make operation somewhat simpler.

The card called PTT Sound interfaces the

computer serial port and sound card input and output to the transceiver. Levels can be set on the card and microphone input is provided for with a push to talk switch. The card is designed to allow the use of an electret microphone.

The PTT Sound card circuit is shown in Fig 2. The components are relatively non critical. Transistor Q1 could be any low noise NPN audio type. The ECG series are just a series of replacement parts which may

be available locally but there are many other local types which would be suitable.

The various input and output levels can be set on the interface card. The jumper J1 can be set for the required PTT input from the computer serial port. This may vary with the software selected. The audio input from the sound card can come from either the left or right channel. The author used the tip or left channel.

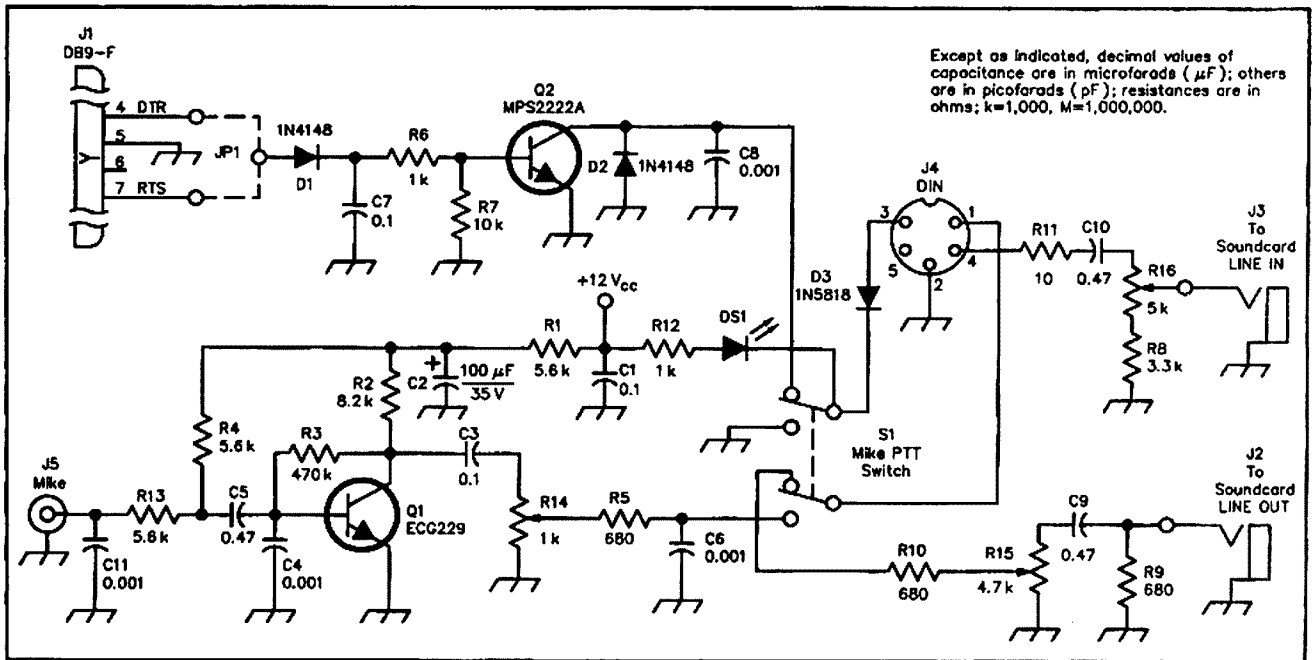


Fig 2. PTT Sound Interface Card.

Erratum

An error occurred in the January 2000 Technical Abstracts which saw the omission of Fig 1. This showed the setup of the original loop described by K Patterson in Electronics Aug 21 1967 and the setup of the AMA loop of Chris Käferlein DK5CZ and Hans Würtz DL2FA originally published in CQ DL Feb and April 1983. These differ in the tuning and matching arrangements. The diagram is shown as Fig 3, which is the original and missing Fig 1 of the Jan 2000 issue.

The diagram comes from the Japanese CQ Ham Radio September 1999 article of JG1UNE.

図1 Pattersonのチューニング方法

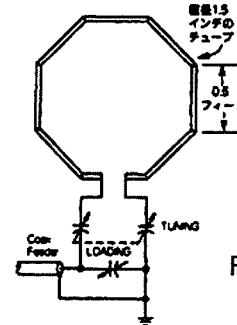


図2 AMAの結合ループ

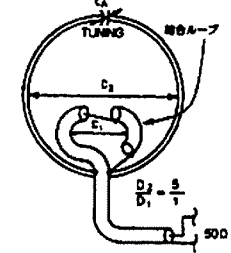


Fig 3. Original Loop of Patterson and the AMA Loop.

ar



Bill Magnusson VK3JT
RMB 162, Melbourne Vic. 3678
Email: vk3jt@amsat.org

Y2K roll-over observations

“Everything went like clockwork ... until...”

THE “NEW MILLENNIUM” has arrived and there has been enough time now to see how it has affected matters relating to amateur radio satellites. How did you fare with your computer problems? From a public point of view it turned out to be a fairly uneventful “event”. There were no major and few minor power failures. It seems that all the work done over the preceding couple of years paid off. All those unsung heroes out there in computer-land are to be congratulated on their collective perspicacity.

The same was not true however in the software department. For some time it had been known or suspected that there would be failures in some software packages used by amateur satellite users.

In my own case, as the custodian of a beloved 9 year-old 486 computer running Windows 3.1, I was interested to see just how the predicted ‘fall-over’ of the WiSP16 package would turn out in real life. As expected, the computer complete with bios patch turned over midnight OK and WiSP continued to run as usual. I watched as it

tracked my antennas to bring in the downlink signal from Oscar-10 and nothing out of the ordinary occurred as the midnight hour came and went. There were some good signals on AO-10 that night too. North America, the Pacific, Japan and all of VK were in the footprint. I closed down the system with light heart and after a nip of muscat to see in the new year, I repaired to bed. The following morning WiSP still appeared to be working OK and I watched as it connected and downloaded the directories and messages from KO-25 and UO-22 as it usually does each morning. Everything went like clockwork ... until the dreaded midnight UT when it suddenly stopped tracking, the date went back to 1st Jan 1970 and that was that!

There is no way out of this situation as the 16 bit version of WiSP is no longer supported. This will mean an upgrade of the computer and installation of Win95 and WiSP32. All that is in the pipeline and I hope to be able to report on the success or otherwise next month. Reports indicate that there were some problems associated with keplerian element updates in many tracking programs. The InstantTrack patch worked well and IT users should all be able to continue using it. The new version is still under review and should be available soon. Keplerian element updates in some of the less popular tracking programs are still not resolved. Some of the older DOS ones are no longer supported and will have to be discarded.

Most of my other software packages have rolled over OK. One of the astronomy programs (a registered copy) is now telling me that the registration is out of date. All others are operating OK. I’ll be contacting the author regarding that.

My registered version of Accuset, the

National co-ordinator:

Graham Ratcliff VK5AGR
Email: vk5agr@amsat.org

AMSAT Australia net:

The AMSAT-Australia net is held on 80 or 40 metre LSB (Lower Side Band) each Sunday evening (except over the Christmas/New Year period). During the winter months in South Australia (end of March until the end of October) the net is on 3.665 MHz +/- QRM with an official start time 1000 UTC with early check-ins at 0945 UTC. During the summer months when daylight saving is in operation in South Australia (end of October until end of March) the net is on 7.068 MHz +/- QRM with an official start time of 0900 UTC with early check-ins at 0845 UTC. The times and frequencies have been chosen as the best compromise for an Australia-wide net taking into consideration seasonal propagation changes and the various state summer time variations.

AMSAT Australia newsletter and software service:

The newsletter is published monthly by Graham VK5AGR. Subscription is \$30 for Australia, \$35 for New Zealand and \$40 for other countries by AIR MAIL. It is payable to AMSAT Australia addressed as follows:

AMSAT Australia
GPO Box 2141
Adelaide SA 5001

Keplerian Elements.

Current keps are available from the Internet by accessing the AMSAT FTP site, ftp.amsat.org and following the sub-directories to “KEPS”.

Telstra computer time setting program no longer works. Again, I'll be contacting the author. Satellite tracking is not the only amateur radio area which could be affected by the roll-over. It will be interesting to read how the contest logging and DX sections fared in regard to their specialised software.

9600 baud ... old hat!

As if to whet the appetite for greater things to come, I received a stunning photograph from Colin Hurst VK5HI via the internet. It

was taken from UO-36 by its earth-imaging camera. This one has to be seen to be believed. The detail is remarkable even though it's been JPEG compressed to send via the 'slower' media.

The photograph shows the town of Nogales, California. You can easily discern individual property lines, tree-lines, crops, even some detail within suburban blocks, and remember this is a JPEGed file. The original file, direct from the CCD would have been very much larger. The need for

higher speed downlinks is evident from even the present state of this exciting activity.

Colin is right in the thick of it and his software, already the 'industry-standard' is continually being upgraded to keep pace with new developments as they occur. Stacey Mills has written this summing up of the present state of affairs. It is re-printed from the AMSAT-BB.

38,400 Baud Satellites

Stacey Mills W4SM.

If you are tired of the "slow" 9k6 baud sats, now may be a good time to look into what it takes to go to the 38k4 downlinks. At least two of the current satellites, TO-31 and UO-36 have this capability. P3D's RUDAK has multiple high speed modems and is likely to be very active at 38k4 as well.

Several of us have been working with Chris Jackson to tweak WiSP to function best with these new satellites, and I believe that they (at least UO-36) will be widely available soon. Even now UO-36 is often transmitting over the US and Australia (437.025) when Colin VK5HI is active in Adelaide. The uplink on these satellites is 9k6 baud, so if you're active on UO-22/KO-25, etc., no changes are needed on the transmit side. However, the extreme bandwidth of the downlink at 38k4 necessitates some receiver changes as all the current ham rigs are too narrow to handle this.

However there is a very good, relatively inexpensive solution. SYMEK (www.symek.com) a German company in Stuttgart, makes a small receiver/demodulator board that intercepts the data stream from your transceiver's IF. These IFD boards cost DEM 235 (about A\$200). They come with excellent installation instructions (in English if appropriate) and are available for most of the major satellite transceivers and receivers used by amateurs. If you don't see your rig listed, drop them a note and they'll work with you

to get you an IFD board. I ordered using a credit card over the internet and my modules were received in a few days. I've installed one in a Yaesu FT-736_R and another in a Kenwood TS-790A. The Yaesu installation is very simple and the Kenwood is only a little more involved. Anyone comfortable making the 9k6 modifications should easily be able to handle this. Importantly, normal function of the radios is not affected.

With regard to a modem that will handle 38k4 downlinks, there are several options. I've been told that the standard G3RUH 9k6 FSK modem can be adapted to run at this speed. There's also been a discussion that a DSP56002EVM board is capable (just) of running at this rate and some software may be available for this modem on the TAPR web site. I have not pursued either of these solutions, so I can't comment further.

Symek has two very high speed modems (up to 614K baud!) that work extremely well. One is a two port version (TNC3S) and the other, less expensive one is single port TNC3IS. Mine is set up to wake up in KISS mode with 38k4 downlink, 9k6

uplink, and a 57k6 PC connection.

The downlink at 38k4 on UO-36 is really spectacular! Watching the byte counter fly by is quite a treat. Efficiencies of 90-100% are easily obtained with directional antennas and a pre-amp. Doppler tuning is not necessary on the widebanded 435 MHz downlink. Downloads of 1.5 Megs are possible on single passes, and all three components of a colour image can be captured in short order. I used to think 9k6 was fast, at least compared to 1k2 on AO-16, now when I look at KO-25/UO-22, the byte counter seems to be moving in slow motion! To me at least, this high speed (internet level) transfer rate, and the ability to grab images on a single pass, really brings some excitement back to the digital sats.

STANDARD DISCLAIMER: I am not an employee of Symek and I receive no compensation from them... just a very satisfied customer wanting to spread the word. Hope to see you in the queue(s) soon.

Stacey Mills W4SM.

73 until next month, Bill VK3JT

ar

NOTICE



FEDERAL WIA CONVENTION

APPOINTMENT TO FEDERAL POSITIONS

The Federal Convention and Annual General Meeting of the WIA will be held in Melbourne on 29/30 April 2000. At this meeting, a number of positions will be filled. Nominations must be received by the Federal Secretary by 17 March 2000.

The positions are

President
Directors (3 positions to be filled)
Company Secretary

Editor "Amateur Radio" magazine
Publications Committee (5 positions)
WIA/ACA Liaison Committee (3 positions)
IARU Region III Liaison Officer

ITU International Regulatory and Radiocommunications Study Officer
Federal Media Officer
Federal Web Page Coordinator
Chairman Federal Technical Advisory Committee
Federal Education Coordinator
Historian
AMSAT Coordinator
Intruder Watch Coordinator

Federal Contest Coordinator
Federal Awards Manager
Federal WICEN coordinator
international Travel Host
ARDF Coordinator
Federal QSL Manager
VK9/VK0 QSL Bureau
QSL Collection Curator
Videotape coordinator

Nominations received direct will be considered but preference is likely to be given to Divisional nominees

VHF AN EXPANDING WORLD

David K Minchin VK5KK
 PO Box 789 Salisbury South Australia 5108
 E-mail: tecknolt@arcom.com.au
 Web page: <http://www.ozemail.com.au/~tecknolt>
 Fax: (08) 82346396
 Phone: 0414 808060 (before 2130 EST please)

All times are UTC

6 Metres

Sporadic E is still around despite the imminent solar peak. Throughout December and early January 2000, various peaks have occurred with Es 6 Metre paths up to 3500km (VK5-3D2 attributed to Es). F2 & TEP openings seemed to curtail around late November except for the reported openings on 14/12/99 to USA & Central America and the odd JA to VK4 & VK6 TEP opening. After the F2 openings, Es was slow to return from a dormant state in most areas.

Overseas it has been much the same with some TE on the USA to South American path around mid December and again around 9/01/00. Subtracting 11 years from today and looking at the conditions in late 88, opinions are varied as to how this cycle is travelling. To be sure I think the next equinox period, i.e. from when you read this to the end of April, will tell much if not all!

Gordon VK2ZAB reported 50 MHz being open from the Sydney area to the Carribean, Mexico, USA, Korea & ZL from about 2200z 13/12/99 thru about 0200z 14/12/99.

VK3's and VK1's were heard working N6XQ on 50 MHz 13/12/99 22:39Z. It appears that the opening extended from VK4 to VK1, VK2 & VK3. At this stage no further details have been forthcoming from other individuals. A slightly unusual time for such an extensive opening!

John VK4FNQ reports working the following, 01/01/00 0800 JA6LZG, 9/01/00 0609 YJ8UU. John also reports hearing the P29BPL beacon on 50.029 MHz, 11/01/00 @ 600, 599.

11/1/00 YJ8UU was also heard -0600Z working into VK4, by Eric VK5LP & Steve VK5AIM. Neither was able to break through the pile-ups. Eric also reports hearing 3D2AG, Antone, on 1/01/00, 3/01/00 & 11/1/00 at 0200-0230 each time up to S8 at Meningie. Again unable to break through the eastern seaboard stations!

John, VK4KK reports that the P29BPL beacon, PNG, has been heard in the Brisbane area on 50.029 MHz. Last

information on this beacon put the location of this beacon as QI30. No further information is available.

Bill VK6JQ writes to correct an item that appeared in this column in December 1999. The callsign heard on 7/11/98 at 842 was IW5BML (not IW5BMI). Also on 8/11/98 Bill heard A45ZN, but did not work him. After the contacts described last month things have been quiet in Broome... "Since the last Europeans came in on the 18th of

November, 6 Metres has died, only one JA Contact on the 30th of November and Nothing Since." ... VK6JQ

2 Metres Sporadic E's

Several 2M Sporadic E openings have been logged so far this season. Interestingly, the recording of ZL to VK3 contacts in Mid November perhaps underlines the complexity of Es during the upper side of the sunspot cycle.

The Japan Century-Cities Award

John Bisgrove, VK4KK (VK4ZJB) of Brisbane has completed a very difficult milestone in VK amateur radio history.

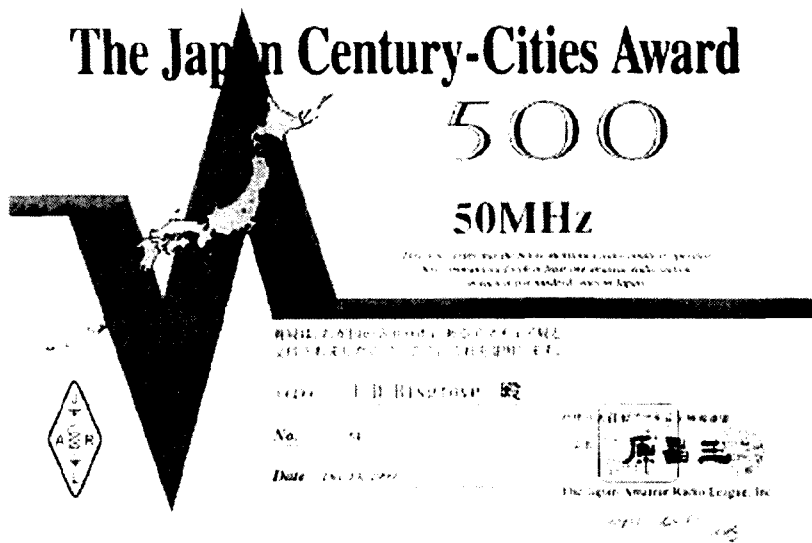
On 15 July 1990, he received Certificate Number 75 for confirming six metre contacts with 400 cities in Japan. For many that would have been sufficient but John kept going and on the 14th of December 1999 was awarded Certificate Number 56 for 500 cities confirmed!

John says "It took me 33 years to collect 500 cities, 23 years of which were during the miserable Channel 0 days. There are a

minimum of 600 plus cities in Japan, but to work more than 500 will be very difficult as most have no six metre operators. To keep track of those stations I had worked, I filled most of the 190 pages in a school exercise book."

This is a great achievement and surely congratulations are due to John for his dedication to the task of achieving the almost impossible. A smaller reproduction of his four colour certificate is shown here.

Thanks to Eric VK5LP for submitting this item.



Ron, VK3AFW reports ... *"Just a note for the record ... 15 Nov 1999, 0859 Max, VK3TMP worked ZL3NW, 0900 Trevor, VK3KEG worked ZL3NW, 0902 Steve, VK3ZXR worked ZL3NW and ZL3AIC (not sure about last letter of*

call, might have been AIT). Steve is at Crib point and was using an omnidirectional vertical.

0945 ZL3TY heard 5x3 in Melbourne and most of SE Victoria for a short

burst, probably a meteor, but possibly a fortuitous tilt of the E layer

giving enhanced propagation. Except for the burst mentioned above, zilch heard from ZL here in 3 hours of monitoring" ... VK3AFW

Gordon VK2ZAB reports the following ZL contacts on 14/12/99 via Sporadic E, 0220z 14/12/99 VK2ZAB - ZL2TAL, 0222z VK2KU - ZL2TAL, 0235z VK2KU - ZL2TE and 0236z VK2ZAB - ZL2TE."

Gordon writes ... "The Auckland 2M beacon was up to S5 here shortly before these contacts were made and the Wellington 2M beacon was also up to S5 about 15 minutes after the contacts. No contacts were made to the Auckland or Wellington areas and the two ZL2s contacted are both from the New Plymouth area roughly halfway between the two beacon sites."

Rob VK3EK\DEM at Bairnsdale (QF32te) reports working the following stations on 144 MHz on 14.12.99. 0752 ZL3TIC 53, 0756 ZL3AIC 59, 0757 ZL3NW 55, 0817 ZL3TY 55, 0820 ZL3NB 55, 0832 ZL3AAN 55, 0833 ZL3TIB 55, 0855 ZL4DK 55

Guy Fletcher, VK2KU reports ... "We had a very brief Es opening yesterday (Monday) morning local time, about 2 days earlier than usual. Actually last year we had no VK2-VK5 contacts but the Mt Lofty beacon was in strongly on 2m for about 15 minutes. 09 Jan 2000 at 2341Z, VK2KU worked VK5AKK (57, 59) and VK5ZBK (58, 59) on 144.180MHz." ... VK2KU

Barry Miller, VK3BJM, reports the following Sporadic E on 10/01/00 ... "It didn't last long, unfortunately. Between about 0205z and 0220z I heard John VK4FNQ worked the following on 2m: VK3XPD, VK3XQ, VK3AMK, VK3BJM, VK3BRZ, VK3ZQB, and VK3BDL. The signal into Box Hill was gone completely while John worked Chas, VK3BRZ, but came back up while John worked Russell, VK3ZQB, and Mike, VK3BDL.

Attempts were made on 70cm with Alan, VK3XPD, and Chas, who both have enough grunt and antenna gain to make it worthwhile, but no reports were exchanged; nothing was heard at either end. Lots of northern Australian 6m beacons were heard

at the time (all the VK4's and the Darwin beacon), but nothing from the Townsville 2m beacon." ... VK3BJM

To expand on the above John VK4FNQ from Charters Towers (QG39EX) reports the following contacts and stations heard on 2 Metres from the 9th to the 11th of January 2000.

9/01/00 0148 VK2MP Heard on 144 MHz

10/01/00 Worked the following on 144 MHz 0207 VK3XQ, 0208 VK3AMK, 0209 VK3BJM, 0211 VK3BRZ, 0213 VK3ZQB 59, 0215 VK3JWZ, 0220 VK3BDL, 0221 VK3KAY, 0224 VK5DK Hrd only

11/01/00 Worked the following on 144 MHz 0236 VK2ZAB, 0238 VK2EM.

Tropospheric DX

Tropo DX has varied across the country; some paths have been up to standard while others, notably the VK3/5 to VK6 path, have almost been totally absent.

Ron Cook, VK3AFW reports ... "VK3CY to VK7XR 5x9, 5x9 at 2110 13/12/99 Est. 550 km +, VK3AFW to VK7XR, 5x7, 5x7 at 2112 13/12/99 420 km

VK7RAE beacons, 144.474, 529, 432.474, 519. VK3AFW & VK7XR tried 432.150 MHz at 2220, nil. 432 MHz beacon gone at 2140. VK5RSE beacon 559 144.550 MHz, 539 with QSB on 432.550 MHz. No other interstate beacons heard."

Chas VK3BRZ reports ... "Both David VK3XLD and I worked Peter VK7ZPB at Whitemark on Flinders Is. yesterday evening (20/12/99) around 0900Z on 70cm. Peter's signal was up to S9 with some QSB" ... VK3BRZ

On 26/12/99 David VK5KK worked Colin VK5DK in Mt Gambier on 432.150 MHz at 1135, 56 both ways. Distance 410 km however through the big lump of dirt in the way to the SouthEast. Maybe I should call it the 30 db Hill!

On 7/01/00, the band opened to Albany on 144 & 432 MHz after a poor previous 6 weeks. VK5KK worked Wally VK6WG on 144.1 MHz @ 1210, 56 both ways followed by 432.120 MHz @ 1218. Signals on 432 MHz down on 144 MHz averaging only 41 - 51. The 144 MHz contact was repeated again at 1300. The arranged sched for 2230, next morning, passed with no signals being heard. Locally, intense enhancement was evident out to Ceduna (~560km) with the usual VHF and UHF (CB) repeaters to the west, the strongest this season. By 08/01/00 Conditions had started to slide through to the east as evidenced from the following report from VK7MO.

Rex, VK7MO at Kingston, 12 km South of Hobart reports working VK3EK at Bairnsdale on 432 MHz on 11/01/00 at ~2200. The distance for this contact was 594 km. At 1950 on 12/01/00 the Latrobe

Valley Beacon, VK3RGI, was 57 in Hobart and quite steady over a ten-minute period.

Forward Scatter on 144 MHz

Emil Pocock, W3EP reports on some extraordinary Forward Scatter 144 MHz contacts in the US ... "Contacts at 144 MHz are rare, yet Jay Liebmann, K5JL (EM15), Don Stradley, WA1JOF (FN44), and others have been having some startling success. WA1JOF has been running with KB8RQ (EN80) around 155 in the mornings over the past year and a half. The pair have never failed to work over their 1050 km path. Signal strength during evening runs were noticeably weaker, but they could still eke out contacts. Don has also made it with WA9KRT (EN61) with similar results. He notes that signals are usually detectable, but there is a surging effect about every 30 seconds when the signal rises above the noise. Sometimes, several minutes may go by until the faint signal is heard again". "K5JL has made some even more impressive ionospheric forward scatter contacts. On November 8, Jay worked VE1ALQ (FN65) at an incredible 2850 km. Well done! He noted that signals were just detectable in the noise most of the time. Necessary exchanges and rogers were made during those period periods when signals rose clearly out of the noise. No distance records have been claimed for ionospheric forward scatter so far, but 2850 km certainly must be one of the longest such contacts ever reported. Jay also completed with WA1JOF on November 11 around 1600 over another impressive distance of 2546 km." thanks W3EP & QST. It should be noted that all stations used EME class power and antennas, still 2850km's is a long way via any mode except TEP.

Microwaves (1296 and above)

On 01/01/00 at 2334z, Gordon VK2ZAB, Sydney worked Rod VK4KZR in Brisbane on 1296.16 MHz SSB. Signals were 51 both ways. Distance is 713+ km and the QSO is thought to be the first such on 23cm contact between Sydney and Brisbane and between QF56 and QG62. Contact made again on the following morning.

Jumping to the other end of the Microwave area, Russell VK3ZQB, reports that his web site has been updated with all the latest 24 GHz developments at Pt Fairy. Russell's Website is well worth a visit at www.anson.com.au/vk3zqb/. For the past few years a group of five amateurs (VK3XPD, VK3ZQB, VK5DK, VK5NC & VK5KK) have pooled efforts on several

continued next page

continued from previous page

microwave projects to get various complete systems going.

The group is loosely called the Australian Microwave Users Group (AMUG for short!). The group meets in Pt Fairy at least once a year, although some have been known to visit Pt Fairy on multiple weekends! The 24 GHz project has perhaps been the most challenging, but on last report Russell has 80mW's out of at least one 24 GHz system!

Now for something different. It may come as a surprise to some (and perhaps not to others) that the quickest growing area of activity above 1200 MHz is ATV. While AM TV has been the mainstay of ATV activity on 70 cm, FM TV has become the dominant mode above with Pockets of activity growing in all states. The loss of 576 MHz outputs for repeaters in a couple of states on 31/12/99 also seems to have people on the move.

Having seen the number of 1250 MHz ATV FM TV kits sold over the last 8 years (more than 200), through the VK5 Equipment Supplies, there would seem to be a definite trend. Perhaps it is the attraction of building something akin to a 1960's VHF AM transmitter and operating in a portion of the spectrum where ultimate stability is of minor concern when you have an 18 MHz wide channel!

Most the activity is on 1200 MHz with some repeaters having outputs on 2400 MHz. VK5RLZ in Adelaide has been running 25 Watts on 2415 MHz (2372 MHz pre-MDS) since late 1993. A few VK5's have also been running 2.4 Ghz simplex with powers between 2 & 10 Watts.

Barry, VK5BQ, at Stansbury, Yorke Peninsula has an impressive Microwave ATV setup. Barry runs ~20Watts on 1250 MHz into a 2.1 metre dish and several watts on 2439 MHz into a 1.2 metre dish. Barry's closest contact, so far, is about 70km's as the first 60km's of any path is over water! Barry can work several Adelaide stations regardless of band conditions with P5 signals. The longest contacts so far are only a few km's short of the current Australian TV Distance records for both bands. And no one has gone portable yet!

At last count Barry has worked over 20 VK5 amateurs on 1250 MHz and above.

Work is progressing on equipment for 5825 MHz for portable work

On a final note regarding ATV, a recent letter from the Australian Broadcasting Authority (ABA) to the Secretary of the WIA SA & NT Division, paved the way for the renewal of the WIA/SA ATV Groups VK5RTV license on Channel 35 (576.25 MHz) AM TV till 31/12/2000. The ABA have been most co-operative in this instance and responded warmly to a 38-page

submission prepared by the SA ATV Group.

As a fallback, the group has now obtained a license to operate 25 watts on 2439 MHz from the O'Halloran Hill Site. This will be commissioned in early 2000.

VHF Communications Magazine

"VHF Communications" and its German parent Magazine "UKW-Berichte" have been part of the global "VHF" Scene for over 30 years. Over these years, the magazine has been at the forefront of Amateur "VHF & Above" equipment design.

The original magazine was translated from the German UKW and published by Terry Bittan from the seventies till his untimely death in a 1985 airplane crash. For the past ten years Michael & Krystyna Wooding have published the magazine as KM Publications, in the UK.

The 4/99 issue marks yet another change in the magazine's history with Andy Barter, G8ATD taking over the role of publisher. Andy has been licensed since 1965 and is active on UHF and SHF contests in the UK, chiefly on 70 & 23 cm's.

The Australian agent for VHF Communications is VK5 division of the WIA. Subscriptions for 2000 can be paid for up to 29/02/00 by forwarding \$47-00 (Seamail) or \$62-00 (Airmail) to the "WIA SA & NT Division Inc" GPO Box 1234 Adelaide SA 5001

Beacon Update

The Adelaide "Mount Lofty" Beacon site, VK5VF, received some long deserved attention to its tower on 4/12/99. VK5VF's antennas have been installed on the same "Stobie" pole (Cement/Steel Power pole) since 1964.

The actual pole has been in place since well before WW2, being made redundant when the TV stations were installed at Mount Lofty in the late fifties! Apart from the vertical mast being replaced in 1978, nothing has been changed to the pole structure for over 35 years. Corrosion had, however, caught up with most of the original brackets. A new vertical mast to 12.5 metres has now been installed with quick release brackets so the main section can be accessed with minimal assistance.

Other changes made include the installation of a temporary 1296 MHz 22 element yagi beaming to give a service area from 120 - 155 deg., i.e. from the edge of Melbourne to Mt Gambier. ERP in this region is estimated at 200 Watts ERP. Colin, VK5DK, has reported hearing the beacon on several occasions since the upgrade. A new 1296 MHz Omni directional slot will be installed later this summer, however if

the South East beam proves useful, this will be still made available on a time share basis (2.5 minutes per antenna).

All other VK5VF beacons from 50 MHz to 10 GHz are operational except for 3 & 5 GHz in various stages of testing.

Colin VK5DK reports that the VK5RSE 144.550 MHz beacon currently has a problem with its NW (Adelaide) beam antenna. Eric VK5LP reports that, as a result, the VK3RGL beacon on 144.530 MHz has been heard on atleast one occasion at a strength greater than VK5RSE, despite near double the distance (530km).

Russian Metaloceramic Tubes

Those who subscribe to various email reflectors overseas, e.g. Microwave and VHF reflectors, would have seen the emails emanating from the Ukraine advertising various Russian made VHF/UHF Power triodes and tetrodes ranging from 400watt to >1.5kW over the past two years.

The GI7B and GS23B are just two of the more common tubes, the former is capable of operation on 23cm @ +300 Watt output. Curiosity got the better of me and after some emails to Alex, UR4LL and a 2 week wait, two GI7B's arrived in a brown paper wrapped parcel tied with string. The GI7B could be described as a rough equivalent to the Eimac 8874 but at about 1/12th the price and the approx. physical size and layout of a 200% enlarged 2C29A!

With the tubes came a detailed "Starting Procedure". Essentially a series of steps from filament only to standing current only 50% & 100% HV then 30minutes at full drive. All this, I gather is aimed to clean the directly heated cathode and stabilise the gas emission effects.

Both tubes have passed the static test (no RF) so the next step is to build a 432 MHz amplifier. I'd be interested to hear from others who have (or haven't) progressed past this with a GI7B project. From what Alex described, a number of VK's have traded with him over the past year or so!

In Closing

Quite a mixed bag this month, I hope that the broad range gave something of interest to all readers. I must thank Eric, VK5LP, again for his help and input this month. Without further ado...

1. Knowledge cannot make us all leaders, but it can help us decide which leader to follow"
2. Patience is the art of concealing your impatience"

Till next month

73's David VK5KK
ar



AWARDS

John Kelleher VK3DP

Federal Awards Officer

4 Brook Crescent, Box Hill South, Vic 3128 (03) 9889 8393

Roll of Honour

VK5MS 331/385
 VK5WO 331/364
 VK3QI 331/345
 VK4UA 331/345
 VK3DYL 331/337
 VK2FGI 331/337
 VK4LC 330/337
 VK6HD 330/356
 VK6LK 330/355
 VK4OH 330/337
 VK6RU 329/384
 VK1ZL 329/335
 VK3AKK 327/338
 VK6NE 325/341
 VK2DEV 325/331
 VK3AMK 321/340
 VK5EE 321/127
 VK3YZ 320/328
 VK4AAR 320/324
 VK2AVZ 319/330
 VK7BC 319/329
 VK6VS 319/323
 VK3CSR 316/325
 VK5FV 314/317

Ord List

VK6AJW 312/317
 VK6APK 310/315
 VK5WV 306/326
 VK6PY 306/312
 VK3JI 304/319
 VK6RO 302/308
 VK3IR 302/306
 VK4DP 293/305
 VK4SJ 292/293
 VK2WU 291/296
 VK4LV 289/291
 VK4BG 286/302
 VK4ICU 286/288
 VK3CYL 282/288
 VK3DP 271/274
 VK4CY 271/273
 VK3GI 263/267
 VK3VQ 259/276
 VK5IE 258/261
 VK4BAY 251/254
 VK3UY 251/253
 VK3CIM 250/254
 VK4EJ 250/252
 VK6ANC 244/248
 VK2PU 243/247
 VK6YF 238/241
 VK7TS 237/238

VK6ABS 235/
 VK2CKW 234/237
 VK6APW 228/229
 VK3DS 226/236
 VK3ETM 226/227
 VK3SM 222/242
 VK5BO 217/222
 VK3DD 213/217
 VK4EMS 208/
 VK4XJ 204/216
 VK3DVT 201/204
 VK3EFT 198/201
 VK4IL 194/
 VK4AU 189/190
 VK2HV 186/
 VK6WJH 183/
 WA1MKS 171/
 VK6APH 168/169
 LU5DSE 161/
 VK4ARB 159/160
 VK2NO 157/
 VK4IT 154/155
 VK4CHB 152/153
 VK2FHN 149/
 VK4DMP 147/148
 VK2GSN 147/
 VK7JAB 147/
 VK2UK 146/149
 VK2SPS 141/143
 VK3DNC 141/142
 VK6LC 139/140
 VK2EQ 139/
 VK6LG 134/135
 VK3DQ 133/147
 VK2LEE 130/132
 VK4AO 127/
 TI2YLL 127/
 VK4VIS 126/128
 YC8EMH 126/127
 TG8NE 125/
 VK3TI 122/125
 SM6PRX 121/126
 HI4YD 118/119
 VK7WD 115/116
 VK5GZ 113/115
 VK4IT 154/155
 VK4CHB 152/153
 VK2FHN 149/
 VK4DMP 147/148
 VK2GSN 147/
 VK7JAB 147/
 VK2UK 146/149
 VK2SPS 141/143
 VK3DNC 141/142

VK6LC 139/140
 VK2EQ 139/
 VK6LG 134/135
 VK3DQ 133/147
 VK2LEE 130/132
 VK4AO 127/
 TI2YLL 127/
 VK4VIS 126/128
 YC8EMH 126/127
 TG8NE 125/
 VK3TI 122/125
 SM6PRX 121/126
 HL4YD 118/119
 VK7WD 115/116
 VK5GZ 113/115
 VK7LUV 113/
 VK4NJQ 111/115
 VK6NV 111/113
 JA8XDM 111/
 C21DJ 109/
 JE9EMA 108
 VK5UO 107/110
 HC2HYB 106/107
 VK4LW 105/
 VK2EJK 104
 JN6MIC 103/104
 ZS6IR 102/104
 KB2NEK 102/103
 C21NJ 102/
 VK2FZR 102/
 JHOHO 101/103
 VK2EJM 101/103
 VK2IRP 100/101
 ON4BCM 100

Roll of Honour

VK6HD 331/352
 VK3QI 331/343
 VK5WO 323/339

CW Ord List

VK3KS 307/335
 VK6RU 278/322
 VK4LV 278/285
 VK4ICU 272/
 VK3JI 271/296
 VK3AKK 270/275
 VK4KU 251/
 VK6MK 243/245
 VK3DP 242/245
 VK2CWS 239/241
 VK3DQ 234/261
 VK7BC 234/243

VK3CIM 228/229
 VK4DA 226/228
 VK4CY 207/208
 VK4DP 205/216
 VK7RO 201/204
 VK6PY 190/194
 VK5GZ 189/191
 VK6HW 179/182
 VK5UO 165/166
 VK7TS 165/
 VK5BO 159/184
 VK3DNC 154/157
 VK4XJ 150/163
 WA5VGI 146/148
 VK4UA 143/145
 VK4AAR 139/141
 VK7DQ 131/132
 VK2TB 123/125
 VK7CQ 120/122
 DK6AP 120/
 SP1AFU 112/113
 VK8KV 112/113
 VK5BWW 110/111
 VK6NV 109/110
 OK1FED 109/
 VK2FYM 106/108
 VK4CXQ 106/
 VK3DG 102/
 VK8XC 101/103
 SM6PRX 101/102

Roll of Honour

Open

VK5WO 331/368
 VK6HD 331/358
 VK4UA 331/347
 VK3QI 331/348
 VK6RU 330/385
 VK4LC 330/377
 VK3AKK 327/338
 VK7BC 327/336
 VK3JA 323/371
 VK6AMK 322/341
 VK2AVZ 320/330
 VK4AAR 320/324
 VK4AAR 320/324
 VK3UY 318/321
 VK3JI 315/344

Open Ord List

VK4DP 309/323
 VK6PY 308/316
 VK6RO 308/314
 VK4LV 307/311
 VK4DV 306/321
 VK3DP 304/308
 VK4CY 297/301
 VK4ICU 297/299
 VK4BG 293/312
 VK3CYL 282/288
 VK3VQ 274/291
 VK3CIM 274/278
 VK5BO 264/264
 TI5BW 260/264
 VK7TS 252/254
 VK6MK 250/252
 VK6ANC 247/250
 VK3DQ 246/275
 VK5UO 246/250
 VK2CWS 245/247
 VK6APW 239/240
 VK2ETM 238/240
 VK4XJ 233/249
 VK4DA 227/229
 WA5VGI 216/218
 VK4EMS 216/
 VK2EFT 202/205
 VK5GZ 198/200
 VK2HV 187/
 VK3DNC 185/187
 VK6APH 171/172
 9A4KA 168/

RTTY DXCC Listings — in Certificate Order

001 Silent Key
 002 Silent Key
 003 VK5RY 100/102
 004 VK2BQS 121/123
 005 VK3EBP 237/239
 006 VK3AMK 100/102

It is hoped that with the slow improvement in conditions, this list will grow accordingly.

Erratum: In the June issue of AR Magazine, referring to the Worked Scandinavian RTTY Award, I am reliably informed that the Award Manager, Bo Ohlsson is a Silent Key. I will attempt to find the details of his successor.

Best regards, and good hunting

de John VK3DP

ar

CONTESTS

Ian Godsil VK3DID,
57 Nepean Highway, Aspendale, 3195

Contest Calendar February - April 2000

Feb 5/6	Ten-Ten Winter Party (SSB)	
Feb 12/13	WW RTTY WPX Contest	
Feb 12	Asia-Pacific Spint (CW)	(Jan 00)
Feb 19/20	ARRL International DX Contest (CW)	(Jan 00)
Feb 26/27	RSGB 7 MHZ Contest (CW)	(Jan 00)
Feb 26/27	REF SSB Contest	(Jan 00)
Feb 26/27	Jock White Field Day NZ (CW/SSB)	(Jan 00)
Feb 27	High Speed Club CW Contest	
Mar 4/5	ARRL International DX Contest (SSB)	(Jan 00)
Mar 11/12	RSGB Commonwealth Contest (CW)	(Feb 00)
Mar 11/12	World Wide Locator DX Contest (CW/SSB)	(Feb 00)
Mar 18/19	John Moyle Field Day (SSB) - VHF/UHF	(Feb 00)
Mar 18/19	Russian DX Contest (CW/SSB)	(Feb 00)
Mar 25/26	CQ WW WPX Contest (SSB)	(Feb 00)
Apr 1/2	SP DX Contest (CW/Phone)	
Apr 7/9	JA DX CW Contest (High Band)	(Dec 99)
Apr 8/9	King of Spain DX Contest (CW/Phone)	
Apr 15	Australian Postcode Contest (CW/SSB)	
Apr 15/16	Holyland DX Contest (CW/Phone)	
Apr 22/23	Helvetia DX Contest (CW/Phone)	
Apr 22/23	SP RTTY Contest	
Apr 24	Low Power Spring Sprint (CW)	(Feb 00)

Thanks this month to ANARTS UBA 4Z4KX VK2CTD RSGB VK6NE

RESULTS ANARTS RTTY CONTEST 1999 from Col VK2CTD Contest Manager

(World pos\call\cat\score)

4	VK2SG	SO	22,014,954	1st VK2/1st OC
32	VK4UC	SO	6,424,992	1st VK4/3rd OC
95	VK2CTD	SO	1,285,270	2nd VK2
106	VK8HA	SO	1,097,920	1st VK8
148	VK2BQS	SO	250,728	3rd VK2
3	VK6GOM	MO	9,145,500	1st VK6/1st OC

RESULTS VK/ZL/OCEANIA CONTEST 1999 (VKs ONLY)

(Call\score)

Phone	CW		
VK2APK	557968	VK2AYD	1329408
VK2FHN	521268	VK2APK	214800
VK3AJJ	2204264	VK2QF	464490
VK3ER	621452	VK4TT	218040
VK3IO	383350	VK4UC	31160
VK4UC	2217330	VK5GN	202872
VK4EMM	2081489	VK5AGX	17380
VK4PJ	3145	VK6ZH	429300
VK5GN	2575126	VK8AV	237600
VK5AM	983252		
VK7JAB	780		
VK8AV	39296		

from Neil Penfold VK6NE

RESULTS UBA CONTEST 1999

CW (Call\cat\score)		SSB (Call\cat\score)	
VK4TT	SO20 1496	VK2APK	SOAB 25168
VK2APK	SOAB 44880	VK5EMI	SOAB 540

RESULTS HOLYLAND CONTEST 1999

(Pos\call\cat\score)

235	VK4ICU	Mixed	143
254	VK8AV	CW	16

Check Log: VK3AMD thank you.

COMMONWEALTH CONTEST 2000

11 - 12 March
1200z Sat - 1200z Sun

OBJECT: to contact as many amateurs as possible in the British Commonwealth and Mandated Territories. Contacts with own call area not permitted.

BANDS: 160 - 10m (no WARC).

FREQUENCIES: contestants should operate in lowest 30 kHz of each band, except when contacting Novice stations.

MODE: CW only.

CATEGORY: Single operator. No assistance of any type is permitted.

SECTIONS: Open - unrestricted operating time; Restricted - maximum 12 hours' operation. Off periods to be clearly marked in logs and to be of minimum 60 minutes.

Also, at least four hours' operation to take place after 0000z 12 March.

SEND RST plus serial number. HQ stations will add 'HQ'.

SCORE: five points per QSO, with bonus of 20 points for first three contacts with each Commonwealth Call Area on each band. Note - entire UK counts as one call area and HQ stations count as additional call area.

LOGS: separate logs and bonus lists for each band. Include Summary Sheet showing section entered and points claimed on each band.

SEND LOGS to: RSGB Contests Committee, 77 Benson Manor Road, Thornton Heath, Surrey, CR7 7AF, UK, by 5 April, 2000.

Commonwealth Call Areas are: 3B6/8/9 3DA 4S 5B/H/N/W/X/Z 6Y 7P/Q 8P/Q/R 9G/H/J/L/N/Y 9M0/2/6/8 A2/3 AP C2/5/6/9 CY0/9 G/GB/GD//GI/GJ/GM/GU/GW (all one area) H4 J3/6/7/8 P2 S2/7 T2/30/31/32/33 TJ V3 (Antigua, Barbuda, Belize) V4/5/8 VE1-9 VK0 (Heard, Macquarie) VK1-8 VK9C/L/M/N/W/X VO1/2 VP2E/M/V VP5/8 (Antarctica, Falkland, S.Georgia, S.Shetland, S.Orkney) VP9 VQ9 VR6 VU VU4/7 VY1/2 YJ Z2 ZB2 ZC4 ZD7/8 (Tristan da Cunha, Ascension) ZF ZK1 (N.Cook, S.Cook) ZK2/3 ZL0-4 ZL7-9 ZS1/2/4/5/6/8 and various HQ stations.

RUSSIAN DX CONTEST

18/19 March
1200 Sat - 1200z Sun

BANDS: 160 - 10 m (no WARC).

SECTIONS: Single Operator; CW, Phone, Mixed; single or all bands.

MODES: CW, SSB Mixed.

EXCHANGE RS(T) plus serial number starting with 001. Russian stations will send serial number plus two-letter Oblast code (max 88 + 3 on each band).

SCORE: 10 points per Russian QSO, five points for QSOs with stations on another continent, three points for stations in the same continent and two points with your own country. Continents as per WAC.

FINAL SCORE is total QSO points by number of DXCC countries and Russian Oblasts worked on each band.

SEND LOGS and summary sheets postmarked by 12 April 2000 to: Contest Committee SRR, PO Box 59, 105122 Moscow, Russia.

Oblast designators are: AB AD AL AM AO AR BA BO BR BU CB CK CN CT CU DA EA EW GA HA HK HM IR IV JA JN KA KB KC KE KG KI KJ KK KL KM KN KO KP KR KS KT KU LO LP MA MD MG MO MR MU NN NO NS NV OB OM OR PE PK PM PS RA RO SA SL ST SM SO SP SR SV TA TB TL TM TN TO TU TV UD UL UO VL VG VO VR YA.

LOW POWER SPRING SPRINT

24 April Easter Monday
1400z - 2000z

MODE: CW only.

BANDS: 160 - 10m (no WARC).

CATEGORY: Single operator only, one-, three- or all-bands.

POWER: A: 1W; C: 5W; Q: 25W; X: 50W; Y: 100W.

EXCHANGE: RST, IARU Locator (first four designators) and power (eg 579 QF22 A). Reception of RST sufficient for non-contest stations.

SCORE: three points per QSO with own continent; nine points with other continents; 18 points per QSO with OM stations.

MULTIPLIERS per band are IARU locators and prefixes (WPX rules).

FINAL SCORE is total QSO points X total multipliers. Note - no cross-band QSOs and unmarked duplicates penalized.

LOGS: separate logs for each band. Show full information for each QSO, with list of multipliers and dupe sheet for each band. Summary sheet must show date, callsign, address, power, valid QSOs, multipliers, points for each band, locator, rig description, antenna.

SEND LOGS to: Radioclub OMN3KFV PO Box 29, 036 01 MARTIN 1, Slovakia, by 23 May, 2000.

WORLD WIDE LOCATOR DX CONTEST

11 - 12 March
0000z Sat - 2359z Sun

OBJECT: to work as many world-wide grid squares as possible.

BANDS: 160 - 10m (no WARC).

MODES: CW, SSB, Mixed.

CATEGORIES: A - single operator CW; SSB; mixed; all bands; duo-bands; single band; low power (max. 100W o/p); high power (more than 100 W o/p). 36 hours' max. operating time. No packet. B - Multi-operator CW; SSB; mixed; single tx 10 minutes rule band and mode; two tx 10 minutes rule; multi-multi. Packet allowed. C - SWL single operator no packet.

EXCHANGE: RS(T) plus WWL (eg QF22).

SCORE: one point for each 500 kms. except on 80m two points per QSO and on 160m four points per QSO.

MULTIPLIERS: first two characters of WWL on each band separately (regardless of mode).

FINAL SCORE is sum of QSO points X total multipliers.

NOTE: It is not necessary for entrants to calculate scores, as Contest Manager will do this.

LOGS: ONLY electronic logs. Any ASCII log accepted, but recommended software is N6TR.

SEND LOGS to: Karel Karmasin OK2FD, Gen. Svobody 636 674 01 Trebic, Czech Republic by 14 May. Logs may be sent by e-mail to: ok2fd@contesting.com or ok2fd@okdxc.cz

continued next page

WORLD-WIDE WPX CONTEST

SSB: 25 - 26 March

CW: 27 - 28 May

0000z Sat - 2359z Sun

OBJECT: to work as many stations world-wide as possible.

BANDS: 160 - 10m (no WARC).

CATEGORIES: single operator single or all-bands; unrestricted power, low power (max. 100W o/p), QRPP (max. 5W o/p); multi-operator single or multi-tx, all bands only. Single operator stations are where one person performs all operating, logging and spotting functions.

NOTE: single operators may only work 36 out of total 48 hours' operation. Off periods must be at least one hour and clearly marked in log. No time limits apply to multi-operator stations. Multi-multi stations must have all txs located within a 500m diameter circle or within property limits of licensee's address, whichever is greater. All antennae must be physically connected by wires to station txs and rx's.

EXCHANGE: RS(T) plus three-digit number starting at 001, continuing to four digits if necessary. Multi-tx stations must use separate numbers for each band.

SCORE: three points (20/15/10m) or six points (160/80/40m) for contacts with stations on different WAC continents and one point (20/15/10m) or two points (160/80/40m) for contacts with stations within same WAC boundary. QSOs with stations in same country are permitted for multiplier credit, but have zero points value.

MULTIPLIER is total number of prefixes worked on all bands (each prefix counted once only regardless of the number of different bands on which it is worked).

FINAL SCORE is total QSO points X total multipliers.

LOGS must show times in UTC, breaks and prefix multipliers first time worked. Logs should be checked for duplicates, correct points and multipliers. They should be accompanied by a sorted alphanumeric list of prefix multipliers and a summary sheet showing call, name, address, category, power, scoring information and a signed declaration that all contest rules and radio regulations have been observed.

SEND LOGS by disk. CT's *.bin file or *.all file; N6TR's *.dat file; NA's *.qdf file or *.dbf files are preferred. ASCII file containing all information is acceptable.

Disk files must be in chronological order for single operator and multi-single stations and chronological order by bands for multi-multi stations.

Please label disks and name your files with call used (eg VK3DID.BIN or VK3DID.DAT). Disks will be required from top-scoring stations.

Send by 6 May (SSB) or 8 July (CW) to: WPX Contest, 76 N Broadway, Hicksville, NY 11801, USA. Indicate SSB or CW on envelope. Logs may be sent via e-mail to:

n8bjq@erinet.com

To be eligible for AWARDS, single operator stations must show at least 12 hours' operation and multi-operators 24 hours' operation.

Single band entries showing points for more than one band will be judged multi-bands unless otherwise specified.

JOHN MOYLE FIELD DAY CONTEST 2000

Presented by Eric Fittock VK4NEF

18 - 19 March

0100z Sat - 0059z Sunday

Overview

1. The aim is to encourage and provide familiarization with portable operation and provide training for emergency situations. The rules are therefore designed to encourage field operation.
2. The contest takes place on the third full weekend in March each year and runs 0100 UTC Saturday to 0059 UTC Sunday. 2000: 18 - 19 March.
3. Contest is open to all VK, ZL and P2 stations. Other stations are welcome to participate, but can only claim points for contacts with VK, ZL and P2 stations.
4. Single operator portable entries shall consist of one choice from each of the following:
 - a. 24 or six hours;
 - b. Phone, CW or Open mode;
 - c. HF, VHF/UHF, All Band
5. Multi-operator portable entries shall be Open Mode and consist of one choice from each of the following:
 - a. 24 or six hours
 - b. HF, VHF/UHF, All Band
6. Home and SWL entries may be either 24 or six hours, Open mode, all band.

Scoring

7. Portable HF stations shall score two points per QSO.
8. Portable stations shall score the following on 6m;
 - a. 0- 49 km, 2 points per QSO
 - b. 50- 99 km, 10 points per QSO
 - c. 100-149 km, 20 points per QSO
 - d. 150-199 km, 30 points per QSO
 - e. 200-499 km, 50 points per QSO
 - f. 500 km and greater, 2 points per QSO
9. Portable station shall score the following on 144 MHz and higher:
 - a. 0- 49 km, 2 points per QSO
 - b. 50- 99 km, 10 points per QSO
 - c. 100-149 km, 20 points per QSO
 - d. 150 km and greater, 30 points per QSO.
10. For each VHF/UHF QSO where more than two points are claimed, either the latitude and longitude of the station contacted or other satisfactory proof of distance must be supplied.
11. Home stations shall score:
 - a. two points per QSO with each portable station
 - b. one point per QSO with other home stations

Log Submission

12. Logs must be accompanied by a summary sheet showing: callsign, name, mailing address, section entered, number of contacts, claimed score, location of the station during the

contest, equipment used and a signed declaration stating "I hereby certify that this station was operated in accordance with the rules and spirit of the contest." For multi-operator stations, the names and callsigns of all operators must be listed.

13. Logs must be sent by mail no later than 24 April to: John Moyle Contest Manager, 108 Queensport Road, Murarrie, 4172, Australia. An ASCII copy on 3.5" disk would be helpful. Also logs may be sent by e-mail to: <esr@powerup.com.au> Logs sent by e-mail must include a summary sheet and declaration, but operator's name is acceptable in lieu of a signature.

Certificates and Trophy

14. Certificates will be awarded to the leading stations in each section. Additional certificates may be awarded where operation merits it. Note that entrants in the 24 hours section are ineligible for awards in the six hours section.
15. The Australian portable station with the highest CW score will be awarded the President's Cup.

Disqualification

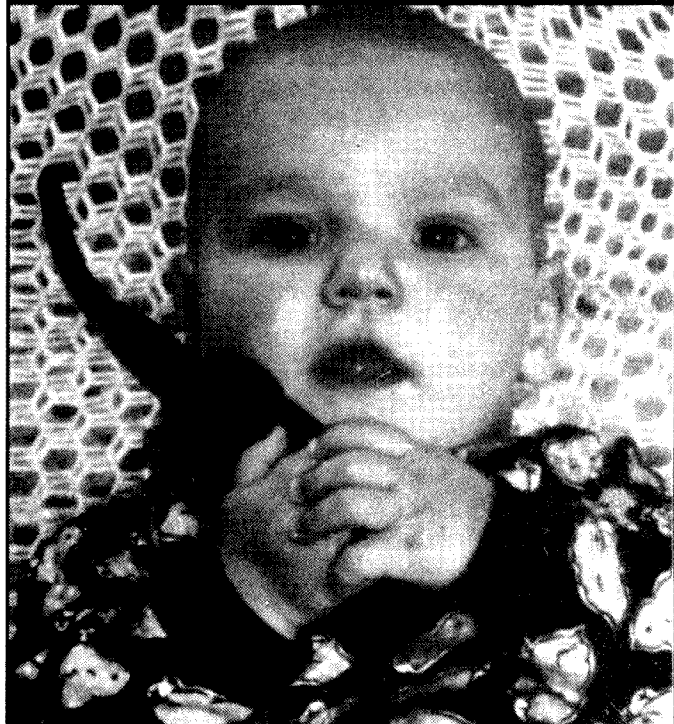
16. General WIA contest disqualification criteria apply to entries in the contest. Logs which are ineligible or excessively untidy are also liable to be disqualified.

Definitions

17. A portable station comprises field equipment operating from a power source, eg batteries, portable generator, solar power, wind power, independent of any permanent facilities.
18. A equipment comprising the portable station must be located within an 800 metres diameter circle.
19. A single operator station is where one person performs all operating, logging and spotting functions.
20. A single operator may only use a callsign of which he/she is the official holder. A single operator may not use a callsign for which he/she is a sponsor except as part of a multi-operator entry.
21. A multi-operator station is where more than one person operates, checks for duplicates, keeps the log, performs spotting, etc.
22. A multi-operator stations may use only one callsign during the contest.
23. Multi-operator stations may use only one transmitter on a given band at a given time, regardless of the mode used.
24. Multi-operator stations must use a separate log for each band.
25. A station operated by a club, group or organization will be considered to be multi-operator by default.
26. None of the portable field equipment may be erected on the site more than 28 hours before the beginning of the contest.
27. Single operator stations may receive moderate assistance prior to and during the contest, except for operating, logging and spotting. Massive logistic support by clubs, etc, is totally against the spirit of the contest and may result in disqualification and, at the discretion of the Manager, may be banned from this contest for up to three years.
28. Phone includes SSB, AM and FM.
29. CW includes CW, RTTY and Packet.
30. It is not expected that any other modes will be used in the contest, but if they are they shall be classed as CW.

31. All HF amateur bands except WARC may be used. VHF/UHF means all amateur bands above 30 MHz. Note: on 6 m the region below 50.150 MHz has been declared a contest-free zone; contest CQs and exchanges must take place above this frequency. Stations violating this rule will be disqualified.
32. Cross-band, cross-mode and contacts made via repeaters are not permitted for contest credit. However, repeaters may be used to arrange a contact on another frequency, providing a repeater is not used for the actual contact.
33. Stations may make repeat contacts and claim full points for each one. For this purpose, the contest is divided into eight consecutive three-hour blocks: 01-04, 04-07, 07-10, 10-13, 13-16, 16-19, 19-22, 22-01 UTC. Repeat contacts may be made once in these three-hour blocks, providing they are not consecutive and are separated by at least five minutes.
34. Exchange RS(T) plus a three-digit serial number commencing at 001 and incrementing by one for each contact.
35. Portable stations must indicate that they are portable by sending their callsigns followed by "P", eg 569003P.
36. Multi-operator stations must use a separate log for each band and commence each band with 001.
37. Receiving stations must record the exchanges sent by both stations. QSO points will be on the same basis as Home Stations, unless the receiving station is portable.
38. For all stations, the period of operation commences with the first contact on any band or mode, and finishes six or 24 hours later
39. The Contest Manager's decision is final and no negotiations will be entered into.

A Slice Off the Old Ham(s)



Jarrold Diggins, Harmonic of Mark VK3JMD and Sue VK3LSL, rag chewing on his Dad's IC-T7A. Amateur radio safe in the future's hands!

SPOTLIGHT ON SWLING

by Robin L. Harwood VK7RH
5 Helen Street, Newstead Tasmania 7250
(03) 6344 2324 E-mail: robroy@tassie.net.au

Millennium erupts in Sunspots and Squabbles

I AM WRITING this in the second week of the New Millennium and propagation has been down due to Sunspots and a Solar Flare. However there has been enough to keep me listening. Of course, there are so many Asian stations on SSB all across the HF spectrum even under international broadcasting stations. Presumably most are pirates or unlicensed but as I do not have direction finding capabilities, I can only suspect that some are on the high seas. It is no use listing frequencies because they alter daily but you will easily hear them in the international aeronautical allocation between 8.8 to 9 MHz and between 10 to 11.5 MHz. They can be on either sideband and are mostly observed from 0900 UTC onwards.

Aftermath of Hijacking

On Christmas Eve, an Indian flight out of Katmandu, Nepal was taken over by a terrorist group closely linked to the separatists fighting for the integration of the Indian controlled Kashmir into Pakistan. One person was murdered and the plane ended up on the tarmac of Kandahar in southern Afghanistan for a week. Negotiations over that period were extremely tense and in the end, the remaining passengers were released in exchange for three Kashmiri rebels held in Indian jails. The terrorists melted away and are believed to have gone into Kashmir. The three Kashmiri activists ended up in Pakistan.

One of them, a Muslim cleric, subsequently called for a Jihad or "holy war" against India. Naturally this has incensed India and a fierce propaganda battle has erupted over the airwaves and in the Press.

Also an irregular clandestine station – "Radio Free Kashmir" has reappeared just above the 90-metre tropical band allocation on 5101 kHz on AM. It has been widely heard across South Asia and is on from 1300 to 1330 and again from 1335 to 1400 UTC. Although it is reported using at least

10 kW, reception here in southern Australia is extremely difficult because AXM located in Canberra is using 5100 kHz for radiofax weather bulletins on behalf of the Bureau of Meteorology in Melbourne. Although the FAX transmissions are not continuous, the sender is transmitting a carrier when there are no pictures.

Voice of Russia blasts Chechen "bandits and terrorists"

As you are aware, Russian troops re-entered this Trans-Caucasian region in September 1999 to fight what they termed "bandits and terrorists". In 1996, Russian troops were forced to withdraw, granting semi-autonomous status to the region. However the Chechens regarded this as independence from Moscow, although no other nation recognized them. The region quickly degenerated into anarchy with no central administration. Many warlords quickly

One callsign, REA4, is believed to be the Russian Air Force with traffic, disguised as METEO bulletins. I have heard it here, close to the band edge on 7 MHz

began fighting amongst themselves as well as with the Russians, kidnapping anybody and holding them for huge ransoms to finance their arms acquisitions.

Terrorist cells became active within the Russian Federation and were blamed for several explosions in many cities across Russia with heavy casualties.

In September Russian troops were fighting incursions from Chechen warlords into a region close to the border with Chechnya. The aim was to establish an Islamic state there similar to Chechnya.

The Chechens were driven back across the

border. The Russians followed and now have a substantial amount of Chechnya under military control. But they have not yet completely gained control of the capital of Grozny. Fierce hand to hand combat for control of every remaining building is happening with heavy casualties of both military and civilian personnel.

Chechen fighters are going to be almost impossible to eradicate because they will hide in the mountainous areas of the Caucasian ranges, mounting hit and run guerilla raids.

The official "Voice of Russia" in Moscow has been putting the Russian viewpoint after American, European and some Islamic opposition to the Russian operation. The Chechens have not been heard.

However Russian forces are still extensively using HF radio, despite their satellite technology. Also Cyrillic MORSE with alphanumeric ciphers has been monitored. One callsign, REA4, is believed to be the Russian Air Force with traffic, disguised as METEO bulletins. I have heard it here, close to the band edge on 7 MHz.

Boris Yeltsin's unexpected resignation on New Year's Eve, Vladimir Putin's elevation to acting President and the resulting election on 25th March, should also be interesting listening over the "Voice of Russia".

This station has been broadcasting since 1929 and now is once more firmly reflecting the official Moscow policy. Moscow is best heard here on 21790 at 0700 UTC and on 9905 at 1000 UTC. Strangely, Moscow is a hard catch these days, compared to being extremely easy to hear only 10 years ago.

Civilian ALE increases security and reliability

HF users are increasingly utilizing a new mode. It is known by the acronym of ALE – Automatic Link Establishment. It operates on a selection of random frequencies and transmitters. A sounding burst is sent and

the receiving station will acknowledge. No one channel is exclusively used and is similar to trunking techniques.

It has increased security and also can take into account interference and propagational anomalies. ALE was in the exclusive domain of the US military but now has been released to the civilian sector, requiring increased security and reliability.

ALE is like a watery bubbly sound. It is designed to fit in the AF passband of a normal SSB signal. It consists of 8 tones (MFSK). They are located 250hz apart from 750hz to 2500hz. The centre of the system is at 1625 Hz. Each tone is 8mS in duration. This gives 125 symbols per second. With 8 tones

(symbols or elements) it can support 3 data bits per symbol. This results in a transmitted data rate of 375 bits per second. It is a robust system and employs a system of triple redundancy in the transmission of ALE data, by interleaving the data, and by use of Golay forward error correction (FEC).

The ALE system is designated Mil.Std 188-141A. As I previously stated, it is increasingly being used by Government agencies and diplomatic personnel outside of the United States. Although hobbyists have written decoder programs, we can rightly assume that it still quite sensitive. Although ALE has been around for a few years, I first really noticed it on top of a

China Radio International frequency. CRI has a habit of transmitting on odd channels anyway. These ALE pulses were on 7620 kHz. However due to the random nature of these ALE transmissions, no time frame can be accurately given. I have absolutely no idea where they are coming from yet they can be sometimes very strong.

I shall be changing my Internet Service Provider and you can use robroy@elaunceston.com in the interim. I will have my new e-mail address next month. 73 de VK7RH

ar

An On-Air Czech

Vic Postoupil
91 Spans Road
Beenleigh 4207

Here is my contribution to your appeal for interesting QSOs.

I applied for my first licence on OK land in 1967. Exams were no problem as I was the holder of a first class military certificate. Those days the licensing body was, believe or not, an institution named, "Union for cooperation with the army". To become a member one had to sign a claim "I will love the Soviet union forever"! The same applied for membership in motoring and other clubs.

One day I received a phone call from a comrade major who managed to dig out something politically unsound in my past. My short fuse went off and I recommended that he roll up my licence and stick it, well you can imagine where... Then I sent him to hell and crushed the telephone. So, that was the end of my ham career for the first eight years. I was happy to be allowed SWLing, like many others in OK let alone by the Soviet Union. But nothing lasts forever and one day the licensing was handed over to the Department of Communications. That was the body I used to work for as an overseas telegraph operator so my licence OKIAXM was in my drawer in a few days.

D day was 1 March 1975. I was waiting with my new homebrew rig - one watt of input power on the 80m band, plus a G5RV one could almost touch with a broomstick, SWR unknown, and a bottle of rum was waiting to celebrate my first QSO. At midnight sharp my CQ went on the air with the callsign OKIAXM/p - the celebration of 30 years of liberation by the red army. Not expecting anything, a shock was there. UA9CM, some 4000km. Not bad, eh, but there was better to come. The required number of contacts for licence upgrading was soon in the log so an all new rig was built quickly. When the solid state part was almost ready up to the pre-driver stage I could not resist trying it on the air so I called

a JA station on 14MHz and we had a no-problem QSO. The input power was 250 milliwatts, there was only a choke in the collector and the (also unfinished) 2 element Yagi with SWR well in the red was beaming west, one of two most impossible directions.

Another good QSO was OK to UB5, 579 both ways with the coax feeder disconnected and well spaced from both arms of the dipole after a storm.

And just one from VK land, where everything is easy, Sydney - Brisbane QSO with VK2BQQ. My antenna was 20m of wire, his the GUTTER. Nothing special? Well try it on 160.

We manufacture a comprehensive range of HF, VHF and UHF antennas, baluns, power dividers, etc. to suit your application.

Some of our log periodics provide continuous coverage from 13-30 MHz including WARC frequencies and replace outdated tribanders.

Now in use in 48 overseas countries.

FREE CATALOGUE AVAILABLE FROM

 **ATN ANTENNAS** PTY LTD

- Create rotators, coax cables & non-conducting guy & halyard materials
- Hard-drawn copper antenna wire
- Insulators for DIY projects
- Inverted vee kits 160-30m
- High gain VHF & UHF amateur, scanning & TV Antennas

- High Sierra HF mobile antennas
- Butt section triangular aluminium towers for fixed or tilt-over applications
- Selection of power chips & TX tubes
- Diamond VSWR/PWR meters to 1300 MHz & accessories

37 Morrison Street
PO Box 80, Birchip Vic, 3483
Ph: (03) 5492 2224
Fax: (03) 5492 2666

NOVICE NOTES

Peter Parker VK3YE
12/8 Walnut Street, Carnegie, Victoria, 3163
E-mail: parkerp@alphalink.com.au
Novice Notes Online: <http://www.alphalink.com.au/~parkerp/nonline.htm>

Making the most of Cycle 23

You've read about the sunspot cycle in the text books - how it peaks approximately eleven years, and how more sunspots mean more ionisation and better HF propagation. Well, according to the pundits, 2000 is when it all happens and Solar Cycle 23 reaches its peak. This article tells how you can maximise your enjoyment of the coming years of high solar activity and good HF conditions.

What to expect

More of HF will be open longer. In low sunspot years 20, 15 and 17 metres go dead at night. When sunspots are high these bands remain open well after dusk. 10 and 12 metres, which open only briefly in low sunspot years, will provide international (DX) contacts almost daily. In peak years, 20 metres becomes almost a 24-hour DX band. The skip zones on 30 and 40 metres shorten with higher sunspots, making them reliable for short and medium distance intra and inter-state communications. Figure One is a log extract of the type of HF contacts that are possible when conditions are good. They were made with 80 watts and a ten metre-long vertical wire antenna from a noisy, high-density suburban location.

Six metre buffs also get excited during the high part of the cycle. Whereas you almost need to make a phone call to get a contact

on six in the low years, on high-sunspot days the band bustles with DX. On particularly good days, the best six metre stations have contacted Europe, while operators running as little as one watt CW into makeshift antennas have worked into Japan.

Propagation paths change when sunspot numbers rise. It is normal for north-south paths (eg between Australia and Japan) to be open longer and later than east-west paths (eg to Europe or Africa). In sunspot years, most contacts made on 10 and 15 metres tend to be with Asian stations. However as the bands improve, a wider variety of locations, such as Europe and North America become workable on these bands.

Sunspot cycles rise faster than they fall. In an eleven year cycle, it may take four years to reach the top from the trough of the previous cycle, and six or seven years to get

to the bottom from the top. This is good news as it means that though this cycle is expected to peak in a few months time, excellent HF conditions will remain for about the next three years. Figure Two shows observed and predicted sunspot numbers for Cycle 23.

High solar activity is not all fun and games - conditions can be very volatile. When sunspot

numbers are high, solar flares become more frequent. After a severe solar flare the bands may go dead, and you may wonder if your rig still has an antenna connected to it.

Preparing for the coming cycle

When conditions are good, and you're on the right frequency at the right time, almost anyone can work DX. However, the higher HF bands are more fickle than bands such as eighty, two metres and seventy centimetres. Follow the four steps below to maximise your success.

Step One - Obtain information about solar activity and DX propagation.

Many amateurs enjoy working anyone anywhere. They might be testing a new antenna, seeing how far their low-powered signal will go, or just enjoy chatting to people. For these people, planning their operating is often merely a matter of tuning around and finding a band that's open.

Others specialise in working a particular part of the world, perhaps to gain points for an award, for a DX contest or to practice a language. For these people, success requires a more rigorous approach.

The first step is to find out the right frequencies and times for contacts to a particular location. Such information is provided in the prediction charts elsewhere in this magazine. Propagation charts are only a guide as conditions vary from day to day - one day, signals might peak at 6pm, the next day they might reach their strongest at 7pm.

Updates on solar activity are given on the WWV time and signal station. These are broadcast at 18 minutes past the hour on 2.5, 5, 10, 15 and 20 MHz. Near real-time propagation information also provided on



Photo 1: In high sunspot years, long distances can be worked with low transmit powers. Pictured is a 5-watt CW transceiver for 40 and 20 metres.

various websites, some of which provide maps showing maximum useable frequencies by region and the progress of the 'twilight zone' around the globe. A search on 'Cycle 23', 'sunspots' or 'radio propagation' should reveal plenty of sites on the topic.

Computers are powerful tools for radio propagation forecasting and analysis. Programs that provide details of likely propagation given a particular set of solar conditions are available. A good way of testing them is to make use of the worldwide network of International Beacon Project (IBP) beacons on the higher HF amateur bands. IBP beacons share a single frequency on each band and are time-sequenced so that only one is transmitting at any given time. They transmit on 14.100, 18.110, 21.150, 24.930 and 28.200 MHz. IBP beacons initially identify at 100 watts and then drop power to 10 watts, 1 watt and then 100 milliwatts - a useful feature that allows one to quickly check band conditions.

Step Two - Erect antennas for the higher HF bands.

You'd be surprised how many amateurs own do-everything multiband transceivers,

continued next page

Date	UTC	Freq	Mode	Station	RST sent	RST rec
29/8/99	0655	14.220	SSB	LA7YX	56	55
	0705	14.180	SSB	1K2VFR	57	59
	0710	14.255	SSB	9A4RX	58	57
	0725	14.120	SSB	F2SY	56	55
	0739	14.220	SSB	PA3GYM	47	5
	0745	14.225	SSB	GM4FDM	57	57
	0800	14.180	SSB	G4YYD	55	44
	0825	21.325	CW	JA5HS	579	559
	0845	21.270	SSB	JQ1LOI	57	54
	0905	21.260	SSB	JA8VS	57	55
	0910	21.260	SSB	VK3FLI	34	5

Figure 1: A night of DX. The log extract is an example of what can be worked on HF when sunspots are high and conditions are good. All contacts were made with approximately 80 watts to a 10 metre-long wire vertical antenna.

SUNSPOT NUMBERS FOR SOLAR CYCLE FROM 1995 TO 2006

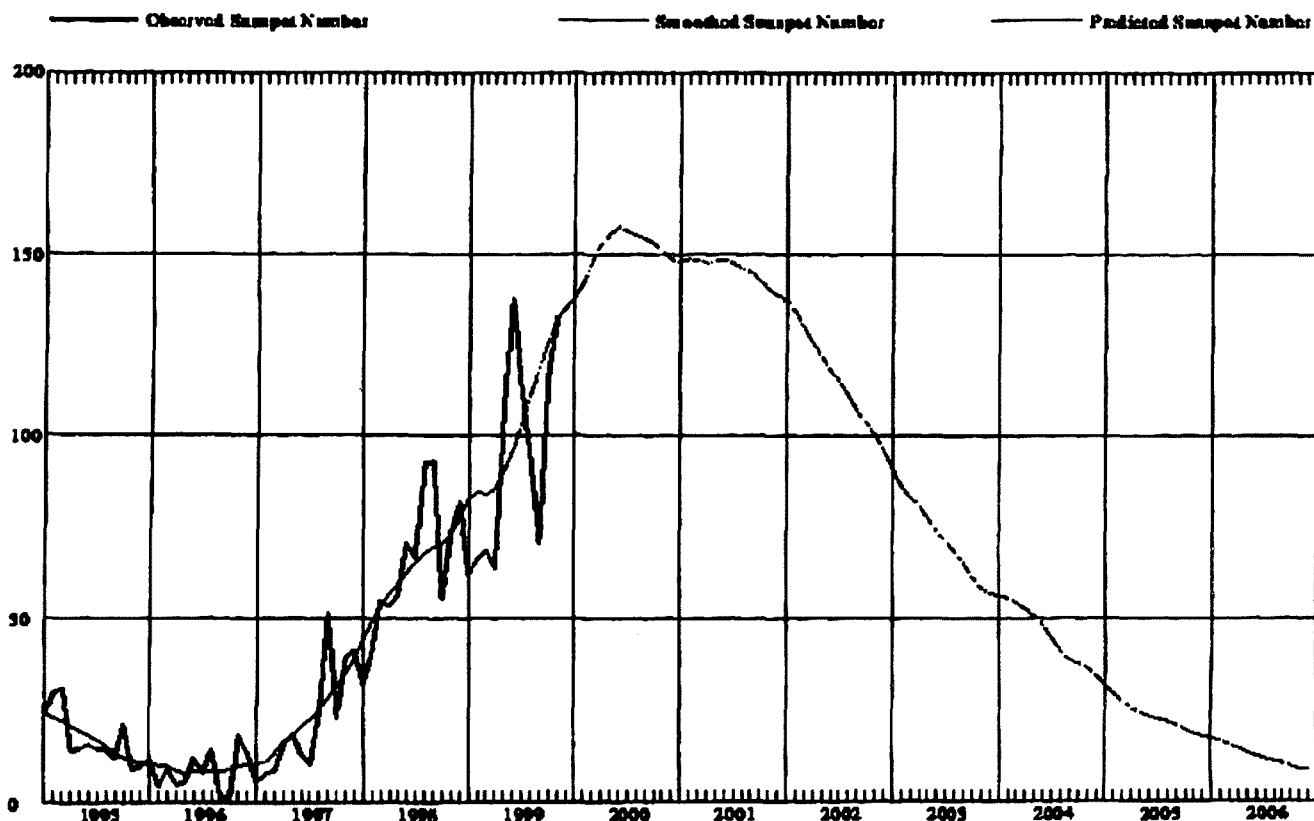


Figure 2: Progress of Cycle 23 to December 1999. Note the large month-to-month variations in sunspot numbers. Source: IPS website (<http://www.ips.gov.au/asfc/current/sunspot.gif>)

but miss out on many bands for the want of five dollars' worth of wire stuck up in the air. Dipoles, ground planes or half-wave verticals will get you started and can provide worldwide contacts at times.

If you like a particular band, erect a directive gain antenna, such as a yagi or quad. Such antennas can either be rotatable (usually made of telescoping aluminium tubing) or fixed direction, with wire elements slung between well-located poles or trees. Gain antennas have the following advantages compared to dipoles and verticals.

- Clearer reception. Gain antennas can usually be rotated to null out interfering stations coming from the rear or side.
- Stronger signals at the other end. A station using a three element yagi and a 100 watt transmitter should sound as strong as a 400 watt transmitter feeding a half-wave dipole.
- Longer operating periods possible. A low gain antenna will provide DX contacts in the middle of an opening. However, at the beginning or end of openings, people with dipoles often find it hard to make themselves heard. A gain antenna allows contacts during these marginal conditions, thus extending the period that stations can be worked.
- A greater variety of stations become workable. The author has found that when using low power and simple antennas the majority of DX stations worked had quite large antennas, such as five or six element yagis. As conditions improved, a more contacts were with people using smaller antennas, such as two or three element yagis. Improving your antennas makes reception easier and therefore aids contact with stations who may be mobile or running low power.

Not everyone can erect towers stacked with beams. Even if you're restricted to verticals or dipoles, there's plenty of things that you can do to improve your signal at the other end. These include:

- Raise the height of your dipole. Most radiation from low dipoles goes straight up, rather than towards the horizon. This is fine for local contacts on 80 and 40 metres, but poor for long distances. Greater antenna height allows more radiation at angles close to the horizon, permitting longer distances to be covered. Increasing you antenna's height from five to ten or (better still) fifteen metres is one of the most cost-effective improvements to your station that can be made.

- Use elevated verticals with above-ground radials. Vertical antennas with buried radials require many radials to perform efficiently, especially in areas of poor soil conductivity. Installing vertical antennas on a support pole several metres high and using above-ground radials allows good performance with only a few radials.
- Use verticals that are less dependent on ground systems. If installing radials is difficult, consider a half-wave vertical. Compared to quarter-wave ground plane antennas, half-wave vertical antennas (such as the famous CB Station Master antenna) can be highly efficient with a minimal ground system. The extra height will help too!
- Consider fixed-wire beams. If you're mainly interested in one direction, wire beams strung up in trees can provide low-profile antennas capable of top performance. A two-element wire yagi can be slung between four well-placed trees, while a two element quad for ten or fifteen metres can be concealed in the canopy of a single tree.
- When all else fails, operate portable. Most Australians have ready access to open spaces, whether in the hills or by the coast. A simple inverted-vee or vertical antenna can yield outstanding results, especially if installed in an over-water location, such as on a boat or pier.

Step Three - Know your station

Once you have some antennas and know the right times and frequencies to try, the next step is to assess if your station is capable of exploiting the propagation available. A full assessment is beyond the scope of this article, as it requires an advanced understanding of wave propagation, antenna gain, radiation angles and receiver noise. However, the following example should succeed in explaining the desirability of having reasonable expectations based on what propagation can provide.

After looking at propagation charts or a computer program you may conclude that 40 metres may currently be open to the US. Turning on your receiver may reveal strong signals from North America. However a full assessment (as mentioned above) is likely to disclose that expecting frequent North American contacts with five watts and a low dipole is unrealistic. You would get very disappointed very quickly if you were expecting regular contacts with North

America using that dipole.

On the other hand, if your ambition is simply to span the Pacific occasionally with low power and are using an efficient, low-angle antenna (such as a high dipole or vertical) there is no reason why you cannot achieve your aim with a little persistence. The lesson here is to set reasonable objectives, and design your station so it can meet them.

Step Four - Polish your operating technique

You may have a good station and antenna installation, but will not be able to use it to its full potential unless you can properly adjust and operate your equipment.

- Set your transceiver up correctly. Excessive microphone gain can cause over-modulation and interference to other band users. Poor earthing gives rise to RF feedback, microphones that zap your lips and rough-sounding audio. A quarter wavelength wire connected to the transceiver's metal case usually fixes these problems where a proper RF earth cannot be installed. Speech processing can raise the intelligibility of your transmission when signals are weak, but too much causes distortion and excessive pick-up of other noises in the shack. A power supply that is too small or poorly regulated causes 'FMing' on SSB and chirp on Morse.

People prefer to answer calls from stations with clean signals, and quality signals penetrate through interference better. See your transceiver's instruction manual for more detailed guidance on adjusting your particular rig.

- Tune around the bands for DX. You'll hear nothing if you're not listening. To learn which bands are open to which places, spend 20 or 30 minutes at various times of the day to tune across the various bands. Note the locations of stations heard on each band and correlate this to the time of day. You don't always have to wait for the station to give his exact location - listening for the callsign prefix and looking up the country in the WIA Yearbook is usually good enough.

After a while you will observe both certain consistent patterns of propagation (eg many strong European stations in the late afternoons on 20 metres) and significant day-to-day differences in conditions. Don't overlook the IBP beacon frequencies (given earlier) in case there is propagation but no activity.

- Use various means to gain contacts. There are several ways to get contacts.

Should I upgrade?

These include calling CQ, answering someone else's CQ, or calling one of the stations involved in a contact that has just finished ('tail-ending'). The latter is particularly effective as you know the band is open and there is a good probability that someone is still listening. When tail-ending, the main thing to watch is to ensure that all parties have properly signed before you call. This is not always easy - sometimes people take five minutes to say 73, may sign off several times and do not always end their contacts cleanly. Count to four or five, and if nothing heard, make your call.

One benefit of being in Australia is that when working DX (eg Europe, Japan, North America), there's many more of them than of us. This works to our advantage in several ways. Firstly, it makes overseas stations eager to work VK. Secondly, if you are calling DX stations (whether answering a CQ or tail-ending), the competition from other VKs/ZLs who may also be calling is relatively light.

Know when to call people I have often heard people whose signals should have been heard, but have missed out on contacts because they timed their calls poorly. They may have been calling while a previous contact was still signing off, or called at the same time as several others. If dozens of stations are calling a particular station, it is likely that he is unable to pick out an individual callsign. It can sometimes be worthwhile to insert your call as soon as the melee dies down. With any luck the DX station will hear you, not because you were the strongest, but because you timed your call best. At other times, DX stations may be tuning up or testing. It sometimes pays to give them a quick call before they call CQ and the multitudes find them. Timing is very important. It can't be taught, but can be learned through regular on-air activity, and observing what works and what doesn't.

- Put out calls if the band appears dead. People will not know if the band is open if no one is using it. It's up to you to activate the band by putting out a call. These days this doesn't mean endlessly pounding the key or calling into a microphone. Cassette recorders, digital voice recorders and even computers can be set up to call CQ automatically, especially if your rig has VOX (voice operated transmit) facilities. Always be in attendance to answer any calls - there's nothing worse than trying to answer someone's unattended CQ caller!

If you have a Novice Limited licence, Cycle 23 will be a non-event if you don't upgrade to at least Novice. If you don't act now, you'll need to wait another decade before you can take advantage of the next sunspot peak.

Limited licencees are a little better off. They have six metres all modes and ten metres FM. However, as the saying goes, six metres is not just a band - it's a way of life. You can spend days by the transceiver, and not hear a thing. Then after returning from a short absence, you're told you missed the biggest, greatest six metre opening there ever was! Six is like that - it waits for no one. 29 MHz FM is also fickle, and is markedly inferior to SSB when signals are weak.

To really take advantage of Cycle 23, Novice is an absolute minimum grade you should aim at. Intermediate grade is also worthwhile, because of the extra frequencies it provides on the 3.5,

21, 28 and 50 MHz bands.

As conditions decline, around 2002-2003, ten and fifteen metres will open less time each day. Twenty metres will once again become the main DX band. An unrestricted licence is particularly desirable in intermediate and low sunspot years because of the 20 and 40 metre privileges it provides. Access to the 12, 17 and 30 metre bands is also useful, especially when 20 metres is very crowded.

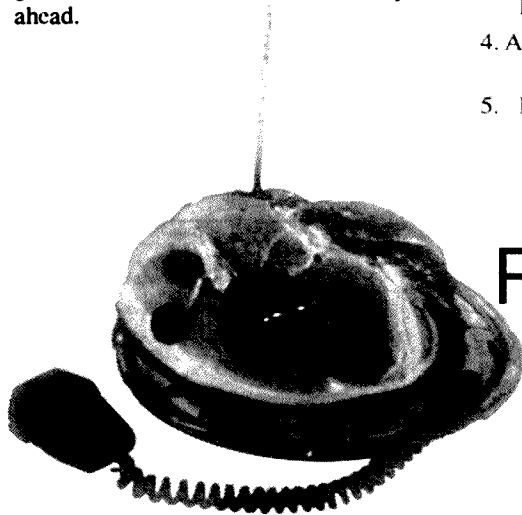
If you've just completed licence study, it is desirable to obtain your AOCIP as soon as possible, while the knowledge and Morse is still fresh. If you've had a Novice or Intermediate licence for some time, and have to make a choice between studying and operating, I would suggest you enjoy the next couple of years on the air and obtain your Unrestricted when conditions start to decline and the middle and lower HF bands become more useful.

Conclusion

This article has, I hope, provided an introduction of what to expect from Cycle 23 and how you can take advantage of it. Many amateurs' most memorable contacts are made in high sunspot years such as this one. Prepare your station and make sure you get a fair slice of the action in the years ahead.

References and further reading

1. Weiss, A. The Joy of QRP - Strategy for Success. Milliwatt Publications, 1984
2. ARRL Handbook, various editions.
3. Moxon, L. HF Antennas for All Locations, RSGB, 1982
4. ARRL's Wire Antenna Classics, ARRL, 1999
5. IPS website: <http://www.ips.gov.au>



REAL Hams
read
**Amateur
Radio**

ar

REPEATER LINK

Will McGhie VK6UU
21 Waterloo Cr Lesmurdie 6076
will2@omen.net.au
VK6UU@VK6BBR

HF-Gateways may be permitted on some lower HF bands

At the last WIA/ACA Liaison meeting in December, promising indications that HF-Gateways may be permitted on some lower HF bands such as 40 metres. The detail still needs to be sorted out but a license application will be submitted soon from

VK6 for a 2 metre FM to 40 metre SSB gateway. This application should speed up the process. Thank you to the WIA Liaison team, who were able to make progress on this new concept.

One other point of interest in the voice

repeater scene that came out of the Liaison meeting was that there is no limit on the number of voice repeaters that can be linked. The information on the ACA web page is incorrect.

Well done, Eric VK5LP

Having put this column together for over ten years, and at times finding the time to do so difficult, I can but applaud Eric Jamieson, VK5LP, for his regular column in AR magazine. I dusted off the earliest copy of AR that I could find, August 1971 and read Eric's column written some 29 years ago. Of particular interest to me was that the WIA had a Repeater Secretariat way back then, the activities of which Eric reported on. I gather FTAC (John Martin) and the Divisional TACs perform this function now, but I must find out a bit more about this long gone position.

Eric started the VHF column long before computers made the task easier and his column required a lot of detailed input from a large number of sources. Well done Eric. I doubt that I have the energy to put in the years you have.

Perhaps an article on how you did it every month for all those years please Eric.

Back on air after some good advice

Our 29 MHz simplex gateway in VK6 has been off air for a couple of months. The transmitter slowly lost power and eventually stopped all together. Eventually I found the time to pull the transmitter apart. After a bit of exploration the fault was tracked down to the PA output low pass filters. One of the ferrite toroids was black and had been very hot. Rewinding the toroid and replacing some of the mica capacitors produced some output but not the full 100 Watts. Advice from Clive VK6CSW, that ferrite cores can change their properties if heated, proved to be the problem. A replacement core and the transmitter is back on air. Worth remembering that heating ferrite cores can destroy their magnetic properties.

While on the topic of 29 MHz gateways,

more systems are planned, and one line of thought is to have them all on the same frequency of 29.120 MHz. The reason being that once we are able to remove the no linking below 50 MHz regulation they can link together. In order for gateways to be on a common frequency on 29 MHz, a CTCSS tone would be required on the 29 MHz transmissions so, other 29 MHz gateway receivers can use the tone to prevent linking. So for the moment the extra circuitry is required to prevent linking between gateways. Once the regulation is removed the CTCSS tone can be removed or perhaps used the other way around so gateway receivers don't receive pirate activity. Gateways would only link between those gateways with the CTCSS tone.

More next month on this topic with some thoughts on what tone frequency to use. FTAC is floating 67 Hz as a discussion point.

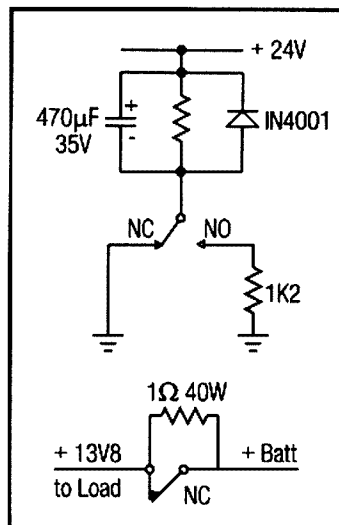
ar

Erratum: Modfying a Linear Power Supply to Charge Gel Batteries

by Warren Stirling VK3XSW

January 2000, page 26

We regret that a drawing showing how a relay is to be connected into Warren Stirling's VK3XSW project was accidentally omitted from the text and is now reproduced. Perhaps you should update your January copy now.



Capacitor charges when DC applied, dumps charge into coil when contacts open to keep relay operating to NO position where resistor provides hold current to coil

On power fail relay drops out and shorts 1Ω current limit resistor

On power restore relay operates and battery charged via current limit resistor

IONOSPHERIC UPDATE

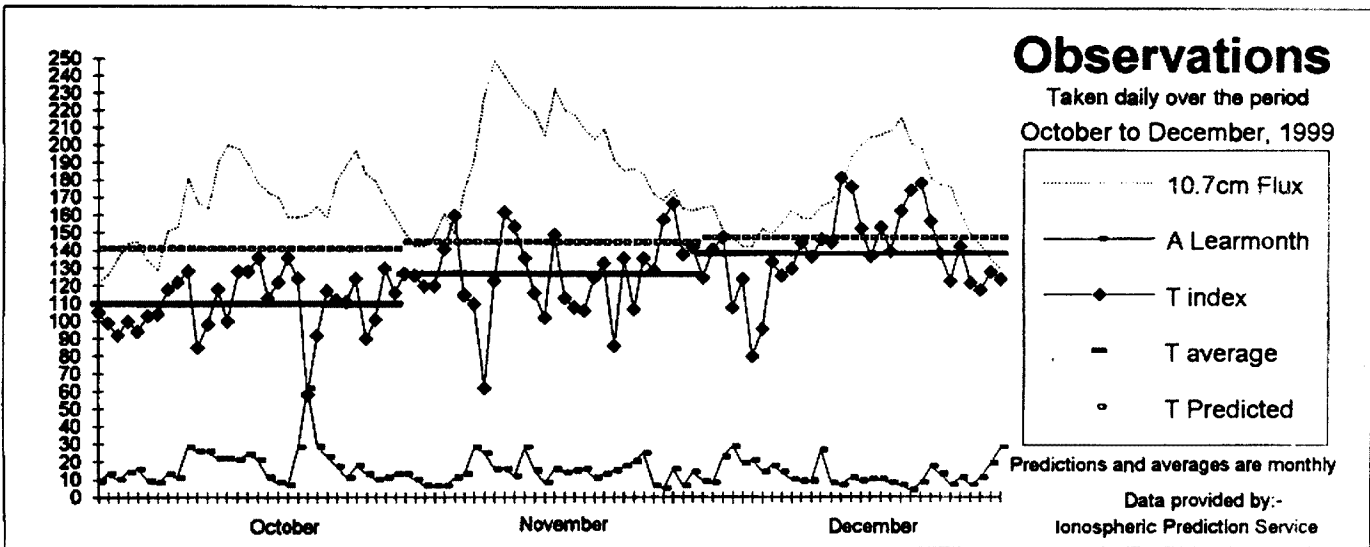
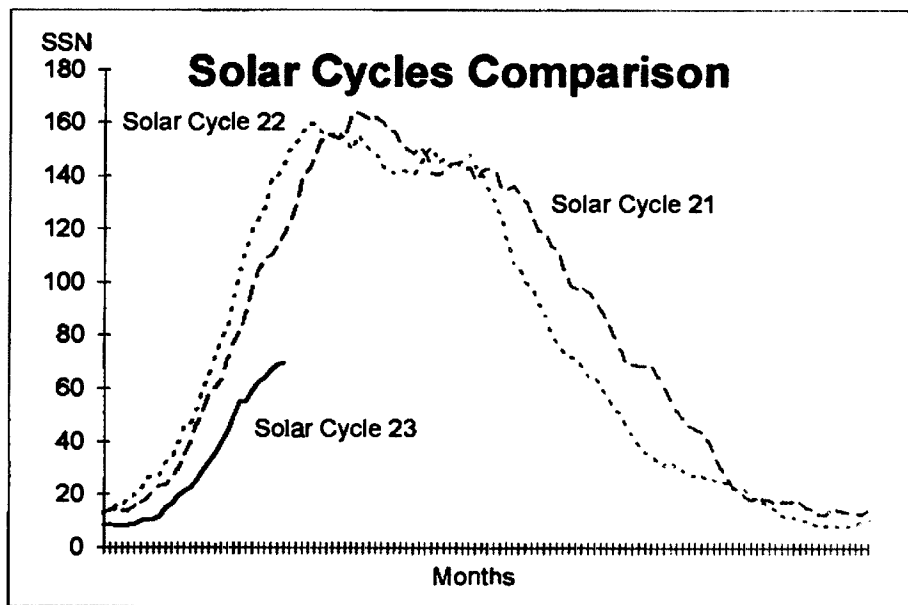
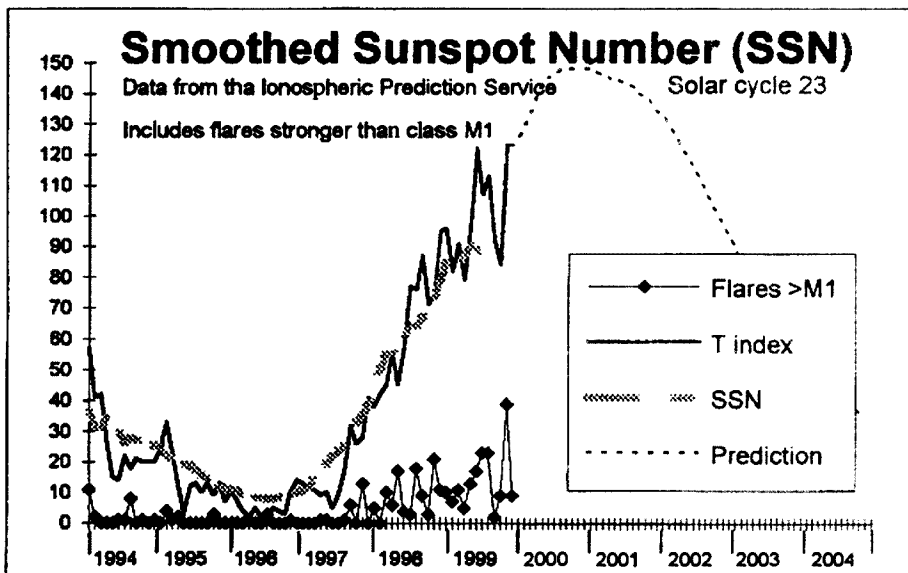
Current solar cycle

A graph comparing the last three solar cycles is again included this quarter. The different shape of the current solar cycle is now more evident. Note the fall off in the rate of increase when compared to the previous two cycles. While the current cycle is not as great, it should be remembered that the last two cycles were exceptional. As more data comes in, the Ionospheric Prediction Service has been revising the T index table used to make our published HF Predictions. These revisions have invariably been down.

It is still expected that the current solar cycle (23) will reach its maximum level this year. Remember that the smoothed sunspot number is an average over a year and so is by nature six months behind. The comparison graph is purely smoothed sunspot number; it does not include predictions.

While the Ionospheric Prediction Service published table is for a predicted maximum smoothed sunspot number of 166 in April 2000, this too may be revised. My understanding is that the predicted smoothed sunspot number table comes from the Solar Environment Committee of NOAA where any revision is considered.

But propagation is opening further as evidenced by the TEP openings now occurring for amateurs in the northern areas of VK4 and VK8. The best is yet to come. Whenever the maximum in the smoothed sunspot number cycle occurs, my experience is that radio activity via the ionosphere has always been best in the years after that maximum. It is as if there is some inertia between theory and practice.



HF PREDICTIONS

by Evan Jarman VK3ANI

34 Alandale Court, Blackburn Vic 3130

These graphs show the predicted diurnal variation of key frequencies for the nominated circuits.

These frequencies as identified in the legend are:-

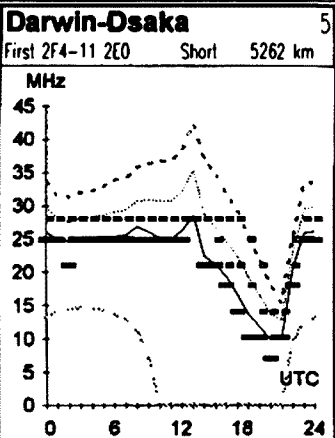
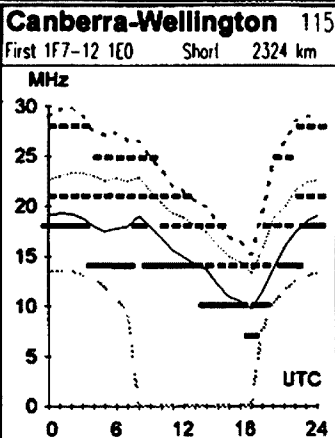
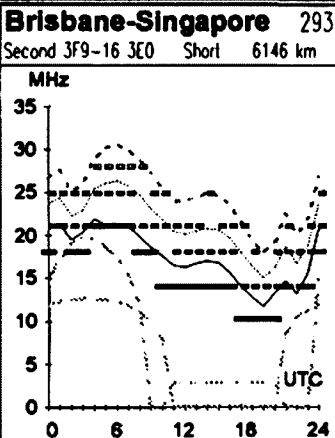
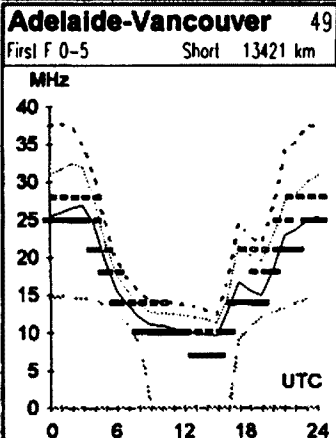
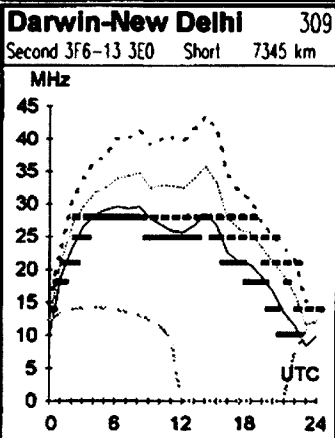
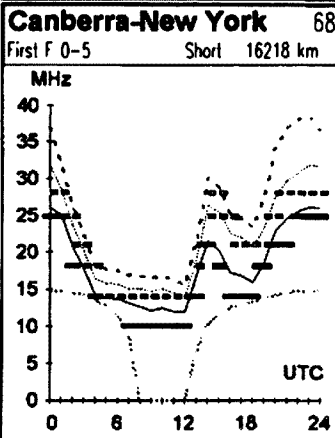
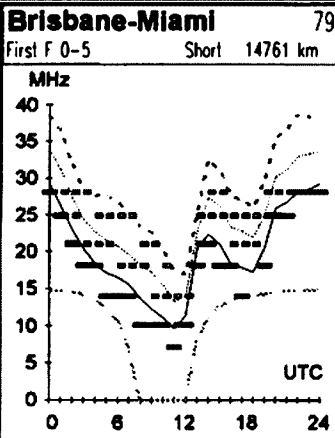
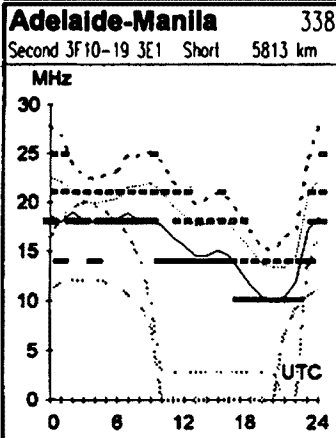
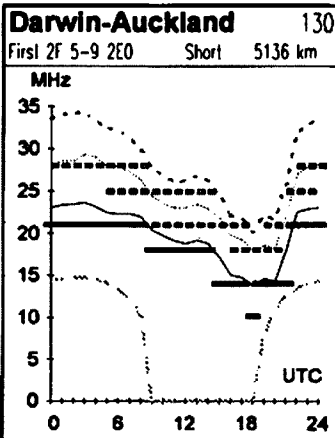
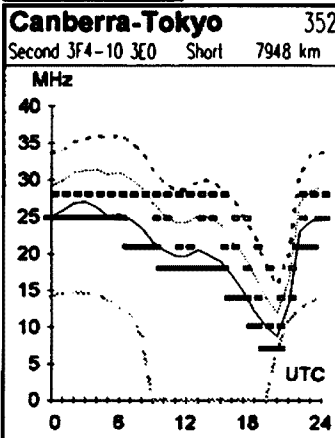
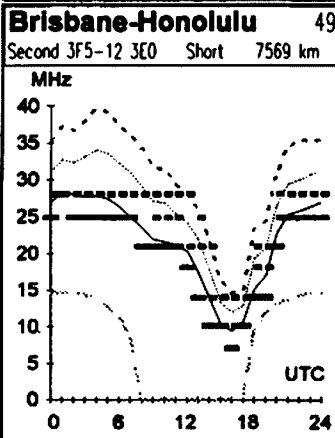
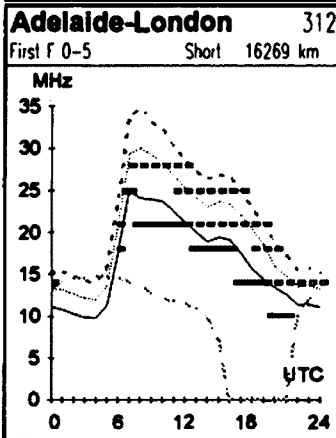
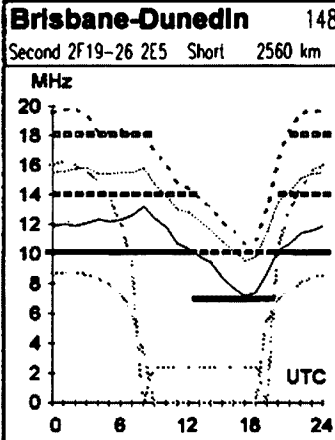
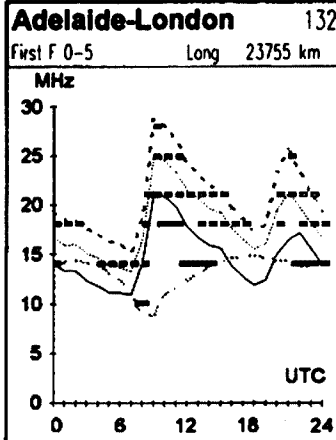
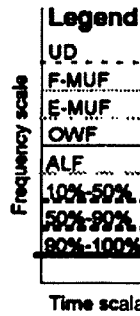
- Upper Decile (F-layer)
- F-layer Maximum Useable Frequency
- E-layer Maximum Useable Frequency
- Optimum Working Frequency (F-layer)
- Absorption Limiting Frequency (D region)

Shown hourly are the highest frequency amateur bands in ranges between these key frequencies; when usable. The path, propagation mode and Australian terminal bearing are also given for each circuit.

These predictions were made with the Ionospheric Prediction Service program: ASAPS version 4.

February 2000

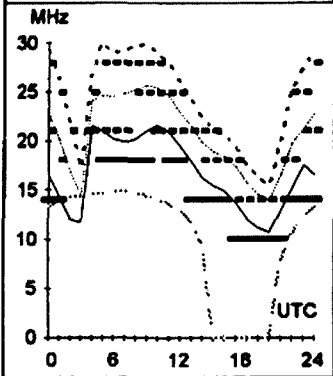
T index: 130



HF PREDICTIONS

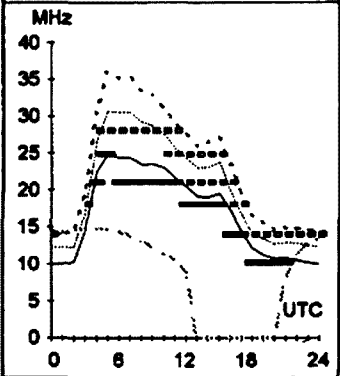
Hobart-Cairo 278

First F 0-5 Short 14263 km



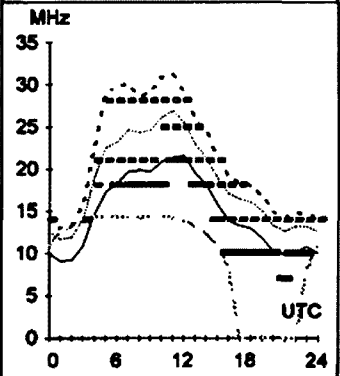
Melbourne-Moscow 316

First F 0-5 Short 14428 km



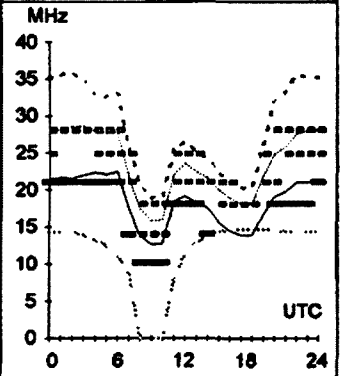
Perth-Capetown 237

First 3F3-10 3E0 Short 8704 km



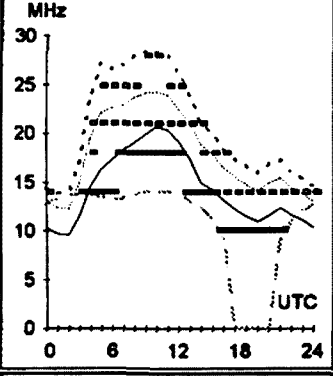
Sydney-Barbados 119

First F 0-5 Short 16155 km



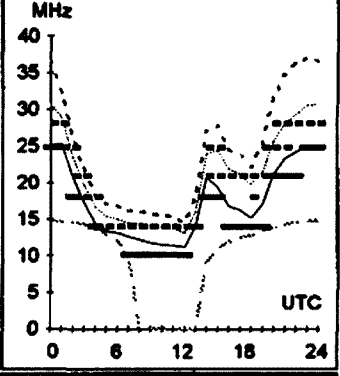
Hobart-Capetown 220

First 3F1-7 3E0 Short 10025 km



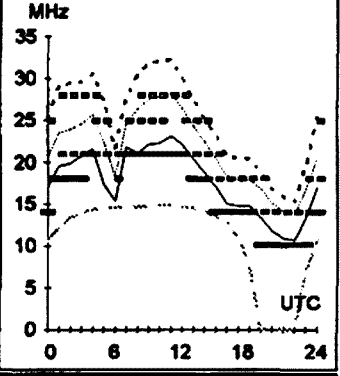
Melbourne-Ottawa 63

First F 0-5 Short 16566 km



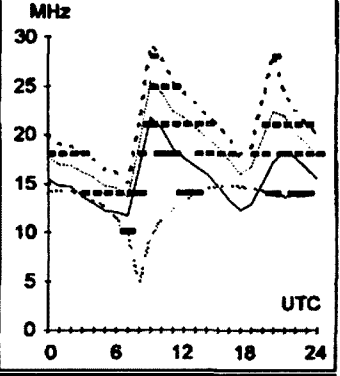
Perth-Dakar 259

First F 0-5 Short 14918 km



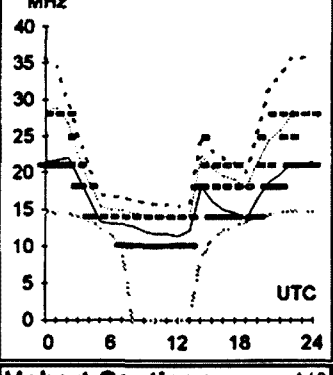
Sydney-London 139

First F 0-5 Long 23032 km



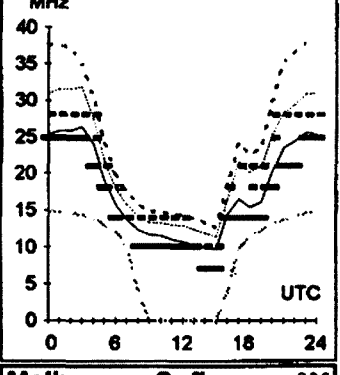
Hobart-Chicago 72

First F 0-5 Short 15576 km



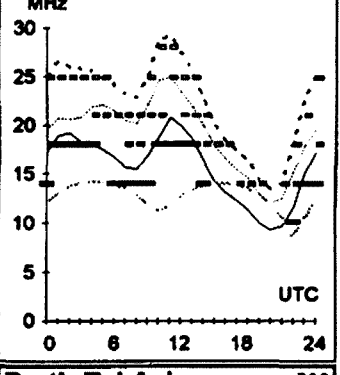
Melbourne-Seattle 50

First F 0-5 Short 13178 km



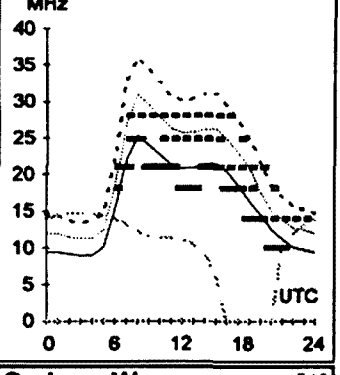
Perth-Montevideo 187

First F 0-5 Short 12536 km



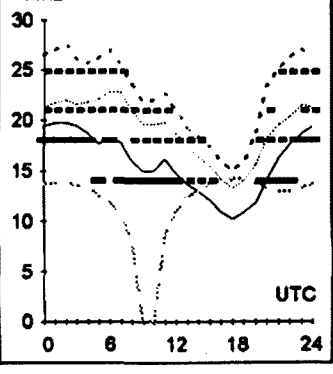
Sydney-London 319

First F 0-5 Short 16992 km



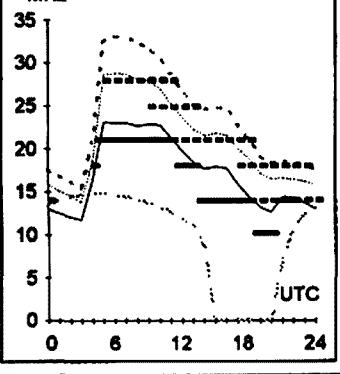
Hobart-Santiago 149

Second 4F5-9 4E0 Short 10686 km



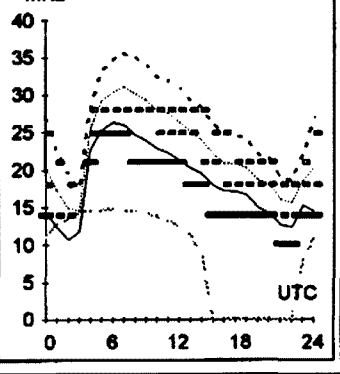
Melbourne-Sofia 296

First F 0-5 Short 15132 km



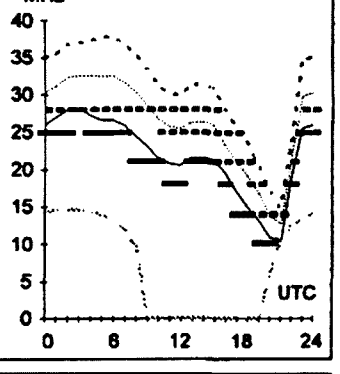
Perth-Tel Aviv 302

Second 4F4-9 4E0 Short 11091 km



Sydney-Warsaw 340

First F 0-5 Short 8325 km



HAMADS

WANTED NSW

•Rotator for Wilson SY-3 beam. Three elements. Phone (02) 9916 1381 email alian@nlc.net.au

•Old valve receivers, military, commercial, dusty, unloved, junked or complete; Marconi, Admiralty, Hallicrafters, Hammerlund, AWA etc. Will put to good use. The heavier the better. Give me a hernia! Call John (02) 9533 6261

FOR SALE VIC

•Yaesu FT100 as new in carton \$1250. •Bonus-Johnson (USA) LPF and Daiwa coax switch. New address, Croydon. Andy VK3UJ (03) 9723 8380

•Estate Ron VK3PRJ. •Icom IC735 HF txcvr plus power supply s/n25827 \$795. •Uniden Bearcat scanner UBC760XLT s/n 25000033 \$200. •Kenwood TS180S HF txcvr s/n 0011847 SP180 ext spkr. No power supply \$385. •Saiko SC7000 scanning receiver s/n 60627346 \$150. •Yaesu monitor scope YO-100 s/n 5D206021 \$95. •Heathkit scope SB620 \$75. Bill VK3PH QTHR 03 5330 1466

•Deceased estate VK3JA Kenwood TS430S (two) with power supply. •Heathkit linear amp, Johnson Viking Match Box, various other items — headphones, multimeter, old ARRL handbooks etc. Inspection at Warrnambool. Some in fair conx only \$800 the lot. Phone (03) 9728 5350 for details.

•Kenwood TS520S serial 810809; also •Hameg oscilloscope Model HM408-1. Offers invited. Doug VK3DE (03) 9804 2156

•Kenwood TS680S all mode multiband HF + 6m xcvr with mic and 30amp Emtron EPS30 power supply cross needle \$1000 the lot. •Diamond MX2000 HF/VHF/UHF triple xer \$50. Martin VK3JAZ (03) 9789 9196

WANTED VIC

•Kenwood SP120 •Kenwood AT130 Tuner •Kenwood VF0120; or accessories in good condition and working order to suit Kenwood TS130S. John Lovell, PO Box 454, Richmond Vic 3121 Ph 0418 318 786

•Kenwood TS770 or TS780 2m/70cm duobander in GC/GWO Damien VK3RX (03) 5427 3121

FOR SALE QLD

•Racal transmitter (TA I04C) with receiver (RA 87D) and remote control (LA 105). All as new with handbooks \$450. •Icom-254 2 metre all mod transceiver v.g.c. with handbook \$240. •4CX250B valve with socket and chimney (all new EIMAC) \$100. Gwen VK4CB QTHR (07) 3202 7137

•IC720A txcvr s/n 12431 0 - 30MHz. Full coverage RX WARC bands incl. Good condition \$500. Phone Lawrie VK4DAH (07) 3888 0501 or write QTHR

- Hamads may be submitted on the form on the reverse of your current Amateur Radio address flysheet. Please print carefully, especially where case or numerals are critical.
- Please submit separate forms for For Sale and Wanted items, and be sure to include your name, address and telephone number (including STD code) if you do not use the flysheet.
- Eight lines (forty words) per issue free to all WIA members, ninth and tenth lines for name and address. Commercial rates apply for non-members.
- Deceased estates Hamads will be published in full, even if the ad is not fully radio equipment.
- WIA policy recommends that the serial number of all equipment for sale should be included.
- QTHR means the address is correct in the current WIA Call Book.
- Ordinary Hamads from members who are deemed to be in general electronics retail and wholesale distributive trades should be certified as referring only to private articles not being re-sold for merchandising purposes.
- Commercial advertising (Trade Hamads) are pre-payable at \$25.00 for four lines (twenty words), plus \$2.25 per line (or part thereof), with a minimum charge of \$25.00. Cheques are to be made out to: WIA Hamads.
- Copy should be typed or in block letters, and be received by the deadlines shown on page 1 of each issue of Amateur Radio, at:

Postal: Newsletters Unlimited, 29 Tanner Street, Richmond, 3121

Fax: 03 9428 4242

E-mail: news@webtime.com.au

Please only send your Hamad once

Please send Hamads by mail OR fax OR email (much preferred).

Please do not send by more than one method for any one ad or issue, it is confusing.

FOR SALE ACT

•KLM KT-34A 4 el Tribander Yagi, with set of brand new Capacitor Caps, Boom Length 4.88m, rated at 4KW, good condition, VK1TX Tex, Ph (02) 6296 2508 or M 0413 139151.

•Vertical antenna 5 band 10-15-20-40-80m Comans, \$150. VK1LD Les (02) 6247 5660 QTHR.

•Yaesu FTDX 401 SSB transceiver. High power, super sensitivity and sharp selectivity in one complete station package. Get on the air for \$175.00 Ed VKINBH (02) 6251 2312 or email gudruned@effect.net.au

FOR SALE NSW

•Txcvr Europa One SSB 12 CH xtal cont HF with 24v PS of two IC-PS15 in series and "Q" match ant. coupler. \$200 + P & P ono. •Yaesu 2 input speaker SP102 with filters S/N 070259. \$25 + P & P. •Yaesu desk mic YO148 Dynamic 600Ω — 50kΩ \$25 + P & P ono. QTHR (02) 6495 9707 VK2GBM Laurie

•Kenwood TS830S HF Trsvr SN 2042198 with AT20 Antenna Tuner SN 3019402 and MC30S Microphone \$ 625. •Yaesu FT 290R SN 3F281064, YMA7 Microphone, Mirage B23G, SN 8751073 and Power supply Panther \$350. All in original boxes with service manuals. VK2KGX QTHR (02) 9525 9473.

•BOOK: "Radiotelegraph and Radiotelephone Codes, Prowords and Abbreviations." 2nd Edition.

\$16 posted Australia. 90 Pages. Q,X,Z Codes, 97 Phonetic, 20 Morse Codes. Phillips, Myer, 10,11,12,13 Codes. Much other info. Internet <http://www.nor.com.au/community/sarc/phonetic.htm>. VK2JWA, John W.A.lcorn. QTHR. 02-66215217 jalcorn@nor.com.au

•INTERNET Connect from Port Macquarie to the Gold Coast from 80c per hour. Summerland Amateur Radio Club. For info - <http://www.nor.com.au/community/sarc/sarc.htm>. Harry VK2XIO, QTHR, cascom@nor.com.au. PO Box 293, Lismore, 2480. Ph (02) 6621 6096

•Oscilloscope sell or swap for military radio, any age. •GOULD OS4200 Digital Storage CRO 500kHz. •TEKTRONIX 5110 with NIC527 signal averager. •TEKTRONIX 7704A dual trace 10khz on screen display. •TEKTRONIX 545B dual trace. •TEKTRONIX 564 dual trace. Wyong delivery. Ray Robinson VK2ILV Sydney (02) 9489 8561 robinson@srsuna.shlrc.mq.edu.au

•Yaesu FT-101Z HF TXCVR S/N 9C020308. G.C. Spare PA valves. Built in fan. DC-DC converter \$250.00 •Two Yaesu FRG-7700 HF Receivers S/ N 1H100251 & 1H100238. Both with FRT-7700 tuning units. Operators manuals. Fair condition. \$100.00 each. •One 10/11m 3 element beam antenna with heavy duty coax cable. 20m of spare cable. \$20.00 •One Yaesu gutter mobile antenna mount. 2m stub and 80m antenna. \$20.00 •One mobile magnetic antenna base \$10.00 •VK2KRQ John Le Fevre (02) 4369 0458 12A Rickard Road Empire Bay NSW

WANTED QLD

•23cm transverter, w/w accs. VK4PJ QTHR (07) 3399 2881

FOR SALE SA

•Morse Tutor Datong model DTO G.C. \$120. VK5CJM John (08) 8381 7905 QTHR

•Radio shack clearance, changing hobby. Everything must be sold. Send SASE to Paul, PO Box 76, Peterborough SA 5422 or phone (08) 8651 2398

WANTED SA

•Four element triband beam 40 foot guyed lattice tower with rotator and indicator or similar. VK5ASN (08) 8725 2526 QTHR

FOR SALE WA

•Hy Gain Beam Explorer 14, 10-15-20m, \$ 200, •Comet 23cm Yagi Group, 4x52 Ele, with matching network, \$ 600, •Maspro 70cm/2m Cross Yagi System for sat-comm. \$ 150, •Comet aluminium roof tower, 12 ft, \$ 200, •Hills crank up tower, 13m, \$ 300, •28 MHz Monoband Yagi, 7 element, 2 reflectors, 9.80m boom, top gun, like new, \$ 500, •Kenwood TS 50, \$ 900, •Kenwood TS 440S, looks bad, but works ok, \$ 500, •70cm Lin Amp, TLA 432-100, 100 Watt out, \$ 500, •TWE Mobile-HF-Amplifier MA 500, 600 Watt, \$ 600, •Metron Mobile-HF-Amplifier MA 1000, \$ 800, •Diamond SX 1000 SWR Meter, 4 Bands, 1.8 - 1300 MHz, new, \$200, •SCS PTC-II Pactor controller, \$ 1,100, •MFJ 249 Antenna Analyzer, battery bracket defect, \$100, •NIR 10, digital noise reduction unit, \$ 200, •AOR AR 2002, Scan-Receiver, poor reception, \$200, •Drake SP 75 speech processor, \$200, Walter in Perth, VK6BCP, (08) 9341 2054, e-mail: vk6bcp@arri.net

FOR SALE TAS

•4 Cisco IGS Router/Bridge, IOS 9.1, 1 Ethernet 1 Serial ports \$100ea ono •1 Cisco AGS+ Router, IOS 9.1, 1 Ethernet, 5 Serial ports \$350 ono. Justin VK7ZTW QTHR (03) 62231351 justin@hmjgc.fam.aust.com

MISCELLANEOUS

•Pactor. Seek modifications for Kenwood TS120-S to obtain fast AGC for Pactor or Amtor. Rob VK5RG QTHR Phone (08) 8379 1889

•If you got your licence before 1975 you are invited to join the Radio Amateurs Old Timers Club. A \$2.50 joining fee plus \$8.00 for one year or \$15.00 for two years gets you two interesting Journals a year plus good fellowship. Arthur Evans VK3VQ or Milton Crompton VK3MN can supply applications forms. Both are QTHR in any Call Book.

•The WIA QSL Collection (now Federal) requires QSLs. All types welcome, especially rare DX pictorial cards, special issue. Please contact the Hon Curator, Ken Matchett VK3TL, 4 Sunrise Hill Road Montrose VIC 3765, tel. 03 9728 5350.

TRADE ADS

•AMIDON FERROMAGNETIC CORES:

For all RF applications. Send business size SASE for data/price to RJ & US Imports, PO Box 431, Kiama NSW 2533 (no enquiries at office please ... 14 Boanyo Ave Kiama).

www.cyberelectric.net.au/~rjandusimports

Agencies at: Assoc TV Service, Hobart; Truscotts Electronic World, Melbourne and Mildura; Alpha Tango Products, Perth; Haven Electronics, Nowra

• **WEATHER FAX** programs for IBM XT/ATs *** "RADFAXZ" \$35.00, is a high resolution short-wave weather fax, Morse and RTTY receiving program. Suitable for CGA, EGA, VGA and Hercules cards (state which). Needs SSB HF radio and RADFAX decoder. *** "SATFAX" \$45.00, is a NOAA, Meteor and GMS weather satellite picture receiving program. Needs EGA or VGA & WEATHER FAX PC card, + 137 MHz Receiver. *** "MAXISAT" \$75.00 is similar to SATFAX but needs 2 MB of expanded memory (EMS 3.6 or 4.0) and 1024 x 768 SVGA card. All programs are on 5.25" or 3.5" disks (state which) plus documentation, add \$3.00 postage. ONLY from M. Delahunty, 42 Villers St, New Farm QLD 4005. Ph 07 358 2785.

<http://www.hamsearch.com>
a not-for-profit site that is a
search engine for hams

*the
balloon
gang*

We now have four QRP H.F. beacons for the y2k balloon.

These will transmit a continuous C.W. message, and ident. The beacons are on 3.58 MHz, 7.045 MHz, 28.075 MHz, and 50.22 MHz. All have 1/2 wave vertical dipoles. If conditions are favorable we expect reports world wide. We are waiting for a favorable (easterly) jet stream, and of course fair to good local wx. See <http://www.caribooweb.com/y2kballoon> for launch, logging, and balloon information. Please pass on to all that may be interested, Tnx de Ric, VE7 CUP, for the "Balloon gang"



Listen!

Have you heard
this week's
DIVISIONAL
BROADCAST?

*Turn the page for times
and frequencies.*

WIA Division Directory

The WIA consists of seven autonomous State Divisions. Each member of the WIA is a member of a Division, usually in their residential State or Territory, and each Division looks after amateur radio affairs within its area.

Division	Address	Officers	News Broadcasts	Note: All times are local. All frequencies MHz.	Fees
VK1 ACT Division GPO Box 600 Canberra ACT 2601	President Secretary Treasurer	Gilbert Hughes John Woolner Les Davey	VK1GH VK1ET VK1LD	VK1WI: 3.570 LSB, 146.950 FM each Sunday evening from 8.00pm local time. The broadcast text is available on packet, on Internet <i>aus.radio.amateur.misc</i> news group, and on the VK1 Home Page http://www.vk1.wia.ampr.org	(F) \$72.00 (G) (S) \$58.00 (X) \$44.00
VK2 NSW Division 109 Wigram St Parramatta NSW (Office hours Mon-Fri 1100-1400) (PO Box 1066, Parramatta 2124) Phone 02 9689 2417 Freecall 1800 817 644 Fax 02 9633 1525	President Secretary Treasurer	Michael Corbin Eric Fossey Eric Van De Weyer	VK2YC VK2EFY VK2KUR	From VK2WI 1.845, 3.595, 7.146*, 10.125, 14.160, 24.950, 28.320, 29.120, 52.120, 52.525, 144.150, 147.000, 438.525, 1281.750 (* morning only) with relays to some of 18.120, 21.170, 584.750 ATV sound. Many country regions relay on 2 m or 70 cm repeaters. Sunday at 1000 and 1930. Highlights included in VK2AWX Newcastle news, Monday 1930 on 3.593 plus 10 m, 2 m, 70 cm, 23 cm. The broadcast text is available on the Internet newsgroup <i>aus.radio.amateur.misc</i> , and on packet radio.	(F) \$89.00 (G) (S) \$58.00 (X) \$41.00
VK3 Victorian Division 40G Victory Boulevard Ashburton VIC 3147 (Office hours Tue & Thur 0830-1530) Phone 03 9885 9261 Fax 03 9885 9298	President CEO Secretary	Jim Linton Barry Wiltton Peter Mill	VK3PC VK3XV VK3APO	VK3BWI broadcasts on the 1st and 3rd Sunday of the month at 8.00pm. Primary frequencies, 3.615 LSB, 7.085 LSB, and FM(R)s VK3RML 146.700, VK3RMM 147.250, VK3RWG 147.225, and 70 cm FM(R)s VK3ROU 438.225, and VK3RMU 438.075. Major news under call VK3WI on Victorian packet BBS and WIA VIC Web Site.	(F) \$75.00 (G) (S) \$61.00 (X) \$47.00
VK4 Queensland Division GPO Box 638 Brisbane QLD 4001 Phone 07 3221 9377 Fax 07 3266 4926	President Secretary Treasurer	Collin Gladstone David Jones Bill McDermott	VK4ACG VK4OF VK4AZM	VK4WIA: 1.825 MHz SSB, 3.605 MHz SSB, 7.118 MHz SSB, 14.342 MHz SSB, 21.175 MHz, 28.400 MHz SSB, 29.220 MHz FM, 53.725 MHz FM, 147.000 MHz FM, 438.500 MHz (Brisbane only), and regional VHF/UHF repeaters at 0900 hrs EAST Sunday. Repeated on 3.605 MHz SSB & 147.000 MHz FM at 1930 hrs EAST Monday. Broadcast news in text form on packet under WIAQ@VKNET.	(F) \$85.00 (G) (S) \$72.00 (X) \$56.00
VK5 South Australian Division (GPO Box 1234 Adelaide SA 5001) Phone 08 8294 2992	President Secretary Treasurer	Jim McLachlan David Minchin John Butler	VK5NB VK5KK VK5NX	VK5WI: 1827 kHz AM, 3.550 MHz LSB, 7.095 AM, 14.175 USB, 28.470 USB, 53.100 FM, 147.000 FM Adelaide, 146.700 FM Mid North, 146.800 FM Mildura, 146.825 FM Barossa Valley, 146.900 FM South East, 146.925 FM Central North, 147.825 FM Gawler, 438.425 FM Barossa Valley, 438.475 FM Adelaide North, ATV Ch 35 579.250 Adelaide. (NT) 3.555 USB, 7.065 USB, 10.125 USB, 146.700 FM, 0900 hrs Sunday. 3.585 MHz and 146.675 MHz FM Adelaide, 1930 hrs Monday.	(F) \$77.00 (G) (S) \$83.00 (X) \$49.00
VK6 West Australian Division PO Box 10 West Perth WA 6872 Phone 08 9351 8873	Acting Pres. Secretary Treasurer	Cliff Bastin Christine Bastin Bruce Hedland-Thomas	VK6LZ VK6ZLZ VK6OO	VK6WIA: 146.700 FM(R) Perth at 0930hrs Sunday relayed on 1.825, 3.560, 7.075, 14.116, 14.175, 21.185, 29.680 FM, 50.150 and 438.525 MHz, country relays 3.582, 147.200 (R) Cataby, 147.350 (R) Bussellton and 146.900 (R) Mt William (Bunbury). Broadcast repeated on 146.700 at 1900 hrs Sunday relayed on 1.865, 3.563 and 438.525 MHz: country relays on 146.350 and 146.900 MHz.	(F) \$69.00 (G) (S) \$59.00 (X) \$38.00
VK7 Tasmanian Division PO Box 271 Riverside TAS 7250 Phone 03 6425 2923 Fax 03 6425 2923	President Secretary Treasurer	Ron Churcher Tony Bedelph John Bates	VK7RN VK7AX VK7RT	VK7WI: 146.700 MHz FM (VK7RHT) at 0930 hrs Sunday relayed on 147.000 (VK7RAA), 146.725 (VK7RNE), 146.625 (VK7RMD), 3.570, 7.090, 14.130, 52.100, 144.150 (Hobart), repeated Tues 3.590 at 1930 hrs.	(F) \$88.00 (G) (S) \$75.00 (X) \$55.00
VK8 Northern Territory (part of the VK5 Division and relays broadcasts from VK5 as shown, received on 14 or 28 MHz).					

Membership Grades

Full (F) Pension (G) Needy (G) Student (S) Non receipt of AR (X)
Three-year membership available to (F) (G) (X) grades at fee x 3 times.

ADVERTISERS INDEX

ATN Antennas	45	WIA NSW Division	IBC
Dick Smith	OBC, 28,29	WIA Call Book.....	IFC
Federal WIA Convention	35		

TRADE PRACTICES ACT

It is impossible for us to ensure that the advertisements submitted for publication comply with the Trade Practices Act 1974. Therefore, advertisers and advertising agents will appreciate the absolute need for themselves to ensure that the provisions of the Act are strictly complied with.

VICTORIAN CONSUMER AFFAIRS ACT

All advertisers are advised that advertisements containing only a PO Box number as the address cannot be accepted without the addition of the business address of the box-holder or seller of the goods.

W.I.A. (N.S.W. Division) BOOKSHOP

The following items are normally available for sale in the N.S.W. Division Bookshop. No price shown indicates out of stock - stock received regularly from USA and UK, so please call for availability. We can arrange special orders for items not normally held in stock - just give us a call.

Order by telephone quoting credit card details, or by mail enclosing cheque, money order or credit cards details to -

W.I.A. (N.S.W.Division), P.O. Box 1066, Parramatta. NSW 2124

Tel: (02) 9689 2417 or Fax (02) 9633 1525

Discounts are available on most items to W.I.A. Members - please check before ordering. Post/packing extra where applicable

	Retail Price		Retail Price
Antennas:			
Antennas & Techniques for Low Band DXing - J. Devoldere ON4UN	37.00	QRP & DX	
ARRL Antenna Book	50.00	Introducing QRP - D Pascoe G0BPS	24.00
Antenna Compendium volume 1	20.00	QRP Power	19.00
Antenna Compendium volume 2	25.00	W1FB's QRP Notebook Doug DeMaw W1FB	19.00
Antenna Compendium volume 3	25.00	Dxing On The Edge - J Briggs K1ZM	46.00
Antenna Compendium volume 4 (including software)		The Complete DXer 2nd Ed - B Locher W9KNI	19.00
Antenna Compendium volume 5 (including software)			10.00
W1FB's Antenna Notebook - Doug DeMaw W1FB	21.00	Packet:	
Practical Wire Antennas - J D Heys G3BDQ	33.00	Your Packet Companion - Steve Ford WB8IMY	21.00
Physical Design Yagi antennas - David B Leeson W6QHS	32.00	Packet - Speed, More Speed & Applications	24.00
Practical Antenna Handbook 2nd Edition Carr	98.00	Getting On Track with APRS	24.00
Antenna Impedance Matching - Wilfred N Caron	31.00	RSGB Pocket Guide -Your First Packet Station - S Jelly G0WSJ	17.00
RSGB HF Antenna Collection - Edited by Erwin David G4LQI	41.00	Packet Radio Primer	29.00
HF Antennas for All Locations - Les Moxon G6XN	49.00	Practical Packet Radio - Stan Horzepa WA1LOU	29.00
Practical Antennas for Novices - John Heys G3BDQ	22.00	RF & Interference:	
Antenna Experimenter's Guide - Peter Dodd G3LDO	57.00	RF Exposure & You	22.00
W6SAI's HF Antenna Handbook - Bill Orr W6SAI	32.00	Television Interference Manual - 2nd Edition - RSGB	12.00
Cubical Quad Antennas - Bill Orr & Stuart Cowan	31.00	Radio Frequency Interference Handbook (Aust)	25.00
Vertical Antennas - Bill Orr & Stuart Cowan	31.00	Radio Frequency Interference - How to Find it & Fix it - ARRL	28.00
Simple Low-Cost Wire Antennas - Bill Orr & Stuart Cowan	26.00	Education:	
Simple Low-Cost Wire Antennas - Bill Orr & Stuart Cowan	26.00	Novice Operators Theory Handbook & Study Guide	30.00
More ... Out of Thin Air	24.00	As above with Exams (Correspondence Course)	49.00
Low McCoy on Antennas	26.00	AOCB Bridging Correspondence Course	49.00
The Radio Amateurs Antenna Handbook - Bill Orr & Stuart Cowan	29.00	Radio Theory Handbook for Amateur Operators - 3rd Ed. Swainston	55.00
Antennas for VHF & UHF	17.00	Amateur Radio Operating Manual - 3rd Edition - RSGB	31.00
VHF-UHF-Microwaves-Satellites:		ARRL Operating Manual	41.00
VHF Amateur Radio Bill Orr & Stuart Cowan	30.00	Ham Radio Made Easy - Steve Ford WB8IMY	29.00
Radio Auroras - Charlie Newton G2FKZ	20.00	W1FB's Help For New Hams - Doug DeMaw	21.00
RSGB Microwave Handbook Vol 1		Understanding Basic Electronics - L D Wolfgang WR1B	37.00
RSGB Microwave Handbook Vol 2		Historical:	
RSGB Microwave Handbook Vol 3		Traeger The Pedal Radio Man - Fred McKay	15.00
Space Radio Handbook - John Branegan GM4IHJ	40.00	In Marconi's Footsteps - Early Radio - P Jensen VK2AQJ	49.95
Spread Spectrum Sourcebook		200 Meters & Down - The Story of Amateur Radio - C DeSoto - ARRL	14.00
Radio Amateurs Satellite Handbook	34.00	Miscellaneous:	
ARRL Satellite Anthology	20.00	Test Equipment for the Radio Amateur - C Smith G4FZH	30.00
UHF/Microwave Experimenter's Manual	36.00	W1FB's Design Notebook - Doug DeMaw W1FB	21.00
UHF/Microwave Projects Manual volume 1		The L F Experimenters Source Book	26.00
UHF/Microwave Projects Manual volume 2	26.00	Your HF Digital Companion - Steve Ford WB8IMY	25.00
Weather Satellite Handbook	31.00	Your Mobile Companion - Roger Burch WF4N	25.00
VHF/UHF Handbook	59.00	The Modern Amateur's Mobile Handbook - D Ingram K4TWJ	25.00
VHF/UHF DX Book	66.00	Personal Computers in the Ham Shack - P Danzer & R Roznoy	29.00
Introduction to Satellite Communications - F A Wilson	20.00	The Internet & World Wide Web Explained	19.00
Handbooks & Projects:		Radiotelegraph & Radiotelephone Codes, Prowords & Abbreviations	12.00
ARRL Handbook 2000 (Avail Feb)		Shortwave Listening for Beginners - A L McCormick	30.00
RSGB RadCom Handbook (Avail Feb)		Passport to World Band Radio - Shortwave Guide	44.00
ARRL Electronics Data Book	32.00	The Best of the New Ham Companion	19.00
RSGB Radio Data Handbook 6th Edition	37.00	Technical Topics Scrapbook volume 1	32.00
The New Shortwave Propagation Handbook	32.00	Technical Topics Scrapbook volume 2	38.00
Your Guide to Propagation (RSGB)	22.00	Transmitter Hunting Radio Direction Finding Simplified	37.00
Hints & Kinks for the Radio Amateur	21.00	Members Only Items:	
Practical Transmitters for Novices	34.00	Metal lapel badges (WIA logo)	4.00
Practical Receivers for Beginners	40.00	Car Stickers (WIA Logo)	1.50
Solid State Design	22.00	QSL Cards -	25 for \$3.00 + 45 cents postage 100 for \$10.00 + \$2.00 postage.
Building & Using Balun and Ununs	32.00		
How to Design & Make your own PCBs	14.00		
More Advanced Power Supply Projects			
Log Books & Call Books:			
WIA Log Book (Portrait Print)	5.00		
ARRL Log Book (Landscape Print)	9.00		
2000 Australian Amateur Callbook	17.95		
Souvenir Key Rings -Metal with WIA Logo (avail Dec/Jan)	7.50		

PRICES SUBJECT TO CHANGE WITHOUT NOTICE

YAESU VX-1R MICRO DUALBAND HANDHELD TRANSCEIVER

Wide receiver coverage, leading edge features, and Lithium Ion technology, packaged for convenience at a price that will surprise!

**PRICE
BREAKTHROUGH**



VX-1R shown full size

The Yaesu VX-1R is one of the world's smallest dualband amateur rigs, sporting a 2m/70cm transceiver with wideband receiver in a case sized just 47 x 81 x 25mm WHD. It has impressive memory and scanning facilities as well as receive coverage of VHF and UHF TV, AM and FM broadcast bands, AM aircraft band and other public service frequencies from 76 to 999 MHz*.

Leading-edge technology from the VX-1R's 500mW MOSFET power amplifiers together with the supplied 3.6V 700mA/H high-capacity Lithium Ion battery will provide many hours of superb local communications. Up to 1W output is available for longer range when external DC power is used. Extensive battery-saving features together with the Li-Ion battery's 2-hour recharge system yields long operating times under real-world conditions.

The VX-1R's extensive memory system provides 291 memory channels, most with Alpha-numeric labelling for easy recognition. A Smart Search™ system allows you to search a portion of a band you define, then loads any active frequencies into 31 special Smart Search™ memories for later inspection (great for finding activity when visiting a new area).

Besides being a fully-featured dual-band amateur transceiver, the VX-1R has extraordinarily wide receiver frequency coverage; you'll also be pleasantly surprised by the great audio on the FM broadcast band. A dual-watch facility is provided – and together with the AM, FM-narrow and FM-wide reception modes – you'll be having fun even when you're not operating on the amateur bands. For selective calling and listening, the VX-1R also includes a CTCSS encoder/decoder and a 104-code Digital Code Squelch (DCS) system as well as a Tone Search facility for both CTCSS and DCS encoded transmissions.

A great range of accessory lines for the VX-1R are available such as speaker/mics, a carry case, as well as a battery holder for 1 x AA alkaline battery which includes an inbuilt voltage step-up converter. Computer programming of the VX-1R is available via the optional ADMS-1E programming kit.

So when Yaesu says "Dick Tracy, we're waiting for your call" you can be sure they have good reason to do so. In fact, call into your Dick Smith Electronics' Hams Shack store for a demo of this fun new rig. Or phone 1300 366 644 for a copy of the Yaesu colour brochure.

D 3665

2 YEAR WARRANTY

\$399

SAVE \$50

YAESU

PHONE FAX AND MAIL ORDERS

PHONE: WITHIN AUSTRALIA: 1300 366 644
(Local Call Charge)

FAX: (02) 9395 1155 within Australia and
(+612) 9395 1155 from outside Australia

MAIL: DICK SMITH ELECTRONICS, Direct Link Reply Paid 160, PO Box 321,
North Ryde NSW 1670 (No Stamp Required)

Excludes packaging and postage. All major Credit Cards accepted.

14 Day Money Back Guaranteed if NOT completely satisfied. (Software excluded)



Visit our web site at
<http://www.dse.com.au>



That's where you go!

*Less cellular coverage



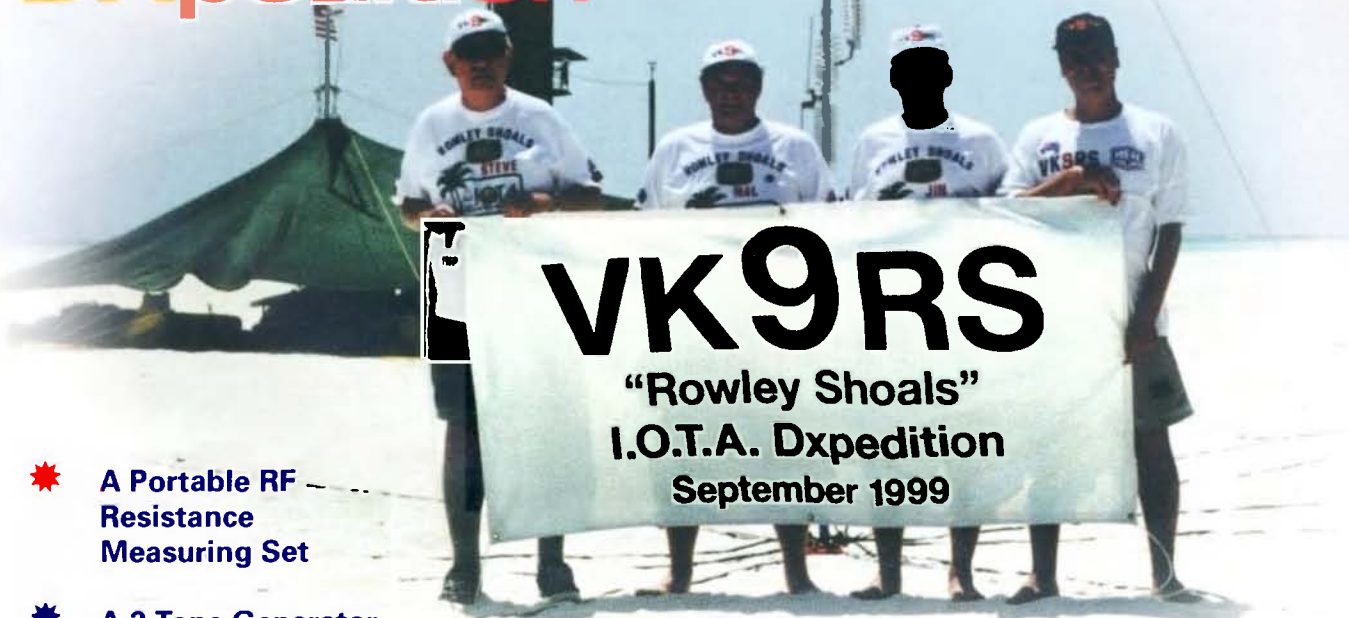
March 2000
Volume 68 No 3

Amateur Radio

"Rowley Shoals"

IOTA

DXpedition



★ **A Portable RF Resistance Measuring Set**

★ **A 2 Tone Generator for Testing SSB Transmitters**

PSK31
the easy way

The need for a new AR communications system that is more efficient in spectrum occupancy has become vital for the continued expansion of the AR service

Eric Jamieson VK5LP
Looks back at an Expanding World.

plus

***ALARA, WIA, Divisional & Club News
& regular columns***

MORE

GREAT

GEAR

FROM

ICOM

NEW!!



756PRO The HF & 6m multimode professional performer. 100 watts of power, newly designed 32 bit floating DSP for noise reduction and autonotch, and AGC loop operation for wider dynamic range. Plus digital IF filter, built-in RTTY Demodulator/Dual Peak APF, and a whole lot more.

T81A A remarkably compact quad bander. Superb clarity on the 6m, 2m, 70cms and 23cm bands. It's water resistant, with tone squelch and pocket beep functions standard, plus you can change volume and bands even quicker with the 'joy-stick' style multi-function switch.



R2 Fit the world's airwaves in your shirt pocket. Just 8.6cm high, wide 0.5 - 1300 MHz frequency range divided into 9 bands plus FM/WFM/AM, 400 memory channels, great sound in rugged water resistant construction.



2800H A totally new approach to dual band mobile. Powerful performance on 2m and 70cm bands, remote control capability, and a first for mobile rigs...a multi-function colour LCD screen! All your information is right in front of you in colourful 3D-like characters and icons.

ICOM
Clearly Ahead

2 YR WARRANTY

See your nearest Icom Dealer, or visit our website at www.icom.net.au



Amateur Radio

The Journal of the Wireless
Institute of Australia
ISSN 0002-6859

Editorial

Editor: Colwyn Low VK5UE
Technical Editor: Peter Gibson* VK3AZL
Publications Committee Members
Ron Fisher VK3OM
Don Jackson VK3DBB
Evan Jarman VK3ANI
Bill Rice VK3ABP
Gil Sones VK3AUI

Advertising

Mrs June Fox,
Tel: (03) 9528 5962

Hamads

"Hamads" Newsletters Unlimited
29 Tanner Street, Richmond VIC 3121
Fax: (03) 9428 4242
e-mail: news1@webtime.com.au

Office

10/229 Balaclava Road
Caulfield, Victoria
Telephone (03) 9528 5962
Facsimile (03) 9523 8191
Business Hours 9:30am to 3:00pm weekdays

Postal

P.O. Box 2175
CAULFIELD JUNCTION
VICTORIA 3161
AUSTRALIA
e-mail: armag@hotkey.net.au

Production

Newsletters Unlimited (03) 9428 3458

Printer

Streamline Press, Melbourne (03) 9417 2766

Postal Service

IMS (03) 9291 5888

Production Deadlines

Advertising booking and articles for
publication 10th of proceeding month.

Hamads and advertising material deadline
18th day of proceeding month

The contents of Amateur Radio are Copyright
Wireless Institute of Australia
C 2000

General

The Golden antenna of Bad Bentheim	5
<i>Gunter Alsmeyer, Mayor of the Town of Bad Bentheim</i>	
VK9RS "Rowley Shoals" IOTA DXpedition	12
<i>Stephen Pall VK2PS</i>	
Eric Jamieson VK5LP: Looking back at an era (Part 1)	30
<i>Eric Jamieson VK5LP</i>	
Invitation from Japanese Amateur Radio Committee	44

Technical

A Portable RF Resistance Measuring Set	6
<i>Drew Diamond VK3XU</i>	
A 2 Tone Generator for Testing SSB Transmitters	22
<i>Keith Gooley VK50Q</i>	
PSK31. The easy way	36
<i>Alan J Gibbs VK6PG</i>	

Columns

Advertisers' Index	56	Hamads	54
ALARA	26	HF Predictions	52
AMSAT Australia	50	Intruder Watch	32
ARDF	27	New Members	4
Awards	45	Over To You	55
Club News	20	Repeater Link	33
Contests	47	Silent Key	35
WIA Division News		Spotlight on SWLing	49
VK1 Notes	17	VHF/UHF - An Expanding World	41
VK2 Notes	17	WIA Comment	3
VK4 Notes	18	WIA News	3
VK7 Notes	19	WIA Division Directory	56
Editor's Comment	2	WIA Federal Directory	2
Education	11		

Our cover this month

VK9RS "Rowley Shoals" IOTA DXpedition, September 1999
Left to Right: Steve VK2PS, Mai VK6LC, Jim K9PPY, Sam CY1EEN
(See story page 12)

Contributions to Amateur Radio

Amateur Radio is a forum for WIA members' amateur radio experiments, experiences opinions and news. Manuscripts with drawings and or photos are always welcome and will be considered for publication. Articles on disc or email are especially welcome. The WIA cannot be responsible for loss or damage to any material. A pamphlet, How to write for Amateur Radio is available from the Federal Office on receipt of a stamped self-addressed envelope.

Back Issues

Back issues are available directly from the WIA Federal Office (until stocks are exhausted, at \$4.00 each (including postage within Australia) to members.

Photostat copies

When back issues are no longer available, photocopies of articles are available to members at \$2.50 each (plus an additional \$2 for each additional issue in which the article appears).

Disclaimer

The opinions expressed in this publication do not necessarily reflect the official view of the WIA and the WIA cannot be held responsible for incorrect information published.

Amateur Radio Service

A radiocommunication service for the purpose of self-training, intercommunication and technical investigation carried out by amateurs; that is, by duly authorised persons interested in radio technique solely with a personal aim and without pecuniary interest.

Wireless Institute of Australia

The world's first and oldest
National Radio Society
Founded 1910

Representing
The Australian Amateur Radio Service

Member of the
International Amateur Radio Union

Registered Federal Office of the WIA
10/229 Balaclava Road
Caulfield North Vic 3161
Tel: (03) 9528 5962 Fax (03) 9523 8191
<http://www.wia.org.au>

All mail to
PO Box 2175 Caulfield Junction VIC 3161
Business hours: 9.30am-3pm weekdays

Acting Federal Secretary

Peter Naish VK2BPN

Federal Office staff

June Fox Bookkeeper
Rita Trebilco VK3IF Examinations Officer

Council

President	Peter Naish	VK2BPN
VK1 Federal Councillor	Glenn Dunstan	VK1XX
VK2 Federal Councillor	Michael Corbin	VK2YC
VK3 Federal Councillor	Brenda Edmonds	VK3KT
VK4 Federal Councillor	Ross Marren	VK4AMJ
VK5 Federal Councillor	David Box	VK5OV
VK6 Federal Councillor	Will McGhie	VK6UU
VK7 Federal Councillor	Phil Corby	VK7ZAX

Executive

Peter Naish VK2BPN
Tony Farrow VK2TJF
John Loftus VK4EMM
Wally Howse VK6KZ

Federal Coordinators

AMSAT	Graham Ratcliff	VK5AGR
ARDF	Jack Bramham	VK3WWW
Awards	John Kelleher	VK3DP
Contests	Ian Godsil	VK3DID
Education	Brenda Edmonds	VK3KT
FTAC	John Martin	VK3KWA
Historian	John Edmonds	VK3AFU
IARU	Grant Willis	VK5ZWI
Intruder Watch	Gordon Loveday	VK4KAL
ITU Conference and study group	David Wardlaw	VK3ADW
Public Relations	David Thompson	VK2NH
QSL Manager (VK9, VK0)	Neil Penfold	VK6NE
Videotapes	Don Bland	VK4TVD

ACA Liaison Team

Peter Naish VK2BPN
Glenn Dunstan VK1XX
Michael Corbin VK2YC
Wally Howse VK6KZ
Canberra Liaison Officer
Richard Jenkins VK1RJ

EDITORS COMMENT

Making the most of new challenges

Getting AR to you is much more complicated than I ever imagined. My February copy arrived, outer Adelaide metropolitan area, 8 days after it went to Australia Post in Melbourne on 10th February.

There have been a number of articles recently on Morse Code, but there are other modes that are not widely used and of which all of us should have a little knowledge. You never know who might be looking for a new challenge. A few years ago I would not have dreamt that I would have a VHF station and a packet capability. Then neither did I think I would have a need for a TH3 !

I would like some articles on packet or digital communication in general. We have an article on PSK31 in this issue. How about an article on the use of this module or similar units from users ?

How about UHF construction ? SA Equipment supplies has some good kits. I had a query, from a friend of one of my sons, about how to get information on these kits. The query came from a RAAF base.

There is also a need for photographs. Not that we print anything that comes. You may have got that impression but a magazine can only be assembled from what is submitted. There have been some

problems in the past about acknowledging material submitted for publication. I am hoping we now are acknowledging receipt by return mail and giving the author the reference number for the article in the AR articles register. We have a few article which have been a while in the vetting process and a few, which in the moves between Victoria, Queensland and South Australia, have been mislaid (I hope). We will use all the material that was submitted more than 6 months ago in the next few months. So there is room for more. I would like to be able to publish issues with themes but there is not enough material to do that at present.

The *Over To You* column is for your views. There is need for an open WIA discussion area. We need views on what the WIA does well and what it does not so well. Criticism is the lifeblood of any organisation, but it has to be constructive. I have read lots of "stuff" on my local packet BBS about the WIA. So I would like to see discussions based in the present and not what Joe ??, who was the WIA ??, did in 1960 being the reason why Bill ?? cannot support the WIA today. Different people different time. Let us accept change and learn to work with it.

Colwyn VK5UE

ar

Thought for the month :-

Learn something new. See if it is really that hard to work on a new band or use a new mode.

Errata *An Experimental LF Band Transmitter* February 2000 pages 20 to 27.

1. VK5HK is referred to in the article as Harry Krause; he uses the name Harro. We apologise for renaming you Harro. A reviewing error.
 2. A 25 ohm load is discussed through out the article. On page 20 last para. and on page 26 first para. under "Dummy Load" a 20 ohm load is referred to. All should be 25 ohm.
 3. The Minifin heatsink is discussed on page 25 at the top. Its thermal resistance was stated as about 1 degree C per watt. However the calculations were done with the more accurate value 1.3 degree per watt and 0.1 for the insulating washer. The difference is 56 degree
- rise in one case and 44 degree in the other, a significant difference.
4. In second last line in center column page 26 the "4 to 4 amperes" should be "4 to 5 amperes"
 5. Lloyd also told us he had had feedback on his assumption of 1 ohm for ground resistance being too low. Earth mats are usually restricted in size and so higher values are normal. However at the ex VIA site the 150ft mast has a mat of 120 radials each 738ft(225m). AR Oct 1998 has an article on the site. In this case 1 ohm is not unreasonable.
- Thank you Lloyd for supplying these corrections.

ar

Rapid access to WIA News on Web

Since the inception of the WIA Federal web site, WIA News culled from Amateur Radio magazine has been copied to its own monthly page on the web. While it forms a useful web-accessible archive of news, by the time it has appeared on the web site it has in many cases lost some of its currency. In the meantime, many distorted and quite often wildly incorrect versions of the news, from unofficial and often poorly informed sources, have circulated both on Internet and the Amateur packet radio network.

For 2000, we are adopting a new format, where the latest news is added to the web site as it comes to hand throughout the month (with a tip of the hat to Graham Kemp VK4BB and the VK4 Division's "Continuous" news service.

Each month, the news items are archived to a separate page on the site and forwarded for inclusion of the next edition of *Amateur Radio* magazine. This will give Amateurs more rapid access to important news on the Amateur Radio scene, and hopefully reduce the spread of unofficial versions of the news.

Drop Morse test speed to 5 wpm: WIA in VK1

WIA moves towards dropping Morse test speed to 5 wpm The VK1 Division of the WIA has decided, by an overwhelming 5/6 majority to favour the drop of the AOCF Morse-speed requirements to 5 WPM. A lively discussion has now ensued about a possible omission of the Morse code requirement for an HF-type license altogether, which could happen at the next WARC conference. (VK1news via QNEWS)

According to the VK3 Divisional web site in early February, the majority of WIA Divisional Councils support reducing the Morse test speed to 5wpm. VKs 1, 3, 5, and 6 had already declared their support for the change; VKs 2 and 4 "appear to be in agreement", and VK7 branches were still to determine their position at the time of writing this column.

continued next page



Comment

WIA Federal President, Peter Naish VK2BPN

This month I wish to again draw your attention to the important event that will take place in Darwin later this year. During the last week of August, the WIA will host the 2000 meeting of the International Amateur Radio Union (IARU), Region 3. These meetings are held every few years to debate important issues facing the amateur radio service and to make strategic policy decisions, which are aimed at strengthening our hobby. I believe that this is the first time that one of these meetings has been held in Australia.

There are many pressures on the amateur radio service worldwide. These include matters related to the very basis of amateur radio such as the international treaty under which the service is established. One of the most familiar of these is the need for Morse code proficiency, before one is permitted to use the HF bands. Other items for debate include international bandplans, the threat to our spectrum allocations, concern about diminishing numbers of radio amateurs and membership of national amateur radio societies, assistance in establishing amateur radio in emerging nations, requirements for EMC and EMR, and a host of other vital issues. The IARU is the international voice of amateur radio and the WIA is an active member on behalf of all Australian radio amateurs.

Work on preparing for the Darwin meeting has been going on for nearly a year now. The pace is picking up, with most of the administrative matters well in hand. As the host the WIA must ensure that the logistics and the preparations are carefully planned. The WIA is delighted that the Darwin Amateur Radio Club has been able to provide the vital "on-the-ground" support that is needed for an international convention of this

nature. We will be welcoming some 100 delegates from IARU member countries throughout Region 3 that includes much of Asia and the Pacific basin.

The Region 3 meeting is a working activity, with some very serious international debate and argument. To prepare for this member countries submit papers on a range of subjects that concern them. Our delegates have the responsibility of progressing the Australian papers and arguing our case in working groups and plenary sessions. It is very hard work and certainly no holiday!

Just in case you are thinking that all this is fine, nothing needs to be done, let's wait to hear about the results, let me remind you that this meeting is our chance to promote our requirements in the international arena. We need to lead the cause, not merely follow the views of others. To this end, a number of papers on topical issues are being prepared by various WIA technical teams and coordinated through the Federal Council and its IARU Region 3 Coordinator, Grant Willis. It is not too late for you as a member of the WIA to have your say. How do you do this? Well, write to the Federal Council in your Division. This gives him the opportunity to pass your views onto the team for consolidation into the Australian submissions. We are a democratic organisation and we need to reflect the wishes of all Australian radio amateurs. Don't just sit back and let the few do all the work! High calibre persons will represent the WIA in Darwin but they need your support and your inputs. Give them the opportunity to be successful in every respect.

A little closer to the date, we will bring you more details of the Region 3 Meeting and a summary of the items that will be discussed. In the meantime, let's all work on this one to ensure the maximum benefit to our hobby.

ar

2001 - International Year of Volunteers

In November 1997, the United Nations General Assembly proclaimed 2001 as the International Year of Volunteers. To prepare for the year, the United Nations Volunteers programme (UNV) has been designated the international focal point. Aiming at increased recognition, facilitation, networking and promotion of volunteering, the International Year of Volunteers 2001 (IYV) provides a unique opportunity to highlight the achievements of the millions of volunteers worldwide. (I.e., Those people who devote some time of their lives to serving others) and to encourage more people globally to engage in volunteer activity.

For more information about the International Year of Volunteers (2001), visit: <http://www.iyv2001.org/>>

ACA Oks HF Gateways

Will VK6UU, speaking to the VK6 Division of the WIA, has said the Australian Communications Authority (ACA) have agreed in principle to the concept of "HF Gateway" services, subject to certain conditions.

A model licence application is now being prepared for the ACA to consider. (VK6MTS, via QNEWS)

New WIA Members

The WIA bids a warm welcome to the following new members who were entered into the WIA Membership Register during the month of October

MRS B EBBELING
 L21170 MR R O JONES
 L31550 MR R LLOYD
 L50752 MR R A PURVINSKIS
 VK1YL MRS R M WORTHINGTON
 VK2HRM MR R T MACKAY
 VK2HV MR P G HANNA
 VK2KYG MR N J JEFFRIES
 VK2ZAB MR G J MCDONALD
 VK3BT MR W MARTIN
 VK5IK MR I N COUSINS
 VK5OK MR L L ROSSITER
 VK5PGH MR G HUGHES
 VK5WAM MR A J MITCHELL
 VK6HL MR M A LANG
 VK6NJ MR J R COX
 VK6RW MR R O WORTHINGTON
 VK6TB MR T V BLAKEMORE
 VK6WR MR G M SELLEY
 VK6YFD MR M I ARMSTRONG
 VK7HIL MR W A STUBBINGS
 VK7MO MR R MONCUR

Hedy Lamarr actress and inventor: SK

Hedy Lamarr, the sultry, sexy screen star of the 1930s and 1940s who also conceived the frequency-hopping technique now known as spread spectrum, has died. Lamarr was found dead in her suburban Orlando, Florida, home January 19. She was believed to be 86.

Born Hedwig Kiesler in Austria, Lamarr came to the US in 1937 after being signed by MGM. Among her most successful films was the 1949, directed Cecil B. DeMille classic, *Samson and Delilah*.

In her 1992 book *Feminine Ingenuity*, Lamarr described how she came up with the idea of a signaling device for radio-controlled torpedoes that would minimize the danger of detection or jamming by randomly shifting the frequency. She and composer George Antheil developed the concept and received a patent for it in 1942.

The concept was not developed during World War II, but when the patent



expired, Sylvania put the idea to use in satellites. Spread spectrum also has found applications in wireless telephones, military radios, wireless computer links, and Amateur Radio experimentation.

A more detailed version of Lamarr's role in spread spectrum is described in the IEEE book *Spread Spectrum Communications*, published in 1983. (ARRL Special Bulletin number 1, 24 January 2000)

Amateur radio in the movies again

Another major motion picture featuring amateur radio has been released; this time, however, ham radio plays a central role in the movie, in a rather unusual way.

Frequency, starring Dennis Quaid, begins in 1969, as the solar cycle reaches its peak. Intense sunspot activity is causing some unusual effects down here on earth.

Quaid plays Frank Sullivan, a New York fire-fighter that shares with his six year old son Johnny a passion for baseball, rock and roll, and amateur radio.

Thirty years later, at the peak of a new solar cycle, John Sullivan is a homicide detective grieving the loss of his dead father. But the intense solar activity leads to what might be described as "exceptionally rare DX"...

At the time of writing the date for *Frequency's* Australian release is not yet known. In the meantime, check out the *Frequency* web site, which features the detailed storyline and theatrical trailer videos, at www.frequencymovie.com

Other recent movies featuring amateur radio have been *Contact*, starring Jodie Foster, and *Phenomenon*, starring John Travolta.

ACA allows more power for MoonBounce

Peter Naish VK2BPN,
WIA Federal President
and
Richard Murnane, VK2SKY

The ACA has finally released the "Inconsistency Clause" in the Amateur Licence Condition Documents (LCDs), so that High Power Permits can now be issued for Amateur Earth-Moon-Earth (EME) transmissions. The effective date was January 19th, 2000 so amateurs interested in EME communications may apply for a High Power Permit immediately. This is yet another win for Australian radio amateurs and is a further example of the good work performed by the WIA on behalf of all Australian amateurs.

It is expected there will be more good news in the months ahead.

Alan Jordan of the ACA comments: - As a result of the gazettal (on 12 Jan) of the Radiocommunications Licence Conditions (Amateur Licence) Determination No.1 of 1997 Amendment 1999 (No.1) the following provision now applies Section 2 (2)

" However, if a condition in this Determination is inconsistent with a condition specified in the licence, the condition specified in the licence applies."

This would allow the ACA to apply a condition in an Amateur licence that would allow an Amateur to use a higher level of power than that provided for in the

Determination. I understand that this would facilitate EME experimentation. As discussed, such authorisation will be on a justified case by case basis. The Determination also contains the changes necessary for the Olympics and some very minor corrections to emission modes.

ar

The Golden Antenna of Bad Bentheim

Prize winners honoured for their intensive personal and unselfish risks

In Germany there is a town which found its heart for amateur radio. It is Bad Bentheim, directly on the border with the Netherlands.

In 1999 amateur radio enthusiasts from all over Europe met at the German Netherlands Amateur Radio Days (DNAT) for the 31st time. Meanwhile thousands of amateur radio enthusiasts found their way to Bad Bentheim during the last weekend in August.

Since 1982 the presentation of the Golden Antenna of the town of Bad Bentheim has been one of the highlights of the celebrations at the DNAT. Amateur radio enthusiasts from the Netherlands Antilles, Brazil, India, Armenia, Rumania, Hungary, Italy and Belgium, The Netherlands, Switzerland and Germany have previously received this prize. With their amateur radio stations they had all helped people in an emergency

caused by accidents or natural catastrophes. Their health or life was in danger or poverty was looming. All recipients of the prize were honoured for their intensive personal and unselfish risks. They established and maintained radio contact without which urgent humanitarian help would not have been possible.

If you, dear reader, know of any amateur radio enthusiast or group of enthusiasts whose utilisation of technology is connected to humanitarian work, please write to:

The town of Bad Bentheim,
P.O.Box 1452
46445 Bad Bentheim
F.R. of Germany

The Jury evaluating these nominations consists of experienced men and women, such as the President of IARU Region I and President and Chairman of the Dutch and German amateur radio societies.

The town of Bad Bentheim will again invite prize recipients to the 32nd German-Dutch Amateur Radio Days (DRAT) and take over the costs for travel and accommodation.

Do help us with your suggestions showing to the public the importance of amateur radio in an emergency.

Guenter Alsmeier
Mayor of the Town of Bad Bentheim
Bad Bentheim, December 1999

A Portable RF Resistance Measuring Set

Drew Diamond, VK3XU
45 Gatters Rd
Wonga Park, 3115

For antenna work, an SWR meter, or bridge, may be used to measure the degree of mismatch at salient points in a system. But these devices are relatively insensitive, and may require anything from 1 W to 50 W to obtain a meaningful reading.

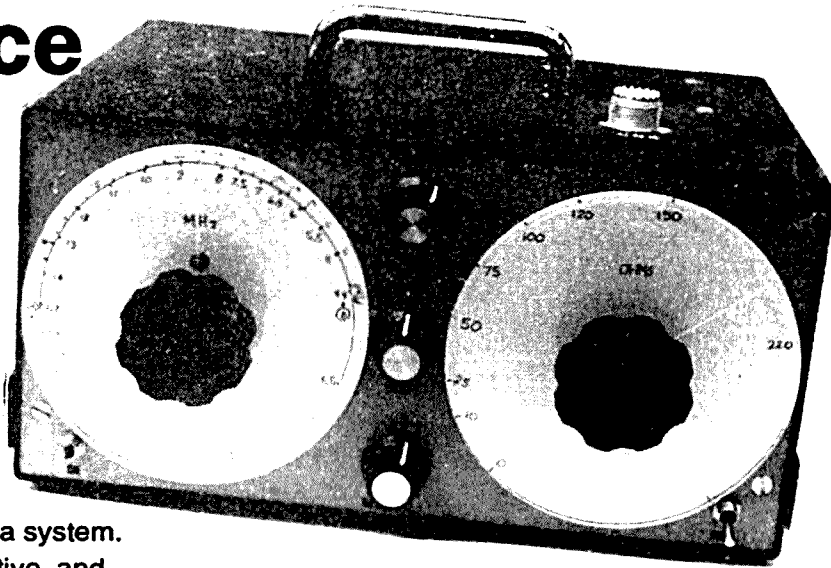


Photo 1: Resistance Measuring Set

The noise bridge an amateur invention (Ref. 1) is better suited to protracted antenna and feedline experiments because impedance readings may be taken at various points in a system using very low power levels. Rather than the traditional laboratory method, which employs a modulated signal generator and straight detector; the noise bridge employs a broadband noise source as signal, and the station receiver serves as tuneable detector in a bridge measurement (Ref. 2).

In practice however, the noise bridge/receiver set may be awkward in some applications, and lacks portability for outside work. So let's look at the "laboratory" method again: The human ear is a very sensitive instrument in radio tests. When making adjustments, it is much easier for us to listen for a null in an audio tone than it is for noise (Ref. 3). By using a tone-modulated RF signal from a generator, rather than noise, we eliminate the need for a sensitive receiver as detector. A simple

diode and audio amplifier has sufficient sensitivity to easily detect a 1 mW signal, and allow adjustment for null in RF impedance measurements (Ref. 4).

Portability is greatly improved by combining the generator, modulator and R-bridge in one reasonably sized box. Something of the sort is now available from one or two of the test equipment makers-but they are rather expensive. It should not be too difficult for an experienced radio worker to make a similar instrument which is capable of reasonable accuracy but at much lower material cost.

In amateur tests, a bridge which measures only the R component may be usefully applied to most measurement problems. We can generally get around the lack of an X (reactance) arm because of our simple desire to have an antenna which presents a matched resistive load, and by reasonable assumption, works most effectively. And this condition is generally satisfied when the antenna is resonant and matched to the transmission line, whose impedance the radio is designed to work into. To us, the value of the X component is usually of academic interest only because, whatever the outcome, it must be eliminated, or reduced to as low a value as reasonably possible. A variation in the generator's frequency allows us to determine whether the antenna is too long, or too short.

To that end, the following portable

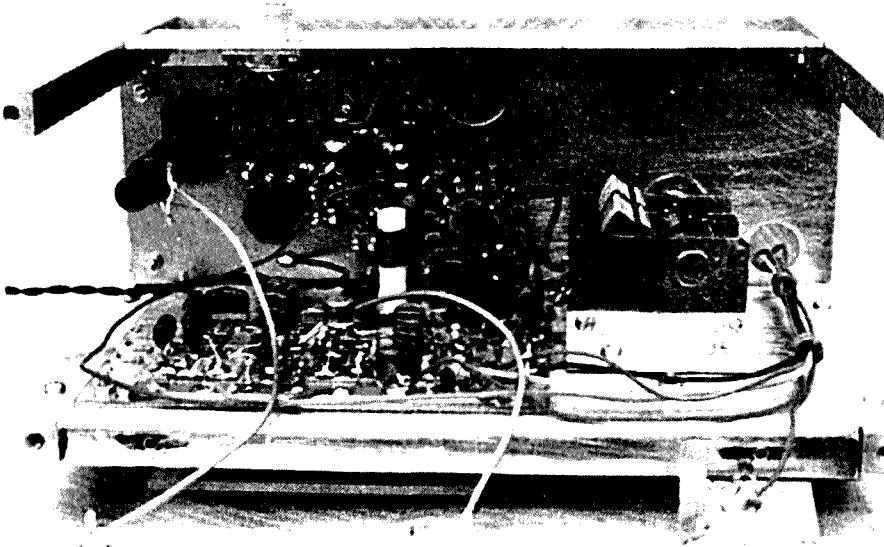


Photo 2: Internal view (rear panel removed for clarity)

measuring set is offered, which may be used to find, with reasonable accuracy;

- the resistance of an antenna feed-point, at resonance,
- velocity factor of RF cables,
- characteristic impedance of RF cables,
- the value of RF input resistance of amplifiers and other devices,
- settings for antenna couplers whilst putting only mW to air, and
- the value of microhenry inductors and pF capacitors.

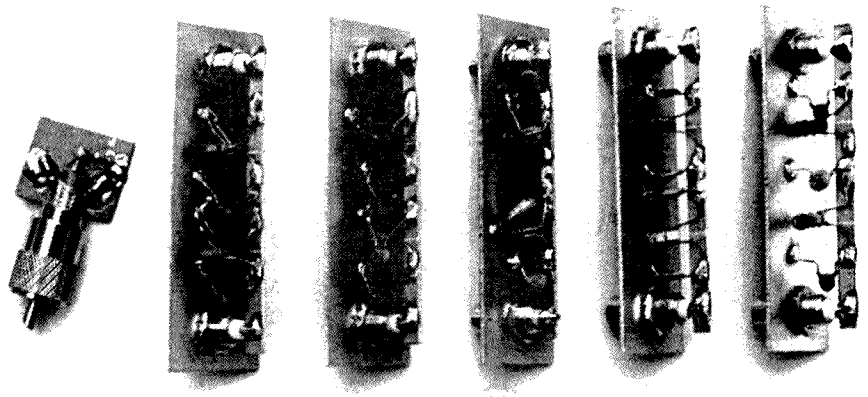


Photo 3: Low pass filters and resistance calibration fixture

Resistance range is 0 to 220 ohms. Internal generator frequency range is from about 1.7 to 31 MHz in three overlapping bands. The bridge may be used with an external generator for measurements between 100 kHz and 60 MHz. Naturally, the internal generator may be applied to other work where such a signal source is required.

Circuit

The measuring circuit is based upon the classic transformer-ratio-arm bridge, where the three identical windings of T4 are connected in trifilar form as shown in the schematic. Two windings are connected in series to create a tightly-coupled source with a neutral wire formed by the centre tap (ct). The signal voltage available at top and bottom windings are therefore identical in

value, and opposite in phase. A diode detector is connected between neutral and chassis ground.

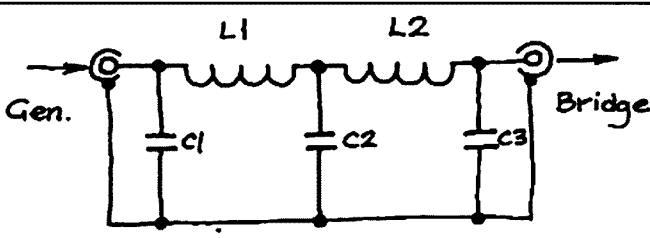
An AM tone-modulated RF signal of a few mW is applied, via balun T3, to the primary winding of T4. The balun is necessary to preserve capacitive balance between the ends of the secondary winding and ground. The bridge will be "in balance" when the value of the non-inductive variable dial resistor is adjusted to exactly equal the resistance applied to the "unknown" connector. Under balanced state, there will be no signal for detection at the neutral point. However, when either the Unk. or dial resistance's differ, balance is disturbed, and a signal is created whose

amplitude is proportional to the degree of imbalance. The detected audio tone, via a 10k sensitivity pot., is presented to a conventional LM386 audio amplifier and miniature speaker.

Operationally, if the impedance connected at Unk. is in the 0 to 220 ohm range, and predominantly resistive, an audible "null" is produced when the dial resistance is adjusted to match that at Unk. Should there be some reactance present, the null will be less pronounced. The generator may be varied in frequency together with the R- dial to obtain a deeper null. More under "Operation" below.

A Colpitts oscillator maintained by an MPF102 FET supplies the test signal from 1.7 to 31 MHz in three bands. Generator signal at the drain is loosely coupled to gate 1 of the BFR84 dual-gate FET buffer amplifier. Generator amplitude is adjusted by varying the voltage applied to gate 2. A 2 V peak-to-peak 1 kHz sine-wave signal from a simple phase-shift modulation oscillator may also be applied to G2 to obtain amplitude modulation of the generator signal. A 2N3053 broadband amplifier raises the signal to a suitable level between about 1 and 10 mW. The 3 dB attenuator is included to establish the generator's output impedance at close to 50 ohms.

The generator output is reasonably sinusoidal, but harmonics are still of sufficient amplitude to spoil the null when measuring frequency sensitive devices (such as an antenna feed-point). The depth of the null is greatly improved by passing the generator signal through an appropriate 5-element low-pass filter before it is applied to the bridge. A set of plug-in filters with roll-offs of 2, 4, 8, 16 and 32 MHz covers the HF spectrum.



Roll-off MHz	C1, C3	C2	L1, L2	~ comprising:
2	2n	4n	4.7µH	stock R.F.C.
4	1n	2n	2.2µH	" "
8	220+220p	820p	1µH	" "
16	220p	220+220p	0.5µH	10t .5 mm ecw on Amidon T37-6.
32	100p	220p	0.3µH	7t .5 mm ecw on Amidon T37-6.

Low-pass Filter Set.

Table 1

continued next page

Construction

The prototype is housed in a home made aluminium box measuring 220 x 150 x 110 mm WHD. Naturally, any metal box of similar dimensions will do. The generator components are accommodated "paddyboard" style (Ref. 7) upon a plain circuit board measuring 100 x 120 mm. The bridge and audio amp. are mounted on a second board measuring 90 x 70 mm. Use reasonably short connections, especially the generator and bridge components. The LM386 may be fitted into a wire-wrap socket, which in turn is mounted "paddyboard" fashion upon the board. The circuit boards may be fixed with 3 mm screws upon a "sub-chassis" as shown in Photo 2.

Balun T3 is very similar to that described previously in Ref. 6. Wind 9 turns (total 27) of 1 mm ecw trifilar onto a 50 mm length of ordinary loopstick rod. Winding starts are the dotted numbers (1. 2. 3.). Note that the start of winding 3 is connected to the end of winding 1, and the end of winding 3 is connected to start winding 2. The balun should then be encased in epoxy cement. Upon assembly, the balun should be cemented into a drilled phenolic or perspex base, which in turn is cemented to the bridge board, as shown in Photo 2.

Bridge transformer T4 has 10 loops of 24 B&S EC wire trifilar wound upon an Amidon FT50-43A core. Make sure the wires are not scratched during winding. Remove about 20 mm enamel from each wire. Using your multimeter on ohms, identify the individual windings. Now connect the start of one winding to the end of another to form the centre tap. The remaining "free" winding is the left-hand primary side shown in the circuit.

To obtain good frequency and resistance resolution, the dials must be as large as can reasonably be managed. Mine are white undercoat spray-painted aluminium discs measuring 100 mm diameter, thus taking the full height of the box. The 250 ohm carbon pot is mounted upon the sub-chassis, with a flexible coupler attached. The perspex cursor is affixed to the back of a suitable knob as shown in Photos 1 and 5. The cursor for the frequency dial is attached to a 6:1 planetary drive, which in turn is flexible-coupled to the variable capacitor spindle. The dial disc components may be produced in the chuck of an ordinary electric drill. Compass, then cut out your aluminium and perspex discs using a rod-

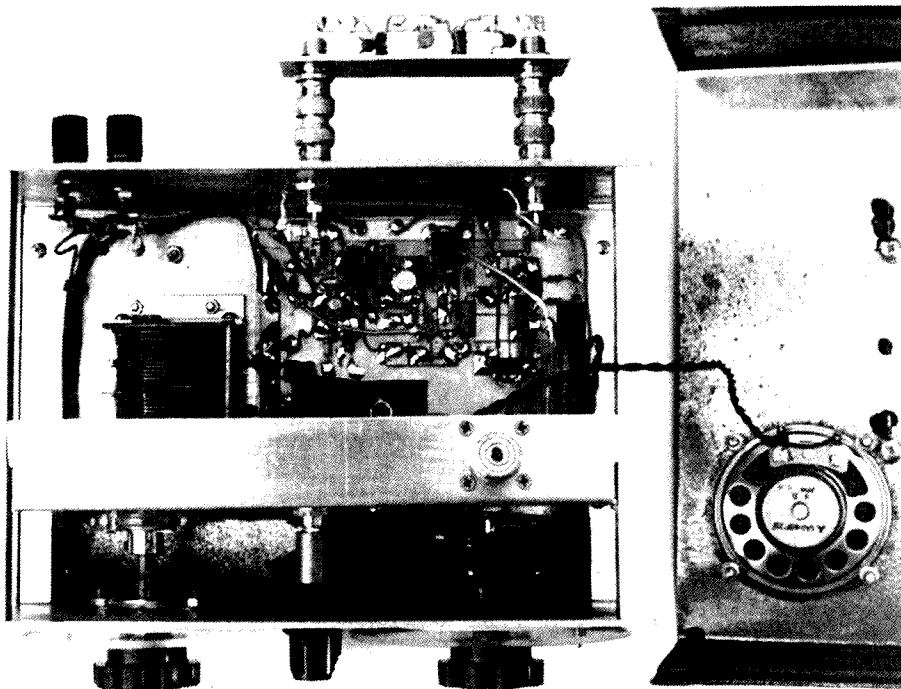


Photo 4: Plan view, top cover set aside

saw or similar. Drill a 1/4" hole dead centre of each. Take a 1/4" Wh. bolt, about 2" length, and cut off the head. Fix the disc in this "chucking piece" using a pair of nuts and washers. Mount the drill in your bench vice. Carefully apply a flat file to the outer edge of the rotating disc to obtain a smooth round finish.

The dual-gang variable capacitor for the generator is not a stock part. However, they are by no means rare items, and can be found at swap-meets, traded with radio friends etc. Measurements upon a number of caps removed from junked Australian BC radios showed that values of between 450 and 480 pF per gang is typical (until I actually measured a number of these, I had assumed that 415 pF was more common). So any well-made dual-gang of 450 or 500 pF will do.

Coils for the generator should be epoxy-cemented upon insulated material, such as phenolic. The frequency range switch is mounted just above the coils to permit wiring with short leads. Range coil A (1.7 to 5.5 MHz) is wound on a T68-1 core, and range B (4.5 to 14 MHz) on a T68-2 core. Only a small inductance is required for range C (10 to 31 MHz), which is wound upon an 8 mm plastic pen barrel. For best stability, build the generator according to VFO rules. Turns details are shown on the circuit.

A suggested construction method for the

low-pass filter set is shown in Photos 3 and 4. 100 x 30 mm rectangles of single-sided circuit board are each fitted with BNC sockets spaced about 75 mm (to match sockets mounted upon the rear panel of the box). An 80 x 7 mm strip of board is divided into three equal "lands" with a junior hacksaw by grooving the copper foil in two places. Filter circuit values are shown in table I. The 2, 4 and 8 MHz filters use stock choke coils as shown. The 16 and 32 MHz filters use coils wound on T37-6 cores. Solder capacitors between lands and ground foil, and coils across the grooves.

Current demand is about 40 mA. The set will work satisfactorily from a battery supply of between about 8 and 12 V. I plan to get a lot of use out of my own model, so have incorporated a 9.6 V radio-control model Ni-Cd battery (D.S. S-3313) sandwiched between perspex sheets, into the space below the sub-chassis as shown in photo 5. Or your battery may be fixed to a holder external to the box, depending on operational preference.

Calibration

Before applying power, go over your wiring and component polarities again and confirm that all is correct. Leave the gen./bridge RF input link (which is made via an LPF or short coax) open for the moment. Switch on. Full clockwise rotation of the

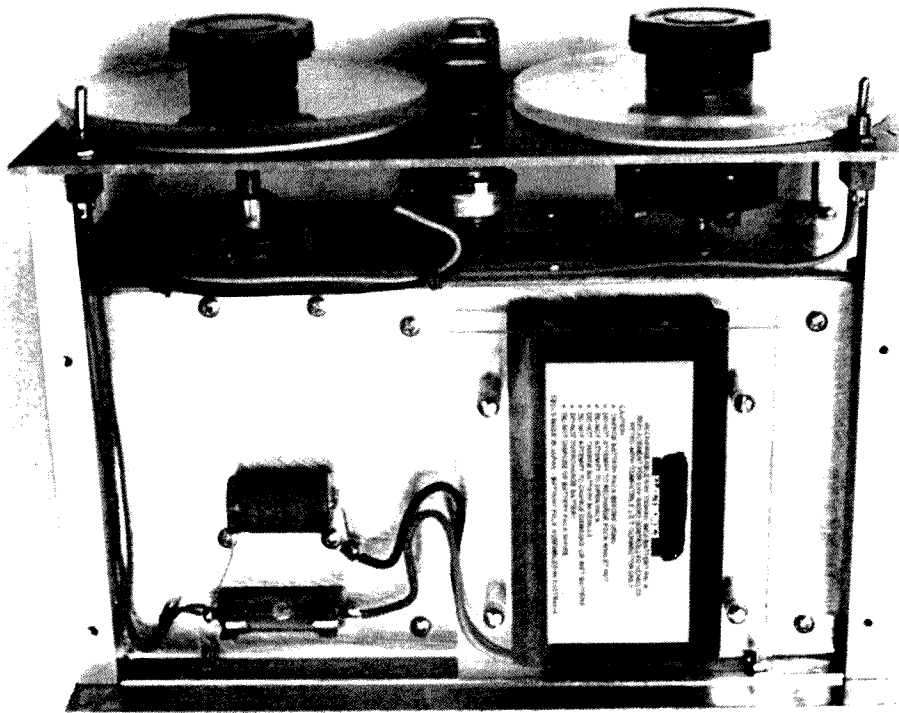


Photo 5: Underside battery compartment

continued from previous page

gain pot should produce a just a soft hiss from the speaker.

If an oscilloscope is available (of at least 30 MHz BW), connect a coax cable between the generator output and 50 ohm thru-terminated o'scope input. Confirm that at least 1.5 V peak to peak (p-p) is output when the generator is tuned through each range. Check that the level control affects a smooth variation in output from about 0.5 V to 1.5 V p-p. Set the level for about mid range, then switch the mod. osc. on. You should observe a 1 kHz modulated RF waveform of about 50 %. Best looking shape and depth should occur at about mid-travel of the level pot.

No o'scope? Connect an RF probe and 10 megohm DMM to the gen. output, which is terminated in 50 ohms. Output should be at least 0.7 V. Listen to the gen. signal on your station receiver in AM mode. Switch on the mod. osc. You should hear a stable pure tone, about 1 kHz. Check frequency range(s) with the means available to you, be it electronic counter, or general coverage receiver, and if satisfactory, calibrate the gen. dial. Pencil salient points around the perimeter first, then remove the knob/cursor and apply calibrations to a circle compassed upon the dial disc using a fine black pencil or rub-on letters. Apply a coat of clear lacquer.

With the gen. working and calibrated, link the output to the RF input connector of the bridge using (say) the 16 MHz LPF. Obtain a set of 1/4 W, 1 or 2% resistors of 10R, 100R (4-off, to make 50, 100 and 25 ohms), 120R, 150R (2-off, to make 150 and 75 ohms), and 220R. Suggested calibration points are 10, 25, 50, 75, 100, 120, 150 and 220 ohms. Starting with the most popular impedance; 50 ohms, take two 100R resistors and solder them to a PL-259 (or whatever you prefer) plug, to which is attached a small square of circuit board, as shown with the filter set in Photo 4. Set the gen. to mid HF, say 14 MHz at about 2 mW (mid-point of the level pot). Switch the internal AM on. You will hear a tone. Carefully adjust the resistance dial for a null, which should be deep and quite sharp. With a pencil, mark this 50 ohm cal. point. Do the same for all other desired cal. points between 0 and 220 ohms. The null at the high resistance end may not be as sharp as those obtained at the low end.

Operation

The bridge finds primary application in antenna work. If physically possible, the feed-point of the antenna is connected to directly to Unk. Sweep the R dial around the nominal impedance whilst listening for a null. Also adjust the generator frequency

for deepest null, then read off the resistance and resonant frequency. Let's suppose we want a ground plane with four sloping radials be resonant at 14.1 MHz and present 50 ohms, but we read 40 ohms and 14.0 MHz. It's too long. Shorten each element a bit and measure frequency again. We could raise the impedance a little by increasing the angle of radial slope, and measure again. Check for inter-action between variables.

It's easy with a ground plane, because we can generally get at the feed point. What do we do with a more remote feed point? "Use an electrical half-wave (or multiple thereof) of low-loss coax feed-line" blithely say's the radio handbooks. To do that we need to know the velocity factor (v) of the cable so that we can be sure of the electrical length. If the velocity factor is known then;

Electrical 1/2 wavelength in metres = v multiplied by (150 divided by f MHz).

For example, the coax maker gives v as 0.66, and we want 1/2 wave at 14.1 MHz, then; length = 0.66 X (150 divided by 14.1), which gives 7.02 m.

Before we go cutting up lengths of precious cable, we can measure the (v) of a sample. Connect one end of a sample length (say 6 m) of cable to Unk. Short circuit the far end (perhaps with an alligator clip). Set the R dial near zero (because zero ohms will be reflected over exactly 1/2 wavelength). Sweep the generator down from 30 MHz looking for the lowest frequency which produces a good null. Note the frequency. Calculate;

Velocity factor = (length m multiplied by f MHz) divided by 150.

For example; a 6 m sample length of coax has lowest null at exactly 16.5 MHz, then; v = (6 X 16.5) divided by 150, which gives 0.66.

Let's say at a hamfest you buy, at bargain price, a mystery coil of coax cable. The person who sold it to you "thinks" it is 50 ohm, but no one is sure. How to measure the characteristic impedance (Zo)? If it is very long, cut off a 3 or 4 metre sample length. Connect one end to Unk using a suitable plug. Solder a miniature 220 ohm carbon trimpot, between one side and slider, to the far end. Set the gen. initially to about 30 MHz and R-dial to the supposed impedance of the coax. Repeatedly adjust gen. frequency, R-dial and trimpot until the null is held constant, regardless of frequency. The value of the trimpot's resistance will then equal the Zo of your cable, which is also shown by the R-dial. The same method may be used to find the Zo of any reasonable length of cable, both coax and twin pair.

To find the value of an unknown microhenry coil; connect the coil IN SERIES with a (say) 100 pF mica capacitor across the Unk connector. Set the R dial to about 10 ohms. Vary the generator frequency and R dial until best null is obtained. Note the frequency. The value of the coil, in microhenries (uH) may be calculated:

$LuH = 25330 \text{ divided by } (f \text{ MHz squared} \times 100 \text{ pF}).$

Similarly, when frequency and inductance are known;

$CpF = 25330 \text{ divided by } (f \text{ MHz squared} \times LuH).$

To adjust an ASTU (or antenna coupler); replace the usual radio coax connection with Unk of the bridge. Set the R dial to your coax impedance (typically 50 ohms). Set the gen. to the required frequency. Now carefully adjust the ASTU, listening for a deep null in tone, then note the settings for each band of interest.

When working with large antennas, you

may hear broadcast stations mixed with the tone (the detector acting as an un-tuned crystal set). Simply ignore the babble and concentrate on the tone, which may be nulled in the normal way.

Parts

The 250R carbon pot (carbonized plastic track- or "Cermet"), Spectrol P/N 350-497, is known to be available from Farnell (02 9645 8888). A similar type is also available from Rockby Electronics (03 9562 8559), where the Cat. number is RB51X250R. Cost is about \$6. See Hamads for Amidon core retailers. The BFR84 is a Dick Smith (D.S.) part. D. S., Jaycar and Electronics World have loopsick rod material for the balun (shorten by grinding a groove around the circumference then snap, as you would break a stick). Quite good flexible couplers may be made from 30 mm lengths of 6.5 mm i.d. rubber fuel hose held captive with hose clips. The remaining parts are available from the usual electronics suppliers.

References and Further Reading:

1. "The Antenna Noise Bridge", Hart, W5QJR, QST, Dec. '67.
2. "A Review of Antenna Noise Bridges", Slutzkin, VK3SK, AR, Mar. Apr. May '81.
3. "A Few Tips On the Design of the Noise Bridge"; Butler, VK5BR, AR Feb. '90.
4. "An RF Resistance Bridge"; Diamond, AR, July '99.
5. "Another Tip For Using the Noise Bridge"; Butler, VK5BR, AR Dec. '94.
6. "A Home-brew HF Balun". Diamond, AR, Oct '97.
7. "Paddyboard Circuit Construction", Diamond, AR, Feb. '95.

ar

EDUCATION

Brenda M Edmonds, VK3KT
PO Box 445, BLACKBURN 3130

What does an incoming amateur need to know?

At this time of the year I am thinking about the annual report of the Education Co-ordinator to the Federal Council. As our financial year runs from 1st January to 31st December, I must report on my activities and achievements during that period.

It has been a very quiet year, most of it having been spent waiting for action from the ACA. We have achieved another set of approved Regulations examination papers, but the ACA seems to have had little time to consider the future of the Amateur Service. We were promised a discussion paper about the further devolvement of examinations, but this has now been delayed until early this year. Consequently, our plans for revision of the examination syllabuses have had to be postponed also.

I have written previously about the need to review the syllabuses. The current syllabuses have lost their relevance as the "state of the art" has progressed. The last major review occurred in about 1984,

before the development and widespread usage of so many "chips". At that time there were still amateurs building and designing equipment from discrete components using resonance nomograms and similar tables to determine the values of components to use. The knowledge that was appropriate at that stage is no longer relevant when a transmitter can be built from a handful of integrated circuits, and the internal functioning of the IC is masked.

So what does an incoming amateur need to know? Some of the basic principles still apply.

Antenna design and function are still with us, as is propagation at all permitted frequencies. It is vitally important to be aware of the possibilities of interference and the steps to be taken to avoid or control it.

Safe operation of both the home station and in the portable/mobile situation must be considered. Some awareness of the use of basic test instruments should be included so

that simple troubleshooting can be carried out. Transmitter and receiver design could probably be reduced to block diagram level, with a knowledge of the inputs and outputs of each stage.

Please be aware that these ideas are largely my own, not those of the Federal WIA or the Education Committee. They have been discussed only very superficially with the ACA. But when the time comes for reviewing the syllabuses I intend to advance them. I will be happy to receive comments from readers on any aspect of syllabus review.

On a slightly different topic, it was pleasing to see the increased demands on WIA Exam Service at the end of the year. It suggests that there are many classes out there operating to advantage. May I wish all this year's classes a successful and profitable 2000.

ar

VK9RS

“Rowley Shoals”



IMPERIEUSE REEF
OC.230

IOTA DXpedition

By Stephen Pall. VK2PS.

The charter boat was slowly approaching Imperieuse Reef. The 900 H.P. twin-screw engines of “Kingfisher III”, the 17 metre long game fishing boat, throttled down from normal cruising speed of 22 knots to 10 knots.

All of the team were on deck, looking apprehensively at a slim, white sand line, barely visible in front of us - at a distance of about 3 kilometres. The white sand line was Cunningham Island a longitudinal sand cay. (170 31' 31" South, 118o 56' 46" East). The island appears much smaller compared to some old photos that were seen previously. There are no trees, shrubs or grass, just gleaming white coral sand. Only a man-made stainless steel lighthouse breaks the line of sand similar to a freestanding rocket, about 40 metres in height that glittered in the sun. The lighthouse is situated on the northwestern side of this small island, about 200 metres away from our landing point, standing in the sea on the edge of a narrow rocky lagoon.

IT WAS EARLY MORNING local time on the 21st of September 1999. The charter boat has dropped anchor just outside the reef and the loading of almost 2.5 tonnes of equipment into two 4.5m aluminium dinghies has begun. It took the two dinghies seven trips across the vivid green waters of the shallow coral reef lagoon, to land the equipment on the island. Fortunately the waters of the lagoon were very calm and crystal clear, so no mishaps occurred. It is now 2340 UTC (0740 am), we are on a narrow beach with mountains of bags, cables, waterproof boxes, generators, tent poles, tents packed in bags, disassembled aluminium tubes belonging to a variety of antennas, drums of fuel and barrels of drinking water.

The aluminium dinghies have departed - the charter boat is now only a small dot on the horizon and we are alone, no other sound except our own. The weather was fine, blue skies, no clouds and, surrounded by the green-azure waters of the lagoon. A merciless blinding sun shone on us. The air was heavy with moisture.

Four radio amateurs facing the unknown on a tiny speck of sand, filled with the zeal of missionaries to activate amateur radio for the first time on a little island which is off limits unless one has a special landing permit.

The Rowley Shoals are located in the Indian Ocean in the tropical far north of Western Australia. They are large emergent shelf atolls rising from depths of between 440 and 230 metres along the edge of the continental shelf. They lie between 300 to 379 kilometres due west of Broome, a

tropical town, home of the largest salt-water crocodiles and center of a large cultured pearling industry. Broome has a moving population of 12,000 and it is very busy this time of the year. Big offshore game fishing and casual holidaymaking is in progress and accommodations are booked out 12 months in advance. The Shoals are ranked as one of the most remote and pristine marine areas in the world, and are part of a great Marine Park established in 1990. It is managed by the West Australian Department of Conservation and Land Management, (CALM). At low tide the water forms ponds within reef walls, gushing over them like waterfalls and our little island is only 1.5 metres above the high-water mark.

The Rowley Shoals consist of three atolls. We are on the most southern, "Imperieuse Reef", that is approximately 18 kilometres long and 10 kilometres wide. The only semi-permanent land in the atoll is Cunningham Island at the northern end of the reef.

Captain Rowley named Imperieuse Reef after his sailing ship in 1800. The island itself changes shape and size often due to the seasonal cyclones, which can be very severe sometimes.

The lighthouse, which now stands in water, was originally built in the centre of the moving island.

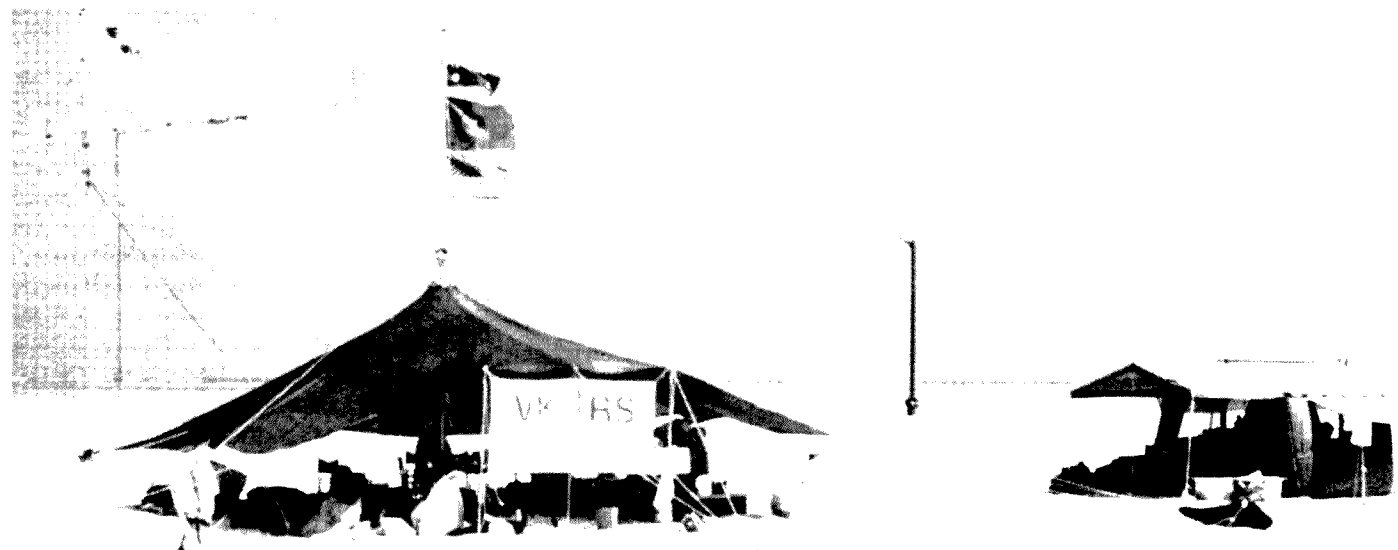
After a 20 hour sea voyage from Broome, luckily for us on a very smooth sea, we gradually haul our DX cargo from the beach, bit by bit, to the middle of the little sand island. Our immediate aim and is to establish our shaded area and this was a large tent-like, square structure that could

be raise and lowered, made of green 90% shade cloth.

The tent was over two metres in height and 7.5 metres square with open sides. This was our home!! The "Rowley's Cafe". Originally there had been plans for two tents, one for the SSB station, one for the CW station, and individual small tents for each of us. Due to the intense heat these plans were changed. Only one tent was erected for the SSB stations and the CW station was squeezed onto a small table in "Rowley's Cafe", which became a combined sleeping, recreational and storage area. In one corner a field gas burner represented the kitchen and meals area.

We had a short flag raising ceremony at 0430 UTC, or just after noon local time the flags of Australia, Portugal and the United States of America fluttered in the breeze, whispering to our silent friends. We continued with the installation of the 20 metre 4 square antenna. With a temperature of 40o plus Celsius in the open, only 20 minutes of work in the sun was followed by a short pause in the tent, where the 32° C in the shade was a welcome relief. The level in our individual 20 litre drinking water barrels started to recede, we were sweating and feeling dehydrated. In addition one of the team was still suffering the effects of a food poisoning bug which he picked up a few days before our departure. All three generators were now working and the chemical portable toilet was in place. The afternoon was spent on laying power and transmitting cables and the shape of the vertical Butternut antenna started to emerge

continued next page



"Rowley's Cafe" and SSB Tent

A thumbnail sketch of the participants.

SAM, CT1EEN

was the youngest in the group, in his early 30's. Sam is a builder who graduated from CB radio. He has had his amateur licence for nine years and after chasing DX soon became an "island hopper" from a variety of Portuguese and Spanish islands, and also Cape Verde D44. Sam flew into Perth via Frankfurt and Singapore, and traveled with Mai from Perth to Broome, a distance of 2232 kilometres. During the road-trip they changed vehicles at Karratha, upgrading from a sedan car and one tonne trailer to a 4 wheel drive and two tonne trailer. Four heavy duty tyres were ruined on the trip from Perth due to road conditions. When I asked Sam what was his most memorable event on the trip to Broome he listed kangaroos kissing the front of the vehicle, the closed roadhouse which meant slowing down to conserve fuel and the innumerable occasions when tonnes of equipment were loaded and unloaded from trailer, storage places, up steps and down steps. According to my calculations the equipment was moved 23 times on the return journey from Perth - Broome - Perth.

JIM, K9PPY

our SSB/CW operator is a professional mechanical engineer and comes from the small town of Itasca, near Chicago, Illinois, USA. He is in his early 50's and a keen supporter of IOTA. He has operated from many American and Canadian islands, and also from Sirat-Al-Kaywar an

IOTA island in the Gulf of Oman as A61AH. He was 16 years old when he started listening on short wave on a simple set bought by his father. For a number of years he was chasing DX, and then in 1989 was introduced to IOTA by a radio amateur friend of his. He now has approximately 870 islands confirmed. Jim arrived in Broome via Los Angeles, Sydney and Darwin. He was disappointed when he was unable to have a short stopover in Darwin due to sudden changes in plane schedules.

MAL, VK6LC

is a professional electrical design engineer, also in his early 50's. He is the "total" DXpeditioner. He has had his amateur licence for 16 years and started activating many Australian and overseas islands about 11 years ago. Malcolm has an excellent record as an IOTA DXpeditioner and has activated 22 Islands establishing 11 brand new references. His self-designed 20 and 40 metre vertical 4 square antennas have never let him down. Much of the auxiliary equipment on this expedition was designed or manufactured by Mai, including the 56 square metre "Rowley's Cafe" tent. He was the organizer, designer, antenna assembler, chief mover of equipment, security, Medic, generator attendant and manager for the group. He even made some time between sleep periods to operate on SSB as a duty operator. Mai's words after the operation: No accidents, No equipment failures, I've

done my job!! We are all back in one piece??? Time for a cold Beer!!

STEVE, VK2PS

in his late 70's, flew in from Sydney via Perth. He is a retired insurance broker and a keen DX-er. For almost 10 years he was the DX.Editor of the national magazine of the Wireless Institute of Australia, "Amateur Radio". Steve's amateur activity started in 1938 in Europe when he was a 16 year old high-school student. He re-activated his amateur life in 1979 and was always a keen supporter of Mai's island activities. This expedition was his life's dream come true and was a good introduction for future IOTA activities. Steve likes to operate in CW mode, and according to Mai this was one of the few IOTA expeditions where operating CW made a good contribution to the overall number of QSOs.

As we all know, DXpeditions to the remote parts of the globe cost money and despite the mandatory personal contributions by the operating participants, outside help in sponsorship and donations is needed.

This was the most expensive DXpedition for Mai, as previous ones were financed mostly from Mai's private resources. Despite careful costing the final budget of the DXpedition came out at US\$15000 (about A\$24000), due to a lot of unexpected expenses. Mai's friendly bank manager is not in a good mood.

of the expedition, Malcolm VK6LC from Perth. Michael, VK6BHY from Karratha provided the 80 metre support link with the mainland. When we left Broome there were only four of us as Dave VK6DLB had dropped out due to ill health. The reduction in manpower meant that the physical work involved in setting up increased for the rest of the expeditioners, delaying the early on-air schedule.

Contacts

At the end of our activity the expedition had approximately 10800 contacts in the logs with seven continents, 132 DX entities and 165 islands. All this was achieved in four 24 hour days i.e. 96 on-air-hours on the following bands: 80 - 40 - 20 - 17 - 15 - 12 and 10 metre bands.

Most of the operation was in SSB mode but over 1000 contacts were made on CW.

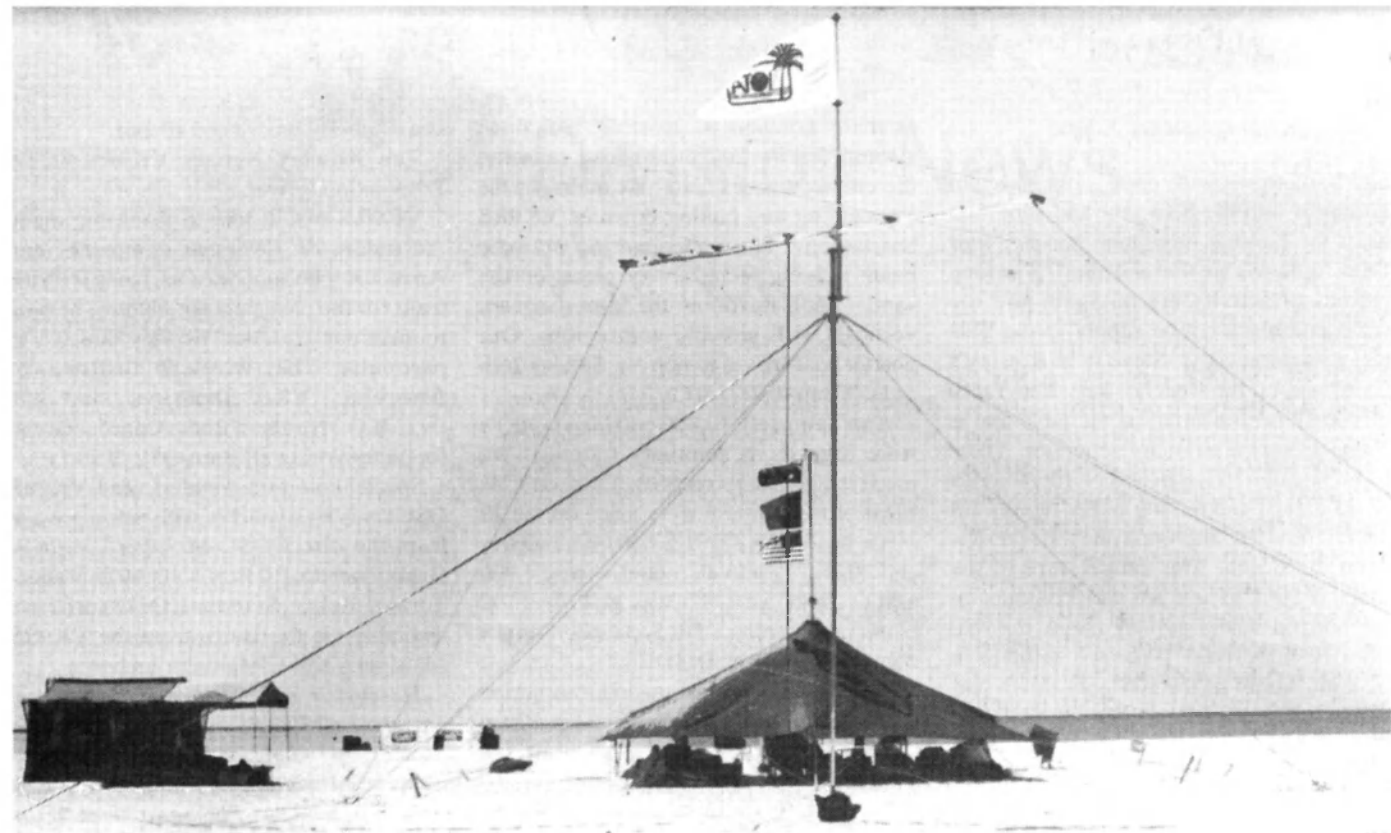
There was only a minimal activity on 40 metres because we were all worn out and down one operator. Jim and Sam made most of the contacts and Mai contributed to the numbers when his other duties allowed. Our 100 watt CW operation started on the 22nd September with intermittent activity depending on availability of antennas. We had a 4 square vertical system for 20m, an Australian six element log periodic for the higher bands, a multiband Butternut antenna and three transceivers. These were all backed up by a 100% redundancy AC/DC power system.

The 4th station was set up with 2 commercial radios used for medical emergency (VZBOI) and ship to shore liaison with the charter vessel.

continued from previous page

from the evening dusk. The length of the dusk in the tropics is very short and at 1810 local time it was pitch dark. The great moment finally arrived after 12 hours and Rowley Shoals, VK9RS was on the air. The first contact was made with KDICT on the 20 metre band at 1139 UTC. Floodlights, brought with us, came into action to complete the remaining setup and at midnight local time - after the hard work we were all ready.

Originally the team consisted of 5 expeditioners. Sam, CT1EEN from Massama Portugal, Jim K9PPY from Itasca Illinois, USA, Dave VK6DLB from Karratha, Western Australia, Steve VK2PS from Sydney and the organizer and leader



"Rowley's Cafe" and SSB Tent: another view

A Typical Day

Here is a typical 24 hour day from our lives on the island:

I wake up, and stare at the shade cloth above me. There is an absolute silence; the SSB tent is quiet. It is 05.30 am. It is dawn but the sun is not up yet. There is a medium breeze from the southwest. The breeze is our natural airconditioner and the usual daytime temperature of our tent is 30-32°C. It is now a very pleasant 23° C. I can hear the fluttering of the national flags above me, on the main mast of the tent. As I turn around, I notice that there is a light dew on everything. The air was full of moisture during the night with the result that everything is now moist. It is now 06.10 am and the sun is up, moving rapidly on the eastern sky. The bluish haze on the horizon dissolves and the water in the lagoon turns a vivid green-azure blue with reflections of bright yellow from the sun, the tide is coming in. Sam and Jim are asleep wrapped up in their sleeping bags as protection against flying sand and bright daylight. They are very tired, and went to bed about 3 hours ago, (1900 UTC) when propagation ceased towards Europe and North America. Malcolm and I are sharing a king-size air mattress, as mine attracted a loose fishing

hook during the sea voyage, and the temporary repair did not work. I switch the electric kettle on; power is supplied by our small reserve generator, and look into the portable refrigerator and our storage bins for something to eat. Meals are taken when there is no propagation. All our bread became mouldy and useless from the high humidity by Wednesday morning, so there was no need for breakfast cooking. Some canned fruit, breakfast cereal and specially prepared milk and coffee was quite an adequate breakfast.

The cool breeze has stopped, there is now a warm breeze from the east and the temperature is rising in Rowley's Cafe. At 09.00 am it is now 30° C. I walk 50 paces down to the lagoon for my morning swim. The water is very salty and warm. One would want to spend hours in this water but it is not possible. The heat affects us and the reflected light on the coral sand of the beach is blinding. We have to be constantly alert for stings from floating sea wasps (a type of box jellyfish) and possible mishaps from deadly sea snakes. We try to avoid stepping on spiky rockfish and wear special reef shoes to avoid cuts or scratches, which could result in coral poisoning.

Mal gets up, does his regular intruder watch, refuels the generators and checks all

the equipment and antennas that have been operating continuously without any failures.

It is getting towards midday, the bands are dead. Jim and Sam are now up and we all compare notes from last night's activity. We discuss bands, the number of islands worked, the number of contacts, and daily reports from our pilot stations. Jim is looking after the Americas. Sam is trying to cover Europe and "keep some volatile southern Europeans" in order.

With my limited CW operation, I use the "first come first served method". Here I am, fighting my way through endless barrages of stations, dog-piles that never seem to end. In the background I hear a loud vibration from Mal: "The pilots have requested more CW"!!

Today was a happy day. Unexpected visitors? The charter fishing boat "Kingfisher III" reappeared on the horizon and tells us, on our special commercial marine transceiver, that they had a very successful side trip of deep sea game fishing. They will send over a large coral trout and a bag of ice to be melted down for cold drinking water. This was the first and last time we did any serious cooking. The fish tasted wonderful - maybe we were hungry too. Mal checks the bands and calls

continued next page

continued from previous page

out"10 metres is wide open", Jim and Sam disappear into the SSB tent and soon one hears the familiar monotone noises: "four Delta Lima you are five and nine". The long periods of activity are on again and the water and black coffee supply to the SSB tent gets under way. Steve is in Rowley's Cafe" and on the Bencher key. The Yacsu FT900AT is on a small picnic table and is connected to the auxiliary generator. There is propagation to Japan and North America on 15 metres and the log pages rapidly fill up. It is now late afternoon and the breeze is from the South. The temperature in the shade is 26° C. There are dark contours on the horizon where the sky meets the sea. Shortly after 6.00 p.m. we witness a majestic sunset as the sun goes down and within 10 minutes there is total darkness. Everybody is now on the air. Malcolm is using my station, so I catch up with my notes. Tomorrow is the last day of our activity.

Saturday, 25th of September. The good weather is still holding but the breeze is getting stronger, and I see a few small tufts of cloud on the horizon. Last night we finished with about 8900 QSO's, most of

as many contacts as possible. All three stations are working at overload capacity; the coffeepot goes cold. At midnight the dismantling and pulling down of VK9RS has begun. The 6 element log periodic beam is lying already very proud on the sand. Soon to follow the 20m 4 square verticals, still glowing with corona. Our charter boat arrives tomorrow, Sunday 26th at 11.00 am (0300 UTC).

Approximately 10,800 combined QSO's were logged. A summary follows: -We made 9,400 QSO's on SSB, 1,400 on CW. Most of the contacts were made on the 20 metre band with 4,050, 3,850 on 15 metres and 10, 12, 17 and 80 metres shared 2,900 QSO's. The last QSO was at 1741 UTC hours on Saturday, 25th September, on the 20 metre band with IK4DRR.

Everything is packed up and transported to the beach, ready to go. Time for a final swim and prepare for the 24 hour sea voyage back to Broome.

Its Sunday morning - still beautiful weather. It is high tide and the two dinghies are busy, ferrying our equipment and ourselves to the anchored charter boat well outside the reef. The beach on Cunningham Island is now deserted, empty, clean and pristine again. Our footsteps in the sand are

is a southerly breeze and silence.

The Rowley Shoals VK9RS IOTA DXpedition is over...

VK9RS would like to thank the many Australian & Overseas companies and Amateurs who supported us, being with the team for the past eighteen months, helping to meet our goal, the "Rowley Shoals", in particular The Wireless Institute of Australia, VK6 Division, and the (N.C.R.G.) Northern Radio Corridor Group for underwriting all Buro QSL cards.

Special coloured double folded VK9RS QSL cards are available with return postage from the direct QSL Manager. I1HYW Gianni Varetto, P.O. Box 1, 10060 Pancalieri, Torino, Italy. Standard QSL cards are available via the Buro, from the VK9RS Manager VK6LC Malcolm Johnson.

This article is the intellectual property of Stephen Pall VK2PS and is copyright. No part or the whole of the article may be reproduced in any form without the author's written permission. Photographic material supplied by the VK9RS Management is for the purpose of Amateur Radio only and not to be reproduced without written permission.

ar

G. & C. COMMUNICATIONS

Graham Brennan VK3 KCS
19 Arleon Crescent, Cranbourne 3977

KENWOOD

GME Electrophone

uniden®

We specialise in Australia-wide mail order

(03) 5996 3298

e-mail: gccom@netspace.net.au

www.netspace.net.au/~gccom

Fax (03) 5995 0184

All major credit cards welcome

An active amateur offering professional service, advice and product.



Division News

VK1 Notes

Forward Bias

Peter Kloppenburg

The guest speaker at the January general meeting was Michael Farrell, VK2FLR. Mike spends a lot of his time on VHF, in particular with the use of the moon as a reflecting medium on 2 metres. This mode of communication is known as EME, short for Earth-Moon-Earth. Mike said that to be successful in this work you need a sensitive receiver with a noise figure of 0.3 dB using GaAs-FETs in the front end, a powerful transmitter, a very directional and rotatable antenna, together with audio filters to reduce the receiver bandwidth down to 25 Hz. Mike had a lot of fun with this work over the years, as he build everything himself and successfully made contacts with other EMEers in all the continents. Mike explained that EME-CW signals are buried in the noise and recovered by passing the detected baseband through audio filters. As a consequence, AM or FM is impossible because of their wider bandwidths. Other problems communicating with amateurs halfway around the world is pathloss and rotation of polarisation. The total distance is half a million km causing RF losses of 252 dB. The windows of opportunity are only about half an hour, when two stations on either side of the earth can see the moon at the same time. Antenna elevation is then no higher than 15 degrees. At those angles the atmosphere plays havoc with polarisation. For those of us who would like to know a little more, Mike provided URLs

of the following EME websites which provide details at various levels of complexity:

<http://web.wt.net/~w5un> (EME primer), <http://www.webcom.com:80/~af9y> (AF9Y EME, SET1, DSP), and <http://ham.te.hik.se/homepage/sm5bsz/index.htm> (SM5BSZ Advanced EME topics). After Mike's talk, the meeting continued with the presentation of certificates of appreciation to four ACT radio amateurs who did great work assisting the Scouts Association during the JOTA/JOTI event last year. The ceremony was conducted by Scout Master David Lyddieth (VK1DL), and recipients of the framed certificates were Philip Longworth (VK1ZPL), Bernard Kobier (VK1KIP), Raymond Reinholtz (VK1PRG), and Peter Westerhof (VK1NPW). Next item on the agenda was the interference problem of the Mt.Ginini 2-metre repeater. Gilbert Hughes (VK1GH) gave details of what caused the problem and how it was going to be resolved. He said that one of the AirServices Australia (ASA) antennas on the shared multi-purpose tower had corrosion, oxidation, and/or rust in or about one of its elements. This caused rectification of carrier signals and resulted in mixer products with frequencies at VHF, and in particular on the receive frequency of the WIA 2-metre repeater. Every time two of ASA's transmitters were being keyed, the

repeater would be activated and transmit audio from both these carriers on its own carrier. Gilbert talked about the futility of taking test equipment up on the tower, such as spectrum analysers and RF voltmeters. They were swamped by the high levels of RF floating about, and it was impossible to take reliable measurements. After much deliberation, a recommendation was formulated, and accepted by ASA, to change the frequency of one of their transmitters. This will take a few weeks as some parts must be made up and some ordered. By the time you read this, the Mt Ginini repeater problem is likely to be solved. The last item on the agenda was the Five Words per Minute (WPM) issue. As most of us are aware, the Morse examination requirement for the full call in the USA, Sweden, and the UK has been reduced to 5 wpm. For a number of reasons it is appropriate that Australia follows suit. Supported by a handout with all the relevant points, Gilbert Hughes, our President, lead a discussion on the various issues associated with the reduction of the requirement. At the end, a vote was taken which resulted in a majority of the members wanting a reduction in the Morse examination requirement from 10 to 5 wpm. The next general meeting of the Division will be held at the Griffin Center, Civic, Canberra City, on March 27, 2000. Cheers to all.

VK2Notes

Pat Leeper VK2JPA
patleep@bigpond.com

Members are reminded that the Annual General Meeting of the VK2 Division will be held on Saturday 15th April at Amateur Radio House, 109 Wigram Street, Parramatta. All members are requested to attend.

The QSL Bureau has had a busy year, handling approximately 32,500 cards inwards, and the same number outwards. Our thanks again to the hardworking

members from the Westlakes Amateur Radio Club who are the backbone of the Bureau. The next posting will be in early April, the following one in July.

The VK2 Division has been issued the callsign AX2000 (AX two thousand) for a 12-month period and looks forward to future activations. The Olympic Games Coordinator, Geoff VK2EO, has been totally disappointed in the lack of club

responses for use of the callsign and hopes to hear from more clubs in the near future.

The Division will be organising an award to cover both Games periods — let your friends know overseas so they can be listening for it when the time comes.

As mementos for this very special year, the Division has ordered watches and keyrings bearing the WIA logo and the

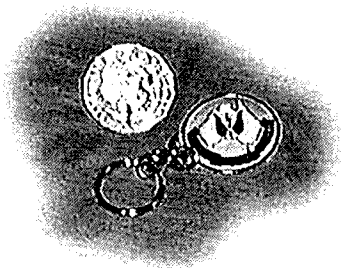
continued next page

VK2 Notes

continued from previous page

words "Wireless Institute of Australia". The watches are gold plated, analogue, with the logo in the top half of the dial and the wording in the lower half.

The keyrings (in bright gilt metal) have the WIA badge on the front, with the reverse being blank and highly suitable for engraving with callsign, etc. At the time of



submitting these Notes to the publisher, firm prices had not been decided by Council for these items. However it is anticipated they will be \$7.50 for the keyring and \$36 for the watch.

And finally ... The next Affiliated Clubs Conference will be on Saturday 6th May 2000. We hope to see a very good roll-up again where items of interest to all are aired and acted on where necessary.

Qnews

VK4 welcomes a new Contest Manager to the Division Team in Trent Sampson VK4TI. Trent is looking forward to the Contests coming up this year, namely Jack Files Contest (1st and 8th of July) and Harry Angel Sprint (25th of April). So I hope everyone is prepared for these ones when the time comes. Details will be in QTC and should be in AR.

Last month I mentioned the WIAQ Web page being spruced up. This will be an ongoing affair and the recent results are excellent. Well done to Webmaster Peter VK4JPH. The page contains the Qnews text, Bookshop promotions, minutes of Council meetings and other information on the Division. There is also the ftp site where the Real Audio version of Qnews is available for downloading. Thanks must go to Powerup our Internet Service Provider. They have extended our E-mails to 8 and continue to provide great service and support. Around 30 or so VK4 Amateurs are also with this ISP as testament to the excellent service. Reach the VK4 Web Page from the WIA Federal Web page at <http://www.wia.org.au/vk4> or directly to <http://www.wiaq.powerup.com.au> The Qnews RA files are found at <ftp://ftp.wiaq.powerup.com.au>

Just to the north of Brisbane, the Sunshine Coast Amateur Radio Clubs 'Col McCamley Award' has gone to a couple for the first time in its 14 year history. Congratulations to Liz and Angus McBain for their tireless organising efforts and contribution to the Club. The award perpetuates the memory of Col McCamley, a founding member of SCARC and driving force in its reformation in 1978 after some 6 years of inactivity. The SCARC Packet Radio User Group had its inaugural meeting in January and scribe VK4KEL Geoff Sanders (a PP of our WIAQ) says those who made the meeting were treated to a great night thanks to Len VK4ALF and Ian

VK4 Notes

VK4KIJ. A demonstration was conducted between their 2 BBS's of using commonly available Internet web browsers to collect packet mail over their LAN. The club held its AGM at the Bli Bli Community Hall on Tuesday Feb 1st. Officers elected this year were:

President: David Eyles VK4KDL Vice President: Kevin Oakhill VK4COP

Secretary: Max Magill VK4TXL Treasurer: Clem Collyer VK4WRM

Committee: Len Falknau VK4ALF, Wayne Cook VK4SWC, June Sim VK4SJ, Geoff Sanders VK4KEL, Angus McBain VK4KMC and Doug Sim VK4BP.

A little further north on February 9th, the Community Access Station on 103.9MHz in Townsville featured guests Snow VK4IFS and Gavin VK4ZZ. The host of the program Alan VK4PS had the team broadcast up to the hour Local, State, National and International Amateur news. The hour-long segment included Snow relating stories of operating portable, which will be continued on the 15th of this month at 8PM. This represents a valuable showing of the Amateur 'flag' by the TARCinc; any publicity is good publicity, great effort from the crew in Townsville. They are also gearing up for a big effort as the Club will be active for the John Moyle Field day Contest from Friday evening 17th March to Sunday afternoon 19th March at Bluewater Girl Guides Camp. TARCinc Amateur class Members, Novice or Limited calls here's your chance to work the unrestricted bands with a full call as your willing slave!

Travelling back towards Brisbane to the Clairview Amateur Radio where their May Day Weekend will be held on the last weekend in April. Mayday is on the 1st of May and also it is at the end of the school

By Alistair Elrick VK4FTL

holidays. You will have to book early for accommodation at Clairview Beach Park on phone 07 4956 0190. More info from Clive VK4ACC clive.sait@ergon.com.au

A New Club is Born

Moving just slightly to the west we welcome the newly formed Lockyer Valley Radio and Electronics Club. A few local Amateurs were surprised when they found 23 licensed Amateurs in a 15-kilometre radius with Plainland as the center and only four were associated with other clubs. They acknowledged the need for a club in the area, which inspired this new entity.

President Nev VK4TNA 5465 6953

WICEN Moreton: Graham VK4YEA 5462 2433

JOTA Liaison: Alan VK4SN, Glenore Grove Scouts, Warren VK4FJ, Laidley Scouts

The Club Net is on 146.900MHz at 7:00pm Sunday nights with the next meeting on the 27th February at the Laidley Scout Den at 1:30pm. The club will be holding a swap meet at the Laidley Scout grounds on the 16th of April. VK4XT, Dalby Club and other supporters have donated 3 radios and hardware for use on a Packet BBS. Info from VK4SN @ VK4SN.#GGR.QLD.AUS.OC.alz@hypermax.net.au or nevt@hypermax.net.au

The paperwork for changes to the Pretty Gully repeater VK2RBR has finally been completed and should see the end of problems between Ewans repeater and the repeater in Ipswich. There will be no cost to Summerland as the expense of this change is being met by the WIAQ. Ewan McLeod VK4ERM will be doing the changeover and Summerland requests anyone who can help him to do so if he needs assistance.

73's from Alistair

VK7 Notes

Early February in a really busy time around the branches of our Division. Many of the readers may not realise that the three 'clubs' around Tasmania are actually branches of the Tasmanian division all hams involved being W.I.A. members.

All had their annual meetings and under is a run-down of the principal officers of those branches,

SOUTHERN BRANCH, (Hobart Area)

President — Scott Evans, VK7HSE
Vice-President — Stephen Clarke VK7SV

Secretary — Dale Barnes VK7DG
Treasurer — Richard Rogers VK7RO

NORTHERN BRANCH (Launceston area)

President — Al. Burke VK7AN
Secretary/ Treasurer — Tony Simmonds VK7TNE

NORTH-WEST BRANCH (Latrobe west)

President — Robert McCulloch VK7MGW Vice-President — Bob Cropper VK7BY

Secretary — Tony Bedelph VK7AX
Treasurer — Terry Ives VK7ZTI.

Nominations are coming in well for our Divisional Council to be elected in March. I always feel that when we see a lot of nominations requiring an election it is a sign of an active, healthy organisation.

At the same time as our annual meetings each branch invited ALL amateurs to come and have their say on the morse issue. Two of our branches last year passed motion requesting morse be dropped as an examination requirement and all branches at these special meetings practically unanimously voted for the interim 5 wpm. proposal.

The Northwest branch is gearing up for the big 'Rally Tasmania' to be held on the 17th/19th. February. Our rally co-ordinator, Phil, VK7PU, is thrilled with the number of volunteers - 23 - offering their help, including some ham friends from Hobart coming up to enjoy themselves (?). Perhaps we'll have more news and pics. in the next issue.

Our web-page co-ordinator is pleased with the number of 'hits' this page is getting. Have YOU accessed it ?. Look for www.wia.tasnet.net and see what's happening on the action island.

Cheers for now. Ron, VK7RN. State President.

ar

These old timers are as good as new

The Great Receiver Set Up is finally ready

John Wright
4/33 Kerrie Crescent
Peakhurst 2210

The finishing touches to the great Receiver Monitoring Set Up are almost complete. As you may be aware, about 6 months ago in *Amateur Radio*, I described what needed to be done in collecting all those old radios, just junk parts etc of yesteryear. [Monitoring Station of Yesteryear *Amateur Radio* July 1999 page 51].

Well the set up at Ermington in Sydney's mid-west is finally almost finished. Opening day was Saturday 26 February at 2pm. For those who are interested the phone number for directions is 02 9533 6261.

On display are about 100 old valve receivers, all in their racks, the vast majority of which have been brought back to life with some tender loving care from my friend Robert Varga, and help from both Ian O'Toole and Ray Robinson whose enthusiasm is always at 100%. I outlined the

purpose of some of these sets in an earlier article. Some of the many working sets on display will be the Admiralty B40, or should I say all 17 of them! There are Kingsley AR7's, AR8/AT5 combination, and a complete Wireless No II set ex SK VK2PA This fulfils Peter's promise that the sets are kept in going condition: AMR300's, AMR100, AR88, HRO a beautifully built homebuilt version of the HRO, Hallicrafters SX24, SX32, SX99, Hammerlund HQ110, HQ145, a beautiful National NC300, and of course a receiver monitoring set up is not complete without a Collins R390A and a R391. The British sets also get a run with Eddystones, a Racal 17E and general Electric BRT402, closer to home the AWA set CH6B and the big heavy Argonaut CR3D.

No monitoring receiving station is complete without frequency measurement. This is done with the 14 BC221's frequency meters: yes, all 14 of them. At the moment some are good door stoppers, but we will make them work!

Once again, thank you to the amateurs who have donated or sold to me radios, parts and junk to get the station going. I am always looking for more, and every couple of months you will see the ads in the classified for these items. Heavy unloved dusty, yes give me them all. Give me a hernia (the CR3D came close), give me a call.

ar

CLUB NEWS

News from the Moorabbin & District Radio Club

Radio on Rails next month

Buoyed by the success of its previous two *Radio on Rails* Fun Days held last year, Melbourne's Moorabbin & District Radio Club is holding its next *Radio on Rails* on Sunday April 9.

Radio on Rails encourages amateurs to operate from trains and trams around Melbourne. Participants get to experiment with VHF/UHF portable equipment and antennas and demonstrate amateur radio to the general public. Entrants also meet other contestants, thanks to the unique 'eyeball contact' rule.

The rules for *Radio on Rails* appear below. There are no changes from last time. Both home and train/tram mobile stations may enter. Participants are invited to meet for lunch afterwards at a city venue to be arranged on the day.

MDRC Radio on Rails Fun Day Rules

Object: To make contact with operators on board trains and trams around Melbourne.

Date: Sunday, April 9, 2000

Time: 9am - 1pm

Bands: FM voice segments of two metres and seventy centimetres only

Mode: FM

Sections: A. Transmitting Mobile (in train or tram, also includes waiting at railway stations or tram stops)

B. Transmitting Home (includes operators at home or in a car)

C. Listening Mobile (in train or tram, also includes waiting at railway stations or tram stops)

D. Listening Home (includes listeners at home or in a car)

Contacts: Train or tram mobile stations may work (or hear) any station for points. Home station entrants may work (or hear) train or tram mobile stations only for points.

Repeat contacts: Repeat contacts are valid for scoring purposes provided at least one hour has elapsed between them.

Use of repeaters: Contacts on repeaters count for scoring purposes.

Exchange: Train or tram mobile stations give their nearest railway station, tram route number or tram stop location (if waiting). Home stations give their suburb. No serial numbers are required.

Eyeball contacts: Stations in Sections A and C may claim extra points for 'eyeball contacts'. An eyeball contact is defined as one where participants can shake hands with one another on a train, tram, railway station or tram stop.

Prearrangement of eyeball contacts before the contest start time is not allowed. However, eyeball contacts may be arranged during the contest period on two metres or seventy centimetres FM only. Unlike with radio contacts, entrants cannot claim extra points for repeat eyeball contacts with the same person. Amateurs or SWLs not active in the contest cannot be claimed as eyeball contacts.

Scoring: Score 1 point per station worked (or heard) on each band. Total score is the number of radio contacts made (or stations heard) on all bands plus the number of valid eyeball contacts made.

Logs: Logs should show time, frequency, callsign and exchanges for each contact. Eyeball contacts should also be logged. Train or tram mobile entrants should staple their used Met ticket to their log. Where this is not practical (e.g. ticket remains current after the contest), a signed photocopy of the ticket will be accepted in lieu.

Logs should be posted to *Radio on Rails*, MDRC, PO Box 58, Highett, Vic, 3190. Logs should be received by 31 April 2000.

Certificates: These will be awarded to the first three placegetters in each section. Other entrants will receive participation certificates.

Results: Results will be announced in the WIA's *Amateur Radio* magazine

and on the MDRC's weekly news transmission (8pm Wednesdays, 146.550 MHz).

This month's MDRC activities

With the New Year now in full swing, there's plenty to do at the MDRC. Important dates for this month include:

- Wednesday March 1: *APC News* transmission. 146.550 MHz, 8:00pm.
- Friday March 3: MDRC Social meeting. Start 8:00pm.
- Monday March 6: Club Net. 146.550 MHz 7:30pm.
- Monday March 6: MDRC committee meeting. 8:00pm.
- Tuesday March 7: Tuesday morning coffee group. Start 10:00am.
- Tuesday March 7: Tuesday evening hobby/technical group. Start 7:30pm.
- Wednesday March 8: *APC News* transmission. 146.550 MHz, 8:00pm.
- Monday March 13: Club Net. 146.550 MHz, 7:30pm.
- Tuesday March 14: Tuesday morning coffee group. Start 10:00am.
- Tuesday March 14: Tuesday evening hobby/technical group. Start 7:30pm.
- Wednesday March 15: *APC News* transmission. 146.550 MHz, 8:00pm.
- Friday March 17: MDRC General meeting. Start 8:00pm.
- Monday March 20: Club Net. 146.550 MHz, 7:30pm.
- Tuesday March 21: Tuesday morning coffee group. Start 10:00am.
- Tuesday March 21: Tuesday evening hobby/technical group. Start 7:30pm.
- Wednesday March 22: *APC News* transmission. 146.550 MHz, 8:00pm.
- Monday March 27: Club Net. 146.550 MHz, 7:30pm.

- Tuesday March 28: Tuesday morning coffee group. Start 10:00am.
- Tuesday March 28: Tuesday evening hobby/technical group. Start 7:30pm.
- Wednesday March 29: APC News transmission. 146.550 MHz, 8:00pm

Meetings are held at the Combined Clubrooms, Turner Road, Highett (Melways 77 J9). Look for the archery range, flyfishing pond and the tower.

Make the MDRC your Club

New members are always welcome at the MDRC. If you'd like a brochure and membership application form, write to

MDRC, PO Box 58, Highett, 3190. Or see our website at <http://www.mdrc.org.au> for further information about the Club. Membership subscriptions are currently \$25.00 full and \$20.00 concession.

Peter Parker VK3YE
Publicity Officer Moorabbin & District
Radio Club
parkerp@alphalink.com.au
(03) 9569 6751

Adelaide Hills Amateur Radio Society NOTES

In January AHARS went to the SCARC Hall for a sausage sizzle and combined meeting. The assembled amateurs and spouses were then given a big screen video show of the tour of the USA taken by four VK5 amateurs, VK5ZBR, VK5ZK, VK5ZCK and VK5ZWI.

The main aim of the tour was to visit the Hamvention in Dayton held on the 2nd weekend in May each year. We have all heard of Dayton and how big it is but now we have seen it with our own eyes. It is amazing, five enormous hall full of stands and a Flea Market area as large as the car parking area around one of our major football venues. Something like 20,000 people go there each year. Unbelievable and the things we saw on sale were equally unimaginable here in Australia.

However, Dayton was not the whole trip. Most of the tourist attractions were fitted into the itinerary, Yellowstone National

Park, Niagara Falls and the NASA facility at Cape Canaveral. There they were amazed to be offered tickets to see a Space Shuttle launch the next morning. When they had been planning this trip one of the things they all wanted to see was a launch but they had reluctantly decided that without travelling back and forth across the US several times this was one part that they were going to have to miss. To discover that there had been enough changes to the launching schedule, that they actually were there on the right day after all, was too much to believe.

The rush to pay their money was too fast for the eye to see. They were not quite so thrilled when they realised that they would have to be ready to leave their hotel at 3.30am to be in time to get to the busses that would take them to the viewing area. However they gritted their teeth and put in an early call for that time. After Dayton this

was possibly the highlight of the trip. Sharing it vicariously was enjoyable for members of both clubs, I am sure.

It was a most enjoyable evening and a good start to the year.

Annual General Meeting

AHARS will hold its AGM on the third Thursday in February which will be followed by a talk by Graham VK5ZFZ about loudspeakers their construction and repair. We all have several loudspeakers in our homes and shacks but rarely consider them. This should be an interesting talk, the first of many planned for the year.

If any amateurs are visiting VK5 and are in Adelaide on the third Thursday of the month they are welcome to join the regular members at the Blackwood High School, Seymour Avenue, Blackwood at 7.30. You can be sure it will be an interesting and pleasant evening.

An Invitation from the Radio Amateurs Old Timer Club

The Radio Amateurs Old Timer Club will have its luncheon and Annual Meeting on Tuesday, March 14. Amateurs belonging to other clubs are invited to join with us.

The speaker will be Mr Peter Young, the area manager of the ACA.

This will be speaking on the huge on site task of licensing, monitoring and sorting interference problems of the many hundreds of radio devices that will be in use at the Olympic Games

An excellent three course meal, including refreshments, will be served at the very reasonable cost of \$25 per head.

The location is the Bentleigh Club in Yawla Street, Bentleigh, Melways map 68 B11. Firm bookings are essential, no later than Thursday, March 9 with Arthur Evans, VK3VQ, 3/237 Bluff Road, Sandringham 3191, telephone 9598 4262.

Hope to see you there, 73

Allan Doble VK3AMD (President)

52nd Urunga Radio Convention

Easter Weekend - 22nd & 23rd April



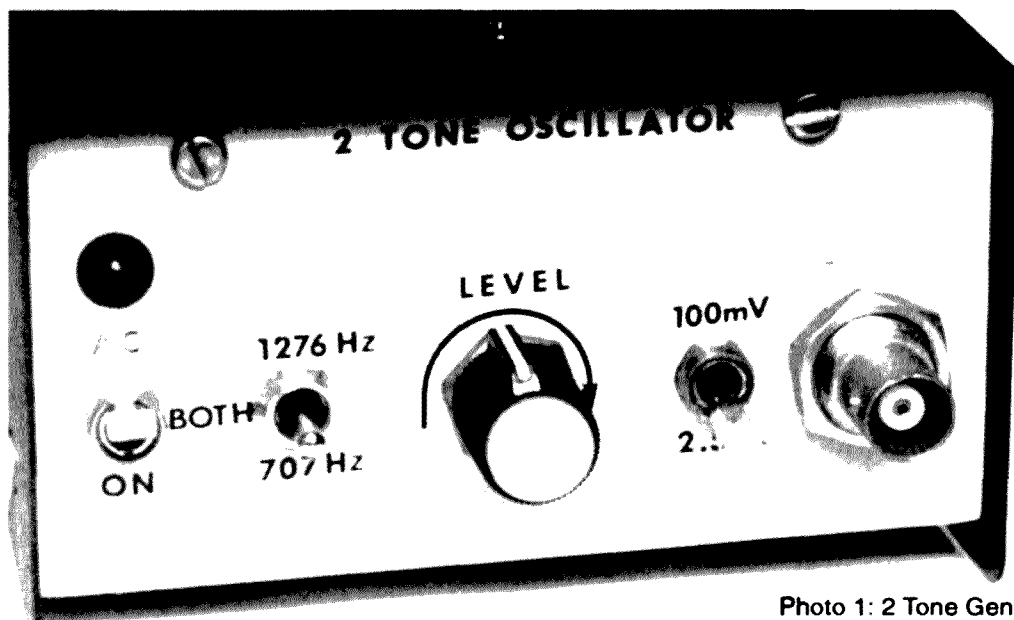
The Urunga Convention will be on again this Easter weekend, the 22nd and 23rd April. The usual events and hunts will be run and special events for junior hunters will be organised on 2 metre and 80 metres.

An invitation is extended to everyone who can attend this convention. The photo shows some of the contestants in a 2 metre hunt, after the event, in Pine Creek State Forest north of Urunga in 1988, the 40th convention.

Best 73s

B J Slarke VK2ZCQ

A 2 Tone Generator for Testing SSB Transmitters



Keith Gooley VK5OQ
Torr-Crest
Tenafeate Court
One Tree Hill SA 5114

Photo 1: 2 Tone Generator Front Panel

Here is a simple little piece of test equipment which will enable you to feed an audio signal into a Single SideBand (SSB) transmitter to test its Peak Envelope Power (PEP) output and check for distortion of the signal.

An audio signal consisting of two non-harmonically related tones has been traditionally used for testing SSB transmitters because simply feeding a single tone into the transmitter's audio section will give a single frequency at the RF output. This has the disadvantage of not easily being able to check for distortion due to non-linearity in the various stages of the transmitter. In addition, only the continuous power output capability of the transmitter can be measured as there is only one continuous frequency existing at the output. With two tones feeding into the transmitter, clipping of the RF waveform is easily seen on an oscilloscope and the PEP output of the transmitter may be measured. This is a more relevant measure for a transmitter designed for voice communication or other modes with a high peak to RMS ratio.

Design and Operation

The generator consists of two audio oscillators, a mixing amplifier, an output buffer and a simple power supply. The

oscillators are the Wien Bridge type known for low distortion. The Wien Bridge network is shown in Fig. 1. $R1 = R2$ and $C1 = C2$. This circuit has the characteristic that when an AC voltage is applied between the input and earth, the output voltage will be exactly in phase with the input at one frequency only and at that frequency the amplitude of the voltage at the output will be exactly one third of the input. This frequency is given by the equation:

$$f = 1 / (2\pi R1 C1)$$

An operational amplifier (opamp) is placed between the output and input with just enough gain to make up for the one third voltage drop and the circuit oscillates.

All such oscillators require a means of controlling the amplitude of oscillation otherwise it would increase until the amplifier was driven into clipping resulting in severe distortion. In this version of the Wien Bridge oscillator, the amplitude is controlled by the positive resistance with temperature of an incandescent light globe. At room temperature with no current

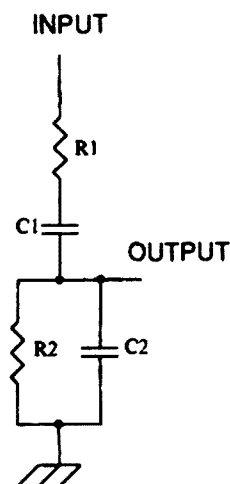


Figure 1: Wien Bridge

through the globe, the resistance is typically one tenth of the resistance when the globe is at its rated temperature. The globe is part of a negative feedback loop around the opamp and as the output voltage increases so does the voltage across the globe and its resistance increases with the heating up of the filament. In this design, I used a 50 volt globe so it never gets near incandescence. The increase in globe resistance causes the

continued next page

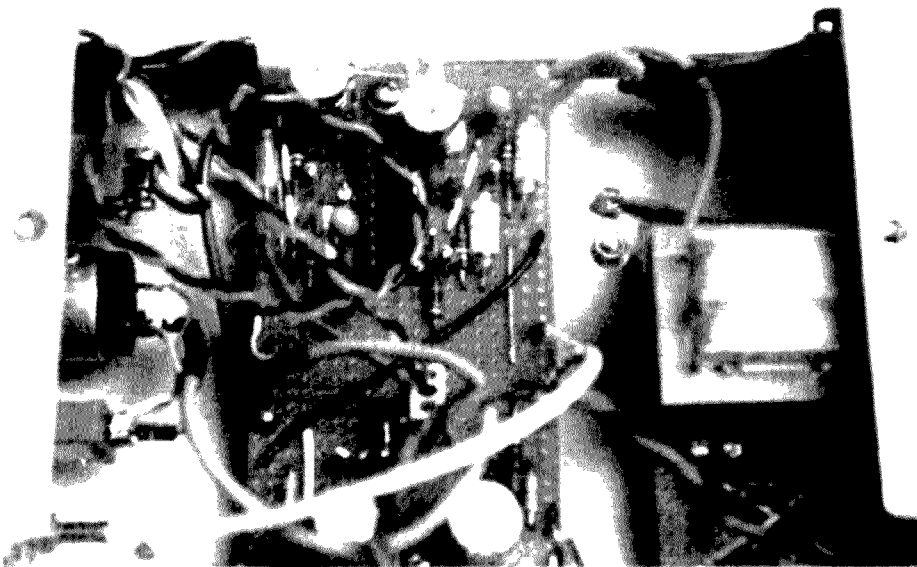


Photo 2: 2 Tone Generator Internal view

continued from previous page

negative feedback to increase, reducing the gain and so equilibrium is reached when the negative feedback just balances the loss in the Wien Bridge. This means that, referring to the circuit, Fig. 2, the resistance of globe H1 is half that of R1 when oscillation has stabilised.

C1, C2, R3 and R4 form one Wien Bridge while the corresponding components C3, C4, R6 and R5 form the other. Either oscillator can be disabled by switch SW2 shorting out part of the Wien Bridge for situations where only one tone is required. In order to get enough voltage on the globe to make its resistance rise significantly, the opamps are powered with as high a DC voltage as possible. With the component values and globe shown in Fig. 2, the voltage at the output of each oscillator is about 7.5 volts RMS or 21 volts p-p. This is reduced to about one third of that value in the mixer stage, UIB. U1C is a unity gain buffer with level controls between the two amplifiers. SW3 selects high or low output voltage range while a 10 k log potentiometer, VR1 gives fine adjustment of the output level. The low level output is suitable for microphone inputs to transmitters while the high level setting gives about 2.5 volts RMS output. The resistor R12 is included to give an approximation to a 50 ohm output impedance; not that audio oscillators are commonly used in 50 ohm systems but the resistor also provides a measure of protection to the output buffer opamp should the output be short circuited.

The power supply is relatively simple and

any voltage which is high enough to prevent the opamps clipping with the chosen globe type will be adequate. The voltages don't really need to be regulated but caution should be exercised to ensure that the supply voltage rating of the opamps is not exceeded. For TL074, LM348, 4136 etc quad opamps and many single and dual opamps the maximum is +/-18 volts. I used zener diode regulators as I had them on hand but 3 terminal regulator IC's could also be used with appropriate bypass capacitors. The PCB is laid out to take either.

Component Selection

The globes are probably the trickiest component to obtain. They should be as high a resistance as possible so that R1 and

R2 are not so low as to load the opamp excessively and as low an operating voltage as possible so as not to require too high a signal voltage at the oscillator output. The globes I used have a hot resistance of 1000 ohms, a cold resistance measured with a DMM of 110 ohms and the resistance is half of R1 or R2 ie 280 ohms when there is 2.5 volts RMS across it. These globes were obtained from Vorlac Industries in Melbourne, a surplus electronic component supplier. They may or may not still have stock by the time this is published. Cat # Z21052. A 28 volt 24 mA globe would probably be suitable. These are available from Farnell Electronics cat # 328-881 or 620-518. One circuit I have seen specifies a 10 volt 14 mA globe but I don't know if these are available in Australia. The commonly available 12 volt 50 mA globes ("grain of wheat" and the like) have about one quarter of the resistance and so R1 and R2 would need to be reduced to about 150 ohms. Then it should work provided the opamp will drive such a low resistance.

Opamps. Virtually any single, dual or quad opamp could be used subject to the power supply precautions mentioned earlier. Although the LM348 is specified on the circuit, I actually used a TL074. A note of warning, the LM349 was available very cheaply from a disposals source in Adelaide a year or two ago. This opamp is an uncompensated high speed version of the LM348 and as such is not guaranteed stable below voltage gains of 5. Since all four amplifiers in this design are operated at low gain, the LM349 is not recommended. I tried one and it made a good 2 MHz oscillator rather than an audio one!

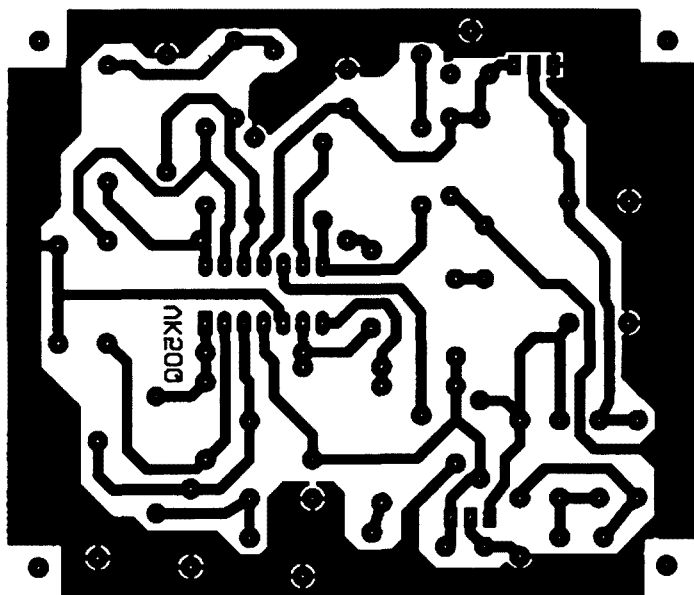


Figure 3: Top view

ALARA

Christine Taylor VK5CTY ALARA Publicity Officer
16 Fairmont Avenue, Black Forest SA 503

Packet: VK5CTY@VK5TTY email: geensee@picknowl.com.au



ALARA on the Net

Have you looked at the ALARA Page lately? This can be found at
<http://homepages.tig.com.au/~bishops/alara/>

Dot VK2DB Editor set up this page several years ago with the help of her son Peter (remember the front cover of AR in November 1998?) and has added to it as interesting events have occurred. Why not take a look next time you are surfing?

A number of the members of the committee are on email, watch for listings in the Newsletter. If you have a query or

comment, please send one of us a message. Your feedback is what tells us whether we are serving you well or not.

If you have any items of news either for this column or for the Newsletter, please send it along either by email or by packet.

Dot's addresses are VK2DB@VK2WI and dbishop@hotmail.net.au or bishops@tig.com.au

My addresses are VK5CTY@VK5TTY or geensee@picknowl.com.au

I must admit my packet has been dead for some time but it is working again now and I hope it stays that way. My email is working well though I am not getting enough information from you. Please do something about that!

The International YL2000 In Hamilton

By the end of March all those who have indicated their interest in going to this event should have received the registration forms etc. Don't waste time filling those in and returning them so the organisers can finalise arrangements. However, if you find that you can come, after all when you had decided it wasn't possible, I am sure you could be accommodated after the closing date.

The Web Pages to look at are:-

<http://www.wave.co.nz/pages/osborne/vl2000> for information about the meet
and www.new-zealand.com/GreatSights
or www.pacificdiscovery.co.nz for tours you could take before or after the meet.

At this time the tours on offer are a Catalina Flying Boat flight over Hamilton and surrounds and a tour to Rotorua, plus a trip to the Bay of Islands, Northland prior to the meet on which a number of YLs are joining Gwen VK3DYL. There is also a possibility of a trip to Norfolk Island where you will have a chance either to work rare DX or to be rare DX. Keep watching and listening for more information as it comes to hand.

The Hamilton Gardens

In the recent WARO Magazines (WARO is the NZ equivalent of ALARA) there have been a series of articles describing the beautiful and unusual Hamilton Gardens. In these gardens there are a number of specific areas that have a particular theme. There is the Chinese Garden, the English Neo-Georgian Garden and the American Modernist Garden, each of them is a copy of its parent garden on another continent.

The beautiful descriptions of the gardens and the history of the Hamilton Gardens as a whole was written by Joline ZL1UJB. Deb VK5JD, an earlier Historian for ALARA met Joline and Celia ZL1ALK when she was in New Zealand earlier this year. Deb has now sponsored Joline into ALARA.

Before Deb undertook this sponsorship the question was asked, whether it is necessary for you to hold a Full licence (or either side of the ocean) to be sponsored. There are no restrictions about Licence grade. It just makes it more difficult to talk to each other on air if one of you has a restricted licence.

The Monday Night Nets

The time of the Monday Night nets will change in March to coincide with the end of Daylight Saving Time in some States so conditions on 80 metres should improve. The half hour extra suntime of the earlier beginning to the Nets does make a difference, particularly for the Queensland and Western Australia YLs. We are grateful for the regulars like Bev VK4NBC, June VK4SJ and Sally VK4SHE who come up week after week to tell us about their activities although often they cannot hear any of our replies.

We do usually hear them well enough to complete our weather report, though. That is the first round topic, most weeks. The range of temperatures and the patterns of the rains are quite fascinating. Our country is so enormous and covers so any climate types.

The timing of our garden produce is another illustration of our seasonal differences. The tomatoes may be finished

in one place before they have ripened somewhere else.

Many of us are bird-watchers and many of us live with bushland quite near so there is usually something new to share with each other. The variety and type of birds and animals we see is amazing. Why don't you listen in or even join us on or about 3.580 MHz one Monday 1000Zulu till Daylight Savings Time ends and 1030 after that.

The ALARA Contest

The outright winner of the of the Contest and the winner of the Florence McKenzie Trophy was Pat VK3OZ. Following close behind her for top score (four points difference) was Susan VK7LUV (ex VK4LUV). Congratulation to you both. Two regular participants took out the Top DX score, Celia ZL1ALK and Top ZL OM (Dave ZL1AMN) with Alan ZK7JAB taking out the top VK OM.

The number of logs sent to Marilyn VK3DMS was very disappointing this time, especially after making repeat contacts possible had been so successful the year before. From the numbers of stations contacted there must have been many more people participating than those who sent in their logs but conditions on the bands was not nearly as good last November.

Quite a bit of effort is involved in arranging to hold a Contest and in checking the logs etc., so it is a shame that we don't all manage to send in our logs.

There is a possibility that some changes could be made to the ALARA Contest to try to improve the situation. Watch this space for information.

ar



Ron Graham VK4BRG
PO Box 323 Sarina Qld 4737

The early “sniffer” gets the fox

Later this year, the next International Region 3 ARDF Competition will be held in China. So far, I haven't heard anything regarding an Australian team being involved. The financial burden of attending one of those events is always a problem. Should anyone be interested, they should contact the Australian ARDF coordinator, Jack, VK3WWW. Indications from the US are that there is quite a lot of interest in the event, even to the stage that some elimination events may be needed to select the competitors.

Sydney Circa Late 1950.

The remainder of this month's column will endeavour to cover ARDF in Sydney around the late 1950's era, then most definitely called “fox hunting”. At that time I was VK2ZBG, the only other person that I have kept in vague contact with who was involved in “fox hunting” in those days is Allan, VK2RX who back then was VK2ZAL. Allan was navigator/radio operator on many occasions, while I did the driving.

I remember a popular starting point being a water tower in the suburb of Canterbury. This was a normal suburban area but quite elevated. The elevation helped you to initially hear the fox, which was (often) quite a distance away. Thus we only held the one event per evening. From memory, there was an average of 6 to 8 cars participating in those monthly events. On occasions we would go for coffee at a late night establishment after the event.

AM Days

This was back in the Amplitude Modulation (AM) days with crystal locked transmitters and crystal locked converters feeding a tunable receiver being the norm for 2 metre operation. Thus most operators had “their” frequency and one knew to look for that particular person. Their home, or base station, frequency wasn't always the same as their mobile frequency. It all depended on what crystals were available from “disposals” at the time. As these disposals crystals were often on the same frequency, it was common practice to grind “a bit off them” so as to end up on ones own unique frequency. This frequency was determined

largely by luck in the grinding process, the main criteria was not to end up on someone else's frequency!

The Valve Era.

As all this happened before the age of the RF transistor, equipment was all valve. Transmitters generally used 8 MHz crystals, that frequency being multiplied up to 144 MHz, which required 3 stages of multiplication. The output stage was, in general, just a few watts. Any figure above this required valves that were harder to obtain, difficult to supply with the necessary DC power and, of course, needed a larger AM modulator as high level (or plate/screen) modulation was normal.

Crystal locked converters were all valve and gave a number of us our first introduction to overtone oscillators. These were used to try and avoid the large number of multiplier stages otherwise required for the local oscillator in the converter. I used a 6 to 9 MHz “command receiver” as a tunable IF. These receivers were also a disposals item and were available with various tuning ranges. The 3 to 6 and 6 to 9 MHz ones being the most common. They used quite a high IF frequency, which reduced their selectivity. However, we used to modify them to a double conversion design with a low IF frequency and end up with quite a reasonable receiver.

Power supplies were a problem. Being fairly serious, I fitted a 28 volt (again disposals) aircraft generator to my (in that era, 6 volt) Holden. Two 12 volt batteries were carried in the boot. The 24 volt supply meant I could use, the then common, disposals 24 volt genemotors to provide the HT for the valve equipment.

Introducing The Transistor.

Germanium transistors, mainly low frequency and switching types were becoming available. We were starting to use the TO-3 size switching devices for DC to DC power supplies. Building these provided good winter entertainment in front of the fire, winding the required torrodial transformers. Lots of turns were needed for the secondary windings, though I remember the voltage doubler configuration being

popular as this meant less of those secondary turns.

DF Antenna.

Antennae were varied .. I used a 3 element horizontal yagi which had the aluminium support tube passing through a hole drilled in the body work in front of the left hand side of the windscreen. This hole lined up with a hole in another bracket that was mounted on a parcel shelf under the dash. Thus the antenna could be easily turned from inside the vehicle. And therein lies a story. A long screw and nut were fitted through a hole through the tube above the bottom bearing. The idea was that the long part of the screw that protruded through the nut “pointed” in the direction of the “front” of the beam. On the night in question we ended up in some paddocks out west of Liverpool. Suspicion was eventually aroused as we ended up further in the paddocks and the average signal getting weaker. Investigation revealed the screw had been fitted the wrong way, which meant we were carefully 180 degrees off course! I would image we double checked that item on future hunts. Oh, and a “high tech” cork was used to block the hole when the antenna wasn't fitted.

The Early “Sniffer”.

Naturally hiding places were as devious as could be devised. Often access to the “fox” wasn't obvious even though it was mostly in a vehicle, or not far from it, due to the lack of really portable equipment and a power source. So it became apparent to me that having some sort of, what is now known as a “sniffer”, could assist. Being able search on foot, could, in some situations, be quicker than trying to find suitable access roads or tracks for the car.

So a sniffer was designed consisting of a full size close spaced two element yagi feeding a 50 micro-amp meter via a diode detector etc. This worked remarkably well over a reasonable distance assisted, no doubt by the fact that most of the hidden transmitters were the owners mobile transmitter running a few watts. It could be a different story these days with the lower powered “foxes”.

DON'T MISS THE ACTION!

VX-5R 6m/2m/70cm Deluxe Hand-Held

Tiny yet incredibly rugged, the VX-5R provides 6m, 2m and 70cm amateur band operation with 5W output as standard (4.5W on 70cm), made possible by a unique PA design and a super high capacity 7.2v 1100mA/H Lithium-ion battery. Plus, ultra-wide coverage VHF and UHF as well as AM medium-wave and shortwave reception facilities are provided, along with a large backlit dot-matrix LCD screen. All this in a diecast aluminium enclosure just 58 x 87 x 28mm WHD (without knobs or antenna)!

Features

- Tx: 50-54, 144-148, 430-450MHz
- Rx: 0.5-1.8MHz, 1.8-16MHz, 47-729MHz, 800-999MHz (cellular blocked)
- Full feature keypad, CTCSS encode/decode, digital code squelch
- Comprehensive menu system
- Over 200 memories
- 8 digit alpha-numeric memory labelling
- 5 battery saving systems, plus Tx/Rx usage monitor
- Spectra-Scope™ for monitoring adjacent channel activity
- Comes with FNB-58LI Lithium-ion battery, flexible antenna and AC adaptor/charger

D 3670

VX-5R Accessories

CSC-73 Carry Case	D 3671	\$26.95
CD-15 Fast Desk Charger	D 3672	\$49.95
FBA-23 Dry-Cell Battery Case	D 3673	\$49.95

YAESU

\$699

2 YEAR WARRANTY



FT-50RD 2m/70cm Handheld

The Yaesu FT-50RD is an amazingly compact 2m/70cm amateur band handheld transceiver which provides MIL-STD 810 shock and vibration resistance, super wideband receiver coverage, simple menu settings for most functions, and compatibility with the optional Yaesu ADMS-IE software/interface package for PC programming of many functions.

Other features include:

- Tx 144-148MHz, 430-450MHz
- Rx 76-200, 300-540, 590-999MHz (cellular blocked)
- FTT-12 keypad provides Digital Voice Recording, CTCSS/DCS scanning, and CTCSS encode/decode
- 2m/70cm RF output: 2.5, 1.0, 0.1W standard, up to 5W with 9.6V battery or 12V DC socket
- "Omni-glow" LCD screen for easier night-time viewing
- 112 memory channels with 4 character alpha naming
- Dual watch allows monitoring of sub-band activity
- Direct FM modulation for better audio quality
- 5 battery saving systems (includes Rx and Tx Save)
- Comes with FNB-40 slimline 6V 650m A/H Nicad battery pack, flexible 2m/70cm antenna and modified M-9626 AC plug pack adaptor for Nicad charging.

D 3660

YAESU

\$499

SAVE \$70



HURRY!
Limited stocks

Yaesu FT-90R 2m/70cm micro mobile

Another engineering breakthrough from Yaesu – a tiny dual-band mobile rig with high power output, a remoteable front panel, and a rugged receiver front-end. The FT-90R provides 50W RF output on the 2m band as well as 35W output on the 70cm band, a solid diecast casing with microprocessor controlled cooling fan for reliable operation, and a large back-lit LCD screen, all in a package measuring just 100mm x 30mm x 138mm.

Also includes:

- Wide dynamic range receiver for reduced pager breakthrough
- Huge receiver coverage – 100-230, 300-530, 810-999.975MHz (Cellular blocked)
- 180 memories and a variety of scanning functions
- Built-in CTCSS encode/decode, battery voltage metering
- Designed for 1200 and 9600 baud packet operation
- Tiny remoteable front panel (requires optional YSK-90 separation kit)

Includes MH-42 hand mic, DC power lead, and easy to follow instructions.

D 3312

YAESU

\$899

2 YEAR WARRANTY

YSK-90 Front Panel Separation Kit

D 3317

\$129⁹⁵



FOR ALL YOUR COMMUNICATION NEEDS

45-Memory Shortwave Receiver

The ATS-808 provides continuous 150kHz to 30MHz coverage, so you'll catch all the action on the shortwave bands plus medium-wave (AM bands) and, with earphones, FM stereo. You can select wide or narrow filters on SW bands (as well as attenuation for extremely strong stations) to ensure optimum reception quality under differing conditions. Requires 6 x 'AA' batteries or mains adaptor (M 9626) recommended.

D 2829



\$199
SAVE \$86

Features:

- Keypad frequency entry • Dual time settings • Desk stand • Signal strength meter
- Narrow/wide IF filters for improved SW reception • External shortwave antenna socket • Built-in whip antenna • 13 SW band divisions with direct access buttons
- Complete with stereo earphones and protective case.

Longwave: 150-519kHz Mediumwave: 520-1710kHz

Shortwave: 1.711-29.999MHz (continuous) or in 13 pre-set SW bands

FM: 87.5-108MHz

6m 1/2 Wave Base Antenna

A rugged Australian-made vertical antenna designed to cover the 51 to 54MHz range, with minimum SWR around 53MHz. Built using high tensile T81 grade aluminium, it's just 2.9m long with a sealed base section and 100W minimum power rating. Complete with mounting hardware.

D 4825

2m Heavy Duty Base Station Antenna

For use where long-range omni-directional 2m band (144-148MHz) coverage is required. This 3.4m long 1/2 wave over 1/2 wave colinear vertical antenna provides approx. 5dB gain, and is housed in a very tough single-section fibreglass radome for all-weather protection. The strong aluminium base section is fitted with an N-type socket in its base for coax cable connection.

D 4822

D&G Antennas

\$69⁹⁵

BENELEC

\$139⁹⁵

Yaesu FT-840 HF Mobile

An ideal first rig for home or vehicle use, the economical Yaesu FT-840 covers all HF bands from 160-10m with 100W PEP output, and provides continuous receiver coverage from 100kHz to 30MHz.

The FT-840 provides:

- SSB/CW/AM operation (FM optional)
- 100 memory channels, two independent VFOs per band
- Large back-lit LCD screen, uncluttered front panel
- Effective noise blanker
- Variable mic gain and RF power controls
- SSB speech processor for greater audio punch
- IF Shift & CW Reverse to fight interference

- Dual Direct Digital Synthesisers for cleaner TX/RX operation
 - Compact case size of just 238 x 93 x 243mm (W.H.D.)
- D 3275

YAESU **\$1675**

FM module suit FT-840 D 2932 **\$109.95**



2 YEAR WARRANTY

FT-3000M 70W 2m Mobile

An amazing 2m mobile transceiver from Yaesu with up to 70W RF output, MIL-STD 810 shock and vibration resistance, wide band receiver coverage (110-180 and 300-520MHz), dual-band or dual in-band receiver facility, 1200/9600 baud packet socket, and a very large back-lit alphanumeric LCD screen. The FT-3000M is supplied with a MH-42A6J hand mic, DC power lead, and detailed instruction manual.

D 3700

Specifications:

Frequency range: Tx 144-148MHz
Rx 110-180, 300-520
800-824, 849-869, 894-999MHz

RF output: 70, 50, 25, 10W

Sensitivity (Ham bands): 0.2uV (Main Rx), 0.25uV (Sub Rx)

Dimensions: 140 x 40 x 180mm (WHD)

Limited stock. Some units may be ex-demo, but full warranty applies.

BELOW COST!

YAESU

\$499

SAVE \$100

2 YEAR WARRANTY

LATEST 2000 RELEASES

WIA Callbook

Wide range of information for Australian Amateurs plus usual callsign and address listings.

B 2344

NEW \$17⁹⁵

ARRL Handbook

77th edition of this famous publication. Incredibly wide range of information for operators and constructors.

B 2237

NEW \$59⁹⁵

PHONE FAX AND MAIL ORDERS



PHONE: WITHIN AUSTRALIA: 1300 366 644
(Local call charge)

FAX: (02) 9395 1155 within Australia and
(+612) 9395 1155 from outside Australia

MAIL: DICK SMITH ELECTRONICS, Direct Link, Reply Paid 160,
PO Box 321, North Ryde NSW 1670 (No stamp required)

Excludes packaging and postage. All major credit cards accepted.
14 Day Money Back Guaranteed if NOT completely satisfied. (Software excluded)

Visit our web site at
<http://www.dse.com.au>

DICK SMITH ELECTRONICS

That's where you go!

Yaesu transceivers and accessories stocked in selected stores only. Other stores can place orders on a deposit-paid basis.

Eric Jamieson VK5LP: Looking back at an era

(Part I)

Most things in life eventually come to an end and the time has come for me to leave the keyboard and cease writing *VHF/UHF - An Expanding World*, after 30 years. That was actually done with the December issue, but this is a final roundup of news and events as I have seen them during a lifetime of association with radio and electronics.

Firstly, it has been a long and happy association with *Amateur Radio* magazine, its editors and production staff. Right from the beginning I set a relatively high standard of writing and I adhered to that at all times, refusing to allow the columns to become an arena for anyone to air grievances against other amateurs, no matter how relevant, as I believed that this would serve no useful purpose for the promotion of the hobby of amateur radio.

I am also very grateful to the loyal band of supporters who, over the years, have supplied material in one form or another for inclusion in the notes, as I usually call them. Also the several Clubs and VHF Groups with their provision of their newsletters without cost. Then there have been the great number of readers, amateur and otherwise, in Australia and from overseas, who have expressed their satisfaction with the information provided, albeit somewhat

sketchy at times. I have tended to stay with the communications side of VHF/UHF, leaving the more specialised modes to those better suited to their writing. Here I refer to satellite and digital communications, packet, repeaters etc., all of which have evolved with the passage of time. No one column can hope to cover everything so perhaps my choice was wise.

It did come as a surprise to find that one of the more popular segments of the notes was the "Thought for the month", so much so, that eventually this was expanded to "Two thoughts for the month" and these remain to this day. Many amateurs advised me that their wives always read the thoughts even if they read nothing else in the magazine!

Let's be nostalgic

But first, let me go back a bit into history. I was obviously born with a "valve in my hand" because my interest in radio really commenced around the age of eight years! Despite being told to refrain I could not leave the house radio to itself - at every opportunity I had to fiddle with the three dials that this battery radio boasted, at times finishing with them hopelessly out of tune.

Exasperated, my father bought me a book dealing with the fundamentals of radio. It was two inches thick, its appearance was quite intimidating, so it became known as the "tome" and sat on the desk in my bedroom.

A shortwave listener

At ten years Dad bought me a three valve regenerative battery set (we had no power until 1950) for 17/6 and I quickly converted this to a shortwave radio using plug-in coils covering from 500 kHz to 20 MHz, smooth regeneration being impossible to achieve at higher frequencies. Anyway, A415 triodes were never intended to operate at such high frequencies. So commenced my shortwave listening days. It was amazing what could be heard - an aerial 100 feet long and 40 feet high in a location with absolutely no noise (no power lines) presented a noise floor which had to be observed to be appreciated, and would be the unachievable dream of everyone today.

At fourteen I provided shortwave listener notes for a column in *The Adelaide Advertiser* each Saturday. So my radio journalism had commenced! These notes continued until I joined the RAAF in 1942, where I served in radio communications for four years, spending the last two on transmitting stations.

Radio really takes a hold

In 1947 I set out to procure my amateur licence but was too busy repairing the district's radios that I put such aspirations aside until later. But I did build for myself a 15 valve battery operated communications receiver that tuned from 500 kHz to 30 MHz. It boasted two RF stages and three IF

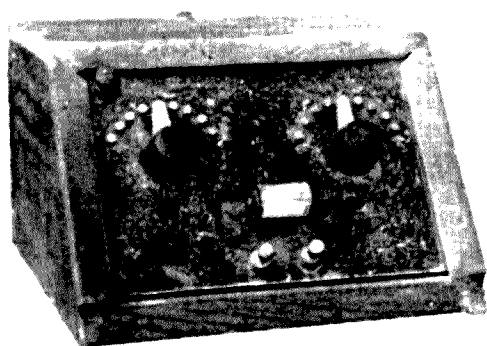


Photo 1: The crystal set

stages, and what a grand performance that gave in the quiet conditions, including broadcast band stations from Europe and America when the path was night-time for most of the distance. Eventually I sold it to an SWL in the back-blocks of WA, but now wish I had kept it.

Still repairing radios, I moved on to 1949-50 when I produced 64 radios for commercial sale. These used a Kingsley Ferrotune Kit and worked on batteries or 240 volts AC, selected by a switch, and were very popular with the locals as the power was slowly making its way to our area, arriving in late 1950.

Amateur radio looms

It was in the early 1950s when I made my first foray into amateur radio with a mate and I constructing one metre (288 MHz) gear, a modulated oscillator for transmitting and a super-regenerative receiver. With an output of about five watts we covered the ten miles between us with ease using dipole antennas. However, we never widely advertised our clandestine operations although the neighbours knew what I was doing, mostly at night from the garage. I was now smitten by the VHF bug!

Through the good years of solar Cycle 19 (1956-59) I did much listening on 50 MHz using a Kingsley tuneable converter joined to an AR7 receiver and a modified Channel 2 TV antenna especially imported from Melbourne where television had already commenced. I logged many signals from Japan, USA, Mexico, New Zealand, New Guinea and from all over Australia. The VHF bug was really biting and I had to do something about it!

I become a radio amateur

Finally, at the urging of my friend Wally Giles-Clark (VK5ZEH then, now VK5TW), in 1961 I sat for my licence and passed at the first attempt and became VK5ZEJ. Wally and I had a lot of fun operating on 50 MHz, one at each end of the then 4 MHz wide band, operating simplex with our antennas side-on to reduce the signal strength sufficiently to allow this to happen - we were two miles apart! When we finally constructed two metre equipment we found cross-band operation a breeze.

Operating on 50 MHz in the early 1960s was an interesting experience. Most stations were crystal locked, so in order to be heard during a wide-spread Es opening, stations spread out and fully occupied the spectrum from 50.000 to 50.500 MHz. I recall on one

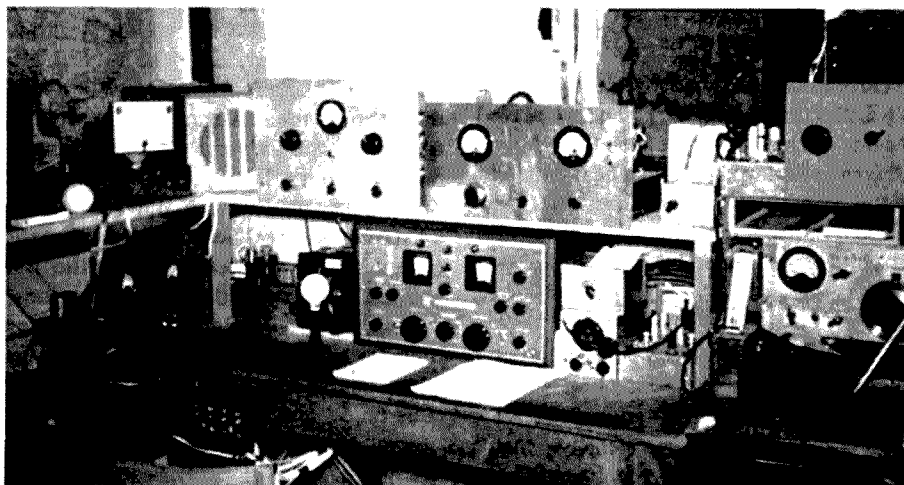


Photo 2: The VK5LP shack of the 1960s with all AM equipment

occasion counting 44 stations using that 500 kHz! Operating procedure was to call and end by saying "tuning from 50 up or 500 down" whichever was your choice. Most chose tuning up. As you were locked on your frequency, you could follow the progress of stations as they tuned up the band working available stations on the way. From this you had a fair idea when it would be your turn to be called when the station immediately below you had completed his contact with the station you were seeking.

We lose part of six metres

We had the use of 50 to 54 MHz until Channel 0 commenced broadcasting, so from 1 January 1964 we lost the segment 50 to 52 MHz. This was a sad blow as it meant we were now 2 MHz higher in frequency than stations in Japan, USA and many other countries. Domestically this was not a great problem but it would become one when Cycle 20 peaked around 1969. So for the next five years we ran a campaign of informing overseas countries that we were still there, but 2 MHz higher.

Cycle 20 was relatively poor but those overseas contacts which were made, usually involved working split frequency - we listened on 50 MHz and hopefully the others listened on 52 MHz. In many cases the 50 MHz stations did not bother to listen for us on 52 MHz when they could work sufficient stations on 50 MHz. Also, their antennas worked less efficiently at 52 than 50. At different times, one could hear a VK station slip down to 50 MHz and tell the stations there, almost in a whispered voice, that we were hearing them and would they look for us on 52 MHz. Such an illegal call lasted only a few seconds but it could have the desired result of split

frequency working for the VKs.

After our confinement above 52 MHz, by mutual consent a calling frequency of 52.050 MHz was introduced. This appeared to be of some value when the band had few signals, but again crystal locked stations had to spread out if they wanted contacts during Es propagation and crowded conditions.

The VFO arrives

Soon after, the wartime American Command transmitters were being rebuilt for use as a relatively stable VFO. The 3 to 6 MHz model was the most popular being inherently stable when used at its fundamental frequency as a mixer VFO with a crystal locked exciter chain. The beauty of this system was that the VFO could be allowed to run all the time and the transmitter silenced by removing the screen voltage from the doubler stage. A capacitor was switched across the VFO tuning capacitor to move its frequency out of the range of the receiver during receiving periods.

Apart from contacts when all manner of subjects were discussed - and some of these contacts were of considerable length with up to four stations involved in a round-table conversation, particularly after crossband operation became more general - we amused ourselves with six and two metre scrambles, working with the lowest possible power, reading frequencies, antenna experiments and so on.

Some interesting contacts involved up to four participants in a round-table conversation utilising both six and two metres. At other times we amused ourselves with six and two metre scrambles, working with the lowest possible power, accurately reading frequencies, antenna experiments and so on.

continued next page

continued from previous page

On one occasion I had a contact with Rod VK5ZDS (now VK2BQJ) when we played a game of chess for more than three hours. Of course Rod won, but then he is a man of larger construction than me so it was prudent of my selfless nature to allow him to win! He will remember!

Becoming VK5LP

Then I joined the VK5 VHF Group, and over the next few years made VHF news tapes for the Sunday morning WIA broadcast and sometimes did the two metre relay. While constructing much equipment (which now extended to 432 MHz) I learned the Morse code and eventually became VK5LP. So it was in 1969 that I was nominated (pushed!) by Geoff VK5TY, the VK5 Federal Councillor, to write the VHF notes for *Amateur Radio* and was welcomed to the fold with open arms. I am still not sure whether I have yet forgiven him for making that nomination!

Writing for *Amateur Radio*

So began a saga which has since spanned 30 years. The column commenced as VHF/UHF – An Expanding World and stayed that way, because that is what VHF/UHF is really – an expanding world! I commenced at a time when Solar Cycle 20 was looming and I had hoped for conditions similar to Cycle 19. This was not to be, it was a relatively poor cycle but I did manage to work JAs, Hong Kong and a couple of W5s and some of the island countries around the Pacific.

Beacons

With the completion in 1965 and obvious success of the VK5 beacons for 52 and 144

MHz, other states were slow to follow. When I began writing the VHF/UHF columns in *AR*, I used the avenues presented there to push for an Australia-wide network of beacons and for years my columns were prefaced with a list of operating beacons. The purpose was two-fold. First to provide a list of operational beacons for the benefit of amateurs, and secondly, as the list showed which states did not have beacons, it was a subtle way of applying pressure for them to be installed. It worked because eventually every state had its beacons, at least on 52 and 144 MHz. Gradually the beacon network was enlarged to encompass 432 and 1296 MHz. Today, beacons exist in several states on all bands through to 10 GHz.

Portable operations

An activity I had always enjoyed was portable operation. This commenced around 1965 when all the heavy equipment from the shack was loaded into the station sedan and caravan and taken to some remote hilltop locality. It was no small task to take full-sized AM transmitters, modulator, power supplies, antennas and kindred equipment plus a heavy duty alternator to supply 240 volts AC.

Over the next 20 years, I did this 49 times to 31 different locations. Fortunately, as time went on, solid state equipment took the place of valves so the load was considerably lightened, but it still took a lot of organising to run equipment for four bands plus FM. I admire those, who today, cheerfully (!) go mountain-topping with eight bands! But there is still something to be said for the lure of going to a remote spot, free of power line noise, with the elevation sufficient to considerably increase the normal range from that of a home station.

AM equipment improves

Gradually my AM equipment had improved. I was rather pleased with the big modulator I had constructed. This was used on six and two metres and consisted of a pair of 809 triodes in Class B complete with high level filtering and clipping. It was capable of 140 watts output but I restricted this to 100 watts to modulate my pair of 807s running at 100 watts. The tailoring of the audio signal was so good that minimal broadening of the signal occurred when full power was applied but the talkpower was 'awe-inspiring, so others told me! The same modulator was used with a QQEO6/40 on two metres with similar results, but in this case I turned the wick down to 70 watts of audio out of respect for the poor old 6/40!

I don't think that there is any question that, despite the advancements in technology which has seen the SSB/CW/FM transceiver take over so prominently on the VHF bands, that an AM signal of the magnitude which I could produce, would be hard to better. No wonder that on a crowded 50 MHz band I received an answer at the first call - it was better to have me out of the way and operating with someone else further up the band, than obliterating others!

For those who were actively involved during the AM days, few would disagree with the statement that they were very good days. You could have as lot of fun building your own equipment, first using crystals to control the frequency, then as techniques improved, moving on to VFO control.

ar

Part II continues next issue



Gordon Loveday VK4KAL
Coordinator, IARU/WIA Monitoring Service
QTH Rubyvale Q 4702

** It may be galling to amateurs, but these countries have over many years ignored all our attempts to remove them. We know of no means to improve the situation, but it is a shining example of what apathy can do to our legit band-space. Had we had more amateur cooperation over the last 20 years, things may have been different. Let it not happen again.

ar

Summary for January 2000

FREQ	DATE	UTC	EMM	DETAILS
3.560	120100	1003	A3E	R. Pyongyang, N Korea Pos ID**
07.098	25/01	0840	A3E	Rep of Indonesia varies freq*
14.098	24/01		A3E	Report only at this stage*
14.1385	24/01	0750	F7B	Ui Helsereiber type signal
14.2115	18/01	0988	F1B	RDL Moscow Nav Radio USSR**
14.290	31/01	1146	A3E	UiBC, H2 of 7.145 MHz
18.075	14/01	1213	A3E	Ui, Sounds like a Harmonic
18.100	21/01	1209	J3E	Ui, Indian, H3. Persistent

28.650 has not been observed in Australia since July 1999 so we must assume it has left our 10 mx band. All 3 Regions worked hard for this.

REPEATER LINK

Will McGhie VK6UU
21 Waterloo Cr Lesmurdie 6076
will2@omen.net.au
VK6UU@VK6BBR

Internet Linking, but is it legal?

The UK is pushing ahead with Internet linking of some voice repeaters. In Australia this type of operation is illegal as far as I know.

This is a spin off of the no connection to the public telephone network regulation. Not only is two way Internet linking between voice repeaters illegal but so is one way linking by placing repeater audio on the internet only. I reported on a VK4 amateur being told by the ACA to cease this type of operation about a year ago. At the rate at

which be are able to change voice repeater regulations in Australia don't expect to hear linked voice repeaters via the internet for a long while.

Amateur Radio

With summer in full swing and so many outdoor activities, amateur radio has taken a back seat. There are several outstanding repeater projects that need attention, one of which is the International HF beacon VK6RBP. There has been an ongoing problem with the multi band antenna for the beacon. The original R5 never had a good

SWR on 18 MHz so it was changed for an R7, which worked fine until a couple of months bank when all bands except 28 MHz developed a high SWR. The intention was to replace the R7 with another R5 and repair the R7. However it appears that the R5 may have a design problem with the 18 MHz band as two have been tested and both have a high SWR on 18 MHz. This now makes a total of 3 R5 antennas all with high SWR on 18 MHz. Work is proceeding and hopefully the International HF beacon will be back on air soon.

All in a day's work in an OB Van

I know I have whinged a bit of late about being busy at work with little time for amateur radio. Well it looks like work is slowing down a bit at long last after 4 months of long hours. Working for the National Broadcaster (ABC Television) is normally not this busy. It all started with a complete re-build of a Television outside broadcast van, OB van for short. This large 8 metre long vehicle was stripped bare and

There is a lot in an OB van, 10 cameras, 50 plus colour monitors, 20 input audio mixer, 20 input video mixer, 5 VHF-UHF communication systems, two of which are full duplex systems for production talk back, at least a kilometre of video cable and a kilometre of audio cable; the list goes on and on.

re-built. There is a lot in an OB van, 10 cameras, 50 plus colour monitors, 20 input audio mixer, 20 input video mixer, 5 VHF-UHF communication systems, two of which are full duplex systems for production talk back, at least a kilometre of video cable and a kilometre of audio cable; the list goes on and on. Extras like air conditioning for staff and equipment, power distribution, very extensive internal communications (ever body has to be able to talk to ever body at an OB) also spring to mind.

Twelve hour days on and off for about 3 months with few days off resulted in the OB van finished in time for a large OB, the Hopman cup. The viewer sits back and watches the tennis with little concept of the mammoth amount of equipment needed for a simple tennis match. Nine de-mountable huts, three OB vans, two other vans for video tape equipment, 20 cameras, 24 video tape machines, 8 microwave in-outs to the outside World to watch the tennis.

My contribution to this telecast over 7 days is the microwave links. Frequencies used are in the 2.5, 7 and 13 GHz bands. To set up for such a large OB requires several weeks of planning and about a week of

rigging before the event. What made it complicated and difficult this time round was the year 2000 World wide telecast the day and night before the beginning of the Hopman cup. A significant amount of the equipment needed for the Tennis OB was also needed for the millenium telecast. This equipment including one of the OB vans, several other vehicles and microwave link equipment. All this equipment had to be set up for the beach concert the day before the concert, the concert OB done on new years eve, then de-rigged that night (midnight) and rigged the following morning ready for the first tennis match on new years day. A few hours sleep between midnight and the next morning was all that could be fitted in.

Microwave links involve a variety of activities, one of which is climbing and installing heavy equipment on towers and buildings. Working till midnight the night before, and then rigging tower number one next morning was job one for the day. Like most estimates of how long it takes to do a job, tower one took twice as long as thought. Microwave equipment had to be hauled up, by hand some 85 metres (270 feet). for

continued next page

continued from previous page

reverse links from the ABC Perth studios to the tennis venue. There are several input links permanent on the tower, so these did not need to be rigged. Reverse links feed network programs for monitoring to the OB site, so the OB program can be timed into the network. Production people need to see the National program they are interfacing with for a variety of reasons. Interesting complication due to satellite and digital delays is the 3 to 4 second delay in seeing what you send to the network coming back to you. The national program that the OB slots into is delayed back at the OB site, so opening titles have to be pre-rolled some 3 seconds before. If this time delay problem is not enough, the picture and sound are not in synchronization due to what is called a frame store. Provided only one frame store is used, the picture to sound delay is usually okay, but more than one frame store can be used in series and the sound of a tennis player hitting the ball can become delayed enough for viewers to ring in and complain. Any way I'm getting off the point of rigging the links.

By the way the tennis venue is line of site to the ABC studios and all the other commercial TV stations, provided you are on the roof, some 30 metres high of the Superdome. This is often not the situation and all links have to go via a microwave repeater set up just for the event, a big enough task in itself. This at least made the job easier.

The next job, and it is now lunch time and the first tennis match starts at 4 PM, was to rig 3 sets of links at a commercial television station (CH9 Perth) for the International link feeds. I forgot to mention there are two tennis feeds, one for domestic and one for International. The commercial television station has the international satellite link required, so 3 links are rigged from the tennis OB site to CH9. At least the tennis international links at the tennis OB site had been able to be pre-rigged a few days

before, as they were not needed for the millenium concert. Why 3 links if there is only one international tennis feed? After all this is just two people hitting a ball back and forth. The reason is failure redundancy. Have you ever wondered why television stations are able to bring you sporting OBs from all over the country for days on end without the microwave links failing? And trust me they do fail. The reason is redundancy. For any major live OB two links are required, both running. In practice 3 links are required just to be extra safe for

Have you ever wondered why television stations are able to bring you sporting OBs from all over the country for days on end without the microwave links failing? And trust me they do fail. The reason is redundancy.

OBs like the Hopman cup.

Needless to say rigging at the CH9 50M (160 feet) tower took 3 times longer than thought. One of the problems was one of the 13 GHz links from the tennis to CH9 did not go. After much panning and tilting of the 1.2 metre dish the second 13 GHz link was to be looked at when times allowed, as time had run out. At least we had one 13 GHz and one 2.5 GHz link for the international feed from the tennis to CH9. With an hour to go there was only one link from the tennis to the ABC for the domestic program. Our next job back at the tennis OB site was to rig the remaining links, 2 backup program feeds and 2 reverse feeds for monitoring. Staff had to leave other jobs and make a start on the link rigging at the OB site as we could not make it in time from the CH9 site to the tennis site.

We went to air with a bare minimum of links for you the viewer to be able to enjoy the tennis, completely unaware of the effort required. This was an unusual situation due to the previous OB requirement the night before and normally most of the links are up and running for a major OB like this,

several days in advance.

One other point, there are differences between program sources such as a tennis match, requiring more link paths. For example the international feed often has no commentary, just crowd effects. There is no point in sending English commentary to a non speaking English country. The commentary is mixed into the crowd effects at the destination country in the local language. This different audio requires its own link. If this is not enough there can be network complications. During the tennis the afternoon matches may go pass 4PM Perth times and this is 7PM Eastern summer time. ABC news time. The tennis feed to the Eastern States has to have an out closing sequence that is not seen in Perth, as the telecast of the match carries on for Perth viewers. Different link feeds for the two different programs for that time, are required.

All in all outside broadcasts like tennis, golf, football etc are much more complex than 20 years ago. The amount of equipment, much of which is sent interstate from other television stations, is staggering. For example why 24 video tape machines at a tennis OB? Well all the replays come from video tape. Slow motion replays are replayed from tape. Also many cameras are iso (isolated) recorded for that "lets have another look at that from a different angle." Also edited highlight you see on the news or highlight packages have to but together and edited on tape. The end result, there is never enough tape machines to go round, and there are always a few not working properly.

Well this has been a brief description of a television outside broadcast. Looks so easy sitting back and watching the finished product at home, but the time, effort and equipment required is mind blowing. Hopefully some time for amateur radio now, or just a long rest as writing about it has left me exhausted.

ar

We manufacture a comprehensive range of HF, VHF and UHF antennas, baluns, power dividers, etc. to suit your application. Some of our log periodics provide continuous coverage from 13-30 MHz including WARC frequencies and replace outdated tribanders. Now in use in 48 overseas countries.

FREE CATALOGUE AVAILABLE FROM



ATN ANTENNAS PTY LTD

A.C.N. 062 557 644

- Create rotators, coax cables & non-conducting guy & halyard materials
- Hard-drawn copper antenna wire
- Insulators for DIY projects
- Inverted vee kits 160-30m
- High gain VHF & UHF amateur, scanning & TV Antennas

- High Sierra HF mobile antennas
- Butt section triangular aluminium towers for fixed or tilt-over applications
- Selection of power chips & TX tubes
- Diamond VSWR/PWR meters to 1300 MHz & accessories

**37 Morrison Street
PO Box 80, Birchip Vic, 3483
Ph: (03) 5492 2224
Fax: (03) 5492 2666**

SILENT KEY

James Rumble VK6RU (1917 - 1999)

It is with deep regret that I have to advise that Jim Rumble VK6RU became a Silent Key on the 21st December 1999.

At the age of 10, as a member of the Subiaco Boy Scouts, Jim first became interested in communications, where he learnt the morse code when communication then was with Aldis lamps.

Leaving school in 1936 he first worked for a land and estate agent but in 1937 he joined his father in the family pharmaceutical business E. Rumble and Co.

However, it was back in 1933 that he first joined the Subiaco Radio Society in the days when Bert Congdon VK6BC was the Secretary. Jim studied for his license through that Society and attended classes run for the WIA by Malcolm Murray VK6MY. November 1937 was the date he obtained his license and the call sign VK6RU that he held continuously until his death.

His first receiver was an OVI; a home built TRF receiver with type 57 and 58 tubes. The transmitter also home constructed with plug in coils and using 6A6 and 807 tubes, was first put to air on CW from the QTH in Subiaco of Ron Hugo (the late VK6KW).

Just before the war Jim joined the WIA when Clarry Cook was the QSL Officer, and in June 1939 took over that position which he held continuously until September 1999. When transmissions were forcibly stopped in Sept 1939 Jim had received many QSL cards with confirmation from 57 countries.

World War 2 caught up with him and he joined the army (at the same time as Ron Hugo) and was first posted as a Wireless Mechanic in the Ordinance Workshops at Bushmead (near Guildford). The late Jack Squires VK6JS was the permanent C/O. Transferred to service in the Pacific, he was posted to RAEME in Bouganville and promoted to Officer rank as a Lieutenant. Various army schools were attended and he was even seconded for some time as a diagnostic troubleshooter with a US Navy radio unit. When the war ended he was in Townsville and was finally demobbed on 24th December 1945. Immediately he resumed his amateur activities.

I personally first met Jim in 1949 when I was studying for my AOCPP where Jim ran the morse class and Ron Hugo was the

theory instructor at the Radio Society of Western Australia (formerly the Subiaco Radio Society). Jim became a DX hound in earnest and had worked 300 confirmed countries by 1948. However the total countries finally worked was 485 and all 485 QSL cards were on the wall of his shack. Postwar he missed out on only three countries - Damien Diu (an Indian State), Portuguese Goa and one other independent African State. One of the three missed only ever made five QSO's and unfortunately, although Jim heard this station, he missed this contact. Only four operators in the world have all these countries, one of who was Jim's friend the late W8GZ.

In the 1950's and 1960's 6RU was in most DX competitions that were held. His most prized certificate was the Golden Jubilee DXCC for which you had to obtain DXCC in one month as a deliberate operation, NOT a contest operation. Jim did this between 1st to 31st Jan 1987 and was the only one in Australia to achieve this certificate. Another achievement was DXCC on three bands in one contest (10, 15 and 20 metre DXCC in one weekend)

Jim traveled extensively and met many of his worldwide contacts from his collection of over 100,000 QSL cards. The most prized card he had was from JY1 - King Hussein of Jordan, worked in Nov 1970

The equipment he finally used was a Collins KWM2A transceiver (previously he had a Collins 32S1) with a Collins 30L1 linear amplifier which had four 572B tubes in the final. Antennas used were a 4-element monoband Yagi on 20 metres and above this a separate duoband radiator for 15 and 10 with separate reflectors and directors.

VK6RU was one of the stalwarts of Amateur Radio in Western Australia; a life member of the VK6 Division of the WIA and did much to advance the organisation and encourage and help new and young members to the hobby.

All members of the Institute and his many contacts worldwide are deeply saddened by his passing and send sincere condolences to Jim's three sons and their families.

Vale **Jim Rumble - VK6 Radio United.**
Tony Savory VK6TS
VK6 Councilor and Broadcast Officer

Ron Wills ZL2TT

It is with great sadness that I advise all Contesters of the death of Ron Wills ZL2TT.

Ron would have been quite well known to many of us in VK, through his strong interest and participation in Amateur Radio in general and contesting in particular.

Ron was diagnosed with a terminal illness around Christmas/New Year and given only two months to live. Sadly, he died in early February.

Ron was an active supporter of NZART, being Contest Co-ordinator for the last eighteen months or so. In this context, and through contest QSOs, I came to know Ron as a dedicated but always fair and helpful contestant. We shared a good rapport in keeping each other up to date with what was happening in our part of the world, as regards contests.

I shall miss him very much, as will his colleagues in NZ amateur radio.

Vale, Ron ZL2TT

Submitted by Ian Godsil VK3DID, WIA
Federal Contests Co-ordinator.

James Robert Walker VK2AJT

Jim passed away on 27th December 1999 after an illness of several years; he was buried at Nowra on the last day of 1999.

Jim spent 51 years in PMG/Telecom including 4 years of War Service. He retired in 1988 on the eve of his 65th birthday. As an Amateur he was a very resourceful and skilled constructor. He had many projects to his credit, from audio through to 433MHz, CW, SSB, RTTY and finally satellites. His last completed project being a real time computer controlled satellite tracking 2m/70cm antenna system.

To Jim's family and friends we extend our condolences.

John VK2BHO. 5 Jan 2000
John Hodgkinson, Warilla, NSW
30 November 1999

The WIA also regrets to
announce the recent passing of:-

(LEO) McGARRIGLE VK4CXR
D S ROBERTSON VK5RN
G J DINEEN VK7DF
D A (Denis) BAILEY VK2NVN
(Harold) HEPBURN VK3AFQ
L (Len) VERMEULEN VK3COD
C W (Cec) PURVIS VK3DEN
M R (Snow) CAMPBELL VK3MR

PSK31

the easy way

Alan J Gibbs, VK6PG

This paper outlines the concept of PSK31, proposed by Peter Martinez, G3PLX, and suggests an easy approach to constructing a simple interface between an Amateur Radio transceiver and the average home computer. A general overview of PSK software is covered from installation and operation of this new mode of communicating on the HF bands.

The future of PSK is also discussed, and conclusions suggest that new innovations in transceiver design, together with the possibility of multi-tone dedicated PSK modems being introduced into the Amateur Radio marketplace early in the New Millennium.

1. The Introduction

The average home computer is now well established in the Amateur Radio (AR) fraternity where assertive operators have devised easier ways of operating their equipment. Packet radio, RTTY, Logging and Control software now offer innovative ideas to keep track of information, and even turn the big beam antenna to coincide with the bearing of an entered callsign. DX tracking via Wormhole clusters, packet BBS nodes, and a massive increase in the use of the Internet has provided AR resources and research information, each uniquely leading to an explosion of information interchange enhancing the enjoyment of AR worldwide.

It has been many years since any "new modes" have been introduced. The more traditional CW, SSB, RTTY and specialised error detecting data modes, like Amtor (G3PLX), Pactor and Clover, have each added to the myriad of unusual "chirping" signals now heard on the international short wave AR bands.

However, with an increasing demand on the HF spectrum, and considering that most of the current modes of AR operation with the exception of CW are "spectrum hungry", the need for a new AR communications system that is more efficient in spectrum occupancy has become vital for the continued expansion of the AR service.

Based on an idea by SP9VRC and

developed by Peter Martinez, G3PLX (1) a new Amateur Mode called PSK31 is emerging. Instead of keying using Frequency Shift, FSK, this mode uses Phase Shift Keying, PSK. It uses an alphabet similar to Morse, which gives a text speed of about 50-wpm. Our experience to date shows that even without an error-correcting algorithm, copy is as good as any and better than most at low signal levels. It is a particularly attractive mode since it requires no lock condition or handshaking with a second radio station, and roundtable QSO's with more than two stations can be enjoyed (6).

Early experiments involved the use of a specialised PSK modem (4). Later, assertive AR operators wrote dedicated PSK computer programs (1) that exploited the digital sound conversion (DSP-CODEC) qualities of the average 16-bit computer sound card instead of acquiring an expensive and customised PSK modem. This concept, together with "freeware" PSK computer programs (7) has lead to a rapid worldwide expansion of PSK operation on the AR HF bands.

Already, the ARRL have approved claims for the first "All PSK" DXCC, and the British Amateur Radio Teledata Group (BARTG) have issued their first certificates to PSK operators, with 40 confirmed countries worked (4), in commemoration the 40th Anniversary of the BARTG. Even WAC using PSK is easily achievable in just one weekend of operation!

The need for a new AR communications system that is more efficient in spectrum occupancy has become vital for the continued expansion of the AR service.

Compiled: 21 November 1999

Alan J Gibbs, VK6PG
223 Crimea Street
NORANDA 6062
WESTERN AUSTRALIA

Telephone: +61 (08) 9275 3348
Email: vk6pg@tog.com.au
Web: <http://www2.tog.com.au/users/vk6pg/vk6sig>
Packet: VK6PG@VK6BBB.#PER.#WA.AUS.QC

For free use by Amateur Radio Operators only
© Copyright. All rights reserved
File: D:\MyFiles\psk_paper.doc

Today, 14Mhz is brisk with PSK traffic from all parts of the globe. Operators keyboard chat to each other in a similar manner to the more traditional RTTY contacts but with a considerably reduced bandwidth and enhanced signal to noise ratio. In fact, the bandwidth of PSK is narrower than keyed CW (1) and up to 60 PSK stations can operate within the usual spectrum occupied by a single SSB station. With all this in mind, PSK is well worth a look at by AR operators with a computer in their shack, and about one evening's work constructing a tiny interface from "junk box parts" connected between the transceiver and the computer.

2. Some Basic Theory

Peter Martinez, G3PLX (1) scanned normal text and compared the character usage with ASCII code for frequently used letters. A new binary code was then developed based upon his findings. From just 10 bits of binary code, all 128 ASCII characters were represented. Later, Peter extended this new code to include other accented characters for potential users in other countries. Naming the new code - *Varicode*, Peter established that with English text, Varicode had an average code length, including the '00' -letter gap, of 6.5 bits per character. By

simulating random bit errors and counting the number of corrupted characters, Peter found that Varicode is 50% better than start-stop code (Eg. RTTY) and verified that its self-synchronising properties worked very well.

When idle, Varicode sends a continuous string of zeros, just like the "diddle" used in RTTY message gaps, and using a reasonable typing speed of 50 words per minute, requires a bit rate of 32 per second. 31.25 was chosen because it is easily derived from the 8kHz sample rate used by many DSP systems. To make things easier, the bit rate was rounded off to 31 and the new mode became known as PSK31. It works by using phase shift keying, but instead of keying the carrier on and off which is wasteful, Peter shifts the phase of the carrier by 180 degrees. The polarity of the carrier is changed, and when "shifted" in this way the resulting Varicode becomes BPSK or Binary Phase Shift Keying. Demodulation of BPSK starts with a narrow bandpass filter of 62.5 Hz at the 50dB-down points. When at idle, the 31.25 BPSK signal offers receive synchronisation making the process reliable at normal text rate (1).

The new PSK31 signal now comprises a very narrow, PSK signal at 31.25 bauds, about 50 words per minute and slightly

slower than the more common RTTY signal running at 50 bauds or 66 words per minute. The "self synchronising" properties of PSK31, and its ability to occupy only a small bandwidth means that the receiving station can considerably reduce the receiver bandwidth hence improve the receive path signal to noise ratio (SNR). All this means lower transmit power, less interference to other users, more stations can be accommodated in the narrow allocations to the AR service, and better chances of working long haul DX in a busy part of the band. And lastly, the addition of a very exciting new mode of communications for Radio Amateurs around the world.

3. The System Requirements

The Internet now offers a large number of "freeware" PSK31 computer programs (9) including DOS based programs suitable for the older Intel 286 systems, through to higher level Window 95/98/00 32 bit operating systems running on faster Pentium III class machines.

Assuming you have a just humble, recycled Intel 486-DX2, 50mHz computer (just like the writer!), with a minimum of

continued next page

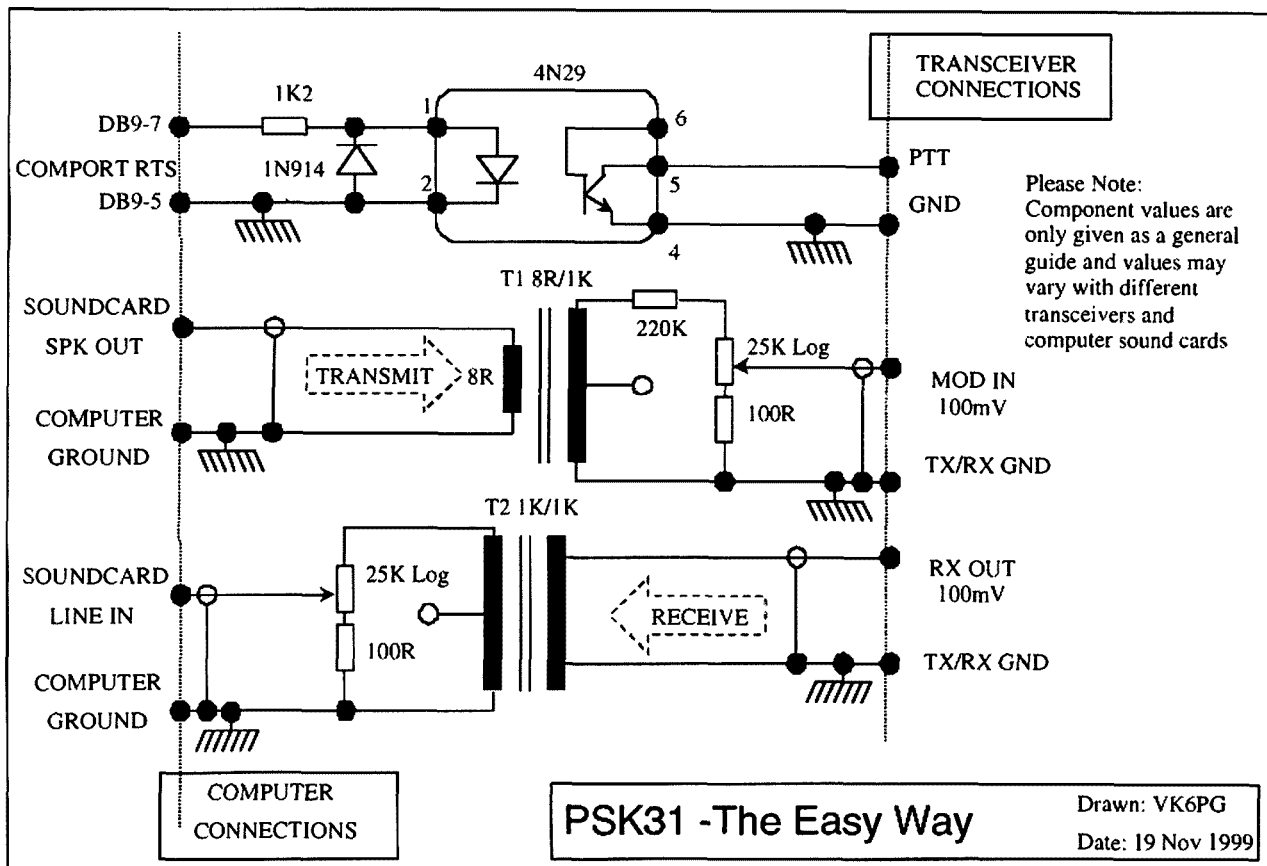


Figure 1: the interface box

continued from previous page

16 megabytes of RAM, a floppy disk drive, a good quality 16 bit sound card such as a SoundBlaster 16, and a spare communications (RS232) port – then you are in business. Windows 95, update 3 will work well on these machines provided you have a “clean system” with plenty of hard drive space available to experiment with different PSK and logging software when running your station.

4. Building the Interface Box

Linking the computer to your transceiver is the easy part, and an opportunity for you to do a little “home brew” in the process. For readers that just want to “try before you buy”, just connect the loudspeaker output from your transceiver to the line input of your sound card. Run your installed Windows sound mixer and select “Line In”. Run the software described in part 5 below and tune around 14.070 listening for a “warbling” sound. Vary the tuning to give an audible output of about 1kHz and you should see words appearing in the middle of the PSK software window. That’s it!

So, once you have listened, and watched the PSK31 QSO’s “warbling” around the world, and you’ve decided that you’d like

to have a go, then turn to the back page of this paper for a detailed circuit diagram of how to build the interface box.

The interface box uses two transformers for DC isolation between your computer and the transceiver.

Two potentiometers allow optimisation adjustments of transmit and receive levels. Fixed resistors “pad” the circuitry to prevent transmit overdrive and receive soundcard distortion. The PTT circuit comes from WM2U, and offers excellent snappy PTT control with the advantage of total optoisolation between the computer communications port and your transceiver. These techniques give you satisfaction that if any “funny business” happens between the computer and transceiver, then nothing will be damaged.

Do be prepared to make changes to the circuit to allow for the equipment variations used in your own shack. Perhaps you are lacking a line input and line output socket on your transceiver. In these circumstances the microphone-input socket might have to be used instead. In this case the input to the microphone socket must have an attenuator with a 100:1 gain reduction to avoid overdrive on transmit. If one of the pots seems to only work when stuck on one end of the rotation, then add/remove/change the values to give the correct levels in the center

of the potentiometer. Once this is done, no further adjustments are needed.

The writer used a normal “plastic style” box, and carried the screened cables through into the box. Remember to use log pots, which can be pre-sets or panel mounted with shiny knobs for later twiddling and fine-tuning. On the rear of the box, the writer fixed a recessed DB9 connector, that can be connected to the computer comport with a standard DB9/DB25 data cable. A small 3.5mm jack socket was used for the sound in, and the sound out used an “RCA” phono socket to avoid accidental cable interchange when “grubbing” around the rear panels of the equipment. The writer has not experienced any problems with RF breakthrough interference, but should this happen in your case, try a few ferrite beads on all input and output leads. Rest easy in the knowledge that you don’t have to build power supplies for this little box! The optoisolator is powered from the computer RTS line at the comport output.

5. The “Freeware” Software

Peter Martinez, G3PLX (2) designed a very simple PSK31 software package (shown in Figure 2) that provides all the features needed in an operational AR station. To

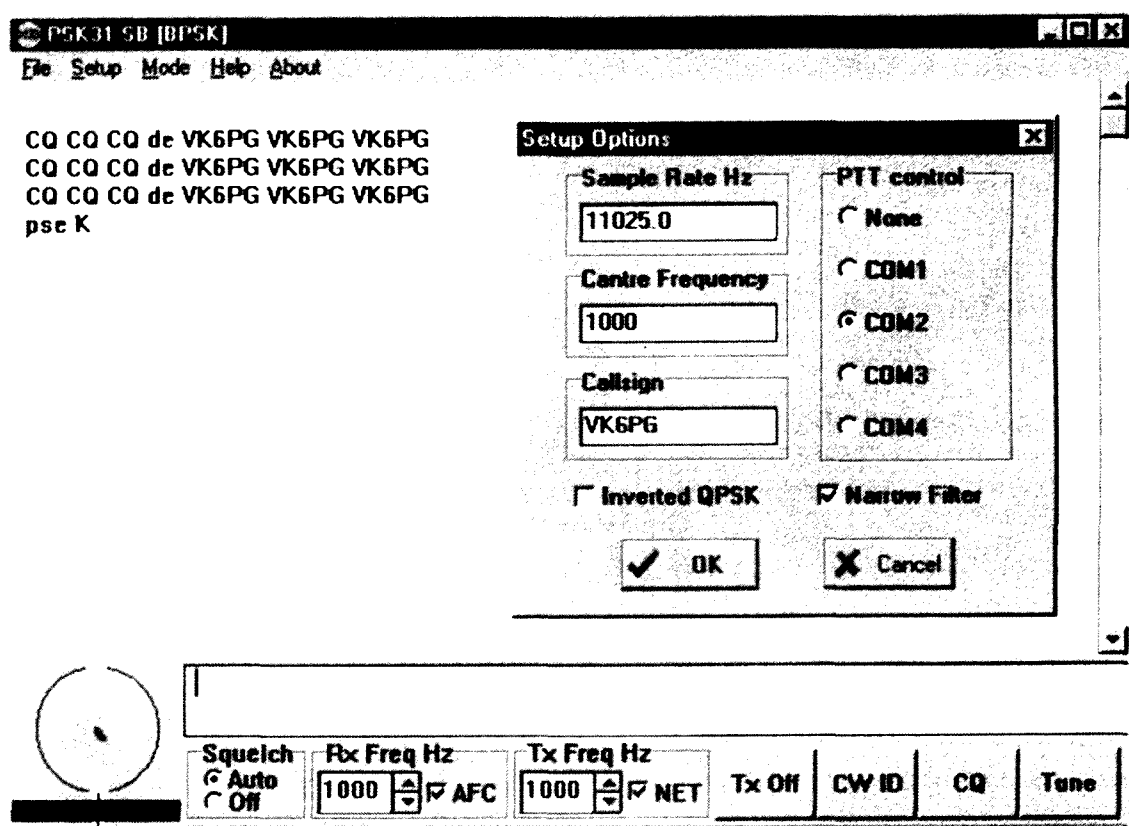


Figure 2: “freeware” software

further promote experimentation of PSK31, Peter has offered the software free-of-charge ("Freeware") to licensed AR operators. Windows 95/98/00 compatible software is freely available on the Internet (9), in compressed format, with the filename - *p31sbw108.zip (179k)*. Simply install this file in a new folder called PSK, Unzip the file using WinZip and place all the files together in the one PSK folder. Place a PSK shortcut pointing to the file - *psk31sbw.exe* on your desktop and you are ready to open the program and run the setup.

From the screen view shown, select the Setup menu to open the Setup Options dialogue box. Enter the sample rate at 11025.0 Hz, Centre Frequency at 1000, your own callsign, and the comport number for PTT access. Check the Narrow Filter radio button and close the box by "clicking" OK.

If you have a 16 bit sound card correctly installed on the computer and taken the mute off your loudspeakers then try "clicking" the CQ button. Your customised CQ will be heard in the speakers, the Phase Scope will display a green vertical line, and you should hear the characteristic "warble" of BPSK keying in the computer speakers. The large upper window will display each character when keyed by the software shown above. On completion, PSKSBW zero idles then automatically sends your callsign as a CW ident to complete your first "test transmission".

Selecting Tune will place the software into idle with a PSK31 signal ready to feed into your transceiver. TX Off simply drops the keyed tone and signals the comport to release your PTT line dropping your transceiver to receive mode. If your tests have been successful thus far, you are now ready to connect the transceiver audio output to the soundcard line input to receive live PSK31 signals off air.

Remember that PSK31 is experimental, and most authors have their own opinions to setting up individual stations. The following extract by WM2U reviews some overall tips and hints:

The simplest and quickest computer to radio interface is to connect the Line Output from the Sound Card to the transceiver audio input with a 100:1 voltage divider to reduce the voltage output, and the Sound Card Line Input to the audio output of the radio. You can use the VOX to switch from Receive to Transmit. To setup this arrangement, adjust the sound card output level using the computer 'mixer' control until maximum transmit power is reached, and the ALC is just starting to read. Then tune to a strong carrier and adjust the soundcard-input gain until the red line goes away as observed on the spectrum display. (Waterfall indicator) This procedure is covered in great detail in the PSK31 Help files under "setting up the sound card" (6.)

6. On the Air with PSK31

With the interface connected, and your transceiver connected to a dummy load, select the Tune button to activate the PTT line and send the PSK31 tone to your transceiver input. Turn down the transceiver microphone gain or disconnect the microphone altogether to avoid acoustic interference to the PSK31 signal. With audio compression switched off, adjust the power output to well below the ALC threshold and measure the output power of the transceiver. A good setting will be say 80 watts output from a 100 watt rated transmitter. This setting will ensure you are not overdriving the transmitter to a point where the transmit intermodulation products (IMD) are poor. This will give you a linear output with IMD figures in excess of 25dB or better.

Check that received PSK31 signals are clearly readable, and that the phase tuning indicator changes to yellow on received signals. When the tuning is "rocked" from side to side, PSK signals can be seen to move horizontally inside the Waterfall display below the phase scope loop. Signals will show up as pairs of white dots crawling slowly down the Waterfall, and fine-tuning allows centring the white dots on the graticule below the loop in the middle of the Waterfall. It takes a little practice but your time will be well spent if you learn how to receive PSK31 signals *before* you start transmitting them. If your received level is too high into the sound card, horizontal red lines with suddenly appear in the waterfall. If this happens reduce the receive level pot at your interface to avoid overload.

Note that on a received signal, the software automatically "Nets" with the incoming signal and the RX Freq Hz display may change to say 885 Hz. Leave the RX Freq Hz AFC box ticked, and the TX Freq Hz at Net to allow the software to "track" and "net" with stations that you wish to communicate with. Next, try re-entering 1000 Hz to both boxes. move the tuning so that a PSK31 signal is heard and within the Waterfall but clear of the graticule. Move the mouse onto the white PSK spots in the waterfall and "click" the mouse. The software will "autotrack" the wanted signal in phase, in the graticule, and will display the receive text in the large upper window.

The waterfall displays about 250 Hz high and low from the optimised 1000 Hz

WM2U's Hints List:

1. Set sound card sampling rate to 8000Hz
This must be at least a 16 bit sound card.
2. No Signal observed? Check WAVE slider is not zero.
3. Set Rx and Tx frequencies to 1000Hz.
NOTE: This value will get you up and running but if you plan on using a filter change it to the center frequency.
4. If using LSB check the "Inverted QPSK".
5. Too much noise! Use a narrow CW filter.
6. Using a Word Processor, write your buffered messages and save them as .txt files, placing eml in a folder called 'buffers' created in the main PSK31 folder.
NOTE: This is NOT a form of type ahead buffer. It is simply a method to pre write 'Standard' messages hence saving you keyboarding time.
7. READ THE HELP FILES.
8. Your sound card output must NOT overdrive your Mic Input.
9. Do not overdrive the sound card input from the Radio.
10. Get used to the Waterfall/Phase indicators for tuning.
11. Do not use your Speech Processor.
12. Be patient. This is a new mode. You will not find all the features you are used to yet!

Table 1: Hints list

continued next page

setting, this gives a visual display of channel activity, interference problems, tuning accuracy and a time display that slowly ripples down the window. A very useful device once you get used to its unusual characteristics.

Lastly, try typing on your computer keyboard. The first character automatically switches the transceiver to transmit, sends a preamble of "00's" and starts the transmission process. To return back to receive, just "click" the TX Off button. Once all this works to your satisfaction, signals can be simply resolved, and your transmissions are "clean and tidy". Now comes your chance to find some DX and have fun with PSK31.

To streamline some of your own activities, try opening the Windows Notepad text editor and type in your own customised CQ file. Save the file as say *cq_psk.txt* and place the file in your PSK folder. Try another file for your "Rig Info", another for your "Personal Info" and another for ... "Thanks for the contact. My QSL is fine via the Buro. 73's de (Callsign) SK" with one hard return at the end of the message. When you try selecting File, Send File, the dialogue box opens your PSK folder and lists all the saved .txt files ready for selection. "Double click" your choice and PSKSBW automatically sends the file for you. To abort at any time just "click" the Abort button and resume your chatting on the keyboard.

Once a file is being transmitted, you can "click" on the CW ID button at any time. Once the file has been completed, PSKSBW will send your CW ID and drop back to receive automatically. This is a nice feature for contests and snappy DX operating on the HF bands.

The main International-calling frequencies suggested by the RSGB (6) are:
3780.150 7035.150 14.070.150
21080.150 and 28080.150

Other WARC band allocations are currently being negotiated with other mode users. However, the following frequencies should be also tried:

3595.150 7037.150 10142.150
14.072.150 18102.150
21082.150 24082.150 and
28120.150

Good luck and fine DXing.

Once you have enjoyed your first PSK31 experiences, the time will soon come when you feel the need to improve your receive capabilities by adding audio DSP filters to minimise white noise and include additional

narrow transceiver receive filters. Just like any other mode, PSK31 is still vulnerable to adjacent channel interference. Tuning has to be very precise, and within a few Hertz to capture signal acquisition successfully.

The writer uses an Icom IC756 transceiver with a Timewave DSP9 to minimise noise and gain some degree of digital filtering. The IF bandwidth on the IC756 is reduced by operating the radio passband controls to prevent adjacent channel QRM from desensitising the receiver when trying to read PSK signals. It's rather like visualising the channel, and making adjustments according to band conditions at the time.

One writer (8) suggests that all these techniques are valid, including fitting a narrow CW filter and programming the receiver to "think" that it has an SSB filter in the IF chain. To do this, the PSK tone has to be shifted to 1200 Hz placing further demands on other devices like the audio DSP device. These are all techniques currently being explored to enhance the already exceptional qualities of PSK31.

The future of PSK looks very bright indeed ...

7. The Future of PSK

New developments in PSK (4 & 5) operations include digital, multi-channel telephony with 60 simultaneous PSK signals all within the spectral occupancy of existing SSB transmissions. Military users have been well practiced in the use of PSK for a number of years now, and the mode is well equipped with encryption technology for national security and commercial confidentiality. Specialised PSK development kits (2. Motorola DSP56002EVM by G3PLX) can be used in AR communications, and in digital telephone and satellite applications. Even the principles of the forthcoming digital television systems rely on PSK for minimising spectrum occupancy.

However, the simple concept of BPSK suggested in this paper is just the dawning of developments to come. Being a part of this euphoria is exciting and fun, yet economic to the average Radio Amateur who just likes to "fiddle" with new things or just aims for a DXCC on PSK31! AR commercial equipment designers and developers have yet to include PSK options with their equipment. But if they start thinking harder on how the digital programming options can be expanded to include these new mode configurations, then we are all in for an interesting New Millennium.

8. The Summary

This paper has been compiled because the writer would like to "give back" a little something to a hobby that has been much loved for almost half a century. This was earlier done with RTTY in the 70's, but with PSK the time is right to try conserve valuable spectrum space and to improve the resolution ability of communications for the benefit of all Radio Amateurs.

Why don't you give it a try?

The writer would like to commend the contributors listed in the reference section of this paper. They not only have demonstrated their own skills and prepared to share them with other AR operators, but also taken the time to write about their findings that we can all learn from their experiences.

9. References

1. Martinez, P. (G3PLX). PSK31: A new radio teletype mode. Part 1. RADCOM 12/98. p14
2. Martinez, P.(G3PLX). PSK31: A new radio teletype mode. Part 2. RADCOM 1/99. p 26
3. Ford, S. (WB8IMY). PSK31: Has RTTY's replacement arrived? QST 5/99. p. 41
4. Talbot, A. (G4JNT). Digital voice communication. RADCOM 10/99. p. 14
5. Talbot, A. (G4JNT). Digital voice communication. RADCOM 11/99. p. 20
6. G0OKD. PSK31 - The New Data Mode. RSARS Mercury. 11/99. p.16
7. WM2U. PSK31. <http://www.qsl.net/wm2u/psk31.html>
8. N1RCT. Adjusting filters for PSK31. <http://www.magalink.net/~n1rct/psk/filters.html>
9. EA2BAJ. PSK31 - The "Official" Web Site. <http://aintel.bi.edu.cs/psk31.html>
10. WD5GNR. PSK31 - PSK Front End Software. <http://www.qsl.net/wm2u/gnr.html>
11. VK6PG. PSK31 Australian download site: <http://www2.tpg.com.au/users/vk6pg/vk6sig>
12. Gibbs, A. (VK6PG). PSK31 - The Easy Way. <http://www2.tpg.com.au/users/vk6pg/vk6sig>

VHF UHF

AN
EXPANDING
WORLD

David K Minchin VK5KK

Postal: PO Box 789 Salisbury South Australia 5108

E-mail: tecknolt@arcom.com.au

Web page: <http://www.ozemail.com.au/~tecknolt>

Fax +61 8 82346396

Phone 0414 808060 (before 2130 EST please)

All times are UTC

6 metres is alive and well!!!

I thought we would get a rest from F2/TE. Wrong!

Neville Mattick, VK2QF, Hargraves, NSW, provides the following summary of 6 Metre Contacts for Dec 1999 through till the end of Jan 2000

13/12/99, YNISW [SSB] 2346z, YNISW 2344 [CW] 100 deg 599, K6MYC [Hrd] 2330z, ZL3JT 2313z, ZL4WA 2306z, XE1BEF [Hrd] 2211-2337z, XE2UZL/B & XE1KK/B 2203z.

14/12/99 TI2K1, TI5BX 2342-2344z 110deg to S9, XE2EED 0156z, 3F3XUG 0130z, WB6AAG 0126z, HP2CWB 0119z, K6QXY [Hrd 0116], WB6AAG 0108z, HP2CWB 0103z, TI2NA/B 0051-0129z, TI5BX, 0031z, TI2ALF 0029z, TI2K1 0027z, TI2RPT 0026z, TI5KD 0024z, TI7WA/4 0022z [CW] 110 deg mostly S9, N5JHV [Hrd] 0008z.

27/12/99 P29KFS 0903z 360deg 5x3, 27th** P29KFS 0903z 360deg 5x3, 15th December HL5XF & JA's heard from 0220z, TI2K1 0014z [running 2 watts] 110deg 5x5!

8/1/00 3D2AG/R 0219z 65deg 5x5.

10/1/00 HP3XUG 0030 106deg 559,

20/1/00 P29KFS 0301z 360 Deg 5x9, P29BPL/B 0827z 360 Deg.

24/1/00 JA2,4,5,6 0815z 330 deg to 599,

27/1/00 JA 0,1,2 330deg to 599,

29/1/00 XE1KK/B from 2327z, XE1/SM0OUG 2323z 90 deg 559, JA Beacons 0236-0411z, TI5BX 0208z, TI5KD 0203z [Hrd only], WILP/MM 0206&0158z, TI7WA/4 0150z, HP3XUG [Hrd only 0042-0105z], FO5DR/b 0054-0307z 96deg to 599,

30/1/00 XE1BEF [Hrd] 2336z, XE1KK/B 2331z, FO5DR/b 0013-0227z, FO5DR

0121 & 0131z 100deg 599, WILP/MM [EK51] 0116z 90deg 5X9, XE1UN

[Hrd], HRIRMG 0044z 95deg

31/1/00 AH6MIO/KH6 0403z 45deg 5x9, XE1BEF [Hrd QRZ-CW] 0031z

The contact to HRIRMG is possibly a HR-VK first as well as the Nicaragua YNISW also being a possible YN-VK first. Neville writes ... *"My feeling is that Sporadic E has mainly contributed to the unprecedented volume of Trans Pacific contacts for Dec/Jan. Mainly evidenced by the strong direct ZL 45V55 video and a number of 40MHz local indicators that are associated with E layer. It [the E propagation] has given us access to the TEP out in the Pacific, rare is the time that for example I hear a ZL working Central America and also work the Central American. Sort of a global opening at times."*

"As the E drifts in all the locals out at 1500+ km become audible too, then the longer paths fail! Interesting stuff and February could be interesting not mention March \ April, shades of 1989 again." ... Neville VK2QF

Wayne VK6JR, Perth, WA, reports ... *"The season started late and was very poor over the Christmas period. January had a number of openings with long skip zones and weakish signals. Amateur signals were heard or worked on 20 days during December and January with a total of 32 DX stations worked, some from the mobile. VK and/or ZL TV were heard on more than half the days.*

Best DX days were the 16/12, 17/1, 30/1." .. VK6JR

John, VK4FNQ, Charters Towers, QLD

reports an opening to Hawaii (KH6) 8/2/00 with the following heard 0615Z 50.064 MHz KH6HI BCN 529, 0618Z 50.061 MHz KH6HME BCN 519, 0626Z 50.110 MHz KH6SX HRD 41. Open to JA from 1000Z. On 14/2/00 0246 50.110 WA7JTM HRD 55, 0305 50.135 W5UWB HRD 31, 0309 50.110 VK8MS CQ 55, 0630 50.028 XE2UZL BCN 539, 0630 50.061 KH6HME BCN 529, 0630 50.064 KH6HI BCN 419, 0646 50.110 KH6SX CQ 419. (That XE2 station is rather late in the opening, see VK4BRG's comments below also)

Ron Graham, VK4BRG, Sarina, QLD, also reports on the openings from late Jan to Feb 2000 ... *"A good long lasting 6m opening from Central Qld. to the area around Panama."*

Monday 27th 0015 WILP/MM 5-5 5-5 Clint in FJ09 (near nth. entrance of Panama Canal 0027 HP3XUG 5-7 given 5-9 rec. EJ88, 0038 TI5KD 5-9 5-9 EJ79, 0057 WILP/MM 5-9 5-9, 0057 to 0144 WILP and HP3XUG heard from time to time calling/working VK stations. WILP commenting that this was the longest opening he had ever experienced considering the distance involved! 0200 copied WILP working VK4LE"

Further on 14/2/00 ... *"An interesting 6m opening to southern US states, essentially S. California to Texas .. commenced, for me, at 0146 UTC on 14th .. worked 12 stations by 0255 .. thought band had closed, so had a sched on 20 metres + lunch .. noticed band open .. worked another group of 11 stations till 0403 UTC."*

"This is late for a US opening, but back

continued next page

continued from previous page

in shack at 0542 and worked, as did some other VK4's, N6XQ. So, I would venture to say, the latest opening ever between VK and the US mainland. One XE worked, but he is close to S. California. The real odd one was W7HAH in Montana" ... VK4BRG

Tony VK3CAT, Melbourne, VIC, reports ... "Sunday morning, 30.1.2000 @ 0123, worked XE1J on 6 metres. XE1J was heard working many VK3s in the Melbourne area as well as to the East and West of the state. Es also present to VK4 and VK2 as well as ZL TV."

From New Zealand Mike Frobisher, ZL3TIC reports.. "On 14/02/00 during the large Stateside opening @ 2130 ZLAAAA worked EH8BPX 50.110 distance 18.900 km!!" ... ZL3TIC.

New Zealand stations reported (in general) excellent conditions to USA/Central America on both 13/2/00 and 14/2/00

David Vitek has sent in a comprehensive list of band conditions over the November to January 2000 period from Adelaide. No recorded openings, to VK5, have occurred to the America's or Europe in this time. The most substantial DX being JA on 26/11, 27/11, 28/11, 29/11, 30/11 and 4/12. Then there is a gap in JA openings till 8/1, 9/1, 25/1 and 31/1. Other log entries include Oceania DX, Asian TV etc. David has logged every opening and the various paths, from VK5 on 6 metres over this period. It makes fascinating reading and has helped give background on the role Sporadic E has played in enhancing F2 this year into other areas around Australia.

Should anyone, studying propagation, like a copy of this log, please let me know and I will forward a copy. Thanks again, David

Finally Scott VK4JSR reports hearing the "new" VK4RTL beacon on 50.087MHz MCW on 31/1/00. Can any one else confirm this frequency???

144 MHz and ABOVE ... TROPO!!!

Whether it has been a good or poor Tropo season varies, as usual, where you are on the continent. As I write this on 15/2/00, if you live in VK5 or 6 it has been well below par in all directions. The VK2 & 3 areas have been a little more fortunate.

Guy Fletcher, VK2KU reports ... "The Auckland (144.240) and Greymouth (144.286) beacons were audible for most of

Friday and Saturday (local) at up to S6 until 1000Z on 5 Feb. No other beacons heard; is the Hamilton beacon (144.256) operational?" Contacts as follows

3/2/00 2042Z 144.1 MHz ZL2TAL (54,56), 2050Z 432.1 ZL2TAL (51,51) - new square! 2115Z 144.1 ZL2VAL (56,56), 2132Z 144.1 ZL2TE (52,53)

4/2/00 2048Z 144.1 ZL3TY (56,55), 2137Z 144.12 ZL2VAL (52,51), 2324Z 144.2 ZL2TAL (31,53)

5/2/00 0621Z 144.1 ZL1IU (54,51) - only 25W at VK2KU

"As usual with ducts the New Plymouth stations were the first to appear. Bob ZL3TY in Greymouth had to be roused with a phone call when his beacon was S6!. Bob could almost certainly be worked on 70cm if he had an antenna to go with his rig." ... VK2KU

Gordon VK2ZAB reports ... "The long awaited duct to ZL came up today (3/2/00). Beacons at Auckland [144.24 MHz] and Greymouth [144.286 MHz] were in all day. Stations worked from here on 3/2/00 were at 2037z ZL2TAL on 2m, 2049z ZL2TAL on 70cm, 2115z

ZL2VAL on 2m, 2132z ZL2TE on 2m and on 4/2/00 at 0334z ZL1IU on 2m. Signal levels here were from S2 [ZL2TAL on 70cm] to S8 [ZL1IU on 2M]. Tried 23cm with ZL2TAL but no joy"

"The duct was maintained through Saturday (5/2/00) with Auckland and Greymouth beacons on 2m in all day. After much calling towards Greymouth without a response, Guy VK2KU 'phoned Bob ZL3TY who came up on 2m and after some difficulty with his transceiver was worked by Guy and then myself at 2146z 4/2/00. He was 5/3 and gave me 5/7."

"The few contacts to ZL were disappointing but there were a couple of interesting observations. The first was that stations in Christchurch and Dunedin heard Sydney pagers. Christchurch and Dunedin have been worked many times on 2m from here but always due to Sporadic Es. This was a duct and the first time in my experience that a duct has managed to transverse the mountain spine of the New Zealand south island. The second was that Bob VK2TG heard a weak 2m signal from FK1 on Saturday (5/2/00) evening. Same thing again — although New Caledonia has been worked on 2m from Sydney several times in the past it has always been due to Sporadic Es. Again this was a duct. First time this has been observed."

"On 8/2/00 Rej VK2MP worked Glen VK4TZL at Hervey Bay on 2m at good

strength over the 1100 plus km path. There was Tropo at the time as indicated by the fact that Rej had previously worked Bill VK2ZCV at Pt. Macquarie which is an unusual event in itself." ... VK2ZAB

On 7/2/00 David VK5KK Worked Wally VK6WG Albany on 144.1 MHz @ 925Z 56-9 and 432.12 MHz @ 932Z 51-2. Phil VK5AKK also worked VK6WG on 144.1 MHz @ ~940Z, 59 and 432.12 MHz @ ~950Z, 56. Wally again worked by VK5KK at 1135Z on 144.100 56. VK6DM was also heard but not worked as far as I am aware. Signals also around on 8/2/00 from 2000Z - 2300Z with the Esperance 2m beacon on 144.567 MHz

On 8/2/00 Trevor VK3KEG at Somerville was heard working VK6AS at around 2255Z on 144 MHz. At 0040Z 144MHz SSB VK3WRE worked VK7ZPB, 0045Z 432 MHz SSB VK3WRE worked VK7ZPB, 0050Z 144.120 MHz SSB VK3KAI worked VK7ZPB 57/57, 0052Z 432.160 MHz SSB VK3KAI worked VK7ZPB 51/33, 0101Z 50.200 MHz SSB VK3KAI worked VK7ZPB 55/55.

On 9/2/00 VK3AFW wkd VK7XR 2113 144.080 MHz 5x8 5x8, 432.180 MHz 5x1 5x1 & 50.150 MHz 1x1 3x1. VK3CY, Wedderburn wkd VK7ZPB Flinders Is 144.150 MHz 5x6 5x6, VK3FIQ, Stawell wkd VK7ZPB

ALBANY Beacon heard in VK5!

I has been nearly two years since the beacon was last heard. Since then it has changed QTH and the propagation has been indifferent! During the opening of the 7/2/00 & 8/2/00 between VK5 & VK6, VK6WG's signal finally reached 59 levels ... a first this year. Phil VK5AKK went searching for the Albany beacon and found it 3.5 kHz low!

Please note that VK6RTW has QSY'ed (drifted?) to 144.560.5 MHz! Copied to 53 by both VK5AKK & VK5KK around 930Z 7/2/00. The current location is well shielded to the Eastern States according to Wally, VK6WG. No further news on the possible relocation. The Esperance beacon, on 144.567 MHz, is fully operational and has been heard during the last two openings.

MILDURA 2 Metre Beacon

Chas VK3BRZ reports on the Mildura Beacon ... "Many of you may be unaware that Mildura has a 2m beacon in operation.

Evidently it went on air some time last year, but the information got to John VK3KWA too late for inclusion in the 2000 Callbook."

The beacon's details are as follows:

Callsign: VK3RRU

Frequency: 144.434 (drifts down to 144.433 on a hot day)

Keying: FSK CW with mark freq. about 500 Hz higher than space freq.

Power/Ant: I believe it's 10W to an Omni (remind me, John!)

Keying sequence: VK3RRU QF15CS MILDURA (sent in about 16 seconds) followed by a silent period (i.e. no signal at all) of approx. 22 seconds.

"It is normally just at or just below the threshold of detection in the evening at my place (Lara, QF21FX). QSB frequently brings it up to S1-2 for short periods. During the day, I hear some quite strong but short-duration (a couple of minutes, typically) lifts up to S3-4 occur at rare intervals, consistent perhaps with aircraft-enhancement. Maybe an aircraft flying somewhat diagonally across the path."

"I don't know who is currently responsible for operating the beacon, but I hope they keep it going. It's great to regularly hear signals from up there. It was very useful in predicting propagation while Les VK3ZLS was in Mildura (and environs) recently. We worked on both 2m and 70cm from QF05, QF15, QF06 and QF16. Not a bad haul, particularly as Les was only running 25W and a 12-el yagi on 70cm. Amazingly, we exchanged 59+ reports both ways when he was in QF06, but signals lasted less than 5 minutes. Definitely aircraft enhancement." ... VK3BRZ

From my recollection, Glen VK3ZGL (now VK5ZGL after moving to Adelaide late in 1999) set up the Beacon sometime ago. The "stealth-mode" between idents makes it a little hard to find but I believe this keeps the duty cycle down on the Transmitter. The beacon can be heard anytime in most parts of Adelaide (~350km) and has some unusual peaks when we have over the land Highs (hasn't been too many of those this year!). As for activity, nothing has been heard this year on 144 MHz SSB, from Mildura.

Microwave activity in the LaTrobe Valley

Peter Freeman, VK3KAI writes ... *"There are only 2 of us active on microwaves locally in the LaTrobe Valley (QF31) (Ralph VK3WRE and myself) (plus a couple of*

others with 23cm FM handhelds). The nearest operators are in Melbourne or at Bairnsdale (QF32 - approx. 122 km away). Most of our activity is on SSB.

I have had contact to QF32 (VK3EK at approx. 122km) from home on 13cm (2403MHz), as well as a few contacts back to the home square whilst playing Rover during the recent Summer Field Day contest, so I can now claim 5 squares worked on 13cm. Equipment used on this band is a G3WDG010 13cm transverter (from 144MHz) to H/B low level PA to VK5 PA kits (MGF0906 to MGF0907). Current power level about 4-5W out - should be able to increase this to about 10W by redesign of the low-level PA (3dB low at present). Antenna used on Field Day was a PayTV grid-pack style dish (approx. 80cm) with dipole/reflector feed. The same antenna is used on 23cm by changing the feed.

I have built the NIBWT 5.7GHz transverter and the Zack Lau 3.4GHz transverter, with some help from Ralph VK3WRE (my local microwave partner). We had a few initial problems with the 5.7 gear, but currently have about 5-6W out via a SS TWTA from Avantek (bought surplus from the UK a couple of years ago). I hope to increase the drive using another MMIC stage to get to 8mW drive, to give about 12W from the PA. On the Field Day Ralph and I had contacts to Mount Gambier (QF02) (VK5SR/p and VK5NC/p) on 5.7GHz - a distance of about 518km, after our first ever contacts over about 108km (VK3XPD/p and VK3KAB/p) - not a bad start to a new band! Antenna was an 800mm offset dish with horn feed which has not been optimised.

I currently have about 8mW on 3.4GHz, with the transverter barefoot. I have a California Microwave amp which needs a power supply to be built and then to be retuned onto the amateur band. I hope to get onto this task in the next couple of weeks. We worked 2 stations at 108km on the field day, again using an 800cm offset dish with a "coffee can" type feed. The kits for these bands are available from Mini-Kits and/or VK5 Equipment Supplies Committee.

So we have had a little success. Some of the other VK3 operators are starting to make noises about 5.7 and 2.4GHz. Barry VK3BJM and Mark VK3TLW currently have project for 5.7 "under construction". There are very few VK3 stations about at present on the bands between 23cm and 3cm. With the introduction of MDS television, we only have access 2400-2450MHz as secondary users. I wonder if

other countries might increase their amateur activity at 2400 after Phase3D is launched - it might make some EME contacts much easier, as well as increase the number of people about in VK with 13cm?? (Our 2.4GHz gear is set up for satellite operation at 2400 with a 144 IF, and we use it at 2403 narrowband with 147 IF).

In addition, we continue to organise a weak-signal VHF/UHF/Microwave theme conference each July - our third one is at the start of the planning process now. This is our effort to promote activity and information sharing here in SE VK. I am currently editing/compiling the Proceedings volume for the 1999 event - a task I hope to complete in the next week or so. Proceedings from the 1998 conference are available at \$15 in Australia (inc. P&P). More details on the Proceedings and of this year's conference soon - mark the dates in your diary now (July 8&9, 2000, venue is at Churchill). Feel free to contact me for further details. The organising committee would welcome expressions of interest from potential speakers"..... VK3KAI

Summer Field Day Jottings

Doug VK4OE writes ... *"It was a superb morning here, and I really enjoyed a couple of hours only on top of one of the commanding hills in Brisbane ... nothing special to report in the way of excellent propagation."*

"Three interesting anecdotes about QSO's in the field: Rod VK4KZR lashing together some disjointed modules across his bench to get himself onto 13cm; Glen VK4TZL breaking a welded bracket while trying to mount a 13cm antenna in the heat of the moment (would have been a good contact); and my finding out later that I had been operating (with some success.... probably due to the excellent location) on 70cm with both ends of the antenna's half wavelength coaxial balun wrenched free and disconnected! ... All good fun though!" VK4OE

On the Saturday night, 15/01/00, I counted only four stations as well as myself out in the Adelaide surrounds plus VK5SR/P in the SouthEast. The near 40-deg day temp kept a few people home it would seem. The SERG club station VK5SR was at Mt Graham about 40km NW of Mount Gambier, manned by Trevor VK5NC, Colin VK5DK & Tom VK5EE.

VK5KK/P/PF94iq Near Mount Compass

continued next page

continued from previous page

and VK5SR/P QF02hi, Mt Graham contacted each other on 144, 432, 1296, 3456, 5760 & 10368 MHz with signals 59 to ++ (especially on 5.7 GHz as always) over the 310km path. VK5SR/P also worked into Melbourne to VK3XPDP/P on the same bands (~500km) as well as working VK3KAI as reported previously.

One notable contact took place at 1305Z, 15/01/00 using 432.150 MHz FM between VK5SR/P and VK5KK/P Handheld to Handheld! Signals 55 on peaks. I don't think a Hand Held distance record "section" exists in VK records! What say John!

VK5KK/P also worked VK3ATL/P QF22dn, near Ballarat on 15/2/00 144.295 MHz @ 1317Z 53, 432.15 MHz 55 @ 1357 & 1296.18 MHz @ 1408Z, 51. Distance 555km. Signals from Melbourne weren't good enough to make it from Adelaide, unfortunately.

24 GHz Records Tumble in VK3 & VK5

The bottom end of VK3 & VK5 has been alive with Narrowband 24 GHz in early February. VK3ZQB, VK5DK & VK5NC have all been out testing gear and breaking records to boot. All equipment is based on DB6NT Mk3 transverters and DB6NT LNA & HPA's running in the region of 70-80mW

Russell VK3ZQB ... "Our contact (VK5NC/P3 to VK3ZQB/P3) 5/2/2000 on 24048 from Portland to Warrnambool was 72.9km distance, just a bit more than the (current) VK3 record. Not bad for a first up contact on new gear! The contact from Heywood to Tower hill was 69.6 km. As soon as we get some lift, we will be able to extend the distance without any effort!" ... VK3ZQB

Colin VK5DK reports.... "On 13/2/00 (Today) Trevor VK5NC & myself extended the VK5 24GHz distance record out to 78.53 kms from the old record of 38.5 kms. Contact was from Mt Graham to Mt Benson. The equipment used was DB6NT designed Transverters using SSB with an output of approx. 70mW into a pair of 400mm dishes at each end (1 for tx & 1 for rx). Signals were 5x9 both ways with excellent stability. More records to follow in the near future. Conditions today were only average with no lift at all and very windy." ... Colin VK5DK

ATV

In a recent conversation with AR's Editor, Colwyn VK5UE he made mention of a growing need for an ATV column. Last month, this column gave some brief ATV jottings, however this was only a small scratch on what is happening in all states. Most will remember the columns in ARA and a number of articles in AR in years gone by. If you would like to take up the

challenge, contact AR NOW!

Thank you to all who have contributed this month. Some general info has been held over till next month to allow some more room for band reports. Next month we will be into the equinox good and proper!

Lastly, while Mark VK5AVQ and myself were visiting Eric VK5LP the other weekend (routine maintenance!) we were left with the following to ponder...

1. Courage is the art of being the only one who knows you're scared to death.
2. Few people know how to hold a meeting. Even fewer know how to let it go.

Till next month

73's David VK5KK

STOP Press!!

On 17/2/00 1215z, VK3ZQB worked VK5NC and VK5DK on 24 GHz from Port Fairy QF11DP to the Bluff west of Mt Gambier QF02GG, a distance of 168.5km by grid locator. Sigs were 5-5 with qsb. At one stage sigs were 5-9 on the crest.at around 1030 - 1100Z. Not only is this a new VK5 & VK3 record, but possibly a new VK 24 Ghz record (subject to confirmation). More next month!

ar

Invitation from Japanese Amateur Radio Committee

We are the group of amateurs who managed to fulfil the dream of long-distance communication with 2mSSB and realised DX transmission with 2mSSB nationwide mobile communication.

This year is the 26th year of nationwide mobile communication and from 1997 we are communicating with some Asian countries by 2mSSB/DX mobile communication.

Among participants are Vladivostok (Russia), Seoul and Pusan (Korea), Taiwan and Hong Kong, and since last year we established QSO with Hong Kong as a major event.

This year we are inviting people from Shanghai, DU/VK to participate also.

We hope to promote international cooperation through amateur radio communication.

The 3rd Pan-Asian 2mSSB DX mobile communication

Time: 3 June 12.00 — 4 June 12.00; use horizontal waves.

We ask participants to inform us by SASE by the end of March (name, address, call sign, telephone number, mailing address). We will send details.

The 26th 2mSSB nationwide mobile communication

Time: 22 July 12.00 — 23 July 12.00; use horizontal waves

Please inform (name, address, call sign, telephone number, mailing address) by SASE by the end of April to the Executive Committee (address below).

We plan to use 21.350 frequency. Call by CQ—Japan and we'll inform the frequency. We also plan to do schedule QSO inside Japan.

Executive Committee
160-0022 Tokyo-to, Shinjuku-ku,
Shinjuku 1-17-13-308
Tel: 81 3 3226 0250
Fax: 81 3 3226 6520

Kiyoshi Honda

OVER TO YOU

We welcome your comments and feedback. Please keep letters as brief as possible, and send them to:

The Editor
Amateur Radio
PO Box 2175
Caulfield Junction Vic 3161

AWARDS

John Kelleher VK3DP

Federal Awards Officer

4 Brook Crescent, Box Hill South, Vic 3128 (03) 9889 8393

Nice to be back in the driver's seat after a sojourn in hospital. Somehow the January column again got lost "in the works!".

To other matters, I had just concluded a letter to a DX country expounding on all the absolute good qualities of the average Australian amateur operator, when, lo and behold, a letter arrived at my desk from a well known and active DXer. He quite honestly complained that his efforts to earn the WIA Grid Square Award on Six Metres was being curtailed by the lack of confirmation of contacts, namely QSL cards. But, that was not the only problem. To verify contacts for the abovementioned award, the Maidenhead Locator and name and address of the responder must be clearly shown on the QSL card.

So, after reading this short epistle, you have a twinge of conscience, please go ahead and make this unhappy operator a very happy little vegemite.

Hold the reins for a minute, can you?

Late in April, or early May, I will find it necessary to return to hospital for my third operation. Instead of begging off, and claiming some R and R, I invite interested persons to submit Award columns for the May and June editions of the magazine. Please adhere to the Production Deadlines published on the bottom of page 2 of your current AR magazine. I also apologise for some tardiness in answering some correspondence.

POLAND

10 SP RTTY Award

This award is available to all licensed radio amateurs and SWLs in the following classes.

- Class 1 - for 10 contacts /Swl rep. In Rtty mode with stations of Poland in all SP areas (SP1-SP9). Additional contacts with Polish Province LE (Leszno) or special event stations with prefix SN SPO

HF0 3Z0 are obligatory. A Qso with Polar Station HF0POL is also valid.

Class 2 - for 10 contacts /Swl in Rtty mode with stations in Poland.

Contacts with all SP call areas 1 to 9 is obligatory.

Class 3 - for 10 contacts /Swl in Rtty mode with different stations in Poland.

No date or band restrictions. Do not send QSL's. A GCR list must be certified by the Awards Manager of your Society, or by a radio club, or by two other licensed amateurs. Fee for the award is 10 IRC's, 10 DM, or 7 USD. Send applications to :-

Polski Związek Krotkofalowcow
Zarząd Terenowy
P.O. Box 42
64-100 Leszno 7
Poland.

Here is a short list of stations known to operate from LE province in RTTY mode on HF:

SP3AMZ, CUG, DKH, FHT, LRS, MIN, PZK, ZFH and SP3ZH.

Pilgrimages of the Holy Father, performed by the Pope John Paul II.

1. Availability. This award is available by individual amateur stations, club stations and Swl's in Poland, and worldwide.
2. Purpose. To commemorate the pilgrimages performed by Pope John Paul II, and to honour the personality of this great Pole. This award will be issued over an indefinite period.
3. Obtainment conditions. To perform confirmed contacts after 16 Oct 1978 with countries by Pope John Paul II during his pontificate. QSO's through satellite will not be acceptable.

4. Award Classes:

HF

Class 1 for contacts with 110 countries.

Class 2 for contacts with 75 countries.

Class 3 for contacts with 50 countries.

VHF

Class 1 for contacts with 15 countries

Class 2 for contacts with 10 countries

Class 3 for contacts with 5 countries.

On HF, contacts with Poland and Italy are obligatory. The fee is 10 IRC's 10 DM, or 7 USD. Send applications (GCR-list) to :-

Awards Manager PZK
Augustyn Wawrzynek SP6BOW
P.O. Box 42
64-100 Leszno 7
Poland.

Prefix list of countries visited up to December 1999, by the Holy Father.

A2, AP, C5, C9, CE, CN, CO, CP, CT, CX, D2, D4, DL, DU, EA, EI, ES, F, G, H4, HA, HB9, HB0, HC, HH, HI, HK, HL, HP, HR, HS, I, J5, J6, JA, K, KH2, KL7, KP4, LA, LU, LX, LY, OA, OD, OE, OH, OK, OM, ON, OZ, P2, PA, PY, S2, S5, S7, S9, SM, SP, T7, T9, TA, TF, TG, TI, TJ, TL, TN, TR, TT, TU, TY, TZ, V3, VE, VK, VU, XE, XT, YL, YN, YO, YS, YV, Z2, ZA, ZL, ZP, ZS, 3C, 3D2, 3DA, 3V, 3X, 4L, 4S, 4U1UN, 5H, 5N, 5R, 5V, 5X, 5Z, 6W, 6Y, 7P, 7Q, 9A, 9G, 9H, 9J, 9Q, 9U, 9V, 9X and 9Y.

Where's DX ?

Swaziland 3DA0 - Andre, 3DA0WPX, is QRV on 20m, usually between 1700 and 0000Z. QSL via ZS6WPX.

Vietnam 3W - Park, HL1ACP is QRV as 3W6AP. QSL via HL2AQN.

continued next page

continued from previous page

Mayotte Island FH - Christian, 6W1QV, is QRV for five months signing FH/TU5AX. Active on 40 to 6 Metres, QSL via F5OGL.

Midway Island KH4 - Paul NZ7Q/KH4, is QRV for another month, using CW on all bands. QSL via N6ZVA.

Franz Josef Land R1FJ - Nick R1FJV is operating daily on 20, 15, 12 and 10 metres until December 31, 2001. QSL via UA3AGS.

Antarctica - Mike, RW1AI is active as R1ANP from Progress base, until the end of March.

Poland SP - Special event station HF70PZK is active to celebrate the 70th anniversary of the Polish IARU member society. QSL via SP3CW.

Ghana 9G - Until March 20th, Andy G4ZVJ will be active using CW only.

QSL direct to Andy Chadwick at 5 Thorpe Chase, Ripon HG4 1UA, UK.

Tromelin Island FT/T - The Lyon DX group will be active from this most wanted country sometime around July or August 2000.

Svalbard Islands JW - LA9FJA will operate from this location signing JW9FJA for the next 7 months.

Switzerland - All Swiss amateurs may use the HB2 prefix during 2000.

Juan Fernandez Island CE0Z - A group from Finland hope to be active on this location from 17 March until 8 April. Calls used will be OH2MXS/CE0Z, OH2NSM/CE0Z and OH3JF/CE0Z. Modes will be cw, Rtty, andddd some SSB. QSL by operator's direction.

Agalega 3B6 - A multi-national team headed by HB9BXE will be active from this QTH in October of this year.

The Andaman and Lakshadweep Islands. VU - Nat, VU2NTA reports that neither of these Islands is likely to be activated in the near future if the local government has its way. This government is clearly not in favour of any amateur operation from any location in this island group.

Brazil ZV - Look for Delson PY4AUN, signing ZV4D until April 30 to celebrate the 500th anniversary of the discovery of Brazil.

Possible New Entity

Chesterfield Islands TX0 - IOTA OC-176, located at 158 deg 19 min east, 19 deg 52 min South, will be activated by a multi-national group, from March 15 through April 1. This operation is sponsored by Yaesu Musen, and supported by the RSGB IOTA management. The Chesterfield Dxpediton web site is at - <http://www.n4gn.com/tx0dx>.

Association des Radio Amateurs de Nouvelle Caledonie, the Amateur Radio Society of New Caledonia announces an IOTA-based Dxpediton which may activate a new DXCC entity as well. The ARANC expedition is headed by Eric Esposito FK8GM. Pending this body's application for IARU membership, the second phase of the operation may turn out to be the initial operation from a new DXCC entity, starting on March 23.

The expedition has secured a landing permit, and the transportation arrangements are being worked out from Koumac, at the northern tip of New Caledonia.

The radio operating team consists of FK8GM, FK8HC, JA1BK, N4GN, OH1RY, OH2BC, OH2BH and team doctor OH2RF. Several experienced pilots are co-ordinating the communications in and out of the Chesterfields and providing a continuous weather watch, because the Coral Sea typhoon season is still very active during March. These pilots include F6AJA, FK8CR, JH1KRC, K6GNX, and VK3EW.

TX0DX will have two QSL managers :- Jarmo Jaakola, OH2BN - for HF QSO's only, and Kan Mizoguchi, JA1BK - for 6 metre QSO's only.

Best 73, and good hunting, de John VK3DP

George Bass Award

The WIA Victoria George Bass Diploma aims to encourage more VHF and UHF simplex operation between mainland Australia and Tasmania - in other words, across the Bass Strait.

To qualify, mainland stations need to contact five VK7's on a single mode and a single band to qualify, while VK7's require to make 20 mainland contacts.

All operation must meet the diploma rules and comply with WIA Band Plans. Disqualification may occur for using FM in a SSB band segment, or prolonged operation on DX calling frequencies.

The rules are simple:

Operation must be two-way simplex telephony contacts across Bass Strait,

between November 1, 1999, and April 30, 2000.

Only FM or SSB modes are permitted on the 6-metre, 2-metre and 70-centimetre bands. Mainland stations must work five VK7 stations on a single band

VK7 stations require 20 mainland contacts on a single band. Diplomas are issued for single mode (FM or SSB) only.

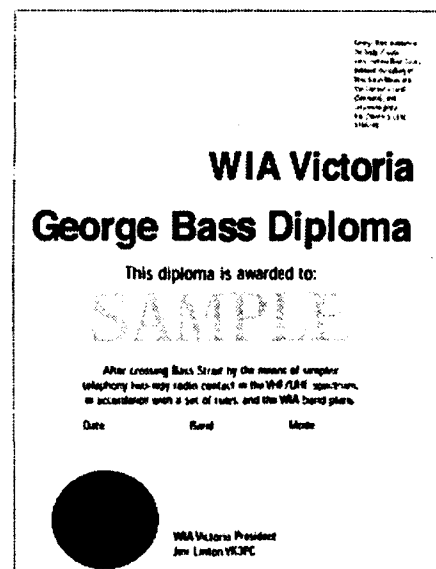
Only one callsign may be used by each radio amateur (no multiple callsigns).

To claim a diploma, send a signed copy of a log of contacts, plus \$5 to:

WIA Victoria
George Bass Diploma
40G Victory Boulevard
Ashburton 3147

Claims received more than one month after the diploma period will not be accepted

ar.



CONTESTS

Ian Godsil VK3DID,
57 Nepean Highway, Aspendale, 3195

Contest Calendar March — May 2000

Mar 4/5	ARRL International DX Contest (SSB)	(Jan 00)
Mar 11/12	RSGB Commonwealth Contest (CW)	(Feb 00)
Mar 11/12	World Wide Locator DX Contest (CW/SSB)	(Feb 00)
Mar 18/19	John Moyle Field Day (SSB) - VHF-UHF	(Feb 00)
Mar 18/19	Russian DX Contest (CW/SSB)	(Feb 00)
Mar 25/26	CQ WW WPX Contest (SSB)	(Feb 00)
Apr 1/2	SP DX Contest (CW/Phone)	(Mar 00)
Apr 8/10	JA DX CW Contest (High Band)	(Dec 99)
Apr 8/9	King of Spain DX Contest (CW/Phone)	
Apr 15/16	Holyland DX Contest (CW/Phone)	(Mar 00)
Apr 22/23	Helvetia DX Contest (CW/Phone)	(Mar 00)
Apr 22/23	SP RTTY Contest	(Mar 00)
Apr 24	Low Power Spring Sprint (CW)	(Feb 00)
Apr 25	Harry Angel Sprint (CW/SSB)	(Mar 00)
May 6/7	ARI International DX Contest (CW/SSB/RTTY)	
May 13/14	CQ-M International DX Contest (CW/SSB/SSTV)	
May 13/14	Sangster Shield NZART (CW)	
May 27/28	CQ WW WPX Contest (CW)	(Feb 00)

Thanks this month to NZART VK4NEF VK4TI

Erratum: Australian Postcode Contest (listed for April 2000) – as I was about to send this to the Editor I received news that this contest will longer be held. It was not very well patronized last year, hut still it is a shame to lose a local event from the calendar. VK2CA has made a suggestion for a revamp for future years.
Thanks Allan.

Greetings to all contesters and readers. How is your station? Good or in need of some checking in preparation for some of the bigger contests, and our forthcoming VK/ZL contest season in Winter. NOW is the time to check through and see that everything is in order.

In December I wrote about some of the difficulties with the RD Contest last year. It saddens me to report that NO-ONE bothered to reply. Do you not care what happens with the scoring, or even that other contesters are concerned to see difficulties and improvements of any type being addressed ? Is it a question of "They" will deal with that?

If that is so, then we are in danger of missing out —just like the operator who was asked if he would help a fellow Ham on another band, but who refused on the grounds that he was talking to his Ham

mates on the Internet. Well, that is his approach, but it will be the stone end of Amateur Radio if we all think like that!!

As regards the RD, I would like some input on the updating of categories to accommodate newer modes, please. Even if you don't want them, please SAY SO. Otherwise "They" WILL fix it up! Don't let the giant sleep, but wake him up.

QRP is very much alive and well both here in VK and overseas. There are several contests for this style of operating and I commend them to you, both as a possible change in your operating habits and as a challenge. They really are good fun, provided that you are prepared to treat them seriously. Please see the Calendar boxes for dates. If the details are not in this column, please ask me by phone or e-mail.

73 and good contesting. Ian Godsil
VK3DID Phone: 0408-123-557

E-mail:<contests@radiomag.com>

continued next page

Results CQ-M Contest 1999

(Call/cat/score/place)

VK8AV SOMB CW 630 2nd
VK4TT SO14 CW 960

SP DX Contest

1/2 April

1500z Sat - 1500z Sun

Categories: single operator (single/all band), multi-operator and SWL.

Bands: 160 - 10 m (no WARC)

Modes: CW and SSB. No mixed mode logs allowed.

Send RS(T) plus serial number. SPs will send RS(T) plus a two-letter province code.

Score three points per QSO with each Polish station.

Final score is total QSO points X number of Polish provinces worked (max 49). In this contest,

Multipliers are counted once only. SWLs must receive the callsign and number sent by Polish stations, plus the callsign worked. Each SP may be logged only once per band.

Send log, summary sheet and multiplier check sheet postmarked by 30 April to: SPDX Contest Committee, Box 320, 00-950 Warsaw, Poland. Disk logs in ASCII format are welcome.

Polish provinces are: *SP1:* KO SL SZ; *SP2:* BY EL GD TO WL; *SP3:* GO KL KN LE PI PO ZG; *SP4:* BK LO OL SU; *SP5:* CI OS PL SE WA; *SP6:* JG LG OP WB WR; *SP7:* K9I LD PT RA SI SK TG; *SP8:* BP CH KS LU PR RZ ZA; *SP9:* BB CZ KA KR NS TA.

Holyland DX Contest

16/17 April

1800z Sat - 1800z Sun,

Object is to work as many Israeli stations as possible.

Bands: 160 - 10 m (no WARC).

Categories: single and multi-operator multi-bands; SWL.

Send RS(T) plus serial number. Israeli stations will send RS(T) plus area code. The same stations may be contacted on both CW and SSB on each band.

Score two points per QSO on 160/80/40 and one point on 20/15/10.

Final score is total points X total areas, with areas counted separately for each band. SWLs should report Israeli stations only, and include time, callsign, station worked, RS(T) plus area code and points.

Send summary sheet and separate logs for each band, postmarked by 27 May 2000 to: Contest Manager, Israel Amateur Radio Club, Box 17600, Tel Aviv, Israel 61176.

Helvetia DX Contest

22/23 April

1300z Sat - 1300z Sun,

Work only Swiss stations, CW on 160 - 10 m and SSB on 80 - 10 m (no WARC). Each station may be worked only once per band regardless of mode.

Score three points per QSO.

Multiplier is total number of Swiss cantons worked (max 26 per band).

Send log to be received by 10 June to: Niklaus Zinsstag HB9DDZ, Salmendorfli 568, CH-4338 Rheinsulz, Switzerland.

Cantons are: AG AI AR BE BL BS FR GE GL GR JU LU NE NW OW SG SH SO SZ TG TI UR VD VS ZG ZH.

SP DX RTTY Contest

22/23 April

1200z Sat - 1200z Sun,

Categories: single operator all bands; multi-operator all bands; SWL.

Use Baudot mode only

Bands 80 - 10 m (no WARC).

Call CQ SP RVG TEST.

Exchange RST plus serial number.

Score two points per QSO with own country, five points with other countries in same continent and ten points with other continents.

Multippliers are the sum of DXCC countries and Polish provinces (max 49).

Send logs postmarked by 23 May to: SPDX RTTY Contest Manager, Box 253, 81-963 Gdynia 1, Poland.

Harry Angel Memorial Sprint

Tue 25 April, 2000

1100z - 1246z

This is the second year of a Contest to remember VK's oldest licensed operator, Harry Angel. Please note the time length of the Contest - 106 minutes, Harry's age when he died in 1998. It is open to all appropriately qualified HF operators.

Object is to make as many contacts as possible.

Band 80 metres,

Modes CW and SSB.

Categories: Single Operator (CW, Phone, Mixed) and SWL.

Frequencies: CW: 3500 - 3700 kHz, Phone: 3535 - 3700 kHz. Contacts in DX window not permitted.

Exchange RS(T) and serial number; revert to 001 if 999 reached.

Score two points per CW QSO and one point per Phone QSO.

Stations may be worked once only per mode.

Logs must show time UTC, callsign worked (both callsigns for SWLs), mode, RS(T), serial numbers sent and received for each QSO. Send summary sheet showing name and date of Contest, name and callsign of entrant, category entered, address, equipment used, points claimed and a signed declaration that the rules and spirit of the Contest were observed.

Send logs to Harry Angel sprint, PO Box 1647, Toowoomba, 4350, by Friday, 26 May, 2000. Logs may also be sent by e-mail in plain ASCII text to:

awards@wiaq.powerup.com.au

QSLs for VKOERZ

QRV at Davis base in the Antarctic is Lance VKOERZ. He is with the expedition down there and has his HF gear with him. He is on the air most nights at about 1200UTC on 14.225MHZ+/-QRM. His QSL manager and father is Humphrey VK2FUN or QSL via the bureau.

SPOTLIGHT ON SWLING

by Robin L. Harwood VK7RH
5 Helen Street, Newstead Tasmania 7250
(03) 6344 2324
E-mail: robroy@tassie.net.au

Digital Radio Broadcasting just around the corner

There was plenty of discussion recently about the many digital standards for audio and video broadcasting. Up to the present, two main standards for the digital radio broadcasting have emerged yet they are incompatible.

There has been some acrimony over which standard should be implemented. There is a European standard, otherwise known as Eureka 147 with some European broadcasters, mainly Germany and the U.K., putting trial programming to air. However there are very few receivers, commercially available at an affordable price.

Just to demonstrate this, one of the London commercial stations was putting out a trial broadcast complete with a 50 Hz hum. Nobody noticed it, including the stations' own technical staff, because they did not even have their own receiver to monitor the transmissions. A technical journalist was the first to report the fault to them, some weeks into their test. Nothing really happened for another couple of weeks until they obtained a receiver! If this had happened on a conventional broadcasting mode, it would have been noticed and speedily rectified in minutes.

To get some uniformity, a recent conference was held in Sydney (NSW) between the broadcasters, planners and importantly the commercial sector, which has to manufacture and market suitable receivers. It was agreed that a uniform worldwide standard is imperative, if digital audio broadcasting is to become commercially viable. So the two major digital audio platforms agreed to work together to achieve this objective.

One thing they did agree on is to rename Digital Audio Broadcasting (DAB) as Digital Radio. Now this will be confusing because there are already digital radios. Digital radios as we have them at present, have digital readouts to distinguish them from analogue and will not be capable of decoding the digital audio. Receivers that currently are available of decoding the Eureka 147 standard are prohibitively expensive in the U.K., costing between 400 to 800 pounds and naturally are not selling

well, as the existing FM standard tuners are more affordable and popular.

The application of digital broadcasting over short wave has already commenced with tests from Bonaire, Rampisham and Juelich. These are three major transmitting sites in Europe. Tests have also been conducted from Sackville in Canada. The format chosen is a modified form of the MPEG-3 standard. Initial tests, as reported by Nigel Holmes of Radio Australia, are promising yet it does depend on the number of hops. Receivers further away from the sender will experience more dropout and distortion, than those between 1,600 and 3,000 kilometres. Significant improvements can be expected at that distance. The tests, although promising, are rather inconclusive at this stage because further evaluation of the technology and the costs of implementing this have still to be worked out. At present, only expensive professional test receivers are capable of decoding these transmissions. Once a suitable format has been agreed, large-scale commercial production of receivers could start. Also the format needs to be uniform for domestic as well as short wave audio broadcasts.

I also think that, as there are many thousands if not millions of existing sets about, it should be very easy to utilize a suitable software programme with the computer sound card to decode these audio transmissions.

Austria in the News.

There were comments on one of the shortwave forums on the Net, about the presentation and content of Austrian Radio International (ORF). Most agreed it was rather boring and probably had few listeners. Well, that has all changed with a new coalition government being formed with the extreme right-wing Freedom Party, a junior member.

The party is led by a Herr Haider (or

Haidl) who has never disguised his admiration for Hitler and the Nazis. Once this party became part of Austria's government, many nations immediately imposed sanctions. Violent demonstrations also erupted in Vienna, in an effort to topple the government.

The audience to the ORF must have dramatically escalated, listening to the continuing drama and upheaval. The best frequency to hear Vienna here is 21 765 kHz at 0930 UTC. It is in English. Another very easy channel is 13730 kHz and this is mainly in German.

Changes: The BBC World Service is to increase the number of programming streams from three to eight, as from March 25th. This is when parts of the Northern Hemisphere adopt Daylight Saving.

The increase in streaming is going to be very interesting yet somewhat confusing. Changing to a lower or high frequency may result in a completely different programme stream to the one you require. "Communications World", the VOA media programme, is once more in a complete 25 minute segment. It was broken up into three separate ten-minute slots. However bowing to the requests of listeners, the programme was revamped early in February. The best time to hear it here is at 0935 UTC on Saturdays.

In conclusion: Don't forget that major frequency and programming alterations from 0100 UTC on the 25th of March. As earlier mentioned, this is when Daylight Saving commences in some of the Northern Hemisphere. We also go off Summer Time on the same date until the last week of August. It is being brought in earlier this year for the Sydney Olympics. Please also take note that my e-mail address is now vk7rh@primus.com.au. Until next time, the very best of monitoring and 73- Robin L. Harwood VK7RH.



RMB 1627 Milawa Vic. 3678
Email: vk3jt@amsat.org

National co-ordinator:

Graham Ratcliff VK5AGR Email:
vk5agr@amsat.org

AMSAT Australia net:

The AMSAT-Australia net meets formally on the second Sunday evening of the month. During the winter months in South Australia (end of March until the end of October) the net meets on 3.885 MHz +/- QRM with an official start time 1000 UTC with early check-ins at 0945 UTC. During the summer months when daylight saving is in operation in South Australia (end of October until end of March) the net meets on 7.068 MHz +/- QRM with an official start time of 0900 UTC with early check-ins at 0845 UTC. The times and frequencies have been chosen as the best compromise for an Australia-wide net taking into consideration seasonal propagation changes and the various state summer time variations.

AMSAT Australia newsletter and software service:

The newsletter is published monthly by Graham VK5AGR. Subscription is \$30 for Australia, \$35 for New Zealand and \$40 for other countries by AIR MAIL. It is payable to AMSAT Australia addressed as follows:

AMSAT Australia
GPO Box 2141
Adelaide SA 5001

Keplerian Elements

Current keps are available from the internet by accessing the AMSAT FTP site, ftp.amsat.org and following the sub-directories to "KEPS".

Multiple Satellite Launch Includes New Pico-Sats

After many delays, a USAF Minataur rocket successfully launched a complex payload into orbit on 26th January. The launch included several amateur radio packages.

A joint project between USAF and Weber State University called JAWSAT served as a launcher bus for Stanford University's Orbiting Picosat Automatic Launcher (OPAL), Arizona State University's ASUSat-1 and the USAF research lab's Optical Calibration Sphere.

The primary payload was the USAF Academy's FalconSat. OPAL appears to be healthy and is responding to commands. At the time of writing one pico-sat has been launched and is being commissioned. The ASUSat-1 ran for a day or so and then due to battery charge problems, stopped transmitting telemetry. The control team is trying to effect a recovery. ASUSat-1 contained an amateur packet hardware system and a 2m/70cm FM voice repeater, so it will be sad if it cannot be recovered. Hank, N4AFL, reports that StenSat is tentatively scheduled to be released from the OPAL satellite shortly after launch.

After the release command, StenSat will be ejected from OPAL with the batteries completely discharged. After approximately one or two hours of exposure to sunlight StenSat should wake up and start transmitting telemetry consisting of a standard 1200 baud AX.25 (AFSK) telemetry packet every 5 seconds and a Morse code ID that will be sent every four minutes. StenSat's uplink frequency is 145.84 MHz and the downlink is 436.625 MHz. More on the outcome of these launches next month as the commissioning continues.

The USAF Research Lab's Optical

Calibration Sphere (OCS) is a 2 metre diameter reflective sphere which has already been sighted with the naked-eye. Opportunities may be limited in this part of the world due to its orbital times being mostly in daylight or dusk periods. Worth a try though. The keps are available from the usual sources.

MIR Space Station News.

Information regarding the fate of MIR has proved to be most unreliable in the recent past, but it appears that Russia has launched a Progress cargo rocket to Mir carrying fuel and supplies. They are planning to send another crew to Mir in March. The supply rocket docked automatically, with fuel, water and other supplies, plus equipment needed to build up pressure inside Mir, which has a minor leak. At this time it's not known if Amateur Radio gear aboard MIR will be reactivated.

International Space Station News.

NASA reports that a team developing a prototype International Space Station 'lifeboat' called the X-38 Crew Return Vehicle successfully flew the largest parafoil parachute in history last week at the U.S. Army's Yuma Proving Ground. They successfully released a parachute with an area almost one and a half times as big as the wings of a Boeing 747 jumbo jet.

Yet Another Antarctic Expedition.

Ronald KE6JAB has been at it again. He sent his report to the AMSAT News Service on his return home from Antarctica last month:

"Hi folks,

I arrived back home from Antarctica 3 days ago, just one month late. We had a very successful time using the Pacsats Uo-22 and Ko-25, uploading daily reports and one or two photos each night. We used the Arrow dual band yagi throughout the trip, and because of the smallness of our tent we had to do all uploads 'outside'. This proved unpleasant in bad weather when the wind was blowing snow or the temperature was just too cold.

(see http://www.thistle.org/dml/photos/index.cgi?r_120~1.jpg)

Having enough power in the batteries was always a concern. We relied on solar panels for recharging everything. Fortunately in the area of our expedition we were blessed with much sunlight for long periods.

One of the most useful devices was the PalmPilot and a satellite prediction program called PocketSat. Mike, KF4FDJ, demo'd this to me at the Amsat Symposium in San Diego. This saved us from powering up the laptop, till just before the pass. It was referred to constantly. We encountered no software problems using Wisp or anything else on the laptop. However, the laptop needed rebooting often when the temperature dropped below -15°F. This was usually in the middle of an upload! Another successful part of the trip was the testing of a small weather station. This was built by Holda, KF6VIC a student of Professor Bob Twiggs at Stanford University. It used amongst other things a MIM module sending telemetry in APRS format. The station was placed high up on a nunatak, and transmitted every 20 minutes towards our area in the mountains, up to 24 miles away. We copied the data using a TH-D7 HT, then

retransmitted it back to Holda on the Pacsats.

(see <http://www.thistle.org/dml/photos/index.cgi?WthrSta.jpg>) Several Hams were key players in helping to get our messages and photos back to our friends and family. They were Ed, KE6IZN, Roy, WOSL, JERRY, K8SAT and KRISTI, N8WS. A very big thank you to all of them and to all the others who sent us messages on the birds. We appreciated reading all the messages while we huddled in our small tent. More on the expedition can be read at <http://www.thistle.org/dml/> best regards, Ronald, KE6JAB".

High Speed Data Acquisition from UO-36 (and others).

The February issue of the AMSAT-VK Newsletter contained a not-to-be-missed article by Colin Hurst VK5HI on this topic. Colin has spent some years developing software to cope with the ever-increasing complexities of the amateur radio satellite imaging systems employed on the current series of satellites, particularly those from University of Surrey, England. The results obtained from the earth-imaging cameras on board UO-36 are spectacular to say the least. In this article, Colin concentrated on the hardware side of things. Whilst there are other approaches, he is developing a system based around a circuit board from a German company called SYMEK. Colin's article details the modifications necessary to the receiver, the TNC and the modem. It is recommended reading for anyone contemplating a move into this exciting area. Colin's results are on the table and the article will make it possible for anyone with a reasonable grounding in the digisats to duplicate his results. As with any project "at the cutting edge", more developments are on the way. They will be reported in detail in the AMSAT-VK Newsletter and are sure to be discussed on-air during the AMSAT-VK monthly nets. This topic has also received its share of bandwidth on the AMSAT-BB bulletin board. Watch for more exciting news on this front as the download baud rates on the birds are increased from 38k4 through to 56k and beyond.

73, Bill...VK3JT

ar

For All Your Requirements

AUTHORISED DEALER

ICOM

KENWOOD

AMATEUR COMMERCIAL

GENERAL COMMUNICATIONS

 Tower
Communications

14 Mary Street
Hazelmere

Western Australia 6055
Telephone: (08) 9274 1118
Facsimile: (08) 9250 3734

E-mail: tower@eon.net.au

www: <http://www.tower.visionimage.com.au>

Andrews

Communications Systems

(EST. 1976 - ACN 001 968 752)



ALINCO

AUSTRALIA'S FIRST AUTHORISED
FACTORY DIRECT IMPORTER
MASSIVE SHIPMENTS EVERY MONTH

FULL 3-YEAR WARRANTY ON
ALINCO and ICOM
WE SELL MOST BRANDS

BALUNS, VERTICALS, YAGIS, P/S.
ICOM-KENWOOD-JRC-AOR-EMOTATOR-
MFJ-DIAMOND-TIMEWAVE-KANTRONICS
-THP - GARMIN - TERLIN - UNIDEN -ETC

**HUGE RANGE OF ELECTRONICS,
ICOM and ALINCO Radios.**

Over 22 Years of
Professional Sales and Service.
Instant Repairs Fridays

HF Transceivers & Linears Wanted

(02) 9636 9060 or (02) 9688 4301

SHOP 8, 41 BATHURST ST, GREYSTANES,
N.S.W. 2145. FAX (02) 9688 1995

HF PREDICTIONS

by Evan Jarman VK3ANI

34 Alandale Court, Blackburn Vic 3130

These graphs show the predicted diurnal variation of key frequencies for the nominated circuits.

These frequencies as identified in the legend are:-

- Upper Decile (F-layer)
- F-layer Maximum Useable Frequency
- E-layer Maximum Useable Frequency
- Optimum Working Frequency (F-layer)
- Absorption Limiting Frequency (D region)

Shown hourly are the highest frequency amateur bands in ranges between these key frequencies; when usable. The path, propagation mode and Australian terminal bearing are also given for each circuit.

These predictions were made with the Ionospheric Prediction Service program: ASAPS version 4.

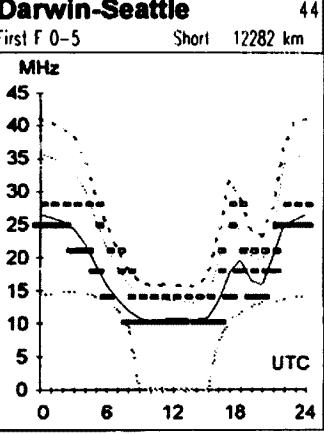
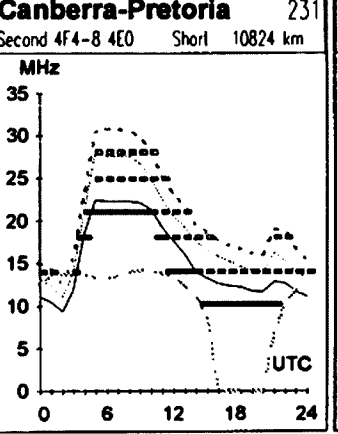
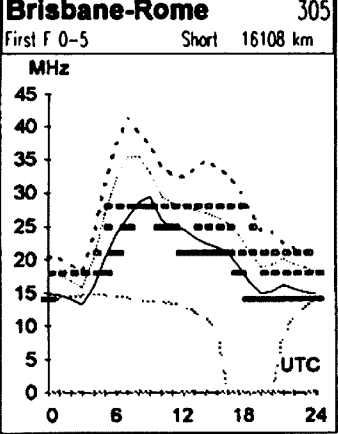
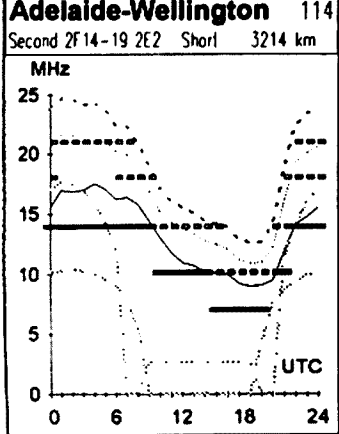
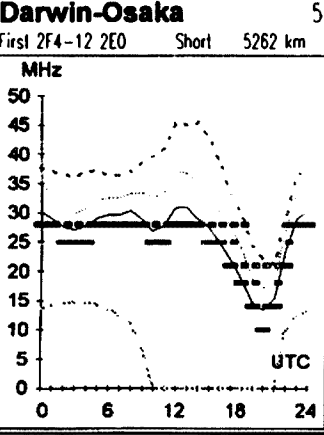
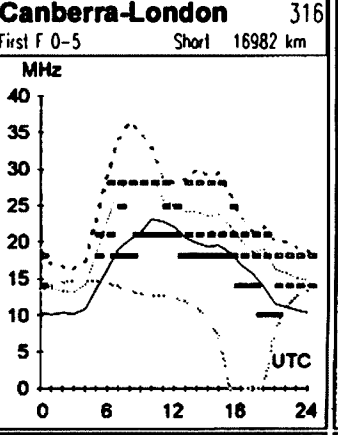
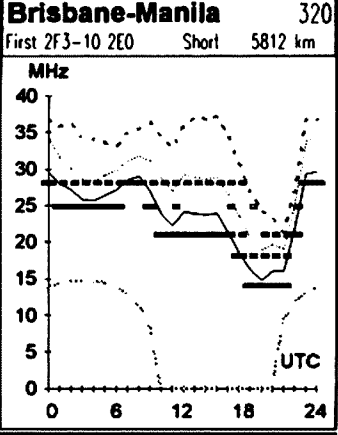
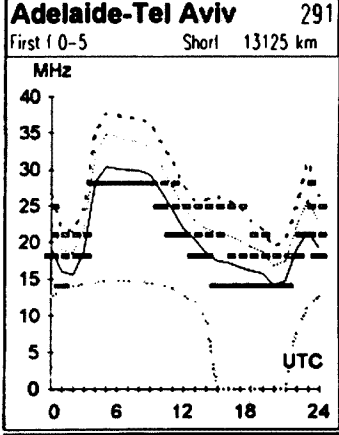
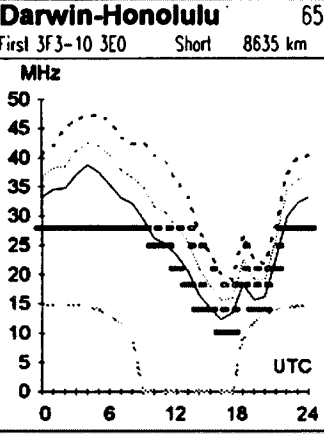
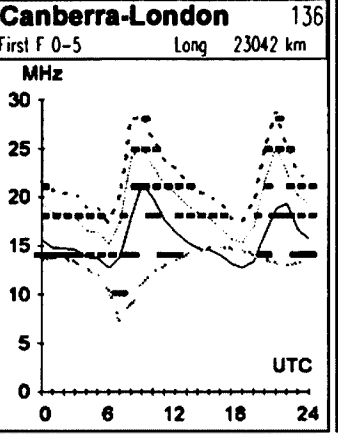
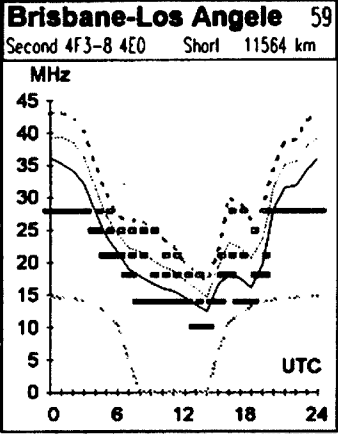
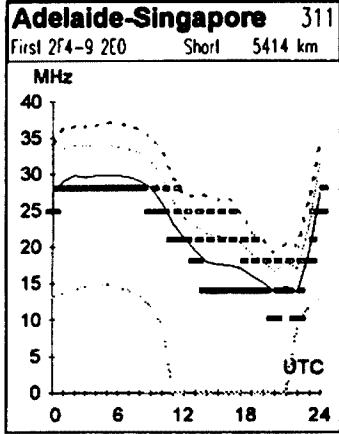
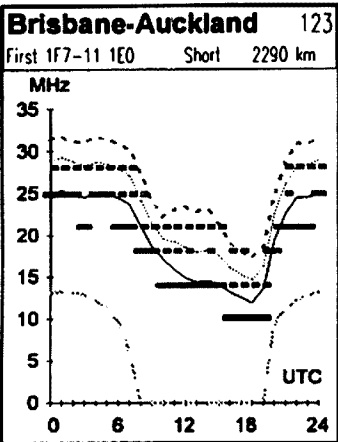
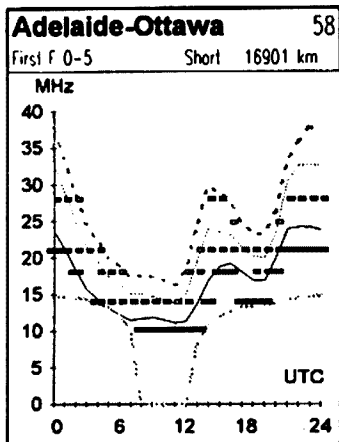
March 2000
T Index: 134

Legend

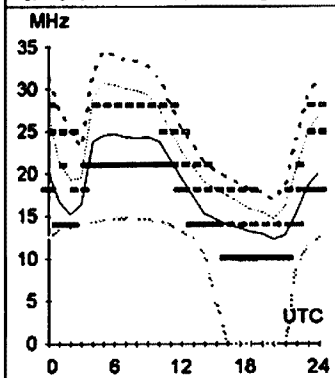
Frequency scale

- UD
- F-MUF
- E-MUF
- OWF
- ALF
- 10%-50%
- 50%-90%
- 90%-100%

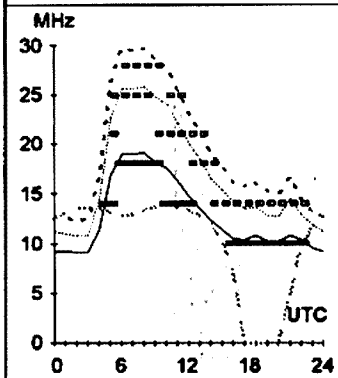
Time scale



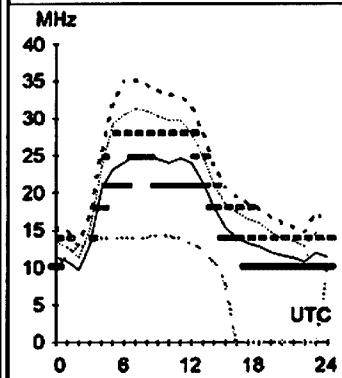
Hobart-Cairo 278
First F 0-5 Short 14263 km



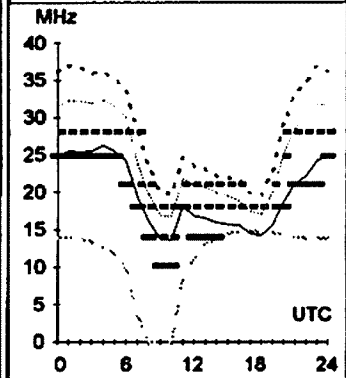
Melbourne-Capetown 222
Second 4F5-10 4E0 Short 10318 km



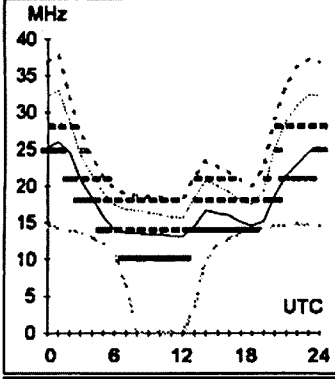
Perth-Johannesburg 248
First 3F3-10 3E0 Short 8315 km



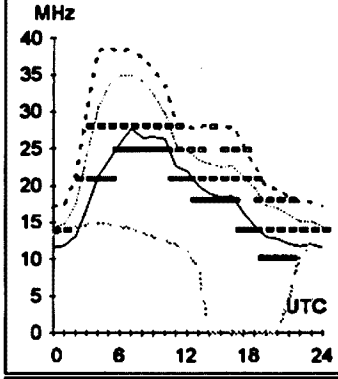
Sydney-Barbados 119
First F 0-5 Short 16155 km



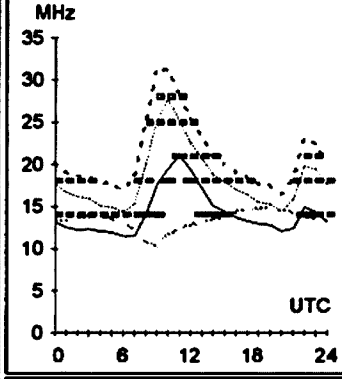
Hobart-Chicago 72
First F 0-5 Short 15576 km



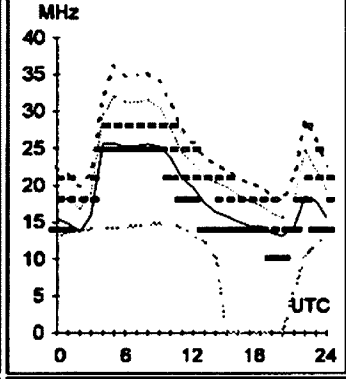
Melbourne-Moscow 316
First F 0-5 Short 14428 km



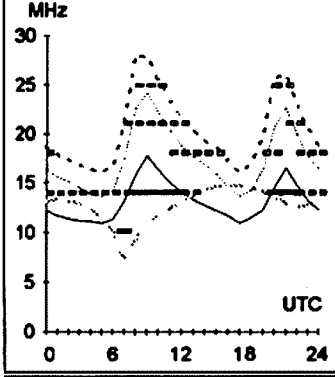
Perth-London 133
First F 0-5 Long 25543 km



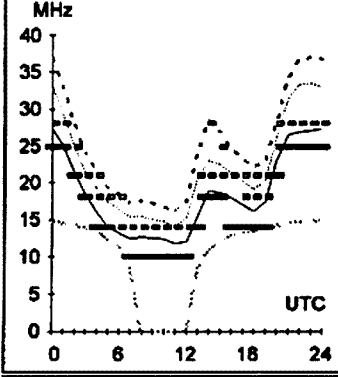
Sydney-Nairobi 255
First F 0-5 Short 12148 km



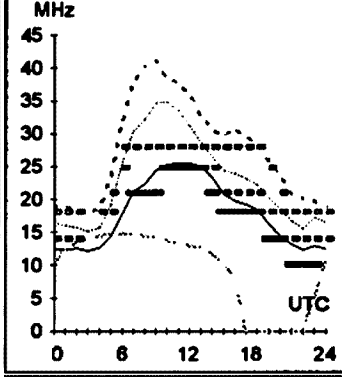
Hobart-Oslo 138
First F 0-5 Long 23451 km



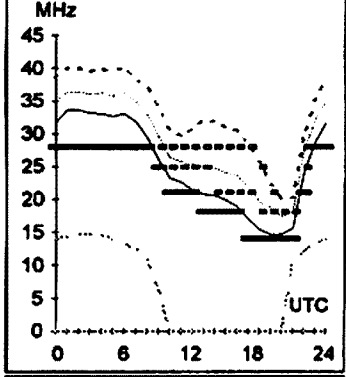
Melbourne-Ottawa 63
First F 0-5 Short 16566 km



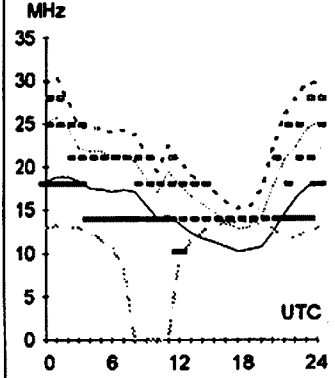
Perth-London 313
First F 0-5 Short 14481 km



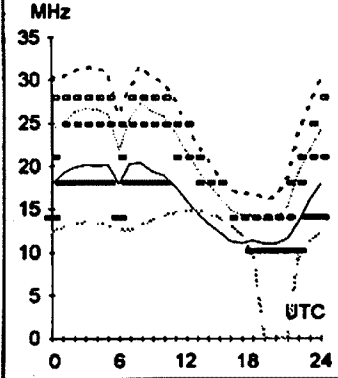
Sydney-Seoul 340
First 3F4-9 3E0 Short 8325 km



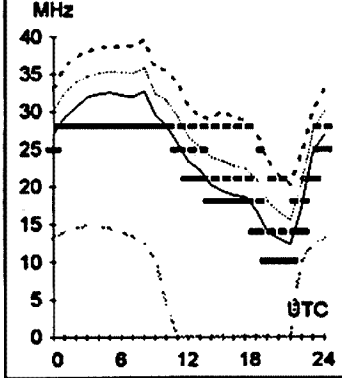
Hobart-Santiago 149
Second 4F5-9 4E0 Short 10686 km



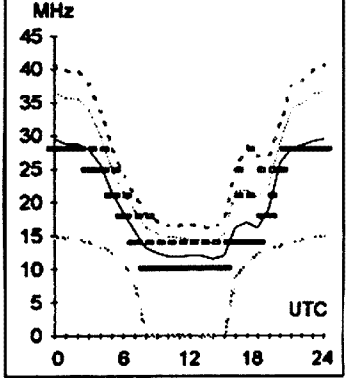
Melbourne-Senegal 219
First F 0-5 Short 16909 km



Perth-Tokyo 20
Second 4F4-114E0 Short 7923 km



Sydney-Vancouver 45
First F 0-5 Short 12501 km



HAMADS

- Hamads may be submitted on the form on the reverse of your current Amateur Radio address flysheet. Please print carefully, especially where case or numerals are critical.
- Please submit separate forms for For Sale and Wanted items, and be sure to include your name, address and telephone number (including STD code) if you do not use the flysheet.
- Eight lines (forty words) per issue free to all WIA members, ninth and tenth lines for name and address. Commercial rates apply for non-members.
- Deceased estates Hamads will be published in full, even if the ad is not fully radio equipment.
- WIA policy recommends that the serial number of all equipment for sale should be included.
- QTHR means the address is correct in the current WIA Call Book.
- Ordinary Hamads from members who are deemed to be in general electronics retail and wholesale distributive trades should be certified as referring only to private articles not being re-sold for merchandising purposes.
- Commercial advertising (Trade Hamads) are pre-payable at \$25.00 for four lines (twenty words), plus \$2.25 per line (or part thereof), with a minimum charge of \$25.00. Cheques are to be made out to: WIA Hamads.
- Copy should be typed or in block letters, and be received by the deadlines shown on page 1 of each issue of Amateur Radio, at:

Postal: Newsletters Unlimited, 29 Tanner Street, Richmond, 3121

Fax: 03 9428 4242

E-mail: news1@webtime.com.au

Please only send your Hamad once

Please send Hamads by mail OR fax OR email (much preferred).

Please do not send by more than one method for any one ad or issue, it is confusing.

FOR SALE NSW

- **Kenwood TS-940** in mint condition to swap for **Kenwood TS-850** in mint condition. I am willing to barter. Phone AH 02 6453 8759 or email mackie@post.com. Bob
- **DSE Model K-3206** 0-40v 3A benchtop power supply. Current limit approx 30 mA to 3.5A in two ranges and features meters for both voltage and current readings. New and never been used. 240v AC input. \$215 ono. Art VK2AS QTHR 02 9416 7784
- **Tech Tradiper TE-15** 440 kc 280 Mc. No book but have full manual. Leader 4DM815 TR DIP meter. Offers S Dogger, Tunnel Road, Stokers Siding 2484. 02 6677 9292 AH
- **Icom IC820H 2m/70cm** all mode base station \$1500. **Yaesu FT650** 6m/10m/12m all mode 100W with CW filter and tone options \$850. **Kenwood TM 461A** 70cm 35W mobile, latest model \$400. **FT290R II** All-mode 2m with FL2025 25W matching linear \$580. **FT790R II** 70cm all mode with FL7025 25W matching linear. All as new. Brad 0413 596 442
- **INTERNET Connect** from Port Macquarie to the Gold Coast from 80c per hour. Summerland Amateur Radio Club. For info - <http://www.nor.com.au/community/sarc/sarc.htm> Harry VK2XIO. QTHR, cascom@nor.com.au. PO Box 293, Lismore, 2480. Ph 02 66216096

WANTED NSW

- **Schematic circuit Compucon** 14 inch advance VGA colour monitor type SV1482 It loses the red colour now and again. Any help with this fault would be greatly appreciated. Art VK2AS QTHR 02 9416 7784

FOR SALE VIC

- **Receiver Manuals and CRO** handbooks sale. Eddystone models EC958, S770U and two of

model 770R. Drake model SPR4 and two of model SW-4A. Also ATE model RLS6 Radio Link manual. \$15 each. Tektronix CRO manuals for type 524AD and type 535/545 and plug-in type 53/54L \$25 each. VK3FFX ph 0409 027 835

- **Scope S54A-P7** excellent condition & handbook \$80. **Polar SP/BB** var caps, several 10, 25, 100 pF \$5 each. **Variacs 240/280** 1 X 4A, several 8A, \$20-\$40 each. **Gas laser & PSU**, Hi-Vis red EC \$40 FC 707 ATU, & handbook \$60, no deliveries. VK3DYD QTHR 03 9555 6714
- **Icom IC551D** Six metre all mode 80 watt output. s/n 01297. Comes with manuals, diagrams etc. In very good condition. \$550.00 Tony . VK3CAT. QTHR 03 95963367 AH
- **Yaesu FT900** (not 100 as Feb AR). All HF bands, all modes, NB, processor, keyer, detachable front panel for mobile etc. More features than the 840. New in carton \$1250. Andy, Croydon 03 9723 8380.

WANTED VICTORIA

- 1) **Radio compass MN-31 BC-433G SCR-269G**. Good price offered for complete manual.
- 2) **Canadian Marconi HF/TX TM11** original condition. Trevor VK3PP 03 5441 1197 reverse charge.
- **Desperately seeking a GELOSO G209-R** the Receiver Companion to the Transmitter G222-TR, I know they must be out there!. If you have one gathering dust I'll be happy to take it off your hands for a good price including shipping. Contact me Clint VK3CSJ on 03 97924500 or BH 03 92124070 or email at csjeffry@ozemail.com.au
- **Wanted to Buy or Swap Collins 32S-3** Transmitter : Dead or Alive (without too many modifications if possible). **Collins 516F** Power Supply: Preferably in working condition but will consider anything. **Collins 30L-1** Amplifier:

Dead or Alive. I'd also like to borrow, or buy if necessary, the Collins Service/Maintenance Videos Tapes for the 32S-3, the 75S-3, the KWM-2/2A and the 30L-1 Linear. Any help would be greatly appreciated. Please contact Carl, VK3EMF. Tel. AH: 97299728 E-mail: carls@alphalink.com.au

FOR SALE QLD

- **Silver Eagle** with TS-120S, no PSU, needs work, 21+28 MHz OK. Also hand mike and handbook. Paul VK4DJ tel 07 4778 6031
- **Mirage D26** 430-450 MHz, all mode 2/60W UHF amp, new condition S.N. 7517.193, 12 volt DC, \$325 posted **MFJ Tunable DSP filter** model MFJ784 12vDC. Good working order \$225 posted. Gordon VK4KAL QTHR or Ph & fax 07 4985 4168 evening please
- **Yaesu FL7000** amp with auto ATU \$2400. **Yaesu FT901** Transceiver \$300. **Kenwood TS-520** and ex-VFO \$280. **Icom IC-701, IC-701PS, IC-EX1, IC-RM3, IC-SM2** \$300. **Leader Sig-Gen** 0.1-30MHz, 75-115 MHz \$200. **Two 3 element Tri Band Beams** \$140 each. **133 Pentium computer** 16mb RAM 1 Gig HD in Minitower, keyboard Windows 95 \$280. John VK4AJS 07 4939 5724 or 0429 395 724
- **HTX-100**, 10 Meter SSB/CW transvr. Complete with Mic, mobile bracket. 25W output. This is a Brand New Radio, tested but never used, in original packaging. Covers 28.0 to 29.7 MHz. 10 mems. Perfect cond. \$150. VK4EJ.QTHR. (07)3205 5098 or vk4ej@telstra.easymail.com.au
- **SHACK CLEARANCE**. All the following are in good to excellent working condition & for sale by tender: **JRC NRD525 HF RX** "The Rolls Royce of radios" 90Hz - 34 MHz, 200 mems, notch, IF shift, scan, sweep etc, etc. Excellent condition. **TONO Theta 7000 RTTY/CW/ASCII computer** 1 - 44 wpm, 45.45, 50, 56.88, 74.2 Baud RTTY with 170, 425, 850 Hz shifts. 110, 300 Baud ASCII. AFSK, FSK, CRO TAPE, TV, PC, RADIO connections. 7 "brag" memories & type-ahead buffer. 12v @ 1 amp. **Yaesu FT77S** HFTX SSB/CW/FM 10 Watts out. 12v @ 3 amps. Used as 6mx TX through FT107R transverter. **Yaesu FT107R** transverter with 6mx, 2mx, 70cm modules, 3 satellite & repeater modes. Has output for 2nd RX using 10mx band. **Yaesu FV700DM** external digital VFO 12 memories, fast/slow sweep. Matches FT77, FT707 etc. **Yaesu FRG8800 HF RX** 150Hz - 30MHz, AM, FM, SSB, CW, 12 mems, 3 scan modes. 12v & 240v. **Yaesu FT707 HFTX** 100W SSB, CW, AM. also works with FT107R transverter. 12v Realistic **Pro2006 400 channel scanner**. 25 - 1300MHz AM, NFM, WFM 12V & 240V **Yaesu FT208R** 2mx Hand-held 10 mems, LCD readout, ext mic, 12v adaptor, desktop charger, spare (dead?) batteries, weighs a kilogram at least, goes well on ext. power. **Pentium 100MHz IBM compatible desktop PC** with 1.2 gig HD, 1 44 FDD, soundblaster, external modem. Win 95, Office 97, Telstra's Easymail (tree e-mail service) etc. **6E1** 6mx beam, **5E1** 2mx beam, TV beams. **ATV & UHF CB** beams, medium duty rotator, 6m high pipe mast, cables, swr, CB's, old CGA monitors, working 286 laptops, color computers (WEFAX), lots of large junk-box pieces etc. Make some offers & take them away! May consider trading. Items may be seen working in Brisbane. Call Steve (vk4khq@telstra.easymail.com.au) or phone 0408-743231.

WANTED QLD

• WWII Transmitter Receiver Type A Mark III, also Type 3 Mark II (B2) or part sets and MCR1 Receiver. Will pay reasonable money for all suitcase receivers, transmitters from WWII. Ray VK4FH PO Box 5263 Daisy Hill 4127 ph 07 3299 3819, fax 07 3299 3821

FOR SALE TAS

• Tono 150W all mode 2 metre linear amp, as new \$250 ono. Yaesu MH1B8 mic, new \$50. HF SWR/pwr meter twin meters. Good condition \$75 ono. Kenwood TH 78A FM Twin band h/held mint charger boom box also complete with SM33 spkr-mic BT8 dry cell case & Cig power adaptor \$550 ono. David VK7ZDJ 03 6425 2030 or 0413 219 680

• Satellite Station, FT736R Txvr (\$1500), TNC2+9600Bd Mdm (\$200), Kenpro 5400B Az/El Rotators (\$700), ATN X-Yagis (\$100), Kenwood R600HF Rx (\$350). Steve ph 0418 535 473 steve.toth@ericsson.com.au

FOR SALE SA

• Icom IC 738 100 Watt HF transceiver, 101 mem, ATU, handbook. Excellent condition, hardly used, in original packaging. \$1500. John VK5HJ 08 8535 4278

WANTED SA

• YAESU FT726 six metre boards and cables and connectors, 50 to 54 MHz D3000 237 and D3000 236. Geoff VK5JDZ 08 8296 7496 after 7pm QTHR

FOR SALE WA

• Drake TR7 + PS7 100 Watt HF Transceiver, Collins 30L-1, HF Linear, MFJ 262 1 kW d/load, MFJ 962 1.5kW ATU, MFJ 262 keyer requires 8044 Chip, IC 02E h/held with speaker mike, AOR 240A h/held, Kyoritsu. K-126-B G.D.O., Sanwa Fet VOM. Bob VK6KRC 08 9277 7049

• KLM 20M6, 6 Element 20m Yagi, 60 ft boom, full size, like new: \$1500.00 ono. KLM 10M6, 6 Element 10m Yagi, 30 ft boom, full size, like new: \$800.00 ono. Hy Gain 40m3, 3 Element 40m Yagi, linear loaded, working order: \$300.00. ono. Bill Hosie VK6ACY hosie@futurenet.co.za

MISCELLANEOUS

• If you got your licence before 1975 you are invited to join the Radio Amateurs Old Timers Club. A \$2.50 joining fee plus \$8.00 for one year or \$15.00 for two years gets you two interesting Journals a year plus good fellowship. Arthur Evans VK3VQ or Allan Doble VK3AMD can supply applications forms. Both are QTHR in any Call Book.

• The WIA QSL Collection (now Federal) requires QSLs. All types welcome, especially rare DX pictorial cards, special issue. Please contact the Hon Curator, Ken Matchett VK3TL, 4 Sunrise Hill Road Montrose VIC 3765, tel. 03 9728 5350.

PLEASE BE KIND TO OUR TYPIST

Our Hamad typist is not an expert in your field. Please write legibly on your form, using both capitals and lower case, and use legitimate abbreviations.

This saves excessive corrections by the proofreader, and reduces the chance of errors being published, which inconveniences everyone.

TRADE ADS

• AMIDON FERROMAGNETIC CORES:

For all RF applications. Send business size SASE for data/price to RJ & US Imports, PO Box 431, Kiama NSW 2533 (no enquiries at office please ... 14 Boanyo Ave Kiama).

www.cyberelectric.net.au/~rjandusimports

Agencies at: Assoc TV Service, Hobart; Truscotts Electronic World, Melbourne and Mildura; Alpha Tango Products, Perth; Haven Electronics, Nowra

<http://www.hamsearch.com>
a not-for-profit site that is a search engine for hams

• WEATHER FAX programs for IBM XT/ATs *** "RADFAXZ" \$35.00, is a high resolution short-wave weather fax, Morse and RTTY receiving program. Suitable for CGA, EGA, VGA and Hercules cards (state which). Needs SSB HF radio and RADFAX decoder. *** "SATFAX" \$45.00, is a NOAA, Meteor and GMS weather satellite picture receiving program. Needs EGA or VGA & WEATHER FAX PC card, + 137 MHz Receiver. *** "MAXISAT" \$75.00 is similar to SATFAX but needs 2 MB of expanded memory (EMS 3.6 or 4.0) and 1024 x 768 SVGA card. All programs are on 5.25" or 3.5" disks (state which) plus documentation, add \$3.00 postage. ONLY from M. Delahunty, 42 Villers St, New Farm QLD 4005. Ph 07 358 2785.

OVER TO YOU

The Kestrel Net

I have read the articles on this with some interest. I get the view we have several different things being discussed. So this month we continue the saga. Ed

Date: Friday, 4 February 2000 13:44

Subject: *Set the record straight.*

Having been associated with the Kestrel net for thirteen years my understanding of the naming of the net is as follows, - The yacht Kestrel was owned & skippered by Lloyd D. Pryke, VK2PZQ a retired dental specialist, the net was formed to keep in radio contact with Lloyd during his trips round the Pacific Islands & New Zealand. I have no record of a Noel Toohey ever

having been involved either on the vessel or a participant on the net. I would suggest that Kevin VK2CE check his facts, I can only assume that he has confused the Kestrel net with an earlier net on the same frequency the Castaways net though checking my log sheets for both nets I can find no call sign for a N. Toohey.

Let us be accurate.

Les Wood. VK2XG.

1927 Callsigns

Greetings once again from VK6ATE. I have today received my copy of Amateur Radio November 1999. I read with interest the paragraph on page 10 "Historic Yachtsman" with reference to Mr. F. Noel Toohey.

According to the text, Ron Fisher VK3OM has found (from pre-war Callbooks) that in 1927, Toohey had the callsign VK3CX. There is just one great problem "it just ain't so!"

To put the matter in correct perspective, no one had a callsign beginning VK in 1927. In 1927, Australian Amateurs (Experimenters) had a prefix OA (O for Oceania, A for Australia).

Ham Notes in the Radio Magazine of November 15th 1928 at page 61 explain how the new International Regulations will affect Amateurs. Amateur stations were to be called "Private Experimental Stations". The wavelengths they were allowed to use were

5-5.35, 10-10.7, 20.8-21.4, 41-42., 75-85 and 150-175 metres.

And finally —

The Australian letters are VHA-VMZ, so we can expect to have a callsign like VK2AX for an Amateur station in NSW. Presumably the Authorities will soon decide on this matter, as the new regulations *come into force in January next* (i.e. 1929 !!)

As I say — "Follow not without question the paths indicated by others, lest you end up in the garden on inaccuracy."

That said, I was nevertheless interested that Ron has access to old Callbooks and have written to him, asking for his help. Most of the information I collect comes from sources (magazines, Newspapers etc.) from within WA. I will also contact the Federal Historian asking for assistance. I look forward with anticipation to your replies.

Dave Handscomb VK6ATE (ex VK6NHD)

(Editors note: I have edited parts of this letter to conserve space, but not information)

WIA Division Directory

The WIA consists of seven autonomous State Divisions. Each member of the WIA is a member of a Division, usually in their residential State or Territory, and each Division looks after amateur radio affairs within its area.

Division	Address	Officers	News Broadcasts	Note: All times are local. All frequencies MHz.	Fees
VK1 ACT Division GPO Box 600 Canberra ACT 2601	President Secretary Treasurer	Gilbert Hughes John Woolner Les Davey	VK1GH VK1ET VK1LD	VK1WI: 3.570 LSB, 146.950 FM each Sunday evening from 8.00pm local time. The broadcast text is available on packet, on Internet aus.radio.amateur.misc news group, and on the VK1 Home Page http://www.vk1.wia.ampr.org	(F) \$72.00 (G) (S) \$58.00 (X) \$44.00
VK2 NSW Division 109 Wigram St Parramatta NSW (Office hours Mon-Fri 1100-1400) (PO Box 1066, Parramatta 2124) Phone 02 9689 2417 Freecall 1800 817 644 Fax 02 9633 1525	President Secretary Treasurer	Michael Corbin Eric Fossey Eric Van De Weyer	VK2YC VK2EFY VK2KUR	From VK2WI 1.845, 3.595, 7.146*, 10.125, 14.160, 24.950, 28.320, 29.120, 52.120, 52.525, 144.150, 147.000, 438.525, 1281.750 (* morning only) with relays to some of 18.120, 21.170, 584.750 ATV sound. Many country regions relay on 2 m or 70 cm repeaters. Sunday at 1000 and 1930. Highlights included in VK2AWX Newcastle news, Monday 1930 on 3.593 plus 10 m, 2 m, 70 cm, 23 cm. The broadcast text is available on the Internet newsgroup aus.radio.amateur.misc , and on packet radio.	(F) \$69.00 (G) (S) \$56.00 (X) \$41.00
VK3 Victorian Division 40G Victory Boulevard Ashburton VIC 3147 (Office hours Tue & Thur 0830-1530) Phone 03 9885 9261 Fax 03 9885 9298	President CEO Secretary	Jim Linton Barry Wilton Peter Mill	VK3PC VK3XV VK3APO	VK3BWI broadcasts on the 1st and 3rd Sunday of the month at 8.00pm. Primary frequencies, 3.615 LSB, 7.085 LSB, and FM(R)s VK3RML 146.700, VK3RMM 147.250, VK3RWG 147.225, and 70 cm FM(R)s VK3ROU 438.225, and VK3RMU 438.075. Major news under call VK3WI on Victorian packet BBS and WIA VIC Web Site.	(F) \$75.00 (G) (S) \$61.00 (X) \$47.00
VK4 Queensland Division GPO Box 638 Brisbane QLD 4001 Phone 07 3221 9377 Fax 07 3266 4926	President Secretary Treasurer Office Mgr e-mail: Web:	Colin Gladstone David Jones Bill McDermott John Stevens office@wiaq.powerup.com.au http://www.wia.org.au/vk4	VK4ACG VK4OF VK4AZM VK4AFS	VK4WIA broadcasts on 1.825 MHz SSB, 3.605 MHz SSB, 7.118 MHz SSB, 10.135 MHz SSB, 14.342 MHz SSB, 21.175 MHz SSB, 28.400 MHz SSB, 29.660 MHz FM (rptr), 147.000 MHz, and 438.525 MHz (in the Brisbane region, and on regional VHF/UHF repeaters) at 0900 hrs K every Sunday morning. ONEWS is repeated Monday evenings, at 19.30 hrs K, on 3.605 MHz SSB and 147.000 MHz FM. On Sunday evenings, at 18.45 hrs K on 3.605 MHz and 147.000 MHz, a repeat of the previous week's edition of QNEWS is broadcast. Broadcast news in text form on packet is available under WIAQ@VKNET. QNEWS Text and real audio files available from the web site	(F) \$85.00 (G) (S) \$72.00 (X) \$56.00
VK5 South Australian Division (GPO Box 1234 Adelaide SA 5001) Phone 08 8294 2992	President Secretary Treasurer	Jim McLachlan David Minchin John Butler	VK5NB VK5KK VK5NX	VK5WI: 1827 kHz AM, 3.550 MHz LSB, 7.095 AM, 14.175 USB, 28.470 USB, 53.100 FM, 147.000 FM Adelaide, 146.700 FM Mid North, 146.800 FM Mildura, 146.825 FM Barossa Valley, 146.900 FM South East, 146.925 FM Central North, 147.825 FM Gawler, 438.425 FM Barossa Valley, 438.475 FM Adelaide North, ATV Ch 35 579.250 Adelaide. (NT) 3.555 USB, 7.065 USB, 10.125 USB, 146.700 FM, 0900 hrs Sunday, 3.585 MHz and 146.675 MHz FM Adelaide, 1930 hrs Monday.	(F) \$77.00 (G) (S) \$63.00 (X) \$49.00
VK6 West Australian Division PO Box 10 West Perth WA 6872 Phone 08 9351 8873	Acting Pres. Secretary Treasurer Web: e-mail:	Cliff Bastin Christine Bastin Bruce Hedland-Thornas http://www.omen.net.au/~vk6wia/ vk6wia@omen.net.au	VK6LZ VK6ZLZ VK6OO	VK6WIA: 146.700 FM(R) Perth at 0930hrs Sunday relayed on 1.865, 3.564, 7.075, 10.125, 14.116, 14.175, 21.185, 29.120 FM, 50.150 and 438.525 MHz, Country relays 3.582, 147.200 (R) Cataby, 147.350 (R) Busselton, 146.900 (R) Mt William (Bunbury), 147.000 (R) Katanning and 147.250 (R) Mt Saddleback. Broadcast repeated on 146.700 at 1900 hrs Sunday relayed on 1.865, 3.564 and 438.525 MHz : country relays on 146.900, 147.000, 147.2000, 147.250 and 147.350 MHz..Also in "Real Audio" format from the VK6 WIA website	(F) \$69.00 (G) (S) \$59.00 (X) \$38.00
VK7 Tasmanian Division PO Box 271 Riverside TAS 7250 Phone 03 6425 2923 Fax 03 6425 2923	President Secretary Treasurer Web:	Ron Churcher Tony Bedelph John Bates http://www.wia.tasnet.net	VK7RN VK7AX VK7RT	VK7WI: 146.700 MHz FM (VK7RHT) at 0930 hrs Sunday relayed on 147.000 (VK7RAA), 146.725 (VK7RNE), 146.625 (VK7RMD), 3.570, 7.090, 14.130, 52.100, 144.150 (Hobart), repeated Tues 3.590 at 1930 hrs.	(F) \$88.00 (G) (S) \$75.00 (X) \$55.00
VK8 Northern Territory (part of the VK5 Division and relays broadcasts from VK5 as shown, received on 14 or 28 MHz).				Membership Grades Full (F) Pension (G) Needy (G) Student (S) Non receipt of AR (X) Three-year membership available to (F) (G) (X) grades at fee x 3 times.	

ADVERTISERS INDEX

ATN Antennas	34
Andrews Communication Systems	51
Dick Smith	OBC, 28,29
G & C Communications	16
Icom	IFC
Tower Communications	51
WIA Call Book.....	IBC

TRADE PRACTICES ACT

It is impossible for us to ensure that the advertisements submitted for publication comply with the Trade Practices Act 1974. Therefore, advertisers and advertising agents will appreciate the absolute need for themselves to ensure that the provisions of the Act are strictly complied with.

VICTORIAN CONSUMER AFFAIRS ACT

All advertisers are advised that advertisements containing only a PO Box number as the address cannot be accepted without the addition of the business address of the box-holder or seller of the goods.



Callbook Listings
Frequency Listings
Band Plans
Repeater Lists
Beacon Lists
Satellite Lists
Licence Conditions
Examiner Lists
Special Interest Groups
Public Relations Notes
Radio and TV Freqs.
and much, much more !

WIA **Yearbook** **2000**

2000 is a great year to have an up-to-date call book.

This YEARBOOK edition contains all of the content you have come to expect of the WIA callbook as well as some new items.

It is more than a callbook, it's a Yearbook, the WIA Yearbook!

The "WIA Yearbook 2000" is now available from Divisional Bookshops and selected outlets.

YAESU VX-1R MICRO DUALBAND HANDHELD TRANSCEIVER

**Wide receiver coverage, leading edge features,
and Lithium Ion technology, packaged for
convenience at a price that will surprise!**

**PRICE
BREAKTHROUGH**



VX-1R shown full size

The Yaesu VX-1R is one of the world's smallest dualband amateur rigs, sporting a 2m/70cm transceiver with wideband receiver in a case sized just 47 x 81 x 25mm WHD. It has impressive memory and scanning facilities as well as receive coverage of VHF and UHF TV, AM and FM broadcast bands, AM aircraft band and other public service frequencies from 76 to 999 MHz*.

Leading-edge technology from the VX-1R's 500mW MOSFET power amplifiers together with the supplied 3.6V 700mA/H high-capacity Lithium Ion battery will provide many hours of superb local communications. Up to 1W output is available for longer range when external DC power is used. Extensive battery-saving features together with the Li-Ion battery's 2-hour recharge system yields long operating times under real-world conditions.

The VX-1R's extensive memory system provides 291 memory channels, most with Alpha-numeric labelling for easy recognition. A Smart Search™ system allows you to search a portion of a band you define, then loads any active frequencies into 31 special Smart Search™ memories for later inspection (great for finding activity when visiting a new area).

Besides being a fully-featured dual-band amateur transceiver, the VX-1R has extraordinarily wide receiver frequency coverage; you'll also be pleasantly surprised by the great audio on the FM broadcast band. A dual-watch facility is provided – and together with the AM, FM-narrow and FM-wide reception modes – you'll be having fun even when you're not operating on the amateur bands. For selective calling and listening, the VX-1R also includes a CTCSS encoder/decoder and a 104-code Digital Code Squelch (DCS) system as well as a Tone Search facility for both CTCSS and DCS encoded transmissions.

A great range of accessory lines for the VX-1R are available such as speaker/mics, a carry case, as well as a battery holder for 1 x AA alkaline battery which includes an inbuilt voltage step-up converter. Computer programming of the VX-1R is available via the optional ADMS-1E programming kit.

So when Yaesu says "Dick Tracy, we're waiting for your call" you can be sure they have good reason to do so. In fact, call into your Dick Smith Electronics' Hams Shack store for a demo of this fun new rig. Or phone 1300 366 644 for a copy of the Yaesu colour brochure. D 3665

2 YEAR WARRANTY.

\$399
SAVE \$50

YAESU

PHONE FAX AND MAIL ORDERS

PHONE: WITHIN AUSTRALIA: 1300 366 644
(Local Call Charge)

FAX: (02) 9395 1155 within Australia and
(+612) 9395 1155 from outside Australia

MAIL: DICK SMITH ELECTRONICS, Direct Link Reply Paid 160, PO Box 321,
North Ryde NSW 1670 (No Stamp Required)

*Excludes packaging and postage. All major Credit Cards accepted.
14 Day Money Back Guaranteed if NOT completely satisfied. (Software excluded)*



Visit our web site at
<http://www.dse.com.au>



That's where you go!

*Less cellular coverage

April 2000

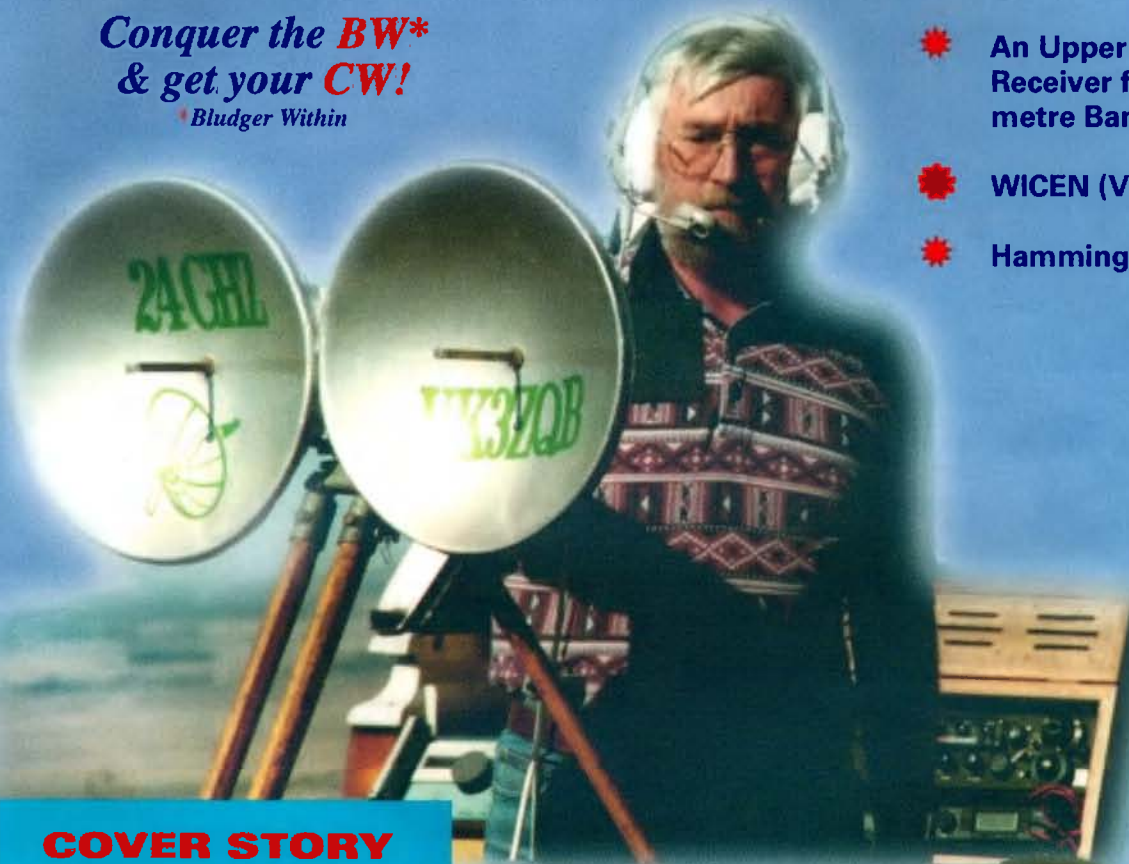
Volume 68 No 4



Amateur Radio

*Conquer the **BW***
& get your **CW!***
**Bludger Within*

- ★ An Upper Sideband Receiver for the 20 metre Band
- ★ WICEN (Vic) and Y2K
- ★ Hamming in the USA



COVER STORY

**New Australian
24 GHz Distance
Record**

plus

ALARA

*WIA, Divisional & Club News
& regular columns*



*I read, I study,
I examine, I listen,
I reflect ...*

Part 3 of

Eric Jamieson VK5LP:

Looking back at an era



WIA Yearbook 2000

***Callbook Listings
Frequency Listings
Band Plans
Repeater Lists
Beacon Lists
Satellite Lists
Licence Conditions
Examiner Lists
Special Interest Groups
Public Relations Notes
Radio and TV Freqs.
and much, much more!***

2000 is a great year to have an up-to-date call book. This YEARBOOK edition contains all of the content you have come to expect of the WIA callbook as well as some new items

It is more than a callbook, it's a Yearbook, the WIA Yearbook!

The "WIA Yearbook 2000" is now available from Divisional Bookshops and selected outlets



Amateur Radio

Volume 68
Number 4
April 2000

The Journal of the Wireless
Institute of Australia
ISSN 0002-6859

Editorial

Editor: Colwyn Low VK5UE

Technical Editor: Peter Gibson* VK3AZL

Publications Committee Members

Ron Fisher VK3OM
Don Jackson VK3DBB
Evan Järman VK3ANI
Bill Rice VK3ABP
Gill Sones VK3AUI

Advertising

Mrs June Fox,
Tel: (03) 9528 5962

Hamads

"Hamads" Newsletters Unlimited
29 Tanner Street, Richmond VIC 3121
Fax: (03) 9428 4242
e-mail: news1@webtime.com.au

Office

10/229 Balaclava Road
Caulfield, Victoria
Telephone (03) 9528 5962
Facsimile (03) 9523 8191
Business Hours 9:30am to 3:00pm weekdays

Postal

P.O. Box 2175
CAULFIELD JUNCTION
VICTORIA 3161
AUSTRALIA
e-mail: armag@hotkey.net.au

Production

Newsletters Unlimited (03) 9428 3458

Printer

Streamline Press, Melbourne (03) 9417 2766

Postal Service

IMS (03) 9291 5888

Production Deadlines

Advertising booking and articles for
publication 10th of proceeding month.

Hamads and advertising material deadline
18th day of proceeding month

The contents of Amateur Radio are Copyright
Wireless Institute of Australia
© 2000

Our cover this month

Russell Lemke VK3ZQB, who with Trevor
Niven VK5NC and Colin Hutchesson VK5DK
broke distance records using Homebrew
Narrowband 24 GHz equipment.
(See story page 23)

General

I read, I study, I examine, I listen, I reflect: Looking back at an era (Part 2)	7
<i>Eric Jamieson VK5LP</i>	
A Trap for an old Player	16
<i>Ian Cowan VK1BG</i>	
Gippsland Technical Conference	16
<i>David Waring VK3ANP</i>	
Conquer the BW and get your CW (Part 1)	17
<i>Dieter Engele DJ6TE/Mike Krochmal VK3KRO</i>	
WICEN (Vic) & Y2K	20
<i>John Kerr VK3BAF</i>	
New Australian 24 GHz Distance Record	23
<i>David Minchin VK5KK</i>	
Hamming in the USA	24
<i>Dom Bragge VK2JNA</i>	
Morse code proficiency is part of the tradition of amateur radio	25
<i>Max Riley VK2ARZ</i>	
52nd Urunga Radio Convention	27
<i>B J Starke VK2ZCQ</i>	

Technical

An Upper Sideband Receiver for the 20 metre Band	10
<i>Godfrey Williams VK5BGW</i>	
The G5RV — A Portable Antenna Option	22
<i>Ian Cowan VK1BG</i>	
New Life for the FT200 (Technical Abstracts)	36
<i>Gill Sones VK3AUI</i>	
Blocking Non Locked PLL signals (Technical Abstracts)	36
<i>Gill Sones VK3AUI</i>	
Elevation Rotator (Technical Abstracts)	37
<i>Gill Sones VK3AUI</i>	
RF Probe (Technical Abstracts)	37
<i>Gill Sones VK3AUI</i>	

Columns

Advertisers' Index	56	HF Predictions	52
ALARA	26	New Members	2
AMSAT Australia	41	Novice Notes	38
Awards	43	Pounding Brass	51
Club News	35	Repeater Link	51
Contests	45	Silent Key	54
WIA Division News		Spotlight on SWLing	47
VK1 Notes	34	Technical Abstracts	37
VK2 Notes	33	Try This	27
VK4 Notes	31	VHF/UHF - An Expanding World	48
VK7 Notes	32	WIA Comment	3
Editor's Comment	2	WIA News	3
Education	40	WIA Division Directory	30
Hamads	55	WIA Federal Directory	2

Contributions to Amateur Radio

Amateur Radio is a forum for WIA members' amateur radio experiments, experiences opinions and news. Manuscripts with drawings and or photos are always welcome and will be considered for publication. Articles on disc or email are especially welcome. The WIA cannot be responsible for loss or damage to any material. A pamphlet, How to write for Amateur Radio is available from the Federal Office on receipt of a stamped self-addressed envelope.

Back Issues

Back issues are available directly from the WIA Federal Office (until stocks are exhausted, at \$4.00 each (including postage within Australia) to members.

Photostat copies

When back issues are no longer available, photocopies of articles are available to members at \$2.50 each (plus an additional \$2 for each additional issue in which the article appears).

Disclaimer

The opinions expressed in this publication do not necessarily reflect the official view of the WIA and the WIA cannot be held responsible for incorrect information published.

Amateur Radio Service

A radiocommunication service for the purpose of self-training, intercommunication and technical investigation carried out by amateurs; that is, by duly authorised persons interested in radio technique solely with a personal aim and without pecuniary interest.

Wireless Institute of Australia

The world's first and oldest
National Radio Society
Founded 1910

Representing
The Australian Amateur Radio Service

Member of the
International Amateur Radio Union

Registered Federal Office of the WIA
10/229 Balaclava Road
Caulfield North Vic 3161
Tel: (03) 9528 5962 Fax (03) 9523 8191
<http://www.wia.org.au>

All mail to
PO Box 2175 Caulfield Junction VIC 3161

Business hours: 9.30am-3pm weekdays

Acting Federal Secretary

Peter Naish VK2BPN

Federal Office staff

June Fox Bookkeeper
Rita Trebilco VK3IF Examinations Officer

Council

President	Peter Naish	VK2BPN
VK1 Federal Councillor	Glenn Dunstan	VK1XX
VK2 Federal Councillor	Michael Corbin	VK2YC
VK3 Federal Councillor	Brenda Edmonds	VK3KT
VK4 Federal Councillor	Ross Marren	VK4AMJ
VK5 Federal Councillor	David Box	VK5OV
VK6 Federal Councillor	Will McGhie	VK6UU
VK7 Federal Councillor	Phil Corby	VK7ZAX

Executive

Peter Naish VK2BPN
Tony Farrow VK2TJF
John Loftus VK4EMM
Wally Howse VK6KZ

Federal Coordinators

AMSAT	Graham Ratcliff	VK5AGR
ARDF	Jack Bramham	VK3WWW
Awards	John Kelleher	VK3DP
Contests	Ian Godsll	VK3DIO
Education	Brenda Edmonds	VK3KT
FTAC	John Martin	VK3KWA
Historian	John Edmonds	VK3AFU
IARU	Grant Willis	VK5ZWI
Intruder Watch	Gordon Loveday	VK4KAL
ITU Conference and study group	David Wardlaw	VK3ADW
Public Relations	David Thompson	VK2NH
OSL Manager (VK9, VK0)	Neil Penfold	VK6NE
Videotapes	Don Bland	VK4TVD

ACA Liaison Team

Peter Naish VK2BPN
Glenn Dunstan VK1XX
Michael Corbin VK2YC
Wally Howse VK6KZ
Canberra Liaison Officer
Richard Jenkins VK1RJ

The Morse controversy continues

Well who would have thought a year ago we would be looking at the removal of Morse as a HF band licence requirement.

The WIA has canvassed its membership, listened to what they and others said and negotiated with the ACA the reduction in Morse qualification for HF access to 5 wpm and will push for a ZERO Morse requirement at the World Radio Conference in 2002/3. If you wonder why

there are articles on learning Morse in this issue it is because it is a mode with a continuing place in Amateur communications and some amateurs wish to become more proficient in its use. The text of the ACA statement is included.

Let's get technical

Now, having had a great John Moyle Field Day, and been exposed to the world above 1GHz, I have to seriously think about building some UHF gear. This will be my step into the unknown for the next few months. Have you decided what yours will be?

One area I would like you all to consider is writing a short technical article/description on your most useful

piece of home brew gear. AR is a place for sharing our experiences and helping each other.

If you cannot find a single article with a technical theme in a future issue you will know that 'somebody' did not write any! If you are not the most fluent writer of English I can pretty it up. Anything from half a page up is acceptable.

Colwyn VK5UE

New Members

November 1999

VK1CW	MR S MIYAKE	VK2XRZ	MR P M ROPER
VK1LK	MR E S HOCKING	VK2ZRF	MR R FREEBAIRN
VK2CHK	MR H D KING	VK3AXH	MR I G MCDONALD
VK2TPD	MR P T PRICE	VK3HEQ	MR A BARRAND
VK2TPL	MR G ROBERTS	VK3TS	MR S MARCINCZAK
VK2TSG	MR S P GREEN	VK5AKJ	MR R K JOHNSON
VK2XTX	MR A BERKUTA	VK5DK	MR C M HUTCHESSON
VK3BGJ	MR G GALANIS	VK5KGB	MR P S GIBBS
VK6JR	MR W A RHODES	VK5KJJ	MR J A JENNER

December 1999

L21171	MR R CEMBRANO	VK5MW	MR K J ATKINS
L21172	MR PA LEVARRE-WATERS	VK5ZCF	MR G T SAWYER
L21173	MR A G ARCHER	VK5ZSN	MR A D SNELL
VK1PY	MR A G PIKE	VK5ZX	MR W J KILPATRICK
VK1WV	MR B H BOOTH	VK6AOM	MR D A LLOYD
VK2AEL	MR A W SPICER	VK6BRN	MR P G HAVORD
VK2GWI	MRS A TOBBE	VK6QL	MRS P K DICKS
VK2JNA	MR D BRAGGE	VK6YEH	MR L IEMI
VK2KPP	MR T SCIFLEET	VK6ZGT	MR G THURSTON
VK2RN	MR R MILLER	VK7PG	MR P H GIBBS
VK2TQE	MR G R ARMSTRONG		
VK2TQQ	MR J S MAGNUSSEN		

January 2000

VK6ANI MR N F IVEY

WIA goes for 5wpm CW

It's now official... the Wireless Institute of Australia favours the reduction of the Morse test requirement from 10 wpm to 5wpm. This policy change was adopted by a unanimous vote of all states and territories. A letter notifying the Australian Communications Authority was sent early this week.

The WIA has been discussing the matter with the ACA since late last year, in the light of similar changes occurring overseas, most notably in the USA, Canada, and the United Kingdom.

The position of Morse Code as a requirement for HF access is expected to be more fully considered at the next World Radio Conference in 2002-2003. In the meantime, however, the WIA shares the ACA's concerns about the impact any changes might have on existing reciprocal licensing arrangements with countries that still require the higher speed Morse qualification.

To address this concern, the WIA has proposed, as an interim

solution, that the existing Intermediate licence class ("J" and "K" calls) be given the same access to the HF bands as Unrestricted class licencees.

The 10wpm test would for the time being remain in place for those Amateurs wishing to have the Morse qualifications accepted by those countries that have reciprocal licensing arrangements with Australia. But in practical terms, full HF access would be available to those passing the 5wpm test.

We expect to hear from the ACA soon regarding our proposals for 5 wpm Morse Code.

ACA facilitates EME experimentation

Alan Jordan of the ACA comments:

As a result of the gazettal (on 12 Jan) of the Radio-communications Licence Conditions (Amateur Licence) Determination No.1 of 1997 Amendment 1999 (No.1) the following provision now applies Section 2 (2)

However, if a condition in this Determination is inconsistent with a condition specified in the licence, the condition specified in the licence applies.

This would allow the ACA to apply a condition in an Amateur licence that would allow an Amateur to use a higher level of power than that provided for in the Determination. I understand that this would facilitate EME experimentation. As discussed, such authorisation will be on a justified case by case basis.

The Determination also contains the changes necessary for the Olympics and some very minor corrections to emission modes.

continued next page

**LATE
BREAKING
NEWS**

● **Progress at last on VK 5WPM**
● See Richard Murnane's report page 6
and President Peter Naish's comments below



Comment

WIA Federal President, Peter Naish VK2BPN

The WIA has received a very positive reply from the ACA regarding our request for a change in the Morse Code requirements for licences that permit operation on the HF bands. This news came to me just as this issue of *Amateur Radio* was about to go to print. The substance of ACA's reply is as follows:

Given the overseas trends, the ACA agrees in principle to implement changes to Australia's Amateur licensing arrangements in relation to the requirements for Morse Code. Australia has established a number of bilateral reciprocal licensing arrangements that are based in part on a 10 wpm Morse component. Recognizing that it is likely that the international requirement for Morse Code will be considered by the World Radio Conference in 2002/3, the proposed changes are minimal at this time. It is proposed that the Amateur licensing conditions be amended prior to the Sydney Olympic Games to permit Amateur Intermediate licencees to operate to the same extent as currently available to

Unrestricted licencees. No changes are proposed to the callsigns of Intermediate licencees who will continue to use distinctive callsigns.

All this may be summarized as a change in the maximum Morse code requirement from 10 wpm. to 5 wpm. for permission to operate with full privileges on the HF bands in Australia. This is a very significant step forward in the Morse Code debate and one that will provide great opportunities to the Amateur radio service. The WIA through its ACA Liaison Committee is continuing to work closely with the ACA in regard to this matter and I expect to be able to give you more details of how and when this change will be implemented very soon.

ar

Unlawful possession of radiocommunications equipment gets fine and good behaviour bond

The Australian Communications Authority (ACA) Chairman Tony Shaw says that a recent and successful prosecution for unlawful possession of radiocommunications equipment should act as a warning to people who use these devices without a licence.

The ACA was fulfilling its regulatory obligations in conducting the investigations," he said.

"We have a responsibility to ensure that radiocommunications users comply with mandatory standards, codes and licence conditions. Our aim is to protect consumers and minimise disruption to communications services."

The ACA seized unlicensed transmitters after receiving complaints from a commercial television network in Sydney

that another station was operating on one of its communications channels.

The unlawful transmitters had been operating in frequencies that were assigned to others, and were being used as private communications channels.

The prosecution followed extensive investigations by ACA Inspectors and resulted in the seizure of twelve transmitters from various locations. A Brief of evidence was forwarded to the Director of Public Prosecution.

The owner of the base equipment, who had been warned by the ACA on previous occasions, pleaded guilty in the St James Magistrates Court to three charges of unlawful possession of a radiocommunications device. He was fined \$2000 and given a \$5000/two year good behaviour bond as well as forfeiting to the Commonwealth transmitters worth over \$10,000.

(ACA web site, 9 March, <http://www.aca.gov.au/media/2000/07-00.htm>)

Olympics Callsign AX2000 on the air...

The Sydney Olympics special event callsign, AX2000, had its first workout last month.

The New South Wales Division of the Wireless Institute of Australia has authorised a number of NSW Amateur Radio clubs to use the callsign during 2000. The Manly-Warringah Radio Society had first bite of the cherry, activating the call in the CQ WW WPX contest on the weekend of 25-26 March. The club will continue to use the callsign through the end of March.

This month, the Wahroonga Amateur Historical Radio Association will be active as AX2000/IMD on International Marconi Day, 29th April.

Other New South Wales radio clubs will activate the call at various times throughout the year, and AX2000 will be running from the WIA (VK2) Divisional headquarters during the Olympic and Paralympic Games. Visitors may apply to operate the station by contacting the VK2 Divisional office.

Dick Smith balloons across the Tasman with Amateur Radio

Australian adventurer Dick Smith VK2DIK and his co-pilot successfully completed the first ever crossing of the Tasman Sea, from New Zealand to Australia, by hot air balloon, with a little bit of help from Amateur Radio.

The main challenge was that the flight was east to west, against the prevailing winds.

The VK2 Division of the WIA operated an Amateur Radio station (VK2AWI/p) at the Australian Geographic headquarters at Terrey Hills in northern Sydney. This station was commissioned by VK2 Division Special Projects Officer, Stephen Pall VK2PS, and James VK2JN, Ted VK2FLB, Richard VK2SKY, and Dom VK2JNA of the Manly-Warringah Radio Society, who helped to run the station, along with a number of other Sydney Radio Amateurs.

VK2AWI's primary role was to provide safety communications for the flight, though Dick did indulge in some rag chewing, especially with schoolchildren who visited "Mission Control". For the final hours of the flight, Dick used Amateur

Radio as his sole means of communication.

To celebrate the success of the mission, the VK2 Division ran a special event station, VI2TAS, which proved very popular on the bands.

The mission raised \$200,000 for the Exodus Foundation, half of which was donated by Dick, the rest by advertising mogul John Singleton, who had bet Dick that he couldn't do it. Dick also used the flight to promote his new Australian food company, Dick Smith Foods.

This is not the first time that the WIA and Amateur Radio have been used in this way: the WIA NSW Division also assisted Dick and John with radio communications during the first ever non-stop crossing of Australia by hot-air balloon, back in 1993.

Sydney Games Radio Award

The New South Wales Division of the Wireless Institute of Australia has announced a new award to commemorate the Sydney 2000 Olympic and Paralympic Games.

The aim of the Sydney Award is to commemorate the Sydney Olympic and Paralympic Games. The award is made for contacts between amateur Radio Operators anywhere in the world and Amateur Radio operators in the state of New South Wales (VK2 or AX2), Australia.

The award is available in three classes:

Bronze: Is available for contacts with four VK2 stations.

Silver: Is available for contacts with eight VK2 Stations

Gold: Is available for contacts with 12 VK2 Stations and must include a contact with the official Olympic station, AX2000, during the Games.

The award is valid for contacts made between 14th September 2000 (the date of the first Olympic soccer match) and 29th

October 2000 (the date of the closing ceremony of the Paralympic Games).

The cost of the award is yet to be determined.

The Certificate will be a full colour photograph of the Olympic stadium at Homebush, suitably emblazoned with the appropriate logos, contact info etc.

For more information about the award, please contact the New South Wales Division of the WIA by one of the following means:

Postal: Wireless Institute of Australia (NSW Division), PO Box 1066, Parramatta NSW 2124

Phone: +61 2 9689-2417

Fax: +61 2 9633-1525

Email: vk2wi@ozemail.com.au

ACA Document updates

The Policy Information Paper (PIP) Amateur Licence Information Paper has been updated to reflect recent amendments to the Radiocommunications Licence Conditions (Amateur Licence) Determination No. 1 of 1997. (<http://www.aca.gov.au/publications/info/amateur.htm>)

The Radiocommunications Licence Conditions (Amateur Licence) Determination No. 1 of 1997 has been amended to incorporate recent amendments. (<http://www.aca.gov.au/legal/determin/lcd/amateur.htm>)

The ACA Information Paper, Licensing Arrangements for Radiocommunications Services Operating in the Broadcasting Services Bands, confirms the continuation of the Amateur Television "drop through" on UHF TV channel 35. The document also notes that existing licences will be maintained in the range 45 - 52 MHz until 9 September 2008; this will be of interest to six metre enthusiasts, as Amateur radio is a secondary service in the 50 - 52 MHz segment of that band. (<http://www.aca.gov.au/publications/info/broadass.htm>)

The ACA has also added or updated a number of consumer fact sheets, which can be downloaded from their web site. Some of those of possible interest to Amateur operators are:

- Bringing Communications Equipment into Australia
- Use of Royal Flying Doctor Service Frequencies by Outback Travellers
- Citizen Band Radio
- Comparison of Radio Equipment
- Distress Beacons
- Radio Propagation
- Good Operating Practices for HF Users

The complete list of consumer fact sheets can be found at <http://www.aca.gov.au/consumer/fsheets/consumer/index.htm>

continued next page

US Senate considers Amateur Radio Spectrum Bill

The Amateur Radio Spectrum Protection Act bill now has supporting legislation in the US Senate. Idaho Sen Michael Crapo has introduced a bill that mirrors the house bill, HR 783. The Senate measure has been designated S 2183.

"In introducing this bill, we want to do something for Amateur Radio in return for all the good it has done the people of Idaho and elsewhere in the US by providing a reliable means of backup communication in times of emergency," Crapo said. He also pledged to promote the bill in the Senate.

Like the House version, the Senate bill, if enacted, would require the FCC to provide equivalent replacement spectrum should it ever be necessary to reallocate Amateur Radio frequencies for some other purpose.

The new Senate legislation was introduced with bipartisan co-sponsorship from Democratic Senators Daniel Akaka and Blanche Lambert Lincoln, and Republicans Susan Collins, Bob Smith and Olympia Snowe. The bill's introduction

comes on the heels of a visit to Capitol Hill by the recently elected ARRL President Jim Haynie, W5JBP, and First Vice President Joel Harrison, W5ZN.

So far, the House version of the spectrum bill has drawn bipartisan support, with 140 cosponsors to date, and has met with no opposition. However, Congress, and the all-important House and Senate Commerce committees, have been preoccupied with non-telecommunications matters and the Amateur Spectrum Protection Act has not yet moved out of committee. The new Senate bill provides additional motivation for the Congress to consider the legislation.

(ARRL Bulletin ARLB013, dated 8th March 2000)

Internet access to be available through power lines

One technology to keep your eyes on... this has already been tried in the UK, where NorWeb received heavy opposition from the Radio Society of Great Britain and other HF users who experienced interference from the power line communications system.

German communications company Veba has announced plans to launch its powerline communication (PLC) product by the end of the year.

PLC will enable customers in Germany to conduct telephone calls and dial into the Internet directly via household powerpoints or plugs, rather than through telephone connections.

Veba says its telecoms unit, Veba Telecom, and its PreussenElektra power utility had successfully completed field testing for high-speed voice and data transmission via electricity distribution networks.

The tests, carried out in eight households, showed that telephony and Internet access could be successfully carried out via power lines.

Veba says extended tests will be carried out with several hundred households, after which the product will be launched by Avacon, a unit of PreussenElektra, before the end of the year.

The company predicts that Internet access via powerline communication will cost less per month than access via traditional telecommunication networks.

The key to the technology is a small box placed next to the electricity counter. The box enables a household's main power lines to be used for voice data transmission with the same quality as traditional fixed telecom lines.

PreussenElektra was scheduled to unveil the new product at the upcoming CeBIT computer trade fair in Hanover, north

Germany in late February.

But Veba is not the only company developing such technology. Rival power group RWE is also expected to unveil its own product at CeBIT.

And German electrical engineering giant Siemens has teamed up with the regional power utility Energie Baden-Wuerttemberg (EnBW) to form a joint venture in powerline communications.

The future market prospects for such a project were "excellent", Siemens and EnBW said earlier this month. And they planned to launch their own finished PLC product before the end of the year.

(adapted from a story on the ABC News Web site, 23 Feb 2000)

ar

LATE BREAKING NEWS

Progress at last on VK 5WPM

WIA President Peter Naish VK2BPN has received from Alan Jordan of ACA a reply to the WIA's letter requesting a change to the licensing conditions in regard to 5 wpm. Morse Code.

The reply includes the following statement:

Given the overseas trends in relation to this matter, the ACA agrees in principle to implement changes to Australia's Amateur licensing arrangements in relation to the requirements for Morse Code.

The proposed changes reflect that Australia has established a number of bilateral reciprocal licensing arrangements that are based, in part, on qualifications that include a 10 words per minute Morse code component. In recognition that, it is likely that the international requirement for Morse code will be considered by the World Radio Conference in 2002/3, the proposed changes are minimal in scope.

It is proposed that the Radiocommunications Licence Conditions (Amateur Licence) Determination No. 1 of 1997 and other Amateur documentation

will be amended prior to the Sydney Olympic Games to reflect the following:

- *The Amateur Intermediate Station Licence will authorise operation to the same extent as that currently authorised under the Amateur Unrestricted Station Licence.*
- *No changes are proposed to the current qualification requirements for the Amateur Intermediate Station Licence.*
- *No changes are proposed in regard to the Amateur Unrestricted Station Licence, and*
- *Amateur Intermediate Stations will continue to be issued with call signs that differentiate the stations from Amateur Unrestricted Stations.*

In order to properly implement the above

changes, the ACA seeks the assistance of the Wireless Institute of Australia to update, where appropriate, Regulation papers that contain questions reflecting the current arrangements relating to Amateur Intermediate Stations.

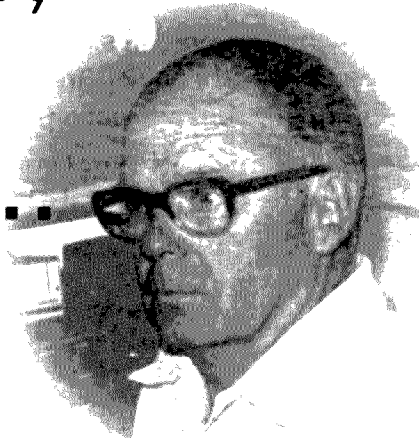
Your earliest advice in relation to the extent of any necessary changes would be appreciated.

Well, there we have it! At last significant progress and a 5 wpm maximum code requirement!

The changes proposed are in line with the WIA request and demonstrates again our excellent working arrangements with the ACA.

Richard Mumane VK2SKY
WIA Federal News Coordinator
pr@wia.org.au

I read, I study,
I examine,
I listen,
I reflect ...



Part 2 of

Eric Jamieson VK5LP: Looking back at an era

The arrival of SSB

The early 1970s saw most amateurs change from AM to SSB. Amateurs were using HF transceivers with transverters for the now 52 MHz band and for 144 MHz. These combinations were very successful, but they slowly gave way to dedicated VHF all-mode transceivers, which were now appearing with well known brand names such as Yaesu, Kenwood and Icom. The early models lacked a few facilities to be found on HF transceivers, but following demand they soon appeared with items such as noise blankers, IF bandpass tuning, digital readout, CW filters, FM modules, improved sensitivity and selectivity, thus rivalling their HF counterparts.

Having thus established the first essentials for VHF operation, that of 52 and 144 MHz, amateurs were now turning their attention to the higher bands. For many, the next step was to operate on 432 MHz and to meet this demand 432 MHz transceivers appeared for those able to afford them, others continued to use transverters (commercial and home-brew). For a brief period I even ventured on to the 576 MHz band using a QQE3/20 valve running about 15 watts to a 32 element phased array

antenna, courtesy of John VK5QZ!

Gradually I moved on. I was now able to run 100 watts on 144 and 432 MHz. In 1970 I constructed another pride and joy with a pair of 811A valves in a 50/52 MHz linear amplifier. It seemed to be the only one of its type at the time so I had to design the circuit. A grounded-grid amplifier would have been the best bet but I was forced to use a grid-driven amplifier because the 50 MHz transceiver could only deliver 12 watts of drive. This meant the valves had to be neutralised, a somewhat tricky problem but one which I eventually overcame. In

In looking back over a period of 38 years as an operator on the VHF bands, it must be said it has been a period of great excitement and change and I am pleased to have been part of that era

operation, it acts just like a solid state amplifier; the directly heated valves are instantly ready at the flick of the filament switch. My *modus operandi* is to use the transceiver barefoot and if more power is required during a contact, I simply stop talking for a moment, flick the switch and resume talking - back on air in two seconds!

After almost 30 years, the linear is still in use and has never required a single repair or adjustment in all that time. It runs a nominal 100 watts output, which can be easily talked

up to 200 watts. By changing to a higher voltage power supply it will deliver almost 400 watts of clean signal but has never been used at that power. The only time 200 watts was used occurred during the last solar cycle when I wanted to make sure I worked several countries in the Caribbean and to Africa.

FM and repeaters

While all these things were going along on the various VHF bands, FM was making inroads into the amateur's realm. In the 1960s ex-commercial gear, such as a Pye

Reporter, were being modified to work on 144 MHz with about 15 watts and usually three channels, A, B and C. I had one of these mounted in my Holden

station sedan together with a 15 watt AM rig. Along with FM came repeaters and then a plethora of FM transceivers for base station, mobile and hand-held operation. The FM repeater network exploded and eventually virtually covered most of the continent.

With the ready availability of so much FM equipment, usually at a price lower than all-mode rigs, came the mass desertion of

continued next page

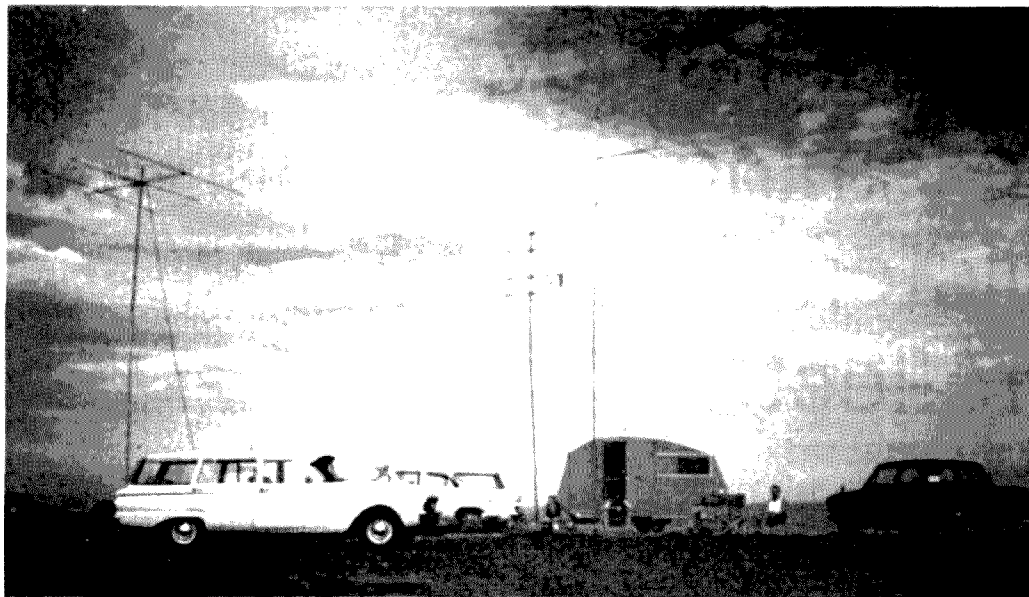


Photo 1: Portable operation with Barry VK5ZMW and Des VK5CU. Note that we didn't stint on antenna performance on 50, 144 and 432 MHz

continued from previous page

operators from the low end of 144 MHz in particular. That portion of the band went through a period of virtual stagnation as amateurs switched to FM, one reason being that it was rare not to find another station on FM or a repeater, so you could always be assured of a contact.

However, there were always the stalwarts who stayed on SSB and CW and today their numbers have increased. The weak signal operators are constantly seeking improvements to their equipment, constructing better and larger antennas and reading the weather maps for indications of improved propagation. These same operators are now also on 432 and 1296 MHz. They are to be found along the southern coastal regions of Victoria, South Australia, and Western Australia and in Perth. Still others can be found around Sydney and associated areas and in Queensland, those on the eastern coasts always on the lookout for signals from New Zealand. Of recent times the northwest coastal areas of Western Australia have been receiving some attention.

The Great Australian Bight

The Great Australian Bight continues to excite amateurs. To most along the southern coastline it presents an almost uninterrupted water path from the east to Albany in the west. Wally VK6WG in Albany has often been the recipient of signals from many operators in VK5 and VK3 on both the VHF

and UHF bands. Wally VK6KZ regularly travels from Perth to areas west of Albany in an effort to work across the Bight when conditions are suitable - and he must be the judge of what represents suitable conditions - but he is not often wrong.

A 10 GHz world record

The ultimate glory for such a journey came on 30/12/94 when he and Roger VK5NY completed a two-way contact on 10 GHz, setting a world record distance of 1912.1 km, which so far has not been bettered. It is the lure of such occurrences that keeps certain amateurs touring the country in search of the ultimate remote VHF location.

Other changes I have seen during my 30 years of writing involve the introduction of satellite operation, increased ATV activity, and Packet radio. EME has taken a step forward when stations with relatively unsophisticated installations including one yagi antenna systems, have been able to work across the world via the moon to stations generally with very large antennas. Nevertheless, single yagi to single yagi contacts have been made without resorting to high power. This will continue as more stations join the fun as technology advances and better solid state devices become available to improve receiver noise figures etc.

Joining the EME club

In the mid-1970s I decided that EME was an area that I should investigate. I had a look at the EME installations of the late Ron Wilkinson VK3AKC who was operating on 1296 MHz, then to Dapto NSW where the

Illawarra University operated a 30 foot dish on 432 MHz, with Lyle VK2ALU at the helm. Next a look at the installations of Ray VK3ATN and Chris VK5MC, both of whom operated on 144 MHz.

Armed with much information and photographs, I decided to build a 9.75 m (32 foot) parabolic reflector (dish) antenna of all aluminium construction but with a steel central hub for strength and rigidity. With the use of a suitable mesh cover it was designed to work on 432 and 1296 MHz.

Using a special wooden template mounted on the floor of one of my sheds, I constructed 24 x 4.87m (16 feet) trusses with a tolerance of

better than 2 mm. Following their completion work commenced on the welded steel central hub assembly.

It was a time consuming task as I was still working as a television technician at the time and all work was done in my "spare" time. It was given a push along when I went to New Zealand in 1980 and met David ZL3AAD who had an operating EME station. I was invited to take the key and was fascinated to clearly hear echoes of my own callsign from the moon.

Now convinced that I was travelling the right path, in between work on the dish I constructed a 1000 watt 432 MHz amplifier in anticipation of an eventual high-power permit. This used the K2RIW circuit. I also constructed a rugged 4.87m (16 feet) high four-legged tower on which to mount the dish, with many cubic metres of concrete around its legs and base to ensure rigidity. It was constructed to allow for an eventual decision whether to use a polar mount or an Az-El mount.

Sadly, all this construction came to an end without completion when I began to notice I had trouble when walking and was diagnosed with a disease of the spine that eventually crippled me. All the parts of the dish were given to Chris VK5MC and Trevor VK5NC in the hope that they would complete the job in my lifetime. I'm still hoping!

The SHF spectrum

It has also been particularly encouraging to see the forward march into the SHF spectrum, with an increasing number of

stations now capable of operating on all bands from 50 MHz to 10 and 24 GHz. Much of this has been assisted by the availability of quality kits and components from overseas designers in countries such as the UK, Germany, Japan and the US. But similar excellent advanced equipment is being produced here in Australia too. I never cease to wonder at the outpouring of ideas and equipment of suitable design from amateurs such as David VK5KK, whose transverter kits for so many SHF bands have encouraged others to move on to these bands.

Of course, hanging over the heads of all operators is the constant threat of continuing requests for use of our bands by vested interests, who see the amateur bands as fair game to be taken for their use and gain. For a long time many of the higher bands have been under populated but this has not always been due to lack of interest. Until recently, a shortage of suitable equipment and components held back the spread of activity to those bands. That situation is now being addressed and we should see the frontiers of activity reaching ever higher in frequency.

The return of 50 MHz

After considerable lobbying in the right quarters, in the mid-1980s Australian amateurs eventually were returned portions of the 50 MHz band. There were restrictions for those operating in Channel 0 television areas, but at least for Cycle 22 we had an opportunity to operate on the low end of the 50 MHz band in an area populated by overseas countries. This was to prove a great boon during Cycle 22, at least if we could hear overseas stations there was every possibility that they would be able to hear us and a contact completed. A number of VKs have worked all continents, with several having the distinction of working seven continents by working Antarctica.

The arrival of computers

With the advent of computers arriving in shacks, amateurs have not only embraced Packet radio, but have moved to the use of e-mails to rapidly disseminate news of openings, and for the posting of various Web pages as sources of information on many aspects of amateur radio. Suddenly

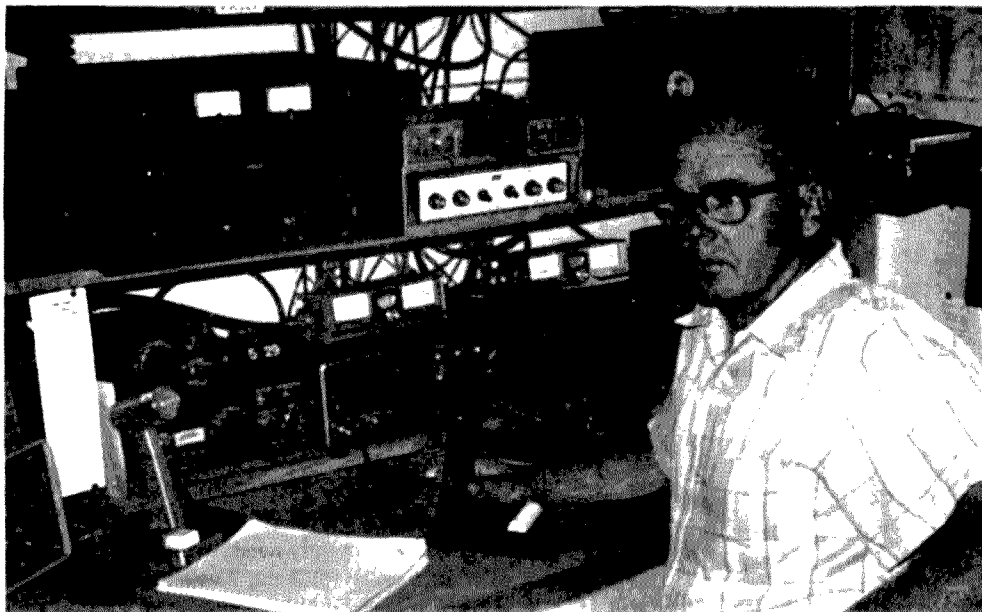


Photo 2 VK5LP in the 1980s shack

the world's amateurs have been brought that much closer. My VHF notes have benefited from the use of e-mails posted on various Reflectors which makes information available to all who subscribe.

The eleven year solar cycles continue to create interest, particularly for six metre operators. As we head towards the peak of Cycle 23, many remember the long distance contacts in which they participated with other countries a full world away. The releasing of 50 MHz to the amateurs of the UK and Europe suddenly produced a flood of countries with keen six metre operators. Soon to make contact with 100 countries became the norm rather than the remote possibility that existed previously. Some European and Japanese amateurs have totals in the 160s or close to it, and there are scores of others filling the spaces in between.

DXCC on 50 MHz

Steve VK3OT is the only VK amateur to achieve 100 countries but several have scores in the 90s. Our remoteness makes it very difficult to readily achieve a high score, but a number of others should pass that total during Cycle 23. The period 1989 to 1992 saw the greatest number of openings to Europe with 7 February 1992 providing well over 500 contacts to VK that was incredible. It will be interesting to see if it can be done again in Cycle 23.

So, in looking back over a period of 38 years as an operator on the VHF bands, it must be said it has been a period of great

excitement and change and I am pleased to have been part of that era. Although my name does not appear in any list of record contacts this is of no great concern to me, because in my own way I have extracted the maximum of interest from operating in the exciting VHF portions of the radio spectrum. I have made many friends and learned much from my association with others and the desire to learn all I could about VHF and UHF, by not only operating there but also constructing equipment for such operating.

So the time has come...

My 30 year stint in writing *VHF/UHF - An Expanding World* has given me a great deal of satisfaction. If I have done nothing else, I feel that at the very least I might have left my mark on the VHF bands through setting standards which have been embraced by others eventually for the overall benefit of everyone who turns on a VHF rig, no matter where they may be located. At least I tried! Thank you all, you have been great company.

A final thought for my writings:

I read, I study, I examine, I listen, I reflect, and out of all this I try to form an idea into which I put as much common sense as I can.

73 from The Voice by the Lake.
Eric Jamieson VK5LP

ar

An Upper Sideband Receiver for the 20 metre Band

VK5BGW
Godfrey Williams,
14 Jenolan Crescent,
Hillbank Estate, S.A. 5112

This receiver makes use of the popular NE602 integrated circuit, both for mixer and product detector. Apart from the ladder filter the design relies heavily on material found in "Amateur Radio" and A.R.R.L. publications.

The ladder filter, employing easily available computer crystals, is one that I have used occasionally for upper sideband reception. It works very well, particularly in its ability to reject the unwanted lower sideband, however on the opposite side of the response, the selectivity skirt is not as steep so later in the circuit an audio filter is included to counter the problem.

The intermediate frequency is 8 MHz so the VFO frequency range will need to be 6 to 6.350 MHz; this allows the use of a frequency counter to display the band ie. ignoring the 6 and mentally substituting 14. To reduce complexity a separate VFO and BFO are not used. With the constructional methods described this works out well, there are no spurious carriers evident.

An IF amplifier (MC1350) allows the inclusion of a useful AGC system. This integrated circuit only needs a change of 2 volts. ie. 5 volts: full gain, 7 volts: no gain, to provide proper AGC action. The AGC circuit features an optional 'S' meter and a switch to select AGC fast, slow, or off.

The final audio amplifier is a departure from the usual LM386 type having less distortion and some audio 'punch'. After breadboarding this project and finalising the design, I completed the documentation and drawings and then built the unit properly using the drawings etc. as if I was a constructor not the author thereby proving a check to ensure accuracy.

Circuit operation (main board).

L1 and L2 with their associated capacitors form a 50 Ω bandpass filter, accepting signals within the twenty-metre band but attenuating signals outside that band. The result is presented to the NE602 mixer via L3 which provides a balanced input, note that the larger secondary winding connects to the mixer because the impedance of the mixer is somewhat higher than 50 Ω .

Capacitors C7, C8, C10 and C11 together

with L4 form a Colpitts type oscillator using the internal transistor in the NE602 device, some of the energy produced is directed to buffer T2 via C9 allowing the connection of a frequency counter.

The variable tuning capacitor should be an old broadcast band type, ie. with an offset rotor shaft. The tuning capacitor used in the prototype had semi-circulator rotor plates with the shaft offset from the centre, this producing a near linear frequency spread.

The VFO needs up to 70 pico-farads variation to tune the band so a fixed capacitor in series with the variable tuning capacitor will be required, its value depending on the total capacitance of the tuning capacitor.

C12 and L5 form a narrow band tuned circuit rejecting unwanted mixing products and providing a balanced output for the mixer. The fourth harmonic of the unwanted image ie. 2 MHz should produce a carrier on the lower band edge but it is not audible in this case.

The ladder filter is in the upper sideband mode ie. Capacitor in series and crystals to ground, increasing the value of the

continued next page

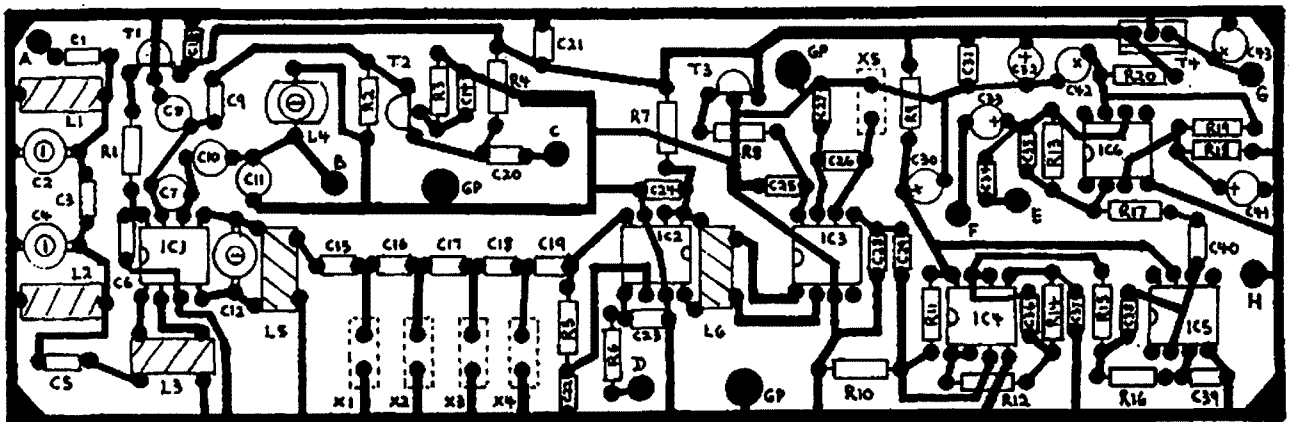
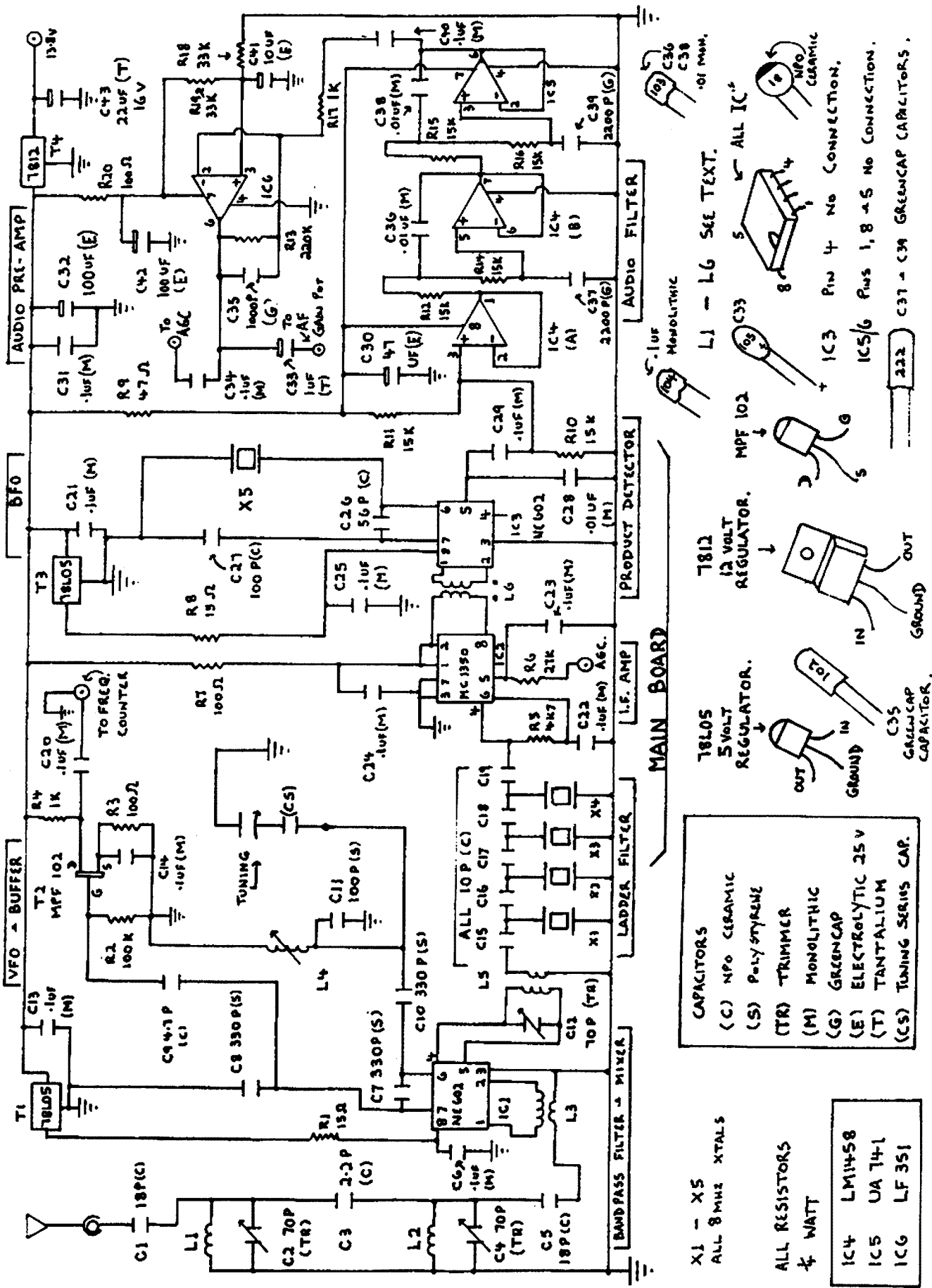


Figure 1: Main Board - actual



- CAPACITORS**
- (C) NPO CERAMIC
 - (S) POLYSTYRENE
 - (TR) TRIMMER
 - (M) MONOLITHIC
 - (G) GREENCAP
 - (E) ELECTROLYTIC 25V
 - (T) TANTALIUM
 - (CS) TUNING SERIES CAP.

- ALL RESISTORS**
1/4 WATT
- IC4 LM1458
 - IC5 UA741
 - IC6 LF351

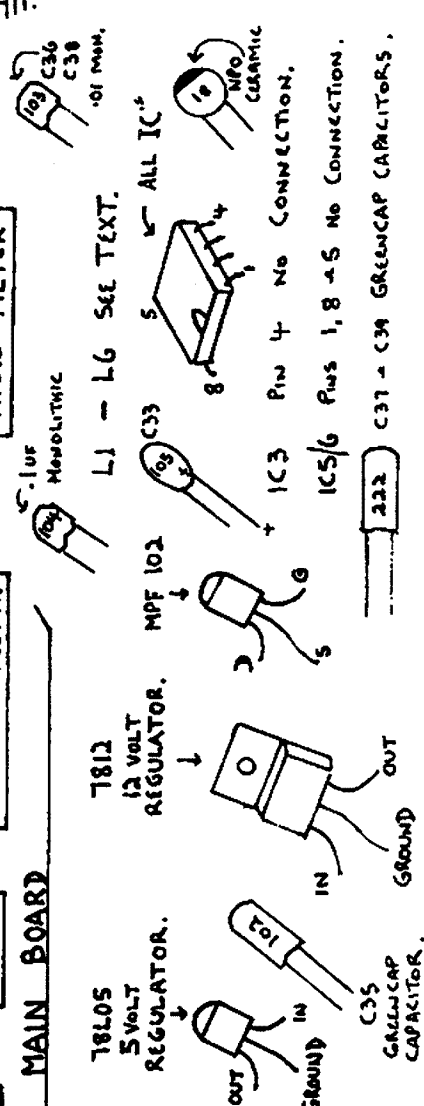


Figure 2: Main Board

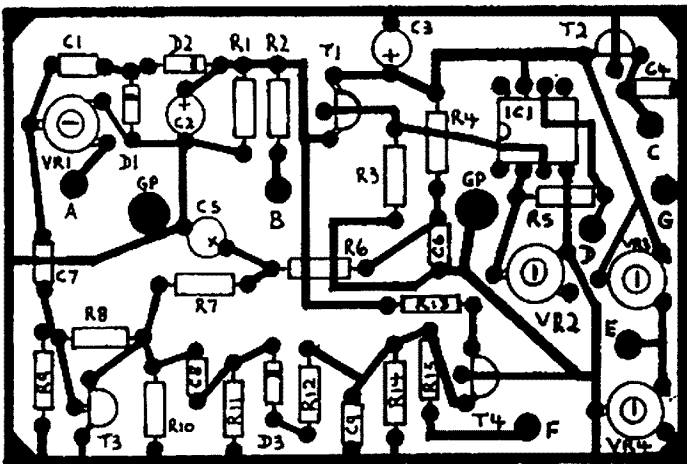


Figure 3: AGC Board

continued from previous page

capacitors widens the bandwidth, decreasing their value narrows the bandwidth. The opposite is the case with ladder filters in the lower sideband mode ie. crystals in series and capacitors to ground.

The following amplifier (MC1350) provides variable gain according to the voltage applied to pin 5 via R6. L6 is a bifilar wound broadband transformer that provides a handy termination and also a balanced input for the NE602 product detector.

Capacitors C26, C27 and crystal X5 together with the internal transistor of IC3 form a Colpitts oscillator, for upper sideband reception the BFO needs to run at about 7999.5 kHz ie. 500 Hz low this is conveniently the case when X5 is connected from pin 6 to ground. Audio output is taken from pin 5 of IC3, C28 filtering the result, with the following audio filter restricting the bandwidth to compensate for the non-symmetrical response of the ladder filter.

Further audio amplification is provided by IC6 (LF351) the gain is set by the values of R17 and R13 with C35 providing some further audio filtering. Output to the audio gain control is via C33 and output to the AGC board is via C34. Both NE602 devices require a regulated voltage supply for oscillator stability, this is achieved internally. The 5-volt external supply ensures that both devices are not overstressed.

Circuit operation – AGC board

Audio signal from C34 on the main board is applied to the AGC board via VR1 a 10kΩ trimpot that allows the signal level to be varied for the best AGC action. The signal is then split two ways, via capacitors C1 and

C7 connected to the detector and 'hang' sections respectively.

Any signal arriving at C1 is detected by D1 and D2, with the result being applied to T1 and IC1. IC1 is a non-inverting op-amp, so that any increase in signal level produces an increase in voltage at pin 6 of IC1. C2 will be charged up and can only

discharge slowly through R1, this means that after a signal or noise pulse has ceased the receiver will be without gain for a few seconds as the voltage at pin 6 of IC1 is being held high.

However audio signal present at C7 is amplified by T3 and routed to D3 and T4, C9 becomes negatively charged (note the polarity of D3) which means that T4 will only conduct when there is no signal present. This then provides a means of discharging C2 quickly after the signal or noise pulse has ceased.

C9 plus R14 allows the signal to 'hang' a little, smoothing the AGC action. R15 when grounded by the AGC switch allows a faster action ie. quicker discharge time for C2. When R2 is grounded by the AGC switch it renders the circuit into an 'OFF' state.

A 'hang' circuit is necessary for audio derived AGC systems to avoid annoying characteristics such as pumping and 'clicky' responses. VR2 sets the voltage at pin 6 of IC1 at 5-volts no signal, VR4 provides zero set for the 'S' meter and VR3 provides adjustment for 'S' meters of varying sensitivity. Note that VR3 and VR4 should not be both turned fully anti-clockwise, as this will provide a dead short across the power rail. It was found that a pre-amp. for the detector section was unnecessary there is plenty of audio signal available, swings of up to 8 volts at pin 6 of IC1 were observed when receiving very strong signals.

Circuit operation final audio board

The final audio amplifier has complementary symmetry output transistors and a low noise op-amp. driver. The output level is sufficient for a small speaker and 'armchair' copy. T1 and T2 will run warm to touch. Diode D1 prevents

latch-up of the op-amp. driver. R3 should not be reduced in value as it protects the input of the op-amp. driver. If driven hard enough this circuit can deliver up to 3 watts into a 4Ω speaker. In that case T1 and T2 will require heatsinks.

Construction

The printed circuit boards are cut from double-sided copper clad board, one side being used as a groundplane. This side is painted so that it survives the etching process. The trackside of the board is then thoroughly cleaned and allowed to dry.

Referring to the layouts shown, draw the tracks and pads with a direct etch pen, later when the ink is dry the boards are etched in a warm solution of ammonium persulphate. Make sure that the etching process is complete. Any fine whiskers or smears of copper remaining can of course short out the tracks.

Each corner of each board and any pads marked GP need to be drilled through allowing a connection to be made to the groundplane. The five crystals are mounted on the groundplane side of the board so holes will have to be drilled for these, remove the copper around the holes before soldering the crystals in place, their cases are soldered to the groundplane to assist in shielding.

The VFO coil L4 uses a readily available 5-mm plastic former with an internal thread to accommodate the ferrite slug. To secure the former in the board a hole is drilled to allow a snug fit, then a drop of superglue is applied to hold it in place.

To wind L4, solder one end of about 400 mm of 33 SWG enamelled copper wire to the earth pad and beginning at the bottom of the former wind on 26 close wound turns keeping tension all the way. Secure the top turn with a smear of superglue, when dry solder the remaining end to the other pad which connects to C10, C11 and connection point B. The windings are then smeared with a layer of polystyrene cement (plastic model glue) and allowed to dry.

Both L1 and L2 have 19 turns wound on a T50-6 (yellow) toroid core using 27 SWG enamelled copper wire. L5, again using a T50-6 core has a primary winding of 45 turns using 33 SWG enamelled copper wire and a secondary winding of 8 turns 27 SWG wire evenly spread over the primary.

L3 uses a FT 50-43 core having a 23 turn secondary and an 8 turn primary wound in the gap; both windings use 27 SWG enamelled copper wire. L6 also uses a FT 50-43 core and has 13 bifilar turns using 33

continued next page

Commissioning

Check over your work carefully, looking for shorted or broken tracks. In particular, check around the integrated circuit pins for these faults. Check for correct polarity and orientation of the integrated circuits, voltage regulators, transistors, diodes, tantalum and electrolytic capacitors.

Check for correct value of components and also ensure that the wiring of the boards and panel controls is correct and inspect all soldered joints. A little care at this stage could save disappointment and perhaps prevent a project from being banished to the 'doesn't work' bin.

Wind the slug into L4 until it is level with the top of the former, set VR1, VR2, VR3 and VR4 to mid position. Without connecting the antenna connect the rig to a 13.8-volt supply, now turn up the AF gain, if all is well you should be able to hear through the speaker the noise inherent in the receiver.

With the variable tuning capacitor fully meshed adjust the slug in L4 so that the VFO output reads 6 MHz, now with the capacitor fully demeshed the VFO should read 6.350 MHz. If the VFO range is too great reduce the value of the series capacitor. Increase its value if the range is short.

With the tuning capacitor fully meshed again, readjust the slug in L4 for a reading of 6MHz. Check again for the correct range and repeat the above steps if necessary until the correct range is established.

If a frequency counter is not available the VFO carrier can be found using a general coverage receiver or the constructed receiver can be used to detect the carrier from a signal generator.

The slug in L4 should be a firm fit, if the slug has not got a rubber strip bonded to it use a short piece of cotton etc. inserted in the thread.

On the AGC board adjust VR2 so that 5-volts is present at pin 6 of the IC1, now adjust VR4 to zero the 'S' meter. With the AGC switch in the off position ie. R2 on the AGC board is grounded, connect an antenna and select the middle of the VFO range. Adjust C2, C4 and C12 for maximum band noise, go over these adjustments a few times until there is a distinct difference heard between antenna connected and antenna disconnected. On a quiet day the receiver noise floor will be just below the band noise.

VR2 on the AGC board is varied to suit 'S' meters of different sensitivity. With a strong signal present, check the voltage swing at pin 6 of IC1, a 59 signal will show a swing to 6 volts.

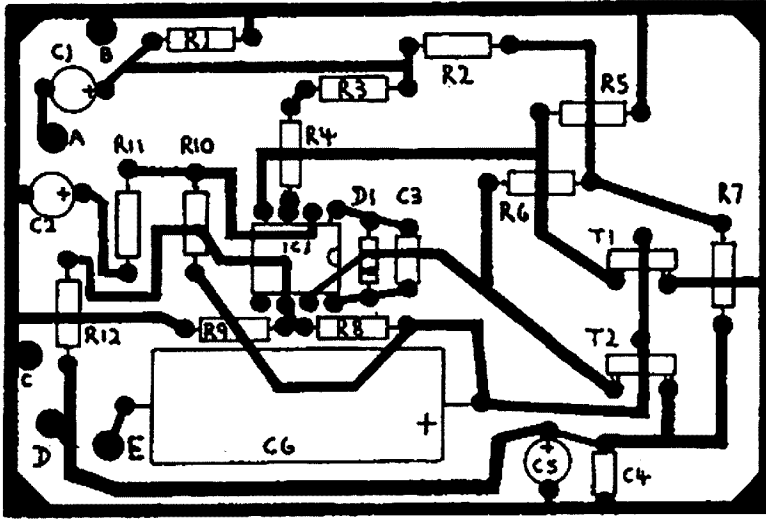


Figure 5: Final Audio Board

continued from previous page

SWG wire, the dots on the circuit diagram indicate the beginning of each winding.

All components apart from the five crystals are soldered onto the trackside of the board, note that each board has its own individual component numbering sequence, also note that on the main board the orientation of IC2 is opposite to the other integrated circuits.

All capacitors are mounted as close as is practical to the board, the resistors can be mounted a little higher to give clearance above the tracks. R7 and R4 on the audio board and R4 on the AGC board are 1Ω resistors used purely as links and can be replaced with wire jumpers if so desired.

T1 and T2 on the final audio board have the metal side of their cases facing toward C5 and C4. The polystyrene capacitors on the main board are secured to one another using a drop of polystyrene glue.

Sockets were not used for the integrated circuits instead 2 mm was trimmed off each lead before soldering to the board.

The prototype was housed in a plastic box with an inner shielding box soldered together using copper clad board, one side of this box making a handy mounting for the vernier drive.

The vernier drive used in the prototype had an outer rotating spindle that allowed the attachment of a circular plate cut from thin aluminium. With an aperture cut in the front panel enabling a view of the aluminium disc and the disc suitably marked we have a frequency indicator. Note that a vernier drive is essential for easy tuning.

To minimise VFO drift the three boards plus all wiring must be firmly fixed in place. A tag strip makes a useful termination point for the capacitor in series with the tuning

capacitor, the 13.8-volt supply and a terminal point for pin 6 of IC1 on the AGC board. Shielded 50Ω miniature cable was used for the frequency counter connection being terminated with a BNC socket on the rear panel.

Each board has a number of connection points identified with as alphanumeric letter and are as follow: -

Main board.

- A. To antenna.
- B. To capacitor in series with the tuning capacitor.
- C. To frequency counter.
- D. To connection point D on AGC board and 'S' meter positive.
- E. To connection point A on the AGC board.
- F. To top of panel mount AF gain pot.
- G. 13.8 volts positive.
- H. 13.8 volts negative and ground.

AGC board

- A. To connection point E on main board.
- B. To AGC switch.
- C. 13.8 positive.
- D. To connection point D on mainboard and 'S' meter positive.
- E. To 'S' meter negative.
- F. To AGC switch.
- G. 13.8 volts negative and ground.

Final audio board

- A. To wiper of panel mount AF gain pot.
- B. 13.8 volts negative and ground.
- C. Speaker negative.
- D. 13.8 volts positive.
- E. Speaker positive.

Trying to use a meter with low sensitivity will load down IC1 and spoil the AGC action. If VR2 is readjusted the meter zero will have to be reset. VR1 on the AGC board is adjusted on receiving a very strong signal, when the signal ceases to distort the output VR1 is adjusted correctly.

Most of the parts used in this receiver were available from W.I.A. equipment supplies here in VK5. The vernier drive, the former and slug for L4 were purchased from D.S.E. the part numbers being P7170, R5020 and R5025. The only component that may prove difficult to obtain is the MC1350; if the constructor has tried the usual outlets without success, one I.R.C. sent to my address will guarantee the swift return of one of these devices.

The ammonium persulphate etchant and direct etch pen are both available from D.S.E. the part numbers being N5654 and N5181. For best performance, the crystals used for the ladder filter should resonate within 20 Hz of one another.

Performance

With 'lids' on and after a warm up period VFO drift is manageable for a receiver. There were no jumps in frequency, just a

slow drift up or down. One can only expect so much from such a set-up.

Note that the capacitors designated as polystyrene should not be substituted, besides being very stable they have a slight negative co-efficient which helps to counteract the positive co-efficient of L4. The polystyrene capacitors used in this rig were obtained from D.S.E. Soon I expect to commence work on an accompanying exciter for this receiver in which case a separate stable VFO will be a necessity.

To assess the performance of this rig I sat it alongside my FT840 using an antenna switch to make comparisons between signals of varying strength. One would expect the FT840 to be better, and it was, but not by a lot. Properly built and adjusted, this little rig gives a good account of itself. I was particularly pleased with the AGC action, although being audio driven, it reacted smoothly in all situations with the ability to prevent overload from extremely strong signals.

There is scope enough for changing the value of some components to suit the individual constructor, eg. I prefer a crisp but not tinny audio response that may not suit some amateurs so C35 on the main

board can be increased in value.

The six 15k resistors concerned with the audio filter can be altered, decreasing their value will widen the bandwidth, increasing their value will narrow the bandwidth.

For an improved response more crystals and capacitors can be added to the ladder filter at the expense of IF gain. As mentioned before, the four crystals should be as close as possible to each other frequency wise, also X5 can be checked to see if it is resonating somewhere in the region of 300 to 600 Hz low.

The string of capacitors in the ladder filter can be changed in small increments eg. 8.2pF for a narrower response, 12pF for a wider response. Ladder filters in the lower side band mode can be used for upper side band reception. However, I have tried it in the past, but was always disappointed with the response.

If the constructor has a commercial 9 MHz sideband filter and a suitable crystal for the BFO these can be used. The VFO frequency will need to be 5 to 5.350 MHz which is easily managed by adjusting the slug in L4. C12/L5 can easily accommodate the 1 MHz change.

Parts list main board

C7, C8, C10 330pF polystyrene.
 C11 100pF polystyrene.
 C9 4. 7pF NPO ceramic.
 C6, C13, C14, C20, C21, 0.1µF monolithic.
 C22, C23, C24, C25, C29, C31, C34 and C40
 C15, C16, C17, C18, C19 10pF ceramic.
 C26 56pF NPO ceramic.
 C27 100pF NPO ceramic.
 C28, C36, C38 0.01µF monolithic.
 C30 47µF 25-volt electrolytic.
 C32, C42 100µF 25-volt electrolytic.
 C33 1µF tantalium.
 C35 1000pF greencap.

C37, C39 2200pF greencap.
 C41 10µF 25-volt electrolytic.
 C43 22µF tantalium 16-volt.

Semi-conductors

T1, T3 78L05 5-volt regulator.
 T2 MPF102 FET.
 T4 7812 12-volt regulator.
 IC1, IC3 NE602AN integrated circuit.
 IC2 MC1350 integrated circuit.
 IC4 LM1458 dual op-amp.
 IC5 UA741 single op-amp.
 IC6 LF351 single op-amp.

Inductors – SEE TEXT

Crystals

X1 to X5 all 8 MHz computer crystals.

Parts list AGC board

R15 1MΩ.
 VR1 10kΩ.
 VR2 50kΩ.
 VR3, VR4 20kΩ.

Capacitors

C1, C4, C6, C7, C8, C9 0.1µF monolithic.
 C2 1µF tantalium.
 C3 47µF 25-volt electrolytic.

C5 10µF 25-volt electrolytic.

Semiconductors

D1, D2, D3 IN914 diode.
 T1, T4 MPF102 FET.
 T2 78L12 voltage regulator.
 T3 BC548 transistor.
 IC1 LF351 single op-amp.

continued next page

Resistors 1/4 watt

R1, R8 15Ω.
 R2 100kΩ.
 R3, R7, R20 100Ω.
 R4, R17 1kΩ.
 R5 4.7kΩ.
 R6 27kΩ.
 R9 47Ω.
 R10, R11, R12, R14, R15, 15kΩ.
 And R16
 R13 220kΩ.
 R18, R19 33kΩ.

Capacitors

CS NPO ceramic to suit tuning capacitor (see text).
 C1, C5 18pF NPO ceramic.
 C3 2.2pF NPO ceramic.
 C2, C4, C12 70pF trimmer.

Resistors 1/4 watt

R1 10MΩ.
 R2 27Ω.
 R3, R5, R7, R9, R10 10kΩ.
 R6 1kΩ.
 R4 1Ω(link).
 R8, R13 100kΩ.
 R11 22kΩ.
 R12 68kΩ.
 R14 4.7MΩ.

Parts list final audio board

Resistors ¹/₄ watt

R1, R2	22K Ω .
R3, R8, R9, R11, R12	1k Ω .
R4	1 Ω (link).
R5, R6	470 Ω .
R7	1 Ω (link).
R10	10K Ω .

Capacitors

C1	1 μ F tantalium.
C2	100 μ F 25-volt electrolytic.
C3	15pF NPO ceramic.
C4	0.1 μ F monolithic.

C5	100 μ F 25-volt electrolytic.
C6	2200 μ F 16-volt electrolytic.

Semiconductors

D1	IN914 diode.
T1	BD139 transistor.
T2	BD140 transistor.
IC1	LM301 low noise op-amp.

Hardware and Miscellaneous

'S' meter.
Speaker.
AF panel mount pot. 10k Ω log.
AGC switch SPDT centre off.

On/off switch.
Tag strip.
Variable capacitor (see text).
Copper clad board.
Antenna PL259 connector.
BNC connector for frequency counter.
Aluminium disc for dial readout.
Power connectors.
50W miniature cable
Hook-up wire
Cable ties
Etching pen and etchant (see text)

a r

Scraping the bottom of the Technical barrel

The Editor has received a few comments on the 2000 AR. The greater number of Technical articles has been appreciated. However this has emptied the technical article bucket. Please consider submitting an article on something you have made, or an

analysis of a circuit or aerial or ? Articles can be anything from half a page to 4 or more. The magazine is a forum for sharing our experiences and for trying out new ideas on each other. I look forward to hearing from you.

Contact The Editor AR by packet VKSUE@VK5LZ.#ADL.#SA.AUS.OC
or e-mail edarmag@chariot.net.au or at 08 82552138

A Trap for an old Player

For years a Realistic DX400 receiver has accompanied me when I have gone bush. Although more than 10 years old now, it is quite a hot receiver, and has been used on the broadcast and short wave bands to keep in touch with news broadcasts, footy results and the like. It has keypad frequency entry, and a few memories in which to store favourite stations. It is fairly large by current standards, but this means that the pushbuttons are big enough to be seen, it has a reasonable speaker and thus acceptable sound quality, and there is room for two decent batteries - a 7.2 volt stack of C cell nicads, and a pair of AA size dry cells for memory maintenance. The nicads are easily charged from a nominal 12 volt supply through a 27 ohm resistor, and keep the radio going for many hours after a charge.

A few weeks prior to another excursion, I decided to recharge the nicads. The radio was going at the time, and in what was not one of my cleverer acts, I connected the battery across the 12 volt supply minus the 27 ohm resistor. There was a really rude noise from the speaker which motivated me to disconnect the 12 volts extremely quickly, but I was still too slow - the DX400 had expired. A few of the pixels remained energised on the display, but none of the pushbuttons or controls did anything.

I had a circuit diagram in the back of the

owner's handbook, (that shows you how old this set is!) and using this poked around inside the set with a DVM looking for anything which might have been damaged by the overvoltage. Nothing found, and I managed to convince myself that the fault lay on the most expensive component in the set - the CPU. I decided to take the set back to the supplier for a post warranty repair, having first found out that the CPU was still available and that the total cost of the job was economically justifiable. The supplier agreed to complete the repair prior to my departure, but as it happened it wasn't, so I got the set back, as dead as ever.

So the trip was completed without the DX400 and during this time I wondered whether I could make use of any of the bits in the thing before consigning it to the tip.

Home again, and I once more tried the DX400. The same few pixels lit, and just as before none of the controls did anything. Whether it was divine inspiration, or my reward for clean living I do not know, but it occurred to me that the CPU memory might have been corrupted by the overvoltage. This was soon checked by removing the backup batteries for a day before putting them back. And that was it. The trusty Realistic came good and seems totally unharmed by the experience.

What a relief!
73 de Ian Cowan, VK1 BG.

Gippsland Technical Conference

As an attendee, along with my wife, to the second annual Gippsland Technical Conference held at Churchill on the weekend of July 10 and 11, we would both like to thank Peter Freeman and the other zone members and wives who were involved in the organisation of the weekend.

The technical programs were excellent; both in subject matter and the professional way in which they were presented.

Like wise the wives/partners of the participants were catered for with visits to the many excellent craft venues, gardens, vineyards and gourmet foods which abound in the region.

Saturday evening at the conference dinner was another success with the opportunity for everyone to socialise in preparation for the microwave demonstrations on Saturday morning while the great BBQ lunch finished off the day and the conference.

I hope next year will see many more attend because they wont be disappointed.

David Waring VK3ANP
RMB 1300
Banksdale Road
Hansonville 3675

Conquer the BW*



and get your

CW!

(*The **B**ludger **W**ithin)

Translated, with comments relating to
Australian circumstances,
by Mike Krochmal, VK3KRO
from an article by Dieter Engels,
DJ6TE in CQDL 8/99
(pp. 659 & 660) and 9/99 (pp. 743 & 744)

Part I

Do you really want to learn CW ? And you're asking me whether you'll ever manage it, with all those Morse code characters ? But of course you will - after all, millions of radio amateurs before you have managed it.

Why should you, of all people, not be able to do it ? Something which those nice people who attend the local ham radio club have been able to do should not present a major problem to you. Or should it ? Piece of cake !

Good prerequisites ?

Excuse me ? In your case, the prerequisites are particularly favourable ? Great, I'm really pleased for you ! Unbelievable : you've done your VCE ? And you studied Electronic Technology - successfully, even. And you are so musical that you can

simultaneously play piano with one hand and violin with the other. And you're financially well off, too ! Forget it : none of that will help you ! Not in the study of CW - that calls for other attributes. Three of these come to mind immediately : 1. Endurance ! 2. Lots of endurance ! 3. Enormous amounts of endurance ! But don't kid yourself : endurance is a pretty rare commodity.

The "Bludger Within"

You might be familiar with him/her, the little but determined "BW" ? Make no

mistake : you, too, have a resident BW. It is he/she who talks with a quiet but insistent voice : "Just for one day, leave that stupid diddly-dah be - there's a great show on the telly". It is also he/she who, much to the amusement of your CW tutor, earnestly insists that you are currently under great stress and therefore have no time to practise. And make no mistake about this, either : your BW knows you really well, and knows all about your weaknesses. To combat him/her is the greatest problem in learning the Morse Code !

continued next page

Frustrated ?

Have you changed your mind now ? Have I frustrated you ? I'm sorry, that was definitely not my intention. But at this point, you can still decide whether you really want to learn CW or whether you would rather do your "Little League License" and just "wait out" the CW exam, because the days of our suffering are probably numbered. Let's consider together the best means for you to learn CW. First, I will introduce you to the various methods which can be used to teach oneself, or be taught, CW. Each of them has pros and cons.

Intensive CW

Let's start with the surest and quickest method of learning CW :

• The intensive courses

These courses (which are advertised in CQDL) prepare candidates for the exam by means of whole-day instruction sessions. The subjects of study are the technology, operating techniques, regulations and sometimes even CW. The courses generally extend over three weeks and are run by highly motivated radio amateurs. Morale is always first class, and the success rate of such courses is better than that of any other type of learning. However, as concerns CW, there is unfortunately one catch : a prerequisite for entering one of these intensive courses is a knowledge of Morse Code characters at 6 wpm - otherwise they will not accept you for the "big" certificate. You will just have to do some learning for yourself first - but then a whole lot more afterwards.

• Morse code course at the local ham radio club

This is probably the most common method of learning CW. Often, Morse code courses are offered in stages. Stage 1 : learning of the Morse code characters up to 6 wpm and Stage 2 : acceleration of speed up to 12 wpm, ie up to exam level. The costs of such local ham radio club courses are usually quite reasonable, but they are higher if the course is being held at a local public secondary school. The success rate is "so-so". For example, I am happy if after 30 to 40 practice nights there are still five to ten hardy survivors left, out of the 30 keen aspirants who attend the first evening. Oh well, it's probably my fault. The reason for this slack result is obvious : the course evenings are usually at the end of a working day. The course participants have usually pretty well had it, are only minimally

motivated, and are difficult to enthuse. Furthermore, the deadlines are set in concrete - get side-tracked with another project, or even a 3-week holiday, and things get really tight for time. And most importantly, because now the "BW" rears his/her ugly head again : additional practice at home is a real must.

• DARC on-air Morse code course

This third option is probably doomed to failure unless supported by some other means of assistance - additional practice with supplementary texts and/or sympathy from an OM or YL. Reason : the 24 lessons are insufficient, even just from the point of view of the available time. An additional means of practice is essential ! My recommendation : ask around in the local ham radio club whether recordings of this course are available. The individual lessons have been put together well, are interesting and professional, and contain a lot of valuable material relating to operating techniques.

Well, that covers those options for learning the Morse code which operate within a fixed time-frame and thus firmly set the speed of learning. But the expectation that you can just sit back and listen "in comfort" to what is happening "in front, there" is a false one. That is not enough. Not in a month of Sundays ! You will need to make use of your own initiative, and if you are unable to make such a commitment, then you might as well just settle down in front of your computer, instead, right now !

The computer knows CW

So now I will bring to your attention some other options which will allow you to learn CW all by yourself, using your own individual time schedule. But I will also not spare you the disadvantages of the isolated learning process :

1. it is easier to learn in a group ! To see that your neighbour has the same problems as you do is immensely uplifting.
2. You will miss out on the benefit of an experienced Morse code teacher. Especially when you are stuck or becoming intensely suicidal because, for example, you have been confusing Q and Y for weeks. The Morse code teacher could console you and/or pass on a

few tips - after all, that is his/her main function !

3. You'd be amazed at the number of times that really interesting programs are being screened on TV at just that same time that you picked to do one of your rare practice sessions ! Don't shake your head ...

• Audio cassette courses (DL1FL)

Three cassettes (38.- DM) - they are not enough by far. Each cassette or CD plays for a good hour, but no more. But just to learn the Morse characters, you are bound to need more than 20 hours. And to properly learn to hear 12 wpm, you will need as much again. To learn through recording media is really very difficult. But it is also no longer sensible, since there are now better ways.

• Computer courses

Their number is legion. I've checked out many - they all fulfill their purpose ! The few bucks which you'll need to spend are thus of no great consequence. Allow me to briefly review just two of these, representative of all the others. They are both free, have been programmed with great experience and effort, can be run from Windows, and are very easy to use. The latest versions of both of these are probably being circulated in the local Ham Radio Club, or on the Internet, or can be obtained from the authors in return for a recognition fee (and kind words !). (Hopefully, they won't lynch me for this, Hi). The programs allow many settings, and they allow the learning of CW in the optimally shortest time, without other auxiliary aids. I found a remark in one of the programs quite comforting, that CW is no harder to learn than touch-typing ("typewriter 10-fingers blind"). There are times when even I believe that there is much too much fuss about the learning of telegraphy to 12 wpm. But now to talk about the two programs, in brief :

- **CW 2.7** by Heinz Peter Niksch, DL4FCH, Sallburgstr. 4, 60385 Frankfurt. Very nicely put together. One can create one's own tapes, because random text can be printed out and allows later checking.
- **CWT 16.7** by Heiner Hanenkamp, DK5LI, Schulstr. 7, 25421 Pinneberg. Visually even prettier than the previous one. Valuable learning hints. Just great !

Thank you, friends - you have really worked hard. Also good are HF-Morse by DL3SDL or EGA-Morse by DL5AAC. They represent the many other Morse programs which I am either not familiar with, have forgotten, or have not been able to find in my mess-heap. So these were programs for PCs - but there are also programs for Apple computers. They are somewhat harder to find, and always in English. (Or does someone know a German one?). I would like to mention just one example :

- **MorseMaster** : The user interface is typical Apple : beautiful. But the adjustment possibilities aren't up to CW 2.7 or CWT 16.7. One thing is common to all programs : They are definitely not as entertaining as "The Box". What I mean to say is that the "BW" can have a whale of a time. The programs only offer the prerequisites for learning - you yourself must also really want to learn. And do not underestimate your own inertia : even starting up a program can become an "insurmountable hurdle" - if you don't really want to practise.

Pocket Tweeter

Microprocessor-controlled units from Switzerland, which are capable of generating CW signals, have been around for some time. Such an instrument in effect replaces a computer as well as its program. These gadgets have the (only) advantage, compared to a computer, that they are always ready for action. But they are not cheap - you will need to spend around 400 DM to 500 DM. Since two years ago, a small Morse tutor which is good value for money has been available from MFJ in the US : the MFJ-418. It costs barely 200 DM, and is the size of a packet of cigarettes. An LCD readout simplifies the learning of Morse characters tremendously, because it displays the characters as they are generated. We at the local Ham Radio Club in Ulm, PI4, loan these tutors (which are owned by the club !) to those of our

members who are keen to learn the code, for a period of up to one year.

Why not have a word with your local Ham Radio Club ? So, those are the various possibilities for learning CW. My recommendation : if a Morse code course is being offered in your vicinity, go for it ! If the timing is not right, or if the venue is too far away (consider the roads in winter, too), then learn using a computer or the MFJ-418.

But, just to say it again : success is determined not by the method or the equipment, but solely and completely by your endurance in your practice.

E-I-S-H-T-M-O or E-L-V-O ?

During the first lesson, is it best to learn the letters E-I-S-H-T-M-O or E-L-V-O ? Two different philosophies of learning hide behind this decision. Unfortunately, the opinions of the "experts" diverge somewhat on this point.

- **The first system (E-I-S-H-T-M-O)** has as its objective the most rapid possible learning of the characters - no matter how - in order to then accelerate to the required speed. The entire set of characters (26 alphabetic letters, 10 numeric digits and a few punctuation and operating characters) is learned in only seven lessons. All ten numbers are learned in the last lesson. The characters which are easiest to learn, namely E-I-S-H-T, are contained in the first lesson, because they are hardest to pick up later (because they 1. have no "sound" and 2. are very short). This system was used by the German Federal Navy; the (American) MFJ-418 Tutor works in the same way.
- **The second system (First lesson : E-L-V-O, then A-S-Q)** aims to prevent the confusion of characters by distributing these characters in lessons which are widely spaced in time. All of the characters are

distributed among a total of 19 lessons. But in practical terms, this means that you will hear the characters for lesson 19 (8 and ?) for the first time at a time when, in the first system, you have already been practising all (!) characters together for twelve evenings. Surely that is a disadvantage. And the supposed advantage is, at best, questionable : that certain characters will not be able to be confused with each other because one of them will have been well and truly learned before the other one is introduced. I have taught in accordance with this system for about 20 years, and at times observed quite the opposite effect. Quite typical : confusion of C with K. The C is often not heard in its entirety, but prematurely and clearly recognised as a K after the dah-dit-dah. So then there are later problems with the K. This recognition of characters without absorbing the entire dit and dah sequence is quite typical and normal, by the way : thus a 9 (dah-dah-dah-dah-dit) is recognised only by its tail (dah-dit). The logical abbreviation for a 9 in contests is thus an N.

Furthermore ...

One can learn the Morse characters using either system - but I prefer E-I-S-H-T-M-O. And now I should really give you a few clues about the actual learning process, because these are very important for an understanding of the problems, which are guaranteed to rear their ugly heads. Unfortunately, the available space is insufficient, so I will report more about these issues in a follow-on article. But that should not prevent you from starting with your practice immediately.

Or, do I hear a murmur — from your "BW" ?

...to be continued



Part II next issue

So you have seriously decided to learn CW? I'm really pleased, because I personally consider telegraphy to be a fascinating operating mode.

WICEN (Vic) Y2K

John Kerr VK3BAF.
State Secretary, WICEN (Vic) Inc,
40 Gwent Street
SPRINGVALE SOUTH Vic 3172.

An extract from a memo to the Secretary WICEN (Vic.) from M.N. (Neil) Comrie, Chief Commissioner Victorian Police

I am writing to express my appreciation for the significant contribution made by WICEN Vic. volunteers in the installation and staffing of a back-up state-wide radio network for emergency response coordination purposes.

The year 2000 and the associated "Millennium Bug" posed significant risks to the community and the State's infrastructure, particularly the essential services. If some predictions of widespread failures to electricity and telecommunications networks had been realised, the community would have been exposed to significant risks.

I am advised that WICEN members devoted a great deal of their time to designing communications corridors, installations of antennae, repeaters and cabling at various coordination centres.

The dedication of volunteers who contribute their time and skills to promoting community safety often heartens me. WICEN volunteers diligence in testing the network and their preparedness to operate it over the year 2000 transition period is exemplary.



Peter Carter VK3AUO operating from his Mobile station

This is how these comments were earned.

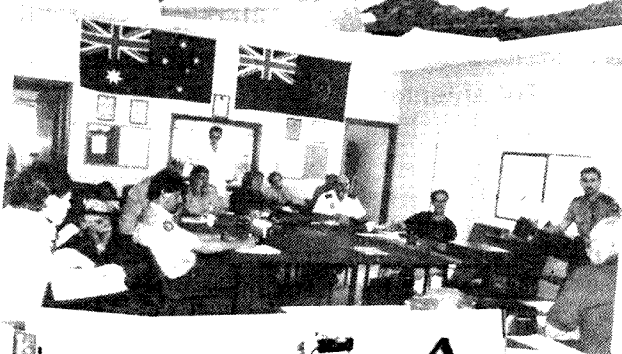
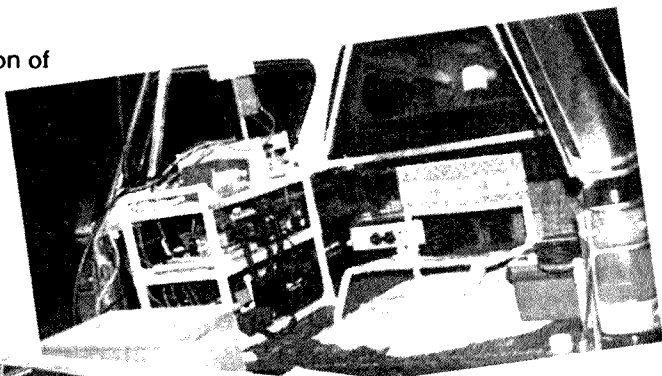
Firstly we must go back to late 1998 when the concept for a communications system was instigated by the Vic. Police in conjunction with WICEN. Basically the system was to provide a State wide communications network to all the new Police District and Divisional headquarters as designated in the new regional planning being implemented by Victoria Police, to be effective by November 1999. In essence this did not appear to be an insurmountable problem to the seasoned WICEN man but in practice the specifications and the vast area of the planned network, provided instant headaches, indicating the need to form some expert teams to lead our planning.

The system called for the installation of a State wide VHF network to provide primary communications, plus a fall back system, and a HF system to cope with those areas not capable of reliable VHF communications. The base station operations and operation centre were to be at the Victoria Police Headquarters at the World Trade Centre in Melbourne. To assist the project, WICEN was given a financial grant to upgrade nominated repeaters and antenna installations to cope with the system and the new Police Regional Communication Centres. All monies spent were subject to Department of Justice audit and certain items remain the property of the Department.

To handle this concept a Technical group was formed to carry out a State wide survey of optimum repeater coverage together with path loss figures so a VHF system could be used together with a HF system where the VHF could not cope with the distances to some of the furthest regions. Working from the results of the survey, various antennae and radios were installed at Police H/Q, and these were then remote controlled from a control point within the Police complex, which was to be called SERCC, (State Emergency Response Communications Centre). Furthermore the WICEN group had to provide the generators and back up power supplies for all this equipment in case of a mains failure

The regions of course had to cope with manning the District Police Stations as they would be a normal field exercise, that is each District under the guidance of the Region Coordinator provided the necessary radios, masts, antennas, with some assistance from the technical group in providing stand-by

Mobile station of John Kerr VK3BAF



Members of WICEN (Vic) at a planning meeting



Home Station set up of John Kerr VK3BAF

batteries, in case of sustained operation under battery power. Of course these operators did not in all cases have the most comfortable operating conditions, but all in all things were not too bad.

Finally came the WICEN Administration Station which was located at the Moorabbin Radio Club rooms, which was ideal for this exercise as VHF and HF aerials were already in place. The main function of the Administration Station was to provide a WICEN control centre which would cope with staffing of field stations in the event of sustained operations etc. and also to handle any administrative problems which may have occurred.

However, this part of the exercise did not come under any great trial because as we all now know there was no real extending of our resources due to the "no fuss" passing of the Y2K Bug! It would have been interesting, and helpful too for future similar occasions if we had been able to test and prove this part of the system as well.

In conclusion some idea of the undertaking can be gauged by the spread of the operations. Some 18 District Police stations were manned, from Mildura to Bairnsdale, from Warrnambool to

Wangaratta, plus Police H/Q., and our own Administration Station. All in all over 80 operators were used on the night of 31/12/1999 and the early hours of the next morning. There were another 50 operators on stand-by for subsequent shifts if required. On the morning of New Year's Day the system was fired up again at 0000 hours Zulu to cover the lag in GMT time, but this time only the country districts were manned, together with our control station and the Administration station. For those of you who heard us on air, you must agree the system worked very well, and WICEN thanks you for your cooperation in keeping the frequencies clear.

It would have been nice to try out our Administration capabilities, but this would have meant we would have had to have a major breakdown somewhere. Undoubtedly it was better the way it was with no major hiccups. This was WICEN's big chance to demonstrate its expertise and there is no doubt it was done very well. Congratulations to all those involved. We now have an efficient State wide system which can be readily activated in the event of a major disaster.

ar

The G5RV – A Portable Antenna Option

Ian Cowan, VK1BG.

For years now my wife and I have been in the habit of disappearing from our home QTH so as to go bush. I usually take portable HF gear with me, both as a means of keeping in touch with the family at home, and as a pastime activity when in camp somewhere. An essential component of my radio gear is a flimsy G5RV antenna.

The aerial is nothing special. It is just a bit of single strand hookup wire of the right length (102 feet) with some 300 ohm TV feeder at the centre, also of the right length (29 feet). The whole thing probably took about 30 minutes to make, and that was about 15 years ago, so it doesn't owe me much. When not in use it is wound on a spool made from a jam tin. When deployed for action, the trusty G5RV couples to the rig via a balun into a coax through the caravan wall, and then an ATU. It has proved to be an effective antenna on 80, 40 30 and 20 metres, and it loads well on the rest.

Getting the antenna up is ideally achieved by throwing strong fishing lines weighted with reasonably big sinkers either over the top of, or through, a pair of tallish trees which happen to be about 120 feet apart, with the caravan placed at centre span. The sinkers are then removed, and the antenna is pulled up using the nylon lines as both supporting medium, and as the insulators. When erected, the antenna is usually hard to see, though the black feeder silhouetted against the sky sometimes gives the game away.

The ideal installation is seldom achieved, because campsites seem to have as many variations from perfect as there are words on this page. In addition, most campsites are owned by somebody either directly, or by someone who has the privilege of temporary occupancy of a site near yours. So compromises in the physical configuration of the antenna are necessary to avoid material or personal conflicts, and these compromises usually involve putting one or more bends in the G5RV, and the use of more than two supports. The G5RV seems to be very tolerant of bends, though I make a point of keeping the ends as clear of nearby objects as possible to avoid dielectric losses and detuning.

Once I decide how to string the G5RV up at a site, there is usually not much trouble

getting it there, though it took a bit of practice before I could throw the sinker reasonably close to where I wanted it to go. I have not hit anyone or damaged any property, and with only one exception the sinker has always made it safely back to ground with the nylon line faithfully following it. The exception was in suburban Perth, where it became tangled high up in a tall beech tree. I could not break the line by hand so I hitched it to the towbar of my car to do the job. This was pretty scary, because I was aware that had the sinker broken free, line tension could have propelled it towards the car like a bullet. Anyway the line broke first and so far as I know, the sinker is still dangling from that tree. Calamity was narrowly avoided on another occasion at Wilpena Pound when a young lad climbed a bullock tree for me to effect the rescue of a sinker. He was a brilliant tree climber, and would have made a marvellous tree surgeon.

With the antenna safely erected, I usually leave the free ends of the nylon lines wound on to spools which are tucked away out of sight either in the trees concerned, or buried.

I used to try to be a bit sneaky about putting up the G5RV, so I usually did this at a time when there were not too many people about. This was to avoid having to deal with the curiosity of those around, and to avoid the risk of being told I couldn't do it by someone in authority. This policy was mostly successful, though not always. Once when throwing a sinker in the Bowling Green National Park in Queensland I was sprung by a ranger who told me that "You can't go fishing here, mate!". I would have thought that to be a bit obvious, as the nearest water was several kilometres away. And occasionally my spools of nylon line have been discovered and stolen. One such occasion was during a visit to Lake Argyle in WA. It was sked time, and just as I was tuning up, the G5RV collapsed across the roof of the caravan. I flew outside in time to

catch a pair of elderly gents congratulating themselves about a handy find, but they soon departed empty handed and with fleas in their ears. In retrospect I think these gents were relatively innocent characters who did not deserve the serve I gave them, but there have been a few other cases of petty theft by people who did not need to resort to it.

So my policy now is one of openness. I usually tell campground managers of my intentions, and tell anyone near my precious spools of line what they are attached to, and in so doing engender some level of protective instinct in those people. The downside of this policy is the need to spend time explaining what amateur radio is about, but time is not usually critical, and it is good PR for the hobby. Another effect is that it tends to flush out the odd broken radio or TV set, but I am getting good at explaining that I have no expertise in these areas. Worthy cases excepted, of course.

Camping ground managers are almost always helpful, sometimes guiding us into their best treed sites. It is rare for one to raise the safety issue, and none has ever raised the possibility that I may cause TVI or whatever. Clearly they have had few bad experiences with radio amateurs, and I try to keep it that way.

The responses from other campers are much more varied. Most have little understanding of what amateur radio is, and the separate nature of it as compared with CB. Many, upon first spotting the G5RV apparently tethered high up in the trees want to know "how did you get that thing up there!", and there is a temptation to have a bit of fun at their expense, but I usually resist that. The G5RV is often thought to be some sort of TV antenna, as the feeder is familiar to many. Some people show a genuine interest in what is going on, and every now and again a real amateur will appear out of nowhere for an eyeball QSO. Openness is much the better policy.

With my old G5RV and a nominal 100 watts from a battery operated rig I have been able to keep in touch with home quite reliably, notwithstanding some pretty poor QTH's sometimes. I have found that at least for intra VK contacts, the nature of the QTH, and the configuration of the G5RV are not good predictors of results. My most ideal installation of the G5RV was in the bed of the De Grey River in WA. The antenna was over sixty feet up tied to a pair of tall and well placed river redgums. I expected great results but there was total and very rare

failure that night! Yet at the Cape Le Grande National Park, also in WA, there are no trees so the poor G5RV was laid across the scrub so low that a passing 4WD vehicle nearly wiped it out. Here we had excellent results, and no one was more surprised than me! Good performance on 20 metre DX can be more easily predicted. Elevated sites, and those near water are best, and the G5RV has carried me into many a remote country from such locations.

The G5RV can be used as a TV antenna at a pinch, and gives a very worthwhile

boost to a broadcast band receiver when the campsite is really remote.

I see and hear of lots of portable stations using whips and random wires for their HF aeralis. These often work quite well, but not well enough to encourage me to toss out the G5RV. It is not as convenient as a loaded whip to use, but I would certainly commend the use of a light weight G5RV to those amateurs who like me have joined the "grey nomads" on Australian roads.

ar

Cover story

New Australian 24 GHz Distance Record

David Minchin, VK5KK

In the past month Russell Lemke VK3ZQB (pictured), Trevor Niven VK5NC and Colin Hutchesson VK5DK have made several successful contacts over ever increasing distances using Homebrew Narrowband 24 GHz equipment. Both the existing VK3 & VK5 Wideband FM 24 GHz records (VK3XPD/3 – VK5KK/3 71km and Vk5DK/5 – VK5NC/5 38km) were broken while the equipment was still being tested!



To date, the best contact occurred on the 29/2/00 between Russell VK3ZQB/P3, Tower Hill, north east of Port Fairy, Victoria and VK5NC/P5 & VK5DK/P5 located at "The Bluff" approx. 35km west of Mt Gambier. The distance of 171.8 km has now been claimed as a new Australian Distance record. The Two way SSB contact was at 1104 GMT with signal reports of 5-5 to 5-3 with QSB. The contact was made during a period of intense local ducting. The current two-way world record is around 405km.

The equipment used is a result of several years' work. Russell's equipment consists of two 400mm-diameter dishes, one for Receive and one for Transmit. Both VK5DK's & VK5NC's 24 GHz equipment uses the same configuration and power

levels. The separate dishes eliminate the need for an expensive (and difficult to find) WR42 waveguide switch.

The heart, of each transverter, is a pair of (Receive & Transmit) DB6NT Mk3 Transverters. DB6NT designed Receive and Transmit amplifiers, along with waveguide filters, are used to obtain a power output of 70mW on transmit. The task of making each module was a combined effort of VK3ZQB, VK5DK & VK5NC with Alan Devlin VK3XPD providing 24 GHz test facilities. Russell performed the delicate mounting of "Surface Mounted" components.

Initial contact was made on 10 GHz. Signals, on 10GHz, were in excess of 5-

9+20 during the time of the 24 GHz contact. The approximate 1-degree beamwidth of the 24 GHz dishes made it imperative to use the 10 GHz dish to find the exact direction and elevation. Interestingly, it is reported that the dishes were aimed above the horizon, presumably towards the upper boundary of the duct.

24 GHz is one of the most challenging bands available to the Amateur operator as it has the distinct disadvantage of being near lowest resonant frequency of a Water Molecule. What does this mean? Well, the net effect of Cloud or rain can be up to 1.5 db attenuation per km of path. Needless to say, conditions were warm and dry during the record attempt!

ar

Hamming in the USA



Dom Bragge (VK2JNA) Lucent
Technologies (SAS) Senior PCB
Designer (R&D) 16 Smith St Chatswood
NSW 2067 Tel: (+61 2) 9935 5792
AUSTRALIA dominicb@iucen.com Fax..
(+61 2) 9417 3862 E:-l http://
www.jna.com.au

I was quite excited about going to North America for a holiday recently, especially when realising how I was going to be able to use my H/T over there. I did some pre-work which included finding out reciprocal licensing arrangements between USA and Australia and Canada and Australia. I also built a 110V battery charger (100mA constant current source) so that I could trickle charge my NiCad's from a power point. And I ordered a copy of the Repeater directory from the ARRL.

I used the World Wide Web on the Internet and came across an FCC website about reciprocal arrangements <http://www.fcc.gov/vAb/amateur/reciparr.html> for hams visiting the United States who wish to operate there. This was extremely useful as it let me know that going to an FCC office and filling in a form was now not needed. Also, I could use my own call sign as long as I tacked on a "/W3" (or appropriate) on the end as well.

When I jumped on the AMTRAK train at Penn Station, New York City, headed for Washington DC I found I had a few hours to kill. I could've read a book but no, the bug got me! I dug out my trusty FT-530, clipped it to the headrest of the seat in front of me and flicked through the Repeater book looking for 2m repeaters in New Jersey (the state I was now travelling through). It was actually quite a busy time as I had to co-ordinate looking up a map to find out what town we were near, program the next memory channel, listen to the conductor 'musically' announcing the next stop (he was quite a comic) and get a few calls out and hold a meaningful QSO before I left the range of the repeater. It was more complicated because I had to learn how to program my radio to use CTCSS while transmitting and there are all sorts of offsets to use. Some are -600 kHz, some are +600 kHz, some are 1MHz, plus or minus and all over the band, not in a neat group like ours. In the North East of the USA I found there were lots of repeaters and although many of them were "private" (a weird idea for us Aussies to cope with) there were still plenty

that were "open" (for all to use). A few times I could access repeaters seemingly easily but got no reply. Sometimes I did get a call back and had a QSO. I was told by one or two people that my accent was so strong that they had trouble understanding me. This might have explained why I didn't get a VHF pile-up. I think that it might be quite rare for them to hear a VK callsign on a local repeater as well!

I programmed in about 23 repeaters along my train route and could access 14 of them. Out of this I had about 8 QSO's on 6 repeaters. It was a lot of fun and those I talked to were quite interested in what I was up to. It was during a normal work day so that probably kept the contacts down somewhat.

While I was in Washington DC checking out the Smithsonian Air and Space Museum, I spent the evenings wandering around 'The Mall' and had my H/T on wherever I went. This was great fun. I made some friends on a couple of the local repeaters and chatted regularly with them during the week. They invited me to use their autopatch and in retrospect, I should have, just for the experience, but I didn't think a telephone call back to Oz would be on the cards anyway! The next weekend was 'Field Day' all over the United States where a lot of Hams get away from the local power supply and into the field to set up portable stations and rack up the contacts. I was invited to go along to the local club's setup but was sadly unable to change my plans at that late stage.

A week later in the holiday, I had to visit my company in Whippany, New Jersey and I found that the local ham club was in the company! When I booked into the Hilton, I asked to get a room as high up as possible - so they put me on the top (5th) floor. From here I could access the repeater at work and had a dozen contacts that night, more than half of whom work for my company or were retired from there. I was amazed that so far in the US I found there were quite a lot of YLs on the bands as well. Most were wives of Hams and it certainly was refreshing

compared to the very male dominated airways in Oz. I made particular friends with one fellow from my work and also talked to his (ham) wife and (ham) son on the air. The next day I met him for lunch and met some other hams there as well later in the afternoon. They took me to the roof to view their antennas and see that they had stiff competition for roof space from the 'Wireless' part of the company as one of their test sites is on the roof as well.

When staying in the 35th floor apartment of friends in the middle of New York City, I was able to hit quite a few repeaters. From here I had a few QSOs with people in the city, New Jersey and Connecticut as well. I didn't find the pager interference unacceptable and had a great vantage point. Again I was having fun trying to work out from the Repeater directory which repeaters would be close and which too far away, as most of the names of places were unknown to me. I also got out and visited a couple of Ham Radio Stores in the city, although they were hard to find. The Yellow Pages were almost non-existent for a visitor and even when I got my hands on one, stores, were listed in the "communications, professional" sections hardly mentioned anything Ham - I had to telephone them and explicitly ask if they had ham gear. A little bit expensive here.

In Los Angeles I attempted to make some contacts on 2m but I found that their system was like our UHF CB repeater system in Sydney - clogged up with idiots. Even when I could find an open repeater being properly used the stations left no room between overs for a weak station like me to get in so that was no fun at all. Zero contacts! In LA I simply had to put up with going to Ham Radio shops like HRO in Anaheim and Jun's in West Hollywood. This was certainly fun and I brought back a few 'presents' (for myself) to round out a good adventure.

73 dom VK2JNA
ar

Morse code proficiency is part of the tradition of amateur radio

Max Riley VK2ARZ
6 Baringa Road,
Mortdale Heights 2223

There has been recently an increased amount of pressure on various authorities to remove the Morse code qualification from the list of requirements of the AOCPE exam.

There has always been pressure, but it seems to be gathering strength as minority groups in the society find the old adage about squeaking wheels and grease has a basis of acceptance.

Frankly I am disappointed and ashamed to think the young Australians particularly cannot develop the skills to cope with learning about thirty Morse code characters. This lack of commitment should be compared with the learning skills of young Japanese students.

Even an eight year old Japanese child has a firm grasp of the fifty symbols of the Hiragana. By the time that student reaches university entrance level he or she needs to know about 1800 Kanji. These can be learnt

only by, at most, two sensory methods. Morse code on the other hand can be learnt by at least three sensory methods.

Learning is not prerogative of the young however. Since my retirement I have had the pleasure of meeting a man who developed an interest in our hobby. He studied the theory by correspondence and subsequently passed the full code test by using the WIA recorded lessons and slow Moors transmissions. He was over 70 when he sat the exams. Since then it has been my pleasure to guide him in various ways so he can trouble shoot defective equipment, with a bit of assistance. He had no skills before starting, and did not have the benefit of an extensive education.

The thing that seems to be overlooked is that Morse code proficiency is part of the tradition of amateur radio. It is as significant as the Trooping of the Colours and the observance of Remembrance Day. When all other means of communication have failed, Morse code can still be used, by a variety of means, to provide effective contact between skilled communicators.

It would appear that a small body of amateur operators will be the only people who will be able to do this in the future. That situation should not be sneered at. It is a powerful reason for us to hold on to our skills in this area.

ar

Radio and **Communications**

Incorporating AMATEUR RADIO ACTION and CB ACTION

Edited by Chris Edmondson, VK3CE/4

PO Box 123, Eagle Heights, Queensland 4271 PH (07) 55450666 • FAX (07) 5545 0622

SURVEY OF READERS

Here is your chance to have your say! Should the amateur service stick with **Morse Code**, or is it time to finally say goodbye?

In the May issue, we canvass this and many other important questions — and so keen are we to get your opinion that you could win a heap of prizes!

Of course we also want to know what you think of **RADIO and COMMUNICATIONS**. Here is your chance to shape the future of the magazine as well!

Not bad...change both the hobby and the magazine, and win at the same time!

Oh, and don't forget our usual fantastic articles!

Rush your newsagent on April 19. Don't miss out...

We have the biggest collection of radio-oriented Classified adverts in the country. There's lots of them because they work so well. Ask your newsagent to keep a copy for you each month. Hurry — you might miss something!

Don't miss out — **RADIO and COMMUNICATIONS** is great reading for amateurs!

Check your local newsagent today!

ALARA

Christine Taylor VK5CTY ALARA Publicity Officer
16 Fairmont Avenue, Black Forest SA 503
Packet: VK5CTY@VK5TTY email: geensee@picknowl.com.au

Internet can be an AR friend

Gosford Field Day

Dot and her helper, Nancy, had a busy day at the ALARA table this year. She had visits from Val VL4VR and Anne VK4ANN. both well known to many of us either on the air or at the ALARAMEETS. Other visitors to the stand were Agnes VK2GW1, Suzanne VE3EPO/VK2EPO and Beryl VK2BBM. Nina VL2INZ stayed for a long chat. She is a newcomer to the radio and to Australia but has come up on the Monday nets a number of times. There were, as always many others who stopped to look at our photos and ask about ALARA

A most interesting visitor to the table was a ten-year-old girl, Gloria, who is doing a Novice course through the Internet. Her father is doing it with her so there may soon be two amateurs in that family. The fact that she can and is doing the course through the Internet indicates the two types of communication can help each other. Many "Jeremiahs" tell us amateur radio will be killed off by the Internet, yet here is a demonstration of how it can help people become amateurs. Let us use the Internet to tell others the benefits of amateur radio, especially the young ones. The address for the Internet Amateur Courses is vk2wi@ozemail.com.au

International YL2000 in Hamilton

All of you who indicated interest should have received the information, and many already filled in forms and sent deposits. However, if you have only just realised you will be able to go after all, I am sure Biny ZL2AZY and her helpers will be interested to hear from you and will be able to fit you in.

I hear there will be a number of DX members at the Meet, so it could be an opportunity to meet those familiar voices.

Touring? or visiting another State

Any time you are in a new city or town it is a good idea to put out a call on 2-metres. There are YLs in many places. They are not always monitoring the airwaves but many OMs are happy to use another band or even the telephone to let the local YL know there

is a visitor. You cannot always fit in a meet, but a chat can be fun and will be remembered by you and by the local lass — there are some YL amateurs who live many kilometres from any other lady with similar interests.

Passing through Bordertown? Mary VK5AMD would love to chat. Mildura? Marilyn VK3DMS can be on 2-metres at most times of the day. Passing through Maleny or travelling up the Bruce Highway? You may catch Val VK4VR or Anne VK4ANN or June VK4SJ. In Murray Bridge, Meg VK5YG always has the kettle on for visitors if she is home. Why not put out a call?

Where there are several YL operators who meet frequently, it may be possible for you to have a cuppa together, or meet for lunch. In VK5 this is always possible, so please don't miss the opportunity. We would all love to say "Hello".

Two recent silent keys — OMs of members

Laurie, OM of Marjorie VK2AMJ passed away late last year and Graham, OM of Bev VK4NBC passed away at the beginning of March. Our condolences go to both ladies and their families. They and their OMs have been part of ALARA's life over the years.

A Flight over Antarctica

Mary VK3FMC recently took one of the flights over Antarctica and loved it. It reminded me of the flight I took many years ago. There is so much to see if you have clear skies over the remote continent.

The 'leads' in the ice through which ships make their way appear as black lines through the sheets of blindingly white ice. Some seem to go forever, others peter out after a short distance. You realise why many of the ships that go to Antarctica have little planes or helicopters on board. If the lead you are using begins to become thinner you need to know if this a temporary thing or if you must force your way through the ice to another lead.

The icebergs you see from the plane must actually be enormous, but they look like irregular white blobs floating in a black sea.

Over the land the reverse is true. Odd

shaped masses of black rocks poke through the sweep of white. These are called Nunatuks and are actually the peaks of mountains. The depth of the ice is unimaginable.

On my trip we were lucky enough to fly over the Russian base, a tiny line of black oblongs that were the huts. We could hear the pilot speaking to the radio operator at Australia's Davis Base although it was not in sight. This was all before I got my licence. Absolutely amazing and mind-blowing.

If you are thinking about going on one of these flights hesitate no more. It will be an experience you will never forget.

Or if you are asked to act as the QSL manager for someone going to Antarctica accept the invitation. We did this for Keith VK5OQ twice and found it most interesting to see all the different places with whom he made contact. Unfortunately he didn't make DXCC from it, but there were 81 separate countries with hundreds of QSL cards.

How to send your news

By packet VK5CTY@VK5TTY By email geensee@picknowl.com.au

Please send me any news that you think might interest others. There are many readers of this column who want to know what you are doing.

Hazards of camping

Mary VK2BEM, camping with a grandson to keep amused, ignored the rain one night to finish a game of Trivial Pursuit. Then she discovered the back flap had been left down. When she lowered it the bucket or so of rain that had collected in it came in though the open window onto the bed. Guess who was changing wet bedding at 10pm??

Townsville is still there!

The Monday night Net was very relieved to hear Sally VK4SHE come up recently — wet but otherwise OK. Down South we had all been hearing about the enormous amount of rain they had had so we were concerned. We were also staggered when Sally told us they had had 28 inches of rain (over 700mm) by the end of February!! No wonder it cannot be absorbed into the soil.

ar

52nd Urunga Radio Convention

Easter Weekend, 22 & 23 April 2000

B J Slarke VK2ZCQ

- Fox hunts
- Old Gear Display and Home Brew equipment
- Lucky door prize, ladies and gents registration
- Disposals Table (included in registration) — bring gear for sale
- Raffles, quizzes & competitions
- 80 metre novice pedestrian hunts for children
- Lunches catered for

Awards:

Overall winner for events over two days
 Jack Gerard memorial Award
 Trophies perpetual shield to winners

Cost:

One day: OM \$8, XYL \$6, Family \$14
 Two days: OM \$10, XYL \$8, Family \$18

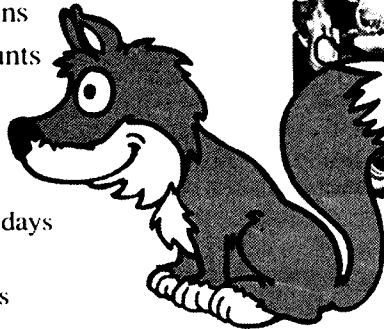
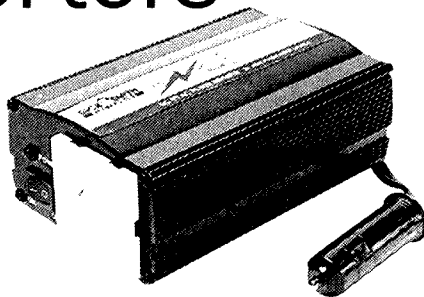


Photo: Crieff Retallick VK2XO founder of the Urunga Radio Convention, in front of the Ocean View Hotel, c1951

Try This

Power Inverters

Dick Smith Electronics has two power inverters for powering a range of 240volt equipment via cigarette lighter or other 12 volt source) in a car or caravan.



The two new inverters are ideal for caravan users and car travellers who wish to power small televisions, VCRs, personal computers, small kitchen appliances and many other items.

The entry model (Cat No. M5100) has 150 Watt output power and the next model (Cat No. M 5101) has an output power of 300 Watts.

Both models have under-voltage and over temperature protection.

The two new models are compact and lightweight — the M5100 weighs only 700

grams while the M 5101 weighs 900 grams.

The Dick Ssmith electronics power inverters are available from Dick Smith electronics stores Australia-wide and Dick smith electronics PowerHouse stores at Penrith, Bankstown, Moore Park in NSW and Carnegie in Victoria for a retail price of \$149 for the M 5100 and \$229 for the M 5101, or mail order by calling Dick Smith Electronics Direct Link on 1300 366 644 or visit the Dick Smith Electronics website at www.dse.com.au

Andrews

Communications Systems

(EST. 1976 - ACN 001 968 752)



ALINCO

AUSTRALIA'S FIRST AUTHORISED
 FACTORY DIRECT IMPORTER
 MASSIVE SHIPMENTS EVERY MONTH

FULL 3-YEAR WARRANTY ON
ALINCO and ICOM
 WE SELL MOST BRANDS

BALUNS, VERTICALS, YAGIS, P/S,
 ICOM-KENWOOD-JRC-AOR-EMOTATOR-
 MFJ-DIAMOND-TIMEWAVE-KANTRONICS
 -THP - GARMIN - TERLIN - UNIDEN -ETC

DX-1600 HF LINEARS FROM \$ 3,799
HUGE RANGE OF ELECTRONICS,
ICOM and ALINCO Radios.

Over 22 Years of
 Professional Sales and Service.
 Instant Repairs Fridays
 HF Transceivers & Linears Wanted

(02) 9636 9060 or (02) 9688 4301
 SHOP 8, 41 BATHURST ST, GREYSTANES,
 N.S.W. 2145. FAX (02) 9688 1995

▶ DON'T MISS THE ACTION!

VX-IR 2m/70cm Micro Handheld

One of the worlds smallest dualband handhelds, just 47 x 81 x 25mm (W.H.D.) including a high capacity 700mA/H Lithium-ion battery! The VX-IR covers both 2m and 70cm amateur bands, plus offers AM/FM and TV sound reception, 2 hour fast charging as standard, simple settings and a large LCD screen.

Features

- Tx: 144-148, 430-450MHz
- Rx: 0.5-1.7MHz, 76-300MHz, 300-580MHz, 580-999MHz (cellular locked out)
- Output: 2m/70cm 0.5W (at 3.6V), 1.0W with external DC
- 291 memories, most with alpha naming
- AM, FM(n), and FM (w) reception modes
- CTCSS encode/decode
- 31 smart search memories
- Tone search for CTCSS and DCS
- Includes FNB-52LI 3.6V 700mA/H Lithium-ion battery, regulated AC adaptor/charger, antenna and belt-clip.

D 3665

YAESU

\$399

2 YEAR WARRANTY



VX-5R 6m/2m/70cm Deluxe Hand-Held

Tiny yet incredibly rugged, the VX-5R provides 6m, 2m and 70cm amateur band operation with 5W output as standard (4.5W on 70cm), made possible by a unique PA design and a super high capacity 7.2v 1100mA/H Lithium-ion battery. Plus, ultra-wide coverage VHF and UHF as well as AM medium-wave and shortwave reception facilities are provided, along with a large backlit dot-matrix LCD screen. All this in a diecast aluminium enclosure just 58 x 87 x 28mm WHD (without knobs or antenna)!

Features

- Tx: 50-54, 144-148, 430-450MHz
- Rx: 0.5-1.8MHz, 1.8-16MHz, 47-729MHz, 800-999MHz (cellular blocked)
- Full feature keypad, CTCSS encode/decode, digital code squelch
- Comprehensive menu system
- Over 200 memories
- 8 digit alpha-numeric memory labelling
- 5 battery saving systems, plus Tx/Rx usage monitor
- Spectra-Scope™ for monitoring adjacent channel activity
- Comes with FNB-58LI Lithium-ion battery, flexible antenna and AC adaptor/charger

D 3670

YAESU

\$699

2 YEAR WARRANTY

BONUS BONUS BONUS

Purchase a VX-5R during April or May 2000 and receive a CD-15 Desk Rapid Charger (D 3672 valued at \$49.95) at no charge!



Yaesu FT-90R 2m/70cm micro mobile

Another engineering breakthrough from Yaesu – a tiny dual-band mobile rig with high power output, a remoteable front panel, and a rugged receiver front-end. The FT-90R provides 50W RF output on the 2m band as well as 35W output on the 70cm band, a solid diecast casing with microprocessor controlled cooling fan for reliable operation, and a large back-lit LCD screen, all in a package measuring just 100mm x 30mm x 138mm.

Also Includes:

- Wide dynamic range receiver for greatly reduced pager breakthrough
- Huge receiver coverage – 100-230, 300-530, 810-999.975MHz (Cellular blocked)
- 180 memories and a variety of scanning functions
- Built-in CTCSS encode/decode, battery voltage metering
- Designed for 1200 and 9600 baud packet operation
- Tiny remoteable front panel (requires optional YSK-90 separation kit)
- Includes MH-42 hand mic, DC power lead, and easy to follow instructions.

D 3312

YAESU

\$899

2 YEAR WARRANTY



YSK-90 Front Panel Separation Kit D 3317

\$129.95

FOR ALL YOUR COMMUNICATION NEEDS

Rugged HF 5-Band Trap Vertical Antenna

The rugged 5BTV incorporates Hustler's exclusive trap design (25mm solid fibreglass formers, high tolerance trap covers and low loss windings) for accurate trap resonance with 1kW (PEP) power handling. Wide-band coverage is provided on the 10, 15, 20 and 40m bands (SWR typically 1.15:1 at resonance, <2:1 SWR at band edges) with 80kHz bandwidth typical on 80m at 2:1 SWR. An optional 30m resonator kit can be installed without affecting operation of other bands. High strength aluminium and a 4mm (wall thickness) extra heavy-duty base section guarantee optimum mechanical stability. At just 7.65m, the 5BTV can be ground mounted (with or without radials, although radials are recommended), or it can be mounted in an elevated position with radial system. Unlike other antenna designs, the 5BTV can be fed with any length of 50-ohm coax cable.



D 4920

\$399



30m Resonator Kit

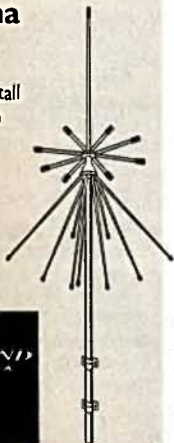
Adds 30m coverage to the 5BTV and includes all hardware

D 4921

\$99.95

D-130J Discone Antenna

Covers the frequency range 25-1300MHz and comes with mast-mounting hardware and instructions. Easy to assemble and install with extensive stainless steel construction making it extremely durable. A wide frequency coverage means that it's ideal for scanning receivers, as well as transmitters up to 200W PEP for the 6m, 2m, 70cm and 23cm amateur bands. Uses an SO-239 coax socket for easy coax connection.



D 4840

\$179



6m 1/2 Wave Base Antenna

A rugged Australian-made vertical antenna designed to cover the 51 to 54MHz range, with minimum SWR around 53MHz. Built using high tensile T81 grade aluminium, it's just 2.9m long with a sealed base section and 100W minimum power rating. Complete with mounting hardware.

D 4825

D&G Antennas



2m Heavy Duty Base Station Antenna

For use where long-range omni-directional 2m band (144-148MHz) coverage is required. This 3.4m long 1/2 wave over 1/2 wave colinear vertical antenna provides approx. 5dB gain, and is housed in a very tough single-section fibreglass radome for all-weather protection. The strong aluminium base section is fitted with an N-type socket in its base for coax cable connection.

D 4822

BENELEC

\$139.95

WIA Callbook

Wide range of information for Australian Amateurs plus callsign and address listings.

B 2344

NEW



\$17.95

ARRL Handbook

77th edition of this famous publication. Incredibly wide range of information for operators and constructors.

B 2237

NEW \$59.95



45-Memory Shortwave Receiver

The ATS-808 provides continuous 150kHz to 30MHz coverage, so you'll catch all the action on the shortwave bands plus medium-wave (AM bands) and, with earphones, FM stereo. You can select wide or narrow filters on SW bands (as well as attenuation for extremely strong stations) to ensure optimum reception quality under differing conditions. Requires 6 x 'AA' batteries or mains adaptor (M 9626 recommended).

D 2829

Features:

- Keypad frequency entry • Dual time settings
- Desk stand • Signal strength meter
- Narrow/wide IF filters for improved SW reception
- External shortwave antenna socket
- Built-in whip antenna • 13 SW band divisions with direct access buttons
- Complete with stereo earphones and protective case.

Longwave: 150-519kHz
 Mediumwave: 520-1710kHz
 Shortwave: 1.711-29.999MHz (continuous)
 or in 13 pre-set SW bands
 FM: 87.5-108MHz



\$199
SAVE \$86

PHONE FAX AND MAIL ORDERS

PHONE: WITHIN AUSTRALIA: 1300 366 644
 (Local call charge)

FAX: (02) 9395 1155 within Australia and
 (+612) 9395 1155 from outside Australia

MAIL: DICK SMITH ELECTRONICS, Direct Link, Reply Paid 160,
 PO Box 321, North Ryde NSW 1670 (No stamp required)

Excludes packaging and postage. All major credit cards accepted.

14 Day Money Back Guaranteed if NOT completely satisfied. (Software excluded)



Visit our web site at
<http://www.dse.com.au>



That's where you go!

Yaesu transceivers and accessories stocked in selected stores only. Other stores can place orders on a deposit-paid basis. Offers expire 30/4/2000.

WIA Division Directory

The WIA consists of seven autonomous State Divisions. Each member of the WIA is a member of a Division, usually in their residential State or Territory, and each Division looks after amateur radio affairs within its area.

Division Address	Officers	News Broadcasts	Fees
VK1 ACT Division GPO Box 600 Canberra ACT 2601	President Gilbert Hughes Secretary Peter Kloppenburg Treasurer Edwin Alcott	VK1GH VK1CPK VK1NBH	(F) \$72.00 (G) (S) \$58.00 (X) \$44.00
VK2 NSW Division 109 Wigram St Parramatta NSW (Office hours Mon-Fri 1100-1400) (PO Box 1066, Parramatta 2124) Phone 02 9689 2417 Freecall 1800 817 644 Fax 02 9633 1525	President Michael Corbin Secretary Eric Fossey Treasurer Eric Van De Weyer Web: http://www.ozemail.com.au/~vk2wi e-mail: vk2wi@ozemail.com.au	VK2YC VK2EFY VK2KUR	(F) \$99.00 (G) (S) \$56.00 (X) \$41.00
VK3 Victorian Division 40G Victory Boulevard Ashburton VIC 3147 (Office hours Tue & Thur 0830-1530) Phone 03 9885 9261 Fax 03 9885 9298	President Jim Linton CEO Barry Wilton Secretary Peter Mill Web: http://www.tbsa.com.au/~wivvic/ e-mail: wivvic@alphalink.com.au	VK3PC VK3XV VK3APO	(F) \$75.00 (G) (S) \$61.00 (X) \$47.00
VK4 Queensland Division GPO Box 638 Brisbane QLD 4001 Phone 07 3221 9377 Fax 07 3266 4929	President Colin Gladstone Secretary David Jones Treasurer Bill McDermott Office Mgr John Stevens e-mail: office@wiaq.powerup.com.au Web: http://www.wia.org.au/vk4	VK4ACG VK4OF VK4AZM VK4AFS	(F) \$85.00 (G) (S) \$72.00 (X) \$56.00
VK5 South Australian and Northern Territory Division (GPO Box 1234 Adelaide SA 5001) Phone 08 8294 2992	President Jim McLachlan Secretary David Minchin Treasurer John Butler web: http://www.qsl.net/wiasant	VK5NB VK5KK VK5NX	(F) \$77.00 (G) (S) \$63.00 (X) \$49.00
VK6 West Australian Division PO Box 10 West Perth WA 6872 Phone 08 9351 8873	Acting Pres. Cliff Bastin Secretary Christine Bastin Treasurer Bruce Hedland-Thomas Web: http://www.omen.net.au/~vk6wia/ e-mail: vk6wia@omen.net.au	VK6LZ VK6ZLZ VK6OO	(F) \$89.00 (G) (S) \$59.00 (X) \$38.00
VK7 Tasmanian Division PO Box 271 Riverside TAS 7250 Phone 03 6425 2923 Fax 03 6425 2923	President Ron Churcher Secretary Tony Bedelph Treasurer John Bates Web: http://www.wia.tasnet.net	VK7RN VK7AX VK7RT	(F) \$88.00 (G) (S) \$75.00 (X) \$55.00
VK8 Northern Territory (part of the VK5 Division and relay broadcasts from VK5 as shown, received on 14 or 28 MHz).			

Membership Grades

Full (F) Pension (G) Needy (G) Student (S) Non receipt of AR (X)
Three-year membership available to (F) (G) (X) grades at fee x 3 times.



Division News

VK4 Notes Qnews

By Alistair Elrick VK4FTL
WIAQ Councilor and QTC editor

Australian Radio Certificate Scheme (ARCS)

This scheme is the brainchild of Ron Bertrand VK2DQ and Chris Edmondson VK3CE who visited the February WIAQ Council meeting to present their proposal. They asked the Council to endorse the scheme and give practical support in the issuing of Certificates. It is a scheme that is hoped to slow or reverse the dwindling ranks of Amateur Radio operators. Ron VK2DQ has put in the hard yards, and Chris VK3CE, Publishing Editor of Radio and Communications magazine, will be the promoter and the WIAQ will supply the manpower.

BUT what is ARCS I hear you say.

The Australian Radio Certificate Scheme is a way of rewarding effort, in showing prospective radio hobbyists that work and effort should have some form of reward. We need to be doing things TODAY that although they may not provide dividends for perhaps two or three years MOST CERTAINLY WILL PROVIDE NEW AMATEURS.

ARCS is a web based study course, approved and endorsed by the WIAQ and is made available as a free download from the Internet. Certificates in 3 grades will be made, and in studying for these grades the hobbyists will eventually find themselves knowledgeable enough to sit for an Amateur Licence. Already target groups include ALL Secondary Schools AUSTRALIA wide, Youth Clubs, CB Clubs and many others.

Now we need YOU to help spread the word and the 'word' in full is in the March edition of Radio and Communications magazine. Look in Editorial Comments on page 5 and at <http://www.radiomag.com>

VK4 QSL Bureau

Laurie VK4BLE will cease as QSL Manager for the VK4 division at the end of

this Council year, 25th of March 2000. Laurie has put some 12 years of working for the WIAQ into our hobby and certainly deserves a 'break'.

He has taken the QSL Bureau from being a liability to an operation that Council has not had to use any of their funds to support. Laurie will also complete the March mail out in conjunction with a new manager (recruit/volunteer) and post out all cards prior to hand over on the weekend of the 25/3/00.

Well done Laurie and thanks come from all the users of the QSL Bureau and the members who realise the sterling service you have given in all aspects of your WIAQ work.

FunDay 2000

A great day was had by all those who attended. Caboolture club and Brian VK4BBS are to be congratulated. Throughout the day close on a hundred amateurs rolled up, plus a thousand or more general "visitors".

Prizes went to amateur displays such as APRS, WICEN, WX SATELLITES, RTTY and PACKET, HF, FOXHUNTS and the major prize for the club who helped make the event by energy and manpower, Caboolture. The Club will hold the Funday Shield for 12 months and also get the 12-month subscription to Radio and Communications magazine.

Barcfest 2000

From the Brisbane Amateur Radio Club comes the date we all look forward to in SouthEast Queensland, BARCFEST. It will be held on May 13th 2000. The venue will be the same as in previous years at the Kelvin Grove High School in the auditorium complex. This will be the 18th BARCFEST and it goes from strength to strength each year.

South Burnett Diplexers are go!

The clubs' working bee in February went

very well with the construction of the diplexers. Jim VK4GYM came up with a novel idea for the construction of the contact fingers and it worked very well. Henry VK4HGS and Peter VK4PGF showed great skill in near vertical cuts with a hacksaw in the end of the outer tube. John VK4JL added much skill in the marking out and cutting for various items for the construction. The diplexers were finished by about 1700 and then the tuning was commenced.

The end results were in line with figures as quoted in the ARRL antenna book, so there were some relieved workers when it was finished. The cavities are all alloy and suitable corrosion / conduction treatment was undertaken on assembly to ensure a long life. Now there are a group of amateurs who have more knowledge on the internals of diplexers, which should help in any future repairs.

South Burnett club members who were unable to make it remember that very soon there will be the tower raising ceremony so keep your monitors warm for the next exciting installment.

History!

Alan Shawsmith, VK4SS, long time WIAQ worker and of late our Historian has honoured the Gold Coast Amateur Radio Society by offering to place his valuable collection of historical equipment in their care. Its value is not able to be calculated but is said to be worth thousands of dollars. Alan is also prepared to donate a considerable sum of money; sufficient to purchase a double prefabricated garage, slab and electrical wiring etc. The advantages of the Gold Coast having such a collection cannot be over emphasised, as it would create a lot of interest not only Statewide but Nationally as well.

We in the Amateur Radio fraternity thank Alan for the many years of dedication to Amateur Radio and the WIA.

73's from Alistair

continued next page

VK7 Notes

“QRM” Tasmanian notes

All the “tumult and the shouting” of the various branch Annual meetings have now passed, all held actually in a very good spirit (definitely not ‘Scotch!’), and we now look forward to the 18th. March weekend when we hold our Divisional Annual meetings and dinner at Kingston, near Hobart - more about that next month.

The Tasmanian Rally car rally in late February was extremely successful from the WIA angle. 23 Amateurs took part, providing Communication from all over the very difficult sector venues - over mountains, through gorges - no problems for our 2metre and 70cm. repeaters and simplex channels. They worked faultlessly. The S.E.S. was handling the police networks etc. but when their system broke down on Sunday we took over the lot!. Wonderful P.R. for us “only amateurs”!!.. We had three reporting desks manned

feeding into a VERY sophisticated computer programme which allowed the Rally organisers to know the exact location of any of the 150 odd cars. The Rally organisers had nothing but praise for the Rally communications manager Phil Harbeck, VK7PU, his radio room manager Tony Bedelph, VK7AX and the other amateurs and helpers. Methinks we’ll keep the job next year!.

In the South, Gavin, VK7HGO and his band of helpers provided the communications for the “Clean-up Australia” day on Sunday, 5th March. Another good job well done.

The 2metre morse practice sessions in the south have the usual problem of not enough helpers - hopefully Mike can find enough to keep going. Theory classes are commencing again in April.

The big challenge down south though is the weekly “yes-no” fox-hunts. Really serious stuff this. At the moment Scott

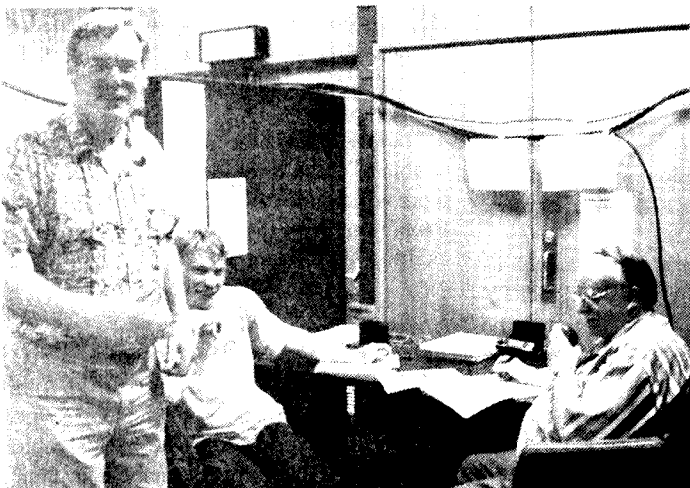
Evans, VK7HSE leads the field but he can feel the other aspirants hot breath on his neck. A case of “listen for the next exciting episode”

Look up our latest Tasmanian website - www.qsl.net/vk7cht - the site for our Central Highlands Amateur Radio Club. You MIGHT be able to talk them out of one of our famous Rainbow Trout but don’t hold your breath.

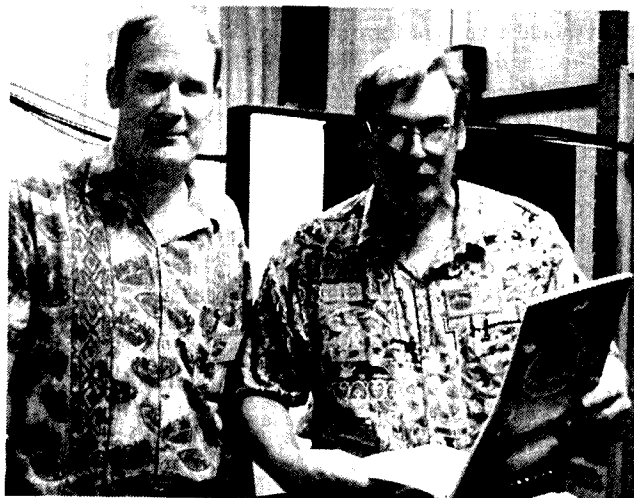
I am not putting up for election as Divisional President again - three years, I feel, is the maximum time that a President should hold office. I must say I have really enjoyed the privilege of holding this office. The Tasmanian amateurs are a great bunch to work with. There are some very able and dedicated people here who could take the reins and I wish the incoming President as good a time in the job as I have had.

Cheers for now.

Ron VK7RN.



Radio Room manager Tony Bedelph VK7AX (standing), Andrew Cooper (Hobart), penciller, with John Webster VK7KDR at the mic



Rally Communications Manager Phil Harbeck VK7PU with Tony Bedelph VK7AX in conference



John VK7KDR pencilling, Ron VK7RN at mic

VK2Notes

Pat Leeper VK2JPA
patleep@bigpond.com

This is a final reminder to members to attend the Annual General Meeting of the VK2 Division to be held on Saturday 15th April at Amateur Radio House, 109 Wigram Street, Parramatta. The Council would like to see a good roll-up to see who the new members of Council will be, as well as take part in discussion as it happens.



A quiet moment on the WIA stand

The Division attended the Central Coast Field Day at Wyong Racecourse on 27th February with a stall featuring new books and deceased estate items. The day was very successful and almost all the Directors were there to answer members' questions and man the stall. The weather held off until late in the event and there seemed to be a very good attendance making the most of the flea market in the morning.

The Division's Packet Radio BBS VK2WI was changed over to the Y2K compliant versions of the FBB program with only minor problems. The only glitch of note was that bulletins from 1999 were not being deleted although they were expired and had to be deleted manually. Despite reports of a decline in packet radio activity the BBS is still quite busy.

There is a magazine search facility on the BBS, which contains the same information as the machine in the divisional library. This facility enables anyone to search for articles in the common amateur radio magazines on selected subjects.

The Division is an active participant in the VK2DQ Internet course. A large number

of enquiries have been received with many enrolling for the course. The total number of students being managed by all the course supervisors, including those appointed by this division, is quite large and must be approaching 100. New students can undertake this free course by sending an email to vk2wi@ozemail.com.au.

A conventional mail correspondence course is also conducted by the Division and enquiries can be made to the WIA N.S.W. Division office by mail, telephone, fax or email to the addresses shown on the Divisional information page at the back of this magazine.

On 29th April the Warringah Amateur Historical Radio Association - now a part of the Hornsby and District Amateur Radio Club - will again celebrate International Marconi Day. The callsign will be AX2000/IMD. The first part of the call has been allocated to the NSW Division to celebrate the Olympic year and should be announced, as Alpha Xray Two Zero Zero Zero. This callsign is available for clubs and members for a period of one week and applications

are available from the NSW office. Nine clubs have already applied for dates, so don't delay if you want to use the callsign for a special period. The VK2 division will be running another special callsign from the divisional station for the period covering 14th September to 29th October, with awards for contacts with this and other VK2 stations. A special QSL card will also be issued.

A correction for your diary — the next Affiliated Clubs Conference will be on Saturday 20th May 2000, not 6th May as previously advised — remember it's now the 20th May. Come along with your ideas and/or grievances and give the Council something to work on for the members.

continued next page

For All Your Requirements

AUTHORISED DEALER

ICOM

KENWOOD

AMATEUR COMMERCIAL

Tower
Communications

14 Mary Street
Hazelmere
Western Australia 6055
Telephone: (08) 9274 1118
Facsimile: (08) 9250 3734
E-mail: tower@eon.net.au
www: <http://www.tower.visionimage.com.au>

VK1 Notes

Forward Bias

Peter Kloppenburg VK1CPK

February is the month in which the ACT Division holds its Annual General Meeting. So it was on the 28th when we got together in a heap, sang the praises of our hard working supporters, complained about the things that went wrong, and decided who was going to be in, on the decision making processes during the coming year. The Division has only 153 members, but to keep them happy involves a lot of hard work. For example, the QSL Bureau managers spend much of their time sorting QSL cards. These include incoming and outgoing cards of which addressees must be checked, packages made up, and postage worked out. Tex Ihasz (VK1TX) and Mike Jenkins (VK1MJ) deserve much commendation for their dedication and enthusiasm in running the Bureau so efficiently. There are others as well. Waldis Jirgins (VK1WJ), who managed the Sunday, broadcasts on HF and VHF, together with Ray Reinholtz (VK1PRG), Tex Ihasz, and Phil Longworth (VK1ZPL). There was Peter Ellis (VK1KEP), who knows how to spread the word in the media about Amateur Radio. Then there was Mike Walkington (VK1KCK) and Neil Pickford (VK1KNP), they managed the Technical Advisory Committee and provided answers to questions from the Committee, members, and non-members alike. Members of the Committee did not sit still either. Gilbert Hughes (VK1GH), with Paul Bell (VK1BX) and Paul Elliot (VK1Tee) spend tremendous effort over long periods of time putting up a new tower at Mt. Ginini. They are still working on it when time permits.

Our WICEN State coordinator, Phil Longworth, provided active leadership to his team and was very successful in a wide range of activities with car rallies, walkathons, etc. John Woolner, our secretary, wrote stacks of letters, organised exams, and provided historical background to events from the past. The Division did very well under the financial leadership of Les Davey (VK1LD) as Treasurer. Les paid all the Division's bills in time, and kept the books accurately and in accordance with accepted accounting rules.

The line up of the Committee Members for 2000 is as follows: Gilbert Hughes, President; Phil Longworth, Vice-President; Glenn Dunstan, Vice-President; Edwin Alcott, Treasurer; Peter Kloppenburg, Secretary; including Chris Davis, Richard Elliott, and Ernest Hocking. Chris and Richard are both heavily involved with the Novice and AOC classes, and Ernest is chairman of the ATAC group. The outlook for 2000 is positive. A reduction is expected in the Morse code speed requirements for the AOC. This fact alone will change the mix of Novice, and Limited, callsign holders, and also provide an incentive to those who are not licensed yet, including Citizen Band (CB) amateurs. One other development affecting ACT amateurs is the proposed system of linking our repeaters with those of other cities and towns. Detailed plans have been distributed to interested clubs and the NSW Division of the WIA. Negotiations are under way for the purchase of suitable equipment. As soon as the money has come in from participating clubs, the required equipment will be ordered, distributed, and installed by

members of the participating clubs. When the installation is completed, you will be able to use your 70 cm gear for making contacts halfway across NSW. Watch this space folks! The Division needs a new Broadcast Officer! Waldis has gone overseas for a well-deserved vacation. He will not do the broadcasts this year because of other developing interests and commitments. Do YOU like gathering bits of amateur radio related information, talking to amateurs with a passion, or just reporting what the Division is up to? There is a need for a broadcast officer who can give weekly updates about what goes on in the ACT. Most of the 153 members, and some of the non-members, get information about the local scene from Forward Bias in A.R. But this needs to be supplemented with fast breaking news to short-circuit the lead-times for A.R. and the interval between General Meetings. Non-members can only find out what's going on from listening to the broadcasts. By the time you read this, a broadcast charter will exist that provides details of how to run a broadcast for amateurs and what should be in it. For details contact Gilbert Hughes on 6254 3266 or email him at ghughes@dynamite.com.au

The Division now organises **Trash & Treasure** events on the following dates this year: **April 24**, August 28, and November 27. The last date is also the last General Meeting of the year, and will be celebrated in a Party atmosphere. I hope to see all of you at the next General Meeting, which will be held on April 24, at the Griffin Center, Civic, Canberra City, at 8.00 pm. Cheers.

ar

G. & C. COMMUNICATIONS

Graham Brennan VK3 KCS
19 Arleon Crescent, Cranbourne 3977

KENWOOD

GME Electraphone

uniden®

We specialise in Australia-wide mail order

All major credit cards
welcome

(03) 5996 3298

e-mail: gccom@netspace.net.au

www.netspace.net.au/~gccom

Fax (03) 5995 0184

An active amateur offering professional service, advice and product.

CLUB NEWS

Adelaide Hills Amateur Radio Society

AGM Report

The AGM was a short one. There were sufficient nominations to fill the vacancies on the committee so no election was held. The current committee is:-

President Geoff Taylor VK5TY
Vice-President Lloyd Butler VK5BR
Secretary Alby Wood VK5TAW
Treasurer Bryan Trott VK5PBT
Committee members
Jim Tregellas VK5XJT
Geoff Bridgland VK5JDZ

There were two 'Amateurs of the Year' nominated by the President:- Nicholas Bluhm VK5CX who joined the club at the beginning of the year and finished the year with a full call, and Lindon May the youngest amateur, who upgraded during the year to VK5SWR and is an active participant in all Club activities.

The talk about the design of loudspeakers was extremely interesting. Standard electromagnetic loudspeakers were explained in detail and demonstrated by the new Rola 15UE being manufactured by Graham VK5ZFFZ, who now owns the "Rola" name.

Then the designs (successes and failures) of electrostatic loudspeakers was explained

and demonstrated with hands-on material. More details of this lecture may appear in a later edition of AR.

2000 program

The program for the next few months will give us two talks, one about the future for VHF/UHF bands by Joe VK5WU and one about shortwave broadcasting by Jerome van der Linden. There will also be a Members' Buy and Sell.

If you live in or near Adelaide or are visiting on the third Thursday of the month come along to a meeting. All are welcome. Committee members are QTHR the Callbook for further information.

John Moyle Field Day

AHARS will be participating the John Moyle Memorial Field Day in the HF section, again. If you hear us, please give us a call. If we hear you we will give you one. As well as being a lot of fun this activity has a serious side as preparation in case it is ever necessary to operate radio equipment under field conditions away from mains power.

High Frequency "Pactor" BBS

VK5BAR

The "Adelaide Hills Amateur Radio Society" continues to operate a PACTOR BBS on 3.6 and 21 MHz, for use by any High Frequency station in Australia. It was established to allow stations not able to access local VHF/UHF Bulletin Boards, to utilise the AX25 Packet Network.

The BBS operates under the Callsign VK5BAR, on dial frequencies 3.632 and 21.075 MHz, using Lower Sideband, with a "Mark" tone of 2095Hz.

These transmissions may be described by some purists, as being on the "Mark" frequencies of 3.629905 and 21072.905 MHz. Frequencies are 21MHz during daylight and 3.6MHz during darkness, in Adelaide, South Australia.

All traffic lodged on VK5BAR is cleared to the AX25 network, via VK5SPG (run by the South Australian Packet Users Group), hourly. Australian Amateurs are encouraged to use the system. Information on conversion of older RTTY Modems, and information on suitable software, for use on PACTOR, is available on request.

Further information on the System, and PACTOR in general, may be obtained from:

Rob Gurr, VK5RG, 35 Grandview Ave.,
Urrbrae, SA, 5064

Telephone: 08 8379 1889

Packet:-VK5RG@VK5SPG

E-mail:- gurrcc@picknowl.com.au

Moorabbin & District Radio Club

Hamfest Reminder

A reminder that the MDRC's Hamfest will be on Saturday May 13, starting 10am. The venue will be the same as last year - the Brentwood Secondary College in Watsons Road, Glen Waverley (Melways 71 D7). Enter off Heath Street. Entry is \$4.00. Some very attractive door prizes will be offered.

Wally Hunt VK3JWH has once again offered himself as hamfest organiser. If you'd like to book a table, contact Wally on 9318 0197 (home), 0419 356 263 (mobile) or 9332 2328 (fax). Tables will be allocated on a first come first served so be quick.

The MDRC Hamfest has become Melbourne's most popular hamfest. Over 400 people attended last year.

Don't miss it!

Hobby Show a success

Once again the MDRC ran a stall promoting amateur radio at the St Kilda Hobby Show back in February. The event was a great success, with numerous contacts being made through amateur satellites. A more comprehensive report and pictures will appear in a future AR.

Radio on Rails logs due

How did you go with Radio on Rails, held earlier this month? If you made contacts in this fun event, make sure you get your logs to us by the end of the month. Logs should be posted to *Radio on Rails*, MDRC, PO Box 58, Highbett, Vic, 3190.

Peter Parker VK3YE Publicity Officer
Moorabbin & District Radio Club
parkerp@alphalink.com.au
(03) 9569 6751



TECHNICAL ABSTRACTS

Gil Sones VK3AUI

30 Moore Street

Box Hill South Vic 3128

New Life for the FT200

In *Technical Topics*, the *Rad Com* column of Pat Hawker G3VA in November 1999, the replacement of the final tubes with 6146Bs was described. This came from an earlier 1995 article in *Radio ZS* by Roger Davis ZS1J/ZS5L. The original line output tube finals were 6JS6 types which are now difficult and expensive to replace. The 6146B being a transmitting tube is easier to obtain and cheaper now.

The circuit and wiring diagram is shown in Fig 1. The sockets must be removed and replaced with octal sockets oriented as shown in Fig 1b. The orange wire supplying the screens should be cut short and sleeved. The screens are supplied from the 350 Volt line supplying the driver, 12BY7, via a series 100 Volt Zener diode or alternatively a series OB2 regulator. The supply can be found at the 'cold' end of the rf choke supplying the driver anode tuned circuits. The zener or regulator tube will drop this to the 250 Volts for the 6146 screens.

The neutralising circuit is modified by placing a 200 pF 1 KV capacitor in parallel with C40 the bypass capacitor at the cold end of the 12BY7 driver tube anode circuits.

In order to forestall a fault found in the FT200 you should also replace C55 the 100

pF coupling capacitor from the driver plate circuit to the final tube grids as this can become short circuit. A 100 pF 1 KV capacitor is required. If one is not available protection can be provided by wiring an additional capacitor of 1000pF 1KV in series. This fault can have serious consequences as when the coupling capacitor fails the finals have positive on the grids and draw excessive current which can be bad for the finals and also for the power supply.

A modification to the power supply was also given to increase the final HV voltage. This involved replacing the silicon rectifier diodes with a eight 1N4007 diodes and 470K parallel resistors. The Yaesu PCB makes provision for this but was originally only provided with four diodes and parallel resistors. The transformer can then be moved from the 460 V tap to the 600 V tap. This increases the HV to 850 Volts. Locally many FT200's were supplied with a local PSU in lieu of the Yaesu PSU so this part of the modification may not apply.

The new finals will have to be aligned and neutralised. First set the bias to 50 mA final current. Then align and neutralise the finals as per the book.

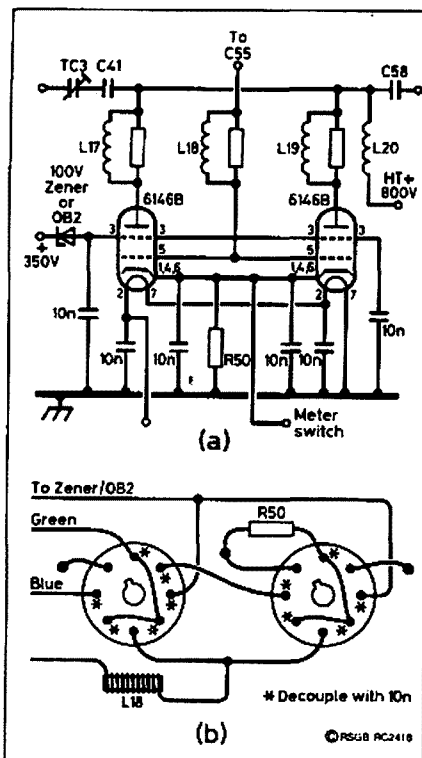


Fig 1. Circuit and Wiring Diagram for Replacement of FT200 finals with 6146Bs.

Blocking Non Locked PLL Signals

A way of preventing the radiation of an unlocked signal at switch on was presented in an item in the *Technical Topics* column of Pat Hawker G3VA in *Rad Com* November 1999. The item came from Dave Porter G4OYX/G3WOF. The original use was in a VHF FM broadcast transmitter.

The circuit used is shown in Fig 5. A 555 timer is used to provide a time delay at switch on. The 555 timer controls the gain of a low power stage in the transmitter and

so allows the PLL time to stabilise before a signal can be put to air.

The time delay used was appropriate to broadcast requirements but a modified version could be used in amateur applications. The circuit could be useful in applications such as beacons or with a packet system to stabilise at switch on prior to putting out a signal.

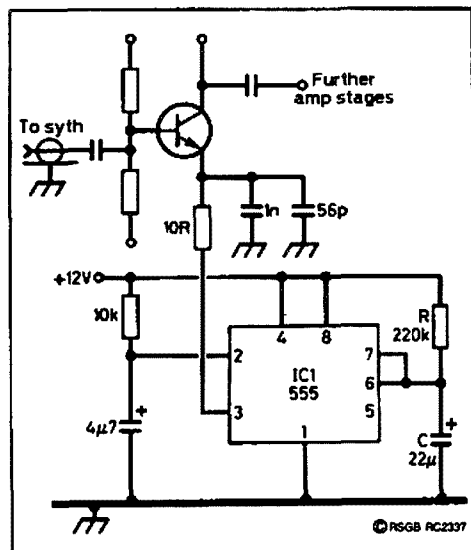


Fig 5 PLL Start Up Timer.

Elevation Rotator

The elevation rotator for a VHF/UHF satellite array can be hard to find. They are not as widely available as the usual rotators and are often lacking in capability for reasonably large arrays. The elevation rotator needs to be as strong and powerful as the normal rotator used for the array. In the In Practice column of Ian White G3SEK in Rad Com December 1999 the use of a satellite TV antenna screw jack actuator as an elevation rotator is described.

The screw actuators are motor driven and have been designed to position satellite TV dishes and so are quite adequate for use with a satellite Yagi array. An actuator is shown in Fig 2. They are an arm whose length is varied by a motor driven jack screw. They have inbuilt limit switches. The use of one as an elevation rotator is shown in Fig 3. This is from a design by WA3USC with input from GM4JJJ and G4ZHI.

The frame is made from 1.5 inch steel angle. The horizontal cross boom is 2 inches in diameter. The cross boom rotates inside a length of larger tubing at least one foot long. The larger outer tube is fixed to the mast by U Bolts and a large plate. Washers are

placed between the ends of the fixed tube and the frame and the frame is attached to the cross boom by U bolts. The actuator clamp is attached to a pivot bolt attached to a plate on the mast and the ball joint on the end is attached to a pivot point on the frame.

The angle of the frame to the mast is varied by adjusting the length of the actuator. The actuator drain hole should be at the bottom of the actuator housing. The

actuator should also be arranged so that the actuator arm is in tension. Compressive forces could tend to bow the arm and this should be avoided. The system should be arranged so as to allow the array to be tilted over 90 degrees from the horizontal to vertical.

Ian White G3SEK has a web site at <http://www.ifwtech.demon.co.uk/g3sek>. This is referred to in Fig 3.

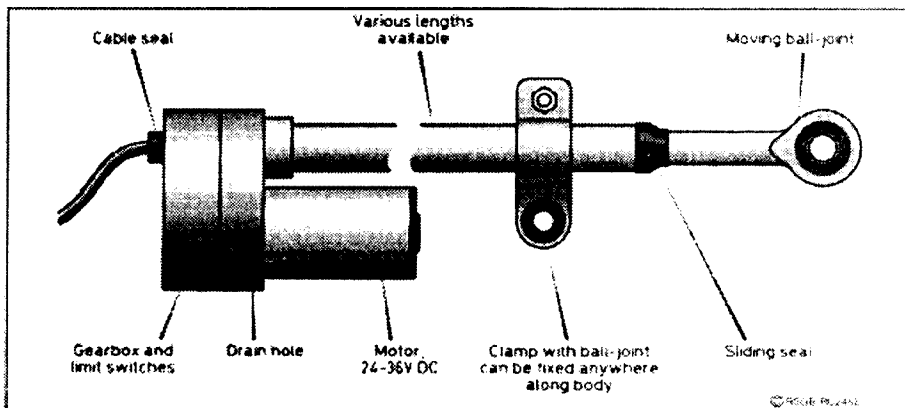


Fig 2 Typical Satellite TV Jack Screw Actuator.

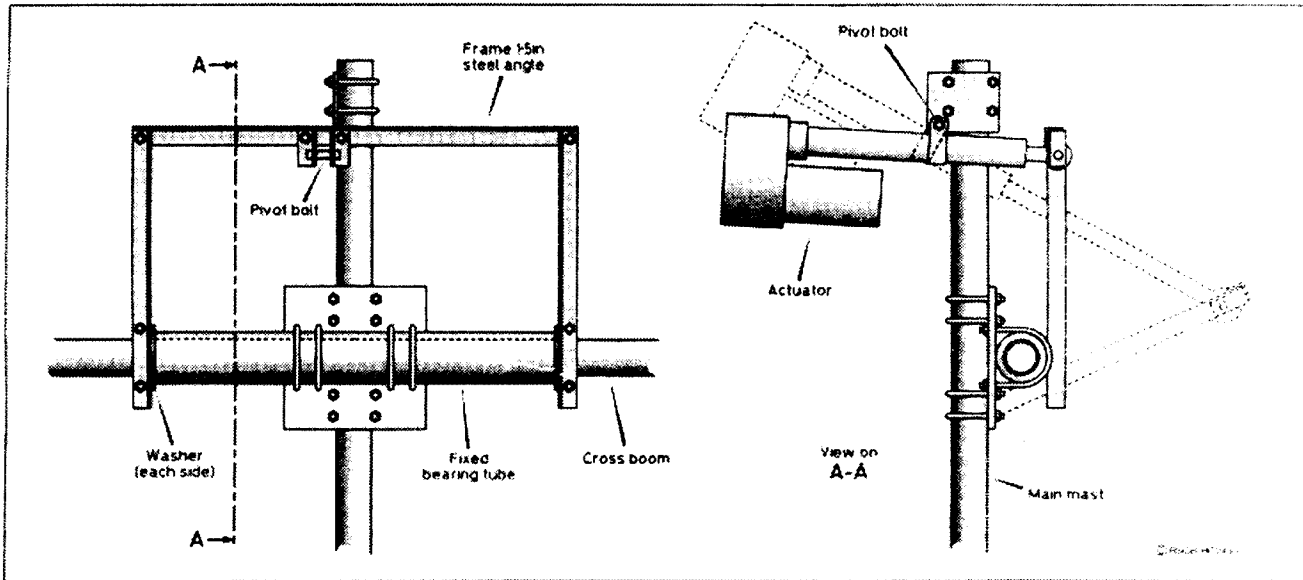


Fig 3. Simple Antenna Elevation System.

RF Probe

The RF probe from G3OKA (reprinted from Tech Topics Oct 99 Rad Com) in the January issue prompted Vic VK4AXM to provide the circuit of the probe he uses. Vic felt his circuit would provide less loading and better sensitivity. Vic felt that the coupling capacitor of 10n was too large and

that the 4.7M resistor will reduce the output voltage.

The circuit is given in Fig 4. The RFC is a few turns on a toroidal core. The Ip8 coupling capacitor should enable light loading of the circuit being investigated.

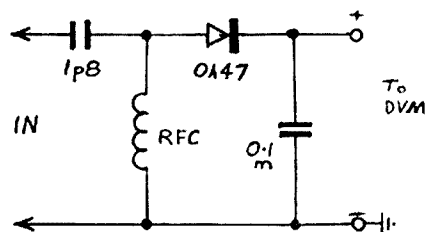


Fig 4. RF Probe.

NOVICE NOTES

Peter Parker VK3YE

12/8 Walnut Street, Carnegie, Vic 3163

Email: parkerp@alphalink.com.au

Novice Notes Online: <http://www.alphalink.com.au/~parkerp/nonline.htm>

Please note that this is Peter's correct address.

Amateur Radio's hidden curriculum

Practical skills the study courses don't always teach

What you need to pass the exam and the practical skills required to be a successful amateur are two quite different things. This month we outline six vital skills for radio amateurs. Mastering them will assist you to fully enjoy amateur radio and further your electronics knowledge. In many cases, possession of these skills is what distinguishes newcomers from experienced hams.

Soldering

If anyone asked me what was the number one skill required for someone in electronics, I'd reply the ability to solder. Despite the availability of solderless connectors, people who can't solder are severely handicapped. Even if you use all store-bought equipment and antennas, sooner or later you'll need to re-solder a loose microphone or antenna connection.

The main alternative to soldering when making connections is crimping. Crimping has its advantages, but the decision to use crimped connectors should be made on a sounder basis than an inability to solder. Antenna and earth connections should always be well-soldered to reduce the risk of interference due to oxidised connections which can radiate harmonics even when the transmitter is clean.

A soldering iron of around 20 watts is satisfactory for most electronic work. The main exception to this is when soldering PL259 plugs onto coaxial cable, where a larger iron, variable temperature soldering station or butane torch will be found handy. Larger irons are also useful when soldering onto large metal surfaces, as would be required for some antenna work.

Successful soldering requires you to apply heat to the joint and then let the joint melt the solder. Soldered connections should be made quickly with a clean, hot tip to reduce the risk of overheating components. Putting solder onto the iron's tip, and then trying to let this solder drip onto the connection is not the right way to do it. Trying to economise by recycling solder from old valve TVs is also a no-no!

Applying too much solder is also undesirable as it causes unwanted bridges to form between adjacent circuit board tracks or plug connections.

Further information on soldering is provided in the beginner's electronic books sold by the major components stockists.

Practical ability to use basic test instruments

All amateurs should be able to use a multimeter and an RF power/SWR meter. An ability to use and interpret readings from dip oscillators, impedance bridges, switched attenuators and noise bridges is essential to the antenna experimenter. Constructors of transmitters and receivers should be able to use RF signal generators, crystal calibrators, frequency counters, inductance and capacitance meters and (ideally) oscilloscopes.

With few exceptions, the above items can either be bought cheaply (eg multimeter) or constructed in a day or two (eg attenuators, dip oscillators, RF signal generators, noise bridges). Ample constructional information on test equipment will be found in back issues of *Amateur Radio*, the standard handbooks and the World Wide Web.

Construct a project from a schematic diagram and make intelligent substitutions

Studying for the exam teaches one how to identify components from a schematic diagram. Students should also have learned

about the basic functions of each component, and the purpose of each component in common stages found in transmitters and receivers.

When it comes to making projects, many beginners are unconfident about tackling a project for which a printed circuit board layout is not provided. Yet, many of the most interesting projects (whether appearing in amateur magazines or on people's websites) lack a printed circuit board layout. This is generally because the builder uses alternative forms of construction (eg matrix board, 'ugly construction' and 'paddy board') that are cheaper, quicker and more easily modified than specially-etched printed circuit boards. Also, developing a reproducible circuit board layout requires time that in many cases experimenters would rather spend on developing the next project.

Being able to construct a project directly from the schematic diagram is one of the most important skills that the homebrewer can possess. This ability greatly increases the range of projects that can be built and makes it much easier to customise circuits to suit one's needs.

A good plan for most projects is to try to base circuit layout as much as possible on the schematic diagram. Have the low-level or input stages on the left-hand side of the board, and the high-level or output stages on the right part of the board. Build and test large projects in modular sections to assist fault-finding, modifications and upgrading.

Before cutting the circuit board to size, draw a plan showing the proposed mounting of components on the board.

There is nothing more frustrating than cutting a board, and finding that it's 2cm too short! More experienced constructors will have an idea of the size of board needed from a cursory glance at the schematic diagram, and may wish to proceed straight from gathering the parts to cutting the board without drawing a diagram.

Also very important is the ability to make intelligent substitutions, especially when building projects developed overseas. This is often not feasible with circuits using rare, special-function integrated circuits such as the MC3362 VHF FM receiver chip. However, substitutions are easier when circuits use discrete components. Constructors should have some idea of the function of each stage and the type of components that are used in it so that they have some idea of suitable substitutes.

As an example, let's take the keying stage in a low power CW transmitter. It may require an esoteric PNP transistor that is unavailable locally. Inspection of the circuit reveals that the stage is a transistor switch that applies voltage to the collector of the final output transistor when the key is held down. Depending on the current drawn by the final, a low to medium power PNP transistor is called for. As the keying stage is not handling RF, an audio transistor such as the BC640 or BD140 would be a workable substitute. Try the BC640 first, and if it gets too hot, substitute the higher power BD140.

Computer literacy

Computers now occupy an important place in most amateur shacks. Whether used as a terminal for digital modes, logging, designing antennas, morse practice, e-mail or running circuit simulation software, a computer will be found indispensable for many amateur activities.

However, a computer will only be useful if you're able to drive it. As a minimum, amateurs should possess the following computer skills:

- Ability to use an operating system such as MS Windows (including use of a mouse, minimising/maximising windows, switching between applications, saving and retrieving files)
- Ability to use common Windows and DOS-based software
- Ability to send and receive e-mail messages
- Ability to read and post on newsgroups

- Ability to use an internet browser (including the use of search engines)

These general skills will serve well for most people. However, many specialist facets of amateur radio require additional computing abilities. Examples include:

- **Controlling equipment with computers.** Programming knowledge and the ability to construct proper interfaces between the computer's input/output ports and the equipment to be controlled is required. Typical applications of computer control include repeaters, antenna rotators for satellite tracking, Morse CQ callers, etc. Microcontrollers (such as the BASIC Stamp) can also be used in many of these applications.
- **Modifying ex-commercial VHF/UHF equipment.** Modem equipment uses programmable EPROMS instead of expensive crystals to set the operating frequency. Converting these sets requires an ability to program EPROMS to allow operation on amateur frequencies.
- **Creating an amateur radio webpage.** You will need to know how to write a webpage, use File Transfer Protocol (FTP) to transfer it to your service provider's machine and inform search engines of its existence. Knowledge of HyperText Mark-up Language (HTML) is a bonus, but not essential, given the large number of webpage editors around. If you want pictures on your page, you must know how to use a (computer) scanner and convert between different image file formats.
- **Circuit simulation, computer-aided drafting, satellite tracking, digital communication and logging.** To get your computer to perform these functions requires special software for each task. The 'user-friendliness' of such software varies enormously, from intuitive to hostile. See back issues of this magazine and various specialist internet mailing lists or newsgroups for user reports on various pieces of software.

Morse proficiency

Notwithstanding the proposed regulatory changes that will make Morse proficiency less important for amateur HF privileges, Morse remains a desirable skill. This is because it can be handy for identifying repeaters and beacons on VHF and its utility as an additional mode, especially when signals are weak. Also, Morse transmitters are much simpler and cheaper to build than transmitters for any other digital or voice mode.

Learners should aim to be competent in the following:

- At least 15 to 20 words per minute receiving speed
- An ability to receive Morse without needing to write it down, using paper only to note important details
- Being able to send off the top of one's head (ie not requiring a written message to send, as provided in the exam)
- A knowledge of commonly used on-air abbreviations

Almost all active Morse operators have the above mentioned skills. However, you will notice that the 5 and 10 words per minute Morse exams test none of these essential abilities. This means that these skills must be learned on air after the exam.

There is thus a large difference between the Morse taught to prepare people for the exam and the mode as used on the air by experienced operators. It is unfortunate that people frequently obtain a jaundiced view of the latter based on their experiences of the former. Morse at 5 wpm is indeed a slow, clumsy and tortuous mode. However, 20 wpm sent and received in one's head, with appropriate use of abbreviations, is many times faster and a fully practical mode for communications purposes.

Operating skills and general knowledge

Passing the regulations exam is a good start, but is not sufficient on its own. There are many skills that are best learned by listening to good operators on the air and reading the operating section of the ARRL Handbook. These topics have already been covered previously (October 1995, June 1996, August 1996), so won't be repeated here.

Have at least a vague idea of what's happening on the bands. This way you won't be caught unawares when asked to

continued next page

continued from previous page

give a number for a contest that you didn't know about. Reading *Amateur Radio* each month and listening to your weekly divisional or club news transmission is usually sufficient.

Gain a broad knowledge of bandplans and the frequencies allocated to each licence class. This is so that you do not cause interference to other modes by operating in the wrong part of the band, or worse, breach your licence conditions by transmitting outside your allocations. All required information on these topics appears in the WIA 2000 Yearbook.

You may be asked questions on amateur activity and clubs in your area. Make it your business to familiarise yourself with local groups, on-air nets, coming hamfests and

examiners near you. Most of the required information is provided in this magazine, the WIA Yearbook, on-air WIA/club news bulletins and what you yourself hear on the air.

These days most repeater channels are referred to by the last four digits of their output frequency. Thus a 2 metre repeater transmitting on 146.700 MHz is 6700 and a seventy centimetre repeater transmitting on 438.525 MHz is 8525. In the early days of channelised two metre FM operation, Australian amateurs used several different channel numbering conventions. You still hear old timers refer to frequencies by their old channel number. Possibly the most common is 'Channel 50' - 146.500 MHz - the national simplex calling frequency. As to repeater frequencies, 146.650 MHz was known as Channel 1, progressing upwards

until Channel 15 on 147.350 MHz.

Also worth knowing is your grid locator square. Knowing your square to four characters is acceptable to give out in contests, but if there is a need to calculate distances, knowing all six characters will be necessary. Grid squares are seldom used on HF SSB or VHF FM, but are commonly used by VHF and UHF SSB operators.

Conclusion

Passing the amateur exam is a great start, but is only the beginning. Learning several of the practical skills mentioned above will assist you to become an experienced amateur better equipped to enjoy what amateur radio has to offer.

ar

EDUCATION

Brenda M Edmonds, VK3KT
PO Box 445, BLACKBURN 3130

An AGM is more than hot air

In May the Annual General meeting or Annual Convention of the Federal WIA will be held. This is the one time in the year when representatives of each WIA Division come together as the Federal Council to discuss the running of the WIA and to formulate policy. Members will be aware that for some years the Federal Council met three or four times annually. This practice was discontinued recently in the interest of saving costs.

Part of the program for the AGM is set by the rules under which the WIA is incorporated. An AGM is necessary in order to receive the financial and auditor's reports, and reports from Directors and Co-ordinators.

In addition, time is given to discussing matters raised by the various Divisions. This section has been reduced of late as much of the business of the WIA has been conducted by mail or e-mail, and motions have been voted on in this way. A discussion in a General Meeting often allows more points of view to be aired and related matters raised, than are possible by mail or electronic means.

Divisional representation

Members will be aware that ideas and proposals can only reach the AGM by way

of the Divisions. If you have a point to raise, you present it to your Division which will then debate it and decide whether or not it should be taken to an WIA AGM. In some cases it may not be taken, either because it conflicts with established policy, because it is in conflict with the Articles of Association of the WIA or because it has been recently debated. If the Division decides to act on your suggestion, it will be presented to the AGM as a formal Motion which, to be passed, must be voted for by a majority of Council - that is four or more of the seven Councillors.

Over the years the situation of each Division having one vote has been raised on a number of occasions, and it is expected to surface again this year. The problem is that each Councillor represents the

members of his/her Division, but the number of members per Division varies greatly.

International AR

Another item, which will have a high priority this year, is the planning for the IARU Region III Meeting to be held in Darwin later this year. This meeting which is held every three years has not been in Australia for many years. It is the forum by which the individual countries can present their views to the IARU which, in turn, can carry those views to the International Telecommunications Union. It is the ITU which formulates the rulings controlling all forms of radio operation throughout the world.

ar



Magnusson VK3J
RMB 1627 Milawa Vic. 3678
Email: vk3jt@amsat.org

UoSat-14 Returns to Amateur Radio Service

On February 24, Chris Jackson reported via the AMSAT bulletin board that he had turned UO-14 back into "amateur radio mode".

To quote Chris:

UO-14 was launched in January 1990 and spent its first 18 months in orbit operating as an amateur store and forward satellite prior to the launch of UO-22. It was then switched for use by VITA (Volunteers In Technical Assistance) who used it for messaging into Africa. Since the computer which is used for store and forward communications is no longer able to perform that task, UO-14 is no longer

usable in this mode. It is however possible to use the satellite as a single channel FM voice repeater, and I have just configured the satellite to do this. The uplink is 145.975, and the downlink is 435.070. I will leave the satellite running in this mode for the next few weeks. If it is useful, then I will probably leave it running - if it isn't used, it will be switched to transmitting telemetry.

Happy 10th birthday UO-14!

Thank you Chris, the return of UO-14 has been welcomed by stations around the world from the first day. Its return to service gives the amateur radio satellite fraternity another great asset, particularly those operators with limited resources. It is definitely one of the "easy-sats" and is operating as a single channel, full duplex, FM repeater. If you have full duplex facility you can hear your own voice as you speak. While this is an advantage, it is not absolutely necessary, as long as you adhere to sensible operating practices. I've worked several amateurs who were using hand-held transceivers. For VK/ZL stations UO-14 has advantages over AO-27 and SO-35. AO-27 is only switched on in the northern hemisphere and SO-35 is only switched on at weekends and then, not always over VK/ZL. There is a strong possibility that UO-14 will be switched into FM repeater mode permanently in which case it will be available for at least four and up to six passes each day.

National co-ordinator:

Graham Ratcliff VK5AGR

Email: vk5agr@amsat.org

AMSAT Australia net:

The AMSAT-Australia net meets formally on the second Sunday evening of the month. During the winter months in South Australia (end of March until the end of October) the net meets on 3.685 MHz +/- QRM with an official start time 1000UTC with early check-ins at 0945UTC. During the summer months when daylight saving is in operation in South Australia (end of October until end of March) the net meets on 7.068 MHz +/- QRM with an official start time of 0900UTC with early check-ins at 0845UTC. The times and frequencies have been chosen as the best compromise for an Australia-wide net taking into consideration seasonal propagation changes and the various state summer time variations.

AMSAT Australia newsletter and software service:

The newsletter is published monthly by Graham VK5AGR. Subscription is \$30 for Australia, \$35 for New Zealand and \$40 for other countries by AIR MAIL. It is payable to AMSAT Australia addressed as follows:

AMSAT Australia

GPO Box 2141

Adelaide SA 5001

Keplerian Elements.

Current keps are available from the internet by accessing the AMSAT FTP site, ftp.amsat.org and following the sub-directories to "KEPS".

Operating tips:

- * Listen carefully before transmitting.

You should be sure to get a full quieting signal from the satellite before you transmit. Even then, PLEASE be patient and wait for a clear channel.

- * Do NOT sit chatting on the uplink frequency with another local waiting for the satellite to rise. You may be getting into the

continued next page

continued from previous page

satellite even though you are not receiving it. The often severe QRM we hear when the satellites are low in our northern sky is testimony to this.

- * **Listen to one or two passes first** to familiarise yourself with operating practices. If at all possible, monitor the downlink while you are transmitting. Stations are often heard repeatedly calling over other contacts. They are obviously not hearing the downlink all that well, if at all. This is where full-duplex is a great advantage.
- * **Remember ... UO-14 is a single-channel device.** If a contact is in progress wait at least for a break to announce your callsign.
- * **Because of the antenna radiation patterns** both at your end and on the satellite there will be times when basically equipped stations will find it hard to be heard, even if the input is clear. This is just a fact of life.
- * **Don't despair.** You have two possible courses of action. Be very patient and wait until a more favourable time, or improve your station.
- * **Get the downlink right first.** A simple outdoor antenna such as a turnstile or a ground plane will be a vast improvement over (say), a rubber-duckie.
- * **Last but not least.** The above tips hold good for all satellite operation but are particularly relevant to UO-14 and SO-35.

International Space Station (ISS) News

NASA recently announced that the first ISS expedition crew and its backup crew have received training on the use of the initial U.S. provided Amateur

Radio station on board ISS. The equipment will be installed as part of the ARISS (Amateur Radio aboard the International Space Station) effort. The training session was conducted at the Gagarin Cosmonaut Training Centre in Russia. As part of the ARISS training effort, NASA's Matt Bordelon, KC5BTL, has prepared a consolidated schedule for

training in the United States and Russia that will include familiarisation with equipment, packet radio theory and hands-on simulation. The ARRL reports that the training will focus on general principles of ham radio as well as preparations to use station equipment-operating modes, including software.

Bordelon has held an initial training session with astronauts and cosmonauts that provided exposure to the actual hardware. Other training has included information required to obtain an Amateur Radio licence. The first ISS crew will include Bill Shepherd, KD5GSL and Sergei Krikalev, USMIR.

UoSats-22 turns "Upside-Down"!

Chris Jackson, G7UPN, reports that UO-22 has entered a period when it will be orbiting in full sunlight. The temperatures of some critical areas of the satellite have increased considerably. Controllers have turned UO-22 upside down to point the critical systems to cold space. This has reduced the temperature on various systems (such as the batteries) by between 5 and 10 degrees. An unfortunate by-product is that the downlink is now weaker than normal. It has been quite workable though and at times it seems to be just as strong as ever. The radiation pattern of the UoSats is purposely designed to favour stations at the edge of the satellite footprints. These stations will be farthest away and therefore benefit most from the increased signal. This situation is of course upset completely by the satellite being "upside-down". The satellite will remain in full sunlight until late March, when controllers will turn it back 'over' again. According to Chris "*over the next few years this situation will become worse as the no-eclipse periods become longer.*" The satellite telemetry is carrying the message that only the 145.900 MHz receiver is available for communications at present.

Why are Eclipses (or lack of them) so important to Satellite Operations?

Most of our amateur radio satellites orbit the Earth in fairly low orbits. This means they can be shaded from the Sun when on the dark side of the Earth. They experience alternate periods of daylight and periods of darkness. If however, the situation arises that the plane of the orbit of a particular

satellite is at right angles to the direction of the Sun, that satellite will be orbiting in full sunlight for all of every orbit and never experience any time in the dark. This could be beneficial for the power budget if the satellite is designed to take advantage of this situation but if it has simply drifted into that position over time it can be very harmful. The satellite can become dangerously over-heated. This is the situation with UO-22 at present. The opposite has been happening lately with KO-23. It has had battery problems and would benefit from more rather than less sunlight. It has been shut down several times by the control station in the past two years due to lack of sufficient sunlight. Why don't we do something about this? Well ... as much as can be done, is done. Since these low-earth-orbit satellites do not carry any propulsion motors or fuel they cannot be manoeuvred once in orbit. Their attitude can be changed, usually by using electro-magnets working against the Earth's magnetic field. This was the case with UO-22. Whilst the (pointing) attitude of the satellite can be changed, the shape or position of the orbit cannot be changed. We would have to pay lots of money to include orbit adjustment propulsion and more again for the upkeep of control stations to monitor and adjust the orbits. Our funds are simply nowhere near large enough for that kind of operation.

Have You Observed OCS?

If you have a satellite track prediction program, have a look for the American Naval Academy's Optical Calibration Sphere (OCS) in the evening or early morning sky. At the time of writing it has been sighted as a moving "pin-point" of light in the western sky on some clear evenings. It is unusual to be able to see satellites low in the western sky shortly after sunset (or in the east shortly before dawn). We are looking at the unlit side of such satellites under these conditions. Even MIR and ISS are difficult to observe under those circumstances. OCS is different in that it is spherical and highly reflective so some part of its surface will always be reflecting the sunlight. Keps for OCS have been included in the standard 'amateur' set from NASA for some time now.

ar

AWARDS

John Kelleher VK3DP

Federal Awards Officer

4 Brook Crescent, Box Hill South, Vic 3128 (03) 9889 8393

DXCC QSL card checking.

Information via Gwen, VK3DYL. The ARRL DXCC Desk says that effective April 1 2000, DXCC members may have their cards checked by local card checkers, without having to mail cards to ARRL Headquarters. Under the new programme. This will apply to all awards except 160 Metre DXCC and all QSLs from any current DXCC entity, and includes both new awards and endorsements.

QSOs made up to 10 years prior will be eligible for field checking, while older cards and those from deleted entities still may be sent to ARRL HQ. The current DXCC Field Checking programme ended March 31, 2000. Reappointment of DXCC Card Checkers under the new criteria will be necessary. For further information contact Bill Moore, NC1L, dxcc@arrl.org;

As this obviously concerns operators who are members of ARRL, those wishing to be appointed Card Checkers would also need to be members.

New Zealand — Nzart Series.

General requirements : GCR accepted under usual conditions. Contacts must have been made after Nov 1, 1945. Special endorsements available for single-band or mode . The fees for all awards are US\$2.00, except WAP, which is \$3.00. For overseas airmail, addUS\$1.00. Send all applications to :

NZART PO Box 108 Gisborne 3815 NZ

Captain James Cook Award.

This award keeps alive the memory of this world famous navigator and seaman. Issued in three classes : Sailor Class requires contacts with a G in Yorkshire, FO, ZL2, VK2 and KH6. Officer Class needs those as for Sailor Class plus ZL1, ZL3, ZL4, VK3, VK4, VK9 or P29., and any Antarctic station. Command Class needs all the preceding plus any 5 of the following - VE2, VO, A35, Y18, FK8, CE0 and KL7.

IARU Region III Award.

Contact stations in member countries after Apr. 5, 1982. The basic award requires 7

countries, and Silver Star and Gold Star endorsements are available for 15 and 20 contacts respectively. Eligible countries are : Australia, Brunei, Bangladesh, China (PRC), Fiji, French Polynesia (FO8), Hong Kong, India, Indonesia, Japan, Korea, Malaysia, New Zealand, Pakistan, Papua New Guinea, Philippines, Singapore, Solomon Islands, Sri Lanka, Thailand, Tonga and Vanuatu. Plus one country credit from U.S. Territories in the Pacific. - Guam, Nthn Marianas, American Samoa, Wake Island, Baker-Howland Group, as represented by the ARRL, and one country credit from Pitcairn Island or Chagos, represented by the RSGB.

New Zealand Award.

Available to all except ZL amateurs. 101 contacts are needed to qualify. - 35 ZL1 stns, 35 ZL2 stations, 20 ZL3 stations, 10 ZL4 stations, plus one contact with a ZL "territory" (either Antarctica, Chatham Islands, or Campbell Island, or even Kermadec Islands. Contacts after Dec. 8, 1945.

New Zealand Counties Award.

Basic level award issued for contact with 20 NZ Counties. Endorsements for 40, 60, 80, and 100, with a special certificate for all 112. Checking sheets must be used, and are returned to the applicant. A special "224" shield was instituted to recognize outstanding achievement, that of double 112 with different stations the second time around. Current cost is \$11.00 and overseas stations add \$2.00 for postage. Applicants for NZ224 must first hold NZC112 award. The operator of a "County Dxpedition" may claim that County for his own NZC credit. Note : overseas applicants - extra \$4 for airmail postage on 224 plaque, or \$2 for surface postage.

Worked All Pacific Award.

Contact 30 different countries of Oceania, as specified in the current DXCC listings.

Where's DX ?

3B6 Agalega Island - Preparations for a 16 day operation in October continue to be on schedule. Further information on Web page - <http://www.agalega2000.ch>

160 Metres - Effective Apr 1, JA stations

will be able to use 1810-1825 kHz, in addition to their current privileges on 1907.5 - 1912.5 kHz.

FH Mayotte - Christian, 6W1QV plans to be active from here for at least 5 months. Qsl is via F5OGL, call book address.

Congo/Alaska - Hazel, TN7OT has returned to Alaska, and offers a new Qsl address. — Hazel Schofield, 35765 Ryan Lane, Soldotna, Alaska 99669.

SY2 Mount Athos - Monk Apollo has applied for, and received special callsign SY2A, to celebrate his tenth anniversary of activity on the bands as the only licensed operator on Mount Athos.

VK9CQ Cocos-Keeling Islands, and *VK9XV Christmas Island* will be activated during August and September.

XW Laos - Hiroo, JA2EZD will again be using callsign XW2A from Vientiane, until May 5.

FRT Tromelin Island - The Lyon DX group is proud to announce a Dxpedition around August or September.

VK0 Antarctica - Listen for Lance, VK0ERZ from Davis Base around 1200Z on 14255 kHz. Qsl via VK2FUN.

TXODX Chesterfield Island - The DXAC has been asked to review charts of the area to determine whether this possible new entity meets the distance requirement to qualify as a new one.

Prince Edward & Marion Island ZS8 - The operator Derek, is Qrv as ZS8D until May 2000. Listen for him on 14260 kHz.

The top 10 most needed entities, according to a number of reliable sources are:

1. P5 North Korea
2. VU4 Andaman Is.
3. A5 Bhutan
4. BS7 Scarborough Reef
5. 7O Yemen
6. 3Y/B Bouvet
7. VU7 Lakshadweep
8. VK0 Heard Island
9. VP8 South Sandwich Is.
10. 3C Equatorial Guinea.

Good luck, and good hunting,
73 de John, VK3DP

Australian Naval Amateur Radio Society

Young Endeavour Award

Young Endeavour left England on 3 August 1987 on her 21,000km maiden voyage to Australia to be presented to the Australian people on 26 January 1988 as a 200th birthday gift from Great Britain. Seven thousand young Australians applied to be part of the crew for this historic voyage but only 12 were selected. The other twelve were young British volunteers. All told, twelve male and twelve female young people undertook the three month voyage to the Antipodes under the command of Captain Chris Blake, one of the few English masters to hold a masters ticket for square rigged vessels. Long before she set sail, Young Endeavour had become symbolic of the two centuries of Australia's and Britain's entwined history.

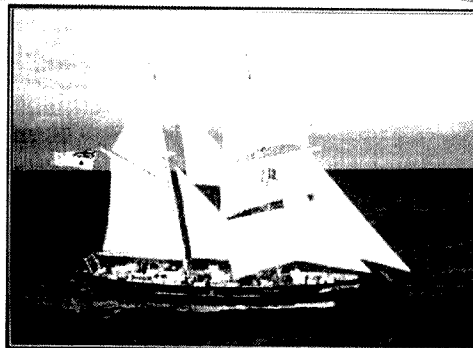
The \$3.7 million barquentine started life in May 1986 in Lowestoft, Suffolk, where she was built by Brooke Yachts – she was originally planned as a schooner but was specially modified for the bicentennial journey. Her designer, Colin Moodie of Britain, is one of the world's most experienced yacht designers. The man behind the project was Arthur Weller, Chairman of the Britain-Australia Bicentennial Schooner Trust, a body set up to design, build, raise funds for and deliver the vessel. Half the cost was provided by the British Government and half by the people of Britain.

Young Endeavour is 44 metres long and is capable of 14 knots under full sail. Twin-masted with nine sails rigged fore and aft, she has square sails on her foremast. The masts are more than 30 metres high and

under them lie a gold British sovereign and an Australian dollar coin in keeping with sailing tradition. The hull, painted "Britannia Blue", is steel. The main deck is teak and the transom and nameplate depict wild flowers of each State as well as the United Kingdom's national flowers.

She resembles a 19th century sailing ship and conjures up images of that transportation era but she has many hidden extras. Two diesel engines for port maneuverability, a watch and chartroom fitted with complex instruments including GMDSS facilities and a state of the art radio room. A dry store, deep freezers and four water tanks all sit below decks along with a reverse osmosis plant. There is also a small laboratory area for oceanographic experiments, a donated library of 1,000 books and films. There is a twelve berth cabin for the male crew members and two six berth cabins for the girls. Most importantly, there is a mess for the 24 volunteers and a galley. The six Royal Australian Navy crew, including the skipper, use the same galley, but eat in the

AUSTRALIAN NAVAL AMATEUR RADIO SOCIETY
YOUNG ENDEAVOUR AWARD



Presented To
Certificate No
Awards Manager

Callsign
Date

wardroom locally referred to as the cafe bar. On 2 June 1987 in the port town of Lowestoft, Suffolk, the Duchess of Kent officially named the vessel and early in July she was a special salutation for Her Majesty the Queen. When the vessel left Cowes on the Isle of Wight on her maiden voyage, she was given a 21 gun salute in the presence of His Royal Highness Prince Philip.

Young Endeavour is a unique and special vessel and the Australian Naval Amateur Radio Society is Proud to have been granted permission to feature this very beautiful Tall Ship on its Award Certificate and QSL card. The Society's web site has photographs of the vessel as well as information about the Society.

<http://www.zip.com.au/~sb/anars>

Award Information

This award is open to all amateur radio operators and short wave listeners. Applicants are required to work 4 of the Society's 7 club callsigns. Contacts from 1 July 1993 will qualify for the award.

The club callsigns are VK1SEA, VK2SEA, VK3SEA, VK5SEA, VK6SEA, VK7SEA and ZL1SEA. They can be worked home based, portable or mobile (aeronautical, marine or land) for the purpose of contact. Contacts are to be on the high frequency bands only and any mode may be used.

The cost of the award is \$5 AUS for VK applicants and \$5US for all other applicants. Qsl cards are not required but a log extract

must accompany each application, which is to be sent to: -

Award Manager VK2CE
PO Box 300,
Merimbula 2548
Australia.

The best chance of making the necessary contacts is on the Society's HF nets which are held as follows: -

SSB
Wednesdays

3.620 MHz 0930 Zulu VK 80 metre net
3.620 MHz 0800 Zulu ZL 80 metre net
(0700 Zulu during NZ daylight saving)

Monday to Saturday

7.075 MHz 0400 Zulu VK 40 metre net

Daily

14.275 MHz 0430 Zulu VK 20 metre net
CW net Monday night on 3.532 MHz at
0930 Zulu.

Skeds can be set up with any of the club callsigns via the following email addresses:-
vk1sea@qsl.net, vk2sea@qsl.net,
vk3sea@qsl.net, vk5sea@qsl.net,
vk6sea@qsl.net, vk7sea@qsl.net,
zl1sea@qsl.net

GOOD LUCK Enquiries about the award
to: anars@asitis.net.au. Fax: if outside
Australia - 61 2 64 950 189

ar

CONTESTS

Ian Godsil VK3DID,

57 Nepean Highway, Aspendale, 3195

Phone:0408-123-557

E-mail: <contests@wia.org.au>

Contest Calendar

April — June, 2000

Apr	1/2	SP DX Contest	(CW/Phone)	(Mar 99)
Apr	7/9	JA DX CW Contest	(High Band)	(Dec 99)
Apr	8/9	King of Spain DX Contest	(CW/Phone)	
Apr	15/16	Holyland DX Contest	(CW/Phone)	(Mar 99)
Apr	22/23	Helvetia DX Contest	(CW/Phone)	(Mar 99)
Apr	22/23	SP RTTY Contest		(Mar 99)
Apr	25	Harry Angel Sprint	(CW/SSB)	(Mar 00)
May	6/7	ARI International DX Contest	(CW/SSB/RTTY)	
May	6/7	Ten-Ten Int. QSO Party	(CW/RTTY)	
May	13/14	Volta RTTY WW Contest		
May	13/14	CQ-M Int. DX Contest	(CW/SSB/SSTV)	(Apr 00)
May	13/14	Sangster Shield NZART	(CW)	(Apr 00)
May	27/28	CQ WW WPX Contest	(CW)	(Mar 00)
Jun	3	IARU region 1 Field Day	(CW)	
Jun	4	Portugal Day Contest	(SSB)	
Jun	10	QRP Day Contest	(CW)	(Apr 00)
Jun	10/11	ANARTS WW RTTY Contest		(Apr 00)
Jun	10	Asia-Pacific Sprint		
Jun	10/11	South America WW Contest	(CW)	
Jun	17/18	VK Novice Contest	(CW/Phone)	(May 00)
Jun	17/18	All Asia DX Contest	(CW)	
Jun	24/25	ARRL Field Day		
Jun	24/25	Marconi Memorial Contest HF	(CW)	

Thanks this month to VK4TI WIAQ NZART

Note: It is with great sadness that I report the death in early February of Ron ZL2TT.

Ron was an avid Contestant and would have been well known to many of us VKs. Ron was the contest co-ordinator for NZART and in that capacity I enjoyed my contacts with him. He will be sadly missed on the bands and our condolences are extended to his family.

Vale Ron.

Further to my note last month about the RD Contest, I was very pleased indeed to receive a letter from Roy Mahoney

VK4BAY on the subject. Roy made some quite valid comments and I thank him most sincerely for them.

Apologies for two errors in February

1. There were some inaccuracies in the VK/ZL/Oceania Results published in February. I thought that I was doing a great stroke in getting these out quickly, but I WAS WRONG. There are results missing, so again I ask you all to accept my apologies. Hopefully they will all be sorted out by next month, when I shall try to highlight some information about this annual contest.

2. A correction to the CQ WW WPX CONTEST (SSB 25 - 26 March, CW 27 - 28 May).

In the section SCORE, the last line should read: "QSOs with stations in the same country are permitted for multiplier credit and have one point value." VKs may work VKs.

Meanwhile, remember that the contesting season is almost upon us, so please get your station working well and let's hear from you in some contests.

73 and good contesting

Ian Godsil VK3DID

Result Helvetia Contest 1999

(Call/cat/mode/score)
VK4ICU SOP CW 438

continued next page

QRP Day Contest 2000

0700z - 1200z Sat 10 June

Open to all CW operators

Object is to work as many stations as possible.

Category: Single Operator only.

Sections: (i) VK, ZL, P29 (ii) outside the above call areas.

Mode: CW only.

Bands: all HF bands (no WARC).

Exchange: RST plus serial number beginning at 001 and incrementing by one for each contact.

Repeat contacts on same band: In order to make greater use of available band space and time, repeat contacts with the same station will be allowed with a minimum of two (2) hours between contacts.

Scoring: the object is to score as many points as possible in your section.

Stations within VK/ZL/P29 score as follows —

VK/ZL/P29 contacts	1 point
Outside VK/ZL/P29	3 points

Stations outside VK/ZL/P29 score as follows —

VK/ZL/P29 contacts	3 points
Outside VK/ZL/P29	1 point

All contacts made with a homebrew transmitter or transceiver score double points.

Final Score is the sum of the total QSO points. Except for the use of homebrew equipment (see above), no multipliers apply.

Certificates: Certificates will be awarded to the following — (i) the first three placegetters in each section, (ii) the top scorer on each band (if the entrant is not already a placegetter).

General: any station claiming to operate QRP MUST NOT exceed a maximum of five watts carrier to the antenna and should add /QRP after its callsign.

Logs showing contacts and points claimed, together with a full description of equipment used, should be sent to —

Ron Everingham VK4EV,
30 Hunter Street,
Everton Park, Queensland, 4053,
no later than 7 July, 2000.
See: <http://www.users.on.net/zietz/qrp/club.htm>

Sangster Shield Nzart

0800z - 1100z

Sat 13 May - Sun 14 May

Object is to contact as many ZLs as possible. All power levels permitted, but serious competitors for the Sangster Shield must not exceed five watts o/p.

Band: 80 m.

Category: Single Operator.

Mode: CW only. REPEAT CONTACTS may be made each half hour, with at least five minutes between repeats with the same station.

Exchange: RST plus serial number beginning at 001. ZLs will send RST, branch number and power (eg 569/11/04).

Score ten points for VK QRP to ZL QRP; five points for VK QRP to ZL QRO; five points for VK QRO to ZL QRP.

Final score is total QSO points X number of branches worked.

Send logs showing QSO details, points claimed, name and address of operator and power level to:

Alan Hughes ZL3KR,
4 Exton Street,
Christchurch 8005, NZ,
before 15 June, 2000.

CQ-M DX Contest

2100z - 2100z

Sat 8 May - Sun 9 May

Bands: all HF bands and satellites (no WARC). Modes: CW; SSB; SSTV.

Categories: Single operator single band CW only, SSB only, Mixed, satellites, SSTV. S/O multi-band CW, SSB, Mixed, satellites, QRP, SSTV. Multi-operator: multi-band, single Tx, mixed, SSTV. SWL: multi-band, mixed.

Exchange RS(T/V) and serial number beginning at 001.

Score one point with own P-150-C country; three points for QSO with another continent. SWLs score one point for log of one station; three points for complete QSO.

Multipliers: each country in P-150-C list counts as a multiplier once only per band. SWLs have no multipliers.

Final score is total QSO points X sum of all multipliers. Various awards will be available.

Send logs by mail to: CQ-M Contest Committee,

Krenkel Central Radio Club of Russia,
PO Box 88,
Moscow, Russia,

by 1 July.

Logs may be sent by e-mail as ASCII text to: <cqm99@mai.ru>

For details of P-150-C list see http://www.mai.ru/~crc/crc_e/award/r150s_e.htm

ar

We manufacture a comprehensive range of HF, VHF and UHF antennas, baluns, power dividers, etc. to suit your application. Some of our log periodics provide continuous coverage from 13-30 MHz including WARC frequencies and replace outdated tribanders. Now in use in 48 overseas countries.

FREE CATALOGUE AVAILABLE FROM



ATN ANTENNAS PTY LTD

- Create rotators, coax cables & non-conducting guy & halyard materials
- Hard-drawn copper antenna wire
- Insulators for DIY projects
- Inverted vee kits 160-30m
- High gain VHF & UHF amateur, scanning & TV Antennas

- High Sierra HF mobile antennas
- Butt section triangular aluminium towers for fixed or tilt-over applications
- Selection of power chips & TX tubes
- Diamond VSWR/PWR meters to 1300 MHz & accessories

37 Morrison Street
PO Box 80, Birchlip Vic, 3483
Ph: (03) 5492 2224
Fax: (03) 5492 2666

SPOTLIGHT ON SWLING

by Robin L. Harwood VK7RH
5 Helen Street, Newstead Tasmania 7250
(03) 6344 2324
E-mail: robroy@tassie.net.au

Oh, to be on *Short Wave*, now that April's here

April has arrived and reception conditions have significantly altered over Short Wave, with signals coming in the daytime as winter propagation takes over, particularly on the lower frequencies.

The BBC World Service has introduced up to eight streams, replacing the three streams, which formerly targeted Europe, Africa and North America. I do not have the frequencies for Australasia but believe that the idea is for News and Current Affairs to be aired at convenient times for listeners in this region.

It will be confusing because other streams will be heard easily and it is going to be difficult ascertaining what streams are being aired and on what frequency. I am anticipating that each stream will be for a few hours and not a continuous 24-hour broadcast.

However tuning on to other streams should allow the listener to become updated with significant news developments. The satellite feed to various domestic stations worldwide will probably be a mix of the various streams.

Other international broadcasters have also made some organizational changes. The "Voice of America" has downgraded some language blocks and also has instituted some personnel changes. The 24-hour programme "News Now" is still being broadcast, although with some minor format alterations.

Fewer Short Wave users

Deutsche Welle in Cologne also has made some further language rationalization but still is broadcasting in English. Audience research has indicated that there has been a significant drop in the number of individuals using short wave in Europe and North America.

Programme placement over domestic networks is still being attempted but it is clear that editorial control has reduced or

altered some programme content.

Research has also shown that there are regions where Short Wave is likely to be a primary source for news from the outside World, because domestic media is poor and coverage often non-existent.

Short Wave in Africa

The areas most affected by this are clearly in Africa and Asia. Internet access has grown significantly in Europe, North America, Japan, Australasia and South America. However, Africa and Asia (outside of China) are well behind Internet developments. Although South Africa is on the Web, Internet penetration is sparse throughout that Continent.

The Internet can fall over and be offline for some time. Internet access can be stopped by governments or through sheer inefficiency. Penetration is poor as we have seen and to reach audiences in these areas, shortwave broadcasting will continue, using existing analogue technology as the economic cost for both digital broadcasting and receiving equipment will be beyond reach of many in the regions.

Webcasting

And while we are on Internet broadcasting, Radio Netherlands is trying a special webcast just a few days after the deadline for this month's column. The timing is not good for us here in Australia yet is ideal for those in Europe and North America where most of the Internet usage is at present. However, the numbers of listeners would not be above five to ten thousand who can simultaneously access the webcast. Webcasting permits smaller interest groups to air their points of view. Net congestion

and bandwidth are going to be the sticking point to further development of this new medium.

A Bill was introduced into the Australian parliament to permit international broadcasters to have facilities to use Australian sites to broadcast outside of this nation.

The Bill was referred to a committee in the Senate to consider the ramifications of this proposed legislation. This Bill would only apply to non-Australian broadcasters, as the existing networks are not covered.

One organization that is keenly interested in establishing a shortwave station is HCJB - the evangelical broadcaster presently based in Ecuador. They have a potential site in NW Western Australia. However it is believed that this legislation may really be about the disused Darwin facility which has been inactive for a number of years. Several international stations have been keenly interested in utilizing it but are awaiting the outcome of this legislative hurdle.

The Belgian International service, "Radio Vlandereen International", is commencing an English service to Australia on 9865 kHz at 1200 UTC. It is from the Petropavlosk facility on Kamchatka Island, just off the Siberian coast and due north from Japan. The programme is for half an hour. A parallel service to SE Asia is on 17690 kHz from Tashkent, Uzbekistan.

Well that is all for this month and if you do have any information for this column, you can send it to me via rharwood@primus.com.au or tai_501@hotmail.com.

The postal address is at the top of this column.

73- Robin L. Harwood VK7RH
ar

VHF AN UHF EXPANDING WORLD

David K Minchin VK5KK
Postal: PO Box 789 Salisbury South Australia 5108
E-mail: tecknolt@arcom.com.au
Web page: <http://www.ozemail.com.au/~tecknolt>
Fax +61 8 82346396
Phone 0414 808060 (before 2130 EST please)
All times are UTC

Important. All amateurs read this now

There has been a significant amount of press, emails and comment in general regarding changes to our allocations above 50 MHz. Two bands are effected, immediately, but I am aware of concerns for another two UHF bands that may seriously effect more amateurs.

The following has been extracted from the ACA's Website and summarises the immediate changes to two microwave amateur allocations removing access to up to 198 MHz of bandwidth in some areas.

Radiocommunications Licence Conditions (Amateur Licence) Amendment Determination 2000 (No. 1) was notified in the Commonwealth of Australia Gazette on 7 February 2000. This amendment deletes the frequency band 2302 – 2400 MHz from the permitted frequency schedules for Amateur Unrestricted, Amateur Limited and Amateur Intermediate stations. This spectrum has been designated, by the Minister for Communications, Information Technology and the Arts, to be allocated by issuing spectrum licences.

The amendment also deletes the frequency bands 3.425 – 3.4425 GHz and 3.475 – 3.4925 GHz from the permitted frequency schedules for Amateur Unrestricted, Amateur Limited and Amateur Intermediate stations in certain parts of Australia. In addition, the frequency bands 3.4425 – 3.475 GHz and 3.5425 – 3.575 GHz have been deleted from the permitted frequency schedules for Amateur Unrestricted, Amateur Limited and Amateur Intermediate stations in certain other parts of Australia.

The affected areas of Australia are detailed in two new Schedules (8 and 9) in the LCD. These specified segments of the 3.4 GHz band are in the process of being declared, by the Minister for Communications, Information Technology and the Arts, for re-allocation by issuing spectrum licences. ... ACA

The current WIA bandplans are now in review, with proposed narrowband segments at 2403 MHz and 3410 MHz. This

is open to public comment; please forward any comment to either John Martin VK3KWA the Federal FTAC officer or myself.

We have just seen collective bids for the 1.8 GHz Mobile Phone band Auction reach past \$1.3B. The 3.4 Ghz part of the Spectrum is up for Auction in May 2000. While the Australian Communications Authority originally envisaged the spectrum to be reallocated for wireless local loops (WLL) for private operators to compete with Telstra's land-based local call network, it is now envisaged that this spectrum will be more useful for high-speed Internet services, including video streaming. At least two Groups are already showing interest in 3.4 Ghz, Austar and the Seven Network for uses other than WLL. Both are now proposing, high-quality broadband Internet services as an alternative to the current cable/optic networks. And with this spectrum, Seven could feed two Olympic channels and a number Pay TV channels to in major capitals without relying on Telstra.

If you live within the Sydney environs then you would be aware of the current restrictions to the 421 – 432 MHz part of the 70cm band, within a 150km radius of the Olympic site until December the 31st, 2000. All indications from the ACA, to date, have shown no change to this particular "Amendment Determination". Infact, it is actually gazetted that equipment from the Olympic system shall not be resold within Australia. But now information has come to light regarding the consideration of the 420 – 430 MHz section in Western Australia for use in a Police Radio network using technology that looks similar to what is being used on the other side of the country. Hmmm, I hope my thinking is wrong!

While we either share or have secondary access to many of our bands above 50 MHz, one saving grace in many countries is the co allocation with military users. This has kept large parts of our 70cm band away from the very obvious threats from commercial users from both ends. Indeed if you do a reality check we are more than lucky to have 30 MHz of real estate right plum in the middle of a Commercial segment.

But now things may change. The proposed Airborne Warning System (AWAK's) is considering a slice of spectrum around 1270 MHz for radar operation. This poses a threat to our current 1240 – 1300 MHz allocation. However, some would be aware, the 23-cm band has shared with radar systems before, i.e. the old airport radar systems centred on 1275 & 1305 MHz many years ago. More than reasonable fear is now surfacing that the military may be prepared to trade-off lesser used parts of the spectrum in order to gain a new allocation. This could be, in part, the shared section on our 420 – 450 MHz band. Again, I hope I am wrong!

On the otherside of the coin we seem to have a bit of protection on allocations where we share with ISM / Unlicensed services, i.e. 2400 – 2450 MHz and parts of the 5650 – 5850 MHz band. This is mainly because it would be hard to put a higher service amongst a large number of unlicensed and uncontrollable transmitters. Interestingly, we do have some clout in these segments against unlicensed or class licenses, as we are indeed licensed "higher" up the list. At least two 2.4 GHz interference cases have been settled in our favour by the ACA and the Clearwire Technologies vs ARRL 2.4 GHz case in the USA, recently, also went in our favour.

What do we do?

Unfortunately some parts of our spectrum will (and already have) fallen victim to commercial interests. We do not have any clout in the scale of finance behind these changes. The entire WIA's assets may only afford about 20 kHz at current rates, yet only a handful would benefit. And we still wouldn't have enough spectrum for a FM channel! Take two steps back and parallel our bands to another plight of the last 20 years .. preservation of land as national parks. Much different is it?? NO! This direction is now being pursued in the US to preserve tracks of spectrum for amateur use either as primary or secondary allocations. Whole bands are not being targeted but realistic sections that will cater for expected amateur growth.

While our use of the target bands is limited, it is increasing, as surplus commercial equipment becomes available. For example, the availability of Qualcomm Sat gear has doubled the 10 Ghz population both here and in the US. It would be ironical if that in five years we have access to volumes of currently installed equipment, as surplus, but have no adjacent allocation to use the equipment!

Consider the National park notion and lobby your local division, we must act now.

50 MHz Continues....

The number of F2 50 MHz openings dropped through mid to late February, in line with the drop in Es, again supporting the Es extension theory. Certainly from previous cycles, in VK5 in particular, Es extension was a factor in many European/Pan American openings. The following reports record the run up to our Autumn Equinox

Neville Mattick, VK2QF report for February 2000:

1/2/00 XE1BEF [hrd "QRZ-CW"] 0031Z"
2/2/00 XE1KK/B 0139~0209z, TI5BX
0146Z 90deg 5x9

5/2/00 JR2HCB 0009z 599, 4th* JH0INP
0634Z 599,

7/2/00 HL5XF 0428Z [hrd], JA0, 1, 2, 3, 7,
8, 0332~0345Z 18 x 599 qso,

10/2/00 HL1LTC 0445z 599, Strong R1 and
FM on 49.224.5 with a periodic female
voice ident, 0410~0550Z,

11/2/00 7J7ACV 0233z 340deg, Strong R1
and FMn on 49.224.5 with a periodic
[now] male voice ident, 0254~0450Z,

15/2/00 XE1KK/B 0215Z, widespread Es,
18/2/00 HL5XF 0310Z 5x9 [heard for over
1 hour at this strength! so where oh
where is a "BY" station?], JA0,

1,2,7,8,9 wkd, mystery 49.224.5 carrier
again which is also audible in Japan and
strong R1 video 0150~0420Z and weak
48.24,25,26 0240~0310Z 340deg,

20/2/00 Major TEP to Japan with very
strong signals 11 QSO's [SSB 5x9] and
107 QSO's [CW 599] 0258~0520z,
strong 43.649 and R1 also from 0115z,

21/2/00 7J7ADB S9+ 0306Z,

22/2/00 Strong R1, weak 48.239.6 & JA8's
0215Z,

23/2/00 R1 & 43.65 from 0150Z, ZL video
b/s, 43.850 from 0045Z,

26/2/00 Band improving daily toward the
equinox, Strong JA QSO's
0400~0449Z, 43.65 & R1 building from
0100Z, ZL video b/s from 0050z,

29/2/00 Strong NA indicators to 40Mhz
prior to UTC day,

Wally Watkins VK4DO reports "*Another
observation of the opening on 14 Feb. to the
States (USA). I appeared to be on the
northern edge of the opening. Ron VK4BRG
160 km south had much better propagation.
My contacts were from 0238 to 0500 UTC,
mostly CW. into DM12, DM41, DM42,
DM51, DM62 and EM00, roughly a
straight line along the north border of
Mexico. The ES opening in the states added
to the confusion. A long opening this late in
the day is unusual*" ... VK4DO.

Ray Elliot, VK4BLK, Yeppoon, QLD
reports the following 6 Metre worked and
heard from late January 2000

26/1/00 FO8DR/B 529 hrd

27/1/00 W1LP/MM (FJ09) wked 51 0007Z,
HP3XUG 559 0033Z, TI5KD 52
0042Z, TI7WAM/4 519 0100Z,
XE1KK/B 0247~0325Z hrd 529

30/1/00 0044 ~0300Z FO5DR/B hrd 589,
TI5BX 55 0055Z, TI5KD 55 0101Z,
FO5DR 559 0123Z, HP3XUG 519
0140Z, ZK1NCI 59 0234Z

4/2/00 YJ8UU 59 2132Z

6/2/00 P29KFS 55 0935Z

7/2/00 HL5XF 57 0334Z, HL1LTC 57
0435Z

8/2/00 KH6SX 559 0635Z

Consulting John VK4FNQ's emailed daily
logs shows a fair scattering of JA, BV and
KH6 type openings through early March
2000. Openings to the lower states not so
prevalent but VK5ZBK, VK5KL were heard
working from 0430Z to JA on 5/3/2000 with
other JA's heard working into VK2 & VK3
at least. Thanks to David Vitek again for
keeping an eye on the band here!

Six Metres peaked again on F2 several
paths around the 12th & 13th Of March 2000.
12/03/00 N6XQ worked a number of VK4's

from ~2205Z, as well as other West Coast
USA stations hearing VK4 & Northern VK2.

VK6JQ was heard working IW1DIM, 50
MHz at 0859Z On 13/3/2000. At the same
time other paths from JA to 5B4, ON4 and
KH6 PY2 were active. Northern
Hemisphere doing better again! Finally it
has been reported that PP1CZ worked
HL5XF on 13/3/2000 but not other details
are available.

Real Time MUF Map

For those who want to watch, in "Real
time", the MUF on various paths, then have
a look at this WWW site: [http://
solar.uleth.ca/solar/realtime.html](http://solar.uleth.ca/solar/realtime.html). The site
has been going for atleast 2 years and does
give a useful picture of what is happening.
There is still a great need for interpretation
but comparing the various reports on 50
MHz contacts and the Path MUF does give
a clue or two. Unfortunately, a crystal Ball
and good location are still needed!

It should be noted that the charts are based
on F layer MUF. Just add a little Es and you
may be lucky enough to lob in an F layer
favoured area.

P29 DXCC Country Classification

Some conjecture has been about for several
years about the DXCC country status pre and
post 1975 Papua New Guinea (now P29). It
now looks like three is a good number!

Eric VK5LP has been following this up
and has obtained this clarification from
K5NX / ARRL " ... 'As far as we are
concerned, Papua New Guinea became
effective on September 16, 1975. Since we
actually go by changes other than prefix,
i.e., the independence date of P.N.G., this
means that the Territory of New Guinea,
and Papua New Guinea both existed until
that date. This is regardless of whether a
VK9 or P29 callsign is used. Date and
location matter, callsign prefix is not a
concern in determining whether one is the
current P.N.G. or one of the other two. So,
depending upon date, that half of the island
might count as any one of three entities for
DXCC." ...Bill K5NX (ex-K5FUV) Thanks
again Eric for this item.

24 GHz New Australian Record

Last issue we inserted a stop press for a 24
GHz new record, for 164km. Well that only
lasted a couple of weeks! Reported
elsewhere in this issue of AR are details of
the latest Record Contact on 24 GHz on the
29/2/00 between Russell VK3ZQB/P3,

continued next page



Trevor Niven VK5NC and Colin Hutchesson VK5DK with the twin dish 24 GHz Transverter Equipment

Tower Hill, north east of Port Fairy, Victoria and VK5NC/P5 & VK5DK/P5 located at "The Bluff" approx. 35km west of Mt Gambier. The distance of 171.8 km has now been claimed as a new Australian Distance record. The Two way SSB contact was at 1104 GMT with signal reports of 5-5 to 5-3 with QSB.

I am told that equipment, as always, still has room for improvement so greater distances (with some decent propagation) are on the cards!

144 MHz and Above

Ray VK4BLK, Yeppoon, QLD reports working Phil VK5AKK on 144.1 MHz SSB at 0215Z, 10/01/2000 51 x 55 signals via 2M Es.

On 18/02/2000 Bob ZL3TY reports working the following VK's via a Trans Tasman Duct 144MHz: VK2KU, VK2ZAB, VK2EM, VK3BWT, VK3DUT, VK2DXE, VK2CZ and on 432 MHz VK2KU, VK2ZAB, VK3BWT, VK3DUT

Ron VK3AFW reports "Max, VK3TMP, told me this morning that he worked Bill, VK6AS, just before 1100Z Saturday (26/02/2000). He also heard and called Wally, VK6WG, but could not complete a QSO. Ralph, VK3WRE called Max on the phone to alert him to the opening. Trevor, VK3KEG, worked both VK6's and Rob, VK3EK, also worked VK6AS."

Further "On Sunday morning the band opened again and a lot of VK3 stations were there calling. Max again worked Bill VK6AS. Bill, VK6AS, worked Bill, VK3AMH, and Rod VK2TWR, two excellent contacts, the latter being across some of the roughest and highest terrain in the country. I think VK6 to VK2 is not a common QSO on 2m. Back in '86 there was an E's opening in which the VK2-VK6 record was set." ... VK3AFW

Gordon VK2ZAB reports working the following stations on the VK2/VK4 Tropo openings on 28/02/2000.

VK4IC Brisbane 144MHz SSB at 2017Z 5/5 5/6, VK4KK Brisbane 144MHz SSB at 2020Z: 5/4 5/5, VK4KZR Brisbane 144MHz SSB at 2021Z 5/5 5/7, VK4KZR Brisbane 1296MHz SSB at 2024Z 5/2 5/3, VK4KZR Brisbane 432MHz SSB at 2025Z 5/4 5/5, VK4TZL Hervey Bay 144MHz SSB at 2035Z 5/3 5/5 and VK4TZL Hervey Bay 432 MHz at 2036Z 5/1 4/1

"The contact (with VK4TZL of 930km is wholly

overland which may be a VK record of sorts or at least very unusual. VK4KZR alerted VK4TZL by phone. Thanks Rod" VK2ZAB

Guy VK2KU reports on more Trans Tasman ducting to ZL on 03/03/2000 "The high in the Tasman was not very big (1022HPa), but we were nevertheless watching its development with interest. No ZL beacons were audible at first, though the Auckland beacon later became intermittently audible. The first sign of the opening was Nick ZL1IU calling CQ when he got home from work. Propagation started in far north ZL, and then extended south through Auckland, and (weakly) down to New Plymouth."

Stations worked by VK2KU on 03/03/2000, 0422Z ZL1IU 144MHz (58, 55), 0526Z ZL1TTS 144MHz (55, 57), 0532Z ZL1TTS 432MHz (54, 53), 0630Z ZL2TAL 144MHz (51, 51), 0633Z ZL2VAL 144MHz (53, 51), 0705Z ZL1AVZ 144MHz (57, 59), 0723Z ZL1AVZ 1296MHz (55, 55) - 2195 km, 0731Z ZL1AVZ 432MHz (56, 56), 0847Z ZL1UYJ 144MHz (54, 53), 0857Z ZL1WTT 144MHz (53, 51), 0900Z ZL1TBG 144MHz (51, 52) - stronger later, 0942Z ZL1TJB 144MHz (51, 52), 1104Z ZL1AVZ 1296MHz (56, 57) - again, 2024Z ZL1GNS 144MHz (55, 57).

"Repeated attempts to work ZL1TBG (running 1W) on 1296MHz were not successful, though Gordon VK2ZAB made it. Propagation faded out slowly some time after 0500 on 4 March - last contact was ZL1IU at 0445." ... VK2KU

It should be noted that Guy VK2KU's contact with ZL1AVZ on 1296 MHz is some 50km greater than the current VK2 record held by Gordon VK2ZAB. Congratulations Guy!

Gordon VK2ZAB elaborates further on the ZL1TBG 1296 MHz contact on 03/03/2000 at 0745Z ... "We believe that this station ZL1TBG, operator Ralph, is the second ZL

only to work into VK on 23cm. The several contacts to several stations in VK made previously had all been made by Brian ZL1AVZ. Ralph was running 1watt to an 18 db horn for this contact." ... VK2ZAB

On the VK5 & VK6 paths several openings into Albany & Esperance occurred, from Adelaide/Mt Gambier atleast on 15/02/2000, 26/02/2000 and 09/03/2000. Unfortunately nothing above 432 MHz on the Great Australian Bight path on any of these days. This is the first season for over 10 years where 1296 MHz has NOT been worked!

Microwave Activity

The Autumn Field day (18th & 19th of March 2000) will be over when you read this. One new station will be on 10 GHz from the VK5 Area, hopefully during the contest ... none other than Eric VK5LP. As of 12/03/2000 Eric now has 10 GHz setup from home (Meningie) with approximately 1 watt into a 650mm offset-fed dish. Equipment is all Qualcomm, driven by a Yaesu FT780R, with a masthead mounted 10 GHz PA and Preamp. The eventual dish height will be 18 metres, however currently on test at 10metres until new guy ropes are installed. Keith VK5AKM (also on 10 GHz from 60km North of Adelaide) and Mark VK5AVQ (ex VK0AQ) assisted/watched the installation!

Eric's first official contact was at 1210Z on 10,368.449 MHz SSB with VK5KK/P over approximately 20km's, 57. Well we just stopped on the side of the road and threw the dish out looking back through a lot of dirt! As soon as the gear was switched on, we could hear Eric whistling away, testing the transmitter on the same frequency we set up on a few hours before. Good stability on both ends!

In Closing

Our head item, this month, is a serious matter. I do encourage feedback, from all quarters. Unfortunately we may be past "Use it or lose it" stage.

Thanks to all the contributors this month. These and most others are still yet to see this equinox in full swing so hopefully by this time next month band openings will have become more general. In the meantime will leave you with the following..

1. A road map tells a motorist everything he wants to know except how to fold them up again!
2. A good leader is doing his job when half the people are following him and half are chasing him!

Till next month
73's David VK5KK

POUNDRING BRASS

S P Smith VK2SPS

4/6 Taranto Rd, Marsfield NSW 2122
(H) 02 9876-8264 (W) 02 9452 4566

Learning Morse Code the *correct* way

Learning the alphabet is easy; all you have to do is whistle or hum each individual letter. It is much better practice if you can deliberately jumble up the alphabet; otherwise when, for instance, you want to turn the letter "P" into Morse you will find yourself mentally running through half the alphabet.

Don't learn the letter N = (— •) as Dash - Dot, memorise the letter N as a long sound followed by a short sound as mentioned in last month's issue.

You should never try and "Pair" the letters by thinking of the letter A (dit-dah) as being the opposite of the letter N (dah-dit).

If you follow this practice you will fall into the bad habit of having to think of the letter N before you can think of its opposite and vice versa with other similar letters of the alphabet.

If you feel uncomfortable about humming or whistling the code you can purchase 'Audio Cassettes' at various speeds from the "WIA Education Services". Enquire with your local branch for contact numbers. These cassettes are an excellent source for learning, let them know what you

want on them and at what speed. Just remember when you can copy about 60 to 70% of the tape correctly increase your speed by about 10w.p.m so your brain is constantly working and that you don't fall into the trap of memorising what's on the tape. A lot of beginners make the mistake of touching a Morse key before they have fully memorised the alphabet and numbers, please don't until that point is achieved.

Having memorised the various letters of the alphabet - and also the numerals, as rhythmic sounds, try humming, whistling or dit-dahing to yourself very slowly in Morse by using sentences from books or newspapers, not forgetting that there should be a pause of five "dits" between each word. Don't rush, learn to do it slowly, rhythmically and with absolute accuracy

and you will find that speed will come automatically.

Reference for this article was made from *Wireless World* - November Issue 1939 pages 13 to 15.

Next month a look at using and adjusting a hand key.

Until then 73
Steve VK2SPS

Editors Note We are running a more detailed article on learning Morse code in this issue which follows these basic starting techniques.

ar

Due to problems with Australia Post my January and February issues had some how become misplaced, I will repeat these articles in coming issues.

REPEATER LINK

Will McGhie VK6UU

21 Waterloo Cr Lesmurdie 6076
will2@omen.net.au VK6UU@VK6BBR

40M Gateway Tail

With the possibility that HF-Gateways may get the go ahead on some HF bands, one small point that may be of concern to the ACA is the length of the tail on the VHF/UHF system. Amateurs who key up the VHF/UHF repeater hear, on the tail, whatever activity is on the chosen HF frequency. The tail length is best found by trial. However a point to consider is that access from the HF frequency is dependent on the tail being activated. If you wish to call on the HF Gateway you will only be heard if the gateway has been triggered for you by an amateur on the VHF/UHF system. The tail creates a window for the duration of the tail that allows amateurs on the Gateway HF frequency to call. It would

be best left to amateurs to determine the tail length, not the regulators. The original concept had a continuous tail, the VHF/UHF repeater transmitted all the time what ever activity was on the HF frequency

Alkaline Tip

Re-chargeable Alkaline batteries have been around in AA and AAA forms for a year or so. I have tried them and found them wanting. These batteries appear to have a higher internal resistance than the standard Alkaline. Placing a multi meter on the amps range directly across these two types of cells produced about twice the current with the standard Alkaline. What I have found to be the problem with re-chargeable Alkaline

cells is that they can't supply heavy switch on currents. My digital still camera is an example. I gave up on the re-chargeable Alkaline AA cells, but I had one of the recommended chargers. I tried the standard Alkaline AA in one of these chargers and was surprised to find the standard Alkaline cell re-charged. Nothing too new as all primary cells can be re-charged to a degree but the normal Alkaline is a better battery all round and extending their life several times over is worth the effort.

At a guess you will get a least 3 times the life by re-charging in this type of charger. I don't leave them in for long, half an hour to an hour, and don't let the cells get more than slightly warm whilst in the charger.

ar

HF PREDICTIONS

by Evan Jarman VK3ANI

34 Alandale Court, Blackburn Vic 3130

Those graphs show the predicted diurnal variation of key frequencies for the nominated circuits.

These frequencies are as identified in the legend are:-

- Upper Decile (F-layer)
- F-layer Maximum Useable Frequency
- E-layer Maximum Useable Frequency
- Optimum Working Frequency (F-layer)
- Absorption Limiting Frequency (D region)

Shown hourly are the highest frequency amateur bands in ranges between these key frequencies; when usable. The path, propagation mode and Australian terminal bearing are also given for each circuit.

These predictions were made with the Ionospheric Prediction Service program: ASAPS version 4.

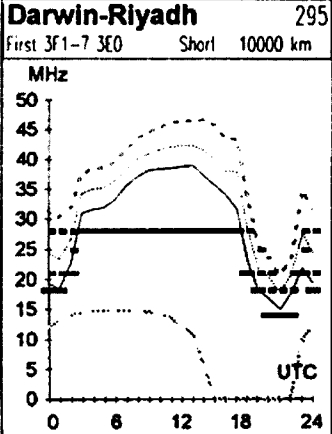
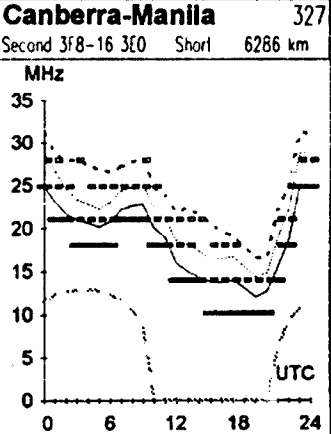
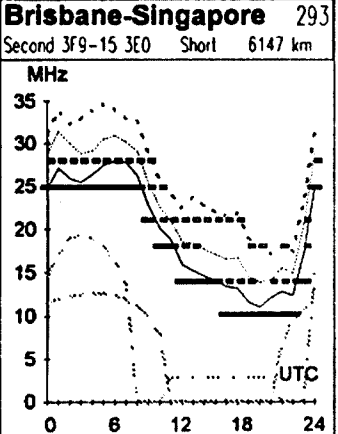
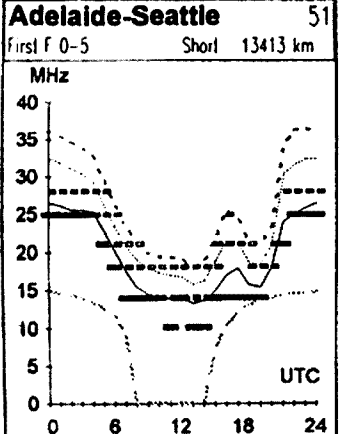
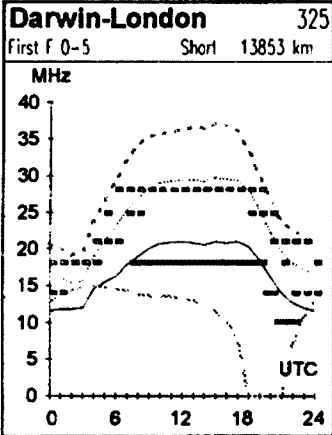
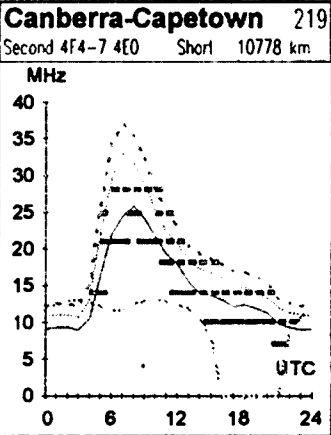
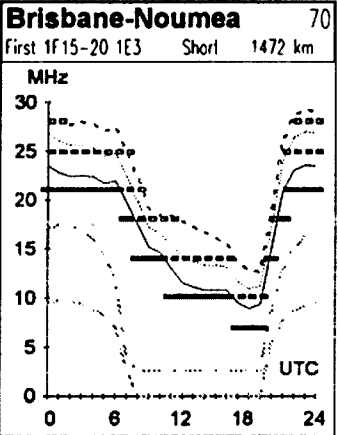
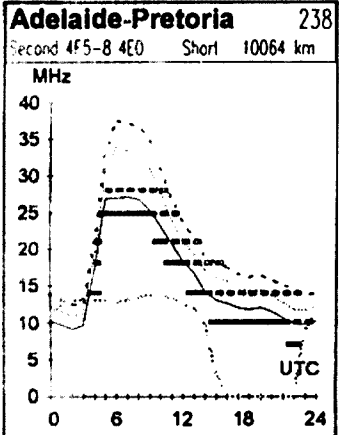
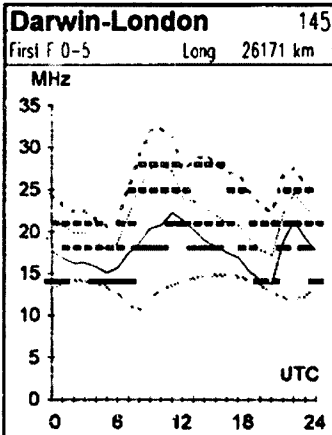
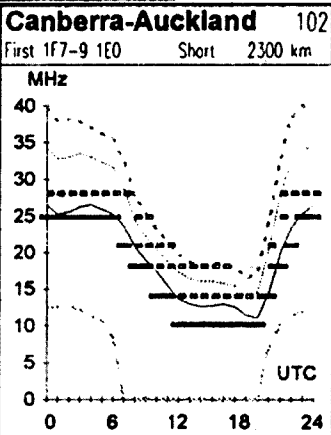
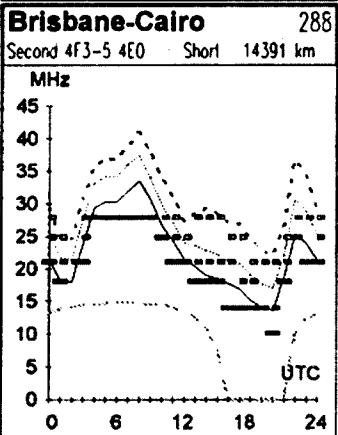
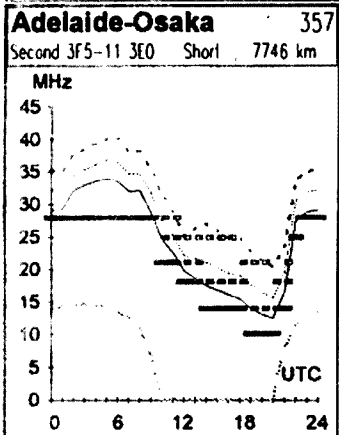
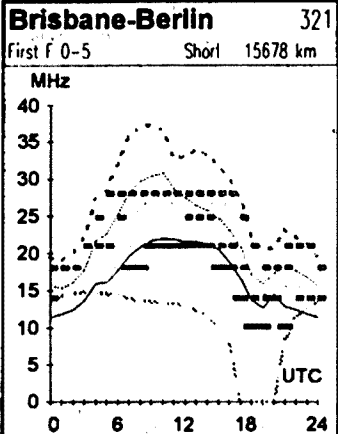
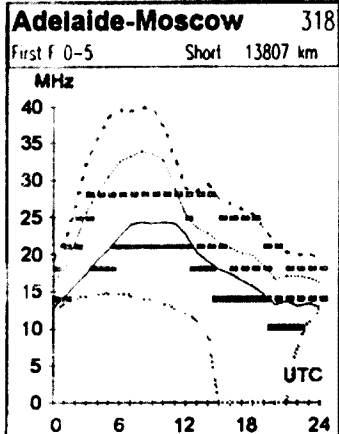
April 2000
T index: 139

Legend

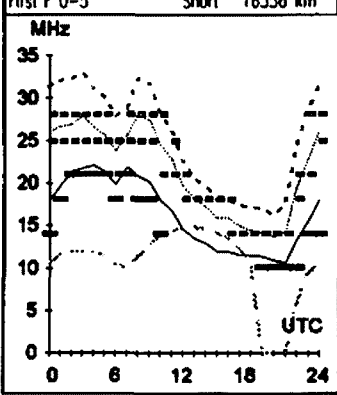
Frequency scale

- UD (Upper Decile) - Dotted line
- F-MUF (F-layer Maximum Useable Frequency) - Long dashed line
- E-MUF (E-layer Maximum Useable Frequency) - Short dashed line
- OWF (Optimum Working Frequency) - Solid line
- ALF (Absorption Limiting Frequency) - Dash-dot line
- 10%-90% - Dotted line
- 50%-90% - Long dashed line
- 90%-100% - Short dashed line

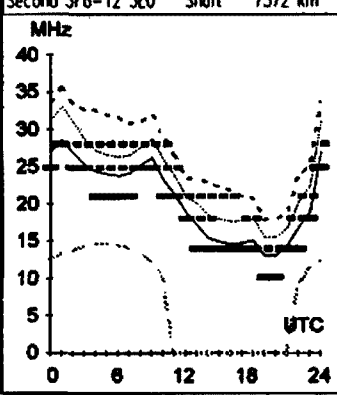
Time scale



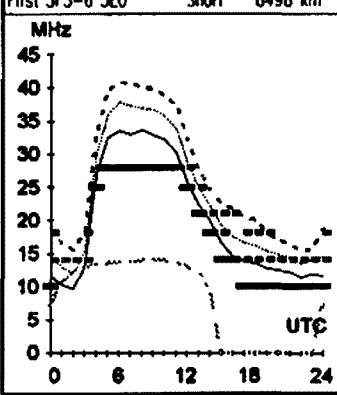
Hobart-Dakar 209
First F 0-5 Short 16556 km



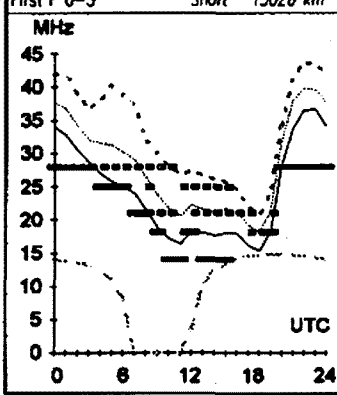
Melbourne-Bangkok 312
Second 3F6-12 3E0 Short 7372 km



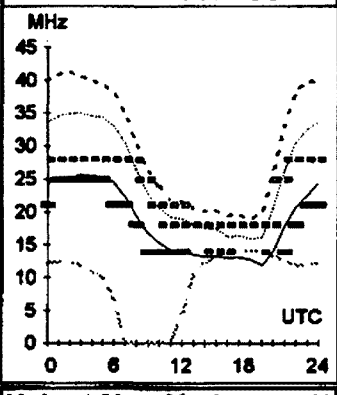
Perth-Harare 257
First 3F3-6 3E0 Short 8496 km



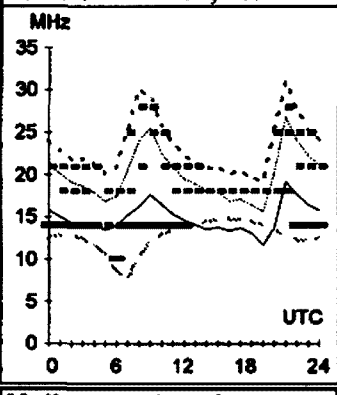
Sydney-Miami 86
First F 0-5 Short 15026 km



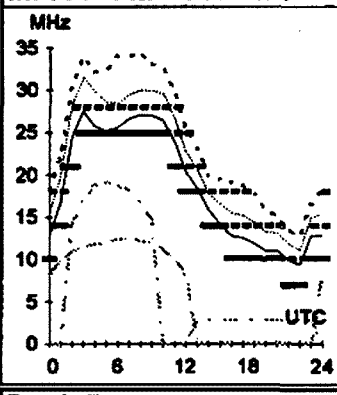
Hobart-Lima 133
First F 0-5 Short 12421 km



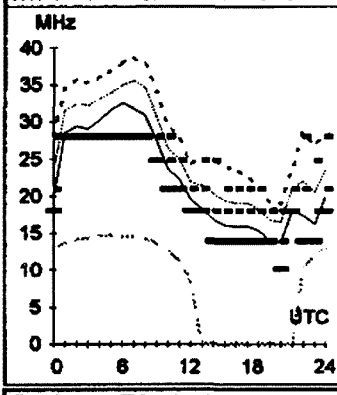
Melbourne-London 131
First F 0-5 Long 23118 km



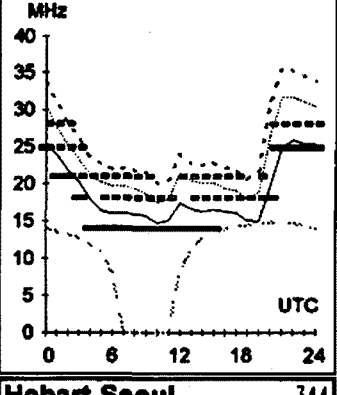
Perth-Maldives 303
Second 3F9-16 3E0 Short 5979 km



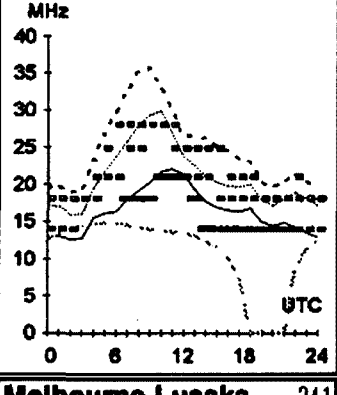
Sydney-New Delhi 302
Second 4F5-11 4E0 Short 10418 km



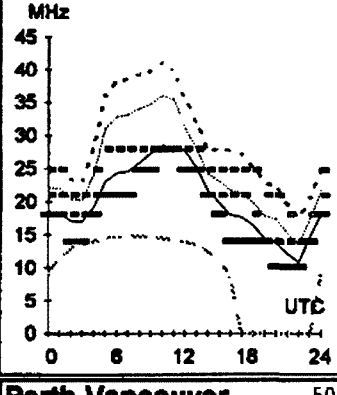
Hobart-New York 80
First F 0-5 Short 16609 km



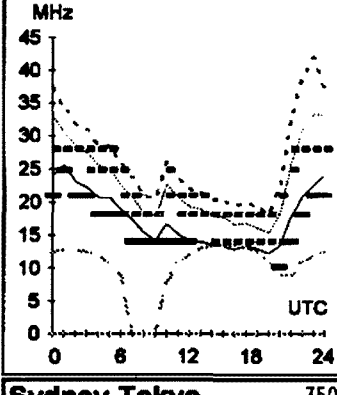
Melbourne-London 311
First F 0-5 Short 16906 km



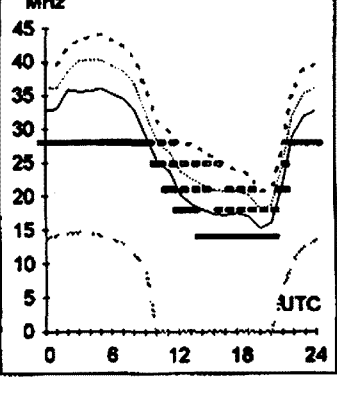
Perth-Rome 303
First F 0-5 Short 13340 km



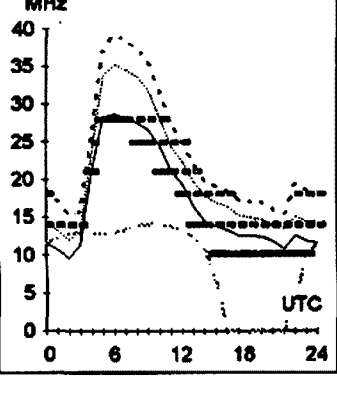
Sydney-RiodeJaneiro 164
First F 0-5 Short 1351 km



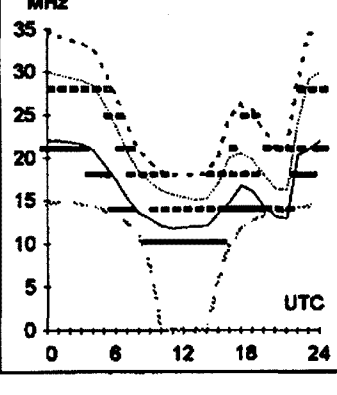
Hobart-Seoul 344
Second 4F7-13 4E0 Short 9175 km



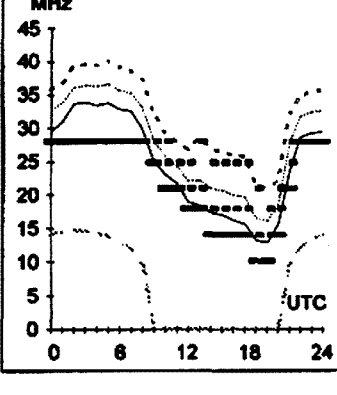
Melbourne-Lusaka 241
Second 4F4-6 4F0 Short 11153 km



Perth-Vancouver 50
Second 4F4-11 4E0 Short 14823 km



Sydney-Tokyo 350
Second 3F5-11 3E0 Short 7825 km



Len Vermuelen VK3COD.

July 2nd, 1927 – Dec. 21st 1999

Family Man, Club Man and Humanitarian.

Paying tribute to the memory of a man like Len is an extremely arduous task, not for the want of things to mention, but for the fear of leaving something out.

Len came to Australia in 1950 and was working as a mechanic when he met, courted and eventually, in 1954, married Stella.

He became interested in wireless and was an enthusiastic operator on the 27Mc Band for quite some time before turning his attention to Amateur Radio.

Len joined the WIA in 1980 and attained his Novice Call Sign VK3NWA. Two years later he upgraded to VK3KGQ. After a further 18 months practice, and with a lot of help and encouragement from a couple of his friends, he finally mastered the 10 wpm Morse and thus was launched VK3COD.

There was an interesting clause in the "help contract" which stated that when he passed the dreaded 10 WPM exam he would have to take CW classes for 12 months to

help others. We all know what that led to, nineteen years of commitment to helping aspiring hams, myself included, attain their CW pass by conducting "On Air" classes. These classes will be maintained by the EMDRC and Len's Call Sign, VK3COD, will be perpetuated by association with them.

Our Club was fortunate indeed to have the services of Len over many, many years, which included terms as Examiner, Committee Member, Vice President and President.

Any Club function always saw VK3COD's hand raised high when volunteers were needed. His house was always available for the Club Station to operate from during contests and to hold exams at. He was a tireless worker and advocate for the Wireless Institute of Australia.

Len's commitment to Amateur Radio is attested to by the number of Awards he has received from various Associations and Clubs, including Life Membership of the EMDRC.

Len's concern for those less fortunate than himself was borne out by the "open door" policy that was in force at Len & Stella's home. Their combined generosity

and hospitality to all who passed through the portals knew no bounds.

I could go on and on, but suffice to say that all of us who had the privilege of knowing Len are the better for having done so. His unselfishness and generosity touched all who came in contact with him. His devotion to Stella, Dean, Vicki and families knew no bounds, he was a glowing example of a family man.

Len will be fondly remembered by all of us who had the good fortune to know him. The courage and tenacity that he displayed while fighting the unwinnable battle against the cancer that had invaded his body was typical of Len's attitude to life—never give up.

73 Len, Rest in Peace.

Carl Schlink VK3EMF
President of the EMDRC.

Staunton McNamara VK5ZH

We regret to announce the death of Staunton McNamara VK5ZH, on Tuesday, 7 February, 2000. He will always be remembered as a radio amateur and a gentleman

73, Christine VK5CTY

Harold L Hepburn VK3AFQ

Born in Bristol UK on 26 June 1922, Harold graduated as an industrial chemist. During his career he worked in the UK, Middle East, USA, New Zealand, Asia and Australia.

Harold migrated with his wife and daughter to Australia in 1960 and set up QTH in East Brighton, Melbourne where he lived until his death.

Harold's devotion to amateur radio, especially projects and kits, was evident in his articles. There was a time when every issue of AR carried an article by Harold Hepburn. He also wrote articles for other radio publications in Australia and overseas. Harold possessed enthusiasm, energy and determination that few of us could match. Heart attacks, by-pass surgery and multiple hip replacements did not deter him.

Harold served on many committees. He was an Executive Officer of the WIA, Moorabbin and District Radio Club and the Radio Amateur Old Timers Club. A Life Member of the Moorabbin and District R.C., he was probably the Club's most devoted member and was a weekly attendee until a few months prior to his death. Harold was diagnosed with lung cancer in December 1998. He died in Peter McCallum Institute on 7 December, 1999.

Harold leaves his wife Barbara (Bobbie), daughter Sue (Bree), granddaughters Kirsty and Cindy and great-grandson Zachary.

The mentor of many, his memory will be held in great esteem by those of us fortunate enough to have been associated with him.

Farewell my friend and mentor of forty years.

73 Harold L Hepburn VK3AFQ

David Rosenfield VK3ADM

Mervyn 'Snow' Campbell

Amateur radio lost one of its most endearing characters when Mervyn Campbell VK3MR, 'Snow' to his many friends, passed away in December 1999. Snow gained his amateur radio licence in 1931 and maintained his interest in radio until his death. He was an unassuming man with a most pleasant personality, with an extensive knowledge of the many facets of radio, in particular aerial systems. In fact, his property at Clyde was called *Rhombi*.

In 1996 he changed QTH to Karingal, the same year in which he celebrated his fiftieth wedding anniversary with his lifelong partner, Marjorie, whom he married shortly after the war. Snow was one of the early enlistments in the RAAF and served as a signals officer in the Middle East before becoming a POW. His radio skill was evidenced by his success in many DX competitions and the vast number of DX contacts he made throughout the world. Apart from the fields of both amateur and commercial radio, Snow maintained an interest in sport, particularly cricket, local history, dancing and music. He was a regular attendee at the Frankston Forest Baptist Church. Snow served as a member of many associations including the local Rural Fire Brigade, Clyde School committee and Westernport Light Opera Society. Old Timers will remember him as an active member of the Radio Amateurs Old Timers Club, which he helped found with the late Bob Cunningham VK3ML.

Having passed away at the ripe old age of 90, he will be sadly missed both by his family and the many friends he made on the air.

Ken Matchett VK3TL

The WIA also regrets to announce the recent passing of:- C. ALLEN VK2ALC, and C.R.(Cleaver) DUELL VK2MUA

HAMADS

- Hamads may be submitted on the form on the reverse of your current Amateur Radio address flysheet. Please print carefully, especially where case or numerals are critical.
- Please submit separate forms for For Sale and Wanted items, and be sure to include your name, address and telephone number (including STD code) if you do not use the flysheet.
- Eight lines (forty words) per issue free to all WIA members, ninth and tenth lines for name and address. Commercial rates apply for non-members.
- Deceased estates Hamads will be published in full, even if the ad is not fully radio equipment.
- WIA policy recommends that the serial number of all equipment for sale should be included.
- QTHR means the address is correct in the current WIA Call Book.
- Ordinary Hamads from members who are deemed to be in general electronics retail and wholesale distributive trades should be certified as referring only to private articles not being re-sold for merchandising purposes.
- Commercial advertising (Trade Hamads) are pre-payable at \$25.00 for four lines (twenty words), plus \$2.25 per line (or part thereof), with a minimum charge of \$25.00. Cheques are to be made out to: WIA Hamads.
- Copy should be typed or in block letters, and be received by the deadlines shown on page 1 of each issue of Amateur Radio, at:

Postal: Newsletters Unlimited, 29 Tanner Street, Richmond, 3121

Fax: 03 9428 4242 **E-mail:** news1@webtime.com.au

Please only send your Hamad once

Please send Hamads by mail OR fax OR email (much preferred).

Please do not send by more than one method for any one ad or issue, it is confusing.

FOR SALE ACT

- **Realistic AX190** 11 band Comet Rx Ham/SW/LB bands speaker \$150. **R5GB Radcom** mag 1995-99 \$15. **Transformer HD** for rewind \$5. Xtals, books, parts. Phone for lists VK1US QTHR (02) 6281 3587
- **KLM KT34A 4el TRIBAND YAGI** 4.8m Boom, brand new set of capacitor caps. Good Cond. \$300 ono. VK1TX Tex Ph: (02) 6296 2508, M 0413 139151, Email: vk1tx@one.net.au

FOR SALE NSW

- **Yaesu FT301D Tx—Rx G.C.** \$350. **Yaesu FV301 VFO** \$200. **Yaesu YO301** Monitor scope \$250. **Yaesu FP301D P/S** \$300. **Yaesu FT901D** \$400. **Yaesu FV901DM** Ext VFO Memory unit \$200. **Yaesu FT101ZD** \$350. **Yaesu FL2100B** Linear amplifier \$700. **Yaesu FT209RH** 2M FM hand held Tx—Rx, Car charger, speaker, mic, Mains charger \$300 ono. QTHR (02) 6367 5095
- **KW Dummy Load** 1kW \$80. **Tekonsha** Electric caravan brake control unit \$100. All above items are in very good condition. Phone (02) 6367 5095 QTHR Peter VK2DBI
- **FT747 HF Transceiver** as new with manual \$600. **Icom IC-3200A** Exc condition 2 metre 70cm FM Transceiver, Manual \$400. VK2ALV Laurie (02) 4272 8280
- **Oscilloscope BWD502** with manual and probe kit. Excellent condition \$175. Post and packing extra. John VK2FUR (02) 4625 1812
- **Kantronics UHF power amp MA440.** Hand-held input, gives 15W output. In box, never used. Cost \$259, sell for \$130. Sid Ward VK2SW QTHR (02) 6922 6082 sward@bigpond.com
- **Yaesu FT101E HF Transceiver** SN 8E 330363 and FV101B Ext VFO. Both in excellent condition. **Hy-Gain DB1015A** Duo-Band antenna. All manuals, cables and mikes. Plus

approx 10m 50 Ohm coax cable. BL50A Balun, MOD110 SWR and power meter. The lot \$380. Martin VK2NNI (02) 4733 4722 (w/e or eve)

- **Hy-Gain** 10-15 three element Duo-Band beam. 1kW rated traps c/w Balun A1 condx \$110 ono. **Transformer 240V** — 110V 2kVA rating in sheetmetal louvered case with carrying handle \$90 ono. VK2AS QTHR (02) 9416 7784. Email astowar@telstra.easymail.com.au
- **Two Yaesu FL2100Z.** One pair 572B tubes. One MFJ 949E A.T.U. One MFJ 1700B Ant switch. Ian S Wilkinson VK2AMM (02) 4932 8935
- **BOOK: Radiotelegraph and Radiotelephone Codes, Proverbs and Abbreviations.** 2nd Edition. \$16 posted Australia. 90 Pages. Q,X,Z Codes, 97 Phonetic, 20 Morse Codes. Phillips, Myer. 10,11,12,13 Codes. Much other info. Internet - <http://www.nor.com.au/community/sarc/phonetic.htm>. VK2JWA, John W.Alcorn. QTHR. 02-66215217 jalcorn@nor.com.au
- **Kenwood TS440S/AT,** owners manual, service manual hand mike & lead, good cond. \$900 o.n.o. Grant VK2VB QTHR (02) 49658658 a.h.
- **Yaesu FT-101Z HF TXCVR** S/N 9C020308. G.C. Spare PA valves. Built in fan. DC-DC converter \$250.00. One light weight **morse code key** \$5.00. One heavy duty **morse code key** with built in spark suppressor \$50.00. One gutter mount **antenna rack** with 11m antenna \$5.00. One **Kraco** 11m 24 channel CB S/N 805477 with crystals to convert to 10m \$100.00. VK2KRQ John Le Fevre, (02) 4369 0458, 12A Rickard Road Empire Bay NSW
- **Kenwood TH-77** hand held dual band (2m & 70cm) xcvr s/n 30300429 with speaker mike SMC-31. Perfect condition \$250 or offer. Ph. Bill (02) 6775 2158. VK2WS QTHR
- **Yaesu YM-38** desk mic \$30.00. **Magnetic ant base** \$50.00. **Phillips FM-900** (low band VHF)

remote head FM xcvr \$70.00. **Kenwood TS-680S** with separate 6m ant socket \$850.00. **Kenwood AT-230** ant tuner \$210.00. Randall VK2EFA QTHR (08) 80875285, vk2efa@pcpro.net.au

• **Kenwood TS-680S HF/6m** with matching Kenwood AT-250 automatic antenna tuner. 100W HF and 20W 6m. Ant tuner handles 200W and has 4way built in ant switch and SWR meter. Both units in absolute mint condition with all cables, manuals and original boxes. \$1200 OBO Earle, VK2TEK 0407 287 030 or email earle@sydnet.com

• **Yaesu FRG-7** communications receiver. This has to be seen to believe the mint condition this unit is in. All original manuals. \$300 OBO Earle, VK2TEK 0407 287 030 or email: earle@sydnet.com

WANTED NSW

• **Big old heavy communication receivers,** working or not. Will collect in the Sydney area. Give me a hernia. Will put the gear to good use as per March AR. So give me a call (02) 9533 6261 John L21068.

• **SIMPLEX Auto Morse key** (bug). Melbourne, Australia. Replies to- Email: jalcorn@nor.com.au J.W.Alcorn, VK2JWA. QTHR. Ph 02-66215217. Please give condition and price.

FOR SALE VIC

• **Prop pitch motor** with DC power supply. See working. Offers invited. Don VK3ASD (03) 9849 0437 Email: donsmith@melbpc.org.au

• **Tram 23 channel AM CB,** Panther power pack. SWR meter \$30. **Rotel tuner AX850** BSR t/table. MA70 Technics tape deck 4 speakers, Marantz audio rack cabinet \$200. George VK3VAM QTHR (03) 9557 6056

• **Yaesu FT-415** 2m. HT ser no 21172769 E.C. complete charger, orig. boxing, handbook \$160. Reg VK3KK QTHR (03) 9469 4200 AH

• **Morse Key "Bathtub"** ex WW2 Aircraft. Collectors item. Never used P/N 10A 7741 \$50. Packed posted Allan Doble VK3AMD QTHR (03) 9570 4610

• **Rotator Up Down** elevator. Suit satellites \$250. Swan xcvr Model 500 \$200. Stan VK3SE (03) 5332 2340

• **Drake HF station.** Drake TR7 Transceiver, L75 linear amplifier, power supplies, microphone, speaker - \$2000 ONO. Alf Chandler, VK3LC, QTHR, Fone (03) 9773 5334.

• **Alinco DR-599T.** VHF/UHF dualband transceiver. MC-55 boom microphone with switchbox. Hand microphone. Brainer ST-7500 mobile dualband antenna. Diamond duplexer. Bullbar mounts and coax, leads, boxes and manuals \$650. Paul VK3DA (03) 5983 1771. Or email: apaulo@vk3da.alphalink.com.au.

• **Manuals - Service** for Bearcat BC-210, Regency M400/E, M100/E. Icom manuals for equipment below. All new. IC240. IC260. IC-255A w/ schematic board layout. 3 available.. IC-551D w/ board layout. IC-402 w/schematic. IC-502w/ schematic. IC-25A w/schematic, board layout. IC-2A w/ schematic, board layout. IC-730 schematic, board layout only. All \$10 ea. posted. VK3IZ QTHR (03) 5156 2053 Email: jupeter@net-tech.com.au

• **Icom IC22S** w/ manual, schematic, mic, mounting bracket, has faulty PLL. \$80 posted.

HP302A wave analyzer \$60. **HP205AG audio signal generator** \$60. **HP8014A sig. generator** O.8 - 2.4 GHz \$500. **AWA 5193Z** distortion and noise meter \$50. **Command SCR274N** complete system 3Rx to 2Tx with mounts, modulator, all cables, tuning shafts, microphone, \$1200. **Marconi TF2300B FM/AM modulation meter** \$100. **BC348Q** with original dynamotor - restored \$450 or trade for ARC-38A. **VK3IZ QTHR** (03) 5156 2053 Email: jupeter@net-tech.com.au

WANTED VIC

- **Circuit and manual** for Heathkit Monitor Scope Model HO-10. Brian VK3WYN (03) 5664 1251 QTHR
- **Integrated circuit** TD62083 AF, 18 pin SMD. John VK3AJL (03) 9481 6771

FOR SALE QLD

- **Signal Generator**, Rhode & Schwarz SMS, 0.1 to 520 MHz, AM/FM, precision attenuator, digital readout of freq., modulation & output level. Handbook, 240 VAC \$950. Gary. VK4AR (07) 3353 1695
- **6m Repeater**, 50 Watts, separate rack mount Tx & Rx. 240 VAC or 12V battery operation. Philips FM814 \$250 Gary. VK4AR (07) 3353 1695
- **Beams:** 10, 15, 20, TH3 Junior, 10, 15, 20 TET, Emtron Morse practice key, dummy load, SWR meter, digital multimeter, Lafayette HA350 receiver, full trailer load of computers, TNCs, disk, drives, software, amateur radio accessories. (07) 4124 1348
- **Kenwood TSS20S** \$275. Excellent. **Kenwood PS 52** power supply new \$425. **Shure 526T** base microphone \$125. **HyGain (USA) HyQuad 10, 15, 20m, 2 element** \$225. **Kenwood AT230 HF ATU** \$225. **Yaesu FP757HD Power Supply** \$275. **Kenwood TS140S** \$650. **Kenwood TS440S** \$850. **Kenwood TL922** \$2100. **Kenwood MC80** \$100. John VK4SKY Email: interfs@netscape.net, 0417 410 503
- **Eddystone Communications Receiver** Model 1830/1 professional Rx covers 120 kHz to 31 MHz in 9 ranges. Solid state 33 transistors with all facilities. Copy of full service manual available with purchase. Excellent condition \$500. **Transmitting tube RCA 833A** unused, boxed \$50. **Roller inductor** new covers 3.5 — 30 MHz, very heavy duty, silvered square Busbar coil Teflon construction. New, unused \$100. **Marconi Universal bridge (L,C,R)** Model TF 2700 as new \$100. **Collins mechanical filters** 455 kHz (3 of) bandwidths 2.1kHz 3.1kHz 6.0kHz \$50 each or the three for \$125. **Wading/tuning gangs** 60 plate app 5mm spacing, new, heavy duty \$50. **Dowkey coaxial relay** DK60 "N" connectors 48 volt unused (1kW rating) \$60. **BNC coaxial c/o relay** 48 volt unused \$40. **Eimac transmitting tube 5CX1500A**, new, boxed \$125. **Eimac planar triodes** 8745 electrically/mechanically similar to

7289, 3CX 100A7 etc, new, boxed, sold as pairs, \$50 pair. **Bird 2500H** element \$75. John VK4KK (07) 3269 6647

WANTED QLD

- **MFJ CW Keyboard**. Ray VK4BLK (07) 4939 2284
- **WWII Services Amenities Receivers**, Australian sound System Type V5, AWA Type C17020, Stromberg-Carlson, Type 6A15, also MCR1 Rx or part sets. Ray VK4FH PO Box 5263, Daisy Hill 4127 (07) 3299 3819 Fax (07) 3299 3821

WANTED SA

- **Motorola MX300** series radios and parts. Please call VK5HJT Henry on (08) 8645 5662
- **FDK Fukuyama Multi—800D** 2mtr FM Transcvr (1978) in any condition. M Millar VK5MX QTHR (08) 8346 7042
- **Hand mic for Kenwood TS-130** in good condition please. Paul VK5MAP (08) 8651 2398 after 7pm
- **WW2 equipment**. 1) RAF transmitter type R1154, 2) Radio Corporation transceiver RC.16B (ATR4A or B) Malcolm Haskard VK5BA. Phone/fax (08) 8280 7192. email:malcolm.haskard@unisa.edu.au
- **Tektronix ISI Sampling unit**. G.R. plug to UHF socket adaptor. Tektronix Probes Types P6032, P6034. (08) 8520 2988

FOR SALE WA

- **Much HF and QRP gear** with operating shack in 4BR, ducted a/con house, two houses from sea. No antennas here. I use those of helpful neighbour VK6GTE. Seaside living about half Sydney price. All for \$250,000. Keith VK6KC QTHR (08) 9528 3336

FOR SALE TAS

- **ICOM 730 HF txcvr** incl WARC bands and service manual- ex condition \$500 ono. (03) 6272 0159 or tspargo@netspace.net.au

TRADE ADS

• **AMIDON FERROMAGNETIC CORES:**
For all RF applications. Send business size SASE for data/price to RJ & US Imports, PO Box 431, Kiama NSW 2533 (no enquiries at office please ... 14 Boanyo Ave Kiama).

www.cyberelectric.net.au/~rjandusimports

Agencies at: Assoc TV Service, Hobart; Truscotts Electronic World, Melbourne and Mildura; Alpha Tango Products, Perth; Haven Electronics, Nowra

<http://www.hamsearch.com>
a not-for-profit site that is a search engine for hams

MISCELLANEOUS

• If you got your licence before 1975 you are invited to join the Radio Amateurs Old Timers Club. A \$2.50 joining fee plus \$8.00 for one year or \$15.00 for two years gets you two interesting Journals a year plus good fellowship. Arthur Evans VK3VQ or Allan Doble VK3AMD can supply applications forms. Both are QTHR in any Call Book.

• The WIA QSL Collection (now Federal) requires QSLs. All types welcome, especially rare DX pictorial cards, special issue. Please contact the Hon Curator, Ken Matchett VK3TL, 4 Sunrise Hill Road Montrose VIC 3765, tel. 03 9728 5350.

SPECIAL SALE

On behalf of
Lt Col. Rod Wells

A lifetime's collection of electrical, electronic and radio equipment, components etc. Test equipment, telephones, HF SSB Transceivers, UHF CB Transceivers. New cable including co-ax, security alarm and photographic equipment etc. etc.

Saturday 8th April. Gates open 9.30am.

Sale starts 10.30am. Cash sales only.

*836 Rushworth — Tatura Road,
Rushworth 3612 (between Mason and
Darby Roads) RACV VicRoads map
Ref 46 B2*

Inspection before sale date only by appointment.

Tel/fax 03 5856 1306, or
enquiries to Bill Jamieson:
VK3HX QTHR

• **WEATHER FAX** programs for IBM XT/ATs *** "RADFAXZ" \$35.00, is a high resolution short-wave weather fax, Morse and RTTY receiving program. Suitable for CGA, EGA, VGA and Hercules cards (state which). Needs SSB HF radio and RADFAX decoder. *** "SATFAX" \$45.00, is a NOAA, Meteor and GMS weather satellite picture receiving program. Needs EGA or VGA & WEATHER FAX PC card, + 137 MHz Receiver. *** "MAXISAT" \$75.00 is similar to SATFAX but needs 2 MB of expanded memory (EMS 3.6 or 4.0) and 1024 x 768 SVGA card. All programs are on 5.25" or 3.5" disks (state which) plus documentation, add \$3.00 postage. ONLY from M. Delahunty, 42 Villers St. New Farm QLD 4005. Ph 07 358 2785.

ADVERTISERS INDEX

ATN Antennas	46
Andrews Communication Systems	27
Dick Smith	OBC, 28,29
G & C Communications	34
Icom	IBC
Radio & Communications	25
Tower Communications	33
WIA Call Book.....	IFC

TRADE PRACTICES ACT

It is impossible for us to ensure that the advertisements submitted for publication comply with the Trade Practices Act 1974. Therefore, advertisers and advertising agents will appreciate the absolute need for themselves to ensure that the provisions of the Act are strictly complied with.

VICTORIAN CONSUMER AFFAIRS ACT

All advertisers are advised that advertisements containing only a PO Box number as the address cannot be accepted without the addition of the business address of the box-holder or seller of the goods.

▶ YAESU'S DONE IT AGAIN



**SCOOP
PURCHASE
SPECIAL**

Yaesu FT-100 Ultra-compact HF/6m/2m/70cm Mobile

AMAZING SCOOP PURCHASE VALUE!

Now you can enjoy the fun of operating on all bands from 160m to 70cm, either at home or in your car, and at a fantastic Yaesu price.

The new Yaesu FT-100 features HF/6m/2m/70cm transmitter coverage with 100W RF output on HF and 6m, 50W on 2m and 20W on 70cm, plus you can easily mount the detachable front panel using an optional lead (YSK-100) for more convenient mobile installations. Powerful interference fighting features such as a DSP based Bandpass filter, Notch filter and Noise reduction, together with an IF based Shift control, all aid reception quality during tough conditions. A Speech Processor and VOX facility are provided for SSB users and an internal Electronic keyer is provided for CW operation. Also included are Dual VFOs, built-in CTCSS encode, 300 memory channels, all-mode operation (SSB, CW, AM, FM, AFSK, Packet 1200/9600bps), 100kHz-970MHz receiver (cellular locked-out), and options for additional AM and CW IF filters.

The FT-100 is supplied with an MH-42B6JS hand mic, DC power lead and comprehensive instructions.

D 3285

YSK-100 remote front panel lead. \$155

D 3286

YAESU

Included as standard:

- Digital Signal Processing on both transmit and receive
- Effective IF noise blanker
- Electronic CW keyer with 50 character message memory
- Spectrum Scope function
- Massive receiver coverage (100kHz – 970MHz, less cellular)

\$2499 **SAVE \$376**

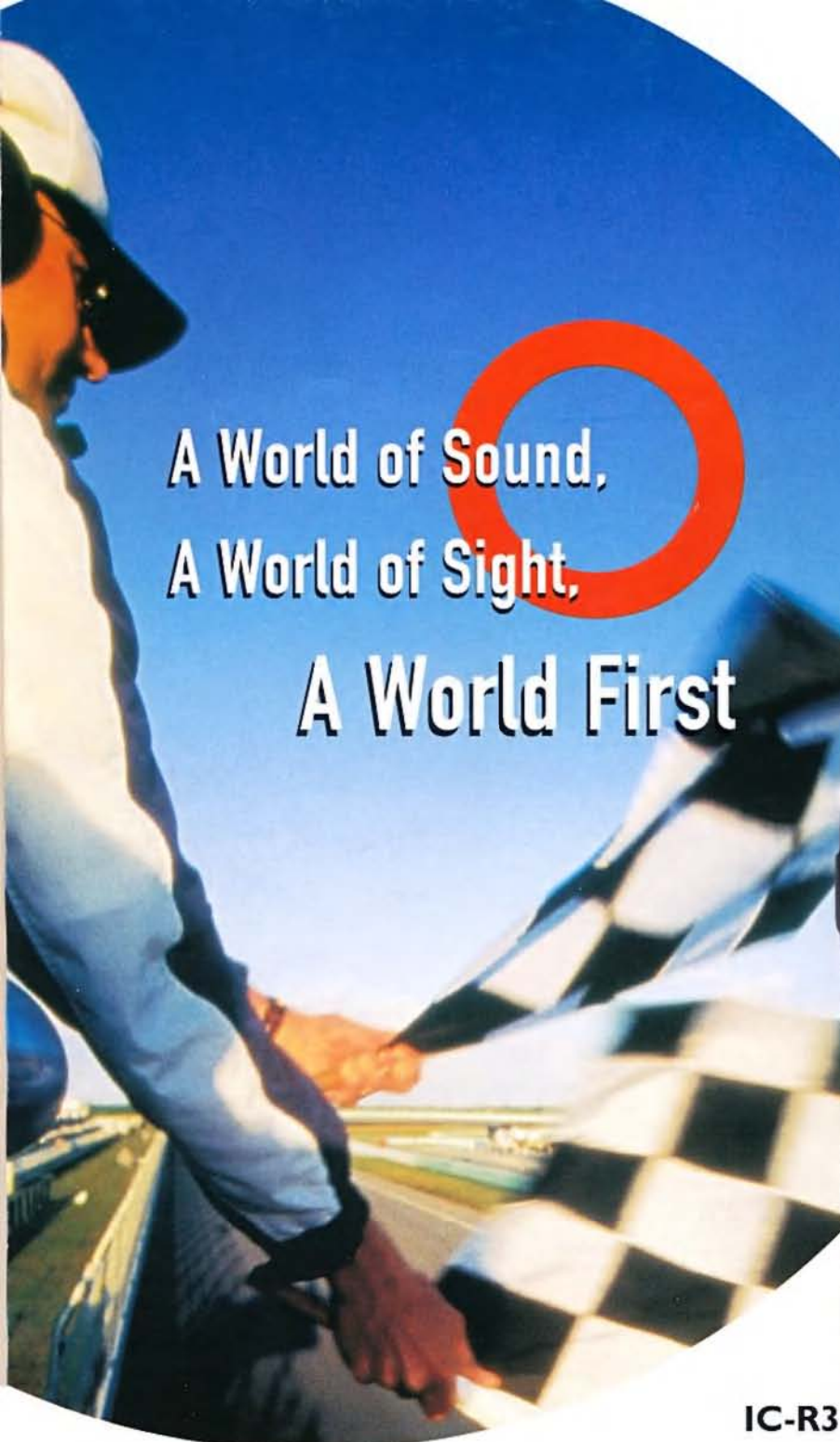
2 YEAR WARRANTY

Offers expire 30/4/2000.

DICK SMITH
ELECTRONICS

That's where you go!

A World of Sound, A World of Sight, A World First



IC-R3

The Ultimate Handheld Receiver is here!

A first for a handheld communications receiver... a 2 inch TFT colour screen! With super wide 0.5-2450 MHz frequency coverage for AM, FM, wide FM and TV picture reception. LCD shows information such as receiving frequencies, tuning steps, and memory channel numbers.

Loaded with features like signal strength level indication, band scope, high speed scanning, a multi-function 'joy stick' switch, 450 memory channels and more. A long life Lithium-Ion battery is supplied but the unit is also alkaline battery ready. Discover the IC-R3's world of sight and sound for yourself soon...it's another first from Icom!

2 YR WARRANTY For the name of your nearest accredited Icom Dealer call Icom on 1800 338 915, or visit our website at www.icom.net.au





May 2000
Volume 68 No 5

Amateur Radio

HOW TO WORK DX IN A TREE

- An Active Frame Antenna for 160m reception
- LF Receiving Converter with Loop-stick Antenna
- Evolution of an Antenna Farm — a photo story

QSLs from Russia and England

plus

WIA, Divisional & Club News

ALARA

regular columns

Awards
Contests

5 WPM Morse Q & A

What does the ACA "in principle" decision on Morse code licence testing mean?

Conquer the **BW***
& get your **CW!**

MAY 2000



WIA Yearbook 2000

***Callbook Listings
Frequency Listings
Band Plans
Repeater Lists
Beacon Lists
Satellite Lists
Licence Conditions
Examiner Lists
Special Interest Groups
Public Relations Notes
Radio and TV Freqs.
and much, much more!***

2000 is a great year to have an up-to-date call book. This YEARBOOK edition contains all of the content you have come to expect of the WIA callbook as well as some new items

It is more than a callbook, it's a Yearbook, the WIA Yearbook!

The "WIA Yearbook 2000" is now available from Divisional Bookshops and selected outlets



Amateur Radio

Volume 68
Number 5
May 2000

The Journal of the Wireless
Institute of Australia
ISSN 0002-6859

Editorial

Editor: Colwyn Low VK5UE
edarmag@chariot.net.au

Technical Editor: Peter Gibson VK3AZL

Publications Committee Members
Ron Fisher VK3OM
Don Jackson VK3DBB
Evan Jarman VK3ANI
Bill Rice VK3ABP
Gil Sones VK3AUI

Advertising

Mrs June Fox,
Tel: (03) 9528 5962

Hamads

"Hamads" Newsletters Unlimited
29 Tanner Street, Richmond VIC 3121
Fax: (03) 9428 4242
e-mail: news1@webtime.com.au

Office

10/229 Balaclava Road
Caulfield, Victoria
Telephone (03) 9528 5962
Facsimile (03) 9523 8191
Business Hours 9:30am to 3:00pm weekdays

Postal

P.O. Box 2175
CAULFIELD JUNCTION
VICTORIA 3161
AUSTRALIA
e-mail: armag@ hotkey.net.au

Production

Newsletters Unlimited (03) 9428 3458

Printer

Streamline Press, Melbourne (03) 9417 2766

Postal Service

IMS (03) 9291 5888

Production Deadlines

Advertising booking and articles for
publication 10th of proceeding month.

Hamads and advertising material deadline
18th day of proceeding month

The contents of Amateur Radio are Copyright
Wireless Institute of Australia
C 2000

General

5 wpm Morse Q & A 7	Jim Linton VK3PC
Conquer the BW and get your CW (Part 2) 10	Dieter Engels DJ6TE/Mike Krochmal VK3KRO
Evolution of an Antenna Farm: a photo story 13	Bernie Wijtes VK4BTf
How to work DX with a tree 15	Ernest H. Sloman VK2BUE
QSLs from Russia and England 21	Ken Matchatt VK3TL
One Active Device Competition 22	— AHARS Competition
Two Old Squares Into Four Squares 24	Steve Mahonay VK5AIM

Technical

An active fram antenna for 160 metres reception 8	Keith Gooley VK5OQ
LF Receiving Converter with Loop-stick Antenna 18	Drew Diamond VK3XU

Columns

Advertisers' Index 55	Education 40
ALARA 17	Hamads 55
ARDF 27	HF Predictions 52
AMSAT Australia 35	Intruder Watch 26
Awards 41	Ionospheric Update 51
Club News 25	New Members 2
Contests 42	Over To You 55, 56
WIA Division News	Pounding Brass 50
VK1 Notes 31	Repeater Link 26
VK2 Notes 31	Spotlight on SWLing 30
VK3 Notes 32	Try This 6
VK4 Notes 33	VHF/UHF - An Expanding World 37
VK7 Notes 33	WIA Comment 3
VK5 & VK8 Notes 34	WIA News 3
DX Notes 49	WIA Federal Directory 2
Editor's Comment 2	

Our cover this month

From serious to frivolous, Field Days are great days out for all the family.
WIA Qld has supplied these snapshots

Contributions to Amateur Radio

Amateur Radio is a forum for WIA members' amateur radio experiments, experiences opinions and news. Manuscripts with drawings and or photos are always welcome and will be considered for publication. Articles on disc or email are especially welcome. The WIA cannot be responsible for loss or damage to any material. A pamphlet, How to write for Amateur Radio is available from the Federal Office on receipt of a stamped self-addressed envelope.

Back Issues

Back issues are available directly from the WIA Federal Office (until stocks are exhausted) at \$4.00 each (including postage within Australia) to members.

Photostat copies

When back issues are no longer available, photocopies of articles are available to members at \$2.50 each (plus an additional \$2 for each additional issue in which the article appears).

Disclaimer

The opinions expressed in this publication do not necessarily reflect the official view of the WIA and the WIA cannot be held responsible for incorrect information published.

Amateur Radio Service

A radiocommunication service for the purpose of self-training, intercommunication and technical investigation carried out by amateurs; that is, by duly authorised persons interested in radio technique solely with a personal aim and without pecuniary interest.

Wireless Institute of Australia

The world's first and oldest
National Radio Society
Founded 1910

Representing
The Australian Amateur Radio Service

Member of the
International Amateur Radio Union

Registered Federal Office of the WIA
10/229 Balacava Road
Caulfield North Vic 3161
Tel: (03) 9528 5962 Fax (03) 9523 8191
<http://www.wia.org.au>

All mail to
PO Box 2175 Caulfield Junction VIC 3161

Business hours: 9.30am-3pm weekdays

Acting Federal Secretary

Peter Naish VK2BPN

Federal Office staff

June Fox Bookkeeper
Rita Trebilco VK3IF Examinations Officer

Council

President	Peter Naish	VK2BPN
VK1 Federal Councillor	Glenn Dunstan	VK1XX
VK2 Federal Councillor	Michael Corbin	VK2YC
VK3 Federal Councillor	Brenda Edmonds	VK3KT
VK4 Federal Councillor	Ross Marren	VK4AMJ
VK5 Federal Councillor	David Box	VK5OV
VK6 Federal Councillor	Will McGhie	VK6UU
VK7 Federal Councillor	Phil Corby	VK7ZAX

Executive

Peter Naish VK2BPN
Tony Farrow VK2TJF
John Loftus VK4EMM
Wally Howse VK6KZ

Federal Coordinators

AMSAT	Graham Ratcliff	VK5AGR
ARDF	Jack Bramham	VK3WWW
Awards	John Kelleher	VK3DP
Contests	Ian Godsil	VK3DID
Education	Brenda Edmonds	VK3KT
FTAC	John Martin	VK3KWA
Historian	John Edmonds	VK3AFU
IARU	Grant Willis	VK5ZWI
Intruder Watch	Gordon Loveday	VK4KAL
ITU Conference and study group	David Wardlaw	VK3ADW
Public Relations	David Thompson	VK2NH
QSL Manager (VKs, VKs)	Neil Penfold	VK6NE
Videotapes	Don Bland	VK4TVD

ACA Liaison Team

Peter Naish VK2BPN
Glenn Dunstan VK1XX
Michael Corbin VK2YC
Wally Howse VK6KZ
Canberra Liaison Officer
Richard Jenkins VK1RJ

Post Problems

This month I have been delving into how Australia Post gets AR to you. AR is transmitted as Print Post and as such is held until all the First Class mail is loaded before it is used to fill the available load space. The primary movement is from Melbourne to the other State Capitals. The times quoted are 2 days around Melbourne, 3 days to Sydney, Canberra, Adelaide, 4 days Hobart, Brisbane and 5 days Darwin and Perth. These are working days. Distribution to local centres and then your post box takes? My copy of April AR arrived 17th April. The posting was picked up by Australia Post on Thursday 6th April. We are asking more questions of Australia Post.

More Morse

5 wpm Morse code is still news and we have Q and A on licence qualifications and spectrum in this issue from John Linton. The answers have been checked with the ACA.

Use it or lose it

The Winter Sprint season is upon us. Cheers and groans from selected sections of the amateur community. I was interested to see AHRS is considering cancellation of The Australasian Sprints next year due to lack of support. Groans and cheers. What I would like to know is does this just mean an activity has outlived its usefulness and those who no longer participate are doing something else in Amateur Radio or are we all getting tired. I still get a kick out of what happens when I turn my FT101E on at night. On 21st April I was listening around and heard a pile up KG4VL? So I put the heaters on, tuned up into my 132' wire, waited till the next roar of unanswered died away and called. Straight back 59.

No one else answered my calls in the next 30 minutes. Funny things happen all the time. If you are not there you miss it. We are seeing VHF/UHF spectrum being allocated to other uses and Amateurs being excluded from sections of spectrum we share. If we do not have a presence and do not let the ACA see we are making use of our allocations, it is inevitable we will lose more of our current allocations. We are in a USE IT OR LOSE IT situation.

Editorial opinion

I notice that I can get quoted by other news providers, so please remember the Editor's Notes are just that, my thoughts, and do not carry any official WIA authority or approval. Further AR cannot be more up to date than two weeks at best and four or five is more likely, AR is in these cases a Journal of record.

Something interesting? Tell us

Lastly I have no desire to be the last editor of Amateur Radio Magazine, but if there is nothing to publish there will be no AR. I would like to be able to construct issues on a theme but all I can do is select from a diminishing selection of submitted articles. I need technical and general articles and photographs for the cover and elsewhere in the magazine. Please see if you can motivate yourself or someone else with knowledge of a good technical topic or an interesting event to write an article for AR.

Action for the month

Take a sheet of paper and write on it why you are a Radio Amateur. Then write what you are doing to keep the hobby alive for you and others.

73 Colwyn VK5UE

New WIA Members

The WIA bids a warm welcome to the following new members who were entered into the WIA Membership Register

FEBRUARY 2000

L10174	MR M S FRANCIS	VK1NPM	MR P L MACARTHUR
L10175	MR D G K KINNON	VK5ZMH	MR R J MITCHELL
L50000	MR P A SIMMONDS	VK6TT	MR R J BURDEN

MARCH 2000

L41025	B McALEER	L41026	J R ANDERSON
VK4CV	N C COOPER	VK4VLC	S MOWATT

VK: 5wpm Morse to get full HF bands by "mid-year" ZL follows suit

The Australian Communications Authority has accepted a proposal from the Wireless Institute of Australia that effectively reduces to 5 words per minute the Morse Code test speed required for full access to the HF Amateur bands.

Following similar moves in the USA and UK, late last year the WIA State Divisions reviewed their policies regarding the Morse Code test, while the WIA/ACA Liaison Committee discussed the possibility of the change with the ACA.

In early March the WIA State Divisions agreed unanimously to propose that full HF privileges be granted to those who pass the five wpm Morse test (plus the usual theory and regulations tests), and this week the ACA accepted the WIA's proposal.

The full text of the WIA's proposal regarding the Morse Code requirement can be found at [http://www.wia.org.au/Issues/5 wpm Morse Proposal.pdf](http://www.wia.org.au/Issues/5_wpm_Morse_Proposal.pdf)

On 30th March, the Radio Spectrum Management Group notified the New Zealand Amateur Radio Transmitters of similar proposed changes to the ZL Amateur Radio licence conditions. See <http://www.nzart.org.nz/nzart/update/changes.html>

WIA moves for amateur primary status on full six metre band

Band I television services will cease operation on 9 September 2008, and that the spectrum presently occupied by TV channels 0, 1 and 2 will be withdrawn from the Broadcasting Service and reallocated to other services.

The WIA has placed on record a formal submission for the return of the band 50 - 52 MHz to the Amateur Service, under the same licence conditions that apply at present to the 52 - 54 MHz band.

In support of this request, the WIA has raised the following points:

1. Apart from the current Australian footnote, the entire 50 - 54 MHz band is listed as exclusive amateur spectrum in

the ITU frequency allocation tables for Regions II and III. In Region I, Band I television is also being phased out and most countries now have a 50 MHz amateur band.

2. The 50 MHz band is important to the Amateur Service because it provides unique opportunities for propagation experiments. All

continued next page



Comment

WIA Federal President, Peter Naish VK2BPN

IARU preparing for important changes

By the time you receive this issue of "Amateur Radio" the Annual Convention of WIA will have been held in Melbourne. It is the once a year opportunity for the Federal Council to get together over a weekend to discuss and formulate national policy.

This year the major item for discussion is the large number of submissions prepared for the IARU Region 3 meeting in Darwin during August.

As I mentioned in one of my earlier reports to you, the IARU is preparing for the possibility of some very important changes, at the WRC scheduled for 2002 or 2003, to the basis of the amateur radio service worldwide.

In particular there is the likelihood of a total recast of the arrangement under which amateur radio is allowed. Part of this will be the role that Morse Code plays in the qualification needed for an amateur licence.

There may be changes to the bands available to the amateur service. At the WIA Convention your Federal Council will be

conscious of the need to develop a strong case for the Australia which reflects our requirements and future needs.

I am pleased to see the very strong support that the WIA is receiving as a result of our work in relation to the reduction to 5 wpm for the Morse Code requirement for full HF band access, plus the availability of high power permits for EME activity. These of course are only two of a number of areas that are close to being resolved. Some news on LF band permits is expected soon as well as a progress report on the 80-metre DX window.

A report on the outcome of the WIA Federal Convention for 2000 will be presented to you next month.

Peter Naish, VK2BPN
WIA Federal President.

WIA moves for amateur primary status on full six metre band

continued from previous page

long distance communication in this band takes place in the low end just above 50 MHz.

3. For some years the full 50 - 54 MHz band has been available without restriction to amateurs in SA, WA, the NT and in overseas territories. It is logical to extend this allocation to the eastern states when the channel 0 allocation is withdrawn.
4. Closure of analog TV transmissions will free up 21 MHz of spectrum (45 - 52 and 56 - 70 MHz); the reallocation of 50 - 52 MHz to exclusive amateur use would not lead to any problems of spectrum scarcity for other services.
5. Some years ago there was for the

reallocation of channel 0 as an ethnic narrowcasting band. If that proposal is still "live" and gets implemented, such stations could experience desensing and interference from existing Amateur operations in the six metre band, and could interfere with Amateur weak signal operations. An allocation above 56 MHz for ethnic broadcasting would be more suitable.

6. Similarly, spectrum close to 50 MHz should not be allocated to other high power services. Currently, receiver desensing and direct interference to weak signal reception is caused by a weather radar operating on 49 MHz in the Darwin area.

The WIA has requested that:

1. That when the revised Australian Spectrum Plan takes effect in 2008, the band 50 - 54 MHz be allocated to the exclusive use of the Amateur Service;
2. That the band 45 - 50 MHz not be allocated for any other kind of broadcasting or narrowcasting service; and
3. That at least several MHz below 50 MHz be kept clear of any high power services.

The full text of the proposal can be found at <http://www.wia.org.au/Issues/45-52> MHz Submission.pdf

NASA spacecraft to study magnetic storms

NASA is about to launch the first spacecraft dedicated to imaging the Earth's magnetosphere — an invisible magnetic field surrounding the planet that is strongly influenced by the solar wind.

IMAGE (Imager for Magnetopause-to-Aurora Global Exploration) is the first of its kind, designed to actually "see" most of the major charged-particle systems in the space surrounding Earth.

Previous spacecraft explored the magnetosphere by detecting particles and fields they encountered as they passed through them. This technique limited their "vision" to small portions of this vast and dynamic field, which extends about 40,000 miles on Earth's day side and about 110,000 miles on Earth's night side. It would be similar to attempt understanding the nature of the world's oceans from a single buoy.

Just as taking a photograph of the night sky allows astronomers to count and study millions of stars at once, images returned by the IMAGE spacecraft will provide simultaneous measurements of the

densities, energies and masses of charged particles throughout the inner magnetosphere using three-dimensional imaging techniques. "IMAGE brings to space weather studies the kind of capability that geosynchronous weather satellites have brought to surface meteorology," said Dr. Thomas Moore, IMAGE Project Scientist at NASA's Goddard Space Flight Center, Greenbelt, MD. "We may soon be treated to evening news images of plasma clouds engulfing those weather satellites."

During its two-year mission, the half-ton IMAGE spacecraft will image remote particle populations in the magnetosphere. These "photographs" will then be linked together to make movies in real time. Their rapid two-minute cadence will allow detailed study of the interaction of the solar wind with the magnetosphere and the

magnetosphere's response during a magnetic storm, which typically lasts a few days.

The total cost of the IMAGE mission, including spacecraft, launch vehicle and mission operations for the first two years is about \$154 million.

The Radio Plasma Imager antennas aboard IMAGE will extend 33 feet parallel to the spin axis and 820 feet in four directions perpendicular to the spin axis, making IMAGE the longest spacecraft currently on orbit.

The IMAGE mission press kit is available at: <ftp://ftp.hq.nasa.gov/pub/pao/presskit/2000/image.pdf> ; more information about the IMAGE mission can be found at: <http://pluto.space.swri.edu/IMAGE/> and <http://image.gsfc.nasa.gov>

Tracking the oldies via Satellite

In Japan, nearly two million elderly Japanese suffer dementia to some degree, and the problem of them "going walkabout" is a growing one.

Now, a group of companies led by Mitsui & Co. has devised a solution - track them by satellite!

The system works a bit like the emergency positioning beacons (EPIRBs) used at sea: a small transmitter is worn by

the person, or attached to his or her clothing. If they go missing, family or relatives use a portable terminal to request that the transmitter be activated, and a computerised map is displayed showing the position of the missing person.

Later this year, local governments in Tokyo and Kikuchi will test the system, which will go into service early in 2001.

(adapted from "Houston, granny is missing", Sydney Morning Herald, 31 March)

Report gives EMC Regulations thumbs up

A five year tracking study evaluating the impact of Australian Electromagnetic Compatibility (EMC) regulations was very positive, according to Australian Communications Authority (ACA) Chairman Tony Shaw.

The report showed a significant increase in industry awareness of EMC regulations since their development in 1995, and an increased acceptance of the importance for products to meet EMC standards in order to minimise disruption to communications services.

A wide range of electrical products must now carry the mark to show that they meet the standards for electromagnetic compatibility. The scheme places an emphasis on industry self-regulation, which is supported by the ACA audit program.

Supplier self-declaration and an

internationally aligned approach were consistently considered the major benefits for Australian organisations. Product improvement, improved test facilities and less interference were among the other benefits identified in the report

The ACA says it will continue to monitor and review the EMC regulations in the light of developing technologies and new international standards and equipment requirements.

For further information, see ACA Media Release No. 10 - 23 March 2000

<http://www.aca.gov.au/media/10-00.htm>

ACA launches EMR Seminars

To address public concerns about electromagnetic radiation (EMR) issues, the Australian Communications Authority (ACA) will be expanding its compliance framework to cover additional radiocommunications equipment, ACA Executive Manager of Standards and Compliance Grant Symons has said.

Australia's public exposure limits are among the strictest in the world. The standard is based on an internationally accepted limit designed to protect biological tissue from heating and electro-stimulation effects.

"Compliance arrangements with the standard aim to ease the regulatory burden on industry, and align with the Government's policy of industry self-regulation," Mr Symons said.

"In some cases, manufacturers and importers of portable radiocommunications devices, as well as licensees of transmitter installations, will be able to self-assess compliance with the standard."

Compliance with the non-occupational limits of the standard is being progressively applied to radiocommunications transmitters in accordance with a consultation process, and the establishment of an appropriate testing infrastructure.

The issue of EMR is receiving considerable public and media interest. This interest stems partly from the increasing use of radiofrequency EMR by mobile communications, but is also fuelled by the visual impact created by some mobile telephone stations.

(from ACA Media Release No. 11 - 30 March 2000, <http://www.aca.gov.au/media/2000/11-00.htm>)

Introducing Amateur Radio to Net Heads

If you've ever had trouble explaining the appeal of Amateur Radio to your Internet-enabled friends, point them at an excellent article called *How Ham Radio Works*, at <http://www.howstuffworks.com/ham-radio.htm>.

How Stuff Works, <http://www.howstuffworks.com/>

www.howstuffworks.com/ is a superb web site explaining many of the mysteries of the world, and is worth a look if you have any doubt about how just about anything works. The Amateur Radio article was written by Gary Brown K4GPB, with assistance from the ARRL and several local Amateurs.

Documents updated

The Australian Communications Authority has updated two of its documents:

- *Citizens Band Radio Service class licence document*, which may be found on their web site, at <http://www.aca.gov.au/publications/info/cbrcl.htm>
- *Amateurs Visiting Australia*, which may be found at <http://www.aca.gov.au/publications/info/visiting.htm>.

The section, "Applying for a Licence" has been amended

VKs can use AX prefix for the Games

The WIA Federal President, Peter Naish VK2BPN, has received confirmation from the Australian Communications Authority that all Australian radio amateurs may use the optional "AX" callsign prefix to commemorate the Sydney Olympic and Paralympic Games. The period during which this may be used is 15 June 2000 to 2 November 2000 inclusive.

LATE NEWS

WIA adopts new "no code" policy

The Wireless Institute of Australia at its 64th annual Federal Convention in Melbourne April 29-30 has adopted a new policy that it support an end to mandatory Morse code amateur licence testing.

In February this year the WIA adopted an "interim" policy to seek 5wpm for full HF band access.

The Australian Communications Authority in response to a WIA submission has since accepted "in principle" that 5wpm be introduced, most likely in the new few months.

In the latest development, the WIA Federal Council in considering the matter further, resolved to support the removal of Morse code testing from the ITU Radio Regulation s25.5.

The WIA will take its new policy to the IARU Region III conference in Darwin in August, when the issue of mandatory Morse code amateur licence tests will be reviewed.

The earliest opportunity to make a change to ITU RR s25.5 will be the World Radio Conference 2003.

Morse code watch, WIA Victoria, www.tbsa.com.au/~wiavic

Australian Federation Satellite won't be active on 70cm

After a lapse of more than 30 years, Australia will re-enter the space race when the Cooperative Research Centre for Satellite Systems (CRCSS) launches FedSat in late 2001.

FedSat will be launched from the island of Tanegashima, about 1000 km south west of Tokyo, by the Japanese National Space Development Agency (NASDA)

The satellite will gather data from the outer atmosphere and measure changes to the Earth's magnetic field. Project manager Jeff Kingwell says, "The interaction operation of those payloads between the Sun and the Earth will give early warnings of disruptions to communication systems. We will gather a lot more knowledge to hopefully intervene in future disruptions."

As well as the scientific and environmental payloads, the satellite will carry a CD-ROM, "time capsule", onto which will be recorded samples of Australian life in the early 21st century. For the princely sum of \$3.95 per minute, members of the public can also add their own messages for inclusion on the satellite's CD - simply ring 1902 974 001 and start talking. The money raised will fund further Australian space research.

The satellite will broadcast the CD-ROM content on its various beacons. It was this function that caused a bit of a stir in

Amateur circles, when Jeff Kingwell of CRCSS was quoted in a ZDNet article that "ham radio" equipment would be required to receive the signals.

This gave rise to some concern among Radio Amateurs, especially those who remembered the "Beat" controversy last year, when Swiss match maker Swatch attempted to promote its .Beat brand using a Sputnik replica satellite purloined from French and Russian Amateurs. Swatch was subjected to a massive international protest from Amateurs the world over, and eventually abandoned the attempt.

A phone call and a few emails resolved the FedSat confusion: by "ham radio", Jeff had meant to indicate that the satellite signals could not be received on normal domestic receivers. In fact, the nearest FedSat will get to Amateur frequencies is with its UHF beacon on 400.4 MHz.

Peter Ellis VK1KEP and Richard Murnane VK2SKY suggested that "scanner" might be a more appropriate term to use in media releases.

CRCSS is also working with the Australian Space Research Institute on

another smaller, more complex satellite and also operating joint missions with overseas space programs. Mr. Kingwell says that CRCSS "would be happy to discuss the FedSat mission with the Wireless Institute of Australia, particularly with a view to ways in which the amateur radio community could track or collect data from the satellite, or participate in educational projects."

Related links:

- CRCSS home page: <http://www.crcss.csiro.au/>
- SPIN - CRCSS Space Industry News: <http://www.crcss.csiro.au/spin/spinmain.html>
- Australian Space Research Institute: <http://www.asri.org.au/research/smallsound/Trial0699/SiZu0699FSMR.html>
- The ZDNet article that caused the concern: http://www.zdnet.com.au/zdnn/stories/zdnn_display/au0001442.html
- Swatch and the Beatnik protest: <http://www.epistolary.org/rob/swatch-protest/index.shtml>

Try This

Testing Toroidal Baluns

Graham Thornton VK3IY

All we need for these tests is a rig with a SWR meter and a dummy load. The techniques given can be used to home brew your own balun on a suck-it-and-see basis.

Firstly, we should check for sufficient primary inductance. Crank up the rig, with the dummy load connected, on the lowest frequency to be used. The SWR should be 1.0. Connect one winding of the balun across the dummy load. There should be no perceptible increase in the SWR - otherwise the balun requires more turns. (If the SWR goes off scale, the transformer has shorted turns.)

Now let us check for leakage reactance. Connect the primary of the balun to the rig and the secondary to the dummy load. The SWR should be close to 1.0 over the whole range of frequencies to be used. If it

increases noticeably at the higher frequencies, leakage reactance is excessive. (Its value may be measured by adjusting a capacitor in series with the primary to bring the SWR back to 1.0. The equivalent primary leakage reactance is numerically equal to that of the capacitance needed.)

If leakage reactance is apparent, the windings must be in more intimate contact. This usually requires the use of enameled wire, with the primary and secondary wires twisted together in bifilar mode.

In the absence of any obvious leakage reactance, the efficiency of the transformer

may be taken to be the reciprocal of the SWR with a dummy load. Thus, if the SWR is less than 1.1, the efficiency will be at least 0.9 or 90%, giving an insertion loss of no more than 0.4db. On most rigs, it will not be possible to measure SWR less than 1.1. If the SWR is 1.5, the efficiency will be 0.67 (67%), with an insertion loss of 1.8db. Thus, if we have only a barely detectable SWR, we have no worries about efficiency.

If, despite the above tests, the transformer core gets hotter than merely warm under full load, we have no choice but to increase the size of the core.

5 WPM Morse Q & A

What does the ACA "in principle" decision on Morse code licence testing mean?

By Jim Linton VK3PC

The following question and answer series reflect the anticipated change in response to the WIA's submission that amateur licence Morse code tests for full HF band access be 5wpm.

Q: I am an Intermediate licensee. Will I be able to use all of the Unrestricted licence HF power limits, modes and bands?

A: Yes. The change to the Licence Condition Determination will afford all of those operating conditions.

Q: As a Novice licensee I want to continue my program of upgrading and think I'm able to pass Morse code at 10wpm. Can I still sit the full-call code exams?

A: Yes. The Unrestricted (AOCP) licence will continue to be available. This arrangement will be reviewed following any relevant changes made at the WRC in 2002/3.

Q: I have been inactive for a few years but have held both Novice and Limited callsigns. How do the changes affect me?

A: You are already qualified for the issue of an Intermediate licence. You will of course need to apply for its issue.

Q: As an active member of my local radio club and an Intermediate licensee will I be able to fully operate the club's station which has an Unrestricted licence?

A: Yes. Intermediate licensees with a Jxx

or Kxx callsign suffix can operate club stations on all HF bands under the conditions of their licence, which will be the same as the Unrestricted licence.

Q: I hold an Intermediate callsign and want to change it. Can I?

A: It is not necessary to change your callsign. Callsigns associated with Intermediate licences are not changing. However you will still need the 10wpm qualification if you wish to qualify for an Unrestricted licence with its associated callsign.

Q: If both the Unrestricted and Intermediate classes continue, it seems there will not be many new full calls issued. Why didn't the ACA just abolish the Intermediate licence and change the Unrestricted qualification to 5 wpm?

A: The ACA did not want to do this because it believes it would require it negotiate new reciprocal licence agreements with other countries. Most other countries haven't changed to the 5 wpm qualification yet. The ACA is of the belief that if the Unrestricted qualification was changed to 5 wpm, Australian full calls might have problems getting full reciprocal licences in other countries which still require 10 wpm or its equivalent.

Q: With an overseas trip planned I wish to operate in another country. Will my

Intermediate licence be recognised?

A: The Intermediate licence will still be fully recognised in all reciprocal licensing agreements because the qualifications for it will remain the same. However, the level of spectrum access granted will probably vary from country to country depending on whether they have changed to the new 5wpm arrangements.

Q: A DX friend is qualified by passing the full grade theory plus 5wpm Morse in his country and his licence is similar to that of the new VK Intermediate licence. Can he obtain a visitors licence for use in Australia?

A: S/he can get a grade of licence that accords with a reciprocal licence agreement (if any) established between her/his country and Australia, or a grade of licence that corresponds with qualifications recognised by the ACA. S/he would need to provide ACA with evidence of the qualifications. Full details are published in the ACA information paper, "Amateurs Visiting Australia".

Q: I am Limited or Novice licence holder. What do the changes mean for me?

A: The change only affects the Intermediate licence. However it is anticipated it will encourage Limiteds and Novices to upgrade.

ar

We manufacture a comprehensive range of HF, VHF and UHF antennas, baluns, power dividers, etc. to suit your application. Some of our log periodics provide continuous coverage from 13-30 MHz including WARC frequencies and replace outdated tribanders. Now in use in 48 overseas countries.

FREE CATALOGUE AVAILABLE FROM



ATN ANTENNAS PTY LTD

A.C.N. 062 557 644

- Create rotators, coax cables & non-conducting guy & halyard materials
- Hard-drawn copper antenna wire
- Insulators for DIY projects
- Inverted vee kits 160-30m
- High gain VHF & UHF amateur, scanning & TV Antennas

- High Sierra HF mobile antennas
- Butt section triangular aluminium towers for fixed or tilt-over applications
- Selection of power chips & TX tubes
- Diamond VSWR/PWR meters to 1300 MHz & accessories

37 Morrison Street
PO Box 80, Birchip Vic, 3483
Ph: (03) 5492 2224
Fax: (03) 5492 2666

An active frame antenna for 160 metres reception

by Keith Gooley VK5OQ

The frame antenna has been around for a long time and was popular in the early days of wireless reception. I am interested in receiving the VK5WI Sunday morning broadcast originating on 160 m with better signals than I could on the Vee beam. This antenna in combination with the 160 m bandpass filter described in an earlier edition of AR and a modified AM broadcast radio does the job.

critical, enamelled or PVC insulated, thick or thin. The two ends are connected to the two stators of a dual gang capacitor. The old air-spaced type would be ideal if you have one in the junkbox but the miniature plastic insulated type would be OK as long as the two halves have the same capacitance to maintain the balance. The two FETs are in a common-source configuration with a wideband transformer coupling the drain circuit to the coax. Power for the amplifier, 12 volts at 4 mA is fed up the coax, eliminating the need for a separate power line.

There are a couple of components put in as a result of experiments in setting up the antenna. These are R8 and R9. I found the coil Q a bit high and the adjustment of the tuning capacitor a bit critical and so R8 was included to lower the Q somewhat. R9 (56 ohms) provides a good 50 ohm source impedance for the filter which is at the other end of the coax. The receiver was prone to instability without it.

Construction.

Make a wooden cross from two pieces 1200 mm long fixed together with a 75 mm square gusset plate. I used garden stakes as they are cheap and up in the air will last a long time. The gusset plate is galvanised iron. Drill five holes in each end of the cross arms to take the wire plus an extra hole where the ends of the coil will be to terminate the end of the last turn. Wind the coil keeping the wire reasonably taut so that it doesn't flap around.


The buffer can be built up on any type of

board; dead bug construction. Drew Diamond's "paddy board", matrix board or veroboard could be used. Almost any RF FET can be used. Possible types are listed on the circuit. If at all possible, select devices with approximately the same IDSS for good balance as this characteristic of most FETs varies over a wide range. (IDSS is the drain current with zero volts on the gate; ie the gate connected to the source).

The wide band transformer was wound on a 14 mm diameter potcore which had an AI value (inductance of one turn) of about 1.5 μ H. An FT50-43 toroid could be used but the primary turns should be increased to 18+18 and the secondary to 5 turns. A wide variety of cores could be used but the main criterion is that the total primary inductance (drain to drain) should be between 500 μ H and 5 mH and keeping the same turns ratio. Bifilar wind the primary, again for good balance.

I put in the 560 μ H choke in the DC supply as a precaution against interference picked-up on the coax. It could be left out along with one of the 100 nF bypasses but I chose to have it in, just in case. Any value from 10 μ H ($X_L=100$ ohms) to 1 mH would do.

The tuning gang and the buffer will have to be housed in a weather proof enclosure if the antenna is to be used outside but there is no reason for it not to work inside a house of conventional brick veneer construction. Clearly, the magnetic shielding of a galvanised iron shed will require the antenna to be outside to work well.

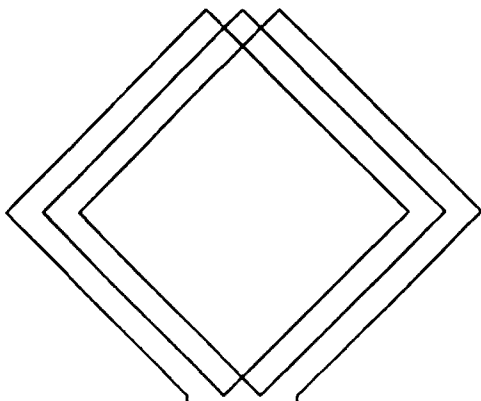


The frame antenna is basically a large coil of a few turns of wire resonated at the required frequency by a variable capacitor. Tapping into the resulting tuned circuit with, for example, a one turn link coil, inevitably lowers the Q and doing so in an unbalanced fashion makes the arrangement susceptible to pick-up of noise and interference from electric fields in the vicinity. If balance is maintained, the antenna will only respond to magnetic fields. Not that noise and interference can't be transmitted by magnetic fields, it can, but if we can reduce the reception of the electric field components we are better off.

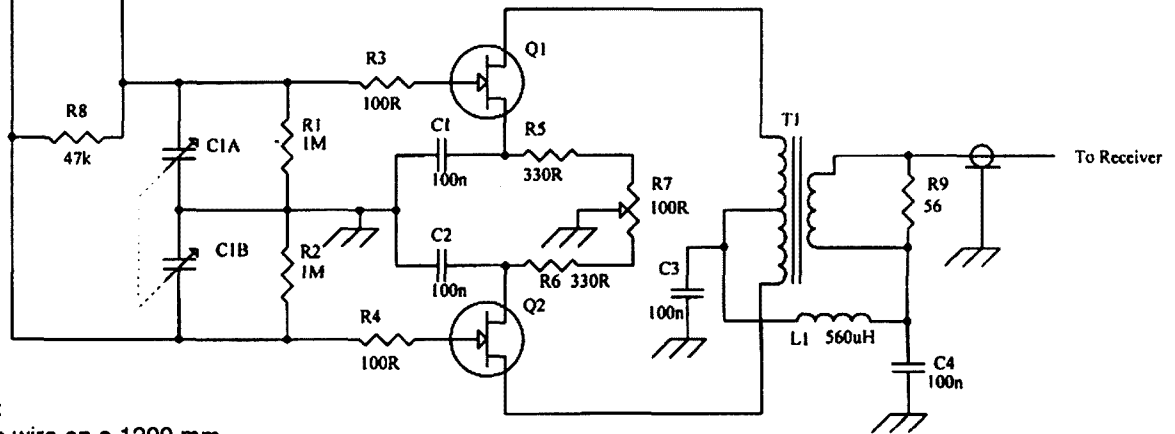
To achieve both these aims, that of high Q and good balance, a push-pull, high input impedance buffer is used between the tuned circuit and the coax line to the receiver.

Description.

My antenna consists of a square coil of 5 turns about 850 mm on the side or 1200 mm diagonal. The type of wire used is not



160m Active Loop Antenna



Antenna Loop:

5 turns hookup wire on a 1200 mm diagonal frame

Q1, Q2 : MPF102, 2N5484, 2N5485, J310, U310

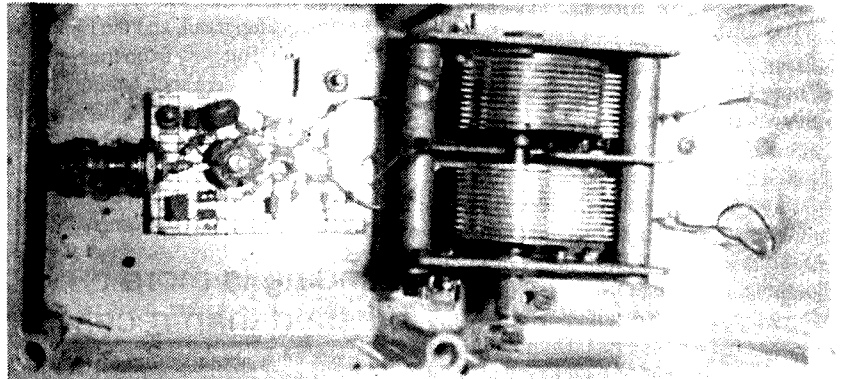
T1: 18 + 18 turns primary, 5 turns secondary on FT50-43 toroid

C1A & C1B: 300 to 400 pF per section tuning gang

Adjustment and Performance.

Before connecting the loop and tuning capacitor to the buffer, apply power to the buffer and check that there is about 0.7 volts on each FET source. Join the two inputs together and apply a signal from an antenna, transmitter on very low power or signal generator and adjust the trimpot in the source circuit for a null at the output. I measured a rejection of 58 dB with well matched FETs for common mode input signals. Applying a signal to one gate results in a voltage gain of 1/2 (-6 dB) to the 50 ohm output. This may seem a bit of a dead loss with a gain of only a half but the high Q of the loop antenna steps the voltage up considerably and the active antenna is quite sensitive.

The buffer output is fed though the bandpass filter described in an earlier AR and into a modified really cheap transistor



radio. One oscillator-mixer transistor, one in the IF and 3 in the audio. More of that in a future article perhaps.

I live 30 km as the crow flies (Crows fly?) from VK5WI and it booms in with quite good signal to noise ratio, though not as good as I would like at about 20 dB S+N/N. But it was well worth the experiment in building an antenna as venerable as the old Frame. (This was measured while VK5WI was still at Thebarton. The need for such an elaborate receive antenna for VK5 WI has been drastically reduced by the relocation to the Water Tower at Elizabeth.)

ar



Advancing Amateur Radio

So you have seriously decided to learn CW ? I'm really pleased, because I personally consider telegraphy to be a fascinating operating mode.

Conquer the BW* and get your Part II CW!



(*The **B**ludger **W**ithin)

Translated, with comments relating to Australian circumstances, by Mike Krochmal, VK3KRO from an article by Dieter Engels, DJ6TE in CQDL 8/99 (pp. 659 & 660) and 9/99 (pp. 743 & 744)

This is where you find out what awaits you during the learning of Morse code characters. Let me state right at the outset : no matter which method you have chosen to learn CW, no matter how musical you are "not" - the one and only thing you will need is endurance. Perhaps a few more comments in this regard.

Two-phase CW

The learning of the Morse code can be basically divided into two different processes :

- **Phase One** : First of all, the Morse characters must be learned, ie. their dot-dash sequence must be associated with a sound (in the case of pure dot or dash sequences, however, there is no sound), and a letter is then connected to this sequence. In this phase of learning, it is quite OK for you to jot down the characters with dots and dashes on a scribble pad. Do not let people put the fear of God into you, this will not do you any harm. In this phase, you will hear a character, you will convert this character mentally into a letter and you will write down the character. Each of these three processes requires time. The time required for thinking, however, will continue to shorten, and the writing process will accelerate.
- **Phase Two** : When all Morse characters are being recognised - regardless of how much time this takes - the second learning phase begins. I call this "getting up to speed". In this phase the only important factor is to banish the learned knowledge into the subconscious. My reason for making

that statement is this : hearing, recognising and writing must all occur at the same time if you are really to reach 12 wpm. But this will only work if the recognition process disappears into the subconscious and if your hand automatically (conditioned reflex) writes the recognised letter. The significance of this is : your hand is writing a letter, your subconscious is recognising another one, and your ears are already hearing a new one, all simultaneously. People who have learned "10 fingers blind", touch typing, know this : the eyes see the text, the fingers tap it out, and the mind goes wandering. But now from the beginning. Is there such a thing as a gift for Morse code ? Yes, I do believe there is - but there is surely nobody who could not hear at least 20 wpm. Only at speeds in excess of this does musical giftedness play a (small) role.

Sending is more blessed than receiving

And now, what about sending Morse code characters ? There is not much to explain, in words - ideally, a skilled OM should be available as teacher. But essentially, the following applies :

- Don't start sending too early. This process may accelerate the learning of the characters, but beginners usually get the pauses between words and characters totally wrong. So only start sending when you can already receive at the highest speed.
- As a matter of principle, start with a manual key and only change to an electronic key later. Reason : the Morse characters must first - as a reflex action - be converted into a body movement. This body movement

(wrist) is then "simply" re-learned as a finger movement when changing over to the E-key (electronic keyer).

- Sending with an E-key requires at least 10 to 20 hours of additional practice time. It is not enough to be able to send flawlessly at a particular speed - you should be able to master every speed between 12 and 20 wpm.
- The examiners (radio amateurs, too, and usually nice ones) have traditionally always been very tolerant when it comes to sending. So : don't panic !
- To send correctly is much more difficult than receiving - with a manual key, 18 to 20 wpm is the limit. So it is better to send slowly, but cleanly. Don't allow the "shakes" to force you into a higher speed - during the exam, there will be some quite different parts of you that will be shaking - and that will result in some ugly intermodulation interference !

Correct adjustment

Sending is only possible with the correct adjustment - of both the key and the body. Set the key pressure to about 100 gram. Don't make the stroke too short : the gap should be about the same as the thickness of two to three postcards. Grip the head of the key in such a way that the key is lifted back upwards by the fingers. The Morse characters are stored in the wrist - during slow sending, the wrist literally pounds the table ! Place both of your arms, relaxed, on the table, at an angle of about 45 degrees. This is how you send CW. Are you a Southpaw (left-handed) ? Fine, then try to send with your right hand. Write with the left - send with the right : this is the stuff that contest winners are made of. Start with the dot-dash sequences. Really ! Practise

these for so long (and again and again) until you can send such sequences without stumbling, at various speeds, for minutes at a time. Only then go on to practise the simple characters. Remember : no pauses that are too small. And don't forget to practise the error character, too - you'll probably have need for it in the exam.

CW without whistling in the ears

Headphones. Do you need a pair ? If so, then don't use the type that you have to plug into your ear. They might be OK for Pop music - but not for CW characters. But also don't use "sealed-off cans" - they'll be full of water in short order. A very ordinary set of headphones is ideal. Don't place them directly on your ears, but rather on your cheekbones. There, they won't press until they hurt, and you will surely be able to avoid tinnitus (ringing in the ears). Oh, yes, before I forget : it is a really good idea to change the pitch of your sound source every now and again. This will allow you to avoid a situation where, after a while, you are unable to distinguish trains of dits. From the start, set your receive for a character speed of 18 wpm. The overall speed can then be adjusted to approximately 6 wpm just by lengthening the spaces between characters, which you can then reduce by and by to the normal value as you proceed through the course. The advantage of this method : the characters have the right "sound" to them right from the start - and you leave yourself a bit more time to think.

Block letters are for masochists

Since we are on the topic of equipment : what to write *with*, and what to write *on* ? The answer : propelling pencil (thin HB lead) on squared paper. In the beginning, you will be unable to recognise the spaces between groups (partly because such spacing seem to last forever), but later you will find that they are easy to spot and should appear on the paper, too. By the way: spaces do not count as errors. How to write? Write in your favourite script, presumably ordinary handwriting, because by nature this will be your fastest script. Beware block letters or All Capitals : to write a capital E with a total of 4 strokes at a speed of 18 wpm borders on masochism. But try to keep it legible. In particular, watch e and l, h and k, r and v, as these often look quite similar. Had enough now ? I don't blame you - but will you forgive me if I still tell you a bit

about the difficulties which await you in the learning of the Morse code ? You just need patience - and a strong hand with your "BW". Everything else will just fall into place by itself. Why don't you spend a bit of time thinking about what nice callsign you will want ?

Problems ? What problems ?

Be brave in the face of gaps ! In the learning phase, it's quite OK to think for a while about a particular character and miss three or four others in the process. It matters not : wait for the end of the group, and then just start anew at the beginning of the next group. And when you've finished, don't compare the entire text. That just wastes time, and gains you nothing - apart from the feeling of being a failure. Just compare the last couple of groups, that's plenty ! You will know where and when you are making mistakes, anyway, even as you are writing it all down. So, for example, you will confuse letters with similar-sounding characters : s with h, b with 6, etc. That is quite normal. You will confuse letters with their mirror images : a with n, and q with y is also popular. So what ? That will settle down, with time. Numbers will initially be hell for you - but later on, they are the easiest things to receive.

Target : 18 wpm

In the second phase, the objective is speed. Try to get to 18 wpm as quickly as possible - you should increase your current speed by 2 wpm as soon as you can get more than 60 % or 70 % of the text correct. Don't argue - just do it ! Or are you trying to learn calligraphy ? But getting less than 30 % correct is no good, either - if that happens, cut back the speed temporarily by 1 wpm. You can just judge the percentages by gut feel. You do have gut feel, don't you ?

Preferably, don't keep going for more than a half hour at a time (with really short rest stops). After 10 minutes, things are going great guns, and then the effectiveness is already all downhill from there. But it's OK to receive for a half hour at a time, five times a day - the more often, the better. If possible, do two receive sessions a day, but at least one. And be warned : to learn only one hour of CW per week means that in ten years' time, you will still not be ready to register for the exam. If possible, don't receive with the headphones. Play some quiet music in the background; especially music that you are familiar with. Doing this will accelerate the shift of the Morse code

characters into the subconscious - that was our objective, remember ? Allow yourself "rewards" when things have gone exceptionally well. And once again : make sure that you get to 18 wpm as quickly as possible. (If nothing else, you will hear three times as many characters in a given time at that speed as at 6 wpm, so the learning effect will triple !)

Plain text - a hurdle

Amateur radio texts, groups, plain text ? Predominantly letter-groups of five - because these contain all the letters. Every now and then, when you feel that you can handle defeat - plain text. But have a listen to number-groups and amateur text, too. And don't totally forget the punctuation characters; you don't have to practise ar and ka, they are not counted as errors. (ka is the operating character that will cause you to shake, and the sweat to run down your back. ar is the character which causes you to let the pencil slip from your stiff fingers, and your lungs to once again fill with air at long last).

There are two particular hurdles that you will ram your head against. Be clever - run around them ! Do you still remember : hearing - thinking - writing ? That works up to 8 or 10 wpm - depending on how fast you can write. At 12 wpm at the latest, you will start to have problems : the (still too long !) space is no longer long enough for thinking and writing. Now the trick is to hear and write at the same time, or to hear and think at the same time. Not to worry : the problem will go away of its own accord. And then, 2 or 4 wpm higher, there is yet another similar hurdle. Because now you will really have to do everything at the same time, because the spaces have become nearly normal. To deal with these two hurdles is essential, and the only thing that will help here, purely and simply, is endurance. If you manage these hurdles, then "Class 1" is as good as yours. In that case, you could soon even receive 20 or 22 wpm. Talent and a musical sense are by far not the issue at 18 wpm. Please do believe me at last !

Now let's get up to speed

If you have arrived at 18 wpm, then slowly start to concentrate on avoiding errors. Don't think about missing letters any more, but just leave them out. In the case of unfavourable combinations, such as the group "essen", you will fabricate real "error groups". Have a good laugh. In the meantime, the groups of five should be

continued next page

continued from previous page

neatly arranged, so that missing characters are obvious at a glance. Even now, you should restrict corrections to the last ten characters, because you can work on the assumption that a letter which has been written down is probably correct. (Unfortunately this only works to some extent for s and h, hi !). On the other hand, a healthy dose of skepticism is in order if, for instance, you have not heard a y for hours. Now and again you should go back to 12 wpm and count the errors properly. Don't register for the exam until you can receive 12 wpm for 3 minutes in the "normal" manner without errors. Corrections after writing are permitted !

You should also set 12 wpm without the extended spaces (ie. slow characters), and write to keep up. Because there have been times when tests were carried out using such "rotten" Morse characters. These slow characters are initially really difficult to receive, but after some acoustic familiarisation they should not present a problem. That is because after your training at 18 wpm, you are no longer relying on the long spaces. And don't worry too much about the punctuation characters, because you can often add them afterwards "by instinct". But remember the slash which can occur in callsigns. And the equal sign or double dash bt is also relatively important, but is fairly easy to receive. You will be able to receive plain text without errors only if you are able to retain a few letters in your head and write them down later. You could try some groups of five with mixed numbers and letters. Because that's what callsigns look like. But the result will be that you not only confuse s with h, but also h with 5, v with 4, etc. But even this will solve itself with time !

No experiments

Please save yourself such extravagances as "the receiving of words in the mind" and the "listening to the short wave bands". You are, after all, not practising for real life, but for the exam. That's the reality, isn't it ? In the case of "hearing in the head", there is a whole other mechanism at play - you will have no use for this in the exam. (And if, after the exam, you really do continue with CW, then the "hearing in the head" will come of its own accord). By the way : the "hearing in the head" is a legitimate way to break the ice in a Morse code course - but it's no more than that ! Yes, and why not listen to the short wave bands ? The answer is simple : wasted time. One hour of effort for perhaps 5 minutes of usable live Morse characters.

Well, my friend, that's about the end of my tips. Perhaps I was able to reply to one or two questions - before they were even asked. I hope that you will learn the Morse code without major difficulties.

Translator's comments by Mike, VK3KRO :

The above article has been translated verbatim from the German original text, so as not to destroy the meaning. Some additional comments follow.

- We are very lucky here in Australia, even under current conditions (though I know that there will be those who beg to differ) : to obtain our full licence (AOCP) we need only demonstrate proficiency at 10 wpm, in contrast with many other countries which demand 12 wpm and even higher for various licence grades. However, for those of us who are suckers for punishment, I believe that certification at higher speeds is available on demand in Australia.
- Note on Pocket Tweeters : 400 DM to 500 DM for the Swiss unit is near enough to A\$ 400 to A\$ 500, which seems a lot. The MFJ-418 unit mentioned in the article is available locally from Strictly Ham (and possibly others) for about A\$ 180.
- I'm sure that I have seen, published somewhere in a magazine, a project for home-brewing one of these Morse tutors, but can't locate it. Perhaps some kind reader can write to the Editor and let everybody know.
- There is an article (title : "Using PIC Microcontrollers in Amateur Radio Projects") showing how to build a simple Morse code practice oscillator using a PIC chip in QST for October 1998, on pages 34 to 40. I don't want to be unkind, but it beats me how (except for learning about PICs) this is better than a piezo buzzer with a battery for a total cost of a couple of bucks !
- Some of the local radio clubs do run CW lessons, but when I checked "Club Corner" in AR and the other magazine, there were no ads to be seen. In my humble opinion, clubs are their own worst enemies by not using these media to their best advantage.
- Good old Len VK3COD has been doing an amazing job for nearly 20 years, turning up on air night after night, running code and patiently listening to callbacks. Well done, Len !

In case you don't know where to find him : 28.340 MHz and 147.425 MHz, every week night at 1030 UTC. There's also the VK3RCW continuous Morse code beacon on 145.650 MHz, which transmits 5 wpm and 10 wpm code. And there are slow Morse groups, especially on 80 metres.

- Readers may like to check out the ham links page on my web site : the URL is www.autoscan.com.au/~autoscan/ham.html
- Five particularly wonderful programs are :
"The Mill", by Jim Farring, W4FOK (see www.morsum.dem.on.co.uk/learners.html)
"Supermorse" by Lee Murrah, WD5CID
"Numorse" by A. Lacy, G4AUD
"MRX" by John Samin, VK1EME (Check out www.mrx.com.au)
"Morsecat" by Gerald DK5CI (freeware !)
I'm sure there are lots of others. Try a search engine, using the search string : + "Morse code" + "training", or something along those lines.
- Great book : "The Art and Skill of Radio-Telegraphy", by William G. Pierpont, N0HFF, available at : www.joates.demon.co.uk/megs/N0HFF/index.htm
- Various links at Morsum Magnificat (last updated 19 August 1998, the magazine, once a beacon of the CW world, is now possibly defunct): www.morsum.dem.on.co.uk/learners.html
(Has a link to "The Mill", and to a bunch of other Morse learning programs)
- For suckers for punishment, check out my personal comments on Morse code on my web site: www.autoscan.com.au/~autoscan/ham.html
The paragraph about the code is headed "The Dreaded Diddli-Dahs"
- For those who really want to get into this, there is a web site that automatically translates text to Morse and Morse to text : <http://www.soton.ac.uk/~scp93ch/refer/morseform.html>
- Version 8.0 of Ralph Taggart WB8DQT's program is now out : <http://taggart.glg.msu.edu/wb8dqt/cwpage.htm>

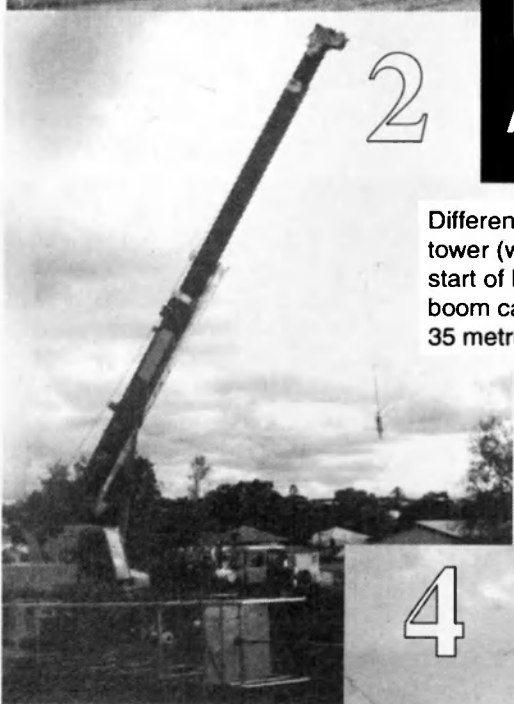
ar



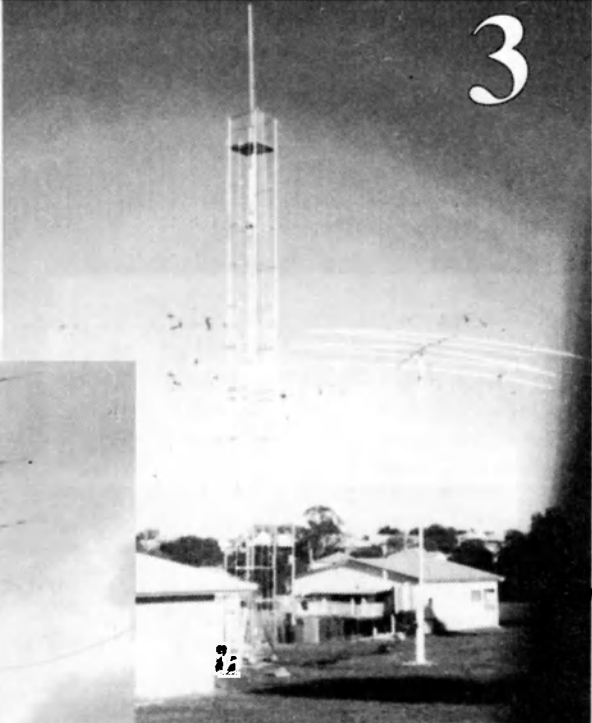
News tower on the ground, about to be hoisted into position by a hired crane

Evolution of an Antenna Farm

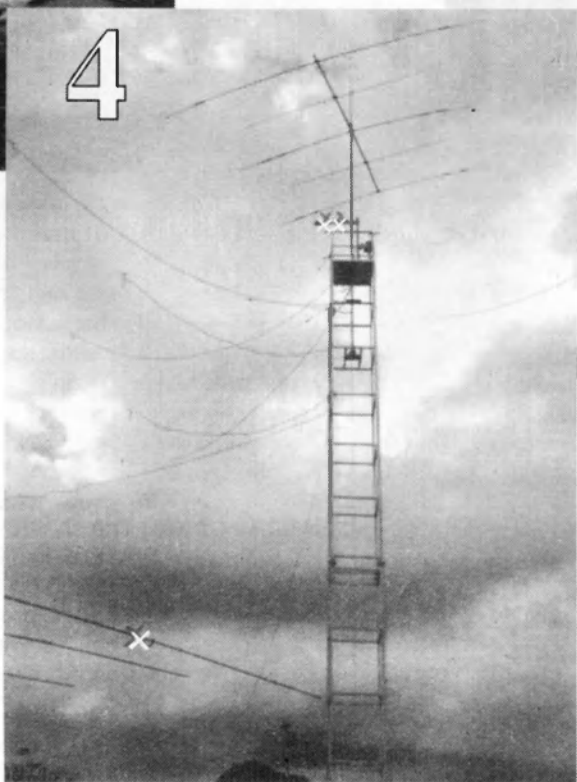
by Bernie Witjes VK4BTF, 9 Hanley Lane, Morgan 4065



Different angle on the tower (weight 1800kg) at start of lift. The crane boom can lift to a height of 35 metres



Tower in position to receive to 20 metre boom. Height to the top is 26 metres. Eventually a lift will be installed to facilitate maintenance at the top



One beam (marked X) in tune up position near ground. Another beam is in position at top. The cross arm (marked XX) near top is a small crane for hoisting beams in position. Sundry wire dipoles have been accentuated in the photograph. These will be discarded as beams are installed for all bands.

continued next page

5

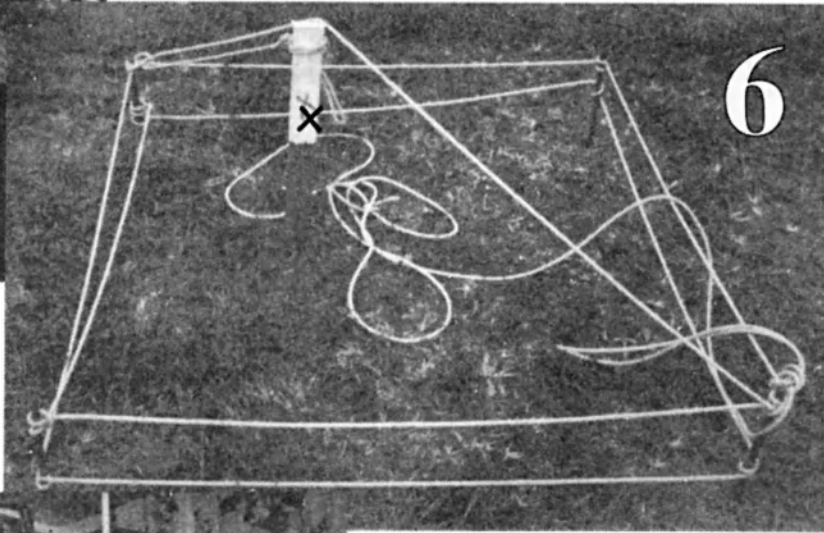
Evolution of an Antenna Farm

continued from previous page

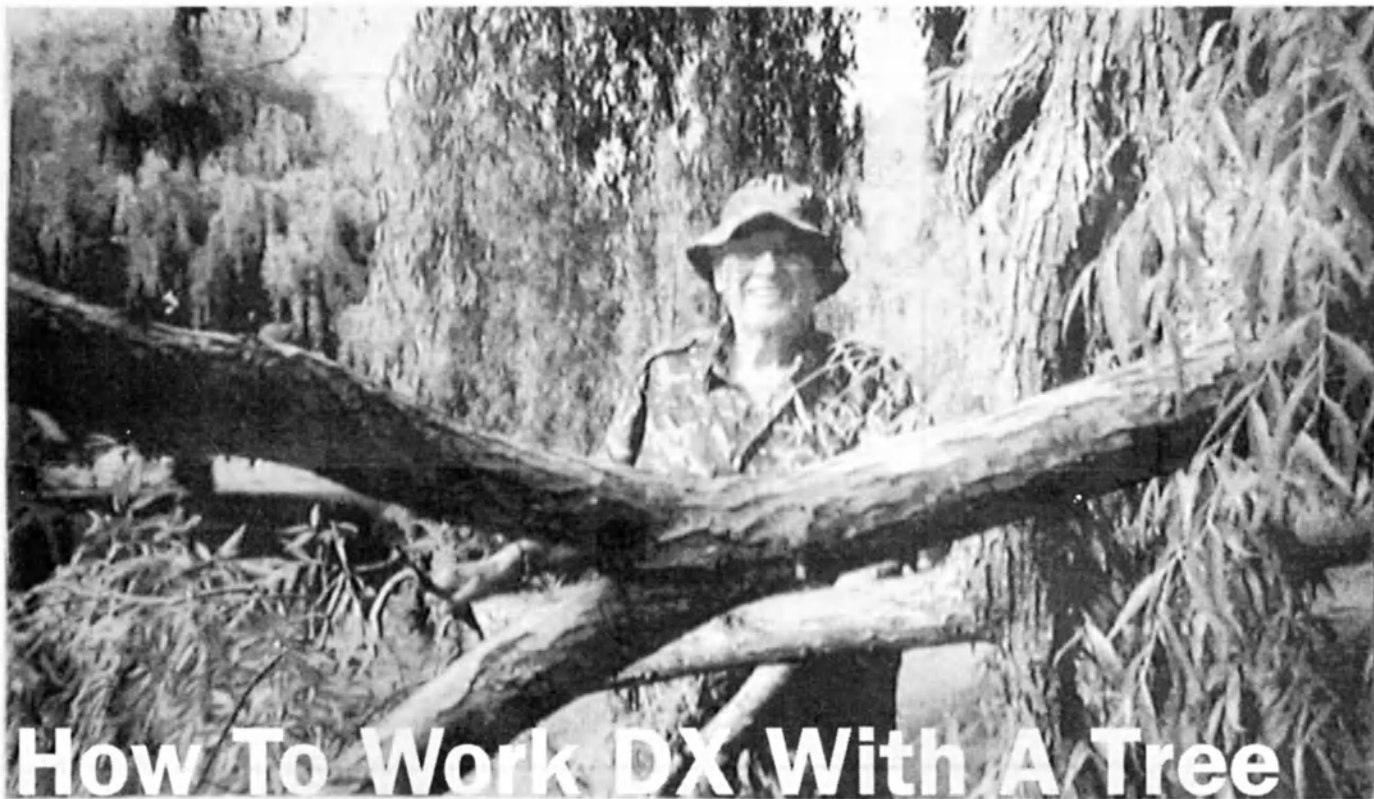
Stacked tri-banders installed for 10, 15 and 20 metres. A 40 metre 3 element beam is planned on a separate tower. All towers are home brew.



Position by satellite



The shack. A TS850S into AL80B linear. Also a FT2200 on 2m. FT one and FT101E are in the picture. The shack and shelving is home brew.



How To Work DX With A Tree

Ernest H Sloman VK2BUE ex ZB1AI

I am working DX on a gum tree. Arthur Andrews VK2AAE aroused my interest with his article in September 1998 Radio and Communications on Arboreal Antennas. There are a lot of interesting facts in his two page article. The most informative being the sketch of the cross section of a tree trunk showing the various areas through to the heart of it, at the centre.

After reading his article several times I started thinking. I've got to find a tree that resonates to the twenty metre band. Twenty metres is a well used band and at about 1700 local time on 14.017 MHz F8AH is calling CQ LP on CW almost daily at RST 599.

It turned out to be a very good choice. At the west end of my shack grows a mature Cootamundra Wattle. Its trunk is almost 10 metres long well over the roof of my shack. I inserted a long thick self tapper into the trunk at 2 metres above ground. I connected the inner of a 50 Ohm coax to the self tapper with the outer connected by a length of braid connected to a metal spike driven into the ground at the base of the tree. A check with a DX200 communications receiver found maximum noise and signals in the 20 metre band. I then connected the coax to the input of an FC700 ATU which was connected to the input of the FC757 automatic ATU feeding my FT757GX.

The FC700 was used as an antenna tuning unit feeding the automatic FC757 tuner which was used to make sure the SWR was within the safe operating range of the

FT757GX. Later I was able to use only the FC700 direct to the FT757 to achieve a suitable match.

The FC700 was adjusted to give maximum received noise at 14.017 MHz and the transceiver was tuned to a signal close to the frequency. Adjustment was then made for best received signal with the FC700 but with the auto tuner switched out of circuit. The tree antenna is now resonated to 14 MHz. The FC757 auto tuner is then brought into circuit in series with the FC700. With about 10 watts drive the auto tuner is used to achieve a match indicated by the two green lights. Now the full 100 watts can be run. With all units indicating 100 watts the SWR was 1.4:1 which was much better than I expected. I tuned to 14.017 ready for the French station to make his almost daily call call on long path in the late afternoon.

On 5th October 1998 at approx 0700 UCT F8AH calling CQ LP answered my first tree call. Signals were RST 539 QSB 339 and we made a complete QSO and exchanged QSL cards direct. Conditions on

14 MHz were fairly good and the band just opened up.

Having proved that a tree can work DX under fair conditions especially when the tree is an acacia type with a trunk that curves over the top of my shack that has a corrugated metal roof, not really ideal conditions, I think John Williams would like it, I decided to find a better situation. I have 4 gum trees in my garden all of them on the remote side of the shack. The nearest one is a Wallangarra white gum, a monster with a huge trunk and lots of foliage. So I put a piece of wood into a large wheelbarrow, put my standby FT101E onto the wood and took my FC700 ATU and the longest screw in probe I could find. This was a large ceiling hook. For power I used an extension lead from the shack.

The tree trunk was enormous so I got a step ladder and managed to get the probe screwed into the lowest bough about 4 metres up. I connected the coax braid to the metal wheelbarrow. I set up the FT101E and the FC700 and found the system resonated

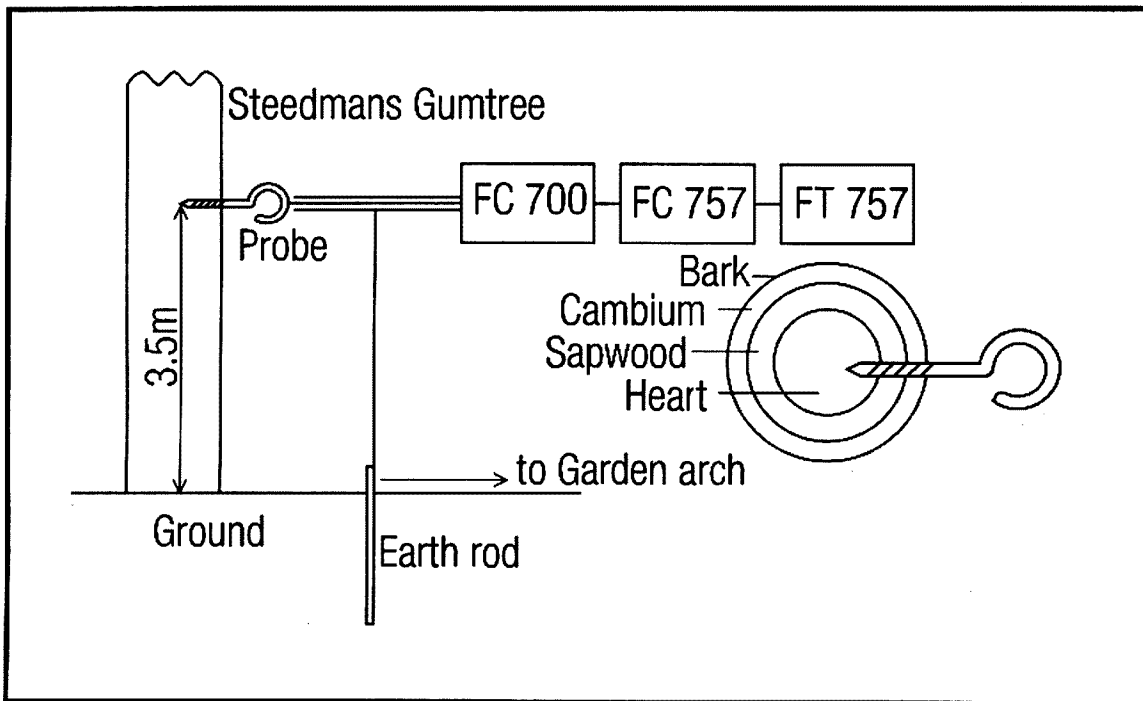
continued next page

to 80 metres. I then QRV'd for a while with quite a good SWR and VK2MAI in Wauchope heard my signal on 3.528 MHz. Now the point is I want to find a tree that resonates to 14 MHz. Well I struck lucky. About 4 metres from my front verandah a Steedmans gum tree grows which my XYL planted about 40 years ago. It has a long trunk with a kind of delta formation of branches at the top. Now according to VK2AAE's diagram of the cross section of a tree bole it is obvious that that a probe has to go right through the sap into the heart of the bole.

I went to the hardware store and found exactly what I wanted - a probe with a screw section that would suit my purpose. The length of the screw section equals the radius of the tree trunk. The round flange ensures the probe is into the tree heart when fully screwed in. It is stainless steel and a really solid job. It is no good putting the probe into the base of the tree. I screwed it in 3.5 metres above the ground.

The next problem was to connect the FT757 rig to the probe via a long length of 50 Ohm coax right across the roof of the house and connect to the probe with a very strong clamp. The earth lead was 3.5 metres long connected to a metal spike at the base of the tree. I loaded up the FT757 and the FC700 and to my delight the tree was OK for 20 metres. I made a CQ DX call and back came HB9KAR giving me RST 539. Then DL5FCZ gave RST 549. I then decided to set up the FT757 rig and the FC700 on the front verandah which must be in a better situation reducing the coax feeder to about 4 metres. Using the new set up I got RST 559 from RW3XW, F6CEL, and F0GPT. I was still dissatisfied.

I mounted a 2 way coax switch and erected a three quarter wavelength sloper so that I could switch from the wire antenna to the tree antenna. I reckoned that my ultimate success depended on a really good earthing



system. I connected braid in parallel with the earthing spike to a large stainless steel garden arch adjacent to the tree. This required a hole to be drilled in one leg of the arch for an attachment screw. The four legs of the arch were strapped together. To my delight the signals went up a couple of strengths. I carefully set up the 757 and FC700 for minimum SWR of 1.3:1. I called CQ and ZL1AW gave me RST579. Then VK7CW gave me RST 599. During the QSO with one of these stations I reduced my output to 10 Watts and still got 559. 20 metres was not yet open for DX. Later in the afternoon I went for DX contacts and the results were pretty good. JA7XGI/P RST 559, T32VU RST559, TI2OY RST 559, IK5ALZ RST 559, and F8AH RST 579. I compared the tree with the three quarter wave sloper and found that the strength only improved 5I. That's good enough because the tree acts as a vertical antenna. I checked the radiation pattern with a field strength meter and got a circular pattern pretty average except to the east. There is my corrugated iron roof west of the tree so I took no notice of that.

On 4th February 1999 I QSO'd with DJ7AA who gave me RST 559 whereas I gave him RST 569. I have decided to use the tree as a permanent facility. The sloper remains as a useful addition and can be used on other bands.

Important details about the probe. First of all determine its exact length as follows. Measure the circumference of the tree trunk exactly where the probe is to be screwed in. Then work out the radius. This will give you the length of the probe. Screw the probe in at 3.5 metres height but not fully. This is very important.

The probe must not go through the exact centre of the trunk but remain a small distance back. The probe is not right through the centre. I use a large stainless steel alligator clamp to connect to the probe which is 8 mm in diameter. Any hardware store stocks these probes and it is the screw in part which must equal the trunk radius. I removed the auto ATU from circuit feeding the tree using only the FC700 ATU and the FT757GX and it works perfectly. My log reads 2 pages of DX QSO's. Also during my experiments I asked VK4RAN to listen for me on 7.022 MHz and he could not hear my signals yet he could hear me on the helical I have connected to the FT101E sitting next to the FT757GX and I reckon there was proof enough there that a tree has a resonant frequency. The only other consideration is that a tree is a calm weather antenna so don't expect it to perform efficiently in the pouring rain or when a strong wind is blowing.

ar



Christine Taylor VK5CTY ALARA Publicity Officer
16 Fairmont Avenue, Black Forest SA 503
Packet: VK5CTY@VK5TTY email: geensee@picknowl.com.au

Olympic countdown

Great news on 5WPM

Have you heard the great news about the new agreement between the WIA and the ACA with regard to the Morse Code requirements?

Before the Sydney Olympics it will be official that current holders of a Provisional Amateur Operator's Licence will be permitted to use all the bands and conditions now only allowed to holders of an Unrestricted Amateur Operator's Licence.

This means that more people (and more YL operators) will be able to operate on the HF bands.

With so many overseas visitors coming and planning to come to Australia for the Sydney 2000 Olympics why not pass the good news to everyone you talk to on the HF bands now that soon you will be able to operate anywhere within the amateur bands. It will make the whole system more user friendly.

The members of all the committees who have worked to make this change possible should be congratulated and thanked by us all.

For ALARA it will make our regular Monday night and committee nets easier if it allows us to use the upper section of 80 metres which are less populated simply because they are not available to everyone. With propagation so variable from one end of Australia perhaps there we will be able to find frequencies which do not suffer from so much interference from overseas commercial stations especially in summer.

Particularly the VK4 girls have a real struggle to hear the Southern states in summer because of strong commercial stations near the frequencies we are forced to use now. It is considerably to their credit that these girls continue to try to join the Net so regularly.

Thank you.

ALARA'S involvement in The John Moyle Memorial Field Day

This year again AHARS participated in the John Moyle Contest and again the VK5 girls

who are also members of AHARS played their part.

Tina VK5TMC and Christine VK5CTY were there for the whole weekend with Leslie XYL of Hans VK5YX and Meg VK5YG was there for most of Saturday.

While the YLs were largely involved in feeding the operators at regular intervals they also picked up the microphone from time to time. Tina was even keen enough to get up in the wee small hours and put out some calls in the hopes that there were some other night owls listening. I believe she made three or four contacts all of which count.

International YL2000 in Hamilton NZ.

By now you will have paid you deposits but you may still be trying to decide whether or not to go on one or more of the tours. Some information supplied by Deb VK5JT after her trip to New Zealand at Christmas time may help you decide.

Deb found the Hula falls and the Waitomo caves some of the highlights and she loved the hot springs area of Rotorua. She didn't go on a four day tour of the Bay of Islands as is being offered in October but she enjoyed the one day cruise she did do. She says she saw Moturoa, Black (volcanic) Rocks, Oihi bay, Motuarohia (or Robertson) Island, Motukiekie, Otehei Bay and much more, including delivering mail to several islands and still had time for a long picnic lunch on Urapukapuka Island which has several high points which afford spectacular views across the water. It all sounds lovely.

We are told that reciprocal licences can be obtained by visiting licensees so if you take even a handheld you should be able to 'meet' some of the locals on the 2 metre repeaters.

For the Auckland area this is 146.900MHz where a regular net is run on Sunday evenings at 7.00pm local time.

As the time approaches more information will be included in these notes.

More Olympic news

YLs who have postcodes in the Sydney area may find they are being chased on the radio during the latter half of Year 2000.

ALARA members in the defined postcode area are:

VK2AMJ Marjorie, VK2DB Dot, VK2HLF Fran, VK2INZ Nina, VK2PXS Bobby, VK2YL Norma and VK3AYL Rae.

Also keep an ear open for VK2TC Wendy postcode 2157.

Sydney Gold - The Gathering Of The Nations Award

Members are encouraged to gain this award. Details are on page 45.

The VKDX Association offers this award to all stations in and out of Sydney who can make 30 contacts with Sydney stations during the last six months of this year, 2000.

The Sydney area is defined as in the following postcodes: 2000-2249 2560-2570 2745-2770

The award is issued in three levels:-

Gold for contacts on three or more bands
Silver for contacts on two or more bands
Bronze for contacts on one band.

All bands and modes may be used.

Repeat contacts with one station cannot be made in less than 24 hours.

Repeaters may be used.

Applications for the award and proof of contacts are by General Certification Rules.

Details should show: callsign of the station worked, band, mode, signal report and postcode, UTC time and date.

Two licensed amateurs are to certify that the log extract is correct.

To claim the award, send details with \$10 to

The Secretary,
VKDX Association
P O Box 299
RYDE NSW 2112

If you need further information please write to John VK2DEJ at the above address or phone 9809 5686

ar

LF Receiving Converter with Loop-stick Antenna

Drew Diamond, VK3XU
45 Gatters Rd.,
Wonga Park, 3115.

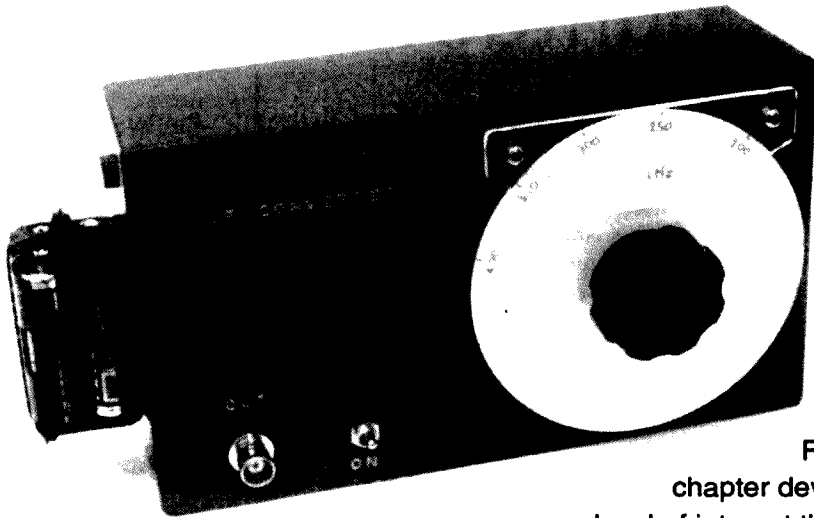


Photo 1: External view

Interest in LF techniques appears to be gaining momentum. Specially licensed experimenters have been transmitting LF test signals in our region, and Amateurs in some European countries have had access to an LF allocation for a few years now. Indeed, the latest

RSGB Handbook now has a substantial chapter devoted to LF, which perhaps indicates the level of interest there.

As with any radio work, it is necessary to gain some preliminary understanding of propagation by listening for stations on that band. Signals from amateur/experimental transmitters are generally much weaker than the navigation beacons there. In addition, electrical noise, even in a leafy residential suburb can be very high. Unfortunately, LF band performance on some general coverage receivers may prove inadequate for serious listening. A simple wire antenna will bring in many of the beacons, along with a galaxy of noise spurs from electrical appliances in the neighbourhood. Unless the receiver has a very remarkable IF filter, and/or some pretty fancy signal processing, it will be very difficult to wrinkle out weak signals.

One of the simplest, and most effective tools in our fight against noise is the loop antenna. Traditionally, a timber (or plastic) frame of perhaps 0.8 square metre, is wound with insulated copper wire, the inductance of which is capacitively resonated, and coupled to the receiver's input. The frame loop has a sharp null running through the axis of the loop, which often allows interfering noise to be placed in the null without serious loss of the wanted signal (see Refs. 5, 7, 8).

However, because of size, the frame loop may be awkward in some circumstances, and is not particularly portable. A reasonable alternative is to use a much smaller ferrite-rod "loop-stick" antenna.

Although not as sensitive as the frame (smaller area, therefore more RF gain required), similar nulls are obtained off the ends of the rod.

The following converter circuit is offered as a simple device that gives listening access to the LF region. A reasonably sensitive and selective shielded HF receiver which tunes the 3, 4, 5, or 6 MHz bands is required as "tunable IF". In operation, the device is remarkably sensitive, and should prove quite satisfactory for reception of amateur signals in the happy event that in due course we obtain an LF band allocation (see Ref. 4 for an excellent source of LF information). Whatever the outcome, the converter allows you to observe propagation characteristics in the 140 to 400 kHz region.

Circuit

See Fig. 1. A high Q coil, wound upon a ferrite rod, couples into the magnetic field component of incoming signals. When the inductance of the coil is resonated at the frequency of the signal, an RF voltage is presented to the high impedance gate of the MPF102 FET amplifier. The 100 pF capacitor is included to by-pass any strong TV signals which may be present.

The amplified signal at the drain is applied to one input port of an NE602 (or SA602 or NE612) Gilbert-cell mixer. An internal crystal-controlled oscillator of 3, 4, 5 or 6 MHz translates the LF band up to a corresponding HF band. For example, when

using a 3 MHz oscillator crystal, a signal on 177 kHz will appear on 3.177 MHz (these round-number crystals are available from several of the electronics suppliers as cheap, standard, computer types). IF output signal appearing at pins 4 and 5 is coupled to the tuneable IF receiver via broadband impedance matching transformer T1.

Construction

A suggested construction method is depicted in Photo 1, which shows the prototype housed in a plastic jiffy box measuring 197 x 113 x 63 mm. These are obtainable from several of the electronics merchants. The ferrite rod measures 10 mm dia x 200 mm long (see Parts below). Wind on 165 turns of #24 B&S (0.5 mm) e.c.w. Start and end may be held in place with masking tape. The rod is installed lengthwise in the box, which is drilled exactly rod diameter each side, and held captive with a blob of epoxy cement at each end. Remember to allow for interference-free operation of the variable capacitor.

The variable capacitor is an ordinary two-gang 450 pF per section broadcast type, salvaged from an Australian BC valve set (for years I had believed that these were 415 pF, but most in my junk-box measure about 450 pF). They are not rare items, and may be found at ham-fests, or swapped from radio mates. Make a suitable cursor and dial/knob for the frequency scale.

continued next page

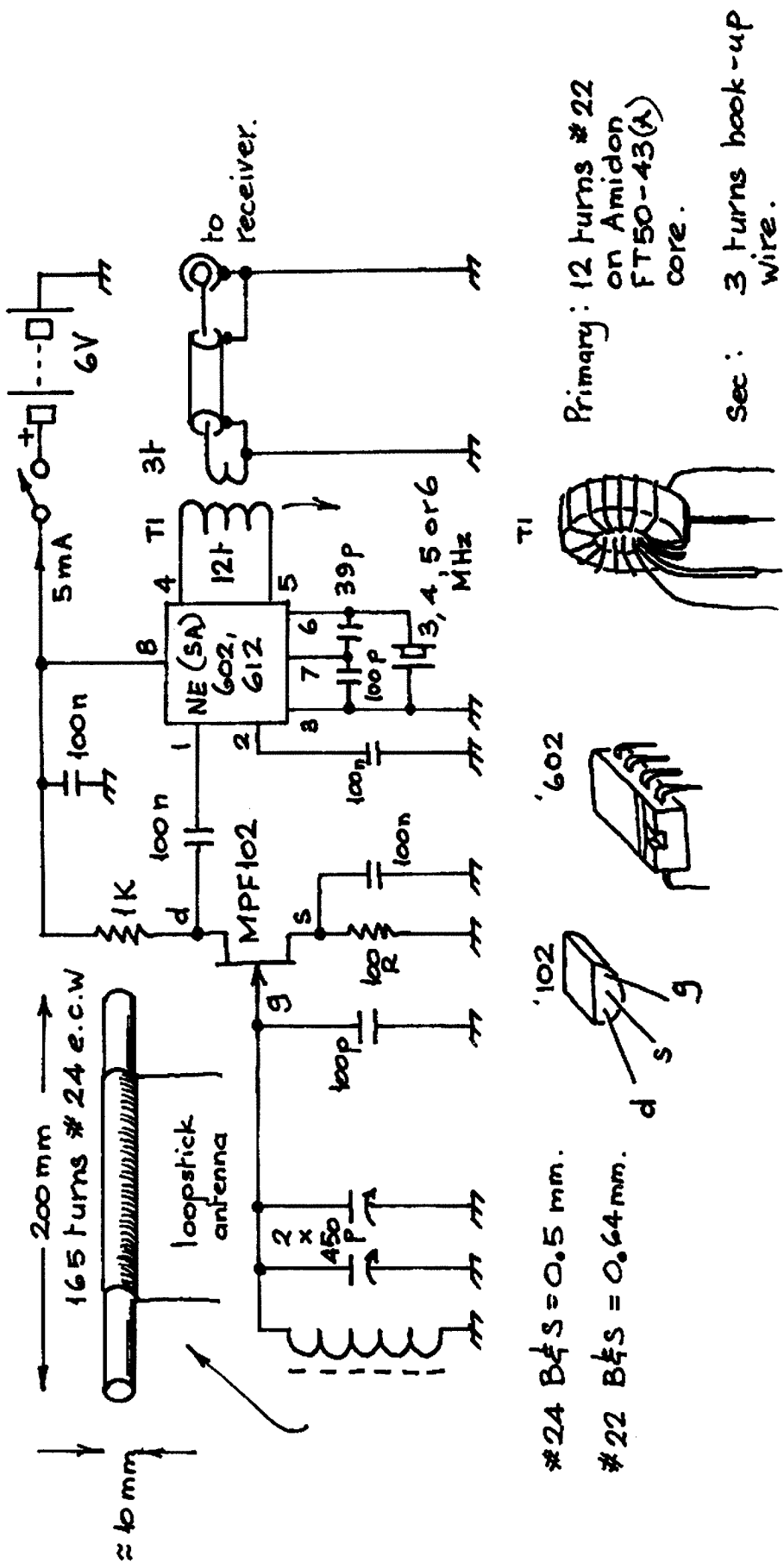


Figure 1: LF Receiving Converter with Loopstick Antenna

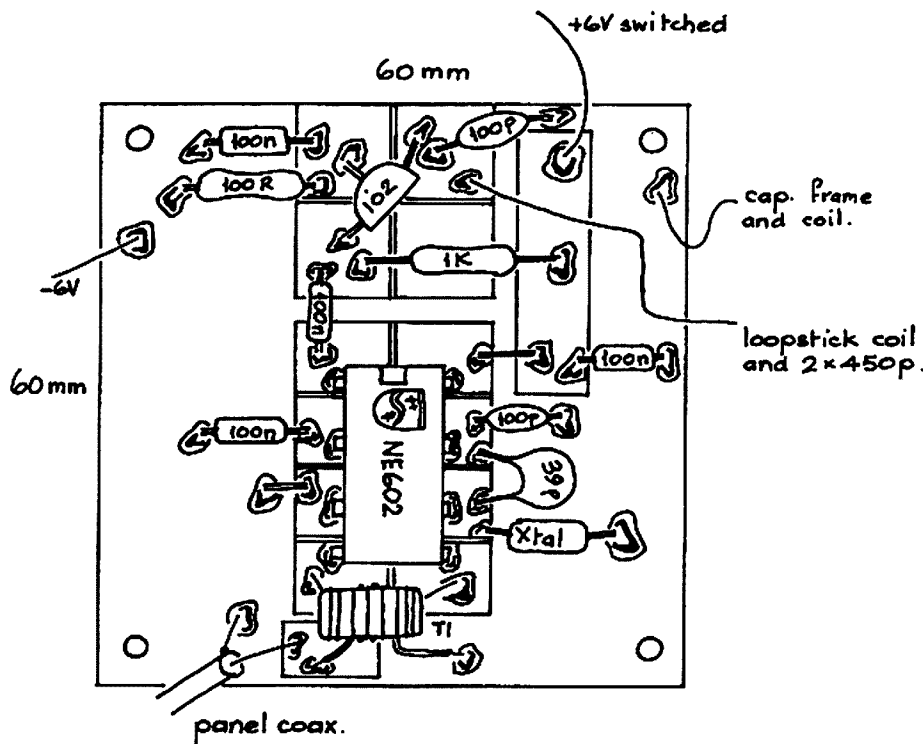


Figure 2: Board Layout

continued from previous page

The circuit is accommodated upon a paddyboard (see Ref. 10), and a suggested layout is shown in Fig. 2. The NE602 is fitted into an 8-pin wire-wrap IC socket (pins gently flared) which in turn is soldered to a substrate board. But any other method that you favour should work, provided that signal connections are kept reasonably short. A battery of four type AA cells in a four cell holder is affixed to the outside of the box with cable ties. Battery switch and output connector are fitted into the front panel.

Operation

Check all wiring and component connections. Connect the converter output to your receiver input using a suitable coax cable, and set the receiver to the appropriate band. Switch on. Tune the receiver to crystal plus about 250 kHz. Adjustment of the variable capacitor should cause a strong sharp peak in noise as the loop-stick is resonated. Search the band for signals, re-peaking as you go. When one is found (probably a navigation beacon with AM

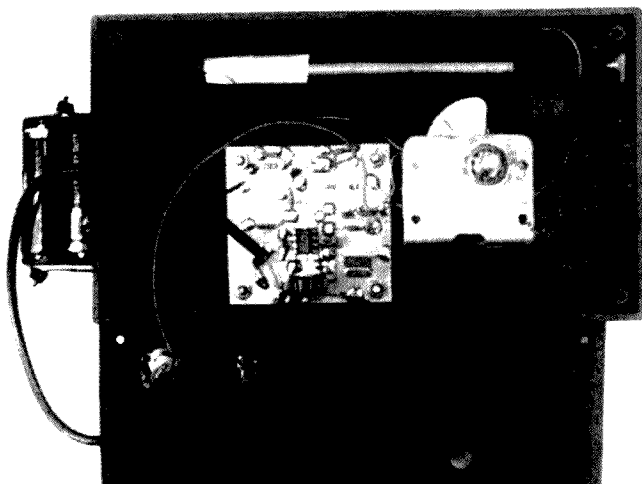


Photo 2: Internal View

Morse call-sign), peak the converter capacitor for maximum response. The setup should sound "lively", there typically being many beacons found. Their call-signs give a clue to locality. Here near Melbourne for instance, in addition to the local signals, I can easily hear FLI Flinders Island, BHI (Broken Hill), DVO (Devonport) and SMI (Smithfield) airfield beacons. Amateur/experimental transmissions have recently been made from AX2TAR in Moonah, Tasmania on 176.5 kHz. Listen also for ZL signals on about 177 kHz.

Local signal strengths are remarkably constant, and vary little from day to night. At night the back-ground static noise level increases significantly, sometimes making it difficult to hear weak signals. If interference is experienced on a particular frequency, rotate the converter box to place the interfering source in the sharp null.

Parts

Most of the components are available from the familiar merchants such as Altronics, Dick Smiths, Electronic World and Jaycar. NE(SA)602 chip and 10 x 200 mm long ferrite-rod (other suppliers may have something similar) are available from Electronics world (ph 03 9723 3860- will answer mail orders).

References and Further Information

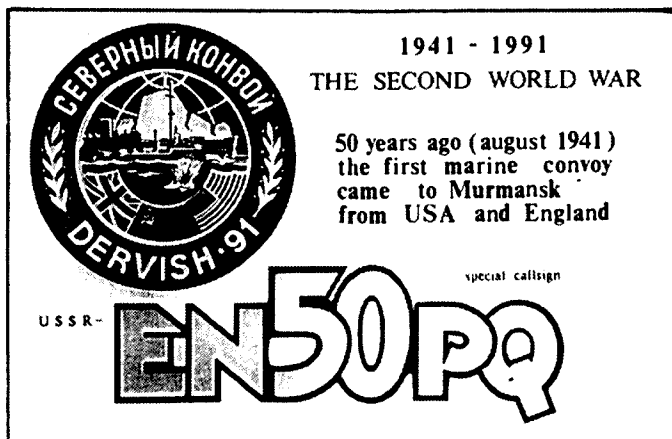
1. Radio Communication Handbook, 7th edition (Ch 7); RSGB.
2. The LF Experimenter's Sourcebook: Dodd, G3LDO (Ed.); RSGB.
3. Secrets of RF Circuit Design; Carr; TAB Books (from DSE).
4. VK2ZTO's LF Home Page, check out; <http://www.zeta.org.au/~ollaneg/aussiel.f.htm>.
5. "Around the Loop"; Marris, G2BZQ, Prac. Wireless (PW) May '95.
6. "A Ferrite-loop Converter for 150 to 500 kHz"; Marris, Short Wave Mag. June '96.
7. "PW Helta- An Experimental Loop Antenna"; Marris, PW Feb. '96.
8. "Small Loop Antennas for MW, LF and VLF Pt 1 & 2"; Carr, Elektor June/July '94.
9. "External Ferrite Aerial Unit for SW, MW and LW Radio"; Marris, Elektor May '93.
10. Paddyboard Circuit Construction" Diamond, AR Feb. '95.

QSLs from Russia and England

Ken Matchett VK3TL
Honorary Curator
4 Sunrise Hill Road
Montrose 3765

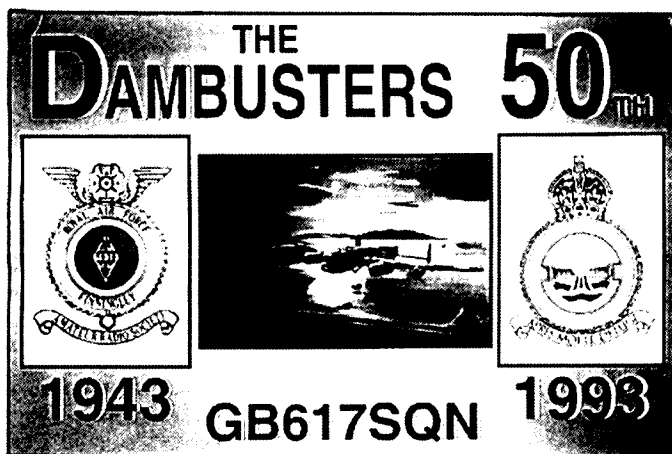
EN50PQ

This QSL card from European Russia, courtesy of the Polar Club amateur radio station UZ1ZZZ in Murmansk celebrated the first of many naval convoys carrying vital war supplies to the port of Murmansk, an ice free port and the largest city north of the Arctic Circle. Due the success of the early U-boat attacks on allied shipping in the North Sea. The system of convoys was introduced thus reducing the vulnerability the merchant ships. Shipping losses in the early part of the war were considerably, due principally to the presence of powerful German cruisers and battle cruisers and the lack of protective cover. To give one example, on 4 July 1942 the greatest convoy disaster of the war occurred when 23 ships out of 34 of convoy PQ17 were sunk. After this disaster, convoys were suspended until the autumn when long hours of darkness in northern latitudes enabled them to fare much better. The two Russian words at the top of the accompanying picture read "Northern Convoy". The code word of the convoy was "Dervish", whilst the flag of the participating nations are also displayed.



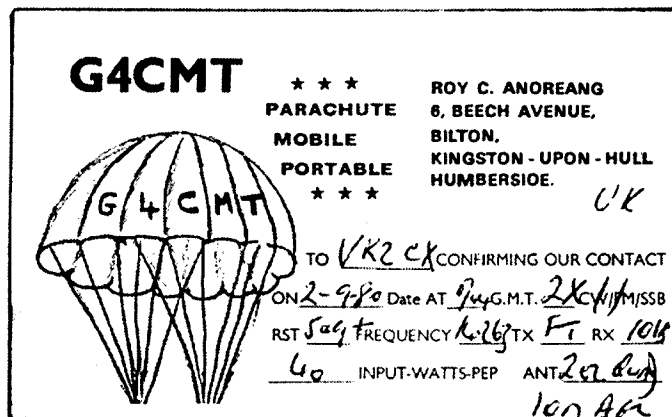
GB617SQN

Multi-numeral GB (Great Britain) prefixes will not be new to most DXers. These have varied from GB1 to GB800. The national QSL collection having received no fewer than 23 different GB prefixes. The accompanying copy is of QSL GB617SQN which celebrated 50 years since the historic RAF air raid in the evening of 16 May 1943. The Lancaster bombers were from the newly formed 617 Squadron. It was the squadron's first operation and was against the Ruhr dams in north west Germany. The Amateur Radio Society at Finningly organised this special radio event from the Derwent Valley in Derbyshire to commemorate the occasion and remember those lost in the operation. The location has special significance since many of the 617 Squadron practice runs were made there.



G4CMT

Although mobile operation is particularly common nowadays, this was not always the case. In some instances special licences had to be obtained and even special call signs used. For example years ago mobile G calls used the prefix GX and more recently Switzerland used the prefix HB1 in place of HB9, and Norway LB in place of LA. Canada used the prefix VE0 to indicate mobile stations while Iberia used ELO. There seems no limit to the ingenuity of mobile operators for we have received QSLs from tractor mobiles, bicycles mobiles and aeromobiles. Station G4CMT was the first station in the UK to make a parachute mobile QSO. It was carried out on Roy's 55th birthday and was his first parachute jump.



Thanks

The WIA would like to thank the following for their kind donation of QSL cards to the collection:

Mavis VK3KS
Barry VK3XV

and friends and relatives of the following silent keys:

Norm Eadie VK3UP courtesy Arthur VK3VO
John Murray VK3AJY courtesy Peter VK3DI
Jack Anderson VK3JA
Arnold Wilkey VK3AGW

ar

One Active Device Competition — AHARS Competition

Remember the Crystal Set Competition run by the Adelaide Hills club last year? Well in 1999 they ran a competition for an electronic gadget made using just one active device.

What device you used was left to your choice. It could be a valve, a transistor or an IC. It could not be a diode. That is considered to be a passive device. The resulting 'gadgets' were as varied as the devices used.

Two people chose to make a one valve radio receiver, but there was quite a difference between the actual type of receiver made. Steve VK5AIM had made a regenerative receiver for 80-metres using a valve, a 12AU7. Neil VK5NTO had made a general purpose broadcast receiver. It used a 1Q5, an even older valve type. Both builders used as many old, genuine parts as

possible, Steve even found an old radio cabinet in which to build his unit. Both rediscovered the forgotten 'health hazard' of flicking solder'!! Do you remember that, too? Neil also showed us a model radio controller in which he had used a 3A5 valve.

The circuit for the mike pre-amp is also shown. This unit was made as an add-on for a rocking-arm microphone on a TS520 transceiver and used a 2N3819 FET. Geoff VK5NDZ, now VK5JDZ no longer has to have the mike gain control wound up to full. How do you like his lovely description of a FET (Fundamental Electric Thing)?

"It has a garden gate, a front door and a back door. As the voice is heard at the garden gate the inhabitants inside the FET gather at the front door to see who is making the noise at the gate, then rush out the back door together making a great deal more noise. "!!!

Lloyd VK5BR had made a TRF receiver. His receiver used a Lockmoss F4069. An HF receiver designed for testing crystals used a CA3046. The same IC was also used to make a signal generator for HF.

A simple scanner for your house made by Lyndon VK5TTL now VK5SWR, used an LM3909 oscillator. The add-on BFO made by Alby VK5TAW used a 3704. This is one of the projects he actually made up before he got his licence. He used a cigarette tin as the chassis illustrating the fact that you do not need to buy new materials to build things. I wonder how many others used tins like this to house their early projects (in the days before they became too sophisticated)?

The active device used and the useful article made varied with the needs or imagination of the maker.

Ted VK5KBM got a bit carried away. He made up three versions of a Field Strength Meter. One of them used a 557 transistor. One was only useful for tests within the shack the other two could be used for field measurements as well, depending on the

accuracy or complexity of the measurements required. The circuits are attached for you to try.

Geoff VK5TY, who teaches others to get their licences, made a Five Cycles a Minute Oscillator with meters to show the wave motion and the variation in that movement when resistors, capacitors (or coils) were inserted in the circuit. The device used for this was a TL702. Because of the limitation of the competition this, as shown, only illustrated the effect of a resistor or a capacitor in a circuit. To illustrate the effect of a coil a complex sub circuit using at least one more active device, is needed. Perhaps the full circuit will appear in a later issue of Amateur Radio.

Two pieces of test equipment were made, a Time Domain Reflectometer for testing the impedance of, and possible defects in cables, for which Jim VK5XJT used a 74LS14 step generator. For the two-tone tester that produced oscillations on 1900Hz and on 700Hz a TL087 was used.

Each of the makers had to demonstrate and explain their 'gadget' and answer any questions from the members. It was a very interesting and informative evening. I am sure many people went away determined to 'have a go' at the next competition. Maybe other clubs would like to take up the idea, too. The devices used and the ideas would be just as varied as these were, for sure.

An audio oscillator won the competition by popular vote. It used a 555. Jeff VK5MFR hung a detector over the rim of a coffee mug which he then filled with water. When the water level reached the detector it triggered the oscillator. It is intended to help blind people to pour a cup of tea or coffee for their guests without burning their finger.

The very simplicity and usefulness of this apparatus is probably what appealed to the voters.

ar

*For All Your
Requirements*

AUTHORISED DEALER
ICOM

KENWOOD

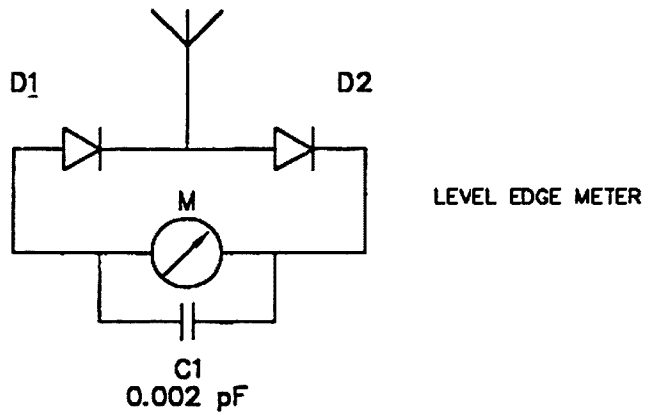
AMATEUR COMMERCIAL

Tower
Communications

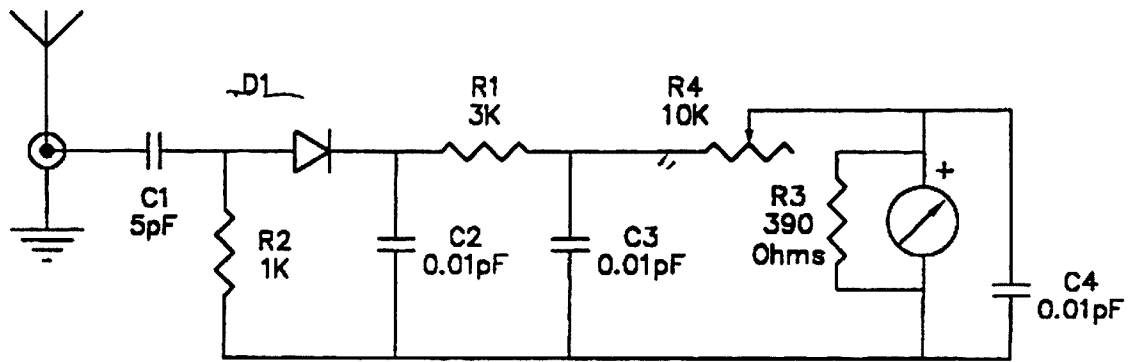
14 Mary Street
Hazelmere
Western Australia 6055
Telephone: (08) 9274 1118
Facsimile: (08) 9250 3734

E-mail: tower@eon.net.au

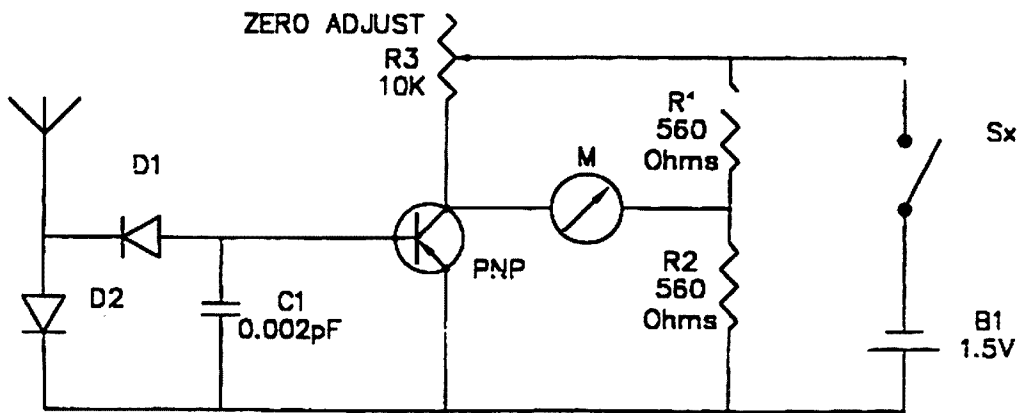
www: <http://www.tower.visionimage.com.au>



BASIC, VK5AHI F.S.M.
IN SHACK MONITOR



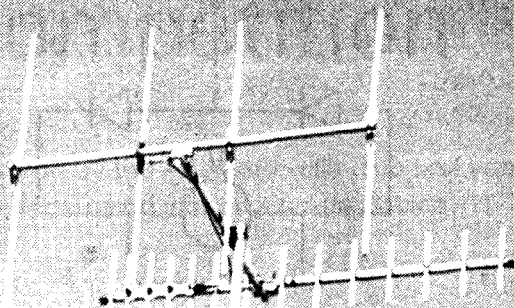
ELLIOT METER F.S.D. 250uA
SHACK AND FIELD



TRANSISTORISED
SHACK AND MORE SENSITIVE FIELDWORK

Figure 1

Two Old Squares into Four Squares



Steve Mahony VK5AIM

Two Old Squares Steve VK5AIM and Colwyn VK5UE, when preparing for another field day realised that one way to improve points scores was to work more squares from more squares. Points on the UHF bands had better multipliers; so that getting close to neighbouring squares became the criteria for selecting an operating area.

Adelaide is in PF95 and the corners of PF95 were looked at for convenient locations. The SE and NE corners are in the Murray mallee country, low elevations; the SW corner is in St Vincent Gulf, too wet and the NW corner is near Kulpara at the head of St Vincent Gulf, a location used for UHF/VHF operations by VK5s.

A look at the road maps showed the area had a good road system and an elevated site

looked possible. A recce was organised to see the lie of the land. We took along a small portable 2m beam, the dual band Xcvr in the vehicle and a dual band handheld. Operating sites were located in each of the squares QF84, QF85, PF94 and PF95.

To save time later we decided to mark the points where latitude 34°S and longitude 138°E crossed the roads. So with Steve driving and Colwyn reading the odometer

we drove from road intersections until the estimated position was reached and graffitied a tree with white spray paint to mark the crossing point. Later we thought it would be wise to check with a better map, so 4 maps and \$30 poorer and the inaccuracy of the road maps for our purposes became clear. However we had seen the country, so choosing new sites was not hard.

The Kulpara area is close to the Locheil Repeater. The Bumbungle range gave some elevation and a clear line of sight to the Adelaide area could be achieved. We were able to access all the Adelaide metropolitan repeaters.

On one of the drive arounds we met one of the local farmers in the customary Ute complete with sheep dog. He wanted to know what we two silly old buggers were up to? A short explanation comparing VHF/UHF Amateur Radio with UHF CB, Yagi Antennas and repeaters and all was understood. Farmers are great users of UHF CB. Once you get away from the Big City there are no "Ratbags" on the channels and it can be used as intended.

So it was decided to go ahead. We would operate two stations on 50,144 and 432 MHz one fixed the other mobile. One of us would stay at the fixed station while the other went mobile to the other 3 squares,



Steve VK5AIM operating the Base PF95, Spring Field Day 1999

then the roles would be reversed.

Steve VK5AIM had obtained several 150mm fiberglass poles that had been the outer case for mobile phone/ pager coaxial dipoles. Once the copper and brass elements had been removed for salvage/scrap, no one wanted the outers. At 3m long, two joined with an aluminum sleeve made a 6m - 20foot lightweight mast. With a specially made tilting base plate, 2 sets of 3 nylon guy ropes with slipping attachment plates, we had an easily transported and erected antenna support with armstrong rotator. A short extension with a cross arm carried the 2 m & 70 cm vertical beams. The 3 element 6m beam was mounted horizontally below. Colwyn VK5UE insisted that some identification be placed on the antennas to show the front, as on a previous contest he had complained about signal strengths only to be told he had the beam pointing the wrong way! We even attached labels to the coaxes so that the correct antenna was attached to the correct rig. Very frustrating to hear weak signals and has a high SWR, only to find you are transmitting into the wrong antenna! This was the basis of the fixed station. The roving mobile had a magnet mount for whips and a light telescopic mast, with a 3 element 2m yagi, which fixed into a plate held to the ground by running the car wheel onto it.

So for the Spring UHF/VHF Field Day 1999 we carted all this along with batteries, generators, food and sleeping gear up to the chosen site. Unfortunately there was little activity and the location of uncut wheat in paddocks beside the road kept us from the best site to work into the Adelaide area. That however is another story.

ar



The new AR editor, Colwyn Low VK5UE. Portable on 6, 2, 70, Spring Field Day 1999. Working Squares, in PF96. Portable 2M mast/antenna

CLUB NEWS

AHARS NOTES

During March AHARS participated in the John Moyle Memorial Field Day again this year. In total there were nearly 20 members with 16 staying for the whole weekend.

If the enjoyment is anything to go by the club will participate again next year and as we increased our total score again this year we were enjoying the improved propagation as the eleven years progresses.

The number of club members heard was great, too. Each contact adds to the club score and increases their score at the same time.

If your club has not previously worked in the John Moyle, why not give it a go next year. We want more stations to talk to!!

The ideas presented by Joe VK5WU were definitely thought - provoking. He made the point that, as amateurs, our frequencies are under constant threat from commercial interests and that it is in our interests to continue to show the world which way radio will be used in the future.

In the early days amateurs were given all the short waves because the commercial interests didn't think they were of any use. We showed them how to talk across the oceans on these frequencies, so now they are used by all countries and we have lost all but part of each band.

Later we showed the potential use of VHF, computers and digital transmission. Now these have been utilised widely and

have given us both digital phones and the Internet and our bands are again under threat.

Perhaps the time is ripe for us to show how to use the microwave bands to their full potential. We should be experimenting and planning our next steps in this area, maybe in the direction of satellite and ground based microwave repeaters, where we have so much bandwidth for experimentation.

If we show that we are using our microwave frequencies we have a much better chance of keeping them. Remember the saying: "Use them or lose them".

REPEATER LINK

Will McGhie VK6UU
21 Waterloo Cr Lesmurdie 6076
will2@omen.net.au
VK6UU@VK6BBR

The pros and cons of a lack of activity

In VK6, there is considerable comment from time to time about the lack of activity on voice repeaters. This lack of activity is not just limited to VK6 but is reflected across Australia. The reasons for this in my opinion are several.

Heading the list is the declining numbers of amateurs. Other reasons include a greater variety of hobby things to do these days. Computers top the list and the Internet. I can only look at my activity that has changed considerably over the years. One other factor could be the age shift. As our average age increases due to lack of new younger members, perhaps our interest in using voice repeaters declines. Perhaps some of us are just talked out.

Holidays

Repeater Link is short this Month due in part being on holiday and in part, travel for work. The holiday part includes some amateur radio in the form of taking a hand held on canoe trips. Several salt and fresh water lakes are in prime voice repeater coverage. The novelty of being in a remote beautiful location isolated from civilization,



Colour original inserted

yet talking from the canoe is one of the better uses of our repeater system. There is the problem of finding someone to talk to but in the course of a day one or two contacts eventuate. Usually once a contact is underway other amateurs appear and join in.

The photograph shows one such lake, Lake Preston, about 100 kilometres South of Perth, which has good voice repeater coverage from Mount William on 6900. The lake is very salty and is some 26 kilometres long by an average of one kilometre wide. A long skinny lake close to the Indian Ocean but not connected to it. There is no life in the lake at all (that I could see) with the water being crystal clear with a near white coloured bottom, mixed with shades of yellow, peach, orange, and light brown in places. One unusual contact on two metres was using the hand held while lying on my

back in three metres of clear warm green blue water. Being so high in salts the buoyancy allows you to hold a hand held (or mobile phone) high and dry above the water, a most unusual sensation. I bought a half litre of the salty water home and evaporated off the water. The resulting salts filled 16% of the container.

What better way to enjoy amateur radio than being out in such a strange but beautiful location and still being in touch via the local repeater 30 kilometres away?

Note the small 300-mW dual band hand held in the right hand while on the salty "dry" land and the buoyant in the water photograph making a telephone call. I hope the photograph does some justice to this most unusual lake. If not have a look at it on my Web page at www.omen.net.au/~will2/lake-preston.htm.

ar

INTRUDER WATCH

as at 8TH APRIL 2000

The March Summary is from VK6 Co-ordinator VK6RO

FREQ	DATE	UTC	Emn	Slpo	Remarks
3.650	2702	1305	A3E	35343	N.Korea
14.100	2902	0210	J3Eu	55555	n/amat, Indonesia
14.210	0103	1340>	A3E	55555	H2/7.105
18.075	2103	1253	A3E	43344	H2/9.0375
21.285	1203	1303	A3E	44444	UIBC atn

F.I.W.C Gordon Loveday VK4KAL

I hope my comments in March AR have not fallen on deaf ears. I do not make these comments lightly to fill up space. I would like them taken seriously and acted upon. Otherwise, I am wasting my time and that of those who go out of their way to assist Intruder Watch in VK, namely our Government Monitoring Service.

My Freepost No 4 is still valid. A. G. Loveday, RUBYVALE, Queensland 4702.

ar

Unfortunately this summary is very small. No new observations have come to me from the usual sources of VK4, by my cut off time. Logs will no doubt arrive, too late for faxes. This is the case with the Region 3 report. Time is the factor now, with the Region 3 Co-ordinator being in India ! However, things should improve as all co-ordinators are going over to e-mail, I should be active on this mode by May or June. (Setting up has taken me somewhat longer than expected, new techniques to be learnt etc.)

Animal Tracking Frequencies

From time to time we hear about, or see something on TV, regarding animal tracking .. or DF'ing. Some of these DF type applications were discussed in an earlier column .. see AR May 1998.

It may be of interest to be aware of which frequencies are used. Some time ago I obtained from the ACA a list of frequencies, applications and power levels relating to Class Licensed Low Interference Potential Devices (LIPD's). Some interesting facts from that list:

FREQUENCIES .. range from 9kHz to 5.875GHz .. with some extremely narrow band segments to others which are reasonably wide.

APPLICATIONS .. range from "all transmitters" to various specific applications.

POWER LEVELS .. range from 30 picowatt to 1 Watt.

The popular VHF frequencies used, and ones which I have some experience with, are in the band from 150.7875 to 152.49375

MHz where a maximum EIRP of 100 mW is permitted. Also, with this power limit, is the band 173.29375 to 174 MHz.

In the lower UHF region, with a maximum EIRP of just 10 μ W, are the bands 225 to 242, 244 to 267, 273 to 303.95, 304.05 to 328.6 and 335.4 to 399.6 MHz.

So the popularity of the 151 MHz band stems from the wide band available and the reasonable allowable power limit. Should one wish to be involved with, or assist others (possibly university departments involved in animal tracking), that will probably be the frequencies involved. Fortunately, the band is reasonably close to the amateur 2 metre band, so similar techniques may be used.



My Last Column.

For a variety of reasons, including the fact that I will be overseas for a considerable period, this will be my last column. Jack, VK3WWW, the Australian ARDF coordinator, has kindly offered to continue. He is in Melbourne where there is quite a lot of ARDF activity, so hopefully, with the assistance of the others, some interesting ARDF type information will result. In the future, I may be able to contribute something from time to time. I am sure that Jack would welcome input from anyone with ARDF related items of interest.

Introducing Jack, VK3WWW.

Jack has been kind enough to forward the following background on himself,

"I was first licensed in 1990 and during my first year in this new hobby I was fascinated by the monthly foxhunt reports on VK3BWI the WIA Victorian broadcast station. It was not long before I was getting gear together and contesting the monthly mobile foxhunts. Since first becoming an Amateur I have taken on a few roles mainly

with my local club but more recently the position of WIA Region 3 ARDF Coordinator. As a coordinator I have found it fascinating, especially dealing with other society coordinators. I hope to be able to keep the column as interesting as it has been for the period that Ron has been presenting it. On behalf of the ARDF community I would like to thank Ron for all the work and time he has put into the ARDF column, and wish him well on his new venture."

Contact information for Jack:

Email: vk3www@alphalink.com.au
Phone: +61 3 98732459 Fax: +61 3 94281589 Mobile: +61 0408037065

China Update.

Jack also reports there are now 3 persons heading off to China for the Region 3 ARDF championships. The event is being held in Nanjing, which is west of Shanghai. It is an interesting area of China where four of us from North Queensland participated in some ARDF activities back in 1991.

We wish the three Australian contestants every success.

Andrews Communications Systems

(EST. 1976 - ACN 001 968 752)

ALINCO

AUSTRALIA'S FIRST AUTHORISED
FACTORY DIRECT IMPORTER
MASSIVE SHIPMENTS EVERY MONTH
FULL 3-YEAR WARRANTY ON
ALINCO and ICOM
WE SELL MOST BRANDS
BALUNS, VERTICALS, YAGIS, P/S.
ICOM-KENWOOD-JRC-AOR-EMOTATOR-
MFJ-DIAMOND-TIMEWAVE-KANTRONICS
-THP - GARMIN - TERLIN - UNIDEN -ETC
DX-1600 HF LINEARS FROM \$ 3,799

**HUGE RANGE OF ELECTRONICS,
ICOM and ALINCO Radios.**

Over 22 Years of
Professional Sales and Service.
Instant Repairs Fridays
HF Transceivers & Linears Wanted

(02) 9636 9060 or (02)
9688 4301

SHOP 8, 41 BATHURST ST, GREYSTANES,
N.S.W. 2145. FAX (02) 9688 1995

DON'T MISS THE ACTION!

VX-IR 2m/70cm Micro Handheld

One of the worlds smallest dualband handhelds, just 47 x 81 x 25mm (W.H.D.) including a high capacity 700mA/H Lithium-ion battery! The VX-IR covers both 2m and 70cm amateur bands, plus offers AM/FM and TV sound reception, 2 hour fast charging as standard, simple settings and a large LCD screen.

Features

- Tx: 144-148, 430-450MHz
- Rx: 0.5-1.7MHz, 76-300MHz, 300-580MHz, 580-999MHz (cellular locked out)
- Output: 2m/70cm 0.5W (at 3.6V), 1.0W with external DC
- 291 memories, most with alpha naming
- AM, FM(n), and FM (w) reception modes
- CTCSS encode/decode
- 31 smart search memories
- Tone search for CTCSS and DCS
- Includes FNB-52LI 3.6V 700mA/H Lithium-ion battery, regulated AC adaptor/charger, antenna and belt-clip.

D 3665

YAESU

\$399

2 YEAR WARRANTY



VX-5R 6m/2m/70cm Deluxe Hand-Held

Tiny yet incredibly rugged, the VX-5R provides 6m, 2m and 70cm amateur band operation with 5W output as standard (4.5W on 70cm), made possible by a unique PA design and a super high capacity 7.2v 1100mA/H Lithium-ion battery. Plus, ultra-wide coverage VHF and UHF as well as AM medium-wave and shortwave reception facilities are provided, along with a large backlit dot-matrix LCD screen. All this in a diecast aluminium enclosure just 58 x 87 x 28mm WHD (without knobs or antenna)!

Features

- Tx: 50-54, 144-148, 430-450MHz
- Rx: 0.5-1.8MHz, 1.8-16MHz, 47-729MHz, 800-999MHz (cellular blocked)
- Full feature keypad, CTCSS encode/decode, digital code squelch
- Comprehensive menu system
- Over 200 memories
- 8 digit alpha-numeric memory labelling
- 5 battery saving systems, plus Tx/Rx usage monitor
- Spectra-Scope™ for monitoring adjacent channel activity
- Comes with FNB-58LI Lithium-ion battery, flexible antenna and AC adaptor/charger

D 3670

YAESU

\$699

2 YEAR WARRANTY

BONUS BONUS BONUS

Purchase a VX-5R during April or May 2000 and receive a CD-15 Desk Rapid Charger (D 3672 valued at \$49.95) at no charge!



Yaesu FT-90R 2m/70cm micro mobile

Another engineering breakthrough from Yaesu – a tiny dual-band mobile rig with high power output, a remoteable front panel, and a rugged receiver front-end. The FT-90R provides 50W RF output on the 2m band as well as 35W output on the 70cm band, a solid diecast casing with microprocessor controlled cooling fan for reliable operation, and a large backlit LCD screen, all in a package measuring just 100mm x 30mm x 138mm.

Also includes:

- Wide dynamic range receiver for greatly reduced pager breakthrough
- Huge receiver coverage – 100-230, 300-530, 810-999.975MHz (Cellular blocked)
- 180 memories and a variety of scanning functions
- Built-in CTCSS encode/decode, battery voltage metering
- Designed for 1200 and 9600 baud packet operation
- Tiny remoteable front panel (requires optional YSK-90 separation kit)
- Includes MH-42 hand mic, DC power lead, and easy to follow instructions.

D 3312

YAESU

\$899

2 YEAR WARRANTY



YSK-90 Front Panel Separation Kit D 3317

\$129⁹⁵

FOR ALL YOUR COMMUNICATION NEEDS

Rugged HF 5-Band Trap Vertical Antenna

The rugged 5BTV incorporates Hustler's exclusive trap design (25mm solid fibreglass formers, high tolerance trap covers and low loss windings) for accurate trap resonance with 1kW (PEP) power handling. Wide-band coverage is provided on the 10, 15, 20 and 40m bands (SWR typically 1.15:1 at resonance, <2:1 SWR at band edges) with 80kHz bandwidth typical on 80m at 2:1 SWR. An optional 30m resonator kit can be installed without affecting operation of other bands. High strength aluminium and a 4mm (wall thickness) extra heavy-duty base section guarantee optimum mechanical stability. At just 7.65m, the 5BTV can be ground mounted (with or without radials, although radials are recommended), or it can be mounted in an elevated position with radial system. Unlike other antenna designs, the 5BTV can be fed with any length of 50-ohm coax cable.



D 4920

\$399



30m Resonator Kit

Adds 30m coverage to the 5BTV and includes all hardware.

D 4921

\$99.95

D-130J Discone Antenna

Covers the frequency range 25-1300MHz and comes with mast-mounting hardware and instructions. Easy to assemble and install with extensive stainless steel construction making it extremely durable. A wide frequency coverage means that it's ideal for scanning receivers, as well as transmitters up to 200W PEP for the 6m, 2m, 70cm and 23cm amateur bands. Uses an SO-239 coax socket for easy coax connection.



D 4840

\$179



6m 1/2 Wave Base Antenna

A rugged Australian-made vertical antenna designed to cover the 51 to 54MHz range, with minimum SWR around 53MHz. Built using high tensile T81 grade aluminium, it's just 2.9m long with a sealed base section and 100W minimum power rating. Complete with mounting hardware.

D 4825

D&G Antennas

\$69.95



2m Heavy Duty Base Station Antenna

For use where long-range omni-directional 2m band (144-148MHz) coverage is required. This 3.4m long 1/2 wave over 1/2 wave colinear vertical antenna provides approx. 5dB gain, and is housed in a very tough single-section fibreglass radome for all-weather protection. The strong aluminium base section is fitted with an N-type socket in its base for coax cable connection.

D 4822

BENELEC

\$139.95

WIA Callbook

Wide range of information for Australian Amateurs plus callsign and address listings.

B 2344

NEW



\$17.95

ARRL Handbook

77th edition of this famous publication. Incredibly wide range of information for operators and constructors.

B 2237

NEW \$59.95



FT-2500M 2m Heavy-Duty Transceiver

Built tough to take the rough stuff, the Yaesu FT-2500M meets US MIL-STD 810C for shock and vibration so it'll provide years of reliable mobile operation. Its easy-to-operate front panel design, rubber coated knobs, and large Omni-Glow display are teamed up with a one-piece diecast chassis to set the FT-2500M apart from other 2m mobiles. For improved front-end performance, Yaesu's exclusive 3-stage Advanced Track Tuning feature and dual-FET mixer reduce overloads from strong signals while providing excellent sensitivity and wide-band receive operation.

D 3632

Also includes:

- 31 tuneable memories
- 7 selectable tuning steps
- Various scanning modes
- In-built CTCSS encoder
- MH-26 hand mic, mobile mounting bracket and DC power lead.

Specifications:

Frequency range: Tx 144-148MHz, Rx 140-174MHz
 Output power: 50W, 25W, 5W
 Sensitivity: better than 0.2uV for 12dB SINAD,
 Image rejection: better than 70dB
 Max audio output: 2.0W into 8 ohms (10% THD)
 Dimensions: 160 x 50 x 180 (W.H.D.)

2 YEAR WARRANTY

YAESU

\$499

LOW PRICE



PHONE FAX AND MAIL ORDERS

PHONE: WITHIN AUSTRALIA: 1300 366 644
(Local call charge)

FAX: (02) 9395 1155 within Australia and
(+612) 9395 1155 from outside Australia

MAIL: DICK SMITH ELECTRONICS, Direct Link, Reply Paid 160,
PO Box 321, North Ryde NSW 1670 (No stamp required)

Excludes packaging and postage. All major credit cards accepted.

14 Day Money Back Guaranteed if NOT completely satisfied. (Software excluded)



Visit our web site at
<http://www.dse.com.au>



That's where you go!

Yaesu transceivers and accessories stocked in selected stores only. Other stores can place orders on a deposit-paid basis. Offers expire 31/5/2000.

915 DPS a/c

SPOTLIGHT ON SWLING

Robin L. Harwood VK7RH
5 Helen Street,
Newstead TAS 7250 AUSTRALIA
(03) 63 44 2324
e-mail : rharwood@primus.com.au

Discontent as Winter approaches

BBC confusion

Well, we are almost into winter and it has been interesting to monitor over the various frequencies. As expected, the BBC World Service decided to introduce additional program streams to confuse everybody. They went from three to eight and published program times in local times instead of the standard UTC or GMT. Yes I know it was still there but not as prominently. At least the channels used for Australia and the Pacific are carrying the East Asia stream, yet many have found other streams directed to North America or Europe. There was further confusion because streams were put on so many channels that wrong programs were put on to the wrong frequencies, due to some initial teething problems. As well, there is a change in emphasis. One frequency that has been dropped, I notice, is 7145 kHz from 0600 to 0810 UTC.

At the same time these changes were introduced, the new BBC Director-General, Greg Dyke, announced that there was going to be another re-organization of the BBC, increasingly concentrating on programming and over 1500 jobs would go across the entire Corporation, primarily at the middle management level.

The pain of unkind cuts

Across the North Atlantic, the "Voice of America" in Washington, also was experiencing some pain with some retrenchments following the curtailment of some language services. In October, the Deutsche Welle in Cologne also cut staff numbers and some language services, due to budgetary constraints.

Now the smaller stations are also feeling the winds of change. Trans World Radio (TWR) decided to close studios in Guam and opt for satellite feeds for KTWR. Also

FEBC Radio International in Manila also decided to cut live English language programs and also go to satellite feed. Also I believe that the Adventist Radio Network are also opting for this delivery method.

Portishead Radio closes

Many will have heard Portishead radio, which has gone by call signs such as GKA, GKB, GKE etc. will be saddened to hear that British Telecom (BT) closed this historic station on April 30th at 1200 UTC. It became a casualty of the economic rationalism within the BT organization, which is a commercial enterprise and no longer in state ownership.

Portishead, along with PCH in the Netherlands, has been there since the early days of wireless. That leaves only WCC, formerly located at Chatham, Mass (Cape Cod) as being the only remaining pioneer station still operating. It started in the first decade of the 20th Century. WCC is part of the worldwide Globe Communications Network and is remotely operated from California. The location of the senders is now in Maryland. WCC is now mainly on Clover or SITOR (Telex over Radio). KPH in California was a sister station and I have not heard it since it was merged with KFS in San Francisco, also part of the Globe empire.

Frequency changes

Here are a few frequency alterations I have picked up since the beginning of the A-00 period. Radio Netherlands is now on the air to Australasia on 9795 kHz from Bonaire, up only 5 kHz from 9790, and on 12065 and 13710 kHz from sites in the Russian Far East. The times remain unaltered but note that the first half-hour is devoted to News

and Current Affairs. This means that feature programs, such as "Media Network" now start on the hour. Ulan Bator in Mongolia is on in English on 12085 between 1030 and 1100 UTC. The Voice of Thailand is in English to Australia on 9885 from 1230 to 1300 UTC. Belgium is on 9865 kHz to Australia from Petropavlosk in the Russian Far East. It is very good too.

Egypt is on to Australia and Asia in English on 17595 from 1215 to 1330 UTC and in Arabic specifically for Australia on 11990 from 2000 to 2100 UTC.

Budapest in Hungary is on 21560 from 1000 to 1100 UTC and from 2000 to 2200 on 11890 in Hungarian. Rome in Italian is on from 1000 to 1100 via Singapore on 11920 kHz. Even Swiss Radio International now broadcasts from Singapore to Australia on 13735 from 1100 to 1330 UTC.

The Voice of Russia World Service used to be the easiest station to find on shortwave up to ten years ago but now it is so elusive. The latest channels I have for Australia are : 9945 15510 15460 15560 from 1200 to 1400 UTC but 15460 is not on after 1300 UTC.

Well that is all for this month. Until next time, the very best of listening - 73 Robin L. Harwood VK7RH

Contributing
to **A
R** is now
as easy as
sending an e-mail!

Send your articles to:
edarmag@chariot.net.au



Division News

Forward Bias: VK1 Notes

Our guest speaker on the 20th of March was Ian Hayes. Ian is the manager of the Spectrum Marketing Division of the ACA. In this role, he is across all the various ways in which the RF spectrum is being divided up amongst the users of it. Ian explained in detail how portions of the spectrum are allocated to users and how some sections of it are sold by auction.

This last bit was a bit frightening to hear when we heard the sums of money that were being paid at these auctions. Particularly so, when we realise that the amateur bands are free to us. We heard that the ACA's vision is for an efficient, competitive, and self-regulated use of the spectrum by the communications industry. Including user safeguards and industry developed technical standards. Ian said that the pressure is on for more available bandwidth in the near future as the use of mobile telephones and other forms of personal communications increases. He mentioned in particular the frequency bands of 800, 1800, and 3000 MHz.

In these bands and in others, demand is higher than supply. Therefore efficiency is served when portions of the spectrum are

sold by auction. However, auctioning of the spectrum does not apply to the HF bands up to about 75 MHz. Here are a few new terms for your vocabulary, as used by Ian: *Winners Curse*; applies to a person who most highly overvalues product at auction, *Simultaneous Ascending Auction*; computer-controlled system of auction where all participants are kept informed of everyone's bid.

This last system was implemented by the ACA, together with its own variants and improvements. Ian provided us with the address of the ACA's website that deals exclusively with spectrum licensing. Here it is: <http://203.37.2.230> Ian's own email address is: ihayne@aca.gov.au

The Canberra Amateur Packet Radio Group (CAPRG), which is associated with the ACT Division, is having regular weekly meetings. At one of these, Thursday, October 21, 1999, some important decisions were made. The group elected an interim chair, as Mike Walkington (VK1KCK) was being posted to the USA for three years as from January 2000. Richard Watts (VK1SW) is interim chair. A permanent chair will be elected later in 2000 when

Peter Kloppenburg VK1CPK membership numbers have settled down and a new venue for the meetings has been found.

Mini-profile: His name is Tex Ihasz, VK1TX. Tex is successful in his pursuit of amateur radio. He got his DXCC in 1997 in addition to WAS, WAC, and WAZ. He also runs the Australian New Zealand Africa (ANZA) net on 14.183 MHz from 05.00z, and for 15 minutes starting from 04.45z, the 15 metres net on 21.205 MHz, especially for Novices. In addition to this labour of love, he runs the 20 metres Southern Cross DX Net on 14.2265 MHz every night from 10.30z. As if this is not enough, Tex has just started his new Webpage. It is still under construction, but nothing stops you from having a look at it. You'll find it at <http://web.one.net.au/~vk1tx> Have a look and tell him what you think of it. *Flash-Flash: As the General Meeting and Trash & Treasure were cancelled for April due to the Easter break, the next Trash & Treasure will be held at the General Meeting in May. The next General Meeting is on May 22, 2000, at the Griffin Centre, Civic, Canberra City, at 8:00 pm. Cheers.*

VK2 Notes

The Division has made available the callsign AX2000 for use by affiliated clubs and members outside of the period of the Olympic and Paralympic Games. Application forms, with sample log sheets have been sent out to clubs, and may be obtained by individuals by contacting the office. Periods are for a week at a time (Monday to Sunday). The Division will be operating a special event station for the Games from the headquarters station at Wigram Street Parramatta, which will be available to visitors daily during the Games period, and manned by a roster of volunteers. This roster is being organised by Stephen Pall VK2PS, the Divisional Special Projects Officer. If you are interested in offering your time, please contact Stephen.

The internet education course run by Ron Bertrand, VK2DQ, is attracting a great response with well over a hundred students. There are too many students for Ron to

supervise fully, so the Division has organised a group of tutors to take several students each, and other amateurs throughout Australia are also acting as tutors. The course is based on the video course that Ron recorded at the Gladesville Amateur Radio Club some years back. In that course Ron lectured to live classes of up to 30 students at a time while being recorded. The "amateurradiopr" list is being used as a discussion group so why not subscribe and join the fun.

The Dural site is being refurbished and upgraded — looks much improved with a coat of paint. A great job being done here by volunteers from the Dural Committee.

The 6m, 2m and 70cm beacons are now transmitting through horizontally polarised, omni-directional antennas mounted on the top of the main building at a height of about 5 metres. They will be transferred to the top of the western 20m pole sometime this year,

along with the 10m beacon antenna. The 10m beacon is currently operating from a vertical antenna on the old tower adjacent to the transmitter building.

The 6m beacon, currently on 52.420 MHz (with FSK ident), will be moved to 50.299 MHz (with CW ident) to avoid an obscure intermodulation problem with the new 6m repeater. This repeater has been operating since late December last year.

The most recent addition to Dural systems is the new 10m repeater. This is a joint venture with the Nepean Amateur Radio Group. There is a receiver on 29.540 MHz at Riverview, linked on 70cm to a 25 watt transmitter at Dural on 29.640 MHz. DX has already been worked into VK6 and North America. so dust off your old 10m FM rig and have some fun as sunspot activity reaches its maximum.

Pat Leeper VK2JPA
patleep@bigpond.com

VK3 Notes

By Jim Linton VK3PC

Annual General Meeting

The AGM of WIA Victoria will be held at St Michael's Hall, corner Victory Boulevard and High Street, Ashburton, Wednesday, May the 31st, at 8pm. A meeting notice and annual reports were included as an insert in the April edition of AR magazine. The notice and reports were posted directly to those financial members who do not receive AR. Financial members are encouraged to attend the AGM and be among the first to take advantage of the Members Only section on the WIA Victoria website to be launched next month. Registration applications for this new membership service will be accepted on the night.

WIA Victoria needs your support more than ever at this time, and one way to do this is to attend the AGM. It is intended that those in attendance will receive a report on the WIA Federal Convention held at the end of April - a topic that had been of keen interest to members at the 1999 Special General Meeting, and the past AGM's.

Come along and meet the new 2000-2003 council, hear about plans for the next three years, and after the formalities stay to chat with fellow members over a light supper.

New direction in the interests of members

WIA Victoria has started the new millennium with a major review of policy that has the potential to affect all members and the ongoing operation of WIA Victoria. In 1989 the Council initiated forward planning that resulted in making WIA Victoria one of the most financially successful WIA Divisions. We have come a long way since 1989, and it is now time to review all our policies and ensure that members are the ones who ultimately benefit from Council's prudent management. In the past decade WIA's assets have increased from around \$280,000 to \$745,000. Unfortunately due to changes in the hobby and economic circumstances, membership numbers have fallen in that time from 1750 to 1200.

During the good years in the early part of the decade, WIA Victoria was able to achieve a substantial boost to its income from the interest payments from investments and trading activities in various fields. To enable us to do this we had been able to afford professional office management and the services of a Chief Executive Officer. Indeed the whole management policy has been thoroughly professional.

The effect of forthcoming changes to the taxation system - namely the Goods and Services Tax - and greatly increased costs of operation of the Federal WIA, coupled with low interest rates, and a general reduction in trading income, all adversely affected the finances of WIA Victoria in 1999.

There is no positive change likely to this situation in the foreseeable future. Members will recall that WIA Victoria strongly opposed the large increase in fees imposed by the Federal WIA on pensioner members for the provision of AR Magazine.

Whilst we were unsuccessful, the Council believes that our older loyal members deserve special consideration. WIA Victoria intends to heavily subsidise these members.

Council is also anxious to increase access to services by members and will be giving consideration to opening the office for a short time on Saturdays, dependent on the availability of suitable volunteers. Whilst WIA Victoria has achieved a high degree of financial stability and a substantial asset base, the Council review of operations concluded that our income level was no longer able to pay for the use of salaried office staff.

Members interests would be better served if we returned to the use of a voluntary labour resource. It is intended that from the 1st of July 2000 the WIA Victoria office will open Tuesdays and Thursdays from 10am until 2.30pm and dependent on the availability of a suitable volunteer, on Saturday from 10am to 12.30pm.

Morse code watch

The adoption of 5wpm Morse code as an amateur licence requirement for full HF band access is spreading throughout the world. The ACA has given "in principle" support for this to happen in Australia. Some 12 months ago the ACA did not support any change in the licence requirement.

It had let it be known that its preference was to wait until the outcome of the World Radio Conference in 2003 when the mandatory Morse code licence requirement is expected to be reviewed.

However, a global trend of adopting the 5wpm standard was established late last year, and the ACA became more receptive, and ultimately responded fully to a WIA submission seeking a lowering of the code speed. WIA Victoria and all other WIA Divisions worked hard during a six-week period to reach a point of unanimous

support for a new WIA policy in support of 5wpm. It was the view that the matter should not wait a further four months for the WIA Federal Convention and a postal motion was most desirable.

Almost immediately after the last vote was cast for the postal motion which set a new policy for the WIA, it made a submission to the ACA. In response the ACA wasted no time in considering the WIA's views, and soon after proposed that 5wpm be adopted.

A few critics of the WIA had their say on the packet network and on the phone bands. Any fair minded person looking at what has been achieved should be in praise of the work that the WIA carried out on their behalf.

Some had a bleat about the failed motions at the 1999 Federal Convention that sought a new policy on the Morse code requirement. The claim made repeatedly is that had those motions been passed, Australia would have led the world, rather than just been a follower. I think not. The fact is that 12 months ago there was insufficient support for lowering the code. As for Australia being a follower, I know this is far from the truth. Many European nations have taken close notice of the WIA's achievement, and the information is helping them now as they seriously look at the code issue. Our neighbours in South East Asia and Asia are also examining the WIA experience as they consider how best to overcome the resistance of their radio administrations to lower the code. The IARU Region 3 conference to be held in Darwin in August is certain to discuss the matter.

Broadcast producer(s) wanted

The VK3BWI broadcast needs a new producer to help share the work. The role does not necessarily involve being an announcer, but anyone with that ability could also read their bulletin. A producer needs to write a broadcast text that runs 25 minutes which is about 3,000 words. It takes about a week to compile a bulletin that consists mostly of very short general interest text written for the spoken voice. Apart from the council news which usually heads each broadcast, and the odd bit of club news, a producer also has to be a newsgatherer, and have basic word processing and Internet surfing skills. Email facilities are essential. If you would like to be a producer please send an email to the above address with a subject line of "Broadcast Producer".

“QRM” VK7 Notes

As a consequence of a very well attended Annual Meeting held in Hobart at the end of March we have some changes in the executive of the Division. Our new President (also our Divisional Federal Councilor) is Phil, VK7ZAX, from Scamander on the East Coast. Anyone from the island up north who has met Phil at recent Federal Council meetings will realise that we are very fortunate to have him in this office. Vice presidents are Mike, VK7FB, and yours truly, VK7RN with the secretary/treasurer portfolio combined and in the capable hands of John, VK7RT. We are looking to appoint a minute secretary to ease the load there.

Following the meeting we had a conducted tour of the Australian Antarctic Centre and then we sat down to a brilliant smorgasbord dinner. FOOD !!! The appetite of some of our hams is amazing. Our Ladies were doing their share too!. The highlight of the night was a great magic show by a very good magician - just ask VK7RO, Richard who became his “bunny”. On the whole a very good day hosted by our Southern branch.

Without inferring that all our Tassy amateurs do is eat and have a good time I must now report on the North-west branch's annual barbecue on the foreshore at

Ulverstone. About 20 amateurs and their XYL's attended. A beautiful day added to the enjoyment of the great Tassy steaks etc. followed by a 'preloved equipment' auction.

Some pretty cunning foxes have given the hunters some tough work finding them in the weekly foxhunts at the Southern branch. One exasperated hunter was heard to state that he had lived in Hobart all his life and didn't know a couple of the little parks the foxes hid in even existed. Your geography must be improving Mike.

Cheers for now. Ron, VK7RN.

Qnews: VK4 Notes

By Alistair Elrick VK4MV

The Qnews broadcast of 12 May created quite a deal of interest and favourable comment. It was co-hosted by an International array of presenters from the copy put together by Graham VK4BB. With Robert Sudock WB6FDF at the anchor desk in Los Anglos, Jeremy Boot G4NJH in Nottingham UK, from Brisbane John Stevens VK4AFS, to Gavin Reibelt VK4ZZ in Townsville, Rick Warnett P29KFS in Papua New Guinea and in Perth, NewsWest Presenter Tony Savory VK6TS. Text messages were exchanged electronically and voices recorded in Real Audio were returned to assemble the broadcast, which went to air on the Qnews network. A lot of work went into this presentation, which went off without a hitch. Fine jobs by all in organising and co-ordinating this co-operative effort from around the globe.

At the March 25th WIAQ Annual General Meeting, Life Membership of the Institute was bestowed on Alan Shawsmitth VK4SS for his life long dedication to Amateur Radio. His interest began at 8 years of age and has not waned after some 75 years. A long time WIA member of 66 years standing and Amateur Radio Historian, he is also the author of the absorbing book 'Halcyon Days' about the early days of AR in Australia and Queensland.

Following this, Merit badges were presented to Long serving Federal Councilor Ross Marren VK4AMJ, QTAC Chairman Paul Hayden VK4ZBV and Office Manager John Stevens VK4AFS for their outstanding service to the WIAQ.

Along with this Distinguished Service Orders were awarded to Bev Clayton VK4NBC, Tom Walker VK4BTW, Col Robertson VK4AKX, Alan Wills VK4YAR, Dale McCarthy VK4DMC, Roger Cordukes VK4CD and Neil Holmes VK4NF for dedication to their work within Amateur Radio and the Division and it's members.

Congratulations to all the recipients.

The Annual General meeting went very smoothly with all scheduled tasks completed in a timely fashion. There was much less of the prolonged debates of past years, as it seems many problems have been overcome with the move to an Incorporated Association. We once again enjoyed the use of the Bronco's Leagues Club for the holding of the meeting, for which we thank the Club most sincerely. Quite a few made further enjoyable use of the downstairs dining facilities for an evening meal, with the usual boisterous re-telling of many 'old radio tales'.

The new WIAQ Council has a full complement of 12 members, with more than half being from outside the Brisbane Metropolitan area. They are Col Gladstone VK4ACG, Dave Jones VK4OF, Bill Riis VK4YCU, Bill McDermott VK4AZM, Bruce Jones VK4EHT all from Brisbane. Clive Sait VK4ACC from Rockhampton, David Eyles VK4KDL from the Sunshine Coast, Trent Sampson VK4TI from

Toowoomba, Gavin Reibelt VK4ZZ and Steve Watson VK4SGW from Townsville, Neil Holmes VK4NF from Dalby and Dale McCarthy VK4DMC from Atherton. These members will form the Council for the 2000-2001 year and look forward to further progressing and promoting the Division and the hobby.

The reports as presented to the AGM are all available in full from the Web site. Access via the WIA page <http://www.wia.org.au/vk4> at the VK4 page click the WIAQ logo on top left, then scroll down for the link to the reports. On packet the Presidents Report is on page 888, QSL report is on 890 and Qnews Report is on page 892.

With the retirement of VK4 QSL Manager Laurie Pritchard VK4BLE, all QSL cards or QSL Bureau correspondence should be directed only to PO Box 638, Brisbane Qld, 4001. Laurie has asked that no QSL mail be sent to him personally, but be directed via the WIAQ Post Office address to the new QSL Bureau team. Laurie will be continuing to offer a QSL card printing service to Amateurs. contact him on 07 3284 8859 after hours.

From the VK4 Contest Manager Trent VK4TI comes some results of the 1999 Jack Files Trophy, winners are: John Loftus VK4EMM with highest in VK4 and Brisbane's Bayside Club with highest club score, Trophies to be presented as soon as practical.

continued next page

VK4 Notes

continued from previous page

In the position reporting activities of APRS, user numbers are slowly growing as enthusiasts take to the latest available technology with Amateur application and development. Traffic can be found on 145.175 with 1200-baud packet signals. An APRS I-Gate Gateway on the Gold Coast with VK4GO, linked to temporary digi of VK4BBS and the full-time digi VK4DMI-3 up 2000 ft on Ocean View on Brisbane's North side.

Software to get you started, UI-View, is currently free with \$20 registration getting you one or two additional bits of the package. Software to upload position reporting to the Pacsat digipeaters on AO16, LO19 and IO26. Look for the program to use your computer soundcard to send Manchester encoded 1200-baud packet data from Doug KA2UPW from the web site: <http://members.aol.com/dquagliana/upw/upw105.zip>

Cheers from Alistair

5/8 WAVE: VK5 and VK8 Notes

Welcome again to 5/8 wave column. Due to lack of volunteers this column has been absent for some time. However a volunteer has been conned into writing what we hope to be regular monthly news of what is happening in the WIA SA & NT Division.

We would like to welcome Mark VK5AVQ and Andrew VK5EX to the council. Mark has volunteered to be our Minutes Secretary, thus taking some of the work load off our busy Secretary. Andrew was recently appointed as Chairman of WICEN SA and as such holds a position on Council.

At our March Council meeting it was decided to reduce our divisional journal to a quarterly publication. The divisional journal is distributed as an insert to AR Magazine. Those who don't receive AR Magazine still receive a posted copy of the Journal. Colwyn VK5UE our previous editor has moved on to bigger and better things, we wish him all the best as Editor of AR Magazine. Our new editor is Glenville VK5ZCF who has volunteered his services. We extend sincere thanks to all those who have volunteered their time to contribute to the hobby in our division.

Our April meeting was a Morse meeting. Possibly seen somewhat radical in this day and age!

An interesting talk and demonstration on high speed morse code was given by Oleg Bezzoubou, a competitor from the 1998 Hi-Speed CW Championship held in the USA. Our May meeting will be held on 23rd of May, this will be our AGM, a full report will follow in a future column.

Earlier this year the divisional web page was redesigned and updated. The web page carries a lot of useful information including contact details for councilors and divisional services, a repeater and beacon listing, clubs listing and much more. Have a look around when you get a moment. www.wia.org.au/vk5

Also in the internet world a mailing list was established by the division. This is for the WIA SA & NT council to keep members informed of events within the Division and WIA in general, and also as a forum for member discussion. Details of how to join the list are on the divisional web page.

Until next time, Joe vk5uj@qsl.net

ar

Radio and Communications

Incorporating AMATEUR RADIO ACTION and CB ACTION

Edited by Chris Edmonson, VK3CE

PO Box 123, Eagle Heights, Queensland 4271 PH (07) 5545 0666 FAX (07) 5545 0622

CAN YOU BEAT THE GST?

Well YES, there are a few ways to beat the GST...but unless you plan to break the law, you'd better spend a little money before July 1

Last chance: Call 1800 25 2515 today and really save a bundle on a new or renewed subscription

In the June issue of Radio and Communications, not only can you Save a whole heap of money, but you could also get cracking building some fantastic antenna designs and lots more!

Oh, and don't forget our usual fantastic crop of regular articles and columns!

Rush your newsagent on May 24

Don't miss out...

We have the biggest collection of radio-oriented Classified adverts in the country. There's lots of them because they work so well. Ask your newsagent to keep a copy for you each month. Hurry — you might miss something!

Don't miss out — RADIO and COMMUNICATIONS is great reading for amateurs!

Check your local newsagent today



Bill Magnusson VK3JT
RMB 1627 Milawa Vic. 3678
Email: vk3jt@amsat.org

Some changes, a launch and a 16th birthday

AMATEUR RADIO SATELLITES.

The AMSAT-organisation.

AMSAT (Amateur Radio Satellite Corporation) is a world wide organisation with its roots in the USA. Its origin can be traced back to 1958, just a year after the launch of Sputnik-1. Since that time AMSAT members have been involved in the design, building, launching, commissioning, upkeep and of course, the day-to-day use of amateur radio communication satellites. The parent body is AMSAT-NA (North America) and many other countries have similar special interest groups.

AMSAT-Australia

Our local organisation is known as AMSAT-VK. The National Co-ordinator is Graham Ratcliff VK5AGR.

Membership of AMSAT-Australia.

AMSAT-Australia operates an open membership system. No formal application is necessary and no membership fees apply. From time to time new software, firmware and hardware is developed and distributed through AMSAT-VK channels. Write to the co-ordinator to express your interest or pop up on the HF net.

AMSAT-Australia HF net.

The AMSAT-Australia net meets formally on the second Sunday evening of the month. During the winter months in South Australia (end of March until the end of October) the net meets on 3.685 MHz +/- QRM at an official start time 1000utc with early check-ins at 0945utc. During the summer months when daylight saving is in operation in South Australia (end of October until end of March) the net meets on 7.068 MHz +/- QRM at an official start time of 0900utc with early check-ins at 0845utc. The times and frequencies have been chosen as the best compromise for an Australia-wide net taking into consideration seasonal propagation changes and the various state summer time variations. The net is open to all amateurs, beginners or experienced who have an interest in amateur radio satellites. Help and information for beginners in particular, no matter how trivial, is freely and cheerfully available on this net.

The AMSAT Journal.

An excellent bi-monthly journal is available with formal membership of AMSAT-NA. It contains details of practical projects and ranges over all aspects of amateur radio satellite operations. As of 01Jul00 the cost of AMSAT-NA annual membership will be US\$45 payable to AMSAT-NA 850 Sligo Ave, Silver Spring, MD 20910-4702 U.S.A. or you can phone, fax or email your subscription using your credit card. The phone number is 0011-1-301-589-6062, the FAX number is 0011-1-301-608-3410 and the email address is martha@amsat.org

All Communications regarding any matters mentioned above should be addressed to:

AMSAT-Australia.

GPO Box 2141, Adelaide, SA. 5001.

(email, vk5agr@amsat.org)

AMSAT-VK newsletter and HF net.

Readers may have noticed some changes in the information box for this column in the last couple of months. This has been brought about by some structural changes to the AMSAT-Australia group. There are three main changes. Firstly, Graham has ceased production of the monthly newsletter as it was considered to have 'run it's race' in light of the quick and easy access to information provided by the internet. Secondly, as the newsletter consumed the major part of membership subscriptions it was decided to continue the group on a less formal basis, not requiring a subscription. Thirdly, the weekly HF net has been replaced by a monthly net. These changes are reflected in the new information panel at left.

AMSAT-VK Mailing List.

In light of the above changes, this service is available for those with internet email capability. From time to time news may break which affects AMSAT-VK members particularly. New software or hardware or items for sale come to mind as examples. In the absence of the monthly newsletter, Graham has offered to establish an email mailing list for this purpose. Send him an email message if you would like to be included in this list. (vk5agr@amsat.org)

continued next page

Phase 3D ... All in Readiness for the Long awaited Launch.

As you read this the phase 3D spacecraft is in storage in Kourou, French Guyana awaiting its integration with the Ariane rocket which will propel it into orbit in July. Let's all hope we have some good news to relate in the August column. Recent launches by the Ariane-5 rockets have proved to be very successful and this augers well for Phase 3D.

MIR Space Station Re-activated.

Early in April a new crew arrived at the MIR space station. Their job was to get things in readiness for full re-activation of MIR. It is hoped this will include the amateur radio equipment. News regarding this venture has been confusing to say the least. A sort-of 'on-again, off-again' saga. I guess time will tell but fingers crossed, by the time you read this the packet PMS and the occasional voice QSOs may be a reality again.

Demise of the IRIDIUM Satellite fleet.

Although not directly connected to amateur radio satellite work, this has been a hot topic recently on the AMSAT bulletin board. A number of my friends who include 'satellite-watching' in their day to day activities have been following this thread with interest.

The IRIDIUM satellites had been popular among satellite watchers because of the spectacular nature of the flashes that resulted when the sunlight caught their highly polished antennas. Special computer software was available to predict precisely when these flashes would occur at any specific location. Well ... all that has changed.

The IRIDIUM satellite company has gone out of business and the satellites are to be de-orbited. This may have already begun to happen by the time you read this column. There has been considerable discussion on the BBS and on the digital birds about the need to de-orbit the IRIDIUM satellites and some interesting points have arisen.

The obvious first question, why de-orbit? Why not just leave them there? It

appears that space in the LEO area is limited and with such a lot of them, they would simply be taking up space which could be used for other satellites. The IRIDIUMs are in a stable orbit and if left uncontrolled they would stay in orbit for many years contributing to the compounding problem of space-junk.

Another popular question, why can't someone else use them? They are very specifically designed beasts; indeed. It would be virtually impossible to re-program them for any other purpose. No other company has expressed an interest in taking them over.

Again, a question. Why can't we (the radio amateur community) grab one or two and use them? It appears that the company is bound by contract to de-orbit them if redundant. This has something to do with conservation of orbital space. The control infra-structure needed to maintain orbital stability would be way out of our league to finance. It is reported to cost millions of dollars per year. Besides that, what would we use them for? They are designed for very high micro-wave frequencies.

One of IRIDIUM's problems has been an on-going feud with the radio-astronomy community due to the proximity of the transmissions to internationally allocated radio astronomy bands. Many countries have refused to licence IRIDIUM earth-stations for this reason. In any case, the spread spectrum technology would put them into the too-hard basket for the vast majority of amateurs.

So it seems they will be driven down into the atmosphere to burn up. There is a problem in that some of the satellites have lost stability and are already out of control and tumbling. For some time avid satellite watchers had noticed that certain IRIDIUM satellites flashes were manifesting themselves as a fast series of weak flashes rather than one longer, strong flash, a sure sign of loss of stability. The de-orbiting equipment on board would probably assume a stable orbit to operate effectively. The out-of-control satellites may not be all that easy to bring down unless this was foreseen in the design phase.

So it looks like the IRIDIUM satellites that flashed brilliantly for us for so long will end ignominiously as a final streak of light across someone's sky. Is that the sound of cheering I can hear from the astronomical community?

OSCAR-11 celebrates its sixteenth birthday.

Since its launch in March 1984, UoSat Oscar-11 has been providing a bonanza of data for educational institutions and for telemetry buffs. It was also the platform chosen to demonstrate the feasibility of digital store and forward type operation on amateur radio satellites. As such it was the forerunner of today's sophisticated high speed digital birds.

After proving the feasibility of digital communications, the design soon became out-dated as subsequent satellites came into service and the digital communications experiment was shut down after a few years of operation. However the telemetry stream is still operating as good as new after 14 years in orbit. This is testimony to the skill of the team at Surrey University who put Oscar-11 together in the amazingly short time-span of six months.

There is a dedicated band of operators around the world who make it part of their day to day activity to monitor Oscar-11's signal and copy the telemetry using a variety of programs which display the data on their computers. They check things like battery voltages and solar array currents and spin-rate. The Whole Orbit Data (WOD) provides a huge amount of detail about the satellite's "health". Seasonal trends can be followed and real-time telemetry can be downloaded as a source of up to date information.

Oscar-11 came into prominence again recently for an entirely different reason. As well as the 2 metre downlink, the satellite carries a beacon on 2.4 GHz. (a pretty far-sighted feature for 14 years ago!). This has been eagerly searched for by operators testing out their "S" mode receive equipment in preparation for the launch of Phase 3D. The Surrey people are to be congratulated for having built a satellite which has successfully bridged the enormous gap between the 80s and the new century. More information on OSCAR-11 is available at the following URL:

<http://www.users.zetnet.co.uk/clivew/>

ar

100%
of fully informed
amateurs read
**Amateur
Radio**

VHF AN EXPANDING WORLD

David K Minchin VK5KK
Postal: PO Box 789 Salisbury South Australia 5108
E-mail: tecknolt@arcom.com.au
Web page: <http://www.ozemail.com.au/~tecknolt>
Fax: +61 8 82346396
Phone: 0414 808060 (before 2130 EST please)
All times are UTC

Equinox Roundup

The last month has been hectic, for me, with trips to VK2, VK3, VK6 & VK8. This column is being written from Darwin in the middle of a substantial F2 event. I have even managed to pack the FT690R for this Darwin trip, managing to work some DX with just the internal whip! The volume of contacts that has occurred precludes the normal reporting detail so I have attempted to summarise contributions by the various VK Call areas that have submitted material.

The expected upsurge in Equinoxial 50 MHz contacts did occur with geomagnetic events leading to TE, F2 & Auroral openings over the period. The major geomagnetic storm on 5/4/00 could not have occurred at a better time setting the pace for the week that followed.

The resultant Auroral display is being proclaimed by many as Cycle 23's most intense, with numerous comparisons of the Auroral displays to the historic March 1989 ones. For those interested in looking at archives on geomagnetic storms will find them listed on the web at...

ftp://ftp.ngdc.noaa.gov/STP/GEOMAGNETIC_DATA/APSTAR/apstar.lst

New South Wales VK2

ED WP4O reports working the following. On 04/04/00 VK2BA 559 CW @ 110Z, VK2BA @ SSB 5/5, VK2BHO @ 2152Z 539, VK2FHN @ 2235z 559 & VK2FLR @ 2251Z.

Numerous VK2 Stations reported working the Caribbean on 9/4/00 with excellent signals.

Andrew VK2TWO reports working V31PC 0055z 5x5 (ek56) on Sunday 9/04/00 from his mobile/portable station, signals 5x4. "I was located at QF56OD. Berry Island reserve, 3km north west of the Sydney CDB. I was running an Outbacker Perth plus on the back of a Nissan Pulsar hatch. 100W pep with an IC706G. Distance is around 13800km. I am very impressed with this result. Especially from the mobile/vertical setup." ... VK2TWO

Queensland VK4

Ray VK4BLK reports ... On 12/3/00 the following was worked/heard by VK4BLK.. 0138Z N6XQ Jack from DM12 539/439 (see further VK6 report), TI5KD 0153 51, TI5BX 0159 51, TI5BX 0220 53, XE2UZL/B 2345 - 0030 Z 529, W1LP/MM EK04 519. On 15/3/00 VK4BLK heard 3C5I/B 2340 - 2353 Z, 429. Reception of this beacon may be the first West Africa long path (over USA) propagation for this Cycle.

On 23/03/00 Wally VK4DO worked TX0DX @ 0730Z 559 & 0851Z TX0DX SSB 55. On 27/03/00 Wally VK4DO worked 9M6BAA @ 0033Z 559 & 0042Z 9M6BAA SSB 59

On 9/4/00 Scott VK4JSR reports the following heard/worked from QG62 - TG9, V31, KP4, W6JKV/5, FO5, XE1, V73, AH8, VP6, J87, VK (1,2,3,4,5,8), ZL (1,2,3), YV, FO0, YN, TI, HP & JA. A total of 18 countries heard, 11 countries worked. During the afternoon, 48.200 and other music channels from South America were RS 59++, leading to the contact with YV.

Adam VK4CP reports hearing the

ZD8VHF beacon several times in the Long Path 2300-2330 timeslot around 13/4/00.

John VK4FNQ provides an excellent summary of DX heard and worked on a daily basis, via Email. His collective database must be impressive! The following detail's stations worked by VK4FNQ between 7/4/00 and 15/4/00, including a number of South America stations. John also worked no less than six ZS stations on 13/4/00 around 0700-0715 Z.

On 7/4/00 0257 J87AB FK93, 0308 WP4G FK68, 0311 8P9HW GK03, 0315 KP4EKG, 0316 WP4U FK68, 0526 JA3JM, 2157 KH2KU, 2159 TI5BX EK70, 2201 TI5ALF EK79, 2218 HP3XUG EJ88, 2248 KH2JU, 2252 VK8MS. 2300 VP6BR, 2309 KH8/N0JK, 2313 HP2CWB, 2316 TI2CDA & @ 2330 YV4YC.

On 8/4/00 0240 JA8GGP, 0956 EY8CQ MM48, 1100 VK2BA, 2129 TI2CDA EK70, 2134 TI5KD, 2144 VP6BR, 2244 TI5RVV, 2250 AH8LGV & 2358 YV5LIX. On 9/4/00 @ 0131 9M2/JI1ETU, 0137 9M2/JI1ETU, 1127 JM1AWR, 1304 T88JU, 2354 ZL3TIC @ 2356 ZL4WA. On 11/4/00 @ 0026 YC1HER, 0121 YC5/PA2GFL, 0133 YC1HER. On 12/4/00 0003 YB0A1, 0006 JO6EDD & 0021 YC5/PA2GFL.

On 15/4/00 @ 0256 9V1UV, 0303 JA8GG, 0529 NY6YK, 1413 BV4Q1, 1433 L43HR FF76, 1446 LU7FA FF96, 1503 LU7DZ FF78, 1507 LU1DMA GFO5PH, 1511 LU6DLB GFO5PH, 1525 JA8KC, 1531 LU4HT FF76LL, 1534 LU8MB, 1544 VR2XMT, 1549 CE4MLN. All LU and CE contacts were long path, beam 305 deg. NO SHORT PATH SIGNALS!

continued next page

continued from previous page

South Australia VK5

Joe VK5UJ reports ... "On Sunday 9/4/00 Martin VK5GN worked XE1BEF at 0227Z at signals 5 7/8. Peter VK5AWP also worked XE1BEF. On 10/4/00 VK5GN worked V73AT 59 0155Z and XE1BEF 59 at 2313Z. On 11/4/00 VK5GN worked T88JU @ 0030Z 59, T88CL @ 0100 59, XE1J @ 2344Z 59"

"The XE's were very loud, some times 59+10-20db. The XE beacon on 50.022 has been available for hours on end and itself has peaked well over the nine." ... VK5UJ.

Western Australia VK6

I spent a couple of days in VK6 recently and caught up with some of the VHF/UHF operators at Wally VK6KZ's QTH. The VK6 5 & 10 GHz beacons are operation at Wireless Hill, in Perth. The new Augusta Beacon antenna's for 144, 432 & 1296 MHz were also viewed. This beacon location will be activated by next summer. Augusta is at the Western extremity of the SW part of VK6. It is hoped it will provide propagation indication on both the North and Easterly paths.

Wally VK6KZ has since gone portable up the coast and reports the following ... "I left on Saturday 1 April for Camballin in the Kimberley where my son is the Principal of the District High School. I did a little operating on 6 metres on the way north working a swag of JAs from Port Hedland from 08.55 to 12.48 UTC on 3 April and then ZL3TY at 00.24 the following morning. From a bush camp 160 km south of Broome on the same day (4 April) from 09.49 until 10.05 worked 13 JAs and then H44PT at 10.48 followed by VR2XVD and VR2XMT at 12.25 and 12.26 UTC."

"Since arriving in Camballin PH22ca about 250 km east of Broome on Thursday 6 April, I have worked quite a number of JAs and until 15 April a total of 15 countries."

"Contacts other than the JAs include, 8 April 0830 DS1GQS, 1329 VR2XVD. 9 April 1316 T88JU, 1318 9V1JA. 10 April 00.42 YB5QZ, 0658 KH6IAA, 1020 EY8CQ. 11 April 0008 ZL2TPY, 0050 HP2CWB. 12 April 0147 KH7R, 14 April 1308 BG7OH, 1507 S21YJ. 15 April 0949 JY9NX (JY9NX was operating split with him transmitting on 50.093 and listening on 50.150 MHz)."

"One of the most difficult countries to get was VK. Finally made it with VK6JQ at Broome this morning. Have heard VK4FNQ and VK3DUT but couldn't get a contact with either." ... Wally VK6KZ

On 08/04/00 Alex EY8CQ from Tadjikistan, was worked by Jack N6XQ/VK6 (Broome, WA). I had the chance to meet Jack during my VK6 trip. Jack's portable 50 MHz set-up consists of a much modified Mizuho 50 MHz SSB Handheld running 1 Watt with packed down 3 element yagi. The complete antenna packs down to 430mm's in length with a PVC tube boom & telescoping whip elements. It can be easily packed into a rucksack. I would have loved that for my VK8 trip so will have to make one too!

On 10/4/00 VK6BE worked YB5QZ (10/4/00) at 0100Z 20 wpm CW. On 11/04/00 VK6BE worked T88JU @ 0008z 50.114 559 599 Op. JA1RJU, FK8CA @ 0052 50.111 559 579 Alain & P29PL @ 0127 50.110 559 579

Northern Territory VK8

On 9/4/00 at 1314Z VK5KK/VK8 worked VR2XVD Hong Kong FT690R 3Watts into the internal whip from the 5th story of a Hotel! VK8OT (Steve VK3OT), at Geoff VK8GF's QTH in Alice Springs, worked VR2XVD at 1317Z. The only station heard from Darwin during my stay was VK8MS. Time precluded much DX working, unfortunately.

On 16/4/00 Steve VK8OT reported having worked 25 countries, on 50 MHz, since his arrival in Alice Springs on 01/04/00

Second VK Station achieves DXCC on 50 MHz

Eric VK5LP reports ... "Following on his recent Japan Century-Cities Award for working 500 cities on 50 MHz (February AR), John Bisgrove VK4KK has achieved another milestone in the form of working 100 countries on 50 MHz. He is the second VK station to do so, the first being Steve VK3OT."

"To give him 100 countries (plus an additional couple for 'insurance', John recently worked the following: 24/3: 2102 TX0DX CW; 25/3: 2103 TX0DX CW; 27/3: 0034 9M6BAA CW; 31/3: 2242 4W6/VK2QF CW, 2245 4W6/VK2QF SSB; 2/4: 2118 CT3HF SSB 5x7. (This latter contact may be a first between CT3 and VK and it's a very

long way. Others to work the CT3 were VK4AFL, VK4CV, VK4APG, VK4CP, VK4ZAA, VK4GPS, VK4KJL and VK4PU.) Confirmations will be presented in due course."

"Congratulations to John for this difficult achievement completed after the dedication of countless hours listening to noise whilst awaiting for the sudden appearance of the required new stations. 50 MHz DXCC doesn't come easily to VK stations." ... 73 de Eric VK5LP.

East Timor DX Summaries for 4W6/VK2QF

The following was extracted from a report submitted by Neville VK2QF re his recent visit and operation from East Timor, on HF as well as 50 MHz

"In total during on air time the expected blackouts lasted for 15 hours and one especially on the 4th during a 6 metre opening to Japan removed an hour or 180 contacts! In total the 6m band opened 6 times during the expedition. Total 6m entities 15, total 6m qso's 379."

Breakdown of qso's for 6m. YB = 10, VK = 25, FK = 1, H44 = 2, JA = 316, 4W6 = 1, P29 = 2, 9M2 = 4, 9V1 = 3, V73 = 1, KH6 = 4, BV2 = 1, BG7 = 2, VR2 = 6, ZL = 2.

E/W 0 DX was Hawaii at 8,962km and N/S to Hokkaido at 5,971km. HF operation went throughout the period when schedules allowed. HF 2,741 qso's.

"Due to freight delays at the docks my rotator was not available until the evening of the 30th. Masting to hold the 6m NBS yagi was a problem. The antenna is overweight but very robust at 13kg! Ross 4W6UN wanted to move a triangular mast from the Marconi site in town where Thor 4W6MM lives but negotiating through Dili with 5m of steel on the side of a Land Rover would not have been easy!"

"The evening of the 1st of April exposed me to the type of opening that is possible from the tropics. Typically at 1130Z no indicators then weak Malay 48Mhz video is audible at 1140Z, by 1150Z it is strong and the R1 is in! At 1200Z the band is open! JA's everywhere and it's on, 180 worked plus some of the other Asian stuff such as P29, YB and 9M2."

Neville continues ... "Total sincere thanks to ROSS BALLANTYNE 4W6UN for his hospitality. Thanks to JR2KDN, JF2MBF, VK8MS, VK3OT, VK9NS\NL for the kind words of

support whilst I was there.... To conserve and share the most I carried all my food into the country and whilst there caught all my own washing water some of which I drank!" Neville Mattick VK2QF,4W6/VK2QF,

2 Metres and Above

Not as much DX to report this month. An opening to VK6AS, from VK5 (Adelaide & Mt Gambier), was noted on 15/3/00 17/3/00. Gordon VK2ZAB worked ZL3TY, ZL2TAL, ZL2VAL and ZL2TE on 2 Metres as well as ZL3TY and ZL2TAL on 70cm, later on 18/3/00. Several VK2 John Moyle Field Day portable stations throughout the day (18/3/00) also made contacts to ZL.

"Several attempts were made by VK2ZAB and ZL2TAL on 23cm with no success. ZL2TAL and ZL2VAL [running 5 watts] were still audible on 2m SSB at this QTH at 0510Z 18/3/00." ... Gordon VK2ZAB.

19/3/00 the Trans Tasman duct was still in place. Gordon VK2ZAB, Gary VK2KYP and Guy VK2KU worked Nick, ZL1TU on/after 740Z on 2M SSB at S9+ till past 0900Z.

The major geomagnetic storm on 5/4/00 resulted in Auroral Contacts from Rex VK7MO, Kingston, Tas to VK3HY, VK3CAT & VK3BDL on 6/4/00 from 2200 to 2245Z on 144.180 MHz. Other contacts were had however details are sketchy.

Ron VK3AFW reports "...After a number of attempts over several months, last night (10/4/00) Des, VK3CY, worked Tom, EI4DQ, for the first Ireland-Australia 2m EM QSO. He now has worked 73 different stations on 2m EME. Des has previously made the first QSO's on 2m EME into Brazil and Yugoslavia. Congratulations to Des." ... VK3AFW

EME DXpedition to Greenland, OX2K

Only two EME contacts have reputedly been made with Greenland on EME.

In the period from 29th of May to 6th of June a group of 25 OZ hams will activate Greenland under the call OX2K on 4 bands.

On 6m OX2K will use 4-el Yagi, 4CX1500 amp.

On 2m OX2K will use 4 long yagis, 4CX1500 amp.

On 70cm will also be 4 yagis, 2 3CX800A7 and LNAs from SSB Electronics. On

1296 OX2K will use a huge dish, shared with other services, so skeds for this band have yet to be set! Further information will be circulated via e-mail and posted on the clusters regarding 23cm.

OX2K has an EME Internet site, where all information about skeds, QSL, donation and so on can be found: <http://www.qsl.net/ox2k>. You can also send e-mail from the site, to ask questions or to arrange skeds.

OX2K will have 2 stations operating HF on all bands with yagi antennas and amps as well. Operation will be 24h a day, split operation around the IOTA frequencies.

10 GHz Portable.. Hand luggage style!

Doug VK4OE reports.. "I just thought that I would briefly describe that on my recent working trip to Melbourne, I had a nice 75km QSO 'across town' to David VK3XLD operating portable in the Geelong area. The distance is nothing remarkable, but we both got a big buzz out of the contact due on my part having brought my portable equipment in my suitcase from Brisbane, and on David's part that this was only his third ever 10GHz SSB QSO."

"David has around 1 watt and a 57cm dish, and I was using similar power to a 20dB horn antenna. An interesting phenomenon prevailed due to my location not having a clear get-away in David's direction (I don't know Melbourne as well as the locals do, in order to find a preferable operating spot). Best signals were exchanged when I was directing my 20dB horn towards an industrial building almost exactly at 90 degrees to the direct line between us, reflecting the 10GHz energy off the front face of the building." ... Doug Friend, VK4OE.

VK5 DXpedition

Our intrepid explorers, David VK3XLD (recently returned from helping VK2s to some much-needed grids) and Les VK3ZLS have now headed VK5-wards. They will be away for a couple of weeks, and activating a number of grids, including some on the Eyre Peninsula. Bands in use will be only 2m (6-el yagi + 80W) and 70cm (26-el yagi + LNA + 50W). David VK3XLD had worked VK5KK, VK5AVQ & VK5ZBK on 15/4/00 (closing time for the column!) from PF85 to Adelaide .. about

270km's on 144 MHz SSB. More next month.

ACA examines future Microwave re-allocation

The ACA has issued a great deal of information concerning the temporary or proposed re-allocation of various Frequency bands of interest to both Commercial and Amateur Users.

For example, the Olympic restrictions on 70cm in a 150km radius of Homebush, now includes the 440 - 450 MHz band. This is in addition to their existing allocation, from now until after the Paralympics. Existing links can stay, but ATV is off air for the duration.

As an epilogue (for amateurs anyway!) a paper, titled "Radiocommunications Spectrum Conversion Plan (2302 - 2400 MHz) 2000", discusses the future of this former amateur band.

The 1-3 GHz segment, in general, suffers from the highest amount of existing tenant "displacement". These displaced services are being re-allocated to higher frequency bands or other technologies.

Another paper titled "Microwave Radio Spectrum Trends" acknowledges the high interest level in Microwave allocations as witnessed in the last few rounds of Spectrum Auctions. The 150-page document examines the future re-allocation and expansion of terrestrial microwave allocations for fixed services.

Demand for microwave fixed services, especially above 10 GHz in Urban areas, is growing at 10 - 50% per annum. Telecommunications is the main driver, but also broadband wireless services (Internet access in particular) figure highly.

The only significant threat to amateur allocations, other than the immediate loss of 100 MHz of the 3.4 GHz band, concerns our 24 GHz band. The paper examines the feasibility of allocating 24.25 - 24.5 GHz and 26.5 - 27.5 GHz as it's first preference to satisfy demand for BWA spectrum.

Commercially the segment below 23 GHz has been used for some time for fixed links over 5 to 20 km's. Frequencies around 24 GHz are close to the first resonant mode of a water molecule. Consequently, atmospheric conditions are a significant factor in any link budget, however for short haul work the path loss variation can be coped with.

The current amateur allocation is from 24 - 24.5 GHz. While 24.192 GHz is the international narrowband segment, by

continued next page

Position Vacant

Senior Radio Technician

RAD-TEL Systems pioneered the use of Radio Telemetry in Australia and currently service approximately 100 Councils remote controlling water supplies and sewerage networks utilising UHF Radio Telemetry.

A vacancy exists for an experienced Radio Technician to assist in the initial set up and alignment of 450-470 MHz systems and field commissioning. The successful applicant will also be required to travel extensively aligning and maintaining existing systems from Southern NSW to Northern Queensland.

The position would ideally suit an active '432MHz home brewer' with a good understanding of and keen interest in micro processor technology willing to travel. Experience is more important than qualifications and a working knowledge of Tait and/or Maxon products would be advantageous.

Salary package negotiable commensurate with experience. Initial applications are invited in writing stating experience to:

Ken Nisbet (VK2KP)

RAD-TEL Systems Pty Ltd

PO Box 73 Thornleigh NSW 2120

continued from previous page

gentlemen's agreement the narrowband segment is 24.048 GHz in Australia. 24.048 GHz is the International satellite allocation, so it made sense to have one set of equipment to do both duties.

Copies of the above papers can be obtained from the ACA website @ www.sma.gov.au. The Wireless Institute of Australia will be making a submission for the 24 GHz allocation.

Grid Square Register

Late last year, I suggested that an activity register should be created to help new and existing stations identify whom, what and where. E.g. a Register of equipped stations listed by Grid square, by operational bands above 50 MHz and proposed active bands.

I have gathered an amount of information from submissions over the past 6 months enough to start the spreadsheet. Any list like this will be only as useful as information provided. Its main aim is to provide a locality guide. I realise that the number of grid squares worked is also of interest so that information will also find its way into the spreadsheet

Please send your details by email, by snail mail or by fax. The first draft is to be

published in August or September 2000 AR with the full spreadsheet being made available on the Web around the same time.

In Closing

John Bird reports ... "I monitor airlines via ACARS (131.55Mhz). Quite often I will pick up transmission between 2000-3500 kms from my QTH. On the 8th of March I monitored 9V-SMI a Boeing 747-400 of Singapore Airlines over Far West Australia. From the lat/long position transmitted the distance from my QTH was 2,784km." ...John Bird. I would be more than curious to know if anyone else has been logging similar events.

Thanks to all the contributors again this month. A fair amount of General info has been held over till next month. Hopefully we will see a bit more out of this equinox yet. And hopefully this Cycle is still on the UP! In the meantime will leave you with the following.

"One should always strive to make things as simple as possible.. but also be careful not to make things any simpler than that!"

Till next month

73's David VK5KK

ar

TUMUT & DISTRICT AMATEUR RADIO CLUB
AFFILIATED WITH WIRELESS INSTITUTE OF AUSTRALIA

FALLING LEAF 2000 AWARD

AWARDED FOR CONTACT WITH FOUR CLUB MEMBERS ON 80 METERS
AWARDED TO= SAMPLE CALLSIGN

CLUB MEMBERS CONTACTED
DATE=.....2000 CALLSIGN
DATE=.....2000 CALLSIGN
DATE=.....2000 CALLSIGN
DATE=.....2000 CALLSIGN

map ref.TUMUT=35.18S
=148.13E

73

MEMBER PHOTO LAKE BLOWING

PRESIDENT: M. M. M. VK2OP2
SECRETARY: J. S. S. VK2MFX

AWARDS

John Kelleher VK3DP

Federal Awards Officer

4 Brook Crescent, Box Hill South, Vic 3128 (03) 9889 8393

I must thank the many readers concerned for my medical situation. The process is not yet concluded, but I am confident of the final outcome. Physically, I will not be able to compile the column for the June issue, so please support me by sending information.

The Falling Leaf 2000 Award.

The following has been received from Bill Minogue VK2DPZ, with a request for urgent publication.

The Tumut & District Amateur Radio Club proposes to run an 80 Metre Net on Wednesday evenings commencing at 7 p.m. local time, on 3.575 Mhz +/- QRM as part of Tumut's "Festival of the Falling Leaf". An award, in colour, has been produced by the Club.

Conditions for the Award.

- 1 - Make contact with four members of the Tumut & District Amateur Radio Club on 80 metres during the year 2000, at any time of day !
- 2 - Second operators only eligible for the award, if in possession of a legal callsign.
- 3 - Please enclose a fee of A\$5.00 to cover costs and postage.
- 4 - Enclose a signed list of 4 Club members contacted, and the date of contacts.
- 5 - Post all applications to :-

The Secretary, Tumut & District Amateur Radio Club, 14 Russell Street, Tumut NSW 2720

USA - The Dear Mabel Award.

For OM operators who wish to acknowledge the kind heart, willing hands, and patient understanding of their XYL. She may not always understand, but it's important to her OM so it's important to her. OM's may nominate their XYL for this award. Send her first and last name, plus your call sign. A beautiful 8 X 11 certificate plus a letter explaining just how she earned this award will be sent to the deserving XYL. Fee is US\$4.00. Apply to :-

Florida Skip Magazine
P.O. Box 501
Miami Springs
FL 33266 USA.

Australia - The VK1 Award.

Contact VK1 stations. VK's need 20 all others need 10. All bands OK. Swl OK. GCR list and 5 Irc or A\$3.00 to :-

Awards Manager WIA VK1 Division GPO Box 600 Canberra, ACT, 2601, Australia

Australia - Wagga Wagga Award.

Sponsored by Wagga ARC, and limited to 80 m contacts. Contact Club Station VK2WG (2 points) and other club member stations (1 point each) for a total of 10 points. Stations previously worked may be contacted after 7 days for another point. Silver upgrade for 40 points (free) Gold for 100 (A\$1.00). GCR list and A\$3.00 to :-

Awards Manager WARC, P.O. Box 294, Wagga Wagga, NSW, 2650

Where's DX ?

Alain, F2HE/FO0CLA left Marquesas on 21 March and is in Tahiti. He plans to operate from some IOTA's in French Polynesia before moving to the Austral Islands. His web site is at - <http://www.ifrance.com/f2he>.

QSL XF4LWY - Ron, AC7DX is not the QSL manager for this operation. Cards should be sent to XE1LWY, Enrique Garcia M., P.O. Box 75-481 , 07300 Mexico DF Mexico.

QSL FT5WI - Cards for Alain, who will be active from Crozet until November, will be handled by F6KDF, but his logs will be available only when he returns to France.

TX0DX - This Dxpedition went QRT some 24 hours earlier than expected, due to adverse weather conditions. The web site is at - <http://www.n4gn.com/tx0dx/> for more details.

BHUTAN - The Kingdom of Bhutan has completed the long awaited Telecommunic- ations Act of 2000 which authorises amateur radio. An International team has been invited by the Ministry of Communications for the initial introduction of amateur radio in Bhutan, May 1-12 2000.

Antarctica - Operator Dave is QRV as KC4AAA from Amundsen-Scott

South Pole Station until November 2000. Look for him on 14243 Khz around 0500Z. QSL is via K1IED.

IRAN - Abdullah EP2FM, is active most days using SSB CW and RTTY usually around 0230- 0400Z. Also look for Masoud EP2ES, operating EP3PTT on Sundays and Mondays. He usually joins the LAZY-DX-NET on 14183 Khz from 1300Z on Sundays.

ZK1 North and South Cook Islands.

Gerard PA3AXU has planned a new schedule as follows :-

South Cook Islands - July 3-7 from Raratonga

North Cook Islands - July 8-15 from Penrhyn

South Cook Islands - July 15-20 from Raratonga.

For more details, check his web site at - <http://www.qsl.net/pa3axu/zk.htm>

VK9WI - Willis Island. An expedition is expected in May 2000. Check the web site at -<http://www.qsl.net/vk9wi>

Mayotte - Christian 6W1QV is signing FH/TU5DX, for the next six months. Qsl F5OGL

Nepal - Nab, 9N1AC is usually found on 40 M cw around 2300Z. Qsl via KC3AJ.

VK9C - Cocos-Keeling Islands. Bert, PA3GIO will be active as VK9CQ from IOTA

OC-003 between August 26 and Sept 1. On SSB only.

VK9X - Christmas Island. The above operator will be active as VK9XV from IOTA

OC-002 September 2-13

Moldova QSL Bureau. Valery Metaxa reports that the new address for the QSL bureau is : ARM QSL Service Bureau, P.O. Box 2942, Kishinev, MD-2071, Moldova.

SRAL QSL bureau The Finnish Amateur Radio League's QSL-bureau has a new address. All QSLs to OF-OJ callsigns should be now send to: SRAL QSL Bureau P.o.box 73 Fin-11111 Riihimaki Finland The new address is working already. Please inform your QSL-bureau. 73's de Markus Ilvonen, OH3RM Office Secretary of SRAL.

73, and good hunting de John VK3DP

CONTESTS

Ian Godsil VK3DID,
57 Nepean Highway, Aspendale, 3195
Phone:0408-123-557
E-mail: <contests@wia.org.au>

Contest Calendar May - June 2000

May 6/7	ARI International DX Contest (CW/SSB/RTTY)	(Apr 99)
May 13/14	CQ-M International DX Contest (CW/SSB/SSTV)	(Apr 99)
May 13/14	Sangster Shield NZART (CW)	(Apr 99)
May 27/28	CQ WW WPX Contest (CW)	(Feb 99)
Jun 3/4	IARU Region 1 Field Day (CW)	
Jun 4	Portugal Day Contest (SSB)	
Jun 10	QRP Day Contest (CW)	(Apr 99)
Jun 10	Asia-Pacific Sprint (SSB)	(Jan 99)
Jun 10/11	ANARTS RTTY Contest	(May 00)
Jun 10/11	South America WW Contest (CW)	
Jun 17/18	VK Novice Contest (CW/Phone)	(May 00)
Jun 17/18	All Asia DX Contest (CW)	
Jun 24/25	ARRL Field Day	
Jun 24/25	Marconi Memorial Contest (CW)	(May 00)
Jul 1	Jack Files Memorial Contest (CW)	(May 00)
Jul 8	Jack Files Memorial Contest (Phone)	(May 00)
July 15	Pacific 160 Metres Contest (CW/Phone)	(May 00)

Thanks this month to VK2TRA VK2CTD VK4TI

This month is mostly about Results. However, I particularly draw your attention to the "NEW EXCHANGE SYSTEM" below. Please look at this and let me know your thoughts.

New Exchange System

The northern hemisphere contest managers are proposing a change to the system of contest exchanges to eliminate the use of the RS(T) section.

They believe that the majority of serious contesters now use computerized logging programs and that these automatically send 59(9) before the serial number. Therefore, what is to be gained by continuing to log those numbers when the important part is yet to come?

Locally, the Australasian Sprints in July

have asked for only serial numbers for some years and some American contests have used only serial numbers for some time, so is it time that the rest of the fraternity joined in? Are there any thoughts on this, please? — especially (1) from regular users of automatic logging systems; (2) would the removal of three numbers cause serious problems?; (3) should WIA-sponsored contests become uniform with those in other parts of the world (if the proposal is adopted)?

73 and good contesting,
Ian Godsil VK3DID

NOVICE CONTEST 2000

from Robert Archer VK2TRA

Sat 17 June - Sun 18 June

0800z - 0800z

Object is to encourage amateur operation in VK, ZL and P2 and to promote contacts with Novice and Club stations. Only VK, ZL and P2 stations are eligible to compete and stations in the same call area may contact each other for contest credit.

Bands: Novice frequencies in the 10, 15 and 80 Metre bands. No cross-band operation permitted.

Categories: Single Operator, Club stations and SWL stations.

Modes: SSB and CW.

Call "CQ N" on CW, "CQ Novice Contest" on SSB and if you are involved with a club station then call "CQ Novice Contest Club Station" followed by your callsign.

Exchange RS(T) and serial number

commencing with 001 and incrementing by one for each subsequent contact. SWLs may log up to 10 sequential contacts made by a station and then log at least five other stations before logging the previous station again. The five stations so logged need be a minimum of one contact only.

Score: two points for contact with Full call stations; five points for contact with Novice / Combined stations and 10 points for Club stations.

SWLs score two points for Novice to Full and Full to Full, five points for Novice to Novice and 10 points for Club stations.

Logs headed "VK Novice Contest 2000" must show date, time in UTC, band, mode, station contacted, exchanges and total claimed score at the bottom of each page.

A summary sheet should show callsign, name, mailing address, category, section, number of valid contacts, claimed score, signed declaration showing signature of operator or responsible club officer for club stations.

Entrants may only submit one log per mode. Logs for entries where the operator uses more than one callsign whilst operating in the contest will not be accepted.

Mail logs to: Novice Contest Manager, Westlakes Amateur Radio Club Ltd., P.O. Box 3001, Teralba, NSW, 2284, by 16 July, 2000. Logs may also be e-mailed to:
<westlakes@hunterlink.net.au>

Awards include the Clive Burns Memorial Trophy for the Novice with the highest CW score and the Keith Howard Trophy for the Novice with the highest SSB score. These trophies are held at the Wireless Institute of Australia Federal Office, with a plaque being sent to both winners. Certificates will be awarded to the highest-scoring Novice in each call area and the highest-scoring station in each section. Certificates are at the discretion of the Contest Manager.

ANARTS WW RTTY Contest

from Colin Davies VK2CDT
0000z Sat 10 June - 2400z Sun 11 June

Not more than 30 hours of operating is permitted for Single Operator stations. Non-operating periods can be taken at

any time during the contest. Multi-operator stations may operate the entire contest period.

A summary of operating times is required with each single operator log.

Bands: 80 - 10 metres (no WARC)

Modes: All digital modes are permitted (RTTY, AMTOR, FEC, PKT, PACTOR).

NOTE : No satellite operation is permitted.

Categories:

(A) SINGLE OPERATOR (One transmitter)

(B) MULTI-OPERATOR (One transmitter)

(C) S.W.Ls

Exchange: to consist of RST, Time (UTC), and (CQ) Zone.

Scoring: For each band - Use the "Exchange Points Table (Marked 1994)" to obtain QSO Points for each QSO. Any contact with VK2SG earns double the table points for that QSO. Count Countries/Multis worked (see definition).

Total all bands used to obtain

- (1) Total QSO Points.
- (2) Total Countries/Multis.

World stations calculate "VK Bonus" which is 100 points for each VK worked on 14MHz: 200 points for each VK worked on 21 MHz: 300 points for each VK worked on 28 MHz: 400 points for each VK worked on 7 MHz and 500 points for each VK worked on 3.5 MHz.

Claimed Score for World Stations is calculated by multiplying

- (1) total QSO points by
- (2) total Cntry/Multis, then that total by
- (3) the number of continents worked during the contest.

(Note that each continent counts once only to a maximum of 6). To the total obtained *add* the "VK Bonus" to show Grand Total Claimed Score.

Example for World Station: 720 points from zone chart

- (1) X 29 cntry/multis
- (2) X 5 continents
- (3) = 104,400 points, plus (+) 6 VK stations worked on 14MHz (that is 600 points) giving a grand total of 105,000 points.

Claimed score for Australian Stations (VK1-VK8) is calculated by multiplying

- (1) total QSO points by
- (2) total Cntry/Multis and then that total by
- (3) the number of continents worked during the contest with a maximum of six as stated above. This calculation gives the **Grand Total Claimed Score**.

In all cases, a station may only be worked once per band, but may be worked on other bands for QSO points and multipliers.

Countries/Multis: Are counted as per ARRL DXCC list of countries, *except that* Australia (Areas I- 8), Canada, Japan, and U.S.A. mainland do not count as separate countries. However, each call area VK1 - VK8, and each call area in Canada, Japan, and mainland U.S.A. *does count as a separate multiplier*.

Contact with one's own country/multi does count for QSO points but *does not count as a multiplier*. (Remember that call areas VK1-VK8, and call areas in Canada, Japan, and U.S.A. mainland are multis).

Logs: Logs must show in this order:

1. Date
2. Time (UTC)
3. Callsign of station worked/heard.
4. Message information sent/received (RST/time/zone)
5. Points claimed.

Summary Report: Summary sheet must show : Callsign of station, name and address of operator, bands used (a separate log is required for each band), the points claimed for each band, the number of countries worked on each band, the number of continents worked and details of VK Bonus calculations for World Stations.

A summary of the calculations made to obtain the **Grand Total Claimed Score** as per the "Scoring" instruction will assist checking.

The general certification regarding compliance with Rules and the signatures and call-signs of operator(s) are also required. Multi-operator logs must contain signatures and callsign of each operator. Single-op logs must show summary of operating times. Dupe sheets will be appreciated for any band log over 75 QSOs.

Awards: Plaques will be awarded to first in World in each Classification. Certificates will be given to 1st to 5th

continued next page

continued from previous page

places in the World, and to 1st to 3rd places in each of six continents, and to 1st to 3rd in each country/-multiplier, in each Classification.. The judges decisions will be final and no correspondence will be entered into. We reserve the right to list multiple awards on any Certificate and/or vary the numbers of awards given without notice. Logs become the property of ANARTS.

Closing Date: Logs must be received by the Contest Manager, ANARTS, P.O. Box 93, TOONGABBIE, NSW, 2146, Australia, by 1 September 2000. Logs may be sent by e-mail before 25 August to: <contests@wia.org.au> and forwarded from there.

Jack Files Memorial Contest

*CW Saturday 1st July 2000,
Phone Saturday 8th July 2000
0800z - 1400z*

from Trent VK4TI

This contest sponsored by the Wireless Institute Of Australia, Queensland Division, honours the late Jack Files, a long serving VK4 WIA Councillor.

Object is for Amateurs to work as many VK4 cities, towns and shires as possible (SWL to hear and log), to encourage portable/mobile activity from the less populated VK4 shires and towns, and to serve as a warm up for the Remembrance Day Contest.

Sections

- Single operator home;
- Club fixed;
- Single operator mobile/portable;
- Club mobile/portable;
- Stations outside VK;
- Short wave listeners;

Bands 160, 80, and 40m only. The contest is in six one hour periods for the purpose of duplicate contacts, i.e. 0800-0859, 0900-0959, 1000-1059 and so on. You may rework a station at any time provided they are not consecutive QSOs and the station has not already been worked during that one hour period. Contacts with stations in other contests are valid as are contacts with DX stations. Contacts on the 80m DX window are not permitted. Cross band contacts are not permitted. SWL entrants are to include the calls and serial numbers of both

stations received, SWL entrants cannot log more than five consecutive from any one station in each one hour period.

Exchange: RS(T) followed by a serial number incremented by one for each QSO, continuing when changing bands. Multi transmitter stations should use a separate log sheet for each band. VK4 entrants send there two letter shire code after the serial number.

Score one point per QSO. Each VK4 shire/town code per band counts as a **multiplier**, as does each prefix per band. To stimulate portable/mobile activity, portable/mobile entrants can also claim one multiplier per band for each VK4 shire/town/city they operate from.

Final score equals total points multiplied by total multipliers.

In this contest only single operators are permitted to have a log keeper. Club stations can use multiple transmitters, provided there is only one station on each band at any one time.

Definitions: A mobile/portable station is one which uses a portable power source i.e.: car battery, solar or portable generator power, and a temporary antenna system.

Logs: attach a summary sheet showing name, postal address and callsign of the entrant, section entered, operator names and calls, station location, equipment used, points claimed, and a declaration that the rules and spirit of the contest were observed.

Send logs to: Jack Files Contest, WIAQ, GPO Box 638, Brisbane 4001. email <awards@wiaq.powerup.com.au> by Friday, 1st September, 2000, to be eligible.

N.B. Contacts made during the contest are eligible for VK4 awards without the need for QSL confirmation. Email the manager for information on awards.

VK4 City/Town/Shire Codes

AL Albert; AC Aramac; AN Arakun (R); AT Atherton; BL Baloone; BA Banana; BC Barcardine; BO Barcoo; BH Bauhinia; BT Beaudesert; BY Belyando; BD Bendemere; BG Biggenden; BX Blackall; BV Boonah; BQ Booringa; BZ Bouila; BW Bowen; BN Brisbane; BS Broadsound; BP Bulloo; BU Bundaberg; BI Bungil; BK Burdekin; BR

Burke; BE Burnett; CB Caboolture; CS Cairns; CL Calliope; CA Caloundra; CM Cambooya; CD Cardwell; CP Carpentaria; CT Charters Towers; CH Chinchilla; CF Clifton; CY Cloncurry; CK Cook; CN Crows Nest; CR Croyden; DY Dalby; DL Dalrymple; DI Diamantina; DG Douglas; DU Daringa; EA Eacham; ED Eidsvold; EM Emerald; EK Esk; ET Etheridge; FZ Fitzroy; FL Flinders; GT Gatton; GH Gayndah; GD Gladstone; GC Gold Coast; GI Goondiwindi; HT Herberton; HB Hervey Bay; HK Hinchinbrook; JE Jericho; JO Johnstone; JY Jondaryan; KY Kilcoy; KK Kilkivan; KG Kingaroy; KO Kolan; LA Laidley; LV Livingstone; LC Logan; LO Longreach; MC Mackay; MA Mareeba; MO Maroochy; MB Maryborough; MK McKinlay; ML Milmerran; MN Mirani; MV Miriam Vale; MT Monto; MZ Mornington (R); MI Mt Isa; MM Mt Morgan; MU Mundubbera; MY Murgon; MX Murilla; MH Murweh; NN Nanango; NE Nebo; NO Noosa; PO Paroo; PD Peak Downs; PY Perry; PR Pine Rivers; PT Piusworth; QL Quilpie; RC Redcliffe; RD Redland; RI Richmond; RH Rockhampton; RM Roma; RO Rosalie; SA Sarina; ST Stanthorpe; TB Tambo; TA Tara; TM Taroom; TE Torres; TV Townsville; WG Waggamba; WO Wambo; WR Waroo; WA Warick; WH Whitsunday; WI Winton; WD Wondai; WC Woocoo.

(R) = restricted area for radio transmission (Shire entry permit required).

Pacific 160m Contest 2000

*Saturday, 15 July, 2000
0700 - 2300 UTC*

Object: for P2, ZL and VK stations to make as many contacts as possible on 160 metres. DX stations are encouraged to participate, but may only work P2, ZL or VK.

Categories: Single Operator; SWL

Modes: CW; SSB; MIXED

Frequencies: CW: 1828 - 1840 kHz.
SSB: 1843 - 1875 kHz

(Note: Guard band J 849 - 1843 kHz. Contacts not permitted)

Exchange: RS(T) plus serial number beginning at 001.

Score: For P2, ZL, VK -

One point for QSO with own call area; two points for other call areas in ZL or VK;

three points for Pacific Islands (ZK1, VK9)

For Pacific Islands –

one point for QSO with own call area;
three points for P2, ZL, VK;
five points for QSOs outside P2, ZL,
VK.

For stations outside P2, ZL, VK or
Pacific Islands –
five points per QSO.

Multiplier: For P2, ZL, VK – total
number of VK, ZL and P2 call areas
worked, plus OTHER DXCC
countries. For stations outside P2, ZL,
VK – total number of P2, ZL and VK
call areas worked.

Final Score: Total QSO points times total
multipliers.

Certificates: to top scorers in each mode,
call area of ZL and VK and in each
DXCC country.

Logs: Please show full details of name,
address; station; category; mode; time
UTC; exchange. Include Summary
Sheet and signed Declaration.

Send Logs:

1. By mail to –

Ian Godsil VK3DID,
57 Nepean Highway, Aspendale, 3195,
Australia

2. By e-mail to <contests@wia.org.au>
by 12 August, 2000

Marconi Memorial Hf Contest

24 - 25 June

1400z Sat - 1400z Sun

Object: To work as many stations as
possible world-wide.

Bands: 160 - 10m (no WARC). 10
minutes rule applies.

Mode: CW.

Categories: Single Operator low power
(max 100w o/p); QRP (max 5 w o/p).
Multi-operator.

Exchange: RST plus serial number
starting at 001.

Score: One point for each verifiable
QSO.

Multiplier: Each DXCC country worked
may be counted as one multiplier. This
multiplier can be counted once per
band.

Final Score: Total QSO points times total
multipliers.

Logs: Separate logs for each band.

Include Summary Sheet showing all
details and signed declaration.

Send Logs by disk in ASCII format, or by
mail to: ARI sez. Di Fano, PO Box 35,
1-61032 Fano (PS), Italy, by 25 July.

Logs may be sent by e-mail to:

<ik6ptj@qsl.net>



The VKDX Association is sponsoring the **Sydney Gold — the Gathering of the Nations Award**

*to commemorate the Sydney
Olympic and Paralympic Games*

The award aims to encourage Sydney,
Australian, and DX stations to contact
Radio Amateurs in the Sydney area, and
applies to contacts made between 1 July
and 31 December 2000.

For the purposes of the award,
"Sydney" is defined as New South Wales
postcode areas 2000 to 2249, 2560 to
2570, and 2745 to 2770.

The award will be issued in three levels:

- **GOLD** for contacts on three or more
bands
- **SILVER** for contacts on two bands
- **BRONZE** for contacts on one band.

Australian and New Zealand stations
require 30 contacts to obtain the
award; stations in other countries
require 15 contacts. Repeat contacts
in a 24-hour period are not counted.

To encourage Sydney Limited and
Novice grade licencees to obtain the
award, contacts may be made via
repeaters, and mobile contacts may
be included using the mobile
operator's home postcode.

Applications for the award and proof of
contacts follow General Certification
Rules.

The application should show callsign of
the station worked; band; mode;
signal report and postcode received;
UTC date and time.

Two licenced Amateurs must certify that
the details of the log extract are
correct.

**To claim the award, send your log
details, and \$10 Australian to: —
The Secretary,
VKDX Association,
PO Box 299, Ryde NSW 1680,
Australia**

For further details, please write to the
address above, or phone John Saunder
VK2DEJ on (02) 9809-5686.

*(Please note that this award should not
be confused with the "Sydney Award"
sponsored by the WIA NSW Division.)*

BERU 2000

Comments from Russ Coleston VK4XA

The Commonwealth contest, known as the BERU, was held over
a 24 hours period during the weekend of 11 - 12 March.

This "CW ONLY" contest has retained its
popularity for 63 years, despite declining
support from Australian stations. This
year, Canadian stations were particularly
active. The only areas not heard were VE8
and VE0. UK stations as usual, were
working hard for overseas contacts, as no
local call areas, apart from the "HQ"
station GB5GC, are available to them.

In Australia, the NSW Division of the
WIA used the special event call,
AX2000, which was activated by
VK2AYD, as a "HQ" station. The other
Australian "HQ" station was VK4WIA,
operated by VK4XA. Canada operated
several "HQ RAC" stations.

Propagation on the lower frequency
bands, 40 and 80 metres, was below
normal. Only VK and ZL stations were
heard on 80 metres, whilst on 40 metres
only a few UK and VE stations were
heard, apart from VK and ZL. 20 metres
provided a continuity of contacts

throughout the 24-hour period. A large
number of UK and VE's, plus local call
areas and DX stations, 9J2, VP9, ZB, P2,
5B, 9G, ZF and 9H, were all good signals
and easily worked. 15 metres remained
open most of the time also, again with
good DX stations as for 20 metres. 10
metres was swamped by Canadian
stations, plus several ZL's, a few VK's and
DX. ZF, V# and 5B4, were easily worked.

Overall an interesting and friendly
contest where you meet old friends
perhaps once a year.

The top contest stations dominated, and
serial numbers around 800 were heard
with 90 watts and suburban backyard
antennas, VK4XA had 333 QSOs for the
VK4WIA HQ station. Greater
participation by VK's in next years'
contest would be welcomed.

73 de Russ Coleston VK4XA

ar

VHF-UHF Field Day Results

— Spring 1999, Summer 2000

Both went well. The 6 hour section single operator was well supported in the Summer Field Day (FD). Few single operators work for 24 hours. Propagation for the Spring FD was ordinary. CW is just about non-existent. Knowing your grid square helps both you and your contacts. Good scores get better if you can work more squares from more squares. In the Spring FD VK6KZ, VK5AIM, VK5UE and VK3KAI had 4. In the Summer FD VK5KAI had 5!

Working on more bands helps a lot. The

12, 9, 6 and 3cm bands need a bit of prearranging but get lots of points.

Scoring raised a few questions particularly for 6m contacts. Most logs were well presented, but in both FD some logs had to be scored from scratch. The scoring tables requested in the rule were not always submitted. These tables help a lot in vetting the logs.

In each FD one or more call areas were not represented. I was wondering if the Spring FD were moved to the first weekend

in November if that would allow more VK4 participation.

Congratulations to Geelong ARC for winning the club section in each FD. Peter, VK3KAI, gets special mention for getting into 5 squares and Charlie VK3KLO did well in his first VHF FD.

Thank you all for your participation, hear you in November 2000.

John Martin VK3KWA
Contest Manager.

SPRING VHF-UHF FIELD DAY 1999: RESULTS

Contest Manager: John Martin VK3KWA

Numbers in brackets show the number of locator squares worked on each band.

Call	Name	Locator(s)	6 m	2 m	70 cm	23 cm	12 cm	6 cm	3 cm	TOTAL
Section A: Single Operator, 24 Hours										
VK5AR	A. Raftery	PF96	22 (1)	396 (9)	430 (6)	-	-	-	-	848
VK5UE	C. Low	PF85.86,95,96	91 (7)	273 (7)	465 (7)	-	-	-	-	829
VK5AIM	S. Mahony	PF85.86,95,96	91 (7)	273 (7)	465 (7)	-	-	-	-	829
Section B: Single Operator, 6 Hours										
VK6KZ	W. Howse	OF77,78,87,88	73 (5)	324 (7)	520 (7)	592 (5)	660 (5)	530 (4)	650 (5)	3349
VK3KAI	P. Freeman	QF21,22,31,32	66 (5)	294 (7)	485 (7)	520 (5)	550 (4)	-	-	1555
VK3WRE	R. Edgar	QF31	59 (4)	354 (8)	455 (6)	472 (4)	550 (4)	-	-	1477
VK3JED	T. Langdon	QF22	29 (1)	213 (4)	260 (3)	368 (3)	-	-	-	870
VK3CAT	T. Middleditch	QF22	42 (2)	270 (6)	315 (4)	-	-	-	-	627
VK3YE	P. Parker	QF22	39 (2)	210 (3)	230 (2)	-	-	-	-	479
VK7JG	J. Gelston	QE39	47 (3)	201 (6)	112 (2)	-	-	-	-	360
Section C: Multi Operator, 24 Hours										
VK3ATL	GARC (1)	QF21	33 (2)	672 (17)	860 (13)	624 (5)	-	-	-	2189
VK5SR	SERG (2)	QF02	34 (2)	351 (8)	310 (4)	272 (2)	-	-	-	967
VK3AEF	(3)	QF03	32 (2)	474 (10)	425 (6)	-	-	-	-	931
VK3EM	(4)	QF23	58 (3)	336 (7)	345 (4)	-	-	-	-	739
VK2IBT	(5)	QF56	42 (2)	243 (3)	220 (2)	-	-	-	-	505
VK2FSC	FSC ARC (6)	QF43	-	363 (9)	-	-	-	-	-	363
Section D: Home Station, 24 Hours										
VK3BDL	M. Goode	QF22	39 (2)	585 (15)	615 (9)	408 (3)	-	-	-	1647
VK3BJM	B. Miller	QF22	63 (3)	501 (10)	535 (6)	432 (3)	-	-	-	1531
VK2TWR	R. Collman	QF43	-	390 (11)	590 (9)	147 (1)	-	-	-	1127
VK3GK	L. Moyle	QF22	39 (2)	312 (7)	245 (2)	328 (2)	-	-	-	924
VK3CY	D. Clarke	QF13	-	498 (12)	375 (5)	-	-	-	-	873
VK3AL	A. Elliott	QF22	-	99 (2)	180 (2)	368 (3)	-	-	-	647
VK3CAT	T. Middleditch	QF22	45 (2)	285 (6)	270 (3)	-	-	-	-	600
VK5LP	E. Jamieson	PF94	-	165 (4)	165 (2)	-	-	-	-	330
VK3DID	I. Godsil	QF22	27 (1)	84 (1)	-	-	-	-	-	111

(1) Geelong Amateur Radio Club: C. Gnaccarini VK3BRZ, L. Sim VK3ZLS, D. Learmonth VK3XLD, A. Gnaccarini (SWL).

(2) South East Radio Group: C. Hutchesson VK5DK, T. Niven VK5NC, T. Aubrey VK5EE.

(3) J. Bywaters VK3AEF, W. Day VK3SWD.

- (4) L. Enriquez VK3EM, G. Sneddon VK3YY, C. Goetze VK3TXA.
 (5) K. Standen VK2IBT, N. Bowden VK2HT, W. Thompson VK2MGE.
 (6) Far South Coast ARC: P. Thomas VK2WPT, K. Bell VK2US, G. McDonald VK2FGM, C. Bell (SWL).

SUMMER VHF-UHF FIELD DAY 2000: RESULTS

Contest manager: John Martin VK3KWA

Numbers in brackets show the number of locator squares worked on each band.

Call	Name	Locator(s)	6 m	2 m	70 cm	23 cm	12 cm	9 cm	6 cm	3 cm	TOTAL
Section A: Single Operator, 24 Hours											
VK3WRE	R. Edgar	QF31	-	822 (17)	990 (12)	984 (7)	670 (5)	220 (1)	330 (2)	-	4016
VK2TWR	R. Collman	QF44	112 (7)	390 (7)	585 (7)	504 (4)	-	-	-	-	1591
VK3EK	R. Ashlin	QF42	82 (6)	507 (11)	510 (7)	352 (3)	-	-	-	-	1451
VK5AR	A. Raftery	PF97	Check log								

Section B: Single Operator, 6 Hours											
VK3KAI	P. Freeman	QF21,22,30,31,32,21	(1)	372 (5)	590 (5)	816 (4)	650 (1)	-	-	-	2449
VK3XPD	A. Devlin	QF21	-	336 (8)	430 (6)	568 (5)	210 (1)	330 (2)	330 (2)	210 (1)	2414
VK3KAB	D. Williams	QF21	-	336 (8)	435 (6)	560 (5)	210 (1)	330 (2)	330 (2)	210 (1)	2411
VK3AFW	R. Cook	QF22	80 (5)	567 (13)	480 (6)	-	-	-	-	-	1127
VK4OE	D. Friend	QG62	-	156 (3)	250 (3)	344 (3)	210 (1)	-	-	-	960
VK3YE	P. Parker	QF22	34 (1)	300 (4)	365 (3)	-	-	-	-	-	699
VK2KU	G. Fletcher	QF56	-	297 (7)	300 (4)	-	-	-	-	-	597
VK4EV	R. Everingham	QG62	-	186 (4)	176 (1)	-	-	-	-	-	362
VK5UE	C. Low	PF95	36 (2)	120 (2)	190 (2)	-	-	-	-	-	346
VK5AIM	S. Mahony	PF95	36 (2)	120 (2)	190 (2)	-	-	-	-	-	346
VK4LP	J. Lemura	QG62	-	186 (4)	115 (1)	-	-	-	-	-	301
VK2YJS	J. Sortland	QF56	-	102 (2)	-	-	-	-	-	-	102

Section C: Multi Operator, 24 Hours											
VK3ATL	GARC (1)	QF22	214 (14)	843 (17)	1120 (14)	1128 (8)	-	-	210 (1)	210 (1)	3725
VK5SR	SERG (2)	QF02	-	327 (8)	405 (6)	560 (5)	-	330 (2)	580 (4)	550 (4)	2752
VK5ARC	SCARC (3)	PF94	61 (3)	516 (9)	490 (6)	-	-	-	-	-	1067

Section D: Home Station, 24 Hours											
VK3KLO	C. Kahwagi	QF22	99 (5)	609 (11)	900 (10)	784 (5)	-	-	-	-	2392
VK3BJM	B. Miller	QF22	82 (4)	480 (9)	625 (7)	720 (5)	-	-	-	-	1917
VK3BDL	M. Goode	QF22	113 (7)	510 (10)	660 (8)	600 (4)	-	-	-	-	1883
VK3GK	L. Moyle	QF22	39 (1)	324 (6)	400 (4)	472 (3)	-	-	-	-	1235
VK3CAT	T. Middleditch	QF22	89 (5)	390 (7)	370 (3)	-	-	-	-	-	849
VK2CZ	D. Burger	QF56	-	165 (3)	250 (3)	184 (1)	-	-	-	-	599
VK3CY	D. Clarke	QF13	-	180 (3)	230 (2)	176 (1)	-	-	-	-	586

- (1) Geelong Amateur Radio Club: M. Trickett VK3ASQ, L. Sim VK3ZLS, G. Noss VK3HQ, C. Gnaccarni VK3BRZ, J. Barrand VK3DFL, D. Learmonth VK3XLD, C. Leone VK3BCL, P. Hapgood VK3ATI, A. Gnaccarni (SWL).
 (2) South East Radio Group: T. Niven VK5NC, C. Hutchesson VK5DK, T. Aubrey VK5EE.
 (3) South Coast ARC: S. Callow VK5PCY, B. Bates VK5KB
 (4) J. S. Bates (SWL).

RESULTS OF VK/ZL OCEANIA CONTEST 1999

Serious followers of the VK contest scene know that each October sees the staging of the VK/ZL/OCEANIA Contest. While it may not be the best-patronized of Australian contests, it is nevertheless our premier world-wide event – in fact, one of the few Australian contests that invites DX participation. For several years the manager has been Neil Penfold VK6NE and I take this opportunity to say a sincere “thank you” to him for a lot of work in receiving and checking logs and compiling results. The Frank Hine VK2QL Memorial Trophy is presented each

year to the CW entrant with the highest score. This year's winner is that well-known Australian contestant **John VK4EMM**. John is no stranger to high scores in contests and this year he notched up 3815735 points. Congratulations John! However, we should not overlook another equally well-known VK contestant in **Martin**



John Loftus
VK4EMM

continued next page

continued from previous page

VK5GN. He, too, has a consistent history of high scoring over many years and this year won the SSB section. The only trouble is that the rules don't make any recognition of a special award for that feat!

The Contest Manager sent some statistics on the 1999 event, viz VK logs received were only 12 for Phone and nine for CW. As he says, "hardly a popular contest!" His feeling is that perhaps the time has come to discontinue the contest. I feel that that would be a shame, as I know that many operators "up there" quite enjoy

working us VKs and ZLs. Also, being optimistic, I hope that more of you will join in our contests next year!!!

Because of limitations on space, the results here are for VK and ZL only. However, full results are available on the Internet at: <http://www.sk3bg.se/contest/> or from me.

Congratulations to all those who took part and thank you. See you again.

Ian Godsil VK3DID Federal
Contests Co-ordinator.

VK/ZL/OCEANIA RESULTS 1999

OCEANIA

AUSTRALIA

PHONE

Call	80	40	20	15	10	Total
VK2APK				557968		557968
VK2FHN			5451	238050	20475	521268
VK3AJJ	29110	3780	214590	242048	51600	2204264
VK3ER		3000	115720	75044	10224	621452
VK3IO			No details supplied			383350
VK4UC			52852	317900	45440	2217330
VK4EMM		5950	26535	195674	491895	2081489
VK4PJ			156	1800		3145
VK5GN		5610	63375	479382	302364	2575126
VK5AM				983252		983252
VK7JAB				280		280
VK8AV		45	288	27510	48	39296

CW

Call	80	40	20	15	10	Total
VK2AYD	250	4200	49226	195566	144096	1329408
VK2APK	560	90090	109125	217932	91161	214800
VK2QF			19118	73612	63825	464490
VK4EMM	90	352800	124215	163374	284928	3815735
VK4TT			28321	37488	7680	218040
VK5GN			202872			202872
VK5AGX			17380			17380
VK6ZH				330000	218400	429300
VK8AV					237600	237600

Check Log — VK3AMD Thank you.

NEW ZEALAND

CW

	80	40	20	15	10	Total
ZL2AGY		263245	64155	99120	1511074	2401165
ZL2BR		12100	87862	223368	56400	1321439
ZL2AIH	40		5063	20768	2835	79032
ZL6QH	16500	687750	82812	462146	363312	6868476

PHONE

	80	40	20	15	10	Total
ZM1IM			256	24738	507	39162
ZL2AZ		180	1716	15	88032	140940
ZL3TX	10		120	12		656
ZL6QH	1200	31825	220854	452978	497724	18251912

ar



Ross Christie, VK3WAC
 19 Browns Road, Montrose 3765, Vic.
 Email Vk3wac@aol.com

DX returns to AR

It has been over a year since the last 'How's DX?' column by Stephen Pall VK2PS in *Amateur Radio*. The column was a great guide to current happenings on the HF bands and for what was planned for the future. I could not imagine a magazine dedicated to Amateur Radio that did not contain a DX column, so I put my hand up to take up where Stephen left off. Stephen will be a difficult act to follow as this is my first attempt at writing for a magazine.

DX chasing means many things to many people. There are the dedicated DX chasers who have magnificent multi-rig stations with huge arrays of yagi beams, and then the QRP operator who likes to try his hand among the big guns (I have a lot of respect for these guys!). I operate a rather modest station comprising an IC746 running 100Watts to a full size G5RV via an ATU and a 20/15m dipole. I mainly operate on 30m and above with the occasional visit to 40m. My DX outlook is restricted; living in the lee of a very tall hill restricts any signals to/from my South to South-East, e.g. South America and Antarctica. Still, I manage to work my fair share from elsewhere.

Can YOU help?

Amateur Radio magazine belongs to the members of the WIA. It is also read by some who are not WIA members, but no matter who reads it they read it for the information pertaining to our hobby. Similarly, this column is by and for members of our hobby, and for the column to be relevant, it will need up to date and accurate information. I have contacted a few overseas groups and DX columnists for pointers to current and accurate information. But AR is an Australian magazine and we should report DX from a VK point of view. To do this I will need your help. Any details or information you can provide on current or proposed DX or upcoming DXpeditions will be appreciated. Also, if you have any ideas what to include in the column please send them to me.

DX News

- JAN MAYEN, JW. Per, LA7DFA, is QRV for 6 to 12 months as JX7DFA. Activity will be on 160 to 2 metres,

using CW, SSB, SSTV and digital modes, including PSK31. QSL via his home call.

- ANGOLA, D2. Fernando, EA4BB, will be back in Angola for a year as D2BB. He will be taking his trusty Drake TR7A and a 6 el yagi and some wire to make some dipoles. QSL route is via W3HMK.
- CHINA, BY. Look for BX5AA on 24923 kHz around 1550z and also BX4AF on 21089 kHz using RTTY at 1500z.
- JAPAN, JA. One for the IOTA operators. Masa, JA6GXX, will be active from Danjo Archipelago, IOTA AS-056, until July 11. He will be active at various times, mainly operating during his spare time. QSL via his home call.
- LAOS, XW. Hiroo, JA2EZD, is QRV as XW2A until early May on all bands and modes. QSL via his home call.
- MAYOTTE, FH. Christian, FH/TU5AX, is looking for QSO's on 6 metres. He says he will be listening on 50.110MHz beginning around 1450z. He can sometimes be caught on 14260 kHz after 0330z and on 10 metres between 28470 and 28500 kHz after 1200z.
- MARTINIQUE, FM. Jacques, F6BUM, will be active as FM/F6BUM from April 27 till May 4. QSL via home call.
- REUNION ISLAND, FR5. Mattheiu, F5PED, has been active as FR5DC since November. He is very active on 80-10 metres CW. Last reports found him on 24898 kHz at around 1520z.
- PALAU, TT8. Jean Luc, F5BAR, will be active as TT8JLB until July. His activity has been mainly CW on 15, 12

and 10 metres. Check 10 and 15 metres after 2200z, sometimes after 1630z. QSL via F5BAR.

- WILLIS ISLAND, VK9WI. David, VK4ZEK, reports that the Dept of Meteorology has allowed an additional operator, P.J Garden, VK4APG, to land on the island, this brings the number of operators to 5. There has also been a change of the DXpeditions 6m-beacon frequency due to crystal frequency availability. The beacon will now operate on 50.515 MHz. Also, operation on 160, 80 and 40 should now be possible, thanks due to George Taft, W8UVZ, for sending a 'Battle Creek Special' antenna.
- BHUTAN, A5. Bhutan has apparently changed their telecommunications laws to allow amateur radio again. An international team consisting of 9VIYC, JA1IG, JA3USA, JF11ST, K3VN, K4UEE, N0MJ, N1DJ, OH2BU, ON4WW, RA3AUU, UA3AB, W0GJ and W3WL have been invited by the Bhutani Telecommunications Ministry to re-introduce amateur radio operation from 1 - 12 May. Three CW, three SSB and an RTTY station will operate 24 hours a day for the duration.
- A multi-national team including Marq, CT1BWW, Mario, DJ0MW, and Yuki, JA9QX, will be active from Alcoutim Castle as CT6C on May 1st for 24 hours. Then, on May 3rd and 4th they expect to be active from Castro Marim Castle as CS5M. To wrap things up, they will finish their tour at the Lighthouse of Vila Real Sto. Antonio on May 5th and 6th as CQ7Q. This is an

continued next page

continued from previous page

important event as this will be the first amateur radio operation from this important lighthouse in Southern Portugal, near the Spanish border. QSL all via the bureau. (Courtesy of Bernie, W3US, Dailydx.)

- OMAN, A4. Tony Selmes, A45ZN, will be back in Muscat, Oman. Tony is returning for three months starting April 19th. His favourite mode is CW.
- ASCENSION ISLAND, ZD8. Jim, N6TJ, is expecting to be back on Ascension Island as ZD8Z beginning May 25th. Jim will put in an effort in the CQ WPX CW Contest and will remain on the island until June 3rd. QSL via VE3HO.

This month's details have been made possible with information provided by Tedd, KB8NW, the OPDX Bulletin, The 599Rpt, DXNL, QRZ DX, 425 DX News.

DX Cluster activity and recent loggings.

I intend to setup a DX cluster monitoring system in the shack so as to get a feel for

what is happening on the bands. Jack, VK3WWW and Tony, VK3TI demonstrated one at a recent EMDRC meeting in Melbourne. It was an impressive display of amateur technology and one that should be very useful to DX'ers. It should provide some good information on who is currently active and from where. Some recent loggings on the DX clusters revealed the following interesting stations.

40m 7X2RO, 9E1C, CE0ZR, FR5FD, FY5KE, TI4CF, TT8JA, V31JP.

30m 3B8MM, FM/F5JOT, J79KS, S79MX, TZ/DF8AN, V31JZ, ZF2LC.

20m 4W/W3UR, FO0HWU, VK0MM.

17m E4/G3WQU, TX0DX, VP6BR, XW2A.

15m 4W6GH, ZK1HCU.

12m 3B8MM, A35MQ, CE0ZR, FR5FD, PA3GIO/HC8, YS1RR.

10m 4W6EB, 9E1C, 9G5MD, 9U5D, H44PT, TA4/DL7CM.

SV2ASP/A Monk Apollo has been active on RTTY from Mount Athos recently on 14086 after 2100z.

ZC4RAF UK Sovereign Bases on Cyprus,

Colin has been active on 14269 from 1815-2100z. QSL via 5B4YX.

Round up

Most of the above information has been gleaned from Internet DX sources and has been edited down to what I believe will be interesting to VK amateurs. Hopefully you will find the information useful and interesting. I will try and source some information on some upcoming DXpeditions for next month's column. The northern hemisphere is heading into their Spring and Summer seasons so perhaps we will hear of some interesting operating from there. Remember: if you hear of some interesting news regarding HF operating please drop me a line so we can all share in it. Best DX and 73.

Sources

Thanks and recognition are due to the following people and organisations. Tedd KB8NW, Tomas NW7US, the OPDX Bulletin, The 599Rpt, DXNL, QRZ DX, 425 DX News and Bernie, W3US's Dailydx.

ar



S.P. Smith VK2SPS
9 Peak Street Bateau Bay NSW 2261
(H) 02 4334 7743

Rhythmic Sounds - not Dots and Dashes

There is no easy way to learn morse, it is a matter of hard and constant practice, practice and more practice.

Morse code as heard over the air consists of rhythmic sounds denoting letters, numbers and punctuation and has nothing to do with dots and dashes which is sometimes recommended to us through other teachings.

If we were all musically inclined which by the way I am not, we could use musical notation and set the dots and dashes down as "Quavers" and dotted "Crotchets" with the appropriate rests between them.

I will now explain to you how to set about learning morse, but firstly to consider briefly where other systems fail.

Letters of the alphabet are denoted by various combinations of a short sound, commonly referred to as a "Dot (.)" and a sound three times the length of a dot but referred to as a "Dash (-)".

Between each dot and dash there is a

space equal to a dot; between each dot and dash combination representing a letter of the alphabet, there is a space equal to three dots and between each word there is a space equal to five dots.

The letter "N" for example is represented by a long sound followed by an interval of a dot and then by a short sound. This can easily be hummed or whistled, which represents the letter "N" as heard by another operator over the airways. Unfortunately it is usually called Dash-Dot and written down as (- .)

The unfortunate effect of this dash-dot inscription may perhaps be realised when it is said that an expert operator can easily read at speed, a morse transmission that is either hummed or whistled to him. On the other hand if he sees a message written down as a series of "Dots and Dashes" he will usually only be able to read it slowly and in a halting manner. Similarly if the sender, instead of humming the sound, actually speaks the words dot and dash when sending the

various letters, the receiving operator will be at a complete loss.

A skilled operator would have no difficulty in glancing at a page of a book and humming it out rapidly in morse code, would fail miserably if asked to speak it out by using the words dot and dash, or to write it down using (.) and (- .). It can often be said that the skilled operator trained to read by sound is usually not much of a hand at deciphering a morse message sent by a signaling lamp or flag.

In conclusion having discovered at some length the incorrect way to learn morse and seen why it is incorrect, we are now in a proper position to consider the correct way, and what is more important is to understand why it is the correct way. The 2nd & conclusive part of this article inadvertently appeared in April's Issue.

Until then best of wishes,

VK2SPS Stephen P. Smith 73

Ref: This article was taken from *Wireless Word*. November Issue 1939, pgs 13, 14 and 15.

ar

IONOSPHERIC UPDATE

Predictions show that the solar cycle is now expected to reach its maximum around December this year. While this cycle is not expected to match the previous two, volatility in conditions indicates that similar radio opportunities are possible. The trick is to be there when it happens as picking the time will not be as easy. It's one of those times when science becomes art.

To quote the Ionospheric Prediction Service bulletin: *At this time of the solar cycle, space weather conditions are frequently determined by short timescale events, not able to be forecast a week in advance.*

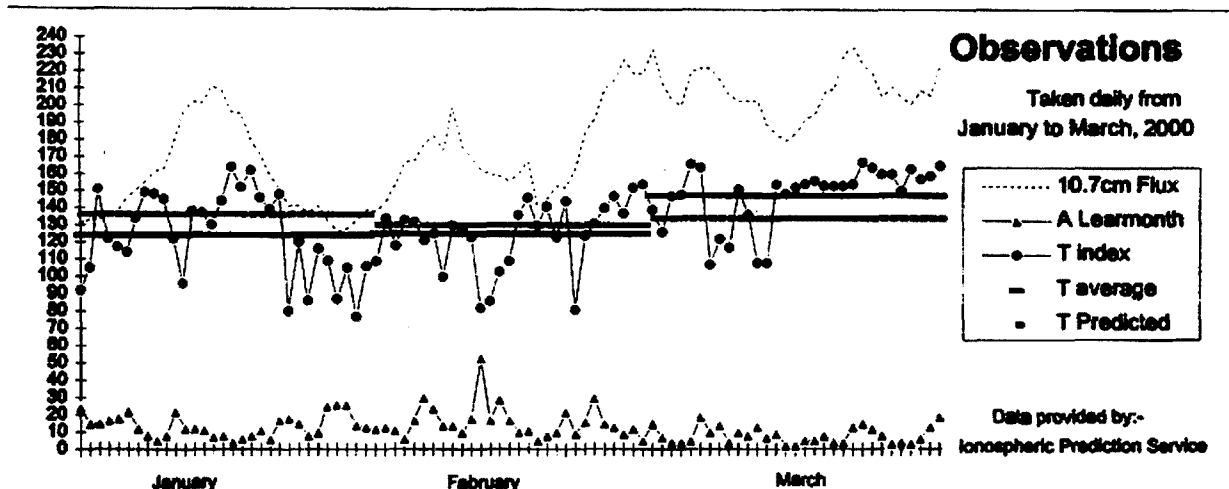
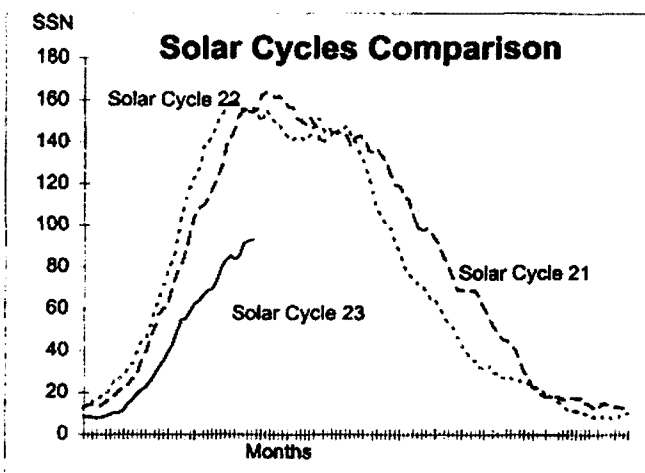
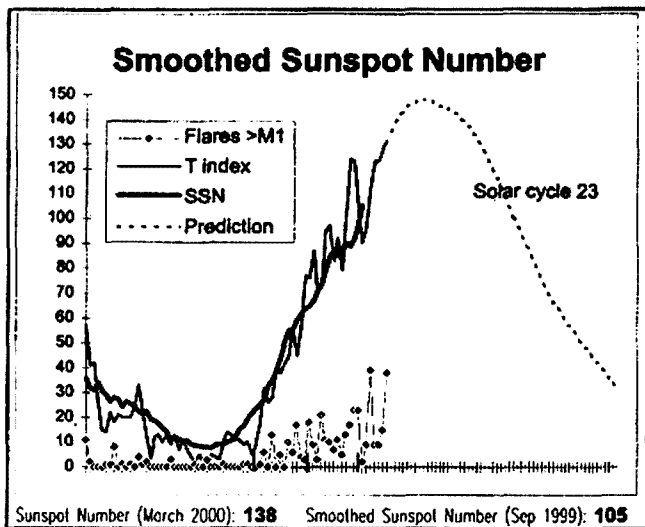
A graph comparing the last three solar cycles is again included this quarter. It includes about half a year's more data. The graph gives more shape to the current solar cycle making it clear that this cycle will not be like the previous two: they were exceptional.

Solar activity is picking up. A flare in early April was the largest for over a decade. A subsequent severe geomagnetic storm starting on 6 April was behind the poor propagation at the time. The Canberra A index rose to 51 and 37 over the consecutive days. The K indices (which are averages over three hours) shows the severe activity was uniform for about 24 hours spread equally between April 6 and 7. For us that would be on April 7 as all times in space weather reports use UTC. It was an early warning of the effects of higher solar activity for some people who are affected by these things: an electricity grid in Scandinavia blacked out. More on this next quarter when the results are in.

As we move into the times high in the sunspot cycle, this sort of activity will become more frequent and more extreme.

During the last quarter, solar activity followed the rotation of the sun. The rise and fall in the solar flux shows the 27 day solar rotation clearly. Flare activity also increased. Not only did the number of flares increase each month during the quarter, the strength of flares is also increasing. It adds to the volatility in conditions and is something to expect at this stage of the solar cycle.

Ionospheric conditions are also more variable. The Ionospheric Predictions Service has issued 26 HF Radio Communications Warnings during the quarter: 11 in January, 10 in February and 5 in March. HF warnings are issued to users requiring certainty in their radio circuits and so would not themselves be of interest to the radio amateurs. Volatility in conditions can mean an increase in the number of warnings correlating to an increase in the number of opportunities for communication on frequencies above the upper decile frequency which would interest amateurs more.



HF PREDICTIONS

by Evan Jarman VK3ANI

34 Alandale Court, Blackburn Vic 3130

These graphs show the predicted diurnal variation of key frequencies for the nominated circuits.

These frequencies as identified in the legend are:-

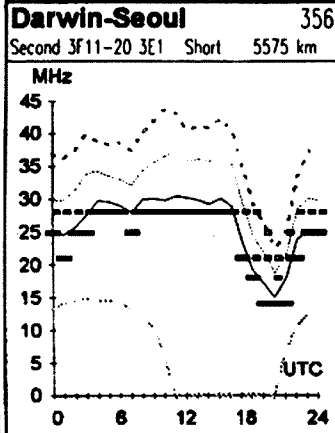
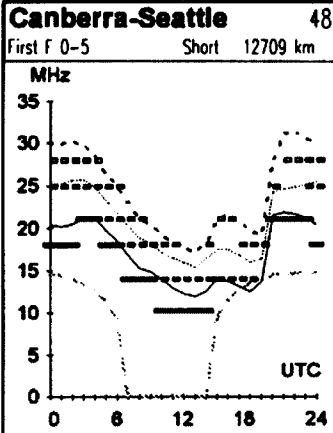
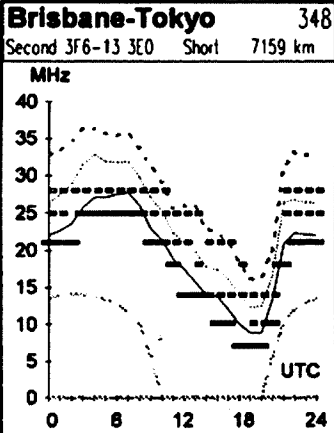
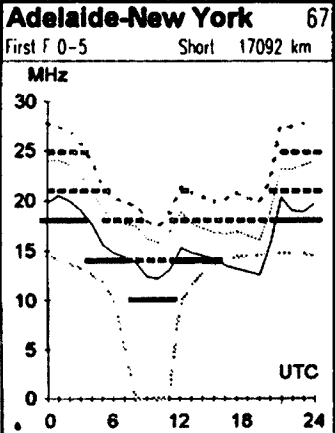
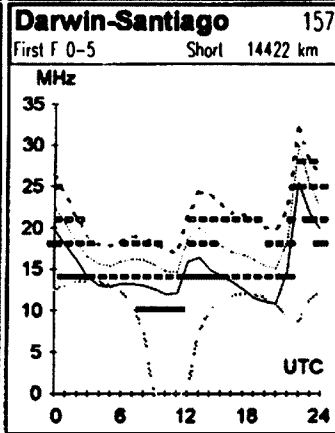
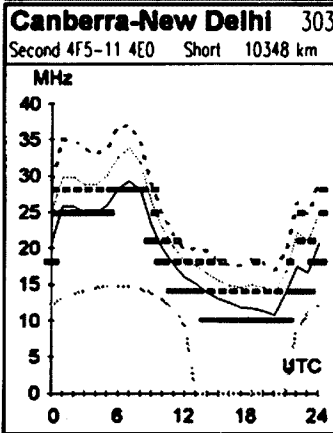
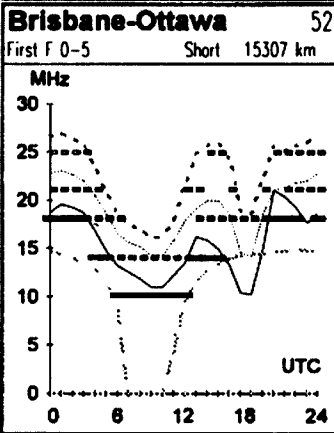
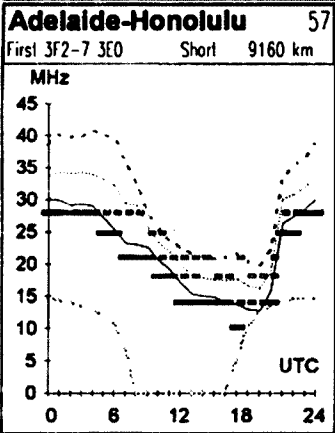
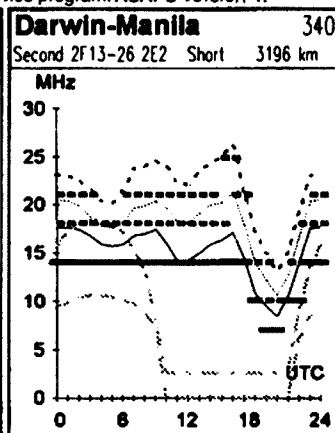
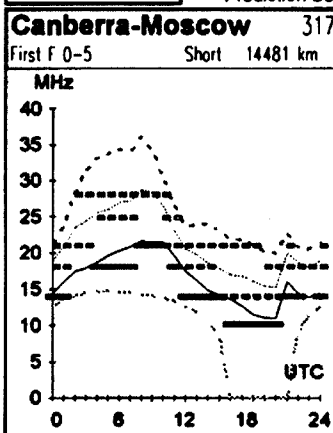
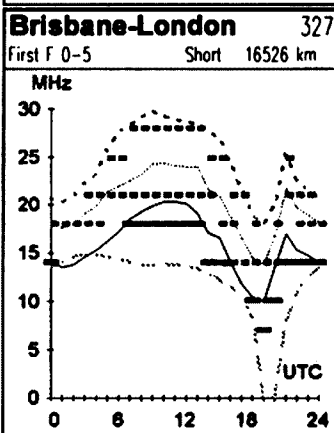
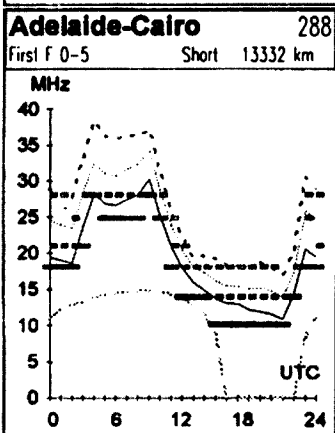
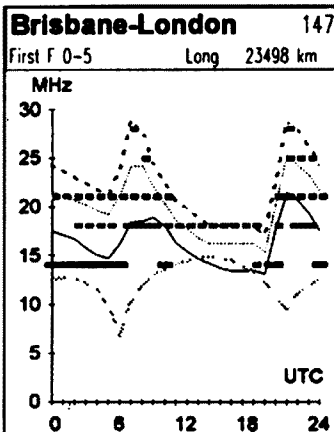
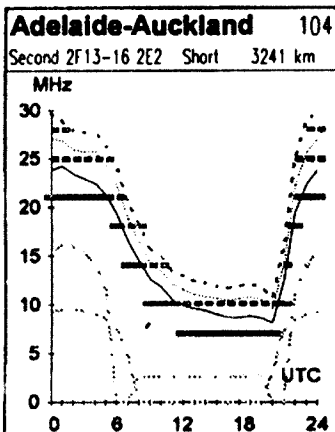
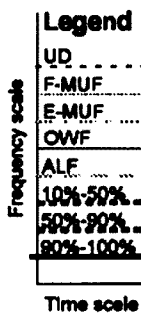
- Upper Decile (F-layer)
- F-layer Maximum Useable Frequency
- E-layer Maximum Useable Frequency
- Optimum Working Frequency (F-layer)
- Absorption Limiting Frequency (D region)

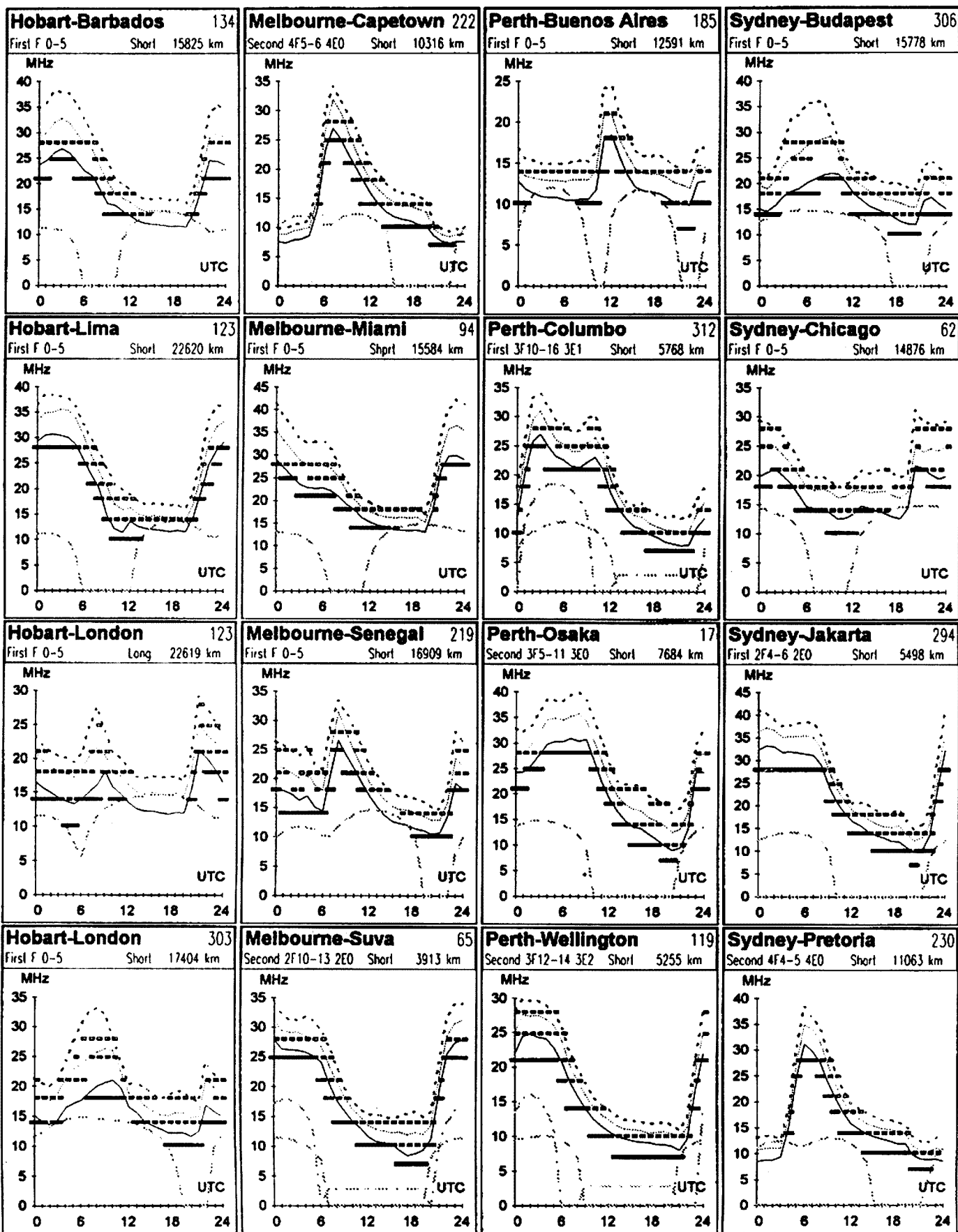
Shown hourly are the highest frequency amateur bands in ranges between these key frequencies; when usable. The path, propagation mode and Australian terminal bearing are also given for each circuit.

These predictions were made with the tonospheric Prediction Service program: ASAPS version 4.

May
2000

T Index: 133





HAMADS

- Hamads may be submitted on the form on the reverse of your current Amateur Radio address flysheet. Please print carefully, especially where case or numerals are critical.
- Please submit separate forms for For Sale and Wanted items, and be sure to include your name, address and telephone number (including STD code) if you do not use the flysheet.
- Eight lines (forty words) per issue free to all WIA members, ninth and tenth lines for name and address. Commercial rates apply for non-members.
- Deceased estates Hamads will be published in full, even if the ad is not fully radio equipment.
- WIA policy recommends that the serial number of all equipment for sale should be included.
- QTHR means the address is correct in the current WIA Call Book.
- Ordinary Hamads from members who are deemed to be in general electronics retail and wholesale distributive trades should be certified as referring only to private articles not being re-sold for merchandising purposes.
- Commercial advertising (Trade Hamads) are pre-payable at \$25.00 for four lines (twenty words), plus \$2.25 per line (or part thereof), with a minimum charge of \$25.00. Cheques are to be made out to: WIA Hamads.
- Copy should be typed or in block letters, and be received by the deadlines shown on page 1 of each issue of Amateur Radio, at:

Postal: Newsletters Unlimited, 29 Tanner Street, Richmond, 3121

Fax: 03 9428 4242

E-mail: news1@webtime.com.au

Please only send your Hamad once

Please send Hamads by mail OR fax OR snail (much preferred).

Please do not send by more than one method for any one ad or issue, it is confusing.

FOR SALE ACT

- Icom IC 725 All HF bands \$800. IC120 Automatic Antenna Tuner to match \$200. Alinco ARL-22HT 144 MHz 45 W \$200. Yaesu YC55D frequency meter to 200 MHz \$75. VK1ABU QTHR (02) 9328 1261 (AH)

FOR SALE NSW

- 6146W, 6146A, 6146B Tubes (matched pairs) and 12BY7A Driver Tubes Phone 041311-4953 or email vk2slo@ausham.zzn.com
- **BOOK: Radiotelegraph and Radiotelephone Codes, Prowords and Abbreviations.** 2nd Edition. \$16 posted Australia. 90 Pages. Q.X.Z Codes, 97 Phonetic, 20 Morse Codes. Phillips, Myer, 10,11,12,13 Codes. Much other info. Internet - <http://www.nor.com.au/community/sarc/phonetic.htm> VK2JWA, John W.Alcorn. QTHR. 02-66215217. Email jalcorn@nor.com.au
- **INTERNET** Connect from Port Macquarie to the Gold Coast from 80c per hour. Summerland Amateur Radio Club. For info - <http://www.nor.com.au/community/sarc/sarc.htm> Harry VK2XIO, QTHR, cascom@nor.com.au. PO Box 293, Lismore, 2480. Ph 02-66216096
- Yaesu FL2100B Linear amplifier serial no 8F290390, bands 80,40,20,15,10. Excellent condition, like new \$550. John VK2DAF, Bega (02) 6492 1779

WANTED NSW

- 2 metre FM Transceiver by disabled aged pensioner, radio OK if working or not. Solid state preferred. Also, HF SSB Transceiver any condition. Help me get back on air with that radio you no longer want or use! Norm VK2ZG QTHR (02) 4965 7923
- **Simplex** Auto Morse key (bug). Melbourne, Australia. Replies to- Email: jalcom@nor.com.au J.W.Alcorn, VK2JWA. QTHR, Ph 02-66215217. Please give condition and price.

FOR SALE VIC

- **Huge Telephone Equipment Sale** on Sunday 4th. June at the Club rooms of Geelong Radio & Electronics Society (VK3ANR) Unit B Plantation Reserve 237a High St. Belmont 3216 Melway Ref. 227 J10 or 451 H12. Over 160 items including ,Group Selectors, Final Selectors, Magneto Ringers, Modems, Commander Systems, lamps, Test Equipment, Tools, Insulators, 10 Line Manual Exchange, Phones, Power Supplies and much more. Viewing from 10 am, sale commences 1pm. Visit our Web Site <http://www.pccare.com.au/~keithv> for more info. or phone Keith (sec) 0352435184 or E-Mail to markes@netlink.com.au
- **Shack Clearance.** Yaesu FT23R 2m hand-held, one owner. Charger, car adapter/charger, mic/head-set, handbook etc, s/n 71764 \$200. Yaesu FT7, 80-10m. Works OK but needs TLC on 20m. Inst. manual s/n 90672 \$200. Scanner Uniden UBC9000XLT auto-scanner 25-1300 MHz. One owner c/w discone antenna, Vic frequency guide, Instruction manual. Suit new buyer s/n 55000381, original packing \$400. Sangean 10 band transistor radio, AM/FM/Stereo s/n 40152315 \$20. Icom IC22S 2m, has external switching mod., mobile bracket etc. Needs TLC. Original packing, s/n 13650 \$100. Icom IC251A 2m all-mode. Looks good, listens, but won't talk Hi (pll fault?) s/n 3028 \$250. Kenwood TR7400A 2m FM xcvr. 5/35 W Mobile bracket. You dial up the desired freq. and off-set. A good piece of gear. Original owner and packing, s/n 560812 \$200. Frequency counter Topward Model TFC-1207 10 Hz - 1GHz, s/n 830918 \$130. Cubical Quad antenna. The original 'boomless' 2 el - 3 band (20/15/10) quad. Excellent performer. built in 1959. Needs 2 new bamboo spreaders and lots of TLC. Will swap for anything useful. Offers will be considered for any of the items above mentioned. Bob VK3AQK QTHR Ph (03) 5744 1676. Email: bobrae@globalfreeway.com.au

WANTED VIC

- Solid state Deltahet receiver as featured in *Electronics Australia* in 1971. There must be somebody out there that built one. Fred VK3JM (03) 9801 4972

FOR SALE QLD

- Kenwood TS-450S. Excellent Condition ATU \$1000, s/n 31200094. Ph (07) 5463 5670
- JRC NRD-525 HF-comm rcvr with 0.5 kHz filter, NVA-88 speaker, manual, exc condx \$1200 ono. POCOM AFR-1000 autom. Baudot TOR RTTY decoder \$250 ono. Monitor MONACOR b & w 12" \$150 ono. Hans L40370 (ex HSI ALK) ph (07) 5479 4561
- Werner Wulf's 5 el Tribander 13 ft boom 10-15-20m similar to TET SH35C. See *Amateur Radio*, June 1981 \$350. VK4AIU (07) 4630 0387 QTHR
- Muirhead facsimile transmitter model D-901-B/S and receiver with power supply model no D-900-B/S G.C. \$75. Gwen VK4CB QTHR (07) 3202 7137
- Yaesu FT-7 transceiver, 80, 40, 20, 15,10, analogue, 10W s/n 8J100467, excellent condition, suit beginner or QRP \$300 or near offer. Doug VK4OE (07) 3391 5526 (H), (07) 3234 1169 (W) QTHR.
- Kenwood TS-440S Transceiver (Auto ATU), PS-50 PSU, MC50 desk mike, MC42S up/down hand mike, \$1000. Mini-Multi MSC-33 beam Antenna for 20/15/10 metres, \$150. Light weight antenna rotator, control unit and 25 metres 6 strand cable, \$60. Aluminium winch-up tower (AR November 1981), but built in 1998 with added safety features, \$1000. Manuals for all. Yaesu FT2 Auto Transceiver, \$100. 100 metres near new RG-213 Co-ax Cable, \$200. Bill VK4AWD QTHR 0407 484 939

WANTED QLD

- **WWII Services Amenities Receivers.** Australia Sound System Type V5, AWA Type 17020, Stromberg Carlson Type 6A15, Kriesler Model No 1167, also AMR 100 Comm. Rx, and MCLR1 Receiver. Ray VK4FH, PO Box 5263, Daisy Hill 4127. Ph (07) 3299 3819, fax (07) 3299 3821
- Motor required for Daiwa MR-750 Rotator. Motor labelled 'Normal Speed Type MR-750' Keith VK4TT QTHR (07) 3396 5249 vk4tt@bigpond.com
- Radio tower 30 - 40 ft. Queensland only. Ph 0741298296 or email dm622@satcom.net.au

WANTED SA

- Loudspeaker, Goodmans 15 Watt 15Ω type Akiom 150 MkII, Philips valve colour TV, probably Model X25k, year approx. 1969-70. Tektronix ISI Sampling unit. Tektronix probes P6032 & 6034. Adaptor for GR plug to UHF socket. Wallposters of Philips Delta Gun and 20ax self converging C.R.T.S. Ph (08) 8520 2988
- **Theo Barker Signals, A history of the Royal Australia Corps of the Signals 1788-1947** The Royal Australian Corps of Signals Committee, 1987. **Theo Barker, Craftsmen of the Australian Army: The story of RAEME** Crawford House Press Pty Ltd, 1992. Tony VK5UA QTHR or AH (08) 8269 4095

FOR SALE WA

- Antenna Emtron TE-23M threeband mini-beam, 6m mast, roof mounting guys \$300 ono.

Peter VK6BCC QTHR 08 9447 7005 Email: robinson@starwon.com.au

• **Shack Clearout - moving.** Kenwood TS430 FM Fitted \$700 ono. Yaesu FT707 \$500 ono. Both excellent condition C/W handbooks cases. Two AWA Forestphones handbooks unmodified \$50 each. Six position quality coax switches \$50 each. Three drawer operating table vinyl top \$100. Two superb Morse keys. Much QRP Gear ATUs SWR meters Vellaman P/S Kit. Much construction material available, many giveaways with purchases. Keith VK6KC QTHR (08)9528 3336 anytime

WANTED WA

• **Power transformer for Yaesu YO-901** Multiscope or unserviceable unit with good transformer. VK6ABS QTHR Ph (08) 9075 4136

FOR SALE TAS

• **2mTR 30w Power Amplifier.** Gavin VK7HGO Ph. 03 62724437 Mobile 0407724431 email vk7hgo@mail.com

• **Tono 150 2 metre linear amp SSB FM CW,** good cond. Twin Meter HF power SWR. Oskeabloch HF-2m SWR power meter. Kenwood IH78A 2m/70cm handheld t/ceiver, mint, complete SM33 spkr mic, BT8 Dry Cell Case, cig power adaptor, also computer access. Ph David VK7ZDJ (03) 625 2030 or 0413 219 680

• **Yaesu FT 3000m Service & Tech Manual,** new \$40. Dentron GLA1000 HF Linear 600 W O/P 80-10meters. Yaesu FRA 7700 active ant. suit Yaesu & all receivers \$40. Two metre wide band base ant. 137-174 MHz, new, low SWR \$85. Allen VK7AN (03) 6327 1171 or 0417 354 410

MISCELLANEOUS

• **FREE** if you dismantle and remove TH3 Mk3 Three element Thunder Bird antenna and 30 ft tower. No longer required. Vic VK5AGX QTHR (08) 8258 0412

• If you got your licence before 1975 you are invited to join the Radio Amateurs Old Timers Club. A \$2.50 joining fee plus \$8.00 for one year or \$15.00 for two years gets you two interesting Journals a year plus good fellowship. Arthur Evans VK3VQ or Allan Doble VK3AMD can supply applications forms. Both are QTHR in any Call Book.

• The WIA QSL Collection (now Federal) requires QSLs. All types welcome, especially rare DX pictorial cards, special issue. Please contact the Hon Curator, Ken Matchett VK3TL, 4 Sunrise Hill Road Montrose VIC 3765, tel. 03 9728 5350.

<http://www.hamsearch.com>
a not-for-profit site that is a search engine for hams

ADVERTISERS INDEX

ATN Antennas	7
Andrews Communication Systems	27
Dick Smith	OBC, 28,29
Icom	IBC
Radio & Communications	34
Tower Communications	22
WIA Call Book.....	IFC

OVER TO YOU

VK2EZQ/MM Electronic Mail via Radio

My unlicensed partner, Sue and myself, Ted VK2EZQ (G4TBF) are travelling on a 34ft yacht. The *Alice Colleen* of Montreal. In 1997 we came across Howard, KF7AZ, during our travels and he showed us how he was using Pactor to send messages home using the internet.

I would like to explain what I do and connect it with packet. My knowledge of packet activity in Australia is limited because I mostly operate Pactor on HF in order to send messages to "Nexus" (which is the internet). When I am in VHF range I can also use VHF packet Bulletin Boards (BBS) or Packet Repeaters to send my messages to "Netlink" MailBOXes (MBO). The operator of the MBO stores my message and sometime later will forward it via the internet to the address I advise. This message can be received by a person who is not an Amateur. The non amateur can send back a message via the same route.

We currently correspond with our relations in the UK and various ham and non ham friends via this method. While we were on our last overseas voyage from Newcastle NSW to Noumea Port Vila and Bundaberg at one point we experienced 6 days of gale force winds in the Tasman Sea. In this case it was a little uncomfortable to type on the keyboard so we reverted to the backup. Using Tony's maritime net on 14315 at 2100UTC I made voice contact with Keith VK2CKH near Jervis Bay. Keith sent out a short bulletin on internet email which reached all our predetermined mailing list. One friend was quite intrigued to receive a message from a storm tossed Tasman Sea, while he as touring in the

Pyrennees mountains. The backup system came in usefull for a time of the voyage when the PK232MBX Terminal Node Controller (Modem) released its "smoke" and I was not able to catch all of it. Luckily amongst the spares kit was a circuit for the modem and 2 spare RS232 interface chips which are socketed in the PK232MBX. Some burned ground trac! had to be replaced with cable and the Modem worked again. During the voyage I operated FK/G4TBF from New Caledonia waters and YJ0AZQ from Vanuatu waters.

If anyone has a PK232MBX and wants to try out operation on PACTOR be advised that the earlier versions do not have firmware to support that mode. Perhaps the required information will be the subject of a further piece as will the details of sending internet email to non hams using Packet/Pactor via Nexus.

73 de Ted, VK2EZQ/MM, QTHR
Internet: vk2ezq@amsat.org {plain text format messages only}
Packet: vk2ezq@vk2age.me.nsw.au

This message was sent from Pittwater via 7047.1 lsb to VK2AGE in Lismore.

NOTICE: Mail to the sender of this message is via a (slow) radio link. PLEASE be brief and send only PLAIN TEXT. Consult the help file for your EMail program for information on how to send Plain Text messages. Also DO NOT copy the sender's message text back to them.

Processed by Amateur Radio Station W9MR, w9mr@midwest.net using NetLink (c) 1996-99, W5EUT, KN6KB .For Help - <http://www.win-net.org>

TRADE ADS

• AMIDON FERROMAGNETIC CORES:

For all RF applications. Send business size SASE for data/price to RJ & US Imports, PO Box 431, Kiama NSW 2533 (no enquiries at office please ... 14 Boanyo Ave Kiama).

www.cyberelectric.net.au/~rjandusimports
Agencies at: Assoc TV Service, Hobart; Truscotts Electronic World, Melbourne and Mildura; Alpha Tango Products, Perth; Haven Electronics, Nowra

• **WEATHER FAX programs for IBM XT/ATs** *** "RADFAXZ" \$35.00, is a high resolution short-wave weather fax, Morse and RTTY

receiving program. Suitable for CGA, EGA, VGA and Hercules cards (state which). Needs SSB HF radio and RADFAX decoder. *** "SATFAX" \$45.00, is a NOAA, Meteor and GMS weather satellite picture receiving program. Needs EGA or VGA & WEATHER FAX PC card, + 137 MHz Receiver. *** "MAXISAT" \$75.00 is similar to SATFAX but needs 2 MB of expanded memory (EMS 3.6 or 4.0) and 1024 x 768 SVGA card. All programs are on 5.25" or 3.5" disks (state which) plus documentation, add \$3.00 postage ONLY from M. Delahunty, 42 Villiers St, New Farm QLD 4005. Ph 07 358 2785.

TRADE PRACTICES ACT

It is impossible for us to ensure that the advertisements submitted for publication comply with the Trade Practices Act 1974. Therefore, advertisers and advertising agents will appreciate the absolute need for themselves to ensure that the provisions of the Act are strictly complied with.

VICTORIAN CONSUMER AFFAIRS ACT

All advertisers are advised that advertisements containing only a PO Box number as the address cannot be accepted without the addition of the business address of the box-holder or seller of the goods.

OVER TO YOU

An open forum for members' comments
Please keep letters short: brevity gets priority

CW and Other Things Amateur

Dear Sir,
CW or No CW ? That is the question! I write this in response to Ian Godsil's article (AR, Feb 2000, p19)

I am currently studying Morse code in preparation for the final stages of AOCF. There is much discussion about the requirement of Morse code at 10 wpm, and I am tempted to take the soft option and wait for the requirement to be dropped or lowered, which seems likely. However, I will persist and I intend to master Morse code for a number of reasons.

It is my belief that if something is worth having, then it is worth working for. To require Morse code for AOCF is part of a process that restricts the amateur bands to those who are prepared to earn the right to use them. In my opinion it requires a certain determination, to win that privilege, and having been won, makes it more appreciated and valued. In my opinion, therein lies the crucial difference between the amateur bands and citizens band. I realize that this is an opinion with which others may disagree.

Secondly, some argue that there is no need to learn Morse because it is no longer an internationally recognized form of communication. After all we have mobile phones, satellite phones, GPS and other forms of technology that make CW unnecessary and obsolete. Computers can be programmed to read and write Morse code. I have even heard that computers can read Morse code in one language and display the text on the screen, translated into another language. The argument goes that if computers can do that then there is no need for amateurs to become proficient in Morse.

Well, that may be so, but what an incredible reliance on technology!

In domestic telecommunications, much use is made of "microwave links" to carry the calls. I have been advised that the microwave dishes must be precisely aligned for this technology to function smoothly. In fact, that if there is an aiming error of a mere 2° the communication system will fail. One

can only ponder how much greater is the precision and technology required to maintain the satellite communication network.

We know that this is modern technology, and nothing can possibly go wrong... go wrong... go wrong... go ... errrr. We have been assured that because the "lessons have been learnt", and communications have been upgraded, that we could never have another "Ash Wednesday", and we were told that because the Titanic was unsinkable, lifeboats were unnecessary!

The truth is that we are extremely vulnerable. A small earthquake here, a bit of terrorism there and suddenly the marvellous technology collapses into a heap of twisted, metallic junk. What then?

It is a simple project to build a direct conversion transceiver, mostly from salvaged parts, that it could be made small enough to fit in a shoebox and that using CW with 5 watts output one could "work the world". Assuming, I guess, that there is at least one other operator out there who can read Morse code! (Two circuits have been published in AR recently viz: AR Dec 99, p30, AR Jan 2000, p6)

Amateurs have played a significant role in the past during civil emergencies and disasters. (See for example AR Dec 99 p21) This is a contribution to our society that I value and cherish. I would hate to see this role die out.

The very fact that Morse code is no longer recognized as an international form of communication is the VERY BEST reason that CW should remain a requirement for the AOCF. It may well be needed in the future and we may yet rue the day of its demise.

I am not swayed by the argument that the numbers of amateurs are dwindling and therefore we need to make it easier for amateurs to become licensed. Using the same argument, would we lower the standards of medicine to attract more doctors? No! Nor should we.

Nor do I accept the argument that it is Morse code that is deterring potential amateurs. There are many competing alternatives to amateur radio, one does not

need much prompting to recognize these. Mobile phones and satellite communications have already been mentioned. In addition there is STD, ISD, the Internet and email.

Amateur radio will never compare favourably with these other forms of global communication if one focuses on convenience, reliability, cost and clarity. "Cost?" you ask, "Isn't amateur radio free?" When one considers the cost of setting up a radio shack, antennas, radios, maintenance, and licensing fees etc. the Internet wins hands down. Of course once it is all set up the price per minute goes down with amateur radio.

No, the strength of amateur radio is its technical *simplicity* not its technical superiority. Some may have become amateurs because they enjoy talking to the world. If that was their only motivation - to talk to the world, then they may be happier using the Internet or other technologies. They will probably be lost to other technologies whether or not Morse remains. Amateur radio is MUCH more than "talking to the world". It's the fascination of connecting a few scraps of wire and a few rudimentary components; the home brewing; the ability to operate *without* a reliance on technology.

The challenge is to attract more of those who would be amateurs, for what are the strengths of amateur radio. The challenge is to resist the attempt to revive amateur radio by lowering standards.

Finally, there is a lot of comment regarding congestion on various bands, and requests are made for allocation of more of the spectrum. Since CW is extremely economical in terms of band width surely its use should be encouraged and facilitated in order to ease congestion.

Sincerely yours,
Rick Lloyd.

Address all letters to the editor:
PO Box 2175
Caulfield Junction 3161
edarmag@chariot.net.au

▶ YAESU'S DONE IT AGAIN

**SCOOP
PURCHASE
SPECIAL**



Yaesu FT-100 Ultra-compact HF/6m/2m/70cm Mobile

AMAZING SCOOP PURCHASE VALUE!

Now you can enjoy the fun of operating on all bands from 160m to 70cm, either at home or in your car, and at a fantastic Yaesu price.

The new Yaesu FT-100 features HF/6m/2m/70cm transmitter coverage with 100W RF output on HF and 6m, 50W on 2m and 20W on 70cm, plus you can easily mount the detachable front panel using an optional lead (YSK-100) for more convenient mobile installations. Powerful interference fighting features such as a DSP based Bandpass filter, Notch filter and Noise reduction, together with an IF based Shift control, all aid reception quality during tough conditions. A Speech Processor and VOX facility are provided for SSB users and an internal Electronic keyer is provided for CW operation. Also included are Dual VFOs, built-in CTCSS encode, 300 memory channels, all-mode operation (SSB, CW, AM, FM, AFSK, Packet* 1200/9600bps), 100kHz-970MHz receiver (cellular locked-out), and options for additional AM and CW IF filters.

The FT-100 is supplied with an MH-42B6JS hand mic, DC power lead and comprehensive instructions.

D 3285

YSK-100 remote front panel lead. \$155

D 3286

YAESU

Included as standard:

- Digital Signal Processing on both transmit and receive
- Effective IF noise blanker
- Electronic CW keyer with 50 character message memory
- Spectrum Scope function
- Massive receiver coverage (100kHz – 970MHz, less cellular)

\$2499 **SAVE \$376**

2 YEAR WARRANTY

Offers expire 31/5/2000.

DICK SMITH
ELECTRONICS

That's where you go!

* Requires third party TNC

A World of Sound,
A World of Sight,
A World First



IC-R3

The Ultimate Handheld Receiver is here!
A first for a handheld communications receiver...
a 2 inch TFT colour screen! With super wide
0.5-2450 MHz frequency coverage for AM, FM,
wide FM and TV picture reception. LCD shows
information such as receiving frequencies, tuning
steps, and memory channel numbers.

Loaded with features like signal strength level
indication, band scope, high speed scanning, a multi-
function 'joy stick' switch, 450 memory channels
and more. A long life Lithium-Ion battery is
supplied but the unit is also alkaline battery ready.
Discover the IC-R3's world of sight and sound for
yourself soon...it's another first from Icom!

2 YR WARRANTY For the name of your nearest accredited Icom Dealer call Icom on 1800 338 915, or visit our website at www.icom.net.au





June 2000

Volume 68 No 6

Amateur Radio

Showing
Amateur Radio
to the
Community



Gil Sones VK3AUI

Technical Abstracts:

*Frequency Shifter
for Fox Hunting*

Diode Matching

Crystal Sets

Silent tuning

plus

*WIA, Divisional &
Club News*

ALARA

& regular columns

Awards
Contests

★ A Wire Log Periodic
Dipole Array

★ Making Air Wound
Transmitting Coils

★ Richard Cortis
VK2XRC goes
Up the Lazy River

★ Tracing the History of
the WIA in WA



WIA Yearbook 2000

***Callbook Listings
Frequency Listings
Band Plans
Repeater Lists
Beacon Lists
Satellite Lists
Licence Conditions
Examiner Lists
Special Interest Groups
Public Relations Notes
Radio and TV Freqs.
and much, much more!***

2000 is a great year to have an up-to-date call book. This YEARBOOK edition contains all of the content you have come to expect of the WIA callbook as well as some new items

It is more than a callbook, it's a Yearbook, the WIA Yearbook!

***The "WIA Yearbook 2000" is now available from
Divisional Bookshops
and selected outlets***



Amateur Radio

The Journal of the Wireless
Institute of Australia
ISSN 0002-6859

Editorial

Editor: Colwyn Low VK5UE
edarmag@chariot.net.au

Technical Editor: Peter Gibson* VK3AZL

Publications Committee Members

Ron Fisher VK3OM
Don Jackson VK3DBB
Evan Jarman VK3ANI
Bill Rice VK3ABP
Gil Sones VK3AUI

Advertising

Mrs June Fox,
Tel: (03) 9528 5962

Hamads

"Hamads" Newsletters Unlimited
29 Tanner Street, Richmond VIC 3121
Fax: (03) 9428 4242
e-mail: news1@webtime.com.au

Office

10/229 Balaclava Road
Caulfield, Victoria
Telephone (03) 9528 5962
Facsimile (03) 9523 8191

Business Hours 9:30am to 3:00pm weekdays

Postal

P.O. Box 2175
CAULFIELD JUNCTION
VICTORIA 3161
AUSTRALIA
e-mail: armag@ hotkey.net.au

Production

Newsletters Unlimited (03) 9428 3458

Printer

Streamline Press, Melbourne (03) 9417 2766

Postal Service

IMS (03) 9291 5888

Production Deadlines

Advertising booking and articles for
publication 10th of preceding month.

Hamads and advertising material deadline
18th day of proceeding month

The contents of Amateur Radio are Copyright
Wireless Institute of Australia
C 2000

Our cover this month

MDRC at the St Kilda Hobby Show.
Tony VK3JED and Tony VK3CAT
(centre) adjusting rigs just before
satellite pass. Terry VK3KBD looks on.

General

WICEN (Vic) wears a proud feather	5
Many a Slip on the way to the true story. The initial years of the Wireless Institute of Australia (WA)	9
<i>D Handscomb VK6ATE</i>	
Forever YL. Ladies In Amateur Radio (Western Australian style)	12
<i>D Handscomb VK6ATE</i>	
Up The Lazy River	14
<i>Richard Cortis VK2XRC</i>	
Australia's first IARU conference: A time for decision making	24
<i>Jim Linton VK3PC</i>	

Technical

Making "Air Wound" Transmitting Coils	6
<i>Drew Diamond VK3XU</i>	
A Wire Log Periodic Dipole Array	16
<i>Robert Hancock</i>	
Frequency Shifter for Fox Hunting (Technical Abstracts)	20
<i>Gil Sones VK3AUI</i>	
Diode Matching (Technical Abstracts)	20
<i>Gil Sones VK3AUI</i>	
Crystal Sets (Technical Abstracts)	21
<i>Gil Sones VK3AUI</i>	
Silent Tune (Technical Abstracts)	21
<i>Gil Sones VK3AUI</i>	
An AM/CW Transmitter for 1.8, 3.5 and 7 MHz (Concluded)	16
<i>Drew Diamond VK3XU</i>	

Columns

Advertisers' Index	55	Education	23
ALARA	13	Hamads	55
AMSAT Australia	45	HF Predictions	52
Awards	36	New Members	2
Club News	18	Novice Notes	42
Contests	38	Repeater Link	50
DX Notes	26	Silent Key	2,35
WIA Division News		Spotlight on SWLing	51
VK1 Notes	31	Technical Abstracts	20
VK2 Notes	31	VHF/UHF - An Expanding World	47
VK3 Notes	32	WIA Comment	3
VK4 Notes	33	WIA News	3
VK7 Notes	34	WIA Division Directory	30
5/8 Wave	35	WIA Federal Directory	2
Editor's Comment	2		

Contributions to Amateur Radio

Amateur Radio is a forum for WIA members' amateur radio experiments, experiences opinions and news. Manuscripts with drawings and or photos are always welcome and will be considered for publication. Articles on disc or email are especially welcome. The WIA cannot be responsible for loss or damage to any material. A pamphlet, How to write for Amateur Radio is available from the Federal Office on receipt of a stamped self-addressed envelope.

Back issues

Back issues are available directly from the WIA Federal Office (until stocks are exhausted, at \$4.00 each (including postage within Australia) to members.

Photostat copies

When back issues are no longer available, photocopies of articles are available to members at \$2.50 each (plus an additional \$2 for each additional issue in which the article appears).

Disclaimer

The opinions expressed in this publication do not necessarily reflect the official view of the WIA and the WIA cannot be held responsible for incorrect information published.

Amateur Radio Service

A radiocommunication service for the purpose of self-training, intercommunication and technical investigation carried out by amateurs; that is, by duly authorised persons interested in radio technique solely with a personal aim and without pecuniary interest.

Wireless Institute of Australia

The world's first and oldest
National Radio Society
Founded 1910

Representing
The Australian Amateur Radio Service

Member of the
International Amateur Radio Union

Registered Federal Office of the WIA
10/229 Balaclava Road
Caulfield North Vic 3161
Tel: (03) 9528 5962 Fax (03) 9523 8191
http://www.wia.org.au

All mail to
PO Box 2175 Caulfield Junction VIC 3161

Business hours: 9.30am-3pm weekdays

Acting Federal Secretary

Peter Naish VK2BPN

Federal Office staff

June Fox Bookkeeper
Rita Trebilco VK3IF Examinations Officer

Council

President	Peter Naish	VK2BPN
VK1 Federal Councillor	Glenn Dunstan	VK1XX
VK2 Federal Councillor	Michael Corbin	VK2YC
VK3 Federal Councillor	Brenda Edmonds	VK3KT
VK4 Federal Councillor	David Jones	VK4OF
VK5 Federal Councillor	David Box	VK5OV
VK6 Federal Councillor	Will McGhie	VK6UU
VK7 Federal Councillor	Phil Corby	VK7ZAX

Executive

Peter Naish VK2BPN
John Loftus VK4EMM

Federal Coordinators

AMSAT	Graham Ratcliff	VK5AGR
ARDF	Jack Bramham	VK3WWW
Awards	John Kelleher	VK3DP
Contests	Ian Godsil	VK3DID
Education	Brenda Edmonds	VK3KT
FTAC	John Martin	VK3KWA
Historian	John Edmonds	VK3AFU
IARU	Grant Willis	VK5ZWI
Intruder Watch	Gordon Loveday	VK4KAL
ITU Conference and study group	Gilbert Hughes	VK1GH
OSL Manager (vks, vko)	Neil Penfold	VK6NE
Videotapes	VK2 Division	
Web/PR	Richard Murnane	VK2SKY

ACA Liaison Team

Peter Naish VK2BPN
Glenn Dunstan VK1XX
Michael Corbin VK2YC
Wally Howse VK6KZ
Canberra Liaison Officer
Richard Jenkins VK1RJ

AR lives on...

Well I am still here. I am receiving input so Amateur Radio will live on.

I was told that the May editorial in QST was well worth reading. I found it most interesting. It was saying (to me) that real Hams were those who loved radio and all that came with it. A licence was not a necessity. Why some people get licences has changed and other forms of public communication have provided solutions to some peoples needs.

However real hams are still out there building equipment, operating equipment, developing new concepts, listening for DX, operating on Field Days, providing communications in emergencies. Then there is training to be able to respond to calls for communications, help in sporting events of all kinds, helping make JOTA or JOTI a success, teaching the courses to enable people to get licences at all ages. Helping fellow amateurs when

they have a job to do, which is beyond their capabilities, and more (I suppose there is more) is all part of being a real Ham.

Now that Morse testing for access to HF bands is no longer flavour of the month (though I know the discussion will continue), what should we be doing as Amateurs to improve our hobby? Please let me know.

In OTU I have had to edit some letters but I hope I am letting people know your concern. However there will be at most two pages for OTU so I hope to have so much material that I have to summarise some topics.

This month's ending: if you have a problem in Amateur Radio first talk to friends, then your local club, then your State Division, then if necessary test the wider waters with a letter to the Editor.

New Members

The WIA bids a warm welcome to the following new members who were entered into the WIA Membership Register during the month of MARCH 2000

L10176	MR S P O'NEILL	VK3FDT	MR D R TOMPKIN
L31551	MR G BEAUCHAMP	VK3FIC	MR Y HASHIMOTO
L31552	MR T TRAVERS	VK3HEW	MR P RICHTER
VK1EL	MR L LAWLOR	VK3LSB	MR S BEMBRICK
VK2AAT	MR J HAZLEWOOD	VK4IK	MR H A WOODWARD
VK2BDR	MR D S RITCHINGS	VK5GH	MR W R G HOLMAN
VK2CT	MR S REEVES	VK5NTT	MR A D BECKMAN
VK2ZDD	MR C JONES	VK7ZPG	MR G P FRITH
VK3ADA	MR R ADAMS		

Silent Keys

The WIA regrets to announce the recent passing of:-

I J BRYAN L20327	J L (JIM) TOBIAS VK3MMD
LJ BAILY L70134	G (Ronald) Clayton VK4BGC
E N NAPPER VK2FIN	L E HAUBER VK5EZ
C (Athol) Pritchard VK3CP	



Peter Naish, VK2BPN
WIA Federal President.

WIA policy prepared for IARU

The Annual Convention of the WIA Federal Council was held in Melbourne at the end of April. Most of the time was spent on the formulation of WIA Policy in preparation for the IARU Region 3 Meeting in Darwin later this year. It was an intensive but highly productive event and some important strategies were established. The Papers for presentation at the Darwin meeting have now been prepared in accordance with these policies. A special WIA web site has been set up to provide information on the IARU Region 3 meeting and it is proposed that access to the WIA papers will be made available soon through this site.

Improved communication between WIA and Amateurs

Also at the Convention, time was set aside to review the possible reasons why many radio amateurs are not members of the WIA. Some useful thoughts were tabled and discussed. It was clear to the Council that the WIA needed to be more reactive to its members requirements and to provide a better understanding to all amateurs of what the WIA had achieved on their behalf. It also needed to inform them about how it was dealing with the many issues that concern the amateur radio service. Each of the Federal Councillors took back to their respective Divisions a determination to improve on the present situation and thereby encourage more amateurs to join and participate actively in the WIA.

ACA reviews "news bulletins" regulations

The ACA recently reviewed the long-standing facility that allows regular news bulletins to be transmitted by WIA stations. It appears that there is no provision for them in the current Radio Communications Act. To resolve this anomaly the ACA propose to modify the amateur radio service Licence Condition Determination (LCD) to incorporate an appropriate additional statement. Details are expected shortly.

One matter that was brought to light by the ACA during their review was the practice by some Divisions of transmitting on behalf of members "sales and wanted advertisements". The transmission of advertisements by radio amateurs is strictly forbidden under the Radiocommunications Act. The ACA have therefore now requested that no such advertisements be carried in these news bulletins even though this may have been tolerated in the past.

It is unfortunate that this service has had to be curtailed but discussions with the ACA by the WIA have confirmed that the ACA are not able or willing to let the advertisements to be continued.

The regular transmission of news bulletins by authorized stations is a vital service to all radio enthusiasts and it is important that the ACA has now recognised them as such by their proposed LCD change.

ar

Prepared, researched and compiled by
Richard Murnane VK2SKY, Federal News Coordinator

Sydney Games Take Another Bite of 70cm 444 MHz ATV operations cease in Sydney basin

The Australian Communications Authority is to allow some Olympic Games radio services to access the 440-450 MHz segment of the 70cm Amateur band. This in addition to the 421-422 MHz and 424-432 MHz segments set aside last year. This new allocation is effective immediately and will continue until the conclusion of the Paralympics on 30 October 2000.

The ACA says, "Existing amateur services will be afforded the usual consideration in regard to interference protection at the time of licensing." with the exception of Amateur Television operations (ATV channel 2), which must cease operation immediately

Games services will be operating on a primary basis in the band and, hence, receive interference protection from Amateur services.

WIA Federal President Peter Naish comments:

This is not a withdrawal of this part of the band (apart from its use by TV operators) but notice that there will be authorised use by non-amateur stations that will be afforded primary status. Amateur licensees will be expected to cooperate to prevent interference to these Olympic operators.

The full text of the statement from the ACA can be found at [http://www.wia.org.au/BandPlans/OlympicsUHF.html#440-450 MHz](http://www.wia.org.au/BandPlans/OlympicsUHF.html#440-450%20MHz).



...a Golden Opportunity to Promote Amateur Radio

We mentioned recently that one of Hollywood's latest offerings,

"Frequency" features Amateur Radio.

Peter Ellis VK1KEP tells us that Village Roadshow will release Frequency in Australia on 3rd August. Ok, so we get to see our hobby on the big screen, but will we sit by passively and let a golden opportunity slip by?

Amateur Radio operators across the United States have seized the opportunity to promote the hobby, approaching local cinemas to place advertisements for their clubs, and operating Amateur stations in the cinema lobbies. They are providing live demonstrations of HF and VHF voice operations, satellite operations, Amateur television and more.

The cinema managements have enthusiastically supported the Amateurs running the stations - it garners extra interest for the movie, of course - and the Amateurs stand to gain new members for their clubs and secure a better future for their hobby.

What will you be doing when Frequency arrives?

“...And That’s the News”

The Australian Communications Authority (ACA) is to modify the Amateur Station LCD to permit the transmission of bulletins of news and information services.

To avoid any conflict with the Broadcasting Services Act 1992, the proposed additional wording to be inserted into the LCD will be:

“The licensee may use an amateur station for the purposes of transmitting news and information services about amateur radio as a means of initiating intercommunication”

While there may be no actual ‘intercommunication’ as a result of the WIA’s news and information services, as long as there is an intention that intercommunication could take place (and that we encourage it), that is enough.

To omit the ‘intercommunication’

phrase runs the risk that your news services could be construed as open narrowcasting services as described in the Broadcasting Services Act.

WIA Federal President, Peter Naish VK2BPN comments, “Please note that the transmission would better be described as a ‘Bulletin of News and Information Services’ rather than a ‘News Broadcast’ to avoid confusion with the Broadcasting Act.

More importantly, the ACA has asked for confirmation that all “for sale announcements” have now ceased.

(via QNEWS)

The International Telecommunications Union WRC 2000

The ITU is holding a World Radiocommunications Conference in Istanbul in May-June 2000. Over 2000 delegates from 140 countries are expected to attend.

The object of this conference is to amend the International Radio Regulations, which have the status of a treaty between nations.

The International Radio Regulations cover Frequency Allocations, Technical Standards and Operational Regulations

Amateurs will be affected by decisions in the following areas:

1. The revision of the already set spurious emissions limits. This will affect the design and use of amateur transmitters, as any increase in the stringency will make it more difficult for amateurs to comply using their current equipment. It is also hoped to align the spurious requirements for amateurs using satellites with the general level for amateur stations which is less stringent than earth stations in satellite services. This is particularly important for amateurs using satellites who use the same transmitters for non-satellite work
2. A move to introduce Synthetic

Aperture Radars belonging to Earth Exploration Satellite Service in 430-440 MHz band. We know this will cause interference to amateurs. The object of this radar is to study tropical forests.

3. Proposals looking at additional frequencies for a further GPS system called Galileo. Some are looking at the 23cm band and this could add an undesirable sharing companion that could make things difficult for amateur microwave enthusiasts.
4. 71 GHz and up. Although amateurs use these bands very infrequently at present, the wrong decisions could impair their future usefulness to the amateur services.
5. Additional frequencies for the mobile satellite service. A number of countries are looking hard at frequencies between 100 and 1000 MHz. Unsubstantiated claims are made as to their sharing ability.
6. Additional bands for IMT2000. This is the next generation of mobile services and does not confine itself to voice. Some countries have amongst

GPS Accuracy Improves

Automatic Position Reporting System (APRS) enthusiasts and users of Global Positioning Satellites (GPS) not only in Australia but globally will welcome a recent statement by the President of the United States to stop degrading GPS accuracy.

This decision became effective at midnight on 1st May, and means civilian users of GPS will be able to pinpoint locations up to ten times more accurately than they could before.

President Clinton said “We have demonstrated the capability to selectively deny GPS signals on a regional basis when national security is threatened.

Civilian users will realize a dramatic improvement in GPS accuracy. For example, emergency teams responding to a cry for help can now determine what side of the highway they must respond to, thereby saving precious minutes. This increase in accuracy will allow new GPS applications to emerge and continue to enhance the lives of people around the world.

From <http://www.whitehouse.gov/library/PressReleases.cgi> and <http://www.igeb.gov/> via QNEWS

their target bands 2300-2450 MHz.

7. Discussion of the spectrum around 7MHz where at the moment the matter of harmonization between the HF broadcasters and amateurs is on the agenda for the next conference. The IARU policy is to seek a world wide 300 kHz allocation
 8. The amateur article in the Radio Regulations S25 will be discussed in relation to its maintenance on the agenda for the next conference. It is of course this article that contains the reference to the Morse Code qualification requirement. There are a number of other amendments to this article that are contained in the IARU FASC report which have been adopted by the regional organizations
- The WIA ITU Conference and Study Group Coordinator, David Wardlaw VK3ADW, has worked on the ACA committee preparing for WRC 2000 in order to make sure the amateur position on all these issues is recognized and receives the support that it should. The WIA work was greatly helped by the vast amount of work done internationally by the IARU

WICEN (Vic) wears a proud feather



Minister for Police and Emergency Services

27

55 St Andrews Place
Melbourne, Victoria 3002
GPO BOX 4356QQ
Melbourne, Victoria 3001
DX 210077
Telephone: (03) 9651 6900
Facsimile: (03) 9651 6910

Mr G Cornell
State President
Wireless Institute Civil Emergency Network
P O Box 106
MITCHAM VIC 3132

Dear Mr Cornell

VICTORIAN UNIT MERITORIOUS SERVICE AWARD

It is with pleasure that I write to inform you that I have decided to confer the Victorian Unit Meritorious Service Award upon the Wireless Institute Civil Emergency Network (WICEN) for its involvement in designing, installing and operating a communications network to provide contingency communications for emergency response co-ordination leading up to the year 2000.

The award also recognises the significant ongoing contribution of WICEN to emergency management in Victoria.

I am proud to confer this Award, on the basis of the recommendations put before me.

It will be my pleasure to present this Award to WICEN and would be pleased if you could contact Ms Diane Sainato of my office to make arrangements for a suitable date.

Yours sincerely


ANDRÉ HAERMEYER
Minister for Police and Emergency Services



WICEN (Vic) Inc Executive receives the presentation from the Minister

Making "Air-Wound" Transmitting Coils

Drew Diamond, VK3XU
45 Gatters Rd.,
Wonga Park, 3115

In applications such as antenna couplers and power amplifiers, where substantial amounts of power are involved, the most popular coil type would probably be "air-wound". That name seems to be applied to any skeletal coil whose turns are supported by insulated ribs, or a single sheet of (say) perspex, rather than a tubular former. Quality (Q) is significantly improved by having a minimum of supporting material in actual contact with the coil wire. And the air-wound style permits easier tap connections to be made to individual turns.

Unfortunately, sources of "Air-Dux" (TM) and "B&W" (TM) coils of appropriate size have just about dried up. Which is frustrating, because amateurs like to make their own linear amplifiers and antenna couplers. For larger coils of perhaps 10 turns of 12 gauge wire, such as used for the popular "Z-match" couplers, a perspex rectangle may be drilled with a series of holes to accommodate the helix. The coil is

wound onto a slightly undersized mandrel, then removed, and threaded or "screwed" onto the former as described in Ref. 1. However, when a larger inductance involving tens of turns is required, this technique is rather awkward, and the results can be below expectation.

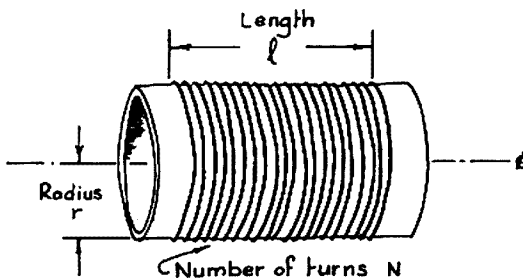
A method of making air-wound coils was described by the writer some 6 years ago (Ref. 2). Having given talks and demonstrations at local radio clubs, it was found that coil winding is rather a hot topic, and so a revision is perhaps timely.

example : coil of radius 1.25 inches,
27 turns, winding length 3.5 inches.

$$L_{\mu H} = \frac{27^2 \times 1.25^2}{(9 \times 1.25) + (10 \times 3.5)}$$

$$= \frac{1139.06}{46.25}$$

$$= 24.63 \mu H \text{ rounded to } 25 \mu H$$



$$L (\mu H) = \frac{N^2 r^2}{9r + 10l} \quad \text{or} \quad = \frac{N^2 r^2}{25.4 (9r + 10l)}$$

where : r = radius of coil (in inches) or (in mm)
 l = length of coil (in inches) or (in mm)
 N = number of turns

and :

$$N (\text{turns}) = \sqrt{\frac{L_{\mu H} (9r + 10l)}{r^2}} \quad = \quad \sqrt{\frac{25.4 (L_{\mu H} [9r + 10l])}{r^2}}$$

(inches) (mm)

Figure 1

Figure 1 shows an accepted, and reasonably accurate method of calculating the inductance obtained for a given number of turns, and conversely, the number of turns required to yield a specific inductance. The formulas hold for solenoids of reasonable dimensions, wire size and winding pitch. The very excellent Ref. 3 gives some useful tips for HF radio coils:

- (a) Q at any frequency within a band, and the frequency for maximum Q both increase with an increase in wire size for a given coil diameter.
- (b) Q increases, and the frequency for maximum Q decreases with an increase in coil diameter for a given wire size, number of turns and number of turns per unit length.
- (c) Maximum Q is obtained with a spacing between adjacent turns which is slightly greater than the bare wire diameter, and, perhaps surprisingly-
- (d) No variation in Q is detectable between coils wound with bare wire, enamelled wire or silver-plated wire. Therefore, ordinary enamelled copper wire (e.c.w.), or plain or tinned wire is fine for air-wound coils. Unless it is done properly, silver-plating adds little benefit.

For the following approach, rather than have the turns running through holes, they are fixed upon a rack or comb cut into each edge of a rectangular former of perspex (polycarbonate, or other low-loss material, about 1/8" thickness). In this example we see the construction of two coils of 27 turns of #18 B&S (1.3 mm) e.c.w. 2.5 inches diameter and 3.5 inches winding length for a "swinging-link" antenna coupler project (I'm using inches here because the inductance calculation is simpler, and there is less chance of error when marking out the rack on the former).

PREPARE a rectangle of perspex which is about 1/4-inch wider than the mandrel described in the next paragraph. The winding pitch is to be 8 t.p.i., so a slot every 1/8" is required. Using a rule with 1/8-inch graduations, carefully mark with a sharp scriber where each slot is to be. Remember to off-set the opposite rack by exactly half this amount- 1/16-inch. With the rack marked out, fix the perspex between soft jaws in your bench vice. Using a rod-saw (Abrafite [TM] or similar), or two ordinary hack-saw blades fitted into a hack-saw frame, cut your rack to about 1/8" depth for each slot. A finished former is shown in Photo 1. If you plan to turn out a number of identical coils, consider making a template of brass or steel sheet, which is clamped with the perspex in the vice and the rack cut accordingly.

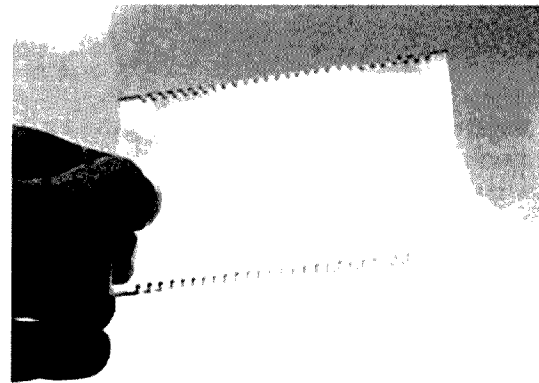


Photo 1: "Perspex" former

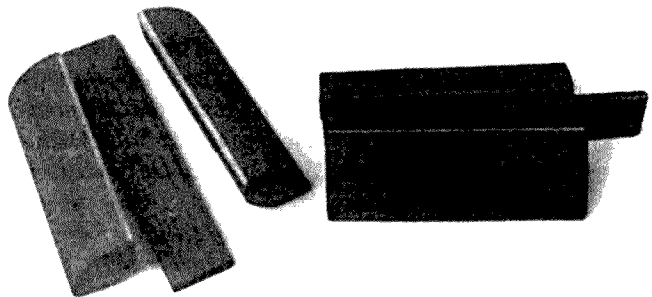


Photo 2:: Mandrel Assembly

THE COIL is wound onto the former with the help of a wood mandrel, whose components are shown in Photo 2. The flat piece is a removable "slip-stick" which allows collapse of the mandrel after winding. Obtain some suitably sized "quad" timber. That shown is described as "30 mm Tasoak quad", which, when made into a cylinder together with former and slip-sticks produces a coil of about 2.5 inches diameter. The quads should be just a bit longer than your former. The slip-stick is made from ply or similar material, about 1/8" thickness and about 1 inch longer than the quads. Plane a slight bevel onto each edge of the four quads, then rub some linseed oil into the mandrel components to ease their removal after the coil is wound on.

ASSEMBLE the former and mandrel with slip-sticks protruding as shown in Photo 3. Wrap some masking tape around the circumference to keep the assembly intact and permit the winding to begin. Calculate or estimate the

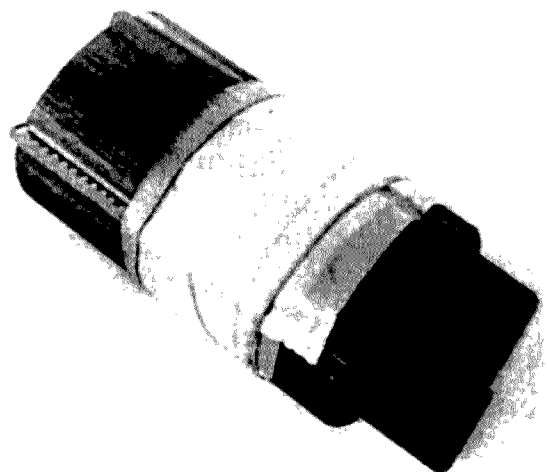


Photo 3: Ready to wind

Continued on page 8

length of wire required for the winding ($3.14 \times$ diameter \times number of turns) then run out your wire and anchor one end. Give the wire a firm pull to remove any small wrinkles. Fix the wire start into the first slot with a bit of spare, and put a bend in the wire right there to hold it in place. Take care not to snap off the first tooth. Whilst keeping the wire taut, carefully rotate the assembly as you walk towards the anchor. Each turn must lie down evenly into each slot, as depicted in Photo 4. The first half-dozen turns will have sufficient holding power to allow the masking tape to be removed and winding completed.

With the winding done, put a bend in the wire similar to the start, then snip with some spare. Leave the mandrel in place. Mix up some two-part epoxy cement and carefully apply a bead along each rack where the turns lie, taking care not to get any on the quads (hence the bevel). Position the assembly vertically so that excess cement runs down the racks and drips off the end. When the epoxy has set, grip each slip-stick with bull-nose pliers and withdraw them, which allows the quads to collapse, leaving the coil intact. The 25 microHenry coils so made for the coupler project are shown in Photo 5.

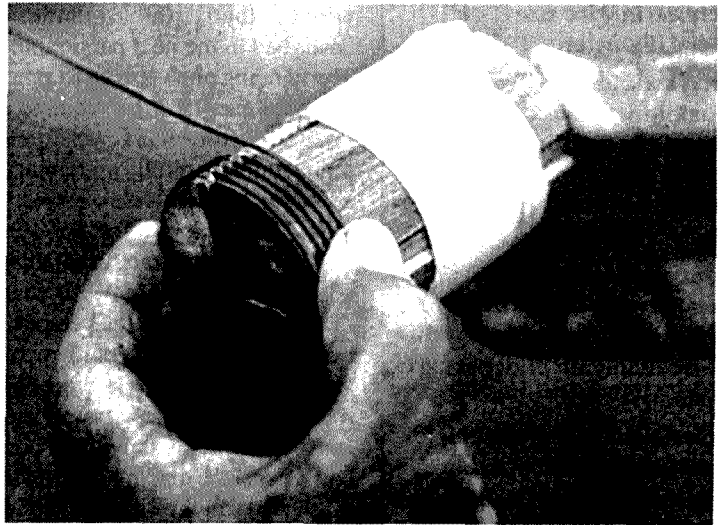


Photo 4: Winding the coil

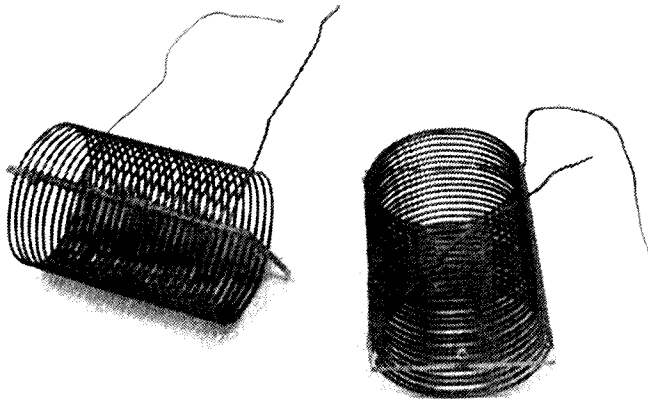


Photo 5: Completed coils

References and Further Reading:

- (1). Radio Communication Handbook (RSGB), 4th edition, P13.36.
- (2). "Making Air-Wound Coils for HF"; Diamond, AR Feb. '94
- (3). Radiotron Designer's Handbook; F. Langford-Smith (AWA), 6th edition.
- (4). "Low-Loss Low-Cost Transmitting Coils; Muldoon, W1FRQ, QST Dec. '34.
- (5). "Constructing Air-Wound Coils"; Johnson, W7KBE, HR Aug. '84.

ar

We manufacture a comprehensive range of HF, VHF and UHF antennas, baluns, power dividers, etc. to suit your application. Some of our log periodics provide continuous coverage from 13-30 MHz including WARC frequencies and replace outdated tribanders. Now in use in 48 overseas countries.

FREE CATALOGUE AVAILABLE FROM



ATN ANTENNAS PTY LTD
A.C.N. 102 210 414

- Create rotators, coax cables & non-conducting guy & halyard materials
- Hard-drawn copper antenna wire
- Insulators for DIY projects
- Inverted vee kits 160-30m
- High gain VHF & UHF amateur, scanning & TV Antennas

- High Sierra HF mobile antennas
- Butt section triangular aluminium towers for fixed or tilt-over applications
- Selection of power chips & TX tubes
- Diamond VSWR/PWR meters to 1300 MHz & accessories

37 Morrison Street
PO Box 80, Birchip Vic, 3483
Ph: (03) 5492 2224
Fax: (03) 5492 2666

Many a slip on the way to the true story

The Initial Years of the Wireless Institute of Australia (WA)

*Follow not blindly the path indicated by others, for verily thou might find thyself in
the garden of Historical inaccuracy*

D. Handscomb, VK6ATE,
P.O. Box 39, Quinns Rocks, W.A. 6030,
Ph: (09) 9305 7297

The Editor, *Amateur Radio*

Dear Sir,

Greetings from VK6

I note with interest the photograph on Page 39 of October 1999 *Amateur Radio*. The photo in question was sent by Will McGhie, and purported to be of the 1927 Annual Dinner of the WIA WA Division. (The WIA [WA] minutes do not mention a Dinner in 1927!). So, as they say in the song: "It just aint so".

The WA Division of the Institute had about 100 members, although the minutes do not record the fact. I have another copy of the same photo. On the reverse of 'mine' is pencilled:

"Annual Convention Dinner Of The
Wireless Institute Of Australia
"Keogh's Hall, Newcastle Street.

"2nd Convention, but 10th Dinner."

An added note indicates that this was held on Monday August 10th 1925 and refers the searcher to *The Western Wireless* of August 5th 1925!

The photograph was given me by Ross Greenaway VK6DA (SK) who in turn was given it (and others) by Jack Park, at the time of this photo 6BB-later to become A6BB/OA6BB and finally, from 1929, VK6BB.

According to the Minutes of the WIA (WA Division), Mrs. Keogh was asked to provide a cold meat meal for the price of 4/-

You may be aware that, for some time, I have been researching the History of the WA Division of the Institute. The time taken has been necessarily SLOW (painfully so at times) because of little

help, and little time, the necessary research being done in my limited spare time. I have included for your consideration to publish in hope that others may be able to help my endeavors

While the minutes of the Institute (WA) are of help, I find that many events, which today we would consider of importance, were either mentioned briefly in passing (either before or after the event) or not mentioned at all. Information has to be discovered in magazines or other sources of the times, of which there were several of WA origin, for example *The Western Weekly* (October 1923- 1927 (99 issues)) - for a time "The Official Organ of the Wireless Institute of Australia WA Division - also *Hoskins Weekly* Western Australian

The history of the development of the WIA

In 1985, members of The Wireless Institute of Australia celebrated the 75th Anniversary of the organisation, both within the Commonwealth and around the world, because it was thought that the Wireless Institute of Australia began in 1910. But did it?

True, we should have celebrated the 75th Anniversary of the oldest Wireless Organisation in the British Empire, and second in the world. But not the anniversary of the WIA what we should have been celebrating was the 75th Anniversary of "The Wireless Institute of New South Wales."

Prior to the 1914—18 war, it is true that

there were Wireless Clubs in each State, for example, "The WA Radio Club" had its first meeting on September 15th 1913. About 6 months later it was decided to extend its scope, and its name was changed to: "The WA Institute of Radio and Scientific Experimenters" and there were similar "institutes" in other States. However, they were all individual

organisations, separated from each other geographically, what one might call "little fish each in their own little ponds". Communication by wireless would have been infrequent, and as for East-West communication, it was unheard of.

I had often wondered how members of the various Institutes got together - Did they meet during Military Service? The answer was provided among reading material sent me by a fellow "searcher of the truth"

At the first post-war meeting of The Wireless Institute of NSW. on January 7th 1919 (as recorded in *Sea, Land and Air* of February 1919) some 50 Members of the Wireless Institute of New South Wales assembled in one of the classrooms of the Marconi School of Wireless, Sydney.

continued on page 10

Photo as published
in Amateur Radio,
October, 1922



New caption: Annual Convention Dinner of The Wireless Institute of Australia. Monday, August 10th, 1925, at Keogh's Hall, Newcastle Street
2nd Convention, BUT 10th Dinner

"Amid laughter, Mr Fisk, who had been invited to take the chair, asked that the minutes of the previous meeting be read (it had been held 4 years, 7 months previously) Mr Fisk then outlined his thoughts on the issue of Post-War experimental licences, and added, 'Another point which I might venture to suggest as advantageous to all concerned would be the amalgamation of every Wireless Institute in the Commonwealth: To form one united body of the whole, and to get together every man & woman interested in radio work. By this means, you would, in a few years, have a very powerful body representing the combined Wireless Institutes in Australia.'"

According to Mr Perry (the Convenor of the meeting) the main business was to form a small committee to interview the authorities with a view to getting back "our interned apparatus." Having

acknowledged that there were some influential people present, he suggested for the committee Messrs. Fisk, C.P. Bartholemew and C. Maclurcan. The resolution was proposed, seconded & carried. Mr Maclurcan then moved that "It be an instruction to the Committee to approach interstate Institutes and obtain their views on the subject of combining action, and to send them copies of the Chairman's address."

A meeting of the WA Institute of Radio & Scientific Experimenters was called by Professor A.D. Ross for October 28th 1919 at The Perth University: (Did it take the Wireless Institute so long to write to "The West": was it only then that there were sufficient returned from Military Service: or was there some other reason?) That meeting was cancelled, but at the First Post-War meeting (also held at the University) on November 3rd 1919, Mr R.

Thomson Snr. moved that the name be changed to "The Wireless Institute Of Australia (WA. Section)" - in conformity with similar institutions in the Eastern States The motion was seconded by Mr. H. McKail, and carried!

They were still a little fish, but in a much larger pond

Although The WIA Book Vol. I records that two days later (November 5) New South Wales also changed its name: it was some time before ALL States did so. A series of short lists obtained from Commonwealth Archives (August/September 1920) indicates issue of Experimental Licences (as opposed to *Permits* as had previously been the case) and some were allowed to both Transmit AND Receive.

Although there was no mention of Western Australians or indeed, New

South Welshmen the following are of interest:

- No.214 University of Melbourne. (Transmit & Receive) Callsign V214
- No.240 Wireless Institute Of Victoria (Transmit & Receive) Callsign V240
- No.250 Wireless Institute of Australia (Transmit & Receive) Callsign Q250- (Queensland Section)

So, presumably, The Wireless Institute of Victoria had not yet (August 1920) changed its name "in conformity with similar institutions". Indeed, "The WIA Book Vol. 1. records (page 28) that in June 1923, The Tasmanian Division of the WIA was formed. (The Launceston Branch to be formed in August 1923)

This would have been the last division of the Institute to be formed, although a number of sub-divisions would be formed later, for example the Albany subdivision of the Western Australia Division.

Any opinions expressed during this article are solely those of the author

Delegates to Convention.

CHAIRMAN:
Mr. B. M. Holt

New South Wales	Mr. H. A. Stowe
Victoria	Mr. B. Jermyn Masters
Tasmania	Mr. P. Oakley Fysh
South Australia	Mr. Clemens E. Ames
Queensland	Mr. W. Phipps, <i>Proxy</i>
West Australia	Mr. H. A. Stowe
	Mr. W. E. Coxon
	Mr. A. E. Stevens

PUBLICITY OFFICER:
Mr. F. H. Goldsmith

HON. SECRETARY:
Mr. J. C. W. Park

ENTERTAINMENT COMMITTEE:
Mr. B. M. Holt (Chairman)
Mr. J. C. W. Park (Hon. Secretary)
Mr. F. H. Narro-way (Hon. Treasurer)

— and —
Messrs. A. E. Stevens, S. E. Bottorill, W. Phipps

"Happy we have met, happy we have been,
Happy may we part and aptly meet again."

PRINTED BY THE PROPRIETORS "WESTERN WIRELESS"
332 MAY ST., PERTH.

The Wireless Institute of Australia

Walter Stephenson
Second

Annual Convention

PERTH, W.A. 1925

Dinner held in honour of the Visiting Delegates

Reynolds Hall, Perth

AUGUST 10th, 1925

CHAIRMAN:
B. M. HOLT, Esq. M.I.E.S. (ENG.)
(PRESIDENT W.A. DIVISION)

Alwyn Macleod
31st

Alwyn Macleod

Part of the programme provided for Delegates and other participants at the Dinner of The 2nd Annual Convention of the Wireless Institute of Australia
Above: Signatures of visiting Delegates.
Below: Speakers were many and varied!

Toast List

"How much my comfort is relieved by this."
— Romeo and Juliet.

The King
"A Prince most prudent and of excellent judgment."
Proposed by the Chairman.

Parliament
"For forms of government, let fools contest
Whate'er is best administered is best." — Pope
Proposed by G. P. Napton, Esq.
Responded to by The Hon. Alex McCallum, M.L.A.
Minister for Works.

The Institute and Allied Societies and Associations
"Vessels late may venture more
But little coals should keep near shore."
— Benjamin Franklin
Proposed by J. Thompson, Esq.,
Gen. Mgr. Westralian Formers Ltd.
Responded to by the Chairman.

Our Guests—The Visiting Delegates
"We thought good manners bound us to invite.
Our worthiest friends to be our guests to-night."
Proposed by F. Kennedy, Esq.
Responded to by K. A. Stowe, Esq.;
C. Ames, Esq.; B. Jermyn Masters, Esq.;
and P. Oakley Fysh, Esq.

6th July

"This was the noblest Roman of them all."
— Julius Caesar.
Proposed by F. H. Narro-way, Esq.
Responded to by W. E. Coxon, Esq.

The Press
"Hearshall the Press the people's right maintain,
Unawed by influence and unsuited with gain."
— Joseph Sturge.
Proposed by A. E. Stevens, Esq.
Responded to by F. H. Goldsmith, Esq.;
E. J. Barclay, Esq.

The Artists
"I thank you for your voices, thank you—
Your sweetest voices."
— Coriolanus.
Proposed by W. Phipps, Esq.
Responded to by W. Savage, Esq.

The Entertainment Committee
"If there had been forgiveness, it had been a gap
in our lives."
Proposed by A. E. Grey, Esq.
Responded to by S. E. Bottorill, Esq.

See next page for history of Ladies in the WIA

Andrews Communications Systems
(EST. 1976 - ACN 001 968 752)

ALINCO
AUSTRALIA'S FIRST AUTHORISED FACTORY DIRECT IMPORTER
MASSIVE SHIPMENTS EVERY MONTH
FULL 3-YEAR WARRANTY ON **ALINCO and ICOM**
WE SELL MOST BRANDS
BALUNS, VERTICALS, YAGIS, P/S.
ICOM-KENWOOD-JRC-AOR-EMOTATOR-MFJ-DIAMOND-TIMEWAVE-KANTRONICS
-THP - GARMIN - TERLIN - UNIDEN - ETC
DX-1600 HF LINEARS FROM \$ 3,799
HUGE RANGE OF ELECTRONICS, ICOM and ALINCO Radios.
Over 22 Years of Professional Sales and Service.
Instant Repairs Fridays
HF Transceivers & Linears Wanted

(02) 9636 9060 or (02) 9688 4301
SHOP 8, 41 BATHURST ST, GREYSTANES,
N.S.W. 2145. FAX (02) 9688 1995

Forever YL

D. Handscomb VK6ATE,
P.O. Box 39, Quinns Rocks, WA, 6030,
Ph.(09) 9305 7297

Ladies In Amateur Radio (Western Australian Style)

Although Experimental Wireless/Amateur Radio has always been a male-dominated hobby, there has occasionally been invasions from "the fair sex", however successful or lasting.

Soon after the WA Radio Club was founded, (September 1913) it was decided to advertise for "Correspondence" members who were interested in the "new art & science" of wireless, but were unable to attend meetings because of distance. In April 1914, an application was received from a "Mrs Pym" on Rottnest Island. Was she WA's first "YL" (Lady Operator)? Designated a "Country Member" her subscription fee was 2/6 per annum (25c.) as compared with 5/- for attending members.

During the years of World War 1 membership fees were suspended, so it is not known if she maintained her membership; her name was not recorded. By October 1923, "L. Pym" of Rottnest had a Receiving Licence, with the Callsign 6AW. Also in the list of October 1923 appears, with a "Receive only" licence, Callsign 6BF, Miss C. Stevens of The District High School, Bunbury. A patient, in my care, told me that he went to school in Bunbury at that time. Miss Stevens, known as "Ghosty" Stevens because of the way she used to flit around the corridors, was the Science Teacher. She kept her receiver in the Laboratory, and would "keep back" achievers to allow them to listen to the only Broadcast Station in WA at that time. 6WF, which was owned by Westralian Farmers. (If they were allowed to receive only, why did they need callsigns?) Miss Stevens obviously had an Experimenters' Permit, but did she carry out experiments with wireless circuits, or was she what today we would call "a Listener"?

But what was there to listen to before June 4th 1924? There would have been only Shipping, Coastal Radio Station VIP and perhaps a few experimental Transmitters in and near Perth. There was no broadcasting in WA. 6WF came on the air as the first broadcast station in June 1924. It was one of the first 4 stations,

later to become "A" Class Stations, which meant, for the first few months, a "sealed Set" station, transmitting on 1250 metres.

During the 1920s, various Radio Clubs and Societies sprung up throughout the Perth Metropolitan area and the "near" country districts. Several times it is recorded that "the company was graced by members of the fair sex" or words to that effect, but it was obviously not considered necessary to record their names.

The advent of the AOPC (Amateur Operator's Proficiency Certificate) in 1925, shows that, even if still interested, YLs had opted for a "Listener's Licence". By now *broadcasting* had arrived, more interesting than experimental work, except for the most dedicated.

In July or August 1931, Miss A. (Gypsy) Jones wrote asking how to join the Wireless Institute. It was agreed that the information be supplied to her, and also that Miss Faraday be advised that "we have an application from another lady member". Who was Miss Faraday? There is no mention of her or her application for membership in either previous or later minutes.

At the General Meeting of 19th November 1931, the following were appointed Operators and Program Managers for (VK)6WL.

December 6th VK6RX & Miss Jones.

Regrettably, nothing further is recorded of either

In April 1936, Ruth Victoria Longley was accepted as a Student Member of the Institute, and at the Annual General Meeting (June 11th) of 1936, was appointed Bulletin Editor. This didn't last long. Four months later "it was decided with regret to accept her resignation as Bulletin Editoress, and an appreciation of her service be recorded in the Minutes". But her interest in Radio was to remain, as did her membership of the

Institute. At the General Meeting of April 12th 1938 with the Callsign VK6YL. Miss Longley volunteered as a Morse Instructor for the institute. She was the first "YL" to attend an Annual Dinner of the Institute (1938 and '39)

It was not until 1939, just before the outbreak of World War 2, that the first "YLs" in W.A. appeared in a list of Callsigns - they were:

VK6JC - Chinnery, Miss, Charlie's Creek, via Donnybrook

VK6MH - Hill, Mrs, 33 Trenton Street, Wiluna

VK6Y1 - Longley, Miss, 7 Cuthbert Street, Shenton Park.

Jess Chinnery (previously of John St. Welshpool) would have gained her AOPC some time before July 1937. Originally working on the 7MC band, she later graduated to 14MC CW. In 1939, Harry Atkinson VK6WZ, then VK6 correspondent to *Amateur Radio* reported that "She had found the Creek, but of Charlie there was no sign"

These then were the pioneer Ladies of Radio in Western Australia.

Like all other Amateurs, the "YL's" radio activities were to be halted during WW2, and when at last licences were re-issued, Ruth Longley's name appeared in the Post-War Callbook, but only once. She gave up her licence. The Callsign VK6YL was later taken by Mrs.A. Cowles of Subiaco, later by Gill Weaver.

Of Jess Chinnery, nothing more was recorded. (Did she ever find Charlie?)

The Callsign has since been allocated several times: by 1957 to B.J.Coles of Perth and later to J.McCluskey, to name but two. Bobbie Hill VK6MH (with OM VK6AH) moved to Busselton, where she became SK in 1988.

Many more Ladies were to follow, especially with the introduction of the "Novice" Licence in 1976. But that's part of another story...

ar



Christine Taylor VK5CTY, ALARA Publicity Officer
16 Fairmont Avenue, Black Forest SA 5003
Packet: VK5CTY@VK5TTY email:geensee@picknowl.com.au

Net-working for winter nights

Congratulations

Bev VK4NBC was very surprised to have several people insisting that she attend the AGM of the VK4 Division, recently. She discovered why when she was presented with an Award of Merit for her outstanding effort, in particular in arranging the ALARAMEET in Brisbane last September. She had made all the arrangements almost unassisted and under very difficult conditions as the health of her OM Graham was a constant worry.

The Award was very well earned. In addition to the ALARAMEET she has also participated in many contests (with some success) including the ALARA Contest in which she won the Florence McKenzie section three times in four years. She has run a number of nets and clubs associated with the RAAF group in which Graham served during the war. You will earn certificates to hang on your wall by winning contests but only if you work at it. You earn those certificates in a way those of us who don't bother with contests will never know.

Congratulations, Bev, from us all.

The Monday Net on 3.80 MHz at 1000 UTC

Now that we are into winter and have left Daylight Saving Time behind us the regular Monday night Net is accessible to all the Australian states. As soon as Daylight Savings ended Poppy VK6YF was there. It is still early in the evening (or late in the afternoon) for her, so propagation is not marvellous, but we can hear her in all the eastern states quite well. After the contact drought of the summer we look forward to hearing of her activities.

The regular VK4 girls can now hear us most times. During the summer they faithfully call in, but often there are few stations they can hear properly, even though they often have readable signals

down South. Unfortunately there are some commercial stations north of them that cause interference when propagation is better, but they can often hear us through the noise. We do appreciate having Bev VK4NBC in Brisbane and Sally VK4SHE from Townsville, calling almost every week but we were surprised not to hear June VK4SJ recently.

June and OM Doug had a very hurried trip to G land for family reasons but they did have a couple of days visiting Margaret G0BMQ whom June sponsors and with whom they caught up on their previous trip across the world. June has been back on the Net again with news from the Sunshine Coast.

Another not-so-common participator who has been heard more often recently is Dot VK2DB. Dot often listens while she is downloading and transferring the VK2 broadcast (which she puts out on packet each week) but does not always join in. With improved propagation it is good to hear her voice.

YL and OM operators who are interested in working towards an ALARA Award will find it much easier during the winter. This award requires that you make at least 10 contacts with YLs and that the contacts include at least five Australian call areas. Why not have a go? The award is an attractive one to hang on your wall.

The 222 Net

This international Net is run each Monday by Dave ZL1AMN on 14.222 MHz with the net starting at 0600 Zulu and call in at 0530 Zulu. Now that we are at the height of the sunspot cycle there will never be a better opportunity to make contact with YLs all round the world. Although it is primarily a YL net is it not restricted to them. OMs are welcome to participate and there are a number who do this regularly.

The VK girls most often heard include Dot VK2DB, June VK4SJ, Bev VK6DE, Maria VK5BMT with frequent visits by

Robyn VK3WX, Poppy VK6YF and more, plus as many ZL call stations. Why not listen in one Monday afternoon and hear for yourself?

On one afternoon recently the following overseas stations were heard, as reported by June, Elizabeth VE7YL, Margaret G0BMQ, Uni LG5LG, using a special call from the border of Norway and Sweden, Olga DJ0MCL and DJ6GS "Wally" from Germany. Lucia CTIYN from Portugal and an OM from Romania. Nely YO3BBM were heard clearly, while DL1RBW was mobile in NA land.

Other YL Nets Available

There is a YL-DX Net run by Christine GM4YMM each Thursday on 14.243 MHz at 0500 UTC. A YL Activity Day is held on the 6th of each month using the frequencies 14.288, 21.288 and 28.588, just listen throughout the day for the call "CQ YL" you can be sure to have some interesting contacts.

Within Australia VK6 has two regular, weekly nets. On Mondays, after the national net (because of the time difference, this is more convenient for the VK6 stations), on 3.585 MHz at 1200 UTC, and on 21.188 on a Friday at 0400 UTC which is run by Bev VK6DE in Geraldton.

On the first Thursday of the month the District Radio Club in Queensland runs a net on 146.900 MHz at 1000 UTC and on 3.565 MHz at 1030 UTC.

OM's are welcome to join any of these nets though we ask that you wait till we have called everyone in and we have had our first round or so of contacts. If you want contacts for the ALARA Award we will be willing to give those to you, either on another frequency during the net time or immediately after the net finishes which is usually approximately an hour after it starts.

ar

Up The *Lazy* River

Richard Cortis VK2XRC
4 Victory St. (PO Box 2126)
Cloveley NSW 2031
richard_cortis@one.net.au



Top: Paddleboat *Liba Liba 3* on the Murray River.
Above: from left, Bill VK3SWD, Richard VK2XRC, Tony VK5ZAI

Some time in mid 1999 my wife and I decided to have a New Year houseboat holiday on the Murray River around Renmark, S.A. and we decided that we would drive over and back. It was a holiday for both of us, so I was allowed to take some radios and associated gear. This was no DX expedition but it was amazing just how much gear was needed to cover expected eventualities. My recent attendance in WICEN exercises meant that there was a certain amount of experience, which suggested that a fair bit of junk was necessary.

The car was OK as it already had 70cm, 2m and 6m FM installed. The gear for the houseboat was another matter, as I had no clear idea of dimensions and details for erecting antennas. I knew there would be a substantial twelve-volt house lighting battery separate from the engine starting battery. All I needed for power was a long heavy power cable of indeterminate length with alligator clips on one end for connection to the battery; easy.

As my aim was to operate ten metres FM, I made up a simple wire dipole with a balun and some RG213 coaxial cable.

Hopefully, the cable would be long enough. As a precaution I loaded some connectors and some more coax. I also packed an SWR meter and an old but trusty EAT300 tuner. For six metres I took my Diamond tri-band vertical, a quarter wavelength whip and associated hardware. The rigs used were an ancient Yaesu FT690 with an amplifier and an Icom IC706 (mark 1). I also had an Icom IC-T7A handheld and associated chargers and cables etc. All of this junk filled a plastic recycling bin and overflowed into the boot of the car. The gear in the bin in

the boat was much heavier, and took up much more space, than the rest of our luggage including the dozen bottles of wine.

For antenna support, I loaded an old fibreglass sailboard mast and an aluminium tube, which was also intended to support the Diamond tri-band antenna. For attachment to the boat I had a roll of cheap plastic rope and the inevitable roll of duct tape. The quarter wave whip for six metres was to be supported on one of those steel brackets used to hang antennae off bull-bars on those Toorak Tractors.

The sailboard mast was tied to the handrail along the starboard side and the aluminium tube was tied and duct taped to the post for the forward sun awning. The six-metre whip was attached to the other end of the sun awning using U-bolts. With a little bit of help from the tuner we were up and going on four bands, 70cm FM, 2m FM, 6m FM, 6m SSB, and 10m FM. Not DX expedition stuff but up and going for a bit of fun on holiday.

While my wife was sunning herself on the deck, I was motoring sedately along the Murray River at about five kilometres per hour (according to the GPS), microphone in one hand, beer in the other, steering with my toe and admiring the landscape. I even had a pretty girl sunning herself on the deck in front of me! What more could anyone ask of a holiday.

As I said earlier, this was a holiday, not a DX expedition so radios were turned off for conversations with my wife, for meals, for the afternoon siesta and in the evening. However, I did manage quite a few interesting contacts around Australia and overseas.

Motoring down the Murray River from Renmark towards Berri, I spoke to Andy, VK5LA on ten metres and later on the local two-metre repeater. When we arrived in Berri on New Years Eve, Andy came down to the boat for a visit and the usual look around and detailed assessment of the station set-up. It was too early in the morning so we restricted the celebrations to a couple of cans of lemonade. It helps to avoid dehydration.

We moved off when my wife returned from her walk in town and headed back upstream, a couple of kilometres above the village of Lyrup where we tied up to the bank in the best mooring site of the whole trip. Ignoring amateur radio, we

started the petrol (noisy) generator, opened a bottle of genuine French champagne and watched the fireworks on TV. As we were not far from Berri as the crow flies, we also had a good view of the Berri fireworks display.

We did not move the boat on New Years Day as it was such a nice spot. However, there were ten metre contacts in abundance. Only lunch, a walk by the river and the obligatory siesta interrupted my games.

Moving upstream, we spoke to Tony, VK5ZAI on two metres and met up with Tony and Bill VK3SWD on Tony's houseboat "Nooralie" which he built himself. It is like a four-bedroom townhouse with ground floor terraces and rooftop sundeck. It even had a separate room for the shack and was complete with 70cm and 2m Yagis for playing satellites from the boat. Tony is a satellite enthusiast, possibly even a fanatic. He provided the local ground station facilities so Andy Thomas could speak to his father in Adelaide from the Mir space station.

Tony was an interesting guy to meet so we did it again. A few days later, we had dinner at the Renmark Hotel with our wives. Lucky the boat was tied up to the riverbank just across the road from the pub. I also had the privilege to visit Tony's

home and be treated to a guided tour of his station. The home built but professional quality antenna rotator system and the console installation in the shack were amazing. Nothing like the tangled mess of wires and cables in my shack!

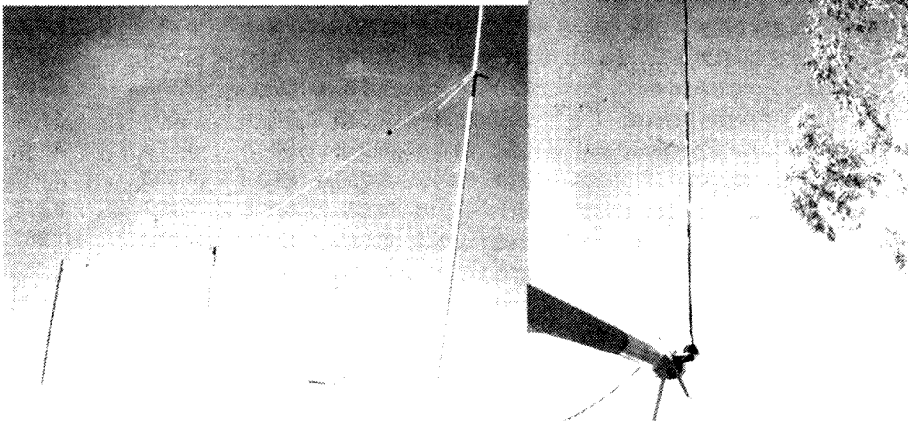
When it was time to come home I dismantled the antennas and masts etc and taped them up ready for the roof rack. It is funny that the gear that just fitted into the recycling bin on the way down seemed not to fit at all for the trip home.

About an hour or so south east of Mildura on the way home, I looked up and noticed that the antenna masts etc were not there. There was that immediate sinking feeling as I realised that they were still lying neatly taped together on the side deck of the houseboat *Liba Liba 3* about 300 kilometres back at Jane-Eliza Landing in Renmark. A quick mobile phone call to Tony VK5ZAI. I imagine he will make good use of his prizes.

Apart from a few contacts on six metres FM from the car and the usual repeater contacts, the trip home was uneventful. All I have to do now is scrounge some more portable antenna mast gear. Does anyone know of anyone who wants to get rid of an old sailboard mast or two?

ar

We did not move the boat on New Years Day... however, there were ten metre contacts in abundance. Only lunch, a walk by the river and the obligatory siesta interrupted my games



10m (left) and 6m (right) Antennae, *Liba Liba 3*

A Wire Log Periodic Dipole Array

Robert Hancock
30 Tottenham Court Road
Port Elliot 5212

If you are looking for a HF antenna which has multi-band coverage with high gain, requires no retuning when switching bands nor any complicated feedline matching adjustments or ground radial systems. Then it would be hard to beat the log periodic system.

Military and commercial HF installations make extensive use of this type of antenna, and commercial models are available[1] which provide around 8-13dBi gain over the range 2-30MHz at SWR of less than 2.5:1.

As in all things, nothing this good comes without some disadvantages. The main ones are lack of rotational capability and the requirement for a large extent of real estate with two elevated supports. But depending on what is available a useful compromise can usually be reached. As I already had a vacant 35m by 16m block with a 10m mast behind my house, the LPDA was an attractive proposition. By running the antenna from one corner of the block to the mast I could aim the antenna along a bearing of 285°, which

would good coverage of the Middle East, North Africa, Europe and the Caribbean (long path).

The next step was to design an array which would fit into the space available. The first consideration was the minimum frequency to be covered. Some rough measurements on a scale diagram showed that the maximum length half element I could use would be around 12 metres, so 7MHz would be the practical lower frequency limit. The upper frequency limit was chosen to be 29MHz, this being the end of the 10m band for SSB operation.

Consulting the trusty ARRL Antenna Book [2], the section on log periodic design was thoroughly digested and transformed into an Excel spreadsheet so that the range

of design parameters could be quickly examined. the basic design process for a log periodic is to start with optimum values for the design constant t (tau) and spacing constant s (sigma), and calculate the resulting element lengths and spacing. The total length of the system is dependent on the design constants and the bandwidth. this is constrained by the maximum distance between the two support points. Some trial and error is therefore required in order to obtain the maximum gain within the physical space available. The final design I arrived at is shown in Table 1.

LOG PERIODIC ARRAY DESIGN						
F max.	29	*MHZ	ZT	5.357		
F min.	7	*MHZ	BOOM	34.806	metres	HALF
tau	0.857828	*INPUT	No. ELEM	13.690	SPACING	ELEMENT
sigma	0.134706	*	L1	21.429	S1	metres
alpha	14.78	degrees	L2	18.382	S2	5.773
APEX <	29.56	degrees	L3	15.769	S3	4.952
BW ar	1.6898638		L4	13.527	S4	4.248
Bs	7.0008642		L5	11.604	S5	3.644
EL. DIAM	0.67	mm	L6	9.954	S6	3.126
Ro	208	Ohms	L7	8.539	S7	2.682
Zav	698.72	Ohms	L8	7.325	S8	2.300
slgma1	0.15		L9	6.283	S9	1.973
Zo	267.92	Ohms	L10	5.390	S10	1.693
FEEDER	1	*mm	L11	4.624	S11	1.452
SPACING	4.67	mm	L12	3.966	S12	1.246
			L13	3.402	S13	1.069
			L14	2.919	S14	0.917
			L15	2.504	S15	0.786
			L16	2.2148	S16	0.675
			TOTAL	133.112	35.076	

Table 1

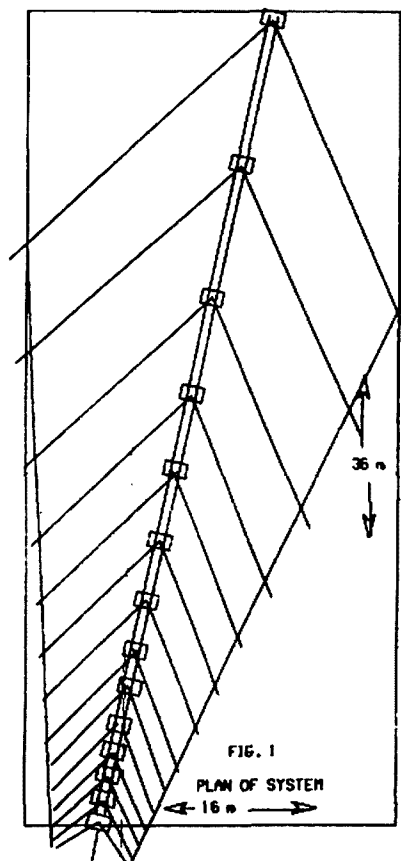


Figure 1

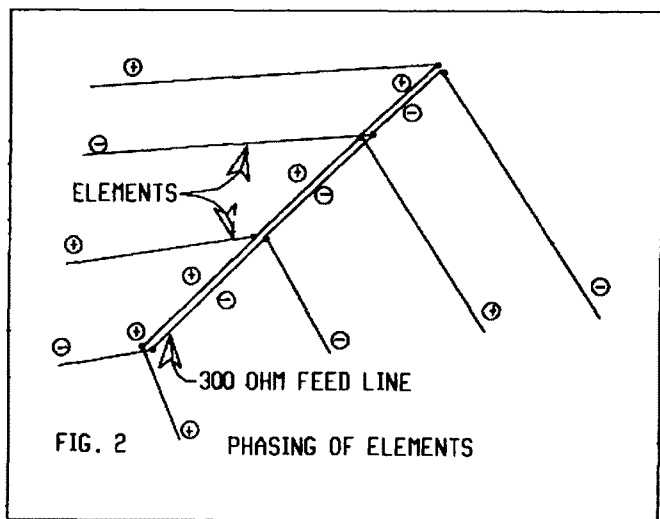


Figure 2

elements must be connected to the feedline in reverse phase as shown in figure 2. At the forward (small) end of the antenna, a 4:1 balun was used to connect to the 50W coax from the transmitter. The entire feedline and insulator blocks were taped to a 36m length of UV resistant synthetic rope to support the weight of the antenna without straining the feedline.

At the outer ends of the elements, small blocks of propylene cutting board were used to attach the elements to the side spreader ropes. The ropes were supported at each end by 4 metre lengths of light wall galvanised tube secured to convenient fence posts. The blocks had holes drilled to allow them to slide along the rope after the ropes were tightened.

The fully assembled antenna was laid out on the ground and the central supporting rope was raised at each end. The side spreader ropes were tightened and the ends of the elements adjusted to remove slack and align each element in parallel with the others. The end blocks were then secured to the ropes with a small tie wire to prevent slippage in the wind.

LPDA IMPEDANCE

LOG PERIODIC DIPOLE ARRAY 7 - 30 MHz

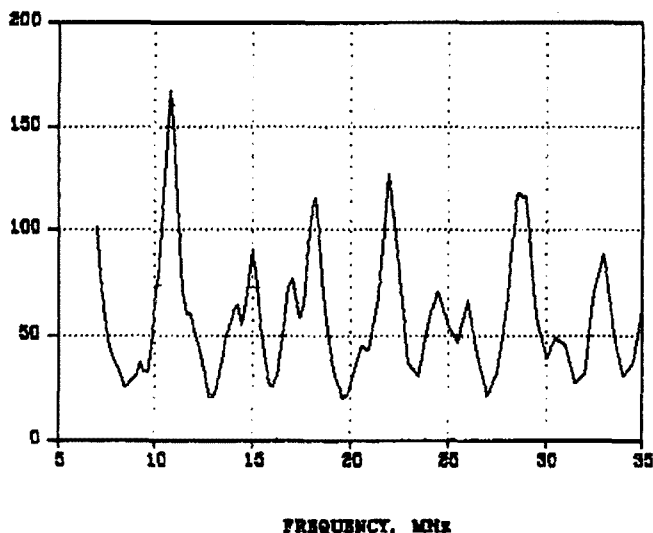


Figure 4

The SWR and impedance characteristics of the completed antenna as measured with an Autek RF-1 analyser as shown in figures 3 & 4. No adjustments were required at the antenna to obtain these results. As mentioned at the beginning, this antenna has a high gain (theoretical 5dB over a dipole), covers all frequencies from 7 to 29MHz, requires no tricky matching or tuning adjustments and no adjustments when changing bands. It does need a relatively large area in which to erect it and is not easily rotatable. Although if sufficient ground space is available even rotation would be possible! I will leave that to your imagination if you have the spare real estate

References:-

- [1] Radio Frequency Systems WLP 230, WLP330, WLP 400
- [2] ARRL Antenna Book 18th edition section 10-1 to 10-9

ar

A further development in squeezing the maximum amount of antenna into the space available is to arrange the elements into a V shape rather than the straight line configuration [See figure 1]. the angle of the V is not critical but should probably not be less than about 85° for good performance and SWR. (The final angle in my installation was about 90°)

Construction of the antenna basically follows the procedures given in the ARRL Antenna Book [2]. The elements were made with insulated 0.7mm single strand copper wire. Since there is little strain on the wire on the element wires, relatively thin wire can be used. When it came to making the feedline, I simply used black 300W TV ribbon rather than constructing a twin-lead line at the calculated spacing of 4.7mm. The effect on the SWR of the system was not expected to be significant.

Insulator blocks at the feed point of each element were cut from 7mm thick polypropylene cutting boards, and the element wires were sealed to the blocks with hot melt glue. Alternative

LPDA SWR

LOG PERIODIC DIPOLE ARRAY 7 - 30 MHz

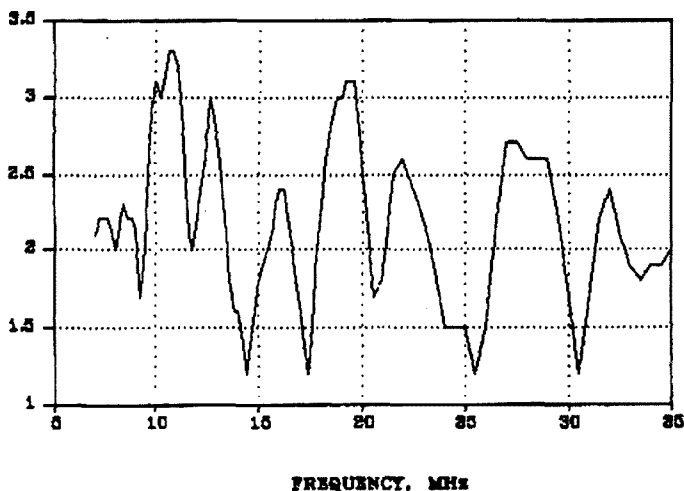


Figure 3

CLUB NEWS

Moorabbin & District Radio Club

Amateur Radio PR in action —

Photos by Keith VK3JNB.

Peter Parker VK3YE, Publicity Officer
Moorabbin & District Radio Club
parkerp@alphalink.com.au (03) 9569 6751

In February 2000 the MDRC ran a stall promoting amateur radio at the St Kilda Hobby Show. As reported in April, the stall was successful, with many people seeing amateur radio for the first time. A highlight was the large number of satellite contacts made from the show. The pictorial spread shows the MDRC station at the show. We hope the pictures provide ideas for other clubs contemplating similar exhibitions.



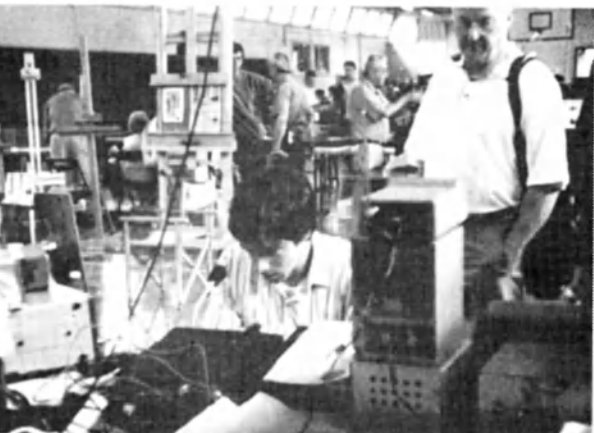
The MDRC's table at the Hobby Show. On the table are:- a computer, several transceivers, a scanner, ATUs and power supplies. We made sure we got a table near the hall's back door (not in picture) to allow easy passage of cables and people to the antennas outside.



Keith VK3JNB's corner of the table Shown is a TS-520S connected to operate as a Morse oscillator. Kids loved it!

It's important for people know who we are.

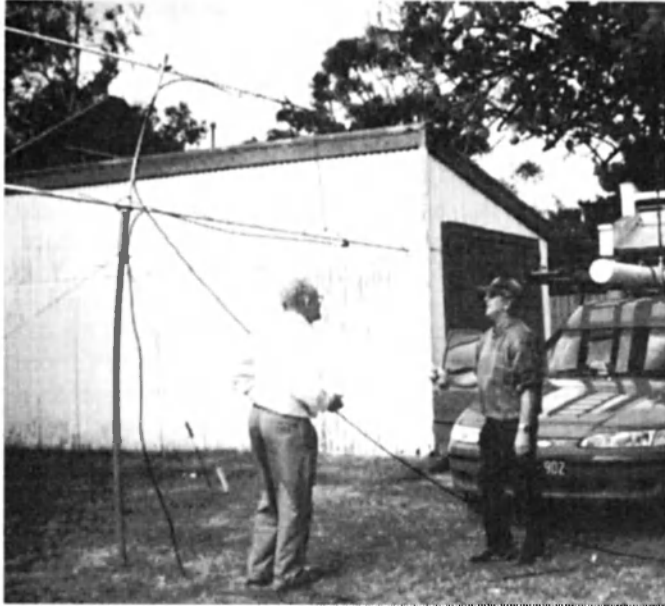
The use of a whiteboard and large 'Amateur Radio' banner helped here. The banner was made by taping letters made from pieces of insulating tape onto a linen cloth. The whole cloth was then spray painted and left to dry. The tape was peeled off to reveal the letters.



Tony VK3JED busily tunes 70 cm rig for a satellite pass. And they call this wire-less!

Terry VK3KBD (foreground) looks at satellite position on the computer while Tony VK3JED tunes the 70cm rig.

MDRC at the St Kilda Hobby Show



Ken VK3CEA and Mai (SWL) adjusting the 2 metre and 70cm satellite antennas. Note that great height is not required for successful satellite operation.



Mal (SWL) and Ken VK3CEA adjusting the antennas during a satellite pass. In the foreground is Tony VK3CAT's 'CatMobile' movable antenna support. The thick pole above the left door is an 8-metre telescopic squid pole used to support the HF wire antenna.

Adelaide Hills Amateur Radio Club

AHARS reflects on its beginnings

The Club Historian, Lloyd VK5BR recently reprinted in the club magazine some highlights of the early activities of what became AHARS which could be of interest to the readers of AR.

"Whilst the AHARS commenced in that name in 1983, it seems that the members at that time felt they were creating a historic link with the Blackwood Radio Club which was established as the first radio club in S.A. The Blackwood club was formed by Owen Griffiths, Gordon Ragless VK5GR and Robert Ragless at the Griffiths' home in Young Street, Blackwood in 1923.

The club affiliated with the WIA in November 1924. It was granted a transmitting licence and first went on the air in August 1926. The transmissions were on 200 metres and the original call sign was A5BR. This became OA5BR in 1927 and VK5BR in 1929.

Transmissions on 200 metres were restricted to times when broadcast stations were off the air, Sunday

mornings and after 10pm in the evening. They included recorded music played from a phonograph acoustically coupled into a microphone although the club also had its own studio orchestra made up of its own members.

The club station later went on HF and operated on 32 metres around the period of 1928 to 1932 and on 80 metres around 1934 to 1935. It was first located at the Griffiths residences in Blackwood, first at Young Street and later Waite Street, then in 1934 to the home of Jack Ferry in Clapham and finally in 1934 to the home of the Hume family in Parkside, the original location of Broadcast Station 5DN.

Similar to the activities of our present clubs, the Blackwood Club ran interesting

technical lectures, outside visits, picnics and field days including one via the SS Karatta to Kangaroo Island. It also published its own technical organ that it called "KEY-CLIX" and ran a monthly dance at the Eden Hills Parish Hall. It also held an annual radio concert at the Boys Club Hall in Blackwood.

The club ceased to be active around 1937, a little before the start of World War II."

I wonder if any of the other club now active also had such interesting beginning? There were certainly many more activities allowed in these early days that are not permitted now and others that are still just as actively pursued.

ar

TECHNICAL ABSTRACTS

Gil Sones VK3AUI

30 Moore Street

Box Hill South Vic 3128

Frequency Shifter for Fox Hunting

Fox Hunting requires a receiver which can handle a very wide range of signal strengths to allow the hunter to peak the beam under all conditions. The signal may initially be weak but as the hunt progresses the signal may become of such a strength that obtaining a peak is difficult. Attenuators are used but the signal may well bypass the attenuator and

enter the receiver directly when the hunter is close. There are many ways of overcoming this. One involves frequency shifting the signal so that the receiver is not listening to the direct signal but to a frequency shifted signal which can be controlled with less problems from direct breakthrough.

A frequency shifter for use with

handheld equipment appeared in JA CQ for December 1999. The author was JJ1GRK. The design was not specific to a band due to the use of a packaged balanced mixer for the mixing device. The oscillator was a 1 MHz crystal. With care in construction the design could be used on both the 144 MHz and the 432 MHz bands. The frequency shift is one megahertz with lower level outputs spaced at the 1 MHz harmonics. The use of a balanced mixer reduces the fed through fundamental which should ease receiver overload.

The circuit of the device is shown in Fig 1. The transistor types are not critical. The input and output attenuators are used to provide a reasonable match to the DBM. Wiring of the input and output, the attenuators, and the DBM should be appropriate to the upper frequency of operation. The oscillator wiring is less critical. Dead bug style wiring using a piece of circuit board laminate would be OK.

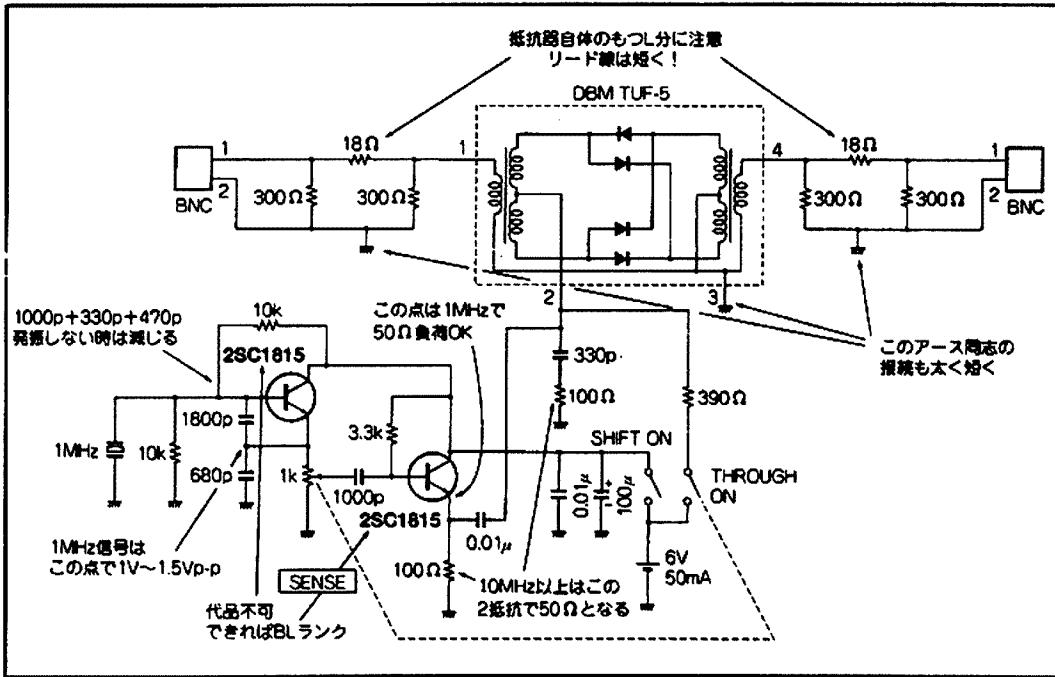


Fig 1. Frequency Shifter for Fox Hunting.

Diode Matching

A simple diode matching unit was described in the Technical Topics column of Pat Hawker G3VA in Rad Com April 2000. The circuit came from J A Ewen G3HGM. Matched diodes are required in many circuits such as balanced mixers.

The circuit shown in Fig 2 is a simple bridge circuit which allows diodes to be matched over a range. The 3.9K resistors must be matched closely. This can be done with a digital multimeter. The meter should be a centre zero type for ease of use.

Adjustment of the 5K potentiometer varies the voltage applied to the bridge and the current flowing in the diodes. Any mismatch between the diodes will show up on the meter. A mismatch of only 1 microamp over the full range of the potentiometer should be achievable for a pair of diodes selected by this means. This is better than the matched diodes which can be purchased.

Well matched diodes should give improved balanced mixer performance.

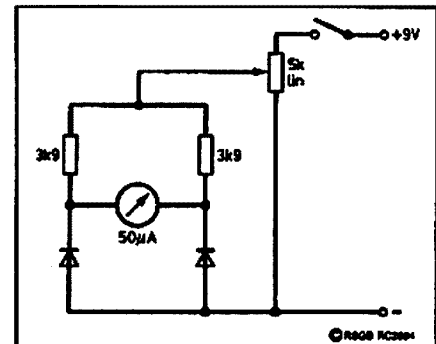


Fig 2. Diode Matching Unit.

Crystal Sets

An interesting idea for a crystal set appeared in the Technical Topics column of Pat Hawker G3VA in Rad Com April 2000. The idea comes from Tony Harwood G4HHZ. The idea is to use a Pi network to match the diode detector to the antenna.

The circuit of the pi network crystal set is shown in Fig 3. The coils used were wound on 4 cm long ferrite rods. The winding is as required to tune the frequency of interest. The 1000 pF variable is two gangs of an old broadcast twin gang capacitor in parallel. The circuit (b) allows for Long Wave reception in Europe and provides a tapped MW coil for optimum operation through the MW broadcast band.

Also discussed was the use of ex disposals low impedance headphones for crystal sets. These had been found to give good results and may be more plentiful than the high impedance headphones. High Impedance headphones were typically 2000 to 4000 Ohms impedance. The low impedance phones were usually of 300 to 600 Ohms impedance. Even modern 16 Ohm headphones had been tried with promising results.

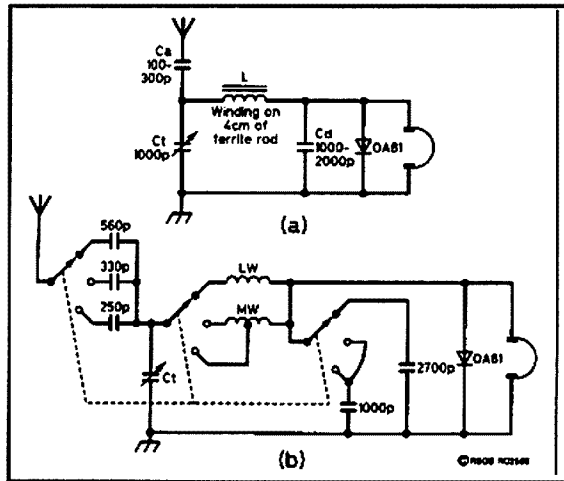


Fig 3. Pi Network Match Crystal Sets.

Silent Tune

Silent tuning is a technique which allows tuning of an ATU without radiating full power. A dummy load is used to load the transceiver and a small fraction of the power is used with a resistive bridge to give an swr indication as the ATU is adjusted. The bridge is adjusted for a null and the rf used and radiated is 20 dB or more down on the full output.

A suitable circuit appeared in the Eurotek column of Erwin David G4LQI in Rad Com April 2000. The circuit is the work of Benny Aumala OH9NB and originally appeared in CQ-QSO December 1999.

The circuit is shown in Fig 5. The dummy load resistor is a thick film resistor which is bolted to a heatsink in order to dissipate the 100 watts of its

rating. The resistor coupling to the bridge is a similar resistor. The Farnell part numbers are 776-324 for the 68 Ohm 100 watt and 551-612 for the 330 Ohm 20 Watt. The RS number for the 68 Ohm 100 Watt is 225-1216. Other resistors can be used if they will do the job.

The bridge uses 0.6 watt 1% 51 Ohm carbon resistors which are readily available. Another way if you want a 50 match is to use paralld 100 Ohm resistors to give 50 Ohm bridge arms.

OH9NB used a diecast box to house the device and used the box as the load resistor heat sink. This is OK for short duration tuning but a heat sink would be advisable if tuning was extended. The case should not be allowed to become too hot to touch.

For a 50 microamp meter with a high swr giving full scale the meter will read 6 microamps for an swr of 1.2 : 1 and 10 microamps for an swr of 1.5 : 1.

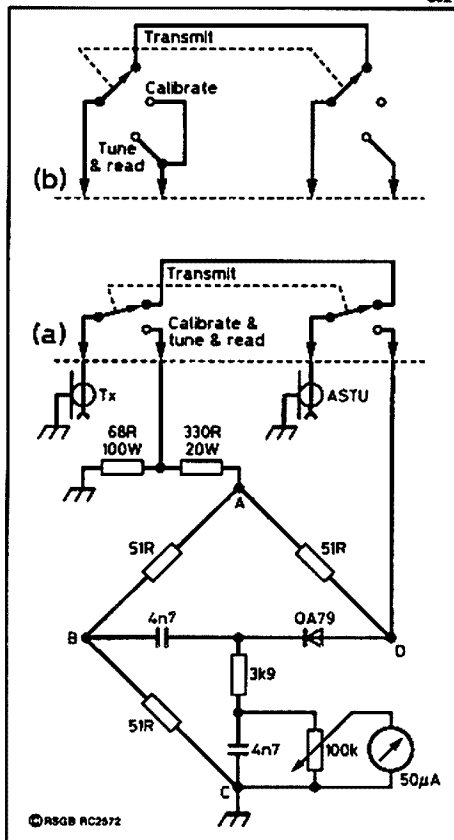


Fig 5. Silent Tune. (a) with DPDT toggle switch and (b) with 3 position switch to add a calibrate position.

Erratum

In the item in April *Technical Abstracts* on the replacement of the finals in an FT200 an error crept into the wiring diagram. The corrected diagram appeared in April 2000 *Rad Com*. The correction came from Tony Hall G0MQG.

The corrected diagram is shown in Fig 4. The correction is a wire link between the two valve sockets joining the pins 1, 4 and 6 of each valve together.

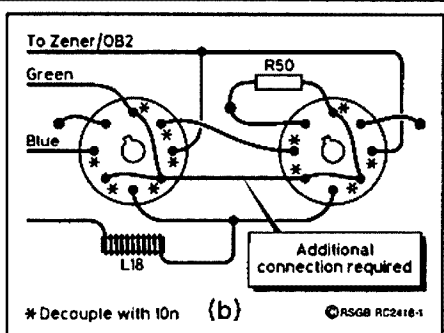


Fig 4. Corrected wiring diagram for 6146 replacement finals in an FT200.

An AM/CW Transmitter for 1.8, 3.5, and 7 MHz (Concluded)

Drew Diamond VK3XU

The first part of this article appeared in Amateur Radio December 1999 on page 30. Due to ? the article was missing the final paragraphs. We apologise to the Author and those readers who have been waiting for the completion. I thank Drew for providing a copy of the text so that the final paragraphs could be printed. *Editor*

Picking up at bottom of AR December 1999, page 32...

Transformer T1 is an Amidon FT50-43(A) core wound with 12 turns of #22 B&S (0.64 mm) enameled copper wire for the primary and 2 turns of hook-up wire for the secondary. T2 is wound with 11 bifilar loops of #24 (0.5 mm) wire thus; take two 300 mm lengths of #24 wire. Twist them together at one end, and fix that end in your vice. Clamp the free ends together in the chuck of a hand-drill. Whilst maintaining a firm tension on the pair, crank the drill until you have about 3 twists per 10 mm. Give the drill a firm tug to set the twist, then remove the pair. Wind the pair onto the toroidal core. Cut the leads to about 15 mm lead length. Remove the enamel from about 8 mm of each wire, then tin with solder. With your multimeter on ohms, identify the windings. Connect the end of one winding the start of the other. Winding starts are shown on the schematic with a dot. Transformer T3 is made in a similar manner to T2, using a pair of 350 mm lengths of #22 wire. If you cannot obtain an FT50-43(B) core for T3, use a stack of two FT50-43(A) cores.

The IRF510 must have an effective heatsink. A 12 x 20 mm rectangular hole in the PA board allows the device to be attached directly, using suitable insulating hardware, to the back panel, which serves as heatsink. Further heat dissipating capacity is provided by attaching a 72 x 110 mm heatsink (Jaycar HH-8566 or similar) to the rear panel. A hole must be provided in the heatsink to access the IRF510 mounting screw.

If just CW mode is required, delete the .386 and 2.2 microfarad capacitor. Connect a 3.3 k ohm 1/4 W resistor

between the "hot" end of the 2 k bias pot, and +12T rail.

The signal from the driver to PA is carried via a length of shielded wire. All connections between the IRF510, low-pass filters, relay and output coax socket must be as short as reasonably practicable, as shown in Photo 4. The 2-pole/3-position output filter wafer switch is mounted on a right-angle bracket adjacent to the filters, with an extension shaft to a knob on the front panel. Photo's 2 and 4 show the switch withdrawn from the mounting bracket. The change-over relay is placed close to, and between the Ant and RX sockets. The Ant. and RX connectors should not be of the same type.

Adjustment and Operation

An oscilloscope, of sufficient bandwidth (at least 10 MHz, with X10 probe) would be very handy (but is not essential) in commissioning the transmitter. If it has been built in stages, as suggested, your power supply should be delivering 12 and 24 volt DC, and VXO/driver should be working satisfactorily. Check that the drive can be varied with the level control. Maximum output from the 2N3053 driver should be about 4 volt peak to peak (P-P) across 56 ohms. If this level is not obtained- find out why. Some typical P-P and DC voltages are shown at salient points in the circuit. Don't worry if the waveforms look a bit "fruity", that's why there is a low pass filter for each band at the output.

The PA is the stage where we have to be particularly careful. Check all wiring,

component placement and polarities again- perhaps after a break for a cuppa. Set the 2 k bias pot to minimum gate voltage. Connect a 50 ohm dummy load/ power meter to the Ant output connector via 50 ohm coax. Select CW mode. Remove any crystal from the VXO (we don't want a drive signal at present).

Close the transmit switch. Carefully adjust the bias pot until drain current flows, as indicated on the 0-3 A meter. Set the pot so that just a small amount flows- perhaps 100mA. Plug a suitable crystal (say 3580 kHz) into the VXO; set the LPF to the band corresponding to your crystal. then close the TX switch again. When the key line is grounded via a Morse key. the drain current should rise to about 1.5 A. and RF power should be indicated on the power meter. Adjust the level control, and check that CW power may be varied between about 12 and 20 W, with a corresponding variation in drain current from about 1.5 to 2 A. Listen to the CW signal on your station receiver. It should be clean, without clicks, chirps or ripple.

Plug in your radio microphone- a rocking armature. or similar dynamic type is recommended. Set the mike gain pot near maximum. Whilst speaking. adjust the drive level until the drain current meter flicks upwards- just a whisker. If you have an oscilloscope. check the modulated output waveform. Adjust both the mike gain and drive level so that you observe nicely rounded peaks, and the troughs just touch zero (that is; you have 100 % modulation).

No oscilloscope ? Don headphones and listen to the signal (on AM mode) on your

receiver. Adjust mike gain and drive for what you feel is best fidelity. Set drive level initially so that about half the maximum CW power is generated for each band, or about 1.5 A drain current. Switch the receiver to SSB mode, then tune around the signal whilst speaking, and check that the sidebands are not spreading excessively. Back-off the mike gain if there are too many "whiskers".

For best modulation characteristics on-air, the load presented to the transmitter's output (which, on CW is very tolerant of miss-match) must have a low SWR of less than about 1.5, even lower if you can manage it.

Some method of muting the receiver on

transmit may be necessary (for my own set-up, I simply turn the receiver's RF gain down so that the CW or AM can be directly monitored on headphones). If you want something better, perhaps a spare contact on the relay would serve to actuate the mute on your receiver.

When operating CW, set the drive to any level desired. A power output adjustment range of about 2 to 1 is typical.

A 3.58 MHz ceramic resonator may be fitted inside a defunct style "D" crystal case; using a gas flame, unsolder the top of the case to expose the crystal. Snip the fine wires attached to the pins, solder a new fine tinned wire to each pin, then attach the resonator. It was found that the

stability of the resonator is significantly improved by filling the case with petroleum jelly (thus increasing the thermal mass) before re-soldering.

Parts

Most components are available from the familiar suppliers such as Altronics, Dick Smith and Jaycar. The BFR84 was a Dick Smith part. If unavailable, try for a near equivalent, such as MFE131, 3N201, 40673 or NTE 222- that have the same pin-outs. Power transformer may be DS M-1991 or Jaycar type 2165, or equivalent.

ar

EDUCATION

Brenda M Edmonds V3KT
PO Box 445
BLACKBURN VIC 3130.

Exam papers must reflect Regulations changes

Readers will be aware of the negotiations taking place between the WIA and the ACA with regard to the status of Morse code as a requirement for an amateur licence. As an interim measure, until the matter is discussed and decided at the International level, the ACA has agreed to allow full access to the HF bands for those amateurs who have passed the AOCF Theory and Morse code at 5 words per minute. It has also been agreed to continue examinations at 10 words per minute for those candidates who prefer it or who need the higher speed to gain reciprocal qualifications.

I do not intend to argue either for or against Morse code at any speed. My concern is that any change to the Regulations relating to the Amateur Service must be reflected in the questions appearing on the Regulations examination papers, and in the material available to candidates for their study.

Even such a simple change as this to the conditions of operation means that an amendment to the Licence Conditions Determination must be produced and gazetted. This inevitably takes time, so there is a time lag between the ACA agreeing, in principle, to a change and the change being implemented. This may be

a few weeks or much longer. All changes must be checked by the Legal Department of the ACA before the gazetting.

The upshot of all this is that candidates who are considering sitting for their Regulations examinations must be aware of the changes, and the Regulations examination question bank and papers must be amended to reflect the changed conditions. This also will take time. I cannot at this stage say how long, but by the time you read this the Examination Committee will be working on the revision of the Question Bank. It is hoped that the revised papers will be in place within a couple of months, but due notice

will be given when they are proposed to be released and used in examinations.

We can assume that changes to the LCDs will be reflected immediately in the LCD released on the ACA Web site. Please keep checking that site to see when the changes are gazetted. Be assured that these changes will not make the Regulations examination any harder. In fact, it may become easier as there will be much less distinction in privileges between Unrestricted and Intermediate licences.

All I can say at this time is:- Watch This Space!

ar

Australia's first IARU conference

A time for **DECISION MAKING**

By Jim Linton VK3PC

The 11th International Amateur Radio Union (IARU) Region III Conference being held in Darwin from August 28 to September 1, 2000, will be hosted by the Wireless Institute of Australia (WIA).

The IARU, now in its 75th year, is the unifying body for national radio societies, such as the WIA. It is structured in three regions, along the lines of the regions used by the International Telecommunications Union (ITU) and defined in the International Radio Regulations (ITU-RR).

Region I is Europe, Africa and generally the area of the former Soviet Union, Region II is North and South America, and Region III is the rest of the world, covering the Asia and Pacific regions.

The IARU has an Administrative Council, made up of two directors from each IARU region, and they meet for two days annually, at the venue of an IARU regional conference - this year in Darwin.

Each member society contributes to the funding of the IARU, firstly to its region, and through it to the IARU International Secretariat.

IARU Region III President, Fred Johnson ZL2AMJ, speaking at this year's WIA Federal Convention explained how the American Radio Relay League (ARRL) had always provided the International Secretariat, an operation that costs around \$US200,000 a year.

That enormous contribution includes the right of the ARRL to select the IARU President, and Vice-President.

All WIA members contribute to the IARU through their WIA membership subscription. Additionally they have paid a \$2 levy this year to help fund the IARU Region III conference in Darwin.

The IARU Region III was founded in Sydney in April, 1968, with a meeting of representatives from the WIA, Japan Amateur Radio League (JARL), New Zealand Association of Radio Transmitters (NZART), Philippines Amateur Radio Association (PARA), and the IARU.

First time in Australia

This year is the first time that IARU Region III conference has been held in Australia, and its deliberations will have an impact on Amateur Radio, not only throughout the region, but worldwide.

The WIA will be welcoming some 100 delegates from IARU member countries throughout Region III that includes much of Asia and the Pacific basin, plus observers from IARU Region I and Region II. Invited guests include Australian and Northern Territory government officials.

...the sharing of information, and experiences, between radio societies at the IARU RIII conference will be of enormous benefit.

Not only will conference debate important issues facing the Amateur Service and make strategic policy decisions, but the event also affords an excellent opportunity to expose our hobby to government dignitaries.

The Darwin Amateur Radio Club (DARC) is providing "on-ground" help to ensure this conference is a success. A lot

of preparatory work has already been carried out by the club.

A special event station is planned to operate from the IARU RIII conference venue. It will be activated by DARC members, is to be available for accredited delegates, and demonstrate our hobby in action to visiting officials.

The last IARU Region III conference was held in Beijing in September 1997 and it considered more than 100 papers. This resulted in 47 resolutions, and each of those will be reported on at the Darwin conference.

Each IARU Region conference builds on the work of the previous conferences in each region, and is reviewed by the IARU Administrative Council.

The WIA Federal Convention in April decided on the make-up of the WIA delegation attend to the conference to be led by the Federal President, Peter Naish VK2BPN. Each WIA delegate has individual and collective team roles to ensure that the conference is a success.

WIA papers proposed

The Federal Council also considered the available WIA papers, although some were still in draft stage, to be presented to the conference. They are expected to include:

- Report on the WIA's activities over the past three years . Harmonised 7MHz band - the WIA position
- Progress report on VK 80 metre DX window allocation . ADSL (a digital landline system) and its potential impact on the Amateur Service
- The Internet and Amateur Radio beyond 2000
- A proposal for a LF band for Region III
- Realignment of international microwave weak signal segments
- EMR (electromagnetic radiation) limits and its impact on the Amateur Service
- Decline of Amateur Radio (a follow-up report)
- Further input to the direction IARU is recommending for ITU-RR s.25 . LIPD impact on 70 cm operation

These are just the proposed WIA papers, a further 90 papers are expected from other IARU RIII member societies.

IARU vital to Amateurs

Fred Johnson ZL2AMJ said, "The work of the IARU is vital. Without frequencies the Amateur Service can't exist."

He said although the IARU operates on a voluntary basis, it has been effective in ensuring the interests of the Amateur Service are protected, at international conferences where big business seek spectrum.

"The IARU also enables radio amateurs worldwide (through their radio societies) to review their policies, and to formulate direction for the future development of Amateur Radio," said Fred ZL2AMJ.

"It is only by banding together, forming associations or societies such as the Wireless Institute of Australia, that we can collectively work together to retain what we have (frequencies), and work out policies to obtain what we would like to have."

He explained that the IARU has a unique position, and the Amateur Service view it puts forward at international conferences is highly respected.

Although the IARU does not have voting rights at World Radio-communication Conference (WRC) and other international meetings, it is regarded as a responsible body which thoroughly investigates problems and comes up with concerns and solutions.

WRC used to be held every 20 years. But with the rapid development of technology and its associated demands on spectrum, WRC are being held every three years.

There are also other conferences that related to radio, plus national preparatory conferences for each WRC.

Fred ZL2AMJ said. "This puts much more pressure on the IARU as it strives to establish policies and responses to WRC agenda items that may have an impact on the Amateur Service.

"Finding radio amateurs with the right skills and time to volunteer for the IARU is becoming more difficult."

But he said the work of the IARU is very important, and must continue. "Membership of the WIA is the way of individual radio amateurs to contribute to the well-being of their hobby, and

ensure it continues for future generations."

Fred ZL2AMJ said the sharing of information, and experiences, between radio societies at the IARU RIII conference will be of enormous benefit.

"I believe that the WIA is well down the track in working out an EMR (electromagnetic radiation) policy with its radio administration, the Australian Communications Authority.

"I am not aware of other societies in the region having got as far as that. We are looking forward to seeing a strong, firm and positive contribution on this issue by the WIA to the conference, providing a model on which they can deal with their radio administrations on the issue," said Fred ZL2AMJ.

Among the other contributions being eagerly anticipated from the WIA include a paper on the class licensed Low Interference Potential Device (LIPD) experience in Australia on the shared 70 cm band, he said.

ar

*For All Your
Requirements*

O AUTHORIZED DEALER

ICOM

KENWOOD

AMATEUR COMMERCIAL

Tower
Communications

**14 Mary Street
Hazlemere
Western Australia 6055
Telephone: (08) 9274 1118
Facsimile: (08) 9250 3734
E-mail: tower@eon.net.au
www: http://www.tower.visionimage.com.au**

DX NOTES

Ross Christie, VK3WAC
19 Browns Road, Montrose 3765, Vic.
Email Vk3wac@aol.com

What price DXCC?

How much money do you think it costs to achieve DXCC?

I was astounded after reading a very interesting article in 'DX Magazine' written by Don Boudreau, W5FKX, and John Barem, W6SL, who attempt to put a figure to it. The article has tables that show a breakdown of the cost into such things as equipment, antennae, QSL cards, IRC's, Green stamps, envelopes, stamps etc. To give just two examples,

- (1) the cost of the DXCC certificate (basic 100 cards) is US\$2189.14 (approx. A\$3648.57), assuming it takes 2 years to achieve, with a successful QSL response rate of 70%, 20% of the cards sent via the bureau and 80% via direct or QSL managers. The real eye-opener is example
- (2) the cost of the DXCC Mixed Mode Honour Role (DXCC 222+ cards). The breakdown for this achievement is a trifling US\$10690.33 (A\$17817.22)!

My own progress towards DXCC is plodding along nicely, I have sent QSL cards for CW QSO's to 122 countries so far and have received replies from 63. Most of my QSL's have gone out via the WIA QSL bureau, only about half a dozen have been sent direct. Being a keen CW operator I have set my sights on achieving DXCC on CW before I attempt it on SSB. In fact, checking my logbook, only 47 out of a total of 4516 contacts have been on SSB. It has taken me around 5 years to get this far, but then there is no hurry, is there?

A new DXCC entity recently appeared on Australia's northern doorstep. East Timor has been allocated the prefix block 4WA - 4WZ by the ITU for use by radio

stations operating in the areas administered by UNTAET (UN Temporary Administration of East Timor). Official radio stations have been issued with the prefix 4U, while UN amateur operations have been assigned the prefix 4U1. Private amateur stations will use 4W6. A number of amateurs have already been active from East Timor lately, notably Thor 4W6MM (TF1MM), Ross 4W6UN (VK8UN) and Antonio 4W6GH. Ross is a UN political affairs officer who has been in East Timor since last year, he will also act as custodian for the UN amateur station 4U1ET which will be established at the UNTAET headquarters in Dili. Ross has a PO Box in Darwin (see below for details) and will QSL *only* if stations send sufficient postage and a self addressed envelope. IRC's are out and QSLs received without enough to cover postage costs will definitely go via the bureau.

The DX

- 4W, East Timor. There are now six active stations in East Timor; Jose 4W6EB/CT3EEB (QSL via homecall; Jose de Sa, PO Box 79, 3860, Estarreja, Portugal); Antonio, 4W6GH/CT1EGH (QSL via homecall); Thor, 4W6MM/TF1MM. Ross, 4W6UN/VK8UN (QSL via VK3OT, Steve R. Gregory, PO Box 622, Hamilton, Victoria 3300, Australia); Nev, 4W6/VK2QF (QSL via homecall, Nev Mattick, Hargraves, NSW 2850, Australia); Bernie, 4W/W3UR (QSL via OH2BN; Jarmo J. Jaakola, Kiillette 5-c-30, 00710 Helsinki, Finland. Bernie is signing as 4W/W3UR and not as 4W6DX as previously announced "due to a misunderstanding at the licencing authority".
- 5I, Yambie Island, Tanzania (New IOTA). Nasser, A41KG is part of a twelve member team of the Royal Omani Amateur Radio Society (ROARS) who will be traveling to the Tanga Province, Tanzania on June 27th, to activate Yambie Island. The ROARS team have obtained permission to activate Yambe Island from the Tanzania Communication Commission. They will use the callsigns 5I3A and 5I3B. They plan to be on the air simultaneously from July 1-10th, operating SSB/CW and digital (PSK31) on all bands. QSL via A47RS, P.O. Box 981. Muscat, Code: 113 Sultanate of Oman. [Thanks to OPDX].
- FR/T, Tromelin Island. A Dxpediton by The Lyon DX Gang all-band all-mode Dxpediton to Tromelin (AF-031) is now scheduled to take place between 1st and 16th August (the first station might be active on 31 July in the evening). The operators will be F5PXT, F5PYI, F6JJX and F5NOD. Further information will be released later. The web site at is <http://perso.easynet.fr/~f6jjx/> [Thanks to 425DXN]
- GM, Summer Isles, Scotland. Jim, MM0BQI will be active on 80-10 metres, no WARC, mostly on SSB (with some CW) as MM0BQI/p from the Summer Isles (EU-092) between 12:00 UTC on 16th June and 16:00 UTC on the 18th June. QSL via MM0BQI either direct (Jim Martin, 3 Lismore Avenue, Edinburgh, EH8 7DW Scotland) or through the bureau. [TNX MM0BQI and RSGB]
- V3, Belize. Baldur, DJ6SI is active as V31OM. QSL via DJ6SI

QRV in Antarctica

Antarctica is a continent that interests many people for many reasons. It is a remote and harsh place and the personnel who winter over at the various bases are to be thanked for activating this vast continent of rock and ice. Here is an extensive list of operators currently QRV there. I was lucky to work Vic, R1AND on 15m CW on April 25th. I heard him call CQ while checking the band for activity and gave him a call. As soon as we finished and I sent 73 the dog-pile began. His signal sounded 'fluttery' due, no doubt, to the effects of the magnetic pole.

- UA1BJ/R1ANZ conducts a daily net called the 'Russian Antarctic Polar Net' on 14160kHz at 16:00z.
- The 'South Pole Polar Net' is another daily net conducted by K1IED on 14243kHz at 00:00z.
- Dave, K1IED, operates KC4AAA (K-08), the USN Mars station at Amundsen-Scott base, Antarctica. He will be active from now until 20 November 2000. Look for him on 14243kHz at approx. 05:00z. QSL to K1IED (Larry F. Skilton, 72 Brook Street, South Windsor, CT-06074, USA).
- LU1ZA (LU-14), NAVY ORCADAS – Laurie Island, South Orkney Islands. This station is active now. QSL via S.A.R.A (Servicio Auxiliar de Radioaficionados de la Armada) via bureau Argentino.
- LZ0A (LZ-02), ST. KLIMENT OHRIDSKI – Livingston Island. Danny, LZ2UU, is active now. He will be QRV every Wednesday and Saturday at 09:00z on 14325kHz. QSL to LZ1KDP (Radio Club, PO Box 812, 1000 Sofia, Bulgaria).
- HF0POL (SP-01), HENRYK ARCTOWSKI – King George Island. Marek, SP3GVX is active now. QSL to SP3WVL (Tomasz Lipinski, Ul.1 Paderewskiego 24m 1, 69-100 Slubice, Poland).
- R1ANF (UA-04), SAAM BELLINGSHAUSEN – King George Island. Operator is Oleg, UA1PBA, and is on the air now. QSL to RK1PWA (Nick Shapkin, PO Box 73, 164744 Amderma, Arkhangelskaja, Russia).
- R1ANZ (UA-07), SAAM MIRNY

QSL Routes and Managers

Call	QSL via
4W6UN	Thorvaldur Stefansson, PO Box 3699, Darwin, NT 0801, Australia
400A (CQ WPX SSB 2000)	via bureau to YU1SRS
5R8FA (IOTA AF 057)	via JE8BKW. NOT via I1PIN
700UY	This station is a PIRATE. Vladimir Drogan, UY0UY, is neither operator nor manager of this station
ED1VHF	via bureau to EA1BSK or via Apartado 6128, E-36200 Vigo, Spain
HC4NGF	Francel Garcia, Box 08-01-224, Esmeraldas, Ecuador
JY5HX	Since the Jordanian QSL bureau is not working reliably Munzer asks for direct QSLs to his call book address, be sure to include return postage. Box 096, 64001-970 Teresina PI, Brasil
PS8DX	Sava, Box 733, Kaliningrad City, 236010, Russia
RN2FS	Direct to CRAG/TG0AA, Box 115, Guatamala 01001, Guatamala. NOT via TG9AJR.
TG0AA	via bureau or Western Sovereign Base Area ARC c/o Air Training Corps. RAF Akrotiri. BFPO 57, GPO, Great Britain
ZC4AKR	

- Guillaume II Coast. Operator Valentin is currently on air. QSL to RU1ZC (Valentin Mykitenko, Akademgorodok 2 1, 184340 Loparskaya, Russia).
- R1AND (UA-08), SAAM NOVOLAZAREVKAYA – Princess Astrid Coast. Operator is Victor Karrasshev (ex R1ANF, R1ANT, 4K1A, 4K0D) is active now. QSL to DL5EBE (Dominik Weiel, Farhrstr. 16, D-27568 Bremerhaven, Germany).
- EM1U and EM1KY (UR-01). Akademik Vernadsky Base – Galindez Island. Pavlo (Pavel) UT1KY, is active now. using both of these callsigns. QSL to UT7UA (Roman Bratchyk, PO Box 19, Kyiv 01001, Ukraine).
- 8J1RL (JA-02), NIPR SYOWA – Ongul Island. Taku, JG3PLH, is active from the Japanese Antarctic base. Taku prefers CW and will be unable to confirm contacts until he returns home in March 2001. QSL via bureau to JG3PLH (Takumi Kondoh, 1-23 Shinke-cho, Sakai City, Osaka 599-8232, Japan).

IOTA Activity

Looking through the various DX news sheets I see quite a lot of IOTA activity planned for the summer in the Northern

Hemisphere. I wonder if there are many IOTA chasers in VK? Drop me a note or email me and let me know.

- (EU-068) A group of Belgian operators will be active from Sein Island in July. They have applied for the calls TM4CK and TM4ON (the latter to be used during the IOTA Contest). They now plan to start operations on 27-28 July and to leave the island on 1 August. More information will be made available later. The expedition site is at <http://www.qsl.net/on6ck> [TNX ON9CGB]

For those new to the IOTA program or would like to give it a go, the IOTA frequencies are:

- CW 28040, 24920, 21040, 18098, 14040, 10114, 7030, 3530 kHz
- SSB 28560, 28460, 24950, 21260, 18128, 14260, 7055, 3765 kHz

Late News

Hans, DK9KX, has released a press release announcing the end of the current operation of the special activity station 7O1YGF in the Republic of Yemen. A team of German operators (DJ7MG, DK1II, DK3KX and DL5EBE) who have been active since their arrival on April 17th, have been requested by the authorities to cease operation. Apparently

continued on page 37

DON'T MISS THE ACTION!

VX-IR 2m/70cm Micro Handheld

One of the worlds smallest dualband handhelds, just 47 x 81 x 25mm (W.H.D.) including a high capacity 700mA/H Lithium-ion battery! The VX-IR covers both 2m and 70cm amateur bands, plus offers AM/FM and TV sound reception, 2 hour fast charging as standard, simple settings and a large LCD screen.

Features

- Tx: 144-148, 430-450MHz
- Rx: 0.5-1.7MHz, 76-300MHz, 300-580MHz, 580-999MHz (cellular locked out)
- Output: 2m/70cm 0.5W (at 3.6V), 1.0W with external DC
- 291 memories, most with alpha naming
- AM, FM(n), and FM (w) reception modes
- CTCSS encode/decode
- 31 smart search memories
- Tone search for CTCSS and DCS
- Includes FNB-52LI 3.6V 700mA/H Lithium-ion battery, regulated AC adaptor/charger, antenna and belt-clip.

D 3665

YAESU

\$399

2 YEAR WARRANTY



VX-5R 6m/2m/70cm Deluxe Hand-Held

Tiny yet incredibly rugged, the VX-5R provides 6m, 2m and 70cm amateur band operation with 5W output as standard (4.5W on 70cm), made possible by a unique PA design and a super high capacity 7.2v 1100mA/H Lithium-ion battery. Plus, ultra-wide coverage VHF and UHF as well as AM medium-wave and shortwave reception facilities are provided, along with a large backlit dot-matrix LCD screen. All this in a diecast aluminium enclosure just 58 x 87 x 28mm WHD (without knobs or antenna)!

Features

- Tx: 50-54, 144-148, 430-450MHz
- Rx: 0.5-1.8MHz, 1.8-16MHz, 47-729MHz, 800-999MHz (cellular blocked)
- Full feature keypad, CTCSS encode/decode, digital code squelch
- Comprehensive menu system
- Over 200 memories
- 8 digit alpha-numeric memory labelling
- 5 battery saving systems, plus Tx/Rx usage monitor
- Spectra-Scope™ for monitoring adjacent channel activity
- Comes with FNB-58LI Lithium-ion battery, flexible antenna and AC adaptor/charger

D 3670

YAESU

\$699

2 YEAR WARRANTY

BONUS BONUS BONUS

Purchase a VX-5R during April, May or June 2000 and receive a CD-15 Desk Rapid Charger (D 3672 valued at \$49.95) at no charge!



Yaesu FT-90R 2m/70cm micro mobile

Another engineering breakthrough from Yaesu – a tiny dual-band mobile rig with high power output, a remoteable front panel, and a rugged receiver front-end. The FT-90R provides 50W RF output on the 2m band as well as 35W output on the 70cm band, a solid diecast casing with microprocessor controlled cooling fan for reliable operation, and a large backlit LCD screen, all in a package measuring just 100mm x 30mm x 138mm.

Also includes:

- Wide dynamic range receiver for greatly reduced pager breakthrough
- Huge receiver coverage – 100-230, 300-530, 810-999.975MHz (Cellular blocked)
- 180 memories and a variety of scanning functions
- Built-in CTCSS encode/decode, battery voltage metering
- Designed for 1200 and 9600 baud packet operation
- Tiny remoteable front panel (requires optional YSK-90 separation kit)
- Includes MH-42 hand mic, DC power lead, and easy to follow instructions.

D 3312

YAESU

\$899

2 YEAR WARRANTY

YSK-90 Front Panel Separation Kit D 3317

\$129⁹⁵



FOR ALL YOUR COMMUNICATION NEEDS

High Performance 2m Base Station Antennas

Diamond base station antennas offer outstanding quality and exceptional value. This stacked collinear type provides high gain, wide bandwidth and a low radiation angle for extended range. The fibreglass reinforced polyester outer radome and gasket seals provide excellent all-weather operation and compact ground-plane radials are supplied. Stainless-steel mounting hardware ensures a long, trouble-free life. Supplied with instruction sheets for easy set-up.



\$169
SAVE \$30
CLEARANCE

2m Antenna F-23A

Frequency: 144-148MHz
Gain: 7.8dB
Max. Power: 200W
Length: 4.53m, max wind 40m/s
Type: 3 x 5/8"
Connector: SO-239 socket

D 4850

FT-2500M 2m Heavy-Duty Transceiver

Built tough to take the rough stuff, the Yaesu FT-2500M meets US MIL-STD 810C for shock and vibration so it'll provide years of reliable mobile operation. Its easy-to-operate front panel design, rubber coated knobs, and large Omni-Glow display are teamed up with a one-piece diecast chassis to set the FT-2500M apart from other 2m mobiles. For improved front-end performance, Yaesu's exclusive 3-stage Advanced Track Tuning feature and dual-FET mixer reduce overloads from strong signals while providing excellent sensitivity and wide-band receive operation.
D 3632

Also includes:

- 31 tuneable memories
- 7 selectable tuning steps
- Various scanning modes
- In-built CTCSS encoder
- MH-26 hand mic, mobile mounting bracket and DC power lead.

Specifications:

Frequency range: Tx 144-148MHz, Rx 140-174MHz
Output power: 50W, 25W, 5W
Sensitivity: better than 0.2uV for 12dB SINAD
Image rejection: better than 70dB
Max audio output: 2.0W into 8 ohms (10% THD)
Dimensions: 160 x 50 x 180 (W.H.D)

2 YEAR WARRANTY

YAESU

\$399
SAVE \$100

**CLEARANCE
BELOW COST!**



PowerHouse stores

A shopping experience like no other!

Dick Smith PowerHouse stores not only offer an expanded range of those original electronics products that have made our stores famous, but now you can experience the fun of using a wide range of communication equipment in our hands-on demonstration area.

Called the "Ham Shack", each PowerHouse store has a dedicated area where licensed staff can show you the latest Yaesu, Uniden, or Magellan communications and GPS products, as well as an expanded range of accessory lines that may not be available in other stores.

Not involved in Ham Radio? Staff can also advise on the installation of a CB radio for your four-wheel drive vehicle, how to get involved in listening to Shortwave radio stations from around the world, or assist you in the selection of a suitable accessory for an existing piece of equipment. For bushwalking or boating users, you can also find out about the latest in inexpensive satellite based navigation receivers or emergency beacons, or just browse through an extensive selection of communications related books.

The PowerHouse is also the place to go if you simply need a component to finish that weekend project, to buy tools, or just to while away a few hours while checking out our

in-store technical books, library CD-ROMS, or our dedicated customer use Internet terminals.

With over 20,000 product lines in the electrical, computer, and communications areas, our new PowerHouse stores get the wavelength right!



PHONE FAX AND MAIL ORDERS

PHONE: WITHIN AUSTRALIA: 1300 366 644
(Local call charge)

FAX: (02) 9395 1155 within Australia and
(+612) 9395 1155 from outside Australia

MAIL: DICK SMITH ELECTRONICS, Direct Link, Reply Paid 160,
PO Box 321, North Ryde NSW 1670 (No stamp required)

Excludes packaging and postage. All major credit cards accepted.
14 Day Money Back Guaranteed if NOT completely satisfied. (Software excluded)



Visit our web site at
<http://www.dse.com.au>

DICK SMITH
ELECTRONICS

That's where you go!

Yaesu transceivers and accessories stocked in selected stores only.
Other stores can place orders on a deposit-paid basis.
Offers expire 30/6/2000.

1074 DPS s.c



Division Directory

The Amateur Radio Service exists for the purpose of self training, intercommunication and technical investigation. It is carried out by amateurs who are duly authorised people interested in radio technique solely with a personal aim and without pecuniary interest.

The Wireless Institute of Australia represents the interests of all radio amateurs throughout Australia. National representation is handled by the executive office under council direction. One councillor for each of the seven Divisions. This directory lists all the Divisional offices, broadcasts schedules and subscription rates. All enquiries should be directed to your local Division.

Broadcast schedules All frequencies MHz. All times are local.

VK1 Division Australian Capital Territory,
GPO Box 600, Canberra ACT 2601
President Gilbert Hughes
Secretary Peter Kloppenburg
Treasurer Edwin Alcott

VK1GH
VK1CPK
VK1NBH

VK1WI: 3.590 LSB, 146.950 FM each Sunday evening from 8.00pm local time. The broadcast text is available on packet, on Internet *aus.radio.amateur.misc* news group, and on the VK1 Home Page <http://www.vk1.wia.ampr.org>

Annual Membership Fees. Full \$72.00 Pensioner or student \$58.00. Without *Amateur Radio* \$44.00

VK2 Division News South Wales
109 Wigram St, Parramatta NSW
(PO Box 1066, Parramatta 2124)
(Office hours Mon-Fri 1100-1400)
Phone 02 9689 2417

Web: <http://www.ozemail.com.au/~vk2wi>

Freecall 1800 817 644

e-mail: vk2wi@ozemail.com.au

Fax 02 9633 1525

President Michael Corbin
Secretary Barry White
Treasurer Pat Leeper

VK2YC
VK2AAB
VK2JPA

From VK2WI 1.845, 3.595, 7.146*, 10.125, 14.160, 24.950, 28.320, 29.120, 52.120, 52.525, 144.150, 147.000, 438.525, 1281.750 (* morning only) with relays to some of 18.120, 21.170, 584.750 ATV sound. Many country regions relay on 2 m or 70 cm repeaters. Sunday at 1000 and 1930. Highlights included in VK2AWX Newcastle news, Monday 1930 on 3.593 plus 10 m, 2 m, 70 cm, 23 cm. The broadcast text is available on the Internet newsgroup *aus.radio.amateur.misc*, and on packet radio.

Annual Membership Fees. Full \$69.00 Pensioner or student \$56.00. Without *Amateur Radio* \$41.00

VK3 Division Victoria
40G Victory Boulevard Ashburton VIC 3147
(Office hours Tue & Thur 0930-1500)
Phone 03 9885 9261

Web: <http://www.tbsa.com.au/~wivvic/>

Fax 03 9885 9298

e-mail: wivvic@alphalink.com.au

President Jim Linton
CEO Barry Wilton
Secretary Peter Mill

VK3PC
VK3XV
VK3APO

VK3BWI broadcasts on the 1st and 3rd Sunday of the month at 8.00pm. Primary frequencies, 3.615 LSB, 7.085 LSB, and FM(R)s VK3RML 146.700, VK3RMM 147.250, VK3RWG 147.225, and 70 cm FM(R)s VK3ROU 438.225, and VK3RMU 438.075. Major news under call VK3WI on Victorian packet BBS and WIA VIC Web Site.

Annual Membership Fees. Full \$75.00 Pensioner or student \$61.00. Without *Amateur Radio* \$47.00

VK4 Division Queensland
GPO Box 638 Brisbane QLD 4001
Phone 07 3221 9377
e-mail: office@wiaq.powerup.com.au
Fax 07 3266 4929

Web: <http://www.wia.org.au/Vk4>

President Colin Gladstone
Secretary David Jones
Treasurer Bill McDermott
Office Mgr John Stevens

VK4ACG
VK4OF
VK4AZM
VK4AFS

VK4WIA broadcasts on 1.825 MHz SSB, 3.605 MHz SSB, 7.118 MHz SSB, 10.135 MHz SSB, 14.342 MHz SSB, 21.175 MHz SSB, 28.400 MHz SSB, 29.660 MHz FM (ptr), 147.000 MHz, and 438.525 MHz (in the Brisbane region, and on regional VHF/UHF repeaters) at 0900 hrs K every Sunday morning. QNEWS is repeated Monday evenings, at 1930 hrs K, on 3.605 MHz SSB and 147.000 MHz FM. On Sunday evenings, at 18.45 hrs K on 3.605SSB and 147.000 FM, a repeat of the previous week's edition of QNEWS is broadcast. Broadcast news in text form on packet is available under WIAQ@VKNET. QNEWS Text and real audio files available from the web site

Annual Membership Fees. Full \$85.00 Pensioner or student \$72.00. Without *Amateur Radio* \$56.00

VK5 Division South Australia and Northern Territory
(GPO Box 1234 Adelaide SA 5001)
Phone 08 8294 2992

web: <http://www.qsl.net/wiasant>

President Jim McLachlan
Secretary David Minchin
Treasurer John Butler

VK5NB
VK5KK
VK5NX

VK5WI: 1827 kHz AM, 3.550 MHz LSB, 7.095 AM, 14.175 USB, 28.470 USB, 53.100 FM, 147.000 FM Adelaide, 146.700 FM Mid North, 146.800 FM Mildura, 146.825 FM Barossa Valley, 146.900 FM South East, 146.925 FM Central North, 147.825 FM Gawler, 438.425 FM Barossa Valley, 438.475 FM Adelaide North, ATV Ch 35 579.250 Adelaide. (NT) 3.555 USB, 7.065 USB, 10.125 USB, 146.700 FM, 0900 hrs Sunday. 3.585 MHz and 146.675 MHz FM Adelaide, 1930 hrs Monday.

Annual Membership Fees. Full \$77.00 Pensioner or student \$63.00. Without *Amateur Radio* \$49.00

VK6 Division Western Australia
PO Box 10 West Perth WA 6872
Phone 08 9351 8873
Web: <http://www.omen.net.au/~vk6wia/>

e-mail: vk6wia@omen.net.au

President Neil Penfold
Secretary Christine Bastin
Treasurer Bruce Hedland-Thomas

VK6NE
VK6ZLZ
VK6OO

VK6WIA: 146.700 FM(R) Perth at 0930hrs Sunday relayed on 1.865, 3.564, 7.075, 10.125, 14.116, 14.175, 21.185, 29.120 FM, 50.150 and 438.525 MHz, Country relays 3.582, 147.200 (R) Catby, 147.350 (R) Busselton, 146.900 (R) Mt William (Bunbury), 147.000 (R) Katanning and 147.250 (R) Mt Saddleback. Broadcast repeated on 146.700 at 1900 hrs Sunday relayed on 1.865, 3.564 and 438.525 MHz : country relays on 146.900, 147.000, 147.200, 147.250 and 147.350 MHz..Also in "Real Audio" format from the VK6 WIA website

Annual Membership Fees. Full \$69.00 Pensioner or student \$59.00. Without *Amateur Radio* \$38.00

VK7 Division Tasmania
PO Box 371 Hobart TAS 7001
Phone 03 6233 3709 (BH)
Web: <http://www.wia.tasnet.net>
email: batesjw@netspace.net.au
Fax 03 6223 7816

President Phil Corby
Secretary John Bates
Treasurer John Bates

VK7ZAX
VK7RT
VK7RT

VK7WI: 146.700 MHz FM (VK7RHT) at 0930 hrs Sunday relayed on 147.000 (VK7RAA), 146.725 (VK7RNE), 146.625 (VK7RMD), 3.570, 7.090, 14.130, 52.100, 144.150 (Hobart), repeated Tues 3.590 at 1930 hrs.

Annual Membership Fees. Full \$88.00 Pensioner or student \$75.00. Without *Amateur Radio* \$55.00

VK8 Northern Territory (part of the VK5 Division and relays broadcasts from VK5 as shown, received on 14 or 28 MHz).



Division News

VK1 Notes

Forward Bias

There was no General Meeting on April the 24th; too many members were away on holidays. It also meant that the Trash & Treasure event was cancelled. By the time you read this in June, T&T in May, has come and gone until the next one on August 28.

The ACT Division welcomes Mr A. (Tony) J. Vickers, VK1VIC, who was VK2VIC in Koorinal, NSW, until recently. Membership stands at 152 presently, having lost one member last month (L10173). While on the subject of members, one of our very own, Philip Longworth, VK1ZPL, has been appointed National WICEN Co-ordinator at the recent Federal Annual General Meeting. Phil has spent much time and effort with WICEN since his arrival here from Albury-Wodonga, where he was Regional Co-ordinator for the Murray district in NSW. Phil also made a name

for himself when living in Victoria, when he was Regional Co-ordinator for the "Papa" district. Given his knowledge, experience, and dedication to this part of the hobby, we can expect a new impetus in WICEN activities throughout the Nation.

Another ACT amateur, who is well known to us all, Gilbert Hughes, VK1GH, was also elevated to an important position in the Federal organisation. Gilbert was appointed Word Radio Conference/ International Telecommunications Union (WRC/ITU) co-ordinator. Gilbert has already attended several ACA meetings in this capacity, where among others, he was given the job of participating in a small team that has the objective of drafting an 'Information Paper' regarding the application of the ACA's EMR standard for the amateur Radio Service. Gilbert says that the paper will be considered by

Peter Kloppenburg VK1CPK

the ACA-chaired Industry committee meeting in June this year.

Last but not least, our Vice-President ACT Division, Federal Councillor, champion of the "70cm linked repeater system", Glenn Dunstan, VK1XX, was reappointed to the ACA Liaison Committee. Glenn is involved in several important issues affecting radio amateurs in Australia. Among these are the 80-metre DX window, the new 160-190 kHz band, the 7 MHz allocation, and Article S.25 (Morse) removal of the Morse code.

Watch this space folks, it won't be long before the smallest Division makes the biggest impact on the future of amateur radio in Australia. Coming down to earth; the next General Meeting will be held on Monday 8pm, June 26, at the Griffin Centre, Civic, Canberra City. Cheers Peter K.

VK2 Notes

by Pat Løper VK2JPA
patleep@bigpond.com

The Annual General Meeting was held on Saturday 15th April and was quite well attended. The day went well, and the barbecue lunch, with steak and sausages provided by Brian Kelly VK2WBK, had

many coming back for seconds.

The result of the 2000-2001 Divisional Council election was announced, and the following people were successful: Ken Westerman VK2AGW, Michael Corbin VK2YC, Barry White VK2AAB, Brian Keegan VK2TOX, Brian Kelly VK2WBK, Geoff McGrorey-Clark VK2EO, Pat Løper VK2JPA, Chris Minahan VK2EJ, and Terry Davies VK2KDK.

There were no motions listed but that did not stop much discussion during general business as usual.

Certificates of appreciation for members with 60 and 50 year

memberships of the WIA were presented after lunch. Only one of the 60-year membership recipients was present this year, with a number of the 50-year recipients. For those unable to attend, the certificates are being posted out.

After the meeting office bearers were elected. The President is Michael Corbin VK2YC, Senior Vice President Brian Keegan VK2TOX, Junior Vice President Terry Davies VK2KDK, Secretary Barry White VK2AAB, Treasurer Pat Løper VK2JPA. Ken Westerman VK2AGW was appointed Affiliated Clubs Officer with the May Conference of Clubs needing to be looked after. Other portfolios will have been allotted at the May meeting by the time you read this.

And that's all for this month from the VK2 Division.



Barry White VK2AAB receiving his 50 year certificate from Michael Corbin VK2YC

VK3 Notes

Website: www.tbsa.com.au/~w1avic

Email: w1avic@alphalink.com.au

By Jim Linton VK3PC

New subscription rate

Members may have noticed the increase in the membership subscription being charged by most Divisions. This is the direct result of the goods and services tax (GST) and the need for the Federal WIA to fully recover the production cost of AR Magazine from ALL GRADES of member.

The WIA Victoria Council conducted a major review of policy in February, and one of the decisions taken was to return to the use of a voluntary labour resource to staff the office from July 2000.

The resultant savings in overhead costs will flow directly into the membership and WIA Victoria will subsidise the subscription rate to maintain a comparatively low fee structure. The greatest subsidy will be for our older loyal "Concessional" grade members who have supported us over many years.

The ongoing success of this WIA Victoria Council initiative will depend entirely on the response by members and their willingness to provide suitable volunteers to open and run our office. We would also like to open on Saturday morning in addition to Tuesday and Thursday.

We only need 4_ hours of your time - once a fortnight - 10am to 2.30pm so if you can help please give the office a call.

The Council will review the subscription rate in December and the response by members.

From July 1 WIA Victoria subscriptions including GST will be:

- Full Member - \$78.00 an increase of only \$3.00 (less than the GST)
- Concessional - \$61.00 No increase
- Without AR- \$47.00
- Associates - \$78.00

The Full Grade subscription represents \$1.50 a week, while those who elect not to receive AR magazine are to pay around 90 cents a week.

The Council has adopted responsible new policies, and is looking for an

increased partnership with the membership at large.

Individual members have a role to play including giving encouragement to others to join WIA Victoria, promoting our hobby particularly those who may be interested in becoming radio amateurs, and to seriously consider how they can contribute the needed voluntary labour resource.

What's new on the website

The WIA Victoria website is continuing to develop. The latest additions are:

- Australia's first Intruder Watch Online. Anyone with a receiver covering the ham bands, and email, can now easily log intruders and transmit the details to Intruder Watch. Individuals and radio clubs will be encouraged to target an intruder each month, and support Intruder Watch, which is help to protect our exclusive HF bands.
- A link has been set up to the BluSat micro-amateur satellite project. The website will bring news about the exciting project in coming months.
- A website visitor's survey form so you can quickly let us know about yourself and the section or sections of the website you read.
- The IARU Region III Conference being held in Australia for the first time. Read all about this most important regional meeting. WIA Victoria is helping to raise awareness of this event that will have impacts on our hobby for years to come.

The previously announced Members Section is due to come online fairly soon. It requires members to register via the website and have their membership status verified. This usually takes five working days, and is confirmed via email. The first batch of registrees signed on at the WIA Victoria AGM on 31 May. The website's

News Online section that is totally updated at the first of each month, and Education Online with interactive trial exams for Novice and AOCPP theory, and Regulations, continue to be highly popular.

Office hours

The WIA Victoria office is open for member services and inquiries on Tuesdays and Thursdays from 10am to 2.30pm. The telephone number is 9885 9261 and fax 9885 9298. The office is to be staffed by volunteers. A couple of members have recently received some initial training in office procedures and WIA Victoria policy. The new "volunteer" system is expected to be fully operational by the end of this month, and if further suitable volunteer labour can be found the office will also open 10am to 12.30pm on Saturdays.

Morse help

WIA Victoria is prepared to run a "Morse Camp" if there's sufficient interest, to assist those wishing to take advantage of the 5wpm Morse code proficiency requirement for full access to the HF amateur bands.

What is a Morse Camp? It is an intensive training session aimed at imparting the learning skills necessary to be code proficient.

The lowered code requirement may be attractive enough to lure some limited licensees, or prospective radio amateurs, to give it a try and qualify for the Morse code exams - who knows they may even fall in love with A1A, a love bug of another kind. They have nothing to lose, but the gains include learning a new skill and being able to take advantage of the good propagation on the HF bands during the peak of the current sunspot cycle. The Morse Camp, a once in a lifetime opportunity, will be advertised on the VK3BWI broadcast and the WIA Victoria website.

VK4 Notes - Qnews

By Alistair Elrick VK4MV

Unrestricted Zone

Non members or prospective members of our Institute can read monthly minutes, WIAQ proposals, AGM and Ex-Officio's reports on our website. These are posted at the earliest opportunity when they become available. Several overseas Societies have this facility for their own members, on members' only websites, but your WIAQ has provided the service FREE to ALL. This is our contribution to open Government.

The address and if you haven't put this in your 'favourites' change it NOW as the VK4 web address is about to change, ALWAYS enter via the link from the WIA Federal website: www.wia.org.au/vk4

IARUMS Reports

Tom Walker, VK4BTW our VK4 Coordinator for IARUMS has reported that some 1238 intruders were logged for the year, with over half of these on 20 metres! The signal receiving the most reports was on 14.211.5 MHz. This is RTTY with 850 Hz shift @ 112 baud, traffic and Mark and Space tones are heard anytime that the band is open.

The very conscientious observers who contributed to the logging and submitted reports throughout the year were KEN VK4JR, HARRY VK4LE, COL VK4AKX, JACK VK4BXC and DOUGAL VK4EKA.

Tom has circulated all the Queensland clubs listed in the 2000 callbook with the idea of appointing observers from their membership. These observers would be asked to actively monitor particular intruders in a concentrated pattern of logging.

All reports are welcomed by the IARUMS co-ordinator and add weight to the submissions to authorities to have intruders moved. Reports can be forwarded to:

I. W. Co-ord. Qld.

T. A. Walker,

13 Bothwell Street, Toowoomba Q. 4305
or Packet VK4BTW @

VK4WIP.#IPS.QLD.AUS.OC

Divisional Broadcasts In Mackay

Brian VK4KBS reports:

"Here I use the RA files to broadcast the News via our local repeater VK4RMK on 147 MHz situated on Black Mountain at Farleigh a few kms on the highway north of Mackay. I usually take the files down on Friday about midday, as this is when I seem to get the best file transfer rate (about 4.00 kb/s). I use a Yaesu FT-767 GX for the broadcast and only need to use a couple of watts output as we live only a couple of kilometres from the repeater site.

Thanks for the News Graham, from Brian VK4KBS."

Well done Brian in the valuable rebroadcasting role for Qnews.

Then there is "RELAY PNG STYLE"

The PNGARS has two major areas of activity and there must be two rebroadcasts.

Rick P29KFS does the Port Moresby broadcast "live" taking the audio from 20 metres which comes from a 2-metre repeater which may itself come from yet another repeater. The aerial is a full wave quad loop with 1/4-wavelength sides about 3 metres off the ground. It has a linear 1/2-wave reflector on the north side to optimise reception from Queensland and this does seem to work well.

The receiver is a Watkins Johnson HF1000 with 2.6kHz audio bandwidth filtering. The audio is fed into an MFJ 784 DSP unit, which eliminates the QRM from Philippine and Indonesian HF CB and the carriers are often plonked right on top of the broadcast. The rough and ready interlink uses headphones to a speaker mike on an old Kenwood TR2500 HH which runs on low power into a special version of a coaxial dipole. This is a "dog food dipole" made out of two PAL cans and a whip. The few hundred milli-watts is quite enough for the P29RPM repeater on Burns Peak to copy noise free and lets Rick ID over the top with a hand held when sitting outside on the balcony.

The repeater is about 4 km away and line of sight from Ricks' home QTH. The repeater is an old FM828 with split antennas and a 10" pass /notch diplexer. As well as this, an extra 5" bandpass cavity in the receive leg is followed by a LUNAR PAG144 preamp before the main diplexer cavities. With 10W transmit power out to another dipole, this is sufficient to cover the Port Moresby area.

Very innovative stuff that! You must pass on the theory behind the "PAL-CAN dipole" Rick, for the next Antenna Compendium of course.

Gladstone Repeaters

In the Gladstone area, by all accounts, they have their 6-metre repeater is still out of action. Both President Geoff VK4GI and Stuart VK4YFI have volunteered to get it up and running again.

Further more people could soon access the 70-cm VK4RGT repeater on Mt. Maurice, when the antenna situation has been addressed. The 2 metre repeater VK4RMV could well be relocation to a better site in the town of Seventeen Seventy, but this is still the subject of discussion. So it looks like the Gladstone club have their hands full in improving repeater coverage in their area.

Which is just another reason that NO MATTER WHERE YOU LIVE, you should give serious thought to providing help to the various clubs that are doing such a great job to give you the best facilities available. It is also quite enlightening to see the repeater sites up close.

73s from Alistair

**Amateur
Radio**
— everything
for the
active amateur

“QRM”, VK7 Notes

How often do we hear the complaint “amateurs are great talkers” but nowhere near as good at the “doing” part.

Well, here’s a story about an enthusiastic amateur who decided to “do his bit”.

It’s about Elwyn Harris, VK7EH. Elwyn for a start decided that he was not going to wait for the regulations change to allow him to get full privileges on the bands. Only two month’s ago Elwyn passed his 10 w.p.m. Morse test and graduated from “KEH” to “EH” and is

now having the time of his life talking all over the world.

Elwyn wanted to share his experiences with his fellow brethren and so, at the local Tamar Valley Masonic Lodge, set up an amateur station. Surrounded by a big group of wide-eyed brethren he then proceeded to talk to Hams around the world, after which he spent the rest of the evening in “question and answer” mode about our hobby stressing what a wonderful post-retirement hobby it could be. We take our hat off to Elwyn for

setting up what is possibly the first “Masonic” radio station.

Another amateur who was determined to get his “Proper” full call with 10 w.p.m. Morse was the Secretary/Treasurer of our Northern WIA branches, Tony Simmonds, now VK7TY. Good work, Tony.

All three VK7 WIA branches are starting Novice and full call classes and we hope these activities will pay off in many new members.

Cheers for now.

Ron Churcher VK7RN.

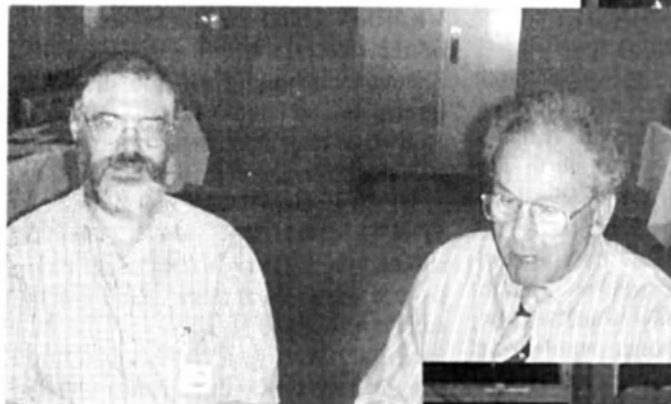
Snapshots from the VK7 Annual Dinner held in Hobart earlier this year



John VK7RT, State Treasurer and Phil, State President/Federal Councillor



Scott VK7HSE, Southern Branch President and Mike VK7FB, State Councillor



Robert VK7RB, Webmaster and John VK7KVB, Broadcast Officer



John VK7KCC, Sylvia (KCC), Heather (KVB) and Dick VK7KVB

5/8 Wave

The SA & NT division held our AGM on Tuesday the 23rd of May. The meeting was well attended by members, and office holders presented the usual reports. The committee for the year 2000/2001 is as follows:

President - Jim VK5NB
Secretary – David VK5KK
Treasurer – John VK5NX
Minutes Secretary – Mark VK5AVQ
Budget Officer – Trevor VK5ATQ
Federal Councilor – David VK5OV
Education Officer – Geoff VK5TY
Membership Recruitment – Michael VK5ZLC

IT & Media – Joe VK5UJ

Also on the council is Andrew VK5EX – WICEN Chairman and Adrian VK5ZSN.

Contact details for all of the above are available on the divisional website www.sant.wia.org.au

In March, the Barossa Amateur Radio Club installed South Australia's first fully

operational 9600-baud packet port on their BBS VK5BRC. VK5BRC is located at the same site as the Barossa Valley repeaters; W.I.A. SA & NT and B.A.R.C jointly fund this site. More details can be obtained from the club website www.qsl.net/vk5brc

In April a new divisional repeater was commissioned, this repeater is on 6metres with the output being 53.775 MHz input on 52.775 MHz. The repeater is located at the WIA Crafers site using the callsign VK5RAD; the Crafers site also houses repeaters on 2m and 70cm. The division would like to extend sincere thanks to Colin VK5ACE for his time and effort put into this project.

In May the division received the licence for the new 70cm repeater in Port Lincoln, the repeater callsign is VK5RPL and operating on 438.225 MHz with a negative offset. Thanks to Michael VK5ZEA and all the hams in Port Lincoln

for their hard work getting this repeater up and running. At present the repeater is still on test, so there may be times when you cannot access it. If you are over in Port Lincoln give it a try.

Recent changes by the ACA to the broadcast definition in Amateur Licences have resulted in the loss of the Disposals Corner segment from our weekly divisional Broadcast. The SA & NT Committee are very disappointed with this state of affairs, as are many members, however the ACA has asked that the segment be discontinued. Currently Barry VK5KCX is still maintaining a list of items for disposal on his web page, just click on the Disposals link on the divisional web page. We will keep members informed of action at a federal level that will hopefully rectify this situation.

Until next time, Joe vk5uj@qsl.net

ar

SILENT KEY

Col Craigen VK2NJC

It is with the deepest regret that the Manly-Warringah Radio Society records the passing of Col Craigen VK2NJC on March 18th. He was 82. A man of distinguished appearance and possessed of a fine intellect, Col lent dignity to all our proceedings. Always regarded as "a gentleman of the old school", Col was liked by all and he carried with him a wealth of experience. Only when the weather was at its worst would Col fail to turn up at the regular weekly meetings.

First licensed in the UK in 1936, he spent his career in radio and television, his experience with television going back to the earliest days of the technology when mechanical scanning was in the experimental stage. At one point Col made a television appearance for Logie Baird and thus could justly claim to have been one of the first people ever televised.

Upon the outbreak of World War II Col joined the Royal Air Force. One day in the summer of 1940, just as the Battle of Britain was getting under way, Col was mystified to be posted to a derelict-

looking factory in Watford, in southern England. There, to his intense surprise, he found himself in the company of eleven other radio amateurs all of whom had been selected by a young civilian called Dr R. V. Jones.

Dr Jones had been charged by the then Prime Minister, Winston Churchill, to discover and thwart the German beam-bombing navigational system which was having a devastating effect. This system enabled the German aircrews to fly to a target and accurately to drop their bombs at a predetermined point. Dr Jones knew that to do this task he needed people of technical imagination and flair and he also knew that such people were best found among the radio amateurs of the day.

Within weeks Dr Jones and his team built special transmitters which had the effect of corrupting the beams and confusing the German aircrews so much so that they were sent off course. In the parlance of the day Dr Jones was popularly credited with having "bent" the beams and once the Germans realised that they abandoned the system.

In the RAF Col met and became a personal friend of Arthur C Clarke who was serving at the same time with him and

together they worked upon the development of radar. Recently Colin recounted to the club how Clarke had explained to him his idea using manned geostationary satellites for radio communication, a theory which Clarke then published in *Wireless World* in October 1945.

(Incidentally, A facsimile of the article can be found at

<http://www.lsi.usp.br/~rbianchi/clarke/ACC.ETRelaysFull.html>)

In 1947 Col migrated to Australia and worked for AWA until his retirement, one of his major involvements being the broadcasting and telecasting of the 1956 Olympic Games in Melbourne. After retiring Col renewed his interest in ham radio and, like many amateurs, he loved to tinker, especially with VHF gear. Most recently, and in order to keep in touch with his nephew in UK, he was working to get active on packet radio but sadly Col passed away before matters were complete.

To Moira, Col's wife, and family, the Society offers its deepest sympathy. He will be sadly missed by all his friends in Amateur Radio.

ar

AWARDS

John Kelleher VK3DP

Federal Awards Officer

4 Brook Crescent, Box Hill South, Vic 3128 (03) 9889 8393

Going after Awards is one of the many pursuits of Radio Amateurs. Awards are the result of engaging in one or more pursuits of radio activity, usually involving making a number of contacts of a particular type. The award may be in the form of a certificate, plaque or trophy. Which brings me to a situation which occurred in an earlier edition of our Magazine. No award can be earned if the original information is incorrect. In this particular case (mea culpa) it was I who published the incorrect address of the NZART Awards Manager.

Bill, VK1WN saw this infringement of the rules, and supplied me with the correct address for ZL Awards. It is :-NZART Awards Manager, PO Box 1733 Christchurch, New Zealand.

Interested parties may join the Awards Net on 3.677 MHz every night from 8 pm NZ local time. Further information can be accrued on the web site :-

<http://www.nzart.org.nz/nzart/awards/awards.html>

There will not be a July edition of the Awards column due to my hospitalization. Some interested parties may submit copy to Editor, if they see fit. The above situation occurred because I had not received a current copy of Break-In, the annual magazine of the NZART.

I must thank Peter, VK3EBP for his continued support, in supplying me with accurate information on the DX situation which is published under "Where's DX."

Andorra. - Andorra 5 bands Award.

Requires contact with five different Andorran stations since January 1, 1989. These may have been on any of the bands 3.5, 7, 14, 21 and 28 MHz, and may be all CW, all SSB, or mixed. Note: only stations using the C31 prefix count. No cost indicated, but return postage is suggested. Send the 5 QSL's to :-

URA, PO Box 150, Andorra La Vella, Andorra.

Balaeric Islands - Diplome Cuitat de Palma.

Sponsored by La Union de Radioaficionados de Palma U.R.P., who make this award available for contacting EA6/EC6 stations after Jan 1 1994.

HF : contact 10 EA6/EC6 stations of the Palma City of Mallorca, members of U.R.P.

VHF contact 10 of the above.

GCR list and a fee of US\$8.00 or equivalent in IRC's to :-

Union Radioaficionados de Palma, Apdo 034 CP 07080, Palma de Mallorca, Islas Baleares, Spain.

Brazil - All Portugese Language Countries Award.

Requires proof of contacts with 10 countries of the world which customarily use the Portugese language. SWL OK. All bands and modes. No time limitations. All contacts must be made from the same country. Land stations only. Endorsement stickers for all 13 eligible countries. GCR list and fee of US\$2.00 or 3 IRC's (endorsement US\$1.00 or 1 IRC). The certificate is in two colours, 310mm x 215mm. Apply to :- Northeast Brazil DX/SWL Group, C/o PS7AB Ronaldo B. Reis, PO Box 2021 59094-970, Natal RN, Brazil.

Eligible countries are :- C9 Mozambique, CT3 Madeira Is, D2 Angola, J5 Guinea-Bissau, PY0F Fernando de Noronha, PY0T Trinitade & Martin Vaz, XX9 Macao, CT Portugal, CU Azores Is, D4 Cape Verde Is, PY Brazil, PY0S St. Peter & Paul Rocks, S9 Sao Thome & Principe.

Canada - Radio Amateurs of Canada Series.

General requirements : GCR accepted. Sponsor may request random cards for checking. Contacts after July 1 1977. Apply to :-Russ A Wilson VE6VK, 1235 Richland Road NE, Calgary, Alberta, Canada T2E 5MT

Canadaward

Confirm contact in each of the 12 Canadian Provinces and Territories. All QSO's must be on one band only. Separate awards for each band or mode. Fee is US\$5.00 for stations outside Canada.

5-Band Canadaward.

A special engraved plaque available for stations who confirm contacts with the 12 provinces and territories on 5 amateur bands. Fee is US\$40.00 for stations outside Canada. List of Canadian Provinces and Territories is as follows :- VO1- VO2 Newfoundland - Labrador, VE1 Nova Scotia, VE1-VE9 New Brunswick, VY2-VE1 Prince Edward Island, VE2 Quebec, VE3 Ontario, VE4 Manitoba, VE5 Saskatchewan, VE6 Alberta, VE7 British Columbia, VE8 Northwest Territory, VY1 Yukon Territory

All bands may be used. Each distinct satellite mode will count as a separate band. Note : VO2 Labrador is a part of the Province of Newfoundland and as such counts for Newfoundland. Some Canadian stations may be using different prefixes. Applicants should note that the award is based on the Province or territory of residence of the QSL card, not the prefix.

Chile - Radio Club of Chile Series

General requirements : GCR list, but must be certified by recognised club or national radio organisation/IARU member society. Fee is 8 IRC's per award for DX stations. Apply to :-Awards Manager, Radio Club of Chile, Casilla 13630, Saniago de Chile, Chile SA.

Worked All Chile - (WACE)

Contact CE stations in each of the 10 call areas. NO SWL. All contacts from the same country.

Republic of Chile Award

Contact any 16 Chilean stations from any call areas so as to form the phrase ; **REPLUBICA DE CHILE** with the last letter of their call sign. GCR list should be composed vertically down to spell the phrase.

Croatia - Diploma Zagreb

Contact stations in Zagreb since Sept 22 1957. YU/9A need 25, other Europeans 10 and all others 5. All bands and modes are acceptable. GCR list and fee of 5 IRC's to :- Radio Club Zagreb, Trg zrtava fasizma 14, Zagreb, Croatia.

Where's DX ?

The Kermadec DX Association wishes to advise that as from Apr 25 2000, all direct QSL cards for both ZL8RI and ZL9CI should be addressed to :-Ken Holdom ZL4HU (also ZL2HU), Kermadec DX Association, PO Box 7, Clyde, Central Otago, New Zealand.

This is now the ONLY address to send cards for the above two Dxpeditions. Due to NZ postal system rules, we cannot

guarantee any reply to cards sent to any previous address. Our Association would appreciate your assistance in arranging to have our new address published in your National or International amateur radio magazines, local Club newsletters, national packet clusters, and BBS's etc.;

East Timor QSL's for Jose 4W6EB

should go to CT1EEB, Jose Emanuel Ribeiro de Sa, PO Box 79, P-3860, Estarreja, Portugal or via the REP Bureau.

4W6MM - Cards for Thor can now be sent to :- Thorvaldur Stefansson, PO Box 3699, Darwin, NT 0801

Lesotho - A group of German operators are planning a Dxpediton between July 3 and July 22, using call sign 7P8AA. QSL via DL7VRO

Chesterfield Islands - This new entity has been added to the ARRL DXCC list wef March 23 2000.

Angola D2 - Fernando EA4BB is QRV as D2BB for about one year. QSL via W3HMK.

Reunion Island - Matthieu F5PED is now active as FR5DC. QSL via home call.

Chad TT - Jean, F5BAR is active as TT8JLB until July, QSL via home call.

Jan Mayen JX - Per, LA7DFA will be active as JX7DFA for up to 12 months. QSL via home call.

Bhutan A5 - Jim, VK9NS is presently active as A52JS from Thimphu. All QSL's should be directed to HIDXA, PO Box 90, Norfolk Island NI 2899.

HM0DX Mystery !! According to Toshi, JA1ELY beam tracking on this station have revealed that signals emanated from the JA7 district. Operator spoke English in a broad Tohoku (JA7 district) accent.

Kingman Reef - Palmyra Atoll. First notice of a Dxpediton to these remote entities probably programmed for October 2000. Good hunting, de John, VK3DP

ar

DX NOTES

continued from page 27

there has been some confusion regarding the licence issue and the official status of the station which has already made 35000 QSOs from 6m – 40m using CW, SSB and RTTY. Attempts are being made to clarify the situation with the authorities so that the operation can be officially recognised. (Thanks to Bernie, W3UR and the DailyDX.)

There has been a bit of 'skulduggery' going on in relation to the upcoming 3B6RF, Agalega Dxpediton. Joe Meier, HB9AJW, wants to let us know that the recent comments on the packet network regarding the QSL arrangements for the planned Dxpediton are 'incorrect'. He says someone (using Joe's callsign) has issued the info with the intent of

sabotaging the event. For more information on the operation, and the real QSL info, visit the official web page at www.agalega2000.ch

Tuji Yonten, A51TY, and Jim Smith (VK9NS), A52JS, began amateur operations from Bhutan on April 27th at 12:01 UTC. Yonten began the operation by conducting the first QSOs. The initial QSO was on CW with Pavel, RW0JR on 20m and the first SSB QSO was with Kirsti, VK9NL also on 20m. [Thanks to OPDX] Maybe I'm showing my personal bias here, but it's great to hear that CW was the mode used for the first contact from A5, the Kingdom Bhutan.

Round up

There has been some interesting DX on the bands recently and hopefully there

will be more on the way. Winter is approaching in the Southern Hemisphere and the longer hours of darkness will hopefully bring better propagation paths. I hope your summer months were spent overhauling those antennas, who was it that said "there are no good joints, only failed ones and failing ones"? It would be a pity to miss some rare DX due to a broken element or a faulty joint in the coax feeder.

Sources

Thanks go again to the following: *The Daily DX* by Bernie, W3UR, The NODXA Rag, ARDX, OPDX, 425DXN.

ar

CONTESTS

Ian Godsil VK3DID,

57 Nepean Highway, Aspendale, 3195

Phone: 0408-123-557 Email: contests@wla.org.au

Contest Calendar June - August 2000

Jun 3/4	IARU Region 1 Field Day (CW)	
Jun 10	Portugal Day Contest (SSB)	
Jun 10	QRP Day Contest (CW)	(Apr 00)
Jun 10	Asia-Pacific Sprint (SSB)	(Jan 00)
Jun 10/11	TOEC WW Grid Contest (SSB)	
Jun 10/11	ANARTS RTTY Contest	(May 00)
Jun 10/11	South American WW Contest (CW)	
Jun 17	Merv Stinson Memorial Sprint (CW/SSB)	(Jun 00)
Jun 17/18	VK Novice Contest (CW/Phone)	(May 00)
Jun 17/18	All Asia DX Contest (CW)	
Jun 24/25	ARRL Field Day	
Jun 24/25	Marconi Memorial Contest (CW)	(May 00)
Jul 1	Canada Day Contest (CW/Phone)	(Jun 00)
Jul 1	Jack Files Contest (CW)	(May 00)
Jul 1	Australasian Sprint (CW)	(Jun 00)
Jul 1	NZART Memorial Contest (CW/Phone)	(Jun 00)
Jul 6	Australasian Sprint (SSB)	(Jun 00)
Jul 8	Jack Files Contest (SSB)	(May 00)
Jul 8/9	IARU HF World Championship (CW/SSB)	(Jun 00)
Jul 15	Pacific 160 Metres Contest	(May 00)
Jul 15/16	SEANET CW Contest	(Jun 00)
Jul 15	Colombian Independence Contest (CW/SSB/RTTY)	(Jun 00)
Jul 22	Russian RTTY WW Contest	
Jul 22/23	RSGB IOTA Contest (CW/SSB)	(Jun 00)
Jul 29	Waitakere Sprint (Phone)	(Jun 00)
Jul 29	SARS Sprint Contest (SSB)	(Jun 00)
Aug 5	YO DX Contest (CW/SSB)	
Aug 5	SARS Sprint Contest (CW)	(Jun 00)
Aug 5	Waitakere Sprint (CW)	(Jun 00)
Aug 5/6	Worked All Europe DX Contest (CW)	
Aug 12/13	Keymen's Club of Japan Contest (CW)	
Aug 12/13	RD Contest (CW/SSB)	
Aug 19/20	SEANET SSB Contest	(Jun 00)
Aug 26/27	SCC RTTY Championship	
Aug 26/27	TOEC WW Grid Contest (CW)	

Thanks this month to ZL2BIL SARS AHARC NZART VK4YZ VK5CTY

Greetings to all Readers.

One of my tasks as Federal Contests Co-ordinator is to keep you all informed about contest rules and results. This is the purpose of this column, of course. However, there are three sites on the Internet (for computer users) that I commend to your attention – <http://www.wia.org.au> <http://www.uq.edu.au/radiosport> <http://www.vk2nnn.com/cgi-bin/calendars/vkcontest/calendar.pl>

The first of these is the WIA Federal Web Site. Here you may read these notes and see details of contests. The second is the page of our well-known and very able contestant John VK4EMM. John has details of contests as well as very pertinent comments relating to all aspects of contesting.

The third is an excellent Page by Allan VK2CA/NNN in Broken Hill. Allan has a variety of things associated with this Page, including a Calendar. Allan has given me permission to keep this Calendar up to date with information about local

contests and I thank him for this. (The address is a bit long, but it is well worth a visit.) I shall devote it to VK and ZL area contests specifically.

Please have a look at these sites. Even if you do not have a computer or access to the Internet, try the local Library. I worked that way for two years and it doesn't cost anything!

WRTC2000

In July two Australian contestants will travel to central Europe to represent us in WRTC2000.

This is a team event held every few years and this year Australia will be represented by George

VK4XY and John VK4EMM. They will be one of 53 two-man teams competing in Slovenia, and they will have special S500XX call signs. David VK2AYD was going over a Referee, but has decided to stay home and add VK to the list of logs received.

This is not a contest in the normally accepted sense of a yearly event, but a series of really tough mini-contests between the teams in speed sending and copying, callsign copying in a pile-up situation, and other goodies. A real challenge, so let's wish these two men well for their journey. (Further information is available on the radiosport web page listed above.) Also, let's all support David VK2AYD in his attempts to make contacts in this contest.

Finally, WARNING N.B. ATTENTION!
 Because of the Olympics, Summer Time will commence on SUNDAY, 27 AUGUST, 2000.
 Please note this NOW.
 73 and good contesting. Ian Godsil VK3DID E-mail: <contests@wia.org.au>

Results Alara Contest 1999

from Christine VK5CTY

Pat VK3OZ 204	Top score overall, Top score VK YL
Top VK CW (Florence McKenzie Trophy-53 pts), Top VK3 Alara member	
Susan VK7LUV' 200	Top phone score, Top VK7 Alara member
Melva VK4TP 111	Top VK4 Alara member
Alan VK7JAB 110	Top VK OM
Dave ZL I AMN 104	Top ZL OM
Celia ZL I ALK 99	Top score DX YL, Top ZL Alara member
Dot VK2DB68	Top VK2 Alara member
Christine VK5CTY 65	Top VK5 Alara member
Marilyn VK3DMS 57	CHECK LOG
Sally VK4SHE 47	
Bron VK3DYF 46	
John VK5EMI 15	
Mavis VK3KS 11	(entered CW only)

Poor response from VK4 stations— at least I know my QRP equipment is operating VK3DID/qrp
 I look forward to many more contests to come. Ian McGovern

The Merv Stinson Memorial Sprint

from Charlie Strong VK4YZ
 1000Z – 1100Z
 Sat 17 June

Purpose of the contest is to aid people in attaining proficiency in procedures, fine tuning of equipment and introducing people to the sport of contesting. Object of the contest is to contact (or log QSOs if an SWL) as many stations as possible in the one-hour period without duplication using SSB or CW. Any contact between Australia, New Zealand, Papua New Guinea and surrounding countries on the 80 metre band is valid. This contest is open to all licensed amateur stations and short wave listeners. Groups are allowed but must only use one callsign and transmitter.

The contest period is from 1000Z to 1100Z on Saturday, 17 June, 2000. This is the same weekend as the VK Novice Contest, therefore extracts from Novice Contest Logs between 1000Z and

1100Z will be accepted as logs for the Merv Stinson Memorial Sprint. Exchange RS(T) and serial number. Logs must show for each contact the time UTC, callsign (or callsigns for SWL) contacted, exchange sent and received. A log must have a summary sheet containing name, address, callsign, date of contest, total number of points claimed and a statement that the operator/s abided by the rules and spirit of the contest. Any comments should also be included. Send logs to: Contest Manager, Redcliffe & Districts Radio Club, PO Box 20 Woody Point, Qld 4019 by Friday 7 July, 2000.

The Contest Manager's decision is final and can disqualify any entry which is in violation of the rules and spirit of the contest or has an excessive number of duplicate contacts claimed as valid contacts.

Certificates will be awarded to the highest score over-all and in each of the Australian call areas and to the highest scores in New Zealand, Papua New Guinea and all other countries combined for both SWL and station logs.

Australasian Sprints 2000

from David Box VK5OV, Contest Manager
 1100 - 1159 UTC

CW: Sat. 1 July, 2000
 SSB: Sat. 8 July, 2000

The Adelaide Hills Amateur Radio Society Inc. is pleased to announce that the fifteenth series of the annual Australasian Sprints. Both of these contests are open to all appropriately licensed amateurs in VK, ZL and P2 call areas. A section is also provided for SWLs.

continued on page 40

Results Jack Files Memorial Contest 1999

from Trent VK4TI, Contest Manager

The Object was for Amateurs to work as many VK4 cities, towns and shires as possible (swl to hear and log), to encourage portable/mobile activity from the less populated VK4 shires and towns, and to serve as a warm up for the RD contest.

Sections

a) Single operator home;

Call	Shires	Prefixes	QSOS	Total
VK4EMM	1	25	120	3000(CW)
VK4JAE/7	5	7	91	1092
VK3DID	2	11	67	871(CW)
VK3DID	4	11	58	870
VK2LEE	9	6	41	615
VK7LUV	1	5	11	66

b) Club fixed;

Call	Shires	Prefixes	QSO	Total
VK4BAR	15	12	156	4212

c) Short wave listeners;

Call	Shires	Prefixes	QSO	Total
Ian McGovern	6	5	81	891

Activity was down apparently, however checking of the logs has shown that activity was fine, log submission was what was down. TO THOSE WHO SUBMITTED LOGS THANK YOU FOR YOUR SUPPORT.

Comments from the logs:

A better representation from vk4 but conditions to Melbourne not all that good VK3DID

My new callsign should be more effective VK7JAB

Unfortunately, it is almost certain that the 2000 Sprints will be the last. The number of entries has been steadily decreasing and last year there was only a total of 18 entries for the two sections. It has got to the stage where the costs involved, and in particular the cost of the two plaques which are the trophies for the two outright winners, together with the amount of time and effort required, can not be justified. It is a pity, but I believe that other contests are experiencing similar problems, so perhaps contests are becoming a thing of the past.

Object: to make (and SWLs to hear and log) as many contacts as possible, without duplication, during an hour of operation on a single band. Any contact with a VK, ZL or P2 station on 80 metres during the contest period can be counted, but a station may be claimed only once.

Eligibility: all licensed amateurs, or groups of amateurs using a single call sign, e.g. club stations, anywhere in the VK, ZL and P2 call areas.

Frequencies: CW — 3.500 to 3.700 MHz may be used.

PHONE — 3.535 to 3.700 MHz may be used.

Call: CQ Sprint CQ Test or CQ Contest.

Exchange: three-digit serial number which may start at any number between 001 and 999, but is to revert to 001 when 999 has been reached. Note that RS(T) is optional but may be required for contacts with contestants in other VK or ZL contest during the same period.

Logs: must show for each contact the time (UTC), callsign of station worked (both callsigns for SWLs), serial numbers exchanged. Enclose Summary Sheet showing name, date, CW or Phone, callsign, name and address of operator, total number of contacts claimed and a statement that the Operator has abided by the rules and spirit of the contest. Where multi-operators enter using a club callsign, the callsigns and names of all operators are to be included. Any special conditions such as QRP, or mobile operation should be mentioned in the statement. Any comments will be welcomed by the Sponsors..

Send logs to: AHARS, POK Box 401, Blackwood, SA 5051, Attention Contest Manager, by Friday, 11 August, with envelope endorsed CW, Phone or SWL Sprint. For 2000 the packet address is VK5OV@VK5PSG.#ADL.#SA.AUS.OC. Logs may be sent by e-mail to: <boxesdnm@lm.net.au>

Awards: Certificate will be awarded to the highest scorer in each VK, ZL and P2 call area for both the CW and Phone Sprints. Trophies will be awarded to the outright winners of both. A certificate will also be awarded to the highest scoring Novice Class operator in the CW Sprint only, provided that this entrant is not entitled to another award for the CW Sprint. Certificates may be awarded to other operators whose performance was, in the opinion of the Sponsors, exemplary. SWLs: Certificates will be awarded to the highest scoring listener log in the VK, ZL and P2 call areas for both the CW and Phone Sprints.

Any entry which is clearly in violation of the rules or spirit of this Contest or which contains an excessive number of claimed duplicate contacts (this does not refer to duplicates which have

been indicated as such and are not claimed), may be disqualified. The decision of the Adelaide Hills Amateur Radio Society Inc. in respect of the interpretation of these rules, the granting of awards and disqualification will be final.

These Contests are recommended as a good Saturday evening entertainment. If you have never entered a Contest before, here is a good, friendly time to start. Join in and enjoy the fun: It might well be your last chance.

IARU HF Championship

1200Z Sat. to 1200Z Sun 8 - 9 July !!!CKEC K!!!!

Bands: 160-10m (no WARC). Categories: Single Operator, CW only, phone only, mixed;

Multi-operator single transmitter mixed mode only. Multi-operator stations must remain on a band for at least 10 minutes at a time (exception: IARU member society HQ stations may operate simultaneously on more than one band with one transmitter on each band/mode, providing only one HQ callsign per band is used).

Exchange: RS(T) and ITU zone (P2=51.VK4/8=55.VK6=58 and VK1/2/3/5/7=59). HQ stations will send RS(T) and official society abbreviation.

Score one point for QSOs within own zone or with an HQ station; three points for QSOs with a different zone in own continent; five points for QSOs with different continents.

Multiplier is total ITU zones plus IARU HQ stations worked on each band. Final score is total QSO points from all bands X sum of multipliers from each band. Include a dupe sheet for 500+ QSOs. Send logs postmarked by 7 August to: IARU HQ, Box 310905, Newington, CT 06131-0905, USA.

Official forms and an ITU zone/prefix/continent map can be obtained from the same address on receipt of a large SASE with two IRCs or equivalent. Certificates to the top scorers in each category, in each state, ITU zone and DXCC country. Also, stations with 250+ QSOs or 50+ multipliers will receive achievement awards.

NZART 80m Memorial Contest

0800-1400Z Saturday 1 July

VKs are invited to join ZLs in this annual contest to commemorate amateurs lost in World War II. It is open to single operator stations on 80 m, fixed and mobile.

Repeat Contacts: The contest has six operating periods, each of one hour, from 0800-1400Z. A station may be contacted TWICE during each operating period (once on phone and once on CW), provided that such contacts are not consecutive.

Exchange: RS(T) plus serial number commencing at any number between 001 & 300 for the first contact.

Score: on Phone 15 points for the first QSO with a scoring area, 14 points for the second QSO with that area, descending to one point for the 15th & subsequent QSOs with that area. The same scoring system is used with CW, except that QSO points remain at five for the 11th and subsequent QSO with that scoring area. Scoring areas are ZL and VK prefixes/areas & DXCC countries. The rules for SWL entrants are similar, except that the callsigns of

the stations heard and being worked must be given and only the exchange of the station heard is required.

Send logs and summary sheets ASAP to: Memorial Contest, NZART HQ, PO Box 40525, Upper Hutt, NZ. Nominate the category entered (Open; Phone; CW; Beginner's CW; QRP; Home-made SSB), and include a points summary showing the number of QSOs & points for each VK/ZL call area worked. Certificates will be awarded to the top three scoring VKs.

Waitakere 80m Sprint

Phone: 1000-1100Z Saturday 29 July
CW: 1000-1100Z Saturday 5 August

This 80m sprint contest is open to all ZL & VK amateurs. In fairness to other amateurs, it is requested that no linear amplifiers be used in this contest.

Categories: Single operator; Dual operators, ie any two operators holding an appropriate licence and using the same equipment and their own callsigns. One will operator for the first half-hour and the other for the second half-hour. [Note: separate logs, both starting at 001.]

Call "CQ Sprint". Exchange: serial numbers commencing at 001 and incrementing by one for each contact. RS(T) is not required.

Logs must show stations worked, with serial numbers sent & received.

Attach a summary sheet and send log to: Sprint Contest Manager ZL1BVK, 14 Takapu Street, Henderson, Auckland 1208, NZ, to arrive by 1 September.

Alternatively, logs may be sent via packet, using three columns only with no commas or other delimiters, to: ZL1BVK@ZL1AB. Logs may also be sent by e-mail to: <zl1bvk@xtra.co.nz> Certificates will be awarded to the overall winner; the best score in each ZL call area and the three best VK scores.

RSGB Islands On The Air Contest

22 - 23 July
1200Z Sat-1200Z Sun

This contest is intended to promote contacts between qualifying IOTA island groups and the rest of the world and to encourage expeditions to IOTA islands.

Sections are: IOTA Island Stations (ie those with an IOTA reference); World and SWL. You can enter as CW only, SSB only, or mixed mode. Single operator stations can enter as unlimited (no time limit), or limited (12 hours max, with off periods at least 60 minutes long and marked in the log).

Bands: 80 - 10 m, avoiding 3.56-3.60, 3.65-3.70, 14.06-14.125 and 14.30-14.35 MHz. Exchange: RS(T) plus serial number, plus IOTA reference number if applicable. Stations can be contacted on both Phone and CW on each band. Use the same serial numbering system for both modes.

Score: 15 points per QSO with an IOTA station (including UK); five points for stations in another DXCC country; and two points per QSO with one's own country or IOTA reference.

Multiplier equals the total IOTA references per mode per band, added together.

Final score is total QSO points X total multiplier.

For each band (but not each mode), submit a separate log, multiplier list and dupe sheet. Send your log and summary sheet to: RSGB IOTA Contest, PO Box 9, Potters Bar, Herts EN6 3RH, postmarked no later than 26 August. A comprehensive range of awards is offered to the leading stations in each category, section & continent.

Southside Amateur Radio Society Sprints 2000

SSB: Sat 29 July
CW: Sat 5 August

Chosen to coincide with the Waitakere Sprint, the object is to contact as many P2, ZL and VK stations as possible.

Bands: 10, 15 and 80 metres.

Times: 0000Z - 0200Z on 10 and 15 m; 1000 - 1100Z on 80 m.

Exchange: serial number only starting at 001. Stations may be contacted once per hourly block, provided that such contacts are not consecutive, or that at least five minutes have elapsed between contacts.

Score three points on 10 m; two points on 15 m; one point on 80 m. QSOs with VK Novice/Limited stations become multipliers.

Final score is total QSO points times total VK Novice/Limited multipliers.

Logs should show all details of date, times UTC, callsign, exchanges, points claimed. Separate logs for each mode, please.

Summary sheets should show callsign, name and address, mode; claimed scores and signed declaration.

Send logs by mail to: SARS Contest Manager, PO Box 294, Woodridge 4114, Queensland; by packet in ASCII format to: VK4WSS@VK4PKT.#BNE.QLD. AUS.OC; by e-mail to: jabba@powerup.com.au Certificates to first three place-getters in each mode and special certificate for combined modes.

SEANET Contest

0000Z - 2400Z
CW: Sat 15 - Sun 16 July
Phone: Sat 19 - Sun 20 August

Object is for stations outside SEANET region to work as many SEANET stations as possible.

Bands: 160 - 10 metres (no WARC).

Categories: Single operator all bands; single operator single band; multi-operator single transmitter.

Exchange: RS(T) plus serial number. Score: one point for each QSO. QSOs in own SEANET country count for country credit only.

Multiplier is total number of SEANET countries X three.

Final score is total multiplier X total QSO points.

Send logs by 31 October to: SEANET Contest Manager, Eshee Pzak 9M2FK, PO Box 13, 10700 Penang, Malaysia.

SEANET countries: A4/5/6/7/9 BV BY DU EP HL HS JA JD1 JY KH2 P29 S2 S79 VK VQ9 VS6 VU V8 XU XV XW XX9 YB ZK ZL ZL9 3B6/8/9 4S7 4X 8Q7 9K2 9M2/6 9N 9V

NOVICE NOTES

Peter Parker VK3YE

12/8 Walnut Street, Carnegie, Vic 3163

Email: parkerp@alphalink.com.au

Novice Notes Online: <http://www.alphalink.com.au/~parkerp/nonline.htm>

Please note that this is Peter's correct address.

Send Morse on your VHF rig

Everyone knows that the best way to practice Morse is to use it on the air. But how do you send Morse if you don't have a multimode HF or VHF transceiver? Well, you could hold a microphone up to a code practice oscillator, and hold the PTT down while pressing the key, but it's very clumsy, and the transmitted tone is likely to be harsh. Clearly something better is needed.

Enter the MorseBox! It lets you send quality Morse from a normal two metre or 70 centimetre FM transceiver. Just plug it in to the rig's microphone socket and you're on the air. Using just one transistor and a handful of other parts, the MorseBox can instantly be switched between Morse and speech - a handy feature for those running Morse practice sessions with readbacks. MorseBox also includes semi-break-in to automatically switch between receive and transmit when the key is pressed and a sidetone to allow monitoring of keying.

Circuit Description

MorseBox consists of two stages. These are a tone oscillator and a transceiver control/timing circuit (Figure One).

The tone oscillator provides a pure tone to modulate the transmitter. It is turned on and off by keying the emitter circuit.

A twin-T circuit was used because it is reliable and reproducible. The output is fed to the transceiver microphone connection via a variable resistor which is adjusted to provide a sufficient audio level for the rig used.

The control and timing circuit tells the transmitter when to transmit and when to receive. Pressing the key activates the relay and causes the rig to switch to transmit. So that the transmitter does not drop out between individual dits and dahs, a large capacitor has been wired across the relay to provide a delay of several seconds. This means that the carrier is on constantly and makes for more comfortable reception. If the key hasn't been pressed for several seconds, the relay drops out and the transceiver switches to receive.

The delay time depends on the value of the capacitor and the resistance of the

relay coil. Slower senders will prefer a longer delay and faster operators will want a shorter delay.

The prototype had a delay of approximately three seconds, which should suffice for Novice speeds. Substituting a smaller value capacitor or lower resistance relay will lessen the delay (and vice-versa). Experimentation may be required to

produce an appropriate delay from the components at hand.

The front-panel switch allows Voice or Morse to be selected. When it is switched to voice, the MorseBox is disabled, and the hand microphone is connected straight to the transceiver. When Morse is selected the audio from the microphone is cut off and power is applied to the audio oscillator and relay circuits.

A useful feature is the sidetone or keying monitor. This allows you to monitor your own sending without needing a separate receiver. Though an IC audio amplifier and speaker could be used, this would increase the project's complexity. Instead it was decided to use a small piezo buzzer wired between the supply rail and key as sidetone. The 10k series resistor reduces the buzzer's volume and extends battery life.

Construction and testing

House the project in a metal case. This is important to prevent the transmitted signal feeding back into the audio oscillator and distorting the tone. The case pictured is a 100x77x130mm box by K&W.

All components except for the capacitor across the key socket, switch, sockets and battery holder are mounted on a piece of unclad perforated circuit board. The parts were a tight squeeze on the 60x80mm board used in the prototype. 75x76mm boards are commercially available and would have allowed a better layout. Component leads are passed through the board and are soldered underneath. Veroboard stripboard could be used, but allows



Photo 1: Front view of MorseBox.

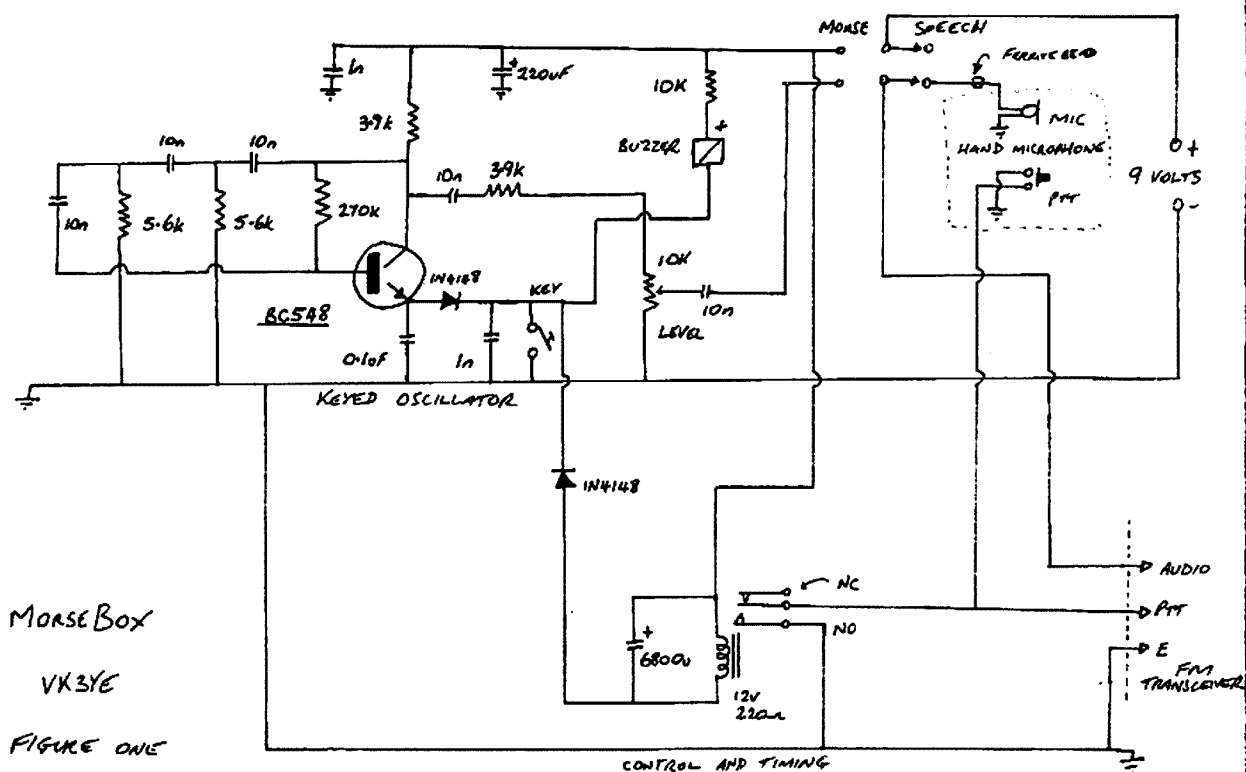


Figure 1: Schematic diagram of MorseBox.

a less flexible layout than the blank matrix board recommended. Because builders will use different component and circuit board types, no component layout diagram is provided. Instead treat this project as an opportunity to build something straight off a circuit diagram - an important amateur skill as discussed in April's *Novice Notes*.

Before commencing construction,

work out where components will be placed on the circuit board. This is particularly important for the larger parts, such as the relay, electrolytic capacitors and piezo buzzer. Allow space for a hole near each corner of the board to accommodate each spacer. Don't forget to connect the case to the supply negative line. This can be done in several places - most conveniently through the key socket.

Use a 6.5mm mono head-phone socket for the key. The only other socket on the rear panel is the connection to the transceiver. This connection should have sufficient pins to suit your transceiver's microphone connections. An eight pin microphone socket and

detachable patch lead was used in the prototype, but if you're really hard-up, this can be replaced with a flying lead with plug to suit the transceiver.

Drill two holes in the front panel. One is for the Morse/Voice switch and the other for the microphone connection. No socket was used for the microphone connection as the ex-commercial microphone used was cheap enough to be sacrificed full-time for this project. However one should be used if you wish to use your transceiver's normal microphone on the MorseBox. Don't forget the ferrite bead on the connection to the hand microphone - this reduces the risk of transmitted RF getting in to the audio.

Install the wiring around the Speech/Morse switch, relay contacts, the microphone and the socket that carries the connections to the transceiver. Take care as this wiring is quite complicated and it's easy to make a mistake. Trust me, you'll almost certainly get it wrong first time! Use the testing process described later to check for such faults before the MorseBox is wired to the transceiver.

The power supply used is up to the builder. Batteries were used in the prototype

Continued on page 44

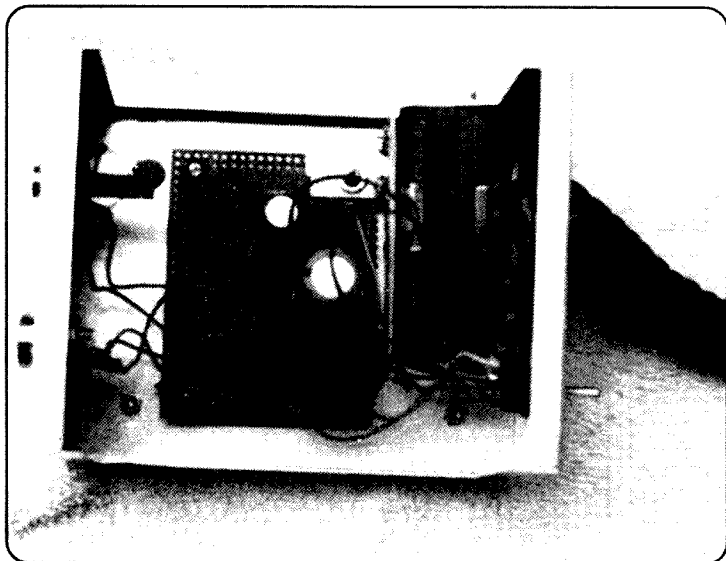


Photo 2: MorseBox with the cover off. Note the battery holder behind the front panel and the circuit board in the centre

to make the unit fully portable and eliminate the need for an external supply. A bank of six 'AA' was used in the prototype. This is a good compromise between battery life, size and cost. The small nine volt batteries could be used, but have limited capacity and may give rise to oscillator chirp near the end of their lifespan.

Connecting MorseBox to your transceiver

To connect the MorseBox to your transceiver you will need to make a cable. Because the required connections vary between transceivers, it is not possible to provide the details here. Instead you will need to study the microphone connections as given in your transceiver's user manual or schematic diagram. Identify the microphone's basic connections (ground, microphone audio and push-to-talk) and note any other leads that may be present.

Transceiver microphones are full of traps for the unwary. Some PTT buttons do more than just key the transceiver - check for multi-section switches that have other functions such as disconnecting the microphone element when receiving. Also many microphones have up-down buttons and other functions that require extra wires. These wires should be provided for in the cable between the transceiver and the MorseBox if these extra features are to be available when the MorseBox is connected.

Be prepared for the possibility that both sides of your rig's PTT connection will be floating above earth. This will affect the way the Morse box is wired to the transceiver. More specifically, the NO terminal of the relay and the earth side of the microphone's PTT (as connected through the front panel socket) should be disconnected from earth and wired directly to the (formerly earthed) side of the PTT.

Connecting the MorseBox to the transceiver is the hardest part of the project for the newcomer. This is especially for transceivers with complicated microphone connections. Seek assistance from a more experienced amateur if in doubt - in extreme cases a wrong connection may damage the transceiver and void the warranty.

Testing and Adjustment

Test the audio oscillator by applying power, switching to Morse and pressing

the key. Set the 10k trimmer potentiometer to about half-position. Connect a pair of high impedance headphones, a crystal earphone or an audio signal tracer to the lead carrying audio to the transceiver socket on the back panel. If all is well you'll hear an audio tone while the key is down.

If nothing is heard, a wiring fault is likely. Firstly check that the top end of the 3.9k resistor is +9 volt relative to earth. If not, look for wiring errors near the Speech/Morse switch. Wrong connections in this area could also mean the oscillator is working but audio is not getting to the transceiver socket. Other reasons for failure include the transistor and the diodes being wrongly connected.

If you've wired in the buzzer, a sound from this should also be heard when the key is pressed. If no sound, check the buzzer's polarity.

Pay attention to the relay's action. Observe it pull in as soon as the key is pressed. The relay should remain in for about three seconds after the key is released. In Morse mode the relay controls the transceiver's PTT. The three-second delay should be long enough to keep the transmitter keyed down between Morse letters. Connecting an audible continuity indicator (such as that found in many multimeters) across the earth and PTT terminals on the rear panel socket should result in a continuous tone while the key is being pressed, only dropping out when three seconds have elapsed after the key was last touched.

Using MorseBox

The Morse Box can be left in the transceiver's microphone lead at all times. The 'speech' setting allows normal voice operation, while the Morse setting allows Morse to be sent when the key is pressed.

The MorseBox has

been set up for semi-break in operation with automatic switching from transmit to receive. Operators can switch to voice at any time with the Morse/Voice switch. This is useful if doing readbacks after text has been sent.

Most people would be satisfied with using the Morse Box on a two metre repeater or simplex frequency. However, crossband operation (possibly using ten metres, six metres or 70 centimetres) can assist communication. This is because receiving stations could ask for repeats or request faster sending while the other station is sending. The effect would be akin to the full-break-in enjoyed by proficient HF CW operators.

Conclusion

A device to allow the transmission of Morse on VHF/UHF FM-only transceivers has been described. It is simple to build and provides an easy way for amateurs to practice Morse on the air. It would also be an ideal club or group project for those wishing to increase their Morse skills together.

ar

Parts List

(DSE catalogue numbers given for convenience)

BC548 NPN transistor	1	Z1308
1N4148 diodes	2	Z3120
3.9k 1/4 watt resistor	2	R1088
5.6k 1/4 watt resistor	2	R1092
10k 1/4 watt resistor	1	R1098
270k 1/4 watt resistor	1	R1134
10k trimpot	1	R1941
1nF disc ceramic capacitor	2	R2307
10nF greencap capacitor	5	R2055
100nF greencap capacitor	1	R2100
220uF electrolytic capacitor	1	R4380
6800uF electrolytic capacitor	1	R4470 (see text)
6-9v, 220 ohm SPDT relay	1	P8008 suggested (see text)
Small piezo buzzer	1	L7020
DPDT toggle switch	1	P7656
Hand microphone with PTT	1	(see text)
8-pin microphone socket	1	P1826
8-pin microphone plug	1	P1836
Mic plug to suit transceiver	1	
6.5mm mono socket	1	P1261
6xAA battery holder	1	S6116
Snap to suit battery holder	1	S6100
100x77x130mm metal case	1	H2804
75x76mm blank matrix board	1	H5310
10mm insulated spacers	4	H1861
Ferrite bead	1	R5425

AMSAT AUSTRALIA

Bill Magnusson VK3JT
RMB 1627 Milawa Vic. 3678
Email: vk3jt@amsat.org

MIR Operations Begin Again.

After months of uncertainty during which many false alarms were put about, the MIR space station is again manned. Despite their very heavy work schedule, the new crew wasted no time in activating the amateur radio equipment. They have been contacted by voice during their recreation time and the packet system and also the SSTV systems have been

monitored at other times. While rumours still abound, nothing certain is known of the future plans for MIR so make the most of the opportunity while it exists. When the crew was announced prior to launch, it was billed as "the final expedition to MIR". Remember that the crew works to Moscow time on board MIR and their day starts at around 7am. They have been active on voice during their breakfast time and they particularly enjoy the passes over Australia when they can have a chat

without the extreme QRM they experience over many other countries.

Oscar-WHO?

AO-10 ... UO-22 ... KO-25 ... How are satellites named, how do they get these reference numbers? Is there any convention? Does it all happen by chance? NO ... OSCAR numbers are issued by AMSAT-NA at the request of Project OSCAR, which built and launched the first Amateur Radio satellites beginning with OSCAR-1 in 1961. Project OSCAR has kept track of all satellite numbering ever since. In order to qualify for an OSCAR designation, certain specified criteria must be met, the most important of which are set forth in a document issued by the International Amateur Radio Union (IARU) entitled 'Information Paper for Perspective Owners and Operators of Satellites Intended for Operation in the Amateur Satellite Service'. Information on this document is available on the IARU Internet web site and also through a link from the AMSAT-NA web page. The IARU document is based on a similar document published earlier by AMSAT-NA. Other criteria include the need for a written request by the person or organization responsible for the satellite to be submitted to AMSAT-NA. This request must include information about the satellite such as frequencies and orbit details as well as a statement that the requirements of the IARU document have been and are being met. Thanks to AMSAT News Service for the above information. Not all amateur radio satellites request or are given an "Oscar-number" of course. Notable exceptions are the Russian "RS" series.

The AMSAT organisation

AMSAT (Amateur Radio Satellite Corporation) is a worldwide organisation with its roots in the USA. Its origin can be traced back to 1958, just a year after the launch of Sputnik-I. Since that time AMSAT members have been involved in the design, building, launching, commissioning, upkeep and of course, the day-to-day use of amateur radio communication satellites. The parent body is AMSAT-NA (North America) and many other countries have similar special interest groups operating.

AMSAT-Australia

Our local organisation is known as AMSAT-VK. The National Co-ordinator is Graham Ratcliff VK5AGR.

Membership of AMSAT-Australia

AMSAT-Australia operates an open membership system. No formal application is necessary and no membership fees apply. From time to time new software, firmware and hardware is developed and distributed through AMSAT-VK channels. Write to the co-ordinator to express your interest or pop up on the HF net.

AMSAT-Australia HF net

The AMSAT-Australia net meets formally on the second Sunday evening of the month. During the winter months in South Australia (end of March until the end of October) the net meets on 3.685 MHz +/- QRM at an official start time 1000UTC with early check-ins at 0945UTC. During the summer months when daylight saving is in operation in South Australia (end of October until end of March) the net meets on 7.068 MHz +/- QRM at an official start time of 0900UTC with early check-ins at 0845UTC. The times and frequencies have been chosen as the best compromise for an Australia-wide net taking into consideration seasonal propagation changes and the various state summer time variations. The net is open to all amateurs, beginners or experienced who have an interest in amateur radio satellites. Help and information for beginners in particular, no matter how trivial, is freely and cheerfully available on this net.

The AMSAT Journal

An excellent bi-monthly journal is available with formal membership of AMSAT-NA. It contains details of practical projects and ranges over all aspects of amateur radio satellite operations. As of 01Jul00 the cost of AMSAT-NA annual membership will be US\$45 payable to AMSAT-NA 850 Sligo Ave, Silver Spring, MD 20910-4702 U.S.A. or you can phone, fax or email your subscription using your credit card. The phone number is 0011-1-301-589-6062, the FAX number is 0011-1-301-608-3410 and the email address is martha@amsat.org

All Communications regarding any matters mentioned above should be addressed to:

AMSAT-Australia.

GPO Box 2141, Adelaide, SA. 5001.

email. vk5agr@amsat.org

continued on page 46

Internet Protocol Tests on Amateur Radio Satellites

NASA recently demonstrated the ability to use standard Internet protocols to communicate with an orbiting spacecraft (just like any node on the Internet). Engineers at NASA's Goddard Space Flight Centre working with the Operating Missions as Nodes on the Internet (OMNI) project, have completed the first step in extending Internet access to future spacecraft. AMSAT-NA's Ron Parise, WA4SIR, is one of the driving forces in the project. NASA has been developing this project by working with UoSAT-12, a spacecraft built by Surrey Satellite Technology Ltd. (SSTL). UoSAT-12 is also known as UO-36 by the Amateur Radio community and carries a number of imaging payloads, digital store-and-forward communications and mode L/S transponders in addition to its commercial payload. Engineers from the GSFC successfully used standard Internet PING packets to communicate with UoSAT-12 through a ground station in Surrey, England. This is the first time that a spacecraft ever had its own Internet address and was a fully compliant active

node on the worldwide web. Subsequent tests will expand on the basic network capabilities established and will demonstrate the use of standard Internet applications to support normal spacecraft operations. Automatic spacecraft clock synchronization will be demonstrated using Network Time Protocol (NTP), reliable file transfer will be demonstrated using standard File Transfer Protocol (FTP) and finally, the Simple Mail Transfer Protocol (SMTP) will be used to demonstrate automated file store-and-forward. Future tests are planned to incorporate technologies required to support full operational deployment of Internet protocols on future space missions. More information about this exciting new development is available at:

<http://www.spacedaily.com/news/internet-001.html>

Information from AMSAT News Service.

Tiny Satellite Being Developed at Surrey

SSTL's first "nano-satellite" SNAP-1, is being constructed at the Surrey Space Centre. SNAP-1 is a highly integrated and sophisticated spacecraft weighing just 6 kg. It has advanced micro-miniature GPS

navigation, on-board computing, propulsion and attitude control technologies, all developed in the UK. It will not have any amateur radio component but it is certainly an interesting direction in commercial satellite. There have been several amateur radio satellites of the "pico-satellite" package size and it appears that Surrey believe there are commercial opportunities in this area that are worth developing.

Next Month:

Twice-yearly update of all active amateur radio satellites, frequencies and modes; also the latest news from the shack of VK3JT, soon to be thrust into the magical world of high speed downloading (38k4 baud) from UO-36. I have been inundated with outside pre-winter work around the property here and all that has happened so far is a test of the TNC/modem at 9k6/9k6 on the current digital satellites. Tests indicate that the new SYMEK TNC works at least as well or better than the currently used and very popular PacComm Tiny2/G3RUH combination. I hope to have the 38k4 setup working and reportable by the time next month's column comes around.

ar

A WORLD FIRST IN SIGHT AND SOUND FOR ICOM

In a world first for a handheld communications receiver, Icom has just released in Australia the IC-R3, a wide band receiver combined with a 2 inch TFT colour LCD and TV screen.

The IC-R3 offers super wide 0.5-2450 Mhz frequency coverage for AM, FM, wide FM and TV picture reception. With the IC-R3 you can capture the excitement of a sporting event like a Formula 1 Grand Prix or the Olympic Games from every camera angle, not just the image being broadcast on television. Or in the security industry, the IC-R3 could monitor every security camera position.

The IC-R3 has an array of

features like signal strength level indication, scanning, a multi-function 'joy stick' style switch, and 450 memory channels. The LCD shows information such as receiving frequencies, tuning steps and memory channel numbers plus TV reception. A Lithium-Ion battery is supplied which gives almost 2 times longer than other types of batteries. And the external DC IN terminal allows you to operate with 3.6-6.3 V DC power source,

or 12 V DC power source via the optional CP-18 Cigarette lighter cable, all day long. This amazing unit comes with Icom's usual 2 Year Warranty and is priced at around \$1100 including the GST. The IC-R3 captures the world of sight and sound for the first time in a handheld receiver and is available through accredited Icom Dealers, or for more information call Icom on 1800 338 915.

VHF AN UHF EXPANDING WORLD

David K Minchin VK5KK

Postal: PO Box 789 Salisbury South Australia 5108

E-mail: tecknolt@arcom.com.au

Web page: <http://www.ozemail.com.au/~tecknolt>

Fax +61 8 82346396 Phone 0414 808060 (before 2130 EST please)

All times are UTC

Mid Year ... Already!

Winter is upon us. The Autumn Equinox extended into May 2000 but has now all but died. A sizable 6 Metre April/May round up will be found further in this column!

Meanwhile, the extent and coverage of Tropo DX has dropped with the temperature. Traditionally this is when we all get busy and start building (for those who do!) equipment for the next season. Starting with this issue, you will find a new series introducing "Microwaves" to the readers. I hope the article will inspire more to aspire!

New 47 GHz Australian Distance Record

Al Edgar VK6ZAY reports, "Over the past 12 months Al Edgar VK6ZAY and Terry Grammer VK6TRG have been assembling equipment for an attempt on the Australian 47 GHz distance record. This goal was finally realised on the 21st of April 2000 with a contact over 24.6 km extending the previous record by 6.3km. Two days later on the 23rd of April this was stretched even further to 45.3 kms with signals 'booming in' at 5-9 ++ over a 1 hour period. The current world record on 47GHz is still some way off at over 200 km."

"The contacts were made over line of sight paths near Perth, Western Australia. On both days the weather was a warm 28 degrees with relative humidity about 60%. Visibility across the 45 km from the Karnet Lookout to Wireless Hill was good without the usual haze often seen over this path. This is considered a major factor in the success of the attempt as attenuation due to water vapour can be as much as 1.5 dB per km. During one 15 minute period over the longer path the signal strength deteriorated by over 40 dB from 5-9 ++ to 4-1 and this coincided with the arrival of the afternoon sea breeze. Once the wind conditions had stabilised the signals returned to their previous strength. This phenomenon demonstrates one of the peculiarities of

radio propagation over line of sight paths at millimetre wavelengths."

"The two way SSB contacts were made possible by the use of temperature controlled crystal oscillators which provide excellent stability even though their outputs are multiplied over 450 times. On each occasion the 47 GHz contacts were preceded by an exchange on 10 GHz were precise bearings and elevations were determined to enable correct pointing of the 47 GHz antennas. This is a critical step in achieving success where 600mm dishes have a gain of over 45dB and a 3 dB beamwidth of less than one degree."

"The equipment used is the result of almost 12 months work. Both units were built by Al VK6ZAY and are practically identical. Single 600 mm dishes are used for transmit and receive in the normal way with a circulator providing the RF 'change over'. Transmit power is in the order of 1 to 2 milliwatts with no post mixer PA or receive preamplifier, this really is a 'barefoot' system. Earlier designs achieved distances of 1 km (MkI) and 6 km (MkII) and depended on surplus diodes salvaged from 5 GHz and 12 GHz equipment for the final transmit and receive mixers. The MKIII versions used in the record breaking contact contain mixer diodes and circulators from surplus 50 GHz Pasolink equipment."

"The heart of each transverter is a temperature controlled crystal oscillator operating at approximately 100 MHz feeding into an 11.75 GHz phased locked 'brick' which puts out about +15 dBm. Two high frequency mixers are used in each unit, one for transmit and local oscillator generation and the other for receive. The 11.75 GHz signal is fed into the transmit mixer diode where it is

multiplied by 4 and added to the 2m IF to provide the 47.127 GHz transmit frequency. On receive, the transmit mixer without the 2 m IF input, acts as the local oscillator and passes through the output circulator to the receive mixer diode where it mixes with the incoming receive signal to provide the 2 m IF output. Circular waveguide made from 5-mm hobby brass tubing is used to carry the signals to Cassegrain feeds, which illuminate each dish. The complete equipment is powered by two 12V Gelcells and draws about 400 mA at 24 volts." ... Al VK6ZAY

N6XQ/VK 6 Meter QRP From Australia

Jack N6XQ reports on his Northern VK6 DX-pedition ... "An opportunity developed to take a 3 1/2 week adventure tour of Western Australia. I knew that six-meter propagation would be enhanced around the equinox and that I would be located in primo latitudes for TEP (12 - 15 degrees S.) I would love to do a little operating on the trip, but was limited to the amount of luggage I could take. A 706, switching PS and big yagi was out of the question. I elected to take an AEA 6-metre ssb/cw handheld that puts out 1 Watt. The transceiver is very sensitive but lacks a little in frequency coverage. I resurrected a 3 El yagi that I had previously constructed for kayaking trips. The yagi consisted of Radio Shack telescopic whips for the elements and chopped up 1/2 inch PVC tubing to make up the 8-ft boom. The maximum length of the tubing segments was 17 inches and took little space in my daypack. I would try to locate a temporary mast in Australia. We took the Indian-Pacific railway from Sydney to Perth to experience some of Southern Australia."

continued on page 48

"The first opportunity to operate was from Monkey Mia (OG64). Monkey Mia is a very nice ocean resort where dolphins come into the shallow water for petting/feeding. Dugongs (relatives of the manatee) also frequent the waters. I borrowed the telescopic pole used for cleaning the coach to use as a mast. The 3-element yagi was set up on a sandy knoll. I was pleasantly surprised with a mini pileup of JA's. I proceeded to work 28 JA's on CW and 2 on SSB. I returned later in the evening to find the band dead. I did not know it at the time, but these were the last QSO's I would make with the yagi."

"The next opportunity to operate was from Exmouth (OG78) (the Northwest cape). Here, I stood on the 2nd story balcony of the motel and used a _ wave whip on the HT. I had my biggest pileup and requested the JA's call by prefix. My HT would not operate split. I worked 56 JA's in the next half-hour and then was called by a ??8CQ.. I thought to myself "This JA can't send his prefix right or his transmitter is not initially keying right". It then sunk in that this was not a JA, but was EY8CQ in Tajikistan. What a thrill, working someplace where I have no idea where it was, but knowing it was exotic DX."

"One of the most exciting spots to operate from was El Questro Station (PH33). Stations are not radio stations, but are cattle or sheep ranches in the outback that usually range from 1000 to 10000 square miles in size. Our quarters that evening was a metal framed 2-man tent. I sat on the cot and extended the whip to hear loud Russian video and many JA's. I worked 11 JA's sitting on the cot holding the HT. In the morning light, I could see a close in mountain to the north in the direction of JA. My launch angle had to be incredibly high."

"I had another nice opening in Port Hedland (OG99) where I worked 10 JA's on SSB while pedestrian mobile walking around the motel. Superb propagation. One of the JA's was himself portable on a mountain and only running 20 Watts. My attempt to make the first intercontinental 6 metre camel mobile contact was aborted due to close in lightning strikes."

"Surprisingly, my total operating time came to only about 6 hours. Totals were (1) VK6, (2) EY8 (worked EY8CQ again while pedestrian mobile), (114) JA's. Heard KH6SX, KH6/K6MIO, HL5XF, VK6JQ." ... Thanks to Eric VK5LP for forwarding Jacks Article.

Equinox Wrap Up For 6 Metres

Bill Webber, VK6JQ from Broome, has sent in a log summary for the Equinox up to mid April. Not long after this time, Broome was hit by a Cyclone. With some luck, most things will be getting back to normal by now. Bill VK6JQ writes "The 6 Metre European DX has come but not quite gone ... the spread of Countries is much smaller than previous Feb/March Openings to Europe. This year, between the 16th of February and the 9th of April I had 35 contacts with 12 countries on 11 days. Compared to 1991, between the 1st of March and 16th of March when I had 63 contacts with 17 countries over 9 days and in 1992, between 31st of January and 3rd of April, 62 contacts in 21 countries over 16 days."

"The most northerly contacts were into DL and PA with only ES0DX beacon being heard from further North. The most frequently heard countries were in Zone 20; 4X - 10 days, JY9 & 5B4 - 7 days. EY8, which was not included in the European contact figures, was heard on 13 days. G4CBW was the only signal heard from the UK."

"My only new 6 Metre country was EH6SA from JM19, on the Balearic Islands. Now for a 6-month wait. To see what may come from Europe next Oct/Nov" ... Bill VK6JQ. Should anyone like a copy of Bill's extensive log please contact me.

Tony, VK3CAT reports ... "Stations worked on Six Metres on Friday morning, 20.4.2000 between 2155 and 2253 UTC. XE1 BEF @5x7, K5AM @5x6, K5NA @5x5, W7CI @5x5, N5JHV @5x9, 3D2AG @5x9, XE1/SM0OUG @ 5x5, XE1J @ 5x2." ... Tony VK3CAT

Steve VK5ZBK reports the following 6 Metre DX into VK5 for April "09.4.00 @ 1.40 UTC 9M2/JI1ETU 5x5, 14.4.00 @ 14.32 UTC JA7WSU KOU 5x2, 20.4.00 @ 09.54 UTC JE2RDD 5x3 PM55, @ 09.58 UTC JH2SMW KAZU 5x6 PM85, @ 10.08 UTC JAS1U JOSHI 5x5, @22.53 UTC W5OZI PAT 5x5 EM00, 21.4.00 @ 02.23 UTC YB0CBI FERRY 5x8 OI33. VK5RO then VK5AKK also worked YB0CBI, 24.4.00 @ 00.07 UTC XE1J PEPE 4x3 DK89" ... Steve VK5ZBK.

John VK4FNQ worked the following US Stations on 50 MHz on 30/4/00. At 0227 N6RMJ DM14, 0237 XE2HWP DL44, 0240 W6KGF, 0241 KF6RDO DM04, 0251 KE6FCT DM04, 0259 K6NDV DM04, 0304 K6MYC, 0309

KC6NBI, 0312 W6NHV CM87, 0315 KK6TE CM97, 0317 W6PXM DM06, 0319 K6MHZ DM06, 0327 W6FM CM95, 0335 WB6AAG CM95, 0345 KH7L, 0349 W6PPT DM04, 0356 WH6O, 0404 WH6T, 0415 WA6PEV, 0419 K6TPG DM03, 0425 WA6JRA, 0428 KJ6HI DM03, 0430 WA6MEM DM03, 0433 N6CA & 0833 7M4IBZ.

On the 8/5/2000, John VK4FNQ worked @ 0649 JI5DWP/M and on 9 May 2000 0154 N6XQ, 0205 XE2EED DM12, 0214 N6KN DM02, 0230 WA6JRA and 0738 JP3VWJ.

Ray VK4BLK, Yeppoon QLD, sent in a summary log showing with some 24 Countries worked over the March to mid April 2000. Contacts to USA and Central America as well as Oceania/Asia. What may surprise some, but not others, is the high percentage of contacts that are on CW. Reviewing this compared to the last few cycles it would seem that CW has not lost any ground.

Willis Island has again been activated on both HF and 6 metres with a DX-pedition landing a few days ago. Contact details are sketchy however atleast one US contact occurred on 15/5/00 @ 00:33 with VK9WI working K6QXY on 50.110 cw 519. VK4APG had the misfortune to break his leg while landing on the island and had to be medivaced back to Cairns. Hopefully all is mended by now.

VK8OT Alice Springs, NT!

Steve VK3OT reports the log of VK8OT (Alice Springs, NT) PG66wg FT650 8 element LP yagi. As luck would have it, Steve was in the Tanami Desert when I dropped into Alice Springs for a day in mid April!

The following is sorted by Callsign QTH Date's worked/Heard in April.

3D2AG Fiji Islands 8, 9, 19, 4W6/VK2QF East Timor 4, 4W6UN 26th, 7J6CCU Okinawa Jpn 13, 16, 21, 7J7ACU/ACV/ADB Misawa Jpn 13,16,21,11,01,04,23,31, etc 9M2/JA1ETO East Malaysia 2 H, 9QSO 9M2KE East Malaysia 23, 9M2NK East Malaysia 2 H, 23 QSO, 9M2TO Beacon only 8,10,12 Heard only, 9M6SMC West Malaysia 13,18,21,22 Beacon heard only 50,014 FSK OJ85ax, 9V1JA Singapore, 2 H, 21 QSO, 9V1UV Singapore 10, 21, AH2DN Guam 8 QSO, AH6TM Hawaii 16, BG7OH PR China, 4, 18, BA7JG China 25th, BV2DPTaiwan, 1 QSO,7 (H), BV3FG Taiwan 18,21, BX2AB China 7,13,22, DS1AFU Korea 9, DS1GQS

Korea 9. DS2GTQ Korea 21. DS2SMU
Korea 8. DS5IJG Korea 1,16. EY8CQ
Kadzik. 8,10. EY8MM Kadzik. 13,22,
25th. FO0TOH Marqueses. 8 QSO.
H44PT Solomon Is. 31,4,5. HL1/JFIEFP
Korea 4. HL1AEY Korea 23. HL1JV
Korea 1. HL1LTC Korea 1,23 51 MHz
FM. HL2AMO Korea 8. HL2WA Korea
1,3,9,18,21,22,23. HL3IUA Korea 9.
HL5CL Korea 7,16,21. HL5OC Korea
16,21. HL5XF Korea 8,21. JS6SKQ
Okinawa 7. JR6HI Okinawa 7.

HP3XUG/UH Panama 14 heard. KH2/
7M3GON Guam 8. KH2JU Guam 31,16.
KH2KU 16. KH6HI/B Hawaii 16.
KH6HME/B Hawaii 16,18. KH6SR
Hawaii 16 (NI6E). KH6SX Hawaii 16.
KH6WU Hawaii 18. KH7L Hawaii 16.
KH7R Hawaii 16,17. KH8/N0JK Am
Samoa 4th, N5OLS/KH8 25th. 26th heard.
LU7FA, LU8MB Argentina 18th Long
path 340 degrees over Pole, set new VK8
DX record 26,768 km. P29ZTL P29KFS
PNG 13th Heard. PJ2/WZ8D NAnt. 16th.
T88JU Palau 9. T88TV 25th, 26th.
T88WX Palau 5th Heard. TG9NX
Guatemala. 5th. TI5BX Costa Rica V3IPC
Belize V73AT Marshalls 4,5,8,9,22.
V73SIX Beacon 1,7. VK2QF,2ZXC,
3AMZ, 3AXH, 4BRG, 4DO,5AYD, 5KK,
6JQ,7ZPB,8AH,8MS heard and worked.

VP6BR Pitcairn 7th. VR2BG Hong
Kong 7. VR2IL 9,21. VR2XMT
1,4,5,7,9,18,21,22. VR2XVD9. VR2YRC
4,21 VR2YYD, VR2ZKP 26th. XE1/
JA8EFY Mexico 9. XE1BEF 9 QSO, 17
QSO. XE1KK/B 17 H. XE1UN 9 Heard.
XW2A Laos 22. YB0ARA/9 Indonesia
9th.YB0CBI 21. YB5QZ 10,12. YC5/
PA2GFL 10,12. YV4AC Venezuela
16,17.YV5LIF 9th.ZF1 Cayman 14th
heard. ZL2TPY, ZL3ADT, ZL3AAU,
ZL3GS, ZL3NW, ZL3TY, ZL4AAA,
ZL4WA 4,20,7th.

In total Steve reported 1100 CW QSO's
with low duplicates and 500 SSB few
duplicates from Alice Springs.

ACA Spectrum Auctions And New WIA Bandplans

The 1800MHz Spectrum Auctions in March
2000, which were led by Hutchison
Telecommunications and One.Tel, resulted in
more than \$1.327 billion being paid for
"Spectrum". Hutchison and One.Tel have
reportedly paid \$671M and \$523M
respectively for large tracts of the re-allocated
1800MHz band.

The Australian Communications Authority
has planned auctions for further major
telecommunications spectrum licences in

2000-01. The Federal Government, in the
May 2000 Budget documents, says it now
expects to receive ~\$2.6 billion more from
the auction of telecommunications spectrum
licences than it had previously anticipated.
Infact, market experts believe the
government could reap anywhere between
\$5 billion and \$10 billion in total!

Telecommunications companies will use
the Auctioned spectrum for varied services,
however most players have invested heavily
to underpin their mobile phone plans in
Australia. This includes introduction of 3G
(Third generation) Technology Services in
the not too distant future.

On a different note, thanks go to those who
have responded to the Spectrum "National
Park" subject, raised two issues ago. Every
month I hope to bring atleast some news or
developments in this area so we can act or
react accordingly.

In the meantime, John VK3KWA has re-
issued the 2.4 & 3.4 Ghz WIA Bandplans.
"The only change to the 13 cm band plan is
reallocation of 2300 - 2302 MHz.

On the 9 cm band, the weak signal segment
has moved from 3456 MHz to 3400 MHz
and the Wideband segments have been
rearranged to make the best use of the
available spectrum" ... John VK3KWA.
Copies of the new bandplans can be obtained
from me via email or snail mail

Microwave Primer.- Part One. The Start

With a number of Microwave bands
available, it is a little difficult for the
newcomer to decide "where to start". Over
the next few months this series will tackle
the basics on where to start and where to
look to get started. Like all things, the first
step is the biggest. With gained knowledge
and planning this step does not have to be
an insurmountable one.

The general interest in the various
Microwave bands has never been higher
and the availability of equipment/parts has
never been better. You may be interested
in weak signal working, contesting, data
or video. All feedback and requests are
welcome. I will be calling on a few guest
writers, both locally and from overseas, to
handle various sections.

For the purpose of this series, bands
above 1000 MHz are classified as being
"Microwave" bands. The six bands are
available in the "Microwave" range those
being 1.2, 2.4, 3.4, 5.7 10 & 24 GHz.
Bands above this point are then part of the
"millimetre" bands, e.g. 47 GHz and
above.

1296 MHz is perhaps the easiest to get
operational. It is an interesting band where
lower frequency Tropospheric
propagation is mixed with microwave type
ducting. Technically, it is still an "UHF"
band, however some microwave specific
propagation anomalies do start to come
into play like reflection, etc. An amount of
ready-made equipment or kit built
equipment is available. Antenna
preferences are for parasitic arrays (either
loop or rod yagis) for terrestrial working.
Equivalent gain dishes have greater
windloading and feed blockage
considerations although dishes are the
preferred antenna for EME applications.

Above 1296 MHz, the popularity of the
various narrowband segments seems to
fall in the following order, 10 GHz, 5 GHz,
2 GHz, 3 GHz and 24 GHz. This does vary
around the country. Many factors
including activity, parts availability and
the degree of difficulty of construction and
tune-up effect preferences. The degree of
difficulty in both equipment assembly and
tune-up is at its lowest in the lower
microwave bands (2, 3 & 5 GHz).
Construction becomes a little more
demanding at 10 GHz and then decidedly
more difficult for narrowband 24 GHz!

Equipment used on each band, in
Australia is largely of the following types
10 GHz Qualcomm, DB6NT, G3WDG,
Gunnplexer

5 GHz N1GHZ, DB6NT
2 GHz WA8NLC, Equipment
Supplies, G3WDG
3 GHz WA8NLC, W1VT
24 GHz DB6NT, Gunnplexer

There are more options. As expected,
parts that can be sourced with a minimum
effort have largely determined popularity.
The Internet has helped enormously, over
the past few years, putting small groups in
touch with other small groups globally.

All designs are narrowband SSB
(&CW!)/FM compatible except for
Gunnplexers. The Gunnplexer approach
should not be overlooked. It is a simple but
effective way to experiment with WBFM or
Video/data linking. While a narrowband
system might have a 20 - 35 dB circuit
advantage over WBFM, there is still plenty
of scope for experimentation. And all
antenna hardware is transferable to
narrowband systems as you advance.

Next month we will look at the lower
microwave bands in more detail.

ar



Will McGhie VK6UU
21 Waterloo Cr Lesmurdle 6076
will2@omen.net.au
VK6UU@VK6BBR

When just being an Amateur is not enough

New Repeater Controller

A VK6 amateur, Mal VK6MT, has been developing a voice repeater controller for more than a year.

The design is based on the Stamp concept and does everything you would want in a repeater control board. The finished board is about 10cm by 8cm and can even have some of its functions remotely programmed via DTMF. A prototype board is in service in VK4 and another one is about to go into service in VK6. Rather than comment in any detail about the design, and perhaps be in error about the design and function, I will find out if Mal can put together an article for next month's Repeater Link.

FM828 Circuit

From time to time I receive a request for the FM828 circuit. These circuits were reproduced in Amateur Radio a few years back but are in sections, each month being a part of the overall circuit. The circuits did line up and could be placed together. However I would like to scan in the actual circuit as it is in the 828 manual. This I hope to do and make it available as a JPG graphic file. The task is time consuming as the circuit is larger than an A4 scanner and requires about 4 A4 scans to copy the complete circuit. These 4 scans are then joined on the computer. I have been trying different scan resolutions (DPI) so as to maintain the information but keep the file size below floppy disk size. Even on a fast computer large graphic files can take considerable time to manipulate. I hope

to have the task completed soon and the circuit available.

The most important event of the year

As usual there is never enough time and this month's Repeater Link is even shorter than usual. Having just returned from the Federal WIA Convention for 2000, my time is being spent on issues from the Convention. My canoe sits waiting to be taken for a paddle, with the weather this time of year perfect for such outdoor activities. However I sit at the keyboard to type in a few thoughts.

The WIA Federal Convention is the most important event for the year and takes up considerable time, if you want to at least put some value into the Convention. What little I have learnt about being a Federal Councillor is just how suitable you may or may not be to hold such a position.

For me, I come from a technical background and I hold an Amateur Licence. These qualifications don't necessarily put you in the best position to be on Federal Council. Much of what takes place at Federal Conventions is to do with finance and budgets along with meeting protocol. Anyone with limited knowledge of meeting procedure is at a disadvantage. Those with this knowledge do have a distinct advantage when it comes to the cut and thrust of debate and putting your Division's (or your own) point of view. We may all be Amateurs but in another life we come from a diverse background. This diversity is well used at Federal Council but for those of us with only an Amateur-technical background,

Federal Council can be a daunting experience. I have seen some Council members come and go in a short period of time.

A range of skills

It may be that when your Division is looking for a Federal Councillor, and such a person comes from the numbers in your Divisional Council, the person who accepts the position may do so with some reluctance. It may be that no one is willing to take on the job and you end up with the position more or less by default. This is no criticism of the way it happens. All such organisations face this limitation on people willing to put themselves forward. But it is important to recognise that the position of Federal Councillor is an important job and takes up time that may be difficult to find. Added to this it may be thought that being an Amateur is the number one requirement, and it is, but close behind is a range of other skills that you have to pick up on the way.

Being ready to expand your knowledge

My reason for writing about this is to say, it has been an experience for me and I have found my lack of interest in budgets, finance and meeting procedure a limitation. Just being an Amateur is often not enough. So if you are thinking about putting up your hand to be a Federal Councillor, be ready to expand your knowledge. Federal Council is not just about Amateur Radio, but a whole range of activities all needed to keep the WIA functional.

ar

SPOTLIGHT ON SWLING

Robin L. Harwood VK7RH

5 Helen Street, Newstead TAS 7250

(03) 63 44 2324 Email : rharwood@primus.com.au

Conditions have dramatically improved over the past six months and we may already have reached the solar maximum for this cycle.

However it is not as high as 1989-90. Propagation on the higher frequencies has been very good with many low -power signals being readily heard here in Tasmania. There are so many heterodynes between 26 and 29 MHz and propagation has even been as high as 40 to 50 MHz.

The big news of late was the spectacular generator fire at Bonaire, in the Netherlands Antilles. On Easter Sunday, the generators powering the Radio Netherlands site were completely destroyed. Initially the damage was considered so severe that the site was expected to be off-air for some time, with damage estimated to be in the millions of Dutch guilders.. However the station was operational within 10 days, a truly heroic effort on the part of the staff on-site.

Arrangements were speedily made to get the Radio Netherlands programmes out on short wave, as North, Central, and South America plus Australasia relied heavily on the Bonaire relay. Other broadcasters also utilise this facility and hastily arranged alternative sites. For example, the Cyprus Creek site of the Christian Science Publishing Society was used along with the Merlin facility on Antigua. Sites within the former Soviet Union were also utilised plus the Flevo site within the Netherlands.

Because Bonaire was off-air on 9795, a Chinese language broadcast was noted on the channel and later transpired it was a Russian site broadcasting on behalf of another organisation. I believe that it is a regular transmission and usually blocked by Bonaire. However it is now easily audible underneath Bonaire from when it signs on at 1020 and the power level at Bonaire may be reduced. Also there was a solar disturbance which caused severe disruption during the first week of May. Congratulations are extended to the Bonaire staff for their sterling efforts at getting the station back up again.

Early in April, the BBC World Service introduced eight different programming streams, an increase from the original 3 streams. They published a guide for the streams, which was available online and in their "On-Air" magazine, but they used local times rather than UTC, which was quite confusing. Also there were numerous technical hiccups during the first few days. Some streams were on frequencies they were not supposed to be on and others were switched during the middle of a programme. I believe that there have been numerous complaints over their introduction. The BBC has since announced that they will give the programme's times in UTC to avoid any confusion.

The service to Australasia and the Pacific, formerly on 7145 kHz between 0600 and 0800 has been dropped. Services to this region are now in our local evening hours on 9740 from 1100. I am hearing an African stream quite easily on 17830 from 0700 to 0800. It is a news programme followed by "Network Africa". I also am hearing another stream at the same time on 17640. It is quite confusing and one is never quite sure what stream you are tuned to. Personally I would prefer a single stream instead of eight.

Africa has been dominating the news lately and the only reliable source for news from this vast area has been from the outside. The BBC, Deutsche Welle and the Vatican Radio. All have quite good news bulletins on African affairs and the only consistent regional broadcaster reliably heard is Channel Africa from Johannesburg. The majority of African broadcasters are not heard very well here, including Johannesburg. They broadcast primarily in French or English plus local indigenous languages. I should also include Radio France International as they target Africa yet they are naturally in French, although they do have a 45 minutes English broadcast at 1200 for the

region. You may be fortunate enough to hear Nigeria on 7255 around their local sunrise, which is between 0630 and 0700. I have heard them very rarely but their diction is poor. I think Africa will be dominating the news for the next 12 to 18 months and it is a pity that African stations are not well heard on shortwave.

I recently came across an English language programme, having some difficulty as the diction was not clear and had to really concentrate. The station was on 12085 from 1030 to 1100, identifying as the Voice of Mongolia from Ulan Bator. It has been many years since I have heard it and attempted to confirm this but was not successful. I think they are on a shoestring, reflected in their programme production. The press review sounded as if it was "a filler" and mostly ad-libbing. They played some rather distinctive and eerie Mongolian music. I also have noted that Radio Free Asia, the American based clandestine network, is using Mongolian sites to rebroadcast into China.

I also came across a extremely weak station on 9072 at 1025, underneath a very strong teletype signal. The station was in Korean and I assumed it was one of the numerous Korean clandestine operations. I did hear some martial music very similar to that over Radio Pyongyang and checked with a known outlet on 11335 and it was an identical programme. I assume it was a spur from one of the Korean sites. Also this month, the first ever summit meeting of the two Korean leaders will take place in Pyongyang. I am certain that it will be extensively covered on shortwave.

Well that is all for June. Don't forget if you have any news, I would love to hear from you. My postal and email address are at the top of the page.

73 and good monitoring
Robin L. Harwood VK7RH

ar

HF PREDICTIONS

by Evan Jarman VK3ANI

34 Alandale Court, Blackburn Vic 3130

These graphs show the predicted diurnal variation of key frequencies for the nominated circuits.

These frequencies as identified in the legend are:-

- Upper Decile (F-layer)
- F-layer Maximum Useable Frequency
- E-layer Maximum Useable Frequency
- Optimum Working Frequency (F-layer)
- Absorption Limiting Frequency (D region)

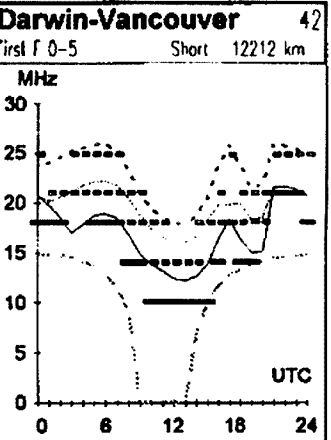
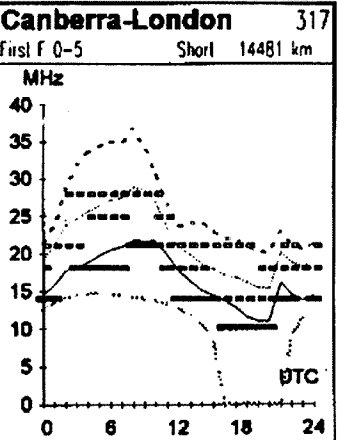
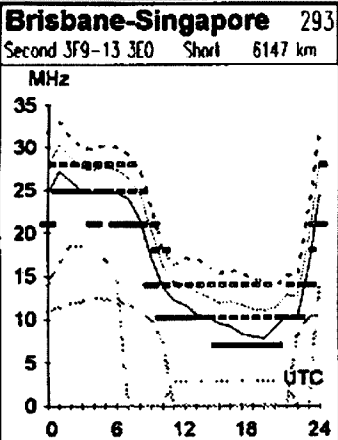
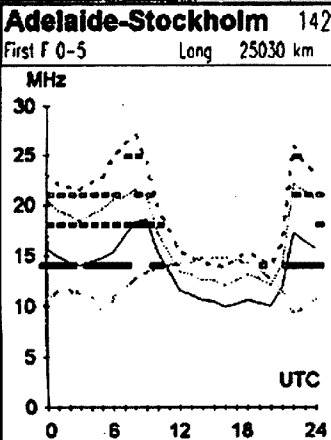
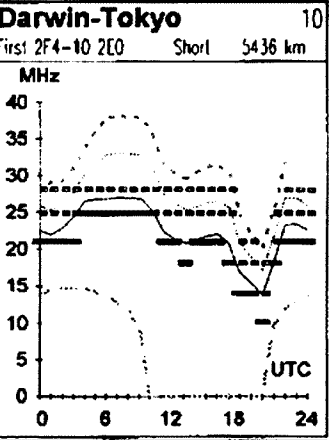
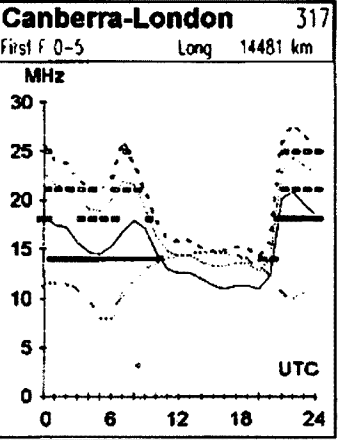
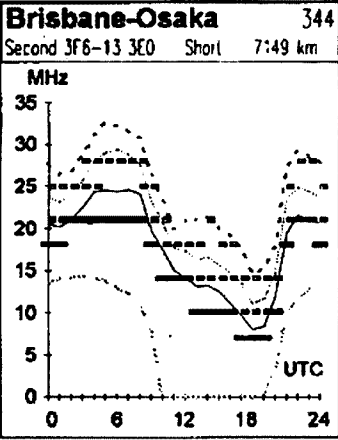
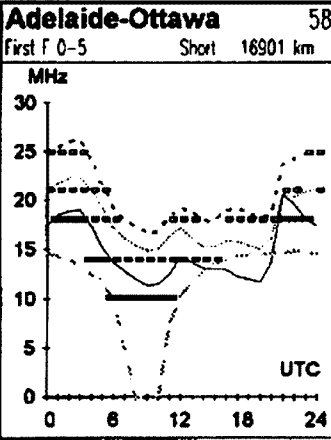
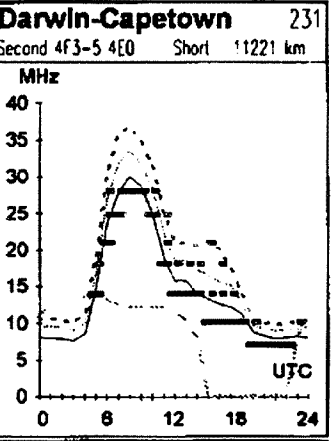
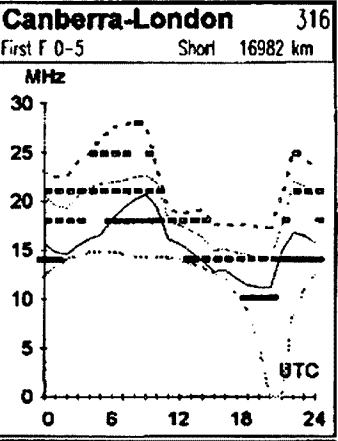
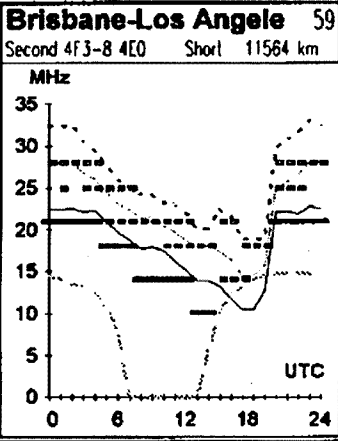
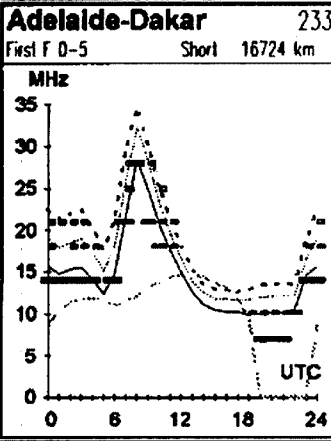
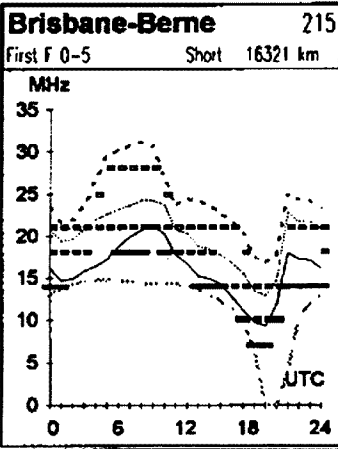
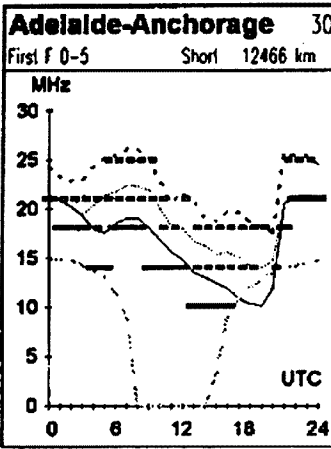
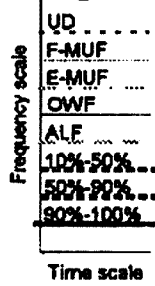
Shown hourly are the highest frequency amateur bands in ranges between these key frequencies, when usable. The path, propagation mode and Australian terminal bearing are also given for each circuit.

These predictions were made with the Ionospheric Prediction Service program: ASAPS version 4.

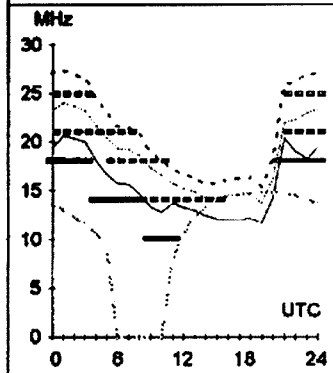
June
2000

T Index: 139

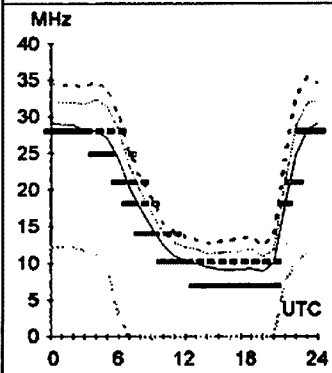
Legend



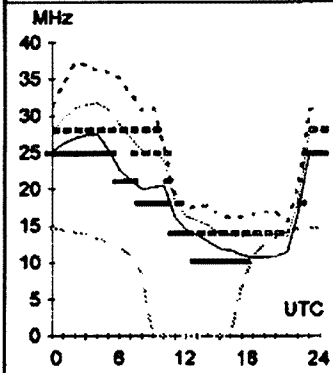
Hobart-Boston 78
First F 0-5 Short 16895 km



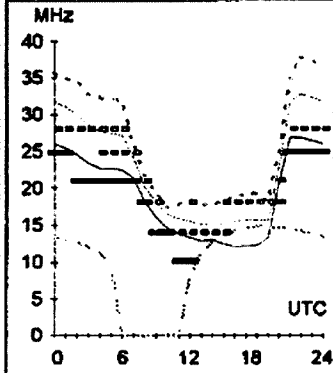
Melbourne-Auckland 97
First 1F4-6 1E0 Short 2623 km



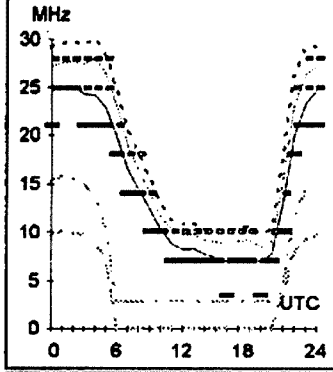
Perth-Honolulu 70
Second 4F4-8 4E0 Short 10905 km



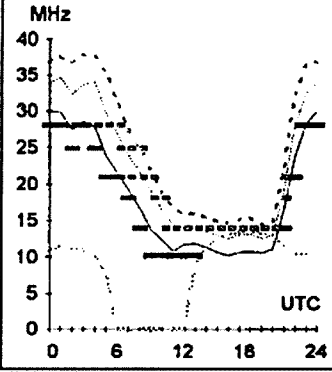
Sydney-Miami 86
First F 0-5 Short 15026 km



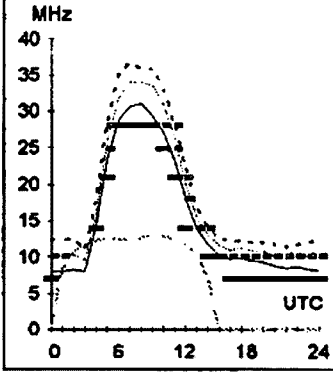
Hobart-Christchurch 101
First 1F9-11 1E0 Short 2040 km



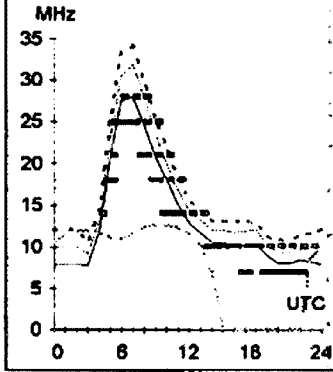
Melbourne-Lima 133
First F 0-5 Short 12950 km



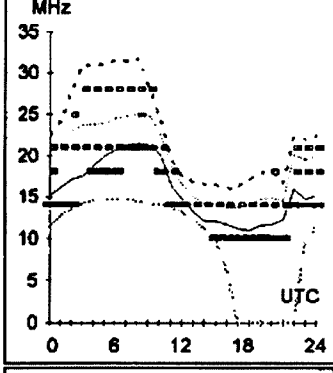
Perth-Johannesburg 248
First 3F4-5 3E0 Short 8315 km



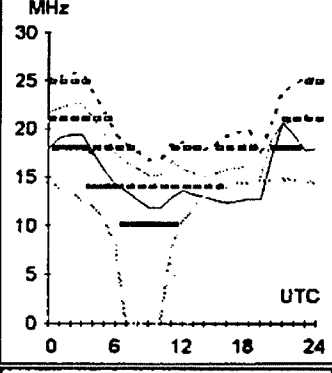
Sydney-Pretoria 230
Second 4F4-5 4E0 Short 11063 km



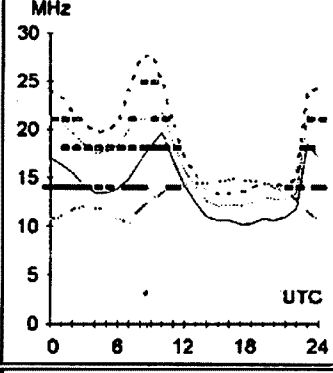
Hobart-Moscow 312
First F 0-5 Short 14962 km



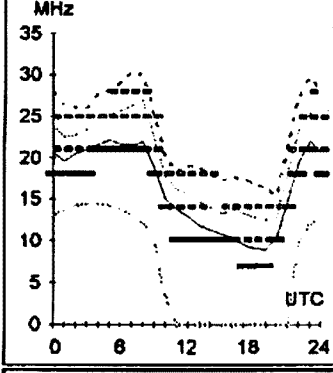
Melbourne-Montreal 62
First F 0-5 Short 16731 km



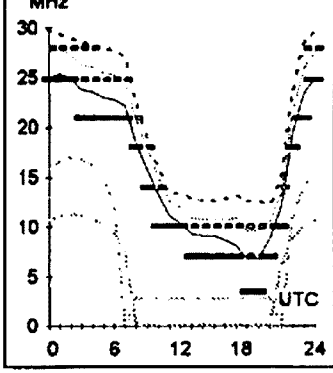
Perth-London 133
First F 0-5 Long 25543 km



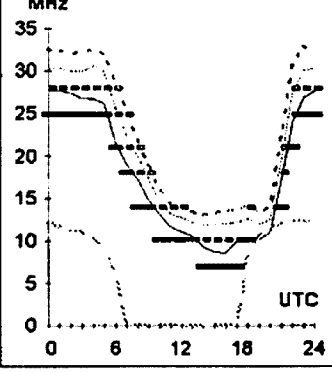
Sydney-Taipei 330
Second 3F6-12 3E0 Short 7261 km



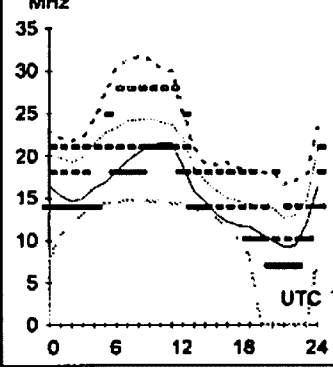
Hobart-Port Moresby 360
Second 2F10-13 2E1 Short 3710 km



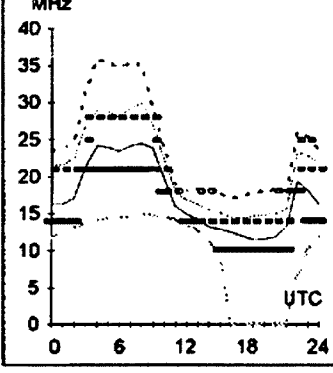
Melbourne-Papeete 90
Second 3F7-9 3E0 Short 6687 km



Perth-London 313
First F 0-5 Short 14481 km



Sydney-Tel Aviv 287
First F 0-5 Short 1417 km



HAMADS

- Hamads may be submitted on the form on the reverse of your current Amateur Radio address flysheet. Please print carefully, especially where case or numerals are critical.
- Please submit separate forms for For Sale and Wanted items, and be sure to include your name, address and telephone number (including STD code) if you do not use the flysheet.
- Eight lines (forty words) per issue free to all WIA members, ninth and tenth lines for name and address. Commercial rates apply for non-members.
- Deceased estates Hamads will be published in full, even if the ad is not fully radio equipment.
- WIA policy recommends that the serial number of all equipment for sale should be included.
- QTHR means the address is correct in the current WIA Call Book.
- Ordinary Hamads from members who are deemed to be in general electronics retail and wholesale distributive trades should be certified as referring only to private articles not being re-sold for merchandising purposes.
- Commercial advertising (Trade Hamads) are pre-payable at \$25.00 for four lines (twenty words), plus \$2.25 per line (or part thereof), with a minimum charge of \$25.00. Cheques are to be made out to: WIA Hamads.
- Copy should be typed or in block letters, and be received by the deadlines shown on page 1 of each issue of Amateur Radio, at:

Postal: Newsletters Unlimited, 29 Tanner Street, Richmond, 3121
Fax: 03 9428 4242 E-mail: hamad@webtime.com.au

Please only send your Hamad once

Please send Hamads by mail OR fax OR email (much preferred).

Please do not send by more than one method for any one ad or issue, it is confusing.

WANTED ACT

- 1) Antenna Rotator to steer two Yagis (VHF/UHF) system. 2) Transverter 144MHz/28MHz to suit TS520/TS820. Please contact Virgil VK1VI on (02) 62555677 (AH) or email at vionescu@ozemail.com.au or packet VK1VI@VK1IBBS.

FOR SALE NSW

- Collectors' Items: ADMY PATT No 7681 Key, Morse, Serial No P 3930, year 1939, heavy duty key, GC.\$100 ono. Leeds & Northrup Standard Resistance Box, 4 decade, 0.1 — 1000 Ohms, Cat no 4776, Serial no 617505, with calibration report, \$100. Also Galbraith (NZ) paddle keyer, unused, \$25. Kokusai Mechanical Filters, 455 kcs with carrier, USB & LSB crystals, unused, offers? "Hudson" Car Radio, 6 valve, 1938 (I owned the car!) complete, less speaker & vibrator, heavy shielded box, \$50. Keith VK2AXN. (02) 9489 0304 QTHR.
- Yaesu FT107M HF Transceiver VGC 2 mics hand and desk \$450. Yaesu VFO FV107 matches FT 107M \$120 or \$500 both. Manuals for both. VK2IGS (02) 6629 8583.
- Kenwood TS120S and PS30 power supply both in v good cond. \$380 for both. Kenwood TS50S plus automatic antenna tuning unit AT50, hardly used, \$1050. David VK2COF. Phone (02) 4861 5734.
- Yaesu FL-2100Z amplifier, new 572Bs fitted, recently serviced, \$400. VK2FGI Graham QTHR (02) 6624 2219.
- ATV homemade transmitter 426.25 MHz Motorola MHW-710-2 final. Includes spare crystal for 444.25 MHz, VGC, \$120, o.n.o. Home made antenna 426 MHz, 12 elements \$30. Peter VK2BPO (02) 9713 1831 QTHR. Email: brunone@bigfoot.com.

- INTERNET Connect from Port Macquarie to the Gold Coast from 80c per hour. Summerland Amateur Radio Club. For info <http://www.nor.com.au/community/sarc/sarc.htm>. Harry VK2XIO, QTHR, cascom@nor.com.au. PO Box 293, Lismore, 2480. Ph 02 6621 6096

- BOOK: "Radiotelegraph and Radiotelephone Codes, Prowords and Abbreviations." 2nd Edition. \$16 posted Australia. 90 Pages. Q.X.Z Codes. 97 Phonetic. 20 Morse Codes. Phillips, Myer. 10,11,12,13 Codes. Much other info. Internet - <http://www.nor.com.au/community/sarc/phonetic.htm> - VK2JWA, John W. Alcom, QTHR. (02) 66215217 jalcom@nor.com.au

- Yaesu FL-110 HF Linear Amp. 1.8 - 30MHz bandswitched. 100W solidstate with ALC and PA protection, 12 - 14VDC, 1 - 15W drive (suit FT-7). Handbook and DC cables included. Good working order and condition. \$90. Ron VK2WB (02) 4232 1794.

- Yaesu FT290RII (2m SSB/CW/FM) incl 25w PA & service manual \$650. Also, Alinco DR605 (2m/70cm FM) \$400. Both excellent condition with orig boxes, manuals etc. Brett, VK2CBD. 0414 200 740

- Yaesu FT-101Z HF TXCVR S/N 9C020308. G.C. Spare PA valves. Built in fan. DC-DC converter \$250.00. One light weight morse code key \$5.00. One gutter mount antenna rack with 11m antenna \$5.00. One Kraco 11m 24 channel CB S/N 805477 with crystals to convert to 10m \$100.00. VK2KRQ John Le Fevre (02) 4369 0458 12A Rickard Road Empire Bay NSW

WANTED NSW

- Kenwood desk microphone MC-80 or MC-60A. VK2IGS. (02) 6629 8583
- Kenwood TS430S. Keith VK2AXN. Sydney. (02) 9489 0304 QTHR.

- Valve 6BN8. Possible swap for other valve if required. VK2BJU. QTHR. (02) 4841 0272. marland@goulburn.net.au

FOR SALE VIC

- Drake Transceiver TR7 \$1800. Drake Linear Amp L75 \$750. MFJ DSP Filter \$300. Yaesu cathode ray monitor scope \$350 ono. Apply VK3LC QTHR. Phone (03) 9773 5334. All with instruction books etc.
- Drake TR7 250W transceiver with PS7 power supply, covers all hambands including WARC, receives 0-30MHz, extras 1-8kHz, 6kHz filters. Fan, slow dial drive, Shure mic, shop manual. Recently serviced by Drake expert \$1200 ono, you collect. VK3WW (03) 5433 3654
- VHF 2 metre equipment. ICOM IC-281H s/n 001702. ICOM IC-W21A Dual Band H/H s/n 02743, with mains & car chargers, & 2 antennas. Diamond F-23A antenna - 2m 5/8 wave 3 element vertical. Home brew Slim Jim antennas. MFJ-812B VHF SWR/Watt meter. Manuals, instructions & articles. All for \$880, or separately by negotiation. David VK3DNG QTHR (03) 9859 4698. email: roddada@rvib2.rvib.org.au
- Alinco DX-70TH with manual, m/bracket and 6m remote head cable. Ex Cond. \$1000. Luke VK3EM (03) 9841 4971

WANTED VIC

- The Australian Army Signals Museum in Melbourne would like to get two WW2 Radios for its collection. They are man pack sets, WS208 and WS128. If you can help, please contact Allan Doble VK3AMD QTHR. Phone (03) 9570 4610 any time.
- One PK232 THC. Kevin VK3MKW. Phone (03) 9836 1587 AH
- Circuit & manual for: Granger SSB Tele-transceiver, model 174-2, and Realistic DX100 General coverage rcvr. Brian VK3WYN (03) 5664 1251 QTHR
- Integrated Circuit TD62083AF, 18 pin SMD. John VK3AJL (03) 9481 6771
- Yaesu FT-901 or FT-902 HF Transceiver. Please contact Paul VK3DA, email: apaulo@vk3da.alphalink.com.au. or (03) 5983 1771.
- Dual band hand held. FT470 or FT530. Must be in good condition. Ian, BH's 0418 579422 . AH 03 57 511631 or email: lorian@albury.net.au

FOR SALE OLD

- Radiotron Designer's Handbook \$50, TR780 2m Tx/Rx \$200, FRG7 \$150, FT107m \$500, FL2100Z and spare vales \$700, KP-200 keyer \$60, rotators Archer \$50, Crown \$150, valve tester Taylor 45C \$120, HRO-5T metal valves, Home brew PSU \$400, Peter VK4APD QTHR. Phone (07) 3397 3751
- Linear RF Power Amplifier, EN1 3200L industrial/laboratory type; Broad-band 250 kHz-150MHz. Class A Linear. Output Power more than 100 Watts into 50 Ohm; maximum input + 13 dbm/1Vrms. Operates into any load. Forced air cooled. Type N connectors; Front panel power meter. 240 VAC Gary VK4AR (07) 3353 1695
- 6 metre FM transceiver: Tait T499, 25 Watts, 100 channel capacity, programmed with ALL repeater, simplex & reverse repeater frequencies, mic, spkr, cradle, circuits, CH list. GC, \$110. Gary VK4AR (07) 3353 1695

• 100W Linear Amp DSE-K6313 \$30. Beams 10-15-20 TH3 JUN, 10-15-20 TET-EMTRON HB43DX, both \$80. Trailer load computers, TNCs, modems, \$30. Phone (07) 4125 1690

• Coaxial relay BNC SPDT 24v new \$40. Coaxial dual isolation relays (2 X SPST) N type 24v new \$40. 8745 Planar triodes, Eimac, new, \$50 pair. MRF245 transistors 12-6v 80W 175 MHz, \$80 pair. Philips PM2505 electronic VAR meter, \$125. AVO 8 multimeter c/w AVO case & leads. Exc cond, \$150. Tektronix dual delayed timebase 7B92A (600MHz mainframe) Exc cond \$500. Valve receivers Eddystone models 770R & 680X, complete clean units, working, excellent for collector/restorer, \$650. The pair, or will neg separately. Fluke 8050A DVM with manual, as new \$225. J D Bisgrove VK4KK (07) 3269 6647.

• Yaesu FT74TGX HF xcvr, 3-30MHz, all mode computer aided, manual, FM board, serial no QJ380134, excellent condition. \$550 QTHR (07) 3269 8848, email: vk4arb@powerup.com.au

• Yaesu FT990 HF all band, all mode, auto tuner \$1800. Yaesu FL-7000 HF amp all band auto tuner 1200W PEP output \$2400, or FT990 and FL7000 together \$3800. Kenwood TS-520, & Kenwood VFO-520 EX-VFO \$220. Gap Challenger vertical antenna 80m-6m \$400. Ph John VK4AJS (07) 4939 5724 or 0429 395 724. All ono.

• Kenwood TS-50S HF mobile txcvr, ser. no. 60800848, as new, c/w headphone, Terlin mobile antenna and spring base, \$1000, Neil VK4WNT, (07) 5484 5883

WANTED QLD

• WWII Suitcase Transceiver type 3 mark II, also type A mark III, MCR I receiver, S-phone type I 3 mark IV, AWA 3BZ transmitter, and matching receivers. Coil boxes for HRO Rx. Ray VK4FH, PO Box 5263, Daisy Hill 4127. Ph (07) 3299 3819, Fax (07) 3299 3821

FOR SALE SA

• Kenwood TS-130S with operators manual, service manual, \$460. Mobile bracket for TS-120 & TS130 \$60. Paul VK5MAP QTHR (08) 8651 2398

• Antenna Emtron TE-23M threeband mini-beam two-element with pole & guys \$200 ono. Mobile whips various HF, offer. Dip-meter trio DM-801 s/n 1040047, offer. Packet radio MFJ TNC2 model MFJ-1274 s/n 02016986, manual, 2 books, cables, etc. offer. Ron VK5SD QTHR (08) 8337 6540.

• Yaesu FT 107M \$500. Yaesu FC 107 Ant tuner \$120. Hidaka Super Trap beam VS-33 \$150. Emotor 502 CXX with 5 metre tube mast for rotator assembly \$350. All items excellent

<http://www.hamsearch.com>

a not-for-profit site that is a search engine for hams

ADVERTISERS INDEX

ATN Antennas	8
Andrews Communication Systems	11
Dick Smith	OBC, 28,29
Icom	IBC
Tower Communications	25
WIA Call Book.....	IFC

condition VK5ALK. Phone (08) 8277 2006. Offers for complete rig sale.

WANTED SA

• Assembly instructions for Hy-Gain TH3 3 element tri-band beam. Copying and postage costs will be reimbursed. Ted VK5ZE (08) 8255 7586 QTHR

• (1) One 100pf. per section, dual variable capacitor, 0.125 inch plate spacing. (2) Two 100pf. variable capacitors, 0.125 inch plate spacing. (3) WW2 number 62 Set in reasonable condition. Ian VK5XA; PO Box 140 Milang, S.A. 5256. Phone: (08) 8537 0243

FOR SALE WA

• Kenwood TH79 VHF/UHF dual band handheld and numerous accessories. Accessories include: 1) SMC 34 speaker/microphone with volume control; 2) 2 cases - 1 spare; 3) 3 nicad battery packs which have all recently been rebuilt; 4) 1 dry cell case; 5) 1 x Kenwood KSC 14 drop-in charger.; 6) Optional sub tone encode/decode board fitted.; 7) Original accessories (inc wall mounted charger). Radio is 4 years old and has been kept in a case since new. Original packaging and handbooks included. Price \$785.00 including postage. Contact Bruce VK6CX ph 08 9310 4740 (H) or email: willijams2@iinet.net.au

MISCELLANEOUS

• FREE if you dismantle and remove TH3 Mk3 Three element Thunder Bird antenna and 30 ft tower. No longer required. Vic VK5AGX QTHR (08) 8258 0412

• If you got your licence before 1975 you are invited to join the Radio Amateurs Old Timers Club. A \$2.50 joining fee plus \$8.00 for one year or \$15.00 for two years gets you two interesting Journals a year plus good fellowship. Arthur Evans VK3VQ or Allan Doble VK3AMD can supply applications forms. Both are QTHR in any Call Book.

• The WIA QSL Collection (now Federal) requires QSLs. All types welcome, especially rare DX pictorial cards, special issue. Please contact the Hon Curator, Ken Matchett VK3TL, 4 Sunrise Hill Road Montrose VIC 3765, tel. 03 9728 5350.

TRADE ADS

• **AMIDON FERROMAGNETIC CORES:** For all RF applications. Send business size SASE for data/price to RJ & US Imports, PO Box 431, Kiama NSW 2533 (no enquiries at office please ... 14 Boanyo Ave Kiama).

www.cyberelectric.net.au/~rjandusimports
Agencies at: Assoc TV Service, Hobart; Truscotts Electronic World, Melbourne and Mildura; Alpha Tango Products, Perth; Haven Electronics, Nowra

• **WEATHER FAX programs for IBM XT/ATs** *** "RADFAXZ" \$35.00. is a high resolution short-wave weather fax, Morse and RTTY

OVER TO YOU

Packet/Internet articles

I refer to the *Over to You* letter in *Amateur Radio* November 1999 titled "More Packet Please".

I have placed a page on the packet teletext concerning sending internet email to non hams via a packet station. I feel that this activity is a good piece of publicity for amateur radio and would like to record my public thanks to the stations who run mailboxes (MBO) and bulletin board systems (BBS). Particularly the Netlink stations, VK7PU, ZL1MA, HS0AC and others which I have used while marine mobile (VK5RQ, VK2AGE, VK3WZ, VK4TN etc). The unsung volunteers army! Is an article wanted on Packet/Internet communications?

Ted Podham VK2EZQ 741
Landbase Australia, Locked bag 25,
Gosford 2250
20 January 2000

Editor's Comment. Let me know if you think we should have a Packet or Digital Modes Column. However I would also like to know who to approach to write it.

PLEASE BE KIND TO OUR TYPIST

Our Hamad typist is not an expert in your field Please write legibly on your form, using both capitals and lower case, and use legitimate abbreviations.

This saves excessive corrections by the proofreader, and reduces the chance of errors being published, which inconveniences everyone.

receiving program. Suitable for CGA, EGA, VGA and Hercules cards (state which). Needs SSB HF radio and RADFAX decoder. *** "SATFAX" \$45.00. is a NOAA, Meteor and GMS weather satellite picture receiving program. Needs EGA or VGA & WEATHER FAX PC card, + 137 MHz Receiver. *** "MAXISAT" \$75.00 is similar to SATFAX but needs 2 MB of expanded memory (EMS 3.6 or 4.0) and 1024 x 768 SVGA card. All programs are on 5.25" or 3.5" disks (state which) plus documentation, add \$3.00 postage. ONLY from M. Delahunty, 42 Villiers St, New Farm QLD 4005. Ph 07 358 2785.

TRADE PRACTICES ACT

It is impossible for us to ensure that the advertisements submitted for publication comply with the Trade Practices Act 1974. Therefore, advertisers and advertising agents will appreciate the absolute need for themselves to ensure that the provisions of the Act are strictly complied with.

VICTORIAN CONSUMER AFFAIRS ACT

All advertisers are advised that advertisements containing only a PO Box number as the address cannot be accepted without the addition of the business address of the box-holder or seller of the goods.

OVER TO YOU

An open forum for members' comments
Please keep letters short: brevity gets priority

Letter from the Editor

Letters need to be short; otherwise I will have to edit them down to about 200 words. Occasionally I will include something longer if it is well written and well researched. In some cases I will publish an abstract. This has happened with this month's letters.

Colwyn VK5UE Editor.

Membership Register.

Gordon McDonald wrote in March on how we record Memberships in AR. We will now try to show transfers separately.

CW

I have received some letters on CW. David Pilley wrote to confirm that CW is not dead and Amateurs will keep it alive. Ian Godsil wrote asking Special event stations to indicate the modes they will be using, which a number do.

Delivery of AR.

Gordon McDonald's second letter with Editors Note.

This month your cover sheet has a request to e-mail Newsletters Unlimited, the publishers of AR, the date you receive AR and your postcode. This information will be put to Australia Post with a 'please explain'.

Have you tried...

DXing, microwaves, CW, high speed data, ATV, operating portable, slow scan TV, QRP, contesting, homebrewing, AM, UHF, packet radio, foxhunting, building repeaters, JOTA, 160 metres or publicising amateur radio?

Write about it
and send it to

Amateur Radio

the magazine which covers
more facets of
amateur radio than any other.

Address for articles:
The Editor
Amateur Radio
34 Hawker Cres
Elizabeth East SA 5122
or email:
edarmag@chariot.net.au

Things we have to do better

12 May 2000

Hello Editor,

I haven't got AR for May yet because I am in an outlying area of Australia called Sydney but I did get some information about the contents via 2m SSB from an amateur in the more densely populated area beyond the Blue Mountains. I was surprised to learn that my "Letter to the Editor" relating to the WIA membership register and to changing divisions etc was not published in the May issue. I would like to know why not. Please oblige me with a prompt answer.

Yours quite seriously,

Gordon McDonald VK2ZAB. WIA member since 1957/58.

Editors Note. I have replied to Gordon about AR and asked the office to vet the new members list for re-entries, so we don't have any more bum ups.

Re Inverters in Try This April 2000 AR

Here are a few cautionary words for those readers contemplating installing an inverter in their vehicle.

The lighter/radio fuse in my Falcon is rated at 15 A which is a typical value for this sort of vehicle. The lighter outlet might therefore supply 180 W before the fuse blows or the under dash wiring blushes. An inverter is optimistically rated 80% efficient under ideal conditions, therefore the best an inverter connected

to the lighter circuit can do is 140W.

If an inverter is used to drive a 140W appliance for 1 hr the energy used must be returned to the battery i.e. 180Whr. Assuming the battery watt hour efficiency is 80% it will need recharging with 225Whr which is 3,75 hours at 5A and 12V. that arithmetic, of course applies to any appliance which uses the vehicle battery as a primary supply whilst the vehicle is stationary for any length of time.

A 300 W inverter will supply, under ideal load conditions, about 240 W and will require an outlet fuze of 25A and vehicle wiring to match. If a 300W unit is used to its full capacity the energy required from the vehicle battery is 300 WHr per hour. The battery will then require 5. A at 12V. for 6.25 hr

Inverters are not suitable for loads which have high starting currents such as refrigerators and compressors which use induction motors permanently connected to the compressors. To be safe use them only for unity power factor loads. If an inverter waveform departs significantly from sinusoidal, power factor correction will not be effective.

Lindsay Lawless VK3ANJ
Box 760 Lakes Entrance Victoria 3909.
17/04/2000

Address all letters to:

The Editor AR
34 Hawker Crescent
Elizabeth East S.A., 5112
e-mail edarmag@chariot.net.au

YAESU'S DONE IT AGAIN

**SCOOP
PURCHASE
SPECIAL**



Yaesu FT-100 Ultra-compact HF/6m/2m/70cm Mobile

AMAZING SCOOP PURCHASE VALUE!

Now you can enjoy the fun of operating on all bands from 160m to 70cm, either at home or in your car, and at a fantastic Yaesu price.

The new Yaesu FT-100 features HF/6m/2m/70cm transmitter coverage with 100W RF output on HF and 6m, 50W on 2m and 20W on 70cm, plus you can easily mount the detachable front panel using an optional lead (YSK-100) for more convenient mobile installations. Powerful interference fighting features such as a DSP based Bandpass filter, Notch filter and Noise reduction, together with an IF based Shift control, all aid reception quality during tough conditions. A Speech Processor and VOX facility are provided for SSB users and an internal Electronic keyer is provided for CW operation. Also included are Dual VFOs, built-in CTCSS encode, 300 memory channels, all-mode operation (SSB, CW, AM, FM, AFSK, Packet* 1200/9600bps), 100kHz-970MHz receiver (cellular locked-out), and options for additional AM and CW IF filters.

The FT-100 is supplied with an MH-42B6JS hand mic, DC power lead and comprehensive instructions.

D 3285

YSK-100 remote front panel kit.

\$155

D 3286

YAESU

Included as standard:

- Digital Signal Processing on both transmit and receive
- Effective IF noise blanker
- Electronic CW keyer with 50 character message memory
- Spectrum Scope function
- Massive receiver coverage (100kHz – 970MHz, less cellular)

\$2499

**SAVE
\$376**

2 YEAR WARRANTY

Offers expire 30/6/2000.



That's where you go!

* Requires third party TNC

1074 IBC 4 col.

MORE

GREAT

GEAR

FROM

ICOM



IC-706MKIIG

The amazing evolution of the legendary 706. Frequency coverage is expanded to the 70cm band and output power is increased for the 2m band. You get base station performance and features in a mobile rig-sized package.

IC-718

A compact HF all band transceiver.

A superior performer with simple, straight forward operation with keypad. Optional AF DSP capabilities, including noise reduction and auto notch function. It's versatile, compact and loaded with features.

NEW!



IC-756PRO

The HF & 6m multimode professional performer. 100 watts of power, newly designed 32 bit floating DSP for noise reduction and auto notch function, and AGC loop operation for wider dynamic range. Plus digital IF filter, built-in RTTY Demodulator/Dual Peak APF, and a whole lot more.

NEW!



IC-2800H

A totally new approach to dual band mobile. Powerful performance on 2m and 70cm bands, remote control capability, and a first for mobile rigs... a multi-function colour LCD screen! All your information is right in front of you in colourful 3D-like characters and icons.



IC-T81A

A remarkably compact quad bander. Superb clarity on the 6m, 2m, 70cms and 23cm bands. It's water resistant, with tone squelch and pocket beep functions standard, plus you can change volume and bands even quicker with the 'joy-stick' style multi-function switch.



ICOM

Clearly Ahead

2 YR WARRANTY

See your nearest Icom Dealer, or visit our website at www.icom.net.au

July 2000

Volume 68 No 7



Amateur Radio

Awards Contests

Walking 'On Air' from Sydney to Brisbane

Foxes & Hounds at Mount Gambier

Story in ARDF column



Australian-Foxhunting Championships

The Winners' Equipment



- ★ A "Swinging-Link" Antenna Coupler
- ★ Using A Regulated Power Supply to Charge a Lead Acid Battery
- ★ An Active Loop Converter For The LF Bands
- ★ The Handlebar & the Halo



plus

*WIA, Divisional & Club News
ALARA
& regular columns*

Gil Sonbs VK3AUI

Technical Abstracts:

Long Wire for Six and Ten

Homebrew ESD Mat



WIA Yearbook 2000

***Callbook Listings
Frequency Listings
Band Plans
Repeater Lists
Beacon Lists
Satellite Lists
Licence Conditions
Examiner Lists
Special Interest Groups
Public Relations Notes
Radio and TV Freqs.
and much, much more!***

2000 is a great year to have an up-to-date call book. This YEARBOOK edition contains all of the content you have come to expect of the WIA callbook as well as some new items

It is more than a callbook, it's a Yearbook, the WIA Yearbook!

***The "WIA Yearbook 2000" is now
available from
Divisional Bookshops
and selected outlets***



Amateur Radio

Volume 68
Number 7
July 2000

The Journal of the Wireless
Institute of Australia

ISSN 0002-6859

Editorial

Editor: Colwyn Low VK5UE

Technical Editor: Peter Gibson* VK3AZL

Publications Committee Members

Ron Fisher VK3OM
Don Jackson VK3DBB
Evan Jarman VK3ANI
Bill Rice VK3ABP
Gil Sones VK3AUI

Advertising

Mrs June Fox,
Tel: (03) 9528 5962

Hamads

"Hamads" Newsletters Unlimited
29 Tanner Street, Richmond VIC 3121
Fax: (03) 9428 4242
e-mail: newst@webtime.com.au

Office

10/229 Balaclava Road
Caulfield, Victoria
Telephone (03) 9528 5962
Facsimile (03) 9523 8191
Business Hours 9:30am to 3:00pm weekdays

Postal

P.O. Box 2175
CAULFIELD JUNCTION
VICTORIA 3161
AUSTRALIA
e-mail: armag@hotkey.net.au

Production

Newsletters Unlimited (03) 9428 3458

Printer

Streamline Press, Melbourne (03) 9417 2766

Postal Service

IMS (03) 9291 5888

Production Deadlines

Advertising booking and articles for
publication 10th of preceding month.

Hamads and advertising material deadline
18th day of preceding month

The contents of Amateur Radio are
Copyright Wireless Institute of Australia
C 2000

General

VISRAS 75th Birthday Celebrations	7
Dayton Hamfest Diary: The Greatest Show on Earth	24
<i>Phil Miller VK2FHN</i>	
Walking 'On Air' from Sydney to Brisbane	28
<i>Tony Whiteaker G3RKL/VK2STB</i>	
Remembrance Day Contest 2000	40
No contest, but plenty of fun in a lighthouse	42
<i>Mike Dalrymple GM4SUC/Kevin VK2CE</i>	
Many a slip on the way to the true story. Part 2	50
<i>D Handscomb VK6ATE</i>	

Technical

A "Swinging-Link" Antenna Coupler	8
<i>Drew Diamond VK3XU</i>	
Using A Regulated Power Supply To Charge A Lead Acid Battery	14
<i>Gil Sones VK3AUI</i>	
An Active Loop Converter For The LF Bands	16
<i>Lloyd Butler VK5BR</i>	
Long Wire for Six and Ten (Technical Abstracts)	20
<i>Gil Sones VK3AUI</i>	
Homebrew ESD Mat (Technical Abstracts)	21
<i>Gil Sones VK3AUI</i>	
The Handlebar and the Halo	26
<i>Gil Sones VK3AUI</i>	

Columns

Advertisers' Index	55	Editor's Comment	2
ALARA	21	Hamads	55
ARDF	13	HF Predictions	52
Club News	22	New Members	2
Contests	38	Pounding Brass	49
WIA Division News		Repeater Link	47
VK1 Notes	34	Silent Key	6, 39
VK2 Notes	31	Spotlight on SWLing	48
VK3 Notes	31	Technical Abstracts	20
VK4 Notes	33	VHF/UHF - An Expanding World	35
VK7 Notes	33	WIA News	3
5/8 Wave	34	WIA Division Directory	30
DX Notes	43	WIA Federal Directory	2

Our cover this month

Some of the equipment used to win the Australian Foxhunting Championship.
See story in ARDF column, page 13

Contributions to Amateur Radio

Amateur Radio is a forum for WIA members' amateur radio experiments, experiences opinions and news. Manuscripts with drawings and or photos are always welcome and will be considered for publication. Articles on disc or email are especially welcome. The WIA cannot be responsible for loss or damage to any material. A pamphlet, How to write for Amateur Radio is available from the Federal Office on receipt of a stamped self-addressed envelope.

Back issues

Back issues are available directly from the WIA Federal Office (until stocks are exhausted, at \$4.00 each (including postage within Australia) to members.

Photostat copies

When back issues are no longer available, photocopies of articles are available to members at \$2.50 each (plus an additional \$2 for each additional issue in which the article appears).

Disclaimer

The opinions expressed in this publication do not necessarily reflect the official view of the WIA and the WIA cannot be held responsible for incorrect information published.

Amateur Radio Service

A radiocommunication service for the purpose of self-training, intercommunication and technical investigation carried out by amateurs; that is, by duly authorised persons interested in radio technique solely with a personal aim and without pecuniary interest.

Wireless Institute of Australia

The world's first and oldest
National Radio Society
Founded 1910

Representing
The Australian Amateur Radio Service

Member of the
International Amateur Radio Union

Registered Federal Office of the WIA

10/229 Balaclava Road
Caulfield North Vic 3161

Tel: (03) 9528 5962 Fax (03) 9523 8191

<http://www.wia.org.au>

All mail to
PO Box 2175 Caulfield Junction VIC 3161

Business hours: 9.30am-3pm weekdays

Acting Federal Secretary

Peter Naish VK2BPN

Federal Office staff

June Fox Bookkeeper
Rita Trebilco VK3IF Examinations Officer

Council

President	Peter Naish	VK2BPN
VK1 Federal Councillor	Glenn Dunstan	VK1XX
VK2 Federal Councillor	Michael Corbin	VK2YC
VK3 Federal Councillor	Brenda Edmonds	VK3KT
VK4 Federal Councillor	David Jones	VK4OF
VK5 Federal Councillor	David Box	VK5OV
VK6 Federal Councillor	Will McGhie	VK6UU
VK7 Federal Councillor	Phil Corby	VK7ZAX

Executive

Peter Naish VK2BPN
John Loftus VK4EMM

Federal Coordinators

AMSAT	Graham Ratcliff	VK5AGR
ARDF	Jack Bramham	VK3WWW
Awards	John Kelleher	VK3DP
Contests	Ian Godsil	VK3DID
Education	Brenda Edmonds	VK3KT
FTAC	John Martin	VK3KWA
Historian	John Edmonds	VK3AFU
IARU	Grant Willis	VK5ZWI
Intruder Watch	Gordon Loveday	VK4KAL
ITU Conference and study group	Gilbert Hughes	VK1GH
QSL Manager (VKs, VK0)	Neil Penfold	VK6NE
Videotapes	VK2 Division	
Web/PR	Richard Murnance	VK2SKY

ACA Liaison Team

Peter Naish VK2BPN
Glenn Dunstan VK1XX
Michael Corbin VK2YC
Wally Howse VK6KZ
Canberra Liaison Officer
Richard Jenkins VK1RJ

EDITORS COMMENT

Amateur Radio is a great hobby

We Amateurs have a great reputation for working together and helping a mate.

The WIA was formed to enable Amateurs to help each other and has become the officially recognised voice of Amateurs in Australia. It has a broad structure, with Amateurs from all sorts of backgrounds who bring many different skills to the organisation.

The basic contact point with the WIA is the state division, which needs to be dynamic and open to all. We need to feel our views will get a hearing there.

Amateur Radio Magazine is the journal of the WIA. It conveys information on changes to the regulations we operate under and the actions being taken to improve our operating conditions.

We also print technical articles and general articles on the things people do, recent and long past.

We provide columns on specific topics and an *Over to You* spot where we can air peoples views and start discussions. This month letters still discuss Morse requirements for access to HF bands and also its usefulness as a communications mode.

The strength of the WIA is its volunteers. Volunteers do just about all the work of the WIA, so give them support in the jobs they do for all of us. If you do not like something please offer

some ideas on how the situation can be improved.

It has been suggested we include articles using old technology. So if I get an article using valves it will be considered, but the parts will have to have a high probability of still being in many 'junk boxes'.

John Loftus, VK4EMM and George Down VK4XY are representing Australia and the WIA in the World Team Radiosport Championship in Bled, Slavonica this month; we have sent them best wishes for success. This is one International activity for Radio Amateurs; there are also Fox Hunts and their variants.

What do you find most satisfying about having and using your Amateur Licence? I took the plunge and bought a 1.2GHz transverter kit. I'll let you know how I get on putting it together and operating it. I'll need a big magnifier to see the SMCs and solder them in place!

This month's suggested activity:

Take part in the RD Contest

It is a mark of respect to all Radio Amateurs who died in war. It is a chance to meet old friends and make new ones. It is a friendly contest. It is a chance for amateurs to work together within a state to win a Trophy. VK7 have won it for the last 4 years!

Colwyn VK5UE

NEW WIA MEMBERS

The WIA bids a warm welcome to the following new members who were entered into the WIA Membership Register during the months of

APRIL 2000

L21093	MR M W WILLING	VK2TST	MR S P SOLOVIEFF
VK2GJT	MR G J TOWELLS	VK3HKR	MR K ROBERTSON
VK2HCU	MR P C BISHOP	VK3VO	DR R C LILE
VK2KZX	MR S H JONES	VK7LCW	MR P S AICHBERGER
VK2TQT	MR L GORDON	VK7XDB	MR D BRAMICH

MAY 2000

L21174	MR R B COOPER	VK2MID	MR D WALKER
L21175	MR F W J NEWLYN	VK2OA	MR A I MADIGAN
L50616	MR D R FABER	VK2TQX	MR C J DINGLE
VK2AFL	MR A J LARK	VK3DLH	MR H SMALL
VK2AXD	MR E A DRUITT	VK3TI	MR T SMITH
VK2HDO	MR C KOOK	VK3WB	MR A WILSON
VK2HPC	MR P R CLEMONSON	VK3ZFI	MR E OSBORN
VK2IQE	MR Y YAMAMOTO	VK4EMS	MR S B SALVIA
VK2KXG	MR R G HENLEY	VK8ZAB	MR A D BAKER

VK could join CEPT licence system soon

Australia is set to join the CEPT Harmonised Amateur Radio Examination Certificates (HAREC) system, once the Australian Communications Authority (ACA) finalises the required internal administrative procedures. When the ACA has done that, and not before, it will mean holders of a HAREC issued by participating overseas countries can operate in Australia, and vice versa.

There are more than 30 countries in the CEPT system, in Europe plus the United States, New Zealand, and South Africa. It is unclear how many have adopted the HAREC facility of CEPT licensing.

Although the European Radio-communications Office (ERO) has announced the acceptance of the Australian qualifications into the HAREC system, the ACA has told the WIA it is not yet ready.

It is understood that the ERO decision does not replace the existing reciprocal licensing agreements that Australia has with other countries, but HAREC is in addition or complements those formal agreements.

The WIA has a long-standing policy to seek recognition of the Australian licence syllabus by the CEPT (European

Conference of Postal and Telecommunications Administrations), and this has now happened.

In July 1999, the WIA wrote again to the ACA to revive the CEPT issue due to an expected large number of overseas visitors to Australia for the Olympic Games. The WIA remains hopeful that the ACA can implement the system as soon as possible so it can be of benefit to visitors during the Olympics.

(WIA Victoria News Online
www.tbsa.com.au/~wiavic)

Standard to Protect Against EMR Expanded

Consumers will soon be protected against electromagnetic radiation (EMR) from a wider range of radio-communications equipment, the Australian Communications Authority (ACA) said today.

The ACA is set to increase the scope of its mandatory EMR Human Exposure Standard from 1 June 2000 in response to community concerns about the possible adverse health effects of mobile technology.

Electromagnetic radiation is the transmission of energy in the form of waves that have an electrical and magnetic component, such as radio waves from mobile phones.

The revised Standard will apply to all mobile phone handsets and base stations, cordless phone handsets and cradles, and satellite phone handsets in the 800 - 2500 MHz frequency range. This includes GSM 1800 MHz cellular mobile handsets, 915, 928 and 2400 MHz cordless phones and 1600 MHz satellite phone handsets.

"The increase in scope will ensure the public is safeguarded against the known effects of EMR from newer mobile technologies," Radiocommunications Standards Manager Ian McAlister said.

"The new regulatory arrangements support current international scientific opinion which maintains that equipment operating in accordance with recognised human exposure safety standards will not pose a health risk," he added.

Responsibility for compliance will depend on the type of radio-communications transmitter.

For hand-held devices, manufacturers, importers and agents must ensure compliance before placing their product on the market. This includes declaring conformity with all applicable standards, creating and maintaining a folder of

supporting documentation, and labelling products.

For transmitter installations, owners and operators must show compliance before the ACA will issue or renew their radiocommunications licence.

The ACA will enforce compliance through a system of random audits of compliance documentation and complaint investigations.

A further extension of the standard is planned later in the year, to capture low power devices including baby monitors and two-way radios.

For more information contact:
Ian McAlister
Australian Communications Authority
Telephone: (02) 6256 5451
(ACA web site, <http://www.aca.gov.au/media/2000/25-00.htm>)

IARU Region 3 Conference website Online

The International Amateur Radio Union Region 3 Conference will be held in Darwin, from 28 August through 1 September 2000, and the official conference web site is now up and running.

The site has been compiled with the assistance of Adrian VK5ZBR, author of the Amateur Radio Experimenters Group web site in Adelaide. The web address is: <http://www.cck.net.au/iaru/>.

This is still under development, and will have further news and information about the conference, and the WIA papers and information added, as the conference date approaches.

Any comments can be directed to Grant vk5zwi@cck.net.au.

(Grant Willis VK5ZWI, WIA Federal / IARU Liaison Officer)

ACA Approves Internet Linking of Repeaters

WIA Federal councillor and ACA liaison committee member Glenn VK1XX, reports that the ACA has approved the linking of amateur repeaters using the Internet.

"The ACA guidelines for linking require that the Internet be used as an end to end link only" Glenn said.

"The stations operating the link must employ security and filtering systems which prevent access to the public telephone network by stations using the link. Access to the link from the Internet must also be prevented. The only way to get access to the link must be to transmit on the input frequency of either repeater".

"I would like to publicly thank Alan, VK6BN for his outstanding work in this

area. Alan's linking experiments served as the catalyst for general ACA approval of Internet linking. His actions typify the true pioneering spirit of amateur radio". Glenn said.

So there you have it. Looking to stimulate more traffic on your local repeater? Why not link it to a repeater in the UK or USA ?

For more information on Internet linking of repeaters, e-mail Glenn at vk1xx@gmdss.com.au.

(Glenn Dunstan VK1XX)

VK Experimenter's Handbook Project

The Amateur Radio Experimenters Group Inc. in South Australia, is interested in publishing an experimenter's type handbook. In the past, quite a few good books have been written by Australian amateurs but nothing like the large ARRL and RSGB handbooks.

Hams and electronic buffs in Australia are all quite clever people and quite capable of putting enough information together to produce such a book. However it needs to have projects with parts we can buy in Australia!

For more information about the project, visit the AREG book web page at <http://www.cck.net.au/areg/book/book.htm>.

You can contact AREG by one of the following means:

- PO Box 6539, Halifax Street, Adelaide S.A. 5000

- email: eagle@cck.net.au

- packet: VK5ZBR @ VK5SPG

(Adrian VK5ZBR via QNEWS)

Marine Radio Op's Handbook On-line

Of interest to maritime mobile operators, or Amateurs interested in marine operations: the April 2000 edition of the *Marine Radio Operators Handbook* is now available in electronic form, from the Australian Communication Authority web site, at <http://www.aca.gov.au/publications/brochure/rib175.pdf> * MERGEFORMATINET

(ACA web site)

Amateur and CB Documents Updated on Web

A number of documents of interest have been updated on the ACA web site, including:

- *ACA Licensing Amateur Operating Procedures* (<http://www.aca.gov.au/publications/info/regs.htm>)

- *ACA Licensing Citizen Band Radio Stations* (<http://www.aca.gov.au/publications/info/cbrcl.htm>)

- *ACA Licensing Disclosure of*

Personal Information (<http://www.aca.gov.au/publications/info/privacy.htm>)

The last of these documents relates to personal information about radio licensees that is publicly available, for example on the ACA web site.

(ACA web site)

PNG Moves to 5 wpm

PANGTEL, the ACA's counterpart in Papua New Guinea has approved full access to all HF Amateur bands, as well as higher bands as previously allowed, for holders of the Intermediate Amateur Operator's Certificate of Proficiency. This follows recent similar moves by Australia and other countries.

The granting of extended privileges

includes access to the VLF band in the range 165 through 190 kHz.

It was not reported when the new privileges were due to come into effect. Similar changes in Australia are expected to come into effect around "mid-year". In the USA, they have been in effect since 15 April this year.

(Rick Warnett P29KFS, p29kfs@daltron.com.pg)

Embargo Clears Way for Bigger 80m DX Window

The Australian Communication Authority's embargo on further spectrum allocations to fixed and mobile services between 3776 and 3800 kHz heralds the start of a clear out of services from what will be an expanded 80m DX "window" for Australian Amateurs.

This band will be reallocated to the Amateur service on 1 January 2004. Existing fixed and mobile services will gradually migrate to other band segments before then.

The band reallocation is the result of

representations made by the Wireless Institute of Australia's ACA Liaison Team (http://www.wia.org.au/Issues/sub_80m.pdf * MERGEFORMATINET).

WIA Federal AGM

WIA Federal President Peter Naish VK2BPN reports:

The 64th. WIA Federal Convention was held in Melbourne over the weekend April 29/30th. 2000. It was attended by delegates from each of the seven WIA Divisions as well Directors. The President, Peter Naish VK2BPN, chaired the meeting.

The agenda included the AGM for WIA Federal which included the adoption of the Annual Report and reports from coordinators. As usual, the various office bearers retired at the AGM and elections for the ensuing year took place. Peter Naish was selected for a third consecutive term as Federal President and John Loftus VK4EMM continues as a Federal

Director. The majority of Federal coordinators were reappointed for a further year.

The main event for this convention was a review of WIA Policy especially in regard to the many papers currently under preparation for submission by WIA at the IARU Region 3 Meeting in Darwin in August. Considerable progress was made and it was pleasing to find the large degree of accord that existed between the seven Divisions on the policy issues. It is proposed that more detail of these matters will be made available very shortly.

The meeting welcomed the attendance of two delegates from NZART, namely

Carol Gaudin ZL2VQ and Fred Johnson, ZL2AMJ who is also a Director of IARU Region 3. These guests participated in the Convention and provided a viewpoint from New Zealand on many matters.

It was one of the most constructive Conventions to be held in recent years and illustrated the strength and dedication of all WIA Divisions in making sensible policy decisions on behalf of all Australian radio amateurs. Everybody went away knowing that progress had been made but conscious of the need to continue to work together on the many critical issues.

(WIA Federal President Peter Naish)

APRS in Marathon

While most of Sydney started getting out of bed on a sunny Sunday morning, the Sydney Marathon, an Olympic Test Event was finishing at the Homebush Bay Olympic Stadium.

The marathon was designed not only to test the course and the athletes, but also to test the technical preparations for the games. In the middle of all these preparations was local amateur Darryl Smith VK2TDS.

Darryl was monitoring a network of TNC's and GPS's from a control centre in the suburbs surrounding the Homebush Olympic park. The network allowed each vehicle or aircraft to monitor the location of all the other mobile units. This allowed

aircraft to stay directly above the camera truck reducing the possibility of the microwave path being blocked by buildings.

What makes this story unusual is that all the equipment and software used was developed for Amateur Radio use. The only parts of the system that did were not from amateur radio suppliers were the radios, and the frequencies they operated on. "This is basically taking what we hams have developed for our own use,

and found a commercial use for it" Darryl commented.

"The system generally worked well" remarked Darryl after the race had concluded. "With any luck this is just the start ..."

More information on APRS is available by contacting darryl@radio-active.net.au
(Darryl VK2TDS)
via QNEWS

WRTC 2000 in Slovenia

Two Australians are to participate in the World Radiosport Team championship (WRTC) - an event held every four years involving the world's best contest operators.

John Loftus VK4EMM and George Down VK4XY will be in Bléd, Slovenia in southern Europe, to compete against 53 other teams for the prized WRTC bronze, silver and gold medals.

To win a medal, a team has to be in the top three after a week of competitive operating events.

The WRTC attracts many spectators keen to see the world's top contest operators in action, either to lend personal

encouragement or learn a few tricks.

The main event is the IARU HF Championship during July 8 and 9. The WRTC teams will be in the contest using Sierra 5 (S5) call signs that have a unique three digit identifier. Listen for them on both SSB and CW, 80 metres through to 10 metres. They will be very keen to work as many stations as possible because the

IARU HF Championship is the final event that determines the medal winners.

Work each station on each mode, on each band. The contest exchange is signal report plus your ITU Zone. The rules of the IARU HF Championship are published in the June edition of Amateur Radio magazine.

Jim Linton VK3PC

WIA seeks tighter controls on LIPDs

In a submission to the ACA, the WIA stated its position as being "that LIPDs, in their present form, pose an unnecessary interference management burden to the ACA, the WIA, and the general public. The WIA is seeking tighter restrictions of LIPDs to lower the level of interference into Amateur Service facilities to a truly 'low potential', rather than the current 'high potential'.

The ACA has been urged by the WIA to mandate major changes affecting the manufacture, sale, use, and licensing of Low Interference Potential Devices on the 70cm band. The ACA had announced earlier that it was revoking the Class Licence for LIPDs and called for submissions ahead of it issuing a replacement licence that would address concerns about interference experienced with LIPDs.

The WIA has been working hard on this issue since it was unsuccessful several years ago in convincing the ACA that LIPDs on 70cm would both cause and suffer interference.

The ACA in the past year has been particularly receptive to the WIA concerns, and undertook to review the situation based on documented proof that interference was occurring.

In a 19-page submission delivered to the ACA on 31 May 2000, the WIA sets out a series of measures it believes will reduce the interference impacts of LIPDs in the 433.05 - 434.79MHz band. The WIA has suggested that as a "partial remedy" to the interference problems being experienced, the ACA adopt the

tighter standards set by CEPT in Europe for LIPDs, known there as Short Range Devices (SRDs).

These include:

- Operation of SRDs is intermittent with a maximum duty cycle of 10%
- Voice and audio devices are not recommended for use
- A maximum output power level is set at 10mW EIRP

In comparison, the ACA has permitted 100% duty cycle, allowed voice transmission which creates a pseudo-CB radio, and 25mW transmit power. In its submission it said, "If the ACA does not see fit to restrict LIPD operation to non-voice applications it is inevitable that there will be continued interference problems. It has provided details of interference from LIPDs suffered by amateur 70cm repeaters serving all mainland Australian states, and a case of LIPD car RF keylocks malfunctioning due to amateur repeater and simplex transmissions.

The submission suggests: "One solution would be to confine the operation of voice LIPDs to frequencies that are not

ordinarily used for amateur repeater inputs." The WIA said as a starting point, the ACA could publish lists of amateur 70cm repeaters and their service areas, and state that usage of LIPDs within 30km of such a repeater is not permitted. However the WIA's preferred position is "to see the 433.050 to 434.790MHz segment deleted from the LIPD Class Licence determination completely."

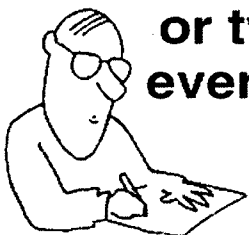
The WIA said it was pleased that the ACA has in its proposal made references to safety of life and commercial implications of using LIPDs, on the 70cm band where they may experience interference. Interference to LIPDs has obvious implications for workplace health and safety should it disrupt an industrial process or other essential signaling.

The WIA referred to use of similar safety warnings used in Europe, and believes that for them to be effective they would need to be included on product packaging and literature. The WIA now awaits the outcome of the ACA's deliberation on the submissions it has received on the 70cm LIPDs.

Jim Linton VK3PC

ar

There's a story
or two in
everyone



Have you submitted
yours to

**Amateur
Radio?**

SILENT KEY

RON DUNNE VK3MEH

Ron was keen on electronics from boyhood in Flinders and during his early adult life he built several small portable radios. Later he built the home amplifier and record player system.

He learnt Morse code as a Scout and built on that foundation as he studied at TAFE in Wantirna in the early seventies. From then on he collected more equipment and enjoyed contacts with numerous other operators. He particularly liked taking the small

'handheld' when we were travelling, making some interesting contacts in the Gippsland and Peninsular areas. On retirement in the mid eighties, he valued increasingly his talks with radio people and when interest waned, due to a long illness, he still liked to listen to ordinary shortwave radio for many hours.

He was a quiet man who valued one to one contacts. Ron died at home in Upwey on May 10th this year.

Heather Dunne

ar

VI5RAS

75th Birthday Celebrations

VI5RAS is being sponsored by the Royal Australian Signals Association (S A) and its operation is approved by the Certi Cito committee in Canberra.

The above mentioned association has a few qualified amateurs within its ranks but would like to involve more amateurs in the running of the station.

Mainly, the station *will be run* from individual home stations *duty rostered*, so if you are an amateur and an ex or serving member, or have an affiliation past or present with a signals unit of HM. Forces and resident in Australia and interested in participating please direct your enquires to VI5RAS 14 Jenolan Cresc – Hilbank, S.A, 5112. Tel. (08) 8252 8939.

It is envisaged that some interstate amateur stations will be appointed to operate VI5RAS on a portable basis having been supplied with the proper authorization. There is scope for non-amateur ex or serving members of a signals unit to contribute as operators under the supervision of a qualified authorized amateur. There is also scope for an authorized operator to operate the station at a special location other than his/hers normal QTH.

Godfrey Williams VK5BGW address as above for VI5RAS

ar

The month of November in the year 2000 marks the 75th birthday of the formation of the Royal Australian Corps of Signals. As a consequence a special event amateur station VI5RAS will be operated for the whole of that month as a celebration.

Celebrating 75 Years
The Royal Australian Corps of Signals



VI5RAS



Certi Cito 75

SPECIAL EVENT STATION ORGANISED BY THE RASIGS ASSOCIATION OF SA INC

CONFIRMING OUR RECENT QSO
RSARS F087

CALL SIGN							
DAY	MONTH	YEAR	TIME (UTC)	FREQ	MODE	R	S

R.A.S.I.G.S. (R.A.S.I.G.S. Inc)

THE ROYAL AUSTRALIAN CORPS OF SIGNALS 1925 - 2000

In the year 2000, The Royal Australian Corps of Signals (RASIGS) is 75 years old. This vital part of the Australian Army was formed by Army order in January 1925, breaking away from the Australian Corps of Engineers, Army Signalmen and Signawomen have supported their fellow soldiers with the communications required for the Army to do its job. During the Past 75 Years, these communications have ranged across lamp and flag signalling, heliographis, telephone lines, radio, morse code, fibreoptical cables, telephones, satellites and even pigeons - used successfully in the SW Pacific theatre in WWII.

*Thank you for your contact and sharing in this important
Celebration of the Corps 75th Birthday.*

SIGNIFICANT DATES:

- 1906 Australian Corps of Signalmen established but tied to Australian Corps of Engineers
- 1925 Separation from Australian Corps of Engineers & Australian Corps of Signalmen to become
- 1948 Title "Royal" conferred by His Majesty King George VI

We manufacture a comprehensive range of HF, VHF and UHF antennas, baluns, power dividers, etc. to suit your application. Some of our log periodics provide continuous coverage from 13-30 MHz including WARC frequencies and replace outdated tribanders. Now in use in 48 overseas countries.

FREE CATALOGUE AVAILABLE FROM



ATN ANTENNAS PTY LTD

A.C.N. 062 557 644

- Create rotators, coax cables & non-conducting guy & halyard materials
- Hard-drawn copper antenna wire
- Insulators for DIY projects
- Inverted vee kits 160-30m
- High gain VHF & UHF amateur, scanning & TV Antennas

- High Sierra HF mobile antennas
- Butt section triangular aluminium towers for fixed or tilt-over applications
- Selection of power chips & TX tubes
- Diamond VSWR/PWR meters to 1300 MHz & accessories

37 Morrison Street
PO Box 80, Birchip Vic, 3483
Ph: (03) 5492 2224
Fax: (03) 5492 2666

A "Swinging-Link" Antenna Coupler

Drew Diamond, VK3XU,
45 Gatters Rd.,
Wonga Park, 3115.

One of the most flexible all-round HF antennas is a horizontal, or inverted-vee doublet, or horizontal or vertical loop fed with "open-wire" line. Well-made open-wire copper line, where the dielectric (the material between the wires) is mainly air, has very low loss, even when operated at high SWR's. A ground-independent radiating wire as short as a quarter wavelength on the lowest band can be made to work quite satisfactorily.

Amateur transmitting amplifiers generally require a low-reactance unbalanced load of nominally 50 ohms for their correct operation. Indeed, solid-state amplifiers ordinarily have circuitry to reduce the power if the load "seen" by the amplifier is not very close to 50 ohms. However, the balanced impedance at the station end of an open-wire fed doublet or loop will show large frequency-dependent variations in impedance. That is, the impedance, as seen at the near end of the line, varies greatly between bands. Furthermore, it is usually of unknown

value, from tens, to thousands of ohms, and may be inductively or capacitively reactive. It is therefore not practicable to simply connect such a line to a transceiver and expect efficient multi-band operation. Some kind of coupler is required.

Although it may appear to do so, an antenna coupler does not "tune" an antenna. The standing wave ratio upon the feed-line, and ratio of wave distribution upon the radiating wire is not altered when the coupler is adjusted so that the system "accepts" power. The coupler simply provides an efficient match

between the output/input of the radio, and the complex impedance at the transmitter end of the line, thus allowing the radio to see 50 ohms resistive. It does not matter that the SWR on our low loss feed-line may be high.

The multi-band doublet or loop, is not a "compromise" antenna, unlike certain trap antennas, which waste much of the available radiating part in the cause of operating convenience. When the coupler is correctly adjusted, an open-wire fed antenna uses all of the radiator, from the lowest band, where it may only be a quarter wavelength long, to the highest, where it will be several wavelengths, and therefore have substantial gain in some directions, and rival rotatable beams in the DX stakes. More later.

A "Swinging-Link" Coupler

Like most amateurs with a preference for wire antennas, I have a keen interest in the various antenna coupler configurations, and have built many of them in my quest for the ideal device (if such a thing exists in reality). The following observations are probably muddled by differences in the efficiencies of my coils and capacitors. Nevertheless, significant variations in measured feed-line

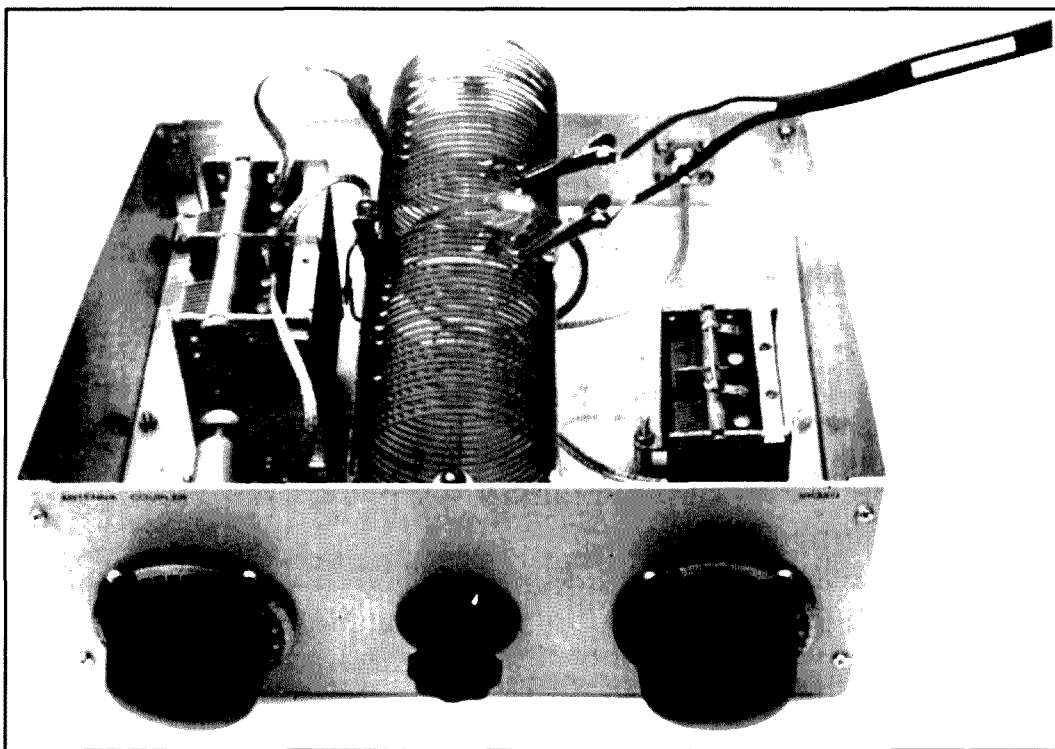
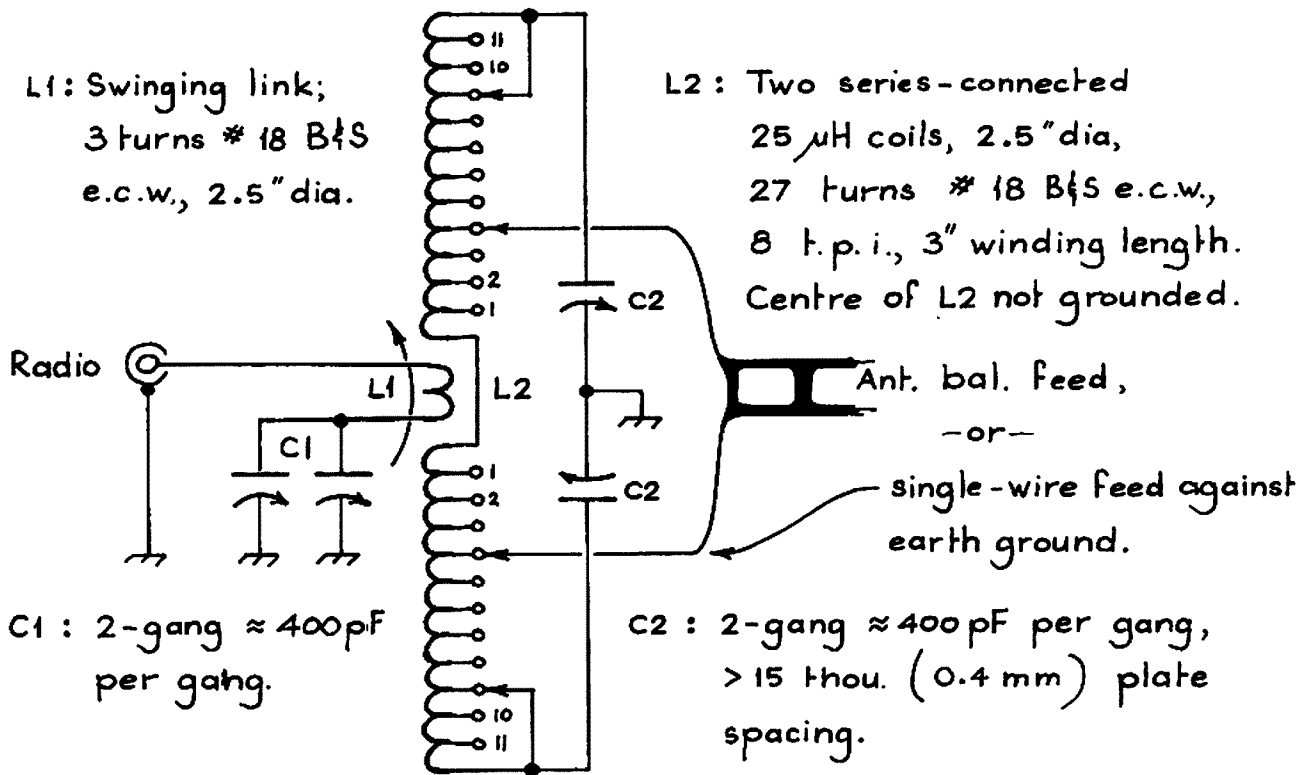


Photo 1



"Swinging-Link"
Antenna Coupler.

Fig 1

current, and accuracy of balance have been observed between circuit types. And some iterations were found to be rather restricted in their impedance matching range.

Very few published designs invite the builder to measure the feed-line current co-incident with minimum link SWR (but see Ref. 1). An achievement of a 1 : 1 SWR on the radio/coupler coax link may not necessarily indicate the best and only coupler adjustment for a specific band (Ref. 2). In particular, the popular American T-network "Transmatch" was found to be lacking in range, and suitability for balanced line work. Their widespread use of a 4 : 1 "balun" to interface between the unbalanced output of the T-network, and the balanced, unknown, probably highly reactive feed-line is very questionable. Certainly none of my attempts with various Transmatch and balun configurations would provide a satisfactory match and identical current in each line.

For some reason, perhaps related to the trend towards no-knob convenience, the swinging-link coupler (Refs 3 and 4, for example) has been absent from the standard radio handbooks for some years now, and is in danger of falling into undeserved obscurity. By having five, instead of the usual two or three variables, the device is capable of efficiently matching our 50 ohms to a very wide range of impedances, both balanced-line and single-wire feed. So let's have another look at this versatile device.

Circuit

See Fig. 1. Two series connected coils L2 are parallel connected with split-stator capacitor C2, whose rotor (frame) is connected to chassis ground. L2 is divided so that coil L1 may be coupled at their "zero-RF" potential point in the centre. Swinging-link L1 is mechanically arranged so as to be variable in the degree to which it may be coupled with L2.

Capacitor C1 is used to series resonate with the reactance presented by L1. Capacitor C2 is tapped across L2 an equal number of turns from the outside of the coil, generally working inwards as operating frequency is raised. The antenna feed-line is connected to equidistant taps (for balanced line) inside those of C2 at a point where, after adjustment of C1, C2 and swinging-link, feed-line reactance is accommodated and a suitable match between the coax link and antenna is obtained.

Construction

The home-made aluminium chassis in Photo 1 measures 260 x 260 x 110 (apologies again for mixed inch and metric in what follows). The making of air-coil L2 was described recently in Ref. 6. Note that the turns of each side of L2 must wind in the same direction, and that the centre connection of L2 is not connected to chassis. The coil assembly

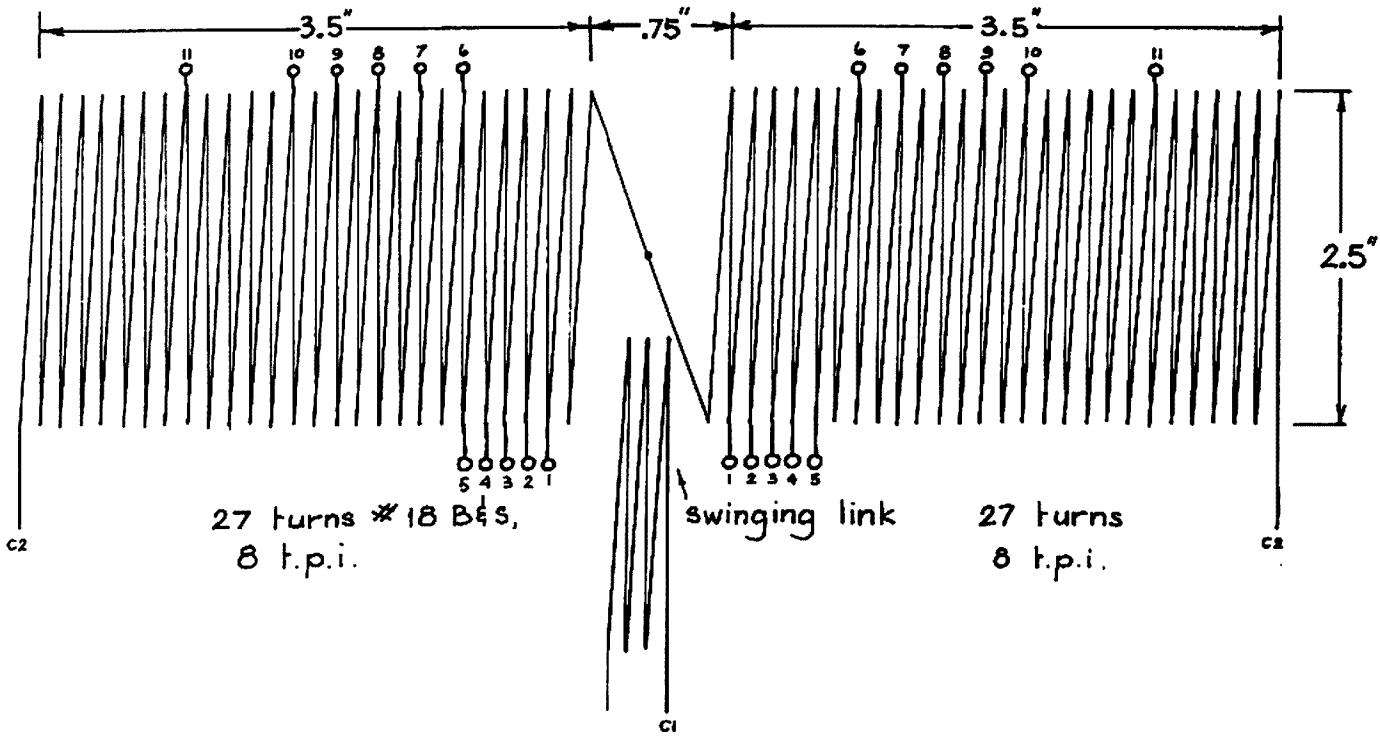


Fig 2

is supported upon two nylon (or similar) rods measuring 80 mm long x 12 mm dia. C2 and antenna feed-line taps are shown in Fig.2. Tapping points may be of shim brass; remove the wire enamel then fold a little tag of brass, about 5 mm x 15 mm around the wire to make a flag, clamp in place with an alligator clip, then solder. Taps 1 - 5 must be staggered a little to prevent shorts.

A suggested method of providing a swinging-link is shown in Photo 2. Coil L1 is three turns of #18 B&S (1.3 mm) e.c.w. wound through holes spaced 2.5-

inch in a perspex (or similar) support, and held there with small blobs of epoxy cement. An extension of the support is drilled 0.25" to accept a control shaft made from 0.25" plastic rod (#3 knitting needles are about this size, and make good insulated shafts for radio work). Fit a small set-screw, or cement to prevent slip.

The control shaft must run through corresponding clearance holes in the two nylon rods. The shaft may run in a plain bearing in rear the panel. Although not a fiddly adjustment in practice, a 6:1 panel mounted reduction drive will be found

useful for operation of the swinging-link. All connections, especially those to the link and C2 "flying-leads" should be made with flexible braid. That shown is the outer braid removed from RG-58 coax. Remember to position C1 (the smaller capacitor in Photo 3) so as to allow interference-free operation of the link coil.

Capacitor C2 must have fairly wide-spaced plates, at least 15 thou/ 0.4 mm. That shown is a fairly commonly available (around the hamfest scene here) older style broadcast receiver type, made by AWA and MSP. C2 in my coupler does not flash over on bands between 3.5 and 28 MHz at power levels up to about 100 W CW. It will only take about 50 W on 1.8 MHz. No firm figures for power handling can be stated here because of the many variables in feed-line impedance. However, from 3.5 to 29.7 MHz, an AWA/MSP cap. should do. If in doubt, use a 2-gang or split-stator with wider plate spacing. Capacitor C1 may be an ordinary 2 or preferably 3-gang broadcast type.

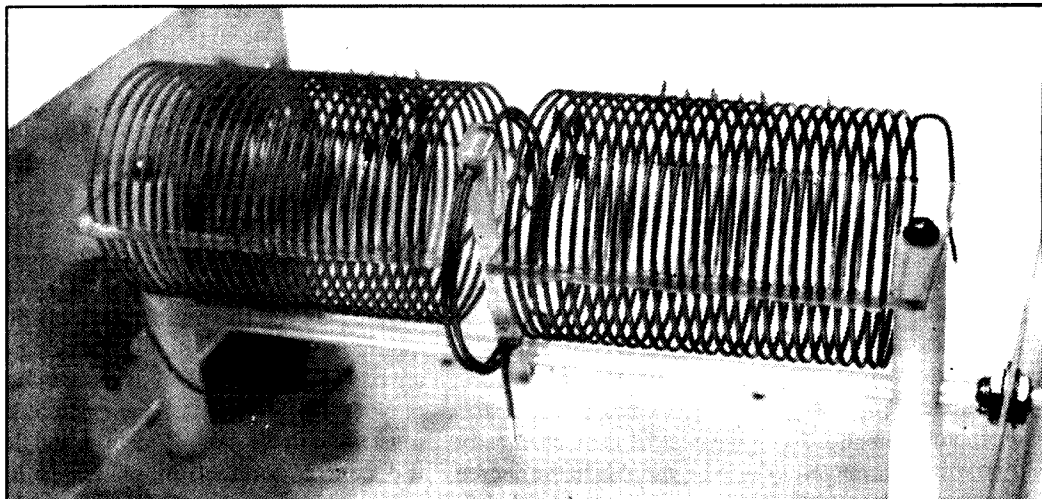


Photo 2

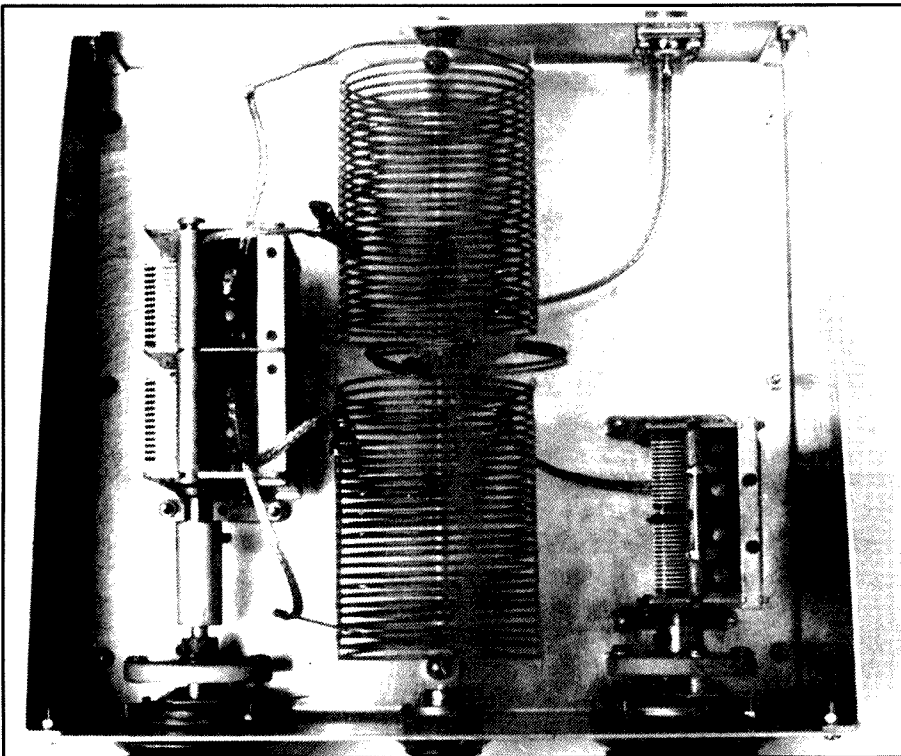


Photo 3

band, the addition (or subtraction) of a few feet of line (or antenna- same each end) should allow a match to occur.

Photo 4 shows some common feed-line types. The best is probably home-made line made from electrical earth wire (or similar), with a perspex spreader about every 3' / 1 m. Hold in place with a copper tie-wire through small holes drilled in the spreader. Line spacing is not critical. In my experience, this line is the least affected by rain and moisture, and that only to a very small degree, not usually requiring the coupler to be re-adjusted after rain.

Black or brown 450 ohm ladder line comes next (that it is "450 ohm" is irrelevant). The earlier line used hard-drawn copper, but new line is of copper-plated steel, which makes it a bit awkward to handle (and a little lossier I suspect). However, it can be routed past window frames and so on. Hint; with scissors or knife, remove alternate webs, which renders the line less affected by moisture. It should be taken down and washed yearly (grime traps moisture making the line more susceptible).

Low-loss "dog-bone" TV type is very good line if available. No longer manufactured, but turns up at hamfests etc. Also needs yearly washing.

Ordinary slotted TV line is the least

The knobs on the shafts of C1 and C2 may be directly coupled, or have vernier dials as shown. C2 is fairly sharp in adjustment and a vernier is recommended. C1 is broader, and less in need of a reduction drive.

All screws and hardware in the immediate vicinity of the coils should be brass, although, interestingly, a small number of steel screws do not appear to introduce measurable loss.

Antenna and feed-line

All of the standard radio handbooks give details of open-wire feed antennas. Some radiator and feed-line lengths will perhaps give an easier match on particular bands. However, in my experience, just about any convenient radiator and feed-line length will be "match-

able". Some of my past (and present) antennas include; a 50-foot radiator + 25 foot feed-line, 70 + 35, 135 + 42, 270 + 35 and G5RV. All of these could be matched via a coupler like this one. If the system refuses to "load-up" on a certain

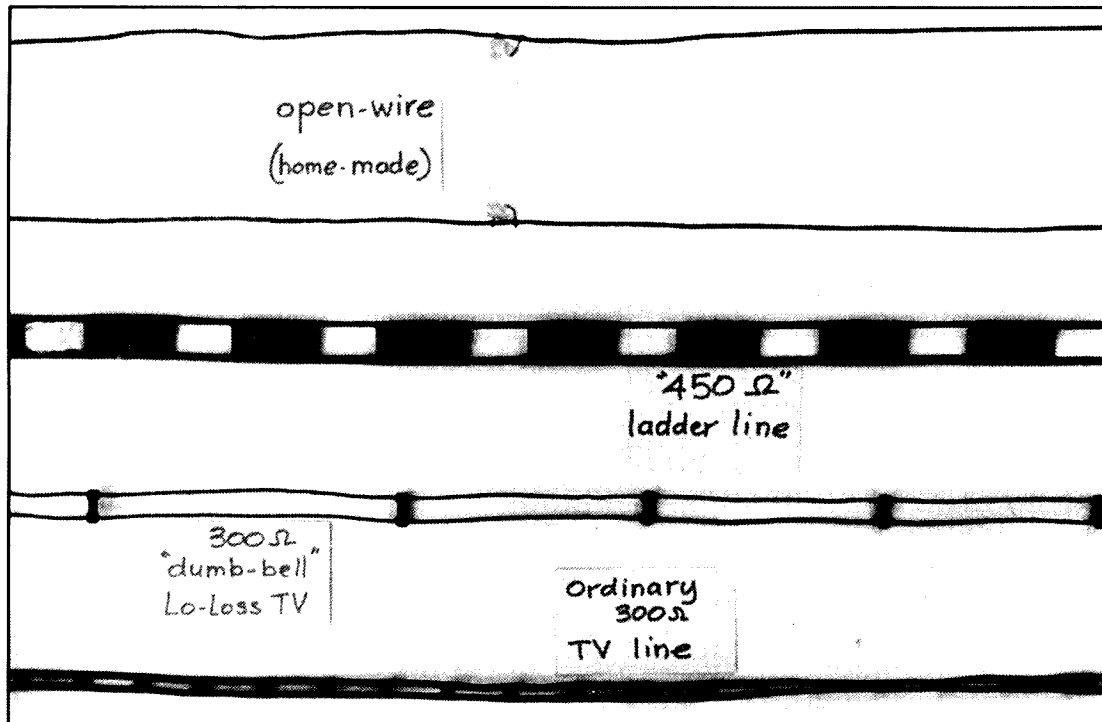


Photo 4

suitable line (most lossy), but quite good in an emergency, or for short runs inside a building or in awkward applications. Significantly affected by moisture.

Operation

Connect your radio to the coax connector of the coupler using a suitable length of 50 ohm coax cable-SWR meter-cable. The tap connections for C2 along L2 are made with a pair of alligator clips. Tappings for C2 and antenna feed-line are usually different for each band, and there can be no strict rules, as tappings depend on individual antenna configurations. As a rough guide; on 1.8 MHz the full inductance of L2 will probably be required, so connect C2 to the ends of L2. On 3.5 MHz taps 11 will (probably) be best. On 7 and 10.1 MHz try taps 6 or 7, 14 MHz try taps 6. On 18, 21 and 24 MHz; try taps 5, and 28 MHz will probably need taps 3 or 4.

The feed-line connection must always be inside (towards the centre of the coil) those of C2. Start by connecting to (say) taps 3. Position C1 and the link initially at full mesh. Now adjust C2 for maximum received band noise/signal. Experiment with all five variables until you feel the coupler is near peak adjustment. Now, on a clear frequency, apply the smallest tuning signal that your SWR meter will properly respond to (say 10 W). Again carefully adjust C2, C1 and link for best SWR (do not touch the taps when transmitting). If it cannot be made less than about 1.1, switch off and try a new pair of taps for feed-line and/or C2. When a satisfactory match is obtained, log the settings for that band on a suitable look-up table. Do the same for every band of interest, working from the outside of the coil as frequency is increased.

A pair of RF thermocouple ammeters, about 2 or 3 A f.s.d. (for 100 W) is the most ideal line current indicator (for balance and comparison- perhaps with other couplers). But these are now rare items, so if you are not the fortunate owner of a pair of meters, consider making a twin-lamp current indicator as described in Ref. 5.

For single-wire feed type antennas, a good earth ground must be connected to the coupler chassis. Adjustment is similar to that described for the balanced feeder. A neon lamp, placed near the line will glow for voltage feed, and a lamp current

indicator (Ref. 5) will glow for current feed. Disconnect the feed-line from the coupler when not in use.

References and Further Reading:

1. "Balanced Line ASTU and Current Indicator"; Garrott, G0LMJ, in RadCom July/Aug '98.
2. "ATU Power Ratings"; Ian White's "In Practice" column in RadCom June '97.
3. "Wide-Range Coupler for Any Antenna"; ARRL H'book, 42nd (1965) edition, p354.
4. "Coupling the Transmitter to the Line"; ARRL H'book, 32nd (1955) edition, p313.
5. "A Current Indicator for Open-wire Transmission Lines"; Diamond, AR Jan. '99.
6. "Making Air-Wound Transmitting Coils"; Diamond, AR June '00.

ar

Trans-Tasman balloons thanks



10 March 2000

Peter Naish,
Federal President,
Wireless Institute of Australia,
PO Box 2175,
Caulfield Junction Vic 3161.

Dear Peter,

As I believe you would know, Australian Geographic hosted Mission Control for the recent Trans-Tasman Flyer balloon crossing. We were particularly pleased that amateur radio operators were able to play such an active role in Mission Control, and feel that their presence added a vital, additional element of safety to the expedition.

It's wonderful that so many of your members were willing to volunteer their time to monitor the crossing, around the clock, and that such interest was shown by radio amateurs, especially throughout eastern Australia and as far away as New Zealand.

We certainly appreciated the involvement of amateur radio operators at Mission Control and hope there may be other opportunities for us to co-operate.

Yours sincerely,

Howard Whelan
Publisher

AUSTRALIAN GEOGRAPHIC PTY LTD
321 Mona Vale Road
PO Box 321, Terrey Hills NSW 2084
Ph: +61 2 9450 2344 Fax: +61 2 9450 2090
www.australiangeographic.com.au

ARDF

Jack VK3WWW

Phone: 03 9873 2459 Fax: 03 9428 1589 Mobile: 0408 037 065

Email: vk3www@alphalink.com.au

Cover Story

Fox-hunting on wheels

As this is my first article I must start off by thanking Ron VK4BRG for his excellent work in promoting ARDF and Foxhunting in his articles over the past couple of years. I do hope I can keep your interest in this facet of our great hobby.

ARDF usually refers to pedestrian style foxhunting, but most of you would be more aware of vehicle type hunts where you drive to the location of the transmitter and in some instances you would have to exit the car and sniff out the fox. Fox for the night could hide the fox just a few metres, or even kilometres from the nearest road. Here in Melbourne we hold regular monthly Foxhunts, usually between 4 and 7 teams compete in at least 6 hunts, mostly on 2m VHF. As for the ARDF side of foxhunting we would hold about 4 events per year, these hunts would be in local parks and forests, sometimes, suburban streets are incorporated in the competition area. Nearly all ARDF events in Melbourne are on maps kindly loaned by some of the Melbourne Orienteering clubs, these clubs have gone to a lot of trouble to create quite detailed maps which are excellent for ARDF events. In future ARDF columns I will try to detail each of many forms of radio direction finding.

Australian Foxhunting Championships

Over the weekend of June 10th and 11th about 12 teams headed off to Mount Gambier to compete in the WIA Australian Foxhunting Championships, if you are at all interested in radio direction finding attending the S.E.R.G. convention is a must. Competition is usually tough, in both the foxhunting and the equipment development stakes. If you suspect that home brewing is not being practiced much these days a tour through one of the competitors cars will change your mind. Under normal local hunts you could afford to make 2 maybe 3 mistakes and still be competitive, but in the national championships making only one mistake

you can easily drop from a possible first, to last place. First event on the program was a distance based 2m foxhunt, at the start and finish of the event your odometer reading is taken and the team with the lowest total kilometres travelled is declared the winner. To take out first place the winning team actually travelled a slightly shorter route than the fox, only basic equipment was allowed giving some of the newer teams a competitive chance. For the rest of the weekend hounds located foxes on 80m, 10m, 6m, 2m, 70 and 23cm. At the end of all the hunts it was declared that the VK3HDF team consisting of Adam VK3HDF, Bryan VK3YNG, Steve VK3YLE, Glen VK3HXP and Bjorn VK3HBD were the 2000 Australian Foxhunting Champions. Congratulations to Adam and the rest of the team, we hope to see you back next year to defend your title.

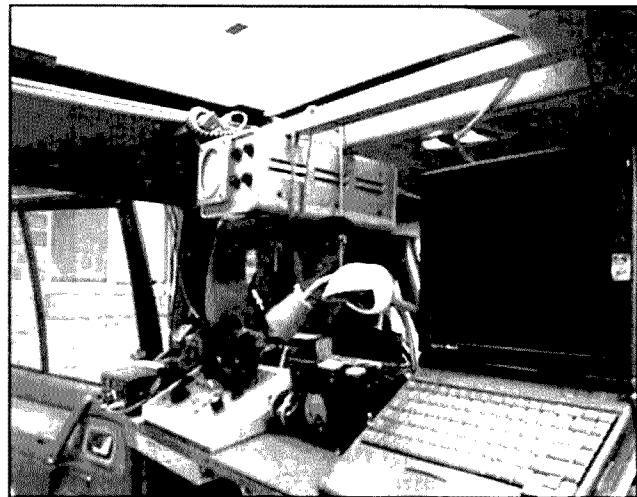
SAR

At the recent Gambier Convention, there was a representative from the Australian Maritime Safety Authority, (AusSAR) recruiting amateurs with radio direction finding skills to assist the National Search and Rescue Organisation in locating distress beacons more commonly referred to as ELT's, EPIRB's. If you have experience

in locating transmitters in the VHF and UHF region, maybe you too should be listed on the database. I will inform readers about future developments for this project when they are worked out. For more information try their website at: www.amsa.gov.au.

If you have any news about ARDF and Foxhunting in your area please let me know about it, I am QTHR or you can E-mail me on: vk3www@alphalink.com.au

ar



Inside the VK3YQN Foxhunting Pajero, notice the laptop for displaying moving maps.



Here is some of the equipment the current Australian Foxhunting Champions used to beat the opposition.

Using A Regulated Power Supply to Charge a Lead Acid Battery

Gil Sones VK3AU1

A regulated power supply can be used to charge and float charge lead acid batteries with only a small amount of work.

Many of the sealed batteries we use are designed for float charge service and may be adversely affected by the use of a normal automotive charger. Also it is possible to use a float charged battery supply as a no break type supply for radio equipment. The float charger supplies the normal drain and if the mains is interrupted the battery takes over automatically. On restoration of the mains the float charger tops up the battery.

If you connect a regulated supply directly to a battery without modification or any extra components you may find that several components in the PSU will be damaged. This is because in the absence of the primary supply from the mains the PSU circuitry is subjected to a reverse voltage. The internal filter capacitor is initially discharged with the mains supply off. When the battery is connected to the output terminals the discharged filter capacitor is charged by a current which passes through the regulator circuit but in the reverse direction to the normal current through the regulator. The regulator is subjected to the charge current for the filter but in the reverse direction to the normal current flow. This can result in the regulator circuit components being damaged. The regulator circuit must be protected from this occurrence.

The simplest way to use a regulated power supply as a float or regulated voltage charger is to simply connect a power diode between the output terminal and the battery being charged. However adjusting the output voltage can be a bit tricky as the output voltage sensing of the supply is on the wrong side of the diode. However it is possible to set this up without too much trouble. The diode voltage drop is around 0.6 Volt and so the supply must be set up to allow for this. If the supply has external sensing then simply connect it to the battery load side of the diode.

A suitable high current diode may be hard to obtain and difficult to mount. It will need a heat sink. A simple solution is to use the diodes contained in one of the potted bridge assemblies. By strapping the AC terminals two arms can be paralleled as shown in Fig 1

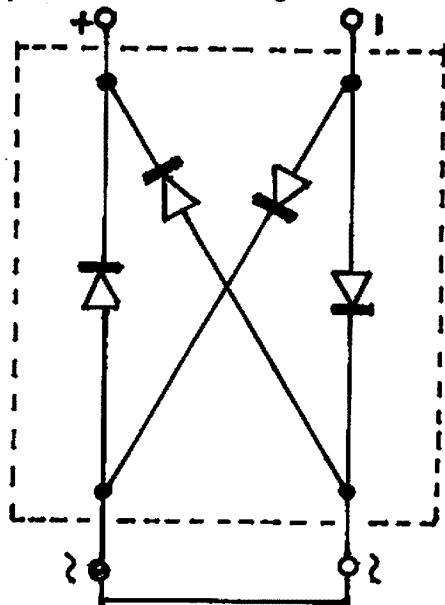


Fig 1. Diode Bridge Strapped to Provide Power Diode.

The diodes have a good current rating

and using a 35 Amp bridge most amateur power supplies can be accommodated. The bridge also has an isolated case which simplifies mounting on a heat sink. You could be dissipating around 10 Watts or more so a heat sink is needed.

There is another way which requires a simple modification to the regulated power supply circuit. This still requires a high current diode but it is only called upon to charge the filter capacitor and does not have to carry continuous output current.

The diode is connected between the regulated power supply output and the Filter capacitor in such a way that during normal supply operation it is reverse biased. If the supply is connected to a battery in the absence of mains input the diode will conduct and carry the filter capacitor charging current from the battery and protect the regulator circuit from the reverse current. This is shown in Fig 2. Note that the diode must still be a high current type but the heat sinking requirement is not as onerous. The main thing is to ensure that the diode can handle the high surge current into the filter capacitor. The diode may need to be a similar type to that used in the main supply rectifier circuit. Also some

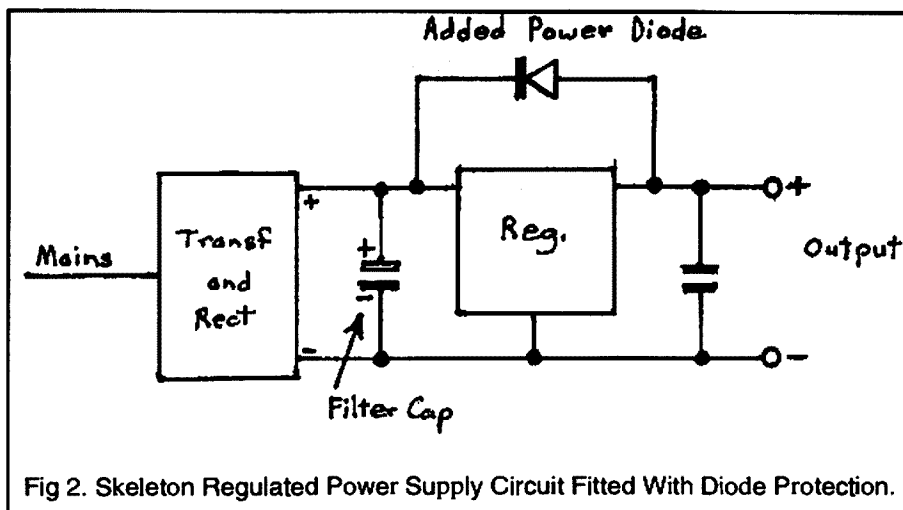


Fig 2. Skeleton Regulated Power Supply Circuit Fitted With Diode Protection.

regulated supplies have two rectifier circuits with one supplying the output and the other supplying regulator circuitry. In such supplies two diodes may be needed in order to charge the two filter capacitors. See Fig 3. Many transceiver DC supplies are of this type. The DSE 20 Amp adjustable supply cat D3800 that many use as a power supply has a separate supply for the regulator circuitry.

A word of caution regarding ratings of regulated supplies is required as many amateur supplies are not continuously rated. SSB transceivers need a supply which delivers a few

Amps continuously but only needs to supply full output for a short time. When charging a battery you can cause overheating of the supply as a dead flat battery will take a high current for a long time. You may have to readjust the current limit to a lower figure to handle this situation. Use a figure below the manufacturers continuous current rating to be safe.

I have used a supply fitted with the diode protection successfully but with the current limit adjusted to around 5 Amps as this was appropriate to the battery used and the power supply rating. The battery can supply the high current peaks which

the transceiver requires as they are of short duration.

The current limit is determined by a resistor which the regulator uses to sense the output current. Depending on the regulator used the current limit operates when the voltage across this resistor is 0.3 V to 0.6 V. The resistor is usually a power resistor or combination of power resistors. A skeleton circuit is shown in Fig 4. For a 20 amp limit and an 0.6V sense voltage the sensing resistor would be 0.03 Ohm. To lower the limit identify the resistors and substitute appropriate values for the limit you want. For the example given

0.06 Ohm would give a 10 Amp limit and 0.12 Ohm would give a 5 Amp limit. You could switch between the lower limit and the higher limit if desired. Remember that the battery charge rate should be at the manufacturers recommendation. This will be the 10 hour or 20 hour rate. For a 70 Ampere Hour battery this is 7 Amps or 3.5 Amps respectively. Most transceiver type supplies will struggle at 10 Amps continuously for an extended period.

This article originally appeared in a slightly different form in WICEN NEWS the WICEN (Vic.) Inc. News Bulletin.

ar

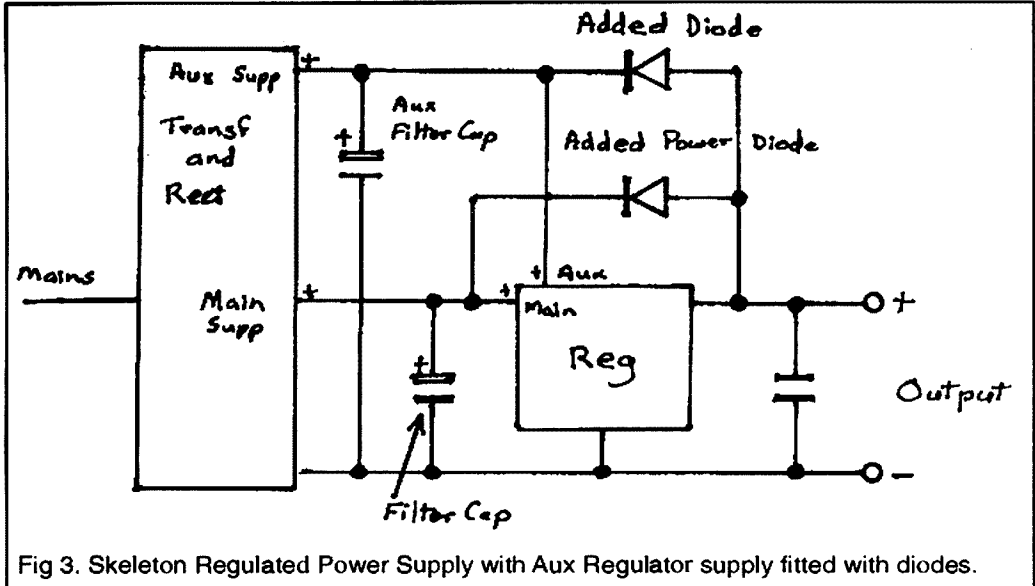


Fig 3. Skeleton Regulated Power Supply with Aux Regulator supply fitted with diodes.

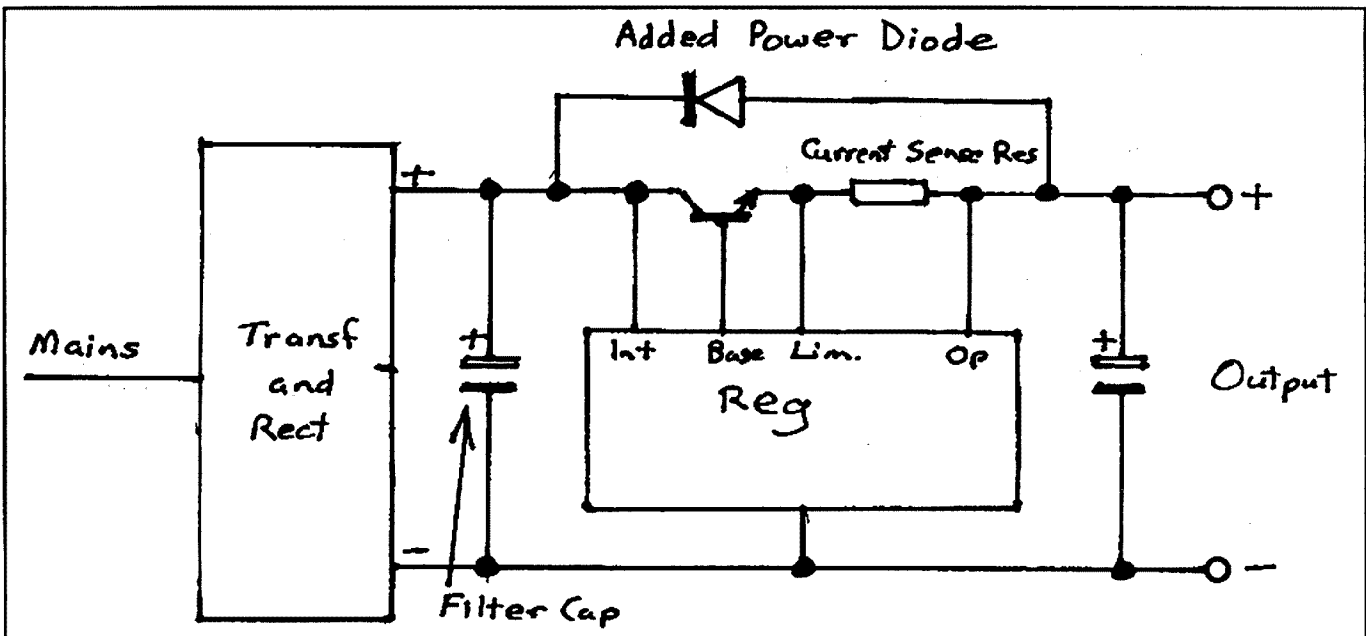


Fig 4. Skeleton Circuit showing Current Limit Sensing Resistor.

An Active Loop Converter For The LF Bands

Lloyd Butler VK5BR

Localised noise interference is a common problem in receiving signals on the Low Frequency (LF) bands. To minimise this noise there should be two essential features incorporated in the LF front end.

The two essential features are

(1) A sharply tuned circuit at the LF frequency. This limits both high level noise and strong signals on other frequencies from cross modulating the desired signal in the following mixer stage. The sharper the tuning, the better this is achieved. Unfortunately many LF converter circuits have broadband front ends.

(2) Use of a tuned loop antenna.

Localised noise predominates in the electric component of the noise field. The small loop picks up the magnetic component of received signal and is insensitive to the electric component of the noise field.

Furthermore, because of its directivity, the loop can be rotated to enhance the level of the desired signal relative to other signals or noise which come from a different direction. Also because the loop null is quite sharp, this can be positioned in the direction of the unwanted signal or noise to some advantage. (Reference 1 gives more information on the loop theory).

In the converter which is described, a loop antenna is used as the only tuned inductive element with *positive feedback* applied to increase its effective Q and sharpen up its tuning. This of course is the old trick called *reaction* or *regeneration* used in the early days of TRF receivers to improve selectivity.

With the adjustable reaction control set to a stable point just below the point of oscillation, Q factors of between 1000 and 2000 are achieved. This means an effective 3db bandwidth of around 100 to 200 hertz at 200 kHz.

A switch selects a choice of three frequency bands. The loop specified has an inductance of about 500 uH and using

this loop the bands are as follows:

Band 1	195 to 490 kHz (Includes the aeronautical homer beacons)
Band 2	150 to 220 kHz (Includes the New Zealand amateur band)
Band 3	128 to 160 kHz (Includes the European amateur band).

For the following discussion on circuit detail, refer to figure 1 on facing page..

The Frequency Converter

The mixer stage employs the now universally used NE602 package (N2), the output of which is fed to the input of a HF receiver. One way to operate this stage is to operate its local oscillator in a tuneable mode with the output as a fixed 1st Intermediate frequency (IF) fed to the receiver.

That system, which I used in a previous converter (reference 2), necessitates the calibration of the local oscillator tuning dial in terms of the incoming LF. In this new converter, I have made use of the idea that Drew Diamond (VK3XU) used (see ref. 3).

The local oscillator is crystal locked on an even multiple of Megahertz and the 1st IF varies with the incoming frequency so that the receiver is tuned over a range equal to the MHz frequency plus the LF. If the receiver is accurately calibrated, the calibration is simply read off on the receiver dial (or digital display) ignoring the MHz.

In this system, the received frequency at the input of the converter is determined by the frequency tuned on the HF receiver.

For the calibration to be correct, the oscillator MHz frequency must be

accurate. Drew used a frequency of 3 MHz. I had available a 3 MHz cheap ceramic crystal and a 4 MHz quartz crystal in the HC25 holder. I started off with Drew's circuit values but found both crystals oscillated at far too low a frequency making the receiver calibration a long way out. (This gets back to the fact that crystals are made to suit a particular circuit constants and when ordering a crystal one should always specify the circuit with the order).

Anyway I settled on the 4 MHz crystal and trimmed my circuit values to make my crystal oscillate on the right frequency (refer values of C16 and C17 in figure 1).

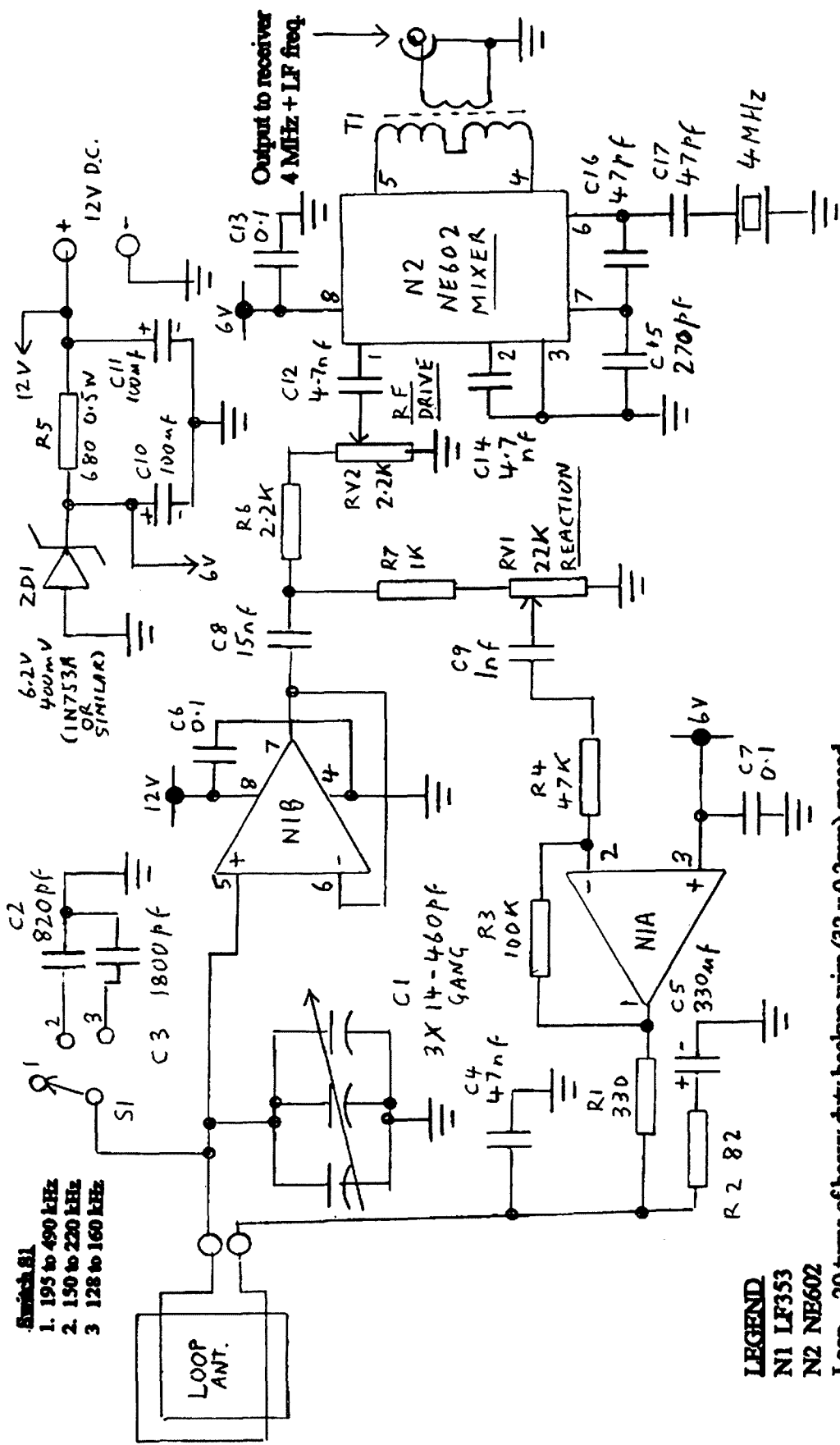
I must point out that the value of these capacitors might not be quite right for some other random crystal.

The Loop

The loop (figure 2) has been successfully used in conjunction with other receiver arrangements and has been mentioned before in my previous articles on VLF/LF in AR. It consists of 20 turns of 32 x 0.2mm hook-up wire spaced laterally 10 mm apart on a wood frame 0.8 metre square.

It works fine indoors and is connected to the converter via 2 metres of figure 8 flexible cable. For other receivers, coax cable was used with the cold end of the loop at earth potential. However in this receiver, the feedback signal is fed in series with the loop and the colder end of loop is at an RF potential a little above ground level.

The only difficulty I have experienced indoors with the short cable is noise from the fluorescent lights. So I just turn these off. The cable can be extended so that operation is possible outdoors but the extra cable capacitance will limit the



- Switch S1**
- 195 to 490 kHz
 - 150 to 220 kHz
 - 128 to 160 kHz

- LEGEND**
- N1 LF353
 - N2 NE602

Loop - 20 turns of heavy duty hookup wire (32 x 0.2mm) spaced 10mm apart on a 0.8 metre square wood frame.

Loop is connected via 2 metres of Figure 8 flex cable. L1 - 10 turns trifilar wound on a suitable ferrite toroidal core (core used was a philips 97050 9mm core $\mu = 5000$).

FIGURE 1 ACTIVE LOOP L.F. CONVERTER

Circuit Diagram

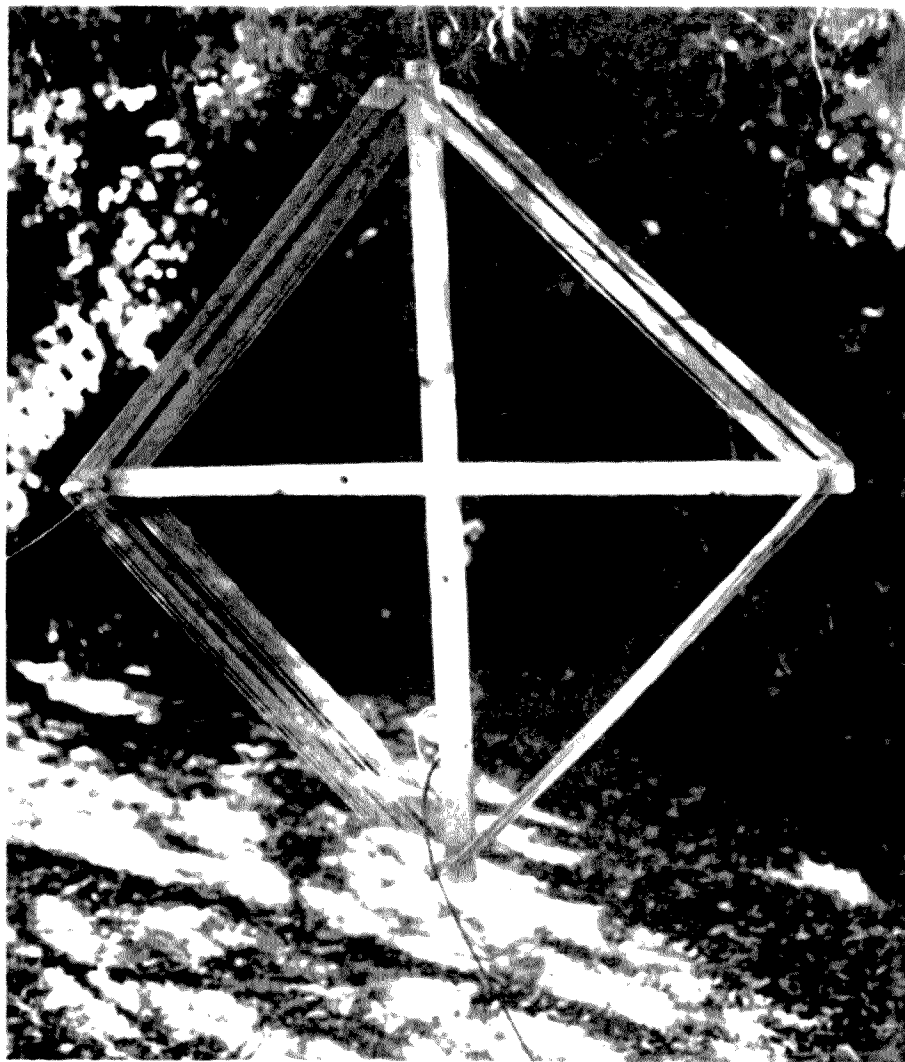


Figure 2 The Loop Antenna

maximum tuneable frequency on hand 1. There seems to be little advantage in hanging the loop more than a metre or so above ground or floor level. If kept well clear of surrounding objects it works fine.

The minimum frequency on band 1 is set by the maximum capacity of 3 gang tuning capacitor C1. The maximum frequency on band 1 is set by the loop inherent capacitance plus its feed cable capacitance. The actual minimum and maximum frequencies are of course also controlled by the inductance of the loop. The frequency range is extended downwards by switching in capacitors C2 or C3. Addition of this capacitance to lower the frequency progressively reduces the range achievable by the adjustment of C1.

With the feedback adjusted for high Q, the tuning is very sharp and a vernier drive coupled to C1 is desirable.

The Loop Interface and Feedback Circuit

The loop is interfaced by one half of twin MOSFET opamp LF353 (N1B) which operates as a voltage follower and which presents a high input impedance across the loop.

A portion of N1B output is fed back into the loop across capacitor C4 via the second half of the opamp N1A. The amount of feedback or reaction is controlled by the setting of potentiometer RV1.

The circuit is an adaptation of a circuit used in a previous simple VLF/LF receiver which I constructed (ref. 4). The reason for the inclusion of R2 might not be too clear but it was added to the circuit in the earlier receiver to stop some undesirable effects caused by the rise in impedance across C4 at very low

frequencies..

The output of N1B is coupled to the input of mixer N2 via drive control potentiometer RV2. This was included so that the RF drive could be reduced in the event of strong signals reaching the mixer input at sufficient level to cause cross modulation. The NE602 package has a fairly low third order intercept point which means intermodulation products can easily be produced at moderately high signal levels. (This was discussed in a previous article, reference 2).

The signal levels induced into the loop are much lower than for a long antenna wire and in the practical testing out the unit, I didn't actually notice any problem here. For my location, RV2 might well be an unnecessary inclusion but it could be needed if the converter is operated a bit closer to a local station.

Powering

The converter operates from a 12 volt DC supply which directly feeds the dual opamp N1. A 6 volt rail is derived with zener diode ZR1 and R5 and this is used for mixer N2 and to centre set the operating points of amplifiers N1A & N1B. The 12V load current is around 13mA. I operated the unit from a bench power supply but with that load current, a 12V bank of AA cells could be used.

Construction

At these low frequencies there are no real problems of lead lengths or inter-circuit coupling.

Minor components (integrated circuits, resistors and capacitors) were mounted on a piece of blank experimental circuit board made for DIL packages. A aluminium box housing the components had to be large enough to accommodate the three gang tuning capacitor and the large dial of the re-cycled vernier drive I coupled to it.

Almost any connector can be used for input and output. I used a twin REC socket (a twin version of the PL259) for the loop connection and a BNC connector for the 4 MHz output.

There is also nothing very critical about the design of the toroidal output transformer T1 and in fact the one I used could do with a few less turns on the secondary to suit the expected low input impedance of the usual HF receiver..

Operation and Tuning

Procedure is as follows: Connect the output of the converter to the HF receiver via a shielded line (coax cable or shielded wire). Hang the loop in a free space and connect its lead to the converter input. Connect the 12V supply and apply power.

Set the receiver tuning to 4 MHz plus the required LF frequency. Set the RF drive control to maximum. Ensure that the Reaction Control is set well below the point of input stage oscillation. (With a little practice one can recognise sounds from the receiver which indicate the oscillation point).

Rotate the loop tuning control (C1) for maximum noise from the receiver. Advance the reaction control as far as possible in the stable state below the oscillation point. Carefully check that the loop tuning is set at the centre of its resonance peak. If a signal is available on the tuned frequency, the peak could be indicated by maximum reading on the receiver signal strength meter. (There are plenty of aeronautical beacon (NDB) signals available for a test).

Rotate the loop antenna 360 degrees and the signal can be heard to fade in and out as it passes through the two peaks and the two nulls of the loop radiation pattern.

It should be noted that if the reaction control is advanced to the point of oscillation, the loop aerial can operate in reverse to radiate a signal at the frequency of oscillation. However this is not too much of a worry as the radiation resistance of the loop is so low that almost all of the energy generated is consumed in the loss resistance of the loop.

One could expect that the signal would be of such a low level, it would hardly be detectable over the back fence.

To quote some figures, I have calculated the radiation resistance of the loop to be close to 1 micro-ohm. The RMS voltage developed across the loop in the state of oscillation has been measured as a little less than 5V. The reactance of the loop at 200 kHz is around 600 ohms so that for 5V, the current through the loop is 8.3 mA.

Power radiated is this current squared times the radiation resistance which gives a power radiated of 68 micro-watts, quite an insignificant figure. However, to minimise possible localised

interference, one should avoid operation in the state of oscillation.

Performance

Correctly tuned up the converter separates weak signals out of the noise as good as anything I have tried out at my location. The only limitation is that is difficult to quickly scan the band with the front end so sharply tuned.

It is really a two hand operation. One has to track the tuning with one hand at the converter with the other at the HF receiver. If we know what we are looking for and know the frequency then there is no problem.

From the loop formula (ref.1) my loop is calculated to give an induced voltage of 0.05 uV per uV/metre of signal received at 200kHz. This is multiplied by the Q factor of the loop at resonance. Assuming an effective Q of 1000, the voltage at the input of amplifier N1b is 50 uV per uV/metre of signal at 200 kHz.

The conversion transfer ratio between the input of N1b at 200 kHz and the mixer output at 4.2 MHz was measured as 0.15 into a 50 ohm resistive load and 0.75 loaded into my FRG7 receiver input (obviously the antenna input impedance of the FRG7 is much higher than 50 ohms at 4 MHz).

From the above, when the loop feedback is set for a Q of 1000, the converter sensitivity at 200 kHz is 7.5 uV of converted output per signal strength of 1 uV/meter when the output is loaded into 50 ohms. Loaded into the FRG7 receiver, the figure is 37.5 uV per uV/meter.

Summary

A simple LF converter has been described which tunes the range of 128 to 490 kHz. This includes the bands allocated to European, British and New Zealand radio Amateurs and the Australian/New Zealand aeronautical non directional beacons.

The converter makes use of the noise reduction features of the small loop antenna which essential operates on the magnetic component of the received EM wave to the exclusion of the electric component which is predominant in local noise.

The loop is the only tuned element in the unit and feedback (or regeneration) is applied to the loop circuit allowing an increase in Q factor to around 1000 to

2000. This narrows the bandwidth, improving the adjacent channel rejection and reducing the susceptibility of the the mixer stage to cross modulation from strong unwanted signals and high level noise.

The mixer oscillator stage is crystal locked at 4 MHz so that the host HF receiver is simply set at 4 MHz plus the LF frequency. The LF is simply read on the receiver calibration ignoring the 4 MHz.

References

1. Lloyd Butler VK5BR - VLF-LF and the Loop Aerial - Amateur Radio, August 1990.
2. Lloyd Butler VK5BR - The bandwidth Limiting LF Converter Simplified Amateur Radio, January 1994.
3. Drew Diamond VK3XU - Simple LF Converter - Amateur Radio, December 1995
4. Lloyd Butler VK5BR - A Simple Regenerative VLF-LF Receiver Amateur Radio, January 1992.

ar

Andrews

Communications Systems

(EST. 1976 - ACN 001 968 752)



ALINCO

**AUSTRALIA'S FIRST AUTHORISED
FACTORY DIRECT IMPORTER**

**MASSIVE SHIPMENTS EVERY MONTH
FULL 3-YEAR WARRANTY ON
ALINCO and ICOM
WE SELL MOST BRANDS**

BALUNS, VERTICALS, YAGIS, P/S.
ICOM-KENWOOD-JRC-AOR-EMOTATOR-
MFJ-DIAMOND-TIMEWAVE-KANTRONICS
-THP - GARMIN - TERLIN - UNIDEN -ETC
DX-1600 HF LINEARS FROM \$ 3,799

**HUGE RANGE OF ELECTRONICS,
ICOM and ALINCO Radios.**

**Over 22 Years of
Professional Sales and Service.
Instant Repairs Fridays**

HF Transceivers & Linears Wanted

(02) 9636 9060 or (02) 9688 4301
SHOP 8, 41 BATHURST ST, GREYSTANES.
N. S. W. 2145. FAX (02) 9688 1995

TECHNICAL ABSTRACTS

Gil Sones VK3AUI

30 Moore Street, Box Hill South Vic 3128

Long Wire for Six and Ten

A long wire antenna which covers both six and ten meters and is coax fed was described in QST April 2000. The author was Bob Witmer W3RW. The antenna is three wavelengths long on ten metres and five wavelengths long on six metres.

The antenna is end fed a quarter wave from one end using two quarter wave sections made from ladder line and using a common long wire section.

The antenna is shown in fig 1. A dual matching section of 75 Ohm coaxial cable is used to convert the feed impedance to 50 Ohm on both bands. This is basically a quarter wave section on each band together with a number of half wave lines. A balun is made by coiling four feet of coax into a four turn coil adjacent to the feedpoint. This is a simple current balun. The antenna is made of a common long

section of 96 feet 6 inches long and a dual band quarter wave section made out of 450 Ohm ladder line.

The coaxial matching line and balun is made out of RG59 solid dielectric coaxial cable with a velocity factor of 0.66. The length of 29 feet provides a quarter wave matching section on both bands together

with a 2 wavelength line on 50.15 MHz or a 1 wavelength line on 28.35 MHz. The line acts as a matching line on both six and ten metres. Other types of coax can be used but watch the velocity factor and watch out for some foam types which dont like being coiled up or being suspended.

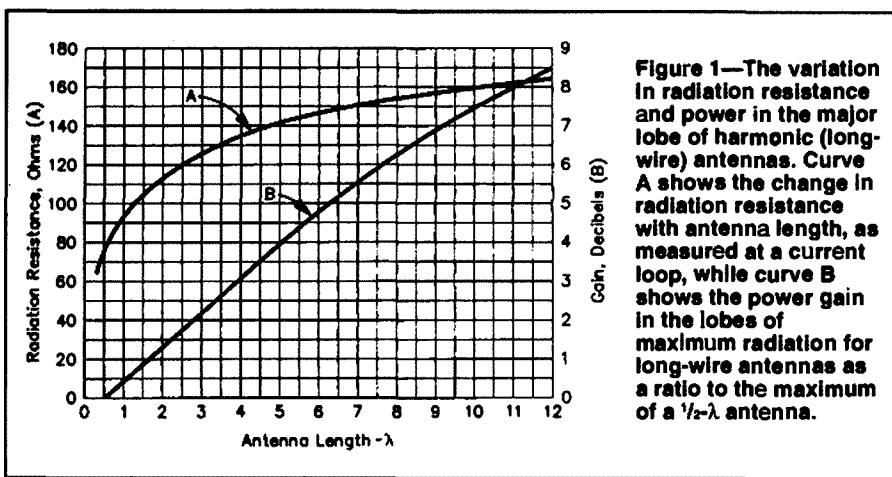


Figure 1—The variation in radiation resistance and power in the major lobe of harmonic (long-wire) antennas. Curve A shows the change in radiation resistance with antenna length, as measured at a current loop, while curve B shows the power gain in the lobes of maximum radiation for long-wire antennas as a ratio to the maximum of a $\frac{1}{2}\lambda$ antenna.

Fig 1. W3RW Dual Band Long Wire Antenna.

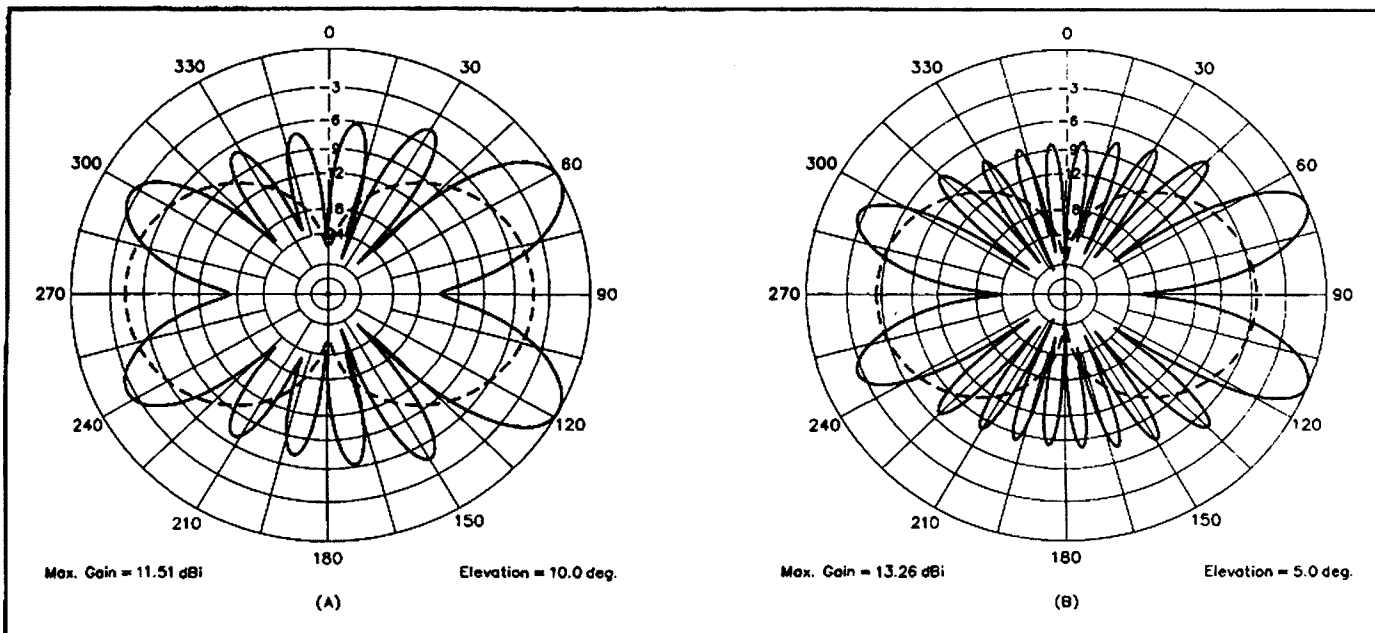


Figure 2—Predicted horizontal radiation patterns of a long-wire antenna as a function of length. At A, pattern of a 50-foot-high 3-λ long-wire antenna (solid lines) compared to that of a dipole (dashed lines). At B, pattern of a 50-foot-high 5-λ long-wire antenna (solid lines) compared to that of a dipole (dashed lines). *Tnx Dean Straw, N6BV*

Fig 2. Predicted Horizontal Radiation Patterns. (A) Pattern for 28.35 MHz. (B) Pattern for 50.15 MHz. Antenna is 50 ft high.

Homebrew ESD Mat

A simple homebrew ESD mat was described by Billy Van Remmen KA2WVJ in the Hints and Kinks column of Bob Schetgen KU7G in QST January 2000. The mat is used when working on static sensitive semiconductors and allows static charges to be drained away before they damage the semiconductors.

The mat is made from a piece of masonite. The masonite is then coated with a conductive solution made from Indian Ink and rubbing alcohol. The ink uses carbon as its pigment and is widely available. Bill used Rapidograph 3080-F ink but other brands would also be suitable. The ink used by Bill is waterproof when dry. He diluted the ink with two parts rubbing alcohol to one

part ink to thin it and to make it soak into the masonite more readily. The mixture was spread about the masonite with a piece of Scotchbrite or other non absorbing material until the entire surface had an even black coating. You should wear rubber gloves when doing this and protect the work surface and surrounds as the ink mixture will stain anything it touches.

When dry the board surface should measure between 100 kOhm and 1 MOhm between any two points on its surface.

The mat is grounded by drilling one corner and attaching a solder lug in contact with the surface using a machine screw and nut and metal washer. A wire is run to a good DC ground. You can also make provision for attaching a wrist strap but make sure it is one with a high resistance in series.

ar



Christine Taylor VK5CTY, ALARA Publicity Officer
16 Fairmont Avenue, Black Forest SA 5003
Packet VK5@VK5TTY Email: geensee@picknowl.com.au

ALARA Annual General Meeting(s)

This year due to problems with the timing of the auditor's statement, ALARA had two AGMs

Nevertheless there were just as many present the second week as there had been on the first occasion. Our AGM is always held on air and always attracts a large number of members. This year we had 17 members from almost every state in Australia. If we count the apology from VK1YL we could say we did have at least one YL from each state!!

This year we have a new President, Bev VK4NBC and the following executive committee members:

Vice President - Robyn VK3WX
Secretary - Margaret VK4AOE
Minute Secretary - Bron VK3DYF

Treasurer - Bev VK4NBC
Souvenir Custodian - Gwen VK3DYL
Publicity Officer - Christine VK5CTY
Editor - Dot VK2DB

Assisted by

Awards Custodian - Jean Shaw
Contest Manager - Marilyn VK3DMS
Sponsorship Secretary - June VK4SJ
Librarian - Kim VK3CYL
Historian - Tina VK5TMC
and our important State representatives

VK1/2 - Dot VK2DB
VK3 - Judy VK3AGC
VK4 - Margaret VK4AOE
VK5 - Jean VK5TSX
VK6 - Poppy VK6YF
VK7 - Helene VK7HD

As you can see there is one gap. We need a Junior Vice-President. If you would like to do something to help amateur radio and the YL amateurs in particular, please offer your services. With such a scattered membership it is not always possible to tell someone nearby that you are interested so they can nominate you so you may have to put yourself forward.

The position of Junior Vice-President does progress eventually to that of president but you will probably have six years to wait for that in which you will realise that there is little to fear at that prospect. From personal experience I can assure you the position of President of ALARA is a pleasurable one. You have the opportunity to meet some lovely people and to make many new friends.

ar



URUNGA RADIO CONVENTION APRIL 2000

The morning dawned clear and fine, that is the 21st of April Two Thousand and a signal was sent to the force above the E layer to let the next two days be fine and bright.

The message was received and answered with two perfect days for the 52nd Urunga Radio Convention, April 22-23rd. A good roll up registered for the two days and two VK3s. Brian VK3YNG and Adam VK3HDF, were also in attendance.

The first event a 7MHz mobile hunt was won by Geoff, 2BYY, followed by a 2 metre pedestrian hunt, won by Brian, 3YMG, second Adam 3HDF. After lunch a three TX hunt, mobile was won by Adam 3HDF, second Ken 2DGT. The final event, mobile talkin, was won by Rod 2URK second Chris 2YMW. Following dinner at the Ocean View Hotel Neil 2EI showed several tapes and talked about Hillarys push to the south pole and his time in Antarctica. He has indicated there will be more of this next year. A cake was produced to celebrate the

52nd Convention and the year 2000. It was cut by Brian and Adam, following the cutting of the cake supper was served.

Sunday was bright and fine, the 40 metre fun event went to Chris 2YMW, Urunga scramble, Johnathan, 2HJJ, the three TX, two metre mobile hunt, went to Adam 3HDF, second Ken 2DGT. After lunch the three TX pedestrian hunt, 2 metre, went to Paul 2KKT, second Brian 3YNG. Fun event talkin hunt, two foxes on two metres, won by Chris, 2YMW, second Dominic 2YGD.

Special events on 80 metres and 2 metres were run for the next generation of amateurs with the winners being, Saturday. Rebecca Lindsley, Sunday. Sara Piper, the juniors appeared to enjoy themselves and next year the events can be a little more sophisticated as they will be a year older and more experienced.

The overall winner for the two days was Adam 3HDF, and the winner of the Jack Gerard award, winner of 3 events, Adam 3HDF.

Raffles, contests and pick the spot, as well as other events, were contested and won, longest distance travelled, 3YNG and 3HDF. Oldest amateur, Bob, 2AWA.

The committee hopes that all who attended the Convention enjoyed the weekend and that they will be there for the 53rd Convention in 2001.

Best 73a from the Urunga Radio Convention Committee. Per B.Slarke, VK2ZCQ.



Brian VK3YNG and Adam VK3HDF with trophy and shield

Adelaide Hills Amateur Radio Society Notes

The talk given by Jerome van der Linden in May was less technical than usual but very interesting. Jerome's interest in radio is short wave listening rather than the operating type interest of amateurs. It is an interest he has held since childhood. He had some radios with him to show us. Those radios and some of the stations Jerome mentioned were very familiar to many of our members.

Jerome had many stories to tell but the one that made the most impression was his experiences in Riyadh immediately before

and at the beginning of the Gulf War.

Jerome actually shared his radio listening with the other Europeans in their compound. There were only a few programs on local radio in English but Jerome had access to the Radio Australia, the BBC and Voice of America through his SW radio. He set up the system to pipe the output from his radio into the compound loudspeakers so everyone could share it and to change frequency at particular times to obtain different stations and programs as propagation

changed. There is nothing like news from home to keep up the morale.

Jerome's on-the-spot description of the Rapier missiles going through the sound barrier as they sped on their way to destroy incoming rockets was very graphic. Few of us had realised that, of course, something like a Rapier must be travelling this fast to reach its target. Even after you knew what it was, the noise of several being sent off one after another was just as bad as the sound of bombs falling nearby.

News from the Moorabbin & District Radio Club

MDRC hamfest successful

This year's hamfest, held on May 13, was another success for the MDRC. More than 500 people were present at the event. Patrons and traders alike seemed well pleased with the day.

The door prizes were a hit, with a 2000 ARRL Handbook, giant squid pole and a year's MDRC membership being awarded to lucky attendees. The squid pole seemed to go on forever, as our president Lee VK3GK telescoped it out over the watching crowd.

Thanks go to Wally VK3JWH and numerous club volunteers for their work for making the MDRC hamfest Melbourne's best.

Missing treasure found

Some months ago, your club committee voted on us procuring a suitable club banner for use on such occasions as Hamfests, hobby shows, and field days.

Professional quotes for banners were around \$120. However, Bill VK3ATW reminded us recently that we already had a banner. It was specially made by Mary, the XYL of one time Club member, George Hoddinott, VK3AYI.

Whilst it had been an odd year or three, we decided to enquire what had happened to this wonderful Club relic. Well the good news is that the banner was found. It appears to be in remarkably good condition.

A full inspection of the lost treasure will be done this week, and we'll let you know of further developments on *APC News*. Not only will this be a valuable cost

saving for the Club, but, perhaps history can be revisited through the old MDRC banner once again flying high and proud.

APC News live on the web

APC News become even more accessible thanks to a live internet relay service that commenced on May 31. The new service, conducted by Tony VK3JED, allows people to hear the news live on their internet-equipped computers. Callbacks to the inaugural webcast were received as far away as Sydney. Though the news text had been available via the World Wide Web and direct e-mail subscription, this is the first time that listeners could tune in to the live transmission without possessing a VHF receiver. We expect that the internet service will be especially popular with newcomers to amateur radio and those living beyond the service area of our VHF transmissions.

To access the live audio, you need to be running Internet Explorer 4 or later, or Netscape 4.08 or later, running under Windows 95, 98, NT or 2000. Point your browser to <http://www.qsl.net/vk3jed/repeater.html>, and the audio software will start installing itself. It is a good idea to do this a little prior to the 8:00 pm news starting time so you don't miss the first part of the bulletin.

In other developments at *APC News*, a new six metre service has commenced for the benefit of listeners living in the Latrobe Valley. The relay is conducted by Graeme VK3GRL on the VK3RDD

repeater on 53.575 MHz. The VK3RDD repeater is sponsored by the Gippsland Gate Radio and Electronics Club. The MDRC thanks the GGREC for the use of VK3RDD for the news relay.

Readers can also receive *APC News* via free e-mail subscription. The news is sent each Thursday morning. Close to 70 people have now availed themselves of this increasingly popular service. Follow the links from the MDRC webpage (www.mdrc.org.au) for information on how to subscribe.

The main news transmission continues to be on 146.550 MHz at 8:00pm each Wednesday. We have been pleased at the steady increase in callback numbers over the last month. Those with contributions for the news (hint: Ham Sandwich ideas particularly welcome!) can e-mail Keith VK3JNB at keith@lcd.net.au or myself at the address given at the end of this item.

Don't forget the net

With the end of daylight saving, the MDRC's Monday night net now includes 80 metres as well as two metres. Tune to 146.550 MHz from 7:30pm and 3.567 MHz LSB (+/- QRM) after 8:00pm for the 80 metre net. Net control is our station officer Tony VK3CAT.

Peter Parker VK3YE, Publicity Officer, Moorabbin & District Radio Club parkerp@alphalink.com.au (03) 9569 6751

ar

Dayton Hamfest diary

The **Greatest** SHOW on Earth

73 Phil Miller VK2FHN

If you ever get the chance, you must go to the world's biggest Hamvention, The Dayton Hamvention and ARRL National Convention at Dayton OHIO U.S.A.

I was asked if I would like to go to Dayton, back in December 1999, with Gerry VK2APG, and of course said yes, with no hesitation, so flights and hotel accommodation were booked, just had to save up now.

The trip started out early at 5.30am on Tuesday 16 May, making sure that my case was packed, camera, film. Passport, airline tickets and money in pocket and of course my 2m.70cm hand held radio, which I left at home last time I left Australia. Gerry arrived about 7.30am, had coffee and a final check, then it's on our way to Sydney airport. After getting checked in seats organised and bags checked we were off to the airport Maccas for breakfast and walk around the duty free shops and relax. It was soon time to go through customs passport checked out okay but I always manage to set off the security scanners when walking through. Security have decided that I must have metal legs.

The 747 jumbo that we were flying on was only half full so we had plenty of room to stretch out with a full row of seats to ourselves. After fourteen hours, a different hemisphere and time zones we landed in Los Angeles International for a plane change. This was supposed to be a two hour change over, but managed to be a four hour delay, it seems that the Pilot for that particular flight had taken a sickie!! Finally we were airborne once again with a three hour flight and another time zone from LA to Chicago O'Hare Airport, which is on the edge of the great Lakes, near Lake Michigan, now that's some Airport, being the second largest and busiest in the world.

We managed another two hour delay and plane change then off to Dayton, this being a short flight of forty-five minutes

and yes another time zone. On arrival at Dayton we soon caught a taxi over to the Marriott Hotel at around midnight on the 16 May even though we had been travelling for nineteen hours.

After a good nights sleep and a hot shower it was downstairs for an all American breakfast which went down very well. The service at the hotel was first class.

Wednesday was spent at the National Air Force Museum, where we saw the first plane that was built by the Wright Brothers, the Kitty Hawk, plus WW1 And WW2 war planes and every plane ever built by the US Air Force, from B52 bombers to the Stealth fighter, there was also a MIG from the USSR plus Space Capsules. We also saw a couple of movies on the Imax Theatre in the museum which is all free admission apart from a small charge for the Imax. After a good day it was back to the hotel for Dinner and a beer or two.

Thursday was spent at a Historical village of Dayton's past history, this was within easy walking distance of the hotel. It included the first house built in Dayton, the school and many other buildings each with it's own guide that would give a short talk on the past history of the building. In the afternoon we walked into downtown Dayton.

The population of the City of Dayton is half a million, with at least half of them Black American.

It was back to the hotel to meet up with some of Gerry's friends that were travelling from out of town to Dayton for the Hamfest and were staying at the same hotel. These guys have a stall in the Hamvention flea market with the other three thousand six hundred and eleven outside stalls. Andy WB8HYO, Dave

KE8KT and Michael WIDRY, a great bunch of guys who were on the same floor in the hotel, along with many other Hams from the States, Brazil, Argentina and Australia. These guys also ran us to the Hara Arena Exhibition Centre and back for the next three days.

At last it was Friday the day Gerry and I had been waiting for since we arrived – the start of the Hamvention. It was an early breakfast, we needed to be at the exhibition centre to help the guys set up their flea market stall and get our tickets which were a three day pass. At 9am the doors to the 49th Dayton Hamvention opened and we were in the queue with some of the thirty thousand hams and visitors who for the next three days walked through the exhibitors and flea markets. Where do we start!

This really is a very big exhibition with six hundred and fifty-seven exhibitors all under cover in the arena and conference halls. All the major manufacturers of Radio, Yaesu, Icom, Kenwood, Alinco and franchisees from different US States displaying and selling the same products. All the commercial and small antenna builders, Cushcraft, Gap Antenna Products, Hy-Gain, Hustler etc, etc.

All the linear amplifier builders plus our very own Emtronics Pty Ltd from Sydney, MFJ Heil sound, Kentronics and Radio Shack just some of the suppliers of extra accessories related to the hobby. Kachina, Winradio, Timewave and other computer related products were in abundance. There were many organisations in attendance, ARRL, RSGB, G.QRP Club and 10-10 International, which myself and Gerry are members, plus the Ford Motor company, also lot's and lot's of software for the computer users.

J and W Software, QSL shop (make your own QSL card) lots of Login programs DX4Win, Writelog and satellite tracking of course. Amsat had a large booth in one of the halls. There were many new products and radios on display.

Over the next three days there were many forums covering Packet, QRP, Radio and the Law, Antenna technology, Dxing, Contesting and an ARRL forum of Meet the President.

Gerry and myself had been invited to the VHF weak signal group banquet on the Friday evening, more on that later. So a check in the Hamvention brochure, which is fifty-five pages, to see which forums to attend. We decided on antenna technology which was at 2.15, the speaker, well known Dxr John Devoldere ON4UN, and at 4.15 the forum was the 10-10 International Group, with President K4CIH, Tom Henderson the speaker.

Okay lets go Shopping! Before we come back for these.

A quick check of all the retailers booth's and pick up on some of the giveaways, Badges, lapel pins and small laminated maps with dealer names all over them. There were lots of Brochures on display, but these did not last too long, only for the first ten thousand through the booths, there was so much to see and look at over the next three days.

I lost count of the number of times we were stopped and asked "have you come all the way from Australia for the Hamvention", or "I know that call, I have spoken to you on the HF bands, I must admit some of these I remember some I didn't".

By this time it was getting round to the time for us to attend the first forum we wanted to go to, they had three large rooms set aside for these forums for the convention, ON4UN spoke on the subject, getting the most out of your vertical antenna, also HF ground radial techniques, this mainly on the low bands. Then Dr Steven Best VE9SRB spoke about wave reflections and impedance matching, this was very well presented, interesting and informative. Once this was over we headed off to find room 2 for the 10-10 forum. We were introduced to the room and members as being the furthest DX, needless to say this was also another well presented forum for those interested in the current and coming events of 10-10.

It was now time to be back in the flea market area to help the guys pack up their stall for the evening and travel back to the hotel, freshen up, a change of clothes for the VHF dinner.

The Holiday Inn Hotel was the venue for the VHF banquet that started about 6.30, in total there were one hundred and sixty five guests, at the start of the banquet each person would stand and give their callsign, name and grid locator. Once again Gerry and myself were deemed the best DX and were given a round of applause. We made many new friends and spoke at length with Dave Sumner K1ZZ of the ARRL and Tom Whitted WA8WZG who gave a talk at one of the forums on VHF/UHF Microwave on the Saturday. Both David and Tom were interested in what is happening with VHF 6m and HF in Australia.

The meal was very nice and was enjoyed by all, a prize draw was held with one hundred prize items ranging from 2m antennas and filters to callbooks. Toward the end of the evening there had been a great deal of Dxing done. Both Gerry and myself have been invited back to next year's hamvention dinner. Thanks to the VHF weak signal group.

Saturday was another early start 6.00am, down to breakfast then back in the van to the arena and help set up the stall for the day. Today was a little warmer so we decided to check the outside exhibitors, three thousand six hundred and eleven spaces are available most of them full. Row upon row of car boot sales Campervans, trucks and stalls some covered some not.

Everything on sale from hundred foot towers to PL259's. New and used equipment, computers, from complete systems or build your own. Badges with your callsign could be made, T-shirts printed or callsigns sewn onto baseball caps. Didn't think we would get around it all plus being stopped and spoken to.

We also had plans for another forum today and to meet up with some other VKs at about 3.30. The Amsat forum was to start at 12.15, which we attended and listened to speakers on the subjects of, getting started on Satellites and "Phase 3-D spacecraft and launch status". After the forum we were to meet at the CQ magazine booth with VK3EW David a well known Dxr from South Australia, VK1TX Tex who is often heard on

14.226.5 helping to run the Southern Cross DX net most evenings, Kerry VK4MZ and Graham VK2FA from Newcastle, we all spent the next half-hour talking about who and what we have seen and done. Had photo's taken with Dxr's from Brazil and the states and talking DX, needless to say another good day was had by all at the Hamfest.

On Saturday evening it was down to the Crown Plaza Hotel in downtown Dayton, the function was the Contest Super Dinner and Presentation, we were unable to attend the actual dinner as tickets had been sold out twelve months ago but we did attend the get together later in the evening, I must say that we felt like little pistols there with all the big guns, but we eyeballed with many of them and everyone was made welcome.

Sunday was soon upon us and the last day of the Hamfest, and our last day in Dayton and the states. Once more we started out early to the arena checking out the prices and picked up any last minute bargains. "Did manage to pick up some goodies", we had a leisurely walk round the outside exhibitors, it was a little cooler today so not such a big crowd. Most were waiting for the grand prize draw, "BIG PRIZES" everything from full station HF rigs FT1000MP, mobile rigs from Yaesu, Icom, and Kenwood to 18 element yagi's for 440MHz plus antenna rotators to hand held radios.

Midday arrived and the time for us to leave for the airport and the trip home, we called by the stall of Andy WB8HYO and the boys to say our good-bye's and thank them for all their help and hospitality, and hope to see them next year.

We made our way to the main entrance with our bags and our new purchases to find a taxi for the start our journey back to Australia. The flight from Dayton to Sydney is very long but comfortable. We arrived back at 6.30am Tuesday morning tired but had had a great time.

I would like to thank Gerry VK2APG for the excellent company and help with our vacation.

My XYL Catherine being left at home, the boys in the states who ran us about and looked after us both. Also to the Dayton Amateur Radio Association for an excellent Hamvention.

It is the Greatest Show On Earth!

ar

The Handlebar and the Halo

Gil Sones VK3AUI

Omni directional horizontally polarised aerials are not very well known. They are useful for mobile operation or for monitoring. They are available from a few antenna manufacturers but are not widely available locally.

A horizontally polarised antenna is desirable to work stations in the SSB part of two metres. Most stations there are looking for weak DX signals and horizontal is the preferred polarisation. Horizontal beams are fairly simple mechanically to support. The cross polarisation to strong commercial signals in neighbouring bands aids in reducing their influence on sensitive front ends.

An omni directional antenna may be difficult to obtain but they are fairly simple to make

An omni directional antenna may be difficult to obtain but they are fairly simple to make. Absolutely circular patterns are hard to provide but a pattern within a dB or so is achievable. Remember this is much less than an S point and minuscule compared to the null off the ends of a dipole or off the back of a Yagi.

While the turnstile is well known and the cloverleaf design is capable of good performance there are other designs which are simple to make and work well. Two of these are the Handlebar and the Halo.

Handlebar Antenna

The handlebar or U dipoles was reported via VK6HK and VK3KWA as being used for Community FM Broadcast antennas. The design is similar to the Rams Horn or U dipole used 40 years ago as an aeronautical antenna by the Collins company and described in the Antenna

Engineering Handbook by Henry Jasik 1st Ed 1961 published by McGraw Hill.

I built one using 3 mm galvanised steel fencing wire for the element. Even coat hanger wire would do. You must either bend the ends into loops or fit corks on them to provide eye protection. The wire bends easily into the U shape with each side about a sixth of a wavelength long. The wire is a half wave dipole length which is 960 mm for 2 metres. You are

bending a half wave dipole into a U shape. I attached the element to the support using wire rope clamps. These are a small U bolt and saddle assembly and work well. The antenna is shown in Fig 1.

For matching I resorted to the well known Gamma Match. This was built out of similar material with a movable short of shim copper soldered in position. This is quite easy to tack solder for adjustment and then can be soldered more securely. The Gamma capacitor was a small 30 pF air trimmer. The trimmer could be a plastic film, ceramic or compression mica type if desired. The trimmer was

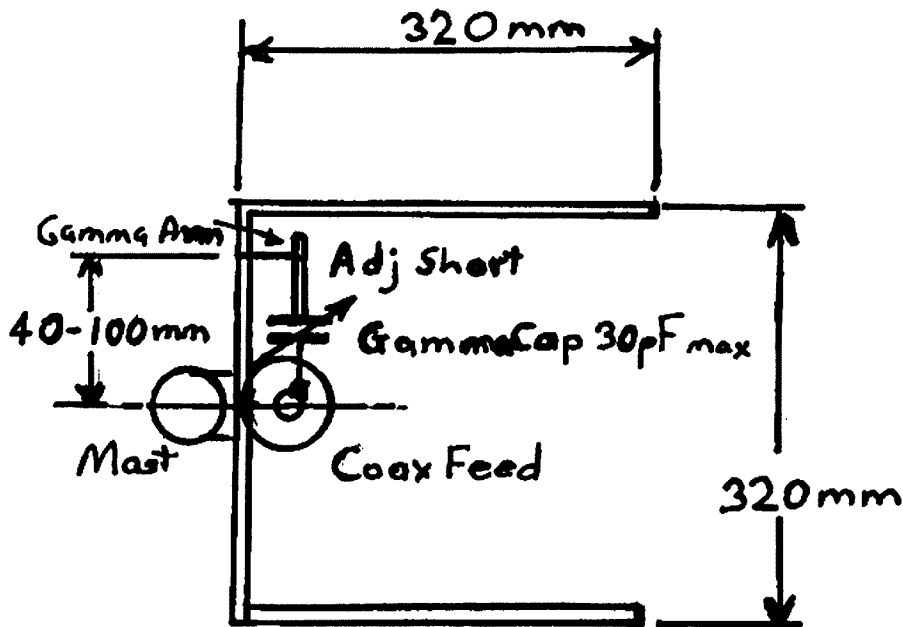


Fig 1. Handlebar Antenna.

protected by a diecast box which also mounted the coax connector. Adjust Gamma Match length and the trimmer to achieve the best SWR. Keep leads very short. If you use a plastic box make sure the earth return for the coax connector is very short and direct.

You can mount the antenna between 300 and 600 mm above the car roof on a short stub antenna mast. I mounted my antenna on a short stub mast attached to a ski bar.

Halo Antenna

The halo antenna is a simple omnidirectional horizontally polarised antenna. It is simply a dipole which has been bent into a circle. There are also some variants commercially available which instead of being circular are in square or triangular shapes. It has been described in many handbooks and designs appear in both RSGB and ARRL publications.

On the two metre band the antenna is approximately 300 mm in diameter. A six metre antenna would be larger but often these are end loaded by capacitance between the bent dipole ends to be of similar size to the two metre antenna. The loading in this case is fairly critical to adjust but for two metres is not usually required.

Matching is by a Gamma match which allows the SWR to be adjusted to a low ratio.

The antenna I built was made by bending some 5/16 th inch tubing into the

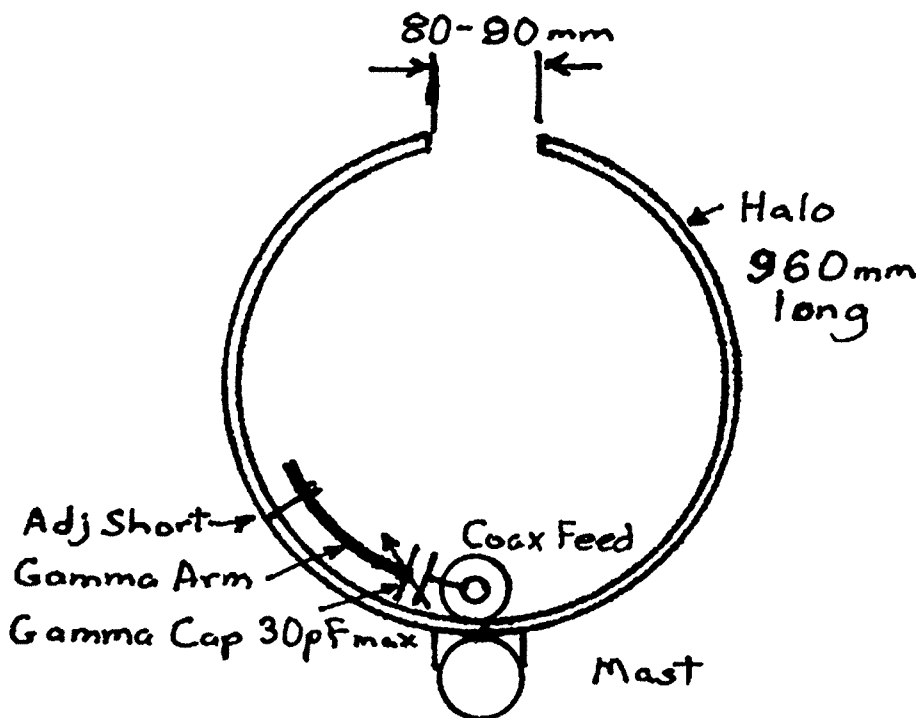


Fig 2. Halo Antenna

circular shape. The tubing was aluminium and was filled with sand during the bending process. The tubing could be 8 to 9 mm aluminium if you need to buy it. I used some scrap tubing. A scrap of pay TV hardline outer could be used if desired. The tubing was the dipole length of 960 mm long for two metres and a gap of 80 to 90 mm was left between the ends. If you make the ends too close together you may experience

capacity effects between the ends with resonance moving to lower frequencies. The antenna is shown in Fig 2.

Matching was by using a Gamma match. The gamma arm was also bent out of the same material and was positioned 25 - 30 mm from the halo. The movable short was a piece of aluminium clamped between the element and the Gamma arm. The Gamma arm should be 40 to 150 mm long to allow for adjustment. The series trimmer was a 30 pF air spaced variable. Just about any type of small trimmer can be used. The capacitor was mounted in a diecast box which also served as the antenna mounting point and a mounting for the coaxial connector. The element was attached using a wire rope clamp which consists of a U bolt and a galvanised saddle in a neat assembly. These are available in hardware shops.

In use you should mount the antenna on a short stub mast to keep the antenna between 300 and 600 mm clear of the vehicle roof. I mounted mine on a short stub mast attached to a ski bar. It would be nice to mount it higher but then overhanging branches could be a problem.

This article originally appeared in a slightly different form in WICEN NEWS the WICEN (Vic.) Inc. News Bulletin August 1999.

Errata

A number of errors crept into the article on *A Wire Log Periodic Dipole Array* by Robert Hancock VK5AFZ. We apologise for this. Please correct you June copy of AR on pages 16 and 17 as set out below. Editor

page 16 title line 2 : author's call sign was omitted. VK5AFZ

column 1 line 9 : "rotation" changed to "rotational"

line 19 : degree symbol replaced by infinity symbol

column 2 line 1 : "produce" omitted before "good coverage"

line 3 : "on" omitted before "long path"

line 12 : "frequency" added before "limit"

line 19 : "the" substituted for "a" before "range"

column 3 line 9 : "this" substituted for "and" before "is constrained"

page 17 column 1 line 5 : degree symbol replaced by infinity symbol

line 6 : ditto

line 9 : decimal point in "0.7" replaced by diamond symbol

line 10 : "on the wires" added before "on the element wires"

line 12 : "300W" instead of "300 Ohm"

line 13 : decimal point in "4.7" replaced by diamond symbol

column 2 line 3 : "50W" instead of "50 Ohm"

line 7 : "propylene" instead of "polypropylene"

line 11 : "hols" instead of "a hole"

ed.

ar

Walking 'On Air' from Sydney

PART ONE

Strange as it may seem, I have never been interested in the popular UK cross-country walks, such as Offa's Dyke, The Pennine Way, etc., even though I have walked the daily 6 mile (~10km) round trip to work for many years. On the few occasions that I have tried longer distances, success has been somewhat patchy, so I am still uncertain as to why I decided to attempt, during our summer of 1995, what is considered to be the ultimate walk in UK.

THIS IS LAND'S END to John O'Groats, the most south-westerly point in England to (almost) the most northerly point in mainland Scotland. Since I am no camper, nor was I able to persuade anybody to provide backup, it meant that I would be completely on my own and would need accommodation at the end of each day's walk. I reckoned I could manage a maximum of about 25 miles (40km) a day, with an average approaching 20 (32km), so, after many hours consulting maps and hotel guides, I produced a viable, all-road route of some 900 miles (1450km). Of course, a very important part of the "holiday" would be to take a radio, so that I could work through the extensive 2m and 70cm UK repeater networks on the way. That trip, as they say, is another story, and I did traverse the country from one end to the other in 43 days, but I only actually walked about three quarters of it. This was due to badly blistered feet in the first few days, which meant that I had to cover some sections by bus and train. However, I learnt many valuable lessons, and so the following year (1996), I went back and successfully completed the outstanding 250 miles (400km), then went on to walk the length of Ireland, Malin Head to Mizen Head, a distance of some 400 miles (640km). Looking to continue the "strolls" and having always

Anyway, hadn't Steve promised that it wouldn't rain until September, and that every day would be wall-to-wall sunshine

provided details of hotels and motels. I was pleasantly surprised at the frequency of motels and, consequently, was able to plan a route which left only three "gaps", sections where the distance between accommodation was greater than a maximum day's walk. If I were to maintain my "ego-trip" ambition of

promised myself a visit down-under, Australia initially looked far too big walking-wise, whereas New Zealand was split into two convenient islands of ~600 and ~700 miles (~1000 and ~1150kms). So, during the ZL winters of 1997 and 1998 I walked from Bluff to Picton, then Wellington to Cape Reinga, in 35 and 40 days respectively, meeting and/or contacting over 200 amateurs on the way, many through the wonderful ZL National System [1] [2]. The question then was, "Where could I go in 1999?", and, since I was planning a visit to Steve, VK4ASG, at Griffith University, what was the possibility of a little walk in Oz, say Sydney to Brisbane?

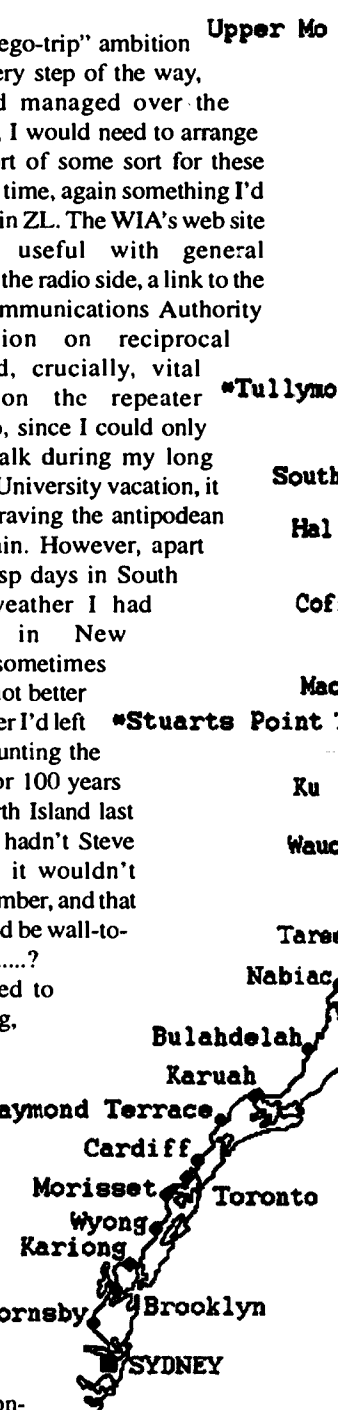
Planning and Equipment

Over the previous years, I'd averaged about 17.5 miles a day (28km), and a total trip distance of some 600+ miles (~1000km). Sydney to Brisbane, via the Pacific Highway, is 600 miles, or a little under 1000kms, the right distance, but was there the accommodation? A local bookshop provided a road atlas, some maps and the Australian Bed and Breakfast Book, whilst the Internet

provided details of hotels and motels. I was pleasantly surprised at the frequency of motels and, consequently, was able to plan a route which left only three "gaps", sections where the distance between accommodation was greater than a maximum day's walk. If I were to maintain my "ego-trip" ambition of

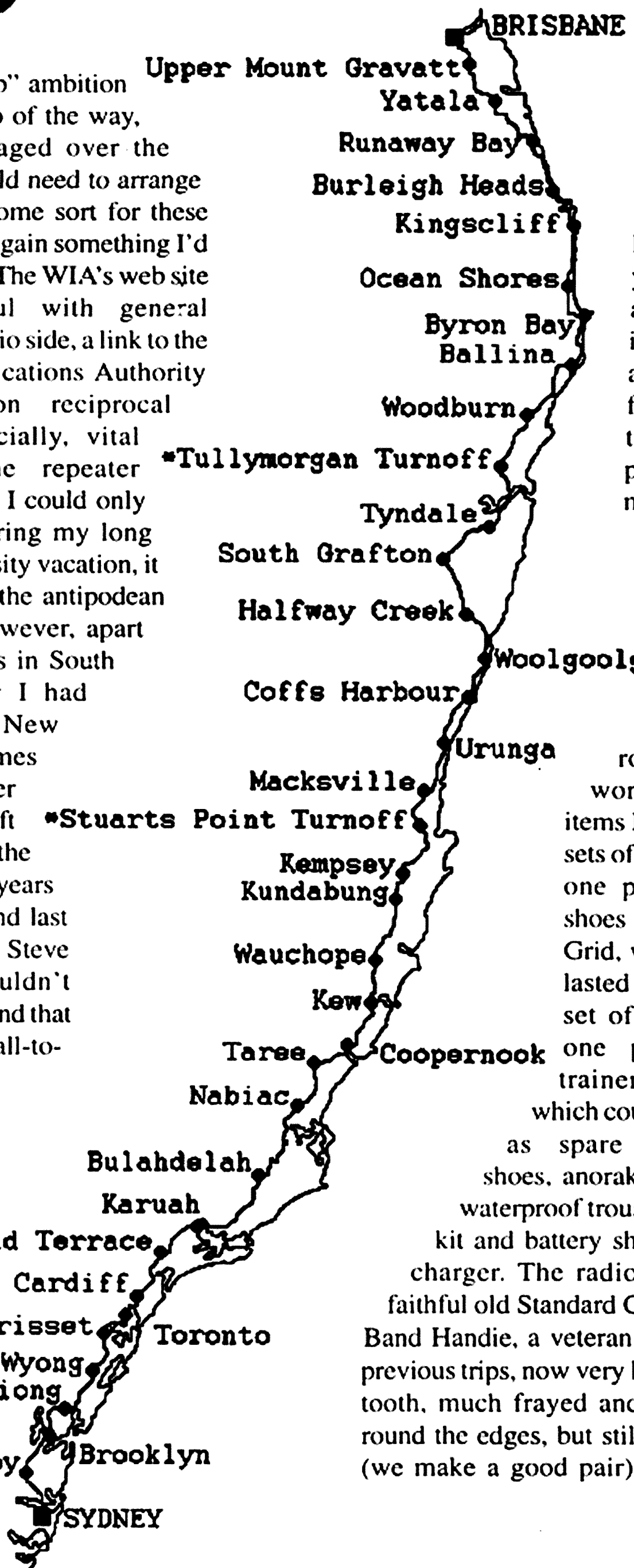
maintain my "ego-trip" ambition of walking every step of the way, something I'd managed over the previous years, I would need to arrange shuttle transport of some sort for these gaps nearer the time, again something I'd managed to do in ZL. The WIA's web site proved very useful with general information on the radio side, a link to the Australian Communications Authority for information on reciprocal licensing, and, crucially, vital information on the repeater networks. Also, since I could only attempt the walk during my long (UK) summer University vacation, it would mean braving the antipodean winter yet again. However, apart from some crisp days in South Island, the weather I had encountered in New Zealand was sometimes as good as, if not better than, the weather I'd left behind, not counting the worst floods for 100 years in parts of North Island last year. Anyway, hadn't Steve promised that it wouldn't rain until September, and that every day would be wall-to-wall sunshine

Being obliged to carry everything, I had, from the first walk, limited myself to a relatively small 45 litre backpack, on the principle of "If it doesn't go in, it doesn't go". Even so, with on-the-road food and drink, the pack could weigh some 35lbs (15kgm), which is probably only what the SAS carry in their sidepockets, but is



ny "ego-trip" ambition
 every step of the way,
 I'd managed over the
 years, I would need to arrange
 transport of some sort for these
 the time, again something I'd
 do in ZL. The WIA's web site
 very useful with general
 on the radio side, a link to the
 Communications Authority
 mation on reciprocal
 and, crucially, vital
 on on the repeater
 Also, since I could only
 e walk during my long
 ner University vacation, it
 an braving the antipodean
 again. However, apart
 e crisp days in South
 e weather I had
 ed in New
 was sometimes
 if not better
 eather I'd left
 t counting the
 ds for 100 years
 North Island last
 way, hadn't Steve
 that it wouldn't
 eptember, and that
 would be wall-to-
 ine?
 bliged to
 ything,
 n the
 k,
 d Raymond Terrace
 a
 ly
 litre
 on
 ble
 it
 o Hornsby
 t
 go".
 with on-

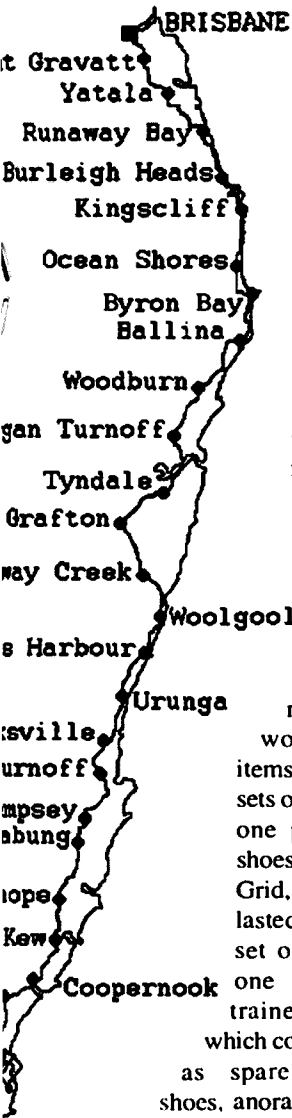
- Upper Mount Gravatt
- Yatala
- Runaway Bay
- Burleigh Heads
- Kingscliff
- Ocean Shores
- Byron Bay
- Ballina
- Woodburn
- *Tullymorgan Turnoff
- Tyndale
- South Grafton
- Halfway Creek
- Woolgoolga
- Coffs Harbour
- Urunga
- Macksville
- *Stuarts Point Turnoff
- Kempsey
- Kundabung
- Wauchope
- Keweenaw
- Taree
- Coopernook
- Nabiac
- Bulahdelah
- Karuah
- Raymond Terrace
- Cardiff
- Morisset
- Toronto
- Wyong
- Kariong
- Hornsby
- Brooklyn
- SYDNEY



cert
 for
 nor
 s p
 How
 had
 year
 appa
 in an
 accli
 feet
 the b
 past,
 mont
 leav
 fill
 w
 my
 roun
 work.
 items I too
 sets of wal
 one pair
 shoes (Sat
 Grid, whic
 lasted the
 set of hou
 one pair
 trainers (
 which could
 as spare wa
 shoes, anorak, pe
 waterproof trousers,
 kit and battery shaver
 charger. The radio wa
 faithful old Standard C528
 Band Handie, a veteran of
 previous trips, now very long
 tooth, much frayed and ba
 round the edges, but still wo
 (we make a good pair), to

ney to Brisbane

Tony Whitaker takes a 1000km Winter's Stroll



certainly enough for this unfit, non-athletic specimen. However, as I had done last year with some apparent success, in an attempt to acclimatise the feet and reduce the blisters of the past, for the two months prior to leaving, I had filled the pack with a 30 litre bag of

with its charger, spare battery packs, speaker-mike and earpieces. It uses battery trays containing 6 AA-sized NiMH cells (so I could use ordinary dry cells if necessary), and I have modified it to fast charge in situ, allowing a complete recharge overnight. The aerial was a 1m long Alinco dual band mobile whip, mounted on a 19" length of aluminium angle (a quarter wavelength at 2m), which slips into the pack sidepocket, fed by 52" of RG58U (three wavelengths at 70cm). As insurance, I took along a tiny Yaesu VX-1R, with aerial lead adapter and speaker mic, which meant I could also listen to the MW and FM broadcast bands.

The Start

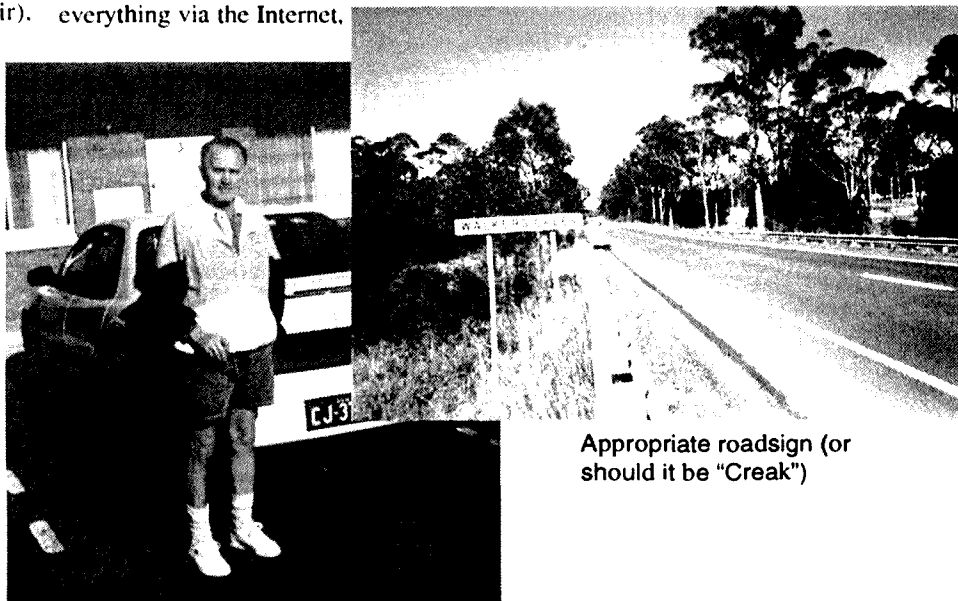
I left Manchester Airport early in the morning of the 30th of June 1999, on quite a reasonable summer's day (though not in the south for the tennis at Wimbledon!), arriving at Sydney during the evening of the 1st of July in weather that the pilot described as "a bit wild". Fortunately, it had cleared up nicely next morning, as I walked through down-town Sydney to the ACA office in Clarence Street to pick up my reciprocal licence. I'd managed to arrange everything via the Internet,

even to the extent of obtaining the appropriate, if somewhat ambitious, callsign of VK2 Sydney To Brisbane. Unfortunately, although now fully certified, I didn't make any contacts during the rest of the day as I looked round the Bridge and the Opera House, since the VX-1 suffered almost terminal front-end overload from out-of-band commercial signals. The C528 faired no better the next day, as I crossed the SHB and headed for Hornsby through the northern suburbs, but the interference eased as the day progressed and I had my first contact in VK with Angus, VK2YCV, through the Blue Mountain repeater. There then followed several more contacts through the local Homsby and North Ryde repeaters, culminating in a meeting with VK2KGM as I arrived at Hornsby. Murray, together with XYL Janne, had driven over specially to video an interview with me for his ATV station, after which we enjoyed a long chat over a Chinese meal. Day 2 saw me in open countryside for the first time, and the

continued on page 46

which could double as spare walking shoes, anorak, poncho, waterproof trousers, wash kit and battery shaver with charger. The radio was my faithful old Standard C528 Dual Band Handie, a veteran of all the previous trips, now very long in the tooth, much frayed and battered round the edges, but still working (we make a good pair), together

Colin, VK2AF, with whom I was in almost daily contact for nearly half the trip



Appropriate roadsign (or should it be "Creak")



Division Directory

The Amateur Radio Service exists for the purpose of self training, intercommunication and technical investigation. It is carried out by amateurs who are duly authorised people interested in radio technique solely with a personal aim and without pecuniary interest.

The Wireless Institute of Australia represents the interests of all radio amateurs throughout Australia. National representation is handled by the executive office under council direction. One councillor for each of the seven Divisions. This directory lists all the Divisional offices, broadcasts schedules and subscription rates. All enquiries should be directed to your local Division.

Broadcast schedules All frequencies MHz. All times are local.

VK1 Division Australian Capital Territory,
GPO Box 600, Canberra ACT 2601
President Gilbert Hughes
Secretary Peter Kloppenburg
Treasurer Edwin Alcott

VK1GH
VK1CPK
VK1NBH

VK2 Division News South Wales
109 Wigram St, Parramatta NSW
(PO Box 1066, Parramatta 2124)
(Office hours Mon-Fri 1100-1400)
Phone 02 9689 2417
Web: <http://www.ozemail.com.au/~vk2wi>
Freecall 1800 817 644

e-mail: vk2wi@ozemail.com.au
Fax 02 9633 1525
President Michael Corbin
Secretary Barry White
Treasurer Pat Leeper

VK2YC
VK2AAB
VK2JPA

VK3 Division Victoria
40G Victory Boulevard Ashburton VIC 3147
(Office hours Tue & Thur 0930-1500)
Phone 03 9885 9261
Web: <http://www.tbsa.com.au/~wivac/>
Fax 03 9885 9298

e-mail: wivac@alphalink.com.au
President Jim Linton
CEO Barry Wilton
Secretary Peter Mill

VK3PC
VK3XV
VK3APO

VK4 Division Queensland
GPO Box 638 Brisbane QLD 4001
Phone 07 3221 9377
e-mail: office@wiaq.powerup.com.au
Fax 07 3266 4929
Web: <http://www.wia.org.au/vk4>

President Colin Gladstone
Secretary David Jones
Treasurer Bill McDermott
Office Mgr John Stevens

VK4ACG
VK4OF
VK4AZM
VK4AFS

VK5 Division South Australia and Northern Territory
(GPO Box 1234 Adelaide SA 5001)
Phone 08 8294 2992

web: <http://www.sant.wia.org.au>
President Jim McLachlan
Secretary David Minchin
Treasurer John Butler

VK5NB
VK5KK
VK5NX

VK6 Division Western Australia
PO Box 10 West Perth WA 6872
Phone 08 9351 8873
Web: <http://www.omen.net.au/~vk6wia/>
e-mail: vk6wia@omen.net.au

President Neil Penfold
Secretary Christine Bastin
Treasurer Bruce Hedland-Thomas

VK6NE
VK6ZLZ
VK6OO

VK7 Division Tasmania
PO Box 371 Hobart TAS 7001
Phone 03 6233 3709 (BH)
Web: <http://www.wia.tasnet.net>
email: batesjw@netspace.net.au
Fax 03 6223 7816

President Phil Corby
Secretary John Bates
Treasurer John Bates

VK7ZAX
VK7RT
VK7RT

VK1WI: 3.590 LSB, 146.950 FM each Sunday evening from 8.00pm local time. The broadcast text is available on packet, on Internet aus.radio.amateur.misc news group, and on the VK1 Home Page <http://www.vk1.wia.ampr.org>

Annual Membership Fees. Full \$77.00 Pensioner or student \$63.00. Without *Amateur Radio* \$49.00

From VK2WI 1.845, 3.595, 7.146*, 10.125, 14.160, 24.950, 28.320, 29.120, 52.120, 52.525, 144.150, 147.000, 438.525, 1281.750 (* morning only) with relays to some of 18.120, 21.170, 584.750 ATV sound. Many country regions relay on 2 m or 70 cm repeaters. Sunday at 1000 and 1930. Highlights included in VK2AWX Newcastle news, Monday 1930 on 3.593 plus 10 m, 2 m, 70 cm, 23 cm. The broadcast text is available on the Internet newsgroup aus.radio.amateur.misc, and on packet radio.

Annual Membership Fees. Full \$78.00 Pensioner or student \$61.00. Without *Amateur Radio* \$47.00

VK3BWI broadcasts on the 1st and 3rd Sunday of the month at 8.00pm. Primary frequencies, 3.615 LSB, 7.085 LSB, and FM(R)s VK3RML 146.700, VK3RMM 147.250, VK3RWG 147.225, and 70 cm FM(R)s VK3ROU 438.225, and VK3RMU 438.075. Major news under call VK3ZWI on Victorian packet BBS and WIA VIC Web Site.

Annual Membership Fees. Full \$78.00 Pensioner or student \$61.00. Without *Amateur Radio* \$47.00

VK4WIA broadcasts on 1.825 MHz SSB, 3.605 MHz SSB, 7.118 MHz SSB, 10.135 MHz SSB, 14.342 MHz SSB, 21.175 MHz SSB, 28.400 MHz SSB, 29.660 MHz FM (rpr), 147.000 MHz, and 438.525 MHz (in the Brisbane region, and on regional VHF/UHF repeaters) at 0900 hrs K every Sunday morning. QNEWS is repeated Monday evenings, at 19.30 hrs K, on 3.605 MHz SSB and 147.000 MHz FM. On Sunday evenings, at 18.45 hrs K on 3.605SSB and 147.000 FM, a repeat of the previous week's edition of QNEWS is broadcast. Broadcast news in text form on packet is available under WIAQ@VKNET. QNEWS Text and real audio files available from the web site

Annual Membership Fees. Full \$85.00 Pensioner or student \$72.00. Without *Amateur Radio* \$56.00

VK5WI: 1827 kHz AM, 3.550 MHz LSB, 7.095 AM, 14.175 USB, 28.470 USB, 53.100 FM, 147.000 FM Adelaide, 146.700 FM Mid North, 146.800 FM Mildura, 146.825 FM Barossa Valley, 146.900 FM South East, 146.925 FM Central North, 147.825 FM Gawler, 438.425 FM Barossa Valley, 438.475 FM Adelaide North, ATV Ch 35 579.250 Adelaide. (NT) 3.555 USB, 7.065 USB, 10.125 USB, 146.700 FM, 0900 hrs Sunday. 3.585 MHz and 146.675 MHz FM Adelaide, 1930 hrs Monday.

Annual Membership Fees. Full \$77.00 Pensioner or student \$63.00. Without *Amateur Radio* \$49.00

VK6WIA: 146.700 FM(R) Perth at 0930hrs Sunday relayed on 1.865, 3.564, 7.075, 10.125, 14.116, 14.175, 21.185, 29.120 FM, 50.150 and 438.525 MHz, Country relays 3.582, 147.200 (R) Cataby, 147.350 (R) Busselton, 146.900 (R) Mt William (Bunbury), 147.000 (R) Katanning and 147.250 (R) Mt Saddleback. Broadcast repeated on 146.700 at 1900 hrs Sunday relayed on 1.865, 3.564 and 438.525 MHz : country relays on 146.900, 147.000, 147.200, 147.250 and 147.350 MHz. Also in "Real Audio" format from the VK6 WIA website

Annual Membership Fees. Full \$69.00 Pensioner or student \$59.00. Without *Amateur Radio* \$38.00

VK7WI: 146.700 MHz FM (VK7RHT) at 0930 hrs Sunday relayed on 147.000 (VK7RAA), 146.725 (VK7RNE), 146.625 (VK7RMD), 3.570, 7.090, 14.130, 52.100, 144.150 (Hobart), repeated Tues 3.590 at 1930 hrs.

Annual Membership Fees. Full \$88.00 Pensioner or student \$75.00. Without *Amateur Radio* \$55.00

VK8 Northern Territory (part of the VK5 Division and relays broadcasts from VK5 as shown, received on 14 or 28 MHz).



Divisional News

VK2 Notes

by Pat Leeper VK2JPA
patleep@bigpond.com

The May Affiliated Clubs Conference was well attended, with 26 clubs and all Councillors. The guest speaker for the afternoon, after business had been concluded, was Robert Bates the VK2 auditor, who spoke on the GST and gave advice on whether clubs had to apply for an ABN or even charge for the GST.

Robert answered numerous questions and made clubs' positions much clearer. The upshot was that the GST will not affect the smaller clubs and so will not have to be included in members' fees.

Robert did have one question of his own. Spying an empty pair of seats bearing the name tag of Fishers Ghost, he wanted to know if we had ghosts as delegates. Alas, they had only had to go home early, but it raised a chuckle.

Chris Dingle had been accepted as a member the night before at the VK2 Council meeting and was standing in for another delegate who had had to withdraw at the last minute. It was pleasing to see Chris taking an active part in club activities right from the start of his amateur life. Chris also did his exams with the Institute earlier this year, passing his final Morse exam not long before the conference.

To bring you up to date with the new VK2 Division Council, here are the

Councillors and the positions they now hold.

Michael Corbin VK2YC: President, Federal Councillor, Deceased Estates; Brian Keegan VK2TOX: Senior Vice President, Trash & Treasure; Terry Davies VK2KDK: Junior Vice President, Assistant NTAC; Barry White VK2AAB: Secretary, Membership Secretary, Parramatta Property, Administration, BBS Sysop; Pat Leeper VK2JPA Treasurer, Publicity, VK2 Notes, Office Manager; Brian Kelly: NTAC; Geoff McGrorey-Clark VK2EO: Olympics. QSL Buro; Ken Westerman VK2AGW: Affiliated Clubs Officer; Chris Minahan VK2EJ: Education' Dural Officer, Broadcast Roster Officer.

Don't forget — if you have any queries or gripes about the way your Division is being run — Let us know! Ring, fax or email the Division as per the Divisional page in AR. Country members can use the free call line.

That's all for this month from the VK2 Division.



During the conference Michael Corbin VK2YC, Divisional President, took the opportunity to present a very new member, Chris Dingle VK2TOX, with his membership certificate.



Some of the delegates at the morning tea break

VK3 Notes

Website: www.tbasa.com.au/~wiavic
Email: wiavic@alphalink.com.au
By Jim Linton VK3PC

WIA Victoria 90 Award

To mark the 90th birthday of WIA Victoria, members are encouraged to join in the celebration and qualify for a special award through personal achievements.

The rules:

Section 1

Mandatory achievements

- a) Participate in and submit an entry to the Remembrance Day Contest 2000

- b) Make contact with nine other WIA Victoria members (not during a contest), and submitting a list of such contacts with your award claim.

Note: A contact with a WIA Victoria Life Member is worth two members.

Section 2

Optional achievements

- c) Submit a log in the VK/ZL/O Contest
- d) Contact a declared WIA Victoria

special event station

- e) Recruit a new member for WIA Victoria
- f) Perform a voluntary membership service delivery role
- g) Have an article or news story published by either AR magazine or VK3BWI broadcast
- h) Publicise WIA Victoria membership

Continued on page 32

through your QSL card (supply sample)

- i) Encourage an individual to study for their amateur licence
- j) Observe and submit an Intruder Watch log entry of at least one intruder

To qualify you must achieve all of the requirements in Section 1, and at least one of the optional achievements listed in Section 2.

Entries for the WIA Victoria 90 Award close on 30 June 2001. There is no charge.

New Council appointments

It was announced at the WIA Victoria Annual General Meeting that the Council had co-opted two members to join it - Brenda Edmonds VK3KT, and Gary Furr VK3KKJ.

At its first meeting the Council resolved the officerbearer positions and portfolios as follows:

President - Jim Linton VK3PC
Vice-President - Bill Trigg VK3JTW
Secretary - Peter Mill VK3APO
Treasurer - Barry Wilton VK3XV
Internet Project Officer - Gary Furr VK3KKJ

The Council also confirmed that the WIA Victoria office hours will be 10am to 2pm on Tuesdays and Thursdays, effective immediately.

The Administrative Officer, John Brown VK3NYE, Brenda Edmonds VK3KT, Peter McCallum VK3FIM, and Rob Carmichael VK3DTR (emergency) will provide the voluntary staffing needs of the office.

Consistently the newsbreaker

There's a saying - "you're damned if you do, and you're damned if you don't" and this applies to the provision of a news service for the amateur radio fraternity. During the past six months WIA Victoria has repeatedly led the way with its news and information to radio amateurs. It has not one, but seven current news services:

- News Online - a popular comprehensive and authoritative news bulletin
- "Morse code watch" - a record of the global trend of adopting 5wpm Morse code amateur licence test speeds ahead of the expected removal of the requirement in 2003

- Members News - available to WIA Victoria members - an application form to join this new membership service will be inserted in the August edition of AR magazine
- IARU RIII Conference - background and reports on this most important event
- VK3 Notes in Amateur Radio magazine
- Twice-monthly VK3BWI broadcast
- Packet News and Info bulletins through VK3ZWI
- News Online and Morse code watch are regularly quoted by overseas ham news services, and is regularly read by local and overseas radio amateurs.
- Because it is the world's authoritative source, print-outs of Morse code watch articles have been handed out at meetings of European radio amateurs where votes have been taken in support of adopting the 5wpm standard.

The IARU RIII Conference webpage gives all radio amateurs an opportunity to see the details of the discussions to take place involving the more than 100 delegates who will attend this WIA hosted event.

Now returning to the opening phrase about being damned - WIA Victoria has received some unreasonable criticism that "all news" should be for "all radio amateurs" - there are no prizes for those who guess the answer!

However, responding to the needs of its members, WIA Victoria is among the first to provide a member's section that includes news for members only.

This will enable the elected council using current technology to more efficiently communicate with the membership.

It is suspected those grumbling about the members section are themselves non-members who are unhappy that this is yet another membership service they can't use for free.

WIA Victoria will continue to strive to provide better services for its members, and keep all radio amateurs better informed through its unparalleled news services.

IARU RIII Conference

This important regional meeting of radio societies happens once every three years. WIA Victoria asks its members to consider the "global" issues affecting our hobby, which are on the agenda for the conference.

The WIA has been extremely busy for the past three months, and enormous personal efforts are being by individual officebearers to make sure the conference is a success.

An IARU RIII webpage www.tbsa.com.au/~wiavic/iaru has been created and it contains details of the conference and extracts of the WIA Input Papers - makes interesting reading.

The webpage will be progressively updated as we head towards the conference, which all WIA members through a levy on their membership subscriptions are helping to fund.

RD Contest 2000

The extremely disappointing unsuccessful bid to win the Remembrance Day Contest last year has led a number of members to re-think our strategy for this year.

The contest supervisors tell us that while we made the best improvement of any Division, the rules that were put in place to break VK3's string of wins, had their effect yet again.

While we boosted our VHF participation, the HF side let us down. Stay tuned to the VK3BWI broadcast and the WIA Victoria website - a renewed campaign for VK3 to win the RD contest has begun.

WICEN(Vic)

As editor of the WICEN (Vic.) Inc. newsletter I have a calendar of events column. Due to confused information, the date of the Rally of Melbourne, a car rally event in which WICEN plays a major role in safety communications, was wrongly printed in our May newsletter.

WICEN (Vic.) Inc. Event Calendar.

Please note that the date for the Rally of Melbourne is the 26 and 27 August 2000 and NOT 12 / 13 August as published in the WICEN (Vic.) Inc. May newsletter.

David VK3XDA, editor, WICEN (Vic.) Inc. May newsletter.

VK4 Notes Qnews

By Alistair Elrick VK4MV

Are your details correct?

On the Qnews broadcast recently it was asked that all South East Queensland Clubs check the entry on both the WIAQ Web Site and the National Packet Teletext System for correct listing of their Club details. It might well be passed to all Clubs Australia wide to do likewise, on the appropriate site for your Division. If we are to attract members and interest, the more accurate the details are, the more 'professional' we Amateurs look.

Meeting days, venues, Club contacts, Callsigns, Club nets & times and any other details that you feel should be on the listing. Keep them up to date and accurate and never miss an opportunity to put your Club forward to both the Amateur fraternity and the general public.

Computer QRM traced to 6 metres

The 6 metre band at the QTH of Doug, VK4ADC was plagued by a constant S1 to S7 carrier (depending on beam heading), radiated on 50.1104 MHz thus obliterating weak signals on the SSB calling frequency. The source was traced using a receiver firstly on 50.110 and then on the 3rd harmonic (150.330) to a house about 160 metres east of the QTH.

The users were in the practice of leaving their computer system on 24 hours a day, so there was no respite except when beaming north so as to null the interference. The problem was tracked to the video clock on an ASUS TX98 integrated motherboard, set to 50MHz in the BIOS setup. After some lengthy negotiations to gain access to the system, changing this setting to 55MHz moved the interference away from '110 and resolved the QRM. One to note in the memory for future reference. Good job of detecting Doug.

The absolutely fabulous radio fun weekend on the Tablelands

The weekend was great, good weather, good friends, and lots of radio fun. On Saturday members of the Tableland Radio and Electronics Club converged on Platypus Park on the outskirts of Atherton. There they were given written instructions, vehicle numbers, section sheets and then left at three minute

intervals to wind their way through the backblocks of the Atherton Tablelands.

The clues that entrants had to find were many and varied and included, platypus, a kookaburra, farm names, public phonebox number, cattlecamps, the "Mice of Morsbey, plus 2 metre check-ins for "Check Point Alpha" ably manned by the wily fox, VK4WL Bill. Once in Mareeba entrants then had to find the fox by listening to clues transmitted on channel 20.

First one to find the fox was Ray, VK4TFT. Overall first place went to Keith VK4BKS and XYL Barbara. The wooden spoon went to Speedy Gonzales - John VK4DJS and his new Calais swiftly manoeuvred by his XYL, Narelle. There was \$500.00 worth of prizes given away and everyone went away with lots of good memories plus a prize. After an enjoyable BBQ and pleasant night, members of the club crossed "live" to Q-News on Sunday Morning.

Next year they'll stage a similar event with even harder clues and more radio work. Sounds like a great event for more Clubs to organise for their members.

And with Club outings being mentioned, after the June social outing to the 'My Fair Lady', Townsville Amateur Radio Club is organising a trip to the Choral Society Theatre Restaurant on 26th of August, bookings by August 4th. Knowing the way the TARC Inc. runs things and the members enjoy themselves, that will be one not to miss if you are in the area. As well during July, there will be the communications support for the Strand Mini-Swim event; don't those people up there know it's winter?

The new 70cm voice repeater in SouthEast Queensland is up and running on 438.475 MHz. It is primarily designated for WICEN, but it is free for use when not active for WICEN business. A 91.5 Hz CTCSS sub-audible tone is required and there is a 60-second time out. Location is the VK4RZC site at Maleny, with 100W fed into a binary array antenna up at about 50 feet on the NorthEastern corner of the tower.

That's it for this month, 73's from Alistair VK4MV.

VK7 Notes

VK7 Division Executive 2000/2001

Divisional Councillors.

Ex Officio Officers.

Mr. Ron Churcher VK7RN
Awards Officer

Mr. John Bates VK7RT

Mr Bob Cropper VK7BY
QSL

Mr. John Bates VK7RT

Mr. John Bates VK7RT
FTAC

Mr. Tony Bedelph VK7AX

Mr. Phil Corby VK7ZAX
Broadcast

Mr. John Rogers VK7JK

Mr. Mike Jenner VK7FB

Mr. Scott Evans VK7HSE
Public Officer

Mr John Bates VK7RT

Mr Mike Jenner VK7FB
Historian

Mr. Richard Rogers VK7RO

Mr Dale Barnes VK7DG
Federal Councillor

Mr. Phil Corby VK7ZAX

Mr. Timothy Holloway VK7TIM
Alt Fed Councillor

Mr. Ron Churcher VK7RN
Membership

Mr John Bates VK7RT
Hon. Solicitor

Mr. Phil Corby VK7ZAX
Education Off.

Mr. Reg Emmett VK7KK
Intruder Watch

Mr. Robert McKenzie VK7RB
Webmaster

Mr. Robert McKenzie VK7RB

VK1 Notes

Tower & Antenna Decision In ACT

A sensible decision has resulted, from an Amateur Radio perspective, on an Amateur Radio 'tower' case in the Australian Capital Territory.

Barry Booth VK1WV, then a Novice, had applied last year for 'planning permission' to erect a 12m single telescopic pole with guy wires supporting a trapped inverted V. ACT Planning And Land Management agreed to the application. Several local residents objected to the ACT Administrative Appeals Tribunal principally "on grounds which related to the visual impact of the proposed antenna and its capacity, when in operation, to cause electromagnetic interference with television, radio broadcast, roller door and other facilities of adjoining lessees."

Mr M.H. Peedom, President of the Tribunal, took evidence during several hearings and a site inspection. Evidence was completed on 24 February 2000. On 29 March 2000 a decision was handed down stating, "I am satisfied, on the evidence, that the proposed antenna, which is to be located at the rear of the main building on the subject land, will not be excessively obtrusive and will be as inconspicuous as is possible in the circumstances and that it will not cause a loss of amenity of any significance to the streetscape...."

The Tribunal heard evidence on the matter of electromagnetic interference from Gilbert Hughes VK1GH (President of the VK1 Division, WIA, and formerly an officer in the Australian Communications Authority), Rob Milikin VK1KRM (a professional communications consultant), Bill Jones (Mgr, Southern NSW Area Office - ACA), and Tim O'Neill also of the ACA.

The Tribunal noted that, "[several witnesses] gave evidence that there were few complaints of electromagnetic interference from amateur radio installations in the ACT. They said that the Australian Communications Authority had procedures for dealing with complaints of electromagnetic interference and could take appropriate steps to address any problems." The Tribunal determined that, "On the evidence in this case I do not consider that there is sufficient reason related to health issues or electromagnetic interference to justify refusal of the development application."

The decision means that the antenna will be erected and some trees planted to give screening along a boundary.

Gilbert Hughes VK1GH (President of the VK1 Division) said that this case was

an example of the support that WIA Members could expect from the WIA ACT Division if they had problems with tower planning and approval.

See full transcript at

<http://www.austlii.edu.au/au/cases/act/ACTAAT/2000/5.rtf>

The full transcript was only loaded to the AUSTLII system last week.

See full story via either of these Internet addresses. (Same story in different visual forms.)

<http://www.austlii.edu.au/cgi-bin/disp.pl/au/cases/act/ACTAAT/2000/5.html?query=%7c+mccubbin>

<http://www.austlii.edu.au/au/cases/act/ACTAAT/2000/5.rtf>

Further detail is available from Gilbert Hughes VK1GH, on (02) 62543266 or email: ghughes@dynamite.com.au

Please note that a different version of this release was sent to R&C Magazine. Apart from other changes, this version plays up the WIA aspects.

Peter R. Ellis VK1KEP PR Officer, VK1 Division

W- (02) 62653276 / H-(02) 62540262

Email: peter.ellis@chr.defence.gov.au

5/8 Wave

Our July General meeting will be held on Tues 25th of July. Adrian VK5ZSN will be giving a talk on Radiation Hazards in a typical Amateur backyard. This is a subject many may not understand fully but due to new RF standards it is a topic of which amateurs should have a good working knowledge.

During August our divisional president Jim VK5NB will be attending the IARU Convention in Darwin as an Australian representative. The Darwin Amateur Radio Club is doing a great job organising the venue for the convention and also the accommodation for the delegates.

More repeaters news. During June the 2m repeater VK5RLZ returned to air, and a new 70cm repeater VK5ROC at Ottway was commissioned. Both of these repeaters are run by the SA VHF Group. The 23cm repeater VK5RWH which was located at O'Halloran Hill has been taken off air for refurbishing before being re-located at a new site.

A couple of oversights from previous columns is that the 438.075 repeater was re-located by the South Coast Amateur Radio Club to Mount Terrible and has a new callsign VK5RSC. Thanks to the hard work by various volunteers the Port

Augusta repeater is back onair on its new frequency of 146.975.

A full rundown on repeater sponsorship by our division will be in a coming column. It has been suggested that our division in conjunction with the Adelaide metropolitan radio clubs run a hamfest in 2001. If you or your club are interested in participating please get in touch with Jim VK5NB. So far we have had interested from at least 3 of the major clubs in Adelaide, at this stage it looks promising.

ar

VHF UHF AN EXPANDING WORLD

David K Minchin VK5KK

Postal PO Box 789 Salisbury South Australia 5108

E-mail: tecknolt@arcom.com.au

Web page: <http://www.ozemail.com.au/~tecknolt>

Fax +61 8 82346396

Phone 0414 808060

(before 2130 EST please)

All times are UTC

Mid Winter DX 144 – 432 – 1296 MHz

A series of High Pressure cells mid/late May and in June 2000 led to a number of "Overland" Tropo contacts extending to 1100km between VK3, 5 & VK1, 2. It is not unusual to get stable Highs, with a Central MSL of 1037 hPa, in winter. However, this combined with stable upper level conditions produced openings on 144 MHz and above almost surpassing those over the same paths last summer

Contacts extended from Southern VK3 & VK5 to far as Sydney and Adelaide in either direction although it would seem no contacts actually occurred from Sydney to Adelaide. Contact information forwarded:

Gordon VK2ZAB reports: "Signals on 1296.1MHz SSB were 5/9 both ways between VK2ZAB and VK3AJN this morning (20/5/00) between 22.00Z and 22.30Z. Signals from VK1ZQR running 10 watts were 5/6. Lyle VK2BE received signals at similar levels at his QTH some 35 km south of me." ... VK2ZAB

Colin Hutchesson, VK5DK, Mt Gambier reports ... "Here are details of DX worked on 18/05/00 VK2MP on 144MHz at 1115 with signals 5 x 9 both ways. VK2MP on 432MHz at 1122 with signals sent 5 x 4 and received 5 x 3. VK2DXE on 144MHz at 1220 with 4 x 2 sent and 5 x 2 received. VK2CZ on 144MHz at 1225 with 5 x 2 x 9 sent and 4 x 1 received and VK2KYP on 144MHz at 1237 with 5 x 2 sent and 5 x 5 received. Conditions at time of contacts Barometric pressure 1029 hPa Temperature 11Deg C RH 83 % High Pressure cell extending right across the lower part of Australia."

"On 19/4/00 from 2130, VK2MP at 5 x 9 on 144 both ways VK2EMA at 5 x 6 on 144 and 5 x 1 on 432 same sigs both ways VK2ZAB at 5 X 2 on 144 received 5 x 1, but no sigs on 432"

"On 21/5/00 @ 0815 VK3ZLS on 144MHz @ 5 x 7 both ways, 1007 VK2QR on 144MHz @ 5 x 8 both ways. 1025 VK1ZQR on 144MHz @ 5 x 1 both ways. 1030 VK2MP on 144MHz @ 5 x 4 both ways, 1100 VK3EK on 144MHz @ 5 x 3 both ways, 1140 VK2QR on 432MHz

@ 5 x 1 both ways & 1200 VK2EMA on 144MHz @ 5 x 3 both ways."

"My 144 MHz yagi has broken in halves, and the 8 elements left are not as directional as the original 13 elements. Putting up 2 x 12 element yagis to replace it in the near future."

"To conclude things I was up and on air at 2130Z this morning 22/5/00, called CQ and back came VK2ZAB at 5 x 9, he gave me 5 x 6-7, so we QSY'ed to 432 and were able to exchange 5 x 1 reports both ways before signals disappeared. This was at 2140 UTC 21/5/00 then worked Reg VK2MP at 5 x 9 again at 2155 UTC on 144 MHz. I rang Russell 3ZQB, who was not hearing signals from Gordon very well, but was able to exchange 5 x 2 reports only on 144MHz. Jim VK3AEF and Geoff VK3FIQ both worked VK2ZAB at good strength." .. Colin VK5DK

Chas VK3BRZ reports .. "23/5/00 at approximately 22:15Z David VK3XLD (Lara) worked Mark VK2EMA (Tottenham) on 23cm. Signals were 52/53. Distance about 700km. Contacts were also made on 2m and 70cm with huge signals." ..Chas VK3BRZ

Trevor VK5NC reports ..."Today the 21-5-2000 VK2MP, VK2ZAB ,VK2KU on phone and CW and VK2CZ on CW were worked in Mount Gambier. Band conditions were reasonable; signals were not strong but quite readable with a long slow deep QSB. Mt. Gambier was totally overcast and the 2.30pm max temperature (briefly) was 15 degrees with light showers. In the evening of 21/5/00 contacts with VK1ZQR, VK2QR, VK2EMA and VK2QR on 70cms. The band was busy

with most of the activity around 144.1 MHz. There was some activity from VK3 and stations heard were VK3AXH, VK3BJM, VK3EK, VK3XPD & VK3ZQB." ... Trevor VK5NC

Several Adelaide stations reported working into VK1 & VK2 with Barry VK5KCX, Gawler (40km North of Gawler) working VK2MP, on 144.1 MHz, around 1100Z on 18/5. VK5KK heard and was heard by VK2MP, after, but no contact. On 21/5/00 VK5KK, Adelaide worked VK2QR, Cabramurra, NSW on 144.150 MHz, 21/5/00 at 1010Z 54/55.

144.150 MHz Wednesday SSB Net

Rob VK3EK reports. "The 144.150 net is still operating of a Wednesday night BUT check-ins are getting very light on ... THIS is your chance to make sure that the old saying of you never hear anyone on the VHF-UHF weak signal segments of the band not be the case. If we want the bands to be there, it will help to keep them by a simply USING THEM. I have had 51 different stations call in on the net since I have been running it from 2710/1999."

The format : we START at 8:30 EST every Wednesday night. Myself, Rob VK3EK, at Bairnsdale calls for Check-Ins on 144.150 and Tony; VK3CAT calls on 3.6500 as a liaison. I have 144.150 MHz 432.150 MHz 1296.150 MHz on and anyone wishing to try on any of these frequencies is welcome we do and have a lot of fun in the process. If anyone wishes to CHECK-IN or I may have missed you, they can either Check-In with

Tony or E-mail MYSELF to look harder for you. Hope to work a few of you NEXT WEDNESDAY NIGHT." ... Rob - VK3EK Bairnsdale 144.150 Net

VK5RAD Adelaide's Primary Repeater Celebrates 30 Years

Adelaide's Primary 2 metre Repeater (147.000MHz) celebrates its 30th year of continuous operation this year. VK5RAD is located at Crafers about 200 metres South of the Freeway and about 3km south of Mt Lofty. The 2m repeater, built by WIA volunteers, was first commissioned in 1970. It has much of the original hardware in use with the RF and control circuitry being progressively upgraded. The same chassis, steel cabinets and original shed are still in the use. Craig VK5ZAW and Neil VK5ZJA have maintained the repeater over many years.

The 2m Antenna relocated from the original tower, a WW2 Army tower, to the New tower about 15 years ago. The 120-foot "New" tower is now close to replacement, its longevity was not helped by falling over in 1991! With telecom's carriers bidding for the site, VK5RAD could well soon be at tower number three!

The VK5RAD 70cm repeater on 438.525MHz, built by Mark VK5AVQ, was installed in 1979. Packet radio equipment on 2m & 70cm MHz was added in the early 90's.

Finally, in Feb 2000, the site received its long awaited 6m repeater. The new VK5RAD Adelaide 6 metre repeater is on 53.775MHz (-1MHz Duplex). COLIN VK5ACE constructed it, using a modified Phillips FM814 Base station and PIC84 controller. Notch cavities using 1 5/8" Heliac and separate wave transmit and receive antennas complete the installation.

The site also has an excellent microwave outlook (No trees!) to both the Southeast and West. The suitability of the site as an alternative Microwave beacon site above 3 GHz has not been overlooked. Some trials are planned for this summer.

Solar Flux Peaks in May

The Forecast Bulletin ARLP019 predicted that solar flux might peak around 220 on 18/5/2000. Instead, on 17/5/2000 the noon solar flux reading was 262, a new high for the current solar cycle 23. The previous high for this cycle was 248.5 on 10/11/99. The solar flux has not been this high since cycle 22, when it was 271 on 3/2/92. In 1992, solar flux from

January 29 through February 3 was 266, 280, 303, 284, 288 and 271.

The most active days were May 12 and 17 2000, when the planetary A index was 22 and the K index was as high as five. Solar flux is expected to bottom out around 130 around 3/6/2000 and reach another peak around the middle of June 2000.

6 Metre Activity from VK3 & VK5

Clarry Castle, VK5KL, Enfield SA reports ... "From the 4th until 13th of April 200, the XE1KK/B beacon was heard every day at times reaching 599 but only on the 12th of April were any amateurs heard .. XE1BEF and XE1JW, but only managed to work XE1BEF, 58 @ 2344 12/4/00" Clarry also reports working 3D2AG 10/4/00 @ 2350 559 and T88JU 11/4/00 @ 0025, 599.

Clarry has been active on 50 MHz for many years. He had the distinction of holding the 50 MHz two way world record, of 8533km, in August 1947 working W7ACS/KH6 in Hawaii from Darwin as VK5KL. Of special note was that the record contact occurred much later in the day than the usual F2 peak. Not credited at the time, this was the first recorded DX QSO via the yet to be discovered mode of Transequatorial propagation. Clarry is still active on 50 MHz as well as on ATV via the VK5RTV ATV repeater.

Gil Sones, VK3AUI reports working 13 countries, on 50 MHz, over the April 2000 period. The XE1KK/B Beacon was consistently heard throughout the period, with contacts to Mexico on 4/4, 8/4, 9/4, 10/4, 11/4, 15/4, 19/4 & 20/4. Also worked on 20/4 was XE1BEF, W7CI, WA7KYZ, K5NA, N5JHV, XE1/SM00UG, WA5IYX, 3D2AG, K5AM & XE1J.

David Vitek has also submitted his logs for the March - May 2000 period and confirms that the period of 20/4 - 25/4 was the best period for the America's into Adelaide with W5OZI and others being heard on 21/4/00 from 2252 - 2258Z. XE1KK/B over this period as well as other XE stations. MUF after this period dropped to below 40 MHz on the US path.

6 Metre PSK QSO With Japan

While not claimed as a first, the following may be of interest for those experimenting with PSK. An excellent

article on PSK, by Alan VK6PG, appeared the March 2000 issue of AR. Steve VK4KHQ reports .. "A PSK31 QSO finally took place between VK4KHQ in Brisbane (QG62LJ), & JR9DGU @ 0845 UTC 30/4/2000 on 50.105MHz USB. Distance about 7300km with marginal propagation. (Only 3 weak beacons audible on 6Mx at the time). My power output was 10 watts to a quarter wave whip & 6 element Yagi at 6 meters height." ... Steve VK4KHQ.

Monitoring Propagation with ACARS on 131.55 MHz

John Bird has forwarded a log of ACARS activity from his QTH over May/June 2000 from his QTH at latitude 37.40.38S, longitude 144.55.38 E. ACARS is short for Aircraft Communications Addressing and Reporting System. The log is a recording of aircraft positioning reports via ACARS.

The file was generated by AirNav 3.1 © 32bit ACARS, Internet, HF and VHF Flight Tracking and monitoring. Software for ACARS tracking can be found at can be found at <http://www.airnavsystems.com> and <http://www.cas.honeywell.com/bcas/products/worldnav.cfm>.

The following is an example of reception over 2800 km's on 28/5/2000

FLIGHT	SQ0217
SELCAL	LMAD
REG	9V-SML
AIRCRAFT	B747
TIME	0136Z
COORDINATES	21.246S 119.451E
DISTANCE	1632.456 nautical miles

Equipment in use:-

Scanner: Tandy PRO-2034 on 131.550 MHz.

Antenna: Mobile One Bandspanner Base @ 30 feet.

Computer: 486DX100

Software:- Wacars, SkySpy, Ai:Nav.

Normal reception range is out to 100-110 nautical miles. Notable exceptions to this limit do occur, as per the above example when a Southwest Cold Front came through.

Microwave Primer Part Two: 23cm Band

As mentioned last month, the 1240 - 1300 MHz (23cm) band is at the crossroads of our UHF & Microwave bands. Of all the bands above 1000 MHz it is perhaps the easiest to

get operational with a variety of Commercial, Kit and Home brew Equipment.

Just what can be expected from 23 cm? The same types of VHF and lower UHF Tropospheric propagation effects this band albeit being more critical and subject to higher over the land path losses. 23cm has been successfully worked over nearly 2500 km on Tropo paths on mainland Australia, not much short of the 144 & 432 MHz records.

23cm can successfully be used from the home QTH as long as you have a favourable horizon in the desired paths. Trees and Foliage have some effect, although no where near as bad as at perhaps 3 GHz. 23cm is a good band for portable operation with beam antenna's rarely longer than 2.4 metres.

The most basic way to create a signal on 23cm is to use a tripler from 70cm! Early equipment used either 2C39 valve or varactor multipliers. Some of the first SSB contacts were actually made using multipliers and special divide by "three" SSB spectrum exciters. A lot of work was done by Reg VK5QR in this area, the equipment being used on the World record contacts on 1296 and 2304 in the seventies. I remember hearing some of these QSO's on 1296 MHz in the seventies; the SSB quality was more than sufficient for UHF work!

My first SSB transverter (1978) was a DF8QK 200mW design with a 28 MHz IF from VHF Communications. Looking at the transverter with a Spectrum Analyser, years after, only confirmed my suspicions that the image and LO rejection was only around 20 db below the wanted signal!

Since the eighties, a number of commercial transceivers have been available for 23cm. These include the Icom IC1271, IC1275, IC970, Yaesu FT736 and Kenwood TS790A as well as a number of FM only transceivers. Despite this most operation still seems to revolve around transverters coupled to lower frequency transceivers. 144 MHz is the most popular IF although 50 and even 28 MHz has been used in the many designs to be found over the last 25 years.

Various Transverter designs have come and gone. Commercially built transverters include several models from Microwave Modules and SSB Electronic. The VK5 Division Equipment Supplies, alone, sold over 100 23cm transverters

between 1989 and 1999. Minikits, run by Mark VK5EME, also supplies a modern 23cm transverter with various options. More details can be found on the Web at <http://homepages.picknowl.com.au/vk5eme/minikits/Kits2.html> Pre-amplifiers typically use inexpensive low noise Gasfet or HEMT devices.

10 - 15 watts of output power for moderate outlay can be had using the ubiquitous Mitsubishi M57762 (with 200mW drive). Rumours circulated a recently about the demise of a large percentage of Mitsubishi modules. Indeed, the M57762 was announced as being obsolete with ALL module details were removed from Mitsubishi's Website! The good news is it is now replaced by a M57762-02, with similar specs and cost.

Valve or solid state amplifiers can be used for higher power. One is the Chip Angle, N6CA, water-cooled 2C39B valve design capable of about 150 Watts. 2C39B's no longer used commercially have been available as surplus for many years.

Solid State methods of gaining power are restricted to paralleling two or four Mitsubishi M57762's. Another method that hopefully will become more affordable is using the New LDMOS "Bi-Fets" designed for 1500 MHz. An amplifier using a single, 28-Volt rated, FET can provide around 100 watts output for 15 watts drive (i.e. a single M57762)

If you need more help on finding information on 23cm please drop me a line. Next month, we will change pace a little and examine some of the specifics of Microwave duct propagation, perhaps giving away some of the secrets already learnt on some of the longer paths. And probably confirming that a lot more is still to be discovered!

In Closing

Pressure for space last month meant the Reminder for GippsTech 2000 was left out, if you live in VK3 you may just get this AR just in time. Another reminder regarding Grid Locator information (i.e. where you are and what bands you are on) must be in by 16/7/00. I will be publishing this information along with Guy's VK2KU's updated Grid Square standings in the August issue of AR

Thats it, except for the final say ... *"If you want to capture your youth, just cut off their pocket money!"*

Till next month 73's David VK5KK

ICOM Clearly Ahead



"VK3LZ calling!"

More sound information from your friends at Icom.

IT'S A WORLD FIRST IN SIGHT AND SOUND FROM ICOM

In a world first for a handheld communications receiver, we've just released in Australia the IC-R3, a wide band receiver combined with a 2 inch TFT colour LCD and TV screen. The IC-R3 offers super wide 0.5-2450 MHz frequency coverage for AM, FM, wide FM and TV picture reception. The LCD shows information such as receiving frequencies, tuning steps, and memory channel numbers...while the TV screen displays any image within frequency range. A long life Lithium-Ion battery is also supplied which gives almost 2 times longer operating time than Ni-Cds.

And for added convenience the unit is also alkaline battery ready.

Everyone at Icom Australia has been knocked out by this breakthrough unit. Why don't you see it for yourself at your local authorised Icom Dealer soon.

RIVERINA HAMFEST A MUST SEE FOR ENTHUSIASTS.

Conducted by the Twin Cities Radio and Electronics Club, the Riverina Hamfest is always well attended by enthusiasts in the Albury/Wodonga area, and from much further afield.

Mark down Sunday, August 13 in your diary with the Murray High School on the corner of Kaitlers Road and Kemp Street Lavington as the venue.

"...73"

FreeCall 1800 338 915
290 -294 Albert Street
Brunswick, Victoria 3056
Tel : (03) 9387 0666
Fax : (03) 9387 0022
www.icom.net.au
ABN 88 006 092 575

CONTESTS

Ian Godsil VK3DID

57 Nepean Highway, Aspendale, 3195

Phone: 0408 123 557 Email: contests@wla.org.au

Contest Calendar July — September 2000

Jul 1	Canada Day Contest	(CW/Phone)	(Jun 99)
Jul 1	Jack Files Contest	(CW)	(May 00)
Jul 1	Australasian Sprint	(CW)	(Jun 00)
Jul 1	NZART Memorial Contest	(CW/Phone)	(Jun 00)
Jul 1/2	Original QRP Contest		
Jul 8	Australasian Sprint	(SSB)	(Jun 00)
Jul 8	Jack Files Contest	(SSB)	(May 00)
Jul 8/9	IARU HF World Championship	(CW/SSB)	(Jun 00)
Jul 8/9	Internet 6 m DX Contest		
Jul 15	Pacific 160 Metres Contest		(May 00)
Jul 15/16	SEANET CW Contest		(Jun 00)
Jul 16	Colombian Independence Contest	(CW/SSB/RTTY)	(Jun 99)
Jul 29	Waitakere Sprint (Phone)		(Jun 00)
Jul 29/30	RSGB IOTA Contest	(CW/SSB)	(Jun 00)
Jul 29/30	Russian RTTY WW Contest		
Aug 5	YO DX Contest	(CW/SSB)	
Aug 5	SARS Sprint Contest	(CW)	(Jun 00)
Aug 5	Waitakere Sprint	(CW)	(Jun 00)
Aug 12/13	Worked All Europe DX Contest	(CW)	
Aug 12/13	RD Contest	(CW/SSB)	(Jul 00)
Aug 19/20	Keymen's Club of Japan Contest	(CW)	(Jul 00)
Aug 19/20	SEANET SSB Contest	(Jun 00)	
Aug 26/27	SCC RTTY Championship		
Aug 26/27	TOEC WW Grid Contest	(CW)	
Sep	2/3 All Asia DX Contest (Phone)		(May 00)
Sep	2/3 Bulgarian DX Contest (CW)		
Sep	9/10 Worked All Europe (Phone)		(Jul 00)
Sep	16/17 SAC DX CW		
Sep	23 Panama DX Contest (SSB)		(Aug 00)
Sep	23/24 SAC DX Phone		
Sep	23/24 CQ WW RTTY DX Contest		

Thanks this month to ARRL S5OU JE1CKA VK6APK

Greetings to all Readers.

Some of the results listed below had a postscript advising that several logs were sent to the wrong address and therefore missed out. This was a point I mentioned in the column recently, so again I take this opportunity to ask you all to be especially careful to find out the rules and to do exactly what is asked - not what you remember from a previous occasion. Also, if you have friends who are not members of WIA but want to participate in our Contests, please either show them your copy of the rules or give them my

address and ask them to contact me. I am quite surprised to know that logs are received from entrants who admit that they have never seen the rules!!!

Apology

From time to time lately I have experienced difficulties in getting most recent information about dates of contests in Europe. Yes, it's easy to make excuses, but with all our modern communication methods, I have at times published incorrect dates in this column, caused by some contest sites not being updated early enough for printed copy like this.

For this I apologize most sincerely. At

the moment I don't know what is an answer, but all dates above I believe to be correct. My thanks to those who take the trouble to point out my mistakes!

Please bear with me and check each month as it comes out.

RD Contest

It's time again for the RD contest. Please see the separate article about that and plan now to get your station working well - if it's not already, of course!

New Exchange System

You may recall that in May I asked for comments on a new exchange system,

whereby the use of RS(T) would be discontinued.

I am pleased to report that several people responded to the request and that opinion was very much in favour. Thanks to those who took the trouble. Now I shall report that to the Region 1 Contest Chairman and also talk to local Contest Managers about possible implementation in 2001 for our VK contests.

I look forward to hearing you all in a contest soon and certainly in the RD.

73 and good contesting, Ian VK3DID
E-mail: <contests@wia.org.au> Phone: 0408-123-557

Results JIDX 1998

(Call\band\score\award)

VK2XT	28	2106
VK4DZ	28	988
VK2APK	14	14194 plaque
VK4BDX	7	26404 plaque

Results CQ/RJ WW RTTY WPX 1999

(Call\cat\score\award)

VK6GOM	SOABH	386880	plaque
VK4UC	SOABL	412720	plaque
VK2KM	SB15	70007	highest VK2
VK6WR	SB20	78010	highest VK6
VK2BQS	SB20	481	highest VK2

Worked All Europe DX Contest

CW: 12/13 August

SSB: 9/10 September

RTTY: 11/12 November

0000Z Sat - 2400Z Sun

Object is to work European stations (except in the RTTY section where anyone works anyone). Bands are 80 - 10 m. In the contest, avoid 3550-3800 and 14060 - 14350 kHz on CW and 3650 - 3700, 14100 - 14125 and 14300 - 14350 kHz on SSB. The minimum time of operation on a band is 15 minutes, although bands may be changed within this period if, and only if, the station worked is a new multiplier.

Categories are single operator all bands; multi-operator single transmitter; and SWL all bands. DX cluster support is allowed. A maximum of 36 hours is allowed for single operator stations, with up to three rest periods (mark them in the log).

Exchange RS(T) plus serial number.

Additional points can be gained reporting QTCs as follows: after working a number of European stations, details of those QSOs (ie QTCs) can be reported during a current QSO with a European station. In the CW and phone sections, QTCs are sent from non-European stations to European stations. In the RTTY section, QTCs can be sent to any station, including non-Europeans, outside one's own WAC continent. A QTC contains the time, callsign and QSO number of the station being reported, eg: "1307/DA1AA/431" means you worked DA1AA at 1307z and received serial number 431. Commence QTC traffic by sending the QTC series and number of QSOs to be reported, eg "QTC 3/7" indicates that this is the third series and that seven QSOs will be reported. A QSO may be reported only once and not back to the originating station, who can be worked more than once to complete the quota. Only the original QSO, however, will have points value.

Multiplier on each band equals the number of European countries worked on that band (or on RTTY only, the number of DXCC/WAE countries), times a band factor. The band factors are four for 80 m, three for 40 m and two for 20/15/10 m. Add the band multipliers together and multiply by the sum of (QSOs + QTCs) to obtain the final score.

SWLs may log each station heard, European and non-European, once per band. **Logs** may be by logging program, or on DOS disc, providing a paper summary is included. **Send logs** by mail to: WAEDC Contest Committee, Box 1126, D-74370 Scrsheim, Germany. Logs may be sent by e-mail to: <waedc@dar.de> Deadlines are 14 Sept (CW), 14 Oct (SSB) and 14 Dec (RTTY).

European countries are: C3 CTI CU DL EA EA6 EI EM/N/O ER ES EU/V/W/ F G GD GI GJ GM GM(Shetland) GU GW HA HB HBO HV I IS IT JW(Bear) JW(Spitzbergen) JX LA LX LY LZ OE OH OH0 OJ OK/L OM ON OY OZ PA R1/FJL R1/MVI R/

U(RUSSIA) RA2 S5 SM SP SV SV5(Rhodes) SV9(Crete) SV(Mt Athos) T7 T9 TA1 TF TK UR-UZ(Ukraine) YL YO YU Z3 ZA ZB2 1A0 3A 4U(Geneva) 4U(Vienna) 9A 9H.

Keyman's Club of Japan

19/20 August, 1200Z Sat - 1200Z Sun

This contest is designed for CW enthusiasts and will particularly suit those who are collecting Japanese prefectures for awards. The only **category** is single operator multi-band.

Suggested frequencies: 1908 - 1912 (split); 3510-3525; 7010 - 7030; 14959 - 14090; 21050 - 21090; 28050 - 28090 kHz.

Exchange: RST plus continent code (OC). JAs will send RST plus district code. **Score** one point per QSO. **Multiplier** on each band is the total number of JA districts (max 62 per band). **Final Score** is total points X total multiplier. Show duplicate QSOs with zero points. Attach **summary sheet** showing usual information and **send logs** to: Yasuo Taneda JA1DD, 279 - 233 Mori, Sambu Town, Sambu, Chiba 389-12, Japan, postmarked no later than 15 September, 2000. ASCII logs on DOS disc most welcome.

2000 Remembrance Day Contest

12/13 August 0800Z Sat - 0759Z Sun
Presented by Alek Perkovic VK6APK
See next page

SILENT KEY

The WIA regrets to announce the recent passing of:

H J (Harry) Hanigan
VK2DHH

S S (Stan) Silver
VK4CDW

F (Fred) Reeve
VK5YK

Remembrance Day Contest 2000

Well, here it is again – another Remembrance Day Contest. Perhaps, like me, you wonder where the last year has got? All I can say is that it just disappeared in work!

It's Time

By the time you read this there will be about one month to go before this year's Remembrance Day Contest. Now is the time to check through your station and see that everything is working fine.

Don't leave it too late, or you may be disappointed!

Changes

There is really only one change and that is in Rule 9b. Yes, I know that some of you will be annoyed, but last year there was strong feeling that (a) this is a contest in memory of an earlier generation of operators; (b) automatic operation is entirely inappropriate under such circumstances, as are modern digital modes.

Historical

I went in search of a list of DIVISIONAL WINNERS for the last few years and this is what I discovered –

1999	VK7	1998	VK7
1997	VK7	1996	VK7
1995	VK1	1994	VK3
1993	VK3		

Further back I was unable to find; but these few years tell a story! How about some more zest from certain Divisions this year?

Logging Program

John VK4EMM has a program called Quick Score that is set up for several Australian contests.

It reads the .bin file from the CT contest logger. I am not very *au fait* with automatic loggers, but I have had a look

at Quick Score and can see how useful it could be to a properly set-up station.

This is available for downloading at <http://www.uq.edu.au/radiosport> under Software. If other Clubs have similar programs, please let me know.

Don't delay – have a go and give yourself a taste of what contesting can be all about, especially if you have not tried before or not for some years..

Contesting is not difficult, not even on CW! There will always be stations waiting to work you.

Please support your Division. Be a competitor – it's a good way to spend a Saturday night and there are other contests to help you hone your skills.

Good contesting. 73 and see you in the RD 2000.

Ian Godsil VK3DID,
Federal Contests Co-ordinator

2000 Remembrance Day Contest

12/13 August 0800Z Sat – 0759Z Sun

Presented by Alek Petkovic VK6APK

are asked to observe 15 minutes' silence prior to the start of the contest, during which the opening ceremony will be broadcast.

Rules:

1. Categories:

- High Frequency for operation on bands below 50 MHz
- Very High Frequency for operation on and above 50 MHz
- Single Operator
- Multi-operator

2. Sections within each Category are:

- Transmitting Phone (AM, FM, SSB, TV)
- Transmitting CW (CW only)

Note: Digital modes such as Packet, RTTY, AMTOR, PSK31 etc are excluded from the contest.

- Transmitting Open (a) and (b)
- Receiving (a), (b) or (c)

3. All amateurs in Australia, Papua New Guinea and New Zealand may enter the contest, whether their stations are fixed, portable or mobile.

4. Cross-band and cross-mode contacts are not permitted.

5. Call "CQ RD", "CQ CONTEST" or "CQ TEST".

6. On bands up to 30 MHz stations may be contacted once per band per mode. i.e. twice per band once using CW and once using Phone.

7. On 50 MHz and above, the same station in any call area may be worked, using any of the modes listed, at intervals of not less than two hours since the previous contact on that band with that mode.

8. Both single and multi-operator entries are permitted. To be eligible as a *single operator*, one person must perform all operating and logging activities without assistance of any type either personal or electronic, using his or her own callsign. More than one person can use the same station and remain a single operator providing each uses his or her own callsign, submits a separate log under that callsign and does not receive operating or logging assistance in any way during the contest.

9a. Multi-operator stations are only allowed one transmitter per band/mode at any one time. Simultaneous transmissions on different bands are permitted. Simultaneous transmissions on the same band but different modes are permitted.

9b. Automated or computer controlled

operation is not permitted. The operator must have physical control of the station for each contact. CW and Voice Keyers are permitted.

10. For a contact to be valid, numbers must be exchanged between stations making the contact. Exchange RS for phone and RST for CW, followed by three figures commencing at 001 and incrementing by one for each successive contact.
11. Contacts via repeater (including satellite) are not permitted for scoring purposes. Contacts may be arranged through a repeater. Operation on repeater frequencies in simplex is not permitted.
12. **Score:** on 160 m two points per completed valid contact; on all other bands one point; on CW double points.
13. **Logs** should be in the format shown below and accompanied by a **Summary Sheet** showing **callsign; name; address; category; section;** for multi-operator stations a list of the operators; **total score; declaration: I hereby certify that I have operated in accordance with the rules and spirit of the contest; signed; date.**
14. Entrants operating on both HF and VHF are requested to submit **separate logs and summary sheets** for each category.
15. VK entrants temporarily operating outside their allocated call area, including those outside continental Australia as defined for DXCC, can elect to have their points credited to their home Division by making a statement to that effect on their summary sheet(s).

16. Send logs and summary sheets to: RD Contest Co-ordinator, A Petkovic VK6APK, 26 Freeman Way, Marmion, WA 6020, by Friday 15 September 2000. Endorse envelope "Remembrance Day Contest" on front outside. Late entries will not be eligible.
17. Certificates will be awarded to the leading entrants in each section, both single and multi-operator; in each Division; P2 and ZL. Entrants must make at least 10 contacts to be *eligible for awards*, unless otherwise decided by the Contest Manager.
18. Any station observed departing from the generally accepted codes of operating ethics may be disqualified.

- (b) For each Division, HF and VHF Improvement Factors will then be calculated. Once again the same formula will be used for both HF and VHF, inserting appropriate figures:
 $I/F = \text{Total points (this year)} / \text{Benchmark}$
 where I/F = improvement factor.
- (c) For each Division, the HF and VHF Improvement Factors will then be averaged:
 $\text{Overall I/F} = (\text{HF I/F} + \text{VHF I/F}) / 2.$
- (d) The Division that achieves the highest overall improvement factor will be declared the winner.

Determination of Winning Division

Unless otherwise elected by the entrant concerned, the scores of VK0 stations will be credited to VK7 and the scores of VK9 to the mainland call area that is geographically closest. Scores of P2, ZL and SWL stations will not be included in these calculations.

For each Division, an "improvement factor" will be calculated as follows:

- (a) For transmitting logs only, HF and VHF "Benchmarks" for each Division will be established, against which its performance for the current year is judged. The same formula will be used for HF and VHF, inserting the appropriate figures:
 $B = 0.25P + 0.75L$
 where B = this year's benchmark, P = last year's total points, and L = last year's benchmark.

2000 Benchmarks

These are the total scores that must be obtained by each Division to improve on its results of last year:

Div	HF	VHF
VK1	626	189
VK2	4339	64
VK3	3551	11342
VK4	3439	767
VK5/8	3747	1551
VK6	2845	4864
VK7	1856	875

Receiving Section Rules

1. This section is open to all SWLs in Australia, Papua New Guinea and New Zealand. No active transmitting station may enter this section.
2. Rules are the same as for the Transmitting Section.
3. Only completed contacts may be logged, i.e. it is not permissible to log a station calling CQ.
4. The log should be in the format shown below.

Example Summary Sheet

Remembrance Day Contest 2000

Callsign: VK3DID
Name: Ian Godsil
Address: 57 Nepean Highway, Aspendale, 3195
Category: HF/Single Operator
Section: Transmitting CW
Total Score: 1000

Declaration: I hereby certify that I have operated in accordance with the rules and spirit of the Contest.

Signed: Ian Godsil
Date: 30 August 2000

Example Transmitting Log

Remembrance Day Contest 2000

Callsign: VK1XXX
Category: HF/Multi Operator
Section: Transmitting Phone

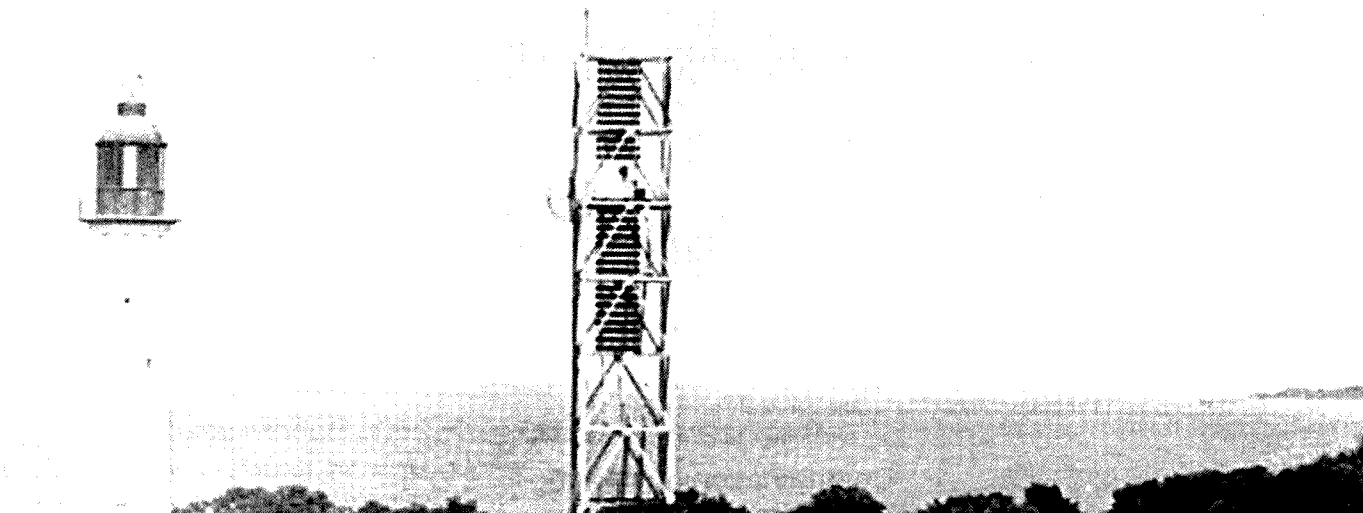
Time (UTC)	Band	Mode	Call	Nr Sent	Nr Rcvd	Pts
0801	14	SSB	VK2QQ	58001	59002	1
0802	14	SSB	VK6LL	59002	59001	1
0806	14	SSB	VK5ANW	59003	59001	1
0808	14	SSB	ZL2AGQ	56004	57004	1
0811	14	SSB	VK4XX	59005	59008	1

Example Receiving Log

Name/SWL Nr: L33071
Category: HF
Section: Receiving Phone

Time (UTC)	Band	Mode	Call	Nr Sent	Nr Rcvd	Pts
0801	14	SSB	VK1XXX VK2QQ	58001	59002	1
0802	14	SSB	VK1XXX VK6LL	59002	59001	1
0806	14	SSB	VK5ANW VK1XXX	59001	59003	1
0809	14	SSB	VK7AL VK2PS	59007	58010	1

ar



No contest, but plenty of fun in a lighthouse

International Lighthouse/Lightship Weekend

NEWS ITEM FROM MIKE DALRYMPLE GM4SUC
Via Kevin VK2CE

Last year the International Lighthouse/Lightship Weekend took place from 0001 UTC on Saturday 21st August until 2359 UTC on Sunday 22nd August 1999, when 218 amateur radio stations were established at lighthouses and lightships in 39 countries. This year the period of the event is from 0001 UTC on Saturday 19 August until 2359 UTC on Sunday 20 August 2000.

The event is NOT a contest; each station decides how they will operate their station regards modes and bands. Participants are not committed to being on the air during the entire period - only as much as they can. There are no restrictions on aerials or power. We wish operators to enjoy themselves and have fun while making contact with as many amateur radio stations as possible. Some operators say fun - 5,000 contacts - OK, but we request that stations take some time to work the slow operator, the newly licensed and QRP stations. As available space in many lighthouses is filled to capacity, our activity does not have to take place inside the tower itself. Field day type set-up at the light or other building next to the light is OK. Permission MUST be obtained from any interested parties.

The event is used to obtain maximum exposure for our hobby. We invite the press and, QTH permitting, also the public and try to underline the obvious parallel between the international aspect in lighthouses, lightships and amateur radio. We might catch a future radio

amateur while creating goodwill for the hobby.

We use the event segment of the 5 'Classic' bands with a centre frequency if conditions are bad, at least we have one place we can (try to) meet. We request that the centre frequencies are not used as primary frequencies but as a last point of call to other participating stations.

CW		
80m	3.510 - 3.540 kHz	Centre 3.521 +/-
40m	7.005 - 7.035	7.021 +/-
20m	14.010 - 14.040	14.021 +/-
15m	21.010 - 21.040	21.021 +/-
10m	28.010 - 28.040	28.021 +/-
PHONE		
80m	3.650 - 3.750 kHz	Centre 3.721 +/-
40m	7.040 - 7.100	7.051 +/-
20m	14.125 - 14.275	14.221 +/-
15m	21.150 - 21.250	21.221 +/-
10m	28.300 - 28.400	28.351 +/-

Because it is not a contest you can operate on any authorised QRGs as per your licence.

To assist other stations we request that participating stations add 'LIGHT' , 'LGT', LIGHTHOUSE' or

'LIGHTSHIP' after their call. UK stations normally obtain a GB callsign with the letter L in the suffix to assist other stations identifying them as a participating station in the event.

So come and join us in the fun of the weekend, establish a station at a lighthouse, lightship or maritime beacon. The more the merrier. If you decide to join us in the fun could you let me know the callsign you will use, QTH and QSL information. This will enable me to notify other stations and the media of your participation.

73s Mike GM4SUC
e-mail: gm4suc@compuserve.com

The North American co-ordinator for the event is Jim Weidner who has a very comprehensive web site showing the list of participants who have registered for this year's Event and also details and photos of last year's event www.waterw.com/~weidner/LH-day-table.htm

Local inquiries in VK may be addressed to Kevin vk2ce@amsat.org

ar

DX NOTES

Ross Christie, VK3WAC
19 Browns Road, Montrose 3765, Vic.
Email Vk3wac@aol.com

Disturbances to propagation normal for this point in solar cycle

The bands have been in good shape in the last month or two and I have been able to work some interesting DX in Africa and South America in late May and early June. Signals from Africa and South America are rare for me, normally I do not hear much from the south due to the location of my QTH. But shortly after this the bands took a downturn and were in a sorry state, from my QTH at least. Propagation must have been disturbed as I have been told that signals coming into VK over the poles have suffered from severe auroral 'flutter'. I suppose at this point in the solar cycle, severe disturbances to propagation are the norm.

There have been reports of spectacular aurorae in Europe and North America, being visible much further south than normal (Did anyone see any auroral activity here in VK?). In the UK, amateur photographers have been having field days (nights!) as far south as Oxford with some beautiful exposures of vivid green and orange curtains. My father, who is a keen shortwave listener and who lives 20km west of Glasgow, tells me that he has heard many stations from SM, ON, OZ, LA, DL on 6m SSB during the last couple of months. He uses modest equipment, a homebrew 6m converter fed from a 'Slim-Jim' cut for 6m and a Yaesu FRG8800 as a tunable IF. Admittedly, these countries are not great distances away from GM but you can imagine the amount of activity going on in Europe and the US under these conditions. And perhaps the best is yet to come for the Southern Hemisphere! Rumours have it that the peak of the cycle will not arrive until late 2000. If this is the case, we may yet see some good openings in VK during summer 2000/2001.

Another prominent amateur radio operator has vacated our ranks. Keizo Obuchi, JK1KIT became a silent key on

14th May 2000. Our condolences go to his family and friends, and to the radio amateurs of Japan, on the death of their Prime Minister Keizo Obuchi, JI1KIT. Mr Obuchi, whose nickname was 'the quiet man' was first licensed in 1975 and was a member of JARL. He was a keen amateur radio operator and a great enthusiast. I wonder if any VK amateurs have his call in their logbooks?

The DX

Some good DX is about to come on the air from some interesting places in the next few weeks. Have a listen on the bands and see if you can work them. If you do, drop me a line and let me know.

3W2LC, Mal (VK6LC) is returning to Vietnam for where he will spend the next 6 months. Look for him to be active from Vung Tau.

KH2, Gus, K4SXT, reports he has shut down his operation from Nimitz Hill, Guam as KH2/K4SXT and will be transferring to Bahrain. He plans to be move in late July and be set up on the air sometime in September. Gus enjoys the low bands, especially 160 metres.

JW, SVALBARD ISLAND. The Modum Group of NRRL (Norway) and a local Ham Group (LA7M) is arranging a one-week trip with 30 people to the Russian area of the Svalbard Islands during the period of July 6-13th. They will travel by boat from the Island airport to the Russian settlements of Barentsburg and Pyramiden.. The main callsign for the group will be JW7M. However, there may be individual participants who will exercise their right to use the CEPT licensing agreement and operate as JW/ homecall. For more information, please E-mail the group at dxpeditio2000@dxpedition.org or, if this adventure piques your interest, take a look at the following web site, <http://www.dxpeditio.org>

PI4TUE, Members of PI4TUE will once again be operating from Liechtenstein from 31st July till 16th August. Activities are planned for 2m through 160m plus 23cm. The group will be active on 6 metres most of the time.

TF/G3SQX, Starting 28th July Ed, G3SQX, will be active from Iceland. Ed will be participating in the RSGB IOTA Contest in the 24 hour CW category. He will be staying in Iceland until 6th August and will be active on CW only. QSL via G3SQX. Check out Ed's Web page at <http://www.g3sqx.net>

VQ9QM. Dale Strieter, W4QM, will be heading out to sea again in late June. He'll be leaving from Jacksonville, FL and plans to arrive on Chagos on approximately 30th July. Dale will be active on CW only on all bands for about 4 or 5 months as VQ9QM. QSL via W4QM.

Mark, KM6HB, says to look for him on the air from the South Cook Islands between 10th and 17th of July. He intends to be active, especially on RTTY, on 10m through to 40m. Callsign to be announced on arrival. QSL via KM6HB.

IOTA Activity

A reminder that the RSGB IOTA Contest takes place from 1200 UTC Saturday 29th July to 1200 UTC Sunday 30th July 2000. This contest now attracts more than 1000 participants annually so it is quite possible to work the 100 different IOTA islands required to qualify for the basic IOTA award during the 24 hours of the contest. Full details of IOTA contest rules can be found on the following web site <http://www.g4tsh.demon.co.uk/HFCC/Rules-2000/iota.htm>

Important note. If you plan to take part as an island station, please check new IOTA Directory 2000 to see that your island counts and that you have the correct IOTA reference number. If it is not

listed in the directory, it could be that your island IOTA status has been withdrawn.

AS-066 Alex, RU0LL, plans to be active from Putyatini Island (AS-066) during the last week of July. He intends to participate in the RSGB's IOTA Contest. Alex will be active on 6m through to 160m on CW, SSB and RTTY. QSL is to IK2DÜW either via the bureau or direct to ARI Servizio quasi diretto Via scarlatti, 31 - 20124 Milano, ITALY.

EU-010 Jim, MM0BQI, will activate the island of Benbecula* in the Outer Hebrides (IOSA OH4) on July 27th - 31st as MM0BQI/P. Look for him to be active during the IOTA contest from the same 'winning location' (Jim's words) as last year.

EU-077 EA1GA/P will be active from Noro Island (EU-077) on 8th and 9th of July and then from Erbosa Islands from 12th and 15th of August. QSL via EA1GA.

EU-008 Operators GM3COB, GM3NIG, GM3UTQ, GM4FDM, GM4YMA, GM0NAI, GM0UKZ and 2M1EDM will be active as GM5V from the Island of Gigha for the upcoming IOTA Contest. For operation outside of the IOTA contest they intend to use the callsign GM5VG/P on all bands. The group will be running 400 watts on SSB/CW/RTTY/PSK31 and have plans to build a large antenna farm with monobanders (if possible). QSL via GM3UTQ.

EU-038 Members of the radio club "UBA" (ON4NOK) and "Radioclub Kempen K.A.R." (PI4KAR) will be active for a period before and during IOTA Contest with the callsign PA6TEX on Texel Island. QSL via ON4ALW, Ronald "Ron" Van Aken, Kapelstraat 5, 2330 Merksplas, Belgium or via the UBA (Belgian) Bureau.

NA-054 Joe, W8GEX, Ron, WA8LOW, Mike, N9NS and Mike, K9AJ will be active from Berry Is, Bahamas (NA-054) for the period 28th - 31st of July, including the IOTA Contest. Two stations will be activated on 6m through 40m, CW & SSB. The team will use the callsign C6DX during the contest and C6AJR outside the contest. QSL to W8GEX.

IOTA frequencies -

CW 28040 24920 21040 18098 14040
10114 7030 3530
SSB 28560 28460 24950 21260 18128
14260 7055 3765

Special Events and Expeditions

News just to hand, Tom Harrell, N4XP, and Garry Shapiro, NI6T, of the Kingman Reef/Palmyra DX Group (KR/PDXG) have confirmed that Dr. Chuck Brady, N4BQW, was due on the Atoll in the latter half of May. He was expected to be active during late May (did anyone in VK work him?). Chuck is one of the first operators of the KR/PDX Groups effort to activate KH5 and KH5K over the coming months. He will ensure the safe arrival of all the equipment forwarded to Palmyra Atoll earlier. Chuck will operate when he has spare time, as his official function is to assist The Nature Conservancy's establishment of a "base camp" on Palmyra. It has been rumoured that future operations from this site may be very unlikely due to it being declared an as international heritage site. These early visits will complete the necessary preparations for both additional activity on Palmyra and the planned major effort to Kingman Reef in October.

The DXpedition to St. Peter and St. Paul Rocks has once again been postponed. It seems that transportation is the only factor holding up this operation. The two-man team is ready and has the funds, but lack the means of transport. They are awaiting the Brazilian Navy to allocate space aboard one of their ships. The group is now hoping to arrive at this semi-rare location in July and hopes to have some kind of a confirmation of transport by mid June. RTTY will also be available on this trip.

A group of French amateurs are heading to Bhutan this September. The operators include Alain, F6ANA; Denise, F6HWU; Alain, F5LMJ; Vincent, F5MBO/G0LMX and Gerard, F2VX. They intend to fly from Paris to Thimphu via Bangkok on 1st of Sept 2000 and return to Europe on 15th of Sept. Gerard says there will be 9-10 days of operating. The group, also known as the Clipperton DX Club, will use the antennas and coax feeders left behind on the roof of the Pinewood Hotel by the recent A52A operation. The radio equipment will consist of a TS-50, FT-706 (IC706?), and FT-757, but no high power amplifiers. The exact callsign/s to be used is not known as yet, but will be released as soon as they find out.

VP6BR Mike, KM9D. If you missed

VP6BR then don't despair. Mike, who also operated as ZR0ZY from San Ambrosio, is currently sailing to Easter Island and plans to travel further into Oceania. He hopes to be active from Pitcairn Island later in the year. QSL via OM2SA.

E4, PALESTINE. Miro, S51GL, is preparing a Dxpedition to Palestine for this autumn. The main objective of the operation is to put Palestine on air with digital modes. He hopes by setting a good example he will be able "to motivate the students at the Gaza College, E44DX, to do the same; since they have already the basics of ham radio and it will be nice to complete their education." While he is there he wants to operate on the WARC and 50 MHz bands. He hopes that the operation will promote friendship between Palestine, H.K. of Jordan, Lebanon and Slovenia and of course, the rest of the world. For more information and updates, go to Miro's Web page at: <http://www.qsl.net/s51gl/>

QSL Information

3A2MG via F9JS
5N3NDP via IK5JAN
8M2000 via JARL
CE0Z/LU7FOM via LU7FOM,
Victor R. Goldin, Pasaje Machado 5878,
2000 Rosario SFE. ARGENTINA

EP2AC via RV6AB
RA0LOM/0 via UA0MF
Z33Z via Z31RB

AX3ITU Send QSLs to this special event station to either one of the following addresses: Eastern and Mountain District Radio Club (EMDRC) - P.O. Box 87, Mitcham Victoria, Australia 3132 or VK3 Bureau, 40G Victory Boulevard, Ashburton Victoria, Australia 3147

EO55UK This is a special event station celebrating the 55th anniversary "Victory of Second World War". QSL to UT4UO.

EX8MF Nikolaj Bubnov (ex-UM8MFO) informs us that the Amateur Radio Union of Kyrgyzstan (ARUK) has a new address, P.O. Box 745, Bishkek, Kyrgyzstan 720017. They also have a web site at www.qsl.net/ex9hq

EO55FI Another special event station celebrating the 55th anniversary "Victory of Second World War", to UX3FW: Yuriy Kucherenko, P.O. Box 62, Izmail, 68600, UKRAINE.

SV1UN QSL to Bill Sarafopoulos, Palia Geotrisi 1, Avlon 19011 GREECE.

T92000 Boris, T93Y, informs us that he has received his QSL cards for the T92000 operation from the printers in Germany. The cards are full colour and he feels those who will receive them will be very pleased indeed. QSL cards that are to be mailed direct will be dispatched before he leaves for the Dayton2000 Hamvention in the USA, and cards going via the bureau will also be delivered to the T9 bureau before he leaves. You can request one of his cards (if you have worked T92000) by contacting him via email at bknezovi@utic.net.ba Boris is also the QSL manager for the following calls 5B4/T93Y, T93Y, T94EU and T9DX. An email to Boris will get you a card for a contact with one of these call signs.

ZL8RI, ZL9CI The Kermadec DX Association has changed the address for **ALL QSL** cards for these DXpeditions. All cards should go to Ken Holdom, ZL4HU, Kermadec DX Association, PO Box 7, Clyde, Central Otago, New Zealand. Note, this is the **ONLY** address.

Tito, LU7EE, gives the following QSL information for a few Uruguayan stations:

CX1JJ, CX1JK, CX3JE via P.O. Box 68164, Salto 50000 Uruguay or CX2AM.

CV9AM (during May 2000) via CX2ABC, P.O. Box 950, CP 11000 Montevideo, Uruguay.

CV7V via CX4ACR

Vasilij, RW6HS, advises that cards to the following stations go direct to their respective addresses.

4J4K - 370000, BAKU, P.O. Box 89, AZERBAIJAN.

4K7Z - 370000, BAKU, P.O. Box 18, AZERBAIJAN.

Recently heard DX

Les Hawkins, VK4DA, Hans Kiesinger, VK4/HE9RFF and Brian Lavender, VK4LV, have all sent me extracts from their log books. They have all logged some impressive DX, and just to prove that all those exotic call signs are not heard only overseas, here they are.

Les, VK4DA

20m Time GMT

EO551X 06:00, QSL via UR61M
 PY500 03:00, QSL via PP1CZ
 9H1GZ 14:00
 CP2A 21:20
 E3/OK1FHI * 03:30

EA9FU 04:20
 EI5HE 05:40
 EA8/SM5AXQ 08:15
 HC8N 05:30
 ZB2AZ 06:00

15m Time GMT

EY8MM 03:00, QSL via K1BV
 XV5JY/p 07:30, QSL via JA1KJW
 HS9CA 08:15
 OH0/LY2TA 09:40
 Hans, VK4/HE9RFF
 20m CW
 VY1JA (QSL via KB51PQ)
 BK2000WF
 VK9LX/mm
 8N2000
 3B8FG
 3B8MM
 RH1F (QSL via RV1AC)
 RH1C (QSL via RV1AQ)
 RH1ARS (QSL via RV1AE)
 FW/G3SXW.

20m SSB

5N2BHF
 9A4A
 V51E
 5N0WFU
 C31PR
 VK9NYR
 N4BQW/KH5 (Palmyra Island)

17m CW

ZL3NM/T16
 RM0M (AS-066)
 Brian, VK4LV
 20m CW 20m SSB
 XV5JY 9A4A
 HR1LW CT1/DJ0MW
 NH6D/KH4 CE0Y/LX1NO
 V51AS ZF2MU
 TE6U
 SV8/I2YYO
 AA1AC
 FP5CJ
 MC0CDX
 ZD7VC

17m CW

FW/G3TXF
 OJ0VR

17m SSB

VK9WI
 15m CW 15m SSB
 5B4/RW9UP XX9TKW
 OH1MM/OJ0VP2EY

DX Cluster activity

I mentioned in my first column that I intended to set up a DX cluster monitor in the shack to monitor what was happening on the bands. Well, I have made some progress towards achieving this goal. A FM900 has been converted and tuned up for the 2 metre band, the software to run on the shack computer has been acquired

and I have homebrewed an interface unit to control the audio levels to and from the TNC. However, I have not located a TNC yet. The local Ham supplier is awaiting a shipment from the USA, so it shouldn't be too long till the setup is up and running.

Computers in the shack are all very well but it doesn't (and shouldn't) make up for listening in real time on the air. The various DX nets are great places to get a feel for how the bands are performing and what paths are open to where. Listening in to the ANZA net on 14183 kHz at 05:00z daily will give you a good idea of what is happening. I managed to work V51GB, Namibia and Z22JE, Zimbabwe, while on the net.

Round up

Great news for those who need Midway Island. Bill, NH6D, and his wife have moved to this Pacific Island and expects to be there for an extended period of time. He has a new job and house. A G5RV and 160-meter antenna have been installed and he is awaiting delivery of a 1kW amplifier. QSL via N6FF.

Michael, 5H3MS, says a call district map for Tanzania can be found at the following web site. <http://www.qsl.net/5h3ms/5h3mszon.html>. The names of the districts and the respective call signs are as follows:

5H1 - Zanzibar and Pemba Island
 5H2 - Arusha, Kilimanjaro, Tanga
 5H3 - Coast, Dar Es Salaam (incl. Mafia Island)
 5H4 - Morogoro
 5H5 - Lindi, Mtwara, Ruvuma
 5H6 - Iringa
 5H7 - Mbeya
 5H8 - Kigoma, Rukwa, Tabora
 5H9 - Kagera, Mwanza, Mara, Shinyanga (including Ukerewe Island)
 5H0 - Dodoma, Singida W

A5, BHUTAN. The Bhutan 2000 DXpedition Team, A52A, has now gone QRT as of the 12th of May. Details on their web site show that the team made a total of 82,087 QSOs. CW = 42088, SSB = 37263 and RTTY = 2736. A breakdown by band is shown below.

	160m	80m	40m	30m	20m
CW	143	970	2038	3107	9989
SSB	0	174	1275	0	9278
RTTY	0	0	1	0	953
17m	15m	12m	10m	6m	
CW	6843	11177	4247	3476	98
SSB	6525	12592	3513	3768	138
RTTY	0	1477	0	305	0

My personal bias might be shining through here again, but the above figures indicate that CW is the most efficient if not the most popular mode amongst DX'ers. No doubt the quick exchange CW makes possible is important in maximising the number of stations logged/worked, but I also suspect that the dedicated operators enjoy pounding the brass. A cost analysis of the recent A52A operation indicates the cost per operator to be in the region of \$3,400. This is a lot of money in anyone's language and donations from clubs and individuals would be very welcome.

And finally for this month. Neville

Cheadle, G3NUG, sends details of a new book on DXpeditioning that has recently been published called "DXpeditioning - Behind the Scenes". Wayne Mills, N7NG, has reviewed the book and comments: "The well-crafted 'DXpeditioning - Behind the Scenes' offers a comprehensive view of virtually all aspects of a major expedition for the traveler and the DXer alike. From the early planning through to QSLing, this book offers a variety of thoughts and suggestions on every facet of the DXpedition. It is by far, the most complete 'how-to' reference available." Chapter summaries can be found on the

Nevada web site at <http://www.nevada.co.uk/book-DX.html> the book can also be ordered from the web site. All the surplus proceeds from sales of this book will be used as part of the funding for a major DXpedition, probably in March 2001

Sources

Special thanks and recognition are due to the following people and organisations. Les Hawkins, VK4DA; Hans Kiesinger, VK4/HE9RFF; Brian, VK4LV; Tedd, KB8NW; Tomas NW7US; The OPDX Bulletin; 425 DX News and The Daily DX by Bernie McLenny, W3UR.

ar

Special AX8IARU Region III Event Station

The International Amateur Radio Union Region III conference will be held in Darwin, Australia, 28 August to 1 September, 2000.

More than 100 delegates from radio societies in the Asian and Pacific regions are to attend the conference hosted by the Wireless Institute of Australia, and discuss a wide ranges of regional and

global issues affecting amateur radio.

At the conference's hotel venue a special event station AX8IARU will be on air activated by members of the Darwin Amateur Radio Club, and conference

delegates. A special QSL card is to be available.

Listen for AX8IARU on the DX bands using both CW and phone.

IARU RIII Conference Media Officer,
Jim Linton VK3PC

ar

Walking 'On Air' from Sydney to Brisbane

continued from page 29

weather was beautiful, solid sunshine from a clear blue sky, with the temperature in the high 60'sF (~20C). Can this be winter? Not for me anyway, as I now had on my full summer walking togs, thin sweat shirt, sleeves rolled up, shades and bush hat.

The road was very quiet, the reason was obvious whenever it came close to the traffic laden Sydney to Newcastle Freeway. That situation continued as I followed the Old Pacific Highway through Gosford and Wyong before branching west through Morisset to meet some distant relatives in Toronto.

Unfortunately, the two months' training with the compost laden pack hadn't quite paid off, as my left knee started to play up on Day 3, especially when going down hill, although on the bright side, no blisters - yet.

At least it was another topic of conversation for the small group of regular contacts that was building up via the repeaters, though I suspect it was a reason for doubting the sanity of 2STB.

Day 7, and a few km south of Cardiff, I exchanged the bush hat for a Westlakes Radio Club baseball cap, after meeting Robert, VK2TRA. I then had lunch with Grahame, VK2FA, who later that afternoon very kindly showed me round the area, even managing a contact to UK via his 20m mobile set-up, before inviting me to his QTH for dinner.

The evening was spent at the Newcastle Radio Club, where we heard a very interesting talk by the intrepid local explorer Graham Burgess on his adventures in Antarctica and Cape Horn, which made my little strolls look like a short walk to the shops.

An hour or so's chat about all things radio then back to Grahame's QTH to send a progress e-mail home and an Internet QSO with the States, before finally getting my head down at 0215. I was glad to get back on the road to Raymond Terrace for a rest!

However, this was possibly the worst day for the knee, which slowed me down sufficiently to prevent a visit to the

Westlakes Club after encountering Steve, VK2TST, and Club President Geoff, VK2EO on their way to the meeting.

I was also becoming a little concerned that I might not complete the approaching two longest scheduled days of Karuah to Bulahdelah to Nabic, both over 40kms, the latter including the oft warned-about "small incline" of O'Sullivan's Gap and the associated narrow, twisty road.

In the event, the knee began to improve, although I did develop a small blister on my right heel, and I successfully made both destinations before dark, having started out at first light.

Walking through the hilly terrain, I was impressed by the coverage of the Cabbage Tree repeater, which I first started to use on leaving Raymond Terrace (Day 8) and would eventually lose north of Kempsey, ten days later.

Its large service area meant that I could keep in touch with most of the people I'd contacted so far, as well as meet new friends on the road ahead.

ar

Part 2 continues next issue

REPEATER LINK

Will McGhie VK6UU
21 Waterloo Cr Lesmurdie 6076
will2@omen.net.au VK6UU@VK6BBR

of bypassing. All pins were connected as they should be, except pin 1 on the 4514, as it went nowhere. Sure enough, measuring pin 1 with a digital voltmeter showed zero volts. But would you believe after measuring pin 1 on the 4514, the circuit refused to work at all! No amounts of trying, along with turning the power on and off several times could make it work!

Pinning down the No 1 culprit

I'm sure the smarter among us would have found this clue many hours before, or designed the circuit correctly in the first place. By placing the multimeter on pin 1, a very high impedance CMOS input, pin 1 had been grounded, even with the high impedance of the multimeter. Pin 1 remained at zero volts even after the multimeter probe was removed. Just what did pin 1 do? Looking up the CMOS information showed pin 1 was a strobe input to a latch circuit. The BCD inputs go through this latch, which is in simple terms an on/off switch allowing the BCD logic into the rest of the 4514 IC.

Ahh it was all clear now. Leaving pin 1 floating was looking for unreliable operation. Even though the strobe function was not required for operation, it was important that the strobe input control of the latch circuit be told what to do. Zero volts on the strobe input inhibits the BCD from being processed by the 4514 IC and a positive voltage passes the BCD information into the rest of the 4514 for processing.

Connecting pin 1 to the supply voltage solved all the problems and did away with the magic finger. So simple when understood but it incurred many hours of frustration. The lesson, make sure all pins on an IC are correctly connected even when not used. Yes I know we all know this but sometimes expediency results in shortcuts and you pay. If you have made up the DTMF decoder from October 1998 Amateur radio, tie pin 1 on the 4514 to the 5 volt supply rail.

More Time

The repeater Controller information referred to in June is not yet available and will be published as soon as possible. Another unit has gone into testing on a new UHF repeater in Perth, VK6RVP

ar

The Fickle Finger of DTMF Frailty

Amateur Radio, October 1998 described a DTMF decoder on page 18.

The circuit decoded DTMF tones using the MC145436 IC followed by a BCD to 16 digit decoder chip, the 4514. All fairly standard, and I had put the two IC's together to produce the final logic output of digits 1 to C (D cannot be decoded due to its BCD code being 0000).

All worked well except for an occasional funny. I use this circuit for controlling various remote devices, such as a 2.4 GHz television repeater for electronic news gathering (ENG). Many live stories on the television news have to go via a high vantage point repeater. This typically has a 2 foot dish that has to be panned and tilted so as to point at the ENG vehicle. Other functions, such as "on" and "off" can be controlled via DTMF as well.

The problem with the DTMF decoder described is that some would not always work as they should all the time. For days on end the circuit would work without a fault, decoding every digit correctly every time. But every now and then the decoder would either decode the wrong digit or not decode at all. One decoder board's difficulties could not be resolved despite checking and re-checking the board. Every solder joint was re-soldered, even though the problem did not appear to be mechanical. In the end another board was constructed and this one worked.

Now comes the strange one. The remote pan and tilt of a small camera, required a DTMF decoder. A circuit was made up from the (mostly) trusty DTMF decoder design. It drove a series of 4 relays for the left, right, up and down action of the camera, relay 1 turning on when digit 1 was pressed etc. Well, it worked at first, then became unreliable with Digit 1 pressed and relay 3 operated some of the time. It would work for long

periods and then behave randomly. Any digit between 1 and 4 could result in any relay between 1 and 4 operating, but not always corresponding correctly.

Magic Finger

An inspection showed correct wiring with no soldering problems. Tapping the board indicated the fault was not mechanical, but revealed a strange phenomena.

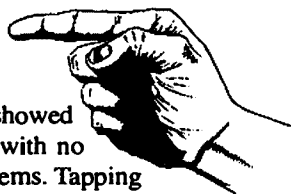
As soon as a finger came near the circuit board, the DTMF decoder behaved correctly! Yes a magic finger coming within 2 centimetres of the board, even without touching, fixed the problem. Even with the wrong relay activated, waving the magic finger near the board caused an instant correction! Extra capacitor bypassing was installed all over the board with no result.

Including a finger permanently on or near the circuit board posed logistic problems. Perhaps other non-animal material might work. Sure enough a screw driver worked as did an all-plastic tuning tool. Any object coming within a couple of centimetres of the circuit board, and in particular the 4514 DCD to 16 decoder, fixed the problem. Especially so near the pin 1 pin 24 end of the 4514.

But if the object was laid on the circuit board and left, the problem persisted. It appeared that human contact was needed. Many readers would be saying the human body is a big pick-up device and is just an extension of the human body. This turned out to be right.

Now for a close look at the circuit. There must be a design fault as these boards had shown sporadic unreliability.

The problem did not appear to be lack



SPOTLIGHT ON SWLING

Robin L Harwood VK7RH
5 Helen Street, Newstead Tas 7250
(03) 6344 2324 Email: rharwood@primus.com.au

Always surprises on Shortwave

I have listening for unusual signals which pop up around this time of the year. Disappointing so far, nothing has been observed. But there has been much happening on shortwave.

The Darwin transmitters were leased to an English Christian fundamentalist group and Radio Australia shut out from using their previous site near Darwin. The ABC vigorously protested, but the Government seemed to think that the inadequate facilities at Shepparton and at Brandon were sufficient for Radio Australia.

At the same time, there were two coups in the South Pacific, the first in Fiji. Gunmen seized the Parliament complex, holding senior officials hostage to restore domination of the indigenous population over the substantial Indian minority. At printing, the situation is unresolved.

Fiji is not on shortwave and has not been active since the early seventies. The foreign media has been the major source of news of the conflict in Suva, although a domestic website was providing excellent local information..

The second coup was in the Solomon Islands to the north of Fiji. This has not captured the attention of the world's media. There has been an ongoing struggle between two ethnic groups on the main island of Guadalcanal, of which Hoonoraria is the capital. The island was the site of a major battle in WW II.

A tribe from the neighbouring islands came to the main island after the war. The local people resent the newcomers obtaining land, hence the dispute. The situation on Guadalcanal has deteriorated.

The Solomon Islands have been on shortwave for many decades, being easily heard in the evening hours in Australia on 5020 kHz. On sign off, they relay the BBC World Service overnight. It was ironic to hear news of the coup via these facilities seized by the rebels.

Bouganville is another hotspot. It too has seen another ethnic conflict between the Nuigini government and local inhabitants wanting their own nation. A

costly civil war was ended with Australian and New Zealand participation in a supervising peace force.

Shortwave was extensively used in a propaganda war between Port Moresby and Bouganville. A clandestine operation was mounted on the island and also the Solomon Islands, known as *Radio Free Bouganville*, using a converted Ham transmitter. I have no details on its current status. It was on 3899 kHz but I have not heard it for some time. A clandestine station backed by the Nuigini government was based at Rabaul and known as Radio North Solomon. This is active on the 90-metre tropical allocation and is no longer classified as a clandestine station. It may have been moved to the nearby Buka Island, just off Bouganville.

Nuigini itself is somewhat unstable and it would be interesting to monitor the various provincial stations on the 90-meter allocation plus the national station on 4890 kHz from Port Moresby. Next door, the Indonesian province of Irian Jaya has been recently renamed West Papua. There has been a guerrilla war going on since Indonesia got this former Dutch colony in 1962. The several Indonesian stations located in West Papua are easily heard here in Australia.

Conflict continues within Indonesia, particularly at Aceh, on the northern tip of Sumatra and also on the island of Ambon in the Molucca Islands. The political situation in Jakarta is very fluid. The national station is heard around the clock on 15150 kHz in Indonesian. Various provincial stations can be easily heard, on tropical band allocations.

The Philippines are also unstable with an insurrection on the main southern island from Islamic militants. Tourists were kidnapped from a Malaysian resort and forcibly taken to a Filipino island as hostages. I am informed these rebels use SSB transceivers on HF.

This region is historically a source of piracy, with only the technology changing over the centuries. Now pirates hide out

among thousands of small islands and use fast craft to get to vessels, overpower or murder the crew and take the cargo, money and occasionally ship. The local navies are too small and ill-equipped to cope.

The Strait of Malacca, between Malaysia and Indonesia is a site for these pirate attacks, as is Borneo and the Philippines. The pirates use HF for their communications and operate on any frequency they choose. They relocate often and use local dialects. A former Intruder Watch co-ordinator ascertained that they were using 20 metres and taped their conversation, which was translated and confirmed as pirate communications.

Piracy was also a problem off China but the authorities cracked down very severely and arrested the Indonesian and Filipino perpetrators.

A few years ago, pirates attempted to seize a Russian cargo vessel near Manila, but it turned out to be a Naval vessel and they were beaten back. The International Maritime Organization is concerned at the proliferation of piracy which is severely affecting commerce within this region.

This winter, propagation on the lower frequencies around the local midday has been disappointing, yet propagation on the higher frequencies has been exceptional. I am hearing literally thousands of low powered stations between 25 and 30 MHz.

Some channels have continuous heterodynes and quite extensively used. Some are even using FM for their communications. Most of them are using Asian languages but there are quite a number of Spanish speaking stations also. These are probably located in Latin America. I also note that the 18 MHz amateur allocation is open worldwide during daylight hours.

Well that is all for July. Keep listening and see what you can hear because there are always surprises to be found on shortwave.

ar

POUNGING BRASS

S.P. Smith VK2SPS
4/6 Taranto Rd Marsfield NSW 2122
(H) 02 9876 8264 (M) 0419 602 520

Pounding Brass Article Menu

Since taking over this column some years ago I've had numerous requests for certain articles to be repeated.

If the response is good for a particular article, I will repeat it at a later date with updated information if I think it is required.

Here is a list of articles, which appeared in this column, starting with the first issue and running through to the current issue (1 to 83). Due to space limitations part two of this article will appear next month.

Issue	Month	Year	Article Contents	Issue	Month	Year	Article Contents
1	July	93	Introduction about myself	22	May	95	Pt 2 on Filters plus circuits & construction
2	Sept	93	Learning Morse Code	23	June	95	Not included
3	Oct	93	Samuel F.B. Morse .	24	July	95	Miscellaneous subjects
4	Nov	93	Overview of the American Telegraph	25	Aug	95	Book Review "Story of the Key"
5	Dec	93	How the Telegraph came to Australia – part 1	26	Sept	95	Telegraph Poems
6	Jan	94	- part 2	27	Oct	95	CW Operators QRP Club. Introduction to Low Key
7	Feb	94	140 Anniversary of the first Australian Telegraph circuit	28	Nov	95	Fist Club of the UK
8	Mar	94	Types of codes ie 1832, 1838, 1844, Bain & 1851	29	Dec	95	NSW Morse Practice Net VK2BWI
9	Apr	94	Letters from members	30	Jan	96	Book Review "The Secret of Learning Morse Code" by Mark Francis GOGBY
10	May	94	Practice Nets	31	Feb	96	Chemical Telegraph
11	June	94	Victorian Morse Nets	32	Mar	96	R.S.T System plus Key clicks & chirps
12	July	94	Victorian, Sth Aust & Old Morse Nets	33	Apr	96	High Speed Telegraph "World Championships"
13	Aug	94	Learning Morse "Morse Cassettes"	34	May	96	Home made Key by Dr J. Lycett GOMSZ – part 1
14	Sep	94	WIA Morse Cassettes	35	June	96	- part 2
15	Oct	94	Morse Programs, British Morse Keys & QRP News	36	July	96	Restoring Knobs & Thumb pieces on Keys & Paddles
16	Nov	94	Sydney Morsecodians Fraternity	37	Aug	96	Introduction to Manual, Semi-Auto & Electronic Keys
17	Dec	94	IC's 8043, 8044, M, B & ABM Versions	38	Sep	96	What to look for in a Paddle
18	Jan	95	Iambic Paddles	39	Oct	96	Bencher Paddle. History, mechanics & adjustments
19	Feb	95	Circuits relating to the 8044 ABM chip	40	Nov	96	QRP Club of Ireland
20	Mar	95	Poem & movies which include morse code				
21	Apr	95	Book review on J-Keys also Passive LC Filter Kit				

Until next month, Best of Wishes

Stephen P. Smith VK2SPS

Many a slip on the way to the true story

Part 2

The Initial Years of the Wireless Institute of Australia (WA)

(continued from last month's AR)

D. Handscomb, VK6ATE,
P.O. Box 39, Quinns Rocks, W.A., 6030,
Ph: (09) 9305 7297

The Tasmanian Division was formed in June 1923 so the organisation could then truly be called "The Wireless Institute Of Australia".

Another example of Historical inaccuracy in Wireless Institute matters came to light as I was looking back through some early copies of *Amateur Radio Action* in an account of the origins Vol.3 No. 7 (also in *Amateur Radio* October 1984, Page 10) is an account of the origins of the VK/ZL Contest, and a copy of the Certificates awarded for the Centenary Contest of 1934. At the bottom, it quite clearly (and, in my opinion, erroneously) states "WIA founded 1914".

The situation at Federal Level, I conclude, especially in those early days is just as inaccurate. In November 1923, The Chief Manager of Telegraphs & Wireless in Melbourne (Mr. Jim Malone) had written to various Scientific Institutions and Wireless clubs, suggesting the formation of a Council, or Executive, with whom he could consult, knowing that it was representative of experimental interests throughout Australia. A meeting was called by Professor Ross (at that time he was Honorary President of the WIA (WA Division) for December 17th 1923. It was attended by a large number of members of the Wireless Institute as well as representatives of The Wireless Development Association, Subiaco Radio Society, Mt. Lawley and Fremantle Radio Clubs (being those clubs in existence at the time) Mr.G.A. Scott (Radio Inspector

of W.A) also attended by invitation the result being the formation of "The Committee of Affiliated Radio Societies of WA".

Similar meeting had no doubt been held in the eastern states. As a result, a Convention was held in Melbourne on May 16th 1924, WA being represented by Mr. Howden 3BQ and Mr. Cox 3BD as proxy delegates.

The next (2nd) Convention Of The Wireless Institute Of Australia was held in Perth from August 7th to 8th 1925, in the Conference Room at 6WF

- Mr B Holt President of the WIA (W-A-Division) was Chairman.
- Mr W Phipps (6WP) was Proxy Delegate for Queensland.
- Mr WE Coxon (6AG) and Mr.A.E. Stevens (6BN) were WA delegates.

From interstate:

- Mr C E Ames (5AV) represented South Australia.
- Mr H W Stowe (2CX) represented New South Wales
- Mr B I Masters (3LM) represented Victoria
- Mr P O Fysh (7PF) represented Tasmania
- Mr J Park (6BB) acted as Secretary
- Mr F Goldsmith was the official Reporter. (He later became VK6FG)

There were 27 items on agenda, the main one undoubtedly being Item 13:

"The uniformity of the Institute's rules and the formation of a Federal Executive."

The opening of the 3rd Session of the Convention (Saturday August 8th) began with Mr. Masters proclaiming:

"I wish to move that we immediately form a Federal Executive of the Wireless Institute of Australia".

He went on to explain, "To form a Federal Executive, we must have uniformity of the various constitutions of the states. As far as the Federal Executive is concerned, I would suggest: President, Secretary and Treasurer and a Board to be comprised of one representative from each state".

Much discussion followed as to the election of Federal Officers.

- Mr Stowe (2CX) nominated as President: Mr Phil Renshaw 2DE, the motion being supported by Mr.Masters. (3LM)
- Mr Stevens (6BN) nominated as Treasurer: Mr Stowe (2CX)

Mr. Masters moved that, "This being the first election of the Federal Executive the election of Secretary be left in the hands of Mr. Stowe in conjunction with the President (Mr. Renshaw) to be dealt with when Mr.Stowe returns to New South Wales: It is no good nominating a man unless we know he is willing to act." Presumably, Mr.Renshaw had been approached beforehand as to the likelihood of his being nominated as the First President of the Federal Executive.

Yet, in The W.I.A. Book Vol.1 (Page 12) under the heading "Federal Presidents" we see that the Federal President for 1924 (the 'year' shown meant the last or major part or all of the

year!) was H K Love 3BM, and the Federal Vice-President/Vice Chairman of the Executive was Ross A Hull 3JU,

If, as is noted in the minutes of the 2nd W.I.A. Convention, held in August 1925, "This being the first election of the Federal Executive" (said Mr. Masters), then how could Mr. Love & Mr. Hull have been Federal Chairman/Federal Vice President *the year before the Federal Executive had been suggested?*

Please don't misunderstand me, I would do nothing to detract credit from these two worthy gentlemen, but were they appointed for 1926 at the 3rd Convention? Certainly, Mr. Holt was *not* the Federal President for 1925. It was pointed out in Perth that WA would cease to be the centre of the Institute once the Convention was finished. Mr Holt was Chairman of the Convention only because he was President of the Institute in WA. However, he *was* appointed the. Federal Councillor for WA by the local branch for 1925-26. Just how much this involved is not clear, but neither he nor indeed anyone

else from WA was to attend another Convention, probably until 1938.

Back to the 2nd Convention. After deciding on the composition of the Executive discussion turned to the location of the 3rd Convention, Mr Masters moved that it be held in Sydney, next year "about July". He went on "Some of the eastern states have been put to great expense in coming over to WA. If we hold it in Sydney, we may have a chance of bringing in Queensland".

Who Was Elected The First Secretary Of The Institute ?

And what of further conventions? I have been able to fill in a few gaps but there are many more questions to be asked. If anyone is able / prepared to help me with information, relating to the development of experimental/amateur radio in wa (vk6) this would be most gratefully welcomed. i would also be grateful for any information / recollection /qsls etc. connection with Wally Coxon (sk) ?/

XYK/6AG/OA6AG/VK6AG.

I would like to thank Colin VK2DYM for information provided so far, and for continued encouragement in researching and writing about The Development of Wireless in Western Australia.

My thanks also to the Council of the Wireless Institute of Australia (VK6 Division) for allowing me access to the Minutes of the Division.

Any opinions expressed during this article are solely those of the author

ar

HEALESVILLE AMATEUR RADIO GROUP Inc.

HAMFEST

The Club has decided not to hold our HAMFEST in October 2000

Instead it will be held on the last weekend in

February 2001

Radio and Communications

Incorporating AMATEUR RADIO ACTION and CB ACTION

Edited by Chris Edmondson, VK3CE

PO Box 123, Eagle Heights, Queensland 4271 PH (07) 5545 0666 * FAX (07) 5545 0622

Chesterfields in COLOUR!

Hey, we've gone to **FULL COLOUR!** Check out our lead story in the August issue, on sale July 26

Know someone who could benefit from the WIAQ-sponsored ARCS Scheme? Learn amateur radio Easy way!

Download your FREE copy of ARCS from <http://www.radiomag.com> today, and spread the good word!

The August issue of Radio & Communications is fit to burst! It's simply bulging with it's usual crop of super yarns! Don't let everybody else tell you what you missed ... find out for yourself!!!

Oh, and if you're quick, the action-packed July issue is still out there too.

We have the biggest collection of radio-oriented Classified adverts in the country. There's lots of them because they work so well. Ask your newsagent to keep a copy for you each month. Hurry — you might miss something!

Don't miss out — RADIO and COMMUNICATIONS is great reading for amateurs!

Check your local newsagent today!

HF PREDICTIONS

by Evan Jarman VK3ANJ

34 Alandale Court, Blackburn Vic 3130

These graphs show the predicted diurnal variation of key frequencies for the nominated circuits.

These frequencies as identified in the legend are:-

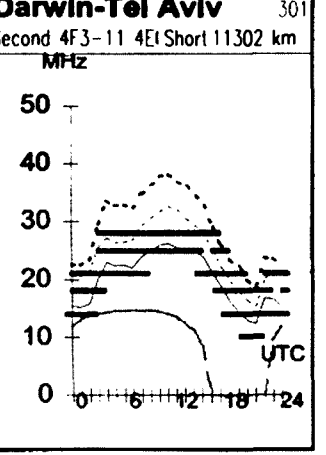
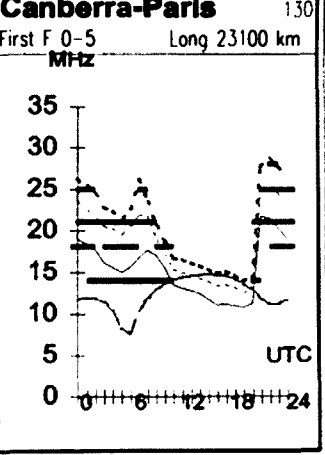
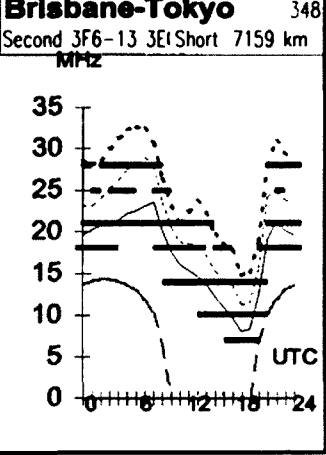
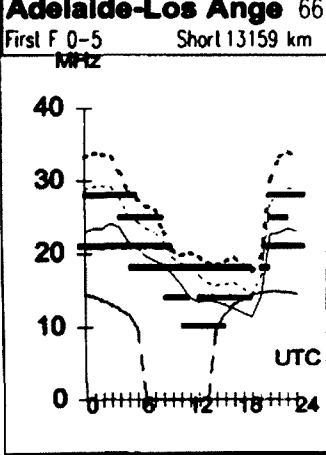
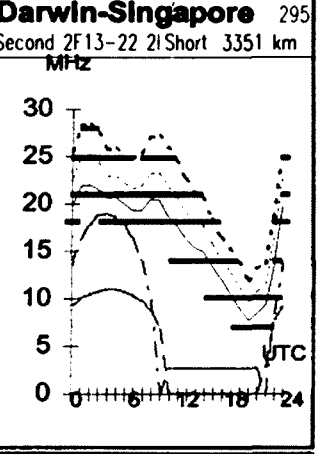
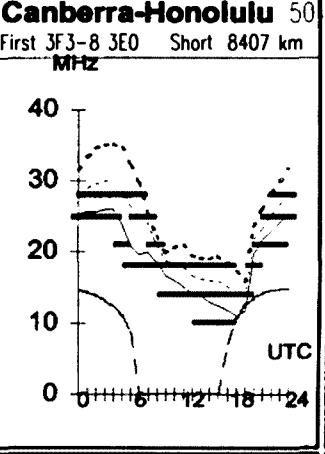
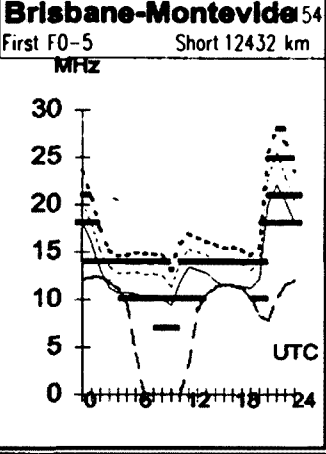
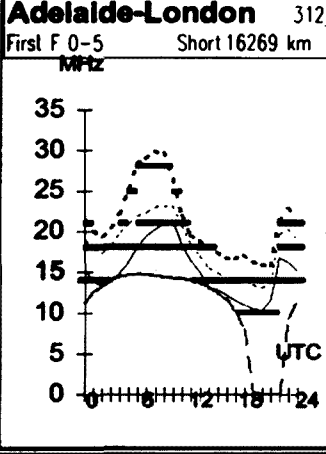
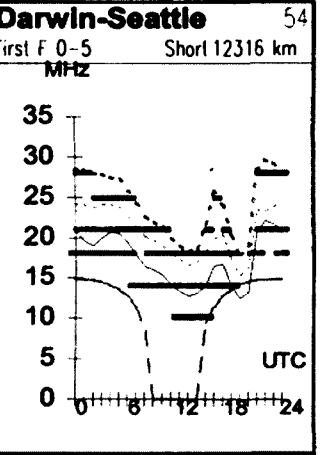
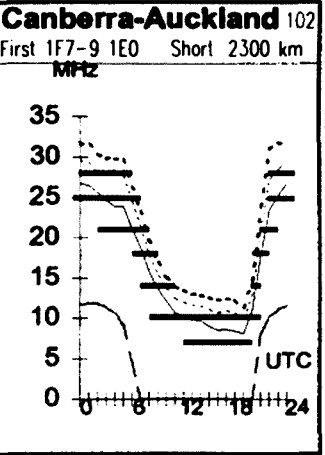
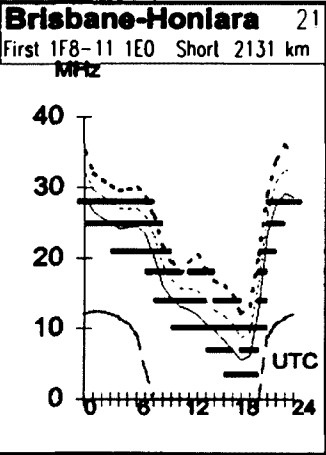
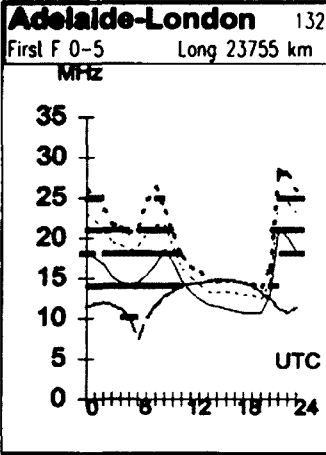
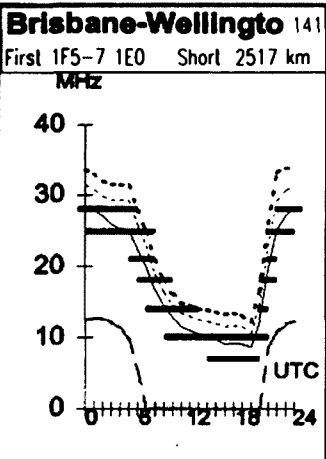
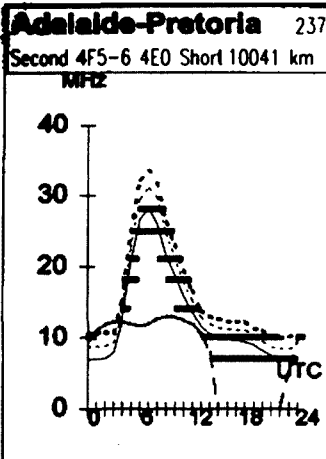
- Upper Decile (F-layer)
- F-layer Maximum Usable Frequency
- E-layer Maximum Usable Frequency
- Optimum Working Frequency (F-layer)
- Absorption Limiting Frequency (D region)

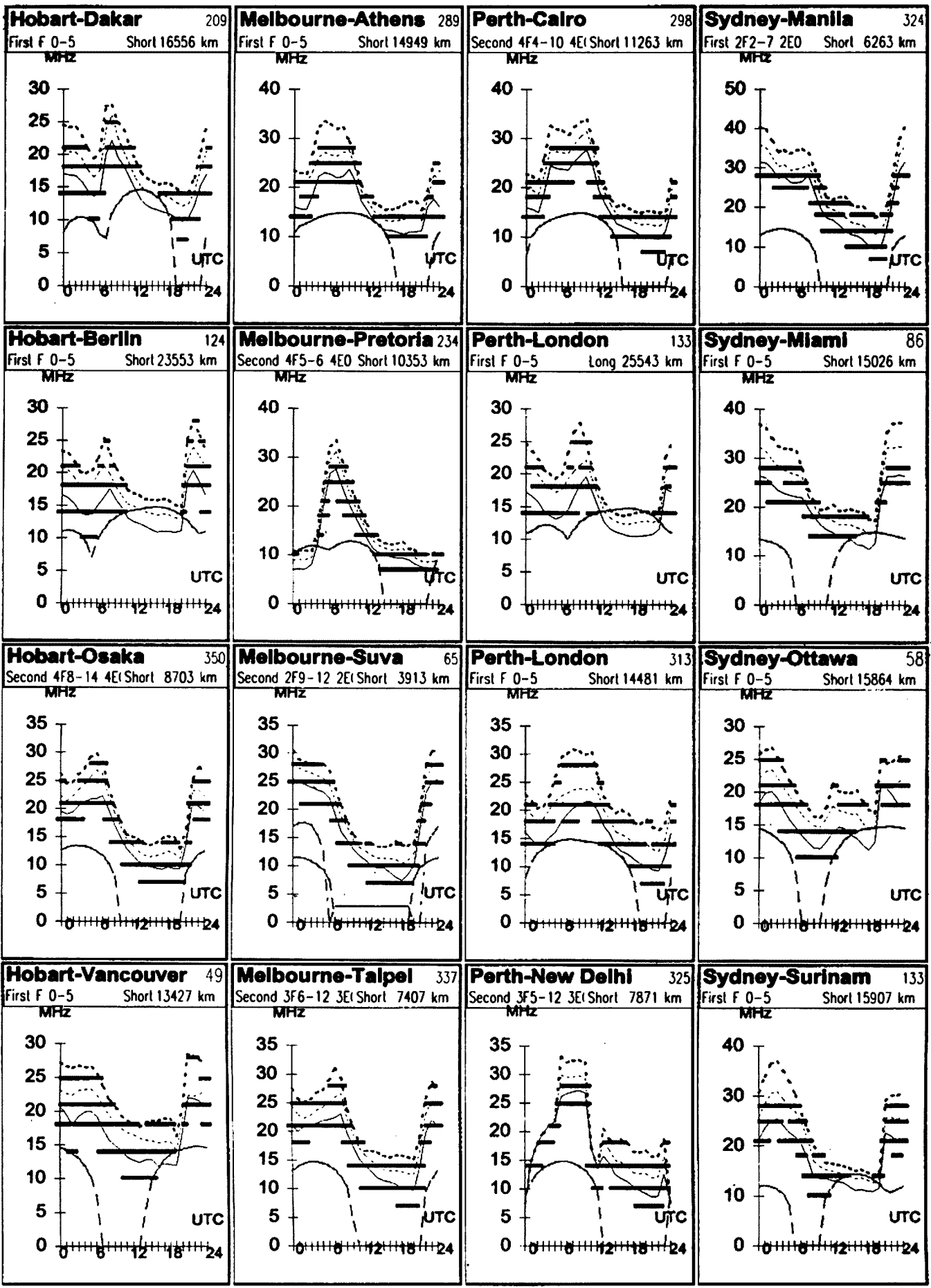
Shown hourly are the highest frequency amateur bands in ranges between these key frequencies, when usable. The path, propagation mode and Australian terminal bearing are also given for each circuit.

These predictions were made with the Ionospheric Prediction Service program: ASAPS Version 4

July 2000
T Index: 141

Legend
UD
E-MUF
E-MUF
OWF
ALF
10%
50%
90%
Frequency scale
Time scale





HAMADS

- Hamads may be submitted on the form on the reverse of your current Amateur Radio address flysheet. Please print carefully, especially where case or numerals are critical.
- Please submit separate forms for For Sale and Wanted Items, and be sure to include your name, address and telephone number (including STD code) if you do not use the flysheet.
- Eight lines (forty words) per issue free to all WIA members, ninth and tenth lines for name and address. Commercial rates apply for non-members.
- Deceased estates Hamads will be published in full, even if the ad is not fully radio equipment.
- WIA policy recommends that the serial number of all equipment for sale should be included.
- QTHR means the address is correct in the current WIA Call Book.
- Ordinary Hamads from members who are deemed to be in general electronics retail and wholesale distributive trades should be certified as referring only to private articles not being re-sold for merchandising purposes.
- Commercial advertising (Trade Hamads) are pre-payable at \$25.00 for four lines (twenty words), plus \$2.25 per line (or part thereof), with a minimum charge of \$25.00. Cheques are to be made out to: WIA Hamads.
- Copy should be typed or in block letters, and be received by the deadlines shown on page 1 of each issue of Amateur Radio, at:

Postal: Newsletters Unlimited, 29 Tanner Street, Richmond, 3121

Fax: 03 9428 4242 **E-mail:** news1@webtime.com.au

Please only send your Hamad once

Please send Hamads by mail OR fax OR email (much preferred).

Please do not send by more than one method for any one ad or issue, it is confusing.

FOR SALE ACT

- Crystals HC6 1/2 inch pin spacing 2330 to 2420 kHz in 10kHz steps, 10 in all. Also 2270 to 2279 kHz in 1kHz steps, 10 in all. Also 10, 5, 2, 1 MHz \$4 ea ono. FT 243 base with bases 3500, 3680, 3800, 7175, 7425, 6900, 7000, 7150, 8000, 8988, \$4 ea. List available. VK1US QTHR 02 6281 3587

FOR SALE NSW

- Telephone 'Ericofon' 1965 model in working order, colour cream, excellent condition. Best offer? Contact Laurie VK2GBM 02 6495 9707 QTHR
- Yaesu FT 101B, Transceiver FV 101 External VFO/Station Clock, 100 watts output, NEC PA tubes, AM, SSB, CW, AC/DC, operation, owners manuals, excellent condition, same owner since new, \$350. Kenwood MC80 desk mike \$100. Shure 404C hand mike, new \$125. Kenwood PS-52 Power supply, new in carton \$495 VK2SUS 02 9897 5440 QTHR
- Kenwood TS830S xcvr, remote VFO 240, Shure 444 mic, collection of AR and R & C magazines \$800 the lot. John VK2FO QTHR Ph & fax 02 4457 1510
- One light weight morse code key \$5.00 One mobile gutter mount antenna rack with 11m antenna \$5.00. One KRACO 11m 24 channel CB S/N 805477 with crystals to convert to 10m \$100. VK2KRQ. John Le Fevre 02 4369 0458 12A Rickard Road Empire Bay NSW
- Yaesu FT107M H.F. Transceiver. Inbuilt AC power supply, plus 13.8 V DC., WARC, Mint

condition with YM35 Hand mike and YM38 Desk mike, and tech. manual. Fully functional. Boxed with all leads and plugs. Original owner \$450 plus freight. Allan VK2AGR 02 4471 1059

WANTED NSW

- Hy-Gain antenna rotator CD-44, Ham II or Ham IV, Bencher BY-1 iambic keyer, Kenwood TS-870 transceiver control software, Swisslog logging software. Tom VK2OE ph 02 9793 2347 (evenings) or vk2oe@arrl.net
- CW transmitter for use on 20m with 813 as final amplifier, complete with power supply and in working order. Commercial or home-brew. Will pay freight from interstate. Ben VK2AJE 02 4457 3220
- Old junk or unloved receivers for completely mad receiving monitoring museum person. People have come close to giving me a hernia. So give me a call. Colin McKinnon's old BL348 found!. Anyway give me a call before the tip! John L21068 02 9533 6261

FOR SALE VIC

- Kenwood TS 820, VFO 820, SP 520, MC 50 Emtron EAT 300A tuner, Kenpro KR400 rotator, TET TE 33 triband beam \$1300. PC 686 P150 & CPUC 120 MHz 3.2 Gig HDD CD ROM 1.44 FDD, 32 meg RAM monitor, keyboard, mouse, BJC 210SP printer \$650. Derek VK3DD 03 9730 1557 (AH only)
- Vibroplex iambic paddle, as new \$160. David VK3DNG 03 9859 4698, email: roddada@rvib2rvib.org.au

• Drake TR7 250W transceiver with PS7 power supply, covers all hambands including WARC receivers 0-30MHz, extras 1.8kHz, 6kHz filters, fan, slow dial drive, Shure mic, shop manual, recently serviced by Drake expert. \$1200 ono. You collect. VK3WW 03 5433 3654

• Yaesu FRG-100 communications receiver 50kHz - 30MHz with FRG-100 keypad for freq. Entry etc., DSE cat (P115) No D 2790 E C \$725. Antenna rotator Kenpro model KR650XL with control unit, rotation 450 degrees, VGC \$400. Len VK3BMY 03 5862 3116 all hours.

• White Elephant Sale. The EMDRC will hold this event on Sunday 30 July 2000 at the Great Ryrie Primary School, Great Ryrie Street, Heathmont, Melways. 49 K11. Doors open 10:30am, table bookings ph: 03 9873 2459 AH or E-mail: emdrc@netspace.net.au

WANTED VIC

- Circuit, manual for tempo VHF FM xcvr model FRT/203 manuf'd by Sankyo Tokushu Musen Co. Circuit, manual for Leader Signal Generator model LSG-10. Circuits for BWD502 and BWD511. Brian VK3WYN 03 5664 1251 QTHR
- Icom IC-481H, 70cm transceiver. Ian VK3MZ 03 9876 3643 or i.stirling@bhtafe.edu.au
- One Paccom PTC1 modem. Please forward details to Ian VK3AXH Ph (03)53413012 or email: igm@netconnect.com.au

FOR SALE QLD

- 2m xcvr TR 7800 \$180, FT 726R 2m/70cm, satellite board \$800. 6m board, also \$200 (both \$950, neg) FL2100Z and spare 572BS \$700. Tentec dual-paddle key \$50. SMPS 13.8v 30A \$200. 148 MHz Stainless Yagis, 70cm crossed Yagi. VK4APD QTHR 07 3397 3751
- Yaesu FT101B HF transceiver with Yaesu FV101 external VFO/clock, AC/DC operation, 100 watts output, SSB, AM, CW, complete instruction manuals, same owner since new \$350. Includes freight. John Abbott VK4SKY, 0417 410 503, email: interfs@netscape.net, PO Box 1166 Coolangatta 4225 Qld.

WANTED QLD

- Plug in coil boxes for HRO-5T comm. receiver, also National HRO for parts and power supply, WWII suitcase tx/rx type 3 Mark II, also known as (B2). Pay top money. Ray VK4FH PO Box 5263 Daisy Hill 4127, 07 3299 3879, fax 07 3299 3821
- Circuits & handbooks for Philips FM 828 VHF sets. Len VK4JZ QTHR 07 5485 3324

WANTED SA

- Operators manual for Nokia 1600 mobile phone, model No NHE-5NC. Photocopy will do. VK5MAP Paul QTHR 08 8651 2398
- R1155 Communications receiver (WWII vintage ex-RAF). VK5AMR QTHR 08 8278 5118 or email mwrieger@senet.com.au

FOR SALE WA

- Yaesu FT707HF with hand mike \$300. Antenna HB 35c 3el tri-beam \$250. Galv pipe 12m with guy wires, fittings \$40. Coax R6.8 30m \$45. Colin VK6ZB 08 9725 8680
- Yaesu FT101E later model (no 27MHz) as is — offers? with DC leads. Must sell. SE 502 23ch converted CB rig 28.300 - 28.600 MHz. DC leads. Any offers? D Handscomb 08 9305 7295
- One 14 m 3 stage windup tower. One 4el triband antenna. One rotator. To be taken down. W Coertse, 120 Calista Ave. Calista WA 6167 08 9419 3879

FOR SALE TAS

- Tono 150W o/p 2m metre linear multi-mode. Kenwood TH78A dual band hand held inc access. Okerblock HF/2m SWR power meter. Dual meter HF SWR power meter, above as new, will negotiate. Boxes, manuals etc. Must sell. David VK7ZDJ 03 6425 2030, 0413 219 680

WANTED TAS

- Vibroplex semi automatic morse key, in good condition. Ph 03 63918925 or email jmcullloch@vision.net.au

FOR SALE NT

- ARDF rxs 2m VK4BRG, kits assembled, working, with antennas. 6 only, bought for Scout operation, not used, \$300 the lot or \$100 each. Frank VK8FT QTHR 08 8983 2954

MISCELLANEOUS

- If you got your licence before 1975 you are invited to join the Radio Amateurs Old Timers Club. A \$2.50 joining fee plus \$8.00 for one year or \$15.00 for two years gets you two interesting Journals a year plus good fellowship. Arthur Evans VK3VQ or Allan Doble VK3AMD can supply applications forms. Both are QTHR in any Call Book.
- The WIA QSL Collection (now Federal) requires QSLs. All types welcome, especially rare DX pictorial cards, special issue. Please contact the Hon Curator, Ken Matchett VK3TL, 4 Sunrise Hill Road Montrose VIC 3765, tel. 03 9728 5350.

<http://www.hamsearch.com>
a not-for-profit site that is a search engine for hams

ADVERTISERS INDEX

ATN Antennas	7
Andrews Communication Systems	19
Icom	37
Radio & Communications	51
Tower Communications	55
WIA Call Book.....	IFC

TRADE ADS

• AMIDON FERROMAGNETIC CORES:

For all RF applications. Send business size SASE for data/price to RJ & US Imports, PO Box 431, Kiama NSW 2533 (no enquiries at office please ... 14 Boanyo Ave Kiama).

www.cyberelectric.net.au/~rjandusimports
Agencies at: Assoc TV Service, Hobart; Truscotts Electronic World, Melbourne and Mildura; Alpha Tango Products, Perth; Haven Electronics, Nowra

• **WEATHER FAX programs** for IBM XT/ATs *** "RADFAXZ" \$35.00, is a high resolution short-wave weather fax, Morse and RTTY receiving program. Suitable for CGA, EGA, VGA and Hercules cards (state which). Needs SSB HF radio and RADFAX decoder. *** "SATFAX" \$45.00, is a NOAA, Meteor and GMS weather satellite picture receiving program. Needs EGA or VGA & WEATHER FAX PC card, + 137 MHz Receiver. *** "MAXISAT" \$75.00 is similar to SATFAX but needs 2 MB of expanded memory (EMS 3.6 or 4.0) and 1024 x 768 SVGA card. All programs are on 5.25" or 3.5" disks (state which) plus documentation, add \$3.00 postage. ONLY from M. Delahunty, 42 Villers St, New Farm QLD 4005. Ph 07 358 2785.

Email address for Hamads is
news1@webtime.com.au
(don't forget the '1', as in the first 5 letters of 'newsletters')

Thanks for the email

We're overwhelmed and pleasantly surprised

For some time we had been hearing grumbles about late delivery of AR into far flung and not so far flung places. So we asked you to let us know by email when you got the magazine and where you were.

This data would tell us if there was a general lag in delivery and/or it would tell us if any particular locations were excessively slow, as sometimes the magazines would clear the lodgement office and then sit around in the regional centres.

The June magazines were lodged or posted in Melbourne on the evening of Wednesday 7th June, and, with a long weekend coming up in most of Australia and fairly heavy mail traffic with the GST and health registration build-up, we were not expecting much until the following Tuesday.

But by 9am Friday 9th the wires were buzzing, reporting a delivery to a private box in Sydney.

Thirty-six hours for one thousand kilometres by 'second class' mail is pretty good.

TRADE PRACTICES ACT

It is impossible for us to ensure that the advertisements submitted for publication comply with the Trade Practices Act 1974. Therefore, advertisers and advertising agents will appreciate the absolute need for themselves to ensure that the provisions of the Act are strictly complied with.

VICTORIAN CONSUMER AFFAIRS ACT

All advertisers are advised that advertisements containing only a PO Box number as the address cannot be accepted without the addition of the business address of the box-holder or seller of the goods.

For All Your Requirements

AUTHORISED DEALER
ICOM
KENWOOD

AMATEUR COMMERCIAL
MARINE COMMUNICATIONS

 **Tower**
Communications

14 Mary Street
Hazelmere

Western Australia 6055
Telephone: (08) 9274 1118
Facsimile: (08) 9250 3734

E-mail tower@comnet.net.au

www.towercommunications.com.au

By Friday evening (10th) most of Victoria and much of NSW had their magazine and on the following Monday WA people were responding, they didn't have a holiday.

By the following Tuesday (13th) we had responses from everywhere in Australia and by Wednesday morning (14th) every State and Territory was represented. Three full working days to all of Australia seems OK to us.

We have yet to assess the total picture given by then 320 responses. Odd postcodes seem slow but they are few and far between. Conversely, for 'second class' mail, five working days to Humpty Doo and six to California seems fair.

We will shortly do a full analysis and present a full report but in the meantime thank you very much for your prompt and helpful responses.

John and Gill Nieman,
Newsletters Unlimited

RE 5wpm for full call

While I can see the advantages I am wondering if the majority decisions are coming from those without experience in the use of Morse. I believe that to say it is hard to learn is wrong. Typing to a usable speed can be learnt in six months with a few minutes practice each day.

5wpm is a useless speed in radio and 10 wpm is OK but most operators work at 16 wpm plus. My observations indicate that many hams operate with all the weight on the key instead of absorbing the shock in the wrist motion as taught to the commercial operators. Learning a foreign

In Praise of Morse code

Doubtless there will be many of our members dismayed at the reduction in the speed required for unrestricted access to the HF band. Their concern is both justified and understandable. There are so many of us who can't see any valid reason for this change let alone the proposed zero morse qualification in the future.

Are we to become glorified CB operators or mobile phone users, perhaps the Internet will provide some thrills for many of our anti-morse fraternity.

We all know that CW uses less of the spectrum than even SSB. With the increase in world population and subsequent increase in amateurs worldwide, surely the

Promoting Amateur Radio and improving AR Magazine

I have, tried in vain to promote amateur radio to get more young people interested in the hobby, I put two good ideas to the Council but they have not been taken up. One was to approach the Head Masters of High Schools about showing the students a short BBC video on radio. 30 minutes devoted to this project might get some interested students to go further. My other suggestion was to have a display at a well known shopping centre, such as Marion.

I wrote to the management of Marion shopping center. They did approve of such an exhibition and demonstration in their center, but the idea, was abandoned when we could not get 50 or more volunteers to man an exhibition from 9am to 5pm for six days. This I feel is a very sad reflection on the attitude of radio amateurs!

language takes many hours a day for many months, but Morse code abbreviations are recognised internationally. Further you can make a CW station with very simple equipment. It does not require an expensive 'Black Box'. I find the Morse culture with its rhythm and sound pleasant and I find it appreciated by the disabled, the blind and YLs avoiding 'ratpacks'.

We have a wonderful hobby. Why not promote its every facet. CW certainly is a good mode and doing much more for HF occupancy than phone. In contests CW gets through when all else fails. It would be nice

use of the less demanding CW mode should be encouraged. If we are trying to attract more people to the hobby by making it easier then the "tail sure is wagging the dog".

In over 48 years of being associated, with Morse code I never heard of anyone who couldn't pass 10wpm. Other higher speeds sometimes were a problem due mainly to the time limit allowable on certain courses. Anyone who seriously wants to learn Morse to 10wpm will apply himself or herself and achieve that aim. Proof of that can be seen by the long list of callsigns in the Callbook.

Someone may also be able to tell why we

Positively no disrespect is intended towards you but Amateur Radio is a very dull and mundane magazine except for DXpedition articles, and possibly one or two other items, many of the existing articles could be left out or given minimal space on alternate months in favour of more dynamic stories and articles. I have been a reader of Electronics Australia, which featured some great technical articles, and very interesting features, for example Mr. Roger Johnson writes an interesting column called Vintage Radio, this: should appeal to readers of AR, other excellent writers in E.A are Peter R. Jensen. VK2AQJ and Peter Phillips, could AR obtain the services of these writers?

Finally in my humble opinion there are

if all contests did recognise CW achievement with a certificate.

It is a shame you can no longer get simple CW transceiver kits. Would Clubs consider sponsoring a joint project? Building the kit would teach a lot more about radio than opening a "Black Box".

The reduction in CW speed required to get on HF surprises me when large numbers of retirees and early retirement people are joining the Amateur ranks. I have no argument with people using computers, I guess they do complement radio activities.

P.A. Orchard, VK2BTT,

have to follow the USA or Canada or UK. in this matter. To have a higher standard than other countries is good. I would think that a standard based on the lowest common denominator is something to be avoided.

CW gets through virtually when nothing else can.CW uses less of our resources and spectrum ... CW is distinctive..... CW makes us somewhat uniqueCW is fascinating ... CW does not have an accent ... and, CW sets us apart from the ever increasing numbers of less qualified people attempting to gain access to our facilities which they have coveted for many years.

W.P. McCarthy, VK4WMC

far too many solid state circuits that would only be of interest to a minority group from the point of view of construction let us face the facts, the advent of the solid state device has sent amateur radio down hill dramatically, from the golden age, of building your own home brew equipment with valves and very high voltages! The ubiquitous black box may be a good way to get more young people into the hobby but when CW is no longer a requirement, I suggest that we get more people interested in the golden age of valves to learn where it all began,

Michael M. Gell

Disclaimer

Opinions expressed in the Over To You page are solely those of the contributors, and do not necessarily reflect official WIA policy

MORE

GREAT

GEAR

FROM

ICOM



IC-706MKIIG

The amazing evolution of the legendary 706. Frequency coverage is expanded to the 70cm band and output power is increased for the 2m band. You get base station performance and features in a mobile rig-sized package.

IC-718 A compact HF all band transceiver.

A superior performer with simple, straight forward operation with keypad. Optional AF DSP capabilities, including noise reduction and auto notch function. It's versatile, compact and loaded with features.

NEW



NEW



IC-756PRO The HF & 6mm multimode

professional performer. 100 watts of power, newly designed 32 bit floating DSP for noise reduction and auto notch function, and AGC loop operation for wider dynamic range. Plus digital IF filter, built-in RTTY Demodulator/Dual Peak APF, and a whole lot more.



IC-2800 A totally new approach to

dual band mobile. Powerful performance on 2m and 70cm bands, remote control capability, and a first for mobile rigs... a multi-function colour LCD screen! All your information is right in front of you in colourful 3D-like characters and icons.



IC-T81 A remarkably compact quad bander.

Superb clarity on the 6m, 2m, 70cms and 23cm bands. It's water resistant, with tone squelch and pocket beep functions standard, plus you can change volume and bands even quicker with the 'joy-stick' style multi-function switch.

ICOM

Clearly Ahead

2 YR WARRANTY

See your nearest Icom Dealer, or visit our website at www.icom.net.au

August 2000

Volume 68 No 8



Amateur Radio

Tony Whitaker:
Walking
'On Air'
from Sydney to
Brisbane
Part 2

plus

*WIA, Divisional & Club News
ALARA
& regular columns*

- ★ RF Voltage Probe
(with notes on power
measurement)
- ★ Novice Notes: A Guide
to Test Equipment

Awards
Contests

Remembrance Day Contest

Gil Sones VK3AUI

Technical Abstracts:

*Crossed Field Antenna
Offset Fed Wire Element
Beam*



Callbook Listings
Frequency Listings
Band Plans
Repeater Lists
Beacon Lists
Satellite Lists
Licence Conditions
Examiner Lists
Special Interest Groups
Public Relations Notes
Radio and TV Freqs.
and much, much more!

WIA **Yearbook** **2000**

2000 is a great year to have an up-to-date call book. This YEARBOOK edition contains all of the content you have come to expect of the WIA callbook as well as some new items

It is more than a callbook, it's a Yearbook, the WIA Yearbook!

The "WIA Yearbook 2000" is now available from Divisional Bookshops and selected outlets



Amateur Radio

The Journal of the Wireless
Institute of Australia

ISSN 0002-6859

Editorial

Editor: Colwyn Low VK5UE
edarmag@chariot.net.au

Technical Editor: Peter Gibson* VK3AZL

Publications Committee Members
Ron Fisher VK3OM
Don Jackson VK3DBB
Evan Jarman VK3ANI
Bill Rice VK3ABP
Gil Sones VK3AUI

Advertising

Mrs June Fox,
Tel: (03) 9528 5962

Hamads

"Hamads" Newsletters Unlimited
29 Tanner Street, Richmond VIC 3121
Fax: (03) 9428 4242
e-mail: news1@webtime.com.au

Office

10/229 Balaclava Road
Caulfield, Victoria
Telephone (03) 9528 5962
Facsimile (03) 9523 8191
Business Hours 9:30am to 3:00pm weekdays

Postal

P.O. Box 2175
CAULFIELD JUNCTION
VICTORIA 3161
AUSTRALIA
e-mail: armag@hotkey.net.au

Production

Newsletters Unlimited (03) 9428 3458

Printer

Streamline Press, Melbourne (03) 9417 2766

Postal Service

IMS (03) 9291 5886

Production Deadlines

Advertising booking and articles for
publication 10th of proceeding month.

Hamads and advertising material deadline
18th day of proceeding month

The contents of Amateur Radio are
Copyright Wireless Institute of Australia
C 2000

General

Hams Span Three Generations	11
<i>Ian G. VK3AQU</i>	
Walking 'On Air' from Sydney to Brisbane (Part 2)	12
<i>Tony Whitaker G3RKL/VK2STB</i>	
30 Years of Service	21
50th Annual Ross Hull Memorial VHF UHF Contes Results	39, 43
International Lighthouse/Lightship Weekend	40

Technical

An RF Voltage Probe (with notes on power measurement)	8
<i>Drew Diamond VK3XU</i>	
Crossed Filled Antenna (Technical Abstracts)	18
<i>Gil Sones VK3AUI</i>	
Offset Fed Wire Beam (Technical Abstracts)	19
<i>Gil Sones VK3AUI</i>	
A Guide To Test Equipment (Novice Notes)	24
<i>Peter Parker VK3YE</i>	
Updated Transponder Designations for Phase 3D	27
<i>Bill Magnusson VK3JT</i>	

Columns

Advertisers' Index	55	HF Predictions	52
ALARA	15	Ionospheric Update	51
Awards	42	New Members	2
AMSAT	44	Novice Notes	24
Club News	16	Over To You	49
Contests	36		
WIA Division News		Repeater Link	22
VK1 Notes	31	Silent Key	7, 17, 20
VK4 Notes	31	Technical Abstracts	18
VK7 Notes	32	VHF/UHF - An Expanding World	46
DX Notes	33	WIA Comment	3
Editor's Comment	2	WIA News	3
Education	7	WIA Division Directory	30
Hamads	55	WIA Federal Directory	2

Our cover this month

REMEMBRANCE DAY CONTEST: The Adelaide War Memorial
All Honor Give to Those Who Nobly Striving, Nobly Fell That We Might Live

Contributions to Amateur Radio

Amateur Radio is a forum for WIA members' amateur radio experiments, experiences opinions and news. Manuscripts with drawings and or photos are always welcome and will be considered for publication. Articles on disc or email are especially welcome. The WIA cannot be responsible for loss or damage to any material. A pamphlet, How to write for Amateur Radio is available from the Federal Office on receipt of a stamped self-addressed envelope.

Back Issues

Back issues are available directly from the WIA Federal Office (until stocks are exhausted, at \$4.00 each (including postage within Australia) to members.

Photostat copies

When back issues are no longer available, photocopies of articles are available to members at \$2.50 each (plus an additional \$2 for each additional issue in which the article appears).

Disclaimer

The opinions expressed in this publication do not necessarily reflect the official view of the WIA and the WIA cannot be held responsible for incorrect information published.

Let us not forget...

The Remembrance Day Contest is this month. The Friendly Contest, The great Inter-Divisional Competition.

Let us not forget what it is, a time to remember those Amateurs who died in war to preserve our way of life and all that entails. Let us take a few moments to think about these people, as we wait for the RD to commence. If you have not listened to the opening address for a while, listen on the 12th.

I have to apologise to the AMSAT readers for an unfortunate glitch that removed the column from the July issue. I am working with Bill to publish the most important information this month and next, if necessary. There are more letters this month. Letters are shortening so we will be able to publish more and present the few that I am still holding.

The ACA seems to be forever in WIA news. Some changes hurt us but are temporary; others seem to be beneficial. See the Presidents Column for the latest news. My personal view is that CW activity will not change much, there will be more phone activity and possible other modes will also show a small increase in activity. Morse classes will be shorter and we will have advanced classes for the few who really want to operate on the HF bands at 10 to 15 plus WPM.

AR content is driven by what is submitted so there is less Technical material this month and the General material is a bit thin. I have had a few articles from overseas Amateur Journals selected for possible use in AR, but the specialists will already have found and read most of them and the more general ones may be less relevant to the Australian situation. This makes me wonder if they should be used as a frequent source of material for AR. However if you come across an article you think deserves a wider Australian audience please let me know.

Well I still have only looked at my 1.2GHz kit. I have practiced soldering SMDs and have modified a FM95 for 432MHz, but I have not been on air. Hope you have had a better month.

WHAT ARE YOU DOING IN AUGUST?

You should have got your station tidied up for the RD 12/13th August. VK3 are working hard to win this year. Will VK7 be able to hold off the challenge? The other major event to prepare for is JOTA 21/22nd October. The good we can do for Amateur Radio in JOTA is immense and the chances for publicity are large. Please make the most of the opportunity.

Colwyn VK5UE

Amateur Radio Service

A radiocommunication service for the purpose of self-training, intercommunication and technical investigation carried out by amateurs; that is, by duly authorised persons interested in radio technique solely with a personal aim and without pecuniary interest.

Wireless Institute of Australia

The world's first and oldest
National Radio Society
Founded 1910

Representing
The Australian Amateur Radio Service

Member of the
International Amateur Radio Union

Registered Federal Office of the WIA

10/229 Balaclava Road
Caulfield North Vic 3161

Tel: (03) 9528 5962 Fax (03) 9523 8191

<http://www.wia.org.au>

All mail to

PO Box 2175 Caulfield Junction VIC 3181

Business hours: 9.30am-3pm weekdays

Acting Federal Secretary

Peter Naish VK2BPN

Federal Office staff

June Fox Bookkeeper
Rilla Trebilco VK3IF Examinations Officer

Council

President	Peter Naish	VK2BPN
VK1 Federal Councillor	Glenn Dunstan	VK1XX
VK2 Federal Councillor	Michael Corbin	VK2YC
VK3 Federal Councillor	Brenda Edmonds	VK3KT
VK4 Federal Councillor	David Jones	VK4OF
VK5 Federal Councillor	David Box	VK5OV
VK6 Federal Councillor	Will McGhie	VK6UU
VK7 Federal Councillor	Phil Corby	VK7ZAX

Executive

Peter Naish VK2BPN
John Loftus VK4EMM

Federal Coordinators

AMSAT	Graham Ratcliff	VK5AGR
ARDF	Jack Bramham	VK3WWW
Awards	John Kelleher	VK3DP
Contests	Ian Godsil	VK3DID
Education	Brenda Edmonds	VK3KT
FTAC	John Martin	VK3KWA
Historian	John Edmonds	VK3AFU
IARU	Grant Willis	VK5ZWI
Intruder Watch	Gordon Loveday	VK4KAL
ITU Conference and study group	Gilbert Hughes	VK1GH
QSL Manager (Vks, Vko)	Neil Penfold	VK6NE
Videotapes	VK2 Division	
Web/PR	Richard Murnace	VK2SKY

ACA Liaison Team

Peter Naish VK2BPN
Glenn Dunstan VK1XX
Michael Corbin VK2YC
Wally Howse VK6KZ
Canberra Liaison Officer
Richard Jenkins VK1RJ

New WIA Members

The WIA bids a warm welcome to the following new members who were entered into the WIA Membership Register during the month of JUNE 2000.

L10177	MR M D THURGAR	VK2TH	MR J J GERHARD
L21176	MR H H BONHS	VK3DGN	MR D GREEN
L21177	MR G C OSBORNE	VK3DXL	MR D BROWN
L21178	MR C J FLAK	VK3GOM	MR G FULLER
L21179	MR J S HASLER	VK3HFB	MR B TOSELAND
L31553	MR P ERNST	VK3JIA	MR A ROGERS
VK1BKS	MR A S BROOKS	VK3KIC	MR D FRIEND
VK2BRB	MR R BOUWMAN	VK3NMK	MR M J W HURNELL
VK2FKU	MR W ROGAN	VK3TZF	MR J FREEMANTLE
VK2GFO	MR R C BROWN	VK3XAR	MR S M BUGHI
VK2HDH	MR C D MEAGHER	VK3YIL	MR I BRANCH
VK2HI	MR G BARROW	VK3ZXR	MR S MATHIAS
VK2KVJ	MR C M EDWARDS	VK5CX	MR N M BLUHM
VK2PDW	MR D W J PALLISTER	VK5NPJ	MR P JACKSON
VK2QG	MR P M REEDMAN	VK7DA	MR D APTED

Australian Licences acCEPTed in Europe

Australian Communications Authority

Dear Mr Naish,

Reciprocal Amateur Qualifications arrangements with European Conference of Postal and Telecommunications Administrations
I wish to advise that the Australian Communications Authority (ACA) has recently finalised -arrangements to establish reciprocal Amateur licensing

arrangements between Australia and the European Conference of Postal and Telecommunications Administrations (CEPT).

As you are aware the operation of Amateur stations in Australia requires a person to hold an Australian Amateur certificate of proficiency or an equivalent overseas qualification or licence before an Amateur licence may be granted.

Continued on page 4

Note – this is my last WIANews column. I'm hanging up my hat after a year of what was originally intended as a temporary fill-in assignment. I'm also standing down from the position of Federal webmaster after some four years in the job, in both official and unofficial capacities. This hopefully will free up time for me to pursue a number of personal projects. (this is my personal GST rebate: **Get Some Time back!**) – 73
Richard VK2SKY
(Thanks Richard your efforts are appreciated. Colwyn VK5UE)



Comment

Peter Naish, VK2BPN
WIA Federal President

This year is proving to be a very significant one for Amateur Radio in Australia. The WIA has been able to make great progress in a number of important areas which are of concern to all radio amateurs. Already there have been several notable achievements in 2000 and they continue to occur. Here are a couple of the most recent of these.

In line with the move in many overseas countries we have obtained permission for those with the Intermediate Grade of Licence to operate in the HF bands in the same manner as those with Unrestricted Licences, thus reducing the Morse Code qualification speed to 5 words per minute for full access to these bands. This is a vital first step to strengthening our hobby at a time when there are other methods of communication, for example the Internet, which have the potential to divert interest away from amateur radio. The great majority of amateurs have welcomed this change but there are a few full-call licencees who see it as a devaluation of their privileges. I am sorry that they feel that way but I believe that they will come see the benefits to amateur radio in due course.

I have just received confirmation from the ACA of their decision to establish reciprocal amateur licensing arrangements with the European Conference of Postal and Telecommunications Administrations, CEPT. Australia is now a participating non-CEPT country. For many years Australia has had reciprocal licensing

with a number of countries which have been negotiated on a one-to-one basis, often after considerable expenditure of inter-government effort. These arrangements will remain but will be enlarged to include additional countries covered by CEPT. The mechanism for this is the adoption of the Harmonised Amateur Radio Examination Certificate, HAREC, which is a common qualification for CEPT countries. An Australian unrestricted or limited licensee will now be able to apply for and obtain an equivalent licence in a CEPT country without further examination. The converse is also true in that a visiting licensee from a CEPT country may similarly apply for an equivalent Australian licence. It should be noted that this arrangement does not apply to the novice licence. Also, it must be noted that it will remain necessary to apply for a licence in the overseas country. The short-term visitors facility available in a number of CEPT countries whereby amateur radio operations may take place without obtaining a specific temporary licence, will not apply to Australian licensees or visitors to Australia. Further information on this

new facility is available on the WIA web site as well as the ACA web site.

At the end of August, the 11th. IARU Region 3 Conference is being held in Darwin. As you will know this is an important tri-annual event at which the countries of IARU Region 3, namely Asia and the Pacific, get together to consider and make decisions on strategic amateur radio policy. Some 70 delegates from Region 3 as well as representatives of Regions 1 and 2 are attending. I encourage you to visit the web site set up by the WIA which contains the full set of papers which have been tabled by the Region 3 amateur radio organisations and which will form the core subjects for the working group discussions. As radio amateurs you should be keep yourselves up to date on all of the WIA activities including our international policies. This is your hobby and the WIA must work to achieve your needs. The Region 3 Conference site and details of the conference papers are available via links from the WIA Federal web site at www.wia.org.au.

ar

Australian Licences acCEPTed in Europe

Continued from page 3

Currently to enable Australian Amateur operators wishing to operate whilst overseas, the ACA has had to establish reciprocal Amateur licensing arrangements with individual countries, to allow Australian qualifications to be recognised and necessary licences to be issued. Through this process the ACA maintains a comparable level of equivalent qualifications and licences that is then in turn used as the basis for granting licences to overseas Amateurs wishing to operate in Australia.

In order to simplify reciprocal arrangements for Amateur operators, the ACA, in 1996 requested CEPT approval to participate in Recommendation T/R 61-02

On 3 February 2000, CEPT extended Recommendation T/R 61-02 to include Australia as a participating non-CEPT country. This inclusion allows for the recognition of Australian Amateur qualifications by other CEPT participating countries, and removes the need to maintain many of the previous individual agreements with these countries.

However, the Australian participation in Recommendation T/R 61-02 does not replace or mitigate the need to maintain existing reciprocal licensing arrangements that Australia has with non participating countries.

Recommendation T/R 61-02 is underpinned by a common qualification agreement know as the Harmonised Amateur Radio Examination Certificate (HAREC).

This arrangement only applies in respect of the Amateur Operator's Certificate of Proficiency (AOCP) and the Amateur Operator's Limited Certificate of Proficiency (AOLCP)

The table below shows how Australian qualifications correspond with HAREC certification, and how in turn CEPT countries HAREC certification corresponds with Australian licensing types,

Australian Qualification	HAREC Equivalent	HAREC Issued by Other Countries*	Australian Licence Type
AOCP	LEVEL A	LEVEL A	Unrestricted
AOLCP	LEVEL B	LEVEL B	Limited

It is important to note that the Australian qualifications NAOCP¹ and NLAOCP² are not covered by HAREC arrangements.

*A list of participating countries is available at:-[www.ero.dk \(documentation/recommendations/TR61-02\)](http://www.ero.dk/documentation/recommendations/TR61-02).

For further information regarding, Australian licence types or operating procedures see the ACA homepage at www.aca.gov.au.

For your information, Australia is not participating in CEPT Recommendation T/R 61-01 which makes it possible for radio amateurs from participating, CEPT countries to operate during short visits in other participating CEPT countries without obtaining an individual temporary licence from the visited participating CEPT country. As such, participation in Recommendation T/R 61-02 does not remove the requirement for either Australian Amateurs visiting overseas countries or visitors to Australia, to apply for, and obtain a licence prior to operation.

On 1 September 2000 the ACA will introduce new certificates³ for AOCP and AOLCP holders. These new certificates will include corresponding HARE certification. Holders of AOCP and AOLCP certificates issued prior to 1 September 2000 may apply for a replacement HARE endorsed certificate should there be a desire by the operator to travel to participating countries, In essence holders of a HAREC will be able to apply for a licence in countries that are participating in this arrangement under Recommendation T/R 61-02 without the need to sit further examinations to prove proficiency. Similarly, overseas operators, holding a current HAREC will be able to apply for an Australian Amateur licence, as indicated in the above table.

One of the benefits of this new reciprocal licensing arrangement is that it encompasses many countries that are not presently covered by an individual reciprocal licensing agreement with Australia.

Should you wish to discuss any of these issues further please contact John Mahlberg on 02 6256 5589.

Alan Jordan, Manager,
Radlocommunications Licensing Policy Team

- 1.NAOCP- Novice Amateur Operator's Certificate of Proficiency
- 2 NLAOCP- Novice Limited Amateur Operator's Certificate of Proficiency
- 3 Further information on the new HAREC compliant certificates is available on the ACA's home page www.aca.gov.au

VK adopts 5wpm Morse code standard

Australia has become the 7th country to adopt the five-words-per-minute Morse code amateur licence test speed for full access to the HF amateur bands.

In an official announcement in the Commonwealth of Australia Gazette on the 12th of July, the Australian Communications Authority (ACA) changed the amateur regulations for the VK Intermediate grade licence that requires only 5wpm Morse code proficiency.

In doing so it lifted the previous HF band restrictions on the Intermediate Licence which can now use all bands below 30 MHz. The change had been anticipated following a submission to the ACA made by the Wireless Institute of Australia in March this year seeking a lowering of the code speed.

Australia is maintaining for the time being, its Unrestricted grade licence, that requires the passing of a 10wpm Morse code test - but this is only to satisfy the needs of reciprocal licensing agreements.

The HF operating privileges and conditions for the Intermediate and Unrestricted licences are now identical. Australia, in adopting 5wpm, has joined Denmark, Sweden, Britain, USA, South Africa and Gibraltar. Others including New Zealand, Canada, Singapore, India, Malaysia, Pakistan, Papua New Guinea, Kenya and countries in Europe are in various stages of seeking to lower the code speed to 5wpm.

Written by Jim Linton VK3PC

IARU Region III Conference

More than 70 delegates from 14 International Amateur Radio Union (IARU) Region III radio societies, plus representatives from Regions I and II, are registered so far for the 11th IARU Region III conference to be held in Darwin.

WIA IARU Liaison Coordinator, Grant Willis VK5ZWI, explained that the IARU is the peak body in the Amateur Service and represents it to the International Telecommunications Union (ITU) and other world radio and telecommunications regulatory and industry bodies.

Grant said that each IARU region meets once every three years (on alternate years) and this is the first time an IARU Region III Conference has been held in Australia. The conference in Darwin, to be held August 28 to September 1, is being hosted by the Wireless Institute of Australia, and partly funded by WIA members through a levy on their annual membership subscription.

The WIA has on-the-ground support from the Darwin Amateur Radio Club whose members will engage in meet-and-greet activities as delegates arrive. The club is also setting up and operating a special event station AX8IARU at the Carlton Hotel, the conference venue. The station will be active during the conference on the main HF bands, as well as on VHF and UHF around Darwin. Some satellite operation on UO-14 may also be attempted. The IARU Region III Board will also be in attendance and meet separately on administrative matters.

Anyone interested to learn more about the conference will find an array of

informative and interesting input papers on a wide variety of amateur radio topics submitted by IARU Region III radio societies. The papers and other conference details can be found on the inter-linked Internet at three websites - www.cck.net.au/iaru/,

www.tbsa.com.au/~wiavic/iaru and www.jarl.or.jp/iaru-r3/

For those who do not have Internet access, a series of IARU RIII Bulletins are being issued over the next six weeks on packet radio - including input papers and conference update reports.

Issued by Jim Linton VK3PC,
IARU Region III Conference Media Officer

WIA papers for Region III Conference

Some of the issues the WIA will raise at the IARU Region III Conference in Darwin include:

- *80m band*: extension of the DX window (3776-3800 kHz) recently negotiated between the WIA and the ACA
- *40m band*: exclusive Amateur access to 7000-7100 kHz (the segment from 7100 kHz is shared with broadcasting services, rendering this portion of the band unusable after local sunset)
- *APRS*: a national 2m frequency for Automatic Position Reporting System operations

- *EMR*: Recent changes to electromagnetic radiation standards and the impact on the Amateur Radio service
- *Internet*: the growth of the Internet and its implications for the Amateur Radio service
- *LF*: proposed creation of a low frequency Amateur band below 200 kHz
- *LIPDs*: those so-called Low Interference Potential Devices and their impact on Amateur operations.
- *Morse Code*: changes to Amateur licensing requirements
- *ADSL*: Asynchronous Digital

Subscriber Line data communications, and the RFI implications for Amateur Radio

- *STARS****: Support of The Amateur Radio Service in IARU Region 3
- *VHF-UHF*: Standardising band plans in Region 3

The official IARU Region Conference web site is located at <http://www.cck.net.au/iaru/>, and details of the WIA's papers for the conference can be found at <http://www.cck.net.au/iaru/papers/papers-index.html>.

Amendments To Amateur Licence Conditions

The purpose of this letter is to advise you of recent amendments to the conditions applicable to Amateur licences.

These amendments, which are contained in the *Radiocommunications Licence Conditions (Amateur Licence) Amendment Determination 2000 (No.2)* (the LCD), came into effect by Gazettal on 12 July 2000. For your information I have attached a copy of the amendment determination.

The changes to the Amateur licence conditions:

- prohibit Unrestricted, Limited and Intermediate Amateur stations from operation in the Sydney Olympic

Area (within 150 kilometres of the Sydney Olympic Park at Homebush Bay) in the frequency band 440 MHz - 450 MHz from 12 July 2000 until 30 October 2000;

- authorise the operation of Amateur Intermediate stations in the same Amateur bands as Amateur unrestricted stations; and
- authorise the transmission of news and information related to the operation of Amateur stations for the purpose of facilitating intercommunications.

A consolidated licence conditions

determination is available on the ACA website at <http://www.aca.gov.au/legal/determin/lcd/amateur.htm>.

The ACA would appreciate the dissemination of the above information through the Wireless Institute of Australia's website and magazine.

If you require further information or wish to discuss these changes, please contact me by e-mail at clive.franklin@aca.gov.au or by phone on (02) 62565239.

Alan Jordan, Manager
Radiocommunications Licensing Policy Group
Radiofrequency Planning Group

More ACA Documents Updated

Further documents of interest that have been updated on the ACA web site:

- *ACA Licensing Amateur Operating Procedures* (<http://www.aca.gov.au/publications/info/regs.htm>)
- *ACA Licensing Citizen Band Radio Stations* (<http://www.aca.gov.au/publications/info/cbrcl.htm>)
- *ACA Licensing Disclosure of Personal Information* (<http://www.aca.gov.au/publications/info/privacy.htm>) - this relates to personal information about radio licensees that is publicly available, for example on the ACA web site.
- *Object and Scope of the Radiocommunications Act 1992* (<http://www.aca.gov.au/publications/info/objectsofact.htm>)
- *Emission Characteristics of Radio Transmissions* (<http://www.aca.gov.au/publications/info/emission.htm>)
- *Prohibited Devices* (<http://www.aca.gov.au/publications/info/prohibit.htm>)

- *Radio-controlled Models* (<http://www.aca.gov.au/publications/info/models.htm>)
- *Testing Radiocommunications Devices Where No Equipment Performance Requirements Are Specified* (Spectrum Impact Assessments) (<http://www.aca.gov.au/publications/info/spectimp.htm>)
- *Third Party Authorisations* (<http://www.aca.gov.au/publications/info/third.htm>)
- *Transfer of Apparatus Licences* (<http://www.aca.gov.au/publications/info/transfer.htm>)
- *Proposals to Operate radiocommunications Equipment that is Inconsistent with ACA Regulatory Arrangements* (<http://www.aca.gov.au/publications/info/outpolaj.htm>)
- *Short Range Spread Spectrum Devices* (<http://www.aca.gov.au/publications/info/spreadsp.htm>)
- *Testing Radiocommunications Devices Against ACA Equipment Performance Requirements* (<http://www.aca.gov.au/publications/info/testpr.htm>)

www.aca.gov.au/publications/info/testpr.htm)

- The *ACA Consumer FAQ (Frequently Asked Questions)* paper at <http://www.aca.gov.au/consumer/faq/index.htm> has two new additions entitled *Human Exposure to Electromagnetic Radiation and Mobile Telephony, Your Health and Regulation of Magnetic Radiation*.
- The Policy Information Paper (PIP) entitled *Amateur Examinations* (<http://www.aca.gov.au/publications/info/amatexam.htm>). The International Telecommunications Union (ITU) References that were previously included in the PIP are now available in an attachment.
- *The Overview of Apparatus Licensing System PIP* (<http://www.aca.gov.au/publications/info/overview.htm>)
- *Amateur Licence* (<http://www.aca.gov.au/publications/info/amateur.htm>)
- *Amateurs Visiting Australia* (<http://www.aca.gov.au/publications/info/visiting.htm>)

(ACA web site)

News and Information transmissions — by all

The Australian Communications Authority (ACA) has in a change to the amateur regulations made it possible for any amateur station in Australia to transmit news and information bulletins.

This not only legitimises a number of existing radio club broadcasts, but also makes it possible for any radio amateur to set up a news and information session.

The WIA in all states will continue with its traditional Sunday broadcasts.

The ACA made the change through an amendment to the Licence Condition Determination for amateur stations which was published in the Commonwealth Gazette on 12 July, 2000.

The gazettal states that amateur licensees may use their station for "transmitting news and information services related to the operation of amateur stations, as a means of facilitating intercommunication".

Contributed by Jim Linton VK3PC

Amateur Licence Fees

The ACA has informed me that Amateur Radio Licences will be affected by the GST and that the component parts of the new fee applicable from July 1st, 2000 are as follows:

SAT = \$22.08 SMC = \$8.92 Admin. charge = \$18.00 GST = \$1.80 making a total of \$50.80.

Peter Naish.

WIA Email Lists Update

Last August, we reported the creation of a number of email lists to allow you to receive WIA news and information via email. Hundreds of news bulletins are sent out to subscribers.

Recently, Onelist.com, which has hosted these lists, merged with eGroups.com. As a result, the addresses of the various email lists has changed (the old addresses still work, but may stop working sometime in the future.)

To subscribe to any of the lists, send a

blank email message to the following addresses:

VK2 (New South Wales news

vk2news-subscribe@egroups.com

VK4 (Queensland) news

QNEWS-VK-subscribe@egroups.com

WIA Federal news

wia-subscribe@egroups.com

Promoting Amateur Radio

AmateurRadioPR-subscribe@egroups.com

VK2000 Olympics news

vk2000-subscribe@egroups.com

As always, subscriptions to these lists are free, to WIA members and non-members alike. You can also set up your own email lists by visiting eGroups at www.egroups.com.

Information about other email lists of interest to Australian Amateurs can be found at <http://www.wia.org.au/links/MailingLists.html>

VK Spread Spectrum Group email list

Dave Horsfall VK2KFU has "decided to re-form the old Spread Spectrum Group from many years ago" for those interested in this form of communications, and has created an email list for those wishing to discuss this mode.

He says, "So, interested in weak signal work? No CW required? Do digital

AX3OLY

Olympic games call sign on air

Special event station AX3OLY has been allocated to WIA Victoria by the Australian Communications Authority to commemorate the Olympic Games being held in Sydney.

WIA Victoria members will be sporadically operating the station on DX bands using phone and CW. Band of operation being chosen to coincide with the best propagation at the time.

AX3OLY was activated for the first time to mark the arrival of the Olympic

modes turn you on (in a manner of speaking)? Then try Spread Spectrum, a technical mode at its finest."

To join the SSG list, send a blank email to vk-ssg-subscribe@egroups.com, or point your web browser at www.egroups.com/group/vk-ssg.

flame in VK3 as it reached the half way mark through its 100 day torch relay around Australia.

The special event station will later highlight the holding of Olympic soccer games in the VK3 capital city of Melbourne, Australia, which also hosted the 1956 Olympic Games. A commemorative QSL card will be available. QSL is to VK3WI. WIA VICTORIA Web site: www.tbsa.com.au/~wiavic

SILENT KEY

The WIA regrets to announce the recent passing of:-

J D ROBINSON	L21160
N A (Neville) LOFFMAN	VK2APL
R (Richard) SOULIE	VK2ARS
G (GEORGE) CRAGGS	VK2AYG
J (John) CRADDY	VK2BOK
J J MCFARLANE	VK2NPX
F (Frank) ROGERS	VK3AAX
G G THOMPSON	VK3AC
L W BENNIE	VK3ALB
O E K (Owen) TINK	VK3ON
K D (REV) HALL	VK5AKH
A F J LEAL	VK5LQ
M G SMITH	VK5TC
I GREGORY	VK6OV
R F (Richmond) GEE	VK7RF

EDUCATION

Brenda M Edmonds, VK3KT
128 Springfield Road
Blackburn North, Vic 3130.

Desperately seeking correspondence

In my last column in the June issue of *Amateur Radio* I mentioned the modifications needing to be made to examination papers as changes to the Regulations relating to Morse Code standards are put into place. At the time of writing this, the changes have not yet been gazetted. Again, once the matters are finalised, you will be notified. We will try to make as little disturbance to the system as possible.

Potential candidates often contact me directly or through the WIA Federal Office for information on classes, courses or examinations. I am at a disadvantage if I cannot answer these queries because I am unaware of activities in the candidates local area. Sometimes I can pass the query to the relevant Division, but I like to be able to do more than that. It is easy to give out web page addresses and hope that the enquirer has access to the Web even if only through their local library (although my experience with local libraries and the Internet has been definitely not encouraging). But the hard ones are those without such access and often in more remote geographical locations.

I have written previously of the need

for a correspondence-type course. This need is being met to some extent by the Internet course recently established by Ron Bertrand VK2DQ, but there is still room for an on-paper or on-tape course.

The hardest part of arranging such a course is finding enough volunteers to monitor and assess the students' responses and provide the necessary feedback at each stage of the course.

It may be that there are such courses already running and I am just not aware of them. If you are running or know of someone who is running such a course, please let me know the details. I would be very pleased to see a copy of the material being used and the monitoring arrangements in place as you understand I am hesitant to recommend a course

without some knowledge of its content and standard. However I would enjoy being able to tell the remote or housebound candidates that such courses do exist, and giving them the contact information.

If amateur radio is to remain as a viable hobby and attract new recruits to make up for those long-standing and dedicated amateurs who eventually become silent keys, it is necessary for each of us to play some part in the recruiting. There have been some uncomplimentary remarks about some of the amateur population published in other magazines of late. We need to retrieve our reputation for manners, helpfulness and balance before it is too late.

An RF Voltage Probe

(with notes on power measurement)

Draw Diamond, VK3XU
45 Gatters Road.,
Wonga Park, 3115.

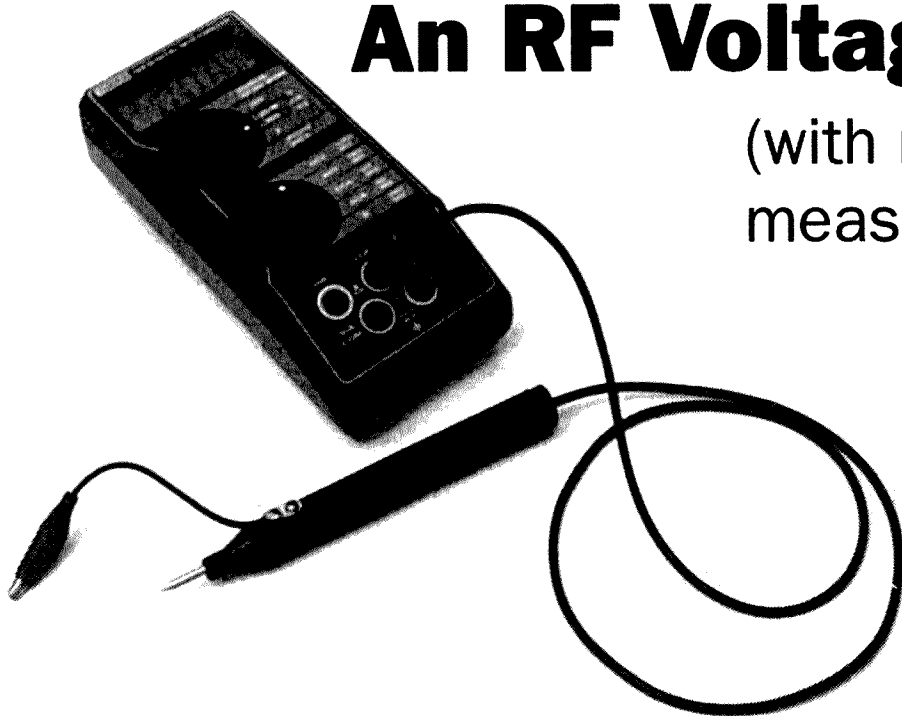


Photo 1: RF Probe and DMM

An ability to measure the amplitude of audio and RF signals is an extremely useful asset in radio repair and experimental work. For instance, published circuits often have handy notations showing typical values of RF voltage that may be expected in a properly working model. But the AC measuring range of ordinary analogue and digital multimeters is generally only sufficiently accurate from mains power frequencies to perhaps 1 kHz. However, if you have a digital multimeter (DMM),

or vacuum-tube voltmeter (VTVM), or other DC voltage measuring device which has a customary input impedance of 10 Megohms, the addition of a simple RF probe will greatly extend the scope of your instrument.

Nearly all of the standard radio texts have details for the construction of RF probes, but generally they are of the single diode detector type (for example, see Refs. 1 and 2). Better sensitivity is obtained if we employ the two-diode voltage-doubler configuration (Ref. 3). A

corresponding DC output voltage (for 10 Mohm DMM) is developed across a divider comprised of two 4.7 Mohm resistors. See Fig. 1. Using a pair of ordinary germanium diodes (hot-carrier/Schottky diodes were found to be less sensitive than germanium in this application), sensitivity is good down to about 0.2 V/200 mV r.m.s. Readings are within +/-10 % of applied signal for sine-waves between 300 mV and 30 V, from 1 kHz to 50 MHz. Effective circuit loading capacitance is typically 4 pF. A

probe using OA90 - 95 or 1N60 germanium diodes will have adequate accuracy for amateur purposes if made in accordance with the following details. With the addition of a suitable 50 ohm termination, the probe and DMM also finds use as a sensitive RF power meter for QRP work.

Construction

For signal measurements in tight corners and upon compact circuitry, a fairly slim probe body is desired. The prototype is housed

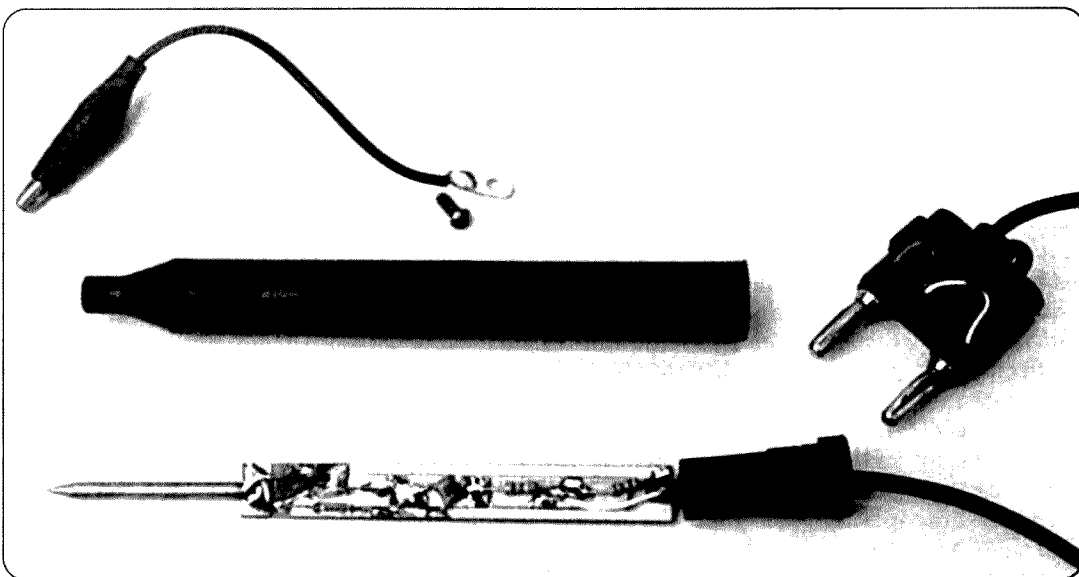
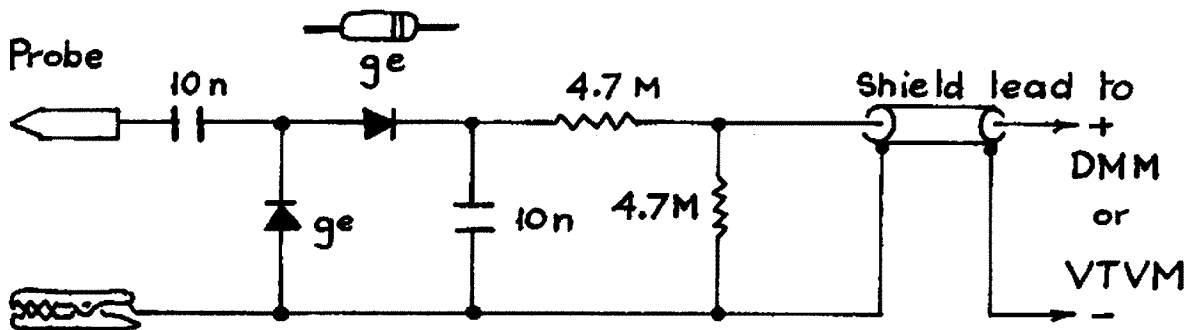


Photo 2: Probe components

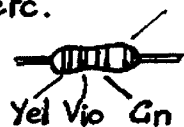


Clip lead

ge : OA90 ~ 95, 1N60 etc.



10n = 0.01 μ F
>50 V WKG.



Red or Bn or gold
4.7M $\frac{1}{4}$ W

Fig. 1.

in a defunct plastic felt-tip pen barrel (see Ref. 4) which is almost ideal for our purpose. Obtain a dried-up felt-tip pen (preferably a plastic one, whose label may be removed). Carefully insert a

knife blade into the join where the end-cap is fitted, then withdraw the cap (more like a snap-fit plug, or bung really). Remove and discard the ink pad and felt tip. Clean up any remaining ink

with a tissue dipped in meths.

A narrow piece of double-sided circuit board which accommodates the detector

Continued on page 10

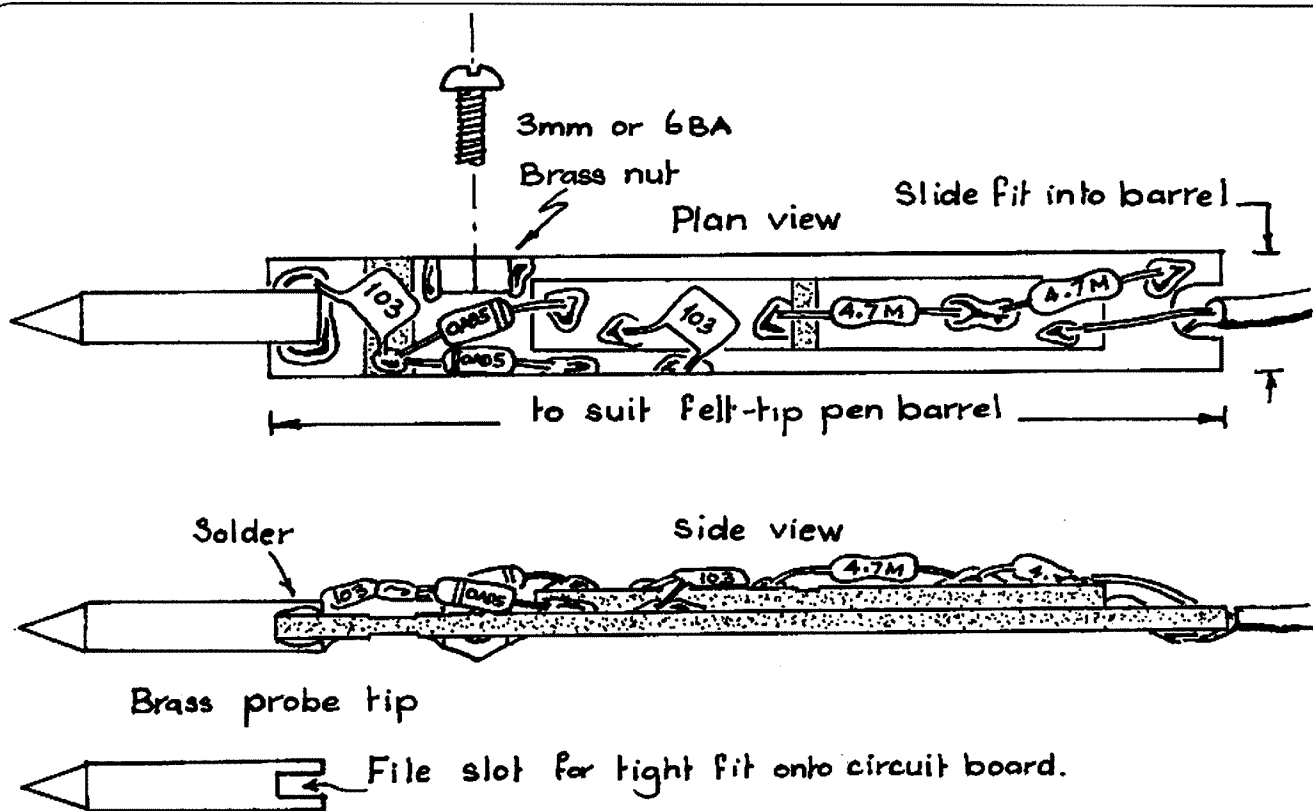
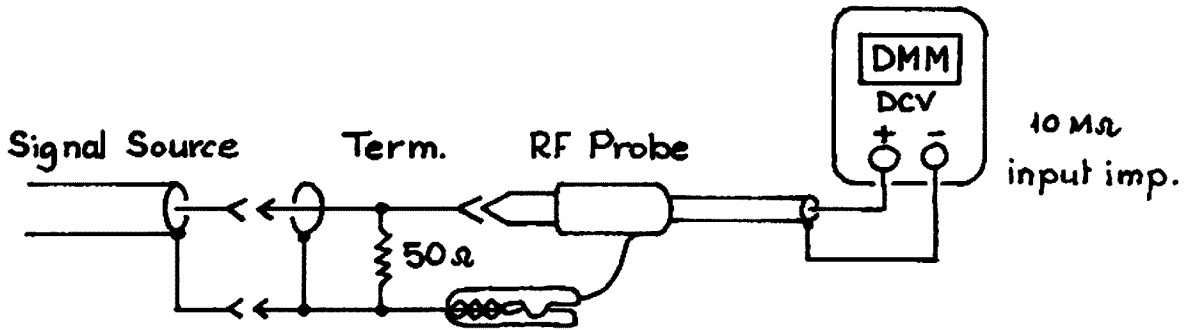


Fig. 2.



Signal must be substantially pure sine-wave.

$$P = \frac{E^2}{R}$$

E_v	.22	.5	1	5	7	10	12	14	16
P_w	.001	.005	.02	.5	1	2	3	4	5

P in Watts (.001W = 1mW), E in Volts, R in ohms (typ. 50 Ω).

Fig 3.

Continued from page 9

components shall be fitted into the barrel. Poke a rod or pencil into the barrel and gauge the internal length available (taking into account that which is required by the end-cap), then insert various drill shanks in order to measure the internal diameter. Make a circuit board of appropriate length and width. Test for sliding fit inside the barrel. Check that the end cap may be snapped home, thus securing the board in place. When satisfactory, file a semi-circular notch in the end of the board to allow the shield cable to easily enter a hole

drilled in the end cap.

Board layout is shown in Fig. 2. File a notch in the side of the board near the probe end, into which is fitted and soldered a 3 mm or 6 BA hex brass nut as shown. A corresponding clearance hole must be drilled in the barrel to take a 3 mm or 6 BA brass screw, which acts as locating device, and chassis ground connection point, via solder tag, short stranded wire and flying clip-lead.

The probe tip should be made from brass rod, or from a length of suitably sized brass screw thread. Using an electric drill mounted in your vice as a

"mini lathe", fix the brass rod in the chuck, then apply a smooth file to the rotating rod to form a point similar to that shown. With a flat needle file, form a slot at the blunt end to provide a good fit onto the board. Carefully remove, by filing, a 5 mm segment of copper foil (from both sides) about 8 mm from the end of the board. Align then "tack solder" in place. Test for proper alignment and straightness inside the barrel and adjust if necessary, then solder properly.

A strip of "paddyboard" with a single dividing cut accommodates most components. Super-glue this strip onto the board. To minimise loading capacitance, the connection between the probe coupling capacitor and diodes is made "ugly style". Take care soldering the capacitors, and especially the diodes- clamp fine long-nose pliers between joint and part when soldering these.

Photo 3 shows two types of 50 ohm terminations for power measurements. These are made from scraps of double-sided circuit board. One is an end termination, the other a 'thru termination (for use with high-

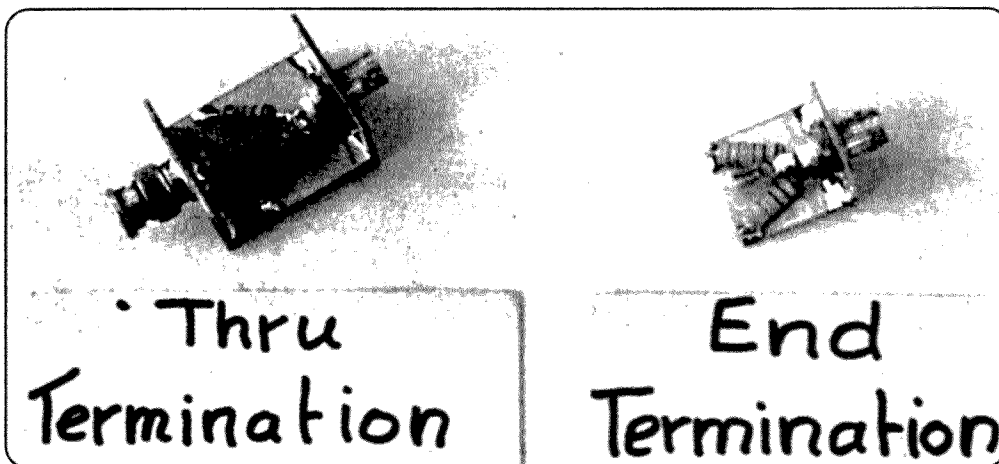


Photo 3: Terminations

impedance measuring devices, such as an oscilloscope). Use resistors of appropriate power rating for projected work. A pair of 100 ohm 2 W metal-film resistors (see Parts below) can take up to about 10 W in short bursts without damage. A lug from an Octal valve socket, soldered to the centre pin of the coax socket may be used to mate with the probe tip.

Operation

In use, the ground connection clip lead should be attached to the "earthy" side of the circuit under test, close to the point of voltage measurement. For best accuracy, the waveform should be reckoned to be a pretty clean sine-wave. Peaky or distorted wave-forms can give erroneous readings. Never-the-less, any kind of measurement is better than guesswork. For instance, to check that an oscillator is working- application of the probe will quickly determine if the circuit is functioning. Similarly, various

parts of a low-power transmitter (or the low-power stages of a QRO transmitter) may be probed, checking for output from each stage, and so on.

A typical set-up for RF power measurement is depicted in Fig. 3, where a source requiring a 50 ohm load is assumed in this example. Apply carrier signal to the 50 ohm termination and measure the corresponding voltage developed across the termination. For a sine-wave, power in Watts equals the measured voltage squared divided by the load resistance in ohms. A table of typical values in QRP work is shown.

Parts

All components for the probe are available from our familiar electronic parts suppliers, such as Dick Smith, Jaycar and (for Melbournians) Electronics World, All Electronic Components and Rockby's. Rockby's and

Electronic World have 1, 2 and 3 W metal-film resistors for the termination(s). If you have genuine difficulty in locating any of the parts specified, I always keep a few spares, so please write to me at the address shown, including an SASE for reply.

References and Further Reading

1. *Radio Frequency Probes*; Watson, G3JME, RadCom, April, 1972.
2. *Test Equipment for the Radio Amateur*; Smith, G4FZH (ed.), RSGB Publications.
3. *A Calibrated RF Detector Probe*; Dooley, VK5BGZ, Electronics Australia, March, 1995.
4. *RF Detector Probe for our Bench Amp*; Evans, Electronics Australia, May 1998.

ar

Hams span three generations

I thought this photo may be of interest to AR readers.

It represents three generations of Hams with my Father Neil VK3AQD at the left, my son Christopher VK3MNI in the centre and myself VK3AQU at a gathering celebrating Neil's 80th birthday. He was first licenced in 1961 and has been a WIA member I think for nearly all of that time. Christopher received his licence in April this year and is working towards full call theory hopefully before Xmas. I was licenced in 1970.



Best 73's
Ian G. VK3AQU

<http://www.albury.net.au/~lorian>

We manufacture a comprehensive range of HF, VHF and UHF antennas, baluns, power dividers, etc. to suit your application. Some of our log periodics provide continuous coverage from 13-30 MHz including WARC frequencies and replace outdated tribanders. Now in use in 48 overseas countries.

FREE CATALOGUE AVAILABLE FROM



ATN ANTENNAS PTY LTD
A.C.N. 012 557 014

- Create rotators, coax cables & non-conducting guy & halyard materials
- Hard-drawn copper antenna wire
- Insulators for DIY projects
- Inverted vee kits 160-30m
- High gain VHF & UHF amateur, scanning & TV Antennas

- High Sierra HF mobile antennas
- Butt section triangular aluminium towers for fixed or tilt-over applications
- Selection of power chips & TX tubes
- Diamond VSWR/PWR meters to 1300 MHz & accessories

37 Morrison Street
PO Box 80, Birchip Vic, 3483
Ph: (03) 5492 2224
Fax: (03) 5492 2666

Walking 'On Air' from Sydney to Brisbane

PART TWO

Tony Whitaker
continues strolling
the *ultimate stroll*

The Middle

Day 12 (Nabiac to Taree) and down came what I can only describe as continuous heavy rain interspersed with periods of very heavy rain, though I was spared the high winds that did some damage around Sydney Harbour. My poncho kept the pack reasonably dry and, more importantly, the C528 (which goes doolally if any water gets inside via the speaker/mic socket), so the sanity of 2STB was once again a topic of conversation as I squelched my way north.

Unfortunately, I didn't fare quite so well, nor did my little log book, so the motel room in Taree took on the atmosphere of a Turkish bath as I tried to dry things out in front of the air conditioner.

Although it had stopped raining, Day 13 nearly lived up to its unlucky reputation. John, VK2SWR, who I met at the north end of the Taree bypass, told me that, according to radio reports, the road was closed by flooding just south of my day's destination of Cooperook. It was, except to large vehicles and mad pedestrians willing to wade through 500m of cold, muddy, knee-high water, with all sorts of creepy-crawlies in and on it.

The thing that I found most disappointing was that my second single-use camera, which I'd just started, failed to work, so I couldn't get a picture of a large truck, with an impressive, white, foaming bow-wave, bearing down on me.

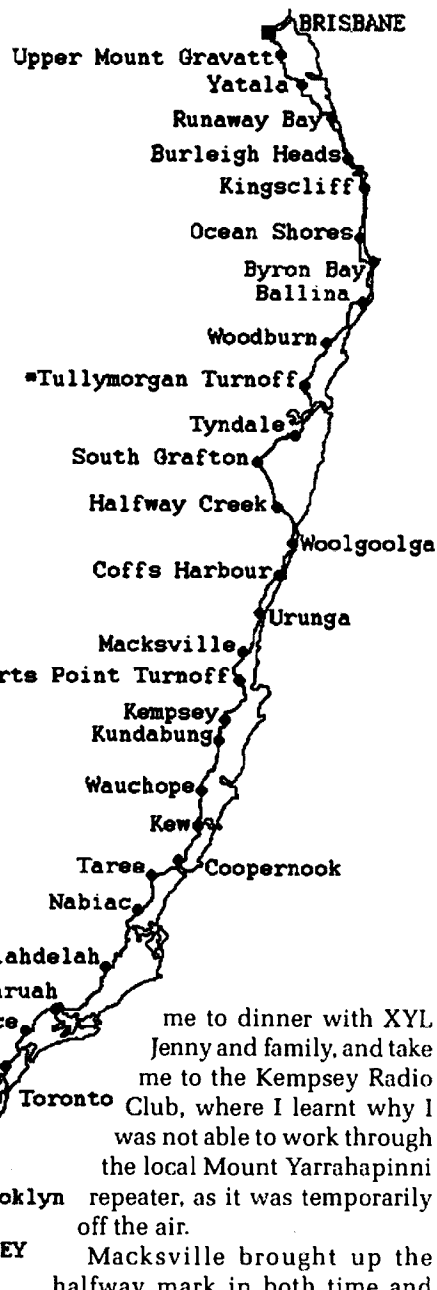
Colin, VK2AF, visited me a couple of days later as I set off from Kew, and the Westlakes baseball cap was superseded

by a Port Macquarie one. He had kept me company nearly every day since I'd been able to access Cabbage Tree and would continue to do so until I finally dropped out of the Dorrigo repeater at Tyndale on Day 26, some 450+kms and 18 days later. "Mind you don't end up as a mascot on the front of a big truck" was a comment made to me when I said I was taking the Bago Road into Wauchope.

In reality, there was little chance, as the road was very quiet with an excellent day's walk in fine weather again through the still blackened gum tree forest. It was very pleasing to see how well the forest has recovered after the devastating bush fires of 1993 (I believe).

On reaching the town though, I was somewhat bemused by Australia's ability to close down on a Saturday afternoon, a sentiment shared with a German couple I met much later in Brisbane city centre, who were unsuccessfully trying to change their flight plans.

The next day (Day 16), I managed to overcome the first of the "gaps", when I found a motel at Kundabung, but there was no repeat for the following 52km section between Kempsey and Macksville. Fortunately, Grant, VK2MAX, had been appraised of the situation by Grahame (VK2FA), and he kindly provided the shuttle transport to the Stirling Point turnoff, as well as show me a little of the district, entertain



me to dinner with XYL, Jenny and family, and take me to the Kempsey Radio Club, where I learnt why I was not able to work through the local Mount Yarrhapinni repeater, as it was temporarily off the air.

Macksville brought up the halfway mark in both time and distance, so now I could think in terms of walking towards Brisbane rather than away from Sydney.

A couple of days later saw me being shown round Coffs Harbour by Ray, VK2BRG, and the next day (Day 22) walking through banana country up to Woolgoolga. I couldn't resist feeling a little smug satisfaction as I reached, then

Dr A.J.T. (Tony) Whitaker G3RKL/
VK2STB,
University of Sheffield, Department of
Electronic and Electrical Engineering,
Mappin Street,
Sheffield S1 3JD. U.K.
Tel: +44 114 222 5359 Fax: +44 114 272
2097



The only "off-road" section. Up the beach to Surfers Paradise

passed, a couple of the holiday complexes (Nautilus and Pelican), remembering the series of advertising boards I'd seen starting days ago and hundreds of kilometres down the road. I was also amused to see at the entrance, in large print, the starting price of a unit to be \$95,000, but, in very much smaller print, with an average of \$434,000! Arnold, VK2ADA, met me just past the entrance to Coffs Harbour Zoo in his large Land Cruiser, which had the appearance of a mobile porcupine due to all the aerials mounted on it.

Later, having established myself at the motel in "Woolly", as he showed me round the area, he did admit to having occasionally picked up the wrong microphone from the large array hanging under the front dash. The weather had taken a turn for the worse again, so the next two days were a case of sunshine and showers as I made my way up to South Grafton, where I met my namesake, VK2BTS, whose callsign, as was pointed out to me, is the reverse of my own.

The End

Day 25 and I ran out of range of the Dorrigo repeater, so I finally had to say farewell to Colin, VK2AF.

Day 26 was the last of the scheduled gaps and the arrangement for a taxi to pick me up from the Tullymorgan turnoff and take me back to Maclean fortunately worked very well. That night was a little different, in as much that there was a total eclipse of the moon, of which I saw just the first part, not because the sky wasn't clear, it was, but because I like my bed too much! I also missed the following total eclipse of the sun, two weeks later, the only total eclipse visible in the UK during the twentieth century, though I did have a better excuse - it was my last day in Oz.

The bananas had given way to sugar cane, but I only saw one small example of cane burning, as I was told that the height of the conflagration season had been severely disrupted by all the rain.

Indeed, talking to a council worker after crossing the bridge at Wardell, he told me that the annual rainfall for the area is 60 to 70 inches, but they'd already had 89.

The Parrots Nest repeater was good copy, though I had difficulty getting in sometimes with my low power, and the Byron Bay repeater was coming into range as I reached Ballina, where I had a very pleasant evening meal with Dennis, VK2RM, and XYL Norma.

Since the only motel in Bangalow had closed down, a change of plan was required, and this involved taking the coast road up to Byron Bay. No regrets though, as Day 29 was a beautiful day, with scenery to match and I even had the chance to access the Gold Coast repeater at Springbrook from Lennox Head before meeting Gordon, VK2AGE, and XYL Heather at his QTH in the village. I could have spent a lot more time there, but I had to press on to Byron Bay, which I found a little strange, possibly because of some of the strange looking people that were wandering round (so I wasn't the only one).

Day 30, a Sunday, and a chance to monitor the rather up-beat VK4WI news on Springbrook, as I made my way back to the Pacific Highway. Graham, VK2GJ, met me at the start of the Brunswick Heads bypass, having ridden out there from town on the XYL's bicycle. He did admit, however, that it was some thirty years since he'd used that particular



Journey's End at Upper Mount Gravatt mode of transport.

The next day was my last full day in NSW, and I enjoyed the lovely sunny weather whilst walking up the coast to Kingscliff, past miles of beautiful, clean, but completely empty, sandy beaches, conditions, I suspect, that the tightly packed hoards of holiday-makers back home would have killed for. I hope Greg, VK2IGW, and XYL Rhoda didn't mind too much when I expressed a hope that

Continued on page 14

their circumstances would improve sufficiently for them to afford shoes - going barefoot seems to be the norm for a farm upbringing in these parts!

The crossing into VK4 was seamless and it took two more days to reach then pass those high-rise buildings at Surfers Paradise that seemed to emerge so strangely from the sea, when I first saw them from Coolangatta. I can see why the area is so popular, especially as a place to retire, if Jim, VK4GIM, a sprightly octogenarian, is anything to go by. I appreciated the evening at home with Jack, VK4YKG, XYL Gloria and "Pampered Pooch Penny", before tackling the nightmare roadworks of the Pacific Highway upgrade.

The reaction at the local Runaway Bay police station hadn't exactly been encouraging, when I'd asked for information. "Get a bus", was the first, followed by "Two roadworkers have already been killed". However, I did eventually make Yatala unscathed, though it was definitely the worst day's walk of the trip. One bright spot was talking to Brian, VK4BCF, who was in contact on 20m with ZL1DAQ. Don had acted as my "Mission Control" last year during the ZL North Island stroll, and has walked the length of New Zealand himself in 1992.

Day 35, and the walk to Upper Mount Gravatt was, by comparison, uneventful, and I had my first real view of the destination city from Edens Landing. I had always intended to finish at Mount Gravatt, as this was the location of one of the nearest motels to Steve at Griffith University.

However, I couldn't resist walking the final 14kms into the city centre, so, at about midday on Saturday the 7th of August 1999 I stood outside Brisbane City Hall, 36 days and some 1000kms after leaving Sydney. No fanfare, no crowds, just me, but that's how it's been at the end of each little stroll - after all, my name's not Ffyona Campbell or Ian Botham.

Epilogue

Although Steve showed me a little of the region, the majority of my last few days were spent as a busman's holiday in the University. Strangely though, I had no further contacts, despite putting a few calls out through the local repeaters from time to time. This contrasted to the 90 or so amateurs that I'd talked to and/or

met on the way, with only two days, 19 and 36, without a QSO. John, ZL2WW, had expressed a wish that "... the VK boys (and girls) treated you well en-route" (as had happened in New Zealand), and I can certainly confirm that to be the case.

I would like to take this opportunity to thank everybody I spoke to, particularly those who went out of their way to keep me company during those long periods of pounding the tarmac - it certainly helped cover the miles. However, I'm especially grateful to those who showed me around their local area and often invited me into their homes or went out for an evening meal with me. It shows that the amateur spirit is still very much alive and well. Neither can I forget the individuals and groups who keep the repeaters up and running.

Having set up three repeaters and two beacons myself, I can appreciate the effort that is required. Without them, my holiday would have been very much the poorer.

As to the future, I have no immediate plans, though I have had a preliminary look at Adelaide to Melbourne to Sydney. So, perhaps, just perhaps, I may return sometime as VK2 Silly Tony's Back.

[1] "73 ZL. A winter stroll the length of South Island." A.J.T. Whitaker G3RKL, Break-In, NZART, May & June 1998.

[2] "73 ZL - Again. Another winter's stroll: the length of North Island." A.J.T. Whitaker G3RKL, Break-In, NZART, July/August & November/December 1999.

ar

Itinerary

Walking Day	Destination	Estimated Daily Distance (km)	Distance From Start(km)
0	Sydney	0	0
1	Hornsby	25	25
2	Brooklyn	23	48
3	Kariong	32	80
4	Wyong	26	106
5	Morisset	26	132
6	Toronto	18	150
7	Cardiff	15	165
8	Raymond Terrace	26	191
9	Karuah	25	216
10	Bulahdelah	44	260
11	Nabiac	45	305
12	Taree	28	333
13	Cooperook	24	357
14	Kew	31	388
15	Wauchope	21	409
16	Kundabung	35	444
17	Kempsey	16	460
18	*Stirling Point Turnoff	29	489
19	Macksville	22	511
20	Urunga	32	543
21	Coffs Harbour	29	572
22	Woolgoolga	25	597
23	Halfway Creek	25	622
24	South Grafton	29	651
25	Tyndale	31	682
26	*Tullymorgan Turnoff	35	717
27	Woodburn	32	749
28	Ballina	35	784
29	Byron Bay	30	814
30	Ocean Shores	21	835
31	Kingscliff	37	872
32	Burleigh Heads	25	897
33	Runaway Bay	22	919
34	Yatala	35	954
35	Upper Mount Gravatt	30	984
36	Brisbane	14	998

* indicates a pick-up point

ALARA

Christine Taylor VK5CTY, ALARA Publicity Officer
16 Fairmont Avenue, Black Forest SA 5003
Packet VK5@VK5TTY Email: geensee@picknowl.com.au

Congratulations are in order

Thelma Souper Waro 2000 VK-YL Winner



Not just this year, but for the fourth year in a row Gwen VK3DYL has won the VK-YL section of the Thelma Souper WARO 2000 Contest. Well done, Gwen, but Gwen says she wants some more competition so

why not have a go next year?

This is a contest held over a weekend early in April. It runs for 3 hours (7.00 to 10.00 UTC) on each of two nights but it is only for contacts on 80 metres. You may use phone or CW so why not make an effort to brush up your CW in time for the contest. As a YL you may contact either other YLs or OMs and there are random appearances of the station callsign ZL2YL throughout the duration of the Contest. Contacts with this station earn a multiplier.

If you are a WARO member you can also earn a multiplier each night by making at least 20 contacts with other WARO members. This is an interesting contest and one in which it should be possible to earn a good score especially in the next few years as the sunspot cycle reaches a maximum.

Why not have a go.

Honorary Life Membership



In recognition of her invaluable service as Treasurer for the last ten years and supporter of her OM Graham VK4BGC (who recently became a silent key) at all

times, but especially including his time as Secretary, Bev VK4NBC was awarded an Honorary Life Membership of AFARN (Air Forces Amateur Radio Net).

Bev and Graham played an important

part in keeping the "Queensland Connection" of this group alive and well. Bev and Graham have been regular participants in all the AFARN activities and with so many friends among the members we are sure Bev will keep her interest in their nets and projects very much alive.

Recently Touring YLs

Mary VK3FMC and OM Dick VK3LDC had a lovely few weeks touring VK7 land. Did you speak to them at all? At round about the same time Val VK4VR and OM Brian VK4RX were also in VK7 land. Maybe you spoke to them instead?

We know that Val and Brian renewed their friendship with Marilyn VK3DMS and Geoff VK3ACZ in Mildura. Another visitor to the new home of Marilyn and Geoff was Elwyn VK2DLT also with her OM but they were heading for VK5 land. They had a great time touring the York Peninsular, where they met friends by arrangement. Your reporter has to say that she didn't manage to make contact with Elwyn but has the excuse that she didn't come closer to Adelaide than Port Augusta.

By a very strange set of coincidences, on the Friday of the luncheon meeting of the VK5 girls in Adelaide, there were two VK3 YLs in Adelaide. We knew in advance that the visitors had schedules that did not permit them to join the luncheon but we actually passed each other "like ships in the night".

As I was making my way up from the railway station I passed a couple heading in the opposite direction as we all crossed King William Street. As I reached the other side I realised that I had "met" Jean Shaw and her OM, Mac. On the Monday night Net next, Robyn VK3WX asked Meg VK5YG if she had been at a particular place at a particular time last Friday? Yes, they had also "met" as they crossed.

Adelaide (and Australia) is a small place, in many ways.

If you are a regular listener to the Travellers' Net you will know that there are always people you know touring. If

you are travelling, put out a call when you come into a new town, there is often someone listening. If you are at home and hear a strange callsign, reply to it. Make a new friend. Enjoy one of the special benefits of our wonderful hobby.

Put this in your plan-ahead diary

Be prepared to listen out for AX9YL in the latter part of September. There is to be a mini-DX expedition to Norfolk Island following on from the YL2000 International Meet in Hamilton. It will be a multi-national group the details of which are still to be arranged.

Full details will be in this column in the next edition but this will give you a little extra time to arrange your life so you can listen out for this station.

There are not very many amateurs on Norfolk Island so this will be a special opportunity. Keep your eye on this spot.

The AX Callsign and CW Changes

Let us have a good representation of YL operators using the "AX" prefix this year to celebrate our Olympic year. It is only for special occasions we are granted the use of the AX prefix so make sure we show that we appreciate it by using it. This callsign always brings renewed interest in Australia so make the most of it.

Novice operators (especially YLs) keep your eyes peeled for the promised variation in the CW speed requirements so you will be able to use those HF bands from which you have been excluded up till now. ENJOY!

Remember the Sydney Gold - The Gathering of the Nations Award

For details see ad in *Amateur Radio*, May 2000, page 17, or if you need further information please write to

John VK2DEJ
VKDX Association
P O Box 299
RYDE NSW 2112

or phone (02) 9809 5686

Summerland Amateur Radio club (Inc.)

Another year has flown by and our annual Radio and Electronic HAMFEST is almost upon us ! Members are busily sorting out their goodies to decide just what they can try to sell , or swap.

SUNDAY , 27th., AUGUST, at the Club-rooms, 412 Richmond Hill Road, Goonellabah, via LISMORE, is the date and the place to remember. A couple of prominent retailers have expressed an interest in attending and

there will be plenty of space and tables for 'slightly used' equipment. Refreshments , BBQ plus 'give-aways' will be on offer as well.

Make a day of it, catch up with some of your old 'on-the-air' friends.

This year the club has successfully re-introduced Construction Days and Tune-up Days .

These have been well attended .

A new idea we are trying out is proving quite popular, C.B. Nets. Weekly nets are being conducted on both the

H.F. and the U.H.F. Citizen Band channels. These are attracting around 12 - 15 participants regularly.

The two year saga of moving the Byron Bay repeater is slowly fighting it's way through the paper work , there is hope that it might actually happen in September (this year).

The attached photograph is of our WICEN Communications van , partly obscured by the 25 folk who took part in a recent training exercise. . Map Reading and Message Handling were the order of the day.

All voted that the day was well worth the effort, we learnt a lot, but needed more practice in message handling, (Transmission and Reception)

Another exercise is already in the planning stages.

Amateur Radio Theory classes are held regularly , in the Club-rooms, and we have had a few successful candidates lately.

Hope to see most of you at the Hamfest.

Graeme Virtue, VK2GV,
Publicity Officer.



Just a little Light Entertainment

Well, yesterday was the day... We've been waiting for a fine Saturday arvo when we were not busy doing something else.

This was it, Time to helio from Parrot's Nest to Rob Gallagher VK2KKG 's QTH on Hogarth Range. The line of sight (LOS) distance is about 45 km (about 34 miles) west from Parrots Nest. We went up and set up about 1330 hrs so the sun was most favourable to signal west. Unfortunately smoke haze meant we could not actually see Rob's place.

Using bearings we had previously worked out and some test flashing Rob was soon able to see our signals. Rob did not have helio gear and coordination was done by 2m. radio. The quickest contact was made by Leith Martin VK2EA using the hand mirror like those supplied and practiced in survival kits. This was quick and gave confirmation

of our aiming direction. It is difficult to send actual traffic this way however. We had two Helios set up. One is a standard Army 5 inch Mk.V Heliograph. The other is a 22 inch (55cm) helio I constructed. (Heliomax). Both worked fine. The flash from the large mirror was brighter than the Mk V but both were easily seen and readable. We spent some time checking bearings, alignment techniques and adjusting for the movement of the sun. We sent short signals to prove adjustments and keep Rob occupied. Having proved the exercise, we packed up and left about 1500 hrs.

We discovered too late that Sam MQS owns a Mk V Helio. Next job will be to set it up at Rob's end and send both ways. Some other fine Saturday. Hihi. Below is a pic from the day. Leith EA handsignalling.



Adelaide Hills Amateur Radio Society

The May meeting of the AHARS was a presentation of the video taken by Greg VK5ZBD at the "Evening with Andy Thomas", last year. For those that were at that gathering it brought back pleasant memories, for those that were not able to be there it was all new and interesting. There is no question but that the digital TV techniques now available help to produce marvellous pictures.

We were fortunate to have the use of a big screen video projector from the school where we hold our meetings so everyone had a perfect view. Our thanks to Greg for the presentation and for the excellent editing he did to make the finished product.

Three country radio clubs are now receiving videos of our meetings on a round robin system. In this way some of our country amateurs are able to see and hear lectures they would otherwise miss out on.

The next meeting of the club will be in the form of the Mid year Dinner. While visitors to Adelaide are always welcome to our meetings they should be aware that the December and July meetings are always dinners though visitors are welcome to those also.

If you are visiting in other months our normal meeting night is on the third Thursday of each month, starting at 7.30 and the venue is the Blackwood High School in Seymour Avenue, Blackwood.

Coral Coast Group

The Coral Coast group has been running for since 28th September 1967, non stop 7 days a week at 21.00hrs GMT on 7.060MHz. The founder Net Controller and mentor of the group is Les Bell MBE(MLY) VK4LZ Arlie Beach Les will be 97 next January.

The Group has now made available a Coffee mug commemorating the Group. The mug has a photograph of Les, the names of the members of the group and their call signs. The mug is available in four colours. There are 36 mugs available so it will be first in best dressed. A life story of Les Bell is being prepared and will be published shortly.

All inquiries to Leslie E. Daniels A.M.I.E.T., M.W.I.A. VK2 AXZ. 9 Highfield Terrace, Cardiff Heights, NSW 2285. Tel (02) 4954 0893.

Redcliffe and Districts Radio Club Inc.

President: John Presotto VK4WX 1st
Vice Pres: Charlie Strong VK4YZ 2nd
Vice Pres: John Maudsley VK4YJV
Secretary: Stephen Harris VK4HRS
Treasurer: Don Laing

Media Liaison: Kevin Jones VK4AKI -
kevjon@bit.net.au

Meetings: EVERY MONDAY with regular guest speakers and ongoing projects. Time: 19:30hrs (Local)

WHERE: Club Premises (Ex Kippa-Ring Guide Hall) - Cnr Klingner Road & MacFarlane Street, Kippa-Ring

Meeting Rooms: Open every Monday evening 19:30hrs (Local)
INCLUDING PUBLIC HOLIDAYS

2nd Monday of each month TRADE TABLE "buy swap sell".

Exams: Nominations for all classes of exams contact.

Laurie VK4BLE on 07 3284 8859.

Exams any time on two week notice.

CLUB NETS: Sunday Evenings at 1900K 2m on 146.925 Redcliffe repeater VK4RRC and 1930K 80m 3.612 +/- QRM VK4RC Net control Tuesday Evening 2000K on UHF repeater 438.325 This is our club's "Technical help net".

REDCLIFFE and DISTRICTS RADIO CLUB Inc.

PO Box 20, WOODY POINT, QLD 4019

URL: <http://www.qsl.net/vk4iz/>

EXAMS: Laurie VK4BLE

NET_1: SUN 1900K 146.925 MHz

NET_2: SUN 1930K 3.612 MHz

REPEATERS: VK4RRC 146.925 MHz

VK4RRC 438.325 MHz

SILENT KEY

Richard Soulie VK2ARS

Richard Soulie VK2ARS passed away about 11pm on Tuesday Night 13th June 2000 after suffering a massive heart attack in hospital. Richard was 55.

Born in Islington England on 30th July 1944. In 1953, Richard, then aged 9, arrived in Australia with his family. On 18th November 1967 Richard married Pat. In 1994 (6years ago) Richard went into hospital to have a Quadruple Bypass, but just after they started they found he only needed a Triple Bypass. One valve was ok.

In 1964 Richard obtained his first Amateur Radio licence VK2ZLF. In 1965 he changed to VK2ZRX. 1968 changed again, to VK2ZSY. 1980 yet another callsign change to VK2YQN. Then in April 1991 Richard obtained his 10wpm CW and his last callsign VK2ARS. Richard was a true amateur. He used the phonetics of "Amateur Radio Station" and that definitely described him. He loved home brewing and restoring old transceivers and was always on the lookout at field days for useful bits and pieces. Richard was a member of the UHF/VHF DX Group also the St George Amateur Radio Club. You could hear Richard's happy voice during the working week days on 146.800 MHz and on other bands nights and weekends. He will be missed by

all who listened and talked to him over many, many years.

His wife Pat said "Richard loved working with electronics and radios, also talking about electronics to everyone on and off the radio, but he always had plenty of time for his family!" During his working life Richard worked at a few places such as OTC, Mitsui, AWA, Philips (where he managed the NATA Calibration Lab) and BlueGum.

Richard made many new friends where ever he went. He always retained all his old friends. If you ever had a problem with your equipment Richard always had time to help you on or off radio. He would go to amateur Radio/Television clubs in and out of Sydney to give lectures about electronics and the equipment he thought you should have in your shack. His knowledge was endless and so was his help.

Richard leaves behind his wife Pat, his 4 sons Mark, Sean, Simon, Luke and 1 Daughter Kylie.

Thank you Richard for all your help and support throughout the years, you will be missed so much by family, friends and acquaintances. The world of Amateur Radio has lost a great asset.

May you rest in peace my friend - Vale Richard, VK2ARS

Advised by Wayne Bradwell VK2TBF and Chuck VK2SS

Crossed Field Antenna

The Crossed Field Antenna (CFA) is an interesting antenna development which is the subject of a lot of interest and discussion.

It was originally described in March 1989 in Electronics and Wireless World with a subsequent article in December 1992. The authors and developers were F M Kabbary, M C Hatley, and B G Stewart. A US patent has been taken out on the design. A number of antennas are in service in Egypt on the broadcast band. Papers have been presented at the IEE International Broadcasting Conference Amsterdam September 1997 and at NAB99. The antenna design offers a small size antenna for broadcasting and may be of interest as a compact HF amateur antenna. The initial work was carried out on the amateur bands.

An article describing a CFA appeared

in the October 1999 issue of Radioamatoori describing the construction of a CFA by Heikki Antman OH2BGC. The article has not been translated but the diagrams offer sufficient information for construction.

The CFA produces Electric ,E, and Magnetic ,H, fields from separate parts of the antenna. The fields are synthesised to be in time phase in the "near field".

The E field is produced by the upper cylinder or E plate and the H field is produced by the D plate which is located between the E plate and the Ground Plane. Both work against a ground plane which is smaller than for a conventional antenna.

The D plate voltage is 90 degrees phase advanced from the E plate voltage. The phasing unit provides the phase difference and also controls the voltage on the plates so that the wave impedance ZW matches the space impedance Z which is 377 Ohms.

The CFA is shown in Fig 1. The ground plane is 1 metre by 1 metre and is hexagonal. The distance between the flats would be 1 metre. The hole in the middle would be 50 - 60 mm in diameter and is needed to allow the feed to come from the phasing unit beneath the ground plane to the E cylinder and the D plate. The plate could be foil on a support plastic sheet if desired for use at amateur power levels. The E plate is 400 mm in diameter with a central hole of 60 mm diameter. The E plate is mounted on insulated standoffs 100 mm above the ground plane. The D cylinder is 200 mm in diameter and 250 mm long. It is mounted 100 mm above the E plate. The whole CFA is thus 450 mm high with the phasing unit and ATU for matching mounted beneath the ground

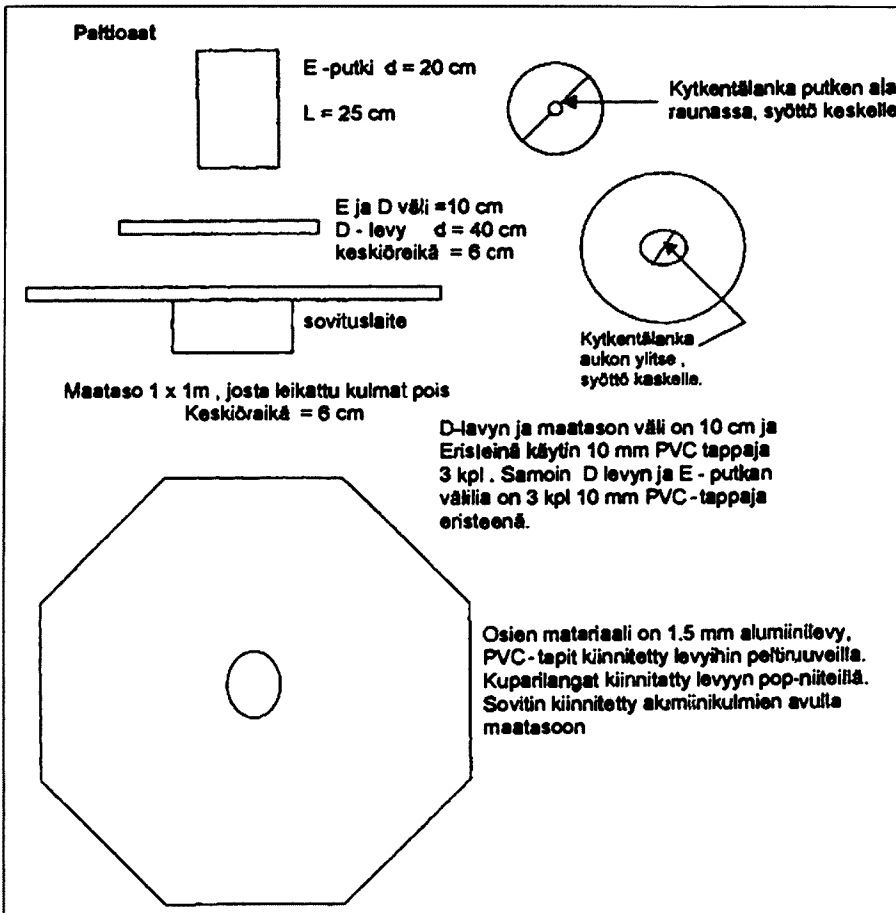


Fig 1. CFA Antenna construction.

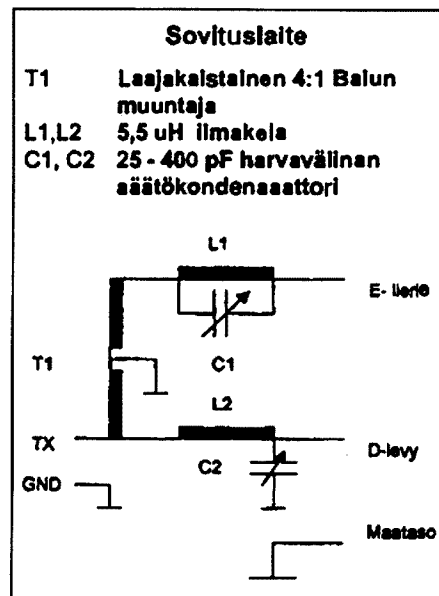


Fig 2. Phasing Unit for CFA.

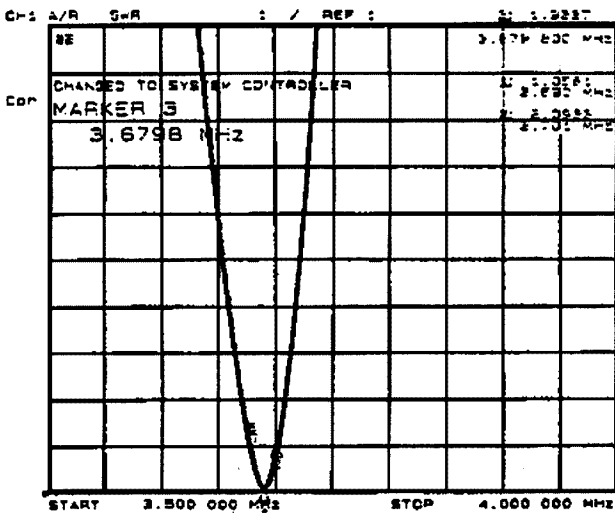


Fig 3. 80 metre SWR Curve

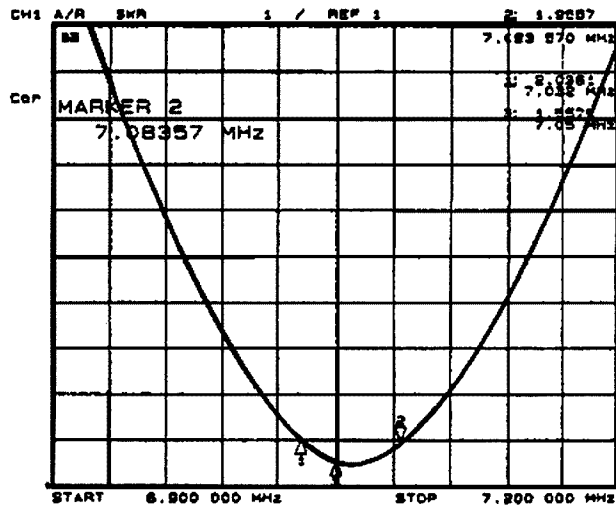


Fig 4. 40 metre SWR Curve

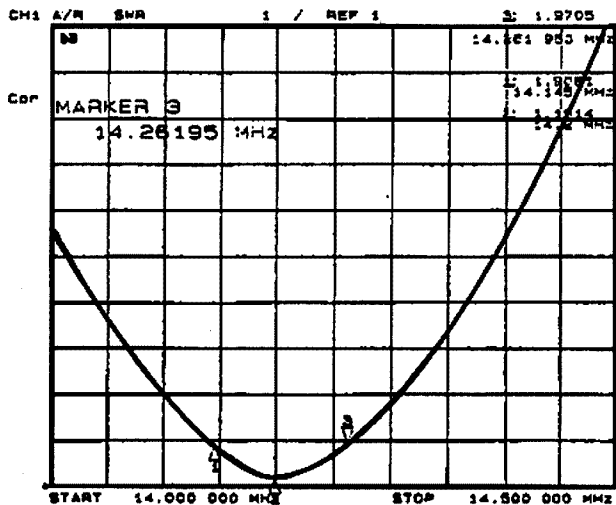


Fig 5. 20 metre SWR Curve

plane. The whole antenna can be mounted on the ground or a couple of metres above the ground. The Broadcast CFA's in Egypt are mounted above the transmitter building in one case. The phasing unit is shown in Fig 2.

The phasing unit in Fig 2 consists of a 4:1 Balun, two 5.5 microHenry inductors and two 25 to 400 pF variable capacitors.

Adjustment would appear to consist of getting the correct phasing and voltage relationship on the E and D plates. The resulting impedance would then be matched to the transmitter by the ATU which in this case was given as an AEA AT300. A field strength meter was also mentioned and it would appear to assist in tuning as the correct phasing and voltage point is approached. Figs 3,4,&5 show the SWR curves obtained on 80 , 40, and 20 metres.

There has been considerable discussion about the CFA which can be accessed on the internet at <http://www.antennex.com> and also on other sites. In addition to the developers there has been some input from Jack Belrose VE2CV who has conducted some of his own tests and Professor David Jefferies of Somerset University Surrey UK. It is an interesting antenna and the CFA has generated much interest and discussion.

Offset Fed Wire Element Beam

An interesting offset feed for a wire element beam antenna was described in QST October 1999 by Robert K Zimmerman NP4B.

This involves feeding the driven element between the centre of the driven element and the element tip. The feedpoint is picked so as to match the coaxial cable impedance of 50 Ohms. The centre of the driven element would require a match to 13.3 Ohms in the beam described but the offset feedpoint allows a 50 Ohm match.

The three element beam is shown in Fig 6. The dimensions are given both for bare elements, no jacket, and for

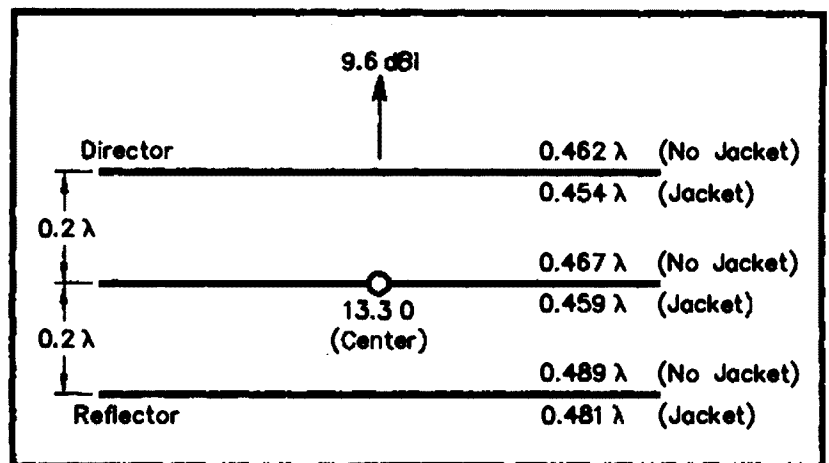


Fig 6. Three Element Wire Beam

Continued on page 20

Continued from page 19

elements made out of RG8X coax , with jacket. The feedpoint impedance at the centre of the driven element is 13.3 Ohms. The calculated gain is 9.6 dBi which is just under 7.5 dB gain over a dipole.

The construction of the offset feed driven element is shown in Fig 7. This is for construction from coaxial cable such as RG8X.

The antenna is shown in Fig 8. with dimensions shown in Table 1. The dimensions in Table 1 are for elements of bare #12 wire and a driven element made of RG8X coaxial cable as shown in Fig 7.

For VHF use the elements can be supported in PVC pipe (conduit) but will need to be shortened by 3% to allow for the effect of the pipe. At HF the beam can be suspended as a fixed wire beam.

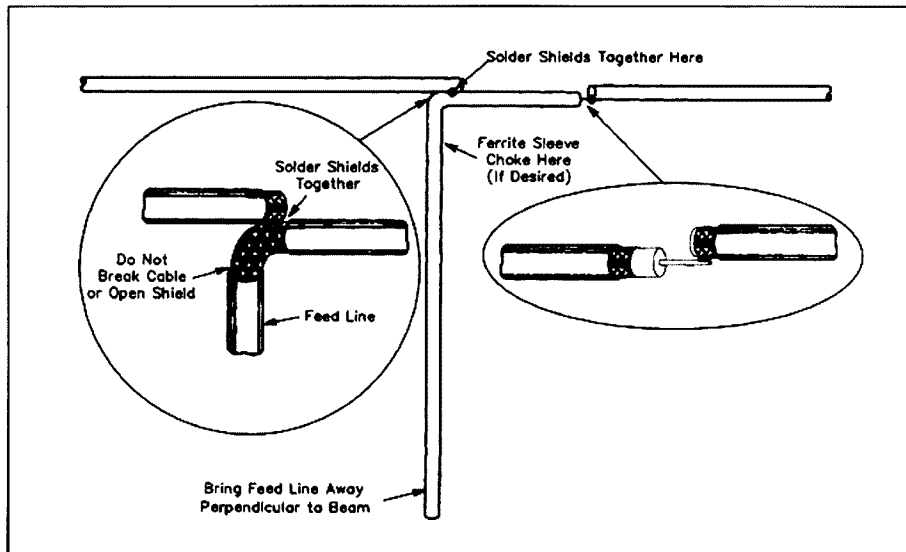


Fig 7. Driven Element Constructed from RG8X.

Table 1.

Frequency MHz	A	B	C	D	E	F
10.125	13.69	6.79	4.44	2.34	14.49	5.93
14.150	9.8	4.86	3.18	1.67	10.37	4.24
18.110	7.65	3.79	2.48	1.31	8.10	3.31
21.200	6.54	3.24	2.12	1.12	6.92	2.83
24.930	5.56	2.76	1.81	0.95	5.88	2.41
28.500	4.86	2.41	1.58	0.83	5.15	2.11
50.200	2.76	1.37	0.90	0.47	2.92	1.20

All Dimensions are in metres.

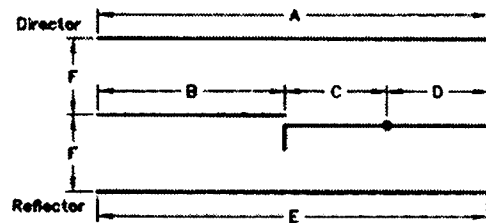


Fig 8. Three Element Beam

SILENT KEY

John Craddy VK2BOK

John Craddy was born in England and served in the R.A.F. during World War II. He was a licenced amateur radio operator and worked in Government Radio in Scotland before coming to Australia in 1958. He lived in Melbourne and worked for the Australian Broadcasting Commission. He later moved to Sydney with the Australian Broadcasting Commission. He was an active amateur radio operator both in phone and c.w.

He did not enjoy good health over the last few years and died in Westmead Hospital on the 21st June last.

He was a very jovial character and made many friends both inside and outside the amateur fraternity.

He was always willing to help a fellow amateur with technical advice and where possible with practical help which was generously given.

He will be sadly missed.

Hilary Chapman VK2BHC

George Craggs VK2AYG

George had been a regular on the "KESTREL" net on 3.600 MHz for many years. Although 84 years of age he was always a pleasure to join on the net each night, his sense of humour and patience in running the net was welcomed by all who listened in. George suffered a heart attack earlier this year and passed away on Sunday the 11th June.

On behalf of all the members of the "KESTREL" net we would like to pass on our sympathy to his wife Doreen and family. George would close the net each evening with the following prayer.

May the road rise to meet you
 May the wind be always at your back
 May the sun shine warmly on your face
 May the rain fall gently on your fields
 And until we meet again
 May God hold you in the palm of his His hand
 Good night from George 4AYG

Les Morrison VK4BAF

30 Years of Service

All callsigns VK5RAD
Refer also to the VHF/UHF Notes in July

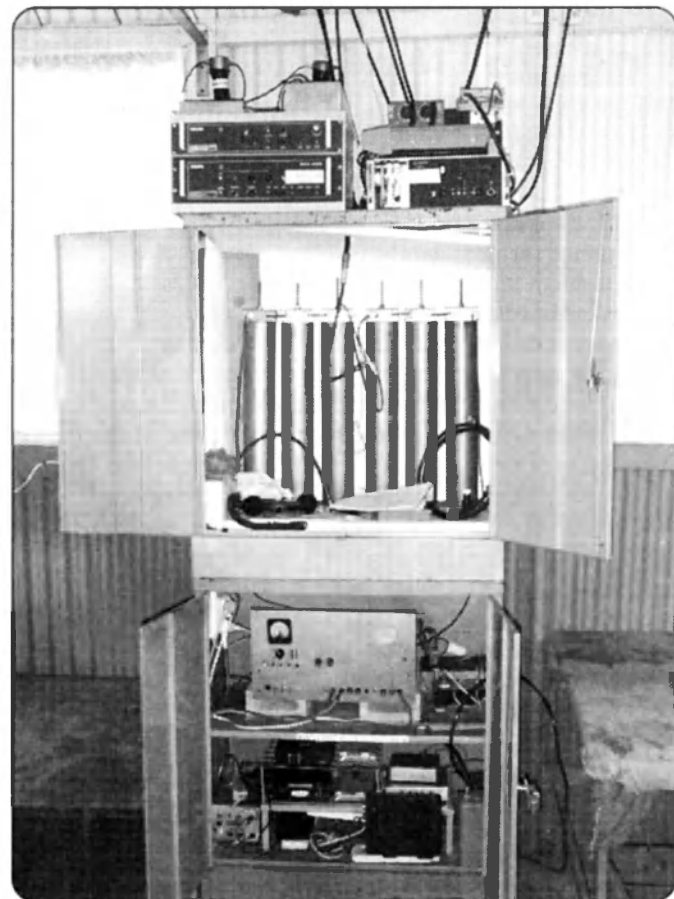
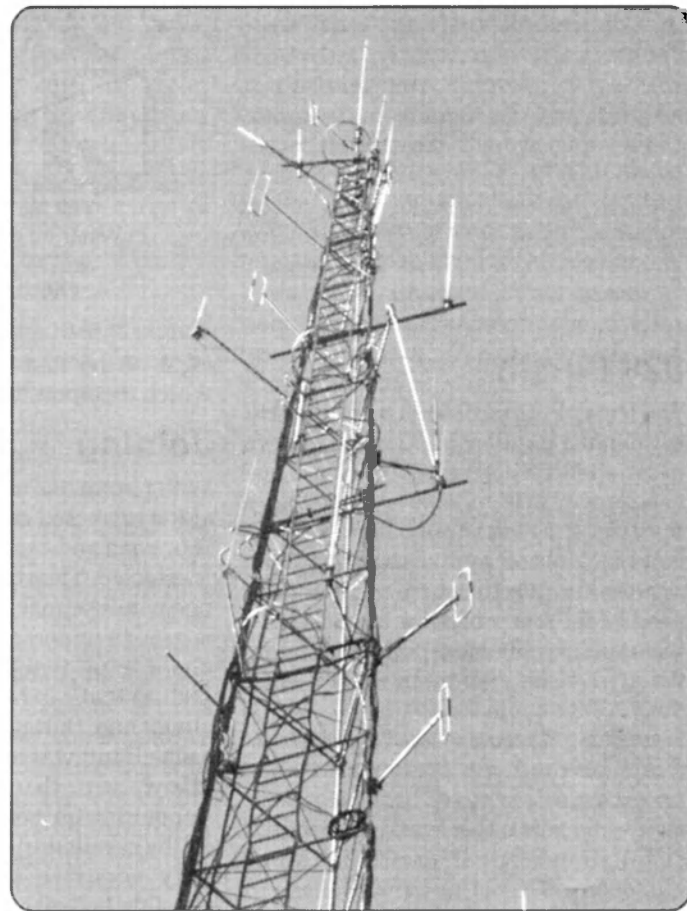
These photographs show the repeater antenna tower and the main rack of equipment.

The rack equipment is

- Top left 53.775 MHz Repeater, Top right 438.525 MHz Repeater,
- Top Cabinet 147.00 MHz repeater cavities,
- Top of bottom cabinet Original 147.000 MHz Repeater

The equipment on the bottom shelf consist of the packet equipment that operates as the VK5RAD rose switch. The user port is on 144.925MHz at 1200 baud with a modified FM92 remote unit (without its remote head) connected to a TNC2 rose switch and diode matrix.

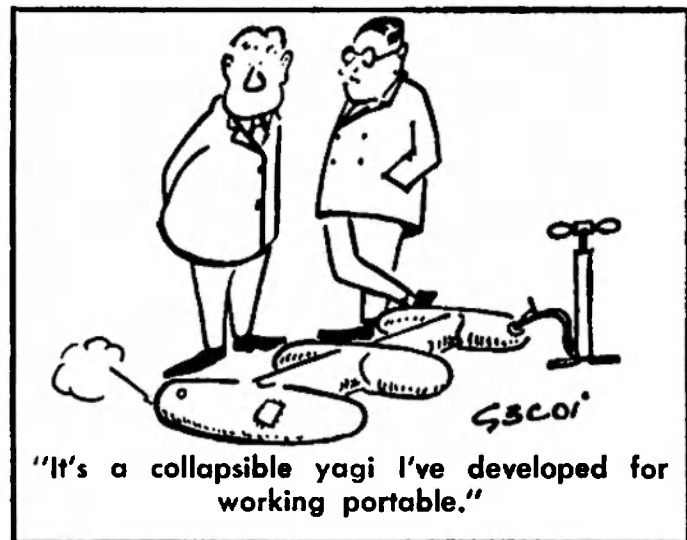
The UHF backbone radio is a Motorola M120 radio on 420.100 at 4800 baud also feeding a TNC2 rose switch



and then into the diode matrix. The backbone radio is directly linked to the central Adelaide BBS - VK5SPG and to the mid north rose switch VK5RLH.

The TNC units and remote reset control unit run from a float charged gel cell power supply to reduce corruption of the TNC RAM information with power bumps and the radios run directly from a 15 amp 12 volt supply.

ar



Source: CQ, September, 1968

REPEATER LINK

Will McGhie VK6UU

21 Waterloo Cr Lesmurdie 6076

will2@omen.net.au

VK6UU@VK6BBR

828 Circuit

The trusty Philips FM828 probably still is the most popular basic radio for two metre voice repeaters in Australia. They have proved to be reliable and don't have the large current supply requirements that many newer synthesised FM radio require. Simple to set up with out the need for E-Prom programming etc. I have the circuit for the most popular version, the mark 2, on computer, drawn using the CAD program Draft Choice, which is available if you so wish. These circuits were printed in Amateur Radio magazine a few years back. However many amateurs either have asked for the circuit in its original form, as a FAX or photocopy. This is not always easy to do, as the circuit is rather large being almost a metre long by a third of a metre wide. Using a scanner, I have been able to scan the circuit onto computer and save the file in GIF format at a reasonable file size. The exercise was an interesting one in solving a number of problems and as such I hope will make for interesting reading.

Size

The first problem was how to scan the circuit, that is a least three times larger than my A4 scanner. The solution was to scan the circuit in three separate scans and join them together using a graphics program on the computer. I used Paint Shop Pro, a great, easy to use, graphic program that allows the three separate parts of the circuit to be joined together. This is done by taking the first drawing file on the computer and increasing the canvas size of the circuit drawing window. As the three circuits were able to be scanned in correctly height wise it was only required to increase the canvas size horizontally. What you end up with is the left-hand part of the circuit in a drawing window on the far left, with lots of empty white space to the right of circuit one. In effect blank space to the

right of the first part of the circuit in which to import the other two drawings.

Joining

With circuit one on the computer screen at the increased canvas size, circuit two is opened and from the edit menu, copy is selected. Then by selecting the circuit one window (making it active) edit paste is used to import circuit two into circuit one. Circuit two imports as a movable picture that can be accurately joined to circuit one. During the scanning process, each circuit was over scanned a little to allow for this joining process. Depending on how zoomed in you are on the circuit during the joining process, very accurate seamless joining is possible between the two circuits. The process is repeated with the third circuit.

All in One

The finished result is all three circuits joined together to make up the original full-length circuit. The canvas size is then cropped to tidy up the drawing size. You always require a larger canvas size to allow for fiddling. The finished result looked good. It requires you to zoom into the part of the circuit you want to read on the computer, but this is easy and also allows moving the circuit once zoomed into, to the right or left with the mouse. The circuit can also now be printed out to what ever size you require, or if you have an A4 printer, three pages printed and the pages stuck together to reproduce the original full size circuit.

File Size

One difficult part of the process was to achieve the best quality scan that captured the detail of the somewhat aging circuit copy I had, while keeping the computer file size as small as possible. A circuit of this size, scanned at sufficient resolution, results in a very big file. From my first attempts, the file size was several megabytes. I wanted the

resulting file to fit on a 1.4 Meg floppy, and preferably less than half a Meg for easy E-mailing. This proved to be an interesting process and worth passing on some of what I learnt. I already have a fair knowledge of graphic files so I knew some of the tricks.

D.P.I.

D.P.I. stands for dots per inch. This is set during the original scanning process. Scanners can be set, via the computer interface software, to scan at different D.P.I.'s depending on how much detail you want retained. After much trial and error 300 dpi was required to capture the detail in the FM828 circuit. Less dpi made already aging circuit values difficult to read. However, the file size was excessively large.

Number of bits

The circuit was reduced to a black and white file. Sure the original drawing was in black and white but up to this point, due to the generally poor quality of the original, I did not think black and white would capture the circuit well enough but it did. When I say black and white, it means just that, the scanner, via the software makes a decision on what it scans to be either black or white. Grey is either black or white. This could mean that any faint Grey parts of the circuit could come out as white and be lost. However, the results were good. Black and white is a 2-bit file, meaning either a one or a zero to represent black or white. Grey scale is a 7-bit file, which can reproduce 256 shades of Grey. The more bits to make up a byte means more definition, or steps of Grey (or colour), but a larger file size. Modern computers use 16 bit or 24 bit file types, which allow for millions of possible brightness and colour variations. The 2-bit, black and white file reduced the file size considerable.

Compression

Even with trying different dpi's and reducing the file to 2-bit, the file was still excessively large. Which file compression type to use? JPG works best on photographs, looking for redundant information, such as areas of sky that are the same colour and brightness, and only saving that area of the photograph as a short code to say "make all this area this shade of blue". JPG can also do a good job on black and white, as in the circuit there are large areas of white. And sure enough JPG compression did considerably reduce the file size to about one quarter, but still too large. With JPG, you can vary the degree of compression, but on black and white lines, it shows up as a blotchy effect around the transitions from black to white. GIF, the other type of graphic file compression most used on Grey scale and black and white drawings did the best. GIF is limited to 256 brightness levels and hence does a poor job on colour photographs with millions of brightness and colour levels. GIF picks the nearest colour of the 256 and hence changes the overall colour of a photograph. Depending on the type of photograph

this may or may not be noticeable. GIF did the job of reducing the file size from several megabytes to just under 600 Kbytes. This is not always true even though GIF is designed for Grey scale and black and white. Sometimes JPG will produce a better result at a smaller file size; it just depends on a range of factors.

Available

If you want a copy of the FM828 circuit E-mailed to you please send me an E-mail and I shall send you a copy.

Compression Everywhere

While on the subject of graphic file compression, my job in Television has seen digital compression explode into the workplace. Most television you now watch is digitally compressed, particularly if you live outside Sydney, where most programs originate from and are relayed via satellite. These satellite links are more and more being digitally compressed to fit extra circuits on the satellite. Where only one analogue television program could fit, now four

can occupy the same bandwidth with no noticeable quality reduction. A broadcast quality television signal converted to digital, with no compression, is about a 270 megabit per second data stream. Digital compression, such as MJPEG (motion JPEG) reduces this to 8 megabits per second with no noticeable reduction in picture quality. It is not until the digital compression is increased to produce a data stream of under 2-megabit per second that picture quality suffers. The picture shows graduated bands of similar brightness and colour indicating excessive compression. The number crunching that is going on to do all this is truly amazing.

This digital compression age has also seen television stations like the ABC and SBS, who network programs from Sydney, and have to time delay the program due to the different time zones, move from automatic tape delay systems to computer hard drive systems. These new systems have to store more than two hours of broadcast quality picture and stereo sound on a computer hard drive. Without digital compression, it would not be possible.

radio and Communications

Incorporating AMATEUR RADIO ACTION and CB ACTION

Edited by Chris Edmondson, VK3CE

PO Box 123, Eagle Heights, Queensland 4271 • PH (07) 5545 0666 • FAX (07) 5545 0622

Ultimate Olympics Guide

That's the Ultimate Olympics RADIO Guide, of course! We list EVERY frequency to tune! Why not?!!

Know someone who could benefit from the WIAQ-sponsored ARCS Scheme? Learn electronics the EASY way!

Download your FREE copy of ARCS from <http://www.radiomag.com> today, and spread the good word!

Get your FREE DICK SMITH ELECTRONICS catalogue in our September issue, on sale August 21.

And check out the great stories while you're at it! We visit the Mt Gambier

Field Day, review a potent new 10m all-mode rig, build stacked

Yagi antennas and an Icom interface, plus lots more!

We have the biggest collection of radio-oriented Classified adverts in the country. There's lots of them because they work so well! Ask your newsagent to keep a copy for you each month.

Hurry — you might miss something!

Don't miss out — RADIO and COMMUNICATIONS is great reading for amateurs

Check your local newsagent today!

NOVICE NOTES

Peter Parker VK3YE

12/8 Walnut Street, Carnegie, Victoria, 3163

E-mail: parkerp@alphalink.com.au

Novice Notes Online: <http://www.alphalink.com.au/~parkerp/nonline.htm>

A Guide to Test Equipment

It's boring, but necessary. That just about sums up many peoples' attitude towards test equipment. Though it might not get as much use as the station transceiver, it can be worth its weight in gold when something goes wrong and you need to fix it fast.

This month we look at five items of test equipment most commonly found in the amateur shack. We describe each instrument, list its uses around the shack and point out features to look for when buying.

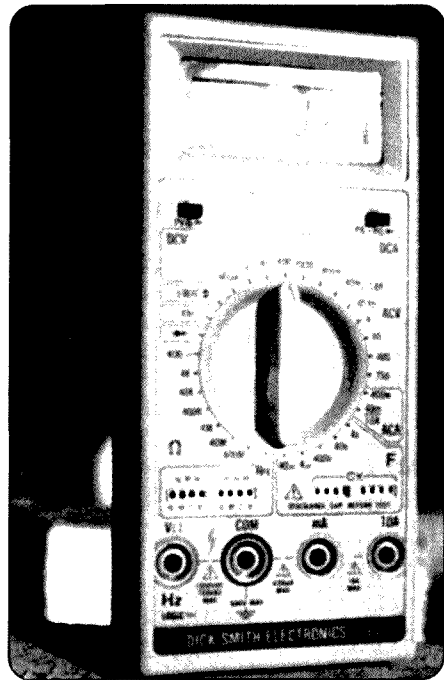


Photo 1

Multimeter

The multimeter is *the* fundamental item of test equipment that all amateurs should own. The cheaper multimeters (around \$30) allow voltage, current and resistance measurement as well as transistor, diode and audible continuity testing. More expensive instruments may include features such as capacitance measurement, frequency counters, bargraphs, temperature ranges, computer connections and mains voltage ratings.

Practical uses for multimeters around the shack include:

- Testing antenna and power connections with continuity tester function.
- Verifying transceivers are being fed with the correct voltage.

- Checking polarity of power connections.
- Measuring the current drawn by station equipment.
- Making voltage and current checks when developing or troubleshooting circuits.

There are two main types of multimeters – analogue and digital. Both have their pros and cons.

Digital meters are so cheap these days that no amateur need be without one. They are easy to use and fairly accurate. There is no need to estimate the indicated value when the meter needle is between two closely-spaced markings. The cheapest digital meters also have functions (e.g. transistor tester) that are missing from analogue meters of equivalent price. Photo One shows a medium-priced digital multimeter that has been the main test instrument in the VK3YE shack for about nine years. It has the usual ranges plus capacitance, frequency and a logic probe.

Analogue meters have advantages over digital for some purposes. Analogue movements are particularly good at displaying varying voltages, such as

audio signals. Also, when aligning transmitters, the fact that you've reached a peak (or dip) when making an adjustment is often more important than the actual value of the voltage (or current). An analogue movement is better at displaying such trends. Some of the better digital instruments have a bar graph function that combines the best features of both meters in one, but some users still prefer to keep the analogue meter handy.

Other features that amateurs should consider when buying a meter are: 20 amp DC current range (most HF transceivers draw up to 20 amps), audible continuity indicator (though missing from budget meters, it's very useful), capacitance, inductance and frequency measurements. The last functions may not work as well on the multimeter as on specialised instruments designed for a single task, but are still useful for much amateur work, especially when budgets are tight.

SWR/Power Meter

SWR and power meters cover a wide span. The cheaper meters provide

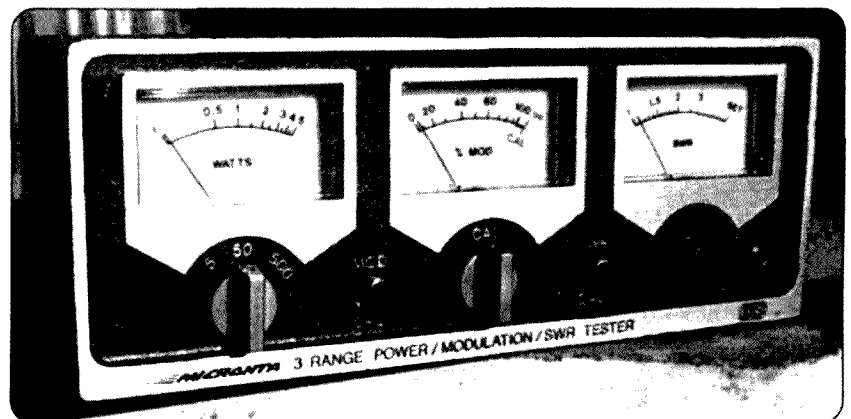


Photo 2

relative indication of the standing wave ratio (SWR) only and do not measure transmitted power. Slightly more advanced meters include RF power output and field strength indication as well. Most of these meters were designed for the 27 MHz CB market, but give useful relative indications up to 148 MHz. At lower HF frequencies (around 3.5 MHz) the sensitivity of these meters falls off dramatically so they can be useless at low transmit powers. Photo Two shows a CB-type instrument with separate meters for power output, SWR and percent modulation (for AM). It must have been designed for the CB pirate in mind, as its power scales range up to 500 watts!

The better meters, such as the Revex range sold in Australia, operate over a wider frequency range than the CB-type meters mentioned above. Their sensitivity is more uniform across the specified frequency range, which may be as much as 1.8 to 1300 MHz. Accuracy is also better, and the use of N-type connectors reduces losses and impedance variations at UHF.

Practical uses for SWR and power meters include:

- SWR measurements – These are almost mandatory for anyone who installs or constructs antenna systems and wishes to obtain the best performance from them, especially with modern equipment.
- RF power measurements – useful for testing transmitters or ensuring one is adhering to licensed power limits.
- Field strength measurements – useful for crude checks of handheld transceivers or antenna or feedline radiation. Measurements given are relative only. Not all SWR/power meters include this function, but a separate field strength meter is very easy to build (See NN April 97).

The SWR/power meter runs a close second to the multimeter as the test equipment item of most use around the amateur shack. The SWR function is most important, as modern HF transceivers do not deliver their full output power if the SWR is high. For such tests, even a relative-reading meter is sufficient. Those who repair, align or construct transmitting equipment are advised to obtain one of the better quality meters with output power indication.

Dip Oscillator

A dip oscillator is one of the main instruments used by the radio experimenter. People who experiment with antennas or build and align tuned circuits as used in HF transmitters and receivers will get most use from them. Applications for dip oscillators include:

- Testing tuned circuits in receivers and transmitters. A dip oscillator can give a reasonable indication of resonant frequency.
- Checking resonance of antennas such as mobile whips.
- Measuring unknown capacitors and inductors (especially handy for unmarked variable capacitors and inductors).
- An RF signal generator to provide test signals to align homebrew receivers or IF strips.
- As a crude beat frequency oscillator (BFO) to allow an AM receiver to tune SSB/CW signals.
- To monitor the quality of AM transmissions and listen for clicks on CW – some dip oscillators have an earphone socket for this purpose.
- RF field strength meter for antenna, feedline and RF leakage tests (though the author prefers to use a separate instrument with antenna for this).

The dip oscillator does all this and more in one or two transistors. It consists of a wide range RF oscillator and a meter. When the dip oscillator's coil is brought close to a tuned circuit that is resonant at the oscillator's frequency, the meter needle dips. What is happening is that the tuned circuit being tested is sucking RF energy out of the dip oscillator's coil, thus causing the meter needle to dip towards zero. The resonant frequency of unknown tuned circuits can be determined by holding the dip oscillator coil close to it and tuning the oscillator until the meter current drops. The dip oscillator's tuning control is normally calibrated in

MHz to allow a direct reading of approximate resonant frequency.

Most dip oscillators come in a long narrow case with plug-in coils on the end. This is so that they can be stuck

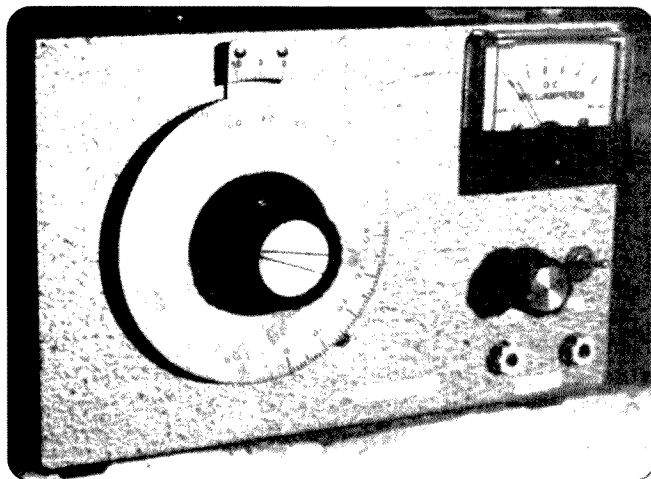


Photo 3

deep into the innards of radio equipment. Commercially-made dip oscillators can be hard to find and quite expensive new. However they are very easy to build and require just one specialised component (dual gang variable capacitor – common at hamfests). This makes them popular amateur construction projects. Photo Three is an example of a homebrew dip oscillator, built to a circuit described by Drew Diamond VK3XU.

Dip oscillators are not known for their accuracy and long-term frequency stability. The need to perform mathematical calculations is another drawback compared to direct-reading instruments. However for a cheap and simple test instrument that can do lot, the dip oscillator is hard to beat.

RF Signal Generator

Yes, this one's a 1950s 'boatanchor', picked up at a local hamfest for not very much (Photo Four). Yet, provided one can tolerate the warm-up time and the drift at higher frequencies, it's still a useful instrument, forty years on. The best RF signal generators have good frequency coverage and stability, easy tuning (possibly via keypad as well as knob), in-built digital frequency readout, synthesised frequency generation and calibrated output levels. These come in 19-inch rack cabinets, and being intended for the professional, have price

Continued on page 26

tags to match. For most amateur applications, however, cheaper hobbyist-type instruments (e.g. Dick Smith Q1312) will do the job quite nicely.

Like the dip oscillator, RF signal generators are versatile instruments. However, due to their larger dial, better frequency stability and calibrated output levels, signal generators are superior for many purposes. Amateur uses for RF signal generators include:

- Test oscillators for receiver construction and alignment. The ability to directly inject signals (rather than rely on RF pickup) and control output levels makes signal generators ideal.
- Receiver converters. A signal generator can be a makeshift local oscillator when testing converters or mixer stages.
- Certain antenna tests, especially when it is not desired to cause interference to others by radiating a high power signal.
- A BFO for AM receivers when receiving CW/SSB signals. The ability to vary RF output level and easier tuning on the signal generator makes this technique superior to using a dip oscillator.
- A low power transmitter. People have had CW contacts merely by connecting a keyed signal generator to an antenna! However best results will be achieved if attention is paid to matters such as impedance matching to the antenna, quality of keying, frequency stability and suppression of harmonics.

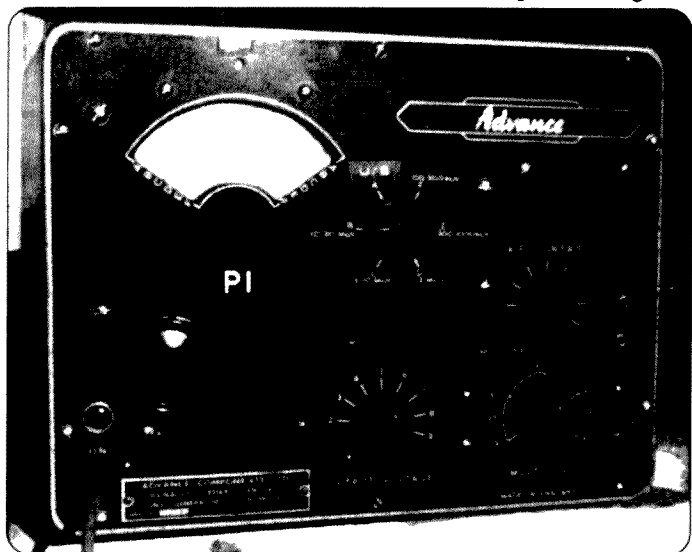


Photo 4

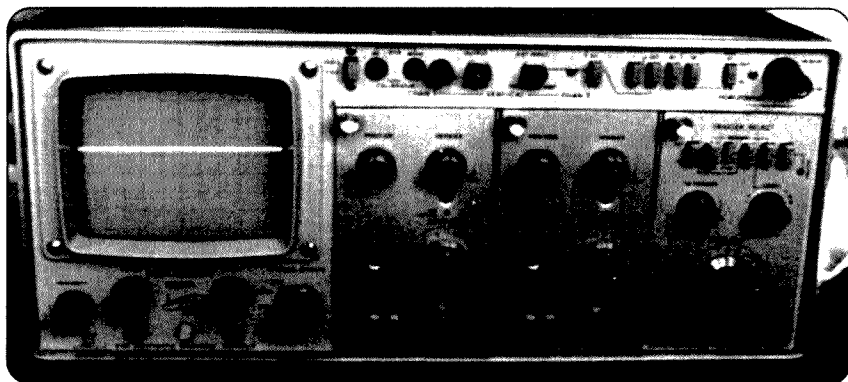


Photo 5

Cathode Ray Oscilloscope

Leaving aside those lucky few with spectrum analysers, RF test sets and other exotic equipments with five figure price tags, the cathode ray oscilloscope (or CRO) is the most advanced piece of test equipment that most of us can reasonably aspire to own.

If you intend to experiment with receivers and build the odd transmitter, you will not need a CRO. You can certainly get a homebrew CW, AM, FM or DSB station on the air without a CRO. However, if you wish to get the best performance and signal quality from homebrew or repaired equipment, a CRO is the way to go. Amongst other things, a CRO allows you to see waveforms from transmitters and oscillators. As you peak a tuned circuit, you can see the signal getting stronger. If you adjust a transmitter's power output setting too high, you may see the waveform depart from a smooth sine wave to one with odd troughs and bumps. If using an RF power meter, the

needle might suddenly jerk up, but the signal still sounds good in the receiver. With a CRO you see things you don't always hear on a receiver and, by moving the probe back from the output stage, you can identify the stages that are introducing distortion.

CROs are more expensive than any other test equipment item

described here. They might not be used often. However they are extremely valuable when used properly, and can provide a better insight into the actual operation of a circuit than any other instrument. For amateur purposes, maximum frequency that a CRO will go up to is important. The unit pictured (Photo Five) will go up to over 50 MHz – sufficient for most amateur work. Dual trace CROs are preferred.

Other items

In addition to the test equipment items mentioned above, ownership of an HF communication receiver (preferably with a digital readout) would be an advantage. The general coverage receivers included in recent HF transceivers are fine, though a separate receiver is preferred if your workshop is some distance from the main station. For VHF/UHF experimenters, a tunable VHF/UHF receiver will also be desirable. A Uniden Bearcat UBC9000XLT scanner, though it lacks SSB and misses most UHF TV channels, should be adequate for most. A frequency counter is nice to have, but not essential if you already have a good receiver with accurate digital readout.

Conclusion

This month's column has looked at the items of test equipment that the amateur should own. If your interests are mainly operating, the first two items are only really necessary. However, if you'd like to keep your equipment in top operating order, wish to make repairs, modifications or build new projects, all of the items described above will be useful. Plans for simple test equipment to build appeared in the April 1997 Novice Notes – also available via Novice Notes Online at the URL above.

ar

Updated Transponder Designations for Phase 3D

Bill Magnusson VK3JT

RMB 1627 Milawa Vic 3678 Email vk3jt@amsat.org

Some time ago it was decided to use a two letter designator to describe the transponders on P3-D. The first letter stands for the uplink, the second letter for the downlink. These new 2-letter assignments are consistent with the usual microwave band designations, where "K" for example means 18-26.5 GHz. Some gaps in the originally published designations have been filled in. Here are the new, hopefully final designations:

Letter	Frequency	Remarks
T	21 MHz	Uplink only
H	24 MHz	Uplink only
V	145 MHz	Uplink and Downlink
U	435 MHz	Uplink and Downlink
L	1.2 GHz	Two Uplinks only, L1 & L2
S	2.4 GHz	Two Uplinks and two Downlinks, S1 and S2
C	5.6 GHz	Uplink only
X	10 GHz	Downlink only
K	24 GHz	Downlink only

Note that the 21 MHz and 24 MHz designations, 'T' and 'H' are AMSAT's own as no commercial designators exist for the HF bands. The job of deciding on the HF designators was given to Matjaz Vidmar S53MV who designed and built the 21 and 24 MHz receivers for P3-D.

Half-yearly Update of Operational Amateur Radio Satellites

AMSAT-OSCAR-10 AO-10

Uplink 435.030 to 435.180 MHz CW/LSB
Downlink 145.975 to 145.825 MHz CW/USB
Beacon 145.810 MHz (unmodulated carrier)
Semi-operational, mode-B. AO-10 has been locked into a 70-cm uplink and a 2-meter downlink for several years. Monitor the beacon and cease transmission if your uplink causes the beacon frequency to vary. Excellent contacts are being made daily, although considerable uplink power must be used to access the transponder when the satellite is in a position to enable international contacts.

UOSAT-OSCAR-11 UO-11

Downlink 145.825 MHz FM, 1200 baud AFSK
Mode-S Beacon 2401.500 MHz
Operational. This aging OSCAR is still a goldmine of telemetry information for schools and experimenters.

RS-13

Uplink 21.260 to 21.300 MHz CW/SSB
Uplink 145.960 to 146.000 MHz CW/SSB
Downlink 29.460 to 29.500 MHz CW/SSB
Downlink 145.960 to 146.000 MHz CW/SSB
Beacon 29.458 MHz
Robot Uplink 145.840 MHz
Robot Downlink 29.504 MHz
Operational, in mode-KA with a 10-meter downlink and a 15-meter and 2-meter uplink.

UOSAT-OSCAR-14 UO-14

Uplink 145.975 MHz FM
Downlink 435.070 MHz FM
Operational, mode J.

Now returned to the amateur service and providing excellent contacts via its cross-band, mode-J FM repeater.

RS-15

Uplink 145.858 to 145.898 MHz CW/SSB
Downlink 29.354 to 29.394 MHz CW/SSB
Beacon 29.352 MHz (intermittent)
SSB meeting frequency 29.380 MHz (unofficial)
Semi-operational, mode-A, using a 2-meter uplink and a 10-meter downlink.

FACSAT-OSCAR-16 AO-16

Uplink 145.90 145.92 145.94 145.96 MHz FM using 1200 baud Manchester FSK
Downlink 437.025 MHz SSB RC-BPSK 1200 baud PSK
Mode-S Beacon 2401.1428 MHz
Semi-operational.

LUSAT-OSCAR-19 LO-19

Uplink 145.84 145.86 145.88 145.90 MHz FM using 1200 baud Manchester FSK
CW downlink 437.125 MHz
Digital downlink 437.150 MHz SSB RC-BPSK 1200 baud PSK

FUJI-OSCAR-20 JAS-1b

FO-20

Uplink 145.900 to 146.000 MHz CW/LSB
Downlink 435.800 to 435.900 MHz CW/USB
Operational. FO-20 is in mode JA continuously.

UOSAT-OSCAR-22 UO-22

Uplink 145.900 or 145.975 MHz FM 9600 baud FSK
Downlink 435.120 MHz FM
Operational and providing a great service to the packet radio community in forwarding international personal mail via the 'satgate' network. After another period of orbiting in full sunlight, UO-22 will be turned upside-down again later this year to cool the instrument package after continuous sunlight. During this period users may experience some degradation of the signal.

KITSAT-OSCAR-23 KO-23

Uplink 145.900 MHz FM 9600 baud FSK
Downlink 435.175 MHz FM
Operational but currently experiencing deep eclipses which tax the power budget. This may result in frequent periods of inactivity in the coming months.

KITSAT-OSCAR-25 KO-25

Uplink 145.980 MHz FM 9600 baud FSK
Downlink 436.500 MHz FM
Operational and carrying the bulk of digital traffic due to KO-23's eclipse problems.

ITAMSAT-OSCAR-26 IO-26

Uplink 145.875 145.900 145.925 145.950 MHz FM 1200 baud
Downlink 435.822 MHz SSB
Semi-operational, the digipeater function is on and is open to APRS use.

FUJI-OSCAR-29 JAS-2

FO-29

Voice/CW Mode JA
Uplink 145.900 to 146.000 MHz CW/LSB

Downlink 435.800 to 435.900 MHz CW/USB
Operational, rotated with digital mode and digi-talker.

Digital Mode JD

Uplink 145.850 145.870 145.910 MHz FM
Downlink 435.910 MHz FM 9600 baud BPSK
Digtalker 435.910 MHz
Operational, rotated with analog mode and digi-talker.

TMSAT-1 TMSAT-OSCAR-31 TO-31

Uplink 145.925 MHz 9600 baud FSK
Downlink 436.925 MHz 9600 baud FSK
Operational and restricted mainly to imaging experiments. Many of the high-resolution colour images transmitted by TMSAT are compressed using a UoSAT compression format. This is quite different to the more common imaging formats like TIFF, JPG, BMP etc. Users will require the latest version of the WISP module ProcMail V2.00G and Colin's (vk5hi) CCD Display program to process the images.

SUNSAT-OSCAR-35 SO-35

Uplink 436.291 MHz FM
Downlink 145.825 MHz FM
Operational, mode B.
AMSAT-South Africa reported recently that SO-35, has started transmitting digital signals. The SunSat package includes 1200 and 9600 baud digital store-and-forward capability. No reports of the digital signals have been received to date. Due to its limited power budget, SUNSAT has been subject to a restricted operating schedule with updates being announced on the AMSAT News Service from time to time.

UOSAT-12 UOSAT-OSCAR-36 UO-36

Uplink 145.960 MHz 9600 baud FSK
Downlink 437.025 MHz 437.400 MHz
The downlink is currently running at 38k4 baud. UO-36 carries a number of imaging payloads, digital store-and-forward communications and mode L/S transponders. It was recently the test-bed for NASA demonstrations using INTERNET protocols on orbiting satellites.

Much of this information was gleaned from the AMSAT News Service, word-of-mouth and from my own operating experience. Whilst every effort is made to ensure it is current at the time of writing, the very nature of the amateur radio satellite service is such that operating conditions can and sometimes do vary on a daily or weekly basis. It is therefore suggested that serious satellite users download the latest information from the AMSAT web-site www.amsat.org or subscribe to the ANS (Amsat News Service) via internet email. This may be initiated via the AMSAT web-site.

ar

DON'T MISS THE ACTION!

3-15V 25 Amp DC Power Supply

Our highest performance power supply, with current up to 25 Amps ICAS at 15 Volt, 20 Amps continuous at 13.8 Volts, and lower currents at lower voltages. It also has front panel metering, plus high-current banana-style and low-current output connections for extra flexibility. An internal heatsink and thermally-switched fan provides cooling without protrusions in the metal case (which measures 320 x 150 x 145mm). Don't confuse this power supply with look-alikes, it's been specially modified to DSE specifications for more reliable long-term operation, and uses a rugged 50 Amp bridge rectifier and a trifilar-wound transformer. We've also provided extensive overload protection through dissipation-limiting circuitry for the pass transistors, a 30 Amp instantaneous current limit, quality AC mains circuit breaker, a transformer thermal fuse and fused auxiliary secondary winding.

D 3800

\$297



VX-5R 6m/2m/70cm Deluxe Hand-Held

Tiny yet incredibly rugged, the VX-5R provides 6m, 2m and 70cm amateur band operation with 5W output as standard (4.5W on 70cm), made possible by a unique PA design and a super high capacity 7.2v 1100mA/H Lithium-ion battery. Plus, ultra-wide coverage VHF and UHF as well as AM medium-wave and shortwave reception facilities are provided, along with a large backlit dot-matrix LCD screen. All this in a diecast aluminium enclosure just 58 x 87 x 28mm WHD (without knobs or antenna)!

Features

- Tx: 50-54, 144-148, 430-450MHz
- Rx: 0.5-1.8MHz, 1.8-16MHz, 47-729MHz, 800-999MHz (cellular blocked)
- Full feature keypad, CTCSS encode/decode, digital code squelch
- Comprehensive menu system
- Over 200 memories
- 8 digit alpha-numeric memory labelling

- 5 battery saving systems, plus Tx/Rx usage monitor
- Spectra-Scope™ for monitoring adjacent channel activity
- Comes with FNB-58LI Lithium-ion battery, flexible antenna and AC adaptor/charger

D 3670

\$660



2 YEAR WARRANTY

YAESU

FT-8100R 2m/70cm Mobile

The Yaesu FT-8100R is a state-of-the-art 2m/70cm band mobile transceiver that combines high power and a highly versatile memory system with an excellent wideband receiver and solid construction. Its US MIL-STD-810 shock and vibration rating is your assurance of years of reliable operation. Includes hand mic, mounting bracket and fused DC power cord.

Features

- 198 memory channels
- 1200/9600 baud packet socket
- Inbuilt antenna duplexer
- Inbuilt crossband repeater facility
- Dual receive capability (VHF/UHF, VHF/VHF, UHF/UHF)
- Optional remoteable front panel

Frequency range: Tx 144-148MHz, 430-450MHz
Rx 110-550MHz, 750-1330MHz (less cellular)

Output power: 2m: 50, 20, 5W
70cm: 35, 20, 5W

D 3314



\$1017

2 YEAR WARRANTY

YAESU

FOR ALL YOUR COMMUNICATION NEEDS

Rugged HF 5-Band Trap Vertical Antenna

The rugged 5BTV incorporates Hustler's exclusive trap design (25mm solid fibreglass formers, high tolerance trap covers and low loss windings) for accurate trap resonance with 1kW (PEP) power handling. Wide-band coverage is provided on the 10, 15, 20 and 40m bands (SWR typically 1.15:1 at resonance, <2:1 SWR at band edges) with 80kHz bandwidth typical on 80m at 2:1 SWR. An optional 30m resonator kit can be installed without affecting operation of other bands. High strength aluminium and a 4mm (wall thickness) extra heavy-duty base section guarantee optimum mechanical stability. At just 7.65m, the 5BTV can be ground mounted (with or without radials, although radials are recommended), or it can be mounted in an elevated position with radial system. Unlike other antenna designs, the 5BTV can be fed with any length of 50-ohm coax cable.



D 4920

\$383

HUSTLER

30m Resonator Kit

Adds 30m coverage to the 5BTV and includes all hardware.

\$98.48

D 4921

6m 1/2 Wave Base Antenna

A rugged Australian-made vertical antenna designed to cover the 51 to 54MHz range, with minimum SWR around 53MHz. Built using high tensile T81 grade aluminium, it's just 2.9m long with a sealed base section and 100W minimum power rating. Complete with mounting hardware.

D 4825

SAQ76 D&G Antennas

2m Heavy Duty Base Station Antenna

For use where long-range omni-directional 2m band (144-148MHz) coverage is required. This 3.4m long 1/2 wave over 1/2 wave colinear vertical antenna provides approx. 5dB gain, and is housed in a very tough single-section fibreglass radome for all-weather protection. The strong aluminium base section is fitted with an N-type socket in its base for coax cable connection.

D 4822

BENELEC

\$136



VHF/UHF Power/SWR Meter

A high-quality SWR/power meter suitable for Amateur, UHF CB and commercial applications. Durable Japanese construction assures you of maximum reliability. With an all-metal case, large meter display, 140-525MHz coverage with less than 0.3dB insertion loss, and 4W, 20W and 200W power scales.

Revex model W540

D 1370

\$182

PowerHouse stores

A shopping experience like no other!

Dick Smith PowerHouse stores not only offer an expanded range of those original electronics products that have made our stores famous, but now you can experience the fun of using a wide range of communication equipment in our hands-on demonstration area. Called the "Ham Shack", each PowerHouse store has a dedicated area where licensed staff can show you the latest Yaesu, Uniden, or Magellan communications and GPS products, as well as an expanded range of accessory lines that may not be available in other stores.

Not involved in Ham Radio? Staff can also advise on the installation of a CB radio for your four-wheel drive vehicle, how to get involved in listening to Shortwave radio stations from around the world, or assist you in the selection of a suitable accessory for an existing piece of equipment. For bushwalking or boating users, you can also find out about the latest in inexpensive satellite based navigation receivers or emergency beacons, or just browse through an extensive selection of communications related books.

The PowerHouse is also the place to go if you simply need a component to finish that weekend project, to buy tools, or just to while away a few hours while checking out our

in-store technical books, library CD-ROMs, or our dedicated customer use Internet terminals.

With over 20,000 product lines in the electrical, computer, and communications areas, our new PowerHouse stores get the wavelength right!



PHONE FAX AND MAIL ORDERS

PHONE: WITHIN AUSTRALIA: 1300 366 644
(Local call charge)

FAX: (02) 9395 1155 within Australia and
(+612) 9395 1155 from outside Australia

MAIL: DICK SMITH ELECTRONICS, Direct Link, Reply Paid 160,
PO Box 321, North Ryde NSW 1670 (No stamp required)

Excludes packaging and postage. All major credit cards accepted.

14 Day Money Back Guaranteed if NOT completely satisfied. (Software excluded)



Visit our web site at
<http://www.dse.com.au>

DICK SMITH
ELECTRONICS

That's where you go!

Yaesu transceivers and accessories stocked in selected stores only. Other stores can place orders on a deposit-paid basis. Offers expire 27/8/2000. All prices shown are inclusive of GST.



Division Directory

The Amateur Radio Service exists for the purpose of self training, intercommunication and technical investigation. It is carried out by amateurs who are duly authorised people interested in radio technique solely with a personal aim and without pecuniary interest.

The Wireless Institute of Australia represents the interests of all radio amateurs throughout Australia. National representation is handled by the executive office under council direction. One councillor for each of the seven Divisions. This directory lists all the Divisional offices, broadcasts schedules and subscription rates. All enquiries should be directed to your local Division.

Broadcast schedules All frequencies MHz. All times are local.

VK1 Division Australian Capital Territory,
GPO Box 600, Canberra ACT 2601
President Gilbert Hughes
Secretary Peter Kloppenburg
Treasurer Emile Hoshing

VK1GH
VK1CPK
VK1LK

VK2 Division News South Wales
109 Wigram St, Parramatta NSW.
(PO Box 1066, Parramatta 2124)
(Office hours Mon-Fri 1100-1400)
Phone 02 9689 2417
Web: <http://www.ozemail.com.au/~vk2wi>
Freecall 1800 817 644

e-mail: vk2wi@ozemail.com.au
Fax 02 9633 1525

President Michael Corbin
Secretary Barry White
Treasurer Pat Leeper

VK2YC
VK2AAB
VK2JPA

VK3 Division Victoria
40G Victory Boulevard Ashburton VIC 3147
(Office hours Tue & Thur 0930-1500)
Phone 03 9885 9261

Web: <http://www.tbsa.com.au/~wlvic/>
Fax 03 9885 9298

e-mail: wlvic@alphalink.com.au

President Jim Linton
CEO Barry Wilton
Secretary Peter Mill

VK3PC
VK3XV
VK3APO

VK4 Division Queensland
GPO Box 638 Brisbane QLD 4001
Phone 07 3221 9377
e-mail: office@wiaq.powerup.com.au
Fax 07 3266 4929

Web: <http://www.wia.org.au/vk4>

President Colin Gladstone
Secretary David Jones
Treasurer Bill McDermott
Office Mgr John Stevens

VK4ACG
VK4OF
VK4AZM
VK4AFS

VK5 Division South Australia and Northern Territory
(GPO Box 1234 Adelaide SA 5001)
Phone 08 8294 2992

web: <http://www.sant.wia.org.au>

President Jim McLachlan
Secretary David Minchin
Treasurer John Butler

VK5NB
VK5KK
VK5NX

VK6 Division Western Australia
PO Box 10 West Perth WA 6872
Phone 08 9351 8873

Web: <http://www.omen.net.au/~vk6wia/>

e-mail: vk6wia@omen.net.au

President Nell Penfold
Secretary Christine Bastin
Treasurer Bruce Hedland-Thomas

VK6NE
VK6ZLZ
VK6OO

VK7 Division Tasmania
PO Box 371 Hobart TAS 7001
Phone 03 6233 3709 (BH)

Web: <http://www.wia.tasnet.net>

email: batesjw@netspace.net.au
Fax 03 6223 7816

President Phil Corby
Secretary John Bates
Treasurer John Bates

VK7ZAX
VK7RT
VK7RT

VK1WI: 3.590 LSB, 146.950 FM each Sunday evening from 8.00pm local time. The broadcast text is available on packet, on Internet aus.radio.amateur.misc news group, and on the VK1 Home Page <http://www.vk1.wia.ampr.org>

Annual Membership Fees. Full \$77.00 Pensioner or student \$63.00. Without *Amateur Radio* \$49.00

From VK2WI 1.845, 3.595, 7.146*, 10.125, 14.160, 24.950, 28.320, 29.120, 52.120, 52.525, 144.150, 147.000, 438.525, 1281.750 (* morning only) with relays to some of 18.120, 21.170, 584.750 ATV sound. Many country regions relay on 2 m or 70 cm repeaters. Sunday at 1000 and 1930. Highlights included in VK2AWX Newcastle news, Monday 1930 on 3.593 plus 10 m, 2 m, 70 cm, 23 cm. The broadcast text is available on the Internet newsgroup aus.radio.amateur.misc, and on packet radio.

Annual Membership Fees. Full \$78.00 Pensioner or student \$61.00. Without *Amateur Radio* \$47.00

VK3BWI broadcasts on the 1st and 3rd Sunday of the month at 8.00pm. Primary frequencies, 3.615 LSB, 7.085 LSB, and FM(R)s VK3RML 146.700, VK3RMM 147.250, VK3RWG 147.225, and 70 cm FM(R)s VK3ROU 438.225, and VK3RMU 438.075. Major news under call VK3ZWI on Victorian packet BBS and WIA VIC Web Site.

Annual Membership Fees. Full \$78.00 Pensioner or student \$61.00. Without *Amateur Radio* \$47.00

VK4WIA broadcasts on 1.825 MHz SSB, 3.605 MHz SSB, 7.118 MHz SSB, 10.135 MHz SSB, 14.342 MHz SSB, 21.175 MHz SSB, 28.400 MHz SSB, 29.660 MHz FM (rptr), 147.000 MHz, and 438.525 MHz (in the Brisbane region, and on regional VHF/UHF repeaters) at 0900 hrs K every Sunday morning. QNEWS is repeated Monday evenings, at 19.30 hrs K, on 3.605 MHz SSB and 147.000 MHz FM. On Sunday evenings, at 18.45 hrs K on 3.605SSB and 147.000 FM, a repeat of the previous week's edition of QNEWS is broadcast. Broadcast news in text form on packet is available under WIAO@VKNET. QNEWS Text and real audio files available from the web site

Annual Membership Fees. Full \$85.00 Pensioner or student \$72.00. Without *Amateur Radio* \$56.00

VK5WI: 1827 kHz AM, 3.550 MHz LSB, 7.095 AM, 14.175 USB, 28.470 USB, 53.100 FM, 147.000 FM Adelaide, 146.700 FM Mid North, 146.800 FM Mildura, 146.825 FM Barossa Valley, 146.900 FM South East, 146.925 FM Central North, 147.825 FM Gawler, 438.425 FM Barossa Valley, 438.475 FM Adelaide North, ATV Ch 35 579.250 Adelaide. (NT) 3.555 USB, 7.065 USB, 10.125 USB, 146.700 FM, 0900 hrs Sunday. 3.585 MHz and 146.675 MHz FM Adelaide, 1930 hrs Monday.

Annual Membership Fees. Full \$77.00 Pensioner or student \$63.00. Without *Amateur Radio* \$49.00

VK6WIA: 146.700 FM(R) Perth at 0930hrs Sunday relayed on 1.865, 3.564, 7.075, 10.125, 14.116, 14.175, 21.185, 29.120 FM, 50.150 and 438.525 MHz, Country relays 3.582, 147.200 (R) Cataby, 147.350 (R) Busselton, 146.900 (R) Mt William (Bunbury), 147.000 (R) Katanning and 147.250 (R) Mt Saddleback. Broadcast repeated on 146.700 at 1900 hrs Sunday relayed on 1.865, 3.564 and 438.525 MHz : country relays on 146.900, 147.000, 147.200, 147.250 and 147.350 MHz. Also in "Real Audio" format from the VK6 WIA website

Annual Membership Fees. Full \$69.00 Pensioner or student \$59.00. Without *Amateur Radio* \$38.00

VK7WI: 146.700 MHz FM (VK7RHT) at 0930 hrs Sunday relayed on 147.000 (VK7RAA), 146.725 (VK7RNE), 146.625 (VK7RMD), 3.570, 7.090, 14.130, 52.100, 144.150 (Hobart), repeated Tues 3.590 at 1930 hrs.

Annual Membership Fees. Full \$88.00 Pensioner or student \$75.00. Without *Amateur Radio* \$55.00

VK8 Northern Territory (part of the VK5 Division and relays broadcasts from VK5 as shown, received on 14 or 28 MHz).



Division News

VKI Notes

Forward Bias

Peter Kloppenburg VK1CPK

The Novice course that was started in early February has ended with an exam on July 30. The course went very well. Using Graeme Scott's text, students were taught enough to pass the Novice exam. Among others, there were two women in the class, one 12-year old boy and a 10-year old girl. Although their husbands, boyfriends, and the kids' father are active hams, none of these students had any practical experience with radios or electronics. Coaches, Chris Davis, Richard Elliott, Gilbert Hughes, and Dennis Gibson spend much time and energy bringing radio/electronic equipment to the classes to show what things looked like and demonstrate their use. Students saw EHT devices, transceivers, Linears, resistors, capacitors and coils of all shades and sizes. They handled transistors and valves, and learned how to use test equipment such as oscilloscopes, SWR meters, and Volt-

Ohm-Current Meters to make measurements on radio communications equipment. The exam results will be an indication of how well the Division organised the Novice course.

Our Treasurer, Ed Alcott, has been forced to relinquish the position owing to a serious illness. We all wish Ed well in the trying times ahead, and a big 'thank you' for a job well done. Committee member Ernie Hocking has agreed to take on the treasurer's duties.

Planning for the upgrade of the 70-cm VK-East coast-Link continues. A number of Philips 815T transceivers have been obtained, and tests are being made in several places in NSW to determine the minimum number of hops between repeaters. Various sites are being evaluated, such as Mt Gray, Mt McAlister, Knight's Hill and Mt Ginini. Other sites are Mt Sugarloaf, Maddens Plains, and Cabbage Tree. Maintaining

a high standard of reliability and audio quality is vital along a chain of repeater links, and this aspect, together with the backbone route planning, is being considered. Once the planning stage is finished, crystals and antennas can be obtained, equipment modified and installation commenced. This is a joint project between VK1 and VK2 clubs and Divisions, and many lively Emails, as to the best way to go, are being exchanged between the parties. The Division is still looking for a broadcast coordinator. The Sunday evening session is normally transmitted on 2 metres and relayed onto 80 metres. If you want to develop your talents in that direction, contact Gilbert Hughes on (02) 6254 3266.

The next General meeting of the ACT Division will be held at Room 1, Griffin Center, Civic, Canberra City, on August 27, 2000. Cheers, Peter K.

VK4 Notes- Qnews

By Alistair Elrick VK4MV

Rally, Really Successful

This month I would like to bring you a report recently presented on Qnews by David Jones VK4OF, the Secretary of the WIAQ, in his role with Brisbane Area WICEN. I think this demonstrates that these dedicated Amateurs and WICEN members have contributed immensely to the public profile of the Amateur service and highlighted the cooperation that exists between groups of willing Club volunteers. Over to you David.

During the weekend of the 2nd - 4th of June, over thirty Amateurs participated in and contributed towards a communications exercise in SouthEast Queensland. This being provision of scores data for Rally Queensland, held in the State Forests around Imbil, to Rally Headquarters at the Rydges Oasis Resort in Caloundra some seventy kilometres away.

Rally Officials would pass start times

to the start operators, and provide the finish data string containing start time, finish time and elapsed time, to the operators at the end of each stage. Almost half of the start operators, and all but one of the finish operators, were using packet radio, operating a simple program written by Brian, VK4XS who was the Amateur in charge of scores communications at Rally HQ. The program is called RForm, which is now up to Version 4.01, so successful has it been. It dovetails with his receiving program, called RScore, which prepares it for output to a printer or another computer, or to an Access database, which Brian had written.

Mt Kandanga Southwest of Gympie was the Rally Base, with a team of four operators. All members contributed to the camp structure and chores, with each responsible for his particular area of expertise. Neville VK4TX established and maintained the packet network,

including the newly installed infrastructure at the site of VK4RZC. Paul VK4ZEM supplied and maintained a continuous 240-volt supply. Geoff VK4AG established and maintained the radio shack. David VK4OF controlled management and voice networks, entering the data in near real time as it was received from those in the field who were not using packet. This meant that within not much more than a minute of a competitor finishing a stage, the score was well on its way to Brian and the State WICEN Co-ordinator Ewan VK4ERM his assistant at Rally HQ, via a full duplex packet network.

The managing director of Philcomm, a commercial communications operator and major sponsor, noted the substantial difficulty transmitting over such considerable distances, using VHF and above. As an example, Mt Kandanga at 576 metres gives a clear path, just to the

Continued on page 32

Continued from page 31

east of Mt Borumba at 624 metres, all through to the Maleny plateau at 440 metres. However, to get to VK4RZC where the packet link was established meant entering the fresnell zone, given that VK4RZC is more than 100 metres below the plateau. And that's before you consider earth curvature.

The main packet link between Mt Kandanga and VK4RZC was a full duplex UHF link on 439.225 MHz, with a tertiary backup at the QTH of VK4RX on 434.050 MHz. The field packet network at both the start and end of stages was on 144.700 MHz and this went through the node on Mt Kandanga, going out on 439.225 MHz. There were also two VHF voice circuits. The first was a simplex on 146.550 MHz, which had to QSY due to intermod problems caused by spurious emissions from a dirty car radio belonging to a rally official. Here special thanks to Nev VK4TX who was able to calculate the frequency source of the emissions and then to determine which radio was causing it. Sincere thanks also to Hoss and the team at Philcomm for locating and replacing the offending radio within thirty minutes of being advised of the problem.

The second circuit was a repeater network established by Brisbane Area WICEN Group President Ray VK4KV on Mt Borumba. Ray was assisted by Doug, VK4JJP, and this repeater was used to augment the voice scores being sent to Rally Base on Mt Kandanga where voice data was being entered into the laptops. It was also used by the stage finish assistants to send elapsed time scores back to the Spectator areas, where this information was eagerly received by the Public Relations people who then broadcast it to the public who attended to watch the event.

A further UHF voice repeater circuit on 438.475 was used by Brian and his assistant, to keep in contact with Rally Base on Mt Kandanga, especially for checking on missing scores. This repeater will be maintained, and become part of the growing infrastructure, which is part of the joint QDG/Brisbane Area WICEN Group Project. Funding for this massive network project, which eventually will reach almost to Coffs Harbour, has already been commenced, with donations from Brisbane Area WICEN Group and the Queensland Division of the WIA allowing

stage 1 to be effectively completed specifically for this event.

The various members at each of the stages 1 to 8 and 10 to 15 teams were: Bob VK4YBN and XYL Louise, Simon VK4TSC, Ed VK4JEN and XYL Karen, Paul VK4KBD, Graham VK4GBS, Bill VK4AZM, David VK4DCG, with XYL Shirley and family, Geoff VK4KEL, Murray VK3JKZ, Richard VK4ZA, Malcolm VK4ZMM, Paul VK4ZBV and XYL Jean, Bruce VK4EHT, Bill VK4HBP, Alan VK4AL. The Sunshine Coast ARC team of Len VK4ALF, David VK4KDL, Sid VK4SJF, Louis VK4KKL, Wayne VK4SWC and Barry VK4KKN at the very difficult Hella Hill Stage 9 at Tinbeerwah.

When you add in the Spectator Team of Julie VK4JJB, Ron VK4FC, David VK4DZA and his XYL Rochelle, and Kerry VK4JKR, you can see just how big this operation really was.

Without doubt, this is one of the premier events involving Amateur Radio assisting the public in a planned exercise, and it gives us great experience in the use of packet and phone circuits in the field. To give you an idea of the amount of data being sent, Neville reported there was a particularly busy period in which over 1500 packets were sent through the network in a fifteen minute period, and the data entry laptops on Mt Kandanga sent over 800 individual scores messages. That's a lot of fast typing.

Sincere thanks to Nev VK4TX, Ken VK4KWM, and the members of the Queensland Digital Group who were responsible for such a great result. Also thanks to the President and members of the QDG, the Sunshine Coast ARC, and Brisbane WICEN who assisted at the two Working Bees installing the infrastructure and sourcing the equipment for this exercise.

On the Sunday evening, my wife Jan and I attended the presentation dinner. We took the courtesy bus from the Oasis to the Caloundra Civic Centre, and were boarding with the Clerk of the Course, Mr Errol Bailey. In almost shaking my hand off my wrist, Errol just looked at us, and said ... "almost too much information, too often, too quick, too accurate ... just simply too perfect". That one moment made all the freezing winds, the driving rain, the bone-chilling cold, the insufficient showers, the over-or-under cooked camp food, the

dust and all the frustration of past radio failures, all melt away. This year, it was an undoubted success, but was in fact the culmination of over seven years of planning, experimentation and many failures in the use of packet as a reliable means of data transmission for WICEN and SES purposes.

On behalf of the Brisbane Sporting Car Club and Brisbane Area WICEN Group, I wish to sincerely congratulate and thank all those who helped make this such a successful exercise and event. David Jones, VK4OF.

Well done all those participants and cheers from Alistair VK4MV.

VK7 Notes

VK7 Division Executive

2000/2001

President/Federal Councillor

Mr Phil Corby VK7ZAX

147 Samander Avenue, Scamander Tas 7215
philcorby@eudoramail.com

Mr Ron Churcher VK7RN

Mr Mike Jenner VK7FB

Mr Dale Barnes VK7DG

Secretary/Treasurer

Mr John Bates VK7RT

GPO Box 371 Hobart Tas 7001
batesjw@netspace.net.au

Mr Timothy Holloway VK7TIM

Mr Scott Evans VK7HSE

Mr Bob Cropper VK7BY

Divisional Councillors

Mr. Ron Churcher VK7RN

Ron.Churcher@tassie.net.au

Mr Bob Cropper VK7BY

Fax 03 6442 5194

Mr. John Bates VK7RT

Mr. Phil Corby VK7ZAX

Mr. Scott Evans VK7HSE

vk7hse@southcom.com.au

Mr Mike Jenner VK7FB

vk7fb@netspace.net.au

Mr Dale Barnes VK7DG

dbarnes@netspace.net.au

Mr. Timothy Holloway VK7TIM

Phone 03 6328 1434, 0419 523 922

Ex Officio Officers

Awards Officer Mr. John Bates VK7RT

QSL Mr. John Bates VK7RT

FTAC Mr. Tony Bedelph VK7AX

Broadcast Mr. John Rogers VK7JK

Mr Mike Jenner VK7FB

Public Officer Mr John Bates VK7RT

Historian Mr. Richard Rogers VK7RO

Federal Councillor Mr. Phil Corby VK7ZAX

Alt Fed Councillor Mr. Ron Churcher VK7RN

Membership Mr John Bates VK7RT

Hon. Solicitor Mr. Phil Corby VK7ZAX

Education Off. Mr. Reg Emmett VK7KK

Intruder Watch Mr. Robert McKenzie VK7RB

DX NOTES

Ross Christie, VK3WAC
19 Browns Road, Montrose 3765, Vic.
Email Vk3wac@aol.com

Disaster has struck my shack!

My IC 746 has developed a fault in the transmitter and only outputs a couple of watts on all of the HF bands. I know I have let it be known that I enjoy QRP, but 2 Watts from a '746 is not exactly efficient or in the spirit of QRP operation. It has been sent off for repair and hopefully it'll be back in the shack soon. I am now using my 'old faithful' FT101Z. Apart from the inconvenience of having to 'tune' and 'load' the PA section the '101 is doing a great job. I managed to work Clive, GM4POI who resides in the Orkney Islands off the North coast of Scotland. He was on 20m in late June. Apart from the normal adjacent channel QRM, which is par for the course on 20m, we managed a 2x 559 QSO. The 500Hz CW filter fitted to my '101 makes copying much easier on a congested band, and in my opinion, works better than the DSP filters on my IC746.

The TNC is still missing from my packet-cluster setup in the shack. Everything else is set up and ready and waiting to be connected to the TNC. Hopefully, one will arrive soon from the land of Uncle Sam.

The ANZA net (daily at 05:00 UTC on 14183kHz +/- QRM) is worth a visit. Some interesting DX stations often appear on this net. I managed to work Dudley, Z22JE (Zimbabwe) and Gerd, V51GB (Namibia) on SSB. Signals were not great but they were easily readable here in Melbourne. I also managed to work Brian, 9J2BO (Zambia) on CW at approximately the same time in the afternoon a few days later. His signals were much stronger, in fact one of the strongest signals on the band at the time.

Early in June there was a severe CME (Coronal Mass Ejection) from the Sun that had me eagerly monitoring the bands to see what effects it would produce on propagation, whether enhancing or depressing propagation. From my perspective 10m and 6m were not affected at all and signals on the lower bands seemed to fade out earlier

in the evening than normal. I would like to learn a bit more about the effects the sun has on the ionosphere. The various types of events on the Sun obviously have different effects on the ionosphere. Sometimes enhancing and at other times depressing propagation, which event causes what effect? Can anyone recommend a good book on the subject? While on the subject of things solar. The Daily DX News lists two web pages dealing with propagation forecasts and current events on the surface of the Sun. A current Propagation forecast, along with the various related indices, can be found at <http://dx.qsl.net/propagation/> Some magnificent solar images can be viewed at http://www.sel.noaa.gov/solar_images/2000

The DX

There is some nice DX around on the bands just now. I have worked stations on 20m and 15m CW in July. The 17m band should be able to produce some good DX, its characteristics should be similar to 20m and although there are many Europeans on seasonally, I have heard little 'rare' DX on this band. The 10m band has also been very disappointing from my QTH. I would have expected much more activity on this band as we are practically at the peak of cycle 23. The regular JA's, HL's and UA9's have been available but little else. Perhaps the band conditions have not been the best lately due to the CME in early June. Hopefully the bands will pick up again for August and if so here are some interesting stations that will be active this month.

BY, China. Fred, WF6Z, will be in China until 15th August as a member of the American K2 North Ridge Expedition climbing team. He will also operate from the K2 camp base in the Xingiang Province as BT0QGL. Look for activity on 40/20/15/10 metres. QSL via K6EXO, Harvey G. Shore, 6433 Pat Ave, Westhills, CA 91307, USA.

C6, Joe/W8GEX, Ron/WA8LOW, Mike/N9NS and Mike/K9AJ will be active as C6AJR. The group will operate two stations (CW and SSB on 6-40 metres) from the Berry Islands (NA-054), Bahamas between the 28th and 31st July.

CT3, Look for Ben, DJ8FW, to be on from the Madeira Islands possibly as CT3/DJ8FW from July 20th to August 20th.

GH4BJC/P. Chris, G0WFFH, plans to be active with this special call sign from the island of Jersey between the 12th and 22nd of August. He will be operating QRP with the ISWL club call on SSB only. QSL via G0WFFH, Christopher Gresswell, 121 Gramby Court, Gramby, Milton Keynes, Bucks MK1 1NG, UK.

M0RAA/VP9, operator Seiji Fukushima, will be on the air 21st - 26th of September. QSL via JH6VLF, Masanori Matsuyama, 303-Junesusuzuki, 1330-Hiregasaki, Nagareyama, 270-0161, Japan.

TF, Iceland. Ed, G3SQX, will be operating as TF/G3SQX (EU-021) from 28th July till 6th August, his activity will be CW only on as many HF bands as possible. Ed will run 100w and a variety of antennas. Check Ed's Web site at: <http://www.G3SQX.net> QSL via G3SQX, Edwin Taylor, 4 Oaklands Avenue, Birmingham, B17 9TU, UK.

VP5. Carlo, I4ALU will be active (on all HF bands CW only) as VP5/I4ALU from Jody's (VP5JM) QTH on Providenciales (NA-002) between the 14th and 28th of August. QSL via I4ALU (Carlo Amorati, Via Battistelli 10, 40122 Bologna - BO, Italy).

VQ9, CHAGOS ISLANDS. Dale, W4QM, will once again be active as VQ4QM from Diego Garcia. He will be active for 4-5 months starting in mid-late July, mainly CW. QSL via W4QM, Harmon D. Strieter, 928 Trinidad Road, Cocoa Beach, FL 32931-3050, USA.

ZS, Vlad, ZS6MG has been authorized to operate as ZS0M till the end of the year to celebrate his 25 years of amateur

Continued on page 34

radio activity. He plans to air the special call in major contests and during the weekends around 14 UTC on 10 or 15 MHz CW and SSB. QSL via ZS6MG either direct (Vladimir Karamitrov, P.O. Box 1788, Bramley 2018, South Africa) or through the bureau. [TNX ZS6MG]

XE. Jack, F6BUM will be active as XE3/F6BUM from Mujeres Island (NA-045) between the 30th of August and the 8th September. QSL via F6BUM, Jaques Mainguy, Buzet Sur Baise, 47160 Damazan, France.

9A, 9A1CZZ reports that special calls 9A900Z and 9A900BP (Krk Island, EU-136) will be aired on all bands and modes through the end of the year. QSL via 9A2DM, Vladimir Talan, PO Box 77, 48000 Koprivnica, Croatia.

IOTA Activity

I received a letter from a reader in Queensland (I've lost his letter and can't remember his name) who tells me that there are quite a few IOTA chasers in VK. This is good to know because I was beginning to think that DX chasing of any kind was dying out here in Australia. IOTA is 'big' in Europe and the US and every new island that qualifies for a reference number seems to be buried under a dog pile when a station does gets on the air. Some have said that IOTA is something to occupy your time on the air after achieving DXCC. I strongly disagree. There are far more islands that qualify as individual entities than there are DXCC recognised countries. Working some of these islands is a much more difficult task than working some rare countries. Some islands have no permanent population, let alone a licenced amateur operator, and are only activated on an annual basis. So if it is the 'spirit of the chase' that gets the blood flowing in your veins then IOTA could be for you. If you missed the IOTA contest during the last weekend in July, try and have a listen on the preferred IOTA frequencies (listed below) and see if you can log some of the following stations

EU-077

EA1GA/P will be active from Noro Island (EU-077) on the 8th and 9th of July, followed by a visit to the Erbosa Islands (EU-077) from the 12th to 15th of August. QSL via EA1GA, Amadeo Rodriguez, PO Box 14, 36640, Ponteguesures, Spain.

NA-NEW

Blaine, KL7AK, and a team will activate the Kudiakof Islands. These are part of the Northern Alaska Peninsula West group, a currently unnumbered IOTA island group. The team expects to be on the island from the evening of the 4th of August UTC, until early in the morning of the 9th. Operators will include Rick, KL7AK; Blaine, KL7TG; Larry, KF6XC; and Tom, WOGLG. They will concentrate mainly on 20 metres because it should be open around the clock. Look for KL7AK on 14260, they will make CW contacts on request. QSL via N6AWD, Fred k Stenger, 6000 Hesketh Drive, Bakersfield, CA 93309, USA.

SA-047 Mel Island.

The 59(9) DX Report says that a group of Brazilian YL's will go to Mel Island on the 10th August. They will be active as PR5YL until the 14th of August. QSL via PP5LL, Jaime Lira Do Valle, PO Box 08, Florianapolis, SC 88.010-970, Brazil.

OC-NEW

Dan, VK8AN, Len, VK8DK and Terry, VK8TM will be travelling to a couple of new IOTA locations early in the coming southern spring. They are planning to operate from Browse Island from September 1st to the 5th, then from Cassini Island from the 7th till the 11th of Sept. Callsigns will be announced shortly. The QSL route is via VK4AAR: A. Roocroft, POB 421, Gatton 4343, Australia. The reference numbers for the islands will be announced as soon as IOTA requirements are met.

AS-028

Alexander, UA0QBA will soon be active from Kotelny Island (AS-028) on CW, SSB, RTTY, PSK-31 and SSTV. He is expected to stay on the island until the summer of 2001. QSL via UA0QBA, Alex, PO Box 145, Yoshkar-Ola, Mariy-El, 424000, Russia.

Special Events

The 'International lighthouse/lightship weekend' is being held on the weekend on the 19th and 20th of August. A continually updated list of participating stations can be found on the web at the following site, www.waterw.com/~weidner/LH-day-table.htm. There are a large number of stations being set up at Lighthouses/Lightships all over the world so it should prove worthwhile to do a bit of searching on the bands for some exotic locations.

Queen Amazona 2000 DXpedition. A

team of Colombian and U.S. operators will use the callsign 5K9AQ to celebrate the "Queen Amazona 2000 DXpedition". This is a very long trip along the Amazon River. The station will be active for the rest of the year. No set schedule for bands or modes is available but I suggest listening on 20 and 15metres during times when propagation favours South America. QSL for the event is via HK3PXA, Roberto Rey, P.O. Box 101939, Bogota, COLOMBIA.

The 225th anniversary of the city of Krivoy Rog is the reason behind the special event stations EO225E, EO225EA, EO225EJ, and EO225EL. These calls will be active on all bands until the 27th of August. If you make contact with these stations (3 QSOs, duplicates are valid on different bands or modes), you will receive the "Krivbass Award" for 5 USD or IRCs. QSLs for all the callsigns are via UT1EJ, Yuri Arkhipov, P.O. Box 101, Krivoy Rog, 50071 Ukraine.

Round up

Amateurs Radio operators on Cyprus have been granted permission to use the special prefix 5B40 (Five Bravo Forty) from 1st of July until the 30th of November 2000 to celebrate 40 years of the Republic of Cyprus. Use of the special prefix by Cypriot hams is optional during the above period.

Thanks to W4KM for translating an article in the 'Russian Patriot Magazine'. The article stated that Russia has returned to a centralised QSL bureau system which is attached to the Central Radio Club (CRC). The SRR (Union of Radioamateurs of Russia) Presidium has confirmed a set of rules for the operation of the QSL bureau. The address is PO Box 88, Moscow, 123459, Russia. But a word of warning, 'Packages, wrappers and letters arriving from abroad indicating no individual recipient will be opened; enclosed money and IRCs are removed and will be credited to the CRC account. Envelopes showing the callsign of the addressee are not subject to being opened'.

Two young German Amateur Radio operators have announced that they intend to operate from Christmas Island in August this year. Stefan, DH1SGS and Toby, DH1TW will be active from the Indian Ocean Island from the 13th to 25th of August as either VK9XY or VK9XW. The pair will take along 2 transceivers, a 400-watt amplifier, an HF9V vertical and a Force 12 C3 beam. Stefan will operate SSB while Toby will handle the

CW pileups. More details of their adventure can be found at <http://www.ql.net/vk9xw>.

E41, PALESTINE. Jess, KR4OJ, recently had a QSO with David, E41/OK1DTP. David informed Jess that he is working at a school in Palestine and will be there until July 2001. Jess looked David up (under OK1DTP) on QRZ.COM web page (<http://www.qrz.com>), and found David's email address (okldtp@hotmail.com). Jess dropped him an e-mail and told him that he still needs E41. David wrote back to him and organised a sked. David said that he will continue to be available on the air (from the school) each Friday. If anyone needs E41 then simply drop him an e-mail and he will set up a sked, SSB or CW. QSLs are handled by his father, Jiri Lunak, OK1TD, U Sporcky 185, 470 01 Ceska Lipa, Czech Republic.

Like listening to the beacons? A nice piece of software called BeaconSee allows you to determine propagation conditions to/from the various NRDX Beacon locations. It displays a great-circle map centred on your QTH showing propagation to/from the various NRDX Beacons. The software can be downloaded for free from the following website <http://sapp.telepac.pt/coaa>

The correct QSL route for EX8M is Vladimir Ya Sudakov, P.O. Box 2, Karabalta 722030, KYRGYZSTAN.

The RSGB has just announced the passing of another famous amateur operator and it is with great regret I pass on the news of the death of Louis Varney, G5RV (ex 8P6DF, CX5RV). Louis 'Reg' Varney became a silent key on the 28th of June at the age of 89. Reg was the inventor of the world famous G5RV antenna. He was a member of the FOC and the RSGB. The number of G5RV

antennas installed above shacks all over the world is testimony to the popularity of a design that has weathered the inquisitiveness of amateur antenna experimenters well for years, and will do so for years to come. Our sincere condolences go to the Varney family.

If you hear or work any DX stations, have any news regarding upcoming events on the bands please drop me a note either via email or the post. I'll be glad to include the information in DX Notes. 73 and good dx.

Sources

Thanks and recognition are due to the following people and organisations. Vlad, ZS6MG, Tedd, KB8NW; Tomas NW7US; 59(9) Report; OPDX Bulletin; 425 DX News and The Daily DX by Bernie McLenny, W3UR.

ar

DXCC listings

SSB

Roll of Honour SSB

vk5ms 331/385
vk5wo 331/384
vk6lk 331/356
vk3qi 331/345
vk4ua 331/345
vk3dyl 331/337
vk2fji 331/337
vk6hd 330/358
vk4lc 330/337
vk4oh 330/337
vk6ru 329/384
vk1zl 329/335
vk3akk 327/338
vk2dej 327/333
vk6ne 326/342
vk4aar 323/327
vk3yj 322/325
vk3amk 321/340

vk5ee 321/327
vk2avz 319/330
vk7bc 319/329
vk6vs 319/323
vk3csr 316/325
vk5fv 314/317

Ordinary list SSB

vk6ajw 312/317
vk6apk 310/315
vk5wv 306/328
vk6py 306/312
vk3ji 304/319
vk6ro 303/309
vk3lr 302/308
vk4lv 295/297
vk4sj 295/296
vk4lcu 294/296
vk4dp 293/305
vk2wu 291/296

vk4bg 286/302
vk3cyl 282/288
vk3dp 271/274
vk4cy 271/273
vk4ej 267/269
vk3gi 263/267
vk3vq 259/276
vk5ie 258/261
vk4bay 251/254
vk3uy 251/253
vk3cim 250/254
vk6anc 244/248
vk2pu 243/247
vk6yf 238/241
vk7ts 237/238
vk6abs 235/
vk2ckw 234/237
vk2hv 234/
vk6apw 228/229
vk3ds 226/236
vk3etm 226/227

vk3sm 222/242
vk5bo 217/222
vk4ems 215/
vk3dd 213/217
vk4xj 204/216
vk3dvt 201/204
vk3eft 198/201
py2dbu 195/197
vk4il 194/
vk2uk 190/194
vk4au 189/190
vk6wjh 183/
wa1mks 171/
vk6aph 168/169
vk7jab 162/
lu5dse 161/
vk4arb 159/160
vk2no 157/
vk4it 154/155
vk4chb 152/153
vk2fhn 149/

vk4dmp 147/148
vk2gsn 147/
vk4bp 146/
vk2sps 141/143
vk3dnc 141/142
vk6lc 139/140
vk2eq 139/
vk6lg 134/135
vk3dq 133/147
vk2lee 130/132
vk4ao 127/
ti2yll 127/
vk4vis 126/128
yc8emh 126/127
vk7lrv 126/
tg8ne 125/
vk3tl 122/125
sm6prx 121/126
hl4yd 118/119
vk2mh 116/118
vk7wd 115/116

vk5gz 113/115
vk4njq 111/115
vk6nv 111/113
ja8xdm 111/
c21dj 109/
je9ema 108/
vk5uo 107/110
hc2hyb 106/107
vk4lw 105/
vk2ejk 104/
jn6mic 103/104
zs6ir 102/104
kb2nek 102/103
c21nj 102/
vk2fzr 102/
jh3oho 101/103
vk2ejm 101/103
vk3kto 101/102
vk1prg 101/
vk2lrp 100/101
on4bcm 100/

CW

Roll of Honour CW

vk6hd 331/352
vk3qi 331/343
vk5wo 323/339

Ordinary list CW

vk3ks 307/335
vk4lcu 279/
vk6ru 278/322
vk4lv 278/285
vk3ji 271/296
vk3akk 270/275
vk4ku 251/
vk6mk 243/245
vk3dp 242/245
vk2cws 239/241
vk3dq 234/261
vk7bc 234/243

vk4da 233/235
vk3cim 228/229
vk4cy 207/208
vk4dp 205/216
vk7ro 201/204
vk6py 190/194
vk5gz 189/191
vk6hw 179/182
vk5uo 165/166
vk7ts 165/
vk5bo 159/184
vk3dnc 154/157
vk4xj 150/163
wa5vgl 146/148
vk4ua 143/145
vk4aar 140/142
vk7dq 131/132
vk2tb 123/125

vk7cq 120/122
dk6ap 120/
sp1afu 112/113
vk8kv 112/113
vk5bww 110/111
vk6nv 109/110
ok1fed 109/
vk2lym 106/108
vk4cxq 106/
vk4ems 104/
vk3dq 102/
vk8xc 101/103
sm6prx 101/102

Roll of Honour Open

vk5wo 331/368
vk6hd 331/358
vk4ua 331/347
vk3qi 331/346
vk6ru 330/385
vk4lc 330/377
vk3akk 327/338
vk7bc 327/336
vk4aar 324/328
vk6amk 322/341
vk2avz 320/330
vk3uy 318/321
vk3jl 315/344

Ordinary list Open

vk4lv 311/315
vk4dp 309/323
vk8ro 309/315

Open

vk4dv 306/321
vk3dp 304/308
vk4lcu 303/305
vk4cy 297/301
vk4bg 293/312
vk3cyl 282/288
vk3vq 274/291
vk3cim 274/278
vk5bo 264/302
tf5bw 260/264
py2dbu 254/259
vk7ts 252/254
vk6mk 250/252
vk6anc 247/250
vk3dq 246/275
vk5uo 248/250
vk2cws 245/247
vk6apw 239/240
vk2etm 238/240
vk2hv 235/
vk4da 234/236
vk4xj 233/249

vk4ems 223/
wa5vgi 216/218
vk2eft 202/205
vk5gz 198/200
vk3dnc 185/187
vk6aph 171/172
9a4ka 168/
sm6prx 162/169
vk4chb 160/162
vk2no 158/
vk8xc 150/152
vk4ems 150/
vk6lc 142/144
vk4njq 133/139
vk4ez 129/138
yb8gh 127/129
vk3vb 126/128
vk7cq 123/125 qrp
vk7hv 114/117
sp1afu 114/115
vk3oz 104/105
vk2aje 100/

CONTESTS

Ian Godsill VK3DID

57 Nepean Highway, Aspendale, 3195

Phone: 0408 123 557 Email: contests@wia.org.au

Contest Calendar August - October 2000

Aug 5	SARS Sprint Contest	(CW)	(Jun 00)
Aug 5	Waitkere Sprint	(CW)	(Jun 00)
Aug 5/6	Worked All Europe DX Contest	(CW)	
Aug 12/13	Keymen's Club of Japan Contest	(CW)	
Aug 12/13	RD Contest	(CW/SSB)	(Jul 00)
Aug 19/20	SEANET SSB Contest	(Jun 00)	
Aug 26/27	SCC RTTY Championship	(Aug 00)	
Aug 26/27	TOEC WW Grid Contest (CW)		
Sep 2/3	All Asia DX Contest (Phone)		
Sep 2/3	IARU Region 1 Field Day	(SSB)	
Sep 3	Panama DX Contest	(SSB)	(Aug 00)
Sep 9/10	Worked All Europe	(Phone)	
Sep 16/17	SAC Contest	(CW)	(Aug 00)
Sep 23/24	CQ WW RTTY DX Contest	(Aug 00)	
Sep 23/24	SAC Contest	(SSB)	(Aug 00)
Oct 1	RSGB 21/28 MHz Contest	(SSB)	(Aug 00)
Oct 7	PSK31 Rumble		
Oct 7/8	VK/ZL/Oceania DX Contest	(SSB)	
Oct 8	RSGB 21/28 MHz Contest	(CW)	(Aug 00)
Oct 14/15	VK/ZL/Oceania DX Contest	(CW)	
Oct 15	Asia-Pacific Sprint	(CW)	(Jan 00)
Oct 21/22	JARTS WW RTTY Contest		
Oct 21/22	Worked All Germany Contest	(CW/SSB)	
Oct 28/29	CQ WW DX Contest	(SSB)	

Thanks this month to VK4TI JE1CKA LA9HW RSGB

Greetings to all contestants. I hope that you are all well and that your station is performing up to its optimum. We are now well into the VK contesting season and I hope to hear you all in the RD contest about the time that this magazine will arrive.

A few general comments——

I am always interested to scan the bands during a contest to gauge the level of participation, whether I am an entrant or not. I would like to record my thanks to those who made the effort in the QRP Day and Novice Contests in June, especially on the CW mode. In the latter event I must commend particularly VK3JRC for consistent calling on CW and for reaping the rewards of many contacts. I was calling just as much lower down, but came to the conclusion that no-one wanted to talk to me as I was just a Full Call! To all those who took the trouble to call repeatedly (VK3YE,

VK2BHO, VK5XE, VK2MQU et al.), very well done and thank you. I hope that the SSB operators did as well.

New Exchange - Revisited

No sooner had I sent last month's copy to the Editor than I received several notes opposing the dropping of RS(T) from contest exchanges. The common point raised was that the signal report may be needed for any new DX countries.

I thank these correspondents most sincerely. However, I can say that the ARRL has not asked for RS(T) for many years. I am trying to ascertain if that applies to other major AR societies or not.

When you think about it, Australia, New Zealand and America have many smaller local contests and only a few DX

events, whereas Europe has international contests every weekend. Probably I fell into the trap of thinking locally and was happy to agree with those who responded originally to the suggestion of just serial numbers.

In the purely local context no doubt serials only will be fine. Perhaps the DX tests may do well to retain the full exchange.

Then there is the habit of logging programs of allocating 59(9) to a contact automatically. All we have to do is add the serial, so why the RS(T)?

RD 2000 - Not Just for CW and phone

PLEASE join in this year's Remembrance Day contest on 12/13 August. Everyone's score counts - and you need the full RS(T) and serial number! Let's have a good representation from all States. After

all, you will be helping yourself as well as your State!

And don't forget that CW and Phone are NOT the only modes allowed. See Rules in July page.40

WRTC 2000

By the time you read this, the international WRTC 2000 event will be over (see references in June and July). However, at the time of writing those comments I was unaware that as well as the contestants VK4EMM and VK4XY, Bernd VK2IA also went along as a Referee. I hope to bring you some results in the near future.

VK2SKY

I would like to thank Richard VK2SKY for his help over recent years in publicizing contests on the WIA Federal web site.

I am no computer expert, but I can see that maintaining a web site must be a difficult and time-consuming task. Coupled with his job of seeking current news items for this magazine each month, he must have been very busy indeed! Anyway Richard, sincere thanks from me. I am sure that the Institute will be the poorer, but whatever you do next will benefit.

AX Callsigns

Most of you will be aware that since mid-June we have been permitted to use the alternative callsign prefix "AX". I am sure that serious DXers have used it well already; however, I suggest that those of you taking part in a contest where there is a reasonable chance that you make some international contacts will consider using this prefix.

The DX stations will be happy to have the call in their logs, BUT please also be prepared to QSL any such contacts made.

CU in a contest. 73, Ian Godsill VK3DID
E-mail: <contests@wia.org.au>

Results CQ/RJ WW RTTY 2000 Contest

(Call\cat\score\award)

- | | | |
|----------------|--------|-------------------|
| • VK4UC SOABH | 617320 | 1st VK4 Plaque OC |
| • VK6GOM SOABH | 150656 | 1st VK6 |
| • ZL6QH SOABH | 406980 | 1st ZL |

Results Harry Angel Sprint 2000

from Trent VK4TI,

WIAQ Contest Co-ordinator

This sprint contest, which is open to all Amateur Stations and SWLs, honours the late Harry Angel VK4HA. Harry who passed away at the age of 106 in 1998 was at the time Australia's oldest living Radio Amateur. Harry served in the Middle East and other areas during the First World War. The Sprint will be unique, as it will last for 106 minutes, Harry's Age, in place of the customary 60 minutes.

The very best of wishes for your 'sprint' event ... what a character he must have been! I can just remember (40 years ago) old Cliff G2RU and Jimmy G6LL telling me how they'd started, at the beginning of the 'last' century without them we'd still be waving flags at each other! Good Luck G3RXO

This sums up the importance of remembering the likes of Harry Angel.

What a great turnout of logs totalling 29 this year. The

popularity of the format is evidenced by the scores. For the second year the top dog and winner of the perpetual trophy was John VK5NJ with a great effort in scoring 56 points, with another VK5 winning the Phone section in the shape of super club VK5SR South East Radio Group in Mt Gambier. Kevin VK5KJ handled the 100 foot high dipole FL2100B TS930 combination with expertise and handed out 49 QSOs in the allocated time. A great result for a great location (SA).

Alan VK4SN grabbed the opportunity to push the barrow for VK4 and took away the top score in the mixed category on 45 points claimed. Toowoomba DX buff Mick VK4ABV cranked up his trusty TS530 into second place, after forgetting that the contest was on and giving others a head start.

This is now the second year of the test and the results show that interest is high. The most common request is to make the contest start time earlier. The format of 106 minutes was questioned by some but the validation for it will stand the contest in good stead.

Thank you again for your participation and thank you to everyone for supporting VK4 contesting

Trent VK4TI

Certificates will be despatched by the first week of August. If you do not receive yours, contact me direct on email llfp-vk4ti@powerup.com.au or phone 0408 497550 *Error! Bookmark not defined.*

Comments from the Logs

VK5XE Ian Northeast

Thanks for the contest it was a bit of a lonely affair after the first 45 minutes but had fun and not much QRM.

VK3DID Ian Godsill

I thought there was fair representation of CW for this event, but was disappointed at not hearing any other VK3s on this mode

VK4EJ Bernie McIvor

Thank you for sponsoring another Harry Angel Sprint Unfortunately the activity was lacking, but I could not (out of respect for Harry) let it go without entering. Harry once lived down the road from my mother at Ennoggera QLD He introduced my uncle VK5LJ to radio and VK5LJ introduced

me to radio, so Harry is indirectly responsible for my passion. I was lucky enough to have worked Harry on ten metres way back in 1983 when he told me he was 91 years young. I feel honoured to have him in my log.

VK4SN Alan Shannon

Both the hand key and the iambic keyer were "joined at the hip" and ready for action. A set of headphones kept concentration at maximum.

VK5NJ John Nieuwenhivon

Tnx for a great little sprint contest. Enjoyed it very much, was surprised on working JAs.

continued next page

VK4GZ Ron Marschke

The numbers where few but I enjoyed the contest

Callign	Category	Certificates	Score
VK5NJ Trophy	C	1	56
VK4OW	C	2	28
VK3DID	C	3	26
VK4XY	C		26
VK5XE	C		26
VK8HA	C		20
VK4TT	C		12
VK4SN	M	1	45
VK4ABV	M	2	36
VK4GZ	M	3	35
P29PL	M		29
VK5UE	M		23
VK5SR	P	1	49
VK2CA	P	2	42
VK4AJS	P	3	36
VK4EJ	P		33
VK3VDP	P		24
VK5AIM	P		23
VK7JGD	P		21
VK3MGZ	P		19
VK4KKN	P		19
P29KFS	P		17
VK4KDL	P		16
VK7JAB	P		14
VK7LUV	P		14
Ian McGovern	swl	1	29
John Ramsay	swl		11
Tony Dawson	swl		10

Results: Ross Hull Contest 1999 - 2000

Panama Anniversary Contest

3 September, 1200 - 2359z Saturday

The Panama Radio Club invites all radio amateurs to participate in its annual contest.

Category: The only category is Single Operator.

Mode: SSB.

Bands: 40/20 m.

Exchange: RS plus serial number.

Score two points for QSOs with HP stations and one for others.

Multiplier is the total DXCC countries worked on all bands.

Various plaques and certificates of participation will be awarded, including a plaque to the highest scoring station in each continent.

Send log postmarked by 27 November to: Radio Club Panama Contest, Box 10745, Panama 4, Panama, or via packet to HP1BYS@HP1BSL.PANCTY.PAN.CA, or via e-mail to: hp1rcp@qsl.net

Scandinavian Activity Contest

CW: 16 - 17 September Phone: 23 - 24 September
1200z Saturday - 1200z Sun

Object is for amateurs world-wide to contact as many stations in Scandinavia as possible, on bands 80 - 10 m (no WARC).

Scandinavian prefixes are: LA/LB/LG/LJ (Norway); KW/JX; OF/OG/OH/OI (Finland); OF0/OG0/OH0 (Aland Isl); OJ0 (Market Reef); OX/OY; OZ/5P (Denmark); SI/SJ/SK/SL/SM/7S/8S (SWEDEN); TF.

Categories (all bands only) are: single operator; single operator QRP (max 5 w o/p); multi-operator single transmitter; SWL.

Exchange: RS(T) plus serial number starting at 001.

Score: For each QSO, score one point on 20, 15 and 10 m, and three points on 40 and 80 m.

Multiplier is the number of call areas (0- 9), not prefixes, for each Scandinavian country worked on each band. Portable stations without a district number count as area 0, eg G3XYZ/LA counts as LA0. OH0 and OJ0 are separate call areas.

Final score is total QSO points (all bands) times total multipliers (all bands).

Use standard format for logs and summary sheets. Show duplicate QSOs with 0 points. Dupe sheets are required for 200+ QSOs.

Send separate logs for CW and phone sections.

Logs on 3.5" DOS disc are welcome and must be in ASCII, one QSO per row, and labelled with the call, contest name, section/s and contest date. Include an SASE if you want your disc returned.

Summary sheet must be on paper. The mailing address alternates between SSA (Sweden), NRRL (Norway), EDR (Denmark) and SRAL (Finland) in that order.

Send logs: For 2000, send your log postmarked by 31 October to: J-E Rehn, Lisataet 18, SE-863 32, Sundsbruk, Sweden, or by e-mail to: sac@contesting.com

CQ/RJ WW RTTY Contest

23 - 24 September, 0000z Sat -2400z Sun

Object is to contact as many stations world-wide as possible using digital modes [Baudot, ASCII, AMTOR (FEC and ARC) and packet] on bands 80-10 m. No unattended operation or operation through gateways or digipeaters, etc.

Stations may operate for full 48 hours.

Categories are: single operator unassisted, single and multi-band; single operator assisted, all band; multi-operator single Tx, all band ("10 minute" rule applies to this category, except that one - and only one - other band may be used during the 10 minute period if - and only of - the station worked is a new multiplier); multi-operator multi-Tx, all band. Single operator entrants can enter the low power section (up to 150 W) or high power (more than 150 W). Stations may be contacted only once per band, regardless of the mode used.

Exchange: RST plus CQ zone; W/VE will send RST, state or area, and CQ zone.

Score: one point for each QSO with stations in your own country, two points for each QSO outside your own country but inside same WAC continent, and three points for each QSO with stations outside your own continent. On each band the multiplier equals the sum of US states (Max 48) and Canadian areas (max 13) PLUS DXCC countries (including W and VE) PLUS CQ zones (max 40). Note: KL7 and KH6 are claimable as country multipliers only, not state multipliers.

Canadian areas are VO1, VO2, VE1 (NB), VE1 (NS), VE1 (PEI), VE2, VE3, VE4, VE5, VE6, VE7, VE8, VY.

Final score equals total QSO points times total multipliers from all bands.

Submit a single summary sheet including scoring calculations for all bands, plus for each band a separate log, duplicate check list, and multiplier check sheet

Send low power logs postmarked by 1 December to: CQ WW RTTY Contest Director, Box DX, Stow, MA 01775, USA. Low power logs may be sent by e-mail to: k1ry@contesting.com

Send high power logs to: Ron Stailey K5DJ, CQ/RJ RTTY Contest Co-Director, 504 Dove Haven Drive, Round Rock TX 78664-5926, USA. High power logs by e-mail to: k5dj@contesting.com

A comprehensive range of plaques and certificates is offered.

SCC RTTY Championship

26 - 27 August 1200z Sat - 1200z Sun

Object: for amateurs around the world to contact as many other amateurs as possible.

Mode: Baudot.

Bands: 80 - 10 m (no WARC).

Categories: Single operator single band; single operator all bands; multi-operator all bands.

Sections: High power (200 w o/p or more); Low Power (less than 200 w o/p).

Exchange RST plus four digits of the number of the year your amateur licence was FIRST issued.

Score: one point for QSO in own call area; two points for QSOs with other Oceania call areas; three points for QSOs outside own continent.

Multiplier: one point for each different licence year worked on each band.

Final Score is total QSO points X total multipliers on all bands.

Logs must show time UTC; band; callsign; exchange; points claimed; multipliers at first time of working.

Summary Sheet should show callsign; address; number of QSOs; points and multipliers for each band; total score; signed declaration.

Send logs in written form or on disk to: Slovenia Contest Club, Saveljska 50, 1113 Ljubljana, Slovenia. Logs may be sent by e-mail to: scc@hamradio.si

All entries by 1 October.

RSGB 21/28 MHz Contest

SSB: Sunday 1 October 2000

CW: Sunday 8 October 2000

0700 - 1900z

Frequencies: SSB 21.150 - 21.350, 28.450-29.000 MHz
CW 21.000 - 21.150 (but avoid 21.075 - 21.125) 28.000 - 28.100 MHz

Categories: Single operator; multi-operator

Sections: Open; Restricted; QRP (max 10w o/p); SWL

"Restricted" entrants must use only one single element antenna at not more than 15 metres height and 100 w o/p.

Any packet cluster or other spotting facilities makes an entrant multi-operator.

Score three points for contacts with UK stations.

Multiplier is each UK district (max 124) worked on each band.

Send logs by mail to: RSGB Contest Committee, c/o 77 Bensham Manor Road, Thornton Heath, Surrey CR7 7AF, UK, by 15 November, 2000.

50th Annual Ross Hull Memorial VHF-UHF Contest

Results

Contest manager:
John Martin VK3KWA

Interest in the Ross Hull Contest seems to be increasing after a slump in recent years. This year there were 26 logs from 20 entrants, which is very much better than last year and a good omen for the future.

The main reason for the improvement seems to be the return to scoring based on the best seven days. All comments on this change were favourable. The two-day

section was also well received, and I expect that this section will become more popular over the next few years.

It was good to see a considerable increase in the number of logs from VK2 and VK4. But the other side of the coin was only one log from VK6 and none at all from VK5.

Speaking of logs, please remember to include the band-by-band scoring table as described in the rules. Otherwise it takes a good deal longer than it should to get the results finalised.

Now to the business end. This year's winner is Rob VK3EK, followed very closely by Gordon VK2ZAB. Congratulations to Rob and Gordon for their excellent scores.

There was an even closer contest for

third and fourth place, this time with only four points between Rod VK2TWR and Guy VK2KU.

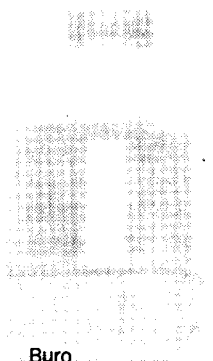
Two special mentions: Roger VK3XRS earns my Lazarus Award for making a comeback this year and operating on seven bands. And Ray VK3ACR gets my special Octopus Award for operating on eight bands including 24 GHz.

In the two day section, the winner is Guy VK2KU, followed by Rod VK4KZR. The other entrants in the two day section all had very good scores, so congratulations all round.

As usual, thanks to all those who sent in logs. Now the contest seems to be on the way up again, I hope to see even more logs next time.

Continued on page 43

International Lighthouse/Lightship Weekend



A list of stations that have already confirmed their participation in this year's event can be found at www.waterw.com/~weidner/LH-day-table.htm

Call sign	Location	QSL information			
Argentina LU2DT	Punta Mogotes, Mar del Plata		OZ7TP	Nr. Lyngvig	Buro
LW4EM	Puerto Quequen	PO Box 115, CP7630, Necochea	OZ8KV	Nr. Lyngvig	Buro
Australia VK2GLH	Greencape, NSW	PO Box 300, Merimbula 2548	OZ8SMA	To be confirmed	Buro
VK3JKY	Cape Ottway	Buro	OZ9HBO	To be confirmed	Buro
VK4CHB	Sandy Cape, Fraser Island	PO B 829, Hervey Bay, Qld 4655	Eire		
VK7WS	Bruny Island	CBA	EJ/GI3VFW	Tory Island	Buro
VK7KBE	Eddystone	Buro	EI5ML	Mizen Signal Station EI5IY	
VK7JAB	Table Cape	Buro	EI8HT	Youghal	
VK7LUV	Table Cape	Buro	EI8HT		
Belgium OR00ST	Lange Nelle	PO Box 110, 8300 Knokke	England		
ON4BRN	Lightship Westhinder II		GB2APL	Anvil Point	Buro
ON9CAT	Blankenberge	PO Box 90, 9900 Eeklo	GB2BHL	Bidston Hill	Buro
Brazil PY1NEZ/P	Faro de Ponta Negra	QSL via PY1NEZ	GB2BPL	Bull Point	Buro
Canada VE3CGJ	Lightship HMCS Haida	QSL via VA3BBW	GB2NBL	New Brighton	Buro
VE3TEQ	Snug Harbour	Buro	GB2PB	Portland Bill	Buro
VE7IV	Cape Beale. B.C.	Cape Beale Lightstation, Bamfield BC	GB2PL	Pendeen	QSL via M5DID
VOR1BO			GB2RL	Roker Lighthouse	QSL via MOAYI
Chile CE1RKY	Faro Punta Gruesa	PO Box 700, Iquique, Chile	GB2SML	St Marys, Whitley Bay	Buro
Denmark OZ7DAL	Lightship XXI	Buro	GB2WL	Whitehaven	QSL via MOBEE
OZ1VYL	Lightship M/F 1	Buro	GBOSBL	Sutton Bridge	QSL via G4PQL
OZ7RJ	Lightship F/S XVII	Buro	GBOSCA	Scarborough	QSL via G0000
OZ1SKA	To be confirmed	Buro	GBOSL	Spurn Lightship	Buro
OZ1VES	To be confirmed [EU-029]	Buro	GBOSLH	Souter, Whitburn	Buro
OZ1LFA	To be confirmed [EU-029]	Buro	Falkland Islands		
OZ2NYB	Romsoe	Buro	VP8LGT	Cape Pembroke	QSL via VP8ON
OZ3EVA	To be confirmed	Buro	[SA-002]		
OZ3FYN	To be confirmed [EU-029]	Buro	Faroe Island		
OZ4SKL	To be confirmed [EU-029]	Buro	OY6FRA	Havni Skansa	QSL via OY6FRA
OZ4EDR	Bornholm Island [EU-030]	Buro	Finland		
OZ5V	To be confirmed [EU-029]	Buro	OH1AH	Uto Island	Buro
OZ7LH	Sletterhage	Buro	OH5AD	LightshipHelsinki, Hamina	Penttilankuja 13, 49420 Hamina
OZ7RD	To be confirmed	Buro	OH6AI	Tankar, Kokkola	PB 251, 67101, Kokkola
OZ7TOM	To be confirmed	Buro	France		
			F6KUM	Dieppe	Buro
			Germany		
			DFOWLG	Greifswalder Oie	Buro
			DLOSH	Kiel Lighthouse	QSL via DH3CH
			GIBALTAR		
			ZB2LGT	Europa Lighthouse	PO Box 292, Gibraltar
			Greece		
			SW8LH	Santorini Island	QSL via SV1ENG
			Isle of Man		
			GT3FLH	The Point of Ayre	Buro
			Italy		
			IQ1L	La Lanterna, Genova	POB 347, 16121 Genova

Lithuania					
LY1CM/A	Cape Vente	QSL via LY1CM	N1L	Ledge CT	Hartford, CT 06146-2644
Netherlands			W1L	Cape Neddick, ME	K7CTW
PA6VEN	Ven	QSL via PD1AIQ	W1HGY	Race Point, MA	W1KSZ
PA6LH	Egmond-aan-zee	Buro		Conspiracy Island, MA	W1HGY
PA6LST	Lightship Texel	QSL via PI4ADH	KB1CEJ	Prospect Harbor, MA	KB1CEJ
PB6KW	Katwijk aan Zee	QSL via PA3HDX			
PI4WAL	Westkapelle	Buro	WB1CQO	Nantucket Lightship CT	PO B 486, Southport, CT 06490
New Caledonia			N2L	Navesink Twin Lights, NJ	KC2EVS
TX8AL	Amedie Light, Noumea	QSL via FK8FR			
New Zealand			W2AMC	Horton Point, NY	POB 113, Peconic, NY 11958
ZL1AB	Tiritiri Matangi Island	Buro	K2L	Buffalo, NY	WB2YQH
ZL2ARG	Nelson	PO Box 414, Nelson	N2CMC	Cape May, NJ	PO Box 302, Rio Grande, NJ
ZL2AFZ	Quartz Hill, Oahu Point		08242		
ZL2AS	Cape Kipnappers	PO Box 15038, Flaxmere, Hastings, 4201	W2C	Miah Maull, NJ	Box 265, Heislerville, NJ
ZL6LH	Castlepoint	PO Box 397, Papakura	08324		
Northern Ireland			W2D	Brandywine, DE	See W2C
GN0LIX	Ferris Point, Larne	Buro	W2E	Elbow Cross Ledge, DE	See W2C
GI4GTY	Mew Island, Copeland Islands	Buro	W2L	East Point, DE	See W2C
Norway			W2R	14-ft Light, DE	See W2C
LA3S	Svenner [EU-062]	Buro	W2S	Ship John Shoal, DE	See W2C
LA5D	Jomfruland [EU-062]	Buro	W2GSB/LH	Fire Island, NY	PO Box 1356, West Babylon, NY 11704
LA5F	Stroemtangen [EU-061]	Buro			AE2T
LA6LI	Lista	Buro	N2SEX	Thirty Mile Point, NY	KC2UFO
Poland			KC2UFO	Tibbetts Point, Lake Ont.	
SN2KM	Krynica Morska	QSL via SP2BIK	K3L	Marcus Hook Range, PA	KE3RJ
SP5PB/1	Swinoujschie	Buro	W3L	Chesapeake Bay, MD	K2JXW
SP2FWC/2	Rozewie	Buro	W3HL	Cape Hatteras, NC	
Portugal			AC4RC	Oak Island, NC	
CS5C	Faror Forte do Cavalo	QSL via CT1BWW	N4ZN	Morris Island, SC	N4ZN
Puerto Rico			W5L	Port Bolivar, TX	PO B 1103, Crystal Beach, TX 77650
KP4ES	Caja de Muertos Island	Box 191917, San Juan. PR 00919-1917	K6AA	Point Fermin, San Pedro, CA	WB6ROH
Scotland			W6L	To be confirmed	K6DF
GB2LBN	Barns Ness	QSL via GM4UYZ	K6L	Pigeon Point, CA	W6JZE
GB2LMG	Mull of Galloway	QSL via MM1BHO	W6LJ	Point Vicente CA	Buro
GB2LO	Orkney Islands	Buro	W6RQQ	Cabrillo Nat. Monument, CA	W6RQQ
GB2LT	Turnberry	QSL via GM0JHF	K7L	Cape Blanco, OR	W7WLL
GB???	Carr Lightship, Dundee	QSL via MM0BTD	K7AM	Agate Beach, OR	K7EWG
GB2RRL	Rubha Reigh	QSL via GM4CHX	W7BU	Lightship Columbia	PO Box 264, Astoria 97103-0264, Oregon
Spain			W8TCM	Travers Bay, MI	2738 Ra-Wa-Si, Traverse City, MI 49684
ED3PGT	Torredembarra	QSL via EA3DGN	K8BLL	Whitefish Point, MI	K8BLL
Sweden			K0RT	Split Rock	K0HB
7S6LGT	Vinga Islands		Wales		
7S1LGT	Hoburgen	QSL via SM1NVW	GB2LNP	Nash Point	MW0CNA
SK0BJ	Landsort	Buro	GB0WUL	West Usk	GW4LFO
SK2AU	Gasoren	CBA	GB2SAL	St Anns Head	Buro
Turkey					
TA3YJ		Izmir - Karaburun Buro			
TA3J		Izmir - Karaburun Buro			
U.S.A.					
K1T	Beavertail RI	K1JD			
K1L	New London	PO B 2644,			

This list is continually being updated and new stations are planning to participate in the contest and entering their details daily. To get the most up to date list a visit to the following web page is recommended <http://www.waterw.com/~weidner/LH-day-table.htm>

AWARDS

John Kelleher VK3DP

Federal Awards Officer

4 Brook Crescent, Box Hill South Vic 3128, (03) 9889 8393

Nice to be back in the driver's seat again, if only in low gear. Naturally, things will improve as time the great healer takes over. What is pleasing and of particular note is the action of Ross VK3WAC in producing an excellent column for DX operators. I definitely applaud him.

Paraguay The ZP Awards Programme

The Radio Club Paraguayo issues the following awards for any amateur, CB operator, or SWL for confirmed contacts or reports, according to the rules of each award. A contact with a ZP Station is mandatory for any award. Contacts with mobile stations (ZP0) before 1991 will be Acceptable for the awards.

All certificates are issued on a mixed basis (no band or mode separation), except for those where all Contacts were made on digital modes (RTTY, Packet, Amtor, Factor, SSTV or any other Computer generated signal) or via satellite.

Send certified list (GCR rules), please NO QSL CARDS, with 5 Irc's or 5 US dollars for each Award to :-

Radio Club Paraguayo

Award Manager

P.O. Box 512

Asuncion 1209

Paraguay.

The All Mediterranean Countries Award

This award is issued for contacts with inland countries, as follows : A2 A5 C31 CP EK (ex UG6) ER (ex UO5) ET EU (ex UC2) EX (ex UM8) EY (ex UJ8) EZ (ex UH8) HA HB HB0 HV JT LX OE OK OM T7 TL TT TZ UJ (ex UI8) UN (ex UL7) XT XW YA Z2 Z3 ZP 3DA0 4J (ex UD6) 4U1ITU 5U 5X 7P 7Q 9J 9N 9U 9X.

Class A: 41 countries. Class B: 30 countries. Class C: 20 countries.

The Tropics of Cancer and Capricorn Award

This award is issued for contacts with countries touched by the Tropics of Cancer and Capricorn as follows:- Tropic Cancer - A4 A6 BV BY C6 HZ KH6 SU S0 S2 TZ VU XE XZ 5A 5T 5U and 7X. Tropic Capricorn :- A2 CE C9 LU PY VK V5 ZP ZS 5R.

Class A: 28 countries. Class B: 20 countries Class C: 12 countries.

The All Zone 11 Prefixes Award

This award is issued for contacts with different prefixes of stations located in CQ Zone 11, from the following list : ZP0 - ZP9, PP0 - PP9, PQ0 - PQ9, PR0 - PR9, PS0 - PS9, PT0 - PT9, PU0 - PU9, PV0 - PV9, PW0 - PW9, PY0 - PY9, ZW0 - ZW9, ZV0 - ZV9, ZX0 - ZX9, ZY0 - ZY9, ZZ0 - ZZ9, and any special or contest prefixes.

Class Gold : 100 prefixes with at least 10 ZP prefixes.

Class Silver: 60 prefixes with at least 5 ZP prefixes.

Class A : 30 prefixes.

Class B : 19 prefixes.

Class C : 12 prefixes.

The South America Award

This award is issued for contacts with stations located in ITU Zones 12 13 14 15 16 and 73.

Zone 12 : FY HC HC8 HK HK0 (Malpelo) OA PZ 8R YV CP (1,8,9).

Zone 13 : PY (6,7,8) PY0 (F de Noronha) PY0 (St.Peter & Paul Rocks).

Zone 14 : CE (1,2,3,4,5) CE0X CE0Z CP (2,3,4,5,6,7) ZP CX LU (A-U, Y)

Zone 15 : PY (1,2,3,4,5,9) PY0 (Trinidad).

Zone 16 : CE (6,7,8) VP8 (Falkland) LU (V,W,X).

Zone 73 : KC4USP LU(Z) CE9 (AA-AM) VP8 (Graham Land) VP8 (South Georgia, South Orkney, South Sandwich, South Shetland).

Class A : 33 countries and 6 zones.

Class B : 25 countries and 6 zones.

Class C : 18 countries and 5 zones.

The Diploma Paraguay (DP) is issued to amateurs living outside of Paraguay, for confirmed contacts with 5 different ZP stations. South American stations should contact 15 different ZP Stations.

The Certificado Radio Club Paraguayo, is issued for confirmed contacts with 15 different ZP Stations. South American stations should contact 50 different ZP stations.

The Worked All ZP Award is issued for confirmed contacts with one station in each of the 9 call areas (ZP1 to ZP9). Special, or contest prefixes are not valid for this award.

The ZP100, ZP150, ZP200, ZP250, ZP300, ZP350, ZP400, ZP450, and ZP500 Awards are Issued for confirmed contacts with such amount of different ZP stations.

The ZP3 Award is issued for confirmed contacts with different stations located in the third call area (ZP3), as follows :-

ZP : 10 stations.

CE CP CX LU PY : 5 stations.

Rest of the world : 2 stations.

The Mercosur Prefixes Award is issued for confirmed contacts with stations located in the countries which are part of the Mercado Comun del Sur MERCOSUR Trade agreement (LU - Argentina, PY - Brasil, ZP - Paraguay and CX - Uruguay), after January 1 1995. At least one prefix of each country is required. Special events and contest prefixes are acceptable for this award.

Class A : 60 prefixes.

Class B : 40 prefixes.

Class C : 20 prefixes.

The Certificates Departamentos del Paraguay, is issued for contacts with one fixed or portable

Station located in the nation's capital city, and each of the following departments into which Paraguay is divided :

Call Depart- Capital City: area ment

• ZP1	XVI	Boqueron Filadelfia
	XVII	Alto Paraguay, Fuerte Olimpo
• ZP2	XV	Presidente Hayes, Pozo Colorado
• ZP3	I	Concepcion, Concepcion
	XIII	Amambay, Pedro Juan Caballero
• ZP4	II	San Pedro, San Pedro del Ycuamandyju
	XIV	Canindeyu, Salto del Guaira
• ZP5		Capital City of the Country Asuncion
• ZP6	III	Cordillera, Caacupe
	IX	Paraguari, Paraguari

	XI	Central, Aregua
• ZP7	IV	Guaira, Villarrica
	V	Caaguazu, Coronel Oviedo
	VI	Caazapa, Caazapa
• ZP8	VIII	Misiones, San Juan Bautista
	XII	Neembucu, Pilar
• ZP9	VII	Itapua, Encarnacion
	X	Alto Parana, Ciudad del Este

Class A : 18 depts.

Class B : 15 depts.

Class C : 12 depts

The ZP1 Award is issued by The Radio Club Filadelfia - ZP1FF (an RCP affiliate) for Confirmed contacts with different ZP stations located in the first call area (ZP1). A contact with ZP1FF is mandatory. South American stations should contact 30 stations. Rest of the

World - 10 stations.

The Fortines del Chaco Award, is issued by the Radio Club Filadelfia for confirmed contacts With stations located in the following Chaco War forts (outposts) : Boqueron, Pitiantuta, Toledo...145 160 and 180 Km; Guachalla, Lagerenza, Campo Via, Nanawa, Trebol, Isla Pof, Tte, Montania, Camacho (Mcal.Estigarribia) Tte Enciso, Tte Martinez, Tte Rojas Silva. The Contact with Fort Boqueron is mandatory. South American stations should contact 8 forts. Rest of the world - 4 forts.

This is the complete ZP Awards Programme.

Good Hunting es best 73 de John, VK3DP.

ar

Continued from page 39

Ross Hull Contest 1999 - 2000 : Results

Call Name 6 m 2 m 70 cm 23 cm 12 cm 9 cm 6 cm 3 cm 1.25 cm TOTAL

Section A: Best 7 Days

VK3EK	R. Ashlin	376	1212	1525	598	110	70	-	70	-	3981
VK2ZAB	G. McDonald	37	1386	1395	1040	-	-	-	-	-	3858
VK2TWR	R. Collman	33	938	915	336	-	-	-	-	-	2222
VK2KU	G. Fletcher	41	1257	600	320	-	-	-	-	-	2218
VK3XRS	R. Steedman	66	617	675	326	30	30	-	30	-	1776
VK4KZR	R. Preston	-	291	455	504	10	-	-	-	-	1260
VK3ACR	R. Cowling	139	216	230	288	130	-	20	70	30	1123
VK3KAI	P. Freeman	7	411	315	184	40	40	100	-	-	1097
VK4TZL	G. McNeil	180	354	325	48	-	-	-	-	-	1007
VK3BJM	B. Miller	22	390	415	160	-	-	-	-	-	987
VK3CAT	T. Middleditch	106	462	335	-	-	-	-	-	-	903
VK3GK	L. Moyle	27	237	270	192	-	-	-	-	-	726
VK7XR	A. Hay	89	237	260	40	-	-	-	-	-	626
VK4BLK	R. Elliott	143	138	170	-	-	-	-	-	-	451
VK3CY	D. Clarke	-	195	230	16	-	-	-	-	-	441
VK2TG	R. Demkiw	89	189	-	-	-	-	-	-	-	278
VK6KZ	W. Howse	-	84	-	8	-	-	-	-	-	92
VK2CZ	D. Burger		Check log								

Section B: Best 2 Days

VK2KU	G. Fletcher	9	408	190	64	-	-	-	-	-	671
VK4KZR	R. Preston	-	102	150	176	10	-	-	-	-	438
VK4TZL	G. McNeil	134	108	105	48	-	-	-	-	-	395
VK3CAT	T. Middleditch	22	201	145	-	-	-	-	-	-	368
VK3GK	L. Moyle	14	105	115	104	-	-	-	-	-	338
VK3CY	D. Clarke	-	117	105	16	-	-	-	-	-	238
VK4BLK	R. Elliott	24	78	40	-	-	-	-	-	-	142
VK2TG	R. Demkiw	36	84	-	-	-	-	-	-	-	120

Andrews
Communications Systems
(EST. 1976 - ACN 001 968 752)

ALINCO

AUSTRALIA'S FIRST AUTHORISED
FACTORY DIRECT IMPORTER
MASSIVE SHIPMENTS EVERY MONTH
FULL 3-YEAR WARRANTY ON
ALINCO and ICOM
WE SELL MOST BRANDS
BALUNS, VERTICALS, YAGIS, P/S.
ICOM-KENWOOD-JRC-AOR-EMOTATOR-
MFJ-DIAMOND-TIMEWAVE-KANTRONICS
-THP - GARMIN - TERLIN - UNIDEN -ETC
DX-1600 HF LINEARS FROM \$ 3,799
**HUGE RANGE OF ELECTRONICS,
ICOM and ALINCO Radios.**
Over 22 Years of
Professional Sales and Service.
Instant Repairs Fridays
HF Transceivers & Linears Wanted
(02) 9636 9060 or (02) 9688 4301
SHOP 8, 41 BATHURST ST GREYSTANES,
N.S.W. 2145. FAX (02) 9688 1995



T. Magnusson VK5

RMB 1627 Milawa Vic 3678 Email vk3jt@amsat.org

The AMSAT organisation

AMSAT (Amateur Radio Satellite Corporation) is a worldwide organisation with its roots in the USA. Its origin can be traced back to 1958, just a year after the launch of Sputnik-1. Since that time AMSAT members have been involved in the design, building, launching, commissioning, upkeep and of course, the day-to-day use of amateur radio communication satellites. The parent body is AMSAT-NA (North America) and many other countries have similar special interest groups operating.

AMSAT-Australia

Our local organisation is known as AMSAT-VK. The National Co-ordinator is Graham Ratcliff VK5AGR.

Membership of AMSAT-Australia

AMSAT-Australia operates an open membership system. No formal application is necessary and no membership fees apply. From time to time new software, firmware and hardware is developed and distributed through AMSAT-VK channels. Write to the co-ordinator to express your interest or pop up on the HF net.

AMSAT — Australia HF net

The AMSAT-Australia net meets formally on the second Sunday evening of the month. During the winter months in South Australia (end of March until the end of October) the net meets on 3.685 MHz +/- QRM at an official start time 1000utc with early check-ins at 0945utc. During the summer months when daylight saving is in operation in South Australia (end of October until end of March) the net meets on 7.068 MHz +/- QRM at an official start time of 0900utc with early check-ins at 0845utc. The times and frequencies have been chosen as the best compromise for an Australia-wide net taking into consideration seasonal propagation changes and the various state summer time variations. The net is open to all amateurs, beginners or experienced who have an interest in amateur radio satellites. Help and information for beginners in particular, no matter how trivial, is freely and cheerfully available on this net.

The AMSAT Journal

An excellent bi-monthly journal is available with formal membership of AMSAT-NA. It contains details of practical projects and ranges over all aspects of amateur radio satellite operations. As of 01Jul00 the cost of AMSAT-NA annual membership will be US\$45 payable to AMSAT-NA 850 Sligo Ave, Silver Spring, MD 20910-4702 U.S.A. or you can phone, fax or email your subscription using your credit card. The phone number is 0011-1-301-589-6062, the FAX number is 0011-1-301-608-3410 and the email address is martha@amsat.org

All Communications regarding any matters mentioned above should be addressed to:

AMSAT-Australia.

GPO Box 2141, Adelaide, SA. 5001.

email, vk5agr@amsat.org

Passing of AMSAT Stalwart

On 13th June 2000 the entire AMSAT community grieved with the news of the passing of Werner Haas DJ5KQ, vice president of AMSAT-DL. Werner was one of the leaders in the design, development and construction of all phase-3 satellites. Phase 3A met an untimely end when a launch rocket veered off-course and sent it plummeting into the ocean. Despite this set back the team kept at it and phase 3B was more successful. The orbit was not quite as planned but the satellite (oscar-10) is still providing good contacts some 15 years later. Phase 3C was next in line and went on to become oscar-13. It was the flagship of the fleet for many years. Phase 3D, a much more sophisticated satellite than any of the above is due for launch in Aug/Sep this year. Werner played a crucial role in the design, building and commissioning of all these satellites. From an early age his fascination with radio began to shape his business and professional career. In 1965 Werner began an association with the University of Marburg where in collaboration with Karl Meinzer DJ1ZC et al, he became a key member of the design team that have given us all of the phase-3 satellites. Although not well, Werner recently traveled to Orlando to perform the final acceptance tests on Phase-3D. This gave him the satisfaction of knowing he had done all in his power to assure the success of the whole mission. Sadly Werner did not live to see the launch of his beloved Phase-3D. His untiring contributions will live on in the hearts of all at AMSAT. Werner was one of the true heroes of the amateur radio satellite community.

Another "First" for Phase 3D.

The following will give readers an idea of the level of sophistication of the phase 3D satellite. It was taken from a document circulated via AMSAT-DL and appearing in the AMSAT-DL Journal, 1/2000. Don Moe, KE6MN/DJ0HC, translated the original document

Infrared Laser on P3-D

By Karl Meinzer DJ4ZC, Dante Bauer DH2FHB, Dick Jansson WD4FAB and Hermann Günther.

Case History

In the summer of 1999 the suggestion was made to expand the P3-D satellite with one more experiment: a "downlink" at 360,000 GHz. Initially it was very unclear whether such an exotic experiment could even be built.

Nevertheless, as a "precaution" a suitable location was identified for it in the satellite and a corresponding control cable was installed. Based on weight considerations, such an experiment seemed totally unfeasible since P3-D already had problems with its mass. However, during spin balancing of the satellite in the fall of 1999, it became apparent that such a laser module would fit right where balancing weights would be required. This realization triggered the actual start of work on the laser project.

A previous physics experiment supplied two Siemens infrared lasers (SFH 482403), which generate 0.5 W output power at a wavelength of

835 nm. These components are similar in appearance to TO-3 power transistors, but have a window in the cover for the light to exit at an angle of 10° x 20°. Additionally, each component contains a Peltier cooler for holding the laser temperature at 25° C, a temperature sensor and a photodiode for monitoring the light intensity.

Link Calculations

The feasibility basis for this experiment is the power balance of the signal path. First we must determine whether enough infrared light even reaches the ground to permit the laser to be received within the capabilities available to amateurs. The computation for the link is performed in a manner similar to radio links: at a prescribed distance of the satellite from the Earth, the transmitter illuminates a certain area on the ground. A small fraction of that energy will be collected by the surface of the receiving antenna and must be strong enough to rise sufficiently above the background noise. The calculation for this requires two steps: a) determine the minimal power required by the receiver in order to demodulate the signal; b) design antenna gains for the available transmitter power in order to actually achieve the minimal power at the receiver.

For this experiment the assumption was made that a maximum data rate of only 400 bits/s could be transmitted, such as our P3-D telemetry data, and that reception would only be possible at night under a clear sky, when no significant levels of other light would interfere with reception. Under these conditions, the atmosphere will absorb nearly 30% of the light and 70% will reach the ground. One further assumption is that a receiving antenna of 10-cm diameter should just suffice.

The achievable sensitivity of the receiver depends largely on the available technology. At this point we made a somewhat exotic assumption, namely that a detector of the "photon counter" type with a high level of quantum efficiency would be used. Such detectors exist in the form of silicon avalanche photo diodes. Using such a detector, approximately 10 photons are needed for each bit. Thus a signal of 10-15 W can just be received.

$(N_e = h * c / \lambda * 10 * 400 \text{ bit/s})$
Under the conditions just described,

this means that at an average power level of 250 mW, e.g. 500 mW with 50% duty cycle for modulation, the diameter of a target area on the ground can be no larger than approximately 1,000 km, in order for the signal to still be receivable. A further calculation also shows that the sunlight reflected by the satellite is at least 10 times weaker under these conditions than the laser light and therefore causes no interference.

At a distance of 50,000 km, a target area of this diameter requires a beam divergence of approximately 1.2°. Since the available laser has a much larger aperture angle, a lens is needed. This lens initially proved to be difficult to obtain, but in December 1999 a suitable lens became available in Munich as surplus.

The module should be flight-ready by the end of March. In addition to modulation with a 400 bit/s data stream, the laser can also be keyed at a slow CW speed. Thus the laser can be observed with night vision equipment and messages could even be transmitted in Morse code.

Technical Implementation

1. Power Supply

Internally the module requires 10 V, which is switched on by the onboard computer. The IR laser module includes a power-off time delay of 5 seconds so that the laser can be keyed using the power-on signal. Thus the circuit does not need to internally restabilize (i.e. PLL) after each keying event.

2. Modulation

The engineering beacon (EB) of the satellite (400 bit/s exclusive-OR with clock) is the primary clock signal to the PLL for synchronizing all switching events. The EB signal is exclusive-OR combined with a 1600 Hz carrier signal. This modulation allows various improvements in the receiver design.

3. Laser Signaling

The laser is kept in the "on" state with a constant current from a switching regulator running at 50 kHz. This power converter is blocked for the "off" state. The converter is fast enough to follow the keying signal without significant flank degradation.

4. Peltier Cooler

Another power converter provides

current to the cooler. This current is controlled in accordance with the temperature of the laser. The temperature sensing is done by an NTC, which is built into the laser component.

Specifications

Frequency: 360,000 GHz_ (approx. 835 nm)

Output Power: 250 mW average, 500 mW peak @ 50% duty cycle

Modulation: 1600 Hz square-wave carrier, BPSK modulated at 400 bit/s, same as P3-D telemetry.

Radiation Properties:

- Radiated direction: Z axis of the satellite
- Radiated shape: approximately elliptical with 1/30 Rad width_ (3 dB) in the plane of the satellite X axis. 1/50 Rad width_ (3 dB) in the plane of the satellite Y axis.
- Effective radiated area: 1/2000 sr (approx. 41 dBi "antenna gain")
- Polarization: linear, E direction parallel to the satellite X axis_.
- Spectral properties: multimode, approx. 2 nm bandwidth

These characteristics have not yet been finalized and are subject to change. Updates will be published later.

Outlook

Naturally the laser experiment will primarily attract the experimenters among the amateurs. Due to the relatively small area of the illuminated zone on the ground, the operational times and the target zones must be predetermined and publicised.

In accordance with the schedule, the onboard computer will aim the laser at the location on the ground by correspondingly altering the satellite's orientation.

After gaining some operational experience in orbit, we can decide whether sufficient signal strength is available at apogee. If not, the laser operating times can be moved to orbit intervals when the satellite is closer to the Earth. Of course the illuminated area on the ground will then be smaller.

Altogether we hope that the infrared laser in P3-D will offer additional interesting possibilities for experimentation. To our knowledge this will be the first laser downlink from a satellite.

VHF an UHF expanding world

David K Minchin VK5KK

Postal: PO Box 789 Salisbury South Australia 5108

E-mail: tecknolt@arcom.com.au

Web page: <http://www.ozemail.com.au/~tecknolt>

Fax +61 8 82346396 Phone 0414 808060

(before 2130 EST please)

All times are in UTC

GippsTech 2000 Symposium

The WIA (Vic) Easter Zone Amateur Radio Club held the 3rd Technical Symposium, aptly named "Gippstech 2000" at the Monash university campus at Churchill, Victoria on the 8th and 9th of July, 2000. This year I had a chance to attend both days. Approximately 60 Amateurs and partners descended on Churchill from many parts of VK3 and VK5. Rex VK7MO, Rod VK4KZR and Wally VK6KZ qualified as the most distant traveler's.

Various papers covering a wide variety of subjects were presented over the two days, ranging from Aircraft Scatter, PC DSP Applications, UHF Power meters, 24 GHz, Switching regulators, Amplifier Sequencing, DX Clusters and VK6KZ's Portable station just a few of the subjects covered. Partners were catered for with a guided tour of the local area and shopping. Saturday's nights dinner and after dinner session certainly will be remembered for a long time!

Peter Freeman, VK3KAI and his team are to be congratulated on what has truly become VK version of the VHF Conference / Microwave Update held annually in the US. The level of enthusiasm and audience participation was something that had to be experienced. I think everyone would have taken something new home. Hopefully more than a few people went away with enough motivation to jump into the next area of endeavour!

From feedback since the symposium, several people have expressed interest in the PC "DSP" software used by Rex VK7MO and others to monitor various beacon paths. Several others (me included!) have been playing with the software since. Beacons over 500 –

600km have been "watched" when not detectable by ear. One of the better "freeware" programs can be obtained on the web at <http://www.radiodsp.com/>. Just feed audio into your SB Mic or Line input from your receiver AF output. The fixed level audio output on some rigs (i.e. that used for packet radio) will give good results when coupled through a 600 ohm to 600-ohm isolation transformer. Using time integration and bandwidths around 1Hz produces useful results.

Copies of the proceedings should be available in due course, for further details or enquiries regarding next year's event, please contact Peter VK3KAI peter.freeman@sci.monash.edu.au or QTHR

1296MHz Mobile Record Claim

Rob, VK3EK has forwarded details of a 1296 MHz mobile record claim to Andrew VK7XR over a distance of nearly 412km ... "Details of the 1296MHz contact on 28-11-99 at 10.30 UTC. From the Great Alpine road North of Bairnsdale at a place called Granite Rock. Rob VK3EK\M QF32uf using 12 watts and a 1/4 wave whip on the roof of the Nissan patrol at 80 kilometres per hour. Andrew VK7XR, at Barrington QE38dq, was using a home brew Transverter and a 22 element loop yagi. Distance 411.9 km. Signals were 5x2/3 both ways. Andrew made comment that the signal had a large amount of flutter on it."

Rob VK3EK also reports on the 144.150 MHz net .. "The 144.150 net last night (21/6/00) was well attended which is pleasing. Keep up the good work. It was good to catch up with some familiar call signs and one new one last night in Brian VK3BE in the Latrobe valley. The contact of the night I think would have

been Between Bill VK3AMH at Nagambi and Ken VK3DMW at Yarram as there are a lot of Mountains in the way. Well done fellers. I had 10 stations on 144MHz and 6 on 3.6500 in the log. Lets keep it up!!!" ... 73's Rob VK3EK at Bairnsdale

6 Metres

Mike VK2FLR reports 4W6UN into Sydney on (triple?) hop Es on June 21 at 0455 UTC. 4W6UN worked VK2BA and VK2FLR and was audible in Sydney for about 10 minutes at up to S7. John VK4FNQ has reported working JA stations, on 50 MHz, on several days in winter including 6 on 30/6/00, 7 on 2/7/00 and 5 on 3/7/00

VHF SWL Equinox DX Log

Todd Emslie from Ryde, Sydney has submitted a "SWL" Log for the last equinox. Of interest is the time Todd has spent identifying the various TV offsets and confirming that the MUF does indeed rise well above 54 MHz on many paths over 10,000km. Todd uses the following equipment. ICOM-R7000, D100 TV tuner, RDX UA-700 Gasfet and BF981 MOSFET pre-amps, 5el (45-60 MHz) yagi, Horiz Pol; 5 el (45-70 MHz) yagi, Vert Pol, ONKYO T909011 FM tuner, 8 el (88-108 MHz) yagis, Vert and Horiz Pol, 14 el (175-225 MHz) band 3 yagis, vertical and horizontal polarisation.

An extract from Todd's Log on 5/4/00, 2329Z 48.2396 MHz Genting Sempah Malaysia, 48.2495 MHz Limbang, 2337Z 50.0224 MHz XE1KK beacon Mexico, 2337Z 50.110 MHz KH8-NOJK - American Samoa, 50.110 MHz XE1J Mexico, 2354Z 55.2401 MHz BFO A2 Monterrey, Mexico, 0000Z 48.2499 MHz

BFO, 36.68 MHz Costa Rica, 49.750 MHz weak Program, 0105Z 50.120 MHz VR2LC Hong Kong, 48.2604 MHz BFO Thailand, 49.7584/75/7497 MHz, 0123Z 49.7584 MHz Program, 0203Z Russian: 44.45, 44.6, 44.73, 49.2245 MHz.0353Z 48.250 MHz BFO Dubai UAE - confirmed over phone by A.Mann (Perth) as well as at 0406Z 48.2598 MHz BFO Teheran Iran.

FCC Tells Amateurs to "Walk the Walk"

The FCC's Office of Engineering and Technology chief, Dale Hatfield W0IF0 has predicted a bright future for Amateur Radio, but added that amateurs "will be under a certain amount of pressure" to justify their free use of the radio spectrum. As a result, he said, it will be more important than ever that ham's actually fulfill their service, good will and educational roles—not just talk about them. Hatfield offered his observations as keynote speaker for AMRAD's 25th anniversary dinner June 17 in Virginia. Hatfield told the gathering, "the key issue for the amateur service is maintaining access to an adequate amount of spectrum." While emphasizing that he was not suggesting any immediate threat, Hatfield said hams would have to do a better job of justifying their current allocations.

Hatfield said hams should actually engage in experimentation to advance the state-of-the-art, provide communication and train operators for emergencies, encourage international cooperation and good will, and offer an important technical educational outlet. "Or, to use a bit of slang, it seems to me that it will be even more important for all segments of the amateur community to 'walk the walk' not just 'talk the talk'," he said.

Hatfield encouraged his audience to explore advanced techniques that conserve spectrum, especially digital techniques. As the rest of the telecommunications world transitions to digital techniques, Hatfield said, "the amateur service will look antiquated if it is not making progress in that direction as well."

Hatfield also said software defined radios could facilitate "a new era of amateur experimentation" and, in many ways, represent "a final merger" of radio communications and computers. The text of Hatfield's prepared remarks is

available on the FCC Web site at <http://www.fcc.gov/Speeches/misc/dnh061700.html> ARRL Letter vol. 19, no 25, dated 30th June 2000.

Gridsquare Standings June 2000

Guy VK2KU has forwarded the following Grid Square standings as of 21/6/00

144MHz Terrestrial

VK2ZAB	Gordon	69
VK3BRZ	Chas	62
VK2DVZ	Ross	54
VK2KU	Guy	53
VK3TMP	Max	53
VK3CY	Des	50
VK3EK	Rob	49
VK2FLR	Mike	47
VK3XLD	David	47
VK3ZLS	Les	42
VK3BDL	Mike	40
VK2DXE	Alan	35
VK3CAT	Tony	33
VK2MP	Rej	32
VK3WRE	Ralph	32
VK3BJM	Barry	30
VK4KZR	Rod	29
VK3KAI	Peter	28
VK6HK	Don	28
VK4TZL	Glenn	25
VK6KZ	Wally	19
VK2TZ	Dale	16
VK3TLW	Mark	16
VK6KZ/p	Wally	16
VK3AL	Alan	15
VK3KME	Chris	13
VK3DMW	Ken	11
VK7MO	Rex	11
VK2TG	Bob	8
VK6BIK	Chris	8
VK2THE	John	5
VK1WJ	Waldis	4
VK2CZ	David	1
VK2TWO	Andrew	1
VK3HZ/8	David	1

144 MHz EME

VK2FLR	Mike	85
VK3CY	Des	62
VK2KU	Guy	18

432MHz

VK3BRZ	Chas	44
VK3XLD	David	42
VK2ZAB	Gordon	40
VK3EK	Rob	28
VK3TMP	Max	25
VK3ZLS	Les	24
VK2KU	Guy	23
VK3BDL	Mike	23
VK3CY	Des	23

VK3KAI	Peter	23
VK3BJM	Barry	21
VK3WRE	Ralph	19
VK2DVZ	Ross	17
VK4KZR	Rod	14
VK3CAT	Tony	13
VK2MP	Rej	12
VK6KZ	Wally	12
VK3TLW	Mark	11
VK3AL	Alan	10
VK6KZ/p	Wally	8
VK7MO	Rex	8
VK3HZ	David	5
VK1WJ	Waldis	4
VK2TZ	Dale	4
VK2CZ	David	3
VK2DXE/p	Alan	2
VK3DMW	Ken	1
VK3HZ/8	David	1
VK3KME	Chris	1

1296MHz

VK3KWA	John	19
VK3XLD	David	16
VK3BRZ	Chas	15
VK3EK	Rob	15
VK2ZAB	Gordon	13
VK3TMP	Max	11
VK3BDL	Mike	10
VK3KAI	Peter	10
VK3WRE	Ralph	10
VK2DVZ	Ross	9
VK4KZR	Rod	9
VK2KU	Guy	8
VK3BJM	Barry	7
VK3TLW	Mark	7
VK3ZLS	Les	7
VK3AL	Alan	6
VK6KZ/p	Wally	5
VK6KZ	Wally	4
VK2DXE/p	Alan	2
VK3CY	Des	2
VK2CZ	David	1
VK2TZ	Dale	1
VK3DMW	Ken	1

2.4GHz

VK3KAI	Peter	7
VK3WRE	Ralph	7
VK6KZ	Wally	4
VK3EK	Rob	3
VK4KZR	Rod	2

3.4GHz

VK6KZ	Wally	4
VK3EK	Rob	3
VK3KAI	Peter	1
VK3WRE	Ralph	1

5.7GHz

VK6KZ	Wally	4
VK3KAI	Peter	2
VK3WRE	Ralph	2
VK6BHT	Neil	2
VK3XLD	David	1

10GHz

VK6BHT	Neil	9
VK6KZ	Wally	5
VK3EK	Rob	4
VK2EI	Neil	2
VK3XLD	David	1

24GHz

VK6BHT	Neil	3
VK2EI	Neil	2
VK6KZ	Wally	2

Additions, updates and requests for the guidelines can be sent to Guy VK2KU, vk2ku@start.com.au, or by mail (QTHR 99+).

Microwave Primer Part Three: Microwave Evaporation Ducts

This month I am reproducing, in part, of an item written by Emil Pocock for his July 2000 QST column on Evaporation Ducts. While much conjecture exists on what occurs over our major "long paths" above 1 GHz, the following looks at the phenomena of Evaporation ducts over short to medium distances on the same frequencies.

"Most VHF operators are probably familiar with long-distance Tropospheric ducts. These natural waveguides propagate 144 MHz and higher signals a thousand kilometres and farther when large-scale weather patterns are favorable. The upper part of a duct is usually defined by a sudden increase in temperature with altitude, called a temperature inversion. Useful inversions are commonly several hundred to a few thousand metres above sea level. A duct may be significantly enhanced by a simultaneous sharp decrease in water vapor content.

In contrast, evaporation ducts are formed almost exclusively as a result of sudden decrease in water vapor content with altitude. Evaporation from lakes, seas and oceans causes the air just above the water's surface to become quite humid that is nearly saturated with water vapor. At a somewhat higher altitude, the air is often naturally drier. If the contrast in water vapor content between the humid air near the water and relatively drier air above is large enough, a duct may form along the boundary sufficient to trap microwave radio signals.

Evaporation ducts are almost constant features above extensive bodies of water on sunny days. Evaporation takes place

faster over warmer water and thus is more conducive to the creation of ducts. Nearly all evaporation ducts form between 3 and 30 metres above the water. More than half of all evaporation inversions appear between 8 and 16 metres altitude.

The more elevated evaporation ducts are usually aided by of light breezes, which mix the humid air a bit higher than normal above the water's surface. Stronger winds may mix the air too much and obliterate the sharp, stable boundary between humid and dry air necessary to create the duct. Evaporation ducts are weaker on cloudy days, disappear at night, and are destroyed by rainfall.

Frequencies

Evaporation ducts are shallower than the higher tropospheric ducts that commonly trap VHF signals. This makes evaporation ducts useful only in the microwave range. The most effective bands are 5.6, 10, and 24 GHz. Ducting is probably rare at 3.4 GHz, because the duct must be more elevated than what is normally observed. Long-distance ducting at 47 GHz and higher may be limited by water vapor absorption, as the air within an evaporation duct is likely to be nearly saturated.

The best choice to get started using evaporation ducts is probably 10 GHz. This band provides a good compromise between optimal frequencies and available equipment. Ducting could be expected to be more pronounced at 24 GHz for the same overall station performance, but most 24 GHz stations run lower power and have poorer receivers than the typical 10 GHz rigs. Relatively fewer evaporation ducts reach the height above water level required to trap 5.6 GHz signals.

On the Beach, Microwave stations must be on a boat or set up right on the shore to get into an evaporation duct. This may not be a serious problem, since most microwave operators are prepared for portable operation. It is not clear how far from the water's edge would still be effective-perhaps no more than 10 metres or so. Some professional studies suggest that in many situations, there may be an advantage to raising antennas 3 - 10 metres above the water line and just under the duct boundary.

There are few reports of amateur microwave contacts in which

evaporation ducts are suspected to have played a major role. Thus it is also not clear what distances might be possible on the various microwave bands. Professional studies (mainly concerned about affects on sea-borne microwave radar) have reported ducting out to several hundred kilometers, at least. Some 10 GHz operators may have already made contacts at similar distances with the aid of evaporation ducts without being aware of it.

A systematic experimental regime might start with a modest path length (say 50 or 100 km) and increase the distance as experience warrants. Use night-time signal strength across the over-water paths as a standard to gauge any daytime enhancement due to an evaporation duct. If a duct is present, signal strength will be substantially greater than what standard path-loss equations suggest. Try different antenna heights and locations. Remember to set up at water's edge and do not get carried away with elevation above sea level-it is easy to put an antenna higher than the duct." ... courtesy of Emil Pocock and QST.

Experience, in VK with evaporation ducts, has suggested that distances that can be covered may be far greater than a few hundred km over favourable water paths!

In Closing

Much quieter on the bands, as you would expect, with winter in full swing. For the up and coming Tropo months the following may be of interest for tracking

"Tropo" on the Internet at http://iprimus.ca/~hepburnw/tropo_au.html. William Hepburn, from Canada, has been a Meteorologist for 30 years as well as having a keen interest in VHF /UHF TV Dxing .. an ideal combination! It remains to be seen just how much of an indicator for VHF Ducting the map can be, so far mid winter results have tallied up with some of the over the land propagation. I have put a link to current Tropo map for VK as well as the 4 day MSL Weather maps on my Website at <http://www.ozemail.com.au/~tecknolt/tropo.htm>

I'll leave you with this thought ...
Everything gets easier with practice ...
except getting up in the morning!"

Till next month

73's David VK5KK

ar

OVER TO YOU

- Note 1** Views expressed in letters are those of the authors and do not necessarily represent the policy of the WIA.
- 2.** Some of the letters have been shortened to allow more letters to be published.

Towers - Builder Beware

Dear Sir,

Re: "Evolution of an Antenna Farm", A.R. May 2000

I have this week received my copy of AR May 2000 and read the above article. As a professional engineer I am concerned about the design of the antenna tower featured in the article. We radio amateurs are licensed to build and experiment with radio equipment within the limitations specified by the ACA. Although antenna masts are part of our hobby, that (ACA) license does not allow us to build antenna masts and other large structures (for example large antenna dishes) without following a full design procedure. Few radio amateurs are professionally qualified to carry out such design and therefore must enlist the services of a professional engineer to carry out the structural analysis and foundation design. From the evidence of the photographs I conclude that this could not have been done. I will explain why briefly later in this letter. It is highly likely in my view that the tower is unsafe and potentially dangerous.

Why do I believe that the tower is unsafe?

Firstly the author states that the tower is home-brew.

Secondly the photographs clearly show that the tower is a space frame (that's a technical term) which uses rectangles without diagonals. Not only is the absence of diagonals unusual for

space frame towers and similar structures but it means that the strength of this tower is achieved solely by virtue of the ability of the joints to transmit (bending) moments. Design of structures based on rigid joints is not uncommon, and is widely used in buildings where diagonal elements would greatly restrict the freedom to design access for doorways, liftwells, air-conditioning ducts etc. The portal frame used in sheds and ground-level workshops is an example. A disadvantage is that the structural elements are large in section, necessary to withstand the bending moments imposed by loads spread over long unsupported sections. Again the portal frame is an example. The cost of extra steel is usually offset by the simplicity and lower cost of fabrication.

Rigidly jointed structures are almost never used for towers for this reason and so they are designed as pin-jointed space frames. They are light-weight and easily erected anywhere without the assistance of heavy-lift equipment. An example is the high voltage power-line pylon. Even though the bolted joints used in these structures confer some rigidity the designer assumes that they act as pins, i.e. joints incapable of transmitting bending moment. The strength and rigidity of the structure accrues directly from the use of the simple triangle.

The tower shown by the photographs does not have joints deliberately

designed to transmit bending moments more than providing for light loads. I am surprised that they survived the bending moments imposed during erection by the crane. A designer would assume that all joints are pins. He could not go further as the structure would collapse under any load.

This is about as far as I can comment on the tower structure in question without more detailed knowledge. There is much more to the design of space frames than I have indicated above, but there is no need to do so for the purposes of this letter and the argument I present.

Of course you are not responsible for the designs submitted by amateurs for publication.

NB The location of the tower in question is I believe Murgon 4605, not Morgan 4065 as printed in AR. Thankfully that is not a region affected by Coral Sea cyclones. But Queensland is prone in some areas to devastating narrow band storms originating in the west. Properly designed antennas towers survive these storms, others do not - I know as I have seen two that didn't survive.

G W Combes B.E. VK4GWC,
201 Kirbys Road, Palmwoods Old. 4555
Tel 07 54459986 Pkt
VK4GWC@VK4KIJ.#SUN.QLD.AUS.OC
UO-22, KO-23, KO-25

Editors Note 12/7/200 Thank you for your constructive criticism. VK5UE

WIA adopts new 'No-code' licensing policy.

I was appalled to learn via the Internet that the Wireless Institute of Australia is adopting a "no-code" licensing policy - without formally consulting its existing membership - in a move to remove mandatory Morse code amateur radio licence tests.

I understand that the WIA Federal Convention in Melbourne on April 29/30 voted in favour of supporting an IARU administrative council policy that there will be an amendment to article

s25 of the ITU Radio Regulations, which requires radio administrations to test prospective radio amateurs on their Morse code proficiency for access to frequencies below 30MHz.

In the last few months, the WIA has negotiated the reduction in the Morse code speed test to 5wpm for unrestricted HF access. Although this will effectively devalue the licences of people like myself who have passed the 12wpm test and render it difficult/impossible for us

to obtain equivalent (reciprocal) HF licences in countries like the USA and the UK, I have been willing to put up with this for the 'possibility' (very faint) that it may attract a few more young people into our hobby.

However, this latest move of the "no code" licensing policy is the thin end of the wedge and I oppose it absolutely - and believe it will only produce division among existing amateur radio licensees

Continued on page 50

and WIA members, along with very few new radio amateurs (read new WIA members).

As someone who has been professionally involved in amateur radio for the last 18 years and is still a relatively young man (44 years old), here are a few home truths.

1. The CB boom in the early 1980s produced a large amount of would-be radio amateurs. Prior to this, the amount of those wanting to become radio amateurs was relatively small - and this situation is the same today. There may be a lot less people getting interested in the hobby as compared to the CB boom years, but the numbers getting interested in the hobby worldwide are quite enough to keep the amateur bands well and truly occupied. The boom days of the 1980s are gone forever - let's accept that and move on.
2. The HF bands are well and truly fully occupied, with all kinds of people working all kinds of modes. However, national bodies like the WIA, RSGB, ARRL are obsessed with their membership numbers and in finding ways of attracting more members, instead of facing the reality that the HF bands are full as ever and CW is still a highly favoured mode of operation. DXpeditions love CW because you can work more people quickly using it than any other mode and thus make more contacts/attract more direct QSL revenue. Let's not get confused here - the activity levels on the HF bands aren't dying, unfortunately just national radio societies.
3. We live in a world where the personal computer is king and people increasingly sit by themselves at home in front of one, rather than going out and socialising with others. Getting people to join any sort of society or group is difficult, especially young ones - and national radio societies are affected by this phenomenon. It is vital to hang onto the members that you have, as well as chasing new ones and keep society costs as low as possible. Annoying long-standing members like myself by changes that are unlikely to achieve anything except annoying longstanding members like myself is

futile and will only cause resignations.

5. As a CW operator, I am fed up with being a scapegoat for the fears of national radio societies that learning CW is the thing that stops them from gaining new members and the ambitions of a few lazy people who are unwilling to even try to pass a 5wpm Morse test. I am also very fed up with the continual harping of the lazy brigade of the 'death' of Morse code in the professional radio communications. CW still plays a very healthy part in amateur radio, particularly on HF - frankly, who cares what modes professionals use?

Let's try an interesting parallel here. Surfing is a fantastically simple, elegant and skilful way of riding the waves on the sea, similar to the way CW works on the radio waves. I don't hear anyone saying that all surfers should give up their boards and replaced them with surf skis.

Radio amateurs have always gone their own way throughout the history of radio and I don't think that we should be any different today. Amateur radio is a great big world and there is room in it for CW, PSK3 1, earth-moon-earth and satellite communications. Let's look at real ways we can make amateur radio and the WIA more attractive for old and prospective members - instead of conveniently hunting to death our great tradition of CW.

73 Steve Ireland,
VK6VZ/ex-G3ZZDNK9XZ,
PO Box 55, Glen Forrest, WA 6071
WIA/Radio Society of Great Britain
member,

Australian Regional Contributing Editor,
ARRL *National Contest Journal*, Editor/
Consultant Editor, *Ham Radio Today* 1983 -
1986
Contributor to *Radio and Communications*
(Australia), *Radio Today* (UK) and
CQ (USA) magazines.

Editors Note. I think the WIA News in July and August AR cover most of the points raised.

Send letters to:
The Editor
Amateur Radio
34 Hawker Cres
Elizabeth East SA 5112
edarmag@chariot.net.au

Editing Letters – Censorship ?

Dear Colwyn

I write to say I don't agree with the policy relating to letters set out at page 56 of the June 2000 copy of *Amateur Radio*.

I think you are being too prescriptive and your policy will be off putting to many who would otherwise write to express their views.

For sure, request letters to be less than 200 words, but otherwise print them as they come. I do a lot of letter writing and enjoy the letters of others. To "censor" these letters is to detract from our enjoyment of this most important aspect of the material in *Amateur Radio*.

Best wishes and keep up the good work.

Ken Fuller VK4KF,
P O Box 396, Wynnum Central 4178

Amateur Radio and Masonic Lodges

Dear Sir

I read with interest "QRM", the VK7 Divisional Notes in the June 2000 issue of *Amateur Radio*.

I must disillusion the writer on the Notes as to this being the first occasion on which our hobby has been demonstrated at the Masonic Lodge, as I had that privilege in 1982 at a now defunct Lodge in Northcote in Melbourne's north.

On this occasion a sked was arranged with John VK3AVY and the equipment used was the venerable IC22S with a quarter wave ground plane sitting at the top of the fire escape stairs. A small PA was used to enable the brethren to hear both sides of the QSO, and as a gimmick for further interest, a CRO was set up to monitor the transmission.

I do not claim this to be the first demonstration at a Masonic Lodge, and have no doubt that their have been other such demonstrations in the past.

John Ireland,
30 Clyde Street, Ferntree Gully 3156

Re:- Call Book 2001

Dear Sirs,

Thanks for call Book 2000. It's a ripper.

You might like to know there's an Australian net which has been going for over 10 years and which amateurs interested in amateur astronomy enjoy.

IONOSPHERIC UPDATE

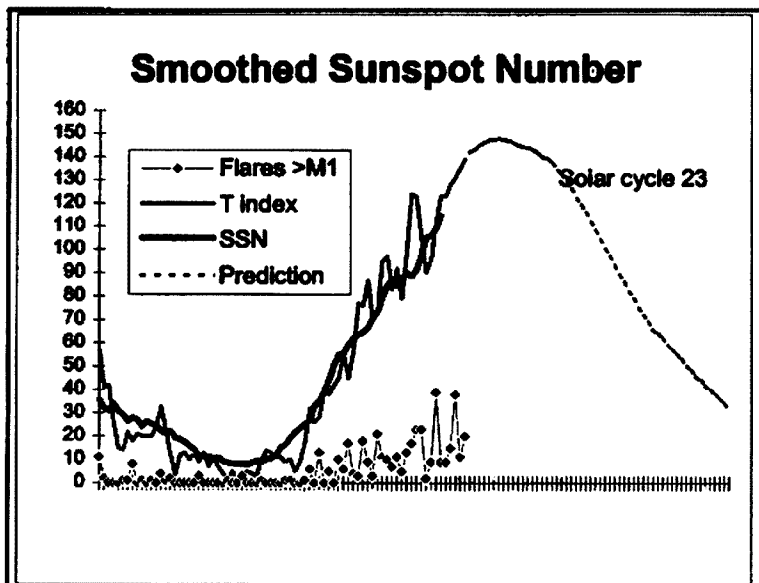
Conditions for ionospheric radio communication have been good over the last quarter as the rise in the sunspot number continues. Sunspot cycle 23 will not be as large nor has its growth been as rapid as the previous two (Sunspot cycles 21 and 22) so propagation will not be as good. It appears that ionospheric conditions are starting to resemble those found around the top of a sunspot cycle. DX conditions continue to improve. The pattern of monthly sunspot numbers continues its consistent rise meaning that the smoothed sunspot number will also be rising at nearly the same rate. Solar activity is also rising. High levels of solar activity were recorded in June with 24 flares recorded of which 4 were class X. Spread F was also observed by the Ionospheric Prediction Service on their southern Australian ionograms indicating a probable degradation in HF communications quality. The wide range in conditions associated with an approaching peak in the solar cycle is becoming more obvious: one day conditions are poor, next day you can be working the world, the day after there is nothing.

Predictions are showing that the possibility for openings on 6 metres is improving. Darwin and Townsville amateurs may care to dust off the 6 metre rig as upper deciles are now approaching 46 MHz. on circuits affected by the fountain effect (TEP) such as those to Japan

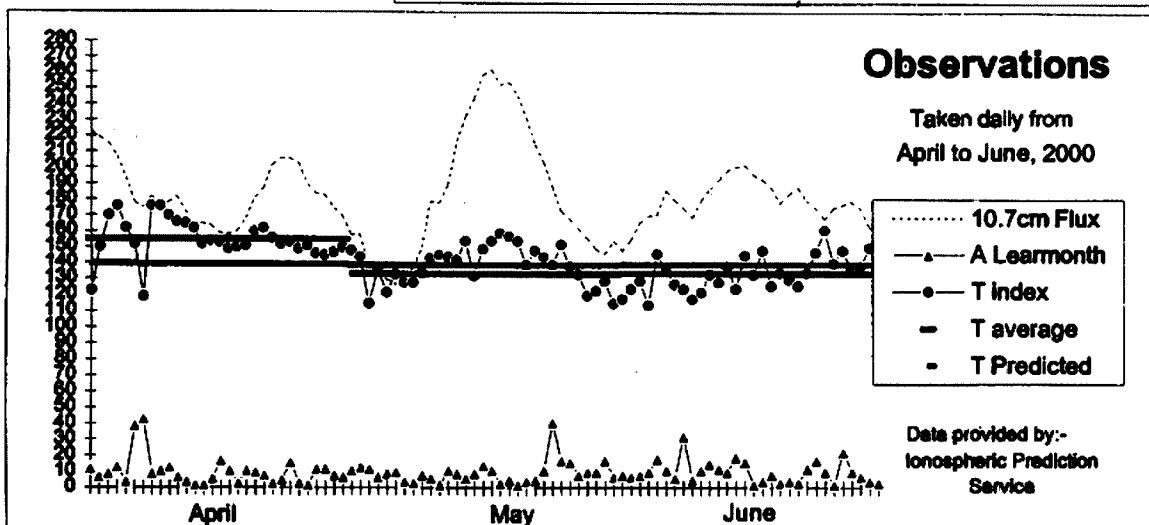
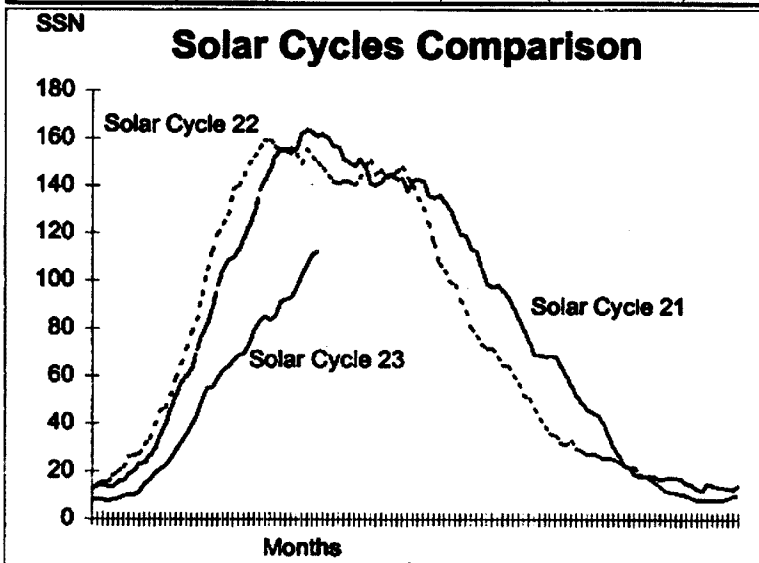
The most severe geomagnetic activity was in May when it peaked with at 41 on 24 May. The disturbance was far more severe in the northern hemisphere where it peaked at 71. Scandinavian observers quote seeing some of the most impressive displays of the northern lights (Aurora Borealis) ever seen.

No change is the predicted maximum in the sunspot cycle has been received from the Solar Environment Committee of NOAA. The graphs of observations appear to be on target for a peak in December 2000, or maybe a little later.

ar



Sunspot number (June 2000): 125 Smoothed Sunspot Number (December 1999): 115



HF PREDICTIONS

by Evan Jarman VK3ANI

34 Alandale Court, Blackburn Vic 3130

These graphs show the predicted diurnal variation of key frequencies for the nominated circuits.

These frequencies as identified in the legend are:-

- Upper Decile (F-layer)
- F-layer Maximum Usable Frequency
- E-layer Maximum Usable Frequency
- Optimum Working Frequency (F-layer)
- Absorption Limiting Frequency (D region)

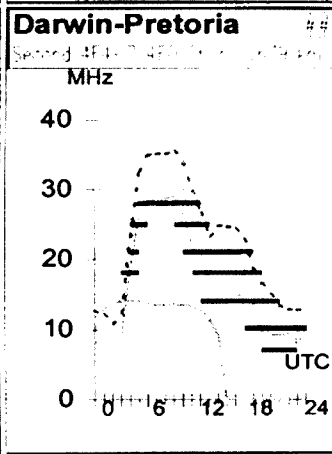
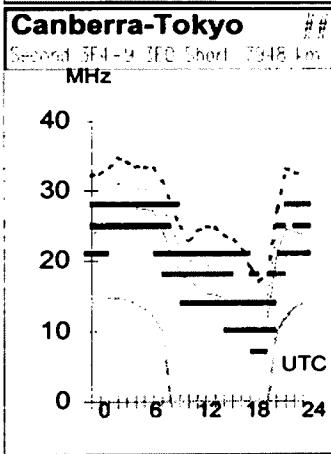
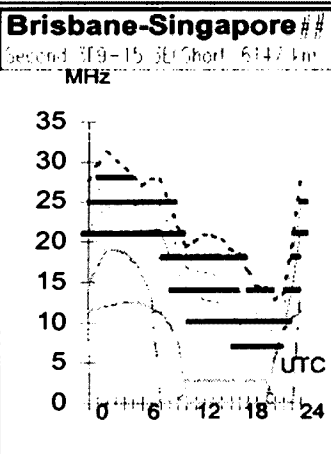
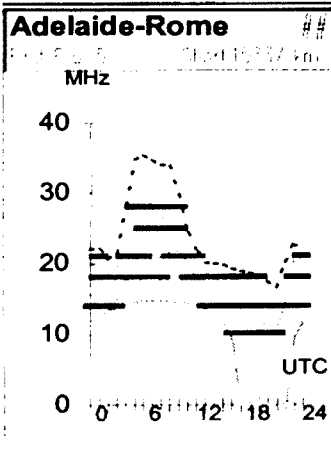
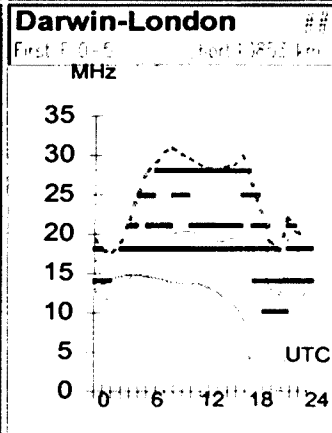
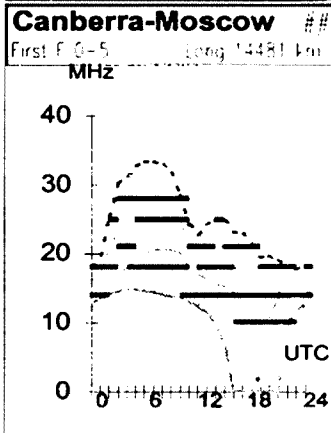
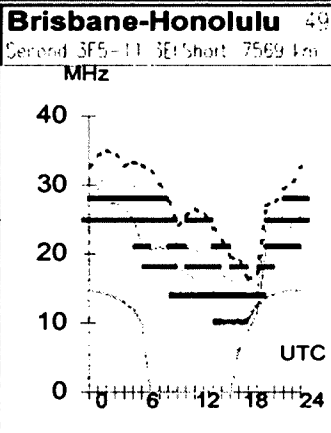
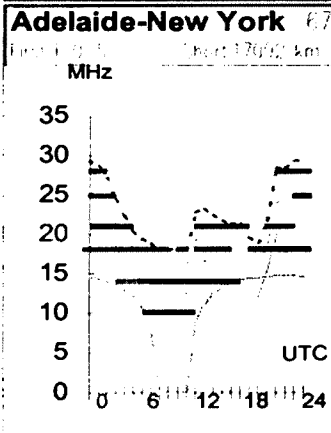
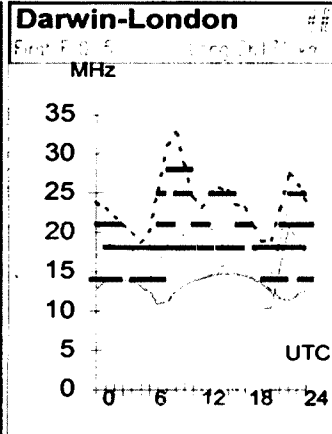
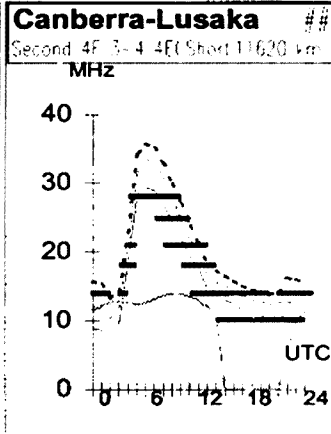
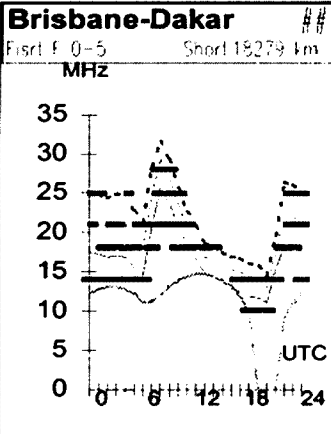
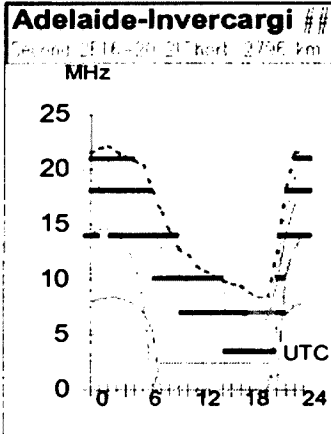
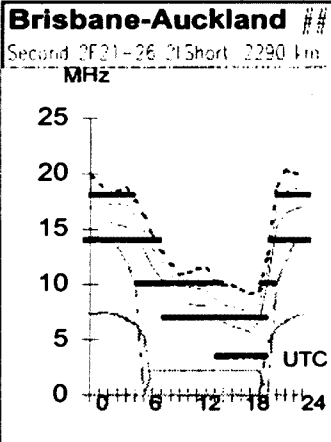
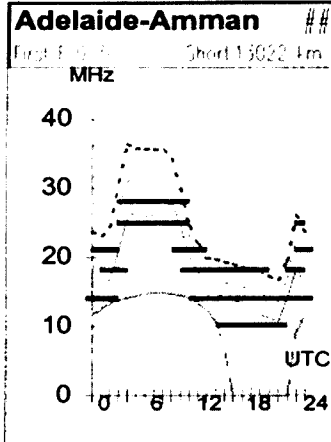
Shown hourly are the highest frequency amateur bands in ranges between these key frequencies, when usable. The path, propagation mode and Australian terminal bearing are also given for each circuit.

These predictions were made with the Ionospheric Prediction Service program: ASAPS Version 4

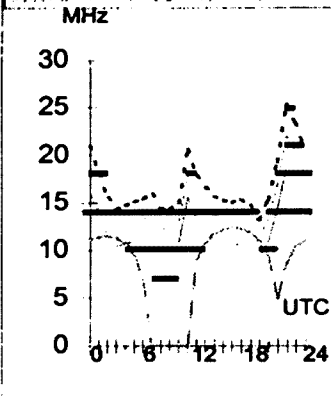
August 2000
T Index: 137

Legend

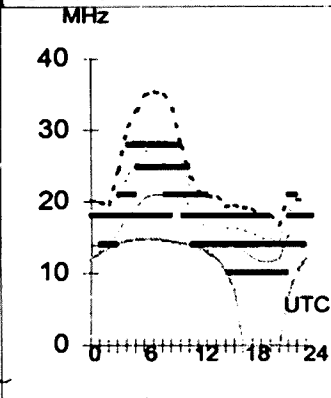
- Frequency scale
- UD
 - F-MUF
 - E-MUF
 - QWF
 - ALF
 - 10%-5
 - 50%-9
 - 90%-1
- Time scale



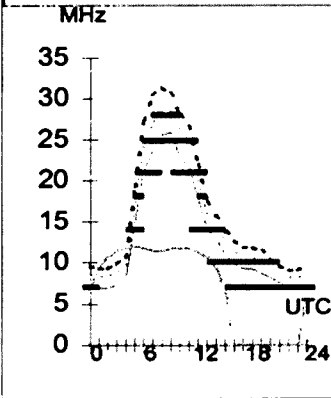
Hobart-Montevideo ##
 Second 4F4-5 4E0 Short 11044 km



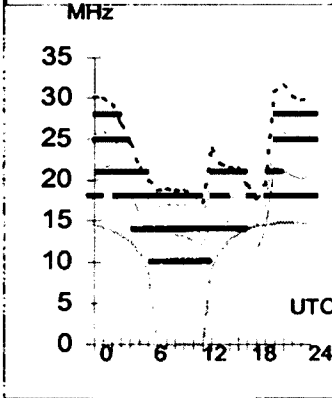
Melbourne-Budapes ##
 First F 0-5 Short 15558 km



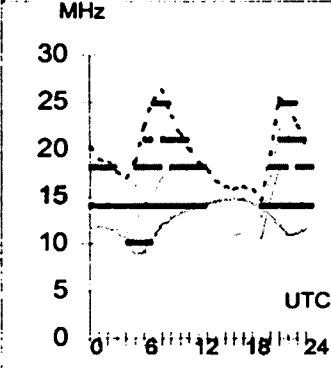
Perth-Capetown ##
 Second 4F8-10 4E0 Short 8703 km



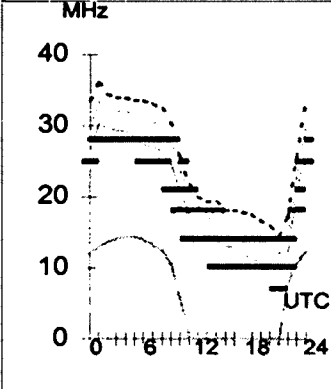
Sydney-Chicago ##
 First F 0-5 Short 14876 km



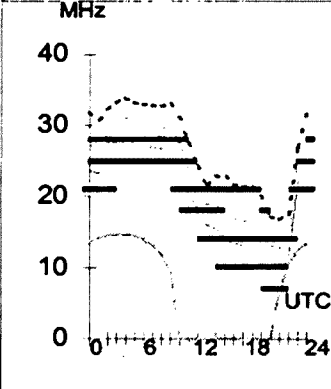
Hobart-Stockholm ##
 First F 0-5 Long 23871 km



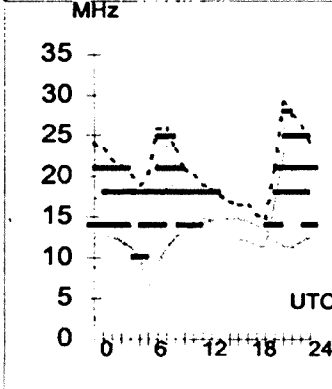
Melbourne-Jakarta ##
 First 2F5-7 2E0 Short 5214 km



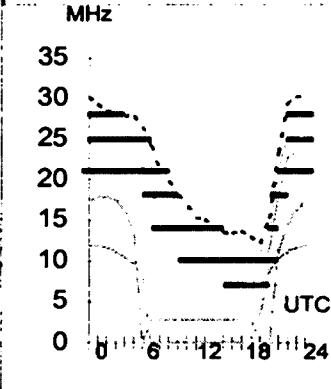
Perth-Osaka 17
 Second 3F5-11 3E0 Short 7684 km



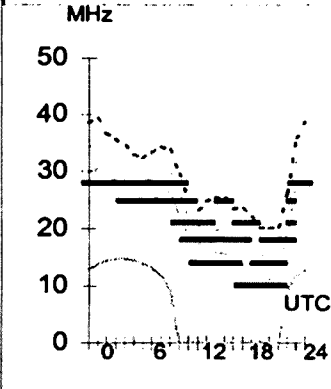
Sydney-London ##
 First F 0-5 Long 23032 km



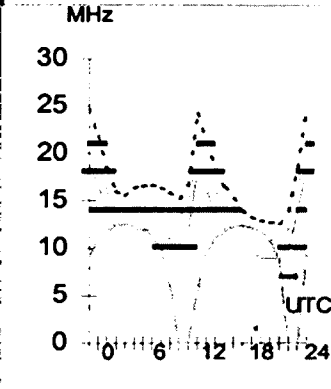
Hobart-Suva ##
 First 0-12 2E0 Short 8011 km



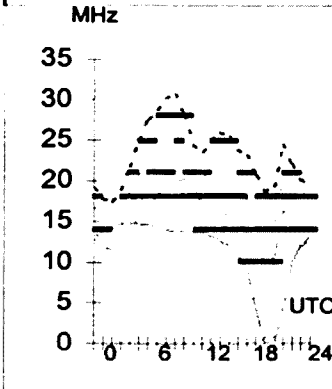
Melbourne-Manila ##
 First 2F1-7 2E0 Short 6341 km



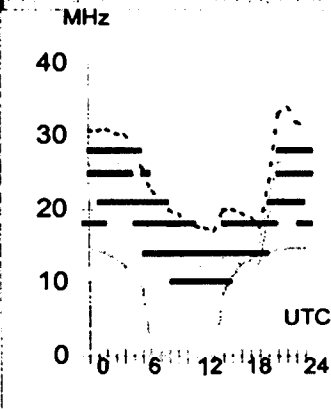
Perth-Santiago ##
 First F 0-5 Short 1709 km



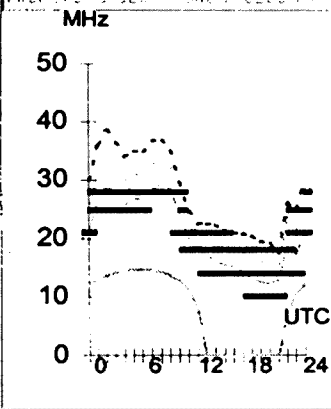
Sydney-London ##
 First F 0-5 Short 11000 km



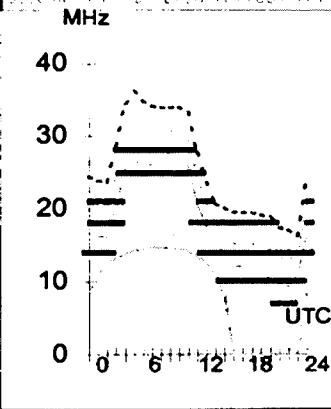
Hobart-Vancouver ##
 First F 0-5 Short 12417 km



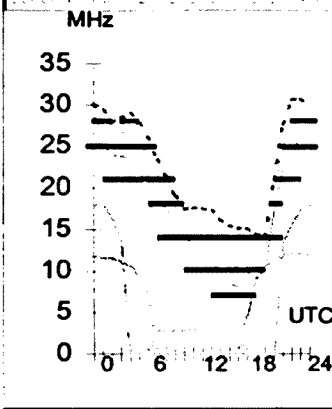
Melbourne-New ##
 First 3F0-6 3E0 Short 6000 km



Perth-Tel Aviv ##
 Second 4F4-10 4E0 Short 11091 km



Sydney-Papeete ##
 Second 3F9-7 3E0 Short 10100 km



HAMADS

- Hamads may be submitted on the form on the reverse of your current Amateur Radio address flysheet. Please print carefully, especially where case or numerals are critical.
- Please submit separate forms for For Sale and Wanted items, and be sure to include your name, address and telephone number (including STD code) if you do not use the flysheet.
- Eight lines (forty words) per issue free to all WIA members, ninth and tenth lines for name and address. Commercial rates apply for non-members.
- Deceased estates Hamads will be published in full, even if the ad is not fully radio equipment.
- WIA policy recommends that the serial number of all equipment for sale should be included.
- QTHR means the address is correct in the current WIA Call Book.
- Ordinary Hamads from members who are deemed to be in general electronics retail and wholesale distributive trades should be certified as referring only to private articles not being re-sold for merchandising purposes.
- Commercial advertising (Trade Hamads) are pre-payable at \$25.00 for four lines (twenty words), plus \$2.25 per line (or part thereof), with a minimum charge of \$25.00. Cheques are to be made out to: WIA Hamads.
- Copy should be typed or in block letters, and be received by the deadlines shown on page 1 of each issue of Amateur Radio, at:

Postal: Newsletters Unlimited, 29 Tanner Street, Richmond, 3121

Fax: 03 9428 4242 **E-mail:** news1@webtime.com.au

Please only send your Hamad once

Please send Hamads by mail OR fax OR email (much preferred).

Please do not send by more than one method for any one ad or issue, it is confusing.

FOR SALE ACT

- Collins 678Y-1 Maintenance kit for Collins 618T models. Complete with accessories and module extenders and Instruction Book. Also Collins 678P-1 Test Harness for testing Collins 618T systems. With incomplete set of connecting cables. For inquiries call Peter VK1CPK, phone 02 6231 1790, FAX 026296 5712.
- Kenwood TR-9130 2m all mode transceiver plus 5/8 whip and 1/4 wave antenna Serial No. 5030197. \$175. VK1ZL QTHR 02 6281-3956

WANTED ACT

- Kenwood transceiver TS770. Please contact Virgil VK1VI on 02 62555677 AH or email at vionescu@ozemail.com.au

FOR SALE NSW

- Rotator KR-600RC c/w display, cable and instruction manual. \$320. John VK2BJU 024841 0272 marland@goulburn.net.au
- Computer old, working, sell or swap for old military radio, or old valve equipment. IBM clone, mini tower case, 486DX, 33MHz, 8Mb RAM, 80Mb disc, 5" floppy, DOS, Windows 3.1, 14" colour monitor, mouse, keyboard, working. Ray Robinson VK2ILV Sydney 02 94898561 robinson@srsuna.shlrc.mq.edu.au
- Icom IC756 TXCVR, absolutely as new. 6 months old. C/W optional sideband filter. Speech synthesizer. Perfect condition. Original Packing. \$3500 VK2APP QTHR. 02 6382 6086 pcpage@dragnet.com.au
- Deceased estate of VK2ARS, Yaesu FT-

ONE, FT-101E, SP-102, FTV-650, FC-102 ATU, Drake TR7, RV7, R4C, Icom IC251A, IC471A, Collins 75S1, KWM2, Codan 7727-TB, Hallicrafters SX117, Radio Shack HTX-100 10m, HTX-212 2m, Heathkit SB102, Shimizu Denshi SS-105S. Reasonable offers accepted. SASE or Email for full list of items and other equipment. Allan VK2GR 02 9022 5412 B, 02 8850 0141 H QTHR
Email: allan.b.mason@compaq.com

- BOOK: "Radiotelegraph and Radiotelephone Codes, Prowords and Abbreviations." 2nd Edition. \$16 posted Australia. 90 Pages. Q,X,Z Codes, 97 Phonetic, 20 Morse Codes, Phillips, Myer, 10,11,12,13 Codes. Much other info. Internet - <http://www.nor.com.au/community/sarc/phonetic.htm> VK2JWA, John W.Alcorn. QTHR. 02-66215217. Email jalcorn@nor.com.au

- "INTERNET Connect from Port Macquarie to the Gold Coast from 80c per hour. Summerland Amateur Radio Club. For info -<http://www.nor.com.au/community/sarc/sarc.htm> John, VK2JWA, QTHR, jalcorn@nor.com.au. 33 Spring St, Lismore, NSW, 2480. Ph 02-66215217"

- 2 ex-RAAF alloy Antenna towers. Seven sections, length 3.6m approx. per section. Base section 1m x 1m, guy points at the top of the 1st, 4th, and 7th sections. Crank up by heavy chain & sprocket. Has a built in, fold down working platform at the top section of each tower. They are already

taken down and are ready to go. Buyer to arrange transport from the site. Located in the Springwood area of the Blue Mountains. \$1000.00 each or genuine offers considered. 1 only Wind-up, tilt over tower approx. 15m still standing. Buyer to take down and transport. \$350.00 or genuine offer. Photographs can be emailed to genuinely interested callers. Greg VK2KGA, QTHR, e-mail vk2kga@dingobluenet.au 0411 025 791, 0247 398895 or Phil VK2FIL, QTHR, derbyfil@optusnet.com.au

- Alinco DR-610 2m/70cm. Comes complete with boxes all remote head mounting hardware, operation and service manuals. Original owner and is in mint condition, \$750.00. Earle VK2TEK 0407-287-030 all hours or earle@sydnet.com

- Revex SWR and power meter model W500 1.8-60MHz 2kW PEP virtually brand new \$95 VK2DX QTHR 02 4751 9795

- Clearance surplus gear suitable repair or at worst spare parts. Icom IC55 50MHz multi-mode, existing faults loss VFO tuning when hot and no memories. Kenwood TS700-SP 144 MHz good performer until internal power supply failed. Both good clean units with manuals. Good potential for technician \$200 total for the two. Sid VK2SW 02 6922 6082

- Commercial type rotator model E motator, 1103 MXX control box, 100ft cable brand new \$1700. Drake TAXC MSA 5 pak P/Supply R-4C transmitter good condition \$600 s/no 22695/24668. Yaesu HF transceiver FTD xx 560 good condition \$450 s/no II 310158. All units have manuals. VK2KVH 02 4630 9158 after 5pm.

- MJF antenna tuner model 941E, coax, open line, long wire, absolutely brand new still sealed in plastic. Genuine snap \$200 Les VK2AXZ 02 4954 0893

- Kenwood TM733A FM VHF/UHF dual band transceiver with mobile mounting bracket. DFK-4B detachable front panel kit, suitable mobile or base, s/n 70105757 all leads VGC \$450 Perth plus mobile antenna HF+6m +2m excludes spring base \$150. Cushcraft Vertical Base Antenna AR270B 2m/70cm \$100 VK2JJS John 02 9498 2248 QTHR Sydney

WANTED NSW

- Old Unloved equipment, big dirty heavy old receivers that you no longer want or cannot move! Spiders and all. Mad nut collects old "boat anchors", for receiver display. Parts, junker set, I am the man with the broom. As per articles previous in AR. Contact John 02 9533 6261 L21068.

- Elmac SK-406A chimney to suit 3-500, 4-400 valve etc. Also HR6 Anode caps Glen VK2FC 02 4982 6800

• Old Telecom ETPs and Els on radio, TV and external plant. Will pay \$\$\$\$ George VK2KGG 02 9411 4442 georgg@acay.com.au

• Crown brand light duty automatic rotator and control box. If control box only is available this would do. Pay good price for right gear 02 4944 8484 L20747 17 Tumut Street Dudley NSW 2290 Grahame Foster.

FOR SALE VIC

• Drake TR7 250W transceiver with PS7 power supply covers all hambands including WARC, receives 0-30MHz extras 1.8kHz 6kHz filters, fan, slow dial drive, Shure mic, shop manual, recently serviced and realigned by Drake expert \$1100 ono you collect VK3WW 03 5433 3654

• Yaesu FT736R VHF-UHF transceiver 6m-2m-70cm with MDIC8 desk mike, manuals, original packing. This unit brand new never commissioned. Reason insurance settlement after fourth shack robbery. Subsequently lost interest gear never used again orig cost \$2664, asking price \$1800 ono Bob VK3ZRY 9578 4961

• Deceased estate VK3DIM/VK6MD Kenwood AT250 \$170, Yaesu FT8100R [2yo hardly used] \$550, Amico Pre-amp PT-2 \$35, Linear FL2100Z \$450, Icom IC-T8E barely used \$550, Yaesu FRG9600 UHF/VHF scanner \$300, Kenwood MA 4000 duplexer \$150, Kenwood SW 200 \$200. TV3300 low pass filter [up to 1000W] \$60. TVbacker multi-band car antenna [has 3 additional bands/frequencies] on modified Reece-Hayman tow hitch \$400 all inclusive. 2 x 2metre car antennae \$50, Rotator & Daiwa medium duty round controller \$250, Yagi beam element [6m/5 band] \$50, Grounded vertical Butternut multiband \$150, Dual band mobile antenna \$50. Coaxial cable used and new, make offer. Yaesu FL2100Z linear amplifier plus 4 valves \$750 all inclusive. Yaesu Landliner phone patch Make offer. YO 100 Monitor scope Make offer. Will sell everything for \$3000. Phone Deborah Sim on 0411 111 430 or 03 9876.2646 after 7.00pm

<http://www.hamsearch.com>
a not-for-profit site that is a search engine for hams

ADVERTISERS INDEX

ATN Antennas 11
 Andrews Communication Systems43
 Dick Smith.....28,29, IBC
 IcomOBC
 Radio & Communications23
 Tower Communications56
 WIA Call Book.....IFC

• Kenwood TS820S & VFO820, comes with DC Converter for 13.8V use and runs off 240V as well, spare valves, circuit boards, chassis, front facia, dials and knobs etc. This radio has been well cared for and would be an ideal first radio or as a backup. Also comes with Owners and Technicians Manuals. \$425. Please Ph. Barry VK3HFB on 03 5278 6513 Email: ceilidh@pipeline.com.au

• Beam 40 metre three element full size 48ft boom adjustable hairpin matching, see assembled on the ground. \$1250 ono VK3CX 03 5422 2860

• Yaesu FL2100Z HF linear amplifier works well \$660. 2 metre linear 25W PEP \$30. Siemens Level Generator and selective level meter 0-1600kHz \$70. CRO DSE 5 MHz with probes \$60. Two Siemens power transformers 140x140x180mm suit power supplies \$10 each. Ken VK3DQW 03 5251 2567 AH

FOR SALE QLD

• Tubes 6JSGC NEC Japanese new, direct replacement Yaesu transceivers pair only \$200 PA tubes. Yaesu FP757HD power supply with built-in communications speaker \$295. Kenwood MC-80 base microphone \$100. Kenwood PS-52 new heavy-duty power supply never used \$475. Kenwood AT-230 antenna tuning unit \$225. John VK4SKY 0417 410 503 benoel@fan.net.au

• ICOM IC251A 2m all-mode circuit diagrams needed for repair will pay for copying or will buy unwanted IC251A for parts VK4FPM 07 4125 1690

TRADE ADS

• AMIDON FERROMAGNETIC CORES:

For all RF applications. Send business size SASE for data/price to RJ & US Imports, PO Box 431, Kiama NSW 2533 (no enquiries at office please ... 14 Boanyo Ave Kiama). www.cyberelectric.net.au/~rjandusimports

Agencies at: Assoc TV Service, Hobart: Truscotts Electronic World, Melbourne and Mildura: Alpha Tango Products, Perth: Haven Electronics, Nowra

• **WEATHER FAX programs** for IBM XT/ATs *** "RADFAXZ" \$35.00, is a high resolution short-wave weather fax, Morse and RTTY receiving program. Suitable for CGA, EGA, VGA and Hercules cards (state which). Needs SSB HF radio and RADFAX decoder. *** "SATFAX" \$45.00, is a

• Plug in coil boxes for National HRO RX also dog house power supply for same. WWII type A Mk3 TX RX and type 3 Mark II or part sets. Ray VK4FH 07 3299 3819 fax 07 3299 3821 Box 5263 Daisy Hill Queensland 4127.

FOR SALE SA

• Kenwood TS820 with SP-820 s/n 540166 \$400. Yaesu FT-301S s/n 303363 not working, best offer 3x 13.8DC power supplies. Vicom model VC-2 SWR power meter s/n 32359. VK5AAM 08 8295 6395 QTHR

• Philips FM93A 9 channels 25W \$100 ono. Phillips FM1680 10 channels 25W includes mobile bracket \$80 ono. Rob VK5CS 08 8568 5411

WANTED WA

• Keen collector looking for old microphones will look at anything any condition Wayne VK6FT. 08 9390 8241, vk6ft@iinet.net.au

WANTED TAS

• Vibroplex semi-automatic morse key in very good condition 03 6391 8925 jmcculloch@vision.net.au

MISCELLANEOUS

• The Australian Army Signals Museum in Melbourne would like to get two WW2 radios for its collection. They are man pack sets, WS208 and WS128. If you can help please contact Allan Doble VK3AMD QTHR 03 9570 4610 any time.

• Swap Collins mechanical filter 500kHz-3.1kHz for 455kHz-3.1kHz similar Collins type VK5RG 08 8379 1889.

NOAA, Meteor and GMS weather satellite picture receiving program. Needs EGA or VGA & WEATHER FAX PC card, + 137 MHz Receiver. *** "MAXISAT" \$75.00 is similar to SATFAX but needs 2 MB of expanded memory (EMS 3.6 or 4.0) and 1024 x 768 SVGA card. All programs are on 5.25" or 3.5" disks (state which) plus documentation, add \$3.00 postage. ONLY from M. Delahunty, 42 Villers St, New Farm QLD 4005. Ph 07 358 2785.

• **Campervans de ZL2QB.** YL-2000 Meet in New Zealand. Campervans with ham radio for hire: www.kiwicampervans.co.nz. Karen and Dieter, Nelson, NZ. Phone Fax 0064 3 543 2022, e-mail kiwicamper@ts.co.nz

TRADE PRACTICES ACT

It is impossible for us to ensure that the advertisements submitted for publication comply with the Trade Practices Act 1974. Therefore, advertisers and advertising agents will appreciate the absolute need for themselves to ensure that the provisions of the Act are strictly complied with.

VICTORIAN CONSUMER AFFAIRS ACT

All advertisers are advised that advertisements containing only a PO Box number as the address cannot be accepted without the addition of the business address of the box-holder or seller of the goods.

OVER TO YOU

Continued from page 50

Perhaps it could be listed in the year 2001 "nets" page.

In your column which lists astronomical events, you might like to list the following:-

The Astronomical Society of Victoria has its own callsign:-VK3EKH. Using that callsign Russell Ward has been conducting an amateur radio net for hams and short wave listeners on the subject of astronomy since August 1989. The net commences each Friday at 22:00EST on 3.543 MHz. Russell lists astronomical news for the week and invites stations to call in. There are a few regular stations that call in each Friday, and over the years, a hundred stations have taken part. Many short wave listeners enjoy listening on the net. Topics discussed range widely over the subject of astronomy and include matters of interest to radio amateurs such as meteor scatter propagation, sunspot and auroral activity, satellite communications and meteor showers.

New stations are made ,most welcome.

Another thing for the Call Book 2001. Please change my call in the examiner's list from VK5NDZ to my present call of VK5JB.

Geoff Bridgeland VK5JB,
2 Plymouth Avenue, Sturt 5047

Morse Code And The Full Call

I have been reading the "CW Debate" with interest over the last few years. There have been many equally good arguments both for and against its retention, or reduction in speed requirements. I am of the opinion, however, that complete removal of it as a requirement makes the attainment of a "full call" less than equivalent to the wonderful privileges and responsibilities that one achieves with the granting of that call. Whether the horse has all but bolted in this matter is difficult to ascertain at the moment, but I would like to make the following suggestion:- That in order to attain the full call the (prospective) amateur be required to pass the Regulations and Full Theory examinations, as at present, plus either the 5 wpm Morse, or an examination in Radio-computer Techniques. For the latter, I suggest that packet radio would be most appropriate. I suggest that the examinee would be required in the exam to connect together the appropriate hardware, install the software, and successfully transmit and receive appropriate messages, using correct protocol and procedures. A short multi-choice test would complete the examination. I wonder how other amateurs feel about this? Surely packet user groups would be pleased to help, both in the setting of standards, training, and the conducting of examinations. Many of those who have been "putting off" this last step because of no interest in, or fear of, Morse, would be happy to take up this challenge. Morse Code ("CW") is a lot of fun and a great challenge, but let us also be seen as a modern and forward-looking organisation, ready to draw in those whose interests have been formed in the computer age.

John Elliott, VK5EMI,
8 Clearview Avenue, Belair, SA 5052.

Band congestion due to contests

The Editor
Amateur Radio.

I decided to write this as the 10 metre band, although open it not useable today due to a contest. You are welcome to publish my call sign and Email address if you wish.

I assume one of the purposes of contests is to increase usage of the amateur bands. Be that as it may it seems logical to increase activity in areas of the bands that get little use. I am a regular 10 metre operator and seldom use other bands. Ten metres is a large band with little use above 28.600 to about 29.000 with the exception of a few spot frequencies. Regular users of 10 metres are generally between about 28.400 and 28.600.

I am constantly frustrated by contests that cause major congestion between 28.400 and 28.600 more specifically 28.450 to 28.500 and do little to activate the rest of the band. Wouldn't it be practical and reasonable, if contests had a no go zone in the band. For example 28.450 to say 28.550 should be reserved for non contest use. There is still plenty of band to activate. We have nominal portions for CW so why not (NC) NO CONTEST. Contests could easily be considered a different mode of operation.

As I stated I don't operate other bands but I suggest that this problem occurs for many non-contest operators of all bands. Perhaps some band space should be set aside in other bands as well. I know there is considerable interest for my suggestion on 10 metres and it would be interesting to run a poll to see just how many operators share my frustration.

Kim Rhodes, VK6TQ,
Email: -rhodesk@bigpond.com

ar

**Have you heard this
week's Divisional
Broadcast?**

**See page 30 for times and
frequencies.**

*For All Your
Requirements*

AUTHORISED DEALER
ICOM

KENWOOD

AMATEUR COMMERCIAL

**Tower
Communications**

14 Mary Street
Hazelmere

Western Australia 6055
Telephone: (08) 9274 1118
Facsimile: (08) 9250 3734

E-mail: tower@con.net.au

www: <http://www.towercommunications.com.au>

▶ YAESU'S DONE IT AGAIN



Yaesu FT-100 Ultra-compact HF/6m/2m/70cm Mobile

AMAZING SCOOP PURCHASE VALUE!

Now you can enjoy the fun of operating on all bands from 160m to 70cm, either at home or in your car, and at a fantastic Yaesu price.

The Yaesu FT-100 features HF/6m/2m/70cm transmitter coverage with 100W RF output on HF and 6m, 50W on 2m and 20W on 70cm, plus you can easily mount the detachable front panel using an optional lead (YSK-100) for more convenient mobile installations. Powerful interference fighting features such as a DSP based Bandpass filter, Notch filter and Noise reduction, together with an IF based Shift control, all aid reception quality during tough conditions. A Speech Processor and VOX facility are provided for SSB users and an internal Electronic keyer is provided for CW operation. Also included are Dual VFOs, built-in CTCSS encode, 300 memory channels, all-mode operation (SSB, CW, AM, FM, AFSK, Packet* 1200/9600bps), 100kHz-970MHz receiver (cellular locked-out), and options for additional AM and CW IF filters.

The FT-100 is supplied with an MH-42B6JS hand mic, DC power lead and comprehensive instructions.

D 3285

YSK-100 remote front panel kit.

D 3286

YAESU

Included as standard:

- Digital Signal Processing on both transmit and receive
- Effective IF noise blanker
- Electronic CW keyer with 50 character message memory
- Spectrum Scope function
- Massive receiver coverage (100kHz – 970MHz, less cellular)

\$2346

2 YEAR WARRANTY

All prices shown are inclusive of GST.

Offers expire 27/8/2000.



That's where you go!

* Requires third party TNC

MORE

GREAT

GEAR

FROM

ICOM



IC-706MKIIG

The amazing evolution of the legendary 706. Frequency coverage is expanded to the 70cm band and output power is increased for the 2m band. You get base station performance and features in a mobile rig-sized package.

IC-718 A compact HF all band transceiver.

A superior performer with simple, straight forward operation with keypad. Optional AF DSP capabilities, including noise reduction and auto notch function. It's versatile, compact and loaded with features.

NEW!!!



NEW!!!



IC-756PRO The HF & 6mm multimode

professional performer. 100 watts of power, newly designed 32 bit floating DSP for noise reduction and auto notch function, and AGC loop operation for wider dynamic range. Plus digital IF filter, built-in RTTY Demodulator/Dual Peak APF, and a whole lot more.



IC-2800 A totally new approach to dual band mobile. Powerful performance on 2m and 70cm bands, remote control capability, and a first for mobile rigs... a multi-function colour LCD screen! All your information is right in front of you in colourful 3D-like characters and icons.



IC-T81A A remarkably compact quad bander.

Superb clarity on the 6m, 2m, 70cms and 23cm bands. It's water resistant, with tone squelch and pocket beep functions standard, plus you can change volume and bands even quicker with the 'joy-stick' style multi-function switch.

ICOM

Clearly Ahead

2 YR WARRANTY

See your nearest Icom Dealer, or visit our website at www.icom.net.au

September 2000

Volume 68 No 9



Amateur Radio

AX3ITU

**Prime Minister
addresses
Remembrance
Day Contest -
Opening**

**The Good Old Days of
Crystal Sets and Morse Code**

**Post WW2 Amateur Radio:
a phenomenal social link**

- ★ Receive SSB on your VHF/UHF handheld
- ★ A converter for the 15 metre band
- ★ A Single Sided Modulator for the LF Transmitter

**Gil Sones VK3AUI
Technical Abstracts:**

*RF Power Meter
Close Coupled
Vertical Antenna
RF Bridge*



WIA Yearbook 2000

Callbook Listings
Frequency Listings
Band Plans
Repeater Lists
Beacon Lists
Satellite Lists
Licence Conditions
Examiner Lists
Special Interest Groups
Public Relations Notes
Radio and TV Freqs.
and much, much more!

2000 is a great year to have an up-to-date call book. This YEARBOOK edition contains all of the content you have come to expect of the WIA callbook as well as some new items

It is more than a callbook, it's a Yearbook, the WIA Yearbook!

Watch for the
2001 WIA Call Book
— OUT SOON —



Amateur Radio

Volume 68
Number 9
September 2000

The Journal of the Wireless
Institute of Australia
ISSN 0002-6859

Editorial

Editor: Colwyn Low VK5UE
edarmag@chariot.net.au

Technical Editor: Peter Gibson VK3AZL

Publications Committee Members
Ron Fisher VK3OM
Don Jackson VK3DBB
Evan Jarman VK3ANI
Bill Rice VK3ABP
Gil Sones VK3AUI

Advertising

Mrs June Fox,
Tel: (03) 9528 5962

Hamads

"Hamads" Newsletters Unlimited
29 Tanner Street, Richmond VIC 3121
Fax: (03) 9428 4242
e-mail: news1@webtime.com.au

Office

10/229 Balaclava Road
Caulfield, Victoria
Telephone (03) 9528 5962
Facsimile (03) 9523 8191

Business Hours 9:30am to 3:00pm weekdays

Postal

P.O. Box 2175
CAULFIELD JUNCTION
VICTORIA 3161
AUSTRALIA
e-mail: armag@hotkey.net.au

Production

Newsletters Unlimited (03) 9428 3458

Printer

Streamline Press, Melbourne (03) 9417 2766

Postal Service

IMS (03) 9291 5888

Production Deadlines

Advertising booking and articles for
publication 10th of proceeding month.

Hamads and advertising material deadline
18th day of proceeding month

The contents of Amateur Radio are
Copyright Wireless Institute of Australia
C 2000

Our cover this month
AX3IARU

General

Prime Minister pays tribute: Remembrance Day Contest	3
<i>Jim Linton VK3PC</i>	
The Good Old Days of Crystal Sets and Morse Code	12
<i>Bill Rice VK3ABP</i>	
Post WW2 Amateur Radio: a phenomenal social link	22
<i>Sid Ward VK2SW</i>	
An unwelcome early Christmas present In VK1	24
<i>Gilbert Hughes VK1GH</i>	
Does the VKZL Contest need a revamp?	40
<i>Tony Burt VK3TZ</i>	
He who expecteth little	47
<i>Ian Godsil VK3DID</i>	

Technical

Receive SSB on your VHF/UHF handheld	4
<i>Peter Parker VK3YE</i>	
A convertor for the 15 metre band	6
<i>Godfrey Williams VK5BGW</i>	
A Single Sideband Modulator for the LF Transmitter	10
<i>Lloyd Butler VK5BR</i>	
RF Power Meter (Technical Abstracts)	16
<i>Gil Sones VK3AUI</i>	
Close Coupled Vertical Antenna (Technical Abstracts)	17
<i>Gil Sones VK3AUI</i>	
RF Bridge (Technical Abstracts)	18
<i>Gil Sones VK3AUI</i>	
Using Cable TV Hardline (Technical Abstracts)	19
<i>Gil Sones VK3AUI</i>	

Columns

Advertisers' Index	55	Hamads	54
ALARA	26	HF Predictions	52
ARDF	38	IARU/WIA Monitoring Service	42
Awards	39	New Members	9
AMSAT	35	Over To You	50
Club News	23	Pounding Brass	48
WIA Division News		Repeater Link	46
VK1 Notes	30	Silent Key	49, 56
VK3 Notes	30	Spotlight on SWLing	27
VK6 Notes	31	Technical Abstracts	16
VK7 Notes	31	VHF/UHF - An Expanding World	443
5/8 Wave	31	WIA Comment	2
DX Notes	32	WIA Division Directory	IBC
Editor's Comment	2	WIA Federal Directory	2

Contributions to Amateur Radio

Amateur Radio is a forum for WIA members' amateur radio experiments, experiences opinions and news. Manuscripts with drawings and or photos are always welcome and will be considered for publication. Articles on disc or email are especially welcome. The WIA cannot be responsible for loss or damage to any material. A pamphlet, How to write for Amateur Radio is available from the Federal Office on receipt of a stamped self-addressed envelope.

Back Issues

Back issues are available directly from the WIA Federal Office (until stocks are exhausted, at \$4.00 each (including postage within Australia) to members.

Photostat copies

When back issues are no longer available, photocopies of articles are available to members at \$2.50 each (plus an additional \$2 for each additional issue in which the article appears).

Disclaimer

The opinions expressed in this publication do not necessarily reflect the official view of the WIA and the WIA cannot be held responsible for incorrect information published.

Amateur Radio Service

A radiocommunication service for the purpose of self-training, intercommunication and technical investigation carried out by amateurs; that is, by duly authorised persons interested in radio technique solely with a personal aim and without pecuniary interest.

Wireless Institute of Australia

The world's first and oldest
National Radio Society
Founded 1910

Representing
The Australian Amateur Radio Service

Member of the
International Amateur Radio Union

Registered Federal Office of the WIA

10/229 Balaclava Road
Caulfield North Vic 3161

Tel: (03) 9528 5962 Fax (03) 9523 8191
<http://www.wia.org.au>

All mail to
PO Box 2175 Caulfield Junction VIC 3161

Business hours: 9.30am-3pm weekdays

Acting Federal Secretary

Pater Naish VK2BPN

Federal Office staff

June Fox Bookkeeper
Rita Trebilco VK3IF Examinations Officer

Council

President	Peter Naish	VK2BPN
VK1 Federal Councillor	Glenn Dunstan	VK1XX
VK2 Federal Councillor	Michael Corbin	VK2YC
VK3 Federal Councillor	Brenda Edmonds	VK3KT
VK4 Federal Councillor	David Jones	VK4OF
VK5 Federal Councillor	David Box	VK5OV
VK6 Federal Councillor	Will McGhie	VK6UU
VK7 Federal Councillor	Phil Corby	VK7ZAX

Executive

Peter Naish	VK2BPN
John Loftus	VK4EMM

Federal Coordinators

AMSAT	Graham Ratcliff	VK5AGR
ARDF	Jack Bramham	VK3WWW
Awards	John Kelleher	VK3DP
Contests	Ian Godsil	VK3DID
Education	Brenda Edmonds	VK3KT
FTAC	John Martin	VK3KWA
Historian	John Edmonds	VK3AFU
IARU	Grant Willis	VK5ZWI
Intruder Watch	Gordon Loveday	VK4KAL
ITU Conference and study group	Gilbert Hughes	VK1GH
QSL Manager (VKS, VKO)	Neil Penfold	VK6NE
Videotapes	VK2 Division	
Web/PR	Richard Murnance	VK2SKY

ACA Liaison Team

Peter Naish	VK2BPN
Glenn Dunstan	VK1XX
Michael Corbin	VK2YC
Wally Howse	VK6KZ
Canberra Liaison Officer	
Richard Jenkins	VK1RJ

Editor's Comment

Evan Jarman VK3ANI, Acting Editor

In the dim dark ages while waiting for the department delays between my licence examination and its issuing, I attempted to improve my knowledge of radio by reading. I had just completed a book by the great J A Ratcliffe called *Earth, Sun and Radio*. It was an introduction to the ionosphere. Being a bit of a smart Alec, I wrote that I wanted to *Investigate the motor dynamo relationship between electrons in the E and F layers at transequatorial latitudes*. as the reason for getting an amateur licence. It's commonly called the fountain effect.

This obviously struck a chord with the Department: My licence was sent by return post. It was only then that I truly started to learn about the things I had read. To fiddle with radio first hand, make the mistakes, and learn from them is the greatest teaching aid going.

I also joined the WIA.

I have continued to enjoy studying the ionosphere.

Technology has advanced. I think the days of homebrew took a big hit when printed circuit boards became the accepted mode of construction. I could not see any amateur building something like the current equipment. You don't have to. The thrill of talking to someone overseas is now not as great: just pick up a telephone.

In the dim dark ages with all the delays and the requirement to build from components up, it amazes me that people like John Moyle were able to achieve so much. But he was a great man and working at a wide frontier.

Maybe frontiers are not as wide now but there are still things to be done. It is also still a lot of fun. Spectrum that was considered worthless in Moyle's day is being auctioned now for figures that only governments understand.

I am still a member of the WIA; I call it preventative band insurance, with some extra privileges. Sharing the cost of a government interface. While others are not as interested in the bands I use, compared with other bands such as UHF; I share the cost of that voice. That is a principle of insurance. I don't agree with everything the WIA does but I still support the general thrust of my theory of insurance.

I do not understand why others spend thousands on equipment and not seventy on insuring the privileges they need to use that equipment and the enjoyment it can give.



More of 70 cm under attack

"The ACA has informed the WIA of their intention to licence a fixed radio service for the WA Police Service in the greater Perth area. It is expected that this network will be operational later this year.

The portion of the band to be used is 420-430 MHz. This contains a number of amateur radio services in the Perth area including a television repeater and a number of fixed links. The 70 cms. band is allocated on a Primary basis to the Department of Defence with the amateur radio service as a Secondary user. It is likely that the Police network will be afforded Primary status and that there would be a consequential impact on our use of this portion of the band.

The ACA have invited the WIA to meet with them at an early date to consider the impact of this new network on the amateur service and to provide the opportunity for the WIA to provide input to any adjustments that may be required to the amateur radio use of these frequencies.

Clearly the WIA sees any restriction to the access which we currently enjoy in the 70 cms band as a very serious matter. There is concern that the WA Police Network may be only the first of a number of similar systems in other parts of Australia. The WIA will press the ACA for an outcome which provides an acceptable arrangement and which ensures our continued and long term usage of the 70 cm band nationally. The WIA/ACA Liaison Committee is preparing the WIA's position in readiness for the meetings with ACA in Canberra.

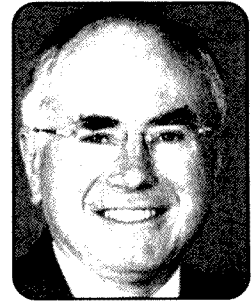
Further information will be made available as soon as possible"

Peter Naish.

Remembrance Day Contest

Prime Minister pays tribute

By Jim Linton VK3PC



In the opening address to this year's WIA Remembrance Day Contest, the Prime Minister John Howard paid tribute to the WIA members who died in World War II.

Mr. Howard, when approached by the WIA through his Canberra office, readily agreed to provide the opening speech. It was a well-researched address drawing on some historical references supplied to him by the historian of the Department of Veterans Affairs.

In his speech (a full text appears below) he mentions the RAAF Wireless Reserve that existed before War War II to which WIA members belonged, and then enlisted when war was declared providing their technical skills and experience to serve with distinction.

Mr. Howard joins former Prime Ministers, Bob Menzies who gave the opening address in 1958, Gough Whitlam in 1975, and Malcolm Fraser 1976.

Prime Minister's opening address

Fifty five years after hostilities ceased in the South West Pacific it is indeed an honour to present this address to commemorate the sacrifice of amateur radio operators who gave their lives in World War II.

When war and invasion threatened Australia between 1939 and 1945 members of the Wireless Institute of Australia offered their service and their special skills to the nation.

Before the war many had been part of the RAAF Wireless Reserve and these men moved into the wartime air force as wireless operators with the RAAF in Europe, the Middle East and the Pacific.

Twenty six names are listed on the Wireless Institute of Australia's Roll of Honour as having lost their lives to the war and 15 of these men died whilst serving with the RAAF.

Typical here were men like Flight Lieutenant Paul Paterson, who was killed while in action at Rabaul in January 1942, as the enemy struck south into New Guinea, and Flight Sergeant Russell Allen, who died in the skies over Germany in April 1944.

But it was not only the air force, which found a use for the special radio skills, fostered by the Wireless Institute. Norman Gunter was the Radio Officer on the Australian Steamship Company's SS Kowarra when, on the night of 24 April 1943, the ship was torpedoed and

sunk as she carried a cargo of sugar from Bowen to Brisbane. Gunter was one of the many who went down with the ship.

Of those military units which served in New Guinea and the islands, one that was highly regarded for its particularly hazardous and vital work behind enemy lines was 'M' Special Unit - the coastwatchers. Lieutenant David Laws was one such coastwatcher who, whilst serving in May 1943 as a radio technician, was killed when he accompanied a group observing enemy activity on the coast east of Madang.

We honour each of these men as we honour others who lost their lives to the war through their service in radio. They are part of a proud Australian military tradition, that has never sought to impose its will upon the world, but only to defend what is right - a tradition I have honoured as far way at Anzac Cove and the Somme; and as close by as with Australian troops in East Timor.

We remember, too, the service of amateur radio operators at times of natural disaster - the bushfires of Black Friday and Ash Wednesday as well as through the winds of Cyclone Tracy.

I am pleased to acknowledge your continued efforts and recognise your work throughout Australia, New Zealand and Papua New Guinea.

In this vein I declare open the Remembrance Day Contest for 2000.

Remembrance Day Contest Honor Roll of WIA members who paid the supreme sacrifice

Royal Australian Navy

J.E. Mann VK3IE A.H.G. Rippon VK6GR

Australian Military Forces

C.D. Roberts VK2JV J.D. Morris VK3DQ J. McCandlish VK3HN S.W. Jones VK3SF

D.A. Laws VK4DR J.G. Phillips VK5BW K.S. Anderson VK6KS

Royal Australian Air Force

F.W.S. Easton VK2BQ V.J.E. Jarvis VK2VJ W. Abbott VK2YK G.C. Curle VK2AJB

T. Stephens VK3GO M.D. Orr VK3OR J.F. Colthrop VK3PL J.A. Burrage VK3UW

J.E. Snadden VK3VE F.J. Starr VK4FS R. Allen VK4PR C.A. Ives VK5AF B. James VK5BL

J.E. Goddard VK6JG P.P. Paterson VK6PP

Merchant Marine

N.E. Gunter VK3NG R.P. Veall VK3PV

"They shall grow not old as we that are left grow old. Age will not weary them nor the years condemn. At the going down of the sun and in the morning, we will remember them."

ar

Receive SSB on your VHF/UHF handheld

Peter Parker VK3YE

12/8 Walnut Street, Carnegie, Vic, 3163

Email: parkerp@alphalink.com.au

The average VHF/UHF handheld transceiver no longer just receives the amateur bands. Coverage of VHF, UHF and even HF frequencies is now offered in smaller and smaller packages.

An example of trends in modern handheld amateur equipment is the Yaesu VX-5R, which was released last year. It transmits on six metres, two metres and 70 centimetres. Reception is provided on 0.5 to 16 MHz and 48 to 999 MHz. Modes available include narrow FM (as used by amateurs, police and taxis), wide FM (as used by TV and FM radio stations) and AM.

This is well and good for VHF/UHF scanning and broadcast reception, but what about HF amateur activity, most of which is CW and SSB? Is it possible to receive these signals on a standard, unmodified VX-5R? As will be demonstrated by the following experiments, the answer is yes. The performance will not cause you to throw away your HF rig or communications receiver, but it's surprisingly good, and quite adequate for casual use.

The remainder of this article describes the author's experiments with the VX-5R as an SSB receiver on several amateur bands between 3.5 and 432 MHz. No modifications are required as use is made of an outboard beat frequency oscillator (BFO) at signal frequency. The BFO recreates the carrier signal in the receiver that has been suppressed in the SSB transmitter.

Equipment needed

All that is needed for the BFO is an RF signal generator or oscillator that will generate an unmodulated carrier signal at the received frequency. If this cannot be achieved, an oscillator with an output that is a submultiple of the desired frequency will suffice.

The BFO should be housed in a solid enclosure and have an output level that can be varied. Band spread should be sufficient to make the fine adjustments

required to adequately resolve SSB signals. Examples of suitable BFOs include an RF signal generator, HF transceiver operating into a dummy load, a properly constructed home made free-running VFO or a variable oscillator made from a 3.58 MHz ceramic resonator. A dip oscillator will work in a pinch, but stability, ease of tuning and ability to control output will be poor.

Using signal frequency BFOs

Using an AM receiver with an adjustable BFO at signal frequency is slightly different to tuning a conventional receiver. The simplest analogy, understandable to those who have used older receivers, is to regard the receiver's tuning control as a preselector (or front-end peak) control and the BFO adjustment as the main tuning control. Because the critical tuning is done by the BFO, the quality of the BFO tuning mechanism greatly affects the useability of this arrangement.

To tune signals, set the rig to AM in the VFO mode. Set the frequency steps to 5 kHz. Because of the VX-5's broad AM receive bandwidth, and the fact that the final tuning is done by adjusting the BFO, signals do not have to be exactly on the VX-5's indicated frequency to be properly resolved.

It is sometimes desirable to adjust the strength of the BFO signal. Very strong signals require more BFO injection than weaker signals. On 20 metres, the best BFO level for tuning around was between two and five bars on the VX-5's S-meter. There is no need to un-mute the receiver – the signal from the BFO should be sufficient to open the squelch at all times.

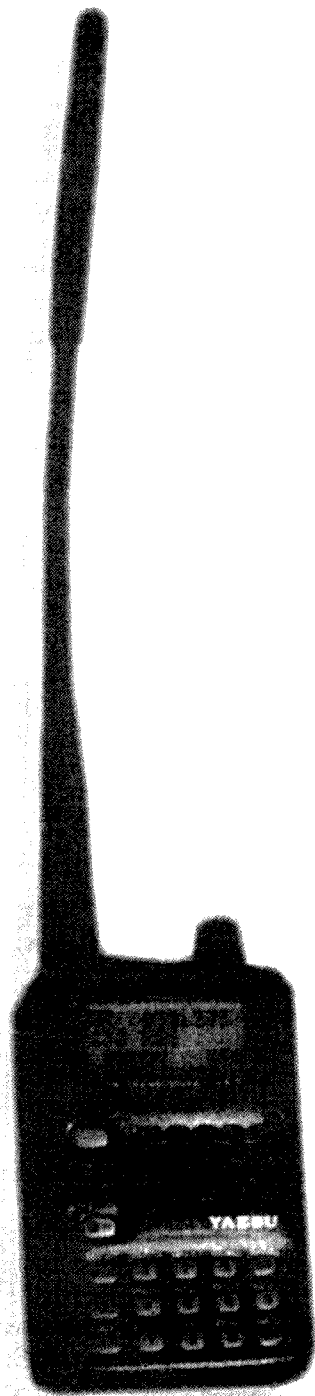


Photo 1: The Yaesu VX-5R transceiver used in the experiments.

Receiving HF SSB signals

Reception experiments were performed on 80, 40 and 20 metres. The antenna was a 3.5 MHz half-wave dipole with open wire feeders. This was connected to the VX-5's antenna socket via an antenna coupler. The first tests were with a homebrew dip oscillator (pictured in August's *Novice Notes*) as BFO. SSB and CW could be resolved, but tuning was critical. Also controlling of the oscillator's injection level meant moving the dip oscillator towards and away from the transceiver.

Using a Yaesu FT-301S transceiver (switched to transmit carrier) fed into an unshielded 50 ohm dummy load provided much better results. This was because of the easier tuning, better frequency stability and control over output level. Reception of SSB and CW signals was excellent on all three bands. Europeans and Americans stations were easily heard on 20 metres.

The main shortcoming of the system was selectivity – it was difficult to hear a weak signal within 5 kHz of a strong nearby station given the receiver's 15kHz-plus selectivity. However, in practice, even this problem was not as limiting as it sounds, especially if the set will mainly be used for local reception on 80 and 40 metres, which are less crowded than 20 metres. Outboard audio filters would also assist, particularly for CW.

Another potential problem is that like all handheld transceivers, the VX-5R is designed to be sensitive with its standard whip antenna. The need for sensitivity means a receive mixer weaker than in standard HF transceivers. However, even on 20 metres, no mixer overload problems were experienced during the experiment.

General performance of the VX-5R/BFO combination as an HF receiver was better than expected. It would certainly rival many homebrew direct conversion receivers. The system is fully adequate for the casual listener, and would even be good enough for less rigorous communications purposes. Its use in combination with a homebrew QRP CW or DSB transmitter (VFO running continuously to double as receiver BFO), would make for a low-cost ultra-small transceiver package capable of HF, VHF and UHF operation.

Receiving UHF SSB signals

The next experiment performed was to receive SSB signals on 70cm on the VX-5R. The 432.300 MHz vertical polarisation SSB net held in Melbourne each Monday (9:00pm local) was a good opportunity to test the technique.

Because the BFO must operate at signal frequency, extreme stability is required for 70cm SSB reception. It has been shown that a 100 Hz drift is sufficient to cause a significant loss of readability on a weak SSB signal. This corresponds to a stability within 0.3 parts per million on 432 MHz. The homebrew dip oscillator was clearly insufficiently stable for this experiment.

Instead it was decided to use the fifteenth harmonic of the FT-301S set to 28.8 MHz as the BFO. The HF transceiver's dummy load was placed about 20cm from the VX-5R.

A half-wave whip on the VX-5R was used as the 70cm receive antenna. The set was tuned to the desired frequency in the AM mode. The HF transceiver was keyed and the VFO adjusted until the harmonic is heard in the handheld transceiver (28.820 MHz for 432.300 MHz). Careful movement of the HF transceiver's tuning knob resulted in SSB signals becoming intelligible.

Weaker signals will require less BFO injection than stronger signals. For this reason a variable output BFO is desirable. The FT-301's Tune control performed this function effectively in the tests described – detuning caused a rapid (and easily controlled) drop in output level. Users of broadband rigs will have to be satisfied with varying the RF power control or moving the dummy load further away from the handheld.

SSB signals from local operators within 5-10km were easily heard in the receiver on the indoor whip antenna. A station approximately 25km could also be faintly heard. This signal became almost readable when the BFO signal was made stronger and the handheld taken outside (about 2-3 metres from the dummy load). Given that the station was about 5/4 when using a proper SSB transceiver and outside vertical antenna on two metres, this result is acceptable. Ease of tuning, though not as good as most experience on HF, was surprisingly good. Drift was noticeable, but only for long transmissions, where retuning

every couple of minutes was desirable. No doubt the use of more modern HF transceivers with PLL frequency synthesisers and slower VFO tuning rates will yield improvements in this area.

Tests were not conducted on two metres SSB, but it expected that the results would be better than on 70cm due to less BFO drift and easier tuning. As with HF, the technique lends itself to use with a companion DSB or CW transmitter/BFO, possibly using a VXO and multiplier chain to generate the required signal.

Conclusion

A simple technique has been described that will allow owners of handheld transceivers and scanners to receive SSB and CW signals. With a good BFO, performance is adequate for most general purpose SSB/CW listening, especially on HF. It is hoped that this method will open a new world of listening to people with modern portable receivers that mostly lack SSB capabilities. For the QRP portable operator, the system could also be adopted to form a multi-band station that is smaller and draws less power than any other combination available today.

Radio Theory Classes for Prospective Novice and Full Call Amateur Operators are currently available. These classes can lead to a nationally recognised Certificate I in Electrotechnology

Radio Theory Classes

The courses are delivered by a professional training organisation by

- Classroom participation
- Correspondence (paper based)
- Internet (on line)

Cost \$290 per person inc GST

Contact Rachel
Ph: (03) 9417 0700 Fax (03) 9417 0221
Email: rachel@silvertrain.com.au
248 Johnston St Abbotsford, Vic 3067

Radio Theory Handbook 3rd ed. by Fred Swainston is available \$60.45 inc GST



A convertor for the 15 metre band

Godfrey Williams VK5BGW
 14 Jenolan Cresc.,
 Hillbank S.A. 5112

This convertor circuit is an add on to the 20 metre upper sideband receiver I described in the April 2000 edition of Amateur Radio. It allows reception in the 15 metre band. Switching between the 15 and 20 metre bands is via two miniature relays that are energized by a simple toggle switch. A NE602 integrated circuit is employed as the mixer its internal transistor being used to form a Colpitts crystal oscillator.

Circuit operation

With both relays inactive the antenna is connected straight through to the input of the main board allowing reception in the 20 metre band. When 12 volt is applied to the convertor board via the bandswitch both relays are energized and 5 volts is applied to the NE602 device via T1 the voltage regulator. Now the antenna is connected via RL1 to the convertor board input and the output connected via RL2 to the input of the main board.

L1 and L2 plus their associated capacitors form a 50 Ohm bandpass filter accepting signals in the 15 metre band. The result is presented to pins 1 and 2 of the NE602 mixer via L3 which provides a balanced input, 21 MHz signals are then mixed with the 7 MHz oscillator the difference signal being 14 MHz which is routed via L4, C7 and RL2 to the main board. We now have a dual conversion receiver with a tunable first intermediate frequency i.e. 14 to 14.350 MHz that will relate directly to 21 to 21.350 MHz, there is no sideband inversion, upper sideband remains as upper sideband. L4 provides a balanced output for the mixer and R4 helps to reduce the noise floor on 15 metres plus normalizing the input of the main board.

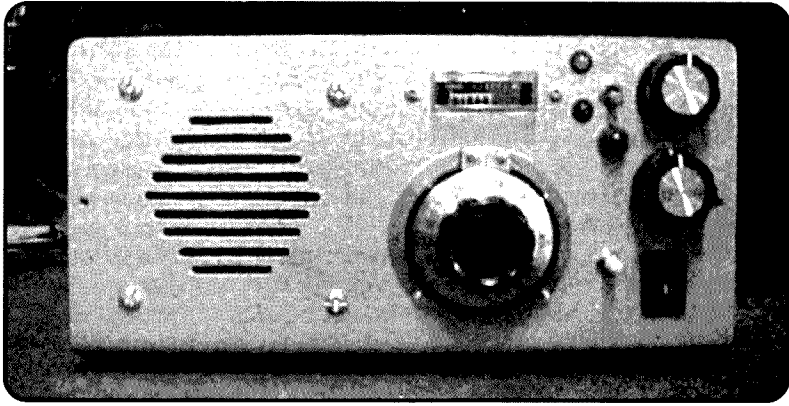


Photo 2

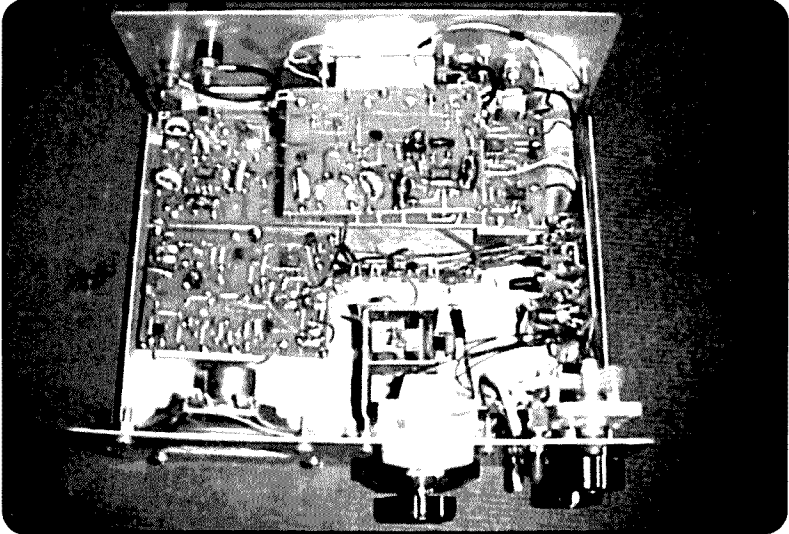


Photo 1

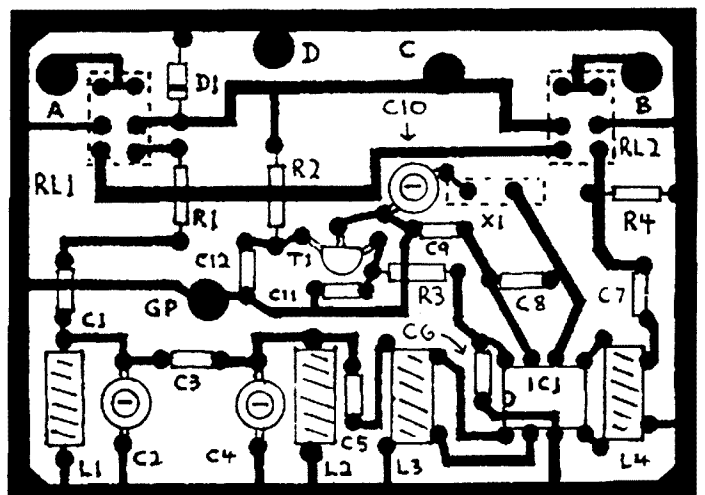
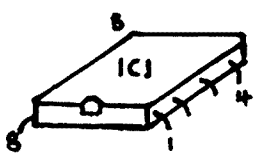
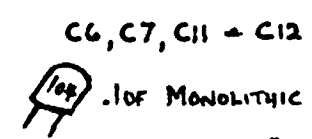
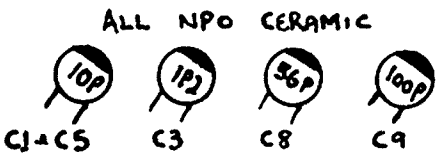
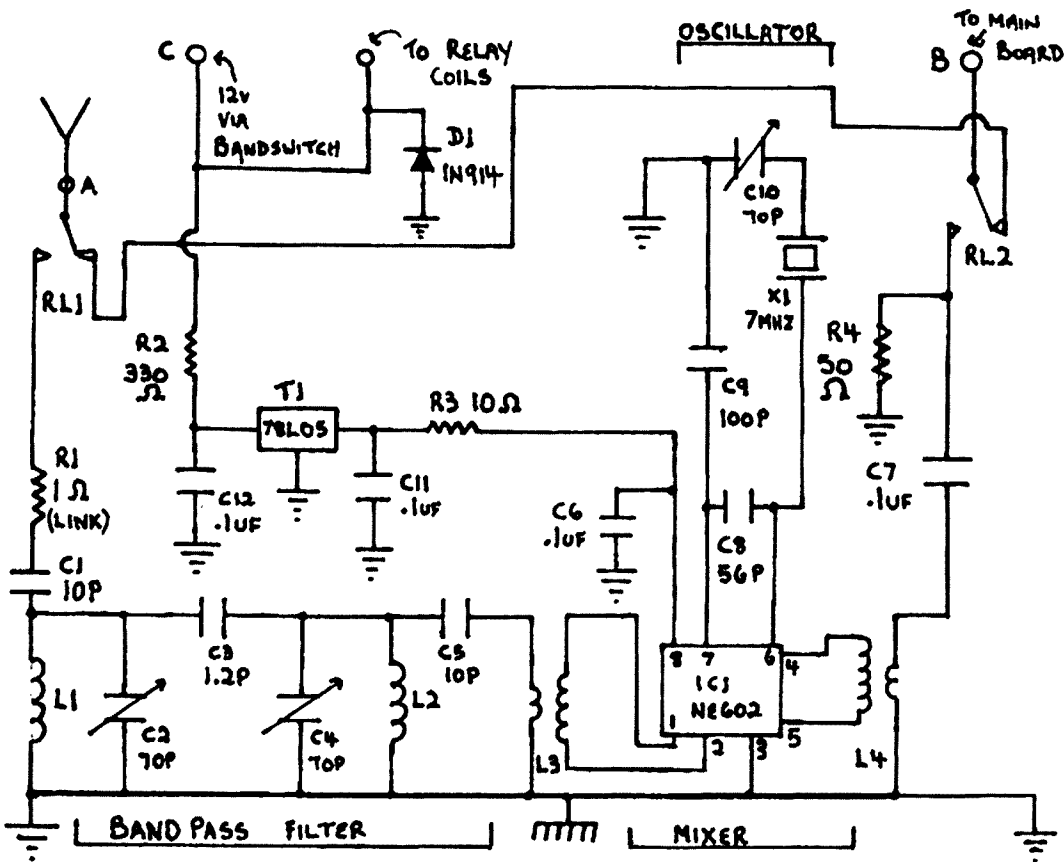
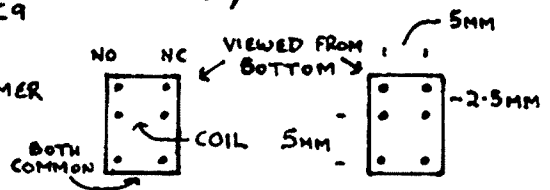


Figure 1: PC Board Actual Size

Continued on page 10



C2, C4 = C10 TOP TRIMMER



RELAY PINOUTS = CONNECTIONS TANDY 2TB-241

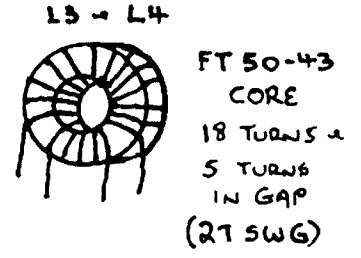
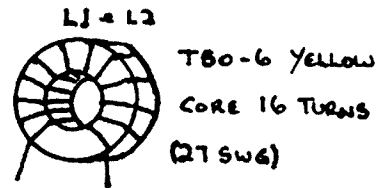
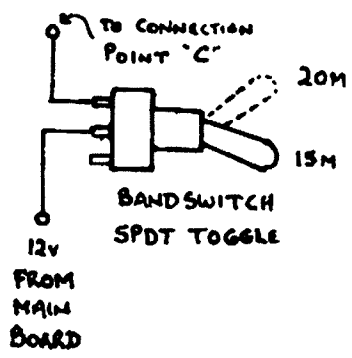


Figure 2: Circuit and components

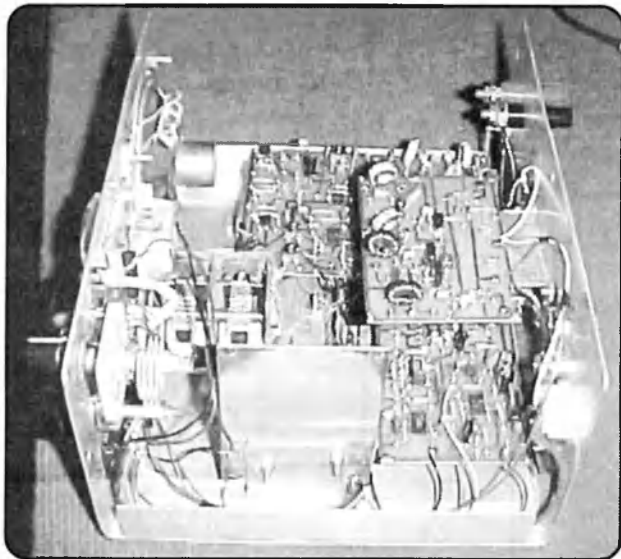


Photo 3

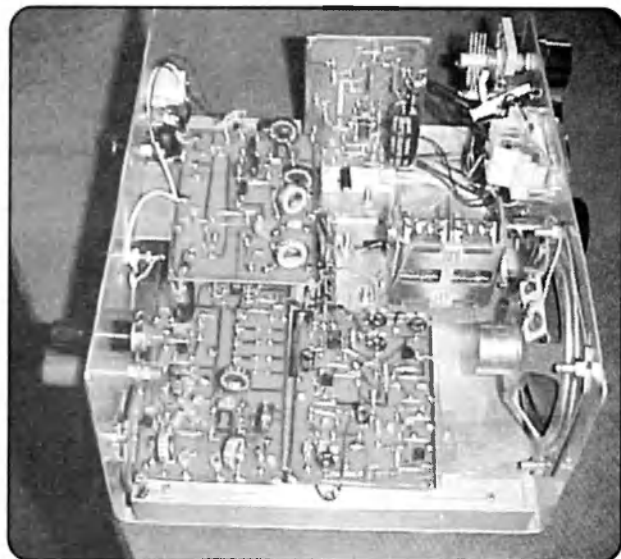


Photo 4

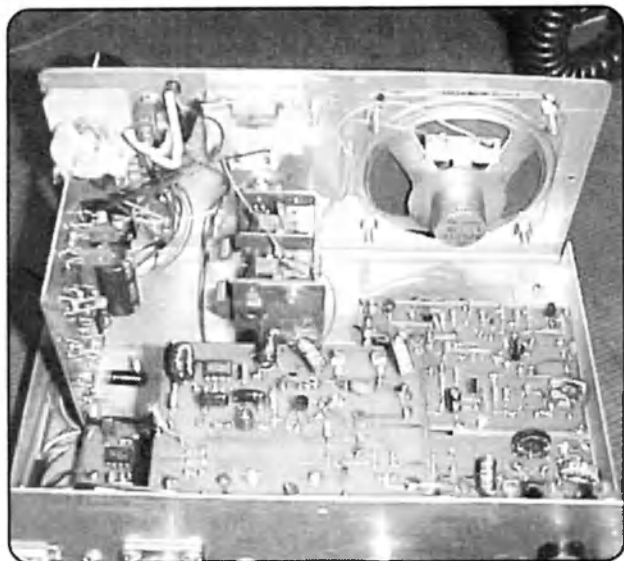


Photo 5

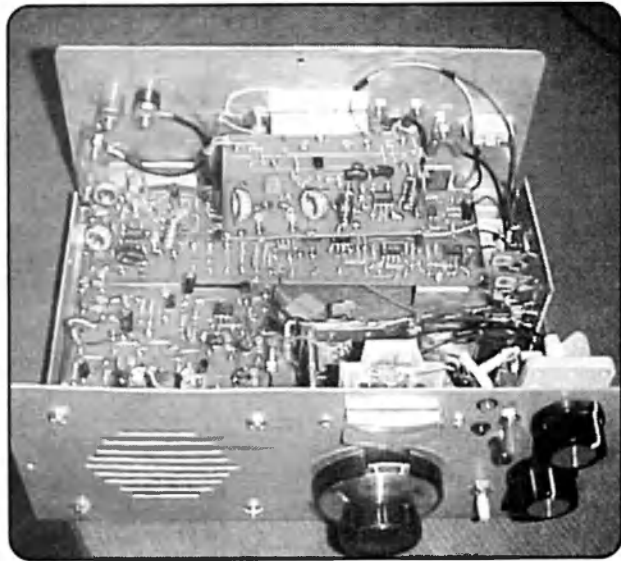


Photo 6

Continued from page 8

Construction

The printed circuit board is cut from a piece of double-sided copper clad board, one side being used as a groundplane. This side is painted so that it survives the etching process, then the trackside of the board is thoroughly cleaned and allowed to dry.

Referring to the layout shown draw the tracks and pads with a direct etch pen, later when the ink is dry the board is etched in a warm solution of ammonium persulphate. Make sure that the etching process is a complete, any fine whisker or smears of copper remaining will short out the tracks and pads. Each corner of

the board and the pad marked GP need to be drilled through to allow a connection to be soldered through to the groundplane side

The two relays and the crystal are mounted on the groundplane side of the board so holes will have to be drilled for these, remember to remove on the groundplane side the copper around these holes using a small drillbit. The remaining components are soldered onto the trackside of the board, mount the capacitors as close as practical but allow the four resistors to sit a little higher to clear any tracks underneath. R1 is used purely as a link and may be replaced with a wire link if so desired.

The four inductors are wound using

27 SWG enameled copper wire, L1/L2 using a T50-6 (yellow core) have 16 evenly spaced turns, L3 and L4 using a FT50-43 core with an 18 turn closely spaced winding and a 5 turn winding wound in the gap. L3 uses the smaller winding as its primary and L4 uses the smaller winding as its secondary (refer to the circuit diagram)

The connection pads on the convertor board are identified with an alphanumeric letter and are as follows.

- A. To the antenna.
- B. To connection point A on the main board.
- C. 12 volts via the bandswitch
- D. Ground and chassis.

Connect A on the convertor board to the antenna terminal and B to the input of the main board. Wire up the bandswitch as shown in figure 2. Give the convertor board its own chassis connection and mount the board so that there is some shielding between it and the main board.

Commissioning

Trimmer capacitor C10 is adjusted to give 7 MHz at pin 7 of IC1. With the AGC switched off trimmer capacitors C2 and C4 are adjusted for maximum band noise. The peak is easily perceived and occurs when both trimmers are approximately half meshed. In order to receive the full 450 kHz of the 15 metre band, the VFO on the main board will have to be expanded so that its range is from 6 to 6.450 MHz, so capacitor CS on the main board will have to be increased in value

Performance

The 7 MHz oscillator produces a strong carrier just under the lower band edge of 15 metres being a product of the second and third harmonics otherwise the convertor performs quite nicely, the extra gain produced by having two active mixers during 15 metre operation lifts the noise floor of the receiver hence the inclusion of resistor R4.

ar



Photo 7

New WIA Members

The WIA bids a warm welcome to the following new members who were entered into the WIA Membership Register during the month of JULY 2000

AP2MY	MR YUNUS CHAUDHRY	VK3JKA	MR R HIGGINS
L21180	MR A J JENNER	VK3JMA	MR M AITKEN
L31554	MR M ADAMS	VK3JRF	MR R FREE
VK2ATO	MR J D THORNTHWAITE	VK3TZD	MR E BENNIER
VK2DDX	MR L P Z TAA	VK3ZAI	MR A ISAACS
VK2JAC	MR G ATHANASSIOU	VK3ZBN	MR B NEVE
VK2TQP	MR W M BAKER	VK5WK	MR G R PRINCE
VK2YDH	MR D C HARDY	VK5ZAZ	MR C L PRICE
VK3JEM	MR L SNIBSON	VK6KDC	MR D CHURCH

PARTS LIST

Resistors.

- R1 1 Ohm(link)
- R2 330 Ohm.
- R3 10 Ohm.
- R4 50 Ohm.
- All quarter watt carbon.

Capacitors.

- C1 and C5 10 pf NPO ceramic.
- C3 1.2 pf NPO ceramic.
- C2,C4 and C10 70 pf trimmer capacitors.
- C8 56 pf NPO ceramic.
- C9 100 pf NPO ceramic.
- C6, C7, C11 and C12 0.1 uf monolithic capacitor.

Semiconductors

- T1 78L05 5 volt regulator
- IC1 NE 602 OR SA 602 integrated circuit
- D1 IN914 diode

Inductors. (See text and figure 2)

Misc

- 7 MHz crystal
- Toggle switch SPDT
- Two miniature 12 volt relays (Tandy part no. 275-241)
- Direct etch pen (Dick Smith part no. N5181)
- Ammonium persulphate etchant (Dick Smith part no. N5654)

Andrews
Communications Systems
(EST.1976 - ACN 001 968 752)

ALINCO

AUSTRALIA'S FIRST AUTHORISED
FACTORY DIRECT IMPORTER
MASSIVE SHIPMENTS EVERY MONTH
FULL 3-YEAR WARRANTY ON
ALINCO and ICOM
WE SELL MOST BRANDS
BALUNS, VERTICALS, YAGIS, P/S.
ICOM-KENWOOD-JRC-AOR-EMOTATOR-
MFJ-DIAMOND-TIMEWAVE-KANTRONICS
-THP - GARMIN - TERLIN - UNIDEN -ETC
DX-1600 HF LINEARS FROM \$ 3,799

**HUGE RANGE OF ELECTRONICS,
ICOM and ALINCO Radios.**

Over 22 Years of
Professional Sales and Service.
Instant Repairs Fridays
HF Transceivers & Linears Wanted

(02) 9636 9060 or (02)
9688 4101

SHOP 8, 41 BATHURST ST, GREYSTANES.
N.S.W. 2145. FAX (02) 9688 1995

A Single Sideband Modulator for the LF Transmitter

(The Phasing System of SSB revisited)

Lloyd Butler VK5BR

The February, 2000 issue of *Amateur Radio* included my article on *An Experimental Low Frequency Transmitter* (ref. 1). The article was published in anticipation of the approval of a new amateur band in the LF region. At the time of preparing this article which follows, approval was still being sought. There was also the question that if such a band was approved, would it allow some mode of speech transmission?

In anticipation of a need for speech operation, I decided I would design a speech modulator for the already built LF transmitter. With the limited band space available in a band in this part of the radio spectrum, a single sideband (SSB) system seemed preferable to the wider bandwidth AM system. So this is what I have built and what I am about to describe.

The simplest way to produce SSB for the LF transmitter might have been to heterodyne down the RF output of the amateur station HF transceiver. However this might have put some limitations on the utility of the LF equipment for use at a unique site away from the amateur

station and I decided to build a stand alone modulator which could connect into the LF transmitter.

These days, most SSB transmitters use the filter method where double sideband is produced with carrier balanced out and one sideband rejected by feeding the other through a steep skirted bandpass filter. The filter is fixed in frequency and frequency transmitted is derived by a heterodyne process. The filter is normally centred in the HF region and the usual amateur method to make such a filter is to use a ladder network with quartz crystals of the same frequency. For application with the LF transmitter, the fixed frequency SSB signal, could be

heterodyned down to the required low frequency.

An alternative method of producing a single sideband is the phasing system. For this system, there are two modulators which balance out the carrier signal fed to them. The carrier to one is fed 90 degrees out of phase to the other. Audio signal generated by speech is fed to both modulators, the signal fed to one being 90 degrees out of phase with the other over the whole speech frequency range. Balancing out of one sideband using this system can be illustrated with the aid of vector diagrams. A description making use of these diagrams, as given in the RSGB

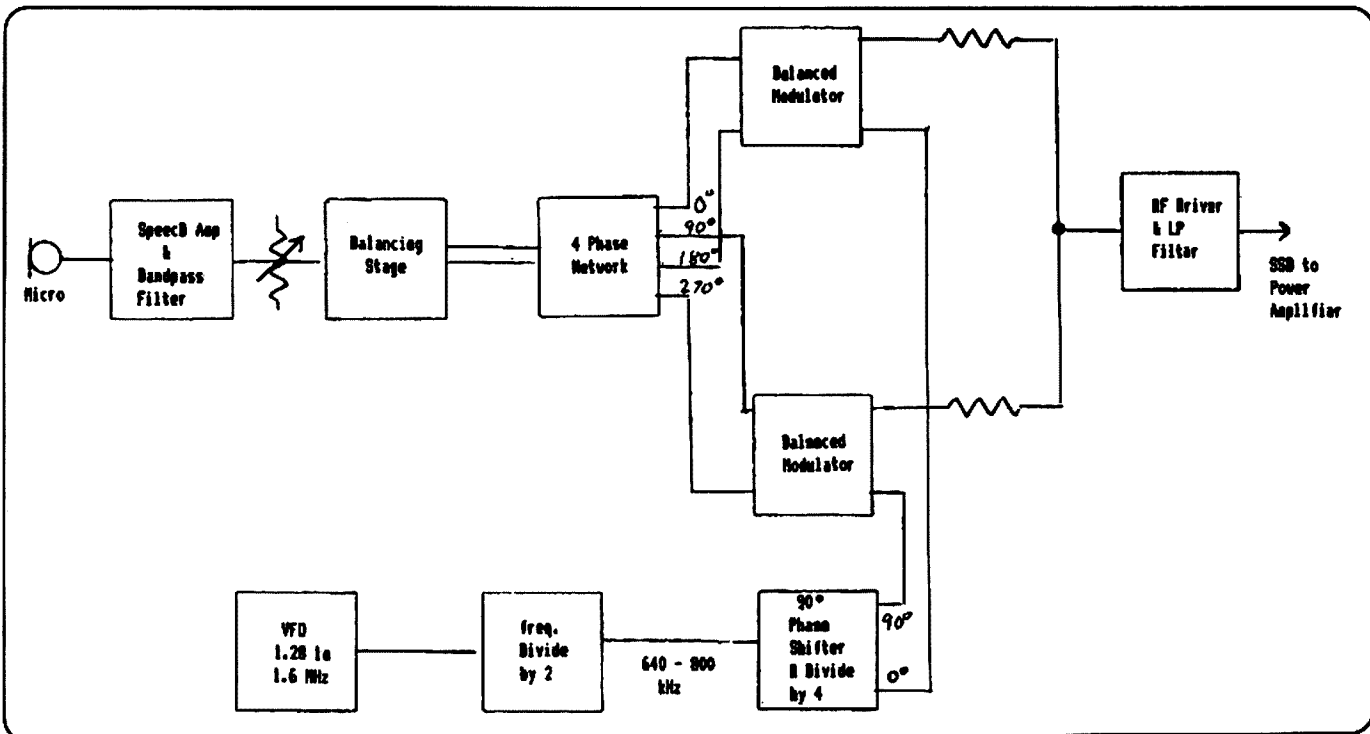


Figure 1: Single Sideband Modulator — Schematic

Radio Communication Handbook, is included in an appendix at the end of this article.

One feature of the phasing system is that it can be made to operate over a wide range of frequencies without any tuned circuits, selective frequency circuits or heterodyning. For the LF transmitter, this system provided some attraction as the whole process could be done at the LF baseband and cover the whole transmitter frequency range of 160 to 200 kHz without any selective frequency elements.

It seems that the phasing system might have lost favour because of difficulties in making a satisfactory audio phase shift network. Whilst a 90 degrees phase shift can easily be achieved at a single radio frequency, it is somewhat more difficult to maintain a constant 90 degrees phase shift over the whole speech frequency spectrum. Some networks used for the audio phase shift have required high precision components and this has discouraged

assembly by radio amateurs. Because of this, my first job was try out an audio phase shift network. As it turned out, this proved to be no problem. Furthermore, I had previously experimented with crystal ladder filters as used in the filter type system (Ref. 2) and my conclusion was that it was simpler to get operating the audio phase shift network in the phasing type system than the ladder filter in the filter type system. Also because of the quartz crystals, the component cost of the ladder filter was greater. With this in mind and with consideration of the advantages discussed in the previous paragraph, I decided to build the modulator around the phasing system and the arrangement figure 1 evolved.

The Audio Phase Shift Network

The circuit of the audio phase shift network used is shown in figure 2. This is a design published in issues of both the ARRL Handbook and the RSGB

Radio Communication Handbook and is referred to as the *polyphase network* by RSGB. Acknowledgement of design is given to M.J.Gingell by RSGB and HA5WH by ARRL. It requires 24 resistors of the same value and 6 different value groups of capacitors, each capacitor in its group the same. This is a lot of resistors and capacitors but according to the documentation, ordinary 10% tolerance components can be used to achieve constant phase shift over the speech range of 300 to 3000 hertz, with a performance of 60 dB of opposite sideband attenuation.

The network is fed from a low impedance balanced source and gives a four phase output of 0, 90, 180, & 270 degrees. From this, two outputs, 90 degrees apart, can be either balanced or unbalanced.

Despite the large number of components, it didn't take me long to assemble them on a piece of matrix board just as they are laid out in the circuit diagram. I put in a matrix pin for

Continued on page 15

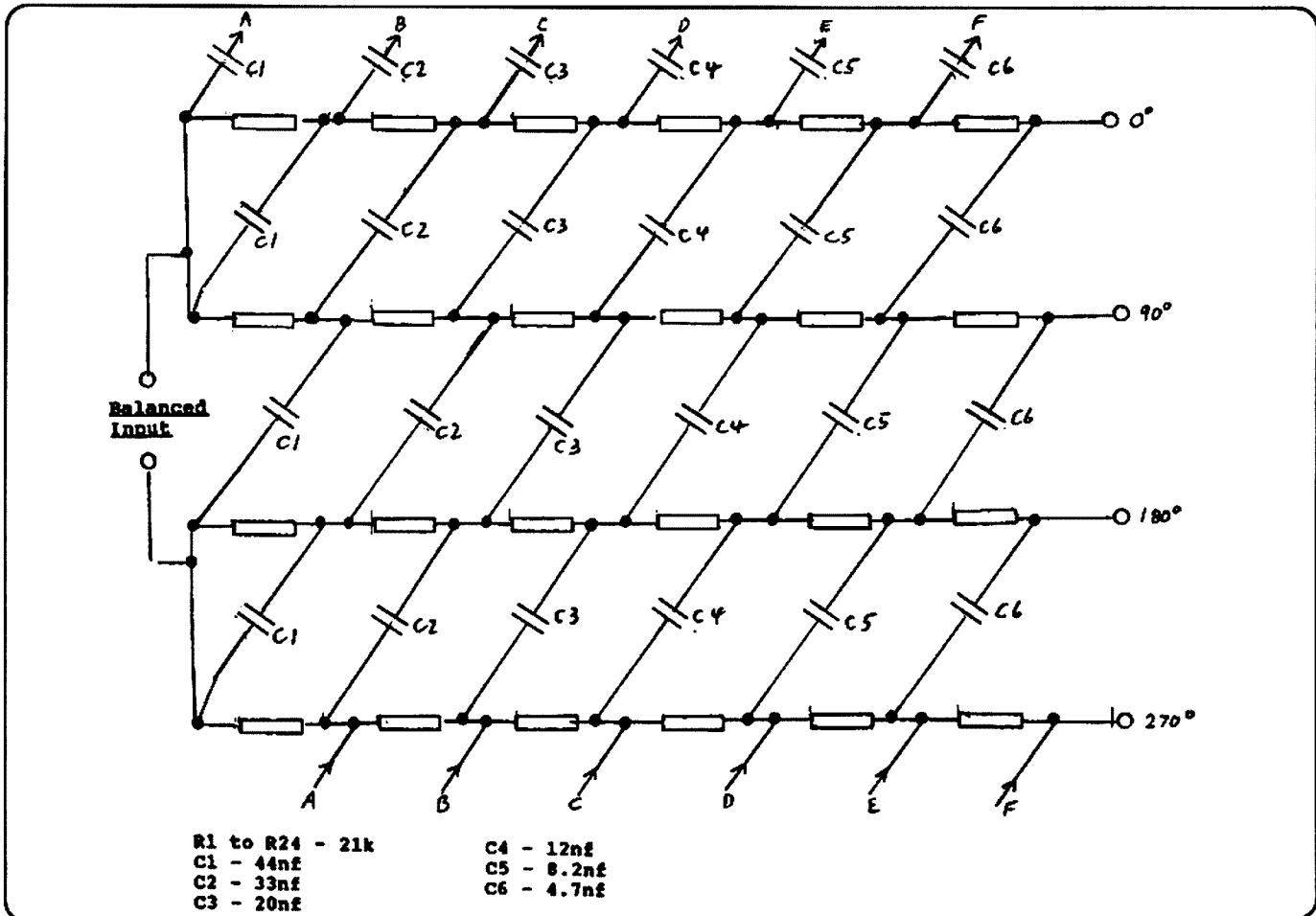
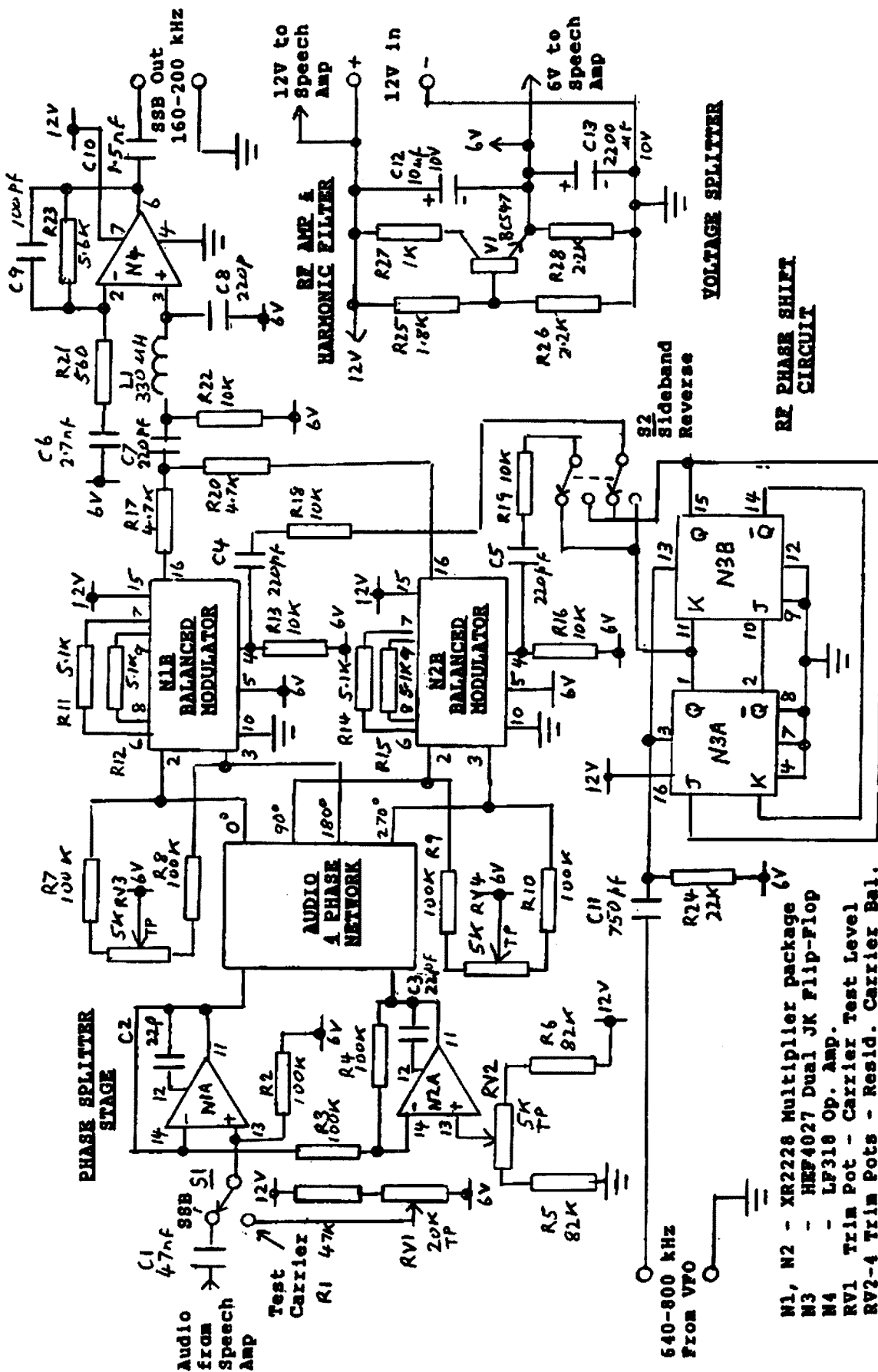


Figure 2: Audio Polyphase (4 Phase) Network



- N1, N2 - XR2228 Multiplier package
- N3 - HEF4027 Dual JK Flip-Flop
- N4 - LF318 Op. Amp.
- RV1 Trim Pot - Carrier Test Level
- RV2-4 Trim Pots - Resid. Carrier Bal.

Figure 3: Single Sideband Modulator, General Circuit Diagram

Continued from page 13

each component junction and soldered the components in. Checking it out over the speech frequency range is simple. An audio oscillator is fed to the input via a balancing transformer. The outputs are checked for correct phasing and equal amplitude using any two of the outputs fed to the two Y inputs of a dual trace CRO. Phasing can be carefully scaled using the CRO graticule. For a single trace, one output can be fed to the X amplifier and the other to the Y amplifier to form a vector trace.

As far as I was concerned, I just wired the right value components in and it all just worked like a charm. So the audio phase shift network was no real problem.

The Single Sideband System

A Block diagram of the single sideband system is shown in figure 1. Circuit detail is shown in figure 3. The main elements of the system are a speech amplifier, the audio phase shift network with balanced driver circuit (N1A,N2A), two balanced modulator stages (N1B & N2B), an RF carrier phase shift circuit (N3) and an output RF driver stage incorporating a lowpass filter (N4).

A number of different well known integrated circuit packages such as the MC1496, NE602 and the SL1640 could have been used as balanced modulators. However I happened to have a number of XR2228 Monolithic Multiplier packages and two of these (N1 & N2) are used for these functions. These devices have balanced X and Y input circuits, a balanced output and a circuit arrangement which looked ideal for a balanced modulator. They can also handle frequencies up to around 3 MHz well above our LF range.

The XR2228 packages also include an operational amplifier each (N1A & N1B) and the pair of these are used to form a balanced low impedance driver for the audio phase network. The amplifier outputs are directly coupled through the network to the X inputs of the balanced modulator sections of the packages (N1B & N2B). Precise DC balance of the complete circuit (necessary to set for best carrier rejection) is set by trimpot RV2. In retrospect, my thoughts are that it might have been better to use a separate op amp package for the driver as the arrangement resulted in the

concentration of a lot of components around the two XR2228 units.

Concerning residual carrier balance, a later addition was the inclusion of trimpots RV3 and RV4 which allow individual adjustment balance of the two balanced modulators and further improvement in the rejection of residual carrier.

A 90 degree phase shift for one of the RF carriers can easily be achieved with simple reactive circuits but this system is somewhat confined to a single frequency. Instead, a circuit using two type D or JK flip-flops can provide two outputs 90 degrees apart for any frequency the flip-flops can handle. For this function, LOCMOS dual JK flip-flop type HEF4027 (N3) has been used. One characteristic of the circuit is that it requires a drive frequency four times the carrier frequency so that for the 160 to 200 kHz transmitter, we need 640 to 800 kHz drive from the VFO. Change between upper and lower sideband is simply achieved by reversing the output leads from N3 which feed the two balanced modulators. Switch S2 is provided for this purpose.

The outputs from the two balanced modulators are combined at the junction of R17 and R20. The single sideband output is insufficient to drive the input of the transmitter and amplifier N4 raises the output level by a factor of 10. The output from the modulators contains higher order frequency components and L1-C8 and R23 -C9 provide a frequency roll-off above 200 kHz to attenuate these components. This is the only frequency dependent section of the SSB system, limiting operation much above 200 kHz. Higher order frequency components are further attenuated in the low-pass filter at the output of the transmitter.

As a matter of interest I did carry out some limited tests to see how high a frequency the system could be made to work. (Of course not including the output filters just discussed). I found I could generate single sideband at frequencies as high as 3.5 MHz, limited probably by the characteristics of the XR2228 packages. I suspect the modulators could be made to go higher using packages such as the NE602. Further to that, higher frequencies could be achieved by heterodyning.

The circuit can be switched from SSB to constant carrier for testing or for CW mode by operating switch S1. It achieves

this by unbalancing the modulators to allow carrier to get through. The level of carrier is determined by the degree of unbalance set by trim-pot RV1. The switch also disconnects the speech amplifier so that modulation cannot take place. Whilst I haven't allowed for it in the switching, it is only a matter of shorting out this part of the switch to allow the speech signal to reach the modulators with the carrier on and we generate amplitude modulation.

The Speech Amplifier

The speech amplifier is shown in figure 4. It uses two amplifier stages to raise the speech level from the microphone sufficient to drive the input of N1A in figure 3. Its overall voltage gain is close to 2000. The output level is set by potentiometer RV5 which is mounted as a front panel control of the modulation level. Input sensitivity is suitable for a typical dynamic microphone.

The amplifier also includes second order components to achieve a frequency roll off below 300 Hz and above 3000 Hz. This inclusion of some attenuation outside the normal speech range seemed desirable as the audio phase shift network is designed for constant phase difference between its outputs only over the 300 to 3000 Hz range. If any speech components outside this frequency range pass through the network, the phase relationships could be different which could cause generation of opposite sideband.

A popular choice of an amplifier package for the speech amp would have been the uA747 dual op amp. However I have accumulated a multitude of type LM349M which have four amplifiers in the one package. The only reason I instead selected the LM349 for this circuit is that I thought I had better start making some use of these.

The input connection for a microphone is a tip/ring/sleeve stereo type socket which is my standard for microphones in my shack. The tip is wired to a terminal outlet for use as Push-to-talk (PTT) if required later for receive/transmit control.

Power Rails

The modulator circuitry (figure 3) and the speech amplifier circuitry (figure 4) are operated from 12v derived in the transmitter unit and initially provided just for the VFO. A further rail of 6V is

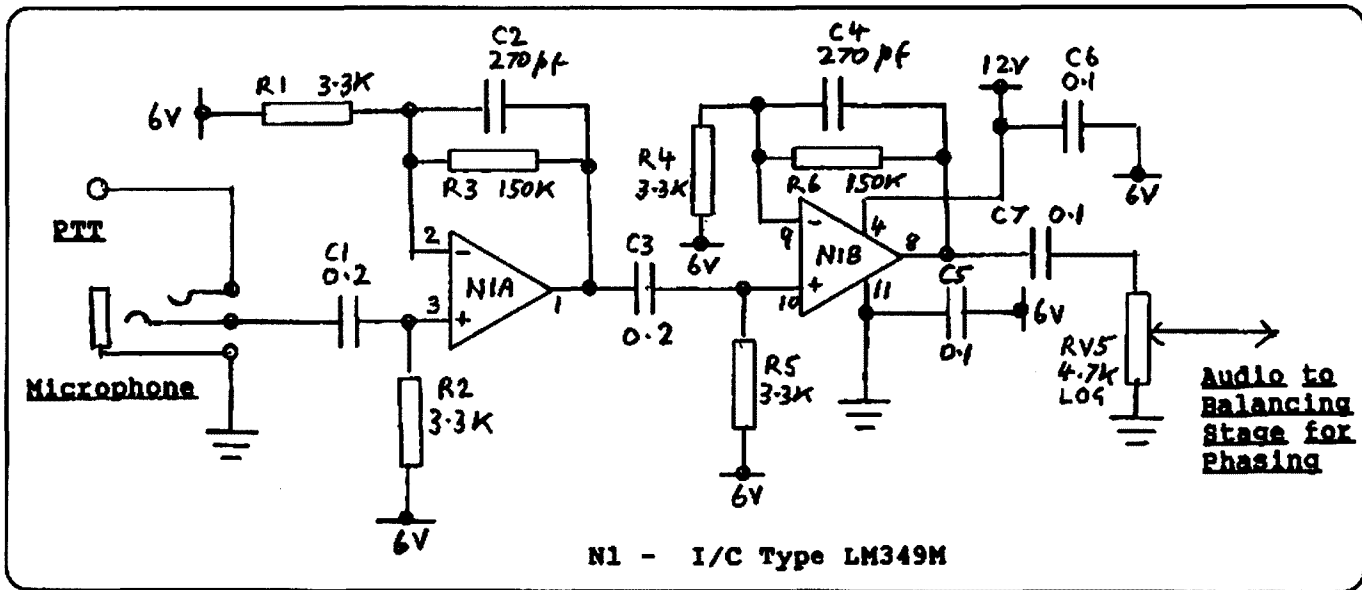


Figure 4: Speech Amplifier

derived by V1 circuit in figure 3 to provide a centre voltage which sets the operating points in the various circuits.

The Variable Frequency Oscillator (VFO)

The VFO is described in my previous article on the transmitter. It initially operated at 10 times the transmitted Low Frequency but this was later changed to 8 times. Some time had elapsed between when the transmitter was built and when I decided write about it in AR. I had forgotten about the change and wrote it up in the article as 10 times.

However if one carefully examines the divider circuit following the VFO, as published, it is clearly a divide by 8 circuit. My apologies for that error.

Because the RF phase shift circuit in the sideband unit uses an RF drive signal 4 times the suppressed carrier frequency, an output from the VFO is now required at only half the VFO frequency. The original HEF4017 counter was replaced with a HEF4024 counter which was connected to give two outputs, one divide by 2 and the other divide by 8, the latter of which was fed through the existing sine shaping filter. The circuit detail is shown in figure 5. If the new

SSB unit is used, the divide by 2 output is connected into RF phase shift flip-flop circuitry input in the modulator. If it is desired to operate the transmitter in its original CW mode and discard the modulator unit, the divide by 8 sine wave output at 160 to 200 kHz can be directly wired to the transmitter power amplifier input.

Alternatively, to operate CW when the modulator is left connected in circuit, switch S1 (figure 3) is operated to generate the 160 to 200 kHz signal fed to the transmitter via the unbalanced modulators.

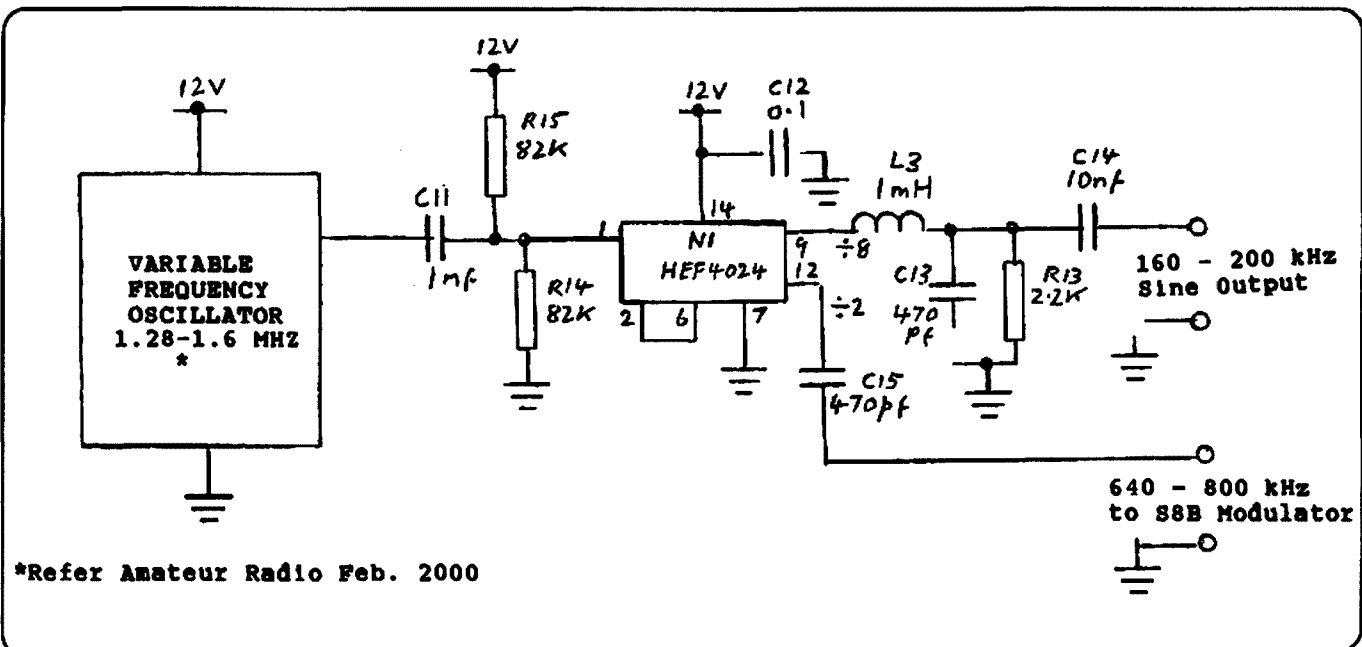


Figure 5: VFO Divider Circuit

Hardware

The integrated circuit packages and associated resistors and capacitors are hard wired on matrix board. The unit is mounted in a small metal box with control switches, potentiometer RV5 and the microphone jack, all on the front panel. It is a stand-alone unit so that the transmitter amplifier and VFO can be used with it or without it. This way, the transmitter can be used on its own for its intended earlier purpose as a keyed CW beacon for transmission tests at a suitable site. As a stand-alone unit, the modulator can also be used on any other LF transmitter we might desire to put to air.

A connector strip at the rear of the metal box provides for connection of *RF in* from the VFO, *SSB out* to the transmitter amplifier and *12 Volt supply*.

Integrated circuit packages used in this project were selected on the basis of them being on hand at the time and may not be readily available from local sources. However there is nothing critical about their selection and if anyone wishes to duplicate the circuitry, there are plenty of alternative packages. For example any general purpose op amp package such as the twin uA747 could be used for the speech amp and following balancing stages. As mentioned before, packages such as the NE602 or MC1460 could be used for the balanced modulator stages. For RF amp V4, a substitute op amp should have a high open circuit gain at 200 kHz. In the case of the digital packages, (the counter and the twin JK flip-flop), CMOS logic was chosen for operation on the 12V rail.

Performance

Peak power output level in the transmitter power amplifier can be achieved with a signal from the output of the modulator of around 6VPP. For this level, an audio level of around 6VPP is required at the input of amplifier N1A (figure 3) and the signal level from the microphone must be not less than 2 mVpp.

With careful adjustment of RV2, RV3 and RV4, the residual carrier level at the output of the transmitter can be set as low as 60 dB below maximum power output.

Optimum settings of these controls are slightly different for the upper or lower sideband. However, I imagine that if a band is approved, we would settle on a standard for which sideband is used and I don't expect there would be a need for

regular on air changing between the sidebands.

I haven't any test figures for opposite sideband rejection. To measure this accurately, one needs a calibrated spectrum analyser which was not available for my tests.

Of course, there are no on air test results as these will depend on approval to transmit or approval of an LF amateur band.

Summary

A Single Sideband Modulator for the Low Frequency (LF) region has been described. The unit was constructed to operate in conjunction with the LF Transmitter previously documented by the writer and published in the February 2000 issue of *Amateur Radio*.

However as a stand-alone unit, it could well be used with any other LF transmitter.

The single sideband system uses the phasing system of balancing out the opposite sideband. The need for precision components in the audio phase shift network in this system is often emphasised as a problem for home constructors. However the writer found that by using the *polyphase network*, it seemed a lesser task than making operational the crystal ladder filter often used in the filter single sideband system.

A feature of the phasing system is that it does not need tuning or frequency dependent circuits in its generation. The only frequency dependent element in this unit is a low pass filter set to cut off higher order components of frequency above the LF band of operation..

References

1. Lloyd Butler VK5BR - *An Experimental Low Frequency (LF) band Transmitter* - *Amateur Radio*, Feb. 2000.2.
Lloyd Butler VK5BR - *The Ladder Filter Revived* - *Amateur Radio*, March 1990.

3. *Radio Communication Handbook (RSGB)*, Sixth Edition, Chapter 7 - HF Transmitters and Transceivers.
4. *ARRL Handbook for the Radio Amateur*, 1989 Edition, Chapter 18 - Voice Communications.

APPENDIX

Explanation of Phasing Method of SSB Generation with Vectors

(From *RSGB Radio Communications Handbook*)

For this explanation, reference is made to figure A1. Diagrams (a) show two carriers A and B of the same frequency and phase, one of which is modulated in a balanced modulator by an audio tone to produce contra-rotating sidebands A1 and A2, and the other modulated by a 90 degrees phase shifted version of the same audio tone. This produces sidebands B1 and B2 which have a 90 degree phase relationship with their A counterparts. The carrier vector is shown dotted since the carrier is absent from the output of the balanced modulators. Figure A1(b) shows the vector relationship if the carrier B is shifted in phase by 90 degrees and figure A1(c) shows the addition of these two signals. It is evident that sidebands A2 and B2 are in anti-phase and therefore cancel whereas A1 and B1 are in phase and additive. The result is that single sideband is produced by this process.

ar

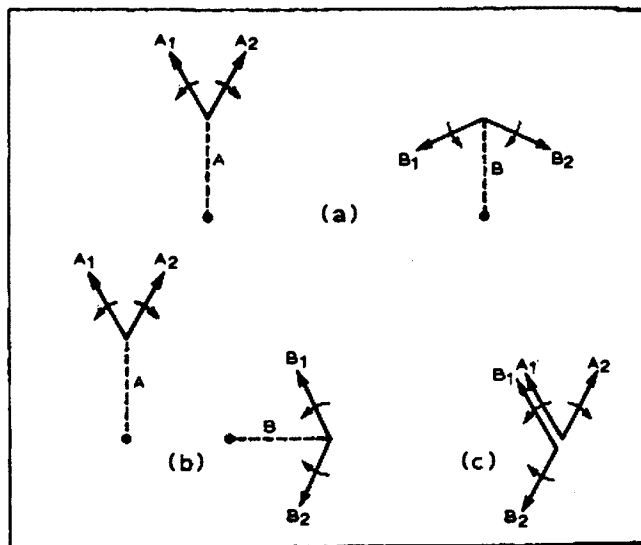


Figure A1: Phasing System Vectors (From *RSGB Radio Communication Handbook*)

Gil Sones VK3AUI

30 Moore Street, Box Hill South Vic 3128

RF Power Meter

A simple and easy to calibrate RF power meter was described in Rad Com Jan 2000 and Feb 2000 issues. The meter was titled the Crawley Power Meter. The authors were Derek Atter G3GRO and Stewart Bryant G3YSX. The meter uses a power substitution technique with a small wire ended light bulb as the measuring element. An accuracy of 1 dB over a power range of 125 microwatts to 150 milliwatts was obtained. The frequency range was within 1 dB up to 280 MHz.

The bulb used was a 6 Volt 55 mA wire ended bulb obtained from RS Components Cat No 587-068. These should be available locally. The basic circuit is shown in Fig 1. The circuit keeps the bulb at a constant resistance

of 100 Ohms by varying the amount of DC current passed through the bulb to keep its resistance constant when RF power is dissipated in the bulb. The bridge circuit varies the DC current through the bulb so as to keep it at a constant resistance. The bulb is a non linear resistance element whose resistance varies with the amount of power being dissipated. More power increases the resistance and less power lowers the resistance. The bridge circuit varies the DC current to hold the bulb at a constant resistance. The RF power is represented by the variation in the DC power.

The RF power is given by the equation:

$$P_{rf} = 10 V \Delta V \text{ mW}$$

is around the RF input and the bulb and 100 Ohm resistor and associated coupling and bypass capacitors. The wiring should be short and direct in order to achieve a high upper frequency measuring limit. All the presets are 10 turn pots to allow easy adjustment and calibration. RV1 is the zero set and should be on the panel. RV2 and RV3 can be set with the aid of a digital multimeter. The resistors used are all 0.6W 1% types. The capacitors with the exception of the 1 microfarad electrolytic are all disc ceramic.

Calibration requires the use of a digital multimeter and a calculator to set RV2 and RV3. The scaling equation is :

$$\frac{RA}{RA + RB} = \frac{10 * V * VM}{Prf}$$

Where RA is the resistance at the input to the DVM module - dominated by RV2 and RV3.

RA + RB is the resistance of RV2 and RV3 in series.

V is the voltage in Volts across the RF head when no power is applied.

VM is the DVM module voltage in Volts when Prf is applied.

Usually 200 mV.

Prf is the power in mW for full scale.

200 mW or 20 mW in this case. All the values can be measured and set with a digital multimeter.

If you are using an internal and an external head you should select and match the bulbs. Use a jig and match for the bias voltage across the bulbs with no RF applied. You should be able to obtain sufficient as the pack size is 10 bulbs from the supplier.

If you want to measure higher powers then an attenuator can be used to increase the power which can be measured. A 30 dB power attenuator would give a 150 watt range.

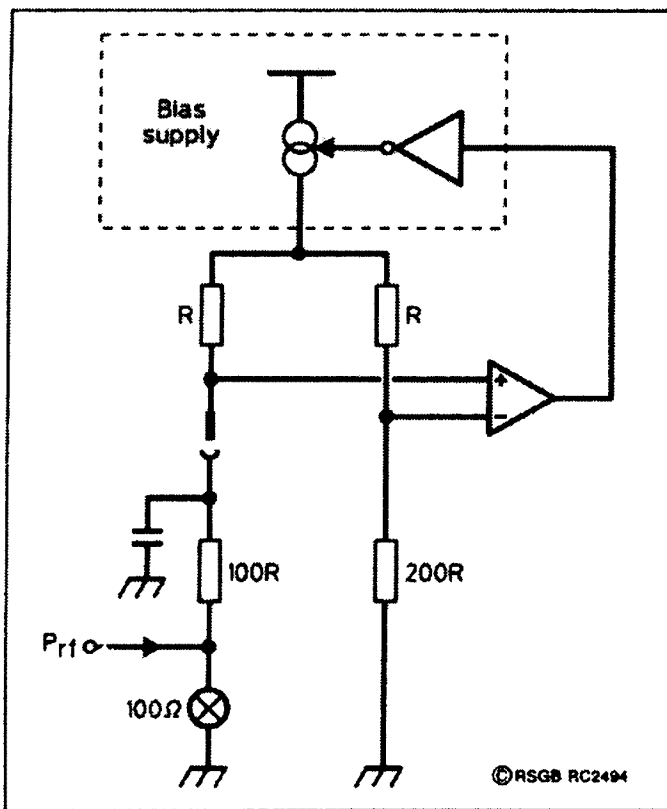


Fig 1. RF Sense Head with Bridge Controlled DC Bias.

where P is the RF input power in mW.

V is the voltage across the RF sense head bulb and 100 Ohm resistor.

ΔV is the is the difference between the voltage across the head with and without RF power.

The power meter circuit is shown in Fig 2. A digital voltmeter module is used as the power indicator. The voltmeter module requires a separate floating supply from the rest of the instrument. Both an internal RF power head and an external power head are provided for. The only critical wiring

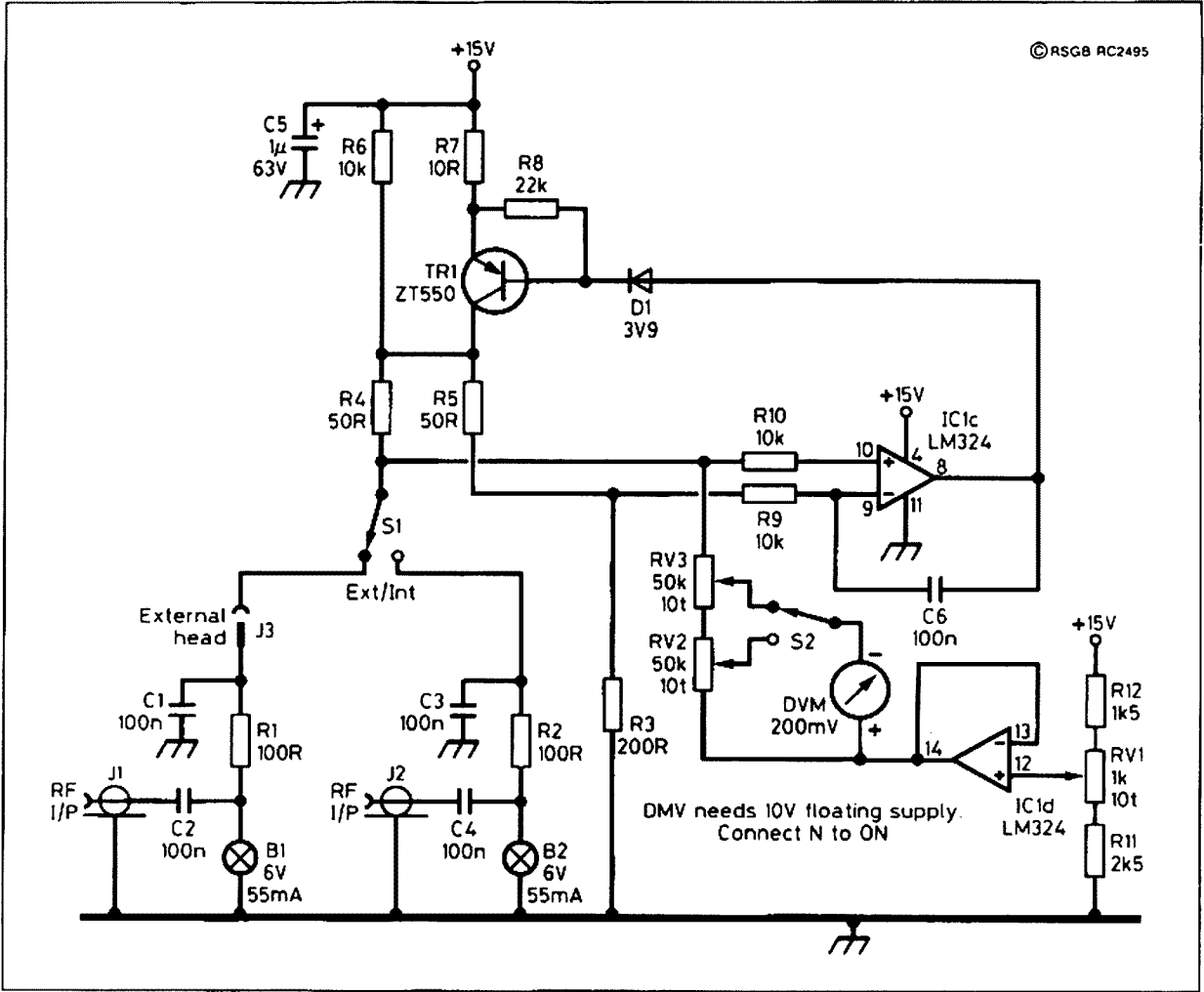


Fig 2. RF Power Meter.

Close Coupled Vertical Antenna

An interesting multiband vertical antenna consisting of a vertical monopole with one or more earthed close spaced parasitic elements was described in the Eurotek column of Erwin David G4LQI in Rad Com January 2000. The antenna is the work of Peter Bertram DJ2ZS and was originally published in CQ DL October 1999. The designs were obtained from an antenna optimisation program using a genetic algorithm. The antenna can be called an Open Sleeve Vertical or a Close Coupled Resonator Antenna.

The antennas are modelled over a perfectly reflecting earth plane and this would mean many radials or wire mesh on top of the ground in practice. They are computer models and so some variation can occur due to practical physical differences. The longest element is fed although this is not mandatory. All elements are 16 mm diameter.

The basic layout of a three band antenna is shown in Fig 3. In the data the feedpoint is the origin of the coordinate system as shown in Fig 4. The spacing of elements is given from the fed monopole. The data does not give the SWR on each

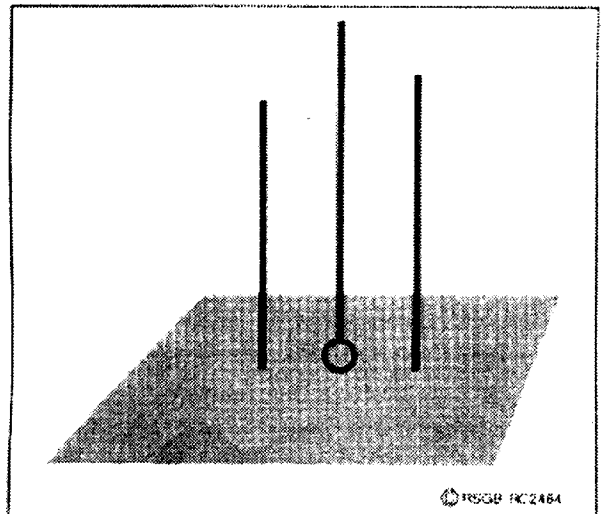


Fig 3. Basic Three Band Open Sleeve or Close Coupled Monopole

frequency but gives the sum of the SWR for the antenna frequencies. Thus a two band model will have a best SWR sum of 2 and a three band model will have a best SWR sum of 3.

Some two band dimensions are shown in Table 1. Three band models are shown in Table 2.

The optimisation program Pascal source code is obtainable from Peter Bertram DJ2ZS, Wittlicher Strasse 30, D-54538 Hontheim. E-mail : dj2zs@t-online.de .

Table 1. Two Band Combinations

MHz	Z	Z	X	Sum SWR
	0	1	1	
24.9 28.1	3.02	2.4	0.15	2.59
21.1 24.9	3.52	2.82	0.26	2.98
18.1 21.1	4.01	3.22	0.38	2.46
14.1 18.1	5.34	3.93	0.23	2.94
10.1 14.1	7.46	5.08	0.27	2.95

Table 2. Three Band Combinations

MHz	Z	Z	Z	X	X	Sum SWR
	0	1	2	1	2	
18.1 24.9 28.1	3.67	2.72	2.52	0.54	-0.24	4.23
14.1 21.1 28.1	5.53	3.32	2.54	0.37	-0.36	4.47
10.1 18.1 24.9	7.37	3.95	2.91	0.25	-0.28	4.09

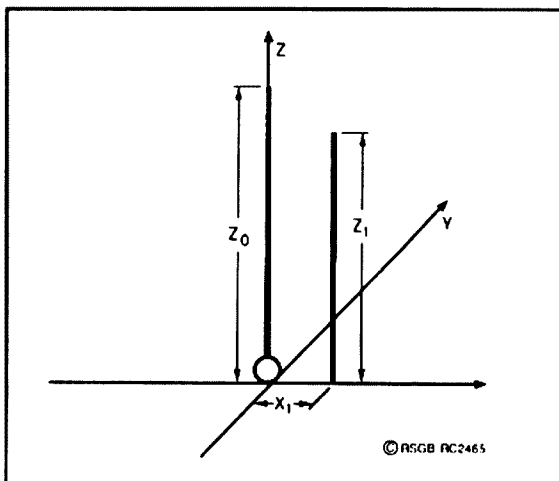


Fig 4. Two Band System with coordinate system.

RF Bridge

A simple resistive bridge appeared in OZ February 2000. The author was Flemming Hessel OZ8XW. The bridge uses Surface Mount resistors to minimise lead lengths and the construction is on a double sided PCB board with tracks acting as microstrip transmission lines. This helps with the extended frequency response as the

effect of lead lengths and discontinuities is minimised.

The circuit is shown in Fig 5. The connection to the unknown is at the junction of C1 and R3 as shown in Fig 7. The 50 Ohm resistors are obtained by paralleling 100 Ohm resistors. This may be easier than obtaining 50 Ohm

components. The PCB is shown in Fig 6. The tracks should be suitable width for 50 Ohm microstrip. The parts layout is shown in Fig 7.

You can drive the bridge with an oscillator or from a transceiver with a suitable output attenuator to give 50 - 200 mW to drive the bridge.

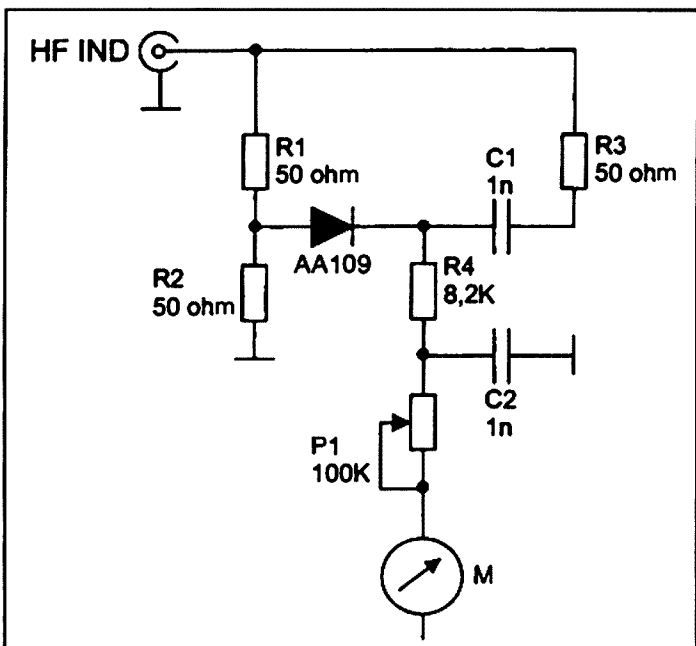


Fig 5. RF Bridge



Fig 6. PCB Track Layout.

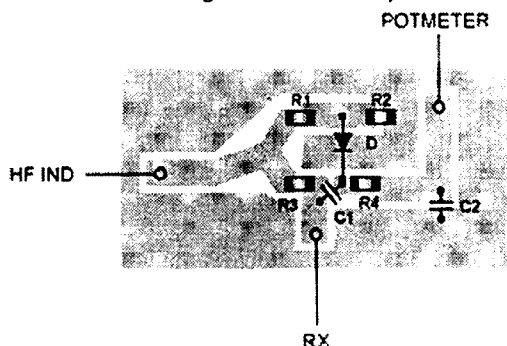


Fig 7. Component Placing on PCB.

Using Cable TV Hardline

CABLE TV HARDLINE in usable lengths is often available as scrap. It is a high quality 75 Ohm coaxial cable with a solid aluminium jacket. It is around 1/2 inch in diameter. The losses are low up through the VHF and UHF bands but connectors are a problem. The 75 Ohm impedance is not a big problem as many antennas can be matched to 75 Ohms and mos rigs will not object to a 75 Ohm load. If the impedance is critical there are a number of simple matching systems which can be used but usually a 1.5 : 1 SWR is quite satisfactory.

The main problem is the supply of suitable connectors. A way of using PL259 plugs was described in the World Above 50 MHz column of Emil Pocock W3EP in QST January 2000.

The cable centre conductor will fit into the connector centre pin. A split sleeve of aluminium tubing is used to connect the cable outer to the barrel of the connector. The sleeve is split and clamped with two worm drive hose clamps to hold it and make the connections.

Cut the cable shield 1 3/8 th inches from the end using a circular tubing cutter. Score a shallow groove at first and then slowly tighten the cutter while cutting so as not to crush the aluminium shield before the blade has had a chance to cut through to the foam insulation. Then snip away the short length of aluminium shield exposing the foam insulation. Then remove exactly 7/8ths inch of foam insulation from the end. Take care not to nick ,score ,or scratch the centre conductor.

The outer connecting sleeve is made from 5/8th inch diameter 0.058 inch wall aluminium tubing. A length of 1 1/4 inches is used. This is split lengthwise by cutting a slit along one side. The sleeve will then slide over the cable outer and the PL259 barrel.

Slide on the split sleeve , two hose clamps, and the outer shell of the PL259 over the cable outer. Then screw the connector barrel onto the end of the cable. Screw the barrel on so that the foam insulation is right past the solder holes. The inner conductor should be up inside the centre pin and can now be soldered. Screw on the outer shell and push up the split sleeve so that it covers both the barrel and the cable outer shield. Do up the hose clamps to compress the sleeve so as to make both electrical and mechanical connection between the sleeve and the coax shield and between the sleeve and the connector barrel.

For outdoor use the connector will require waterproofing. Several layers of good quality tape should be used.

The cable should be protected from kinking as it is easily ruined by unwise bending. Use a generous bend radius.

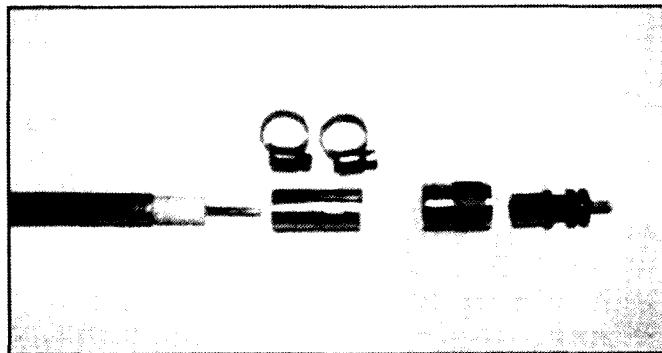


Photo 1. Prepared Cable End with adapter sleeve , two hose clamps and connector ready for assembly.

Errata

IN THE ITEM in June Technical Abstracts on Diode Matching an error crept into the wiring diagram. The corrected diagram appeared in May 2000 Rad Com. The correction came from Pat Hawker G3VA.

The corrected diagram is shown in Fig 3. The correction is to reverse the diodes. The diodes were originally shown reversed.

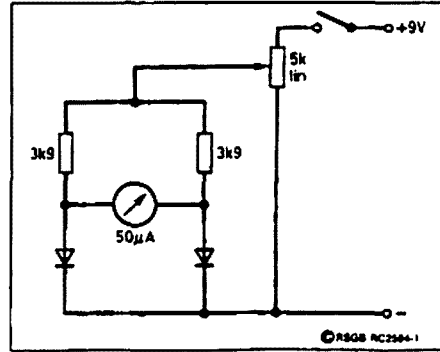


Figure 3: Corrected wiring diagram for Diode Matching

GREMLINS GOT INTO THE Long Wire for Six and Ten in the July Technical Abstracts. The gremlins got into both the original QST article and then had another go with AR.

In the QST article Bob Witmer W3RW in QST April 2000 the length of the long wire section of the antenna was given as 96 ft 6 inches instead of the correct length of 93 feet 6 inches.

In AR the antenna diagram was incorrect and Figure 1 should have been one which showed the layout of the antenna. A correct diagram appeared in the Technical Topics column of Pat Hawker G3VA in Rad Com July 2000. This is the diagram which is shown here as Figure 7. This has been used in preference to the omitted and incorrect diagram from QST.

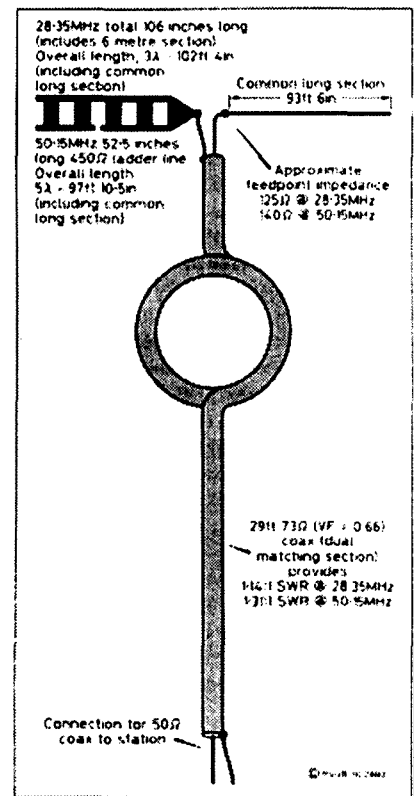


Figure 7: W3RW Dual Band Long Wire Antenna



there to be used

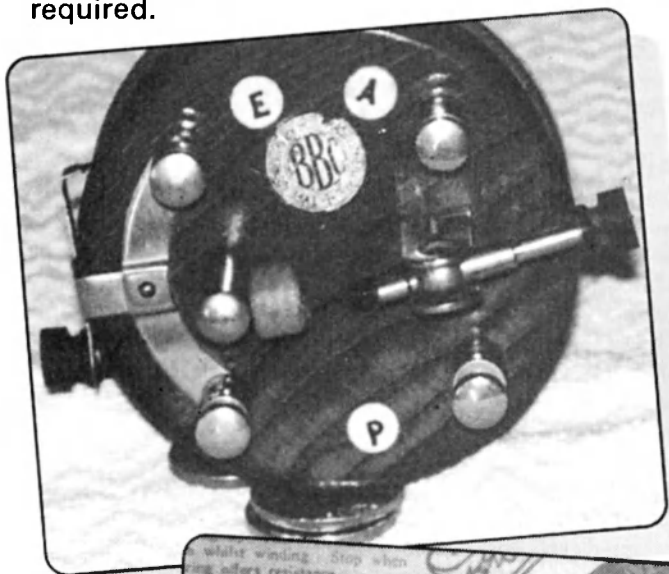
The Good Old Days of Crystal Sets and Morse Code



Jim Davis VK7OW has a great collection of Amateur Radio historical items and stories. In AR May 1999 page 20, the move of American Radio Astronomer Grote Reber to VK7 20 years ago was described.

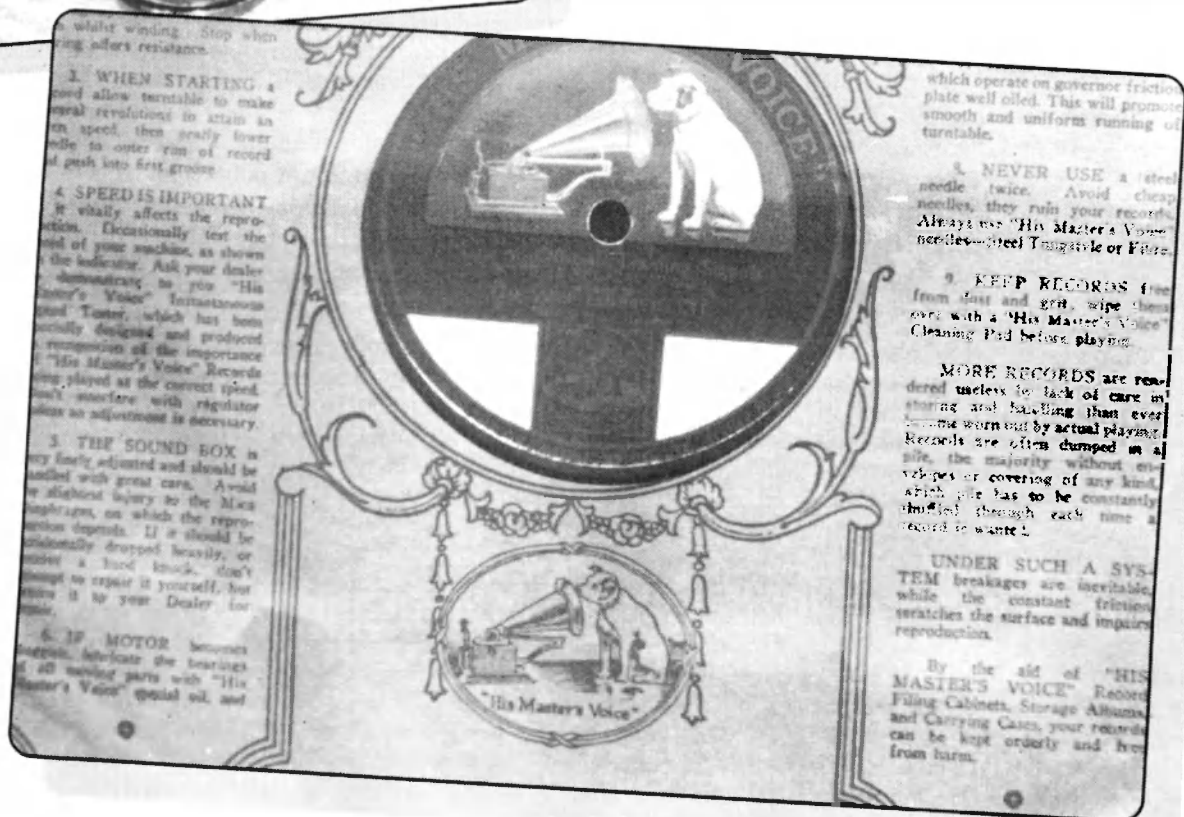
In AR January 1999 page 6 there was an article on "The great crystal set competition" Jim has sent us some photos of early commercial Crystal Sets with cat's whisker detectors from his museum. There is a "HOWE" and a "LEMCO" from the USA and a British "REVO" with a BBC approval sticker

Jim's collection does include practical teaching aids. He has the original HMV 78rpm disks containing the Marconi Official Training Signals used to train radio operators around the WW1 1914-1918 period. Unfortunately, it is rather difficult to do justice to audio items in the pages of Amateur Radio. Jim provided us with a cassette tape of the recordings which includes Jim's notes on the content of each track. The editor should be able to supply a copy of the tape if required.



Jim suggests that a humorous introduction to an article might be "So you want to learn Morse code? It's simple! All you need is a phonograph; a stroboscope for setting the turntable speed at exactly 78rpm; an oil can (for oiling the governor leather- see instruction No 7 on the record sleeve) and a supply of Marconi Official Training Signals recorded by HMV".

Bill Rice VK3ABP



Post WW2 Amateur Radio: a phenomenal social link

Sid Ward VK2SW reviews a period of home brew and hectic activity, bolstered by a never-ending supply of wartime surplus equipment

Sid Ward VK2SW.

Firstly, this article has not been put together to simply enable old timers to drift back to the way things were in the dim dark ages. Far from it, my sole reason for putting the following together is to hopefully encourage the newer arrivals to Amateur Radio to be aware of, and maybe learn a little of what has happened in the past.

A little bit like a written time capsule.

I will commence my story from the most likely logical point in amateur radio time, after WW2, when confiscated pre-war transmitting equipment was returned to the then, current, pre-war licensees.

This was a period of great excitement. Enthusiasts had been denied access to the worldwide hobby and naturally it did not take too long for signals to appear on all current bands. Many amateur licence training courses became available to the enthusiasts. It was a period of hectic activity. There was a never-ending supply of wartime surplus equipment becoming available... transmitters, receivers, power supplies, crystals, valves.... You name it.

Within six months or so, there was an escalation in new call signs appearing over the whole of Australia (and I dare say, around the world.) Almost every item of transmitting equipment on the air in Australia was fully or part "home-brewed". In the majority of cases, even the receivers were in this same category. Wartime receivers were generally excellent for military use, but fell a long way short of the special high sensitivity and high selectivity required for serious amateur work. (Particularly up on ten metres, which was enjoying some excellent sunspot, numbers around this period). Essential to every shack were a soldering iron, a multi-meter, a junk box of radio bits and pieces, and a copy of the ARRL handbook.

There was no shortage of amateurs on the air on *all* licensed bands (inc. VHF) and the days of the long rag-chews were with us, as almost every amateur on air was greatly involved and interested in

the type of equipment that was being developed in the various shacks. There was no shortage of subjects to be spoken of or listened to. It was really activity with a capital "A". Until the arrival of SSB technology some time later, almost every bit of home manufactured RF or VHF gear was either for AM or CW. CW incidentally was every bit as popular as phone, as it easily outstripped AM when working the rarer DX. It was also a lot cheaper and easier to make. Remember ... these were pre-SSB days.

It is interesting to note that at this time, the habit of exchanging QSL cards was paramount. Almost every on-the-air amateur or short wave listener had his/her own individually designed card, and it was considered good manners to have your card adorning the wall of every

...almost every country town had its own prominent amateur, who seemed to be always on the air. He was the person one contacted before any visit to his town was made. He, and his family, would be the ones to welcome the amateur visitor to their town, quite often providing accommodation to boot.

station that you worked. It didn't take long for most shack walls to be covered. Long lasting personal associations and friendships were established, further enhancing this great, innovative hobby. Incidentally, The "WIA emblem" would have been displayed prominently on easily the majority of cards.

Mobile operation was very popular both on VHF (166MHz allocation) and 40 metres. Most people that could afford motor cars usually organised the fitment of applicable amateur gear. Fox hunts on 166MHz were almost a weekly event, with each participant trying to prove that his radio and antenna system was the star performer,

That famous and never-tiring amateur John Moyle, VK2JU was around during this period. He would have likely contributed more to Australian amateur radio than any other man would. For a long time he was editor of Radio and Hobbies, and equipment designed by him was duplicated in so many shacks in Australia. His contribution to amateur radio was there right up to the point where he passed away at a relatively young age. He was a tireless worker for our hobby. The John Moyle National Field Day is an on-going tribute to this top amateur of the post war years.

Another phenomenal thing that existed in these early years, was the fact that almost every country town had its own prominent amateur, who seemed to be always on the air. He was the person

one contacted before any visit to his town was made. He, and his family, would be the ones to welcome the amateur visitor to their town, quite often providing accommodation to boot. He would be looking for you on the air before you arrived, as an amateur visitor in a country town often was a BIG event. We were not a mobile society in those days. It was a phenomenal social link, applicable to the period. It is also interesting to recall just how socially active forty metres was in that period. It always seemed to be populated with dozens of AM/CW contacts under way, irrespective of the time of day or night. A far cry from what 40 is like today!

In the late '50s and mid '60s, the basic AR scene started to see change. The first signs of imported commercial SSB were with us (mainly USA), with the more

affluent of the amateur fraternity becoming involved. This was great new stuff... and when coupled a little later with the entry of the Japanese VHF-FM transceivers into the market place, the great changeover to ready-made versatile gear was really under way. From the late '60s onwards, the overall tendency for most amateurs was to go "commercial" in the main items in the shack and in the motor car. On two metres, well-sited repeaters were doing all the work, and

many amateurs slacked off in regards to base station aerials etc. The hand-held portable was soon with us.

However there was still plenty of equipment and ancillary equipment to be made by the amateur on his own workbench, if he so desired. These items included such items as aerial systems, test equipment, regulated high-current bench power supplies etc. Over succeeding years, unfortunately for the technical side of our hobby, even these

relatively simple ancillary items were now being purchased from dealers, rather than being made by the amateur himself. This skill of manufacture has, no doubt, been replaced by the mammoth in-roads of technology into other very complex areas such as digital communications, satellites, high-level commuter work and the like. It has been an extremely captivating half-century. Good luck to the newcomers....

ar

Club News

AHARS Mid-year Dinner

A number of years ago it was suggested that AHARS had a Christmas Dinner. The first one was so successful that the members suggest the club have a Mid-year Dinner as well.

Usually the Mid-year Dinner is less well attended than the one at Christmas because a number of members go north to escape the cold. However, whether fewer went north or because of the increased membership recently, this

year's mid-year dinner had the best ever number present.

There were 64 people that night to enjoy one of the best meals yet. Instead of the happy half hour before the dinner, this year the Club picked up the GST part of the cost of the dinner. An idea approved of by everyone. As a party it could be considered a success if the number of people who lingered till the last minute is any criterion. No one was in any hurry to get home, for sure.

The next meeting, on the third Thursday of the month will be a talk by Graham VK5ZFZ about using 'dead' computer parts to make 12 or 13.8 volt power supply for the shack.

Remember, if you are visiting Adelaide contact the Geoff VK5TY or Alby VK5TAW for details and come along to a meeting of AHARS on the third Thursday of every month except for December and July. Visitors are made to feel welcome.

News from the Moorabbin & District Radio Club

Radio on Rails Results

Results of April's Radio on Rails have now been released and are as follows:

Section A: Transmitting Mobile 1st VK3JED - 68 points: 2nd VK3YE - 55 : VK2EKG/3 - 21 points

Section D: Receiving Home 1st Craig White (SWL) - 15 points

No logs for Sections B and C were received. Thanks to all participants for supporting this event and also to those who contacted mobile stations.

MDRC Annual General Meeting

The Club's Annual General Meeting was held on Friday July 21. Official MDRC positions are:

President: Lee Moyle VK3GK

Vice President: Chris Arthur
VK3JEG

Secretary: Paul Girling VK3ALE

Treasurer: Keith McCarthy VK3JNB

Committee: Above plus Rick Podolski VK3TRZ, Tony Middleditch VK3CAT and Tony Langdon VK3JED.

Other positions:

Publicity Officer: Peter Parker
VK3YE

Public Officer: Ken Millis
VK3TKR

QSL Officer: Tony Middleditch
VK3CAT

Station Officer: Tony Middleditch
VK3CAT

Paul Girling is once again looking after APC magazine and the club web page. Peter Parker and Keith McCarthy will continue to produce the weekly APC News bulletin.

An important issue is that of Education Officer, which remains unfilled. It is essential that this position be filled to ensure that study courses can resume and the club benefits from a steady stream of new members. Anyone interested should contact any member of the committee.

Our guest speaker was Andrew Rennie from the Space Association. Andrew's subject was well chosen covering Satellite communications, and space missions, past and present, done with an excellent commentary and some top

quality coloured slides. Thanks to Andrew for a very interesting talk.

APC News now on HF

The MDRC's weekly APC News service continues to expand, and is often quoted on interstate and international news bulletins. Our latest innovation is an HF retransmission, being conducted by Chris VK3JEG. This transmission is becoming popular with country and interstate listener. It has been heard as far away as southern Queensland.

To hear Australia's only midweek amateur news service, tune to 3.565 MHz LSB at 8:00pm Wednesdays. Call backs will be held after the session.

Summer net season begins

With the commencement of daylight saving, the MDRC's Monday night net has reverted to two metres only. Tune to 146.550 MHz from 7:30pm and 3.567 MHz LSB (+/- QRM) after 8:00pm for the 80 metre net. Net control is our station officer Tony VK3CAT.

Peter Parker VK3YE Publicity Officer
Moorabbin & District Radio Club
parkerp@alphalink.com.au (03) 9569 6751

An unwelcome early Christmas present in VK1

Gilbert Hughes VK1GH

While attending an amateur Christmas drinks function on 19 December last a number of members mentioned that the Mt Ginini 2 metre voice repeater was re-transmitting aeronautical traffic. A couple of weeks earlier I had briefly heard the same problem while mobile and assumed some temporary unusual set of circumstances was responsible and had given it no more thought.

A quick listening test confirmed we had a major problem. Every transmission of a new aeronautical en route service on 133.15 MHz was retransmitted in its entirety by our repeater. This was occurring frequently, and effectively prevented the repeater being used.

The Mt Ginini repeater receives on 146.35 MHz and transmits on 146.95 MHz. Our hut is in the AirServices compound some 60 metres away from the AirServices towers. We have enjoyed interference free operation on this prime site since the early 1970s. Being very aware of the need to ensure that we never cause interference to AirServices, we installed band pass duplexing with extra cavity filters on both transmit and receive services, and isolators on the transmitters. Like all users on Mt Ginini, the only problem we have had is with ice build up on antennas in winter, frequently associated with high winds resulting in mechanical failure.

A check of assigned frequencies on the site, confirmed by listening, quickly pointed to the likely source of the signal on the repeater input. A continuous transmission of Aeronautical en route information service (AERIS) on 119.95 MHz, the new service on 133.15 MHz and the repeater input on 146.35 MHz are all *exactly* 13.2 MHz apart, i.e. we were faced with the worst possible situation — an on-site third order intermod.

At this point things became really interesting. AirServices are one of the few organisations who do take a very wide look when assigning frequencies and would not normally have made an assignment that, despite the wide frequency spacing, was highly likely to result in serious interference. A discussion with the frequency assigning

area of AirServices revealed the startling fact that the ACA data base at the time of assignment had no listing of our 146.35MHz repeater input frequency on the site. We quickly checked and confirmed that this was indeed the position. (No, we had not forgotten to renew our licence).

Our local ACA folk quickly corrected the database, but solving the interference was a different matter. A series of joint site visits by AirServices, ACA field staff and ourselves identified the following:

1. The level of the mixing product on the repeater input, measured after the cavities, was around minus 90 dBm, and at times up to 5 dB higher.
2. Both Air Services transmitters, and the amateur repeater, have two cavities in series, and all co-ax is 214 double screened. The levels of the other services were almost too low to measure on the equipment side of the cavities, ruling out any internal mix in the equipment.

A continuous transmission of Aeronautical en route information service (AERIS) on 119.95 MHz, the new service on 133.15 MHz and the repeater input on 146.35 MHz are all exactly 13.2 MHz apart, i.e. we were faced with the worst possible situation — an on-site third order intermod.

3. Employing a tunable band-pass filter and spectrum analyser, the level of the interfering mixing product was examined using a spare 160 MHz antenna on the AirService tower. The level was 20 dB higher than at the input to the amateur receiver, and was observed to vary by about 10 dB. This variation appeared to closely correlate to the gusts of wind.

4. In an ambitious attempt to positively identify the mixing point, quality monitoring equipment and filters

were taken to the platform on the AirServices mast some 4 metres from the two transmitting antennas. This was a very big ask in terms of dynamic range, and failed to prove anything.

5. Temporarily moving the 133.15 MHz transmitter to the low gain antennas on the second AirServices tower about the same distance from the amateur repeater reduced the interfering product by about 5 dB but did not solve the problem. It was not practical to test with the 119.95 MHz antenna in a different location.

After a lot of hard work by all involved we knew that the mixing product was generated on the AirServices tower, possibly in the AERIS antenna, but this theory could not readily be proved owing to the obvious requirement to keep the AirServices facilities operational all times.

Clearly there were only three real fixes to this problem — one of the three frequencies had to change or move off the site. A close look at the options for the Amateur service revealed major problems. Owing the height and coverage, any change would require distant existing amateur services to change — possible but very difficult to achieve.

We took our problem to senior AirServices staff, who asked relevant questions and advised the matter would be considered. We were delighted too shortly afterwards receive advice that AirServices would change the frequency of the AERIS transmitter. Obviously an operational aeronautical service cannot be quickly changed in these circumstances, and while it was not until early March 2000 that the change

could be made, AirServices kept us fully informed of progress. It was worth the wait, for as soon as the 119.95 MHz service was changed to 128.65 MHz the interference ceased.

It would have been interesting, if the suspect antenna could have been changed, to see if this was the principle mixing point. However it is very easy to forget that in on-site third order situations there is little real gain in identifying and 'silencing' mixing points – either you then hear the ones you could not hear before, or you think that the problem has been solved and it always eventually comes back. A frequency/site change is the only sure fix.

The first point of the story? All repeater groups should regularly check

the ACA database on the ACA home page "aca.gov.au" and ensure that your services are correctly recorded in terms of site and frequency. The second point? Stay calm and patient, work with all the parties to gather the facts and discuss possible solutions.

At the end of it all, we were delighted to write to the CEO of AirServices and thank him for ready assistance we had experienced from his staff in solving a problem not of their making.

In case you are wondering why we did not go for a CTCSS solution, consider the following:

- a) Ginini is a remote high site and the interference was greater than many amateur signals. CTCSS would mask the problem but would still have left

us with a very unsatisfactory repeater that would have constantly dropped out on the users.

- b) All users would have to have fitted CTCSS encoders – a big ask for older rigs.

Some readers may be asking why the AM aeronautical services were heard so clearly on our FM repeater. The answer is that in any mixing situation, there is always some FM produced along with the original AM.

All this happened in the middle of a major upgrade of our Mt Ginini site – a new all welded solid bar mast, new antennas, diversity reception, upgraded equipment. Once all this is completed and proven it will make another story!

ar

Radio and Communications

Incorporating AMATEUR RADIO ACTION and CB ACTION

Published by Chris Edmondson, VK3CE

PO Box 123, Eagle Heights, Queensland 4271 • PH (07) 5545 0666 • FAX (07) 5545 0622

Tracking the Trunking!

Okay, so we amateurs use transceivers — but you really should check out Uniden's remarkable new scanner!

Know someone who could benefit from the WIAQ-sponsored ARCS Scheme? Learn electronics the EASY way!

Download your FREE copy of ARCS from <http://www.radiomag.com> today and spread the good word

Read of the race to get BHUTAN, A5 activated. It's a great story — and VK played a pivotal role!

And check out the other great stories while you're at it! BUILD a NiCd battery charger with a twist.

Hey this one charges ALKALINE cells too! VK2DQ's great educational series continues,

we check out the DX and latest repeater changes, plus lots more!

R&C has the biggest collection of radio-oriented Classified adverts in the country. There's lots of them because they work so well! Ask your newsagent to keep a copy for you each month. Hurry — you might miss something!

Don't miss out — RADIO and COMMUNICATIONS is great reading for amateurs!

Check your local newsagent today



Christine Taylor VK5CTY, ALARA Publicity Officer
16 Fairmont Avenue, Black Forest SA 5003
Packet VK5@VK5TTY Email: geensee@picknowl.com.au

It Is Our 25th Birthday This Year!

ALARA celebrates its birthday on July 25th each year with a session on 80 metres on the nearest Saturday to that date and often with special luncheons during the month. This year, unfortunately there were not many YLs on the air that Saturday night, partly because it clashed, in VK5, in particular, with a Mid-year dinner for the radio club to which most of the VK5 YLs belong. However I hear there was at least one ZL station, Bev ZL1OS there to help us celebrate.

For next year the committee suggests that we operate for the period from 1000 to 1200 UTC (on or near 3.580MHz, as usual) and that the President open the session officially. We hope that next year most of the committee will be able to be on air - and lots of other YLs, too.

The VK5 girls had a well attended Sunday luncheon at which the birthday was toasted by 13 YLs and 7 OMs, one of the largest numbers we have had for a while. VK3 celebrated the birthday on the 2nd Friday of July and the VK6 YLs on the third Friday. Remember all visitors are welcome to join the regular lunches or a special lunch can be arranged. Just contact someone on 2-metres or by the phone. It is fun to meet face to face those voices you hear.

At the VK5 luncheon were Myrna VK5YW, who ran some of the earliest 80-metre nets for, first LARA and then ALARA, and Janet VK5NEI. Neither of them are very active, but they both enjoy the chance to meet the local YLs on this once-a-year day. Like many YLs licensed in the last 25 years, Janet became a member of ALARA almost as soon as she got her licence.

One of the newest licensees and newest member of ALARA, Faith VK5ZFC was a welcome new face, along with Judy VK5BYL, well known to many of us for the recipes she used to send on VK5WIA in CW for the practice sessions, Mary



VK5AMD who regularly listens out on 146.500 for travellers passing through Bordertown, Maria VK5BMT, Meg VK5YG, Debbie VK5JT with her two daughters, Sarah and Chloe, Tina VK5TMC and Christine VK5CTY. We were hosted by Jean VK5TSX, our State Rep. who had chosen the new venue and generally organised us so well.

You Can't Beat The Weather!

Marlene VK3WQ and OM Jim VK3DL make it a regular thing to escape from the cold weather in VK3 to their second home in Hervey Bay. This year the weather beat them. When they arrived in Hervey Bay it was colder than it had been in Melbourne. What is more it stayed that way for quite a while!! Life is not fair, is it?

A Special Station To Listen Out For

AX9YL - a YL mini-DXpedition to Norfolk Island. A multinational team of YL operators (mainly ALARA members) will be active on both SSB and CW from Norfolk Island from 5th - 12th October.

They have called it a "mini" DXpedition because they will not be using either amplifiers or beams - just wire antennas plus a vertical borrowed

from Dave, ZLIAMN, and will operate in between sightseeing trips around the island. However, they will still be very active on the airwaves so if you hear them on please call in and say hello.

This special call was obtained by the WIA Victoria, so QSL will be via the VK3 Buro or direct to Gwen, VK3DYL, with return postage and SAE, without which cards will be returned via the Bureau.

ar

by Robin L. Harwood VK7RH

“Listening In” to the Olympics

Well, the Olympics have arrived and commence on the 13th of this month, two days prior to the Opening Ceremony in Sydney. The first event will be a soccer match in Melbourne at the site of the 1956 Games. I believe that these games will be extensively covered in all forms of the media including shortwave radio. Expect live commentary in a multitude of languages and frequencies. I do know that Radio Australia will be giving extensive coverage of the Olympics. However since Atlanta I know that listeners outside of the South Pacific are experiencing difficulties finding Shepparton and it is unlikely that they will get to use Darwin.

I noticed that our friends across the Tasman at Radio New Zealand International have resumed their relay of sports descriptions from a private network.

In August I was up on Queensland's Sunshine Coast and the only receiver I had was a Chinese-made "Digitor" model I acquired many years ago. Listening just on a whip was an interesting exercise and I found the best results were on the 13, 16 and 19 metre broadcasting allocations. The Digitor has two shortwave bands- the first is from 3.2 MHz to 7.3 MHz and the second is from 9.5 to 21.75 mhz. Here in this block

of units the lower band has been very disappointing and the only bands that are bringing in signals are the above-mentioned allocations.

Radio Australia comes in very easily on 15240, 15415 and 17750 in the daylight hours. Also Radio New Zealand International on 17675 can be good at times but it is not reliable. However it is the 13 meter allocation which has proved to be very interesting with the Middle Eastern stations on 21630 and 21735 from the Gulf that are booming as is the Voice of Turkey from Ankara on 21715 kHz.

Another station probably UAE Radio in Dubai is on 21705 kHz. Generally signals from Asia are much stronger than they are back home in northern Tasmania and I also note that propagation is open longer on the higher frequencies than it is in Tasmania.

I note that this Digitor has double conversion and the images are 910 kHz below the fundamental and can be better as well. As I mentioned, the band allocation is somewhat limited yet I can hear stations on their image frequency although their fundamental is not covered.

For instance the Voice of Russia on 21790 is supposed to be outside the band yet I can hear them on 20900. Also the maritime allocation on 22 mhz breaks through on images.

This particular Digitor is no longer manufactured and tunes in 5 kHz steps.

It does not have a BFO yet it does have five memory positions. It has AM and FM plus the two shortwave allocations.


On FM it is interesting as there are about 30 stations I can hear from my unit. Some are in Brisbane but there are many from the coast and the adjoining hinterland. I note many of the tourist information stations at the bottom edge of the band have gone, just as they have in Tasmania.

Well, that is all for this month. All the best listening in to the Olympics via shortwave, if you can tear yourself away from watching on television or fortunate actually being there.

73, Robin L. Harwood VK7RH

ar

Turn
off
the TV,



Turn
on
the Rig!

*For All Your
Requirements*

AUTHORISED DEALER

ICOM

KENWOOD

AMATEUR COMMERCIAL

Tower
Communications

14 Mary Street
Hazelmere
Western Australia 6055
Telephone: (08) 9274 1118
Facsimile: (08) 9250 3734
E-mail: tower@con.net.au
www: <http://www.tower.visionimage.com.au>

DON'T MISS THE ACTION!

High Performance VHF/UHF Base Station Antennas

Diamond base station antennas offer outstanding quality and exceptional value. These stacked collinear types provide high gain, wide bandwidth and a low radiation angle for extended range. The fibreglass reinforced polyester outer radome and gasket seals provide excellent all-weather operation, and compact ground-plane radials are supplied. Stainless-steel mounting hardware ensures a long, trouble-free life. Supplied with instruction sheets for easy set-up.

2m/70cm X-50A

Frequency: 144-148MHz, 430-450MHz
 Gain: 4.5dB on 2m, 7.2dB on 70cm
 Max. power: 200W
 Length: 1.7m, max wind 60m/s
 Type: 6/8λ (2m), 3 x 5/8λ (70cm)
 Connector: SO-239 socket

D 4855



\$135 **SAVE \$9**

Digitor 2m 30W RF Power Amplifier

If you use your 2m band FM hand-held at home or in the car, but find that 2-3W RF output isn't enough for reliable communications, then this compact 30W RF amplifier may be the answer. It works with inputs from 0.5 to 5W and produces up to 30W output with just 3W input. A switchable 12-15dB gain low-noise GaAs FET receiver pre-amplifier can be selected for improved receiver performance on less sensitive hand-helds when being used in RF quiet areas. The amplifier offers a large heatsink for extended duty-cycle transmissions, fused DC power lead, and SO-239 input/output connectors. Frequency range 144-148MHz, FM only. Size: 100 x 36 x 175mm(WHD).

D 2510

digitor **\$96** **SAVE \$20**

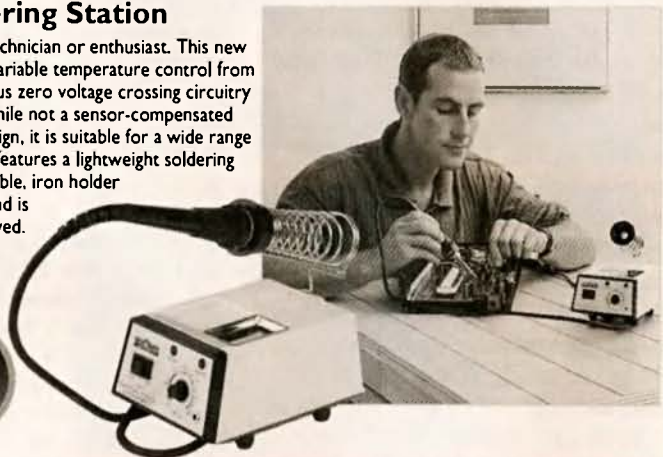


Economy Soldering Station

Affordable quality for the technician or enthusiast. This new soldering station provides variable temperature control from approx. 250°C to 450°C, plus zero voltage crossing circuitry for low noise operation. While not a sensor-compensated temperature-controlled design, it is suitable for a wide range of soldering applications. It features a lightweight soldering pencil with heat-resistant cable, iron holder and a tip cleaning sponge, and is full Energy Authority approved. Supplied with a long-life 1.6mm plated tip.

T 1975

\$98 **SAVE \$25**



PowerHouse stores

A shopping experience like no other!

Dick Smith PowerHouse stores not only offer an expanded range of those original electronics products that have made our stores famous, but now you can experience the fun of using a wide range of communication equipment in our hands-on demonstration area.

Called the "Ham Shack", each PowerHouse store has a dedicated area where licensed staff can show you the latest Yaesu, Uniden, or Magellan communications and GPS products, as well as an expanded range of accessory lines that may not be available in other stores.

Not involved in Ham Radio? Staff can also advise on the installation of a CB radio for your four-wheel drive vehicle, how to get involved in listening to Shortwave radio stations from around the world, or assist you in the selection of a suitable accessory for an existing piece of equipment. For bushwalking or boating users, you can also find out about the latest in inexpensive satellite based navigation receivers or emergency beacons, or just browse through an extensive selection of communications related books.

The PowerHouse is also the place to go if you simply need a component to finish that weekend project, to buy tools, or just to while away a few hours while checking out

in-store technical books, library CD-ROMs, or our dedicated customer use Internet terminals.

With over 20,000 product lines in the electrical, computer, and communications areas, our new PowerHouse stores get the wavelength right!



DON'T MISS THE ACTION!

VX-IR 2m/70cm Micro Handheld

One of the worlds smallest dualband handhelds, just 47 x 81 x 25mm (VHD) including a high capacity 700mA/H Lithium-ion battery! The VX-IR covers both 2m and 70cm amateur bands, plus offers AM/FM and TV sound reception, 2 hour fast charging as standard, simple settings and a large LCD screen.

2 YEAR WARRANTY

Features:

- Tx: 144-148, 430-450MHz.
- Rx: 0.5-1.7MHz, 76-300MHz, 300-580MHz, 580-999MHz (cellular locked out).
- Output: 2m/70cm 0.5W (at 3.6V), 1.0W with external DC.
- 291 memories, most with alpha naming.
- AM, FM (n), and FM (w) reception modes.
- CTCSS encode/decode.
- 31 smart search memories.
- Tone search for CTCSS and DCS.
- Includes FNB-52LI 3.6V 700mA/H Lithium-ion battery, regulated AC adaptor/charger, antenna and belt-clip.

D 3665

\$370
YAESU



PRICE BREAKTHROUGH!

Yaesu FT-90R 2m/70cm micro mobile

Another engineering breakthrough from Yaesu – a tiny-dual band mobile rig with high power output, a remoteable front panel, and a rugged receiver front-end. The FT-90R provides 50W RF output on the 2m band as well as 35W output on the 70cm band, a solid die-cast casing with microprocessor controlled cooling fan for reliable operation, and a large back-lit LCD screen, all in a package measuring just 100mm x 30mm x 138mm .

Also includes:

- Wide dynamic range receiver for greatly reduced pager breakthrough.
- Huge receiver coverage – 100-230, 300-530, 810-999.975MHz (Cellular blocked).
- 180 memories and a variety of scanning functions.
- Built-in CTCSS encode/decode, battery voltage metering.
- Designed for 1200 and 9600 baud packet operation.
- Tiny remoteable front panel (requires optional YSK-90 separation kit)
- Includes MH-42 hand mic, DC power lead, and easy to follow instructions.

D 3312

SAVE \$100

2 YEAR WARRANTY

YSK-90 Front Panel Separation Kit

D 3317

\$129⁹⁵

\$749
YAESU



PHONE FAX AND MAIL ORDERS

PHONE: WITHIN AUSTRALIA: 1300 366 644
(Local call charge)

FAX: (02) 9395 1155 within Australia and (+612) 9395 1155 from outside Australia

MAIL: DICK SMITH ELECTRONICS, Direct Link, Reply Paid 160,
PO Box 321, North Ryde NSW 1670 (No stamp required)

Excludes packaging and postage. All major credit cards accepted.

14 Day Money Back Guaranteed if NOT completely satisfied. (Software excluded)



Visit our web site at
<http://www.dse.com.au>

DICK SMITH
ELECTRONICS

That's where you go!

Yaesu transceivers and accessories stocked in selected stores only. Other stores can place orders on a deposit-paid basis. Offers expire 30/9/2000. All prices shown are inclusive of GST.

1471 DPS/col.



VK1 Notes

Forward Bias

Peter Kloppenburg VK1CPK

The long awaited GST has now become reality. As expected, the membership fees have gone up since July 1, but not to the extent you were expecting. So, what are the new fees? Full members (F) pay \$77, Pensioners, Needy (G) and Students (S) pay \$58, Non-receipt of AR (X) pay \$49. The increase in fees is only a small amount considering the seachange of increases and decreases in the cost of goods and services that is occurring right now in Australia.

The break-in at the Maddens Plains (NSW) repeater site is bad news for all of us. This Division suffered a break-in at Mount Ginini some years back, which had nasty consequences. Equipment had to be replaced, repairs made to building and entrance doors, and many hours spend by dedicated volunteers getting the system operational again. As a precaution and with a sense of good management, the Division now pays a premium of over \$500 a year for

comprehensive insurance. That's where your money goes, folks!

Speaking about money, the Division has placed an order for the purchase of an MFJ-259B 1.8-170 MHz SWR Analyzer. This device is for use by members who want to do measurements on their antenna systems, Ls and Cs, transmission lines, baluns, antenna tuners etc etc. The analyzer is portable and battery powered, and can therefore be taken into the field, onto towers and building roofs. Exactly how it is used will be demonstrated during a future General Meeting. For those who want to know now, visit the manufacturer's Website at: www.mfjenterprises.com

The Novice Examination event on July 30 went very well, with a pass rate of about 80% overall. Due to the publicity given to the event in amateur circles, candidates were a mixture of young and old, members of the WIA and non-

members, students from the WIA Novice Course, and even a NSW candidate.

The use of the 70-cm band by radio amateurs is likely to be reduced in the near future. Information received says that the Armed Forces have relinquished the first 10 MHz as primary users, and the ACA has handed that part over to the Western Australian Police Services and other Government Departments. The WIA - ACA Liaison team will have a meeting with the ACA to discuss this matter, but it is suspected that Police Services in the other states will demand the same sort of access to the 70 cm band in the not too distant future. The question is: Will Australian Amateurs have access as secondary users as before?

The next General Meeting of the ACT Division will be held on September 25, 2000 at the Griffin Center, Civic, Canberra City, 8 pm. Cheers, Peter K

VK3 Notes

By Jim Linton VK3PC

who rose to the occasion and helped show our hobby in a better light than the image portrayed in the movie.

Each cinema had a non-working HF rig, plus an operating 2-metre FM transceiver on display. Sadly, few people saw the two screenings of the movie on opening night, indicating that it might have a very short season indeed. However the WIA Victoria members who mounted the displays did get to talk to cinemagoers, explained what amateur radio is about, and gave them a handout information sheet on the hobby. Using the Melbourne repeater VK3RML there was a flurry of activity by the cinema portable stations. Thanks to those operators who made contact QSOs and took part in the demonstration.

WIA Victoria display material, including a QSL card display by Ken

Matchett VK3TL, a poster "Seen Frequency the movie? Now learn about real amateur radio!" and a handout called "Amateur Radio - the hobby for everyone" remained at the cinemas for the season of the movie. It does not end there! When Frequency comes out on video WIA Victoria will seek further public relations opportunities in terms of display posters at selected video hire outlets.

Tough battle ahead

Are you in there fighting? Amateur Radio is certainly facing some stiff competition from computers, the Internet and many other forms of 21st century telecommunications. Some radio amateurs get bogged down in debating whether the code should stay or go, while mostly ignoring the

Frequency - the movie

The film is certainly not a box office blockbuster - but still provided a public relations opportunity for WIA Victoria and amateur radio when it showed at cinemas last month.

Teams of WIA Victoria members mounted active displays on Thursday, August 3, for the opening of the movie "Frequency" - which includes the use of amateur radio in its plot.

Three teams of members took part: Ray Cowling VK3ACR, Michael Pain VK3DCP at the Balwyn Cinema, John Brown VK3NYE and John Bell VK3FJB - Cameo Belgrave Cinema, Ron Cook VK3AFW and Maggie Iaquinto VK3CFI - Dendy Brighton Cinema.

The WIA Victoria Council expresses a sincere thank you to those six members

enormous innovation occurring in commercial and domestic communications.

These are threats. Worldwide there are more than 2.5 million radio amateurs and contrary to what is happening in Australia where numbers are stagnating, participation overseas is growing. The IARU reports that radio amateur numbers globally have never been higher. New digital modes have arrived on the amateur radio scene but very few are willing to take their hands off the traditional microphone and/or Morse code key.

Still extremely popular in a global sense is the *Jamboree on the Air (JOTA)*. Do enough VK's take advantage of this event that shows youngsters our hobby? The doomsayers among us point to the fact that the radio amateur population is steadily growing older, and so is the general population. There is pressure to squeeze radio amateurs off the spectrum. Whether it be broadcasting, cellular phones, pagers, and a host of new

emerging uses of spectrum. Commercial interests are ready to pay top dollar for radio real estate, and governments are more than willing to sell it - just look at the recent spectrum auctions here and overseas.

Think what you can do to support your hobby, in addition to being a member of WIA Victoria.

Remembrance Day Contest

Did you get on air for the RD Contest? Exchange numbers and have a bit of fun? Well make that participation count by submitting a valid entry and contribute towards VK3's participation level. For VK3 to win this year there must be an increase in both VHF and HF activity - this is where your log, no matter if it only has a handful of contracts, it will still count and be most welcome. Check your log sheets for the call signs of friends, and give them a friendly reminder to submit

an entry, or offer to help if they are not sure what to do.

Send logs and summary sheets to: RD Contest Co-ordinator, A Petkovic, VK6APK, 26 Freeman Way, Marmion, WA 6020, by Friday 15 September, 2000. Endorse envelope "Remembrance Day Contest" on front outside.

WIA Victoria is striking a new perpetual trophy to be awarded to the individual radio amateur who contributes the most points to the VK3 score. Another trophy for the best "newbie" or rookie station with the highest score will also be awarded.

WIA Victoria Tel: 9885 9261 40G Victory Boulevard Fax: 9885 9298 Ashburton 3147

Office Hours: Tuesday & Thursday 10.00am to 2.30pm VK3BWI broadcast 1st/3rd Sunday at 2000 hours.

Web site: www.tbsa.com.au/~wiavic
Email wiavic@alphalink.com.au IARU Region III Conference page - www.tbsa.com.au/~wiavic/iaru

VK6 News

All radio enthusiasts, be they CB, Amateur, Short-wave Listeners or Scanner groups are advised that there will be an OPEN DAY at Wireless Hill on Saturday 23rd September 2000 from 10 am until 3 pm.

It will be BYO BBQ, for those who wish to cook, otherwise make it a picnic for the family.

The purpose of this gathering is for different radio groups to meet and chat about their hobbies. Maybe also to bring

some budding amateurs closer to their dreams. This event will, we hope, become an annual social gathering. Thanks to Peter Larkin VK6HAO for his input.

Please contact Ron Brown at the address below.

Ron Brown, c/o UHF Association, W.A., P.O. Box 316, Cloverdale, 6105.

Phone 0409 887 120

Fax (08) 9207 2774.

Submitted by Peter VK6HAO,

VK7 QRM

There is open warfare in our Southern (Hobart) branch. And it's not just spasmodic - it's a weekly battle!! Every Thursday night you see amateurs charging all over the city hunting the elusive fox with the fox trying their best not to be caught. As I write comes reports that the fox positioned itself in the middle of a vast crowd welcoming the Olympic torch. At this point our intrepid web-page editor, Robert, VK7RB with his offside VK7DG are leading followed VERY closely by VK7FB, Mike's posse. It's deadly serious stuff !

The film "Frequency" opened in Hobart with Southern branch members manning an information table in the Theatre foyer. The theatre management was very impressed.

Rex, VK7MO is having a great time experimenting with "Wobble visual frequency shift keyed C.W." on 144Megs. Apparently odd stuff. The dots/dashes appear on the computer screen using very narrow bandwidth and signals below the noise threshold. Kingston (south of Hobart) to Moe in Victoria is the longest distance covered

5/8 Wave

"A few years ago the VK5 Council asked Michael Gell VK5ZLC to arrange a tour of the ABC complex at Collinswood. It was very successful and enjoyed by all who attended.

The Council has now asked Michael to arrange a tour of the ABC Transmitting centres at Mt Lofty and Pimpala to take place on normal meeting nights October 24th and November 28th this year. It is also on the cards that a further visit to ABC Collinswood can be arranged in the new year. Please contact Michael Gell Phone (08) 8294 6906 if you would like to go on one of these tours.

M. Gell VK5ZLC

as yet. Rex is the guest speaker at the Northern Branch's meeting in September and with that intriguing mouthful of a subject a good attendance is assured.

The Northwest branch is targeting the Lions and Rotary Clubs in their quest for new members. The 40 to 60 year olds, they reason, have financial stability - home paid for - kids off their hands - and retirement to look forward to. Institute members will be addressing hopefully all the Lions and Rotary clubs on the coast in the next couple of months.

Cheers for now. Ron, VK7RN.



DX Notes

Ross Christie, VK3WAC
19 Browns Road, Montrose 3765, Vic.
Email vk3wac@aol.com

As I mentioned last month my transceiver has developed a fault and has been sent off for repair so I have had to fall back to my old faithful FT101ZD. While my main rig is off for repair I have taken the opportunity to do a bit of maintenance on my antenna system and also to install a new $\partial/4$ vertical and some radials for the 40 metre band. I could not layout as many radials as is recommended in the various antenna handbooks (120), but I managed to get six laid out in straight lines at various angles from each other from the base. Vertical antennas are more susceptible to noise than their horizontal counterparts, so I am not expecting any miracles in performance. I'll operate on 40 metres for a while and try and compare the performance of the vertical to my G5RV and I'll let you know how it compares.

The NOAA Space Environment Center reported that the Boulder sunspot number reached 401 on July 20th. This is the first time during the current solar cycle that the index broke the 400 mark. Such a large value is rare. During most 11-year solar cycles, the Boulder sunspot number will exceed 400 on no more than a few days. Perhaps the cycle has now reached its peak and from now on the sunspot numbers will begin to diminish. From my point of view, I cannot say that DX has improved markedly these last couple of years. Certainly, checking back in my logbook, there was more European DX on the 10metre band a couple of years ago than there is now at the peak of the current cycle.

The prime DX bands have been pretty quiet again at my QTH and there has been little in the way of DX. I did manage to work CO2JD in Havana, Cuba on 20 metres who was buried under a pile-up of JA's. Hopefully others have been more fortunate in working DX than I have this month.

The DX

5R MADAGASCAR. Ken, AD6KA, plans to arrive in early September and operate until the 27th of

September. He has not yet been assigned a callsign, however Patrick, 5R8EW, has jumped in to help out. His activity is expected to be on 10, 15 and 20 metres SSB with some PSK31, CW and RTTY. He will take with him a TS-940, TS-430, AL80A amp and use a Cushcraft R-7000 vertical. If space is available, Ken will try to put up some antennas for the low bands. Most of the operation will take place from the capital Antananarivo. During his trip Ken hopes to activate Nosy Be Island (IOTA AF-057). He can be contacted on email: ad6ka@hotmail.com

5A Vladimir, UY5ZZ reports that George, UY0MF will be signing UY0MF/5A from near Tripoli "during 2000". George prefers to operate on the 17 and 15 metre bands only. QSL via UX5MZ.

5B Dez, G0DEZ will be in Cyprus for the next three years until 2003. He hopes to obtain a 5B4 and ZC4 licences very soon, but for now he is using 5B4/G0DEZ. QSL via G0DEZ, whose address is: Dez Watson, 12 Chadswell Heights, Lichfield, Staffs WS13 6BH, England. [TNX 5B4/G0DEZ]

5B40 CYPRUS. Attention Prefix Hunters. The 59(9) DX Report states Cyprus amateurs may use the 5B40 prefix until the 30th of November. The special prefix is to celebrate 40 years of the Republic of Cyprus.

A9 BAHRAIN. Gus, KH2/K4SXT, has closed down his activities from Nimitz Hill, Guam. He will be active from A9 again in September. Gus has a preference for the low frequency bands, especially 160 metres.

AX8 AUSTRALIA. Steve, AX8AM, will be operating as AX8AM, mainly on CW, from Darwin Northern Territory until the 2nd of November. He has been spotted on 20 metres CW as early as 0630z and as late as 1300z. Also check 40 metres around 1230z. QSL via VK8AM, Steve Salvia, 1

Elliott Point, Larrakeyah, NT 0820, Australia.

D2 ANGOLA. Hossam, SU1HM, is now active as SU1HM/D2 from Luanda, the capital of Angola. He can be found every evening on or around 14160 kHz (+/- QRM) on SSB. Hossam begins operating around 2300z. QSL direct via Hossam El Shenawy, 16 El Daher Square, Cairo 11271, Egypt.

E4 Arie, 4X6UO reports that Gunter, OE1GZA will be active as E4/OE1GZA from Ramallah on an almost regular basis from now on. QSL to Gunter Zwickle, c/o SICT, P.O. Box 1133, Ramallah, Palestine.

FM Gerard, F2JD will be active, on CW and SSB, as FM/F2JD from the island of Martinique (NA-107) for 4 months beginning early September. If he has the opportunity, operation from other Caribbean islands might take place. [TNX F6AJA]

HO1 PANAMA. Operators Wil/DJ7AA, Manfred/DK1BT and Tina/DL6MYL will be active as HO1A from the 16th of September until the 1st of October. The primary purpose of their DXpedition is to participate in the CQWW DX RTTY Contest. However, they plan to be active before and after the contest on all HF bands. Panama is really not a rare country but the team wishes to be active on the WARC and low bands on CW and RTTY which are still very much in demand. For this reason, they will concentrate mainly on these modes and bands. They will pay special attention, particularly on the low bands, to Europe and Asia. For more details and information visit their Web site at: <http://www.qsl.net/ho1a/>

HR HONDURAS. A group from Spain will be active from here from the 17th to the 25th of September. Activity will take place on all HF bands, SSB, CW and RTTY. One of the tasks the group has set themselves is to install 9 new digipeaters. The Spanish team will consist of 6 OM's and 1 YL. They will

work in conjunction with the "Radio Club de Tegucigalpa". This will be more than a simple DXpedition. Although the members are all experienced Dxpeditors, they also have the skills and know-how to work with TNCs, antennas, Transceivers, Eproms, etc. Operation will be from two HF stations, 24 hours a day. Currently callsigns have not yet been issued but the team has requested HQ1R, and is still awaiting the local authority's answer.

M0RAA/VP9 Operator Seiji Fukushima will be on the air from the 21st till the 26th of September. QSL via JH6VLF. Email to s.fukushima@ee.ucl.ac.uk.

Hans, VK4/HE9RFF has sent me a note informing me that he will be off the air for a bit while he reorganises his shack and included a list of stations logged over the past few weeks.

Hans also sent along a couple of

Brian, VK4LV has also sent in a list of stations that he managed to work during June and July.

soon. QSL via VK4AAR, A. Roocroft, POBox 421, Gatton 4343. Australia. Once all the requirements have been

June			July		
Mode	Band	Call	Mode	Band	Call
CW	15	T13TLS	CW	12	7P8AA
	20	9A10C (QSL via 9A7K)		15	7P8AA
	20	CO2JR		15	OM2000
	40	RA0LOM/0		17	7P8AA
SSB	12	ZS5LB	20	J75KG	
	20	4W6GH	20	3A/OH2TA	
	20	FR5FD	20	V51AS	
	20	ZD7HH	SSB	15	A25NL (via JA6NK)
	20	V51E		15	7A32AR
	20	9A4A		20	7P8AA
	20	TX8JNN		20	KL7/W6IXP
				20	1A0KM

IOTA Activity

NA-072 HP, Panama. Wil/DJ7AA, Manfred/DK1BT and Tina/DL6MYL will operate as HO1A from Contadora Island,

met, the reference numbers will be announced, early in the operation.

Special Events

Look for the special event station SN600UJ to be active from the 20th of July until 20th of October. The station will be celebrating the 600th anniversary of the re-founding of "Jagiellonian University" in Cracow. The station is expected to operate on all bands CW, SSB and RTTY. QSL via SP9PKZ [TNX SP9GKM].

SI9, SWEDEN. Another one for the prefix hunters. In conjunction with "King Chulalongkorn Day", the new "Visiting Station in Sweden", SI9AM, will officially be opened on the 19th of July around 0900-1000z at the permanent QTH Utanede, near the King Chulalongkorn Memorial Building (Grid Locator is JP82iw). Special HF activities will take place until 1700z on the 23rd of July. QSL via SM3CVM, bureau or CBA. Operation after the 23rd of July will be open to visiting operators who will be welcome to use SI9AM. The prefix is very rare and SI9AM is the only station in Sweden using the SI9 prefix! For more information, send an Email to si9am@qsl.net or check the Web page at <http://www.qsl.net/si9am>

DXpeditions

AX9YL - YL DXpedition to Norfolk Island. A multi-national team of YL operators from 7 countries will be active on both SSB and CW from Norfolk Island from 5th - 12th October next. The special callsign was obtained by the WIA Victoria for this trip, so QSL will be via the VK3 Bureau or direct to VK3DYL, QTHR, with return postage and SAE.

Mode	Freq. kHz	UTC	Call	QSL
CW	21025	0040	V63KQ	
	18071	0215	4K9C	Bor, Box 315, Moscow 103062 Russia via JH7FQK
	14003	0440	JY9NX	
	14005	1300	BV9C	
	14010	0615	HB0/DA1WA	
SSB	14150	0520	ZK1AXU	via PA3AXU
	14183	0500	KX2J	
	14193	0700	T11Z	via TI4ZM
	14195	0440	JY8TT	
	14200	0500	8P6FU	

interesting snippets of info,

- KB0VE/AM (aeronautical mobile) in a Boeing 757 over Colorado on a flight to Las Vegas working VK3MW. Signals were excellent on 14254kHz at 05:55 UTC.
- SP5AUC is a Polish diplomat in Vietnam operating as 3W7CW. He operates CW only and those who work him can QSL via POB 11, 02-800 Warszawa, Poland.
- The QSL manager for TX0DX has been quick off the mark with the Dxpeditors QSL cards, Hans has received his after only a 3 month wait, very good going indeed. He sent his card out on the 23rd of March and he had his TX0DX card in his hands on the 28th of June. He says he has had a few quick responses recently, 9U5D replied within a month and T77C within 3 months. Congratulations on three good contact Hans.

Panama (NA-072) between the 16th of September and the 1st of October. They will concentrate on CW and RTTY and on the WARC and low bands and will participate in the CQ/RJ WW DX RTTY Contest on from the 23rd and 24th of September. QSL is via DL6MYL. The home page for the expedition is at <http://www.qsl.net/ho1a/> [TNX DJ7AA]

EU-012 The GM7V Multi-Multi team will be operational as GS2MP from Shetland (a separate multiplier from GM) for the CQ WW Phone Contest in October 2000. For more details, visit the Web page <http://www.gm7v.com>

VK8AN Dan, will be joined by VK8DK, Len, and VK8TM, Terry, in a trip to a couple of new IOTA locations in September (Australia's springtime). The operation will take the ops to Browse Island from 1st to 5th of September and Cassini Island from the 7th to the 11th September. Both of these islands will be new IOTA locations (OC-NEW). Callsigns will be announced

KH5 & KH5K, Kingman Reef and Palmyra Atoll. The Kingman-Palmyra DX Group will activate both of these rare ones, Kingman Reef (KH5K) and Palmyra Atoll (KH5) this year. Both prefixes are high on the 'most wanted list' so keep your ears open. Activity will take place in several operations during the northern summer and autumn. The islands are located approx. 1600km south of Hawaii, Palmyra is privately owned and is currently in the process of being sold. The group plan to complete the AR activities with a large operation planned for Kingman Reef sometime in October with activity will be on all bands.

Members of the GACW (Grupo Argentino de CW) are planning an expedition to the Argentine Antarctic Base of Vicecomodoro Marambio (WABA LU-03) located on Seymour Island in the Joinville group (AN-013). Hector, LU6UO, an Antarctic veteran, will be one of the ops. Exact dates for this operation have not yet been determined, but it is expected after September. A special callsign has been requested.

ZD9ZM Tristan da Cunha. Bob Henderson, 5B4AGN/G3ZEM, is planning to begin his activities on Tristan da Cunha on 5th September. If his plans pan out, he will depart Cape Town on 31st of August and arrive on Tristan on 4th of September and be on the air as ZD9ZM on the 5th. All his equipment has been forwarded to rendezvous with the MV SA Agulhas at Cape Town, South Africa. He will be using Cushcraft A3S

and A3WS yagis on 20 metres and above, a Titanex V160S vertical for 160 – 40 m and a dipole is planned for 30m. He has a Kenwood TS870 driving a 1kW amplifier as his main rig with an Alinco DX70TH as a reserve and for checking 6m. His operating will be mostly CW and will be operating a +2kHz split, frequencies ending in 3 will be favoured (e.g transmitting on 14003 receiving 2kHz up). Some RTTY activity will take place if he gets a chance and will be using a HAL DXP38 with a PC running the popular WFB software. Departure from Tristan da Cunha is on the 25th September. QSL is via William G McDowell, K4CIA, 13208 Norwood Road, Raleigh, NC 27614-9134, USA. If you intend to send a QSL direct then be sure to include an SAE with adequate return postage. Cards can also be handled via the bureau in the normal way or requested via Email to k4cia@mindspring.com.

QSL Routes

AX9YL Gwen Tilson, VK3DYL, 3 Gould Court, Mt Waverley, Victoria, 3149, Australia.

XX9AU Cheang Vai Ip, XX9AU reports that "P.O. Box 8005, Macau" can be used also for sending cards to other XX9 stations. He is the "POB Manager" and will forward cards to the appropriate individual.

3A2ARM A.R.M., P.O. Box 2, MC 98001, Monaco Cedex

5H3RK Ralph Karhammar, P.O. Box 9274, Dar es Salaam, Tanzania

5H5A Box 167, Iringa, TANZANIA

5X4CFr. Sebastiano Bianchi, P.O.Box 43, Lira, Uganda

A22HH P.O. Box 13, Maun, Botswana

A47RS P.O. Box 981, Muscat 113, Sultanate of Oman

DL7VRO Fritz Bergner, Sterndamm 199, D-12487 Berlin, Germany

E21EIC Champ C. Muangamphun, P.O. Box 1090 Kasetsart, Bangkok 10903, Thailand

IS0JMA Roberto Alaimo, P.O. Box 41, 07026 Olbia - SS, Italy

PS8DX Raimundo Jose Junior, Rua Cinegrafista Marques 1145, Ininga,

64049-510 Teresina-PI, Brazil

PY2ZY P.O. Box 45436, Sao

Paulo-SP, 00479-970, Brazil
V51AS Frank Steinhauser, P. O.
Box 2516, Swakopmund, Namibia
XW2A P.O. Box 2659, Vientiane,
Laos

Round up

The DXCC has announced a special DXCC certificate to celebrate the new millenium. Amateurs who work 100 countries in the year 2000 will be eligible for the certificate. No QSL cards will be required for confirmation but a certified log must be submitted.

Some 6 and 30 metre news from India. Jose Jacob, VU2JOS, reports that Indian amateurs have been given permission to use 10100 – 10150 kHz and the spot frequencies 50.350 and 50.550 MHz from the 1st of August until the 31st of December 2000.

If you are looking for information on a DX callsign from the recent past, give me a call. I have amassed a large number of DX news-sheets that contain a lot of details that were out of date before it reached me. I have them all archived on my hard-disk and searching for a call should be relatively easy.

Well that's it for this month. Hopefully my rig will be back from repair soon and I can get back on the air and work some DX. If you work some interesting DX or a rare station, please, drop me a line so I can include it in the column. I'd like to know what I've missed on the bands, so would many others!

Sources

Finally, thanks go to the everyone for the items of DX news, including special thanks to the following people and organisations, Gwen, VK3DYL, Hans, VK4/HE9RFF, Brian, VK4LV, F6AJA The OPDX Bulletin, 425 DX News and The Daily DX.

NOTE: In the August edition of AR, acknowledgement of the source of the list of stations participating in the 'International Lighthouse/ Lightship Weekend' was inadvertently omitted. The list was compiled by Bernie McClenny W3UR, who is the author of *The Daily DX News Bulletin*. The list was printed with the kind permission of Bernie McClenny W3UR.



The WIA
Callbook
2001

OUT SOON!



AMSAT
Australia

Bill Magnusson VK3JT

RMB 1627 Milawa Vic 3678 Email vk3jt@amsat.org

The Trend Towards Higher Speed Downloads

The launch of UoSAT-12, now known as UoSAT-Oscar-36 (UO-36) in April 1999 saw a number of 'firsts' for satellites carrying amateur radio equipment. UO-36 is an amateur radio satellite in the sense that it is the latest in the series of educational and scientific satellites from the University of Surrey in England and it has down links and command facilities in the amateur radio satellite bands. From the outset the Surrey group have put a great deal of emphasis on the scientific and educational applications of their spacecraft. That was their initial

purpose and it's still high on their agenda. We are fortunate indeed that Martin Sweeting, G3YJO who headed up the program, saw in the early days, several advantages in making the UoSats "amateur radio satellites".

This decision has meant that amateur radio satellite operators have been able to take part in the march-of-technology that has been associated with the UoSats. It also meant that many schools and colleges were able to elicit the help of local amateur radio operators to use the satellite telemetry for educational

purposes. The Surrey team have also benefited from the large number of "beta-testers" out there in amateur-radio-land.

So Martin's original idea to include amateur radio satellite operators in the team turned out to be a resounding success all round. CCD earth-imaging cameras have long been a feature of the UoSAT program. UoSAT-1 was their first satellite and it became known as UoSAT-Oscar-9 or UO-9 to amateur radio operators when its beacon was turned on in the 2 metre amateur band. UO-9 carried a CCD camera into space back in 1981. It was a ground-breaking effort. CCD cameras had not reached the public domain at that time.

Decoding and display of the images was a daunting task. Home computers of the day were mostly monochrome, CP-M devices. Routines and programs often had to be keyed in by hand as hard drives and even floppy drives were something of a luxury. Pictures were printed in strips on thermal paper and joined together to get the final image. I know of operators who hold those early pictures very dear and still consider them to be among their greatest achievements.

The images were rudimentary by modern standards but the effort required to retrieve them was monumental. UO-9 received so much acclaim that it became the forerunner of a stream of more sophisticated educational satellites and many more CCD imaging projects on a host of different Oscar platforms. Indeed it seems these days that no amateur radio satellite is complete without an imaging experiment.

As CCD chips became more capable, with ever increasing pixel counts, inevitably the final image files became larger. You can't get something for

The AMSAT organisation

AMSAT (Amateur Radio Satellite Corporation) is a worldwide organisation with its roots in the USA. Its origin can be traced back to 1958, just a year after the launch of Sputnik-1. Since that time AMSAT members have been involved in the design, building, launching, commissioning, upkeep and of course, the day-to-day use of amateur radio communication satellites. The parent body is AMSAT-NA (North America) and many other countries have similar special interest groups operating.

AMSAT-Australia

Our local organisation is known as AMSAT-VK. The National Co-ordinator is Graham Ratcliff VK5AGR.

Membership of AMSAT-Australia.

AMSAT-Australia operates an open membership system. No formal application is necessary and no membership fees apply. From time to time new software, firmware and hardware is developed and distributed through AMSAT-VK channels. Write to the co-ordinator to express your interest or pop up on the HF net.

AMSAT-Australia HF net

The AMSAT-Australia net meets formally on the second Sunday evening of the month. During the winter months in South Australia (end of March until the end of October) the net meets on 3.685 MHz +/- QRM at an official start time 1000utc with early check-ins at 0945utc. During the summer months when daylight saving is in operation in South Australia (end of October until end of March) the net meets on 7.068 MHz +/- QRM at an official start time of 0900utc with early check-ins at 0845utc. The times and frequencies have been chosen as the best compromise for an Australia-wide net taking into consideration seasonal propagation changes and the various state summer time variations. The net is open to all amateurs, beginners or experienced who have an interest in amateur radio satellites. Help and information for beginners in particular, no matter how trivial, is freely and cheerfully available on this net.

The AMSAT Journal

An excellent bi-monthly journal is available with formal membership of AMSAT-NA. It contains details of practical projects and ranges over all aspects of amateur radio satellite operations. As of 01Jul00 the cost of AMSAT-NA annual membership will be US\$45 payable to AMSAT-NA 850 Sligo Ave, Silver Spring, MD 20910-4702 U.S.A. or you can phone, fax or email your subscription using your credit card. The phone number is 0011-1-301-589-6062, the FAX number is 0011-1-301-608-3410 and the email address is martha@amsat.org

All Communications regarding any matters mentioned above should be addressed to:

AMSAT-Australia.

GPO Box 2141, Adelaide, SA. 5001.

email, vk5agr@amsat.org

nothing. Better resolution results in larger image files, like it or not. It wasn't long before this began to pose a problem as the larger the file, the longer it takes to download and even the longest low-earth-orbit satellite passes rarely last more than 18 - 20 minutes or so.

The Surrey satellites have long been using a standard download speed of 9600 baud. This has proven to be quite satisfactory for normal satellite BBS, personal mail and even satgate work where files up to 100k - 200k in length are commonplace. Such files can usually be downloaded in one pass.

But things are changing and it's a different story these days. The newer CCDs can produce original 'off-the-chip' files which are many megabytes long. New compression algorithms have been devised to minimise the file size that is transmitted by the satellites but even so, the file size from the high resolution cameras is such that it would take several passes to successfully download each file using 9600 baud down links.

As a result, UO-36, the latest from the Surrey stable, was designed with experimental high speed download capability. Currently the 38.4 kilobaud (38k4) downlink is turned on.

"Great", I hear you say. Yes it is great. It solves the problem of download time but like most innovations, it imposes more stringent requirements somewhere else along the line. In this case, on the ground station. Years ago when downlink baud rates went up from 400 to 1200 and then to 9600 we found that it was no longer possible to feed the audio signal into the microphone socket as the bandwidth of the audio section of amateur receivers was far too narrow for the job. Even using direct Frequency Modulation of the carrier rather than Audio Frequency Shift Keying (AFSK) was not sufficient at 9600 baud to allow the data to be fed in via the microphone socket. That meant modifications to the transceiver.

Although a number of manufacturers claimed to address this problem it was not until very recently that one could buy a transceiver off the shelf that would cope with 9600 baud satellite work. The late model Icom 821 and more recently the Yaesu 847 still have the field to themselves. Most operators undertook modifications to their transceivers which included tapping points at the balanced modulator and discriminator

sections for the input and output of the data. Even the ubiquitous Yaesu FT-736-R which found such favour with satellite buffs needed this treatment to cope with 9600 baud data from the satellites.

So now we come to the current 'fly-in-the-ointment'. Increasing the baud rate to 38k4 imposes requirements that cannot be met in the same way as the 9600 baud solution. The IF bandwidth of amateur radio transceivers isn't wide enough, nor do they have the pass-band shape to cope with the passage of 38k4 data. In the world of commerce, specially designed data transceivers are available but these are very specialised and expensive.

Another problem is that they are designed for point to point operation and satellite operation introduces an additional problem in compensating for doppler shift. Since most amateur ground stations use automatic doppler correction these days it would be very desirable to retain the front-end of your transceiver for this purpose. Using a fixed frequency data receiver could make it difficult to implement auto-tuning.

A German company, SYMEK (with whom I have no connection other than being a satisfied customer) have come up with a solution. They produce data transceivers and it so happens that at least one of the company Principals has an interest in amateur radio satellites. They have introduced a product into their range which neatly addresses the 38k4 situation. They call it an IFD board. Essentially it is the IF strip of one of their data receivers. It is inserted into the signal path prior to the normal IF strip in your transceiver and introduces a wide band, flat topped response to suit the higher speed data. Output to the 38k4 modem is taken directly from the IFD board.

I recently installed one of these boards in my aging Icom IC-471 transceiver. The installation involves identifying and cutting a track on the RF-YGR board and soldering in two thin co-axial cables which route the signal out and through the IFD board and back again. Normal operation of the transceiver is not affected. Of course you need a modem capable of working at or above 38k4.

If you are using a G3RUH modem in conjunction with a packet TNC, as many present digisat operators do, it is possible to do some mods to achieve

38k4 operation. I am gathering information on these mods for a future column. I believe however that 38k4 is about as far as you can stretch this mod and any future increases in download speed would mean a new modem altogether. For this reason I chose one of the range of high speed modems available from SYMEK.

My modifications went smoothly and the station is now happily downloading megabytes of data on each UO-36 satellite pass including individual picture files of well over a megabyte each. The download rate is quite startling. My connection to the internet ISP (theoretically) allows 56k download rates.

But the proof of any pudding is in the eating. In practice I can download at the rate of about one megabyte every 10 - 12 minutes. Some will better this no doubt but mine is a pretty typical installation and that's all I need at present as I rarely ever 'surf-the-net' and email is my main concern.

It seems to compare favourably with other internet friends who have a 'normal' ISP account. By comparison working with PacSat Broadcast Protocol rather than TCP/IP as on the net, I can achieve a download rate of up to one megabyte every 4.2 minutes from UO-36. I have a friend who maintains a dedicated high speed line for internet use. His main area of interest is real-time video-conferencing so he has installed the best high speed link available to facilitate that. He can download a megabyte every 15 seconds or so and regularly downloads 180-200 megabytes in an hour.

Now to be sure the satellite isn't in the sky all the time and the system lacks the "instant gratification" of the net, but it's not all that bad. It's even caused a few of the friendly knockers among my computer-buff friends to re-assess their situation. With the expected increase to 68k7 and higher, the satellite connection will be far more capable than an average internet connection and exceeded by only the fastest and most expensive dedicated lines (and it's all happening on Amateur Radio!!).

I certainly feel the effort was well worthwhile even though it is imposing strains on my equally ancient computer to adequately store and process the image files. Oh well ... more upgrades on the horizon. It seems that there is always a "weakest link" at the ground

station every step of the way in this satellite business. But that just serves to keep you on your toes! Even higher baud rates are planned, so the future of amateur radio satellite imaging seems certain to remain a source of fascination for more and more operators around the world.

The current state of the art in the Surrey satellites produces images which are stunning. Their narrow angle cameras have an on-the-ground pixel size of some 10 metres square. Compare this with the NOAA HRPT pixel size of about 0.9 km square, remembering of course that the NOAAs are designed to take cloud pictures and make no claim to great ground detail. On UO-36 pictures taken over large metropolitan areas, streets and individual properties are discernible. In images of coastal areas, piers and marinas and larger boats become visible.

Many of these pictures looks more like high altitude aerial photographs than satellite images. The multi-spectral images allow almost natural colouring to be achieved by marrying together three images from different parts of the light spectrum. This feature would have been quite impossible using even 9600 baud download rates. It involves downloading three quite large files and their associated thumbnail images to reconstruct the final picture.

Colin Hurst VK5HI has been a key figure in this sequence of events. His editing and display programs have become the 'industry standard' in amateur radio satellite imaging. Colin has spent countless hours developing his programs to the stage where they are so intuitive and reliable that we almost take them for granted. In fact we would all be lost without them. We owe people like Colin and Chris and Martin and the team at Surrey a huge debt of gratitude for the marvellous educational tools that these satellites are ... and have been since the very early days.

Many teachers, myself included used UO-9 and UO-11 telemetry downloads back in the early 1980s in the teaching of lab electronics and maths. Things have certainly come a long way since that time but the Surrey satellites are still playing an important role in schools and colleges and in University education. They have been used by humanitarian aid agencies, supporting technical and medical services, working with highly

portable, compact ground stations capable of being taken into remote, unserviced problem areas. Surrey, through its commercial arm Surrey Satellite Technology Limited (SSTL) has pioneered this form of affordable satellite communication. Its UoSat series has spawned a very successful venture called "technology transfer" where students from overseas universities go to Surrey and become involved in the design and construction of their own UoSat-based communication satellite.

Back in their own country they arrange for launching and commissioning and establish the control facilities. The idea being that these people will go on to form the backbone of their country's emerging communication industry. (See "Advance News" announcement below).

The SYMEK company maintains a site, www.symek.com on the world-wide-web. Information regarding their modems and IFD board is available from that source. It would be great to see more VK/ZL callsigns in the broadcast queue of UO-36. Plenty of help is available for those contemplating a move to the high speed down links. They appear to be the way of the future. More next month.

Advance News of More Digital Satellites for the Amateur Radio Bands

News is just to hand from the Amsat News Service at the time of writing, of more imminent launches of experimental satellites carrying digital amateur radio packages. Hopefully these packages will be in the commissioning stages when you read this column.

New Saudi Amateur Radio Satellites

The first Amateur Radio Satellites from the Kingdom of Saudi Arabia are presently being built by the space research Institute at the King Abdulaziz City for Science and Technology in Riyadh. Tentatively set for launch August 25, 2000, these satellites will be capable of 9k6 digital store and forward operation (Pacsat Broadcast Protocol compatible) as well as FM bent pipe mode.

These satellites will use the following downlink frequencies. Uplinks are in the VHF Band and will be announced after commissioning.

SAUDISAT-1A

SAUDISAT-1B

Downlink 437.075 MHz

436.775 MHz

New Malasian Amateur Radio Satellite

The first Malaysian Amateur satellite 'TIUNGSAT - 1' is to be launched on 25th August, 2000 from Baikonur Cosmodrome, Khazakstan which is the same launch as Saudisat, above.

Details of 'TIUNGSAT - 1' (named after the malaysian bird "Myna")

Data transmission will be in FM and FSK modes at a data baud rate of 9K6, 38K4, and 76K8.

Tiungsat-1 will have RF links as follows,

Uplinks 144.460,
145.850 and 145.860 MHz.

Downlinks 437.300,
437.325, 437.350 and 437.375 MHz.

This is as a result of technology transfer collaboration between Astronautic Technology, Malasia and Surrey Satellites Technology Ltd. (SSTL), England.

ar

Astronomy net

The Astronomical Society of Victoria has its own callsign: VK3EKH. Using that callsign, Russell Ward has been conducting an amateur radio net for hams and short wave listeners on the subject of astronomy since August 1989. The net commences each Friday evening at 10.00 est on 3.543 MHz. Russell lists astronomical news for the week and invites stations to call in. There are a few regular stations that call in each Friday and, over the years, over a hundred stations have taken part.

Many shortwave listeners enjoy listening to the net. Topics discussed range widely over the subject of astronomy and include matters of interest to amateurs such as meteor scatter propagation, sunspot an auroral activity, satellite communications and meteor showers. New stations are made most welcome.

ar



Jack VK3WWW

Phone: 03 9873 2459 Fax 03 9428 1589 Mobile: 0408 037 065

Email: vk3www@alphalink.com.au

“Home and Away” Fox Hunts

China 2000. During the month of September and early October many competitors attending the 10th ARDF world Championships to be held in Nanjing China, (2hrs from Shanghai) will be training very hard and making lots of equipment checks making sure the body and equipment are in top shape. Friday October 13th is arrival day but most competitors will be worn out from travelling great distances to attend, so usually, there are no activities planned for that day.

Saturday is training day, and the opening ceremony. Training for most consists of testing and tuning your 2m and 80m equipment eliminating any problems before they occur. It is customary for the Society, in this case the Chinese Radio Sports Society (CRSA) to provide test signals. For those interested in equipment and what the opposition is using, this is probably the best time to compare notes and test out some of your competitors equipment.

Following the training is the opening ceremony, this event provides a great photo opportunity with all the teams wearing team colours, and carrying their national flag. Sunday. 2m event, this is

when you find out how good your preparation has been. I remember waiting to be transported to the start of an International event watching the rain come thundering down. I was carrying a plastic bag to cover the sniffer just in case, but you would be amazed how many competitors were not prepared for this situation. Many a competitor who experienced equipment failure due to water learned a hard lesson. According to an information sheet October is the best season for the competition area.

Monday is a rest day, a good chance for the cuts and scratches to heal. Usually before the first event there is a lot of tension, but once it is over friendships are much easier to make. So during the local tour planned for the rest day everyone has a great time chatting.

Tuesday. 80m, this is similar to the 2m event but should be in a different area one good thing about 80m is the size of the equipment, you don't have to lug around a large yagi. If you ever get a chance to attend a local ARDF event and all that is left for loan are 80m sniffers, don't stress for with a good sense antenna 80m dfing is much easier than 2m. Tuesday evening is the Closing

Ceremony followed by a Banquet, and providing you have not over indulged too much Wednesday is departure day. I have been informed members of the VK team will stay on for a few extra days for some sight seeing.

I am sure you will all be cheering for the Australian team.

Ballarat Hamfest. On Saturday October 28th 2000 there will be an ARDF event. This event will loosely follow International rules, and by doing this, give those interested in the sport a chance to experience real ARDF competition. Listen to your local broadcast for more information or visit: <http://www1.tpgi.com.au/users/ddi/barg/barg.htm>

Since writing my last column I have received a few requests for sniffer engines and antenna designs, in the next article I will list some designs and contact details for information.

In closing I would like to thank Luke Gillett (SWL) from the VK3YQN foxhunt team who provided me with the excellent digital images taken during the Australian Foxhunting Championships held in Mount Gambier, and published in the July edition of AR.

ar

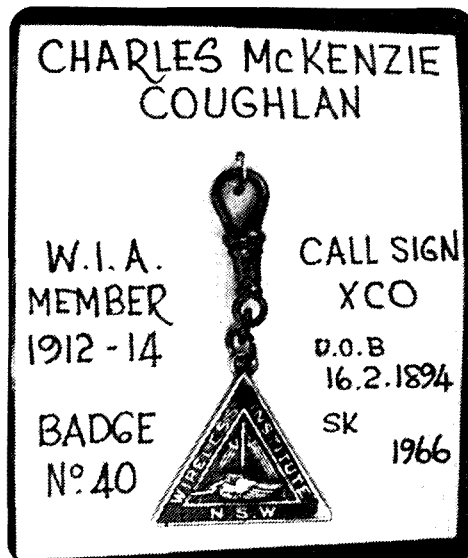
Charles McKenzie Coughlan XCO

Charles Coughlan joined the WIA NSW in 1912. When World War 1 broke out in 1914 he enlisted in the army. At wars end he stayed in the Army for a further two years in England. On his return to Australia he did not pursue the hobby of Wireless Experimenter(Amateur Radio).

His membership badge is shown in the attached picture and the original is in the WIA NSW Museum. Charles was born on 16 - 2 - 1894 and died in 1966.

Note - Callsign XCO would now be VK2CO

A. Jopp VK2AXT VK2 Librarian and Curator of the VK2 Museum. PO Box 883 Parramatta NSW 2124.





John Kelleher VK3DP
Federal Awards Officer

4 Brook Crescent, Box Hill South Vic 3128, (03) 9889
8393

Listening around the HF bands lately has been a real pleasure. On one day alone, over a period of three hours, I heard over 70 stations worldwide. This must be a real boon to DXers and award chasers

In response to requests for award information on certain DX countries, I am including those with a definite Scandinavian flavor.

Norway — WALA (Worked all LA Award)

OZ, OH, SM, LA, TF and OY applicants need 2 contacts on separate bands with 19 counties of Norway. All others must work 19 different LA/LB's at least 6 of which are north of the Arctic Circle. JW/Svalbard, JW/Bear Island, and JX/Jan Mayen count. Contacts after Jan 1 1950. SWL OK. No repeater, satellite, or crossband. GCR list and Fee of US\$3.00 to :-NRRL, PO Box 21 Refstad,N-0513 Oslo 5, Norway.

The list of counties required.

A-Oslo; F-Buskerud; L-Rogaland; V-Nord-Trondelag; JX-Jan Mayen; B-Ostfold; Z-Vestfold; R-Hordaland; W-Nordland; C-Akershus; H-Telemark; S-Sogn ag Fjordane; X-Troms; D-Hedmark; I-Aust-Adger; T-More ag Romsdal; Y-Finnmark; E-Oppland; K-Vest-Adger; U-Sor-Trondelag; JW-Svalbard/Bear

Sweden The WASM II Award

This diploma, issued by Sveriges Sandareamatorer (SSA) is available to amateurs all over the world. The Class A is for amateurs located in LA, OH, OZ and SM. The Class B is for amateurs worldwide. All contacts must have been made since Jan 1 1953. Any one of the amateur bands is allowed, and contacts to be made in CW or phone, or any combination of both. Sweden is divided into 25 different laens (or Counties) :

A-City of Stockholm, SM5 and SM0; B-Stockholm laen, SM5 and SM0; C-Uppsala, SM5; D-Sodermanlands SM5; E-Ostergotlands, SM5; F-Jonkopings,

SM7; G-Kronobergs, SM7; H-Kalmar, SM7; I-Gotland, SM1; K-Blekinge, SM7; L-Kristianstads, SM7; M-Malmohus, SM7; N-Hallands, SM6; O-Goteborgs och Bohus, SM6; P-Alvsborgs, SM6; R-Skaraborgs, SM6; S-Varmlands, SM4; T-Orebro, SM4; U-Vastmanlands, SM5; W-Kopparbergs, SM4; X-Gavleborgs, SM3; Y-Vasternorrlands, SM3; Z-Jamtlands, SM3; AC-Vasterbottens, SM2; BD-Norrbottnens, SM2

Amateurs in the Class B area must submit proof of having established 2-way communication with each of the 25 laens on two different bands (50 QSL's).

Applications for the WASM II must be accompanied by a verified list of claimed stations and 7 IRC's or equivalent. QSL cards need not be sent, provided the list of claimed stations is signed by an officer of the applicant's own radio society, certifying that he has seen the cards.

Address the application and confirmation list to :-

WASM II Manager, SM6ID, Karl O. Friden, Morup 1084 311 03 Langas Sweden.

Finland The OHA Award

This award is available to all licensed amateurs. GCR rules are accepted. Contacts must have been made after June 10 1947. The fee for this award is US\$3.00, unless otherwise specified. Applications should be sent to :-

SRAL Award Manager, Jukka Kovanen, Varuskunta 47 as 11, Riihimaki 31 SF-11310, Finland

Non-European applicants need contacts with 15 different OH including at least 5 OH areas on any band or combination of bands. Contacts made on 3.5 MHz will count for 2 contact points. CW, phone or mixed mode contacts counts. Minimum acceptable report is 338 RS(T).

Denmark Worked Scandinavia on CW

Applicants work 100 cw stations from 5 of the following : LA, OH, OY, OZ, TF and SM.

SWL OK. Contacts since Jan 1 1988. The award is a full colour photo of a peaceful scene of a family picnic somewhere in Scandinavia. Special sticker for QRP stations. Logbook list confirmed by two other amateurs with fee of US\$7.00 to :-

Rick Meilstrup OZ5RM,
Geelskovparken 12/1, DK-2380
Virum, Denmark.

Thank you for your continued support. Best 73 de John, VK3DP.

4S7RS 50 Years of Amateur Radio

Special Event Callsign Prefix To Mark The Golden Jubilee Of The Radio Society Of Sri Lanka

The Radio Society of Sri Lanka (RSSL) will be celebrating its Golden Jubilee in July 2000. To mark this event the members of the RSSL will be using a special Radio Amateur Prefix during the period July 1st 2000 to June 30th 2001.

A special Jubilee Awards Certificate would be presented to any radio ham (outside 4S7), who produces proof of 2-way contact (one or more modes, multimode/multiband) with 20 Radio Amateurs located in Sri Lanka, during the contest period.

To obtain this certificate the applicant should:

- 1) Submit proof of contact with required 20 contacts on different bands with certification by 2 other active hams.
- 2) Send to: The Awards Manager,
The Radio Society of Sri Lanka,
P.O.Box 907,
Colombo,
Sri Lanka.

With written application and 5 IRC's.

Tks es 73,
T.Adrian – 4S7PR,
Hon. Secretary,
The Radio Society of Sri Lanka.

Does the VK/ZL Contest need a revamp?

Tony Burt VK3TZ

3 Moyston Cl., Vermont South 3133

It was with dismay that I read the results of the 1999 VK/ZL contest in the May edition of AR. The commentary by the Federal Contest Coordinator, Ian, VK3DID indicated that the contest manager felt that perhaps the contest should be abandoned. This was very disheartening to me, but the number of entries from Oceania, certainly indicate that there is a distinct lack of interest. Thus, I concur that the viability of the contest is certainly in question. With the passing of each year, I am disappointed with the lack of interest that only seems to get worse.

However, I feel that it is important for the contest to continue, as I believe that it is the only truly international DX contest representing Oceania. I feel that it is important that at least one international contest is run from this continent, for contesting as well as Dxing from Oceania is suffering as a result. The attention paid to Oceania DXers by the major DXpeditions is dwindling and making it more and more difficult for Oceania DXers to achieve some of the major milestones in Dxing, such as DXCC honour roll, 5BWAZ or the new 1500 Band country DXCC award.

Therefore I suggest that the all facets of the contest should be closely scrutinised to identify why there is a lack of activity from here and abroad. Hopefully, any failings that are identified may be addressed and the event may return to its more successful past. I have identified a number of points that I feel could be used to address the current situation and hope that others may voice their thoughts, either in support or disagreement so that "our" DX contest can return to the world stage.

Awards and certificates

The contest does not really recognise any of the efforts made by international competitors or the participation of entrants from other countries within Oceania. In fact, the only awards that I know of are for the best CW entrant from VK. This is a poor state of affairs and needs to be addressed. There should be recognition for the best entrant in each category, for each of the continents, and for each country within Oceania where there is an entrant. This may only be a special certificate and a mention within the results in AR magazine but it needs to be done to acknowledge effort and success where it is due. I personally

believe it is not too much for the major national organisations within Oceania to each sponsor a trophy or plaque, the cost of which should not be more than \$50 or so per annum. I may even go as far to say that each division within the WIA, as well as a number of the major regional clubs, could easily afford a minor award. If the ARRL (KH6) NZART, FK, YB and one or two others, sponsored a trophy we could have the following:

Plaques

No.	Category	Sponsor
1.	Best Score Oceania SSB	WIA Federal
2.	Best Score Oceania CW	NZART
3.	Best Score Oceania Multi-Single	FK
4.	Best Score Oceania - Sprint Category SSB	YB
5.	Best Score Oceania - Sprint Category CW	KH6 (ARRL)
6.	Best Score EU - SSB	VK3 DIV WIA
7.	Best Score AS - SSB	VK2 DIV WIA
8.	Best Score NA - SSB	VK7 DIV WIA
9.	Best Score EU - CW	VK4 DIV WIA
10.	Best Score AS - CW	VK5 DIV WIA
11.	Best Score NA - CW	VK6 DIV WIA
12.	Best Score SA - SSB	Club or individual Sponsor
13.	Best Score AF - SSB	Club or Individual Sponsor
14.	Best Score SA - CW	Club or Individual Sponsor
15.	Best Score AF - CW	Club or Individual Sponsor

There should also be recognition for the best scores from each call area in VK and ZL, and if warranted YB. This may simply be a certificate and a special boxed area within the reporting of the results in AR to indicate the top scoring stations.

Multi-multi versus multi-single category

For the past couple of years, myself, VK3WWW, VK3BF and a quite a few

members of the EMDRC have spent a good deal of time setting up portable antennas in a remote location, field day style, as a multi-operator entry in the SSB section of the contest. As far as I am aware, we were the only multi/multi effort in the contest. The fact that the station was not indicated as such within the results was also disappointing. Was the ZL6QH operation a Multi-multi, their scores were certainly *fantastic!*

We have certainly gone to a lot of effort to erect three beams and low band

antennas, assemble multiple computers with logging, amplifiers, rotators, towers, cables, etc. I think we actually spend more time and manpower erecting the antennas and assembling the operating stations than we do on air. Our preparedness leaves a good deal to be desired, and our results are a lot poorer than many of the top single operator stations, but we are attempting to

give new operators and contest novices a chance to operate with some experienced people in a quite rural spot.

However, I doubt that all the extra effort required to set up a multi-multi station is worth the effort. There is not the expertise to do it correctly, nor the interest. I think that only the crew at ZM2K have operated reasonably successfully in a multi-multi configuration from Oceania. Sure there have been other top class Oceania multi-multis but these have been manned by

European, American or Japanese crews. My point is that it would be far more appropriate to have multi-single category than a multi-multi category. How many multi-multi equipped stations in Oceania do you know about? However, I believe that there are plenty that would be suitable as a multi-single!

A category for the time poor contestor

One of the reasons I think many skilled operators, who have effective and very capable stations, do not enter contests is that they simply do not have the time to dedicate a whole weekend to a contest. And let's face it, there is far less motivation to participate if there is little hope of actually winning an event. As far as international HF contesting is concerned our contest is a short one, being only 24 hours in duration. But to be competitive an entrant must compete for much of this 24 hour period, including a distinct lack of sleep. If there was a category that allowed capable operators to compete, with a chance of winning something without tying up a whole weekend, then I believe this would result in an increase in participation rather than a decrease.

Thus, I propose that a new category be introduced that permitted entrants to submit a log with a maximum operating time of 8 hours. This would permit a couple of stints at the radio and allow the operator the luxury of structuring their operating around such things as work, family, known TVI blacktimes, meal times or whatever the operator chooses. Only entries in the 8 hour category would be judged against each other. I believe this category would make contesting a lot more fun, rather than turning contesting into a seemingly endless grind. I guess it is a bit like asking the average jogger to compete in a marathon rather than a 10km fun run. The activity is the same but more suited to the average "man on the street". Even though the thrill of winning the marathon may be far more rewarding, participating in the fun run is probably more enjoyable for the majority.

The 8 hour category may also bring a lot more strategy into the contest rather than brute power or persistence. I truly believe such a category will result in more participation and more enjoyment.

Start and Finish times

With regard to the start and finish times for the contest, I also believe that there could be an improvement here. The 6.00 pm finish on Sunday night leaves the EMDRC little time to pack up the field day station, so we start dismantling early in the afternoon. We loose operators and operating time, as well as incentive. For the ZL guys it is worse and for any Oceania stations further East it is ridiculous. I think that it would be better to schedule the contest so that the contest starts mid afternoon in Eastern VK.

It is not too late to operate from ZL, FK or 3D2 before the eyes get too heavy. At the moment these guys are starting the contest at 8.00 or 9.00 pm, not what I consider ideal, but some input from ZL and the Pacific Islands is needed. For the VK6s and YB0s the contest would start around midday on the Saturday, enough time to do the shopping in the morning and play with the kids, or a round of golf on the Sunday afternoon after the test.

Contest name and emphasis

I believe that the contest emphasis should be shifted from VK/ZL to Oceania. For this contest to be better patronised the contest must be able to attract entrants from other parts of the globe as well as Oceania. Remember that this is a HF contest, the only one that is run specifically for Oceania. We should drop the VK/ZL from the contest name and simply call it the Oceania DX contest.

To shift this emphasis to Oceania we also need to ensure that some of the other more populous countries within Oceania participate in reasonable numbers. There are literally thousands of hams in Indonesia and quite a few from the Philippines and New Caledonia. We need to address this by requesting their participation and ensuring that they feel it is their contest as well.

Bands

The last time 160m was included in the VK/ZL contest was some years ago. I think that the band was deleted from the contest when a well known, very successful and competent contestor suggested that the contest should be structured as a DX contest rather than a

local contest. I agree with that sentiment but believe that at the moment we need both local and DX participation to renew the contest.

At the time, each QSO on 160m was worth 20 points per QSO as well as each prefix on that band adding a multiplier. As such, it only took a few QSOs to make quite a significant change to the final score. Perhaps the score increase was more than was warranted by the few QSOs made and the ease of making them, but I believe that the deletion of the 160m band from the contest has also contributed to the decline in interest. The rules at the time were there for all to see, read and analyse before the contest. It was not worthwhile to spend the whole contest on 160m but it was worth while to spend some time there, perhaps 20 – 30 minutes working mostly local QSOs. The winner of any contest should be not be due only to a better equipped station, greater skill or experience, but also due to a better strategy.

I therefore suggest that the 160m band be re-introduced into the contest, knowing that QSOs on this band are most likely to be Oceania to Oceania, but realising that activity on 160m should be encouraged. To ensure that the relative merit of QSOs on each band is kept reasonably fair, the points per QSO on 160m should be adjusted as described in the following section.

Oceania to Oceania QSOs

The first time I ever put in a serious effort in the VK/ZL contest was in 1994. At this time the rules included QSOs on 160m and permitted VK to VK and ZL to ZL contacts on the low bands. This made the contest part DX contest and part local contest, since the majority of QSOs on the low bands were between contest stations in the Oceania continent. The points scoring system meant that there were easy points to be made by single hop or local contacts on 160 and 80m. Each 160m contact was worth the equivalent of 20 QSOs on 20m! Whilst this points scoring system did little to encourage DX contacts during the evening, it did encourage some local activity and activity on the low bands.

In the SSB contest, there is a distinct disadvantage for VKs on 80m due to the DX window that is so narrow to permit only one station at a time. The ZLs have

a much better opportunity to work quite a few multipliers into the USA and Japan since they have a good deal of bandwidth in the DX portion of 80m.

I propose that the 160m section of the contest be re-introduced and the rules be changed to permit intra-country contacts on any band, but with the proviso that these contacts are not worth as many points as a inter-continental QSO. Since the low bands permit relatively easy contacts within the Oceania region there should be no difference between the points scored for a 3D2 to VK3 contact and the points scored for a VK6 to VK4 contact. I suggest that there be no distinction between intra country QSOs and inter-country QSOs within Oceania. My proposal for the points scoring on each band is as follows:

Band	OC to	DX to
	OC QSO	OC QSO
160m	3	20
80m	2	10
40m	1	5
20m	1	1
15m	1	2
10m	2	3

Multipliers

Currently the multipliers for the contest are the number of prefixes worked on

each band. I suggest that this be altered so that the emphasis is to work DXCC entities (countries) and the different region of the more populous countries of Japan, the USA, Russia and Canada as well as the call areas for VK, ZL and YB. For the DX the multipliers are the number of current DXCC countries from Oceania worked on each band and the number of different call areas for ZL, VK and YB.

So for Oceania stations, working a N1 is a multiplier and working a W1 or K1 is the same. Thus, there would be 334 entities plus ten multipliers from VK, ZL, YB, USA, VE, JA and UA. For non Oceania stations the multipliers are the 60 or so DXCC entities in Oceania and then multipliers from VK, ZL and YB. I have pondered using the states of the USA, provinces of VE, prefectures of JA and oblasts of UA as multipliers but the difficulty in obtaining the correct information would probably make this unworkable for all but the major contests. The "call area" multiplier is easier for the contestor as well as contest coordinator to score and administer.

This moves away from the prefix as the multiplier and places emphasis on working DXCC entities. Since the attraction to work Europe has a distinct advantage here, the additional

multipliers for Japan and North America helps to alleviate this disadvantage. Thus, the Oceania contestors should pay roughly equal attention to the three major population areas.

I am tempted to suggest that multipliers for the continents of SA and AF be awarded double or perhaps triple value, to increase the time Oceania contestors spend looking towards these continents. Thus, working a ZS or a PY would increase the multiplier count by three rather than just one if a station from North America was worked. Since for most Oceania stations, the paths to these continents do not cross the equator, there should be a greater reward for working them since the non trans-equatorial paths are more difficult.

Summary

I am sure that there are more options to try. What do you think? I am keen to get your opinion via a response to AR or via email to jennyb@alphalink.com.au. The most important question is:

If these suggestions were incorporated into the "Oceania DX contest" would you participate and submit a log?

Regards, Tony, VK3TZ.

ar

IARU/WIA Monitoring Service SUMMARY FOR JULY/2

Gordon Loveday VK4KAL,

Email: vk4kal@telstra.easymail.com.au

FREQ	DATE	UTC	EMM	DETAILS
01.823	300700	0930	J3Eu	UiBC + UiCARR. Lang U/known
03.560	2007	1105	A3E	R.Korea I.D. Pos Pyongyang
14.060	0307	0955	R7B	Uidata sigs 4 kHz wide
14.177	1007	0930>	R7B	WBD (wide Band Data) nil info
14.210	200700	1000	A3E	UiJam, R.Taipei, H2/7.105
14.2115	2007	0952	F1B	RDL Mosc Military Radio CIS
14.222	1007	1000	R7B	UiData type signals, nightly
14.230	2407	1040	A3E	H2/7.115.V of PUJIANG-Shanghai
14.245	1807	0918>	N0N	UiCarr, Nil bearing given etc
14.250	200700	0930	A3E	R.Korea Pos I.D. H5/2.85 Lo Mod
14.290	2007	0840	A3E	H2/7.145m N.Korea Pyongyang
21.435	1907	2130	A3E	R.Korea, Same Pros as 14.290
28.650	1002	2215	A3E	This Cuban Stn has not been heard since this time, so we must assume it has left our frequency. Some notes interest— JJY on 8 MHz and 10 MHz, has been issuing magnetic storm warnings for July 14 to 16 by CW ... U U U; WWW/H has more detail at 18 mins past/hr and 45 mins/hr. It would seem Cycle 23 is getting "into gear", so reception of intruders will be unusual until condx settled down. For July, over 30 data intruders were observed, not included in summary, no point at this stage.

Late Reports

14.100	3107	0000	J3E	YBO amateurs/CB QSO. Much QRM
14.115	3007	0620	J3E	CB type op/much QRM, 2 way net
14.120	1107	0830	J3E/1	M & F voices + Beacon
18.130	1007	1107	J3E	Non amateur ops
18.155	2607	0026	A3E	Ui stn, very weak.



AN
EXPANDING
WORLD

David K Minchin VK5KK

Postal PO Box 789 Salisbury South Australia 5108

E-mail: tecknolt@arcom.com.au Web page: <http://www.ozemail.com.au/~tecknolt>

Fax +61 8 82346396 Phone NEW NUMBER 0403368066

All times are in UTC

Aurora Australis Strikes In Southern Australia

The 11th of August 2000 saw a significant Solar event resulting in Aurora's in both Northern & Southern hemispheres. While the Aurora was not as widespread as some (i.e. to more Northern areas) it certainly provided a number of contacts throughout lower VK2, 3 & VK5.

Russell VK3ZQB reports ... "Worked a heap on 2m Aurora 12/8 from 0750 to 0917 UTC. by then everyone had worked everyone else and it was down to taking turns calling CQ. Worked VK7JG 3-9 0750UTC, VK3XPD 3-9 0800UTC, VK5DK 4-9 0805UTC, VK3KEG 4-9 0819UTC, VK5DJ 4-5 0834UTC, VK3TLW 4-9 0839UTC, VK3YY 4-9 0840UTC, VK3ZLS 4-9 0913UTC, VK3AEF 4-9 0914UTC, VK5LP 4-7 0915UTC, VK3EK 4-9 0917UTC. Heard a VK2 in the dog pile at one stage but did not work him. There were many others there as well VK7ZPB is one I heard. 1200UTC all seems quiet, can't hear any signs even on the beacons... A good turn-up for a otherwise dull day." ... VK3ZQB

Doug VK3UM reports on the Aurora but also some of the more finer details of Auroral propagation as well as some tips towards more effective operation ... " Thanks to Trevor VK3KEG I was able to get on and enjoy an extended Aurora opening commencing about 1800 hours EST 12/8/2000. It lasted to well after 2100 when I 'gave it away'. Given the length of the opening I was able to observe the Doppler shifts and relationships to distance and beam headings, something I had wished to do for ages.

At the outset I wish to make it quite clear that the Doppler offset frequencies I quote may not be exact as assumptions of the transmit frequency, in some instances was not confirmed. However on the other hand most were confirmed either verbally or by listening to the stations fundamental transmit frequency. I was using a Yaesu FT-847 at the time and the measurements given below were very easy to tabulate.

The Aurora coverage was also interesting in that it did not seem to extend much further west than Millicent (VK5DJ) and further south than 'Launceston' VK7JG & VK7XR, north/east to Nimmitabel VK2TWR and probably north to myself? We were aware that Adelaide, Sydney and Canberra were alerted but nothing from them (nothing workable from Metro Adelaide .. VK5KK) was heard from these areas at this QTH. This is a little different to many past openings I have participated in over the years, when the coverage area extended greater than that witnessed on 12/10/00.

Now to some observations. At 1800 the single peak (in the past I have noted multiple peaks) was about 160° and with time moved through 180° to about 195° and slowly returned to about 165° at 2100. It was interesting to watch the shift in Doppler by turning the beam. For example listening to Russell VK3ZQB (who was 9+) from beam headings of 160-190°, the Doppler varied from 235- 375 Hz. Thus beam heading (as has been known for ages) has a bearing on Doppler off set. On 144MHz this is not too important but on 432MHz (or 3 times 144MHz) it takes on more serious implications.

Any way this is what I observed for what it's worth. VK3KEG 4/8 +225 ... VK3ZQB 4/9 +235 ... VK5DK 4/9 +525 ... VK5DJ 3/5 +568 ... VK7JG 4/9 +465 ... VK2TWR 4/5 +280 VK3EK 4/8 +410 ... VK3TLW 4/8 +430 ... VK3AEF 4/7 +500 ... VK3DMW 4/5 +440 ... VK7XR 4/9 +323.

As I mentioned above I could further vary the Doppler shift by greater than 150 Hz by shifting the beam heading.

One may postulate why this is so. I have always used the analogy of 'looking

up at a waterfall'. The moving water coming towards you relates to the positive Doppler shift and from where you are standing relates to its magnitude.

What does this all mean? Well to anyone coming across an Aurora signal for a first time, with its 'rough distorted raspy note' there are a couple of fundamental things you can do to make it more easy to work stations.

1. Turn your beam south
2. Work cw! It is the most efficient communication for this propagation mode!
3. Switch to Tx Rx split VFO or use your RIT
4. Do not try to transmit on the received station resolved frequency. (You will end up chasing yourselves in circles)
5. Assume the transmitting station is transmitting on an even kHz increment.
6. The received station will always be higher in frequency to what he is transmitting on. This will vary, but set your RIT to about +450 Hz as a good starting point.
7. Speak slowly, use correct phonetics, don't yell.. you are distorted enough as it is! and spread out in 5 / 10 kHz intervals. Everyone cramming on the 'call frequency' will not help. Its not a contest ... enjoy the experience and observe the unusual characteristics of the signal. Call a friend interstate ... and spread the word.

It will happen more and more frequently in the coming months ... we just have to be alert. Leave you beam south, put you receiver on scan (if you can) and include a 'smattering of beacons'. It can happen anytime day or night and you don't need a lot of power

to be successful! I am looking forward to getting the dish commissioned and getting back on 70cms. There should have been QSO's on 70cms given the strength of the opening." ...Doug VK3UM

The Fate Of 420 – 430 MHz In VK

In this column, nearly six months ago, details were published regarding plans, in WA, by the Emergency Services to get primary usage of the 420 – 430 MHz portion of the 70cm Amateur band. At this time I made mention of negotiations being held with the primary user of this segment, the Defence Department of Australia. The following extract from a letter to the WIA from Geoff Hutchins, Manager, Spectrum Planning Team, ACA, is sadly, self-explanatory.

"I am writing to advise the WIA of recent developments in the radio frequency band 420 - 430 MHz in the Perth area. As you are probably already aware, the Australian Radio frequency Spectrum Plan currently allocates this band domestically to the Radiolocation service on a primary basis, and to the amateur, fixed and mobile services on a secondary basis. Footnote AUS11 of the Spectrum Plan specifies that assignments to users other than the Department of Defence or the Australian Defence Force will not normally be authorised for the radiolocation service in this band.

The Western Australia Police Service, on behalf of the Government of Western Australia including the State emergency services, has been negotiating with the Department of Defence regarding access to the band 420 - 430 MHz for an integrated trunked land mobile network supporting these essential and emergency services in the greater Perth area. The ACA, as spectrum regulator, has been facilitating these negotiations. The trunked radio system, known as ESCADCOM, is expected to commence operation later this year. Given the nature of these services, it will be essential to ensure that they are not subject to interference from amateur. In order to give appropriate regulatory weight to this development, the ACA intends to adjust the domestic allocation arrangements for this band in the Spectrum Plan in due course. Most likely this would involve promoting the

mobile service to primary status, in a manner consistent with the ITU-R Radio Regulations Table of Allocations for ITU-R Region 3; possible regulatory options have, however, not yet been fully explored."

It is expected that other subordinate legislation such as the Radiocommunications Licence Conditions (Amateur Licence) Determination would also need adjustment.

Preliminary studies indicate that transmissions from amateur systems within 200 km of Perth may cause interference to the proposed WA Government trunked land mobile system. Amateur receivers in this area may also experience interference. I note that one amateur television repeater and eight amateur links are currently licensed in this frequency band within this area. I will be writing to the licensees of these systems to inform them of these developments and the expected implications.

I should mention also that the ACA is experiencing increasing pressure from a number of essential and emergency services organisations in the eastern States of Australia that aspire to access this spectrum for similar purposes to that in Western Australia. Noting these developments, we would appreciate meeting with the WIA for discussions on migration implications for amateur services, on regulatory options, and on ways in which the WIA could assist."

Wally VK6KZ reports ... "have a look at <http://www.radio.gov.uk/busunit/research/lpdguide/lowpower.htm> dealing with the issues and highlights emerging problems. It is worth looking at..." ...Wally VK6KZ. More on this matter next month.

6 Metres Still Hanging In

Chris VK4DFE reports ... "I worked JA1VOK on voice (50.110), at 2238Z on 21/7 (i.e.: Sat am unusually early at 8:38 am local), S6 to S9. I run 100W into a 5/8 vertical; QTH is Maleny on Blackall Ranges North of Brisbane. VK4JSR also wkd him at 5/9. Small opening only lasted about 5-10 mins." ... Chris, VK4DFE

Further North, John VK4FNQ Charters Towers, has been reporting almost daily propagation to the North (JA) and on a few occasions to KH6 (Hawaii) On 20 Jul 2000, VK4FNQ worked @ 0855

NH6YK, 2327 JA8CAR QM13 and 2330 JH2SMW PM85LA all on 50 MHz.

Microwave Primer Part Four: 2.4 & 3.4 GHz

I have grouped both of these bands together as they have many similarities in equipment requirements and propagation. Notwithstanding, significant segments of both bands, very recently, have been or are in the process of being removed from the Amateur service. Both moves by the ACA have required the weak signal portions to be re-allocated. As a result, weak signal activity has declined with a large portion of equipment still being tuned to the old segments.

2.4 GHz is by far the more popular of the two, with a degree of FM ATV activity on the two allocated channels (2415 & 2439 MHz). The availability of ex MDS converters and ISM band data equipment makes it somewhat trivial to get something Wideband going on this band! 2.4 GHz has also been a popular satellite downlink band for a number of years. With Phase 3D being orbited soon; the 2401 MHz segment will see new activity. Converters for 2.4 GHz are not that difficult to construct, with several designs being still available.

3.4 GHz is perhaps the least used of all of our Microwave bands, excepting 24 GHz and above. This is a global problem stemming partly from the lack of ex commercial equipment in adjacent bands, the technological jump that existed in multiplier technology up until recently and perhaps that the band is not universally allocated around the globe. Putting all that in perspective, today it is no harder to get equipment going on 3.4 GHz than it is 2.4 GHz. Almost all the same devices used on 2.4 work and give the same power on 3.4 GHz.

3.4 GHz, despite losing 100 MHz, still has 4 times the allocated bandwidth of 2.4 GHz making it far more suited to FM ATV operation. Some cities already have congestion on the shared 2.4 GHz ISM bands with only two channels!

Transverters represent the most popular method of Narrowband Transceiving. Designs for both bands use similar techniques. The new weak signal segments start at 2403 & 3401 MHz. CW, SSB & Beacon segments run in typical fashion from this point. If you use a 144 – 148 MHz IF, you now need a 94.000

MHz crystal for 2403 (IF=147 MHz) and a 90.444 MHz crystal for 3401 (IF=145 MHz). If you use an IC202 tied to 144 MHz you will need to adjust these crystal frequencies to suit. 432 MHz is also suitable as an IF for both bands. It is handy having at least a few 432 MHz IF's for portable multiband operation .. enabling crossband contacts on at least a few pairs of bands.

For Power amplification, the most common devices used are the Mitsubishi MGF090* series. The MGF0907 will provide 10 watts on 2.4 GHz with reduced gain on 3.4 GHz. A better choice (although lower power) for both bands is the MGF0906 with 6 watts output and 13 db gain on 2.4 GHz (about 8db on 3.4 GHz).

Antennas are perhaps the only area of significant difference between the two bands. 2.4 GHz is typically the highest band parasitic element yagis (loop or planar) are used. The most popular choice is the USA designed Loop yagi's like the 52 element "Super Looper" on a 2.4 metre length boom. You can also use the DL6WU design. By the time you get to 3.4 GHz, tolerances make yagi manufacture laborious. A 600mm dish will give around 20db of gain for far less effort, even on 2.4 GHz a 600mm dish is a useful alternative only being marginally worse than a well built 52 element loop yagi.

Both 2.4 & 3.4 GHz experience very similar effects from tropospheric ducting. Evaporation Ducting has limited effect (refer to last months article) on either of the bands. Greenery does start to take its toll on both bands with 3.4 GHz suffering a small but measurable impediment over 2.4 GHz. By "Rule of thumb", from a few years of using both bands, 3.4 GHz experiences a 4 - 5 db deficit in path loss after all other factors are considered. Even in Tropo paths, there does seem to be a bias towards 2.4 GHz. At some point between 3.4 & 5.7 GHz this downward trend reverses. 5.7 GHz can outperform both bands even under only slightly above average conditions. This is due to other Propagation factors e.g. Evaporation and other low altitude enhancements having significant effects at these higher frequencies. 3.4 GHz being near this seeming "crossroad" might be another factor in its low popularity.

Summary: If you are contemplating getting going on one or the other of 2.4 or 3.4 GHz bands what should you do??

For serious portable or home weak signal, either band is suitable. For Wideband operation, like data or ATV, I would tend towards 3.4 GHz as it has 200 MHz of usable spectrum; the upper part can be covered by unmodified C-band Satellite down converters. 2.4 GHz has more equipment available, albeit potentially unusable in some parts of the country due to the proliferation of unlicensed ISM & Spread spectrum devices.

Next Month 5.7 GHz, the band of surprises.

VK2TK's "DX-pedition on 11 & 12 Aug 2000

The following is an extract from a report by John VK2TK.... "This expedition started with 2TK & 2KU meeting at the 2KU QTH in the Blue Mountains for a test setup. Arrival at Mt Lambie revealed the need to enter a farm, and seeing no signs threatening to break our knees or nuke our grandchildren, we ventured briskly past the homestead to a hill full of radio towers, and quickly drove up and around these to the trig station where the takeoff east was excellent.

Opening the doors of the Landcruiser proved a serious mistake, because someone had obviously left the fridge door open on that mountain for some time. Additional layers of clothing and numb-fingered later we put up the mast less the 2m yagi (the halo was enough). Easy contacts were made back to 2ZAB on 70 & 23cm. A rapid pickup ensued given the appearance of an official looking vehicle before awkward questions were asked.

At 5:30am next morning we really learned what "wandering about in a fog" actually meant. We wandered around for over a couple of hours by which time we were decidedly less foggy and had to settle for high ground north of Mt Ulandra with no good takeoff south. It was well after 9am local time when we finally got on the air and contacted Barry, Rej and the omnipresent Gordon.

Then on to QF34. An abortive trip up the Tumut road revealed terrain much like the Mt Ulandra area, so we pressed on and turned off the Hume onto the Tumbumba road and into the Kyeamba state forest towards a very promising hill containing - you guessed it - radio towers. Fortunately there was a slight suggestion of a track up the hill beside the fence which brought us up a narrow

ridge to the towers and a fabulous, gob smacking near 360 degree view of the surrounding country. The halo-to-Gordon test quickly confirmed this would be OK. As the 2KU & 2TK logs tell, lots of contacts, new grid squares for a number of people.

Mt Lambie Lat 33deg 28.38min S, Long 149deg 59.25min E, Locator QF46xm 11/8/00 0425 VK2ZAB 144.1MHz (using halo only), 0451 VK2ZAB 432.160MHz 59, 59, 0453 VK2ZAB 1296.160MHz 56, 57

North of Mt Ulandra Lat 34deg 50.29min S Long 147deg 58.90min E Locator QF35xd 11/8/00 2325 VK3BJM/p (Katoomba) 144.200MHz 56, 56, 2326 VK2ZAB 144.2MHz 55, 55, 2328 VK2MP 144.200MHz 59, 59, 2335 VK2MP 432.160MHz 59, 59, 2339 VK2ZAB 432.160MHz 55, 53, 0003 VK2ZAB 1296.160 41, 41

Kyeamba State Forest Area Lat 35deg 31.57min S Long 147deg 35.55min E Locator QF34tl 12/8/00 at 0413 VK3BJM/p (Katoomba) 144.100MHz 59, 57 12/8 0414 VK2ZAB 144.100MHz 59, 57, 0421 VK3BJM/p (Katoomba) 432.160MHz 51, 41, 0422 VK2ZAB 432.160MHz 51, 52, 0452 VK2ZAB 1296.160MHz 41, 41, 0455 VK2MP 432.160MHz 52, 55, 0459 VK3XPD 144.180MHz 53, 53, 0509 VK3KWA 432.160MHz 52, 53, 0544 VK3BDL 144.1 MHz 52, 52, 0550 VK3WDE 144.100MHz 55, 55, 0555 VK2CZ 144.1Hz 55, 54

Equipment Used: 144MHz IC821H & Gasfet Preamp, 100W, 6 element 10dBd yagi, 432MHz IC821H 30W 11 element yagi and 1296MHz IC1271E 5W 22 element 16dBd yagi "... John VK2TK

In Closing

The RSCB reports that Indian amateurs have permission to use 50.350 and 50.500MHz (single frequencies only) till 31/12/00. Hmmm spot frequencies, good news along way from 50.110MHz!! Lets hope it results in some activity as India is an easy path from many parts of VK2,3,4,5,6 & 8.

Please note that I have a new Phone number at the top of the page. The old number will redirect for some months until the changeover is complete. I'll leave you with this thought ... "You can lead a cow up a flight of stairs but never down ..."

Till next month
73's David VK5KK

Repeater Link

Will McGhie VK6UU
21 Waterloo Cr Lesmurdie 6076
VK6UU@VK6BBR
will2@omen.net.au

Cold and Cows

Already running behind with this months Repeater Link, today, Sunday was at least free to put the article together. No sooner had I finished breakfast and the phone rang to say I was rostered on and where was I? A simple oversight of not reading my roster meant a quick shower and off to work. Having spent the previous Saturday crouched in a four wheel drive on the top of a windswept hill in almost continuous rain, with the temperature peaking at 12 degrees, Sunday was to be a well earned day off. The Saturday was a country outside live broadcast from the town of Toodyay, 100 kilometres from Perth, and I was one of two people providing the first hop on an 8 GHz dual link back to the city. What A day, surrounded by cows, rain, clouds and freezing temperatures it was not all bad, but I could have done without the rain and the cold. However the views were fantastic. Microwave links can be a refreshing day out.

Digital Television

Like it or not we are headed towards the next revolution in television, Digital Television (DTV). The ABC is flat out learning about the new technology and rebuilding all of its facilities in order to be at least, ready for the introduction of Digital Television, in about 6 months time.

Training of its staff is required, so an understanding of Digital Television is grasped by all. As a consequence I have just spent two days attending a basic introduction to Digital Television and perhaps what little I picked up could be of interest to amateurs. However don't take this article as necessarily being accurate in all respects as my understanding of these basics could well be wrong from time to time.

Digital Television is really good, compared to our present analogue system. If you have seen a video DVD

on a good analogue television you have seen Digital Television. The first thing you notice about DTV is the lack of noise on the picture, some 10 dB less. Our present analogue Television has a vision signal to noise at best of 40dB. I say at best, as this assumes you have a strong signal from the television transmitter with little or no ghosting.

Digital Television does have a signal to noise. There is noise in a digital signal that is intrinsic and it is directly related to the number of bits that is chosen. Digital Television is 8 bit. This means there are 256 levels or possible differences, be they brightness levels and /or colour shades. These 256 levels define the signal to noise as 1:256 as a voltage ratio. This equates to a 50dB signal to noise. 10 bit has a 1:1024 voltage ratio resulting in a 60 dB vision signal to noise, but is just too expensive, and is only used in master editing if it can be afforded. High quality colour cameras produce an analogue output with a signal to noise of better than 60dB. As soon as this signal is digitised, 10 dB of noise is added to the picture. However the 50dB signal to noise is very good and just can't be seen. This is an interesting point, Digital Television is not noise free, it just a long way down, and much better than our existing analogue system. However why is there noise in a digital system?

A to D

Noise is generated in the analogue to digital converter (A to D converter). The A to D converter takes the analogue signal, which has infinite variations of brightness and colour and converts this levels to one of the 256 digital levels available in an 8 bit system. The problem facing the A to D converter is what to do with all those signal levels that fall in between one of the 256 levels available to it. Say a voltage level that is in between 103 and 104, 103.5. The A to D

can't make up its mind and in a random way makes the 103.5, 103 one time and 104 the next. This indecision generates noise and this noise is called quantisation noise. All analogue to digital converters generate this noise. The more bits available means the more digital levels available and hence the more accurate conversion of the differing analogue voltage levels to a close approximation of this level as a fixed digital equivalent. And as a result the indecision between these smaller voltage levels result in smaller quantisation noise.

You may well now have the impression that digital creates problems, and it does. However from camera to television receiver, digital out performs analogue by a great degree. Analogue is able to represent more accurately the infinite level differences in a television picture. Digital on the other hand restricts these infinite variations of colour and brightness to 256. This means for example, you can only have 256 shades of red and 256 levels of grey scale. On a computer monitor having a setting of 256 colour (8bit) results in rather middle of the road colour reproduction of colour pictures (photographs). Change the computers colour setting to 16 or 24 bit and there are now millions of possible colours and grey scale levels and the colour pictures looks great. Digital Television is able to get around this limitation to a degree, by first generally being a moving picture which masks this limitation, and by alternating colour differences between pixels when an exact pixel colour can not be reproduced. A particular red is made up by the nearest plus and minus red colour available from the 256 shades of red.

A lot of clever thought has gone into tricking the eye to some degree. There is no need to send information that the eye responds to poorly. Only

information that creates a good looking picture needs to sent. If the eye says it looks good then it does.

Compression

Without digital compression there would be no Digital Television. Something like 95% of the raw digital television picture is not transmitted! Digital compression is a process of removing information. The digital television signal is made up of blocks of 12 complete pictures, only two of which are complete pictures. The other pictures are made up of any differences between successive pictures. If, as in most situations, there is little change between successive pictures, only the changes are transmitted. This is an oversimplification of the 12 sequence block of pictures as these differences are divided into what are called spacial and temporal differences. Spacial means parts of the picture occupying the same space and temporal meaning the same brightness and colour. It is not possible to go into the detail here, due in part to my scant knowledge of the subject. Why

not only send one original picture and then from that point on only the differences? Why do we have to keep sending an update of what the current picture is? The reason is digital television makes mistakes. Errors creep in all the time all along the transmission path. These errors can be fairly high, and with 50 frames (pictures) being sent every second these errors mount up. After a short time the resulting picture would not be anything like what it currently should be, as errors compound errors. It is interesting to note that before any error correction and checking takes place in a digital signal, the error rate can be as high as one in every ten bits! Lots of clever error checking and correction gets this error rate down to one in several million.

What happens when the error rate is too high, due to lack of signal or interference? The digital picture starts to break up in random squares and may freeze from time to time. The reason that the effect is random over the entire picture, rather than just in the area where the errors occur is due to the way

the digital signal is transmitted. Digital Television is broken up into small square areas and sent in a random fashion. In other words the picture is not sent sequentially from top left to bottom right, but in a random fashion. It may be that a small square part of the picture in the centre is sent first followed by a similar square from the bottom left. Mind numbing is it not, and we have only started. The complexity of Digital Television is a marvel to mankind's ingenuity.

On and On

When I started to write this I thought half a page would give the reader a little information about digital Television, but there is so much more and the dead line for this article is way overdue, so there will have to be a part two and perhaps a part three. One final point is, Digital Television is transmitted using Packet Radio, yes good old Packet Radio, and would you believe the Television transmitter puts out 8,000 separate carriers in its 7 MHz band space. Yep 8,000 carriers, more next month.

ar

He who expecteth little

By Ian Godsil VK3DID

How easy it is to become caught up in new-fangled things and leave the activities that have supported us, sometimes for many years.

At the end of January I discovered what it was like to be able to "surf the Net" and send e-mails FROM HOME. I had done it from the local Library for two years or so, so roaming the Net for specific things was not new; but being able to do it at any time in my own shack/office was.

So far so good—but it only took a week for me to realize that my number one radio love—CW—was falling aside. Oh well, I thought, its harder now to get a contact on CW anyway and especially QRP CW that I have always loved for the challenge of making the contact, as well as communicating via a means other than speech.

On Saturday, 5 February, my wife and I had been for a walk along our local beach and around 9 p.m. I thought "I'll just have a listen around the bands for a few minutes". I had no expectations of any type, just the satisfaction of hearing

the band noise and possibly some CW. I expected little or nothing!

I am a lover of the 12 metre band and often listen across it for any sounds. This summer there has been precious little on that band except noise (QRN). Imagine my surprise and joy when, on tuning to 24.900 MHz, I heard CW! A quick tune of the band revealed one Japanese SSB station calling. But imagine my unbridled exhilaration on returning to the CW signal to discover it was a 4S7 in Sri Lanka. He was busy working Germans.

Now, I have never worked into India or Sri Lanka, although I have occasionally heard stations from those parts. Good operators don't intrude themselves into QSOs not for their area, but I wanted that 4S7! Carefully I called several times and—JOY OF JOYS—was rewarded with a contact. I make no apology, but I was ecstatic. However, I consider myself sufficiently in control not to let my feelings swamp my reading of CW signals, especially if those signals are not "wall to wall". The contact was

made—can you feel my joy radiating from the page?—But bearing in mind "Do or die", "Nothing ventured nothing gained", etc, I asked the Sri Lankan operator if he could read me on QRP? With one flick of a switch I went to 100 mW and lo! There was little variation in my signal. What a beauty! Oh what a marvel! Whooppee! I expected nothing and came away with a new country and an opportunity for a CW Operators' Club Award when I get his QSL card.

How many of you can get a feeling like that from SWLing (for which I have the healthiest respect), or the Internet (which I also respect, but suspect is a great time-waster)?

Come on VKs; let's hear you on the air. There are operators in other countries that actually LIKE to work us "down unders" and who often wonder if we have abandoned Amateur Radio here. What about doing your bit and in the process giving someone else, as well as yourself, a thrill? There's nothing quite like it!

ar



Pounding Brass

S.P. Smith VK2SPS
 4/6 Taranto Rd
 Marsfield NSW 2122
 (H) 02 9876 8264
 (M) 0419 602 520

PB Retrospective

Here is the final part of previous columns that have appeared in issues of Pounding Brass, continuing from Issue 40 and concluding with this months issue.

Issue	Month	Year	Article Contents	Issue	Month	Year	Article Contents
41	Dec	96	Not included	66	Jan	99	Book Review "The Telegraph" by Lewis Coe
42	Jan	97	QRP Plus Transceiver	67	Feb	99	No Issue
43	Feb	97	MFJ-486 Grand Master	68	Mar	99	No Issue
44	Mar	97	Morse Programs	69	Apr	99	History of the Paddle (repeated demand)
45	Apr	97	Instant Morse CD-Rom by the R.S.G.B.	70	May	99	QRP Transmitter
46	May	97	Operating Practices	71	June	99	
47	June	97	CW Abbreviations	72	July	99	
48	July	97	Photos of Australian Keys	73	Aug	99	Radio Awards from the CW Operators QRP Club (Milli Watts / KM Award)
49	Aug	97	Buying a Key via 2 nd hand market	74	Sep	99	Radio Society of Germany & Austria
50	Sep	97	PT 2 Buying a Key	75	Oct	99	Photos - Military Air Force Keys as used by the British & Commonwealth Nations
51	Oct	97	Book Review "Encyclopedia of Telegraphy" by William Maver	76	Nov	99	Photos of Keys
52	Nov	97	Cassette Motor Control by Derek O'Brien	77	Dec	99	Millennium Bug from Vibroplex
53	Dec	97	New Keys from Vibroplex	78	Jan	00)
54	Jan	98	Photos of Australian Keys PT 2	79	Feb	00) Lost in mail
55	Feb	98	Local/International Radio Contests	80	Mar	00)
56	Mar	98	What is "Zero Beat"	81	Apr	00	PT 2 Learning Morse Code
57	Apr	98	Morse Examinations	82	May	00	Rhythmic Sounds (Not Dots & Dashes)
58	May	98	Sending, Morse Examinations	83	Jun	00	Early Forms of Communications
59	Jun	98	Oleg Bezzoubov UA4FBP, High Speed Telegraph Champion	84	Jul	00	PT 1 Pounding Brass Articles
60	Jul	98	Operating Techniques for the Beginner	85	Aug	00	PT 2 Pounding Brass Articles
61	Aug	98	Photo's American Semi-Auto Keys				
62	Sep	98	Cryptic Codes				
63	Oct	98	Bandwidth of a CW Signal by George VK3TES				
64	Nov	98	Gravity Cells				
65	Dec	98	Happy Christmas				

Until next month, Best of Wishes
 Stephen P. Smith
 VK2SPS

The WIA regrets to announce the recent passing of:-

J G (Jim)	Cowan	VK2ZC
A T C	Butters	VK3LAA
E (Arthur)	Walz	VK4AW
(Bert)	Newman	VK4NA
G A (George)	Moss	VK6GM

Farewell to a Life Member George Moss VK6GM (1904 – 2000)

George Moss VK6GM a Life Member of the VK6 Division of the WIA became a Silent Key on 15th July 2000 just 6 weeks before his 97th birthday.

A Memorial Service was held on the 18th July attended by many members of the Radio Amateur Old Timers Club.

George's first employment was as a piano tuner but his interest in radio started as early as 1923 with a home built crystal receiver and a 10 shilling experimenter's license. He joined the WIA in 1925 and was issued the callsign A6GM in 1926. This allowed him to play records on air before the first radio station 6WF commenced transmission.

Prewar he joined Nicholsons and became Manager of their Radio Department whilst during the war he was seconded as a radio trade instructor at the Perth Technical College.

Although he retired as a lecturer from the West Australian Institute of Technology in his 80's he still conducted laboratory sessions there.

In his younger days Georges other hobby was hydroplaning where he won many speedboat races at the RFBYC.

George was a Fellow of the Institution of Radio and Electronic Engineers Australia and bestowed Life Membership of the WIA in 1965 having held the offices of Secretary and President. It is with sorrow that we note the passing of George Moss VK6GM and the Institute offers it's sincere condolences to his widow Betty and son and daughter Ray and Lorelie

Tony Savory VK6TS

VK6 Councillor and Broadcast Officer

Vale Bert Newman VK4NA

Big Bert as I always knew him (6'4" in his socks and as wide as a standard door frame) finally succumbed to a long illness on 20th January 2000.

The younger generation of hams probably will not know him – nor will some OTs. He mostly soft-pedaled his way through life. A sort of gentle giant, who's electronic know-how no one questioned. I knew him more than half a century ago, in that era spoken of as the 'good old PMG days' where we both worked.

In spite of his low-key approach to AR, he, nevertheless, was a complete Amateur. In fact the term 'over qualified' would have been quite appropriate. He worked DX, socialised in the Nets but his main love was 'home brewing' electronics. Here he excelled. Anything Bert put together worked at maximum efficiency. It is heart warming to see a couple of pieces of his handwork, which still grace my shack.

By vocation Bert was a PMG 'Trunk Test Technician' and none kept the vital heart beat of communication working more smoothly that he.

Bert was a long time WIA member, a home brewer with many articles published and an improver.

Two sons, Bruce and Warren and a daughter, Susan, survive him. He will be sadly missed.

Bert was a neighbour of mine and I too will miss the momentary darkening of my shack as he entered.

Via Con Dios old mate.

Alan Shawsmith VK4SS

Arthur Edward Walz VK4AW

Arthur was born in 1908 and died on 15th May 2000. He was a Life member of WIAQ and one of the last pioneers of Wireless.

First licenced in 1924 as OA4AW, later VK4AW, his WIAQ membership goes back more than 70 years. This puts him in a very select company. There was much more to VK4AW than years of membership. In the 75 years of WIAQ, Arthur was the longest serving President 1933 to 1940. This was when, well-attended, monthly meetings were held in the clubrooms, 1st Floor, Celtic Chambers. This was the period of peak Amateur activity before WWII and there was no shortage of aspirants for Council positions.

Arthur also had the distinction of being a persistent VHF researcher. This was when VHF was considered useless for communication, but not for the 5Mx Hams. VK4AW with a small group of like-minded Amateurs was able to demonstrate the possibilities of VHF. Chapter 5 of "HYCLON DAYS" gives more information on 5Mx research conducted by VK4AW. His prophetic speech given at the WIAQ 8th Annual Dinner to 100 guests is worth reading.

Arthur began his working life as a plumber, but very soon saw the possibilities of 'wireless' and began to trade as 'Walz Radio Eqpt'. He never looked back.

VK4AW is survived by his wife Hazel, 3 sons and a daughter. Almost all his mate have become SKs. Those who are left will remember a slim, quietly spoken man, who carried of the position of President of WIAQ with quiet dignity. A man who chose his words carefully.

For me, I take this opportunity to pay my respects to an OTer who never failed to assist me with information only he possessed, when I was researching 'Hyclon Days'

The WIAQ should see him as one of the last pioneers, a genuine pioneer.

Rest in Peace Arthur, I am one who knows you earned it.

Alan Shawsmith VK4SS

Note 1 Views expressed in letters are those of the authors and do not necessarily represent the policy of the WIA.
 2. Some of the letters have been shortened to allow more letters to be published.

Re Promoting Amateur Radio and improving AR magazine

I read with interest Michael's letter (AR July 2000) about problems promoting Amateur Radio. With respect, I'd suggest that if his efforts were limited to putting forward ideas, then I'm not surprised these efforts came to naught.

I frequently receive ideas that various people believe that "the WIA" should act upon. When I ask whether they are willing to take an active role in implementing their idea, they usually shy away, mumbling that it's "the WIA" that should do it.

Most people don't make the connection between "the WIA" implementing their great idea, and the individual volunteer taking yet more time away from his friends, family, hobby, and other interests to do the work. In my experience, most volunteers are already overloaded doing multiple jobs because too many others are unwilling to do just one.

Many well-intentioned individuals say, "the WIA should...", but very few add "... and I want to help make it happen."

I think Michael was heroically optimistic to even dream that 50 Amateurs could be organised for the Marion Centre event. Getting even a dozen Amateurs to commit to any activity is a major undertaking, but 50 is on a par with herding cats!

One would think that, in a hobby demographically dominated by retirees, one would find a few people with some spare time on their hands...

Moving on to Michael's comments about Amateur Radio magazine: if Michael is so interested in vintage radio and "golden age" valve home brewing, then what on earth prevents him from submitting regular articles on these topics himself?! How about just one?

Remember: when you point a finger at someone else, you have three more pointing back at yourself!

73 Richard Murnane VK2SKY

Who Writes AR ?

Regarding Michael Gell's letter, I meant to comment that I thought you might have put in an editor's comment to the effect that articles in AR are volunteer efforts contributed by members, rather than commission from professional authors. Michael seems to think that it's "the WIA's" fault that "they" are not coughing up for material more to his taste.

73 Richard VK2SKY

Re: Compulsory CW testing

Well it's finally happening, that is, the end is in sight for the compulsory testing in CW for HF access. It's about time too! Now I'm not saying that we should do away with Morse and I'm not saying that I'll never use Morse. What I am saying is that it is too stupid for words to maintain this archaic anachronism as a compulsory entry to our great hobby.

Let us examine a few parallels from academia. It wasn't all that long ago that Latin was a compulsory prerequisite for entry into law and medicine. I can remember the howls of indignation when this requirement was dropped. I don't think that either profession has suffered from not having to carry this burden. I seem to remember that Latin, or at least a foreign language, was a prerequisite for entry into Architecture yet the very necessary subject of Technical Drawing was not recognised by the Architecture Faculties as a prerequisite. To maintain that Morse is necessary to be a 'full' amateur is as sensible as saying that we should return to spark transmitters.

Arguments are advanced from the pro-Morse fraternity that 10WPM never kept anyone out of getting a full call. What rubbish! There are plenty of amateurs with Novice licences who just cannot spare the study time or else have an auditory problem or just have a sheer nerve problem at examination time. Using a key is a lot different scenario from just doing a written test.

It is said that keeping Morse keeps the

'riff-raff' from our hobby. What arrogance! Who gave these dictators the right to pass judgement on others? Anyway, we still have rigorous testing in the necessary subjects of theory and regulations. These tests will ensure that people who wish to become amateurs will value their call when gained.

I don't know how many times I have mentioned that I am an amateur and inevitably get asked about entry requirements. I am now used to the incredulous look of amazement when I mention that Morse is a requirement.

I know that my own case that I found the theory and regulations rigorous but not too onerous and sufficiently interesting to maintain my interest. I estimate that I could have passed full theory and regulations in about 4 to 8 month's study BUT it took me two lousy years to get 10WPM passed. Is it any wonder that a lot of amateurs heave the key in the river the minute that they pass?

I have visited shacks of full Morse supporters and looked for their key or bug. It is inevitably stuffed away in a cupboard or under a pile of books or else they sheepishly admit to sending computerised Morse. What hypocrisy!

As a side issue; the full Morse brigade often bewail about the so called lack of amateurs willing to 'home brew'. Well what about the many hams who build their own antennas, GDO's, ATU's, QRP transceivers, power supplies, linear amplifiers, SHF experiments, Internet linking of VHF repeaters etc? We cannot live in the past so it's no use moaning and groaning about the lack of valve circuits etc. If those people wish to be stuck in a time warp that's their problem; it sure isn't mine.

Ian Gray VK2IGS

The Language We Use

In recent issues of Amateur Radio there has been a "push" to show amateur radio off to the public. It seems to me there needs to be some determined changes to make the hobby more understandable. From time to time I have visitors or neighbours drop in, and have taken the

opportunity to demonstrate my hobby. After listening for a while they ask: "What was all that about?" How about we as Australians set a new standard and set a new standard and speak in understandable language! Q codes are for CW operations, so leave it at that and don't use them on voice channels. The incessant use of QSL for example on voice when the speaker really means "over" or "Romeo" (roger) or "Okay" is most annoying. I had a visitor who runs a communications business and he remarked "After listening to that, no wonder a ham is half a pig's ass!"

Let us communicate like other services; in simple plain language. Civil; aviation voice circuits seem to do very well using regular everyday speech.

Lets all try it!

Victor Kitney, Bunbury

Re: Morse Code and Amateur Radio

The Morse code comments by W P McCarthy VK4WMC in open forum of *Amateur Radio* July 2000 are commendable and his/her thoughts and words about CW get my full support.

A new comer to Amateur Radio but a veteran Morsecodeian I think some people are being too hard on Morse code when they continue to demote it the way they do. There is a place in Amateur radio both for Morse code and SSB etc. Could the keyword in the debate be envy? Or is it that there are too many self doubting radio people? I think that if more positive people gave Morse code a chance everything would happen on cue. Bingo!

After listening to and working with many Morse code amateur operators on the radio bands, I know with certainty that there is a place for CW in the HAM world. Morse code is not defunct nor is it outdated because it is an enjoyable challenge to so many radio amateurs worldwide.

Doubtless, the campaign to get rid of CW will continue, but thankfully none of us can forecast the future. I wonder where Morse code will be "25 years down the wire".

I also wonder why anyone would eat tripe when they can have fillet steak.

Allan Madigan VK2OA

Another Survey

Radio and Communications has conducted another survey. Another

commercial venture and a good opportunity to knock CW? It has all been done before. R&C editorials have been angling for years for a reduction in CW speed, as far back as Radio and Hobbies. The WIA has had to work within the International Regulations. I know that entry requirements will have to change but why lower standards? The State and Federal WIA is now in the hands of a new generation and I understand their leaning to lowering the licence speed requirement. But I ask you "What can you do with 5wpm?" Even the Services recognise it is useless. So what next? No code - No CW on transceivers? The operative word is standards. You need them to get an Amateur Licence. It should not be given away on a Wheatie packet. Food for thought!

G W. Lanyon VK2AGL

Contests

The comment in the "Contests" column that the "RST" should be dropped has provoked me to write this.

What is a Contest? It is a test of skill and the end results are judged on ability to read/hear the call and report sent to you correctly. A letter or figure wrong in your log can cause havoc to your final score. In world wide contests such as the IARU, you have to read the call, rst and zone correctly. In our own VK/ZL we have to log the call, RST and serial number correctly. That is part of the skill. The other parts of the skill include the ability to hear and read very weak stations, or select one of say five stations calling you, correctly. You need to know which band you should be on at a given time and to know what direction your antenna should be pointing. Short path or Long path. Personally I would like to see contest reports expanded to include more cyphers such as perhaps the operators age, number of years licenced, etc.. The European Contest requires a length of cyphers referencing previous QSO's. A simple mis-reading of these causes points to be lost. For those that use computer logging, such as myself, when a station sends 579 instead of 599, it means attention on the keyboard. If I just recorded 599 and not 579 I am deemed to lose points with a good contest examiner that has complete cross log checking facilities. So, keep the RST, but send a honest report and get those hot shots, big scoring contesters, to think and not just sit back and record calls and serial numbers.

Now to those who complain about contests cluttering up the bands. Firstly,

there is not a contest every weekend that effects us in Australia. In fact probably only 6 weekends of the year effect both CW and the Phone sections. There is plenty of spectrum for everyone. No one amateur "owns" a frequency, or band.

Perhaps we should remind those whingers that Amateur Radio is a fraternity, where understanding and tolerance is a major part of the mandate. If contests upset you for say 25 days of the year; surely those who are not participating would be prepared to offer this time to those interested in contests. It leaves 340 days for the non-contester to have the bands all to themselves.

If you cannot tolerate this, I would respectfully suggest you try CB or the internet chat lines.

Or, next time you hear a world wide contest, test your own skills. See how many countries you can contact in say two hours, or even try for a DXCC. If it's the ARRL contest, see how long it takes you to log every U.S. State. (In fact Contest organisers could encourage more activity if they offered awards for these achievements).

Whatever you feel about contests, be tolerant. It costs nothing and shows that you are a worthy and understanding member of our great fraternity.

David A. Pilley VK2AYD

(50 years plus as a Radio Amateur).

Towers

In reply to the article in *Amateur Radio* August 2000 under "Towers - Builders Beware," I wish to express that I have been professional in the engineering work for 40 years. I will not stand for the unbelievable story you have written about the tower in question.

The design of the tower was mine as an Engineer but the structural drawing was done by two Civil Engineers at the cost of time and materials approximately \$30,000 - the most costly tower for Amateur Radio use.

You have turned two Civil Engineers and two Council Engineers in disgrace of their profession, to me they are the best. I will make copy of the letter and will send it to them. I am very upset, I can't believe that our radio magazine can do that to their own members - defammation of character.

The drawings are within my QTH.

B G Witjes VK4BTF

HF Predictions

by Evan Jarman VK3ANI

34 Alandale Court Blackburn Vic 3130

These graphs show the predicted diurnal variation of key frequencies for the nominated circuits.

These frequencies as identified in the legend are:-

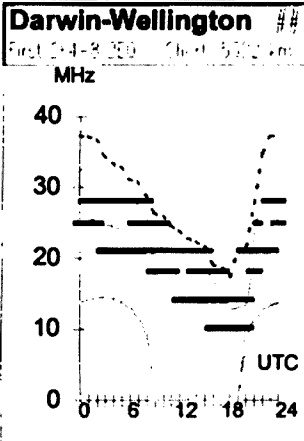
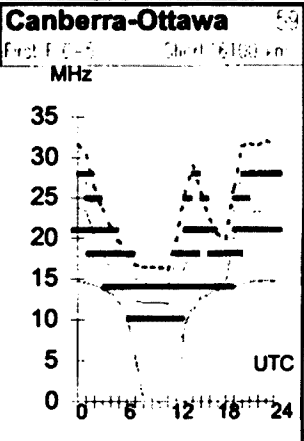
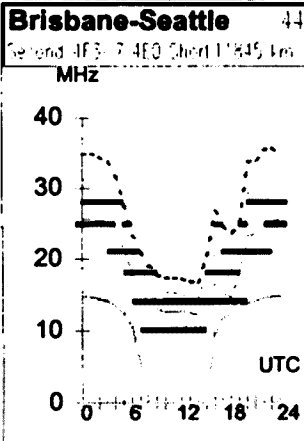
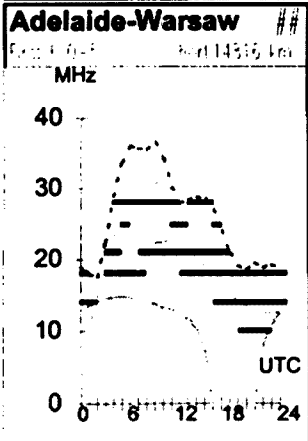
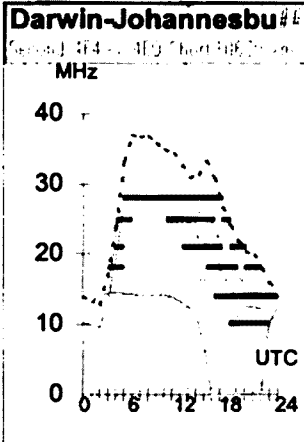
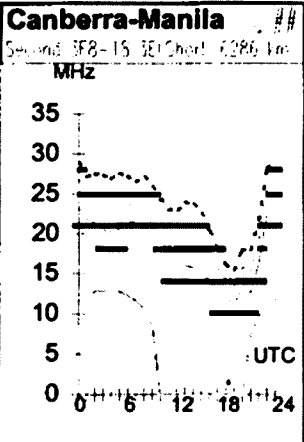
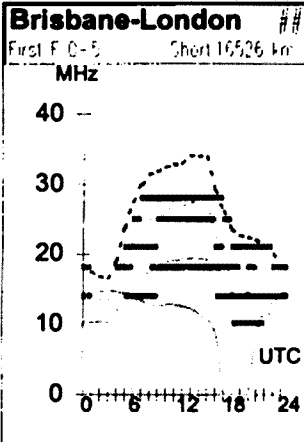
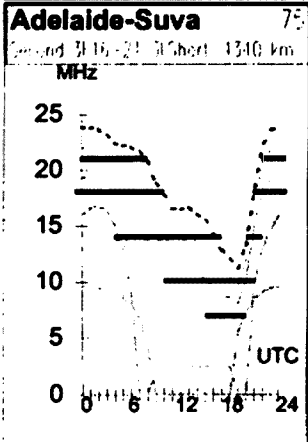
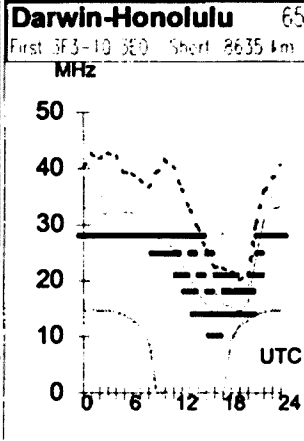
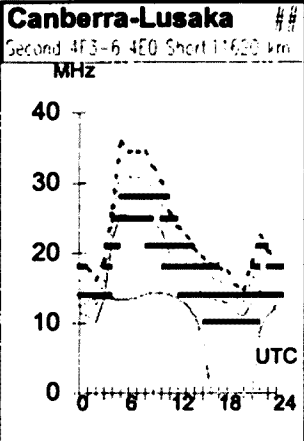
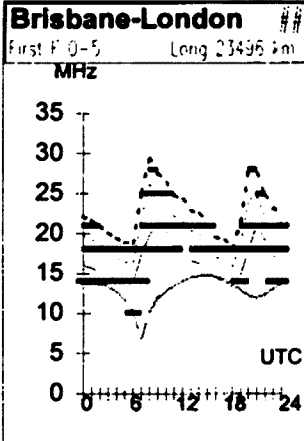
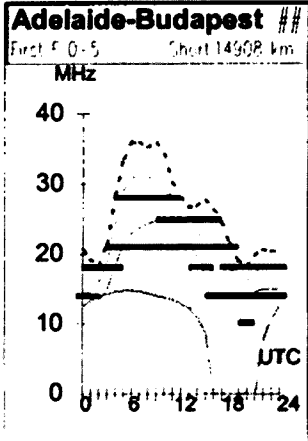
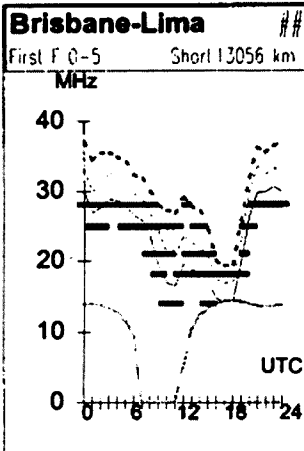
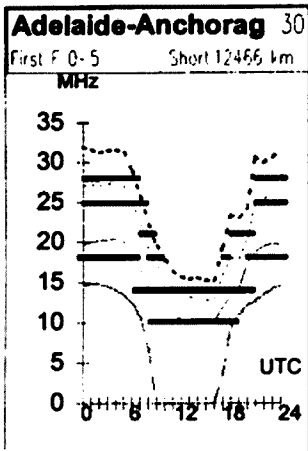
- Upper Decile (F-layer)
- F-layer Maximum Usable Frequency
- E-layer Maximum Usable Frequency
- Optimum Working Frequency (F-layer)
- Absorption Limiting Frequency (D region)

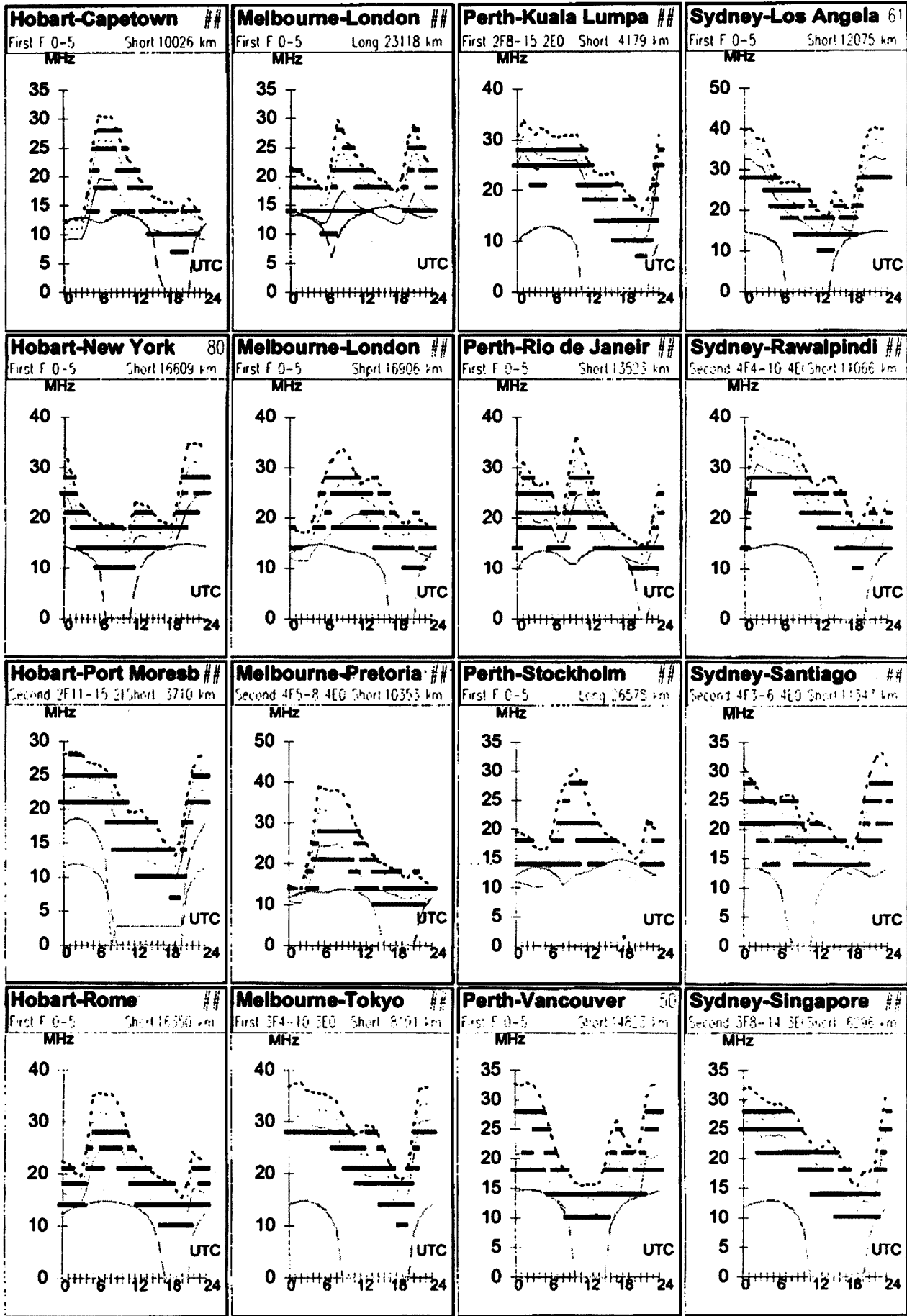
Shown hourly are the highest frequency amateur bands in range between these key frequencies, when usable. The path, propagation mode and Australian terminal bearing are also given for each circuit.

These predictions were made with the Ionospheric Prediction Service program: ASAPS Version 4

September 2000
T Index: 139

Legend
UD
E-MUF
E-MUF
O-WF
ALF
10%-5
50%-9
90%-1
Time scale





HAMADS

- Hamads may be submitted on the form on the reverse of your current Amateur Radio address flysheet. Please print carefully, especially where case or numerals are critical.
- Please submit separate forms for For Sale and Wanted items, and be sure to include your name, address and telephone number (including STD code) if you do not use the flysheet.
- Eight lines (forty words) per issue free to all WIA members, ninth and tenth lines for name and address. Commercial rates apply for non-members.
- Deceased estates Hamads will be published in full, even if the ad is not fully radio equipment.
- WIA policy recommends that the serial number of all equipment for sale should be included.
- QTHR means the address is correct in the current WIA Call Book.
- Ordinary Hamads from members who are deemed to be in general electronics retail and wholesale distributive trades should be certified as referring only to private articles not being re-sold for merchandising purposes.
- Commercial advertising (Trade Hamads) are pre-payable at \$25.00 for four lines (twenty words), plus \$2.25 per line (or part thereof), with a minimum charge of \$25.00. Cheques are to be made out to: WIA Hamads.
- Copy should be typed or in block letters, and be received by the deadlines shown on page 1 of each issue of Amateur Radio, at:

Postal: Newsletters Unlimited, 29 Tanner Street, Richmond, 3121
 Fax: 03 9428 4242 E-mail: news1@webtime.com.au

Please only send your Hamad once

Please send Hamads by mail OR fax OR email (much preferred).

Please do not send by more than one method for any one ad or issue, it is confusing.

FOR SALE ACT

- Hewlett Packard test gear surplus to requirements.
- Signal Generators HP 606A 50 kHz to 65 MHz, HP 618C 3.6 GHz to 7.6 GHz. Also AN/URM 49 model TS 418A 400MHz to 1000 MHz. For inquiries call Peter VK1CPK phone (02) 6231 1790 fax (02) 6296 5712"

FOR SALE NSW

- Yaesu FT101E with brand new NEC finals. \$280. Midland 70324B 25w 2M FM mobile. \$100. Maxon HR146 2M FM handheld. \$150. Kenwood R1000 communications receiver. \$350. Jim VK2ZVJ. (02) 4443 2277. Email. brownsarre@fastrac.net.au
- Yaesu 2m/70cm handheld FT50R with speaker mic, MH34 and SMA-BNC antenna adaptor. Bought new Feb this year, still under warranty. Total cost \$550 will sell \$400. Licensed amateurs only. Noel VK2BCA, QTHR. Tel (02) 4977 3449. email, ncherry@acay.com.au
- Oscilloscope sell or swap for suitcase radio, Army backpack, or old military radio. GOULD OS4200 Digital Storage CRO 500kHz, TEKTRONIX 5110 with NIC527 signal averager, TEKTRONIX 5110 storage CRO 1MHz. Ray Robinson VK2ILV Sydney (02) 9489 8561 robinson@shlrc.mq.edu.au
- Yaesu FT-707 HF Transceiver. Compact, solid state, 80-40-30-20-17-15-12-10m, 100w, manual, circuit diagram. Yaesu FV-707DM Digital External VFO. 12 Memory channels, Scanning. Yaesu YM-35 Scanning mike for FT707/FV707DM. Yaesu YM-34 Desk mike. \$425. Neil VK2KCN QTHR (02) 98945678 neilcorp@one.net.au
- Kenwood TS-440S A/T HF Transceiver S/

N 00110641, Kenwood TS-120V HF Transceiver S/N 0042009, Kenwood SP 180 Speakermatches TS-180, UNIDEN UBC9000XLT scanner, PALOMAR TX100PLUS linear amplifier 10-30 MHz, EMONA EAT301 ATU 300W, power supply 13.8V 20A., EST.VK2MFT. reas offers. Tony VK2BTS (02) 6642 3641 ajsmith@hotmail.net.au

● BOOK: "Radiotelegraph and Radiotelephone Codes, Prowords and Abbreviations." 2nd Edition. \$16 posted Australia. 90 Pages. Q, X and Z codes, 97 Phonetic, 20 Morse Codes. Phillips, Myer, 10,11,12,13 Codes. Much other info. Internet <http://www.nor.com.au/community/sarc/phonetic.htm> VK2JWA, John W. Alcorn. QTHR. (02) 66215217. jalcorn@nor.com.au

● INTERNET Connect from Port Macquarie to the Gold Coast from 80cents per hour. Summerland Amateur Radio Club. For info - <http://www.nor.com.au/community/sarc/sarc.htm> - John, VK2JWA, QTHR, jalcorn@nor.com.au. 33 Spring St, Lismore, NSW, 2480. Ph (02) 6621 5217.

● Antenna rotator control cable, heavy gauge, multi-core, many uses. We got it at the right price can sell cheap, Goulburn Amateur Radio Society. Ring David VK2BDT (02) 4821 5036

● ALINCO DX70 bought Wyong this year no longer needed, manual, carton etc. David VK2BDT QTHR (02) 248215036 \$1150.

● Linear amplifier HF 160m-10m Home-made copy from 1995 ARRL handbook 13.40. Separate high voltage power supply 3 Kilovolts at 1 Amp continuous using EIMAC 887 (3CX1500A7) high mu triode in

grounded grid; amplifier, 1 year old \$2950 VK2SUS QTHR (02) 9897 5440.

● FT7 transceiver modified to drive transvertors and linear amplifiers \$250 N Chivers VK2YO QTHR (02) 6674 2095.

● ATV homemade transmitter 426.25 MHz - Motorola MHW 710/2 final - Approx. 5 watts output - Includes spare crystal for 444025 MHz - VGC - \$ 120 - Home-made antenna 426 MHz, 12 elements \$ 40. - Peter VK2BPO - (02) 9713 1831 QTHR brunone@bigfoot.com

FOR SALE VIC

- Kenwood TS-811 70cm all-mode 25W out, power supply built in EC \$900. Two Kenwood TS-711 2m all-modes 25W out, power supplies built in, one \$750(EC), one \$700(GC) All user and service manuals included, Two Kenwood SP-430 speakers \$50 each. Richard VK3ZCL AH (03) 9729 1947
- DRAKE L75 600 Watt linear amplifier with spare 3-500 tube and manual \$750 ono, also Yaesu monitor scope VO-100 \$300 ono. Alf Chandler VK3LC QTHR or (03) 9773 5334
- Antenna 10/15 metre Duo band vertical gp as new never used \$180 ono Michael VK3MRG AH (03) 9747 9342.

WANTED VIC

- Want a rural QTH? No TV? One hour from Melbourne, RHOMBIC four wavelengths leg 20 Mx VHF UHF Yagis, seven acres, modern home, central heating, air conditioner, spa, solar heated pool, nice garden, large steel framed shed, near Nagambie \$153,000. vk3amh@eck.net.au (03) 5794 2004. Early inquiries 0438 130 737.
- 1.825 MHz Crystal. Preferably HC6/U size. Phone Peter VK3YE (03) 9569 6751 (ah) or e-mail parkerp@alphalink.com.au
- Circuit & Layout of Palec Model VCT-2 (s/n 694) Multimeter Valve Tester made by Paton Electric Sydney. Information by .jpg to ghq@hyperlink.net.au or by post to W.R. Gronow 17 Walstab St. East Brighton Vic. 3187.
- Circuit manual for LO-KATA radio direction finder LW-MW-SW-DF made by Magnetic Components Ltd, Falmouth Cornwall UK and circuit for Zenith modulated oscillator Model 512 (two valve circuit). Brian VK3WYN QTHR (03) 5664 1251.
- Valve type modulation transformer 60w or thereabouts multitap preferred. Don VK3ASD (03) 9849 0437.

FOR SALE QLD

- Copies of CB Action, Amateur Radio and Amateur Radio Action from late 1970's to date. Enquiries to Allan VK4VAT atomic@isisol.com.au Phone (07) 4127 1006
- TR7800 2M FM TX/RX \$160 FT-726R 6M/2M/70cm base rig and satellite board, 10w O/P \$700. PAKRATT PK-232 \$160. SMPS NEC 13.8V 30A \$160. Stainless Yagis 148 MHz 70cm crossed Yagi Peter VK4APD 17 Paxton St Holland Park QLD 4121 (07) 3397 3751.
- YAESU 101ZD with FM board 101DM Yaesu digital VFO FC901 antenna tuner \$500 lot FL2100B linear AMP \$400. (07) 4125 7167 VK4OH QTHR.
- HF FT107M \$400 2m TXRX TR7800 \$160 FT726R 2M/70cm satellite board \$700 also

6M board \$180 (both \$850 neg) SMPS NEC 13.8V 30A \$180. 148 MHz stainless Yagis 70cm crossed Yagi. Peter VK4APD QTHR (07) 3397 3751.

WANTED QLD

● ROTATOR. Ph. David 0741298296 email dm622@satcom.net.au

WANTED SA

● HF Mobile linear amplifier, 250 watts upwards, for 13.8 volt use. Any make considered with minimum range 3.5 - 30 MHz. Contact Kevin VK5KJ ph (08) 8725 9248, fax (08) 8723 9350 or vk5kcb@seol.net.au

WANTED TAS

● Philips PRM8025 or PRM8030 in 'A' band 146-174MHz. Brian VK7BW (03) 6229 5888 bwelch@southcom.com.au

MISCELLANEOUS

- If you got your licence before 1975, you are invited to join the Radio Amateurs Old Timers Club. A \$2.50 joining fee plus \$8.00 for one year or \$15.00 for two years gets you two interesting Journals a year plus good fellowship. Arthur Evans VK3VQ or Allan Doble VK3AMD can supply application forms. Both are QTHR in any Call Book
- The WIA QSL Collection (now Federal) requires QSLs. All types welcome, especially rare DX pictorial cards, special issue. Please contact the Hon Curator, Ken Matchett VK3TL, 4 Sunrise Hill Road, Montrose Vic 3765, tel. (03) 9728 5350

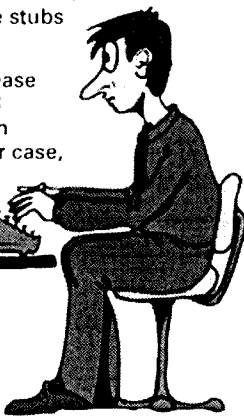
PLEASE BE KIND TO OSCAR

Meet Mr Oscar Goldenboy, our Hamad typist

Oscar is not an expert in your field — he thinks Megahertz is what happens when he stubs his toe on a rock.

To help Oscar, please write your hamad legibly, using both capitals and lower case, and use legitimate abbreviations.

This will reduce the chance of errors being published, which inconveniences everyone.



ADVERTISERS INDEX

Andrews Communication Systems9
 Dick Smith.....28, 29, OBC
 Radio & Communications25
 Radio Theory Classes.....5
 Tower Communications27
 WIA Call Book.....IFC

TRADE ADS

• MIDON FERROMAGNETIC CORES:

For all RF applications. Send business size SASE for data/price to RJ & US Imports, PO Box 431, Kiama NSW 2533 (no enquiries at office please ... 14 Boanyo Ave Kiama). www.cyberelectric.net.au/~rjandusimports

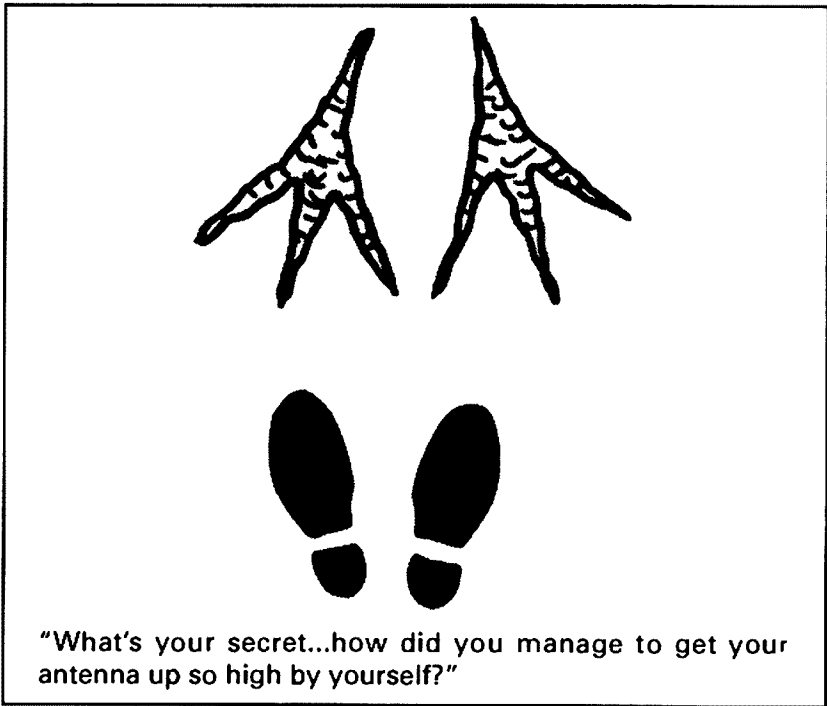
Agencies at: Assoc TV Service, Hobart: Truscotts Electronic World, Melbourne and Mildura: Alpha Tango Products, Perth: Haven Electronics, Nowra

- WEATHER FAX programs for IBM XT/ATs *** "RADFAXZ" \$35.00, is a high resolution short-wave weather fax, Morse and RTTY receiving program. Suitable for CGA, EGA, VGA and Hercules cards (state which). Needs SSB HF radio and RADFAX decoder. *** "SATFAX" \$45.00, is a NOAA, Meteor

and GMS weather satellite picture receiving program. Needs EGA or VGA & WEATHER FAX PC card, + 137 MHz Receiver. *** "MAXISAT" \$75.00 is similar to SATFAX but needs 2 MB of expanded memory (EMS 3.6 or 4.0) and 1024 x 768 SVGA card. All programs are on 5.25" or 3.5" disks (state which) plus documentation, add \$3.00 postage. ONLY from M. Delahunty, 42 Villers St, New Farm QLD 4005. Ph 07 358 2785.

- Campervans de ZL2QB. YL-2000 Meet in New Zealand. Campervans with ham radio for hire: www.kiwicampervans.co.nz. Karen and Dieter, Nelson, NZ. Phone Fax 0064 3 543 2022, e-mail kiwicamper@ts.co.nz

<http://www.hamsearch.com>
 a not-for-profit site that is a search engine for hams



We LOVE emails

If you are emailing your Hamad, the method MUCH preferred by our typesetters, could you please assist by following these two guidelines:

- 1) Please use upper and lower case in normal text (not caps please)
- 2) Please enter the words directly into the body of the email

Have you heard this week's Divisional Broadcast?
 See inside back cover for times and frequencies.

TRADE PRACTICES ACT

It is impossible for us to ensure that the advertisements submitted for publication comply with the Trade Practices Act 1974. Therefore, advertisers and advertising agents will appreciate the absolute need for themselves to ensure that the provisions of the Act are strictly complied with.

VICTORIAN CONSUMER AFFAIRS ACT

All advertisers are advised that advertisements containing only a PO Box number as the address cannot be accepted without the addition of the business address of the box-holder or seller of the goods.



Geoff Thompson VK3AC in his shack about 1975. Keyer bug and straight key under the rig, keyboard on the table at right

Geoff Thompson VK3AC 25.2.1911 — 30.4.2000

Geoffrey George Thompson passed away unexpectedly in his sleep on Sunday April 30.

Geoff was born at Clifton Hill where he attended the local school and, later, Collingwood Technical School and what was then known as the Working Men's College and is now RMIT University. At the age of 16 Geoff went to work at the Herald and Weekly Times as a copy boy. Many old timers will recall first reading about wireless and how to build their first crystal set by reading a wonderful boys' magazine, *Pals*, published by HWT until it was superseded by *The Listener In*.

As a schoolboy Geoff had passed through crystal set days and progressed to the point of obtaining his Amateur Licence in 1926, a little after his 16th birthday, with the call sign VK3GT which he held until the war years. He contributed many articles about wireless construction to *The Listener In* and also wrote a book, *The All Electric Receiver*, which was published by the Herald company in 1932. This was a time when AC operated receivers were beginning to replace battery operated sets.

Geoff combined his love of radio with photography and cinema photography

and so became deeply involved with the newly formed Herald Cinesound company whose newsreels always preceded the main picture at theatres all over Australia. During this period he built and installed a base radio transmitter receiver combination and a matching battery operated combination to establish communication between head office and the mobile camera crew's cars. They were licenced as VHM and VHL. During this period he built and installed a state of the art broadcast receiver for his Managing Director, Keith Murdoch, father of Rupert.

Like others in his age group he was called up for compulsory military service at the age of 18 and served for about 2 years in the 57th Battalion until compulsory training was replaced by a voluntary system in November 1929. Soon after this, Geoff met the late Stewart Embling VK3DC who was the Captain in charge of the wireless section of 3rd Division Signals at South Melbourne and later, Albert Park. Embling persuaded Geoff to join 3rd Division Signals and this is where I met

him after I transferred from the compulsory 1 year in infantry but still under the compulsory system. (3rd Division Signals was commanded by Colonel J S (Jack) Stevens who became Major General Sir Jack Stevens in World War 2).

As VK3GT Geoff operated on all bands and all modes and was always keen on CW. His life work was cinema photography. He was an accredited cinema photographer and war correspondent through both World War 2 and the Korean War including the occupation of Japan. His plan to form a business partnership with his friend the late, very famous photographer Damien Parer could not be fulfilled because of the tragic death of Damien Parer in New Guinea.

In 1946 Geoff came back to his first love, amateur radio, with the call sign VK3AC which he held until his passing. In the post war years he was an earlier operator in the SSB mode and delighted in high speed Morse code, gradually working up from hand held key and bug to keyboard operation in which he was an early operator. The machine in his shack was not connected, but a hand key and a keyer were wired into his rig.

Sadly, Geoff had to give up activity on the radio over the past 3 year or so because he had become profoundly deaf, but he retained his licence. After the war he had a holiday home at McCrae where he kept another set of equipment and also operated mobile. Geoff contributed a number of interesting articles to our magazine OTN, the most recent of which were in our March 1998 and March 2000 issues.

Geoff is survived by his wife of 60 years, Doreen and daughters Wendy and Sue. He deeply mourned the untimely death of his son Douglas in 1962. He was a long time member of the WIA and member number 12 of the Radio Amateurs Old Timers Club. He was widely know and admired throughout Australia and the wider world as a dedicated amateur who upheld the highest traditions of our hobby. He will be greatly missed.

Allan Doble VK3MD
ar



Division Directory

The Amateur Radio Service exists for the purpose of self training, intercommunication and technical investigation. It is carried out by amateurs who are duly authorised people interested in radio technique solely with a personal aim and without pecuniary interest.

The Wireless Institute of Australia represents the interests of all radio amateurs throughout Australia. National representation is handled by the executive office under council direction. One councillor for each of the seven Divisions. This directory lists all the Divisional offices, broadcasts schedules and subscription rates. All enquiries should be directed to your local Division.

VK1 Division Australian Capital Territory,

GPO Box 600, Canberra ACT 2601
 President Gilbert Hughes VK1GH
 Secretary Peter Kloppenburg VK1CPK
 Treasurer Ernie Hosking VK1LK

VK2 Division News South Wales

109 Wigram St, Parramatta NSW
 (PO Box 1066, Parramatta 2124)
 (Office hours Mon-Fri 1100-1400)
 Phone 02 9689 2417
 Web: <http://www.ozemail.com.au/~vk2wi>
 Freecall 1800 817 644

e-mail: vk2wi@ozemail.com.au
 Fax 02 9633 1525
 President Michael Corbin VK2YC
 Secretary Barry White VK2AAB
 Treasurer Pat Leeper VK2JPA

VK3 Division Victoria

40G Victory Boulevard Ashburton VIC 3147
 (Office hours Tue & Thur 0930-1500)
 Phone 03 9885 9261
 Web: <http://www.tbsa.com.au/~wiviac/>
 Fax 03 9885 9298

e-mail: wiviac@alphalink.com.au
 President Jim Linton VK3PC
 CEO Barry Wilton VK3XV
 Secretary Peter Mill VK3APO

VK4 Division Queensland

GPO Box 638 Brisbane QLD 4001
 Phone 07 3221 9377
 e-mail: office@wiaq.powerup.com.au
 Fax 07 3266 4929

Web: <http://www.wia.org.au/vk4>
 President Colin Gladstone VK4ACG
 Secretary David Jones VK4OF
 Treasurer Bill McDermott VK4AZM
 Office Mgr John Stevens VK4AFS

VK5 Division South Australia and Northern Territory

(GPO Box 1234 Adelaide SA 5001)
 Phone 08 8294 2992
 web: <http://www.sant.wia.org.au>

President Jim McLachlan VK5NB
 Secretary David Minchin VK5KK
 Treasurer John Butler VK5NX

VK6 Division Western Australia

PO Box 10 West Perth WA 6872
 Phone 08 9351 8873
 Web: <http://www.wia.omen.net.au/~vk6wia/>

e-mail: vk6wia@omen.net.au
 President Neil Penfold VK6NE
 Secretary Christine Bastin VK6ZLZ
 Treasurer Bruce Hedland-Thomas VK6OO

VK7 Division Tasmania

PO Box 371 Hobart TAS 7001
 Phone 03 6233 3709 (BH)
 Web: <http://www.wia.tasnet.net>
 email: batesjw@netspace.net.au
 Fax 03 6223 7816

President Phil Corby VK7ZAX
 Secretary John Bates VK7RT
 Treasurer John Bates VK7RT

Broadcast schedules All frequencies MHz. All times are local.

VK1WI: 3.590 LSB, 146.950 FM each Sunday evening from 8.00pm local time. The broadcast text is available on packet, on Internet [aus.radio.amateur.misc](http://www.aus.radio.amateur.misc) news group, and on the VK1 Home Page <http://www.vk1.wia.ampr.org>

Annual Membership Fees. Full \$77.00 Pensioner or student \$63.00. Without *Amateur Radio* \$49.00

From VK2WI 1.845, 3.595, 7.146*, 10.125, 14.160, 24.950, 28.320, 29.120, 52.120, 52.525, 144.150, 147.000, 438.525, 1281.750 (* morning only) with relays to some of 18.120, 21.170, 584.750 ATV sound. Many country regions relay on 2 m or 70 cm repeaters. Sunday at 1000 and 1930. Highlights included in VK2AWX Newcastile news, Monday 1930 on 3.593 plus 10 m, 2 m, 70 cm, 23 cm. The broadcast text is available on the Internet newsgroup [aus.radio.amateur.misc](http://www.aus.radio.amateur.misc), and on packet radio.

Annual Membership Fees. Full \$78.00 Pensioner or student \$61.00. Without *Amateur Radio* \$47.00

VK3BWI broadcasts on the 1st and 3rd Sunday of the month at 8.00pm. Primary frequencies, 3.615 LSB, 7.085 LSB, and FM(R)s VK3RML 146.700, VK3RMM 147.250, VK3RWG 147.225, and 70 cm FM(R)s VK3ROU 438.225, and VK3RMU 438.075. Major news under call VK3ZWI on Victorian packet BBS and WIA VIC Web Site.

Annual Membership Fees. Full \$78.00 Pensioner or student \$61.00. Without *Amateur Radio* \$47.00

VK4WIA broadcasts on 1.825 MHz SSB, 3.605 MHz SSB, 7.118 MHz SSB, 10.135 MHz SSB, 14.342 MHz SSB, 21.175 MHz SSB, 28.400 MHz SSB, 29.660 MHz FM (rptr), 147.000 MHz, and 438.525 MHz (in the Brisbane region, and on regional VHF/UHF repeaters) at 0900 hrs K every Sunday morning. QNEWS is repeated Monday evenings, at 19.30 hrs K, on 3.605 MHz SSB and 147.000 MHz FM. On Sunday evenings, at 18.45 hrs K on 3.605SSB and 147.000 FM, a repeat of the previous week's edition of QNEWS is broadcast. Broadcast news in text form on packet is available under WIAQ@VKNET. QNEWS Text and real audio files available from the web site

Annual Membership Fees. Full \$85.00 Pensioner or student \$72.00. Without *Amateur Radio* \$56.00

VK5WI: 1827 kHz AM, 3.550 MHz LSB, 7.095 AM, 14.175 USB, 28.470 USB, 53.100 FM, 147.000 FM Adelaide, 146.700 FM Mid North, 146.800 FM Mildura, 146.825 FM Barossa Valley, 146.900 FM South East, 146.925 FM Central North, 147.825 FM Gawler, 438.425 FM Barossa Valley, 438.475 FM Adelaide North, ATV Ch 35 579.250 Adelaide. (NT) 3.555 USB, 7.065 USB, 10.125 USB, 146.700 FM, 0900 hrs Sunday. 3.585 MHz and 146.675 MHz FM Adelaide, 1930 hrs Monday.

Annual Membership Fees. Full \$77.00 Pensioner or student \$63.00. Without *Amateur Radio* \$49.00

VK6WIA: 146.700 FM(R) Perth at 0930hrs Sunday relayed on 1.865, 3.564, 7.075, 10.125, 14.116, 14.175, 21.185, 29.120 FM, 50.150 and 438.525 MHz, Country relays 3.582, 147.200 (R) Cataby, 147.350 (R) Busselton, 146.900 (R) Mt William (Bunbury), 147.000 (R) Katanning and 147.250 (R) Mt Saddleback. Broadcast repeated on 146.700 at 1900 hrs Sunday relayed on 1.865, 3.564 and 438.525 MHz : country relays on 146.900, 147.000, 147.200, 147.250 and 147.350 MHz..Also in "Real Audio" format from the VK6 WIA website

Annual Membership Fees. Full \$69.00 Pensioner or student \$59.00. Without *Amateur Radio* \$38.00

VK7WI: 146.700 MHz FM (VK7RHT) at 0930 hrs Sunday relayed on 147.000 (VK7RAA), 146.725 (VK7RNE), 146.625 (VK7RMD), 3.570, 7.090, 14.130, 52.100, 144.150 (Hobart), repeated Tues 3.590 at 1930 hrs.

Annual Membership Fees. Full \$88.00 Pensioner or student \$75.00. Without *Amateur Radio* \$55.00

VK8 Northern Territory (part of the VK5 Division and relays broadcasts from VK5 as shown, received on 14 or 28 MHz).



YAESU'S DONE IT AGAIN

VX-5R 6m/2m/70cm Deluxe Handheld

**SUPER
PERFORMANCE
HANDHELD**

YAESU

2 YEAR WARRANTY



VX-5R pictured showing large frequency digits

Offers expire 29/10/00

Tiny, yet incredibly rugged, the VX-5R provides 6m, 2m and 70cm Amateur band operation with 5W output as standard (4.5W on 70cm), made possible by a unique PA design, super high-capacity 7.2V 1100mA/H Lithium-ion battery, and a diecast metal case. Plus, ultra-wide VHF and UHF as well as medium-wave and shortwave reception facilities are provided.

Another really useful feature is the large backlit dot-matrix LCD screen that can be configured to suit your operating needs.

You can choose large frequency digits, dual line displays (VFO "A" and "B" frequencies, VFO "A" frequency and battery voltage and even VFO "A" frequency as well as other data such as recent Tx/Rx times or transceiver internal temperature), or even 8-digit alphanumeric memory labels. All this in a diecast aluminium enclosure just 58 x 87 x 28mm WHD (w/o knob or antenna)!

Other features include:

- Tx: 50-54, 144-148, 430-450MHz
- Rx: 0.5-1.8MHz, 1.8-16MHz, 48-729MHz, 809-999MHz (cellular blocked)
- Full feature keypad, CTCSS encode/decode, Digital Code Squelch
- Comprehensive menu system
- Over 200 regular memories, plus 10 pairs of "Band limit" memories
- Fast battery charging from the supplied AC adaptor
- 5 battery saving systems, plus Tx/Rx usage monitor.
- Spectra-Scope™ for monitoring adjacent channel activity
- Comes with FNB-58LI 1100mA/H Lithium-ion battery, flexible antenna and AC adaptor/charger

D 3670

\$599 **SAVE \$60**

DICK SMITH
ELECTRONICS

For further information, orders, or the location of your nearest store: Phone 1300 366 644 (local call charge) Or Fax: (02) 9395 1155

October 2000
Volume 68 No 10



Amateur Radio

Awards
Contests

plus

*Divisional & Club News
ALARA
& regular columns*



Jamboree On The Air

Photo courtesy of
Northern Star Services

Build the Funway 80

Transform a \$15 Kit into
an 80m Receiver

- ★ A Superhet Receiver for
Three HF Bands
- ★ PIC Controlled Transmitter

Visit The Skoux Club

Gil Sones VK3AUI

Technical Abstracts:

**Giant LF Loop Stick
Giovannini D2T
Antenna**



WIA Call Book 2001

OUT SOON

It is more than a call book, it's a Yearbook, the WIA Yearbook!

*The "WIA Call Book 2001" will
soon be available from
Divisional Bookshops
and selected outlets*



Amateur Radio

Volume 68
Number 10
October 2000

The Journal of the Wireless
Institute of Australia

ISSN 0002-6859

Editorial

Editor: Colwyn Low VK5UE
edarmag@chariot.net.au

Technical Editor: Peter Gibson VK3AZL

Publications Committee Members

Ron Fisher VK3OM
Don Jackson VK3DBB
Evan Jarman VK3ANI
Bill Rice VK3ABP
Gil Sones VK3AUI

Advertising

Mrs June Fox,
Tel: (03) 9528 5962

Hamads

"Hamads" Newsletters Unlimited
29 Tanner Street, Richmond VIC 3121
Fax: (03) 9428 4242
e-mail: news1@webtime.com.au

Office

10/229 Balaclava Road
Caulfield, Victoria
Telephone (03) 9528 5962
Facsimile (03) 9523 8191
Business Hours 9:30am to 3:00pm weekdays

Postal

P.O. Box 2175
CAULFIELD JUNCTION
VICTORIA 3161
AUSTRALIA
e-mail: armag@ hotkey.net.au

Production

Newsletters Unlimited (03) 9428 3458

Printer

Streamline Press, Melbourne (03) 9417 2766

Postal Service

IMS (03) 9291 5888

Production Deadlines

Advertising booking and articles for
publication 10th of preceding month.

Hamads and advertising material deadline
18th day of preceding month

The contents of Amateur Radio are
Copyright Wireless Institute of Australia
C 2000

General

IARU R3 set course for future direction	3
<i>Jim Linton VK3PC</i>	
The Skaux Club	17
<i>Henryk Kotowski SMØJHF</i>	
SSB is older than you are!	26
<i>Steve VK5AIM</i>	

Technical

Build the Funway 80	4
<i>Peter Parker VK3YE</i>	
A Supertet Receiver for Three HF Bands	9
<i>Drew Diamond VK3XU</i>	
PIC controlled transmitter	20
<i>Jeremy Lemke VK3TFH</i>	
Giant LF Loopstick (Technical Abstracts)	24
<i>Gil Sones VK3AUI</i>	
Giovannini D2T Antenna (Technical Abstracts)	25
<i>Gil Sones VK3AUI</i>	
Aerial Circuit for 12' Whip	27
<i>Robert Milne VK7ZAL-AX2TAR</i>	

Columns

Advertisers' Index	55	Hamads	55
ALARA	16	HF Predictions	50
Awards	39	Intruder Watch	49
AMSAT	36	Over To You	56
Contests	40	Novice Notes	52
Club News	18	Repeater Link	45
WIA Division News		Silent Key	54
VK1 Notes	31	Spotlight on SWLing	15
VK3 Notes	32	Technical Abstracts	24
VK4 Notes	31	VHF/UHF - An Expanding World	47
VK7 Notes	32	WIA Comment	2
DX Notes	33	WIA Division Directory	30
Editor's Comment	2	WIA Federal Directory	2
Education	19	WIA News	3

Our cover this month

North Coast scout Andrew Cowperthwaite, 10, talks to scouts in South Australia during the 1999 Jamboree On The Air. With him is Scott Hyland, 10, and Kirsty Smith, 15. They are members of the 1st Goonellabah Scout Troup.

The operators assisting were Duncan Rayment VK2DLR and Leith Martin VK2EA. JOTA also operated a group from the Dunoon area with operators Bill Cross VK2WJC and Bill Parker VK2KDI assisting.

Photo first appeared in *The Northern Star*, 19/10/99. Used here by permission

Contributions to Amateur Radio

Amateur Radio is a forum for WIA members' amateur radio experiments, experiences opinions and news. Manuscripts with drawings and or photos are always welcome and will be considered for publication. Articles on disc or email are especially welcome. The WIA cannot be responsible for loss or damage to any material. A pamphlet, How to write for Amateur Radio is available from the Federal Office on receipt of a stamped self-addressed envelope.

Back Issues

Back issues are available directly from the WIA Federal Office (until stocks are exhausted, at \$4.00 each (including postage within Australia) to members.

Photostat copies

When back issues are no longer available, photocopies of articles are available to members at \$2.50 each (plus an additional \$2 for each additional issue in which the article appears).

Disclaimer

The opinions expressed in this publication do not necessarily reflect the official view of the WIA and the WIA cannot be held responsible for incorrect information published.

Amateur Radio Service

A radiocommunication service for the purpose of self-training, intercommunication and technical investigation carried out by amateurs; that is, by duly authorised persons interested in radio technique solely with a personal aim and without pecuniary interest.

Wireless Institute of Australia

The world's first and oldest
National Radio Society
Founded 1910

Representing
The Australian Amateur Radio Service

Member of the
International Amateur Radio Union

Registered Federal Office of the WIA
10/229 Balacraiva Road
Caulfield North Vic 3161
Tel: (03) 9528 5962 Fax (03) 9523 8191
http://www.wia.org.au

All mail to
PO Box 2175 Caulfield Junction VIC 3161

Business hours: 9.30am-3pm weekdays

Acting Federal Secretary

Peter Naish VK2BPN

Federal Office staff

June Fox Bookkeeper
Rita Trebilco VK3IF Examinations Officer

Council

President	Peter Naish	VK2BPN
VK1 Federal Councillor	Glenn Dunstan	VK1XX
VK2 Federal Councillor	Michael Corbin	VK2YC
VK3 Federal Councillor	Brenda Edmonds	VK3KT
VK4 Federal Councillor	David Jones	VK4OF
VK5 Federal Councillor	David Box	VK5OV
VK6 Federal Councillor	Will McGhie	VK6UU
VK7 Federal Councillor	Phil Corby	VK7ZAX

Executive

Peter Naish VK2BPN
John Loftus VK4EMM

Federal Coordinators

AMSAT	Graham Ratcliff	VK5AGR
ARDF	Jack Bramham	VK3WWW
Awards	John Kelleher	VK3DP
Contests	Ian Godsil	VK3DID
Education	Brenda Edmonds	VK3KT
FTAC	John Martin	VK3KWA
Historian	John Edmonds	VK3AFU
IARU	Grant Willis	VK5ZWI
Intruder Watch	Gordon Loveday	VK4KAL
ITU Conference and study group	Gilbert Hughes	VK1GH
QSL Manager (VK9, VK0)	Neil Penfold	VK6NE
Videotapes	VK2 Division	
Web/PR	Richard Murnance	VK2SKY

ACA Liaison Team

Peter Naish VK2BPN
Glenn Dunstan VK1XX
Michael Corbin VK2YC
Wally Howse VK6KZ
Canberra Liaison Officer
Richard Jenkins VK1RJ



Editor's Comment

Spectrum: Use it or lose it in the Olympic aftermath

Sydney and Australia are reluctantly returning to normal after the Olympics, but how much if any of the 70cm band we will eventually regain access to is uncertain. We have to be continually aware that our hold on spectrum is very dependent on our being seen (heard?) to use it. It is very much a case of populate it or lose it.

Five weeks in the UK saw me with limited petrol, lots of Roman ruins and 10th century churches. I have learnt that to properly keep on top of this job I needed a laptop with a gig or so of hard drive. Sorry for the omissions etc. which have crept into September and October AR. I continually learn that I must continually adapt.

Much takes place this month and next in the Contest/activity area. The ZL/VK Oceania contest is on October 7th and 14th so there is still time to participate. The ALARA Contest is on Saturday November 11th and JOTA is

on Saturday 21 Sunday 22nd October, with perhaps some activity on the Friday night. JOTA uses many modes, the most popular being SSB on HF and FM on VHF and then Packet. JOTA also operates on the Internet. Please help present the good face of Amateur radio to these young people. Local groups always need extra help or have suddenly realised JOTA is next week. A VHF mobile with a whip in an urban area can always provide a few contacts.

I thought Solar Sunspot maximum was almost upon us, but have been told it could have been in August. We should getting the most out of our stations to work DX for our own satisfaction or to help others achieve their ambitions. You cannot be a communicator on your own.

I have been asked to locate a program, which gives bearings from a designated location to capital cities round the world. Can anyone point me in the right direction?

73 Colwyn VK5UE



WIA Comment

The five day IARU Region 3 Conference held in Darwin recently was a great success. Delegates from all of the Asia/Pacific region attended and progress was made on many important matters affecting amateur radio in this area.

Threats to our continuing use of the 70 cms band are intensifying. For some time the spectrum around 434 MHz has been available to class-licensed devices known as Low Interference Potential Devices (LIPDs). The WIA representations to the ACA that LIPDs should not be permitted in this part of the spectrum have so far have been rejected. ACA see LIPDs as a 'public benefit' and consider they should be allowed to continue operation on frequencies throughout the spectrum.

Now, a new, serious restriction is to be placed on this band. From next year, a digital land mobile network is to begin in WA around Perth. The band between 420 MHz and 430 MHz will cease to be available to the amateur radio service within 200 km of Perth.

And there is worse to follow, as similar systems will probably soon appear in the other major areas of Australia.

We could soon lose the use of the bottom 10 MHz of 70 cms nationally where we now operate many fixed links, amateur television and similar strategic activities. The WIA is working with the ACA on this threat, seeking to mitigate the impact on our traditional operations. WIA's technical advisory committee is also examining our band plans to determine a possible long-term solution.

Many commercial organisations, here and worldwide, are hungry for spectrum in the 400 to 500 MHz region. In Australia the amateur radio service is only a secondary user of 420 to 450 MHz with Defence having primary use. For many years we have operated problem-free under this arrangement.

The proposed introduction of digital land mobile radio systems will change this happy balance.

Peter Naish
WIA Federal President.

IARU R3 sets course for future direction

The eleventh IARU Region 3 (R3) Conference held in Darwin recently was busy. Much discussion was about protecting and furthering amateur radio within the region, and globally.

The region's 17 member societies willingly tackled the numerous issues facing the Amateur Service and Amateur-Satellite Service in the 21st century.

Conference chairman, and WIA President, Peter Naish VK2BPN, commented on the positive approach taken at the week-long conference, saying it clearly showed that IARU R3 spoke with a single voice.

ITU Radio Regulation s25, currently requiring Morse code proficiency in amateur licence testing, generated considerable discussion at Working Group 3 (WRC-03).

At the end of the day, the general intent of a WIA input paper on the ITU RR s25, which is to be reviewed at WRC-03, were adopted. The Conference resolved to support lowering the amateur licence Morse code test speed temporarily, and the ultimate removal of Morse as an ITU licence requirement.

At the final plenary session a WIA motion, seconded SARTS, read:

IARU Region 3 strongly supports Morse code as an effective and efficient mode of communication. However, it believes that the position of Morse as a qualifying criterion for a HF amateur licence is not relevant to the healthy future of amateur radio. Therefore:

1. That IARU Region 3 urges member societies to seek, as an interim measure, the reduction of all Morse code testing speeds to five words per minute.
2. That setting aside any previous relevant decisions of earlier Conferences, a policy of the removal of Morse code testing as an ITU requirement for an amateur licence to operate on frequencies below 30 MHz be adopted by IARU Region 3.
3. Further, we recommend that the Administrative Council adopt the above position as IARU policy.

This passed, ARRL voting against, and HARTS, who three years ago supported retention of Morse Code, abstaining.

Another ITU RRs25 related motion

was the preliminary draft recommendation for WRC-03 (M-AOQ, ITU-R Document 8A/TEMP/91-E), which includes "Radio Telegraphy" as an Operating Skill for the amateur licence.

The concern was that "Operating Skills" could be mis-understood, and was wrongly seen by some as requiring the retention of Morse code telegraphy skills.

Delegates heard that in ITU terminology, Radio Telegraphy meant all digital transmission modes. A motion, proposed RSGB, seconded ARRL, instructed the R3 representatives on IARU Administrative Council to replace M-AOQ term "Operating Skills" with "Methods of Communication".

The conference noted crowding in the 40 metre band, particularly in countries with narrow allocations, and the IARU objective of obtaining an exclusive worldwide 7MHz allocation of no less than 300 kHz, was reaffirmed. The conference instructed the Directors of IARU R3 to treat this objective as a highest priority, and R3 member societies were urged to give support.

Emergency and disaster communications traditionally provided by the Amateur Service should be strengthened by the Conference recommending the establishment of a regional committee for disaster communications. It proposes to appoint R3 disaster communications coordinators, identify the recurring needs for disaster communications and those deployable resources for international assistance in event of a disaster.

The Conference also gave its support for seeking a band allocation around 5MHz, and to consider defining HF band segments (not 10, 18 or 24MHz) for use during international disaster emergency communications. It was noted that IARU R2 has addressed this in its band plans.

Among many other resolutions were:

- * **Harmonisation of licensing in IARU R3.** A new position will continue surveying member societies on their amateur licence syllabuses and examination standards.
- * **Monitoring of interference from non-amateur transmissions to amateur**

satellites. The objective is to establish a series of terrestrial monitors, similar to the IARU Monitoring System (Intruder Watch) to gather information on intruders so action can be taken against them.

- * **Internet based amateur licence education,** and on-demand computerised licence testing, now available in Australia and New Zealand.
- * **LIPDs** An awareness of the problems of so-called Low Interference Potential Devices (LIPDs), and to lobby against their licensing on the 70cm band, particularly where amateur repeater activity occurs.
- * **Self assessment** Radio societies to lobby their national administrations to adopt self-assessment for amateur stations to enable them to meet Electromagnetic radiation (EMR) standards, with education programs for radio amateurs.
- * **Low Frequency band** The seeking of an amateur allocation for a Low Frequency band, either 165-190kHz and/or 135.7-137.8kHz. IARU policy is to pursue LF bands in all regions.
- * **High speed data** The emergence of high speed data technology, eg xDSL, and its intrusion into amateur bands.

Six radio amateurs to the IARU Monitoring System (Intruder Watch) were recognised with certificates commending them for their long term efforts. They were: Rohan Wahrich ZL1CVK, Gordon Loveday VK4KAL, B.L. Manohar VU2UR, Isamu Kobayashi JA0AD, C.C. Robertson VK4AKX, and N. Yatheedandran 9V1JY.

A final matter was the election of the IARU R3 directors for the next three years. They are Fred Johnson ZL1AMJ, Peter Naish VK2BPN, Yong S. Park HL1IFM, Yoshiji Sekido JJ1OEJ, and KC Selvaduras 9V1UV. The directors appointed Fred ZL1AMJ as chairman.

The IARU Conference in 2003 will be hosted by CTARL and held in Taiwan.

Jim Linton, VK3PC

WIA Media Officer for IARU Region 3 Conference, Darwin, Australia)

Build the Funway 80

Transform a \$15 kit into an 80 metre receiver

Peter Parker VK3YE

12/8 Walnut Street, Carnegie, Vic, 3163

Email: parkerp@alphalink.com.au

The beginner wishing to hear HF on-air amateur activity is confronted with two choices. Either buy a set or build one from scratch. Both options have their pros and cons. Building a receiver is fun but the parts can be hard to obtain and results are by no means guaranteed.

Now there's another choice. Build the Funway 80 (Photo One). Part kit, part homebrew, the Funway 80 is your key to 80 metre listening enjoyment. Because many parts come in a \$15 kit, construction costs are kept low. Most components are mounted on the printed circuit board that comes with the kit. The chance of constructor error is reduced compared to a set built from scratch. It all adds up to a set that's cheap, easy to build and likely to work first time.



Photo One: Front view of the Funway 80 Receiver.

The kit on which the Funway 80 is based is a Dick Smith Funway 2 Shortwave Receiver kit for beginners (K-2640). The kit is a tuned radio frequency (TRF) set for the HF bands. Specified frequency coverage is 11 to 35 MHz.

The set includes a one transistor RF amplifier stage. This is followed by a single tuned circuit and diode detector (Figure One). A 4007 digital IC biased to operate in linear mode amplifies the audio to drive a speaker. This stage is not shown in the diagram.

TRF receivers have many shortcomings that make amateur reception difficult. The first is that they are designed to receive AM - now seldom used by amateurs. Secondly, the diode envelope detector normally used is poor at detecting weak signals. Thirdly, because all selectivity is provided by just one tuned circuit at the received frequency, incoming signals cannot always be separated. The absence of bandspread (provided either

electrically or mechanically) is another factor making many simple receivers difficult to use.

All these limitations must be overcome to properly receive amateur signals. The changes described, though simple, convert the set from TRF to direct conversion and allow vastly better amateur reception.

What the modifications achieve

1. Reception of SSB and CW signals.

This was achieved by converting the diode envelope detector into a product detector. This is very easy and requires just two additional components.

The product detector needs a signal on the frequency to which the set is tuned in order to operate. This is provided by the one transistor oscillator circuit shown in Figure Two. It covers 3.5 to 3.7 MHz with one half-turn of the tuning knob.

2. Improved sensitivity. Another benefit of the diode product detector is its

improved sensitivity over the envelope detector that it replaced. Sensitivity is now fully adequate for the 3.5 MHz band.

3. Better selectivity. There are two aspects to consider here - audio selectivity and RF selectivity.

Because direct conversion receivers have no crystal filters or IF amplifier stages, their close-signal selectivity is determined in the audio stage. Changing component values in the audio amplifier stage alters the receiver's audio selectivity. Wiring a 0.001 uF capacitor across the 500k preset volume control provided a worthwhile narrowing of the amplifier's audio response and thus improved selectivity.

RF selectivity is also important. This is because there are hundreds of strong signals present at the antenna and their presence can reduce receiver performance. A good tuned circuit greatly reduces the strength

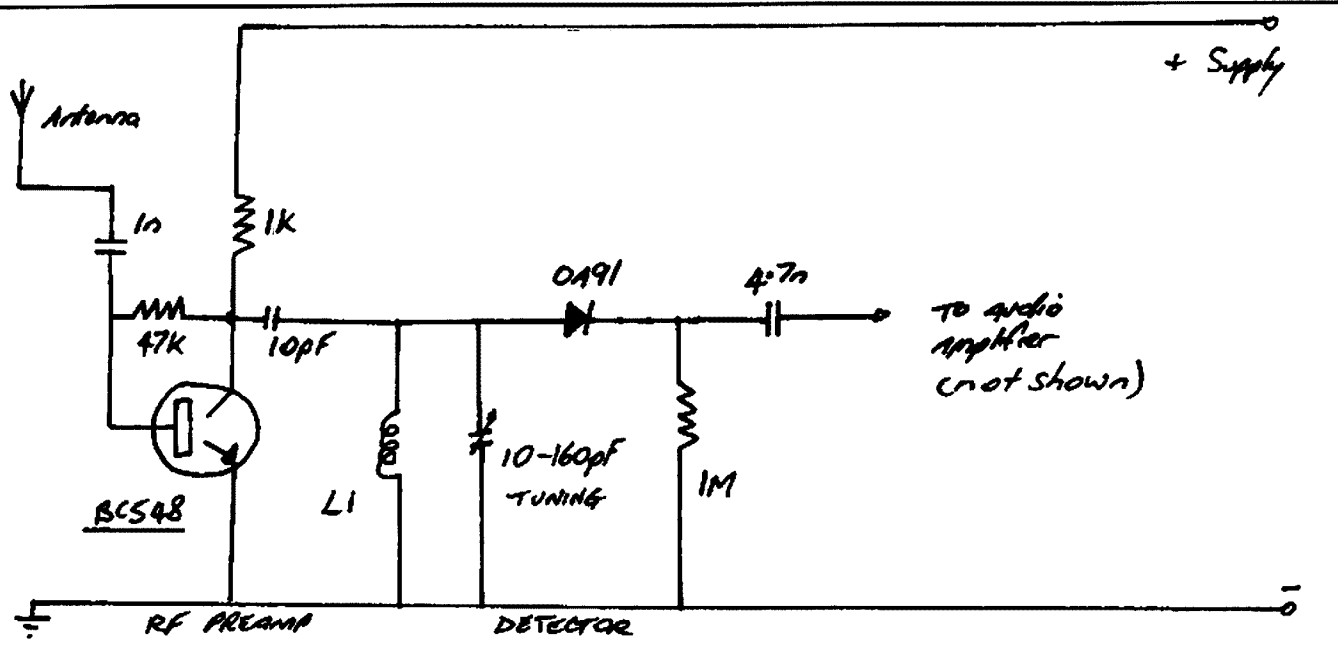


Figure One: Schematic diagram of original front-end

of unwanted signals, while allowing desired signals (in the 3.5 MHz band) to pass.

The tuned circuit following the RF preamplifier stage has been modified to resonate at 3.5 MHz. The kit's original tuning control becomes a 'peak' control in the modified design. It should be re-adjusted with every 40-50 kHz movement of the tuning control.

A low-pass filter ahead of the RF amplifier attenuates all signals above 4 MHz. This reduces pick-up of 7 MHz broadcast stations - a real possibility with simple direct conversion receivers and random wire antennas. Though the receiver will work without this filter, the improved performance is well worth the three components it requires.

4. *Bandspread for easier tuning.* SSB signals are much harder to tune in than AM signals. Most simple receivers that are satisfactory on AM are not easily usable on SSB. The use of a 'bandspread' or 'fine tuning' control allows coverage of small sections of the band, and thus better tuning of SSB signals.

5. *RF gain control.* Many people prefer to have the volume set high and reduce RF gain on loud signals. A trimpot is supplied in the original kit as the volume control. It was decided to retain the pre-set trimpot and

include a panel-mounted RF gain control. This is normally set to maximum and wound back when strong signals are present.

Construction

Purchase a copy of the Funway 2 book (B-2605) and the Shortwave receiver kit (K-2640). Assemble as instructed. Connect a wire antenna at least 10 metres long. At various times of the day tune around and explore what can be heard. You should hear at least one or two international stations, which may not be completely separable.

Once satisfied that the kit is working, perform the necessary tasks to allow it to tune 3.5 MHz SSB signals. The circuitry of the receiver's original front-end is reproduced at Figure One. Figure Two shows the modified front-end plus the new VFO. A suggested construction layout is shown in Figure Three.

Consider what type of box the receiver will be installed. The enclosure for the prototype (Photo Two) is made from single-sided printed circuit board material. Three pieces form a shallow U, with short braces to relieve pressure on soldered joints. The front panel in the prototype measured 152 x 165 mm. The sides were 152 x 73mm each. However, the use of a smaller front panel (152 x 152 mm) would allow standard-size blank boards to be used with a minimum of cutting and wastage.

It is suggested that modifications proceed in the following order:

Constructing the variable frequency oscillator

The VFO is the only part of this project where significant new construction is required. Its job is to provide a stable signal capable of being varied between 3.5 and 3.7 MHz.

The VFO was built on a piece of printed circuit board material about 5 x 5 cm (Figure Four). This board was then soldered to the main chassis at two points for both mechanical support and electrical connection. Earthed parts were soldered straight to the board; unearthed connections were left hanging. This worked out to be quite mechanically stable in practice. An attempt was made to keep wires short. This succeeded in the prototype, except for the long lead to the fine tuning control.

To keep construction easy for first-time builders, a 10 uH RF choke was used in the VFO's tuned circuit. More experienced constructors could substitute their own coil (either air-wound or toroidal) in this spot, and perhaps gain improved frequency stability. Other measures that could be taken to aid stability include housing the VFO in a separate metal box within the receiver, using a three-terminal voltage regulator instead of the zener diode used, using only quality capacitors in the VFO circuit and substituting an air-

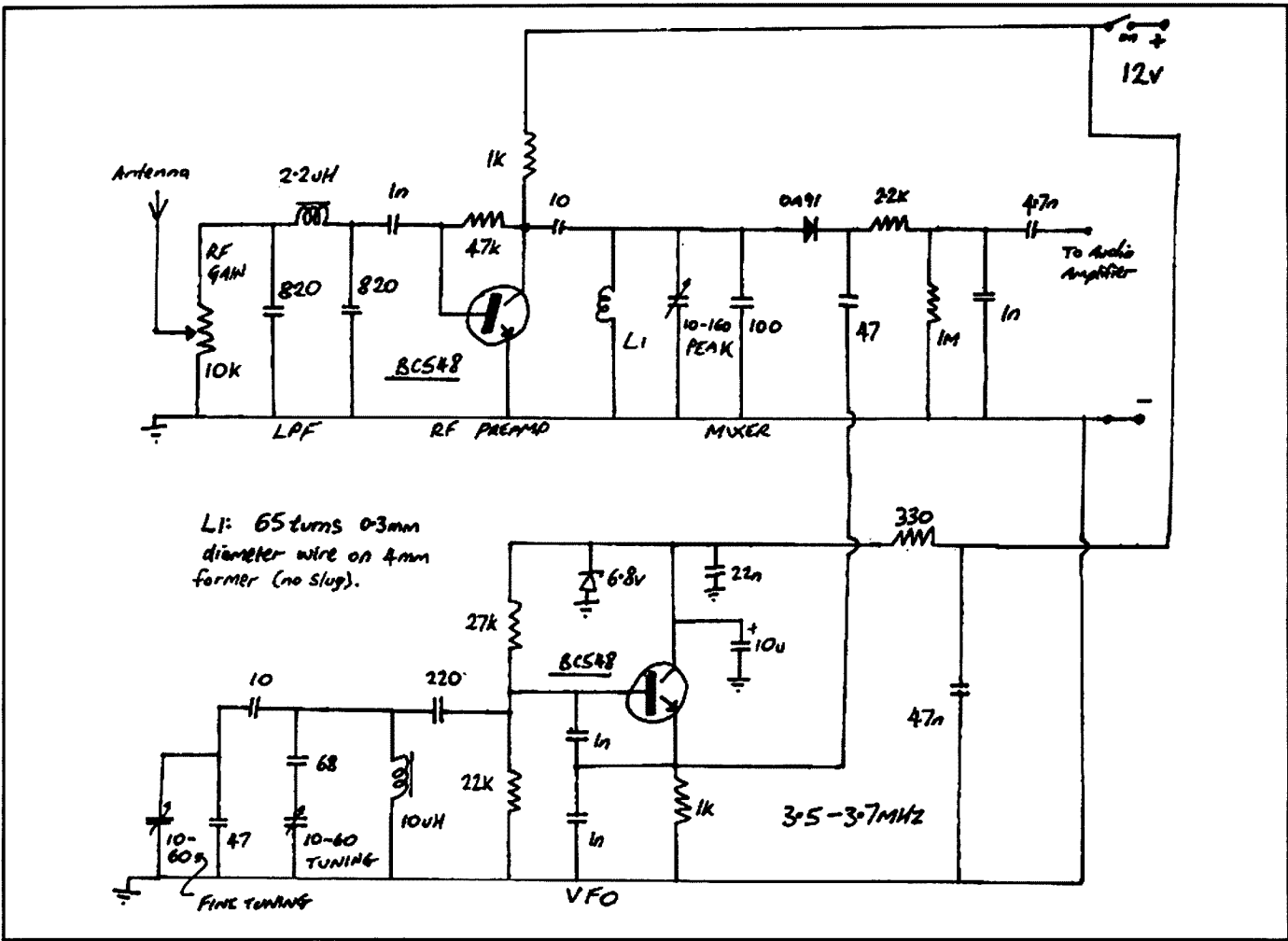


Figure Two: Schematic diagram of modified front-end and VFO.

spaced tuning capacitor (preferably with vernier reduction drive) for the plastic dielectric unit used.

Access to another 3.5 MHz receiver is desirable to test and align the VFO. Apply power (9 to 12 volt) to the VFO board and locate the signal in the receiver. Set the main tuning anticlockwise and the fine tuning control to mid-position. Adjust one of the trimmer capacitors on the rear of the main tuning control until the VFO's signal is 3.5 MHz. One trimmer capacitor will vary the frequency, but the other, being for the unused 60pF section, will not.

Those without a receiver can use an RF probe to test the oscillator's operation. A one transistor 3.58 MHz crystal oscillator can be handy for providing test signals and aligning the VFO when the receiver is complete.

Modifying the mixer tuned circuit

For this step, two components are needed. These are a new inductor and a 100pF disc ceramic capacitor.

Wind the coil (L1) on a 5mm former with no slug (eg DSE R-5020 former, R-5010 former base). L1 comprises 65 turns of 0.3mm enamelled copper wire. Wind this over about a 15mm length of the former, using several layers if necessary. Solder the ends of the wires onto two of the connections on the former base. The former base connections chosen should be those that will eventually mate with the circuit board - see later.

A way must be found to mount the coil on the receiver printed circuit board. Solder two PC board pins in the holes occupied by the old coil's leads. Place the short end of the pin in the board - length will be required to provide sufficient clearance for the coil.

The object of this exercise will be to have two pins on the coil base mating with the two circuit board pins. When a good position is found, make the two solder joints required. Cut the unused pins on the coil base short (with wire cutters) to allow an easy fit.

Mounting the 100pF capacitor is easy. Simply trim its leads and solder it on the underside of the printed circuit board beneath the variable capacitor.

Converting the diode detector to a mixer

Again two parts are needed - a 2.2k resistor and a 1nF disc ceramic capacitor. Wire the 1nF capacitor across the existing 1M resistor. A good spot to do this is underneath the circuit board.

Apply the soldering iron to the diode's cathode (banded end) connection under the circuit board and gently ease the cathode lead out. Either a small flat-blade screwdriver inserted under the diode or piece of enamelled copper wire will help here.

Insert one end of the 2.2k resistor into the hole left vacant by the diode's cathode. Solder and cut lead short. Solder the free end of the 2.2k resistor to the diode's cathode. Connect the VFO output (via the 47 pF coupling capacitor)

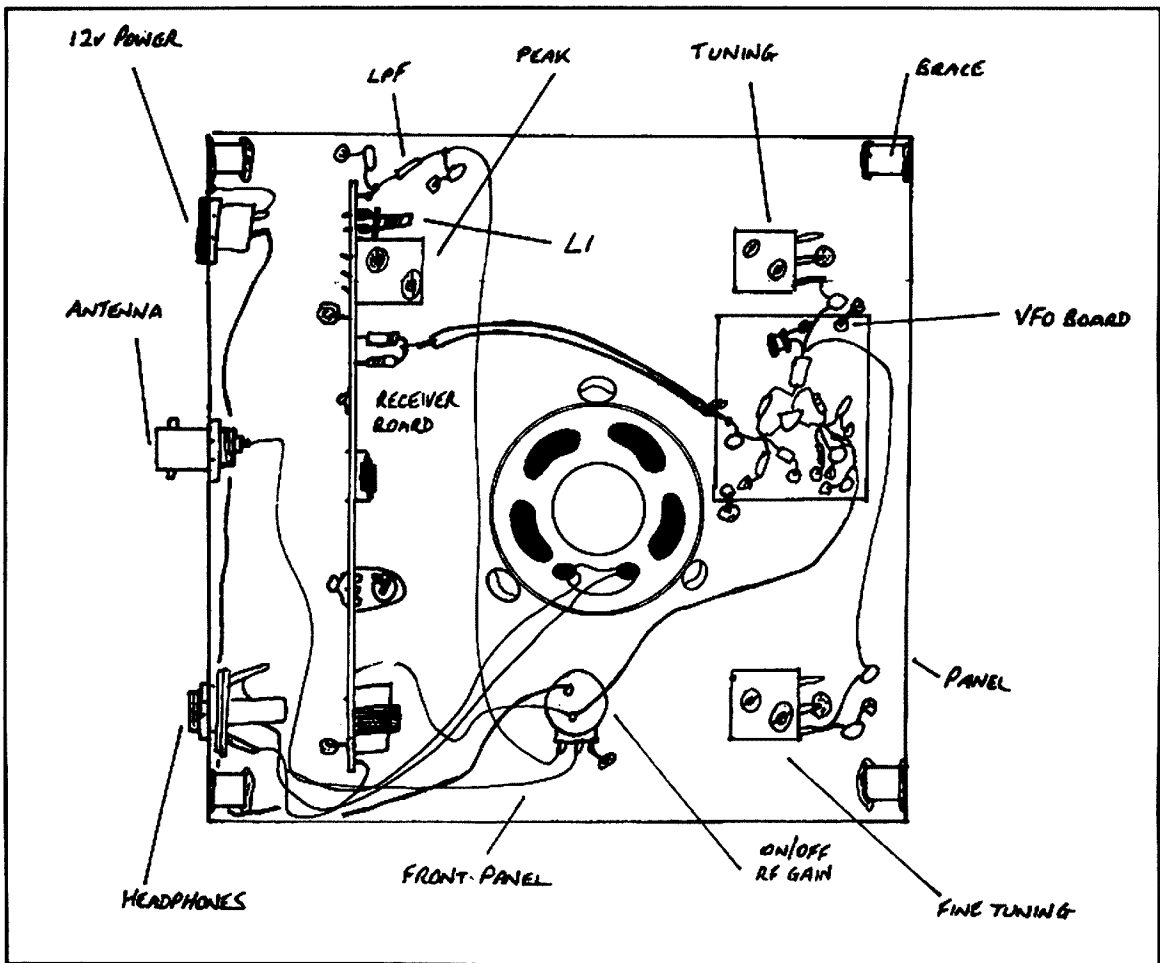


Figure Three: Internal construction of receiver, showing sockets, controls and layout of boards.

to this point with shielded cable. Either RG174 or thin audio cable will suffice.

At this point it should be possible to hear amateur signals on the modified receiver provided the VFO has been set to tune the correct range. Connect an antenna and switch on during the evening. Tune in a few SSB signals to prove that the receiver works. Annoying heterodynes from 7 MHz broadcast stations will make reception unpleasant. Also it will be difficult to separate stations closer than about 8 - 10 kHz because receiver selectivity is still poor. The following two modifications will make the receiver a better performer.

Adding extra front-end selectivity and the RF Gain control

The pi-network low-pass filter makes use of a commercially available 2.2 uH RF choke. The 820pF capacitors specified may be polystyrene, silvermica or disc ceramic. The components used in the filter are soldered to the copper rear of the PC board front panel near the RF preamp circuitry.

The potentiometer is mounted below the speaker on the front panel. It acts as the RF Gain control – desirable when strong signals are encountered. In the prototype this control was combined with the on/off power switch.

Modifying the audio amplifier

Very little needs to be done here. Just wire a 1nF disc ceramic capacitor across the volume control pre-set potentiometer. While you're at it, set the potentiometer to maximum audio gain (wiper nearest 4007 IC).

How it works

A direct conversion receiver consists of three main stages - mixer, variable frequency oscillator and audio amplifier. The variable frequency oscillator (VFO) is tuned to the desired frequency of reception. Two signals are applied to the mixer stage - the incoming signal and the signal from the VFO. Two signals are present at the output of the mixer. These are the sum of the mixed frequencies (around 7 MHz) and the differences

between the two frequencies (audio frequencies). It is these audio frequencies that are amplified sufficiently to produce a sound in the speaker.

Because direct conversion receivers have no filters at the intermediate frequency, selectivity is determined in the audio stages. Low pass and high pass filters are simple to build from op-amp ICs and can greatly improve the selectivity of a direct conversion receiver. However, unless complicated circuitry is added, direct conversion receivers will never be as selective as superhet receivers, at least for SSB signals.

Operation

Using the Funway 80 is very simple – switch the receiver on, set to maximum RF gain, set the peak control for maximum noise and tune around for a signal. The Fine Tuning control should initially be set to centre position. Once a signal is encountered, it should be

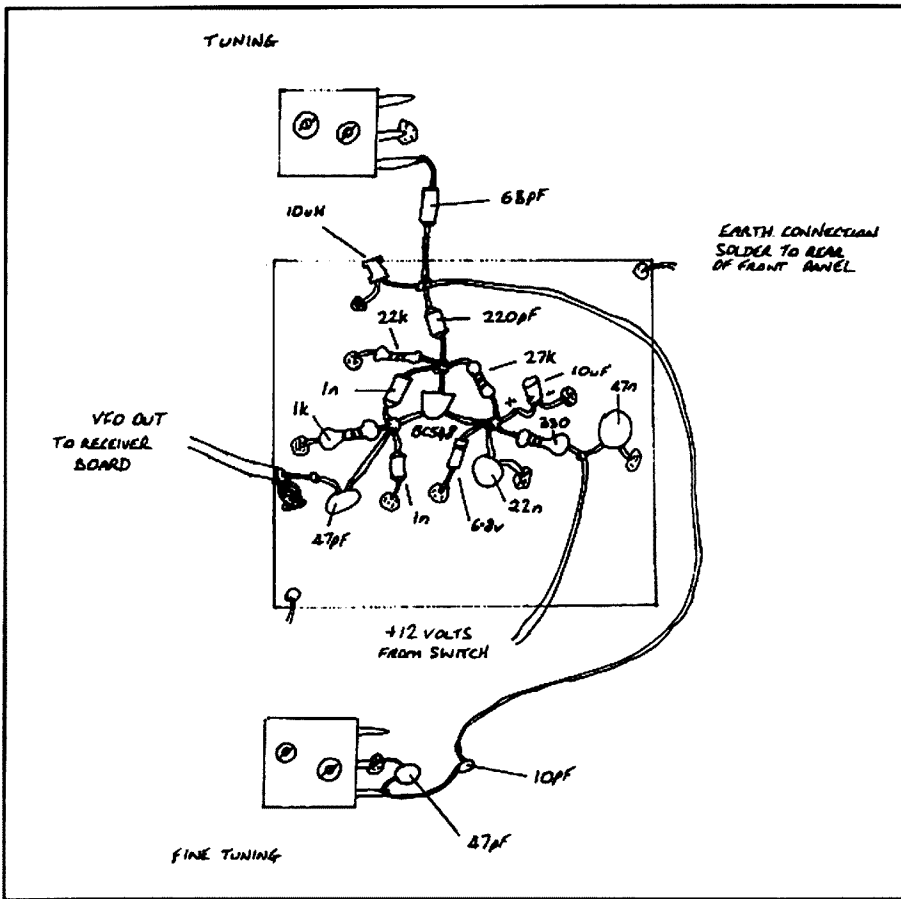


Figure Four: VFO board parts layout.

will be within about 200 or 300 kilometres. Weekly WIA news and callback sessions (operated by most Divisions) and club nets are good opportunities to test reception with a variety of stations on the one frequency.

Further thoughts

The author considers that the Funway 80 is the absolute minimum design practical for 80 metre amateur reception. Once the basic receiver has been constructed, several modifications can be made to improve its performance and capabilities. Examples include:

Better stability on 3.5 MHz: This involves accepting reduced frequency coverage (3.500 - 3.620 MHz only) in exchange for the superior stability of a 3.58 MHz ceramic resonator local oscillator. Circuits of suitable variable ceramic resonator oscillators have appeared in past issues of *Amateur Radio* and *Lo-Key*.

7 MHz reception: Change the resonant frequency of the bandpass filter and the pi-network to pass 7 MHz signals. In this case the second harmonic of the VFO is used to provide reception of 7 MHz signals.

Improved selectivity and strong-signal performance. Good selectivity requires the addition of audio filtering to restrict the audio response to 300 - 3000 Hz. Better strong signal performance can be achieved by using a more elaborate mixer circuit.

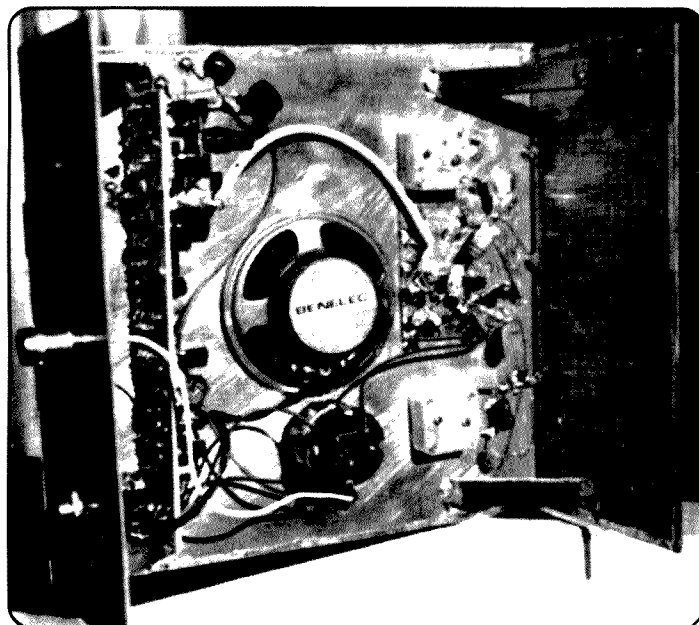
The above changes will improve the quality of reception possible on this set. However, the builder seeking a genuine high-performance receiver should start with a new design, rather than modify the set described here. Such a receiver (to be called the DC-2000) is being developed and will later be described in these pages.

Reference:

Dick Smith's *Funway into Electronics* Volume Two, p108.

ar

Photo Two: Inside the Funway 80 Receiver. The main receiver board is mounted vertically and appears left of the speaker. The VFO is directly right of the speaker. The upper tuning capacitor is the main tuning, and the lower capacitor is the fine tuning. Immediately below the speaker is the on/off and RF gain switchpot.



adjusted for best clarity. Wind back the RF Gain control if strong signals are encountered.

An outdoor antenna is required for best reception. An eighty metre dipole or random length wire at least 10 metres

long is suggested. Reception of stations up to 500 to 1000 kilometres should be routine on a set such as this during the evening. During the day 80 metres suffers from high ionospheric absorption, and stations heard, if any,

A Superhet Receiver For Three HF Bands

Drew Diamond, VK3XU
45 Gatters Road
Wonga Park 3115

It is generally agreed that for an amateur wishing to build a receiver for one or more of the HF bands, a conventional well-made direct-conversion (DC) job will provide a surprising level of performance, particularly with regard to sensitivity. I confess a great fondness for the simple beauty of DC receivers, especially for CW reception. However, their lack of single-signal selectivity under crowded band conditions can be a little wearing at times. A number of radiomen have published plans for DC receivers which do provide single-signal performance, but at significantly greater complexity.



Photo 1. 3-band HF Receiver

After hundreds of hours of study and experiment, when cost, complexity and parts availability are considered, it seems to me that a receiver built around a good HF crystal filter probably still represents the most viable option for the amateur receiver builder. And a crystal filter forces the application of the superheterodyne principle.

The risk of internal spur production is significantly reduced if a single-conversion scheme is adopted, and that the oscillator operates "on the high side" (signal frequency + IF crystal filter frequency). With only one mixer (the weakest component in any superhet) in the path of strong unwanted signals, signal handling is also improved. Furthermore, a reasonably high IF crystal frequency will also help to keep spurs down. As 9 MHz is quite a common filter frequency, and just such a filter was on hand, an experimental model was built around that IF, later

changed to 8.867 MHz in the prototype to suit prevailing parts availability.

To keep things fairly simple, the prototype covers just three popular HF bands; 3.5, 7 and 14 MHz. We see now that the oscillator (VFO) must tune (in round figures) signal + 9 MHz. Therefore, for example, on 14 MHz the VFO must operate at $14 + 9 = 23$ MHz. Perhaps surprisingly, it is quite possible to build, using ordinary parts, a switched LC VFO which has satisfactory stability and low phase-noise at these frequencies.

Another criticism of simple DC receivers is their lack of AGC. Popular DC circuits do not generally have circuitry which easily lends itself to the application of AGC. However, in a superhet there are additional points where gain control may be effectively used. For this model, AGC is applied to three key gain stages, which results in

quite acceptable automatic gain control.

Our English and American colleagues live in regions where there are many very powerful transmitters, and their circuits, particularly those we see in American journals, often reflect this problem by their complexity. In our area however, we are not usually bothered by front-end crushing signals, except perhaps from a near neighbor. So we can generally get away with an easy to use NE602 (Ref. 1) as mixer, which I have done here. No claims of "high-performance" are made for this model. Nevertheless, the receiver is sensitive, selective, has nice audio quality and is pleasant to operate. Only my near neighbor, some 900 m distant, causes significant overload problems, which is easily handled by insertion of some front-end attenuation. The prototype has the following measured characteristics:

Bands:	3.5 to 3.75, 7.0 to 7.3 and 14.0 to 14.5 MHz
Sensitivity:	0.2 microvolt for 10 dB S + N : N.
Selectivity:	Crystal filter pass-band 1.8 kHz at -6 dB points.
IF Rejection:	Worst case (on 7 MHz) -90 dB.
AGC:	AF output rises 6 dB from 3 microvolt to 30 microvolt input, then another 4 dB from 30 microvolt to 1 V.
Dynamic Range:	Third-order DR 80 dB.
Spurs:	Internal spurs just above receiver's noise floor at 3.545, 7090 and 14.180 MHz, which are inaudible with an antenna connected.

Table 1

oscillator drive (about 0.5 V p-p) make this chip agreeable to work with and a regular favourite. And you can buy two. In order to keep harmonics out of the mixer (thus minimum spur production), a separate local oscillator (VFO), injected at pin 6, is employed.

VFO signal is supplied by a conventional Hartley oscillator, maintained by an MPF102 followed by another MPF102 as buffer. For the 3.5 MHz band, a 2 uH coil is resonated to supply a 12.367+ signal. On 7 MHz, a 2.6 uH coil is paralleled with the 2 uH so that 15.867+ is generated, and for 14 MHz, a 0.75 uH coil is paralleled to give 22.867+ MHz (Ref. 5). VFO signal is passed through a 270 ohm resistor, which, with the capacitance of the connecting shielded cable forms a simple RC filter that greatly attenuates harmonic energy before it is applied to the mixer.

The 1.5 kohm input/output impedance of the NE602 is not an easy value to match into and out of a crystal filter. A filter impedance of about 500 ohms is more common and better to work with. An MPF102 serves as impedance transformer between the mixer and crystal filter, and again between filter and another NE602 as product detector (Ref. 6). These FETs also serve as gain-controlled stages for the application of AGC voltage.

The variable crystal BFO (VXBFO) frequency may be varied from one end of the crystal filter's pass-band to the other, thus permitting upper or lower sideband resolution, and, with the ability to place the BFO frequency anywhere in the filter's response; offers improved CW reception under crowded band conditions.

Product-detected audio signal is applied to a conventional LM741 and LM386 AF amplifier which provides adequate power to drive loudspeaker or 'phones. A pair of back-to-back silicon small-signal diodes are connected at the output of the '741 pre-amp to clip the amplitude of any transient noise spikes which are too brief for the AGC loop response (Ref. 7).

To generate the AGC voltage, a sample of detected signal is picked off at the output of the '741 pre-amp and applied to second LM386 wired as a DC amplifier. A pair of germanium diodes in voltage-doubler configuration supplies a negative DC signal to the '386

Circuit

In order to further simplify the circuit, yet provide a satisfactory level of performance, an ordinary mechanical frequency dial and LC VFO are used here. Conventional wafer switches, rather than diodes do the frequency band changing (Ref. 2).

To prevent unwanted out-of-band and IF signals from entering the mixer, a three-resonator band-pass filter (Refs. 3 and 4) is switched in for each frequency

range. The NE602 mixer chip has a noise figure of about 15 dB, so the prudent application of about that amount of RF gain is provided by an MFE131 (or similar) dual-gate MOSFET- chosen for its high input impedance at gate 1, and suitability to RF gain control with an appropriate potential at gate 2.

An (SA)NE602(AN) does duty as mixer. Whilst not the strongest contemporary mixer, the 1.5 kohm input/output impedances, and ease of

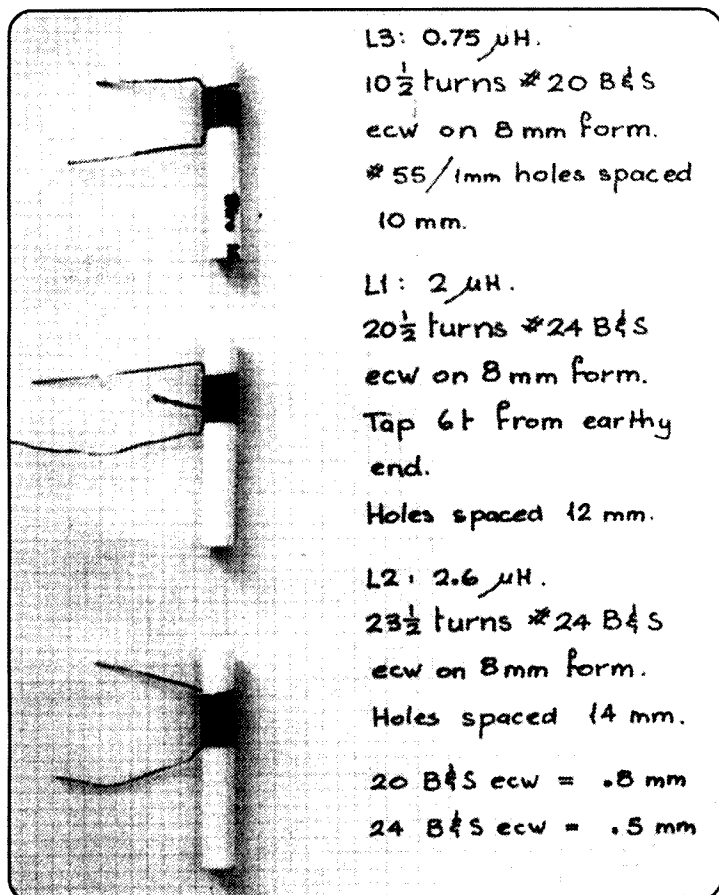


Photo 2. VFO Coils

input which is proportional to the strength of the signal(s) passing through the crystal filter. When the signal from the antenna is less than about 0.5 uV, the output of the AGC '386 rests at about half the main rail, i.e. +6 V, and thus supplies drain voltage to the two FETs in the IF, and gate 2 voltage for the RF amp MOSFET. As input signal level is increased, or a stronger station is tuned in, the DC output of the '386 will fall, thereby proportionately reducing RF and IF gain. A 1 mA meter is connected in a virtual bridge to give a roughly logarithmic indication of signal strength. A 1 uV signal produces 0.1 mA deflection, and 50 uV ("S9") causes a 0.7 mA reading.

Current demand for the set is about 250 mA from the 12 V rail, including 50 mA each for the dial and S-meter lamps, and is just beyond the capacity of the smaller power transformers, which forces the use of a 1 A transformer for the power supply. The 15 Vac 1 A transformer, type 2155, is loafing in this application. So too are the 7812 (12 V) and 7806 (6 V) regulator chips, which supply our +12 V and +6 V regulated supplies.

Harmonics from a 500 kHz calibrator signal, derived from an 8 MHz crystal oscillator integral to a 74HC4060 osc/divider chip provide a bottom band-edge dial check point.

Construction

Most of the "electronic" components are available from our usual suppliers, but we can no longer obtain new off-the-shelf, slow-motion dial drives. However, they are not hard-to-get items, being generally available in various forms at hamfests etc. Although not intended for exact duplication, the following guidelines are given for the experienced home-brewer.

The type of dial chosen dictates the chassis/case form required. Everyone seems to have their own ideas about dials, so I will just say a few words about that shown, which was obtained from a defunct BC-221 frequency meter. These show up regularly at 'fests here (better to be re-born as a receiver dial than to rust away in some dusty shed). Mine was in pretty poor shape, and had to be stripped-down, cleaned, greased and re-assembled. In addition to providing an excellent anti-backlash 100 : 1 reduction, the drive output is at 90

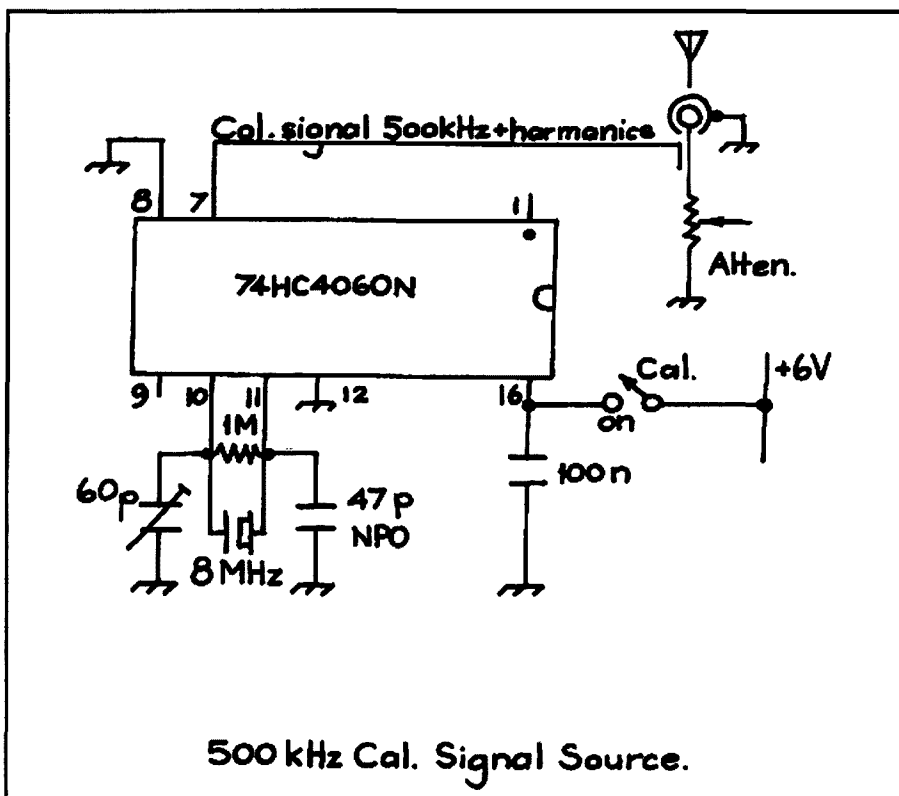


Figure 2

degrees to the knob spindle, thus allowing the main tuning capacitor to fit at right angles, and in turn permits the band switch shaft for the VFO coils and band-pass filters to run right through the VFO box.

Case dimensions are 190 x 220 x 120 mm LWH. If desiring to make another one, I would allow a bit more case width for the VFO box, which was a bit of a squeeze (I'm not a great fan of making things small, but it worked out in the end).

It is probably a good plan to build the bare bones VFO assembly first, and get that going, which, when working (should) give spur to press on with the remainder of the set. The VFO box measures 70 x 95 x 45 mm LWH. A lid is not essential. If size is not a problem, something slightly larger would ease things considerably. The VFO coil switch wafer and clicker-plate are mounted upon one wall of the VFO box, and an extension shaft coupler takes the switch action to two more wafers similarly mounted upon the main circuit board for selection of the appropriate band-pass filter.

Use a well-made variable capacitor of about 50 or 60 pF for the VFO. The

spindle must rotate easily and smoothly, otherwise there will probably be a hysteresis effect on the tuning, and perhaps some mechanical instability also. Interpose an effective flexible coupler between the capacitor and drive. If desired, include a small (about 5 pF, or one plate) variable capacitor for dial cal. adjustment. The 82 pF cap must be a silver mica or NPO type.

The VFO coils are wound upon 8 mm diameter tube material made from lengths of Biro (TM) plastic pen barrels (Photo 2). Drill a pair of 1.0 mm (or #55) holes across the diameter at the distances shown. Windings may be secured with a small amount of super glue. Coils so made have been found to be quite stable and of high Q.

The VFO circuit was built using "ugly" (Ref. 8) style with reasonably short leads. The coil formers may be cemented to the base of the VFO box with super glue. My VFO had some significant frequency wobbles traced to poor grounding of the switch spindle in the clicker plate. The problem was remedied by fitting a stiff bronze wire across the spindle shaft under tension, soldered one end. A nylon coupler was fabricated to take the switch action

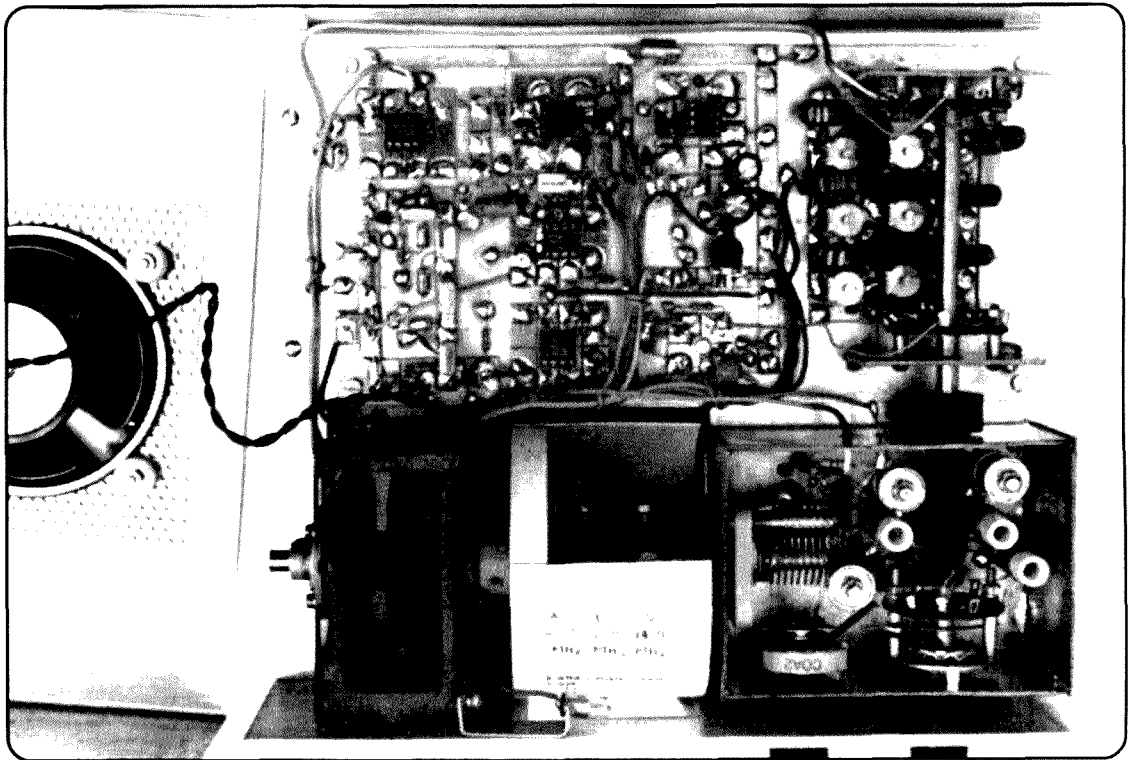


Photo 3. Main circuit board above chassis

through the VFO box to the band-pass filters located behind.

Main board, VXBFO, power supply and cal. signal board are all made "paddyboard" style (Ref. 9). "Ugly" style would also suit. Main board measures 220 x 120 mm, which accommodates the band-pass filters, RF amp, mixer, crystal filter, product detector, AF amp and AGC amp. Actual layout is not particularly critical, provided that signal and by-pass connections are reasonably short. Above chassis plan view of the VFO and main board is shown in Photo 3. The band-pass filters are at right, the RF amp is just left of the filter assembly at bottom, then signal flows clockwise around the board finishing at the AF output '386 just left of the filter assembly and above the RF amp. AGC '386 amp is the chip near the centre. Power supply, VXBFO and calibrator are located below chassis, as depicted in Photo 4.

If you have a likely-looking 9 MHz crystal filter waiting for an application, then this could be it. A 27.000 MHz crystal (3rd overtone 9 MHz) should drop straight into the VXBFO circuit. Otherwise, use the suggested ladder filter comprised of four 8.867 (twice colour burst- available from TV parts suppliers) plus one crystal for the VXBFO.

A rectangle of 1.2 mm al. sheet was made to wrap around the existing BC-221 dial drum (using a honey jar as mandrel with a rolling-pin action) after first filing off the rivets and removing the original 0-50 graduated scale. The dial drum was then lightly sanded and sprayed with two coats of white auto undercoat to receive appropriate calibration scales.

Operation

If, as suggested, you have built the VFO first, connect regulated +6 Vdc to the VFO circuit. If an oscilloscope is available, observe the output waveform using a X10 probe. It should be a reasonable sine-wave of about 500 mV to 1 V p-p. Otherwise, apply RF probe and DMM and read about 400 mV. Connect the VFO output to a frequency counter (if available, otherwise, look for the signal on a general coverage receiver). With the main tuning cap. at full mesh it should be possible to set the 25 pF trim cap for a 12.367 (or 12.5 for a 9 MHz IF) signal in the 3.5 MHz switch position. Now step to the 7 MHz position and set its trim cap for 15.867 (16) MHz, then step to the 14 MHz position and adjust the trim cap in the 14 MHz position to generate 22.867 (23) MHz.

Any further alteration of the trim cap in the 3.5 MHz position will cause all three ranges to change.

When wiring is complete, check it all again- perhaps after a break for a cuppa. Apply power. Measure the +12 and +6 V rails. Advance the AF gain control- should hear a soft hiss and perhaps just a trace of hum at full gain. Measure the dc output of the AGC amp '386- should be about +6 V. Zero the S-meter with the 500 ohm trim pot. It should be possible now to sweep the VXBFO through the crystal filter's response. Adjust the 25 pF trim cap in the VXBFO so that a similar hiss sound (sssss-shooosh-sssss) is produced at each end of the 150 (or 200) pF VXBFO variable cap. travel (i.e. there is LSB and USB reception). If you can do this, it indicates that the set is "gainy", and probably working thus far.

Connect an antenna (or sig. gen. if you have one, set initially to about 30 uV) to the receiver's input. Set the receiver for about 3.6 MHz. Peak, and re-peak the three trim caps for the 3.5 MHz band filters. Set the receiver to about 7.1, then 14.2 MHz and do the same for those bands.

Even with a small antenna connected, the set should now sound lively. Signals will cause the S-meter to deflect

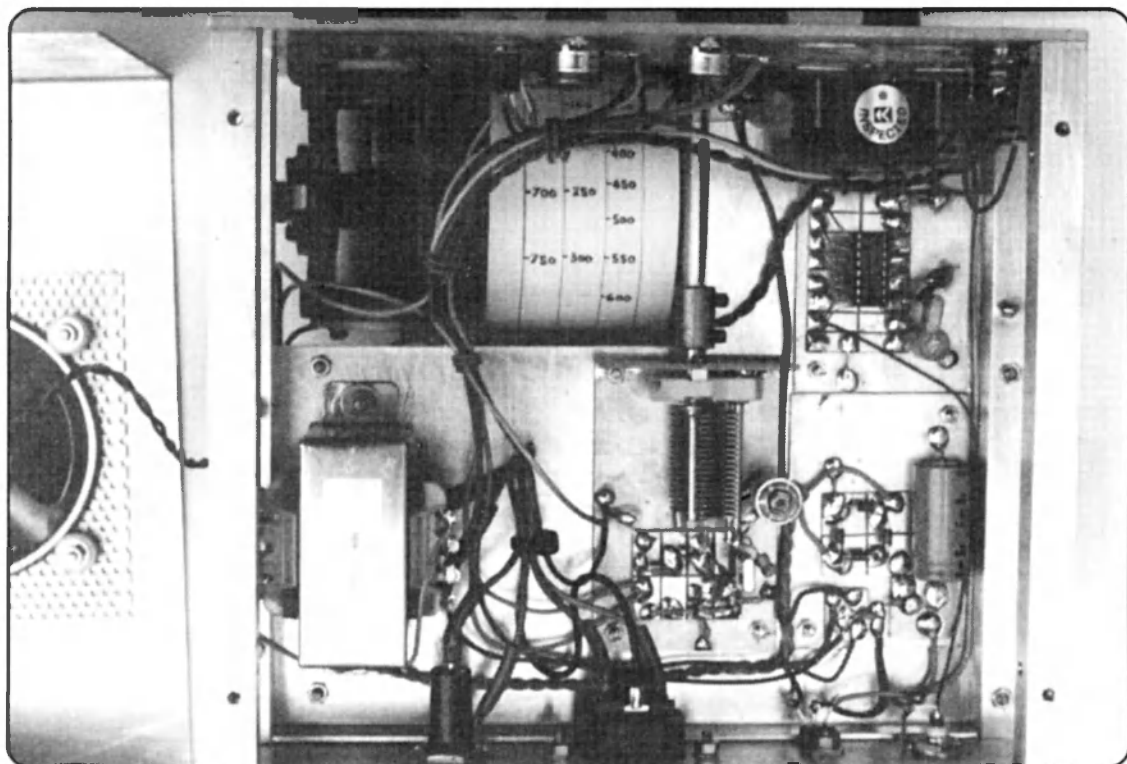


Photo 4. Below Chassis

*For All Your
Requirements*

AUTHORISED DEALER
ICOM

KENWOOD

AMATEUR • COMMERCIAL
RATONS COMMUNICATIONS

Tower
Communications

14 Mary Street
Hazelmere

Western Australia 6055
Telephone: (08) 9274 1118
Facsimile: (08) 9250 3734

E-mail: tower@con.net.au

www: <http://www.tower.visionimage.com.au>

upwards, indicating that the AGC amp is working. Strong and weak signals should sound clean, without distortion or fuzziness.

Parts

All of the ordinary components are available from our usual electronics parts suppliers such as Altronics, Dick Smiths and Jaycar. Additionally, near Melbourne we have; All Electronic Components (039662 3506), Radio Parts (039329 7888), Rockby Electronics (03 9562 8559, for MFE131's) and Electronic World (039723 3860). Electronic World also have NE (SA) 602AN's, Amidon cores, 8.867 MHz crystals, 1 nF feedthru caps, trim caps and 200 + 100 pF variable capacitors. See Hamads in AR for other Amidon vendors.

Bibliography

1. *NE602 Primer*; J. Carr, *Elektron Electronics*, Jan. '92.
2. *An Empirical Approach to Building an HF Receiver*; Diamond, AR, Oct. '94.
3. *The Double-Tuned Circuit*; W. Hayward, W7ZOI, QST, Dec. '91.
4. *Extending the Double-Tuned Circuit to Three Resonators*; W. Hayward, W7ZOI, QEX, Mar/Apr '98.
5. *Solid-State Design for the Radio Amateur*; Hayward & DeMaw, ARRL, p170.
6. *Toward Simpler Superhets*; DeMaw, W1FB, CQ, May '97.
7. *Correspondence with Vic, VK4AXM*.
8. *Build it Yourself* from QST; B. Hale, KB1MW, QST, Apr-Jul '92 (series).
9. *Paddyboard Circuit Construction*; Diamond, AR, Feb. '95.

ar

Turn
off
the TV,



Turn
on
the Rig!

Spotlight on SWLing

by Robin L. Harwood VK7RH



I do apologise for the non-appearance of the August column. It is a mystery where it, went as it just disappeared from the editorial desk to the printer.

A few months ago, I was awakened from my slumbers by a phone call at 2 a.m. asking me to switch over to my fax. I was very puzzled at the odd time for this request, as I could not make any sense from the caller, quickly deducing that the call was from outside Australia. The caller kept persisting and later in the day we found out that an engineer in Somaliland wanted some specific broadcasting equipment, making the assumption that I was a dealer or manufacturer of electronic equipment. He obtained the information from the address at the head of this column. His English comprehension was very poor and later several e-mails came through via Norway and I was able to inform him that I was only a listener. The proposed station was planned for the North Eastern part of the country.

Radio Australia has received an additional grant to extend broadcasting hours to South-East Asia, particularly Indonesia. The Communications Minister announced this in early August after a Cabinet meeting and it has been widely welcomed as many listeners in this region have had difficulties finding Radio Australia on shortwave. The Darwin transmitting site, which was acquired by British evangelical broadcaster, "Christian Voice" may also be used by Radio Australia. The negotiations were held in London and Melbourne but I do not know the final outcome. Thanks to Drew Diamond, VK3XU, for the clipping from the "Melbourne Age" newspaper.

Diana Janssen, one of the co-hosts of Media Network over Radio Netherlands, left in mid-September to pursue a position in a private IT company as a consultant. Jonathon Marks will be continuing to host this popular weekly show.

The United Nations Radio has been absent from shortwave for some decades and recently an agreement was signed between Merlin Communications and the United Nations, for the

transmissions of programs via shortwave. These commenced in the first week of September, coinciding with the Millennium summit at UN headquarters.

The transmissions are as follows:

French 1700-1715 6120 (Meyerton, 76 degrees to Madagascar), 17580 (Skelton, 180 degrees to W. Africa), and 21490 (Meyerton, 500 kW, 342 degrees to Kinshasa)

English 1730-1745 6125 (Meyerton, 5 degrees to S. Africa), 15265 (Woofferton, 140 degrees to E. Africa), and 17710 (Ascension, 65 degrees to Nigeria)

Arabic 1830-1845 15265 (Woofferton, 140 degrees to Cairo) and 17565 (Skelton, 180 degrees to Morocco and Algeria).

Each 15 min program includes five minutes of world news, a three-minute in-depth report on one of the main items in the news, and two three minute features targeted to various geographical regions and focusing on issues including gender, environment, health and development. These programs, along with UN broadcasts in Chinese, Russian and Spanish, will also be carried on satellite by Merlin for broadcast on partner stations around the world.

They would very much like to receive reports. They can be sent via E-mail at smithd@un.org, or by postal mail to: David Smith, UN Radio, Secretariat Building, Room S-850-M, New York, NY 10017, USA. Tel. 1-212-963-5201, FAX 1-212-963-1307.

Another station also made a surprise comeback to short wave at the beginning of August. The American Armed Forces Radio and Television Network (AFRTS) decided to suspend use of the INMARSAT communications satellite network and revert to HF feeders. Several sites throughout the world have been nominated to transmit their unique output. Here is the proposed frequency table of AFRTS.

All transmission in the USB mode and all frequencies in kHz.

Location	Daytime	Evening
Key West, FL	12689.5	12689.5
RR, Puerto Rico	6458.5	6458.5
Sigonella, Sicily	4993.0	10940.0

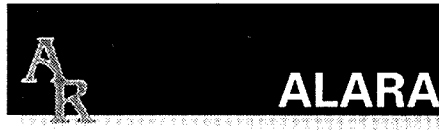
Barrigada, Guam	13362.0	5765.0
Diego Garcia	12579.0	4319.0
Keflavik, Iceland	10320.0	6350.0
Luualaei, HI	6350.0	10320.0

These senders are operated by the US Navy and not by the AFRTS. E-mail reports can be sent to QSL@mediacen.navy.mil. So far the Florida, Puerto Rico and Sicilian sites have been heard although Hawaii and Diego Garcia in the Indian Ocean have been reported testing. My thanks to Larry Horne of Monitoring Times magazine. Incidentally the station in Sicily alerted people to the commencement of Shortwave relays by accidentally transmitting on exactly the band edge of 20 metres on 14.000 MHz.

Europe and North America will revert to standard time on the last Sunday of this month. This also is the time when the majority of broadcasting organisations alter their frequencies to allow for propagation and time scheduling. Expect major changes on that date. Australian states that normally switch over to daylight time at this time, made the changeover at the end of August, because of the recently completed Olympics.

There have been recent cat-and-mouse games between the Falun Gong and the Chinese authorities between 2200 & 2300 UTC. The Falun Gong station, Shijie Falun Dafa Guangbo Diantai, appears to have been testing on various out-of-band frequencies around the 11 and 13 MHz bands, noted 1 and 3 Sept on 12130, switching to 12140 at 2230. Both frequencies subjected to heavy noise jamming and interference from Chinese National Radio at times; the jammers noted to move from 12130 to 12140 a couple of minutes after the Falun Gong station, allowing a clear identification announcement to come through on the half hour, with a wrong frequency announcement of 9915 kHz! Location is unknown, but it may be related to Radio Free Asia, yet it may be very hard to determine.

Well that is all for this month. In next month's column, I hope to be reporting on the Olympics coverage over shortwave in the November column.



Christine Taylor VK5CTY
VK5CTY@VK5TTY or geencee@picknowl.com.au

YLs *doing things*

A Surprise Visit

Last month, just as four YLs (Jean VK5TSX, Meg VK5YG, Maria VK5BMT and Christine VK5CTY) were sitting down to lunch at "Berties", Dot VK2DB walked in to join them.

Dot has a family of boys so her grocery bills (and the accompanying "Fly Buy" point) mount up quite quickly. Dot uses these accumulated points to visit the other states. This time it was VK5. It was great to renew our friendship with her. We enjoyed the year Dot and her family spent in Adelaide and have missed her since she returned to Sydney.

The Nets

The Monday nets have moved to the daylight saving time early because of the Olympic Games and atmospheric conditions have been variable. With the better overall propagation at this stage of the sunspot cycle, this year should be better than average.

The number of participants has been down but I am sure that will change as we adjust to the new times. However, discussion is as varied as ever though we still begin by looking at the weather all round Australia. It is fascinating to watch the seasons reverse each year.

The 222 Net has been very active, leading up to the YL2000 International Meet in Hamilton in October. More German YLs than usual have been active, along with the Italian and UK, and of course ZL and VK YLs. I suspect someone wanting some YL contacts could set them up via the 222 Net on Mondays on 14.222 call in starting at 0530 UTC.

I am pleased to tell you that after a health scare Dave ZL1AMN is recovering well and was active in the Lighthouse celebration at the end of August, hope you had a contact with him.

A Blast From The Past

In a "CQ" for December 1954 there is an article about ham radio in God's service

with a mention of marriage ceremonies conducted on air etc., but of particular interest to YLs are the nuns who held amateur licences at that time.

Mention is made of four amateurs, Mother Lawrence W9CLE, Mother Reilly W9CLW, Sister Charlotte W7MUT and Sister Emiliana W1HUH. Sister Emiliana must be among the earliest holders of an amateur licence as she passed in 1933. The sisters set up several radio clubs for their students in the US and in South America and helped many budding amateurs to pass their exams.

This item from nearly 50 years ago was of particular interest to me as the first YL I sponsored into ALARA was Sister Barbara, a nun at the Convent of St Elizabeth in New Jersey with whom I had several years of interesting correspondence before she became a Silent Key. As a letter I received from the Convent telling me of her passing, said, Sister Barbara made many friends through amateur radio and thoroughly enjoyed all the time she could spare for it. It is a great hobby and one that spans all walks of life and all ages.

We Do Things Outside Amateur Radio.

For the eight or ninth year in a row Barbara VK3BJM has scooped the pool in the dressmaking section of the Royal Adelaide Show. This year she excelled herself with at least five First Prizes and three Second Prizes for the most beautiful underwear and night attire. The clothes would be a delight to wear - if you were brave enough to crush them by wearing them!

In previous years there have been more YL prizes at the RAH but Barbara is the most successful. How about some others of you entering the Royal Show competitions? Some of the craftwork on show in Perth and Brisbane would win prizes, I am sure. Let us give Barbara a run for her money next year.

Joy VK5YJ has a most interesting

activity — presenting the afternoon session each Wednesday. She has been doing this for five or more years and has many regular listeners. 5UV is a radio station set up originally by the University of Adelaide in the University grounds but several years ago it moved into the City. It now has a new location on North Terrace. Joy spends many hours planning her programs and uses much of her own very large and catholic collection of records.

Meg VK5YG reads for the vision impaired. This is different to the regular and useful daily paper reading that are now conducted in every State. Meg is part of a local program serving the people around her town of Murray Bridge. She scans the newspaper each week and picks out items that she thinks will appeal to her listeners to make up an hour's tape. She is part of a roster of local people who produce a tape each week, so each of them are rostered every couple of months. The tape is distributed by the lady who set up the scheme. An interesting variation on a theme and one that other people might like to copy.

The ALARA Contest

Remember the ALARA Contest will be on again in early November. Now is the time to be getting your station ready for it.

Please do participate. Last year was very disappointing. Unless we do have an improved participation rate and an improved log completion, Contest may cease to be viable. If that happens we have only ourselves to blame.

OMs and Club stations are very welcome. This is an enjoyable contest. No one is so eager to just make contacts that they do not have time to chat.

You can use contacts made during the ALARA Contest towards the ALARA Award. It is a beautiful certificate, one you will be proud to hang on your wall. Why not make this year the year of the ALARA Award?

ar

The SKØUX club

(near Stockholm)

Henryk Kotowski SMØJHF

SKØUX

We have heard from a number of hams visiting Stockholm that it is difficult to find the most interesting club station in the area. In order to facilitate this and spread more information about our club station, let me present some facts.



SMØTTV and EAY-YL



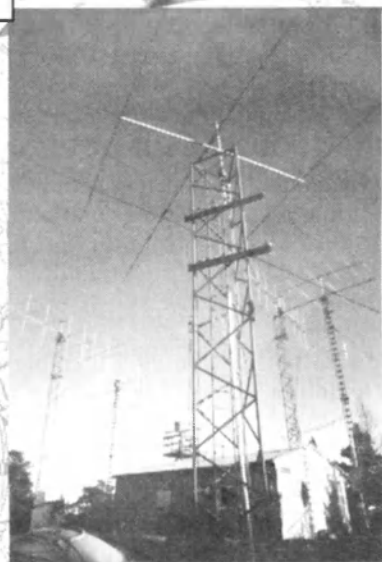
SMØDRD (far) and SMØTQX



SMØCOL



SMØKCO



The club called Kvarnbergen Amatorradioforening, was founded in 1993 and took over the callsign SKØUX and the present site from a local club of the Stockholm suburb of Täby. Since the a number of new towers and antennas have been accomplished. Through a unique agreement with a few other clubs, hundreds of their members have access to this place. The club itself has 35 members. They are interested in all aspects of amateur radio and willing to share their knowledge, experience and facilities with anyone attracted by our hobby. We welcome anyone visiting Stockholm for longer or short periods to join the club or just use the station. We have antenna covering almost the whole

spectrum allocated to amateur radio. There are 9 towers at the club, some of which carry impressive arrays. Still, there is space for more antennas, permanent or experimental. Access is restricted so it is wise to contact the author by telephone (+46 707 561493), e-mail smøjhj@chello.se or send a message through the club's reflector skøux@sk7do.te.hik.se. The location is marked on the map just above Ullnasjon (Ullna lake) some 30 km north from the centre of Stockholm, along the E18 motorway. These pictures some of the antennas and some of our activities. Come and join us next time you happen to be in Stockholm, Sweden

South East Radio Group Awarded Major Emergency Grant

The South East Radio Group VK5SR, based in Mount Gambier has received a \$5,000 grant under the South Australian Emergency Services Grant Program. Grant applications were invited from volunteer and emergency organizations, currently operating in South Australia without direct Government funding.

SERG members were recently in the news having successfully located a number of Emergency Locator Beacons (EIRPBs) operating on 121.5 MHz, activated in their area.

"A grant application was prepared for a project to construct a Mobile Radio Trailer for EIRPB tracking and for establishing emergency communications wherever required. Our

application was supported by recommendations from a number of government agencies and emergency services including the Local Council, the SA Police, the SES and CFS and our local politicians." said Kevin Johnston VK5KJ, President of SERG. "The grant will allow this group to purchase a pneumatic pump-up mast and 240v petrol generator mounted on a four wheel trailer. I only wish we had had the equipment for all the Y2K stations we activated at the beginning of the year." he said.

SERG members Kevin VK5KJ and Wayne VK5ZX received the

five thousand dollar Grant Cheque from Rt. Honorable Rory McKewen, Independent MP for Gordon.



Adelaide Hills Amateur Radio Society

The last meeting of AHARS was a lecture by Graham VK5ZFZ in which he explained how to convert a computer power supply for use in the amateur shack. He talked about what to look for in the original power supply if you want to convert it. The first and most important point is that you must have a working power supply. There is no advantage in using something in which you must first find the fault. There are plenty of working computer power supplies available. The dead ones are

just that - dead - good only as boat anchors.

The topic of converting these power supplies is of such interest that we hope Graham will write it up for everyone to read. There have been several articles published in various magazines, one of which was in "Radio and Communications" for Nov and Dec 1998.

Next month members will be bringing along various projects they have made either recently or over the years. The

meeting will be in the form of a "Show and Tell" as each presenter talks about their project. This is the format used previously that has been very interesting. I am sure this year will be no exception.

If you are in Adelaide in the latter part of the month and would like to attend an AHARS meeting they are held at the Blackwood High School, Seymour Avenue Blackwood, starting at 7.30 on the third Thursday of the month.

Redcliffe Radio Club Construction Competition

The Redcliffe and Districts Radio Club is holding a construction competition and those wishing to enter the first contest must have entries submitted no later than 2nd October and is open to all comers.

You do not have to be a member of the Redcliffe Radio Club to enter the competition.

PRIZE is a \$20 GIFT VOUCHER (Dick Smith - Jaycar)

The Competition will be held quarterly (every three months).

Purpose:

To encourage experimentation,

homebrewing and construction within the hobby of Amateur Radio, Shortwave Listeners, CBers etc.

Antennas, kits or homemade entries of an electronic or radio communications theme only.

Main guidelines are:-

Neatness in soldering kit or homebrew
General appearance

Construction technique Operational (whether it works or not)

Rules:-

- Must be own work
- Technical assistance/trouble shooting is permitted

- Entries must be submitted by or on the first Monday of the judging month
- Judges' decision is final
- All entries must be shown at the next Club meeting following the judging.
- All entries must have been constructed from the year 2000 on
- Any entries from the Executive will be judged by the members.
- Entries to VK4YZ, VK4WX or VK4HRS for judging.

GOOD LUCK & HAVE FUN.

Kevin VK4AKI
Media Officer

The Bayside District Radio Club

Our members decided that for our supper after our June monthly meeting, we would have a "support Australia" theme. What better than Dick Smith? Nearly thirty members and visitors attended our meeting; and made short work of the supper. With the tables loaded with an assortment of Dick Smith biscuits, home made pikelets, Dick Smith jam and what we called BARS bubbles. These are made from rice bubbles, golden syrup and Dick Smith peanut paste. From all the comments I received the night was a great success.

Jim Grevett VK4WJG



Photos:

(Top) Pictured from left are:- Bob VK4XDO, Brian VK4VBL, Paddy VK4JPD (President), Ken VK4KF (club magazine editor) Vic VK4WST, Geoff VK4FK (Treasurer), Keith VK4TT and Bob VK4MCI

(Bottom) Detail of the Aussie feast



Education Notes

Brenda M Edmonds, VK3KT.
PO Box 445, BLACKBURN 3130.

New Licence Conditions

The new Licence Conditions Determination has now been gazetted accepting the 5 words per minute Morse speed as the maximum required for full AOCIP privileges. This means that those holding an Intermediate level of Certificate, or Limited licence plus 5wpm, now have access to all the amateur bands, with full power rating.

At present there has been no change to the naming of the levels of qualifications, and the 10 wpm examinations will remain available for those who wish to achieve that qualification for reciprocal licence purposes or just to be able to say that they have passed that level. (Any incoming recruits with a background of competence in Morse code may well find the 10 wpm examination easier than

the 5 wpm.) There is also no plan to alter the allocation of callsigns.

Regulations examination papers currently in use have been checked for their compliance to the modified regulations, and amended as appropriate, so new candidates should be aware of the bands and power limitations for both AOCIP and Intermediate licencees.

We have also been notified recently that the ACA has completed arrangements to establish reciprocal Amateur licensing arrangements between Australia and the European Conference of Postal and Telecommunications Administrations (CEPT). This allows for the recognition of Australian Amateur qualifications by

other CEPT participating countries, and removes the need to maintain existing agreements with many countries. It does not, however, remove the need for Australians travelling to other countries or visitors to Australia to obtain a licence before operating. Note, though, that there is no CEPT equivalent of NAOCIP or NLAOCIP at present.

By the time this column is published, the IARU Region III Conference in Darwin will be completed. A number of matters for discussion relate to examinations and qualifications and the possible development of some system similar to the CEPT arrangements for the countries in Region III. Reports on the Region III Conference will be presented later in the year.

ar

PIC controlled transmitter

by Jeremy Lemke VK3TFH

One problem faced by any amateur who has a mast head pre-amplifier and a high transmitter power, is protecting the pre-amplifier from accidentally being transmitted into.

Direct switching of the pre-amplifier, power amplifier and transceiver might work sometimes, but a cough or a sneeze into the microphone at the time of pressing the PTT, can often mean disaster for the mast head pre-amplifier.

A sequencer eliminates this problem and there are many ways of accomplishing the correct switching sequence of the pre-amplifier, relays and transmitter.

A simple diode, resistor, capacitor LC circuit can be used, or a more complex TTL timer circuit will also do the job a little better.

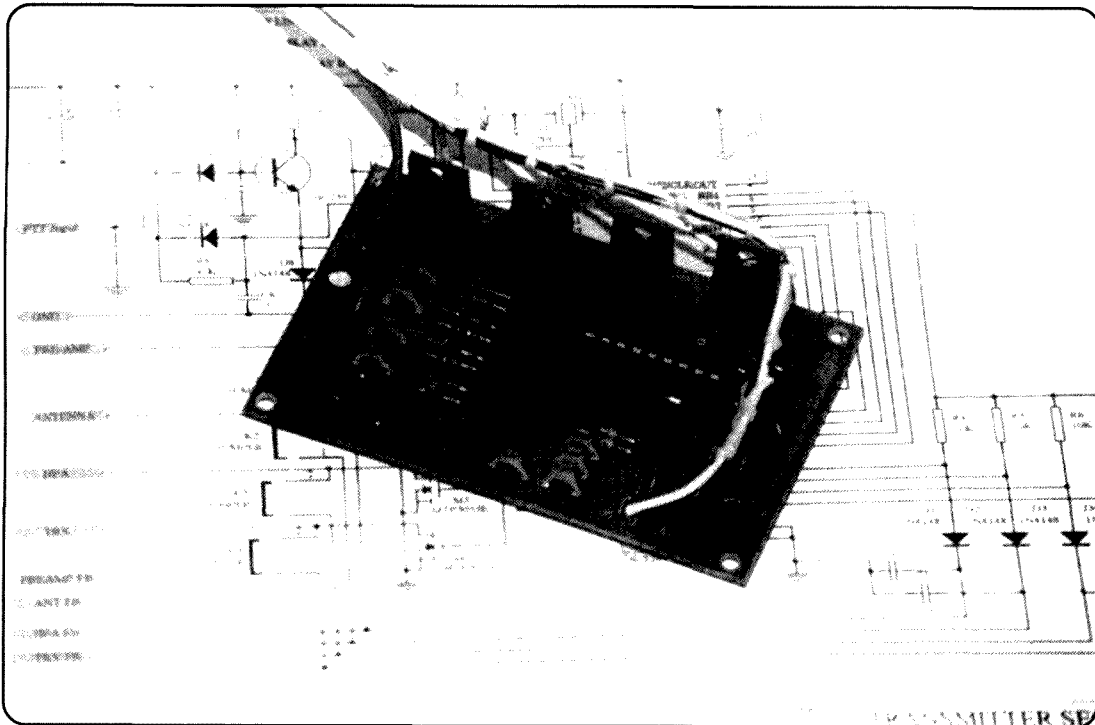
In this article I have gone for the ultimate and produced a PIC controlled digital sequencer. It offers intelligent control of the pre-amplifier, antenna co-ax relays, high power amplifier and the exciter.

Optional feedback from the peripheral devices allows the controller the ability to further protect the pre-amplifier, by testing that the operation has been successful before advancing the sequence.

It also prolongs relay life by completing all relay operations before RF power is applied.

Circuit Description

The sequencer uses the 16F84 PIC as a intelligent controller to correctly sequence the switching of a station mast



head pre-amplifier, antenna co-ax relays, high power transmitter amplifier and the exciter transceiver.

separates each switch operation.

The sequencer offers two time delays, 36ms between operations with link 5 open, and 18ms with the link in place.

These time intervals will be sufficient for most relays but if you have some very slow relays that you need to control, a longer time can be programmed into the PIC on request.

The controller has intelligent feedback sensing. Auxiliary contacts within each of the controlled station components, are

connected to the controller giving feedback of the control operations success.

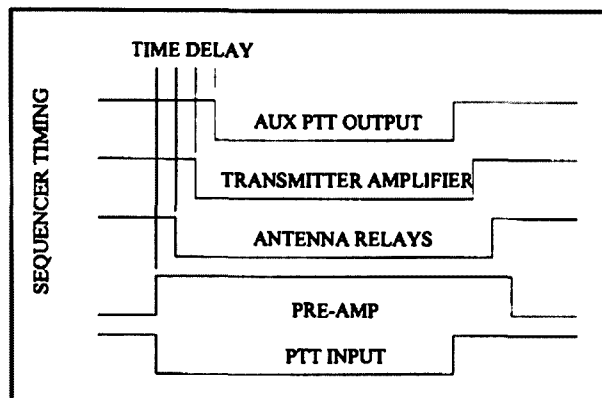


Figure 1

Fig 1 demonstrates the switching sequence of the apparatus under control, showing that the selected time interval

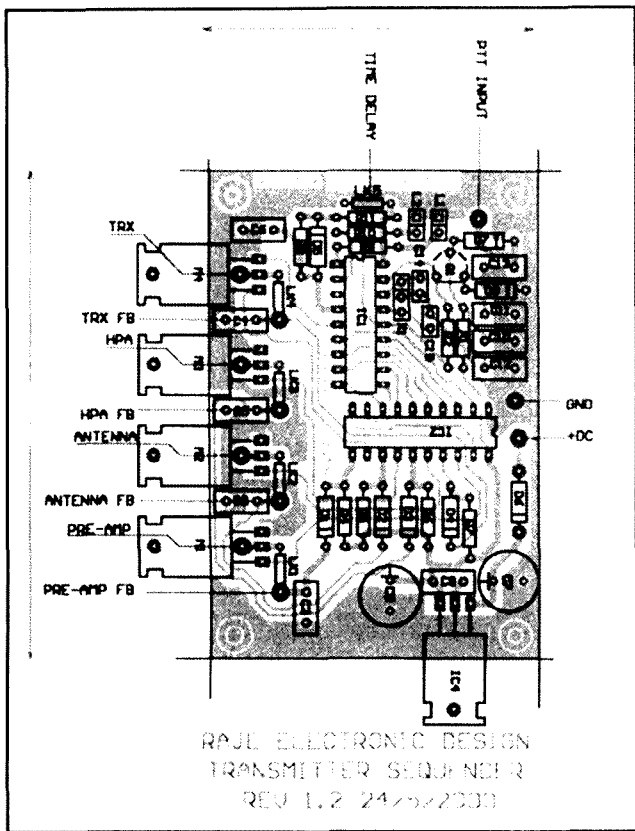


Figure 2

The controller will not increment the step, unless it has been proven that the device under control has responded.

This is a safety feature of this controller that will eliminate control mishaps and subsequent damage to the equipment.

If extended feedback is not required or available, the respective sense line can be linked to the power output device for that control leg.

This completes the intelligent feedback requirements of the PIC program by insuring that at least the output FET's have completed the switching operation.

Each power FET output switch has the ability to switch 8 amp at 60 volt if suitably mounted to a heat-sink.

The output sequence assumes that the pre-amplifier has a control relay arranged so that if power fails, the pre-amp will default to off and by-pass the antenna.

In receive mode M1 is switched on, M2, M3, M4 are off, the RX proven LED will light. In transmit mode M1 is off, M2, M3, M4 are sequentially switched on and the TX proven LED will light.

LED's L1 and L2 indicate when the TX or RX operations have successfully

completed and if any part of the sequence fails, neither the TX or RX proven light will light.

If a fault in the sequence is detected the system will remain in the receive state with the pre-amplifier deactivated.

Release of the PTT will re-establish normal receive condition.

Grounding the PTT will start the sequence. When the sequencer is controlling the exciter PTT, the PTT line needs to be exclusive to the sequencer.

If only the pre-amplifier, antenna coax relays and HPA are to be used, then the PTT input to the sequencer can be

sampled from the exciter microphone PTT. Then the exciter control line is not used and its feed back sense line can be linked to allow the sequencer to achieve a proven state for that line.

A suggested circuit of the sequencer connection is included.

All inputs to the sequencer are active low. They are diode and buffer protected to safeguard operation of the controller.

Assembly

The sequencer is constructed on a single sided PCB pre-drilled to fit the components.

Firstly fit all resistors, capacitors and diodes using the component overlay as a guide observing the polarity of the electrolytic capacitors and diodes.

Cut the excess component legs off and solder in place. Save the off-cut pieces for use as board links if required.

Next fit the 18 pin IC socket for the 16F84 PIC followed by the other IC's and transistors observing correct polarity, solder in place.

Make sure precautions for static handling are observed

The four power FET's M1 - M4 will need to be mounted to a heat-sink if high current switching is required

Heat-sink insulator mounting kits will be needed because the drain leg of the FET is also the heat-sink mount.

Depending on the required time delay, link 5 can be installed, 18ms link open, 36ms link closed. If the extended feedback sensing is not required, place links 1 - 4.

Testing.

After all components are fitted, (less the 16F84 PIC), check the board for shorts or incorrect assembly.

Apply a voltage between +8 and +16 to the +DC input. Current draw should be minimal, around 45ma.

Measure the voltage at pin 1 of the 7805 regulator, pin 14 of the 16F84 socket and pin 20 of the 74LS244. All should read around +5 volt.

Disconnect power and fit the 16F84 observing the correct placement of pin 1.

As a temporary test setup, connect relays from 12 volt to each of the outputs. With the links 1-4 in place, apply power, the pre-amp relay should close and the green LED should light indicating correct receive condition.

Ground the PTT. The sequencer will sequentially step, opening the pre-amp relay and closing relays 2 to 4 in sequence.

On the completion of the TX sequence, the red LED will light indicating TX proven.

When the PTT line is opened, the relays will open sequentially 4 to 2, and relay 1 will close.

On completion of the sequence, the RX proven LED will light again.

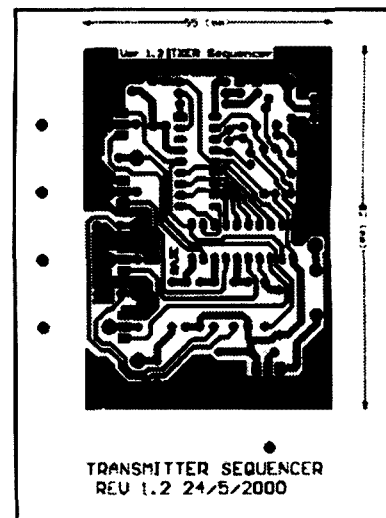


Figure 3

If during the sequence, if one of the functions fails to successfully switch, the sequencer will halt and return to receive condition.

The sequencer is now ready for wiring into the station control circuit.

It is good practice to mount any control apparatus operating in a High energy RF field, in a metallic enclosure with all input /output connections suitable bypassed. The sequencer does have on-board bypass capacitors to protect it against RF fields, and it has been tested operating with a 140 watt power amplifier. Still I recommend that for best operation, the sequencer should be enclosed in a shielded box and all cabling bypassed.

Printed circuit artwork and component overlay are supplied for those who wish to produce their own boards.

The 16F84 PIC can be purchased fully programmed from VK3TFH at a cost of \$25 including postage within Australia.

A full kit of parts including the 16F84 PIC is also available at a cost of \$60 plus \$5.80 pack and post.

These are available from
Jeremy Lemke VK3TFH
P.O. Box 101

Port Fairy. 3284

or EMAIL : raje@ansonnic.com.au

or visit my web site at

<http://www.ansonnic.com.au/raje/>

Comments or inquiries on the sequencer are welcome and I invite you to contact me by either snail mail or email.

ar

Sequencer parts list	
Designators	Comment
C10	.01
C11	.01
C12	.01
C13	.01
C14	See note 22PF
C15	See Note 22PF
C2	.01
C3	.01
C4	.01
C5	.01
C6	.1
C7	10uF
C8	10UF
C9	.01
D1	1N4148
D2	1N4148
D3	1N4148
D4	1N4148
D5	1N4148
D6	1N4001
D7	1N4148
D8	1N4148
IC1	PIC16C84-10/P(18)
IC2	74LS244
IC4	MC78L05CP
L1	LED
L2	LED
M1	MTP3055E
M2	MTP3055E
M3	MTP3055E
M4	MTP3055E
Q1	BC239
R1	10K
R10	220
R11	10K
R2	10k
R4	10K
R5	10K
R6	10K
R7	10K
R8	47K
R9	220
X1	4.18MHZ



Australian
Communications
Authority

EMR Compliance Self-assessment Trial

The Australian Communications Authority (ACA) invites eligible radiocommunications licensees to take part in a trial of materials for self-assessing electromagnetic radiation (EMR) compliance.

The draft materials will allow licensees of some radiocommunications transmitters to self-assess compliance of their transmitter against the limits in the *Radiocommunications (Electromagnetic Radiation—Human Exposure) Standard 1999* (as amended from time to time).

Although the standard currently applies only to transmitter installations supporting cellular mobile telecommunications services, all radiocommunications transmitters will be subject to the standard by the end of 2001.

When the regulatory arrangements are fully in place, the ACA intends to allow some licensees to determine, for themselves, whether their installations comply with the standard. In anticipation of these changes, the ACA is making the self-assessment materials available

to licensees to trial on a voluntary basis.

The trial will assess the effectiveness and user-friendliness of the self-help guidelines by obtaining feedback from the licensees, which will enable the ACA to fine-tune the materials. The trial will also provide licensees with the opportunity to bring their installation into compliance before compliance becomes mandatory.

The self-assessment materials include charts and graphs that will allow trialing for the following radiocommunications services:

- Fixed Link
- Land Mobile Base Station
- Low Power TV and Radio Broadcast
- Paging
- Amateur Radio
- General Radio

The materials are designed to assist licensees to make a simple assessment of whether their transmitting facilities comply with the EMR standard.

The self-assessment materials are available for trial from 15 September 2000 to 15 January 2001. Licensees using the materials are required to return an evaluation questionnaire to the ACA. Participants may also be offered a free validation of their assessment through measurement by the ACA.

Licensees wishing to take part in the trial may obtain the materials via the ACA's website www.aca.gov.au/standards/emr.htm or by contacting the ACA on telephone:

(02) 6256 5552.



Gil Sones VK3AUI

30 Moore Street, Box Hill South Vic 3128

Giant LF Loopstick

A loopstick for reception of LF signals in the 70 to 340 kHz range was described in QEX Mar/April 2000 by Richard Q. Marris G2BZQ. This covers both the European LF band and the US lower band as well as the NZ allocation. A loopstick is used in broadcast radios and is much more compact than a loop. For LF a somewhat larger core is desirable and hence the giant LF loopstick.

To obtain superior sensitivity, selectivity and directivity a 12 inch 1.125 inch diameter ferrite rod was used. Such a rod is not a regular catalog item. The rod was made out of six 12 inch long 0.375 inch diameter rods cemented in a circle. F14 or equivalent ferrite rods were used. Even 12 inch rods are hard to find and

they were made by cementing shorter rods end to end with Super Glue or any similar cyanoacrylate adhesive. Locally 4 inch /100mm rods are available as well as rods 200 mm long. The rod ends should be cleaned and rubbed with fine abrasive paper to slightly roughen them prior to glueing. The fabrication of 12

inch rods is shown in Fig 2.

The 12 inch rods are then assembled into a bundle of six around a centre core as shown in Fig 3.. The centre core is a 12 inch long 0.375 inch diameter wood or plastic dowel. The assembly is held together for glueing with strong elastic bands. The rapid setting adhesive is then

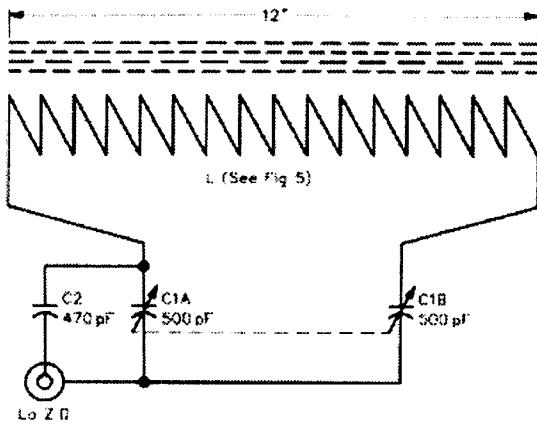


Fig 1. Giant Loopstick Schematic.

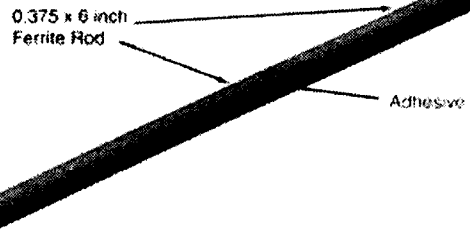


Fig 2. Fabrication of 12 inch Ferrite Rod from Two Shorter Rods.

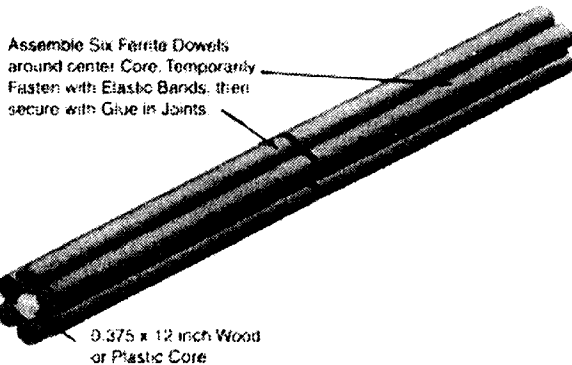


Fig 3. Fabrication of Giant Loopstick from Six 12 inch Ferrite Rods.

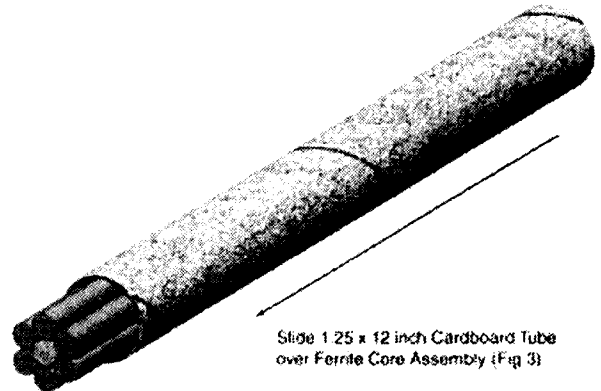


Fig 4. Cardboard Sleeve from box of kitchen wrap used as sleeve former for coil.

run into the valleys between the rods. Allow 24 hours for the glue to cure before cutting and removing the rubber bands. During the glueing process it is advisable to wear rubber gloves.

A 12 inch long 1.125 inch inside diameter thin wall cardboard tube is now required to be slid over the ferrite core as the coil former. Have a look at the tubes used in rolls of kitchen films or even a mailing tube. The tube is shown in Fig 4 and the coil is shown in Fig 5. The coil is an 11 inch long closewound winding of 24 AWG centered on the core.

The circuit of the giant loopstick is shown in Fig 1. The tuning capacitor is a twin gang 500 pf per section originally used in a broadcast radio. Capacitor C2 is a 470 pF silver mica capacitor which is used to match the loopstick to the 50 ohm output to the receiver.

The loopstick was mounted on a

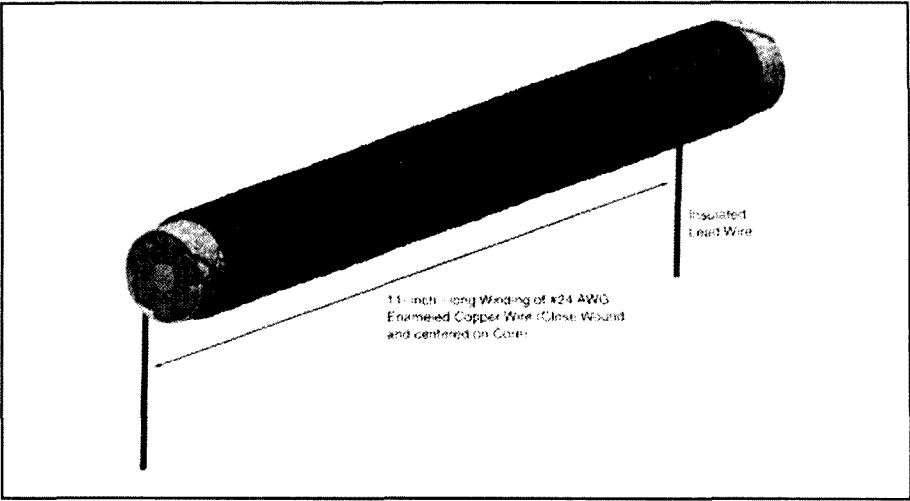


Fig 5. Coil Winding .

wooden base with the tuning and matching circuit mounted in a plastic box attached to the wooden base. The tuning range obtained was from 70 to

340 kHz. Slight differences can be expected due to component differences but should not cause significant problems.

Giovannini D2T Antenna

An interesting wideband antenna was reviewed in CQ June 2000 by L. B. Cebik W4RNL. The antenna is the Giovannini D2T which offers a low SWR below 2:1 over a wide frequency range from the region of 160 metres through the two metre band. It uses a non inductive resistor to provide a termination and is one of an antenna class which includes the T2FD design marketed by B & W. Similar antenna types are used for a variety of commercial and military uses where wide coverage together with an acceptably low SWR are important considerations.

The antenna looks a bit like a ZL Special as it consists of two elements joined by a crossed transmission line. The elements are folded dipoles with an 820 ohm termination at the centre of one and a matching transformer at the centre of the other. The antenna is shown in Fig 6, together with the T2FD design marketed by B&W. Both use a termination and a matching transformer. The matching transformer is a wideband design which matches the 50 ohm feed to the antenna 800 ohms.

The Giovannini D2T is made out of wire of approximately 14 AWG. The boom is aluminium and the elements are supported by fibreglass spreaders. The termination resistor which must dissipate a significant amount of power is mounted in a fibreglass tube as weather protection.

At lower HF frequencies the gain decreases below 10 MHz. However gain is probably the wrong word as the antenna is small at these frequencies and losses are considerable. However it does radiate and if the signal is sufficient and the SWR does not upset the radio this may be acceptable.

Above 10 MHz the antenna efficiency improves and at higher HF frequencies some directivity is evident for the 12 and 10 metre bands.

While the antenna provides SWR performance into the VHF region it may not be an antenna of first choice for 6 or 2 metre band operation. At the upper

end the pattern exhibits a number of lobes.

The antenna is made by Giovanni Elettromeccanica, Via Enrico Mattei 9, 50039 Vicchio (Florence) Italy. Giovanni's website is <<http://www.antenna.it>>. The price in the USA is in the US \$ 500 to \$ 600 region.

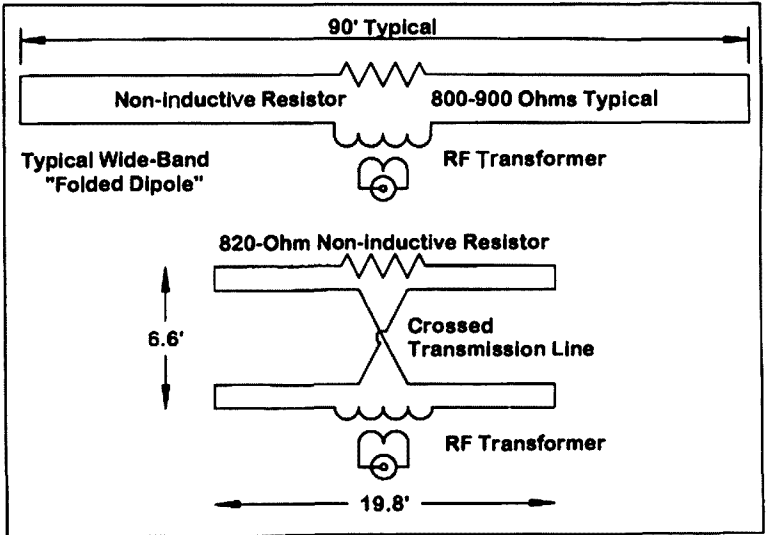


Fig 6.T2FD and Giovannini D2T Antennas.

SSB is older than you are!

Steve VK5AIM

If most Amateurs today were told that SSB is older than they are, they would deny it.

Way back in 1914 John R Carson, employed by the American Telegraph and Telephone Company, was asked to study the problems of Telephony over long distances.

In his study Mr Carson came to conclusions that were highly debatable in those days. Like many brilliant ideas they were much discussed and debated at the time. His conclusions were this: of the total power transmitted, the greatest amount of that power is in the carrier, which transmits no useful information. The other components of the transmitted power are two "voicebands" or sidebands, as we now know them, which carry identical information.

Outside the telegraph companies no one in the radio field took much notice of Mr Carson's conclusions. The ideas on modulation of a radio wave were vague. The existence of these of "sidebands" was hard to grasp. Others believed that a carrier was a must! The fact that modulated oscillators were the principal method of RF power generation in those days led to the confusion.

Since the Atlantic had not yet been

spanned by voice, the distance was formidable. The power required to cross the distance seemed incredible. Every watt of power was needed in the carrier!

Mr Carson pointed out that by eliminating the carrier component the RF power required could be halved. He devised a "balancing out modulator" to remove the carrier. Amateurs brought up on valves will recognise the "Balanced Modulator". See Fig 1.

Mr Carson showed that with the same main source of power, by eliminating the carrier the RF input to the transmitters could be doubled. This doubling of power could be achieved without losing any intelligence. He showed that it was not possible to tell that the carrier was removed. To do this it required a little more work at the receiver end. A different "demodulator" or detector was required. Mr Carson did this by having the receiver supply the missing carrier, the BFO in the modern SSB receiver. He pointed out that the amount of power required at the receiver was minute in comparison to that of the transmitter.

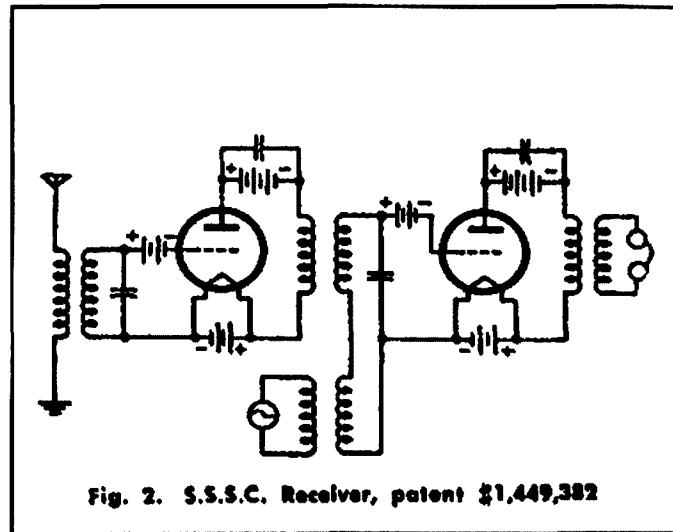
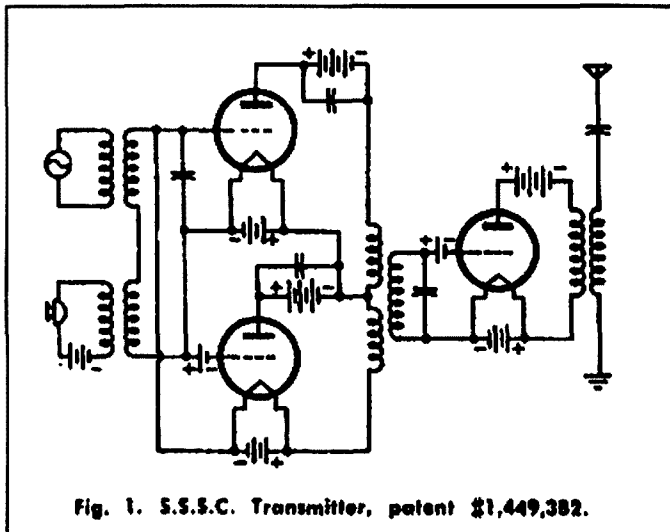
He had just "Passed the Buck" by supplying the carrier from the transmitter to the receiver. See Fig 2. A

fifty percent power saving was real.

Mr Carson noted the two sidebands, both with the same info on each. Why not get rid of one and save more power. Removing one would not destroy any of the info transmitted. More power saved. So he set about a system to remove one of these sidebands. This was done with a filtering system at the transmitter. Remember this was all done at VLF or long waves, frequencies at which LC filters were manageable.

Now he had eliminated twenty five percent of the power required by removing one of the sidebands, add this to the fifty percent previously removed with the removal of the carrier and you had saved a whopping seventy five percent of the power required. "Ah"! They said, "The signal will be so weak no one will hear it!" "Wait a minute," said Mr Carson you had all that input power in the first place, use all of that now to generate this SSSC Single Sideband Surprised Carrier signal.

While at 100 Watts of RF the reduction was not as significant, multiply it by ten or one hundred to Kilowatts and the saving is significant.



The savings didn't stop there, said Mr Carson. By removing one of the sidebands you narrowed the bandwidth required by the transmitter. This was a bit hard to grasp in those days, as bandwidth with modulation was not all that clear. He also pointed out that bandwidth of the receiver, thus the selectivity, could be improved; this would also remove some of the noise.

Mr Carson was thinking away a head of his time when we consider that Spark transmitters were still in use and Valve transmitters were mostly Modulated

Oscillators. By December 1, 1915 Mr Carson had a system working well enough to apply for a patent in the USA. Figs 1, and 2. Showed his CCT's.

Unfortunately World War 1 got in the way and Mr Carson's patent, modestly called "Method and Means for Signalling with High Frequency Waves", was not granted until April 27 1927, Patent No. 1,449,382.

This invention has proved of inestimable value since that time, both

in Telephone and Radio Telephone transitions.

As Amateurs know, the power required for our modern HF SSB transceivers has allowed the development of the likes of the TS-50, IC-706, and FT-100. What would Mr John Carson think and say if he could see one of these and many others of these transceivers today?

Sourced from a copy of CQ December 1955.

ar

Aerial Circuit for 12' Whip

Robert Milne VK7ZAL-AX2TAR
11 Clifford Street,
Moonah Tas 7009

This is a circuit that I have developed, which I use in conjunction with a 12 foot long ex tank whip.

Because the man made noise is very high at my QTH I have to move to a quiet area to listen to low frequency signals, from New Zealand.

I travel about two thirds of the way up Mt Wellington to a quiet spot.

The only answer that I have found for the high man made noise is to move away from it.

All the fets are MPF102's
Q1 has a 10kohm source resistor. This high negative feedback stops broadcast stations from going through the amplifier in conjunction with L1 and C1.

L1 and C1 are tuned to the frequency of the desired signal.

When I get to my listening place, I mount the whip aerial up next to the roof

of my car. I have heard most of the New Zealand LF operating hams on this setup.

The New Zealand hams usually transmit on 181.4 kHz.

This aerial system which is very portable allowing it to be set up in a quiet LF location.

ar

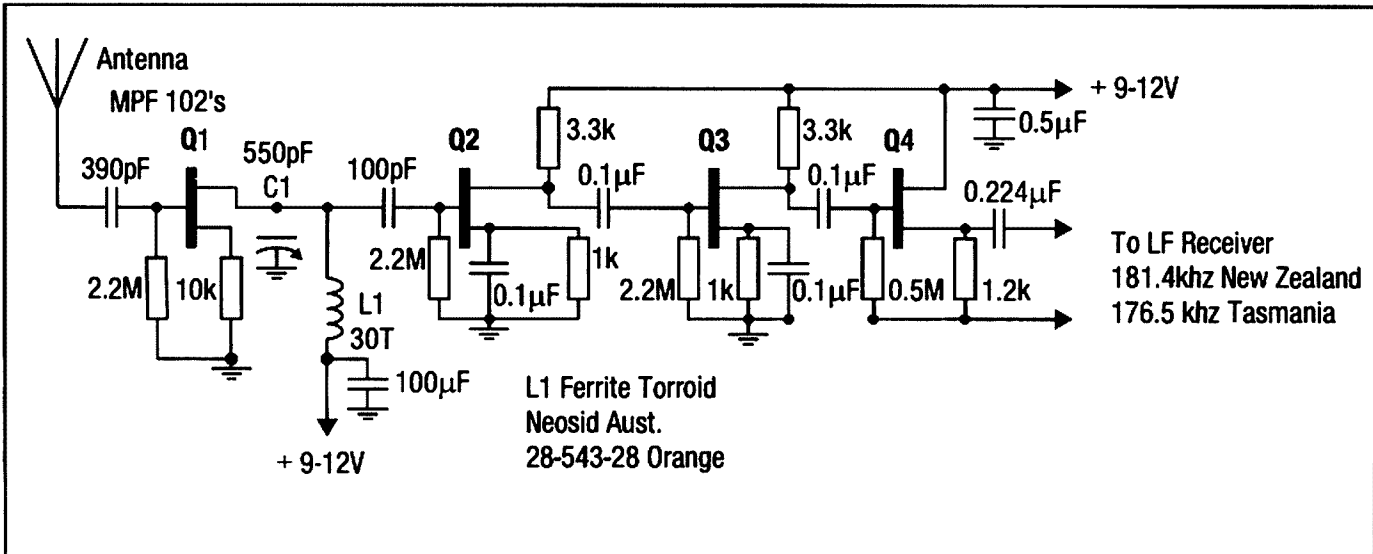


Figure 1

▶ YAESU'S DONE IT AGAIN



FT-920 HF/6m Transceiver with DSP

Now there's no excuse for not taking advantage of the advances in Digital Signal Processing, transceiver design plus the fun of 6m operation. The stunning Yaesu FT-920 is a high performance HF/6m multi-mode base station transceiver that provides 100W PEP output on the 160-6m bands, incredible front-end performance based on the FT-1000MP design, and a huge array of features that make it a pleasure to use.

At first glance Yaesu's renowned Omni-Glow LCD screen is obvious, and its wide-angle view provides a wealth of information about the transceiver's operating status with multi-function metering, dual frequency displays and an Enhanced Tuning scale for DSP bandwidth, CW tuning, FM discriminator and more. Inside, the FT-920 is built around a rugged diecast unibody chassis which provides excellent heatsinking for the low distortion dual MRF255 160-6m FET power amplifier.

For more comfortable operating when weaker signals are present Yaesu's engineers dedicated themselves to enhancement of real-world signal to noise ratios, and after thousands of hours of design and testing have produced an industry-leading 33.3MIPS (millions of instructions per second) processing speed DSP in the FT-920 that provides a two-parameter noise reduction system with 32 steps of front panel adjustment. This amazing system also provides dual control DSP passband tuning, DSP auto-notch filter, an amazing new transmit Digital Speech Processor, DSP mic equalisation, fast acting DSP VOX circuitry as well as a Contest-ready Digital Voice Recorder!

Offers expire 29/10/00

Other features include an all-band (160-6m) auto antenna tuner which also provides greater receiver band-pass protection, Direct Digital Synthesis for clean local oscillators, selectable frequency-optimised receiver front-end pre-amps, and a Shuttle Jog tuning ring for fast QSY.

A Dual Watch receive system allows you to check for band openings, especially handy when monitoring 6m. Also provided are SSB/CW operation (AM and FM optional), 127 memories with alphanumeric labelling, IF Shift and IF noise blanker to fight interference, plus an extensive menu system for selecting most "set and forget" functions. The FT-920 is supplied with an MH-31B8 hand mic, DC power lead and comprehensive instruction manual.
D 3420

**Why not call for a copy of
the Yaesu 6 page FT-920 colour brochure
to learn more about this efficient transceiver
that's without peer in its price class.**

2 YEAR WARRANTY

YAESU

\$2750

DICK SMITH
ELECTRONICS

For further information, orders, or the location of your nearest store: Phone 1300 366 644 (local call charge) Or Fax: (02) 9395 1155

DON'T MISS THE ACTION!

VX-IR 2m/70cm Micro Handheld

One of the worlds smallest dualband handhelds, just 47 x 81 x 25mm (VHD) including a high capacity 700mA/H Lithium-ion battery! The VX-IR covers both 2m and 70cm amateur bands, plus offers AM/FM and TV sound reception, 2 hour fast charging as standard, simple settings and a large LCD screen.

Features:

- Tx: 144-148, 430-450MHz.
- Rx: 0.5-1.7MHz, 76-300MHz, 300-580MHz, 580-999MHz (cellular locked out).
- Output: 2m/70cm 0.5W (at 3.6V), 1.0W with external DC.
- 291 memories, most with alpha naming.
- AM, FM (n), and FM (w) reception modes.
- CTCSS encode/decode.
- 31 smart search memories.
- Tone search for CTCSS and DCS.
- Includes FNB-52LI 3.6V 700mA/H Lithium-ion battery, regulated AC adaptor/charger, antenna and belt-clip.

D 3665

2 YEAR WARRANTY

\$370
YAESU



PRICE BREAKTHROUGH!

Yaesu FT-90R 2m/70cm micro mobile

Another engineering breakthrough from Yaesu – a tiny-dual band mobile rig with high power output, a remoteable front panel, and a rugged receiver front-end. The FT-90R provides 50W RF output on the 2m band as well as 35W output on the 70cm band, a solid die-cast casing with microprocessor controlled cooling fan for reliable operation, and a large back-lit LCD screen, all in a package measuring just 100mm x 30mm x 138mm .

Also includes:

- Wide dynamic range receiver for greatly reduced pager breakthrough.
- Huge receiver coverage – 100-230, 300-530, 810-999.975MHz (Cellular blocked).
- 180 memories and a variety of scanning functions.
- Built-in CTCSS encode/decode, battery voltage metering.
- Designed for 1200 and 9600 baud packet operation.
- Tiny remoteable front panel (requires optional YSK-90 separation kit)
- Includes MH-42 hand mic, DC power lead, and easy to follow instructions.

D 3312

YSK-90 Front Panel Separation Kit D 3317

\$129⁹⁵

\$749
YAESU

SAVE \$100

2 YEAR WARRANTY



PHONE FAX AND MAIL ORDERS

PHONE: WITHIN AUSTRALIA: 1300 366 644
(Local call charge)

FAX: (02) 9395 1155 within Australia and (+612) 9395 1155 from outside Australia

MAIL: DICK SMITH ELECTRONICS, Direct Link, Reply Paid 160,
PO Box 321, North Ryde NSW 1670 (No stamp required)

Excludes packaging and postage. All major credit cards accepted.

14 Day Money Back Guaranteed if NOT completely satisfied. (Software excluded)



Visit our web site at <http://www.dse.com.au>

DICK SMITH
ELECTRONICS

That's where you go!

Yaesu transceivers and accessories stocked in selected stores only. Other stores can place orders on a deposit-paid basis. Offers expire 29/10/2000. All prices shown are inclusive of GST.

1536 DPS/col.



Division Directory

The Amateur Radio Service exists for the purpose of self training, intercommunication and technical investigation. It is carried out by amateurs who are duly authorised people interested in radio technique solely with a personal aim and without pecuniary interest.

The Wireless Institute of Australia represents the interests of all radio amateurs throughout Australia. National representation is handled by the executive office under council direction. One councillor for each of the seven Divisions. This directory lists all the Divisional offices, broadcasts schedules and subscription rates. All enquiries should be directed to your local Division.

Broadcast schedules All frequencies MHz. All times are local.

VK1 Division Australian Capital Territory,
GPO Box 600, Canberra ACT 2601
President Gilbert Hughes
Secretary Peter Kloppenburg
Treasurer Ernie Hosking

VK1GH
VK1CPK
VK1LK

VK1WI: 3.590 LSB, 146.950 FM each Sunday evening from 8.00pm local time. The broadcast text is available on packet, on Internet aus.radio.amateur.misc news group, and on the VK1 Home Page <http://www.vk1.wia.ampr.org>

Annual Membership Fees. Full \$77.00 Pensioner or student \$63.00. Without *Amateur Radio* \$49.00

VK2 Division News South Wales
109 Wigram St, Parramatta NSW
(PO Box 1066, Parramatta 2124)
(Office hours Mon-Fri 1100-1400)
Phone 02 9689 2417
Web: <http://www.ozemail.com.au/~vk2wi>
Freecall 1800 817 644

e-mail: vk2wi@ozemail.com.au
Fax 02 9633 1525
President Michael Corbin
Secretary Barry White
Treasurer Pat Leeper

VK2YC
VK2AAB
VK2JPA

From VK2WI 1.845, 3.595, 7.146*, 10.125, 14.160, 24.950, 28.320, 29.120, 52.120, 52.525, 144.150, 147.000, 438.525, 1281.750 (* morning only) with relays to some of 18.120, 21.170, 584.750 ATV sound. Many country regions relay on 2 m or 70 cm repeaters. Sunday at 1000 and 1930. Highlights Included in VK2AWX Newcastle news, Monday 1930 on 3.593 plus 10 m, 2 m, 70 cm, 23 cm. The broadcast text is available on the Internet newsgroup aus.radio.amateur.misc, and on packet radio.

Annual Membership Fees. Full \$78.00 Pensioner or student \$61.00. Without *Amateur Radio* \$47.00

VK3 Division Victoria
40G Victory Boulevard Ashburton VIC 3147
(Office hours Tue & Thur 0930-1500)
Phone 03 9885 9261

Web: <http://www.tbsa.com.au/~wivic/>
Fax 03 9885 9298
e-mail: wivic@alphalink.com.au
President Jim Linton
CEO Barry Wilton
Secretary Peter Mill

VK3PC
VK3XV
VK3APO

VK3BWI broadcasts on the 1st and 3rd Sunday of the month at 8.00pm. Primary frequencies, 3.615 LSB, 7.085 LSB, and FM(R)s VK3RML 146.700, VK3RMM 147.250, VK3RWG 147.225, and 70 cm FM(R)s VK3ROU 438.225, and VK3RMU 438.075. Major news under call VK3ZWI on Victorian packet BBS and WIA VIC Web Site.

Annual Membership Fees. Full \$78.00 Pensioner or student \$61.00. Without *Amateur Radio* \$47.00

VK4 Division Queensland
GPO Box 638 Brisbane QLD 4001
Phone 07 3221 9377
e-mail: office@wiaq.powerup.com.au
Fax 07 3266 4929

Web: <http://www.wia.org.au/vk4>
President Colin Gladstone
Secretary David Jones
Treasurer Bill McDermott
Office Mgr John Stevens

VK4ACG
VK4OF
VK4AZM
VK4AFS

VK4WIA broadcasts on 1.825 MHz SSB, 3.605 MHz SSB, 7.118 MHz SSB, 10.135 MHz SSB, 14.342 MHz SSB, 21.175 MHz SSB, 28.400 MHz SSB, 29.660 MHz FM (rptr), 147.000 MHz, and 438.525 MHz (In the Brisbane region, and on regional VHF/UHF repeaters) at 0900 hrs K every Sunday morning. QNEWS is repeated Monday evenings, at 19.30 hrs K, on 3.605 MHz SSB and 147.000 MHz FM. On Sunday evenings, at 18.45 hrs K on 3.605SSB and 147.000 FM, a repeat of the previous week's edition of QNEWS is broadcast. Broadcast news in text form on packet is available under WIAQ@VKNET. QNEWS Text and real audio files available from the web site

Annual Membership Fees. Full \$85.00 Pensioner or student \$72.00. Without *Amateur Radio* \$56.00

VK5 Division South Australia and Northern Territory
(GPO Box 1234 Adelaide SA 5001)
Phone 08 8294 2992

web: <http://www.sant.wia.org.au>
President Jim McLachlan
Secretary David Minchin
Treasurer John Butler

VK5NB
VK5KK
VK5NX

VK5WI: 1827 kHz AM, 3.550 MHz LSB, 7.095 AM, 14.175 USB, 28.470 USB, 53.100 FM, 147.000 FM Adelaide, 146.700 FM Mid North, 146.800 FM Mildura, 146.825 FM Barossa Valley, 146.900 FM South East, 146.925 FM Central North, 147.825 FM Gawler, 438.425 FM Barossa Valley, 438.475 FM Adelaide North, ATV Ch 35 579.250 Adelaide. (NT) 3.555 USB, 7.065 USB, 10.125 USB, 146.700 FM, 0900 hrs Sunday. 3.585 MHz and 146.675 MHz FM Adelaide, 1930 hrs Monday.

Annual Membership Fees. Full \$77.00 Pensioner or student \$63.00. Without *Amateur Radio* \$49.00

VK6 Division Western Australia
PO Box 10 West Perth WA 6872
Phone 08 9351 8873
Web: <http://www.omen.net.au/~vk6wia/>

e-mail: vk6wia@omen.net.au
President Neil Penfold
Secretary Christine Bastin
Treasurer Bruce Hedland-Thomas

VK6NE
VK6ZLZ
VK6QO

VK6WIA: 146.700 FM(R) Perth at 0930hrs Sunday relayed on 1.865, 3.564, 7.075, 10.125, 14.116, 14.175, 21.185, 29.120 FM, 50.150 and 438.525 MHz, Country relays 3.582, 147.200 (R) Cataby, 147.350 (R) Busselton, 146.900 (R) Mt William (Bunbury), 147.000 (R) Katanning and 147.250 (R) Mt Saddleback. Broadcast repeated on 146.700 at 1900 hrs Sunday relayed on 1.865, 3.564 and 438.525 MHz : country relays on 146.900, 147.000, 147.200, 147.250 and 147.350 MHz.. Also in "Real Audio" format from the VK6 WIA website

Annual Membership Fees. Full \$69.00 Pensioner or student \$59.00. Without *Amateur Radio* \$38.00

VK7 Division Tasmania
PO Box 371 Hobart TAS 7001
Phone 03 6233 3709 (BH)
Web: <http://www.tased.edu.au/tasonline/vk7wia>
also through <http://www.wis.org.au/vk7>
email: batesjw@netspace.net.au
Fax 03 6223 7816

President Phil Corby
Secretary John Bates
Treasurer John Bates

VK7ZAX
VK7RT
VK7RT

VK7WI: 146.700 MHz FM (VK7RHT) at 0930 hrs Sunday relayed on 147.000 (VK7RAA), 146.725 (VK7RNE), 146.625 (VK7RMD), 3.570, 7.090, 14.130, 52.100, 144.150 (Hobart), repeated Tues 3.590 at 1930 hrs.

Annual Membership Fees. Full \$88.00 Pensioner or student \$75.00. Without *Amateur Radio* \$55.00

VK8 Northern Territory (part of the VK5 Division and relays broadcasts from VK5 as shown, received on 14 or 28 MHz).

VK1 Notes

Forward Bias

Peter Kloppenburg VK1CPK

It appears that the movie "Frequency" definitely attracts people with a general interest in radio and electronics. Peter Ellis (VK1KEP), our Publicity Officer, together with several other amateurs set up a stand with radio gear in the foyers of suburban Canberra theatres over the opening weekend (7-10 August) and proved that, indeed, 'people are funny'. Peter said 'For me, it ranged from the drunk teenager who had a long and very sensible conversation with me about electronics, through the chap who collects old electronic bits and intends to get an amateur licence "one day", the

many who looked at my rig and posters, to a teenage girl who thought it cool to take a leaflet then drop it in front of me'. Peter found that the managers were universally understanding and helpful, 'Yet I could also sense that the young theatre staff couldn't understand why someone would be there for no pay and what they might think is little result'. He added "Try this for an exercise in restraint; I found it curious that staff were using "two-ways" throughout the theatre yet had questioned my dual-band HT!

By the time you read this, the new

Regulations Course has just started on 5 October and goes on for four weeks. The exam is set for 2 November 2000. The Regulations Course is an add-on to the Novice course that finished recently with an exam on August 30. Eleven candidates sat for it, and the pass rate was 72 % These results are a good incentive for the Division to continue with the Novice course next year. The next General Meeting is on October 23, 2000. See you in Room 1, Griffin Center, Civic, Canberra City.

Cheers to all.
pkloppen@dynamite.com.au

VK4 Notes — Qnews

70 Years On

On Wednesday August 16 Commercial Radio station 4BC celebrated its 70th Birthday with a reunion of mammoth proportion.

Back then 4BC on its first night on air invited the Radio Amateurs of Brisbane to a special "do" as it was the end of an era for the Hams. From that point in time the hams of Brisbane were not allowed access to what is now known as the MF broadcast band. Up until the birth of the "Big BC" many a ham was on the band playing "DJ" complete with musical programs.

Oh and the 70th Anniversary bash... from what Graham VK4BB can remember, he had a great time. Hi!

VK4 Area EME

Trevor VK4AFL recently attended a meeting of International Moon Bounce operators in Rio de Janeiro. VK4AFL is probably the only "active" EME operator in this part of the world, and has regular 70cm EME contacts with his Northern Hemisphere counterparts via his excellent home brew antenna system.

Sunshine Coast Club Rescue

Recently on Qnews mention was made of the Lighthouse activation weekend by the club.

While returning from the Lighthouse the members of Sunshine Coast AR Club came across a 'wave trap'. In fact a very wet young couple, honeymooners from Sydney hit the drink right in front of the Sunshine Coast vehicles. While driving along the beach, trying to beat the incoming tide, their van hit a deep water-filled trap

Sunshine Coast members had to pull the couple out through the windows as the water rose because the central locking locked all the doors as soon as the salt water hit the electronics!

As Len VK4ALF said "all a big panic but we can all smile about it later, the full story and pics on the club web page". <http://www.ozemail.com.au/~vk4len/scarc/lighthouse.html>

VK4GKM BBS

As you heard in a recent QNEWS, Graeme VK4RD had decided to close

down his VK4GKM BBS at Biloela at the end of the month. However there is good news and it goes to show that lots of people listen to QNEWS without being known. After the report of the closure, several packet operators (or prospective packet operators) came out of the woodwork and pleaded with Graeme to keep the BBS going.

So the good news is that, due to the sudden escalation of user support Graeme has decided to keep the VK4GKM BBS at Biloela open. Thanks for deciding to keep a vital link open Graeme... we do hope though that you still get some time aside to see the family and keep up the research for the book!

VHF-DX

Due to massive temperature inversions across the north, the VHF skip has been tremendous, includes seeing the Clermont digi direct into Townsville. P29 stations accessing into the packet system in Cairns. Contacts have also been direct into Townsville on 2 metres and 70 cm by John VK4JKL to P29PL and P29KFS.

National Teletext Upgraded

Gary VK3KKJ operating VK3ZWI has been busy bringing the Victorian pages of the VK/ZL/P2 linked teletext system up to date and devising many new pages. Gary has also designed a much quicker way of indexing the divisional pages; an idea, which comes into it's own for TT users who have to 'digi-peat'.

Check out the new index, teletext page 108, also the WIA Victorian section, currently indexed on page 803, VK2 on 802, VK7 on 807 etc etc.

Bill VK5IE has just issued a reminder to the South Australian Packet Users Group [SAPUG] about the wealth of material on the VK/ZL/P29 linked TeleText system. TeleText has a host of information, which will be useful to all stations at some time or another. If your BBS or a BBS which you can digipeat to DOES NOT RUN TELETEXT don't despair, send a personal (sp) message to

VK4WIE and request the page numbers you want.

The index pages are: -

- 101 BBS commands
- 102 Experimenters U-Build it.
- 103 NZART (ZL)
- 104 PNGARS (P29)
- 105 VK Packet services
- 106 Club information VK3/5/6/7/8
- 107 WIA Federal information
- 108 WIA Divisional information
- 109 Club information VK1/2/4 and Special Interest Groups
- 110 Index for YOUR local BBS.

(This is the index for items pertaining to area served by your BBS and is NOT posted on the linked system)

599 Shows all stations, a good way to find your closest TT BBS.

999 Shows this months new pages into linked system

If you have a bright ideas or hints and tips and would like them included in the local pages or general pages, please send them by packet to the following stations VK4BB @ VK4WIE or VK3 users

to VK3ZWI @ VK3FRS, VK5 users to VK5IE @ VK5SPG and ZL users to ZL2TZE @ ZL2TZE.

Although coordinated by Graham VK4BB, TT is an International service, serving all VK Call areas P29 and ZL. If you'd like TT on YOUR BBS, ask your sysop to contact VK4BB @ VK4WIE to request the free software. (Also available in Linux).

WIAQ Meeting

25th November in Rockhampton.

The WIAQ Council proposes to meet in Rockhampton Saturday 25th November joining the RADAR CLUB for its Annual Dinner. The meal will cost \$16 for three courses with private room and bar. The venue will be the New Rockhampton Leagues Club.

Clive VK4ACC can arrange accommodation at the DAVID MOTEL, if we book now we will ensure our accommodation. (Clive Sait VK4ACC clive.sait @ ergon.com.au) Ph 4931 2244

VK3 Notes

By Jim Linton VK3PC

Special message to members

As previously advised, the WIA Victoria Council took the step on 1 July, 2000, to return to entirely voluntary labour to provide membership services and other activities.

This necessary and responsible policy decision was taken after duly considering the future financial performance of WIA Victoria in a climate of increasing costs and falling membership and amateur licensee levels.

The Council stressed that the success of this change depended on the membership providing adequate suitable voluntary labour. Insufficient volunteers have come forward since the return to voluntary labour was announced earlier this year.

We need ten volunteers immediately to get actively involved in our organisation. This figure represents less than one per cent of the total membership.

As an absolute minimum, the following vacancies exist:

- WIA Victoria Office - 3 (a regular one day a week)
- VK3BWI broadcast - 2 (writer/editor/producer - one broadcast a month each)
- Council - 3 (a company director position with associated duties and responsibilities)
- Education - 2 (novice theory and novice Morse code instructor)
- Without these additional volunteers (except for education), it is highly unlikely that the office can remain open, the VK3BWI broadcast will continue, and the workload level on council can be sustained.

It is your organisation, it needs your support.

VK7 Notes —QRM

First-up - congratulations to our Federal President, Peter Naish, on his elevation to the Region 3 executive. Peter, you ARE a tiger for punishment but we know that you will be an asset to that body and will represent us mere members really well .

It was disappointing to our north-west branch members that we had only two applications for the "over the Strait" award this year - one each way, northwards and southward. Hopefully, if we run it again next year, it will attract more interest.

Our branches are working hard on membership recruitment. The southern branch had a busy time with their display at the screening of the film, "Frequency". A lot of promotional material was distributed with 45(+-) requests for membership application forms. We have our fingers crossed that some will convert to members. The northwest branch welcomed two new members at the September meeting, Shirley Hardstaff,(XYL of Max, VK7KY), who has just achieved her novice licence, and John Webster, VK7KDR.

Southern members are gearing up for their communications job in this year's "Southern Safari". The terrain these vehicles travel over (flat country is rare!!) really tests the expertise of our members. Portable repeaters are a must but each year these fellows seem to get better at it.

6metres is having a good resurgence in our northern (Launceston) area. Joe, VK7JG has reprocessed a lot of RT85 rigs and members are getting on air for the first time

Cheers for now,
Ron Churcher, VK7RN

Ross Christie, VK3WAC
 19 Browns Road, Montrose 3765, Vic.
 Email Vk3wac@aol.com

When signals are not heard

I received a letter recently (I will keep the name and call confidential) from a relatively new amateur who complained that although he spends many hours each day listening on the bands he rarely hears any of the DX stations listed in 'DX Notes'. Now, the tone of his letter was not accusing or humorous but I do think he was serious. He states in his letter that he understands that propagation conditions from many parts of the world do not always favour Australia every day, but is adamant that surely some of the DX stations should be audible here if they are on the air operating. I can only point out that propagation, although important if signals are to be heard at all, is not the only influence on whether a particular station can be heard.

The DX station in question may only operate restricted hours, the hours he does operate may not be when most VKs are awake, his antennas may not favour the VK direction, he may be running barefoot with 100 watt to simple antennas, his antennas may not be performing well, he may not be targeting VK at all.

The DX station may not be heard for many reasons. There could also be problems at the receiving end. How good is your antenna system? Can it be steered to receive signals from one direction and reject signal from all other directions? Is your local noise level conducive to hearing the 'really weak ones'? One problem I have personally encountered is trying to establish the ID of a weak station underneath a dogpile. If a dogpile is running then there is probably a rare one underneath, all you have to do is find out whom, and if you need him, try and make him hear you! Some serious concentration and patience can sometimes pay off here, but at other times it can be so frustrating that it is best to give up rather than persist, especially when conditions are marginal.

My best advice is to try to identify the country/station of interest and gauge when propagation between VK and the station is likely to be optimum; this should prove to be the best time to successfully establish a QSO. But, remember, the best propagation times will not always, if ever, coincide with the times a DX station is likely to be on the air. Most amateurs have jobs, family commitments and other interests and may not be on the air every day. This also applies to temporary DX stations, e.g. hams holidaying in exotic locales who may have more than amateur radio on their minds, or those amateurs on extended working contracts in DX locations. Listening, patience and persistence and understanding are what it takes to succeed in DXing. As for the accuracy of the information published in 'DX Notes', the information is gleaned from some of the most reliable sources of DX news there is and is more often that not supplied by those engaged in or involved in DX operations. If they are wrong or misleading, then 'DX Notes' will be wrong too. But why would anyone deliberately misinform or mislead us on DX operations?

I have been very busy at work these past weeks and have had little opportunity to switch the rig on let alone work some DX. Perhaps you have fared better than I in this respect. October should have some interesting stations on air for those of us with the time and patience to have a listen.

The DX

4W EAST TIMOR. Dennis, K7BV and Wolf, N6FF, are mounting a DXpedition to East Timor. The DXpedition will use the call 4W6DX, the call of the East Timor Amateur Radio Association. The anticipated dates for the operation is from the 6th to the 17th of October. During

daylight hours, the pair will be on the bands above 40 metres, during the hours of darkness they will be found on 30, 40, 80 and 160 metres. Some operation might take place using 4W/K7BV (QSL via KU9C) and 4W/N6FF (QSL via N6FF). Rod, WC7N will be the pilot station and can be contacted via email at wc7n@wave.net if information or a sched is required. A website with information on operating plans and frequencies is available at <http://www.qth.com/k7bv/timor/> [TNX K7BV and 425 DX News].

5B4 CYPRUS. Look for Dez. 5B4/G0DEZ, to be active until 2003. He seems to like 17 metres CW/SSB. Check between 1830 and 0300z (sometimes as early as 1430z). He is hoping to obtain a 5B4 and ZC4 callsign. QSL via G0DEZ. [TNX OPDX]

5V DJ7UC, DL4WK, DL7BO, DL7DF and DL7UFR are travelling to Togo and will be on the air from the 3rd to the 9th of October. Plans are to operate on all HF bands and 6 metres on SSB, CW and RTTY. Particular emphasis will be on the low bands. QSL via DL7DF either direct (Sigi Presch, Wilhelmsmuehlenweg 123, D-12621 Berlin, Germany) or through the bureau. A web site for the operation can be found at <http://www.qsl.net/dl7df/> [TNX DJ7UC & 425 DX News]

FM MARTINIQUE. Gerard, F2JD (ex PY2ZDX, HK3JBR, IIP1XBI) has announced a change in his departure date for the island of Martinique. He has delayed his departure for 1 month. He now intends to leave for Martinique in early September and will stay for approx. 4 months. Gerard will use the call FM/F2JD and intends to be active on SSB and CW on the HF bands. If he has the opportunity he will also try and

operate from some other islands in the Caribbean. [TNX F2JD & OPDX]. J2DJIBOUTI. "The 59(9) DX Report" reports that Houssein, J28FH, is a new operator in Djibouti. He is using a 10 metre only rig with a small amplifier (70 W) to a mobile antenna 3 metres high. He is building a 3 element beam for the HF bands. OPDX has found that he frequents the frequency 28580 kHz after 1930z. QSL via WA2VUY. [TNX The 59(9) DX Report and OPDX]

KC4 ANTARCTICA. Bert, WA1O, is heading back to Antarctica in November as part of the International Trans-Antarctic Science Expedition. The expedition will be setting up temporary camps for 3-4 days at a time along the route and Bert will try and operate from these camps in his spare time. Look for KC4/WA1O. [The 59(9) DX Report & 425 DX News]

KL7 ALASKA. In honor of the Canadian/American servicemen and women who served in the Aleutians, station KL7USI will be active from the Museum of the Aleutians on Unalaska Island, Alaska (AK-005S and NA-059), on the 24th (possibly also the 25th) of November. Also, look for a new island in the Alaska area (AK-NEW) for the "United States Island" award to be activated only for 24 hours on the 26th of November. Frequencies for both operations, check 28460 kHz (primary) and 14260 kHz (secondary). QSL via KL7JR. [TNX The Daily DX]

XT DJ7UC, DL4WK, DL7BO, DL7DF and DL7UFR will be active from Burkina Faso between the 10th and 15th of October. Plans are to operate on all HF bands, and 6 metres, SSB, CW and RTTY with an emphasis on the low bands. QSL via DL7DF either direct (Sigi Presch, Wilhelmsmuehlenweg 123, D-12621 Berlin, Germany) or through the bureau. The web site for the operation is at <http://www.qsl.net/dl7df/> [TNX DJ7UC & 425 DX News]

XU Toni, EA5RM and Pedro Luis, EA7DBO will be active as XU7ABD from Sihanouk Ville, Cambodia between the 3rd and 11th of October. They expect to operate on 10-80 metres SSB and RTTY with some

CW. QSL via EA4URE (Union de Radioaficionados Espanoles, Apartado 220, E-28080 Madrid, Spain). [TNX EA5RM & 425 DX News]

IOTA Activity

G The members of the Western DX Cluster Group Bill, G3WNI; Tom, G0PSE/Tom and Doug,

G0WMW will be active as GB0SM from the Isles of Scilly (EU-011) between the 30th of September and the 7th of October. They will operate on all bands 10-160 metres and possibly 6 metres on CW, SSB and probably RTTY as well. QSL via G3WNI either direct or through the bureau (bureau cards can be requested at g0pse@qsl.net). [TNX G0PSE & The Daily DX]

MJ JERSEY. Barry, N0KV (M0CQS), currently living in the UK, says that he just received permission from the Jersey Amateur Radio Society to use their club station for the CQWW SSB Contest (October 28-29th). He will use the callsign MJ/N0KV from LaMoye, Jersey, Channel Islands, UK, from Zone 14 and operate as a Single Op or Multi/Single if he receives some local support. Barry also plans on operating for a period prior to the CQWW contest beginning on the 22nd of October. QSL via N0KV: Barry Mitchell, 12200 Boothill Dr., Parker, CO 80138 USA [TNX OPDX]

VK A large group of VK2s (including VK2EO, VK2NP, VK2RD, VK2PB, VK2ZL, VK2ARY, VK2JW and VK2XN) will be active (on SSB, CW and PSK) as VI2BI from Broughton Island (OC-212) between the 6th and 15th of October. QSL via VK2EO either direct (GeoffMcGrorey-Clark, P.O. Box 76, Medowie, NSW, 2318 Australia) or through the bureau. [TNX VK2EO & The Daily DX]

VK9 Cocos/Keeling. Wal, VK6KZ and Don, VK6HK will be active as VK9CZ and VK9CK from Cocos/Keeling (OC-003) between 21st of October and the 4th of November. Two stations will be in operation with main concentration on 6 metres SSB and CW (conditions permitting). HF operation (40-10 metres) if 50 MHz conditions allow. [TNX VK6HK and VK4FW]

VP5 Frankford Radio Club members

WA2VYA, WA3RHW, K2WB and N2VW will operate VP5/ from VP5JM's QTH on Providenciales (NA-002), Turks and Caicos Islands, between 24 and 31 October. QSL via home calls. They will participate in the CQ WW DX SSB Contest (28-29 October) as VP5T (Multi-Multi). CW, WARC bands and PSK31 activity before and after the contest. QSL VP5T via N2VW (bureau cards can be requested via n2vw@arrl.net). [TNX N2VW & 425 DX News]

Special Events

AX8 Australia. Steve, AX8AM, will be operating as AX8AM, mainly on CW, from Darwin, Northern Territory until the 2nd of November 2000. Steve has been heard operating CW on 20 metres as early as 0630z and as late as 1300z and also on 40 metres at approx. 1230z. QSL via VK8AM, Steve Salvia, 1 Elliott Point, Larrakeyah, NT 0820, Australia.

GS2MP Scotland. The GM7V contest team will be using the callsign GS2MP from the Shetland Islands in the CQWW contest in October. The Shetland Islands count as a separate country, and so multiplier, from the rest of Scotland. Their web page is <http://www.gm7v.com>. [TNX The Daily DX]

SN600UJ POLAND. Look for the special event station SN600UJ to be active from the 20th of July until the 20th of October. The station will be celebrating the 600th anniversary of refounding of "Jagiellonian University" in Cracow, Poland. They are expected to operate on all bands CW, SSB and RTTY. QSL via SP9PKZ. [TNX OPDX]

VE Canada. A large group of operators will be active as VB2R from Zone 2 (James Bay Region, northwest Quebec) between 22 October and 4 November. They will participate in the CQ WW DX SSB Contest and might do some six metre operation (from rare Grid FO10) and possibly AO27 or UO15 if time permits. The special call commemorates the 100th anniversary of the birth of E.S. Rogers, Canadian amateur radio pioneer and inventor of the AC radio. QSL via VE3BY. The web site is at <http://www.fortunecity.com/marina/>

westindia/597/zone2 [TNX VE3SRE and 425 DX News]

HF, POLAND (Special Event). Now through November 6th, look for station HF6WR. The station is active to celebrate the 1000th anniversary of Wroclaw City in Poland. Activity will be on 80-10 metres, as well as 6/2 metres. Most of the activity seems to be on 15 metres between 1400 and 1930z. QSL via SP6ZDA, via bureau or direct address: Scouts Radio Club SP6ZDA, Box 41, 51-673 Wroclaw 9, Poland. A special diploma is available. For further information, check the Web page at: <http://www.wroclaw.tpsa.pl/user/sp6pwr> [TNX OPDX]

KH5K Massimo Mucci, I8NHJ (ex 1A0KM, JT1Y, E30GA etc.) has joined the team, which now includes AA7A, AH9B/W5, JH7OHF, K4UEE, KH6ND, KH7U, N4XP, NH6UY, NI6T, OH2BU, RZ3AA, VE7CT, WA1S and WB4JTT. They will depart Honolulu on 15 October for Kiritimati Atoll (Christmas Island, Eastern Kiribati)-Palmyra (where they may have the opportunity to spend some time)-Kingman Reef. During at least 12 days at Kingman, they will be QRV on all bands from 160 to 6 metres, on CW, SSB and RTTY with up to six stations. They will depart at the end of October for Kiritimati and will return by air to Honolulu on 5 November. The team's major targets are Europe, where Kingman is most-wanted, WARC bands, low bands, RTTY and six metres. The pilots for the operation will be JA3AAW (Japan), DL1XX (Europe) and K6GNX (North America). Expenses for this DXpedition include over \$50,000 for transportation individuals and DX organizations, especially in Europe, are invited to send their contributions to N4XP (Tom Harrell, 2011 New High Shoals Rd, Watkinsville, GA 30677, USA). [TNX NI6T and 425 DX News]

Round up

Peter, ON6TT, who is a seasoned world traveller and DX'er (currently 9A/ON6TT) has informed the DX community that he is moving on from his current assignment in Kosovo. Peter has been in Kosovo since February

working for the UNWFP. He is moving on to a new assignment and location in Pakistan. He expects to arrive in Islamabad sometime in November and expects to be in Pakistan for the next four years. He will try and set up a station for amateur operations while there. Mario, 5X1C, will also be part of Peters team in Pakistan. [TNX OPDX]

One phenomenon that all amateur radio operators, whether HF or VHF, should respect and take note of is lightning storms. The amount of damage and destruction that a single lightning strike can cause is incredible, and if it happens to be your station it can be soul (and rig) destroying. An interesting web page that explains the phenomenon of lightning was found in a recent issue of the 425 DX News. The web address is <http://lightningstorm.com/lightningstorm/gpg/lex1/mapdisplay.free.jsp>. The site is maintained by a US agency so the info contained is probably relevant to the US, but I found the info enlightening and the almost real-time maps entertaining.

I received an email from Len, VK8DKA, who informs me that a new group called 'The Timor Sea DX Group' was formed recently for the express purpose of activating new and rare Islands in and around the Timor Sea. Unfortunately, the email from Len went astray in the system somewhere and I received it only after the two Dxpeditions Len was writing to me about were over. The Dxpeditions were to Browse Island (using VK6BM) and Cassini Island (using VK6CJ). Both of these islands are situated on the northwest coast of Western Australia (CQ zone 29) and were to be new IOTA entities. It is a great pity that Len's email went astray, it was a great chance to let VK operators know of an event planned and staged by an Australian group. However, hopefully the group will have other projects in mind, and if so, I am sure they will let us know. The DXpedition to Browse and Cassini Islands seemed to be well organised and equipped. The group had with them a three band Yagi, a Cushcraft R-7 vertical and a trapped dipole for 40, 75 and 80 metres, ICOM and Yaesu transceivers and a 400W linear amplifier. The station logs were to be uploaded to respective web sites via satellite phones for QSO checking. Travel and accommodation for the Dxpediton team members was

aboard the catamaran 'Tearaway' and some /mm operation was also planned using the members own callsigns. The team members were Dan, VK8AN, Terry, VK8TM, Len, VK8DK and Wally, VK8YS. The Timor Sea DX Group is a non-profit organisation and all expenses were met out of their own pockets, so donations would be welcome to cover costs. Donations, to help cover the cost of the two operations mentioned above, can be sent to The Financial Controller, Timor Sea DX Group, PO Box 1434, Katherine NT, Australia 0851. Web sites for the two operations can be found at, www.qsl.net/vk6bm/index.htm for Browse Island, and www.qsl.net/vk6cj/index.htm for Cassini Island.

Sources

Thank you to those who have called me and congratulated me on the DX Notes column. However, I must point out that the bulk of the information is gleaned from the sources mentioned at the end of each nugget of information. Without the kind permission of these people, organisations and publications there would be no DX Notes. So, please, if you have or hear of any news regarding DX, especially from a VK point of view, forward me a copy either by normal mail or email.

Finally, thanks go to the everyone for the items of DX news, including special thanks to the following people and organisations, The OPDX Bulletin by KB8NW/OPDX/BARF80, 425 DX News and of course Bernie W3UR & 'The Daily DX'.



The WIA Callbook 2001

OUT SOON!



Bill Magnusson VK3JT

Towards a permanent place in space

Imminent launch of Phase 3D

By the time you read this column, things should be getting into top gear at Kourou for the launch of the long awaited Phase 3D satellite. Many disappointing launch delays have put this, the new flagship of the AMSAT fleet a couple of years behind its original launch date. AMSAT-DL Vice-President Peter Guelzow, DB2OS, recently reported that the Phase 3D satellite "will be launched at the end of October or beginning of November." Ariane 5 launches have been postponed until several components could be

checked aboard the launcher. DB2OS reports that Arianespace re-assigned the launch numbers. "There will be two more Ariane 4 and one Ariane 5 launches," said Peter, "but because Arianespace did not yet publish the new official launch manifest, I can't be more precise." DB2OS also reported that more news should be available after the AR-506 launch, currently scheduled for September 14th. "We are indeed on AR-507," said Peter, "and the Phase 3-D launch campaign should start on September 11th in Kourou!" [Courtesy of ANS].

The many launch delays of P3D have

caused lots of discussion in various amateur radio forums. Much criticism has been levelled at the AMSAT organisation and the vast majority of this has been ill-informed or wrongly motivated. The facts are simple. Firstly; We (the amateur radio service) are a secondary, non-paying customer. We could not possibly pay for a commercial launch. This will always be so except in the cases where the amateur package 'hitches' a ride on a larger commercial payload. Phase 3D unlike many is a purely amateur radio satellite. It has to take its place in the launch queue as a secondary payload to be launched if and when space is available. A paying customer comes along and we lose our place.

Secondly; A number of the delays were due to problems with the launcher itself. This also delayed launch of many commercial payloads which pushed P3D further back in line. Why not negotiate a launch on a different launcher? This brings us to point three. Phase 3D is designed to be a high altitude satellite. Its orbit will take it out 50 000 km from Earth in a huge elliptical orbit giving hemisphere-wide coverage. The vast majority of satellite launches are into low-earth-orbits which are roughly circular in shape and usually no more than a thousand kilometres in altitude. These launches are very common but they are no good for satellites like P3D. There is a fourth and very important reason. The mechanical launcher interface, a huge fabricated aluminium structure, had to be designed to fit a specific rocket launcher system and is in fact part of that system, the builders simply had to stick with Arianespace. Phase 3D is a very sophisticated satellite with many advanced communication systems. It will be at the forefront of amateur radio experimentation for many years. The wait will be worth it. If you require a complete up-to-date listing of

The AMSAT organisation

AMSAT (Amateur Radio Satellite Corporation) is a worldwide organisation with its roots in the USA. Its origin can be traced back to 1958, just a year after the launch of Sputnik-1. Since that time AMSAT members have been involved in the design, building, launching, commissioning, upkeep and of course, the day-to-day use of amateur radio communication satellites. The parent body is AMSAT-NA (North America) and many other countries have similar special interest groups operating.

AMSAT-Australia

Our local organisation is known as AMSAT-VK. The National Co-ordinator is Graham Ratcliff VK5AGR.

Membership of AMSAT-Australia

AMSAT-Australia operates an open membership system. No formal application is necessary and no membership fees apply. From time to time new software, firmware and hardware is developed and distributed through AMSAT-VK channels. Write to the co-ordinator to express your interest or pop up on the HF net.

AMSAT-Australia HF net

The AMSAT-Australia net meets formally on the second Sunday evening of the month. During the winter months in South Australia (end of March until the end of October) the net meets on 3.685 MHz +/- QRM at an official start time 1000utc with early check-ins at 0945utc. During the summer months when daylight saving is in operation in South Australia (end of October until end of March) the net meets on 7.068 MHz +/- QRM at an official start time of 0900utc with early check-ins at 0845utc. The times and frequencies have been chosen as the best compromise for an Australia-wide net taking into consideration seasonal propagation changes and the various state summer time variations. The net is open to all amateurs, beginners or experienced who have an interest in amateur radio satellites. Help and information for beginners in particular, no matter how trivial, is freely and cheerfully available on this net.

The AMSAT Journal

An excellent bi-monthly journal is available with formal membership of AMSAT-NA. It contains details of practical projects and ranges over all aspects of amateur radio satellite operations. As of 01Jul00 the cost of AMSAT-NA annual membership will be US\$45 payable to AMSAT-NA 850 Sligo Ave, Silver Spring, MD 20910-4702 U.S.A. or you can phone, fax or email your subscription using your credit card. The phone number is 0011-1-301-589-6062, the FAX number is 0011-1-301-608-3410 and the email address is martha@amsat.org

All Communications regarding any matters mentioned above should be addressed to:

AMSAT-Australia.

GPO Box 2141, Adelaide, SA. 5001.

email, vk5agr@amsat.org

transponder designations, modes and frequencies to be used on P3D, try looking at <http://www.uk.amsat.org/satfreqs.htm> on the internet. It also features complete lists for all other operational amateur radio satellites.

ARISS Takes Shape

Things are beginning to look good for the amateur radio operations on board the International Space Station [ISS]. Recent Space Shuttle journeys to the ISS have begun the task of delivering and installing the amateur radio apparatus on board the crew's quarters. Latest news indicates it will use a temporary antenna system when the first crew arrives and will be connected to its permanent antennas when they are delivered to the ISS. The antenna system to be installed on ISS was built by a team comprising amateurs from Italy, Russia and USA. The antennas are completed and ready for delivery but they are not scheduled for flight to ISS until some time in 2001. When fully operational the ARISS [Amateur Radio aboard the ISS] will consist of transceivers, modems, computer, software and connecting cables allowing a wide range of activities including voice modes, data modes, ATV, SSTV etc. Many of the operations such as SSTV can be automated. ARISS is designed to give amateur radio a permanent place in space. It will be a worthy successor to the amateur radio operations on MIR and on the Space Shuttle. We can look forward to an increased interest in AMSAT operations generally as a result of this permanent presence. Congratulations to the ARISS team whose efforts over the past 3 years or so have resulted in this new system being accepted by the International Space community as an integral part of the ISS crew's recreational activities. So much so that the gaining of an amateur radio licence is now considered to be a 'normal' part of the Astronaut/Cosmonaut training program.

Best Bangs for Bucks.

This is a well known piece of computer jargon which, roughly translated means getting the best value for your money. This is often a concern to operators contemplating involvement in the amateur satellite field. Where to put your hard earned cash to work for best effect. There is an old maxim that applies equally to satellite operation or HF DX.

"Get your antenna right and the rest is easy".

The most common source of dissatisfaction and frustration in new operators stems from neglecting this important point. You may be able to get along with little more than a piece of wire on some of the lower HF rag-chewing bands. I have made many successful contacts using rudimentary antennas. You simply cannot expect to do well with the satellite signals unless you give it your best shot. But even supposing you put most or all of your resources into the antenna system, there still remains the question of priorities. Few of us have the luxury of being able to set everything up according to the book with the best equipment available.

So, just taking the antenna system as an example, what are the priorities? The essential elements are: the antenna itself, the pre-amplifiers, the rotators, the feedline and the feedline connectors. I've assumed a couple of things here. If you want good results you will need to use a steerable high-gain system. You will hear stories about working MIR on a hand-held etc. and I've done this sort of thing myself but if you are serious about satellite operations you will soon learn that conditions have to be perfect for this type of contact. Conditions are rarely perfect.

Here we see the old maxim come into force. Money spent on the antenna will far out-perform a similar amount spent on obtaining more power output. So let's take it a step at a time. Money spent on a good, high gain yagi is money well spent. It could be circularly polarised with polarity switching but that can wait. The gain doesn't have to be bank-breaking. Antenna gain is the reciprocal of beamwidth and you have to 'find the satellite' with the antenna. Too high gain is just as bad as too low gain. Ten to twelve dB is a good starting point and this can easily be achieved in low cost home-brew designs. I won't even contemplate not using a receive pre-amplifier. This is one of the most important bits of gear in any satellite station. Satellite signals are weak. They come from a long way off. They often emanate from a transmitter running no more than a fraction of a watt. You need to present the signal to the first GaAsFet in as good condition as possible. This is where we establish the entire system's signal to noise ratio, and this is the spot

where most 'bangs for bucks' will be obtained. Get it right here and the rest is easy. Get it wrong here and no amount of money poured into the rest of the system will fix it. Make no mistake, the place for the pre-amp is right at the antenna feedpoint. Or as close as possible. Try really hard to do this, it's the most critical part of the system. GPS receivers work because the base of the antenna is welded directly onto the input gate of the first GaAsFet.

Next, remember that any length of feedline, no matter how short, is important at VHF/UHF. Don't run away with the idea that just because you only have 50 feet or less of feedline that you can get out that old bit of co-ax from the box under the bench and press it into service. You will be disappointed and you may never find out why. Probably blame AMSAT or the satellite itself or conditions or sunspots or ... no. Buy some new co-ax, it won't break the bank and while you are about it buy new connectors rather than de-soldering old ones. Seal the co-ax connectors carefully at each end. A dollar spent on co-ax sealing compound will be worth \$50 to you in a years time. You can't leave out any of the above steps if you want to have a successful satellite earth-station. A couple of hundred dollars spent here can make the difference between working the birds and not being able to hear them. Just about any rig can be used if it works, provided you have not skimmed on the antenna system. I regularly use as little as 5 watts to uplink to the digital satellites. Even large picture files can be uploaded at this power level without repeat requests if you get the antenna system right. Best bangs for Bucks ? Put them into your aerial system.

Moon Pictures on UO-36.

Twice in recent months the cameras on board UO-36 have been turned around to photograph the Moon. The images have been excellent. In one case a picture of a large crescent of the Earth centred around the North Sea and looking towards Iceland was in the immediate foreground and the Moon, a tiny dot centred in the background just above the Earth horizon. This picture was taken with the wide angle camera and it was spectacular. The latest picture taken in early September was a narrow angle shot of the Moon in which it is

possible to see the mares and larger craters.

Both these pictures have something in common. They will both have required very accurate orientation of the satellite to aim the cameras in the right direction. UO-36 is in a low-earth-orbit, some 700 km altitude. It is stabilised by a slow spinning motion around its "Z" axis, perpendicular to Earth and also by means of a 'gravity-gradient-boom'. This device is a telescopic mast several metres long which is deployed after the satellite is safely in orbit. At the end of the boom is an instrument package which constitutes a mass designed to react with the main satellite body and the Earth's gravitational field to form a three body couple. When set up this system is very stable and keeps the bottom of the satellite facing towards Earth. This is the surface that houses the earth-imaging cameras.

The spin can be stopped for taking panoramic series of earth-images. But to take pictures of the Moon means re-orienting the satellite and pointing it at the Moon rather than straight down. As you can imagine this is a delicate process which has to be performed slowly by remote control from the ground station.

It is a credit to the control team at Surrey that such successful pictures of the Moon have been taken using this method. Use your web search engine to visit the University of Surrey's UoSat web site. It will provide a host of information about this series of satellites and an exciting look at things to come.

Old Favourite Tracking Programs.

Many operators have been waiting patiently for news of the release of the updated version of InstantTrack. I have no further news except that 'reliable sources' still say that release is imminent. The final version has been in the hands of the beta testers for some time and all that remains to be sorted out is the distribution method. News came to hand a few days ago of another old favourite, "QuickTrack" AMSAT-NA announced recently that there are updated DOS and Windows versions of this program available now. Both versions are compatible with the y2k NASA keps format. The cost is \$US25 and it is available by email attachment if you get in touch with Martha at AMSAT-NA headquarters. Her email

address is martha@amsat.org and the transaction can be done by credit card.

Telemetry Programs for Monitoring Phase 3D.

Peter DB2OS who is presently in Kourou doing the final pre-launch tests on Phase 3D has announced that once the tests are complete he will release the precise format of the engineering telemetry blocks to be broadcast by P3D. The data format will be the same as for P3C, ie. 400 baud psk. If you have the G3RUH decoder for this format you are in business. I must dust mine off and fire it up. It has been in storage since P3D de-orbited. The telemetry format is similar but not exactly the same. Windows and DOS software for the deciphering and display of this data is ready for release when Peter has finalised the checks. It should be in our hands prior to the launch date. The more stations set up to monitor this data in the early days, the better the control stations will be able to monitor the health of the new satellite. If you have the gear, please get it ready for the launch. The data from the first few orbits could be vital.

ar

radio **Communications**

Incorporating AMATEUR RADIO ACTION and CB ACTION

Published by Chris Edmondson, VK3CE

PO Box 123, Eagle Heights, Queensland 4271 •PH (07) 5545 0666 •FAX (07) 5545 0622

Join in the JOTA fun!

JOTA hits the air waves mid-October. Will you be a part of one of the hobby's greatest schemes?

Know someone who could benefit from the WIAQ-sponsored ARCS Scheme? Learn electronics the EASY way!

Download your FREE copy of ARCS from <http://www.radiomag.com> today, and spread the good word!

Our close neighbour Malaysia is building its own amateur satellites — and don't forget P3D is ready too!

And check out the other great stories while you're at it! We review the Dragon SY130, and all-new two metre FM rig. VK2DQ's great educational series continues, we check out the DX and latest repeater changes, plus lots more!

R&C has the biggest collection of radio-oriented Classified adverts in the country. There's lots of them because they work so well! So watch this space to learn what's coming up in the future for your magazine!

Don't miss out — RADIO and COMMUNICATIONS is great reading for amateur

Check your local newsagent today!



Awards

John Kelleher VK3DP, Federal Awards Officer

4 Brook Crescent, Box Hill South Vic 3128, (03) 9889 8393

A few words about obtaining awards.

Most award sponsors allow the general certification rule (or GCR) list, in lieu of actually sending QSL cards. You need to have the cards ! Your GCR list should be made in strict observance of the rules specified by the award manager/ sponsor. It also means obtaining the signatures of two witnesses, verifying the fact that you indeed possess the necessary cards to obtain the award, and that your application is correct in every detail. If the award specifies club officials you should make sure that their title follows their signature(s). A tiny minority actually want to see the necessary cards. If you want the award, you are going to risk the cards. Check in advance to see if photo-copies of the cards are acceptable. Personally, I have not lost any cards, but then, I don't rest easy until they are returned.

To get the cards you require for awards, you've got to make lots of contacts. If you have been reasonably active for a few years, then you've got it made. If you have been diligent in sending cards for all your DX contacts, fine. If not, you can always refer back to your logs, can't you ?

A few words about your QSL card. If you want a good percentage of replies your card should be neat, interesting, and accurate. Size should be no larger than 13 x 9 _ cm, which can vary by a few mm. In brief, your card should :-

Be reasonably attractive : (pictures are great, but not always necessary)

Contain all the QSO data in logical format.

Show the contact time accurately in UTC.

Indicate your QTH, and any awards your card is good for.

Do not apply for awards until you possess all the necessary cards !

International Reply Coupons or IRC's are the most universal medium of currency amongst award hunters, and can be obtained from General Post Offices, or from another operator who has plenty in his/her possession !

Always send valid IRC's of the current edition, which are postmarked on the left hand side. I have found that post office labels, and not stamps should be affixed to the envelope containing your application(s). If you require any further information, I will gladly answer any queries I receive.

Finally, keep an eye on DX bulletins which are published almost daily on certain web pages, or just ask your Dxing friends what's happening around the bands. Or peruse the DX information column published elsewhere in this magazine.

Bulgaria

Bulgarian Federation of Radio Amateurs Series.

General requirements : Available for contacts or SWL on CW SSB/AM or mixed modes. GCR list accepted. Fee for each award is 10 IRC's. Apply to :-

BFRA
PO Box 830
Sofia 1000
Bulgaria.

Black Sea Award.

Make 60 contacts with different amateur stations located in countries bordering the Black Sea. Contacts since January 1, 1979.

Republic of Bulgaria Award.

Work Bulgarian stations since Jan. 1 1965. DX stations need 10 contacts with LZ1,LZ3,LZ5 and 10 with LZ2,LZ4 and LZ6, with no band restrictions. Total of 20 contacts.

W 100 LZ Award.

100 contacts with different LZ stations during one calendar year. Contacts after Jan. 1, 1979.

W 28 Z ITU Award.

Contact the following countries of ITU Zone 28 since Jan. 1, 1979. Y2 DL FC/TK HA HB9 HB0 HV I IS LZ T7 OE OK OM S5 SP SV SV5 SV9 SY YO YU ZA 1A0 4N4 4U (Vienna) 9H and 4U1ITU(Geneva).

The award is issued in 3 classes :-

Class 1 – 28 different stations in 20 of the above listed countries.

Class 2 – 28 different stations in 16 of the above listed countries.

Class 3 – 28 different stations in 10 of the above listed countries. In addition, 5 QSO's are needed with different LZ stations.

5 Band LZ Award.

Contact one LZ1 and LZ2 on each of the bands 3.5 7 14 21 and 28 Mhz

For a total of 10 contacts. QSO's since Jan 1, 1979.

Ghana

G.A.R.S. Fellowship Award.

Contact 5 different 9G stations who are members of the Ghana Amateur Radio Society on a single band on or after Jan 1, 1994. GCR list and fee of US\$5.00 to go to :-

Award Manager
PO Box 3936
Accra, Ghana.

Gibraltar

ZB2 Award.

Work 5 different ZB2 stations. No time, band, or mode restrictions. SWL OK. GCR list and fee of US\$3.00 to :-

Gibraltar Amateur Radio Society
PO Box 292,
Gibraltar.

Guam

Worked Guam Award.

Contact any 5 Guam stations. No time, band, or mode restrictions. GCR

List and US\$2.00 to :-
MARC
Box 445
Agana Guam 96910.

Guantanamo Bay

Worked All Guantanamo Award.

Work 6 KG4 stations during a 3 year period and send GCR list for stations Still on base and photocopy of cards for amateurs no longer stationed there. No charge, but return postage would be thoughtful. Not available for SWL.

Send to :-
GARC
PSC 1005
Box 73, FPO AE
09593- 0011

Good hunting and best 73 de John,
VK3DP now at redtoo@rabbit.com.au

ar



Ian Godsil VK3DID

E-mail: contests@wia.org.au

**Contest Calendar
October — December 2000**

Oct	1	RSGB 21/28 MHz Contest (SSB)	(Aug 00)
Oct	7	PSK31 Rumble	
Oct	7/8	Oceania DX Contest (SSB)	(Oct 00)
Oct	8	RSGB 21/28 MHz Contest (CW)	(Aug 00)
Oct	14/15	Oceania DX Contest (CW)	(Oct 00)
Oct	15	Asia-Pacific Sprint (CW)	(Jan 00)
Oct	21/22	JARTS WW RTTY Contest	(Sep 00)
Oct	21/22	Worked All Germany Contest (CW/SSB)	(Sep 00)
Oct	28/29	CQ WW DX Contest (SSB)	(Sep 00)
Nov	1-7	HA QRP Contest (CW)	
Nov	4/5	WIA Spring VHF-UHF Contest	(Oct 00)
Nov	4/5	Ukrainian DX Contest (CW/SSB)	
Nov	5	High Speed CW Club Contest	
Nov	10-12	Japan Int. DX Contest (SSB)	(Dec 99)
Nov	11/12	WAE RTTY Contest	(Sep 00)
Nov	11	ALARA Contest (CW/SSB)	(Sep 00)
Nov	11/12	OK/OM DX Contest (CW)	
Nov	18/19	LZ DX Contest (CW)	
Nov	25/26	CQ WW DX Contest (CW)	(Sep 00)
Nov	25/26	CQ WW SWL Challenge	
Dec	2/3	EA DX Contest (CW)	
Dec	9/10	ARRL 10 Metres Contest	(CW/SSB)
Dec	16	OK DX RTTY Contest	
Dec	16/17	Croatian CW Contest	
Dec	16/17	Stew Perry 160 metres Distance Challenge	(CW)
Dec	16/17	International Naval Contest	(CW/SSB)
Dec	17	RAC Canada Contest	(CW/SSB)
Dec	26 Jan	Ross Hull Memorial VHF-UHF Contest	(Nov 00)
Dec	30/31	Original QRP Contest	(CW)
Dec	31/1	15 th Internet CW Sprint	(CW)

Thanks this month to VK2FI VK4EV JE1CKA VK3KWA

Greetings to all readers and contestants. So the year is moving on, with time now to prepare for the VHF-UHF events for the coming Spring and Summer. These have always been a focal point for many operators, but whether they can be called "popular" may be open to debate. There is room for all of you, so please check your station and get ready for some higher frequency work for a change.

Also, please do not forget the ALARA Contest next month. This is a good one for practice, and although intended to let the girls have a try, should not be left to them alone. The late Ivor VK3XB was most regular in calling on CW in order to help the ladies along. I hope that someone else will take up this task this year.

Results

I am pleased to list some results below,

especially of VK events. However, I am personally saddened to note the comment about absence of a CW log from any Novice. I cannot believe that CW is so hated by all Novices that no-one at all will ever use it! By comparison, just look at the score for VK3JRC!

Stewart is becoming quite active on several bands and particularly on CW. Good luck Stewart and hope to see your call more often in

Contest results.

RD

There were mixed comments about the level of participation this year, especially on CW. I must confess I did not do well, but not for the want of trying. The results when they come should be most interesting.

Oceania Contest

I hope that you gave of your best efforts in the Oceania DX contest. I use past tense, because probably by the time you read this the contest will have finished. However, now the work of preparing the log begins, so please do not neglect that important part of the contest.

VK2APK

It would seem that I may have printed a wrong score for Dietmar VK2APK in the May notes. Apparently his total score was 2,148,000 points in last year's VK/ZL Contest.

By any standards this is an impressive score. We all know Dietmar as one of VK's leading contestants (just look at his scores for the 1999 SAC below).

No doubt one needs a certain natural ability to do well in contesting as in other things, but effort and application are what get us through. In other words – DETERMINATION. What I say is please let's have more of it, certainly in contesting where your own skills and satisfaction level will be enhanced, but also in all aspects of our hobby.

SWL — Ever Tried It?

The day the Pacific 160 Metres Contest was to be held I had a dose of the 'flu. Instead of taking part I listened for an hour or so.

I really enjoyed this and it has shown me that there is another dimension to contesting, viz tracking down contacts and writing down the details. I do not doubt that it can be just as demanding as giving numbers, but to some extent the pressure to make as many contacts as possible presumably would not be there.

Most contests have an SWL section and if you do not want to take part in the transmitting department, try a listener's log. It is all good fun, contributes to the activity of the event and enhances your experience. Some Europeans even have special contests just for SWLs!

CNS

A note from the Bavarian Contest Club says that they will be operating again from Morocco as CN8WW in the CQ WW Contests. If you need this country, here is an opportunity.

Thanks

Finally this month, my thanks to some readers who sent suggestions via e-mails. One was about SWLing and another was from a very well-known contestant, Martin VK5GN, following my notes about contest logging programs earlier in the year. Thanks to you all.

73 and hear you in a contest soon.

Ian VK3DID E-mail: contests@wia.org.au

Results SAC 1999

SSB

(Call\cat\points\mult\score)

VK2APK	SOHP	162	81	196	15876	OC Plaque
VK4ICU	SOLP	130	62	132	8184	OC Plaque

CW

VK2APK	SOHP	167	237	82	19434	OC Plaque
VK8HA	SOHP	98	98	54	5292	
VK4TT	SOHP	85	95	46	4370	

Results VK Novice Contest 2000

From Bob VK2FI, Contest Manager
(Call\name\mode\score)

	PHONE	CW		
VK2IBT	Ken	71	-	
VK2HT	Nev	28	-	
VK2CW	Greg	07	-	
VK2CA	Allan	455*	-	
VK3YE	Peter	36	22	
VK3JRC	Stewart	19	67*	
VK3DID	Ian	-	24	
VK1MOJ	Olaf	77*	-	
VK5EMI	John	09	05	
VK7LUV	Susan	137*+	-	
VK7JAB	Alan	63	-	

*= certificate

+ = plaque

Keith Howard VK2AKX Trophy for Novice with highest Phone score goes to Susan Brain VK7LUV. Congratulations Susan

However, it is sad to note that no Novice CW log was received, therefore the Clive Burns Memorial Trophy cannot be issued this year.

Thanks to all who took part.

Results QRP Day 2000

From Ron Everingham VK4EV, Contest Manager
(Call\score\place)

* VK3DID/QRP	114	points 1 st Place
* VK3LK/QRP	56	points 2 nd Place
* VK5BLS/QRP	30	points 3 rd Place
VK2BO/QRP	22	points
VK2PH/QRP	14	points
* VK3YE/QRP	13	points
VK3BYD/QRP	11	points

* = station used homebrew transmitter or transceiver.

Results of Pacific 160 Metres Contest, July 2000

CW (Call\score)

1	ZL2AS	378 points
2	W8JI	270
3	AX2BQQ	216
4	VK6VZ	168

SSB

1	VK3EW	820 points
2	ZL2AS	252
3	ZL1BRY	238

MIXED

1	VK4AXM	189 points
2	ZL2AWH	125
3	ZL2AJB	76
4	VK2PH	68

SWL

1 VK3VP 261

Comments: Conditions were reasonable on the night, with W8JI being well received by several of the participants. The introduction of the Mixed category seems to have been a success, and it was also pleasing to see an SWL log for the first time. Thanks to all who took part, even if you did not send in a log. VK3DID, Contest Manager

Results Commonwealth Contest (BERU) 1999

VKs only. (Place \call \score)

OPEN	RESTRICTED				
9	VK2BJ	7122	3	VK6VZ	3999
12	VK4EMM	6725	6	VK2APK	3929
40	VK6HQ	2687	17	VK4TT	2759
51	VK5GZ	2294	24	VK8HA	2463
53	VK3ZC	2207	34	VK6AJ	2015
56	VK2DID	1854	40	VK2BQQ	1498
66	VK3KS	767	42	VK5GN	1254
68	VK5HO	498	47	VK4XW	534
48	VK8AV	450			

ALARA CONTEST

Saturday 11 November, 2000 0001z - 2359z

OBJECT: Open to all licensed operators, YLs work anyone, OMs and Clubs work YLs only.

BANDS: 80m - 10m (no WARC). SUGGESTED FREQUENCIES: 28.380 - 28.410 MHz; 21.170 - 21.200 MHz; 21.380 - 21.410 MHz; 14.250 - 14.280 MHz; 7.070 - 7.100 MHz; 3.560 - 3.590 MHz.

MODES: CW; SSB. Note: CW is very much encouraged, but please keep it within the suggested frequencies.

CATEGORIES: CW; SSB; MIXED; SWL. CALL: Phone "CQ ALARA CONTEST"; CW: YLs call "CQ TEST ALARA"; OMs call "CQ YL".

EXCHANGE: RS(T) plus serial number starting at 001; name; whether ALARA member or Club station. Note: Stations may be re-worked on the same band and mode after an interval exceeding one hour. No net, list, crossmode or crossband operations permitted.

SCORE: CW/Phone - five points for ALARA member contacted; four points for YL non-member contacted; three points for OM/Club contact. On CW, QSO where one operator is a Novice, score DOUBLE points.

LOGS to show date; time UTC; band; mode; callsign worked; exchange; name of station worked; whether Club; points claimed. Logs may be single entry, except Australian YLs entering for the Florence McKenzie CW Trophy should use separate CW log. Show name, address, callsign of operator, points claimed. Contest Manager's decision will be final.

SEND LOGS by 31 December, 2000, to: Mrs. Marilyn Syme VK3DMS, 99 Magnolia Avenue, Mildura, 3500, Australia.

Various CERTIFICATES will be awarded.

SPRING VHF-UHF FIELD DAY 2000

from John Martin (VK3KWA), Contest Manager

Sat. 4 November - Sun 5 November

VK6 only: 0400z Sat - 0400z Sun

Other Areas: 0100z Sat - 0100z Sun

The next Spring VHF-UHF Field Day will take place on November 4 and 5, 2000. The date is a week earlier than in past years, in order to avoid clashes with other events including the Leonids meteor shower. There are no rule changes this time.

There are several ways of getting a good score in the Field Day. The first three are - as estate agents say - "location, location and location". Adding an extra band will increase your number of contacts and your grid square total. Alternatively you can make significant scoring gains if you are able to hop between grid squares.

Please check the log requirements carefully. Every year some entrants forget to claim points for the grid squares they operated from, and some logs do not show clearly whether the grid square total includes the squares activated as well as the squares worked. It could be helpful to include a list of squares activated and worked for each band, as a reminder to claim the full score that you are entitled to.

A computer program is available which will convert between map co-ordinates and Maidenhead locator squares, and calculate the distance between stations. It can be obtained from the addresses given below.

Please also note the dates for the next Summer Field Day - January 13 and 14, with the same rules as below.

Duration

VK6 only: 0400 UTC Saturday November 4 to 0400 UTC Sunday November 5, 2000. All other call areas: 0100 UTC Saturday to 0100 UTC Sunday.

Sections

- A: Portable station, single operator, 24 hours.
- B: Portable station, single operator, any 6 consecutive hours.
- C: Portable station, multiple operator, 24 hours.
- D: Home station, 24 hours.

Single operator stations may enter both Section A and Section B. If the winner of Section A has also entered Section B, his log will be excluded from Section B.

If two operators set up a joint station, they may enter Section C under a single callsign, or sections A/B under separate callsigns. Stations with more than two operators must enter Section C.

General Rules

One callsign per station. Operators of stations in Section C may not make contest exchanges using callsigns other than the club or group callsign. Operation may be from any location, or from more than one location. You may work stations within your own locator square.

A station is portable only if all of its equipment, including antennas, is transported to a location which is not the normal home location of its licensee.

Repeater, satellite and crossband contacts are not permitted. No contest operation is allowed below 50.150 MHz. Recognized DX calling frequencies must not be used for any contest activity. Suggested procedure is to call on .150 on each band, and QSY up.

Contest Exchange

RS (or RST) reports, a serial number, and your four-digit Maidenhead locator.

Repeat Contacts

Stations may be worked again on each band after three hours. If the station is moved to a new locator square, repeat contacts may be made immediately. If the station moves back into the previous locator square, the three hour limit still applies to stations worked from that square.

Scoring

For each band, score 10 points for each square in which your station operates, plus 10 points for each locator square worked, plus 1 point per contact. Multiply the total by the band multiplier as follows:

6 m	2 m	70 cm	23 cm	Higher
x 1	x 3	x 5	x 8	x 10

Then total the scores for all bands.

Sample Scoring Table

Band	QSO Points	Locator Pts	Multiplier	Total
6 m	100	+ 200	x 1	= 300
2 m	60	+ 120	x 3	= 540 etc.
Overall Total				= 840

Logs

For each contact: UTC time, frequency, station worked, serial numbers and locator numbers exchanged, points claimed.

The front sheet should contain the names and callsigns of all operators; postal address; station location and Maidenhead locator; the section entered; a scoring table; and a signed declaration that the contest manager's decision will be accepted as final.

Entries

Paper logs may be posted to the Manager, Spring VHF-UHF Field Day, 3 Vernal Avenue, Mitcham, Vic 3132. Electronic logs can be e-mailed to jmartin@xcel.net.au. The following formats are acceptable: ASCII text, Office 97 RTF, DOC, XLS, MDB, or PUB, or Works 99 WKS. If you use Office 2000, please save the files in Office 97 format.

Logs must be received by Friday, December 1, 2000. Early logs would be appreciated.

OCEANIA DX CONTEST 2000

For many years this event has been known as the "VK/ZL/Oceania Contest". It is managed alternately by WIA and NZART. This year it is the turn of the latter society and the Contest Manager, Brian ZL1AZE, decided that it was time to try and encourage more activity into this event.

Changes

Consequently, he has introduced five changes and I commend them to you all. They are –

1. change of name to "Oceania DX Contest" in the hope of getting more participation from other countries than just ZL and VK within the Oceania boundaries.
2. introduction of 160 metres, with an allotted score of 2Δ POINTS for any contacts on this band.
3. allowing Oceania stations in the same country to contact each other for points and multipliers. It is hoped that this

will encourage activity on 80/160 metres, where it is often difficult to make true DX contacts.

4. addition of a Single Band entry category.
5. institution of the the ZL2TT Memorial Cup in honour of Ron Wills, keen contest operator and NZART Contest Co-ordinator at his death in February this year (see note "AR" Contests, April 2000, page 45). This cup is to be awarded to the highest scoring Single Operator Phone station in Oceania and the successful entrant will receive a nicely engraved small cup in recognition of his efforts.

Advertise Yourself and Your Country

This contest will occur over the first two weekends in October. For some years it has seemed that our really great opportunity to present ourselves on the bands has been sadly neglected by many VKs - and, I suspect, ZLs as well.

This year we shall still be using the AX callsign at this time, so here is a WONDERFUL OPPORTUNITY for us all to be heard, let others know that we are not all asleep or gone to the footy or recovering from the Olympic Games or whatever.

Help Others

I am sorry to say that the concept of doing something for others is not a popular one in our society at the present time. The emphasis is on ME – what do I get out of it? Blow you, I'm OK. Me and my friends (instead of my friends and I). OK, so what would you get out of it? Practice, experience, the satisfaction of having contributed to a national event and the knowledge that you helped a fellow amateur with a DX contact. Of course, it follows that you may have to be prepared to send him a QSL card at some time, but that too is a recognised part of DXing.

Let me assure you that there are many DX stations come on for this contest in the expectation that they will work VKs and ZLs, which they cannot always do with ease. Please consider their disappointment and concern when they hear so few of us.

THIS YEAR IS THE GRAND OCCASION TO CHANGE THIS and I urge you all to tune your stations now in order to join in in October. SSB will be on the first weekend and CW on the second. Between these two modes there is something for everyone.

Software

For those of you who use logging software, don't despair. There is an excellent program by John VK4EMM called Quickscore. Intended to read the .bin file of the CT logger, John has designed his program to cover several of the important – no, sorry, they are ALL important – major VK contests. It may be downloaded from <http://www.uq.edu.au/radiosport/>

(And while you are there, have a look at the Monthly Report. This is always well worth keeping an eye on, even if you have to turn off your speakers whilst you concentrate!)

Make the Manager Work

Give the Contest Manager something to keep him busy – after all, he tells me that he has an excellent Internet connection and logs of 40 pages should not worry him! (To which I say - BRAVE FELLOW!) So how about we put him to the test? Let him make good his boast!

So there it is – it's up to us all. The Rules are below. Please read them carefully and prepare.

Meanwhile, good contesting and 73

de Ian VK3DID

E-mail: contests@wia.org.au

Results WRTC2000

First places to the team K5TJ/K1TO

VK team operated as S546Q

(Mode\place\score)

CW 41 825 SSB 53 258

2000 Oceania DX Contest

(formerly VK/ZL/OCEANIA DX Contest)

from Brian ZL1AZE, Contest Manager

1. General: The aim of the contest is to promote contacts with stations in the Oceania region (VK, ZL, Pacific Islands and other locations within the IARU Oceania WAC boundary).

2. Contest Period:

Phone Contest: 7 - 8 October, 1000 UTC Saturday to 1000 UTC Sunday

CW Contest: 14 - 15 October, 1000 UTC Saturday to 1000 UTC Sunday

3. The Object is for

- Oceania stations to contact as many stations as possible inside and outside Oceania
- Non-Oceania stations to contact as many stations as possible inside Oceania

4. Bands: 160 m - 10 m (no WARC bands).

5. Categories are:

- Single operator all bands
- Single operator single band
- Multi-operator all bands
- Multi-operator single band
- SWL (Receive Only)

Single operator stations are where one person performs all operating, logging and spotting functions.

6. Exchange: RS(T) plus a three or four digit number starting at 001 and incrementing by one for each contact. Multi-operator all band entries may use a separate serial number for each band.

7. Multiplier: On each band this is the number of prefixes worked on that band. A "prefix" is the letter/numeral combination forming either the first part of the callsign, or else the normal country identifier for stations using their home callsign in another DXCC country, e.g. W8, AG8, HG7 and HG73 are all separate prefixes. The prefix for both N8ABC/KH9 and KH9/N8ABC is KH9. Portable designators without numbers are assumed to have a zero after the letter prefix, e.g. N8ABC/PA becomes N8ABC/PA0. Any calls without numbers are assumed to have a zero after the first two letters to form the prefix, e.g. RAEM becomes RA0EM. Suffixes indicating maritime mobile, mobile, portable, alternate location, and licence class do not count as prefixes, e.g. /MM, /M, /P, /A, /E.

8. Points: All stations score twenty points per contact on 160 m; ten points on 80 m; five points on 40 m; one point on 20 m; two points on 15 m; and three points on 10 m.

9. Final score is total QSO points multiplied by the total number of multipliers. Note that the same multiplier prefix can be claimed once on each band.

10. Logs:

Transmitting stations are to submit a separate log for each band showing date; time in UTC, callsign of station worked, RS(T) and serial number sent, RS(T) and serial number received, points claimed and new multipliers.

SWL stations are to submit a separate log for each band showing date; time in UTC; callsign of station heard; callsign of station being worked; RS(T) and serial number sent by the heard station; points claimed and new multipliers.

All logs must be checked for duplicates, correct points and multipliers. They must be accompanied by a list of prefixes worked on each band and a summary sheet showing callsign; operator name/s; address; mode and category entered; number of valid QSOs; points and multipliers on each band; claimed score and a declaration that the contest rules and radio regulations were observed.

11. Electronic submission of entries is encouraged. The required log and summary information is to be submitted in DOS ASCII file format. Please name the files with your call and an appropriate extension, e.g., if ZL2WB submits an all band entry then the log files should be named ZL2WB.160, ZL2WB.80, ZL2WB.40, ZL2WB.20, ZL2WB.15, ZL2WB.10; the prefix file is ZL2WB.PFX; and the summary sheet file is ZL2WB.SUM.

12. Logs are to be submitted via email, 3.5" DOS diskette, or on paper.

Email logs are to be sent to: <octest@nzart.org.nz

Logs on paper or 3.5" DOS disc are to be posted to:

Oceania DX Contest Manager, c/o Wellington Amateur Radio Club Inc

PO Box 6464, Wellington 6030, New Zealand.

Please use airmail if you are submitting a log from outside VK or ZL.

All logs must be sent/postmarked NO LATER than 27 November 2000.

13. Awards: Certificates will be awarded to the top scoring station in each category listed under Section 5 for

a. Each IARU WAC continent

b. Each country

Where justified, additional awards may also be made at the discretion of the Contest Manager.

The VK single operator CW entrant with the highest score will be awarded the Frank Hine VK2QL Memorial Trophy and receive an attractive wall plaque for permanent recognition of that achievement.

The Oceania single operator PHONE entrant with the highest score will be awarded the Ron Wills ZL2TT Memorial Cup and receive a miniature cup for permanent recognition of that achievement.

14. Disqualification: Violation of the contest rules, unsporting conduct, taking credit for excessive duplicate contacts, unverifiable QSOs or multipliers will be deemed sufficient cause for disqualification. In matters of dispute, the Contest Manager's decision will be final.

AR Repeater Link

Will McGhie VK6UU

21 Waterloo Cr, Lesmurdie 6076
will2@iinet.net.au VK6UU@VK6BBR

Restoring links in East Timor

E-mail

My E-mail address has changed due to my ISP being bought by iinet. The old address should still work but I gather it will eventually only work @iinet.

East Timor

One day back from East Timor and yet another deadline for this column is due. My week spent in Dili East Timor may make for interesting reading, as told from the radio Amateur perspective. An opportunity to help repair Dili's television transmitter and studio link to the transmitter came my way. A friend had already been to Dili and the television transmitter had been restored to basic operation. The microwave link from the studio to the transmitter was not operational and there had been reports that the television transmitter was producing more than one output, interfering with some VHF communications around Dili.

The Damage

The damage done to the television system in East Timor after the referendum last year was considerable. The Dili transmitter site suffered considerable damage, mainly to the power distribution and some components were removed such as power supplies. However prior to my visit, three days of effort had seen the television transmitter "operational". However, there was no link to the transmitter from the temporary studio, as the microwave links had suffered bullet damage and had been removed for

repair. It was lucky that the transmission site had not been burnt, as much of Dili and other towns had.

Dili is a much larger town than I thought. Flying in from Darwin, you fly across the island, as Dili is on the northern coast. The Island is very mountainous and hazy. Dili is sandwiched between the sea and a 600 metre (2,000 ') mountain range and the town is spread for about 7 kilometres along the coast by 2 kilometres between the beach and mountain range. The drive from the airport showed the damage done to the town. Most of the concrete houses had been burnt with the roofs falling in. Once the rubble had been removed, all that was left was the walls and the floor. No windows, no roof, no furniture, just a shell. Reconstruction was well under way, but with in excess of 80% of buildings burnt and trashed there is a long way to go.

Traffic Jams

Dili is a very busy place. With the UN and several Nations in East Timor, traffic jams are a regular occurrence in down town Dili. All sorts of military vehicles and local cars, motor bikes, trucks and push bikes all jockey for "right of way". Right of way means, he that gets there first. Stop signs were being installed while I was there, but many of the locals did not know what they meant so they just drove straight through. Some of the biggest traffic humps I have ever seen were being removed, as they were way over the top. Any speed faster than one kmh resulted in spinal damage.

Amateur Radio

Communications are everywhere in Dili. There are towers all over the place, brisling with all manners of antennas, most of it new, installed by the various forces. There was even evidence of amateur antennas, but most looked in disrepair. Two metres is used throughout the islands but little of it is amateur radio, so the two metre beams and verticals gave no indication of amateur activity, past or present. A couple of HF antennas looked amateur, along with the odd HF mutiband vertical, but they would have to wait until the basics of living have been restored. East Timor is under United Nations administration until a new government is restored and amateur radio could well be way down the list.

The Transmitter

With only limited time to sort out the television transmitter and studio to transmitter link, we landed in the morning, checked into our accommodation, a 3 by 4 metre box, and headed for the transmitter site, some 10 kilometres by road from Dili. The spectrum analyser showed no spurious output from the transmitter. Other test confirmed the television transmitter was clean. We wound up the transmitter to full power, 2kW, as it had been wound down while it was suspect. Sides were fitted to the transmitter cabinet to improve the ventilation, as they had been removed and were no where to be found. Air conditioners had been installed in the transmitter building but where they were plugged in, there was no power. The power lead was re-run and connected to the 240 volt mains and they were up and running. By the way, did I mention Dili is hot and humid? The air conditioners were considered essential to keep the solid state transmitter happy. The original air conditioners had been ripped from their mounts. The transmitter was up and running at full power with a clean bill



Colour original inserted

of health. The only programming that Dili had had so far was from video tapes driven up to the transmitter site and this was limited to the odd hour or so very day or so. Until the studio to transmitter link was repaired and installed, there was little programming. However a satellite receiver at the transmitter site was fired up and Australia Television connected to the transmitter. Dili had a mixture of Australian soaps and sport.

The Link

The microwave link equipment was all collected together, some two receivers and three transmitters were found, along with 2-foot dishes and various bits of mounting hardware. Bullet damage was evident to some of the dishes and one transmitter had a bullet through the base plate into the unit itself. All attempts to separate the base plate from the transmitter head unit failed, the two were welded together. The bullet appeared to still be inside as there was no exit hole. This transmitter was put aside as with limited tools we could not fix the unit. The remaining receivers and transmitters all worked, and bullet damage to the dishes and weather shields was repaired.

Two days were spent installing the microwave receiver and transmitter between the temporary studio and transmitter site and it worked. Now programming could come from the studio rather than the limited transmitter site.

Drive in the Country

With a day and a half to spare, one afternoon was spent driving through the countryside. Our contact in Dili was Ric, the head of Television and he wanted to see how far the television transmitter would go towards another big town to the East. This drive in the country was most interesting. Destruction was everywhere. We visited a television complex about 40 kilometres from Dili that had been burnt until it melted. Steelwork in this once modern installation was bent by the heat. Familiar television equipment, like studio lights, video tape recorders and racks of other assorted television equipment only had the metal parts left. The roof had fallen in and the complete complex was useless. Even the thick concrete walls of the building showed structural damage due to the intensity of the fire. The complete building would

have to be bulldozed and rebuilt. This television complex was next to a large technical collage that also had been destroyed by fire. What a waste.

While out in the country we were on the look out for any houses that had television antennas. Sighting a satellite dish we stopped and walked over to the house and received a warm friendly greeting, with lots of "hello mister". Everywhere you go in Dili you are greeted by "hello mister". It is so popular that a new supermarket just opened in Dili is called the "hello mister supermarket." There are three languages in East Timor, the local language, Indonesian and Portuguese. Ric could speak the local language and we were able to have a look at their satellite system. Nothing worked, as the satellite receiver was only partly connected and there was no antenna for the VHF television. The house had 240-volt power and with some electrical wire, we were able to make a crude dipole and feed line. Holding the "antenna" at head height produced a sort of picture from inside the tin house. As soon as a sort of picture, with sound appeared, kids came from all over. The area had a number of village houses throughout the trees and before long about 20 children and teenagers were crowded into the earth floored tin house. All the time the mother of the house was busy in the next room, the partly outside kitchen, cooking the evening meal on an open wood fire. Smoke filled the whole house and the television was moved outside to get a better picture and move away from the smoke. To excited cries of "Aussi Rules" the kids crowded around the television set watching football. We had to leave and told them the "antenna" needed to be higher and showed how it could be attached to pieces of wood to make this happen. We drove further down the road to a beautiful beach for a brief swim before passing the house on the way back with the television. In the space of less than an hour, the house now had a TV antenna sticking up from the roof, and many children crowded around the outdoor television. I bet the mother was



Will (on the left) and fellow worker Ian with the Dili TV transmitter. The spectrum analyser in the foreground shows how clean the signal is

overjoyed at the large crowd she now had around her house.

Tropo

A telephone call from ABC Darwin wanting to know was the television transmitter in Dili turned on, and if so what channel was it on? The answer yes and channel 6. "Oh no" was the reply, Darwin is on channel 6 and the ABC is having complaints from viewers that they are seeing interference from various non-ABC programs. Dili is about 900 kilometres from Darwin and sure enough with a water path between the two, tropospheric propagation was the cause. The complete time I was in East Timor it was classic inversion weather, with light winds and a thick hazy layer up to 1,500 feet. Even the ACA rang, but there was nothing we could do. East Timor does not come under Australian telecommunications law. How the decision was made to put Dili Television on the same VHF frequency as Darwin, only some 900 kilometres away across a water path is unknown. The inversion lasted for 36 hours. Time will tell how often this occurs.

ar

David K Minchin VK5KK
 Postal: PO Box 789 Salisbury South Australia 5108
 E-mail: tecknolt@arcom.com.au
 Web page: <http://www.ozemail.com.au/~tecknolt>
 Fax: +61 8 82346396
 Phone: NEW NUMBER 0403 368 066
 All times are in UTC

New 10 GHz World Tropo Record In Europe

As reported last month, Australia's 5 year old 10 GHz World Record, held by Wally VK6KZ/P and Roger VK5NY/P, has finally been broken. The following was lifted from a report in the Israel Amateur Radio Club newsletter.

"On June 25 at 16:51 UTC two German Radio Amateurs broke the long-standing distance record for communication on 10GHZ. From the upper floor of a Hotel in Netanya, Israel, Dieter DJ4AM contacted his friend Adalbert DJ3KM on the Italian Island Lampedusa, in the Mediterranean Sea, a distance of 2079 kilometres. The QSO lasted about an hour. Netanya is about 30 kilometres north of Tel-Aviv. They broke the previous record of 30th December 1994 held by VK6KZ and VK5NY who beamed their signals over the Australian Bight for a distance of 1912 kilometres."

"The equipment used by both German hams was identical and consisted of a transverter designed and built by DL1RQ fed into dish antennas with a diameter of 60 centimetres. The calculated gain was 33db using output power of 5 watts. They made lengthy calculations with the aid of maps and GPS's to get the angle right for pointing their dishes, because the dishes have an opening angle of only one-degree. Dieter spent 21 days in Israel but only managed to make the one contact."

The New record is well within VK's sights, in fact the record can be still broken between VK5 (from SouthEast) & Torbay, in VK6, where VK6KZ operated for the 1994 world record. VK3 to VK6 could take that out to 2400 km before having to go further west from Torbay. All that is needed is some propagation this year!! The challenge has been laid down, let's get to it!

New World 24 GHz Tropo Record In Italy

If 10 GHz wasn't enough, IOLVA reports ... "In reference to my activity I inform you that on June 18, 2000 at 12.28GMT I have made the new record on 24GHZ with a distance of 461 km. The QSO was made from M. Maielletta 42°06 N - 14°07 E near Chieti, JN72CD, to M. Pizzoc 46°03 N - 12°20'E near Treviso JN66EB."

"I made the qso SSB x CW with my dear friend Costante IW3EHQ/3. The equipment details are as follows:

IOLVA: Tx 250 mW - N.F.: 1.5 dB - dish: 90 cm. - swan neck temperature 8 °C - 2000 m a.s.l. RST Tx: 52 - RST Rx: 519 IW3EHQ/3: Tx 750 mW - N.F.: 1.5 dB - dish offset 85 cm. - temperature 18 °C - 1560 m a.s.l. I have also heard I3SOY/3 with a signal of 51 but Paolo didn't copy my signal." ... Silvano IOLVA. Silvano is one of the pioneering Italian operators on 24 GHz; several of his 24 GHz designs have been published in Dubus over the past 8 years.

VK6RSW Augusta Beacon On Air

Don VK6HK reports ... "A new set of 2mx, 70cm and 23 cm beacons has commenced operation from Augusta in the extreme South-West of Western Australia. The beacons operate on 144.562, 432.562 and (temporarily) 1296.555 MHz. The latter needs a crystal replacement and when this occurs a higher stability oscillator will be added, to maintain the nominal 1296.562MHz. The antenna systems are yagis for 2 and 70cm with a 4 x three halfwave length dipole and backscreen array for 23cm. Lobes are radiated North and East from Augusta, with about 50 watts ERP on all bands in each direction. Keying is VK6RSW AUGUSTA in FSK Morse in

all cases. Mark is the high frequency on the nominal *.562."

"The beacons are licensed to the WA VHF Group and were installed on Monday 4th September 2000 by Wal VK6KZ, Cec VK6AO, Bruce VK6BMD and Don VK6HK. The site has been kindly donated by Mr. Lance Collins. Any reports, particularly on the West-East path, would be most welcome to patndon@cygnus.uwa.edu.au" Don VK6HK

916 - 928 MHz ISM Band. Can we share?

The loss of 420 - 430 MHz, to amateurs around Perth, is now a forgone conclusion. More so further evidence is mounting of use of frequencies around the Olympics around 445 MHz (not an image of 420 MHz I am told!). The ACA database is a little sketchy on this and other anomalies. With ever increasing pressure being felt on our various bands above 300 MHz, there are now real opportunities for "bargaining" compromises against our losses.

The idea has been floated that we do some tradeoffs to retain other parts of the 430 - 450 MHz band. Another idea that has been suggested is gaining privileges to some or all of the 916 - 928 MHz ISM band. This band sits just below the current Mobile phone GSM band and is used for ISM and unlicensed low power devices, not dissimilar to our 2.4 GHz allocation. It perhaps would follow that we could use 916 - 928 under similar conditions. There are a few paying licenses in this area, but even part of this band would be of benefit as 916 MHz sits well between 432 & 1296!

The USA hams have had access to a segment above 902 MHz for some time now. In the US, 900 MHz it has become a true experimenters band, fuelled by the

never ending availability of ex analogue mobile phone and sundry base station equipment running 50 or more watts. Both narrowband and ATV has a good following. Even transverters are available. Maybe we would be lucky enough to get a segment wide enough to run Narrowband and an AM ATV channel? Start lobbying now!

50 MHz proving to be Sluggish

The title says it all. Mid September is here and not much into the lower parts of VK. Summarily not much Sporadic E about to assist. Limited 1 & 2 hop DX in Northern VK as well as ZLTEP from late August 2000. By next month one would hope it is on again.

David Vitek, Adelaide, SA has sent in his log for 30 – 60 MHz for the June through August, 2000 period confirming MUF's rarely rose above 35 MHz on F layer, although mid winter Sporadic E was quite prevalent. The various solar Flares created a number of bumps but little co-incidence between Es and F layer for extending 50 MHz. If anyone would like a copy of David's log, please drop me a line.

Eric VK5LP reports ... "John VK4KK advised that he has received his Six Metres DXCC No. 267 dated 13 June 2000. This is the second DXCC for VK (No. 1 being VK3OT) and the first in VK4. He also received an additional DXCC certificate numbered 36,000+ being his position in the world total of all such certificates awarded! Our congratulations to John for his efforts."

"John also advised that as of September 2000, PY5CC has confirmed 195 countries worked on six metres. He has hopes of reaching 200 countries but is finding it increasingly difficult and still has not been able to work YJ8. Another good effort." Eric VK5LP

On Higher bands, up North, Glenn P29XXX reports on 08/09/2000 ... "For the last 3 days, the Cairns FM broadcast stations have been noise free in Pt Moresby. We have a local link receiver on 89.1 MHz and an associated transmitter on 105.1 MHz. This setup is used for O/B work for one of the local broadcast stations. It is sited on Burns Peak - a local hill here. For the last few days, we have been able to drive around Moresby and listen to a Cairns community FM station that just happens

to be on the same freq. as our link-input (89.1). Make a nice change from the local stations!!" ... Glenn P29XX/VK1XX

Glen VK4TZL reports ... "At 0549, on 07/09/2000 worked P29PL on the Gladstone repeater whilst mobile in Maryborough (linked through to 146.800 that I was on). Then worked him again at 0608 from home QTH on the Moresby or Mackay repeaters (147.000) Just after 5pm local, worked P29PL mobile on his way down from Burns Peak through the Mackay Repeater and then on Anti 5/9. Also worked VK4FNQ, 4AIV and 4JKL on 147.000. 93.1 FM from Moresby is breaking through here as I write at 0729." ... Glenn VK4TZL

Phase 3D Launch Update

AMSAT-DL Vice-President Peter Guelzow, DB2OS, recently informed ANS that the Phase 3D satellite "will be launched at the end of October or beginning of November." As ANS has earlier reported, Ariane 5 launches had been postponed until several components could be checked aboard the launcher. DB2OS reports that Arianespace re-assigned the launch numbers. "There will be two more Ariane 4 and one Ariane 5 launches," said Peter, "but because Arianespace did not yet publish the new official launch manifest, I can't be more precise."

DB2OS told ANS to expect more news after the AR-506 launch, currently scheduled for September 14th.

"We are indeed on AR-507, " said Peter, "and the Phase 3D launch campaign should start on September 11th in Kourou!" ... AMSAT NEWS

Microwave Primer Part Five 5.7 GHz

The 5650 – 5850 MHz (or 6cm band) is an interesting one that we share with several other users. It is an ISM band, much like 2.4 GHz, providing us atleast one user who has lower priority to us on the band!

Construction techniques are similar to that employed on the lower GHz bands. The "size" of various components is still quite manageable, even if you have less than ideal eye sight! Several Watts of power can be had without much effort with easily available surplus IM5964 IMFET's. Despite large amounts of Surplus equipment 5.7 GHz, until very recently, has been another neglected

band. Perhaps bypassed by many who went straight to 10 GHz.

For narrowband portable work, I think 5.7 is perhaps one of our best performers. On many occasions over many paths 5.7 GHz has returned the strongest signals when compared to 2.3 & 10 GHz. A 600mm (2 foot) dish provides about 26 dB of gain with a manageable 5-degree beamwidth ... more than sufficient for portable work. That with 4 Watts will give you 1 kW ERP about the same that can be achieved portable, on 144 MHz, with 100 Watts into an 8 or so element beam.

For Wideband work, 5.7 offers another 200 MHz of spectrum that can be used in much the same way as 3.4 GHz. The availability of surplus 5.9 – 6.4 GHz converters, multipliers, filters and antenna feeds is a bonus. The best source of all of this equipment is the metal recyclers, as Telstra and other utilities progressively dump old microwave bearer equipment. Go digging and you will be surprised what you find!

So where do you start? Several transverter designs are available. The DB6NT Mk1 design and the N1GHZ design are the most popular. They can be built from locally available component/kit sources. It uses plumbing "pipe caps" for the 5.7 GHz resonators. The DB6NT design provides about 200mW of output power, useful by itself for much work. Adding an amplifier with 2 stages using IM5964 IMFETs will give you 4 Watts.

The MK1 design requires direct Local Oscillator drive at 5.6 GHz. This adds a bit to the complexity of the project. LO drive can be obtained by using an external multiplier following a 1 or 2 GHz Local oscillator such as the G4DDK designs. The DB6NT Mk2 design is better, with the complete local oscillator on the one PCB. This design is a bit more expensive to make as it uses R4003 ceramic-based PCB and several harder to get helical filters. Kits are available for the MK2 from DB6NT himself.

The N1BWT/GHZ design is an interesting one. While the DB6NT design makes use of Gasfets for all active devices, this design uses ERA series MMIC's. The same style of pipecap filters as the DB6NT design are used. The power output available is in the region of 20mW's, limited by the specs for the ERA3 PA MMIC. One big advantage over the MK1 DB6NT is the LO

requirement.... 20 mW at 560 MHz, 1/10th the final LO frequency. Several easy options are available to generate a suitable LO signal.

Both transverters can be used with either a 144 or 432 MHz IF. I have started to use 432 MHz for all transverters over 5 GHz. Apart from avoiding interference from normal 144.1 MHz operation while portable, 432 MHz relaxes the image filtering required especially on 10 GHz and above. And if you use 144 MHz for 1.2 or 2.4 GHz you can run two bands at once for aiming or talkback. If you are lucky enough to have a good spare 432 MHz set for use portable it is well worth setting up.

Suitable antennas are simple to make. For short-range work a simple Horn type antenna can be made to give you 20 dbi of gain. For more gain either a prime focus or offset dish can be used. A prime focus dish is easy to aim however some feeds can give poor to mediocre results with efficiencies of around 35 - 40%. This is most apparent on deep dishes being fed by dipole or "penny" type feeds. A better solution is perhaps a chaparral type feed although the

increased blockage from the chaparral "rings" may be the ultimate gain limit on a 600mm dish.

Alternatively, easily obtainable 650mm offset dishes can be used. When fed with a correctly dimensioned horn type feed, efficiencies can approach 65%. That coupled with the feed being out of the line of fire can mean up 2-dB difference for no extra effort. The only downside is finding the horizon as most dishes are offset by up to 29 degrees! A simple method is to bolt a spirit level or sighting tube to the side of the dish so you can quickly find the correct angle when you are in the field.

Designs for suitable dish feeds are available in several publications, most recently the Microwave Update series available from the ARRL. Next Month we move onto 10 GHz. The pressure is on for VK to get the World Record Back. Time to stir up more interest on 10 GHz!

In Closing

Gordon VK2ZAB reports working his 23cm Grid Locators # 17 & #18 respectively on the 14/15th of September ... "14/9 Ross #17 VK2DVZ was portable

at Cape Hawke near Forster. From 0248z until 0313z his 23cm SSB signals here were 5/5 with QSB. Ross gave me 5/3. He was running 10 watts to a 23-element DL6WU type Yagi. Grid Square is QF67[gs] and is only 220km from here, QF56[nj], but had not been worked before simply because there was nobody there. 15/9 23cm Locator #18 at 2327z contact made on 23cm SSB with Ross VK2DVZ portable just north of Gloucester in Grid Square QF58 [xa]. Signals 5/1-5/3." Gordon VK2ZAB

John VK3KWA reports ... "I have just finalised the dates for the spring and summer VHF contests. They are Spring Field Day - November 4/5. Ross Hull Contest - Dec 26 - Jan 14. Summer Field Day - Jan 13/14" John VK3KWA

Please note that I have a new Phone number at the top of the page. The old number will redirect for some months until the changeover is complete. I'll leave you with this thought.. " A Diamond is a chunk of Coal that made good under pressure"

Till next month
73 David VK5KK

ar



A G Loveday VK4KAL

Your bands are being stolen! What will YOU do?

For some time I have been urging Amateur Radio operators in VK to join the Intruder Watch, and submit observations of intrusions into our legal operating bands. Sadly this has been ignored. Probably 99.99% of amateurs think the problem is of no consequence or that it will go away, so they sit on their hands and do nothing, apparently never even listen.

Well I've got some disturbing news for you all. I have in front of me seven A4 sheets of intrusions listed for the 40 metre band. Maybe all are with the 'blessing' of the ITU. The info comes from our own ACA monitoring station at Quoin Ridge, so it is legit info. These are Commercial stations, mostly AM B/C, but have a few FX type of transmissions for good measure. Obviously the amateurs have not made themselves heard through the

monitoring service, not just in VK but all regions. China has gained the most frequencies, with Vietnam in for their share along with THA and BGD.

The Frequencies are spaced through 7.000 to 7.060 MHz, as under: 7.000 - 7.010 - 7.015 - 7.016 - 7.020 - 7.025 - 7.026 - 7.028 - 7.030 - 7.035 - 7.040 - 7.042 - 7.050 - 7.055 - 7.058 - 7.060 MHz spot freqs but the total operations will seriously hamper amateur operations, there being 255 transmx possible. I have been supplied with Geo coordinates, if anyone is interested.

I am at a loss to understand the attitude of amateurs. I can remember getting up to 10 pages of obs each from 30 or more obs per month. Maybe I've been in this job too long? But I do think our organisation could take a more positive attitude from the top down.

ar

Andrews

Communications Systems

(EST. 1976 - ACN 001 968 752)



ALINCO

AUSTRALIA'S FIRST AUTHORISED
FACTORY DIRECT IMPORTER
MASSIVE SHIPMENTS EVERY MONTH
FULL 3-YEAR WARRANTY ON
ALINCO and ICOM
WE SELL MOST BRANDS
BALUNS, VERTICALS, YAGIS. P/S.
ICOM-KENWOOD-JRC-AOR-EMOTATOR-
MFJ-DIAMOND-TIMEWAVE-KANTRONICS
-THP - GARMIN - TERLIN - UNIDEN -ETC
DX-1600 HF LINEARS FROM \$ 3,799
**HUGE RANGE OF ELECTRONICS,
ICOM and ALINCO Radios.**
Over 22 Years of
Professional Sales and Service.
Instant Repairs Fridays
HF Transceivers & Linears Wanted

(02) 9636 9060 or (02) 9688 4301
SHOP 8, 41 BATHURST ST, GREYSTANES,
N.S.W. 2145. FAX (02) 9688 1995

HF Predictions



by Evan Jarman VK3ANI
34 Alandale Court Blackburn Vic 3130

These graphs show the predicted diurnal variation of key frequencies for the nominated circuits.

These frequencies as identified in the legend are:-

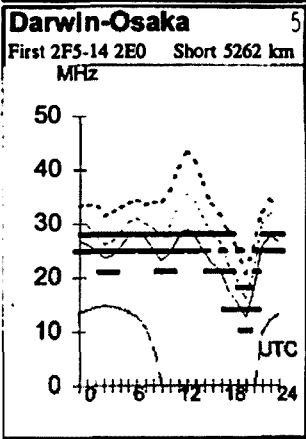
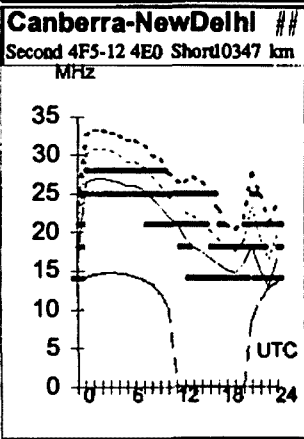
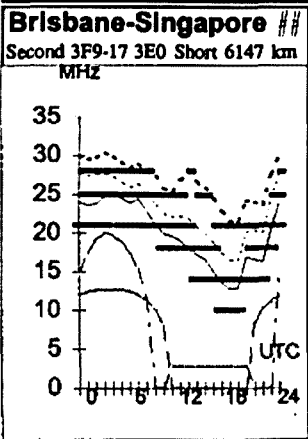
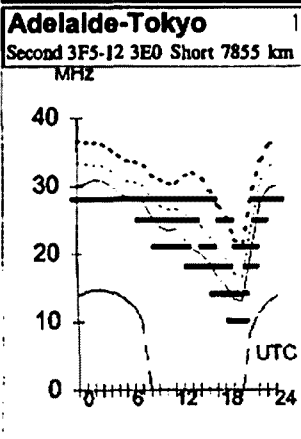
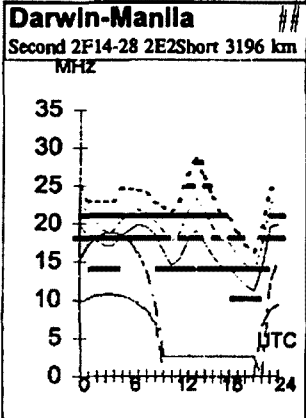
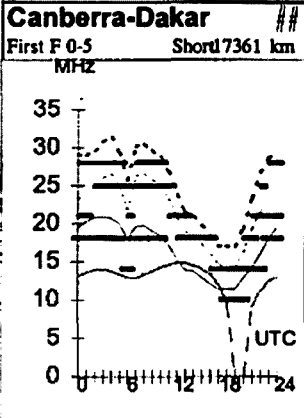
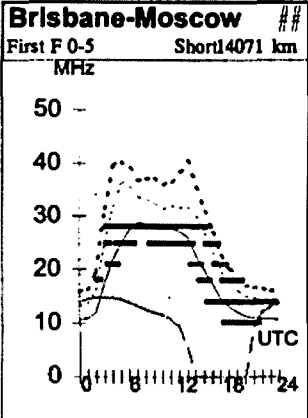
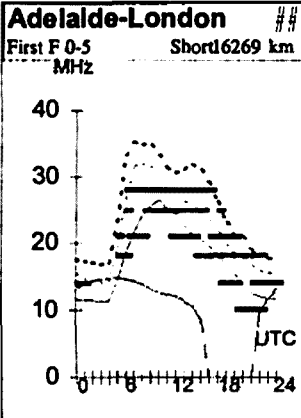
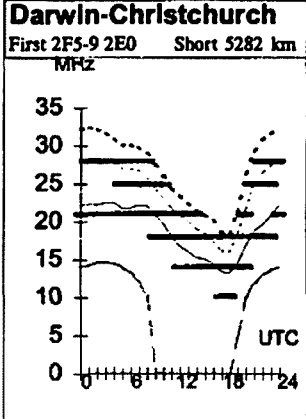
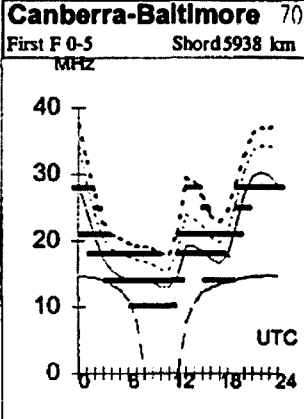
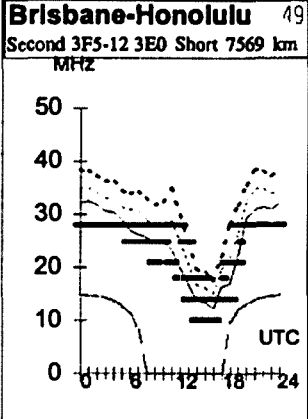
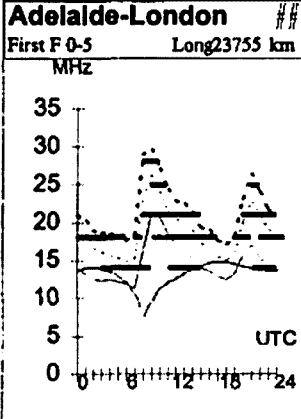
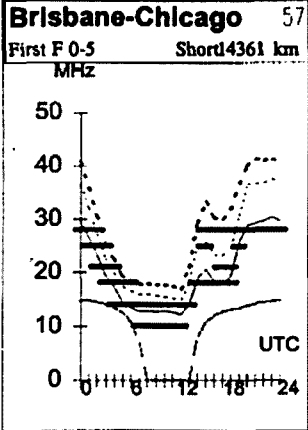
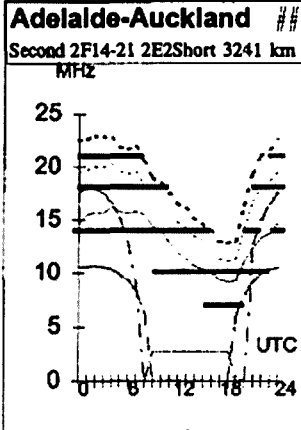
- Upper Decile (F-layer)
- F-layer Maximum Usable Frequency
- E-layer Maximum Usable Frequency
- Optimum Working Frequency (F-layer)
- Absorption Limiting Frequency (D region)

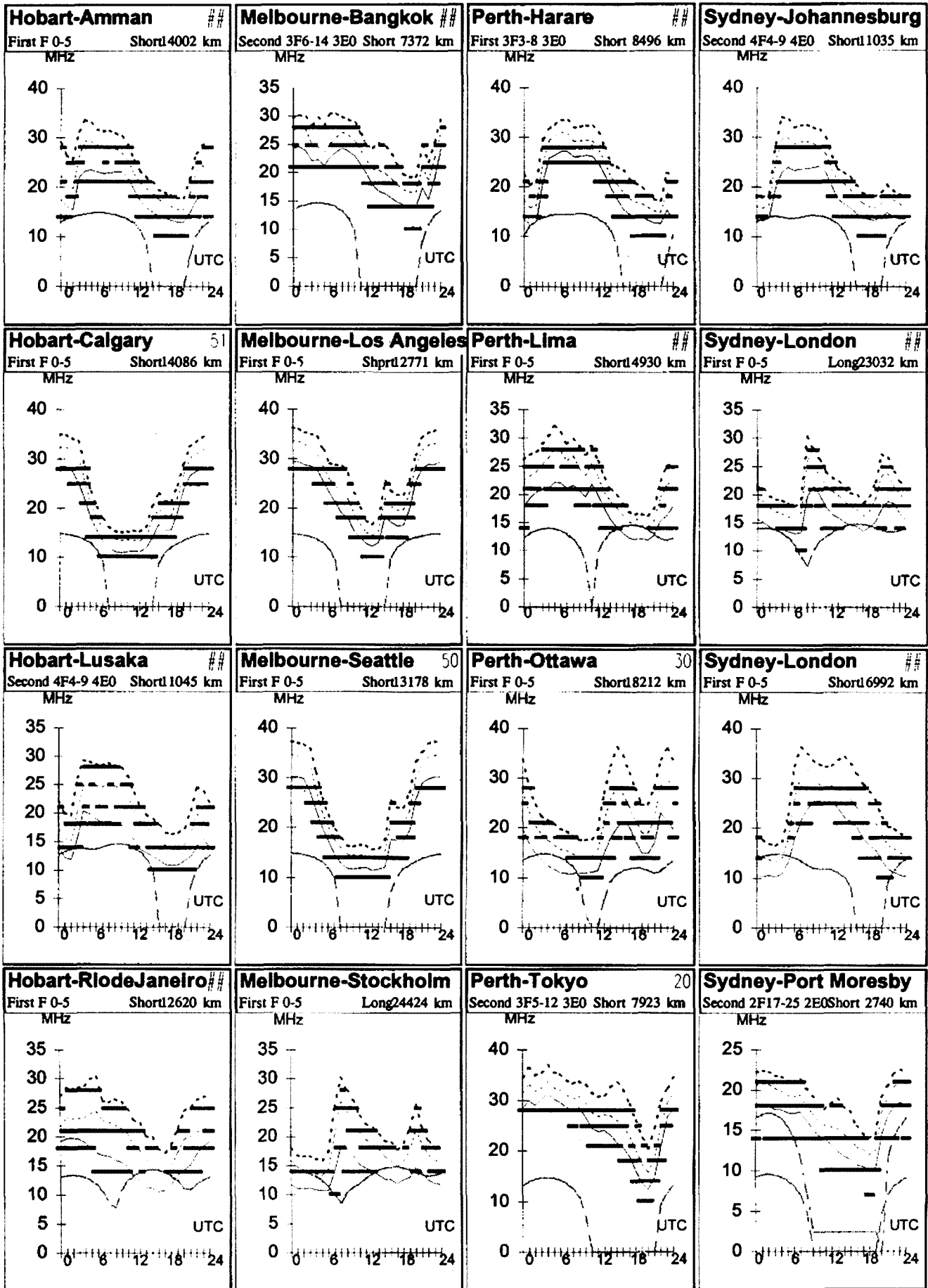
Shown hourly are the highest frequency amateur bands in ranges between these key frequencies, when usable. The path, propagation mode and Australian terminal bearing are also given for each circuit.

These predictions were made with the Ionospheric Prediction Service program: ASAPs Version 4

October 2000
T Index: 137

Legend
UD
E.MUF
E.MUF
OWF
ALF
10%-50
50%-90
90%-10
Time scale





Peter Parker VK3YE

12/8 Walnut Street, Carnegie, Victoria, 3163

E-mail: parkerp@alphalink.com.au

Novice Notes Online: <http://www.alphalink.com.au/~parkerp/nonline.htm>

HamBabble

Making sense of what we hear!

By and large, amateurs are an articulate, well-spoken and intelligent lot. However when tuning the bands, one sometimes hears some strange contortions of the English language. This twisted terminology perplexes the newcomer and grates on the ears of the experienced operator.

Neither necessary to explain a technical concept nor useful to express a new thought, insight or observation, there are various terms and expressions unique to radio amateurs. Their inappropriate use makes amateurs sound strange to the uninitiated and hinder clear communication. If you've just got on the air, read this article and avoid the phrases listed unless you really mean them. If you count yourself as one of the uninitiated, treat this list as a guide to understand what the babblers on the bands are really saying.

I have attempted to go beyond a simple listing of words to identify specific patterns of communication unique to amateurs. For example you will be introduced to *Amateur Action words*, *Intention Phrases* and *Sign-Off words*. Many of the terms used by amateurs can be placed into one of these groupings. Their existence may tell us something about the personality of amateur operators, who have many more words to announce their intention to end a conversation than to welcome a station with which contact has just been established. Then there's specific patterns such as *Lengthening words* and *Regurgitating Rogers*. The topic is ripe for further study - is there a psychologist in our ranks who is willing to conduct a content analysis of amateur communication and report the findings?

The following list has been derived from both personal observation and suggestions from others. Additions would of course be welcome and can be sent to the author.

Affirmative: Yes. An example of a *lengthening word*. Also see *negative*.

Amateur Action words: Except when they are trying to climb towers, amateurs are generally a sedentary lot ('Another cuppa - thanks Dear'). However on air hams like to convey the impression of being on the move - hence the constant use of 'going' as in 'going clear' or 'went' as in 'went QRT'. *Getting out* and 'coming back' are other *amateur action words* occasionally heard.

Best 73: 73 means best wishes, so best 73 must mean best best wishes! It has entered such common use that complaining about this is probably futile.

Break (Break): An abrupt and impolite way of interrupting a conversation already in progress. It's much better to simply insert your callsign in the breaks between transmissions that all good operators leave.

Breaker: An import from CB. Even worse than *break*. Fortunately rare on the amateur bands.

Device: George Orwell's *NewSpeak* replaces established terms with specific meaning with general terms of less specific meaning. The result is awkward communication that doesn't get to the point. The word *device* is an example of this misuse. Someone who asks if they are 'making it into the *device*' really wants to know if they have a decent signal through the repeater. Repeater is not much longer to say than *device*, but carries a more specific and accurate meaning.

(see you) Further down the log: HamBabble for later. Remains popular, even though most amateurs don't keep logs nowadays. *Further down the curly cord* or *further down the power bill* are variants, possibly borrowed from CB. All are common *sign-off words*. Adding 'will' converts them into *intention phrases*.

Getting out: Transmitting and being heard. An SWR reading of 1:1 does not always mean that you're *getting out*. Your coaxial cable might be very lossy, or you're transmitting into a dummy load.

Go: A terse contraction of 'go ahead'. Occasionally used on the amateur bands. A variant is found on 27 MHz, where the 'o' sound is extended and raised in pitch. It's quite entertaining - have a listen one day!

Going: Another *amateur action word*. Unless you're mobile, you're not going anywhere! Why is it that amateurs are often 'going clear', 'going QRT'. or, heaven forbid, 'going thataway'? Often turned into an *intention phrase*, eg 'will go clear', etc. Over-used.

Intention phrases: Amateurs often prefer to say that they intend to say something rather than actually saying it. What's wrong with us - is the overuse of intention phrases an unrecognised form of mike-shyness? *Will say 73* is the most common intention phrase you'll hear, closely followed by 'will go clear' - also an example of an *amateur action word*.

It: What is it? I don't know. Ask those who are always handing 'it' over to you or putting 'it' down. Once you have the answer, let me know.

Lengthening words: Often used in phonetics – most commonly Victor Kilowatt rather than Victor Kilo. Also *affirmative* and *negative* rather than yes or no. Presumably the repeated consonant sounds in the longer words kicks the needle on the linear amplifier higher up the scale. The average power is higher and the signal cuts through the static better. When said very quickly with non-standard phonetics and the speech processor wound up you will succeed at making yourself as unintelligible as any other DX hound on 20 metres.

(VK....) Listening: A weak euphemism for calling CQ used on VHF/UHF FM. Common on repeaters for no logical reason and even sanctioned in published operating guidelines. Like *intention phrases*, it's another example of amateurs not saying what they really mean.

Negative: Does not only mean the black power lead on your transceiver. Like *affirmative*, it is an example of a *lengthening word*. *Negatory* is the CB variant, almost extinct these days.

Over and out: Though popular in movies, these two words mean two different things, and should never be used together. 'Over' is an invitation to transmit. 'Out' means 'clear', QRT, 'pulling the big switch' or any of a multitude of other terms.

Over words: When conditions are good and operators know each other's voice and intonations, the term 'over' can be dispensed with. Over isn't the only word used to pass it to the other station – some use the equally respectable 'go ahead' or the in-your-face 'back'. Some HF DXers say 'over over' (said slowly), which may have some merit when signals are weak. See *Lengthening words*.

Personal: Normally pertains to matters that are private or not of interest to other people. However some newcomers use it as a jargonish alternative to the plain 'name'. Handle is similar, but is more accepted in amateur ranks than *personal*, which is popular on CB. However not everyone likes *handle*;

heard recently on 40 metres was the comment 'I don't have a *handle*, I have a name'.

Place words: If amateurs are going to be constantly on the move (see *amateur action words*) it makes sense for there to be places to move between. That's why there is a need for the amateur lexicon to feature the words 'here' and 'there'. 'The name here is Bob'. Does Bob carry a deed poll form in his pocket and change his name when he goes somewhere? If not, the 'here' is superfluous. The famous British spy did not say 'The name *here* is Bond - James Bond'. Neither should you.

Put it down (with): Something your vet might advise should be done with your ailing dog. However it's yet another sign-off word. Presumably the '*it*' is a hand microphone, and you're *putting it down* when you finish. Also see *it*.

QRZ the breaker: An ugly embellishment of plain old QRZ? Who is calling? Is the plain language version?

QSL: The meaning of this term has broadened from the original acknowledgment of receipt of message (presumably one does not have to understand the message content as in *roger*) to almost a synonym for yes or *affirmative*. 'Are you running 100 watts?' '*QSL QSL*'. Also see *roger* and *regurgitating roger*.

QSL question: We don't seem to send as many QSL cards as we used to, but QSL remains popular in amateur parlance. QSL is sometimes appended to yes/no questions to which the answer of QSL is desired. Example: 'Your QTH Perth, QSL?' When signals are poor, stations may go through several iterations of repeating callsigns to each other until '*QSL QSL*', is heard, which means that stations have received each other's callsign correctly, or are too lazy to care. Given that the meaning of QSL relates to acknowledging receipt of messages, the *QSL question* is quite legitimate and is probably not true HamBabble. It only appears here because it's overused at times. A close relation is the *roger question*.

(Can I have a) **Radio check?:** A question

asked by those who would like to know if they are *getting out* but are uninterested in holding a full conversation with those on the frequency. The usual response is 'you're working'. The question is common on CB, where it probably fulfils a useful role on a busy repeater. Use on the amateur bands identifies the questioner as either a pirate or someone who hasn't listened much before talking.

(the) Regurgitating Roger: It's a good idea to confirm salient details with your contact when conditions are poor, but occasionally people go overboard, even when signals are strong. Sometimes you hear almost a playback of your last transmission, punctuated by *roger* between each item. Example: 'Roger your name is Peter, roger on the QTH, roger that you're running ten watts, roger on the FT-301S, roger on the new dipole, roger on the 15 degrees, roger that you're off to work soon, et cetera'. It's boring, repetitive, and tells you nothing you don't already know. The 'regurgitating QSL', is used in a similar manner.

Roger: Message received and understood, but also used to mean yes or affirmative. It's not unlike the CBER's 10-4, use of which has diminished greatly since the 1970s. See also *regurgitating roger*.

Roger question: Like *QSL*, *roger* is used as a question if given a questioning intonation at the end of a transmission. This can sound quite odd, as in 'Your name is Justin, *roger?*' Those using the *roger question* appear to invite their contact to reply by saying either *roger*, *roger*, *affirmative* or *negative*.

Roger dodger: A pretentious version of Roger. Let's kill this one off, *roger?*

Roger that (or Roger there): Just plain roger will do.

Romeo: Part of the phonetic alphabet for the letter 'R'. However it's also misused to mean *roger*.

See you: Unless you use amateur television, saying that I'll *see you further down the log* can't possibly be true. In radio talk, when you speak to someone, you 'see' them.

73s: 73 is an old telegraphic abbreviation for best wishes. Is 73s twice as good? If so, should we wish

people 146 to save them from having to do the mental arithmetic themselves? A variant is 'seven-threes', to which the correct reply should be 21.

Sign-off words: Of any fraternity in the world, radio amateurs must be the one with the largest number of words that mean ceasing transmission or saying goodbye. These are often combined to result in a sign-off that is almost as long as the original contact. An example: 'Will let you go and I'll pull the big switch *this end*. 73s for now and see you *further down the log*'. This is repeated several times in turn until everyone signs. Strangely enough we don't have nearly as many initial greeting words. Does this imply that almost as soon contact is established (confirming that equipment is working but without lowering oneself to ask for a *radio check*) most amateurs are itching to end the conversation ASAP?

This end: A crude telephone can be made with two jam tins and a piece of taut string. You talk into your end and your partner hears you at his end. Someone famous once said that radio operates the same way except there is no string. But the ends remain, and amateurs are incessantly

talking about things happening *this end*. See *place words*.

This way: A similar *place word* to *this end*. According to Ron VK3OM the term appeared to originate with Australian amateurs, spread to New Zealand, and came in to use by UK stations about 5 years ago. If there is a *this way*, there must also be a *that way*. And indeed there is as in 'What's the name *that way*'?

We: Hams should realise that they don't just mumble into microphones on the end of curly cords – they are actually in control of an Amateur Radio Station. See the Regulations if in doubt. And any self-respecting radio station must surely have a staff of more than one. If it doesn't, make it sound as if it is does. Maybe that's why amateurs talk about their station activities as 'we', as in 'We are operating an FT-1000MP and homebrew linear running 400 watts to a five element monoband yagi at 25 metres. *We* will QSL via the bureau'?

Will let you go: Another *intention phrase*. A series of *sign off words* invariably follows. The implication is that your audience has just been given a long earbashing by you. You've run out of things to say, so

want the contact to end in a dignified manner. What better than ostentatiously parading your consideration for others by generously granting your contact their freedom by uttering 'Will let you go'?

Will say 73: The most common *intention phrase*. Why do amateurs announce their intention to wish others best wishes more often than they actually give these wishes?

Will sign: Another *intention phrase*. When spoken, it sometimes sounds like a threat. See *will let you go*.

Conclusion

Well, we've exceeded the word limit *this way*, so *will let you go*, and pull the big switch *this end*. We'll give you *best 73s*, *put it down* for now and catch you *further down the curly cord*. Hope to see you on the *device* again some time soon, *roger*?

Acknowledgments

Thanks to Ron VK3OM and Keith VK3JNB for suggesting some of the phrases defined here. Also to the babblers on the bands without whom this article would not have been possible!



VK3BD Robert Charles Krummel 1914-2000

Born in Mount Gambier Bob spent six years in South Africa from 1930 to 1936 where he obtained his amateur licence.

In 1938 he enlisted in the RAAF as a W/T Operator. Bob served as aircrew wireless operator with No 8 Squadron. First in Douglas Dakota (C47B) aircraft and then in Lockheed Hudsons.

Bob went with No 8 squadron to Singapore in 1940. When Japan entered WW2 he flew on many dangerous patrols before the squadron was evacuated just ahead of the fall of Singapore.

For the rest of WW2 he served in WA, NT, and QLD rising to the rank of warrant Officer Signals.

At the end of WW2 Bob joined the recently formed Department of Civil Aviation in which he served until his retirement, rising to the position of Senior technical Officer (Radio). Within the DCA he was noted not only for his technical competence but also for his compassion and very dry sense of humour.

On retiring Bob ran the morning "Kooka" net on 80m, keeping in touch

withold comrades from No 8 Sqn and other military and civilian friends. This net still operates with George VK3VAM 8Sqn, Mike VK3WW 10 Sqn, Geoff VK3AGF 42 Sqn, Arthur VK3VQRAAF Wireless units and Ken VK3AKY Army.

Bob was a highly skilled radio amateur and will be sadly missed by his many "on air" friends. He is survived by his wife and two children to whom we offer our sincere sympathy.

Mike VK3WW (Kookascribe)

HAMADS

- Hamads may be submitted on the form on the reverse of your current Amateur Radio address fliersheet. Please print carefully, especially where case or numerals are critical.
- Please submit separate forms for For Sale and Wanted items, and be sure to include your name, address and telephone number (including STD code) if you do not use the fliersheet.
- Eight lines (forty words) per issue free to all WIA members, ninth and tenth lines for name and address. Commercial rates apply for non-members.
- Deceased estates Hamads will be published in full, even if the ad is not fully radio equipment.
- WIA policy recommends that the serial number of all equipment for sale should be included.
- QTHR means the address is correct in the current WIA Call Book.
- Ordinary Hamads from members who are deemed to be in general electronics retail and wholesale distributive trades should be certified as referring only to private articles not being re-sold for merchandising purposes.
- Commercial advertising (Trade Hamads) are pre-payable at \$25.00 for four lines (twenty words), plus \$2.25 per line (or part thereof), with a minimum charge of \$25.00. Cheques are to be made out to: WIA Hamads.
- Copy should be typed or in block letters, and be received by the deadlines shown on page 1 of each issue of Amateur Radio, at:

Postal: Newsletters Unlimited, 29 Tanner Street, Richmond, 3121

Fax: 03 9428 4242 E-mail: news1@webtime.com.au

Please only send your Hamad once

Please send Hamads by mail OR fax OR email (much preferred).

Please do not send by more than one method for any one ad or issue, it is confusing.

FOR SALE NSW

- Yaesu FT 720RVH 2m Transceiver, demountable control panel, S/N O1060774, with unused mobile mount & remote cable kit E72L, \$200. Kenwood SP820 speaker & AF filter unit, SN 821306 \$40. Kenwood external VFO 120, S/N 921295 \$60. Morse keys, small PMG 1942 \$20, Hi-Mound HK 707 \$30. AOI desk microphone, cardioid dynamic model UD-112 50k ohms \$30. All EC. RF thermocouple ammeters (6) all tested OK on DC, 0-0.3A Palec, 0.5A Weston, 5A Weston, 5A Air Min., 8A G E \$10 ea. All gear open to offers. AF Sig. Gen. 10Hz-550kHz 5 band, 6 valve, Wien Bridge, built-in VTVM, mains op (my home brew 1952), working, free to good home, heavy, new owner collects! Keith VK2AXN QTHR Sydney (02) 9489 0304, Email kandpa@bigpond.com

WANTED NSW

- Two metre linear amplifier must be as new minimum 150 watts with preamp complete with H/Book box etc. also Terlin Perth plus mobile antenna with mounting etc. A.Walsh Phone (02) 4861 2092 anytime.
- Hallicrafters SX-101A or similar valve receiver in good condition. Phone Glen VK2FC (02) 4982 6570, email radtec@ozemail.com.au

FOR SALE VIC

- Icom IC-281H Mobile 2m transceiver S/N 001702 with manual (& home brew Slim Jim antenna) \$345. Mobile antenna MFJ 1728B 5/8 wave mag base \$25. Diamond F-23A antenna-2m 5/8 wave 3-element vertical \$95. MFJ-812B VHF SWR/Watt meter \$35. Operating Instructions. David VK3DNG QTHR (03) 9859 4698, email roddada@rvib2.rvib.org.au
- Tower 35ft windup tilt-over, Tet 3-element HB 33M tri band antenna, h/duty rotor, all good condition, still erected and in use, \$500 the lot, moving house. Bob VK3CF (03) 9336 3985

- ICW2a dual band hand held with BP72 drop in charger & H/brew ext mic/spkr. Battery pack recently rebuilt to 9.6v 1500mah. Ex. cond. \$350 or best offer. Ian VK3AQU AH's 03 57 511631 BH's 0418 57 9422 Email :- lorian@albury.net.au

- Nally 14m Towers, 2, bases rewelded ready for installation, with computations, \$650 each. CDE rotor with controller and 29 metres of cable, \$250. 2m 13el yagi (6.7m boom), \$80. 70cm 16el yagi (3.8m boom), \$50. Yaesu FT230R, s/n 2D030847, 25W 2m mobile rig, \$250. HF150 100W HF linear, 12 volt, \$125. Don, VK3BKU, (03) 5156 3302.

- Want a rural QTH? No TVI? One hour from Melbourne, RHOMBIC four wavelengths leg 20m, VHF UHF Yagis, seven acres, modern home, central heating, air conditioner, spa, solar heated pool, nice garden, large steel framed shed, near Nagambie \$153,000. vk3amh@eck.net.au (03) 5794 2004. Early inquiries 0438 130 737.

- Icom 271A 2m all mode, excellent condition, optional internal pre-amp fitted, includes full service manual \$850. Call Charlie AH (03) 9572 3583.

- Sockets (2) for 4CX type valves Johnson 124 - 110 \$50 each. Ceramic collar (one) Eimac SK 626 \$25. Transmitting valves boxed 807, 809, 815, 832 \$15 each. New unopened Taylor 35T \$50. Vidicon tube Philips 55850 AM \$40. Insulators two piece 1.5 inch and 1 inch cone and base 40¢. VK3DS QTHR (03) 5332 3226.

WANTED VIC

- AM Board for FT101ZD. Circuit & handbook for BWD Model 521 oscilloscope. Circuit & manual for Realistic DX 160 HF rcvr. Circuit & manual for Telegrouping CRO Model S-43. Brian VK3WYN QTHR (03) 5664 1251
- Three or four element triband yagi: Hy-Gain TH3 or similar, must be reasonable cond, can arrange freight. Des VK3VDP QTHR Ph. (03)

5157 1784 or email: pendergast@i-onet.com.au

- FT101 early model dead or alive for wrecking, or second mixer box for the 101. (03) 5147 1763, email gooloo@netspace.net.au
- Sweep Generator, Valve or Solid State. Fred VK3JM QTHR (03) 98014972

FOR SALE QLD

- Kenwood TS50 Transceiver all bands plus 6m, with power supply, brand new with manuals \$1350 or near offer. Owner ill. Serial Number 60800 810. In first instance ring Ken (07) 5548 2293 QTHR
- HTX-100 10 metre SSB & CW Transceiver, Serial No. 95000498, Complete all accessories, new and in original carton never been used. \$250.00 Firm John VK4VK phone (07) 55381759, email tenalu@alphatech.net.au

WANTED QLD

- Keyboard for Decstation 5000 computer. Any one of the following will do: LK401, LK 201. A keyboard from a VT220 or later terminal will do. The keyboard has a 4 pin 'RJ' style connector. Malcolm VK4ZMM (07) 3298 5454.
- Article on EA Tx pre 1965. Has 6 band Geloso 4-104 tuner CB band on band 2. Also info on small linear with 2 line output valves and 2 power transformers for 115 and 230 volt and EEB on circuit boards. John VK4DJS QTHR (07) 4091 2705

MISCELLANEOUS

- If you got your licence before 1975, you are invited to join the Radio Amateurs Old Timers Club. A \$2.50 joining fee plus \$8.00 for one year or \$15.00 for two years gets you two interesting Journals a year plus good fellowship. Arthur Evans VK3VQ or Allan Doble VK3AMD can supply application forms. Both are QTHR in any Call Book
- The WIA QSL Collection (now Federal) requires QSLs. All types welcome, especially rare DX pictorial cards, special issue. Please contact the Hon Curator, Ken Matchett VK3TL, 4 Sunrise Hill Road, Montrose Vic 3765, tel. (03) 9728 5350

TRADE ADS

• AMIDON FERROMAGNETIC CORES:

For all RF applications. Send business size SASE for data/price to RJ & US Imports, PO Box 431, Kiama NSW 2533 (no enquiries at office please ... 14 Boanyo Ave Kiama). www.cyberelectric.net.au/~rjandusimports

Agencies at: Assoc TV Service, Hobart: Truscotts Electronic World, Melbourne and Mildura: Alpha Tango Products, Perth: Haven Electronics, Nowra

- WEATHER FAX programs for IBM XT/ATs *** "RADFAXZ" \$35.00, is a high resolution short-wave weather fax, Morse and RTTY receiving program. Suitable for CGA, EGA, VGA and Hercules cards (state which). Needs SSB HF radio and RADFAX decoder. *** "SATFAX" \$45.00, is a NOAA, Meteor and GMS weather satellite picture receiving program. Needs EGA or VGA & WEATHER FAX PC card, + 137 MHz Receiver. *** "MAXISAT" \$75.00 is similar to SATFAX but needs 2 MB of expanded memory (EMS 3.6 or 4.0) and 1024 x 768 SVGA card. All programs are on 5.25" or 3.5" disks (state which) plus documentation, add \$3.00 postage. ONLY from M. Delahunty, 42 Villers St, New Farm QLD 4005. Ph 07 358 2785.

- Note 1 Views expressed in letters are those of the authors and do not necessarily represent the policy of the WIA.
 2. Some of the letters have been shortened to allow more letters to be published.

Re Evolution of an antenna farm

Further to my letter to the Editor published in *Over to You*, *Amateur Radio* August 2000 I have to inform readers that telephone advice from Bernard, the builder of the tower, is that he designed the tower for 160 km/h winds and had the drawings checked by a professional engineer before getting Council approval. Regardless of whatever reservations I may have about the rigid frame design used, readers should know of this information as I do now. From what Bernhard has said to me the tower is well-designed and perfectly safe for the purpose and he is justifiably proud of his effort, something which I did not fail to notice in his article of the May 2000 issue.

Geoffrey Coombes VK4GWC

Band Threat

It took a bit of plotting and plea bargaining to get my XYL to agree. I ordered the rig through my local Ham store and within a few I was able to collect this miniature of a modern marvel!

A handheld VHF/UHF transceiver, no bigger than you average hand microphone. Magic I thought, so lets try it out on a repeater or two.

I triggered 9 repeaters around VK3 but not a soul responded!

I hit 5 repeaters on VHF and 4 on UHF and I nearly gave up when a VK3HIS came back via the tenth repeater. Thanks Steve; if it hadn't been for you I would have taken the rig back... hi!

My point is this: if we don't make an effort to use those bands the commercial interests will! At the moment our Victorian Division is responding to the Western Australian Government which

wants the lower end of our 70 cm band as primary users.

The 70 cm band has been partially nabbed for the Olympic games and so it goes.

Have a look at the advertisement in the latest catalogue from a prominent electronics store a walkie talkie operating in "the less crowded 433 MHz UHF band".

Come up on air lads before its too late!

M Morris VK3GMM

Chesterfields revisited

The recent DXpedition to the Chesterfields is not the first time radio messages were sent from that QTH. On 4 September 1941 Catalina A24-3 surveyed those islands looking for a suitable site for a seaplane base. I was the senior W/T on A24-3 and while airborne over the islands I sent to the RAAF HQ at Port Moresby, by CW, a preliminary report of the survey results. That, I believe, justifies my claim to be the first radio operator to send a message from the Chesterfield Isles.

After a first light take off from Noumea we arrived at the Chesterfields about midday. the survey consisted of a wave top fly over in several directions to judge take off and landing distances and to take photographs. A landing was not possible because the lagoon was occupied by a pod of large whales which ignored our presence and obviously had no intention of giving way to intruding flying machines.

The survey proved the site suitable for limited flying boat operations but the RAAF shelved the plans project after considering the final report. Future DXpeditions could only use a flying boat

as transport. The small lagoon is part enclosed on three sides by reefs and a sand cay and is reasonably sheltered from most wind directions.

It would be necessary to persuade the whales to find somewhere else to do what they were doing.

It was interesting to read about the DXpedition's difficulty in finding exact positions. The captain/navigator of A24-3 reported position errors on Admiralty charts used and also an uncharted wreck. Some more recent charts don't agree about the position. Even GPS is useless if charts are inaccurate.

The radio (wireless) on A24-3 performed excellently as always and did the job as well as any modern equipment. The TX was an 8 channel Bendix TA 2J with 6 HF channels and 2 MF channels. the power input was 100 Watts and the aerial was a sorta Windom. The aerial was V shaped; the apex anchored to the tail fin and the ends anchored to each wing tip. The feeder was a single wire connected one third the arial length from the starboard wing tip and to a hull feed through insulator on the starboard side.

The Rx was a Bendix RA 1B; "they don't make them like that anymore". RX and TX supplies were genemotors; 24/240V for the RX and 24V/1000V for the TX. These were conveniently located for use as operator foot warmers.

The stations available to accept messages were, aeradios at Port Moresby distant 951Nm, Rabaul distant 1013Nm and at Tulagi distant 653Nm. Rabaul aeradion accepted my message to QSP Moresby. Tulagi was probably skip and Moresby was probably at morning tea; the Pacific war wasn't serious at that time. The frequency used was 6540 kHz.

Lindsay Lawless VK3ANJ

ADVERTISERS INDEX

ACA.....	23
Andrews Communication Systems	49
Dick Smith.....	28, 29, IBC
Icom.....	OBC
Radio & Communications	38
Tower Communications	14
WIA Call Book.....	IFC

TRADE PRACTICES ACT

It is impossible for us to ensure that the advertisements submitted for publication comply with the Trade Practices Act 1974. Therefore, advertisers and advertising agents will appreciate the absolute need for themselves to ensure that the provisions of the Act are strictly complied with.

VICTORIAN CONSUMER AFFAIRS ACT

All advertisers are advised that advertisements containing only a PO Box number as the address cannot be accepted without the addition of the business address of the box-holder or seller of the goods.



YAESU'S DONE IT AGAIN

VX-5R 6m/2m/70cm Deluxe Handheld

**SUPER
PERFORMANCE
HANDHELD**

YAESU

2 YEAR WARRANTY

Tiny, yet incredibly rugged, the VX-5R provides 6m, 2m and 70cm Amateur band operation with 5W output as standard (4.5W on 70cm), made possible by a unique PA design, super high-capacity 7.2V 1100mA/H Lithium-ion battery, and a diecast metal case. Plus, ultra-wide VHF and UHF as well as medium-wave* and shortwave reception facilities are provided.

Another really useful feature is the large backlit dot-matrix LCD screen that can be configured to suit your operating needs.

You can choose large frequency digits, dual line displays (VFO "A" and "B" frequencies, VFO "A" frequency and battery voltage and even VFO "A" frequency as well as other data such as recent Tx/Rx times or transceiver internal temperature), or even 8-digit alphanumeric memory labels. All this in a diecast aluminium enclosure just 58 x 87 x 28mm WHD (w/o knob or antenna)!

Other features include:

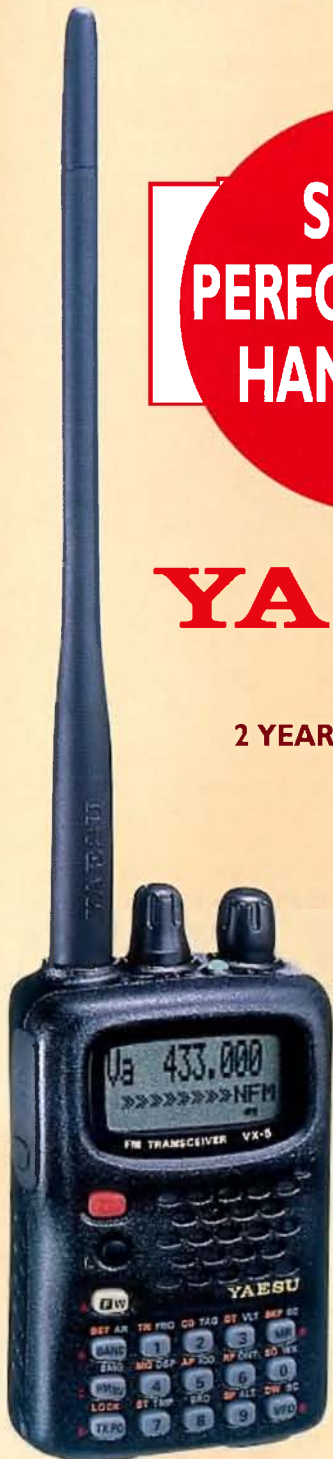
- Tx: 50-54, 144-148, 430-450MHz
- Rx: 0.5-1.8MHz, 1.8-16MHz, 48-729MHz, 809-999MHz (cellular blocked)
- Full feature keypad, CTCSS encode/decode, Digital Code Squelch
- Comprehensive menu system
- Over 200 regular memories, plus 10 pairs of "Band limit" memories
- Fast battery charging from the supplied AC adaptor
- 5 battery saving systems, plus Tx/Rx usage monitor.
- Spectra-Scope™ for monitoring adjacent channel activity
- Comes with FNB-58LI 1100mA/H Lithium-ion battery, flexible antenna and AC adaptor/charger

D 3670

*10kHz steps only

\$599 **SAVE \$60**

DICK SMITH
ELECTRONICS



VX-5R pictured showing large frequency digits

Offers expire 29/10/00

For further information, orders, or the location of your nearest store: Phone 1300 366 644 (local call charge) Or Fax: (02) 9395 1155

MORE

GREAT

GEAR

FROM

ICOM



IC-706MKIIG

The amazing evolution of the legendary 706. Frequency coverage is expanded to the 70cm band and output power is increased for the 2m band. You get base station performance and features in a mobile rig-sized package.

IC-718

A compact HF all band transceiver.

A superior performer with simple, straight forward operation with keypad. Optional AF DSP capabilities, including noise reduction and auto notch function. It's versatile, compact and loaded with features.

NEW



NEW



IC-756PRO

The HF & 6mm multimode professional performer. 100 watts of power, newly designed 32 bit floating DSP for noise reduction and auto notch function, and AGC loop operation for wider dynamic range. Plus digital IF filter, built-in RTTY Demodulator/Dual Peak APF, and a whole lot more.

IC-2800H

A totally new approach to dual band mobile. Powerful performance on 2m and 70cm bands, remote control capability, and a first for mobile rigs... a multi-function colour LCD screen! All your information is right in front of you in colourful 3D-like characters and icons.



IC-T81A

A remarkably compact quad bander. Superb clarity on the 6m, 2m, 70cms and 23cm bands. It's water resistant, with tone squelch and pocket beep functions standard, plus you can change volume and bands even quicker with the 'joy-stick' style multi-function switch.



ICOM

-Clearly Ahead-

2 YR WARRANTY

See your nearest Icom Dealer, or visit our website at www.icom.net.au



November 2000

Volume 68 No 11

Amateur Radio

YL 2000 Hamilton NZ

Special
Ionospheric Update:
Solar Cycle 23



Women in Amateur Radio

The First Australian Call Sign from Space

- ★ The Feld-Hellschreiber
a home-built, direct printing
telegraph system
- ★ A HF to LF Transmit
Frequency Converter
- ★ Noise Cancelling at HF
and VHF

Gil Sones VK3AUI

Technical Abstracts:

*Low Band
Receiving Antennas
Diode Probe
Commercial RF
Probe*



WIA Call Book 2001

**OUT
SOON**

It is more than a callbook, it's a Yearbook, the WIA Yearbook!

*The "WIA Call Book 2001" will
soon available from
Divisional Bookshops
and selected outlets*



Amateur Radio

Volume 68
Number 11
November 2000

The Journal of the Wireless
Institute of Australia
ISSN 0002-6859

Editorial

Editor: Colwyn Low VK5UE
edarmag@chariot.net.au

Technical Editor: Peter Gibson* VK3AZL

Publications Committee Members

Ron Fisher VK3OM
Don Jackson VK3DBB
Evan Jarman VK3ANI
Bill Rice VK3ABP
Gil Sones VK3AUI

Advertising

Mrs June Fox,
Tel: (03) 9528 5962

Hamads

"Hamads" Newsletters Unlimited
29 Tanner Street, Richmond VIC 3121
Fax: (03) 9428 4242
e-mail: news1@webtime.com.au

Office

10/229 Balaclava Road
Caulfield, Victoria
Telephone (03) 9528 5962
Facsimile (03) 9523 8191
Business Hours 9:30am to 3:00pm weekdays

Postal

P.O. Box 2175
CAULFIELD JUNCTION
VICTORIA 3161
AUSTRALIA
e-mail: armag@hotkey.net.au

Production

Newsletters Unlimited (03) 9428 3458

Printer

Streamline Press, Melbourne (03) 9417 2766

Postal Service

IMS (03) 9291 5888

Production Deadlines

Advertising booking and articles for
publication 10th of proceeding month.

Hamads and advertising material deadline
16th day of proceeding month

The contents of Amateur Radio are
Copyright Wireless Institute of Australia
C 2000

General

Commemorating The First Australian Callsign From Space	13
CQ CQ CQ de VK3BYE: My Story	15
<i>Len Poynter VK3BYE</i>	
Lighthouse Weekend Wash Up	22
<i>Ross Berlin VK2DVZ</i>	
Women In Radio (ALARA)	26
<i>Christine Taylor VK5CTY</i>	

Technical

The Feld-Hellschreiber. A home-built, direct printing telegraph system	4
<i>Dale Hughes VK2DSH</i>	
A HF to LF Transmit Frequency Converter	11
<i>Lloyd Butler VK5BR</i>	
Noise Cancelling at HF and VHF	18
<i>Ian Cowan VK1BG</i>	
Easy CW-2	21
<i>David Pilley VK2AYD</i>	
Low Band Receiving Antennas (Technical Abstracts)	24
<i>Gil Sones VK3AUI</i>	
Commercial RF Probe (Technical Abstracts)	24
<i>Gil Sones VK3AUI</i>	
Diode Probe (Technical Abstracts)	25
<i>Gil Sones VK3AUI</i>	

Columns

Advertisers' Index	55	FTAC Notes	34
ALARA	26	Hamads	54
ARDF	38	HF Predictions	52
Awards	41	Ionospheric Update	50
AMSAT	35	New Members	2
Contests	43	News Snippets	3
Club News	37	Over To You	56
WIA Division News		Pounding Brass	21
VK1 Notes	31	Silent Key	42, 55, 56
VK2 Notes	31	Spotlight on SWLing	23
VK3 Notes	32	Technical Abstracts	24
VK4 Notes	33	VHF/UHF - An Expanding World	48
VK7 Notes	33	WIA Comment	3
DX Notes	46	WIA Division Directory	30
Editor's Comment	2	WIA Federal Directory	2

Our cover this month

YL 2000, Hamilton NZ — see story page 26

Contributions to Amateur Radio

Amateur Radio is a forum for WIA members' amateur radio experiments, experiences opinions and news. Manuscripts with drawings and or photos are always welcome and will be considered for publication.

Articles on disc or email are especially welcome. The WIA cannot be responsible for loss or damage to any material. A pamphlet, How to write for Amateur Radio is available from the Federal Office on receipt of a stamped self-addressed envelope.

Back Issues

Back issues are available directly from the WIA Federal Office (until stocks are exhausted, at \$4.00 each (including postage within Australia) to members.

Photostat copies

When back issues are no longer available, photocopies of articles are available to members at \$2.50 each (plus an additional \$2 for each additional issue in which the article appears).

Disclaimer

The opinions expressed in this publication do not necessarily reflect the official view of the WIA and the WIA cannot be held responsible for incorrect information published.

Amateur Radio Service

A radiocommunication service for the purpose of self-training, intercommunication and technical investigation carried out by amateurs; that is, by duly authorised persons interested in radio technique solely with a personal aim and without pecuniary interest.

Wireless Institute of Australia

The world's first and oldest
National Radio Society
Founded 1910

Representing
The Australian Amateur Radio Service

Member of the
International Amateur Radio Union

Registered Federal Office of the WIA
10/229 Balaclava Road
Caulfield North Vic 3161
Tel: (03) 9528 5962 Fax (03) 9523 8191
<http://www.wia.org.au>

All mail to
PO Box 2175 Caulfield Junction VIC 3161

Business hours: 9.30am-3pm weekdays

Acting Federal Secretary

Peter Naish VK2BPN

Federal Office staff

June Fox Bookkeeper
Rita Trebilco VK3IF Examinations Officer

Council

President	Peter Naish	VK2BPN
VK1 Federal Councillor	Glenn Dunstan	VK1XX
VK2 Federal Councillor	Michael Corbin	VK2YC
VK3 Federal Councillor	Brenda Edmonds	VK3KT
VK4 Federal Councillor	David Jones	VK4OF
VK5 Federal Councillor	David Box	VK5OV
VK6 Federal Councillor	Willi McGhie	VK6UU
VK7 Federal Councillor	Phil Corby	VK7ZAX

Executive

Peter Naish VK2BPN
John Loftus VK4EMM

Federal Coordinators

AMSAT	Graham Ratcliff	VK5AGR
ARDF	Jack Bramham	VK3WWW
Awards	John Keieler	VK3DP
Contests		
Education	Brenda Edmonds	VK3KT
FTAC	John Martin	VK3KWA
Historian	John Edmonds	VK3AFU
IARU	Grant Willis	VK5ZWI
Intruder Watch	Gordon Loveday	VK4KAL
ITU Conference and study group	Gilbert Hughes	VK1GH
OSL Manager (VK6, VK0)	Neil Penfold	VK6NE
Videotapes	VK2 Division	
Web/PR	Richard Murnane	VK2SKY

ACA Liaison Team

Peter Naish VK2BPN
Glenn Dunstan VK1XX
Michael Corbin VK2YC
Wally Howse VK6KZ
Canberra Liaison Officer
Richard Jenkins VK1RJ

Editor's Comment

Colwyn Low VK5UE

What is Amateur Radio ?

I suppose AR is all things to all people. We each have our own interests and we each practise part of the possible range of Amateur activities.

In the beginning I suppose all Amateurs were experimenters of some sort. Just getting on air or listening meant you built your own equipment. As time passed you could buy your equipment and there were as many "fights" over who were the real amateurs, like we have had recently based on Morse Code testing for Amateur Licences.

At this time Amateur ranks gained people whose primary goal was to keep in contact with a few friends and who were technically aware enough to get an Amateur licence, get on the air and communicate. A number of Amateurs continued to experiment.

More recently other means of communication became readily available to the public with computers and the Internet and with mobile phones. This means a lot of people now never even think about becoming Amateurs.

So what is Amateur Radio ? Why should it have access to MHzs of precious spectrum ? Why should one group of people continue to have free chat time ? Does the community appreciate what we Amateurs do in providing backup communications and sometimes primary communications in time of natural disaster or horrific accidents ? Do we need to prepare for these emergencies by just using radio equipment so that we understand its limitations and capabilities ? Do we have to provide first class communications to the organisers of canoe races or bicycle races, or car rallies or orienteering competitions or fun runs or ???

Well then what is it that makes you an Amateur ? Drop me a short letter on why you are an Amateur and maybe we can sort out what we could do to encourage more people to become Amateurs.

By the way I have at last started to build the boards for my 1.2GHz transverter. The oscillator board is complete.

73 Colwyn VK5UE

New WIA Members

The WIA bids a warm welcome to the following new members who were entered into the WIA Membership Register during the month of SEPTEMBER 2000

L21181	MR M PATTERSON	VK3JJJ	MR C HARRIS
L30978	MR J MALONE	VK3TE	MR P BRENNAN
VK1DBO	MR J R HOULDER	VK3TZH	MR R GREENBANK
VK1KBN	MR D T TSIFAKIS	VK3WX	MRS R GLADWIN
VK2KZW	MR H ONODA	VK3YUN	MR C BULL
VK2RS	MR D HABERECHT	VK5ZMB	MR C B CLELAND
VK3CEA	MR K MORGAN	VK6BEG	MR T NISHIURA
VK3DBF	MR A SCHELLAARS	VK7HSC	MS S J HARDSTAFF
VK3GIL	MR G MCDAVID	VK7KDR	MR J H WEBSTER



Peter Naish
WIA Federal President.

This month I am concentrating on some important activities taking place in the international arena and the part being played by the IARU.

This year an ITU World Radiocommunication Conference was held in Istanbul (WRC-2000). The most important outcome from this meeting as far as Amateur Radio is concerned was an agenda-setting process for the next WRC expected to be held in 2003. The agenda for WRC-2003 has now been determined and includes a number of significant matters affecting radio amateurs. These include a review of the ITU articles that define amateur radio and the qualifications needed to obtain an amateur radio licence. Additionally, there is to be consideration of a realignment of the 7 MHz band with the target of a harmonised band worldwide allocation, hopefully 300 kHz wide. Also, in the HF spectrum, there is a strong push being made by commercial HF broadcasters for digital modulation techniques. Some review of HF

broadcasting in 4 to 10 MHz area is also likely. In the UHF and microwave areas of the spectrum, WRC-2003 will consider the use of earth exploration satellites and land mobile systems in the 400-500 MHz band, an international allocation for disaster and emergency communications, the expanding use of so called Little LEO's (low earth orbiting satellites) as well as a number of other matters concerning communications satellites using microwave frequencies.

WRC-2003 will be one of the most important conferences of recent times with the potential to shape the future of the amateur radio service for many years to come. Therefore, the IARU will be spending the next few years concentrating on its preparations to meet the expected challenges. To this end a core team of IARU personnel is already in place, lead by the IARU President,

Larry Price W4RA. This team will make WRC-2003 its major focus and they will be augmented as required to ensure that amateur radio's objectives are heard and supported by the ITU delegates from every country participating in the conference. Unless the groundwork is done well and early, the voice of amateur radio could easily be drowned out by the increasing number of large and wealthy commercial interests.

The WIA is an active participant in IARU through its membership of IARU Region 3 and it will continue to press for the needs of the Australian radio amateur. The contribution that you make to IARU through your membership of WIA is a vital element of the work to be performed to ensure a satisfactory outcome from WRC-2003.

Peter Naish
WIA Federal President.



DARWIN - IARU CONFERENCE – Promoting Amateur radio

At the 11th IARU Region 3 Conference held in Darwin in August 2000 a Workshop was held to consider the promotion of Amateur Radio.

A PowerPoint display about promoting Amateur Radio was used. This uses about 14 slides. The file is designed to support a live speaker but no speech notes are provided, however you CAN customise the file for display to groups of radio amateurs. Add new slides, delete slides, alter the wording and add new graphics, as you require.

You must have PowerPoint 97 or later, or the free viewer to run these files. So download them - and enjoy the display!

Just email iaru-r3@jarl.or.jp and get the download instructions. (The ppt file is 115 kb)

CALLBOOK 2001

We see Federal office has notified the VK7 division that the 2001 Australian Radio Amateur callbook WILL be ready for distribution at the end of November this year.

It will contain the listings for just on 16000 amateur stations, plus reference data, accredited examiners list, band plans, repeater and beacon list, and DXCC country listing.

This is a Wireless Institute publication and another important service to members and amateur radio. Invaluable in and around the station.

INTERNATIONAL

IARU - Administrative Council Meets

The next scheduled meeting of the Council will be held in Guatemala on 6-

8 October 2001, immediately after the Conference of IARU Region 2. IARU President is Larry Price, W4RA and Vice President our own David Wardlaw, VK3ADW. Local region 3 representatives include Fred Johnson, ZL2AMJ, Yoshiji Sekido, J11OEY and Peter Naish, VK2BPN.

EUROPE

The European Radiocommunications Committee at its meeting in Lisbon 16-20 October adopted 18 new draft ERC Decisions for public consultation. The draft ERC Decisions deal with harmonised frequencies, technical characteristics and exemption from individual licensing of Short Range Devices. The draft ERC Decisions may be downloaded from the ERO web site <http://www.ero.dk/eroweb/consult.htm>

ar

Thanks to Q-News

The Feld-Hellschreiber

A home - built, direct printing telegraph system

by
Dale Hughes, VK2DSH

Amateur radio operators have access to many transmission modes. A mode that has generated much interest in the last few years is called Hellschreiber. It allows the user to send text in real time using on-off keying of the transmitter. A recent activity day attracted an estimated 200 operators from all around the world.

Free software is available to send and receive Hellschreiber signals using an ordinary PC equipped with a sound card. This is the method most people use as it is easy to set up and operate. Another option is to build, or otherwise acquire, an electromechanical machine based on the original design. This article describes one possible approach to building such a machine.

It is not intended to give a detailed and complete description of the machine, but is presented as a collection of ideas about how such a machine may be constructed from 'junk box' components. No mechanical drawings are presented, however it is hoped that the photographs and description that follow, along with the cited references, will be sufficient for interested readers to build their own machine.

Some History

Rudolf Hell first developed the original Hellschreiber telegraph system in Germany in 1929. Many pre and post war news services transmitted their bulletins over Hellschreiber circuits, both radio and landline. During World War 2, the German armed forces used

Hellschreiber machines extensively. Initial amateur Hellschreiber activity was based on WW2 surplus machines. The system remained in active use until the early 1960's, after which it was supplanted by more conventional teletype systems which offered superior performance – albeit with extra complexity. See reference (1) for an interesting and detailed historical survey.

The Hellschreiber messages are not encoded in the same sense as conventional teletype messages, rather each character is sent as a 'bit map' in a 14 by 7 matrix of pixels. As no encoding is done, noise or distortion introduced during transmission cannot change the code from one character to another. The user relies on his or her eyes and brain to sort out the signal from the noise. Such a system is described as 'fuzzy'(1) as it is a mixture of digital and analog processing.

As can be seen from the following example, not all pixels are used. At least two pixels on all four sides of the character are left white to maintain readability, except for characters Q, 3, 5, 6, 7, 9 & ? where the characters extend

into the normally white region. Otherwise, each pixel in the matrix can have two states – either black or white – that is, printed or not printed.

The characters are transmitted as a sequence of columns starting at the bottom left hand corner of the above example and working up each column to the right, one column at a time. Note however that single pixels are never transmitted: only groups of two or more are sent. This is done so that the transmitted bandwidth is minimised. Since at least two pixels are always transmitted, the minimum pulse width is 8.16mS, so the maximum Baud rate is $1 / 8.16mS = 122.5$

In the original system, reception was accomplished by using a two turn helix rotating at 1050 RPM past a paper tape. The helix was coated with a film of ink applied by an ink pad. A magnet pressed the paper onto the rotating helix every 'mark' pixel. Thus each character was made up of a sequence of lines. There are two main advantages of this system:

- (a) Its simplicity.
- (b) It performs well in the presence of noise as the eye is very good at (visually) recognizing characters amongst the background of dots caused by any noise pulse.

An important fact to note is that the system does not rely on start or stop bits or special codes to ensure synchronism as in conventional teletype systems. All that is required is that the transmitting and receiving machines are running at approximately the same speed. Of course it is best that the machines at either end of the circuit run as close as possible to the same speed. The effect of speed differences is to make the received text slope one way or the other, it does not cause corruption of the received characters.

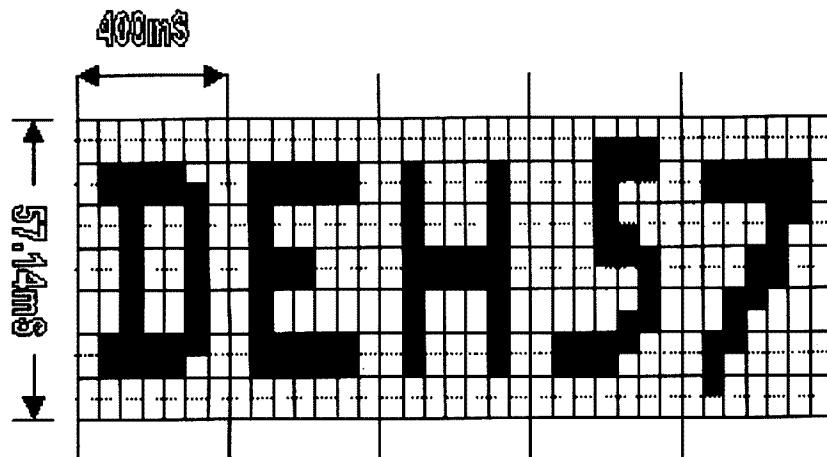


Figure 1: Example character fonts.

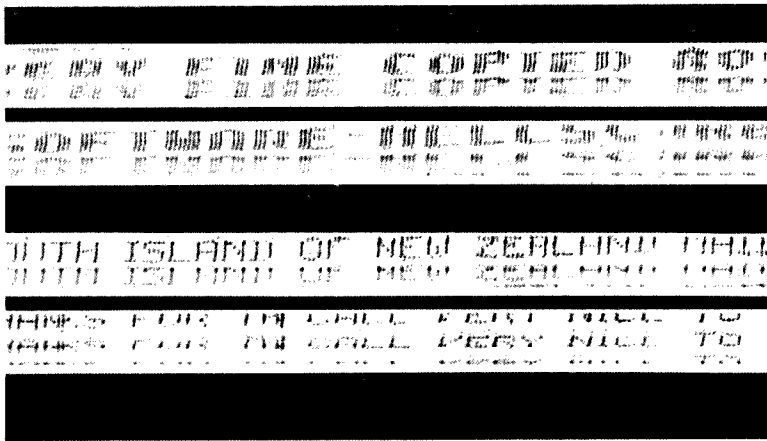


Figure 2: Examples of text printed by the machine, showing double and normal width characters.

As can be seen on the above examples, the text is printed at least twice so that a full line of characters are always visible. This is a function of the receiver alone because the receiver helix has two turns.

The following pages describe the machine that I built based on information found in the various sources cited at the end of this article. In particular I refer people to the excellent web site of Murray Greenman ZP1BPU (ref 1) for historical information as well as links to other sites where software and other data is available.

- the helix drive motor is from a DEC LA120 printer,
- the paper tape feed motor is from a 5.25 inch floppy disc drive,
- the printer magnet is a 3000 type telephone relay,
- an encoded ASCII keyboard from a junked terminal,
- paper tape reel from a junked paper tape punch,
- various other components for the modem and power supply,
- a 65C02 based single board computer system.

The machine consists of three main parts:

- (a) The transmitter, which uses a 65C02 microprocessor board to generate the transmitted codes from a stored bit map, reads the keyboard and writes to the display.
- (b) The receiver based on a rotating helix and magnet system. The messages are printed onto teletype paper tape.
- (c) A modem for radio transmission and reception of the Hellschreiber signals.

The technical details of these systems follow:

The transmitter subsystem.

A 65C02 based single board computer allows the operator to perform the following tasks:

- (1) Enter text into memory for later transmission,

- (2) Transmit memory contents,
- (3) Transmit keyboard characters 'live', i.e. as they are typed,
- (4) Display contents of the text memory,
- (5) Synchronize the CPU to the mechanical operation of the helix @ 17.5Hz
- (6) Generate a continuous 980Hz tone to tune the transmitter,
- (7) Send automatic CQ sequence,
- (8) Display help screens.

The critical parts of the software are interrupt driven, as this ensures that the timing of the transmitted pulses is always correct. In the 'live' transmission mode a type ahead buffer is implemented.

All timing and tone generation is done using the inbuilt hardware timers of a pair of 65C22 chips. These are driven from a 2MHz crystal, so the accuracy and stability of the timing and transmitted tone is high.

The keyboard is an encoded keyboard with a parallel output. This is read via a parallel port of one of the 65C22 chips. Each key press raises an interrupt, and the character is then read into a buffer. Characters are displayed on a 16 character by 2 line liquid crystal display, which is driven by a parallel port from a 65C22. The keyboard is from a junked TTY machine and is over 20 years old!

Characters to be transmitted are generated as a sequence of logic levels which are then gated with a 980Hz tone. The gated tone is then passed through a filter to produce a suitable sine wave for transmission. See the following modulator circuit for details (Figure 4).

Source code and a printed circuit board layout for the above microprocessor system can be supplied to interested readers

The receiver subsystem.

The demodulated tones are amplified and filtered to drive a FET which controls the printer magnet. The printer magnet is a modified 3000 type telephone relay. I was initially doubtful whether the magnet would respond fast enough, but it seems to work just fine. However, it takes approximately 1 amp to operate. Each 'mark' signal causes the paper tape to be pushed against the rotating helix. The helix has a film of ink applied to it from a piece of sponge rubber soaked with ink. Ink is

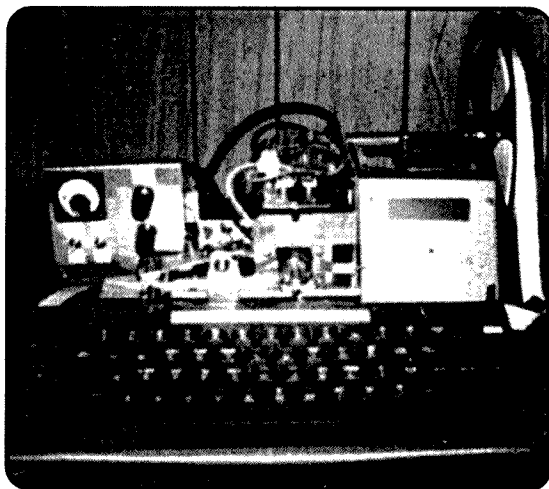


Figure 3: Home-built Hellschreiber machine.

This machine was built from mostly 'junk box' parts. The parts I had determined the end result, so I will only describe the system in general terms (the construction of an identical machine would be most unlikely). For instance, the following parts were on hand:

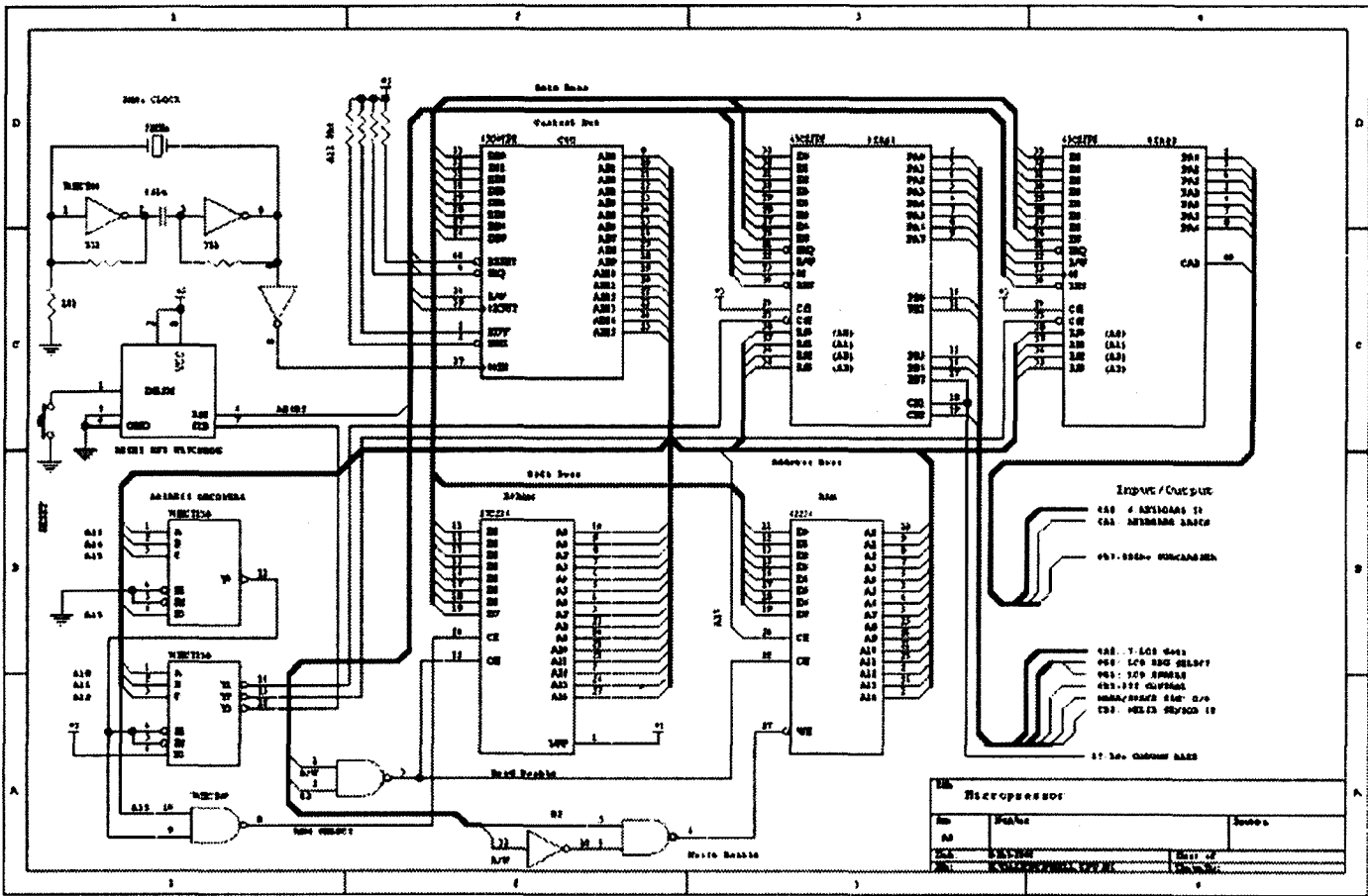


Figure 4: CPU Circuit

transferred to the paper tape when contact is made with the helix. The paper tape is advanced for every rotation of the helix, and a photon-coupled interrupter synchronizes the stepper motor so that it does not advance while the line is being written. The paper advance can operate continuously or only when characters are being received. Adjustment of the tension on the paper tape is possible, so that the paper advances consistently. A stepper motor, formerly used to move the heads of 5.25 inch floppy disk drive, actuates the paper advance. The stepper motor is driven by a simple circuit from the 'Silicon Chip' magazine of June 1997 (ref 4). Pulse rate and duration is adjustable to give the best paper advance operation. The spool of paper tape is held on a wheel originally from teleprinter tape punch. Paper passes from the spool to the printer mechanism through a channel just wide enough for the tape, designed to keep the tape correctly aligned with the printer helix.

To ensure that the receiver helix runs at the correct speed of 1050 RPM, a speed control system based on an

LM2917 speed control IC is used. The motor I used had an existing shaft encoder at one end, so it was a simple matter to provide a closed loop feedback control. This works very well, and holds the shaft speed to 1050 RPM as required.

The printer helix is a small cylinder

of brass, about 25mm in diameter, wound with two turns of 22 gauge steel wire. Dimensions of the helix are not critical, except that its length should be slightly less than the width of the paper tape. Ideally, the wire should be secured in such a way that it does not move.

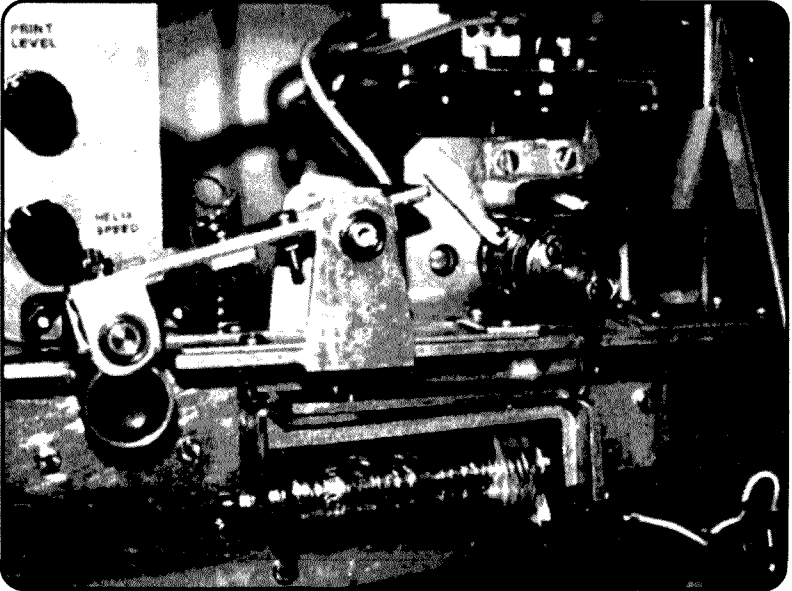


Figure 5: Close up photograph of the printer mechanism showing the printer helix, printer magnet and paper tape advance mechanism.

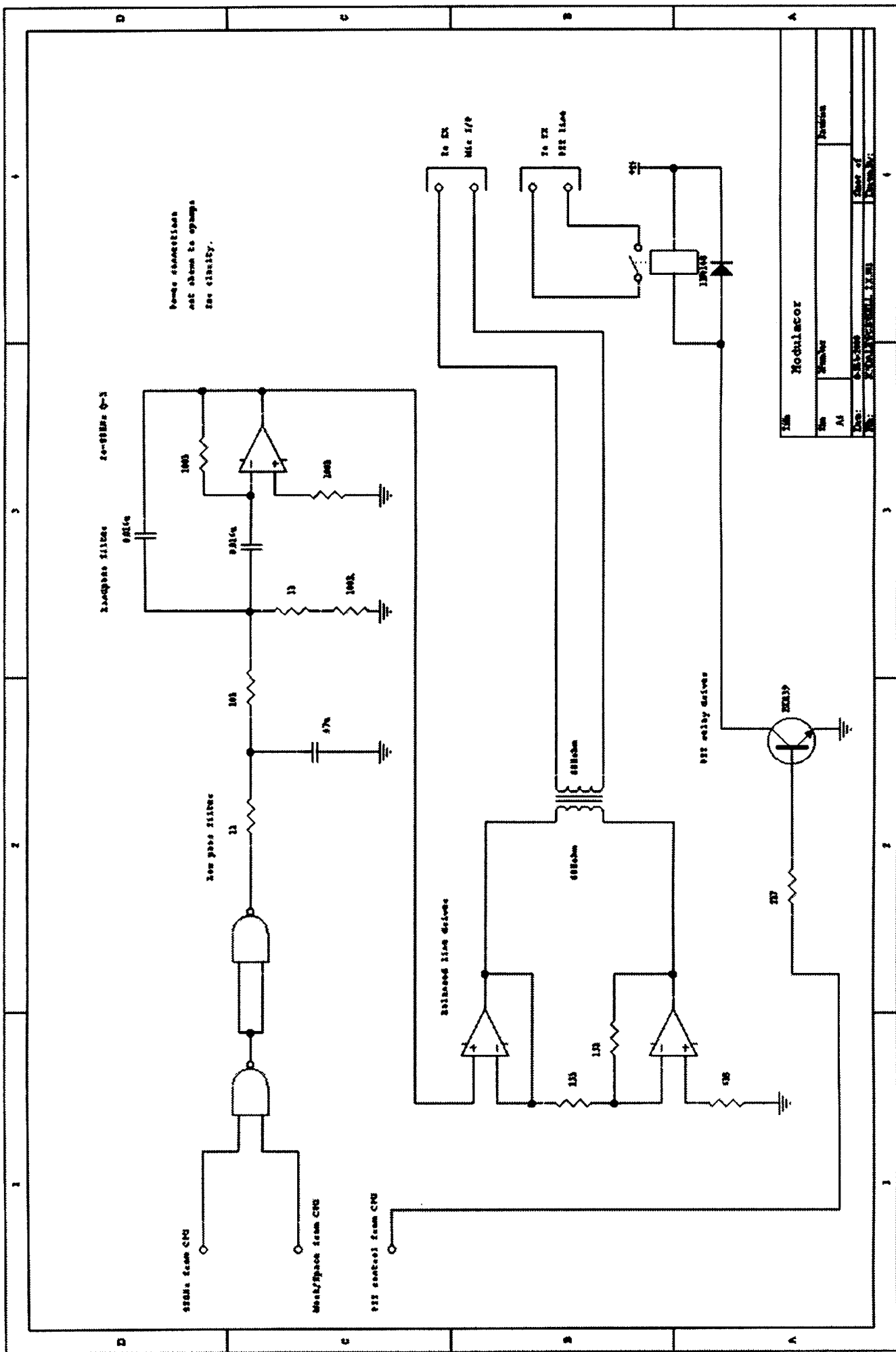


Figure 6: Modulator circuit.

The modem

The gated tones generated by the transmitter are passed through a low pass filter then a band pass filter with a Q of 5. The rising and falling edges of the tones are nicely rounded by the filters to minimize transmitted band width. The tone bursts are then amplified by a pair of op-amps forming a push-pull amplifier driving a 600Ω/600Ω transformer. This balanced output

then drives the transmitter microphone input through an attenuator so that the transmitter is not overdriven. The attenuator and transceiver interface are located in a separate module. Received tones from the receiver output are coupled to the modem via an input transformer with a selectable input impedance. The tone bursts are amplified and then passed through a two stage band pass filter. Each section of the filter has a Q of 5 and a centre frequency

of 980Hz. A full wave rectifier, low pass filter and Schmidt trigger produce a voltage to drives the printer magnet. Printer magnet drive can be either from the modem output or from the local keyboard.

No pin numbers or op-amp types are shown on the schematic diagrams as they depend on what parts are used. The unit I built used TL084 devices, but the selection is not critical.

Conclusion

I have found the Hellschreiber mode works very well and have enjoyed a number of QSO's. It was a lot of fun to build the machine and to get it to work, and it is very satisfying to use. As I was able to use components from my 'junk box', the cost of constructing the machine was only about AU\$50, \$10 of which was for a can of suitable spray paint for the front panel!

Two main improvements to the machine could be made:

(a) Use a machined helix instead of the wire and cylinder, this would ensure consistent character height. In the current arrangement, the wire shifts slightly when the printer magnet is actuated, sometimes causing distortion of the printed characters.

(b) The 'live keyboard' mode does not allow editing of typed characters even though they have queued in the transmit buffer. Thus any spelling errors are transmitted....

I hope the ideas presented above will encourage others to have a go at building their own systems or at least use the mode.

Reference Material:

I found the following reference material very useful as a source of ideas and information:

- (1) <http://www.qsl.net/z11bpu/FUZZY/Contents.html>
- (2) Radio Communication, April 1981, Cook, G5XB
- (3) Ham Radio, December 1979, Evers, PA0CX
- (4) Silicon Chip, June 1997

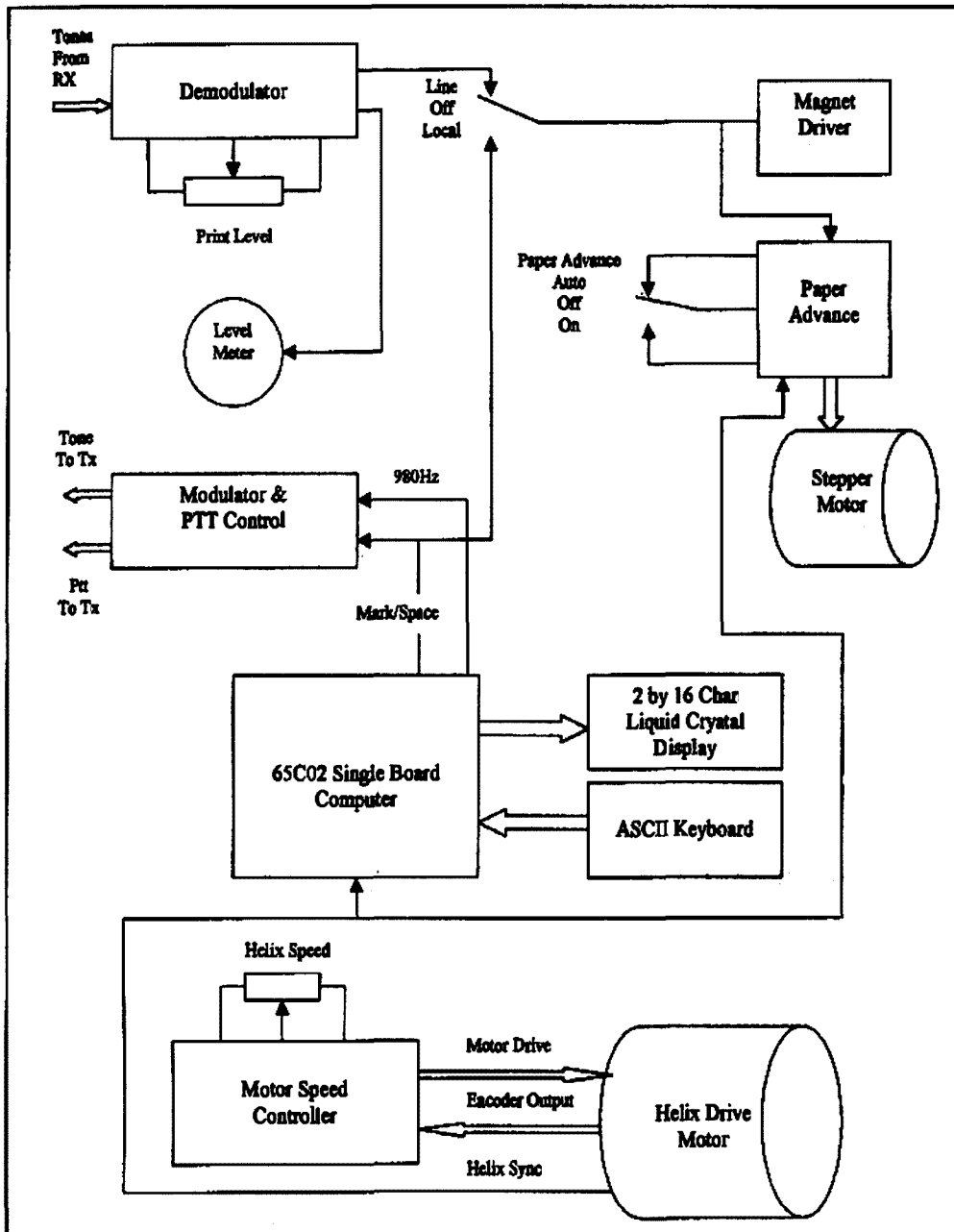


Figure 9: System block diagram.

A HF to LF Transmit Frequency Converter

Lloyd Butler VK5BR

Any mode (e.g. CW, AM, SSB, FSK) which is initiated in the HF transmitter or transceiver can be regenerated at LF (100 to 200 kHz) using this simple converter. The output at LF can be used to drive an LF Power Amplifier.

The February, 2000 issue of Amateur Radio (ref. 1) contained an article I had submitted on an LF transmitter. The transmitter was designed for CW operation but the power amplifier was operated in a linear mode and it was only a matter of replacing the VFO with some form of AM or sideband generator with an LF output to operate on speech.

The article was followed up with a further article (Amateur Radio September 2000 ref 2) on a Single Sideband Generator using the phasing technique. The design aimed at making a stand-alone unit because of the possibility of using the unit at a site away from the amateur station. However it was pointed out that a simpler arrangement might be achieved at the amateur station site by heterodyning down from the HF output of the local HF transceiver. This third article describes a circuit designed to do that conversion and provide sufficient LF output level to drive the original power amplifier.

The Converter circuit

The circuit diagram of the converter is shown in figure 1. The conversion takes place in V1 (type NE602). The V1 circuit is almost identical to that used in my Active Loop Converter (Amateur Radio July, 2000 - ref 3) except that the input and output frequencies are reversed. I used the same 4 MHz xtal as in the receive converter as I had another one spare. Most HF amateur transceivers tune up to 4 MHz on the 3.5 MHz band so that it is simply a matter of setting the transceiver frequency to 4 MHz minus the LF transmission frequency. (4 MHz plus LF transmission frequency could also be used if the transceiver is tuneable above the 4 MHz. - This would make easier setting of the required HF frequency. Of course there is nothing to prevent some other crystal frequency

being used with appropriate setting of the transceiver output frequency.).

The overall circuit gain of V1 and V2 is arranged so that the HF input to V1 operates around 20 to 30 mVPP for peak signal level. This was chosen as it was anticipated that above these levels, steep increase in the level of intermodulation products could cause distortion in the audio signal when demodulated. This effect, relevant to the NE602, was discussed in one of my previous articles (A.R. Jan 1994, ref 4).

HF Transmitter Pick-up

There is no point in running the HF transmitter at high output level to generate a signal. I reduced the power on an FT101B used to around 1 watt by backing off drive to the PA. The output is loaded into a dummy load and paralleled off to an attenuation network R1-RV1-R2-R3. (Note the connection via the coaxial T connector in figure 1.). The precise amount of drive for a given HF transmitter power is set by RV1. Diodes D1 and D2 provide some protection to V1 in the event of excessive RF level.

LF Output

To attenuate mixing products above 200 kHz, the LF output from converter V1 is fed into a low pass network formed by L1-C9 and the feedback circuit of V2. The following LF Power Amplifier requires 6VPP at maximum swing and stage V2 raises the output from V1 to this level. The circuit is similar to that used at the output of SSB modulator (ref 2) but the gain has been raised from the original value of 10 to around 70 by changing the values of R5 and C8 to those shown. With this arrangement, the 6VPP is achieved with around 25mV of HF signal at V1 input. Maximum possible output level from V2 is 9VPP.

DC Power

The complete converter is powered from 12V DC and when operated in conjunction with the Power Amplifier (ref 1), the supply it is picked up from 12V in the Amplifier unit. A further 6V rail is derived with Zener diode ZR1 and resistor R7. This is used to power the NE602 converter, V1 and to set the operating point of amplifier V2 at half its 12V operating supply. Load current at 12 volts is 15mA.

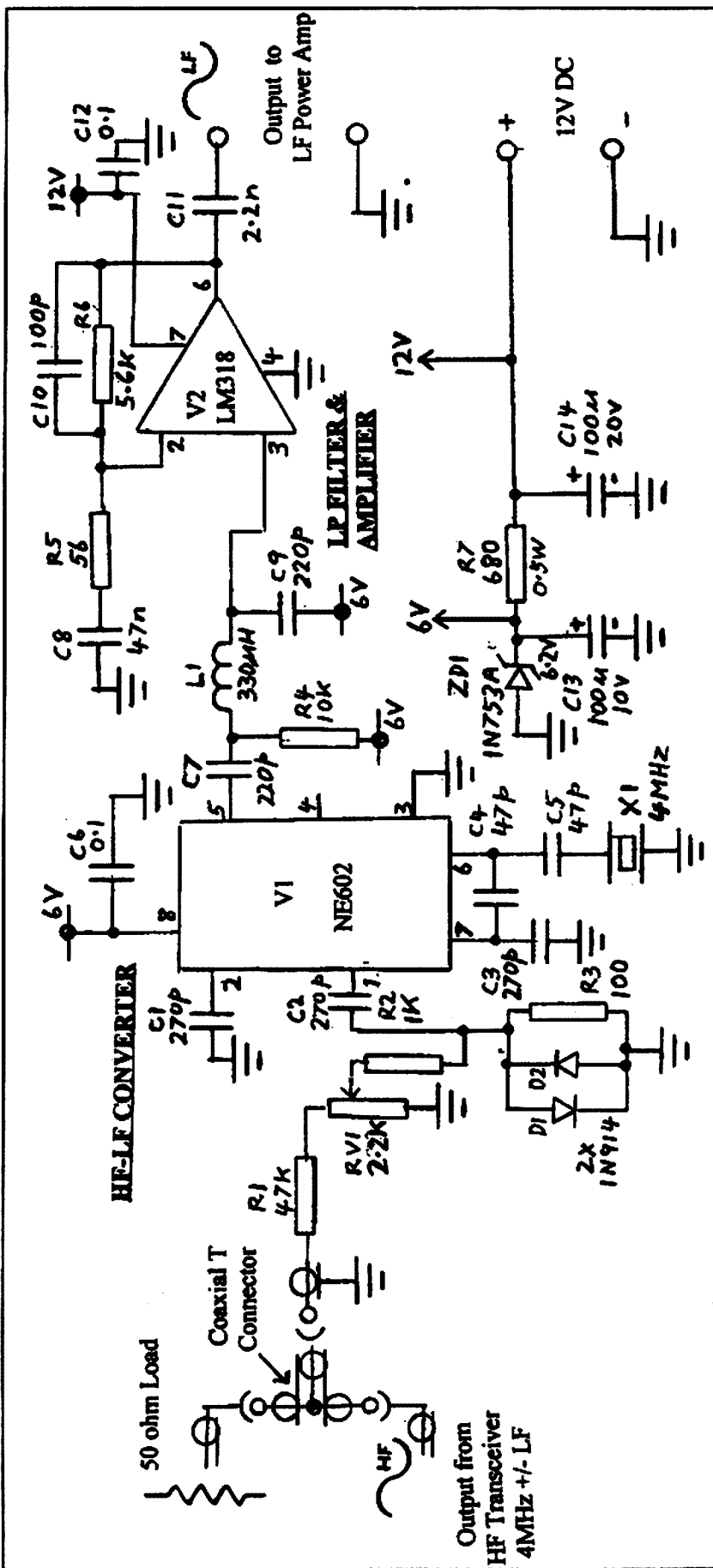
Components

There are no specialised components. L1 is a miniature choke available from electronics stores. The two I/Cs are mounted in 8 pin DIL sockets. The 4MHz crystal was a HC25 style but any crystal of suitable frequency could have been used. The precise frequency of the crystal can be adjusted by varying the values of C4 and C5. The input connectors, including the T, are BNC type but some other type could have been used. The small components (except R1) are mounted and interconnected on a piece of blank circuit board. To prevent stray coupling from the high level at the input to R1 from getting into the rest of the circuit, I found it necessary to remove R1 from the board and shield it and its connecting lead to the input connector. The complete unit is mounted in a 100mm x 60mm x 45mm aluminium box.

Adjustment, Operation, Performance

The only adjustment is the input level control RV1. For operation with the nominated power amplifier, RV1 is set for a maximum signal level of 6VPP at the output of the converter.

The converter has been tested in conjunction with a HF transceiver using



CW, AM, and SSB modes and with the LF Power Amplifier loaded into a dummy load. At the time of writing, negotiations by WIA for a new LF amateur band were still in hand. Hence, no air tests to date have been possible.

Performance Summary:

- Low Frequency output range - 100 to 200 kHz
- Input Frequency (with 4 MHz Crystal) - 4 MHz +/- LF
- Maximum LF output level - 9VPP
- Nominal working level at converter (NE602) input for 6VPP LF output - 20-30VPP
- Mode - any form at HF input (e.g. CW, AM, SSB, FSK)
- Power rail - 12VDC
- Power rail load - 15mA

Summary

A frequency converter has been described which can reproduce, at 100 to 200 kHz, any mode of transmission from the output of a HF transmitter or transceiver. Its output circuit was specifically designed to drive the power amplifier in the LF transmitter described in February 2000 AR. However it could be used to drive other LF power amplifier as required.

References

1. *An Experimental Low Frequency Band Transmitter* - Lloyd Butler VK5BR
Amateur Radio, February 2000.
2. *A Single Sideband Modulator for the LF Transmitter* - Lloyd Butler VK5BR
Amateur Radio, September 2000
3. *An Active Loop Converter for the LF Bands* - Lloyd Butler VK5BR
Amateur Radio, July 2000.
4. *The Bandwidth Limiting LF Converter Simplified* - Lloyd Butler VK5BR
Amateur Radio, January 1994.

Figure 1: HF to LF transmit Converter

Commemorating The First Australian Callsign From Space

Many Australian Amateur Radio operators were able to make contact with Andy Thomas when he was on the MIR Space Station operating under the "Special Event" callsign of VK5MIR. This callsign was allocated for such use following an approach to the ACA Adelaide office by Ian VK5QX.

One aspect that may not have been fully appreciated was that Andy's operation resulted in the first use of any Australian radio callsign from space. It was obvious that, with such an operation as this, some kind of a special QSL card would be needed.

Whilst operating from MIR, Andy was not in a position to be able to keep what many of us would regard as a standard operations log. Thus it was not possible to provide confirmation of contacts made with regard to a particular time or date, as is the normal approach.

However, with this being the case it became possible to effectively "kill two birds with one stone", as the saying goes.

Ian had realised the potential for provision of a card which could be used as a QSL card as well as providing a commemoration of this unique event in Australia's history. He thus devised a card which served both of these functions.

The resultant composite multi-colour card depicts Dr Andy Thomas dressed in his "Russian" space suit as well as a photograph of the MIR Space Station which was taken by Andy during his departure from the Space Station in the USA Space Shuttle. It also carries Andy

Thomas' signature.

The card carries the following wording:- "This card commemorates the first use of an Australian radio call sign from space", with the callsign "VK5MIR" appearing in large letters. It then continues; "This 'Special Event' callsign issued by the Australian Communications Authority was used by Dr Andy Thomas for contact with other amateur radio operators during his mission on the MIR Space Station from January 22 to June 12,

1998. Copies of this card have been provided to operators who made two way voice contact with VK5MIR."

On the lower portion of the card provision is made for entry of the callsign, name or position held by the person to whom the card is presented.



Dr Andy Thomas VK5MIR/VK5JAT

A copy of this "QSL" card was provided to all who had made contact with VK5MIR and who submitted their request for a QSL together with a self addressed, stamped envelope.

Arrangements were made by Ian for production of the card, which he



Dr Andy Thomas VK5MIR/VK5JAT examines his VK5MIR Station Licence



The "QSL" card which was provided to those who had made contact with VK5MIR

designed, with the computerised graphics/art work being done by his friend, Simon Bruce who, incidentally, happens to be the son of Robin VK5PRB.

In this commemorative form the card was most suitable for both intended purposes and has resulted in the event being recognised on an official bases by the government and Prime Minister of Australia.

As well as the normal postcard size cards a number of larger (A4) sized versions were printed and suitably framed. These were in turn presented to various people who had either contributed to the overall operations, in one way or another, or were in some suitably influential position.

These included the following: -

The Prime Minister of Australia, John Howard.

Senator Nick Minchin, Minister for Industry, Science and Resources

Senator Richard Alston, Minister for Communications and the Arts


Dr Reece Jennings, Mayor of the City of West Torrens

Mr John Wilson, South Australia Area Manager, Australian Communications Authority.

The framed copies of the commemorative card for the Members of Parliament were initially presented to The Hon. Warren Entsch, Parliamentary Secretary to the Minister for Science, who in turn personally presented them to the Prime Minister and Senators.

A postcard size replica was also provided to the particular individuals concerned.

It was made clear in accompanying letters to the Members of Parliament that the mementos were to be kept within the


PRIME MINISTER
CANNBERRA

29 May, 2000

Mr Ian Hunt
8 Dexter Drive
SALISBURY EAST 5109

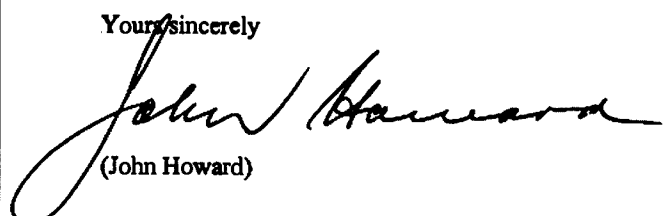
Dear Mr Hunt

Thank you for the memento you sent to me commemorating the first use of an Australian radio call sign from space by Dr Andy Thomas.

It was very thoughtful of you to forward this to me and it will remain the property of the Prime Minister's department.

With kind regards.

Yours sincerely



(John Howard)

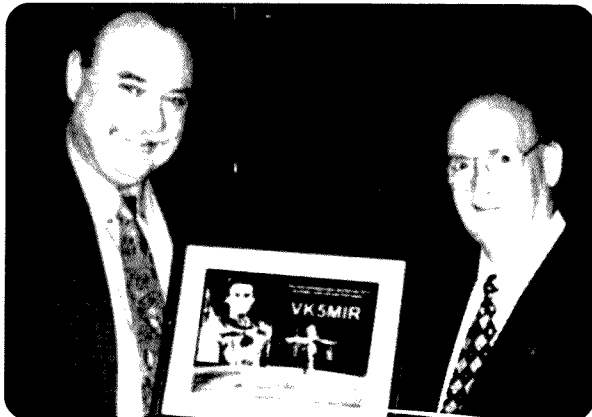
cc: The Hon. Warren Entsch MP

office of their Ministries on behalf of the people of Australia. Written acknowledgment was received from both the Prime Minister and Senator Nick Minchin.

Thus a record has been established which will remain in the hands of the

Australian people for posterity and which also helps to ensure that in the future the pursuit of the hobby of Amateur Radio will be remembered as having been part of such space operations.

ar



Ian VK5QX (R) presents VK5MIR Commemorative Card(s) to the Hon. Warren Entsch MP, Parliamentary Secretary, who accepted them on behalf of the Prime Minister and Senators Minchin and Alston



Ian VK5QX (L) presents the Commemorative Card to Dr Reece Jennings, Mayor of the City of West Torrens.

CQ CQ CQ de VK3BYE:

My story

Len Poynter VK3BYE

I became interested in amateur radio early in life and my first experience was pre-war; when commercial broadcasting stations only operated for limited hours; particularly at weekends. Outside these hours the amateur radio operators filled in broadcasting to listeners on the broadcasting band. Two stations I have memories of were VK3PA at West Preston and VK3GK in Brunswick. 3PA Perc' Anderson was popular as he played Stanley Holloway records of R' Albert. Quite comical renditions popular at the time. '3GK Stewart Maclean played

general music of the day. Now it came to pass that '3GK was situated up in Sydney Road Brunswick near Albion Street and happened to be on the route taken when visiting my grandparents who lived nearby. On one such occasion Stewart happened to be "on the air" as I passed with my sticky nose on the window. I drooled over the sight of him operating his station. He walked to the door saying "Hello young fellow, Would you like to have a look at my station?"

OH, YES PLEASE In I went. Well that was the start of my infatuation with amateur radio. I had to have one of those. I had to be part of the wonderful hobby. My very own radio station.

Unfortunately the war intervened. All the amateur stations were closed down for the duration. But the bug had bitten.

I continued with my interest in radio, getting into the construction of radios. I started with single valve receivers and gradually getting bigger and better. Most of these designs came from *Radio and Hobbies*: a popular radio hobby magazine that started just prior to WW2. Parts were difficult to obtain during the war, but we managed. My largest project was a seven valve super dooper, dual wave receiver with two RF stages and a four gang tuning capacitor: a really hot receiver. I started listening on short wave. I could now hear the world and it opened new horizons for me. I do recall listening to London and Germany. I had a neighbour who had knowledge of German and he translated it for me. What caught my attention were the German martial songs, that were played. I quite enjoyed hearing them without knowing

exactly what the words were. This was early WW2 propaganda.

I also discovered that you could hear long distance on the broadcast band, and was overjoyed to hear European, Asiatic and American stations. I was particularly pleased to hear so many American stations.

I also became acquainted with sending listener reports and the thrill of receiving confirmation of my reports: the QSL card. My pride and joy was the reception of WOAI in San Antonio Texas. Broadcasting on a clear channel with 50 kilowatts, to the world. I was sent their QSL and regularly received station promotional material. I even heard my report read over the air.

"A report from our most distant listener... Leonard Poynter in Melbourne Australia... hears us often ... conditions permitting". Greeting Leonard from your friends in San Antonio Texas"

I was to hear many low powered German stations. One in particular normally running 25 watts, but only using their standby transmitter on 10 watts. Those were the heady days of BCB DX (DX means long distance). This was toward the end of the war.

Being part of it all

On short wave I was to listen to many South East Asian station toward the end of the war. My best one was to listen to the last ten minutes of radio Shonan (Singapore) under Japanese control and the first broadcasts under allied control. Then there were messages from Australian prisoners of war from Radio Shonan, passed on to the Red Cross. The war finished and hundreds of US hams started to flood the 20 metre band. it was a real pleasure to be part of it all, even as just a listener. It was to be some time before I was an active participant.

With the return of amateur radio in Australia the first thing that changed was no more broadcast band amateur stations. That put an end to my ambitions of my own radio station. I had to learn about the communication part of the hobby at a later date.

I guess I was too busy enjoying myself in the ensuing years and the only contact I had with amateur radio was during my stay in England when I met up with G3EOG who was just up the road from where I lived in Southampton. I had a few enjoyable hours chatting to friends

in the West Indies. I also had a good receiver during my sojourn in Southampton and was able to hear many VK contacts into England on 20 metres. This did make me aware of the values of amateur radio.

After my return from England and my marriage I began to take a more active interest. In the late 1950s the WIA formed a short wave listeners group. I joined and became an Office Bearer. I can't recall my SWL number. There are still a few originals around.

When living in Tottenham I built some 288MHz gear. A modulated oscillator transmitter and a super regenerative receiver. I had built a 16 element phased array and began my amateur career as a pirate: VK3~~ and had many interesting contacts over the city and as far as Ballarat.

On moving to West Heidelberg, I commenced a course with the Wireless Institute to acquire the knowledge to sit for my licence. That was early 1958. I sat for the July exam for experience but was agreeably surprised to find the examination paper was a piece of cake.

I passed!

When the results came out I had passed and became VK3ZGP in September 1958. I had achieved my ambition: my amateur licence. A little different to what I had envisaged, but I was there. The next hurdle was to equip my station. In those days it was virtually impossible to purchase any equipment, unless you were rich. I wasn't, so I had to build mine. I constructed a three stage crystal controlled transmitter and a converter for the 50 MHz 6 metre band. Fairly straight forward 6CL6 oscillator, 6CL6 multiplier, 832A final about 20 watts input. Modulators in those days was push pull 6L6's in AB1 and a crystal microphone. I had built a version of the BiSquare antenna: a relative of the Cubical Quad and got it up to 35 feet.

Joining WIA

In the early 60's I joined the WIA VHF Group which was a very large group. It was reformed and I was chairman for a while. Some well known amateurs of today were members of that group.

Almost immediately, I was into the DX. In those days interstate was the best DX: VK's 1, 2, 4, 5, 6, 7, 8 and 9. The real DX across to New Zealand: ZL's 1, 2, 3

and 4. When VK9 became P2, it was also like working real DX. I made WAVKCA on 6 metres after working VK0.

TV: the bane of the amateur!

At the same time I learned all about TVI: television interference. The bane of the amateur: front end overloading of the television set. I had some 30 televisions within 100 metres of me. The solution to that problem was quite simple. A trap across the antenna terminals of the TV to trap out my signals. Very effective in those days. I could live again. One of the problems was poor antenna design and installation. The geographical location and bad luck. The trap cured most of the problems, except for the people who took the traps off.

In 1960, we moved to Fawkner that was another situation. Took a while to get up and going, but eventually we got there. Then channel 0 arrived and a whole new ball game started. There was so much trouble that I was forced into semi retirement.

My favourite band in Melbourne was all but useless. I did manage to make it into Japan when I had the use of a 6 metre SSB transceiver and this was a bonus. Over the following years those who did not have channel 0 problems began to work the world. I got involved with credit unions and that kept me out of mischief for quite a few years.

Back to VHF

In 1973 I was able to purchase a used Yaesu FT200 SSB transceiver. I had visions of getting onto VHF again with more up to date gear. I had made a new friend who had just got his full call: VK3WU Alan Greening from Glenroy. Got into the habit of visiting him at the weekend. He constructed a cubical quad for 20 metres and had an old AM/CW transmitter.

Suggested we try my FT200 on the quad and we started to have a ball. The quad really worked; so too did the FT200. We were having great fun working new country after new country. We decided to try and make a DXCC in 12 months. That is to make contact with, and confirm a two way contact with 100 countries. Although it was quiet sunspot wise, we found it relatively easy to pile on the countries. Though, it was a little tough keeping the late hours we did.

Burning the midnight oil!

The band did not come alive until late evening and then going until the wee small hours. We burnt a lot of midnight oil, but we had a fabulous time. We even worked shifts to keep the DX happy and rolling. Many contacts were with stations working their first and only VK. Very satisfying to all. Well, we did it. In just 365 days we worked 252 countries to achieve 100 confirmations! It was hard work but we enjoyed every bit of it. As a result of this I became interested in propagation. Trying to find out why and how there were times you could and times you couldn't. Others talked about sunspots, the solar flux and A index. They were then starting to become available through WWV. I started to study available information about the phenomenon. Did I find some information? I could not believe how much was available on the subject. For that matter how many experts were prepared to go into print on the subject, and their pet theories. Very baffling to the uninitiated. I was able to gain access to all locally measured and recorded data. This told me how local conditions could be at variance with the empirical models of the ionosphere. No matter what happens (for it to directly affect you) the path has to be in daylight. Then a storm will affect your communications. The warnings given by WWV are of importance, specifically if the time of the event is known. I developed a nose for sniffing out events as they were about to happen; particularly recurring events.

Why is it to your advantage to keep a record of solar activity?

I found it was to my advantage to be on HF to follow events, observe the effects and note what these events produced.

This culminated with the arrival on the Novice class licence. Had to make 5WPM Morse then sat for the first Novice examination and finished as VK3NAC: No 3 Novice licence in Victoria. I then started to earnestly DX on 21MHz and 28MHz. I tried to use all my knowledge and experience when I commenced operations.

Morse therapy

I genuinely became interested in using the Morse code and CW, spending a considerable part of my time on CW. I made the first Novice WAC and first Novice DXCC. I made a CW WAS on 21MHz, not the first novice as a VK2 had made it on 28MHz SSB. I had worked some 5000 W's as a novice and the majority on CW. That was across the period 1977-1979. I was working toward my full call late in 1979 when I had a slight stroke (CVA), and finished up in hospital on the day of the Morse test. When I was discharged I had lost the use of my right arm (temporarily). My rehabilitation was using the Morse key. Supporting my right wrist with my left hand I was able to use the key, slowly getting back the use of my right hand with flexibility and to also write again. That was a relief. I was able to sit the first test in 1980. I made the full licence and the call VK3BYE; surrendering VK3ZGP and VK3NAC.

It was then into more serious DXing. I finished on 28 MHz in 1982; the band was no longer open when I was around. I purchased a 3 element monoband Yagi for 14MHz and proceed to make hat while the sun shone. Though it was a sunspot minimum I was able to work a fair share of the DX. I had obtained a TS820S with external VFO and a 500Hz CW filter in 1979.

Working very well on 28 MHz along with a 5 element Yagi and worked around 200 countries on 10 metres, before going to 20 metres. Working the DX at the time was limited by the usual commitments, but I managed a fair share.

On retiring in 1986, at the bottom of the cycle, I spent about 6 months waiting for the commencement of the new cycle. This kicked off in May 1987 and my knowledge of the signs of the new cycle enabled me to get a good start into North America before the big guns started firing. I was fortunate to be able to work many new countries in the oncoming years. I spent 75% of my time on CW, only using a hand key. I had incurred a disability after my CVA in 1979. I had difficulty in reading anything faster than 10WPM and, as I could not remember, I had to write it down.

So long as the speed remained constant I was safe. Most of the time I got by. I slowly took my country count

to 287 confirmed. there are another 20 that I will never get confirmed as I had a thing about direct QSLing for a few years.

I have lost all chance of them being confirmed, unless I can work them again in the future. At the peak of my activity I was able to manage up to 35 CW QSO's a day and the odd batch of CW contacts. I had made many friends all over the world and over the years have had visits "eyeball QSO's" with about 25 hams from USA, Holland, Japan, Germany and England.

Still a challenge

I have retired from 20 metres now. My antenna has been damaged beyond repair. I have since rebuilt my 21 MHz 4 element monoband Yagi and patiently await the return of conditions to get into the DX again. Somewhere along the way the TS820S or I will bite the dust. Don't know who will be first. I haven't regretted my decision to become an amateur. I feel that it was and still is a challenge. I have always operated with a minimum of equipment. Fortunately, I have had some good antennas, especially my 9 element long Yagi on 6 metres. The 30 foot boom did a beaut job but the TVI problem short-circuited that. But, I had a great time being one of the mob. My only regret: missed working JY1. Perhaps one day.

PS

Some two years later I look back at events over the period. I had plunged into DX on 21MHz. This was in the ascending period of cycle 23. Yes my TS820S did bite the dust not long after I posted the above comment. It proved to be a difficult repair. I eventually replaced the finals and all the high voltage capacitors. There were other glitches but with the assistance of my learned friends out of the chaos it re-emerged; not quite the old box of tricks but still capable!

Career Highlight comes late

The DX season of 1997/1998 was to be the highlight of my career. On 1 January 1998 I managed 48 QSO's. By far the best effort I have ever participated in. Over the remainder of the year and into 1999 I was able to greatly increase my DX totals. Then early in 1999

following the installation of telephones via the street coaxial cable I became aware of what I considered interference being radiated from the cable. Following requests to the operator and tests with various filters it was now apparent that life on the DX bands was not going to be the same. It was well nigh on impossible to hear weak signals arriving via my 4 element Yagi. I had to make some big decisions.

Unfortunately, on the side a domestic problem had been building for some years reached a climax. To settle the situation we made the decision to put our home up for sale. I decided to completely retire from chasing DX. Neither decisions were easy to make. In September 1999 VK3BYE closed down from the Fawknor QTH.

For the time being VK3BYE continues to operate on 144MHz, chatting with a small group of friends.

73, Len Poynter VK3BYE

ar


*For All Your
Requirements*

AUTHORISED DEALER

ICOM

KENWOOD

AMATEUR COMMERCIAL



14 Mary Street
Hazelmere
Western Australia 6055
Telephone: (08) 9274 1118
Facsimile: (08) 9250 3734
E-mail: tower@con.net.au
www: http://www.tower-visionimage.com.au

Noise Cancelling at HF and VHF

Ian Cowan, VK1BG.

This is a story which tells how an old ATU was used to rid the HF bands of crud from nearby switch mode power supplies, and in turn to rid the two metre band of some very annoying computer type birdies

For some time now I have been the victim of what must surely be some of the dirtiest switch mode power supplies in the business. I suspect that the offending equipment is installed in a house near mine. It is in operation most of the time, puts unstable S9+ birdies every few kHz across the 80 and 40 metre bands, and between the birdies there is continuous hash of S7 or greater. The crud from this equipment extends to the higher bands, but the levels fall with frequency, and it is most offensive below 10 MHz. Not only that, but this gear also radiates in the two metre band, with two distinct noise centre frequencies at 144.185 and 144.235 MHz (the former being a recent addition) and masses of birdies extending up and down from each of these.

This has gone on for some time, but I have until recently done nothing to counteract the noise, hoping, I think, for the obviously inferior equipment to self

destruct or otherwise be replaced with something modern. So it was some time before I built up enough angst to do anything about it. The belated result is a design that is capable of killing the noise completely on both HF and 2 metres, and leaves me wondering why it took me so long to do so little for such a good result. The outcome of this exercise may be of interest to others, so the general arrangement described below.

There have been several articles published in this magazine about noise cancellers including a passive design by Drew Diamond, VK3XU, which appeared in October 1976, and two active designs by Lloyd Butler, VK5BR which appeared in September 1992 and January 1993. All use the same basic idea; namely that two antennas are used simultaneously for reception. The main station antenna is used as the primary gatherer of the wanted signal. This also

picks up crud, which spoils the signal to noise ratio at the receiver front end. A second antenna is used to pick up as much of the offending crud as possible, but preferably not much of the wanted signal. The crud antenna need not be anything flash, but the closer it is located to the noise source the better. Drew Diamond suggests a wire strung along the boundary fence, and that sounds good to me. Because the two antennas are separated in space, the outputs of the two differ in phase, and the phase relationships should be different in each for the wanted signal with respect to the noise. By careful adjustment of the phase and amplitude of the signal from the crud antenna with relation to that from the station antenna, it is possible to cancel out the crud without significantly affecting the wanted signal. This is a result akin to magic!

The approaches by Drew Diamond and Lloyd Butler did not entirely suit

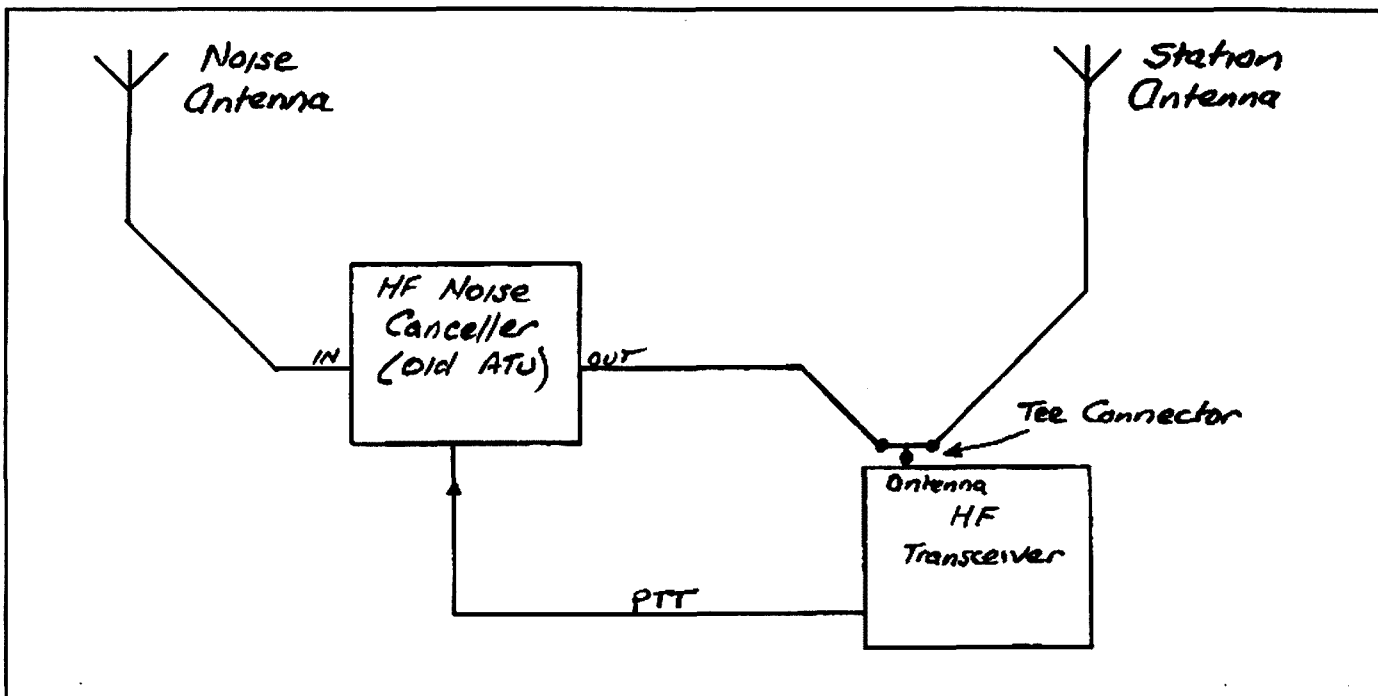


Figure 1

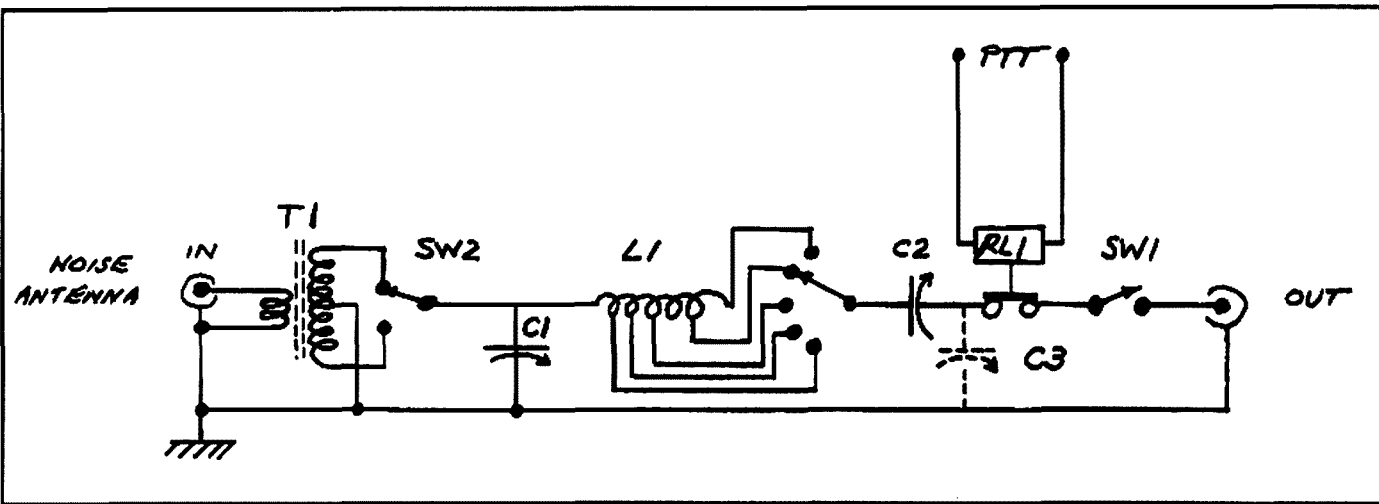


Figure 2

me. Drew's approach made use of potentiometers in the signal path, and Lloyd's meant undertaking some solid state construction. Both approaches require fairly extensive external RF relay work for their use with a transceiver. I was after a quick fix, and started with HF.

It so happens that there was a redundant HF ATU sitting on my shelf. This unit is a derivation of the wide range ATU described by Ron Cook, VK3AFW, in the February 1983 issue of the magazine. Its most interesting feature is that it uses a series tuned circuit arrangement (plus shunt capacitors) to achieve the wide matching capability. A series tuned circuit can provide substantial phase shifts when tuned either side of resonance. It also happens that there already was a second HF antenna available at my QTH, and that it collects even more crud than does my main station antenna, as it is closer to the offending noise source. My quick fix solution for the HF problem was to use the old ATU to provide the necessary phase and amplitude control of the noise from the second antenna, and to feed this into the transceiver, along with the signal from the main station antenna, via an ordinary coaxial Tee fitting. Figure 1 shows the general idea, while figure 2 details the circuit of the noise canceller module. In practice the old ATU is connected backwards, in that the nominal input of the ATU, which normally would go to the transceiver, connects to the crud antenna instead. A normally closed contact on a relay powered from the PTT line in the transceiver was added to the ATU, and

isolates the noise canceller when transmitting.

The system worked well from the beginning. 80 and 40 metres were virtually unusable without the noise canceller, but with it, the crud could usually be tuned out completely. With the original configuration, finding a null could be a bit tricky on some frequencies, involving juggling the settings on three capacitors to get the best result. To overcome this, I have followed the lead of Diamond and Butler, and installed a phase reversal switch. This makes finding a null easier and eliminates the need for one of the three variable capacitors (shown as C3 on figure 2) as well. It does not take long to find the best settings for a deep null, and it is like magic when doing this on a really loud birdie to discover that underneath it is a clean intelligible signal. An unexpected bonus is that the noise canceller can also be used to cancel out other forms of electrical noise (commutator or power line noise for example) but it can only fully null out one source of noise at a time. Drat!

Looking more closely at Figure 2, SW1 and RL1 provide for manual and PTT isolation of the noise canceller from the transceiver. RL1 prevents energisation of the sense antenna through the noise canceller when transmitting, and SW1 allows the system to be disabled when not required. T1 and SW2 provide 180 degree phase switching, useful for speeding up the null finding process. T1 is a small toroid that has a trifilar winding of about 10 turns wound onto it. I don't think the number of turns or type of toroid is at all critical. C1 has

capacity variable up to about 1200pF. In my case it comprises a three gang tuning capacitor from an old valve type broadcast receiver, but there are other ways of getting the necessary variable capacitance, for example switched fixed capacitors and a smaller variable.

L1 and C2 form the series tuned circuit which is the heart of the system. C2 is a variable capacitor that can be somewhere between 50 pF and 100 pF. It is mounted on an insulating support, and is fitted with a plastic control shaft to maintain isolation from ground. The coil L1 is also non-critical. Mine is fairly large as a result of its ATU heritage. It comprises about 40 turns wound onto a piece of plastic drain pipe about 43 mm outside diameter. Taps are selected to provide for resonance in the bands of interest with C2 at about mid range. The whole lot is built into a small aluminium box.

There is nothing hard about the installation of this system provided a decent amount of crud can be collected the noise sensing antenna. This can be checked by comparing noise levels at the transceiver, when each antenna is connected alone. I have the choice of two antennae for noise pickup. The first is a half size G5RV that I used for my first noise cancelling experiments the other is a random long wire which runs along the back fence. Both work OK, but the long wire performs better on 80 metres, so I use it as a matter of course.

Tuning for a noise null is largely a matter of selecting the appropriate coil tap and then juggling the capacitor settings to first find, then refine the null. If there is no null, or it is too shallow,

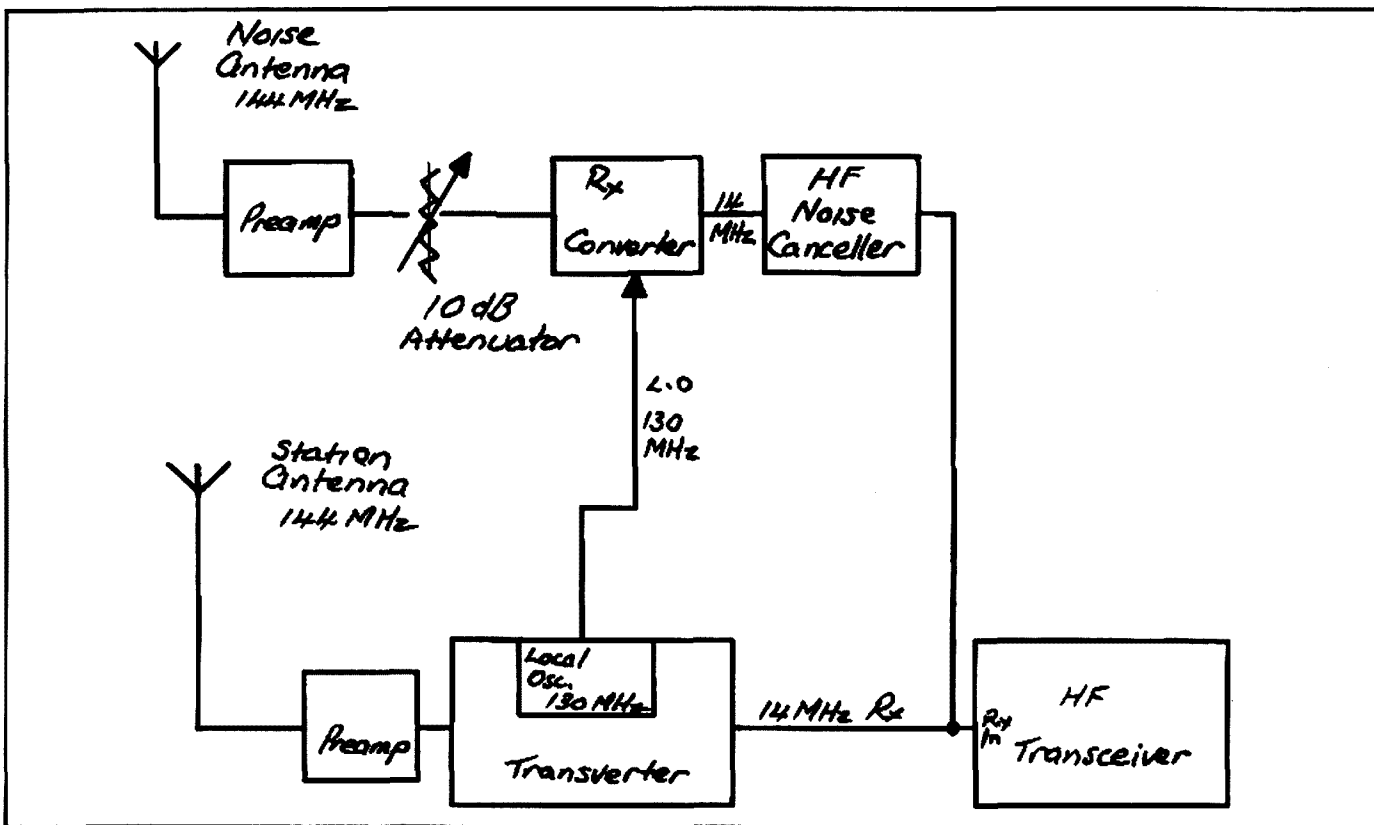


Figure 3

repeat the exercise with the phase selector switch in the other position. There is often more than one combination of capacitor settings to achieve a null.

The success of the HF canceller led to some more experiments to see if the principle would also work on 2 metres. In this case I was not confident that phase cancellation could be easily achieved directly at 144 MHz, and in addition I did not want to put anything in the signal path which might degrade the noise factor of the station receiver when the crud was not present. My 144 MHz station uses a home brew transverter to allow access to the SSB portion of the two metre band using an old FT101E as the base transceiver. So I opted to perform the cancellation at the first IF, which in my station is 14 MHz. This was simply performed using an old two metre converter that happened to be in my junk box, modified to accept the master oscillator signal generated by the main transceiver. This modification was essential, as it is the only way the outputs of this external converter, and that already in the transverter can be guaranteed to remain locked in phase. Without this, phase cancellation at the IF would be impossible. The general

configuration is shown at Figure 3. For simplicity this shows the receive line only. The noise antenna is a 5 element NBS type Yagi, pointed at the suspected noise source (and away from the station antenna). Because it has lower gain than the normal station antenna, and because of the necessarily long cable run from it to my shack, I have used a preamplifier (also from the junk box) at the antenna so as to yield plenty of noise signal in the shack to play with, and I control its output in the shack with an adjustable 10dB attenuator (Neither of these measures was found necessary with the HF canceller). The HF part of the noise canceller configuration is the same as in the HF version shown in figure 2, though there is no need for band switching for operation on a single VHF band. Isolation of the system when not needed is achieved using SW1 in the noise canceller. As the canceller in the VHF system is outside the transmit signal path, there is no need for a PTT operated isolation relay.

Once set up, the adjustment of the VHF canceller is the same as for HF, except that the best noise nulls are achieved by adjusting the noise preamp output as well as the capacitors in the HF noise canceller.

The improvement offered by the VHF canceller is just as dramatic as that from the HF version, and because the VHF noise sources appear to be crystal stabilised there is little need for tweaking to counteract frequency drift of the noise. However readjustment is needed to compensate for rotation of the main station antenna as this affects both the phase and amplitude of the noise signal picked up by that antenna. In my case this is an acceptable imposition, as I generally don't need noise cancellation except when beaming NorthEast.

For me, the result of this exercise has been better than expected, and I have regained the use of the 80 and 40 metre bands, and the North East sector on 144 MHz. There are undoubtedly other amateur radio operators living close to people with non EMC compliant electrical equipment, and the simple approach to noise cancellation presented above may provide some ideas leading to a quick, cheap and effective remedy, hopefully making use of odds and ends from the station junk box.

73 de Ian Cowan, VK1BG.

ar

Easy CW-2

David A. Pilley VK2AYD
e-mail: davpil@midcoast.com.au

In AR December 1998, I introduced you to "Easy CW" and a simple way to decode good telegraphy from your receiver to the computer. The response was good and I hope that all those that made the simple interface unit enjoyed the results.

The transmitting side is even easier! I recently had the opportunity to evaluate the "WINCW" programme developed by Stephen Stunz, NOBF. This is simplicity in the making!

The programme has been designed for Windows 3.11, 95 and 97 and is quite small, only requiring 61 kb of hard disk space. This includes the .exe, .dll, .ico and .set files. It arrived on a standard 3.5 inch floppy and was very easy to install.

I installed the programme on an old 486SX machine that operates under Windows 3.11. This is my work horse computer that is used for contesting, logging, electronic workshop, etc. It's ancient, but never fails me. It grew up with me - and I'm ancient! The programme took only a few seconds to install and, using my existing keying cable attached to serial port 2, I was sending telegraphy.

The programme is a full screen display, with a menu bar that really is a reminder pad in case you forget the "F" key or "Ctrl" key functions. You can store 10 messages and call them up as needed and they can be edited at any time. A "repeat" function is provided so that the message(s) can be repeated at time intervals, like calling "CQ". The code speed can be from 5 to 90 wpm. Yes - 5 wpm without a pump handle to send it! Side tone is provided from the computer speaker so you also practice "off air".

A buffer, or backspace-correction, is provided so if you are a speed typist at say 50 wpm and you are only sending at 20 wpm, you can back space and correct any errors before it is sent. NO, you can't correct it after you have sent it!

Provision is made for the selection of serial port so you are not stuck with Com

1. However, you will need to make up an interface cable between the computer and your transmitter. You will have to search through the junk box for a PNP transistor and a 10k resistor. This is to protect the computer from any fancy keying voltage getting back into the computer. If you do have any high voltage keying systems, you should provide a relay to interface.

I also installed the programme on the Pentium III 550. Again, simple and no problem. For those interested in adding this to your modus operandi, you can obtain a copy of the programme directly from Stephen Stunz NOBF, 3413N Duffield Ave., Loveland, CO 80538.

Cost: \$US25 plus postage.

73

David VK2AYD
ar



S.P. Smith VK2SPS

4/6 Taranto Rd, Marsfield NSW 2122
Phone (H) 02 9876 8264 (M) 0419 602 520

Ham Radio Accessories are the sole agents in Australia for the German made Schurr hand made keys and Iambic Paddles.

I've used these keys over the years and have some in my collection; the keys and paddles are made of full brass MS 58. Hard silver is used for the contacts with needle bearings of finely sanded hardened steel. The brass surfaces have been polished and are tarnish proof. All keys and paddles are supplied with a flexible cable and are hand made in Germany.

Some of the Keys and Paddles offered are as follows: -

Mahogany Hand Key	\$349.00
Small Straight Key	\$279.00
Mini Key	\$209.00

Profi - 2 (Iambic Paddle) \$369.00
Portable Iambic Paddle \$309.00
Further enquiries can be made to: -
Ham Radio Accessories,
Carsten Alex Pedersen VK40A
98 Thiess Drive
Albany Creek QLD 4035
Ph: 07 3264 6443 Fax: 07 3264 1774
E-mail: pedersen@powerup.com.au
"The Art and Skill of Radio
Telegraphy" by William Pierport NO HFF
This great book is now available in
"French" and was kindly translated by
Maurice Golombani-Gaillieur F6IIE, it
can be downloaded from: - h t t p : / /
f6iie.free.fr

Other interesting websites to look at are:
1) <http://www.net-magic.net/users/w4fok/>

2) Dr Jon Oates - <http://www.joates.demon.co.uk/megs/>
3) Dave Clarke - <http://www.raes.ab.ca/book/index.html>

I have a special request to ask of readers of this column. I am trying to obtain information especially drawings of and photographs of the vessel "Empress of India" first of the Canadian Pacific Railways Royal Mail Line to the Orient. The Skipper was Capt O. Marshall, her sister ships were - Empress of Japan and Empress of China. They were built by the Naval Construction & Armament Company at Barrow-in-Furness. Any information would be greatly appreciated.

See you next month.
Stephen P. Smith VK2SPS

ar

Lighthouse weekend wash up

Ross Barlin, VK2DVZ
rbarlin@turboweb.net.au

A great weekend was had by all at the Crowdy Head lighthouse (QF68jd) over the 21-22 August weekend. The AX2000 special event call sign also proved to be very much sought after, particularly on the HF bands.

On 2m we managed to work as far north as VK4TZL at Hervey Bay (QG65), VK4IC (QG63) and VK4ALM (QG62) and to the south VK1VP and VK2MP (QF44). A few traces of the boys at Green Cape lighthouse (QF52) were heard on 2m on Sunday morning, but the signals did not rise enough to manage a contact. All the same to hear some signals from a halo antenna, if I'm not mistaken, over an approximate distance of 640 km with a very average setup using a 12 element DL6WU Yagi and RX preamp in the 80 watt solid state PA. was pleasing to say the least.

I hope to try out a halo for myself some time to get a feel for what they are capable of.

On 70 cm we did not fare as well, with just a hand full of contacts.

Thanks to those who made the effort to work us. We look forward to more contacts when next we work portable from Crowdy Head.

Incidentally, the light house keeper is a great bloke with a lot of experience with many of the 'exotic' locations around our vast coastline. He gave us access to the building after we gained permission from AMSA, encouraged us in our efforts, joined in our BBQ's, shared our overnight accommodation and invited us back again. Perhaps we will be able to get him to join us with a VK call sign sometime in the future?

The public relations side of things went off well, with the TV crew arriving



Taree ARC, AX2000: from left Ross VK2DVZ, John VK2SWR, Roy VK2EBR, Kevin VK2ZKC, Ken VK2KYO

before we were properly set with transmitters, etc. They still gave our setup a good airing on the local news broadcast on Saturday evening. On Sunday, the local newspaper photographer arrived and took lots of shots, so we wait to see what will come out in the way of a story. They gave us at least 3 lots of pre event write ups before last weekend.

A steady stream of visitors came by to enjoy the scenery, watch for whales, and to see what the 'mad amateurs' were up to. We gave out our information sheets about amateur radio, the weekend and our local club. Members the Great Lakes

amateur radio club also called by to offer encouragement and to check cut their neighbouring club in action.

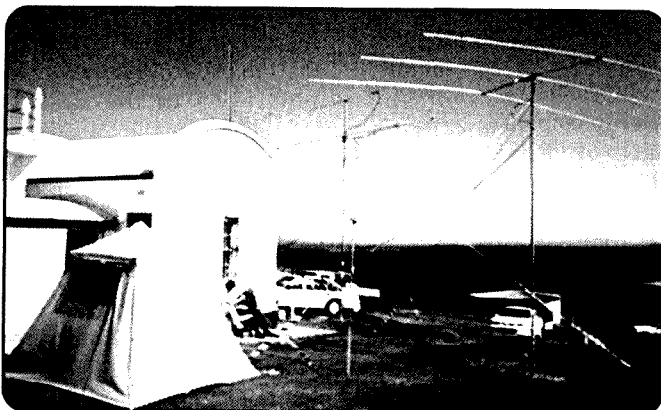
Sleep was short with most of the participants having at most two to two and a half hours rest. We have since made up for the loss.

Much was learned as a result of the outing; so next time those bugs will be sorted out.

I hope all other participants around VK, ZL and in fact around the world enjoyed the non contest weekend as much as members of the Taree and District Amateur Radio Club Inc. did.

73 and good DX, de Ross Barlin, VK2DVZ

ar



Two views of Crowdy Head Lighthouse

Robin L. Harwood

After the Ball

Well the XXVII Olympiad and the Paralympics that followed shortly after, have both now ended and all the hoopla has now subsided. However because of the vexed question of rights, many shortwave stations did not broadcast live events, either over shortwave or over their Internet browser. In fact, organizations like the BBC and our own ABC, completely closed down their audio streams in case any Olympic events were accidentally aired live. Apparently the American NBC network acquired the Internet rights to stream events on to the Net, which was not openly available but on subscription. A similar arrangement apparently was in place here in Australia with access1. They apparently had the C7 Pay TV only available on subscription.

The NBC network decided to delay telecasts of the events by up to 12 to 18 hours, airing them in prime time in the evening, so as to maximize advertising exposure. However it backfired as most managed to get the results from the Net or from news sources. However other networks that did not have the rights were not able to show highlights in their newscasts before the particular event had been first shown on NBC. They had to rely on still photos and a report from somebody well away from the Olympic venue. Also the IOC was particularly suspicious of the Internet and many dot.com reporters were not accredited.

Our own Radio Australia did broadcast the Games live around the clock and many thousands tuned in to hear the broadcasts on two dedicated frequencies. However if the Darwin site had been available or arrangements made for the use of overseas relays, the audience would have been in the millions instead of the thousands. The BBC World Service did have some descriptions available but they seemed to be replays.

The main Trans-Pacific HF channels for aero communications from Brisbane were really busy on the day after the

Olympic Closing Ceremony, when everybody wanted to get home speedily. I have never heard the channels as busy as they were on that day.

The Paralympics were not as frenetic as the Olympics, with a lower profile. The publicity was not as extensive as the main Games, another network had the rights and the media presence was not as large.

In Late September, Radio Netherlands announced that their very popular communications programme, *Media Network* was no longer going to be broadcast over radio as from the 26th of October. Jonathon Marks has been producing the programme since 1980 and was joined in recent years by Diana Jansen. Diana left the programme in mid September

And as Jonathon had other commitments with the RN organization, it was felt that the programme had outlived its usefulness. The programme may have ended on radio but it will be available on the Internet as what they call an *e-zine* or electronic magazine from the RN website. Former WRTH editor, Andy Sennitt, will be compiling it.

Naturally there are many upset fans of *Media Network*, including yours truly. As many have pointed out, the majority of shortwave listeners do not have Internet access, especially in Asia, Africa and other regions lacking a suitable communications infrastructure. The cost of the Internet means that only a very select few have ready access to the Net. As the Olympics Internet saga has demonstrated, commercial as well as political interests can muzzle the Net, when there is a perceived conflict of interest.

Dr. Kim Andrew Elliott, will continue to host *Communications World* over the VOA on Saturdays. It is the natural successor to "MN". Glenn Hauser does host a weekly review of media developments, aired over several stations yet it has to be recorded in

advance for some stations. Marie Lamb hosts *Cumbre* over World Harvest Radio (WHRI, WHRA & KWHR) but this is primarily a DX programme. I have not heard HCJB's *DX Partyline* for some time.

The next broadcasting period (B00) commenced on the 29th of October at 0100 UTC.

Expect quite a number of changes and even whispers of a major international broadcaster quitting HF altogether. Programming to Europe and North America has been steadily declining and this decline will probably escalate. However shortwave is far from dying as there are plenty of signals still about. You only have to hear the thousands of voices on SSB all over the HF spectrum, often ignoring ITU bandplans to realize that shortwave is still being used to communicate.

The Croatian Radio from Zagreb, ceased broadcasting from the Julich, Germany site as from September 30th. This was a good signal here into Australia and interesting also as it had a short English news broadcasts during their broadcasts. However European monitors report that Croatian programs are continuing from the site of Deanovac in Croatia in the 49 metre band as well as 9830 kHz. Radio Yugoslavia also lost the use of the senders that are in Bosnia.

The Presidential election will be held on Tuesday November 7th and results will be available on Wednesday from about midnight UTC. Expect extensive coverage on the VOA and the BBC World Service on shortwave. Incidentally those AFRTS stations I mentioned recently being back on shortwave have been easily heard here. However each feeder has a separate programming source, allowing a wider choice. 6350 is the best channel here. However I am unsure which base it is coming from.

Well that is all for this month. Until next time, all the best in monitoring

Robin L. Harwood

Gil Sones
30 Moore Street, Box Hill South, Vic 3128

Low Band Receiving Antennas

Receiving DX signals on 160 metres and 80 metres is often limited by noise and interference. A directional antenna can help by reducing noise and interference coming from different directions to the wanted DX signal. The Beverage antenna is well known but it requires a lot of land to accommodate it. There are other approaches such as loops and the EWE antenna. The EWE antenna was described in QST Feb 1995 by WA2WVL.

A group of ground independent terminated receiving antennas was described in QST July 2000 by Earl W. Cunningham K6SE. These antennas are the Flag, Delta, Pennant, and Diamond antennas. These antennas and the EWE are shown in Fig 1. Work on these antenna designs has been carried out in a number of cases by Jose EA3VY.

A 160 metre Point Terminated Pennant has a 14 foot vertical section with the point of the pennant 29 feet from the vertical section. The bottom of the pennant is 6 feet above ground and

the terminating resistor is 903 ohms. The antenna has a cardioid pattern with a 37.5 dB null at the rear. Feedpoint resistance is 860 ohms. The antenna is not greatly affected for antenna heights between 1 foot and 25 feet. The antenna exhibits a deep null to the rear on both 80 and 40 metres and the feed impedance is still around 900 ohms. The pattern is shown in Fig 2. and Fig 3. The patterns are typical of all of this type of antennas.

A variant is the Point Fed Pennant. The dimensions are the same but the terminating resistor is 860 ohms and the

feedpoint impedance is 903 ohms. The performance is similar to the Point Terminated Pennant.

The Flag was developed by EA3VY to reduce the effect of the earth on a EWE design. The vertical sides of the Flag are 14 feet with the two horizontal sides being 29 feet long. The feed point and the termination are in the middle of the vertical sides. The feed point resistance and the termination resistance are both 945 ohms on 160 metres. The null at the rear of the cardioid pattern is 35 dB with respect to the front. The performance is similar on both 80 metres and 40 metres. The signals from the Flag are 5 to 6 dB greater than from a Pennant on 160 metres.

The Diamond is a rotatable version of this class of antennas. The vertical dimension is 14 feet and the horizontal dimension is 29 feet. The termination and feed point impedances are 925 ohms.

The Delta is another rotatable configuration which is 17 feet vertically and 28 feet horizontally. The feed point and terminating resistances are 948 ohms on 160 metres.

To feed the 900 ohm feed point impedance a transformer is required. The author used a Palomar FT-140-43

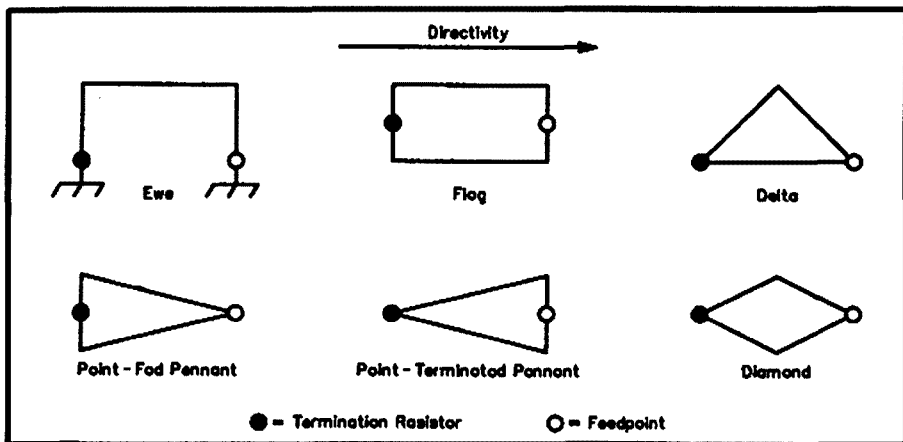


Fig 1. Ground Independent Low Band Receiving Antenna Configurations.

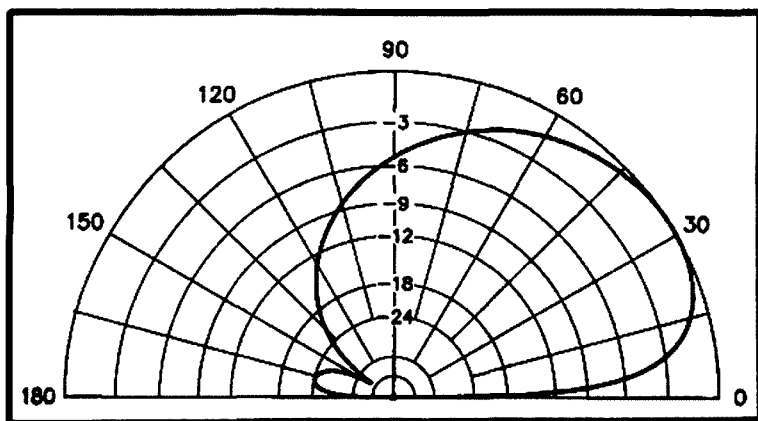


Fig 2. Elevation Plot of Point Fed Pennant over good ground.

Commercial RF Probe

For those who just want to use an RF probe there is a commercial RF probe which is available from a local firm. It has wide frequency response and good performance. It has been on show at some clubs and hamfests. It is available from RF Probes PO Box 6 Greensborough Vic 3088. The company can also be found on the web at www.rfprobes.com.au.

toroid core to wind a transformer. The primary and secondary were wound on opposite sides of the toroid core. The low impedance winding was 8 turns. The high impedance winding was 34 turns if 50 ohm coax is used and 28 turns for 75 ohm coax.

The use of a preamp is recommended as the antennas have low gain. Also to reduce common mode currents on the cable a choke balun is recommended at the transformer end of the cable. A suitable choke balun can be made by winding a coil of 10 or 12 turns of the feedline 12 inches in diameter. An alternative choke is to cover about 12 inches of the cable feedline with high- μ ferrite beads.

The antennas were modelled with EZNEC which is available from Roy Lewallen W7EL, PO Box 6658 Beaverton OR 97007 USA. Email is w7el@teleport.com .

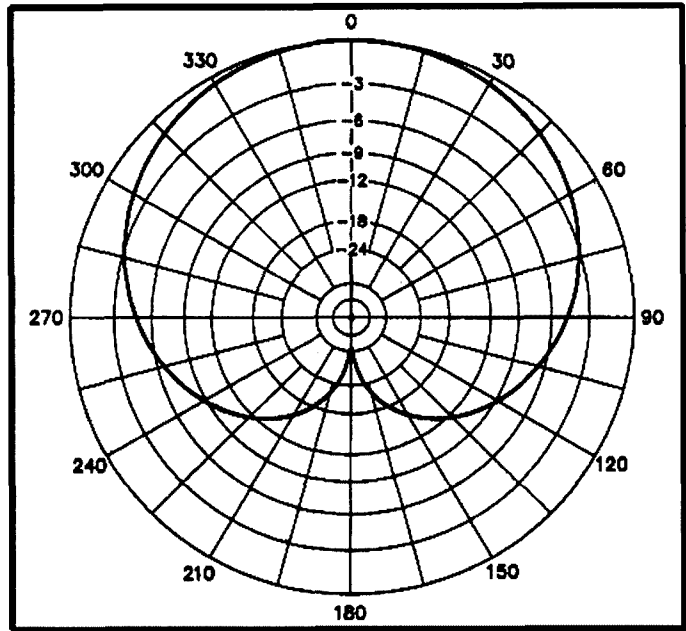


Fig 3. Azimuth Plot of Point Fed Pennant at 30 degree elevation angle over good ground.

Diode Probe

Following publication of the RF Probe in the April issue VK4BBL referred the item to his friend Ned Raub W1RAN who responded with a different design.

Ned W1RAN pointed out that the use of a 1.8 pF coupling capacitor and an RFC in the probe could lead to some problems. The capacitor value will limit the lower frequency performance and the RFC can influence performance at both the lower and the upper frequencies. The design of wide range inductors for RFC's is complex and compromises are made.

Ned W1RAN proposes a circuit shown in Fig 4. which is reminiscent of the circuit published in Jan which prompted

the circuit published in April. Ned uses a 10 nF coupling capacitor to a shunt diode followed by a 1 Mohm resistor to another 10 nF filter capacitor at the output to a high input impedance DVM.

The 10 nF capacitor is charged rapidly on the first negative half cycle and is subject only to the drain of the 1 Mohm resistor and the DVM. Thus on the following positive half cycle the loading is minimal as the coupling capacitor is charged and the only loading is the 1 Mohm resistor and the back biased diode. On the subsequent negative half cycle the still charged capacitor is of little account for loading. The circuit loads the circuit only with the current

through the 1 Mohm resistor and the DVM input impedance.

The circuit supplies close to twice the peak voltage to a high input impedance DVM input. For 10 Mohm input impedance of the DVM the input divider of the 1 Mohm resistor and the 10 Mohm input will present an input to the DVM close to 90% of twice the peak RF voltage. To read peak voltage a DVM input impedance of 1 Mohm is required. This can be achieved by using a shunt resistor at the DVM input. For RMS reading then the 1 Mohm should be 1.36 Mohm and the DVM input should be shunted to 636 Kohm.

ar

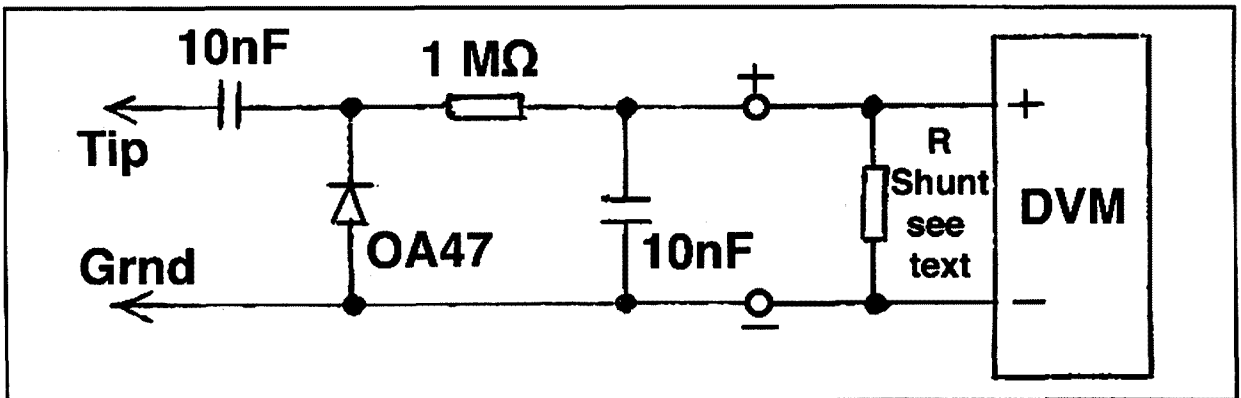


Fig 4 RF Probe.



Women in

YL2000 International From Hamilton



Back row: Bev VK6DE, KayWAØWOF, Sally VK4SHE, Christine VK5CTY

Row 3: Muriel (SWL), Maria VK5BMT, Unni LA6RHA, Bev ZL1IOS (hidden), Lynn ZL2PQ, Ruth LA6ZH, Evelyne F8RPB, Ella GØFIP, June VK4SJ, Eileen ZL1BRX, Fortuna ZL1TOZ, Ruth IT9ESZ, Dot VK2DB, Margaret ZL3UD, Jill ZL1BDO, Celia ZL1ALK

Row 2: Biny ZL2AZY, Rosemary ZL1WRD, Jaqueline ZL1JAQ, Alma ZL1WA, Carol ZL1ASL, Poppy VK6YF, Ada ZL1ALE

Front row: Cathy ZL2ADK, Carol ZL2VQ, Pat ZL1LD, Raija SMØHNV, Gwen VK3DYL, Elizabeth VE7YL, Alison ZL1TXQ, Robyn VK3WX, Sue ZL3AHY

The weekend in Hamilton was amazing. There were nearly 200 people there, with over 100 YLs. Fourteen countries were represented. It was a very well run weekend. The ZL committee of Biny ZL2AZY, Carol ZL2VQ, Cathy ZL2ADK, Bev ZL1IOS and Jill ZL2BDO deserve all the credit possible for their efforts. It is difficult to imagine anyone who could have chaired the whole weekend more efficiently than Carol. She never missed a beat and coped with the unexpected as well as following the program.

From the moment we arrived at the informal gathering on the Friday evening there were no hitches and no drop in the level of happy talk. Can you imagine how many languages there were with

people from 14 countries all in one room? I rather suspect the VK and ZL amateurs were the least multilingual but, if words did fail, the smiles were enough to share the happiness. Australia was represented by 13 of us including 2 brave OMs. VK2, VK3, VK4, VK5 and VK6 were all there. We all met many old friends and made a number of new ones.

The next International YL Meet will be in Palermo in June 2002. More will be heard of this in this column as the time gets closer. Although 2002 is also the year of the next ALARAMEET in Murray Bridge we hope that a number of the international YLs and many ZLs will be able to combine both meets,

perhaps in a Round the World tour.

A couple of highlights that come to mind are the beautiful voices of the five Korean YLs when they sang, both in the "cathedral" of the Waitomo Caves and, dressed in national costumes, at the formal dinner on Saturday night; the spontaneous singing of "Waltzing Matilda" by the ALARA members as they were lined up for a group photo; and the marvelous sight of Hamilton, laid out like a toy train set, from the bubble of the Catalina (though the fact that a minor problem with one engine had had to be fixed by the application of a YL nail file did upset one or two passenger).

Radio

Christine Taylor VK5CTY
VK5CTY@VK5TTY or geencee@picknowl.com.au

In Hamilton New Zealand at the YL2000 International there were a number of DX YLs known to many DX operators so your reporter took the opportunity to interview some of them. It is only when you have time to talk to people you realise both how different their lives are from your own and how similar they are.

RUTH LA6ZH

Ruth has been licensed since 1963; she has a husband and 3 sons. One of her son's got his amateur licence in the 1950's and suggested that Mum should get a licence, too. If he thought this would keep his mother at home more he was right, but it is certain that he did not realise that through amateur radio his mother would gather friends from all round the world.

Ruth operates 95% of her time with a key but she does have a microphone for contacts with those who "do not understand CW". Ruth will be well known to many others who talk to the world through their fingers

UNNI LA6RHA

Unni has held her licence for 10 years and has enjoyed amateur radio and the island of Svalbaard to such an extent that in 1998 she hosted the very first international gathering of YL, in Svalbaard. Svalbaard belongs to Norway but has a population of 0.35 when the number of people is compared with the number of polar bears!! It is not surprising that Unni owns and can use a 357 magnum!!

Unni is the reporter for the Norwegian YL magazine, so is well known in her world. She also uses her radio skills with the fire/rescue services in Norway as are so many VK YLs. She will be on the Norfolk Island Tour that follows the YL2000 in Hamilton so hopefully many of the readers of "Amateur Radio"

MARCIA K6DLL

Marcia has held an amateur licence since 1950, at which time she lived in Florida and was given the callsign W4STU. Her husband was stationed in Florida then with the air force, but when he was sent overseas she moved home to California where she was allotted her current callsign.

Marcia is a regular on the YL 14.222 Net on a Monday afternoon and has been a WARO and ALARA member for many years.

CELIA ZLIALK

Celia has been licensed since 1960. She is well known to many amateurs who have visited New Zealand as she and Geoff have hosted many of them during the years that they have been active in radio. They have 3 sons one of who has a licence but is inactive. When the children were young there were many family activities such as transmitter hunting that they all enjoyed. Do radio clubs still run fox-hunts and so on that families can participate in or are we all too busy to organise them?

Celia is well known to all YLs in ALARA. She was one of the foundations members of the ZL YL organisation, WARO, and is one of the voices heard in all the ALARA Contests and Birthday Greeting Days



Left: Christine VK5CTY and Marcia K6DLL
Below: Inge OZ7AGR and Bjarne OZ2UV



Above: Unni LA6RHA
Right: Maria VK5BMT, Ella GØFIP and Eileen ZL1BRX



Above: Pat ZL1LD, Biny ZL2AZY and Bev ZL1OS

DON'T MISS THE ACTION!

Uniden 245XLT Trunk-Tracker™ Scanner

Now you too can follow the activity on the "trunked" radio networks used by many Government, business, and emergency services organisations. The new Uniden 245XLT Trunk-Tracker is a specially designed scanner that can read the control channel data on a number of trunked radio systems, allowing the receiver to follow specific users, or groups of users, as their transmissions automatically change frequency through a trunked network. Compatible with many Motorola and EDACS analogue trunking systems, the 245XLT is also supplied with a PC interface cable for use with third-party software. The 245XLT covers 66-88, 108-174, 406-512, and 806-956MHz and provides 300 memories in 10 banks for storing favourite frequencies, 5 pre-programmed Search-bands, Multi-Track scanning that allows you to scan a mix of conventional and trunked systems, and 10 Priority channels (one per memory bank). Super-fast Scanning and Search facilities are also provided (Scan at 100 channels per second for non-trunked services, and Search at either 100 or 300 steps per second), as well as battery-free memory back-up, Data skip to limit reception of data transmissions, an Attenuator to reduce overload from very strong signals, and a Battery Save facility to extend battery life. Each 245XLT is supplied with a NiCad battery pack, AC charger, flexible antenna, PC interface cable, and detailed instructions.

D 2735

Uniden™

\$529



Yaesu VR-500 Multi-mode Scanner

The new VR-500 is more than just a scanning receiver, it's more like a miniature high performance monitoring station! Providing almost continuous coverage of the 100kHz to 1300MHz range, the VR-500 includes reception of narrowband FM, wideband FM (for FM and TV broadcast audio), SSB (for Amateur, CB, and HF reception), CW, and AM (for shortwave and broadcast station) signals. A large backlit LCD screen not only displays the receiver operating frequency, but also displays channel steps and reception mode. For monitoring band activity above and below your current listening frequency, the VR-500 even provides a 60 channel Bandscope to display local activity (within a range of 6MHz max when used with 100kHz steps). A total of 1091 memory channels are provided, with 1000 of these being "regular" memories with alpha-numeric tagging, and the balance being for special features (such as Search band memories, Preset channel memories, Dual Watch memories, and a Priority memory channel). A Smart Search™ function, which sweeps a band and finds in-use channels, allows you to allocate up to 41 memories that can automatically note these active frequencies. The VR-500 operates from just 2 x "AA" size alkaline batteries, and can be connected to an external 12V DC source (such as a vehicle cigarette lighter) using the optional E-DC-5 adaptor. For easier operation, the VR-500 can also be connected to your PC using the optional ADMS-3 interface/software package.

D 2799

YAESU

\$699



PowerHouse stores

A shopping experience like no other!

Dick Smith PowerHouse stores not only offer an expanded range of those original electronics products that have made our stores famous, but now you can experience the fun of using a wide range of communication equipment in our hands-on demonstration area.

Called the "Ham Shack", each PowerHouse store has a dedicated area where licensed staff can show you the latest Yaesu, Uniden, or Magellan communications and GPS products, as well as an expanded range of accessory lines that may not be available in other stores.

Not involved in Ham Radio? Staff can also advise on the installation of a CB radio for your four-wheel drive vehicle, how to get involved in listening to Shortwave radio stations from around the world, or assist you in the selection of a suitable accessory for an existing piece of equipment. For bushwalking or boating users, you can also find out about the latest in inexpensive satellite based navigation receivers or emergency beacons, or just browse through an extensive selection of communications related books.

The PowerHouse is also the place to go if you simply need a component to finish that weekend project, to buy tools, or just to while away a few hours while checking out our

in-store technical books, library CD-ROMs, or our dedicated customer use Internet terminals.

With over 20,000 product lines in the electrical, computer, and communications areas, our new PowerHouse stores get the wavelength right!



1890 DPS.spot.cool

DON'T MISS THE ACTION!

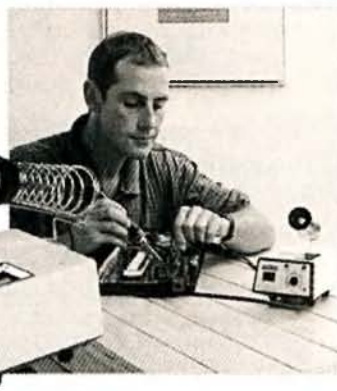
Economy Soldering Station

Affordable quality for the technician or enthusiast. This new soldering station provides variable temperature control from approx. 250°C to 450°C, plus zero voltage crossing circuitry for low noise operation. While not a sensor-compensated temperature-controlled design, it is suitable for a wide range of soldering applications. It features a lightweight soldering pencil with heat-resistant cable, iron holder and a tip cleaning sponge, and is full Energy Authority approved. Supplied with a long-life 1.6mm plated tip.

T 1975

\$78

SAVE \$20



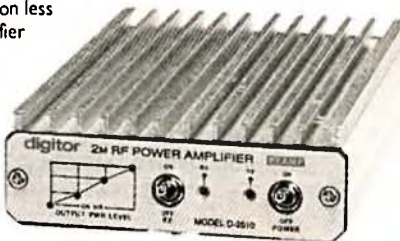
Digitor 2m 30W RF Power Amplifier

If you use your 2m band FM handheld at home or in the car, but find that 2-3W RF output isn't enough for reliable communications, then this compact 30W RF amplifier may be the answer. It works with inputs from 0.5 to 5W and produces up to 30W output with just 3W input. A switchable 12-15dB gain low-noise GaAs FET receiver pre-amplifier can be selected for improved receiver performance on less sensitive hand-helds when being used in RF quiet areas. The amplifier offers a large heatsink for extended duty-cycle transmissions, fused DC power lead, and SO-239 input/output connectors. Frequency range 144-148MHz, FM only. Size: 100 x 36 x 175mm(WHD).

D 2510

digitor

\$99⁹⁰



Rugged HF 5-Band Trap Vertical Antenna

The rugged 5BTV incorporates Hustler's exclusive trap design (25mm solid fibreglass formers, high tolerance trap covers and low-loss windings) for accurate trap resonance with 1kW PEP power handling. Wide-band coverage is provided on the 10, 15, 20, and 40m bands (SWR typically 1.15:1 at resonance, <2:1 SWR at band edges), and 80kHz bandwidth on 80m. An optional 30m resonator kit can be installed without affecting operation of other bands. High strength aluminium and a 4mm (wall thickness) extra heavy-duty base section guarantee optimum mechanical stability. At just 7.65m long, the SBTV can be fed with any length of 50 Ohm coax cable.

D 4920

HUSTLER

\$425



Yaesu FT-90R 2m/70cm micro mobile

Another engineering breakthrough from Yaesu – a tiny-dual band mobile rig with high power output, a remoteable front panel, and a rugged receiver front-end. The FT-90R provides 50W RF output on the 2m band as well as 35W output on the 70cm band, a solid die-cast casing with microprocessor controlled cooling fan for reliable operation, and a large back-lit LCD screen, all in a package measuring just 100mm x 30mm x 138mm.

Also includes:

- Wide dynamic range receiver for greatly reduced pager breakthrough.
- Huge receiver coverage – 100-230, 300-530, 810-999.975MHz (Cellular blocked).
- 180 memories and a variety of scanning functions.
- Built-in CTCSS encode/decode, battery voltage metering.
- Designed for 1200 and 9600 baud packet operation.
- Tiny remoteable front panel (requires optional YSK-90 separation kit)
- Includes MH-42 hand mic, DC power lead, and easy to follow instructions.

D 3312 **2 YEAR WARRANTY**

AMAZING VALUE!

\$699
YAESU

YSK-90 Front Panel Separation Kit

D 3317

\$124



PHONE FAX AND MAIL ORDERS



PHONE: WITHIN AUSTRALIA: 1300 366 644
(Local call charge)

FAX: (02) 9395 1155 within Australia and (+612) 9395 1155 from outside Australia

Visit our web site at <http://www.dse.com.au>

MAIL: DICK SMITH ELECTRONICS, Direct Link, Reply Paid 160,
PO Box 321, North Ryde NSW 1670 (No stamp required)

Excludes packaging and postage. All major credit cards accepted.

14 Day Money Back Guaranteed if NOT completely satisfied. (Software excluded)

DICK SMITH
ELECTRONICS

That's where you go!

Yaesu transceivers and accessories stocked in selected stores only. Other stores can place orders on a deposit-paid basis. Offers expire 31/12/2000. All prices shown are inclusive of GST.

1890 DPS-spot.col



Division Directory

The Amateur Radio Service exists for the purpose of self training, intercommunication and technical investigation. It is carried out by amateurs who are duly authorised people interested in radio technique solely with a personal aim and without pecuniary interest.

The Wireless Institute of Australia represents the interests of all radio amateurs throughout Australia. National representation is handled by the executive office under council direction. One councillor for each of the seven Divisions. This directory lists all the Divisional offices, broadcasts schedules and subscription rates. All enquiries should be directed to your local Division.

Broadcast schedules All frequencies MHz. All times are local.

VK1 Division Australian Capital Territory,
GPO Box 600, Canberra ACT 2601
President Gilbert Hughes
Secretary Peter Kloppenburg
Treasurer Ernie Hosking

VK1GH
VK1CPK
VK1LK

VK1WI: 3.590 LSB, 146.950 FM each Sunday evening from 8.00pm local time. The broadcast text is available on packet, on Internet aus.radio.amateur.misc news group, and on the VK1 Home Page <http://www.vk1.wia.ampr.org>

Annual Membership Fees. Full \$77.00 Pensioner or student \$63.00. Without *Amateur Radio* \$49.00

VK2 Division News South Wales
109 Wigram St, Parramatta NSW
(PO Box 1066, Parramatta 2124)
(Office hours Mon-Fri 1100-1400)
Phone 02 9689 2417
Web: <http://www.ozemail.com.au/~vk2wi>
Freecall 1800 817 644
e-mail: vk2wi@ozemail.com.au
Fax 02 9633 1525
President Michael Corbin
Secretary Barry White
Treasurer Pat Leeper

VK2YC
VK2AAB
VK2JPA

From VK2WI 1.845, 3.595, 7.146*, 10.125, 14.160, 24.950, 28.320, 29.120, 52.120, 52.525, 144.150, 147.000, 438.525, 1281.750 (* morning only) with relays to some of 18.120, 21.170, 584.750 ATV sound. Many country regions relay on 2 m or 70 cm repeaters. Sunday at 1000 and 1930. Highlights included in VK2AWX Newcastle news, Monday 1930 on 3.593 plus 10 m, 2 m, 70 cm, 23 cm. The broadcast text is available on the Internet newsgroup aus.radio.amateur.misc, and on packet radio.

Annual Membership Fees. Full \$78.00 Pensioner or student \$61.00. Without *Amateur Radio* \$47.00

VK3 Division Victoria
40G Victory Boulevard Ashburton VIC 3147
(Office hours Tue & Thur 0930-1500)
Phone 03 9885 9261
Web: <http://www.tbsa.com.au/~wiavic/>
Fax 03 9885 9298
e-mail: wiavic@alphalink.com.au
President Jim Linton
CEO Barry Wilton
Secretary Peter Mill

VK3PC
VK3XV
VK3APO

VK3BWI broadcasts on the 1st and 3rd Sunday of the month at 8.00pm. Primary frequencies, 3.615 LSB, 7.085 LSB, and FM(R)s VK3RML 146.700, VK3RMM 147.250, VK3RWG 147.225, and 70 cm FM(R)s VK3ROU 438.225, and VK3RMU 438.075. Major news under call VK3ZWI on Victorian packet BBS and WIA VIC Web Site.

Annual Membership Fees. Full \$78.00 Pensioner or student \$61.00. Without *Amateur Radio* \$47.00

VK4 Division Queensland
GPO Box 638 Brisbane QLD 4001
Phone 07 3221 9377
e-mail: office@wiaq.powerup.com.au
Fax 07 3266 4929
Web: <http://www.wia.org.au/vk4>
President Colin Gladstone
Secretary David Jones
Treasurer Bill McDermott
Office Mgr John Stevens

VK4ACG
VK4OF
VK4AZM
VK4AFS

VK4WIA broadcasts on 1.825 MHz SSB, 3.605 MHz SSB, 7.118 MHz SSB, 10.135 MHz SSB, 14.342 MHz SSB, 21.175 MHz SSB, 28.400 MHz SSB, 29.660 MHz FM (rptr), 147.000 MHz, and 438.525 MHz (in the Brisbane region, and on regional VHF/UHF repeaters) at 0900 hrs K every Sunday morning. QNEWS is repeated Monday evenings, at 19.30 hrs K, on 3.605 MHz SSB and 147.000 MHz FM. On Sunday evenings, at 18.45 hrs K on 3.605SSB and 147.000 FM, a repeat of the previous week's edition of QNEWS is broadcast. Broadcast news in text form on packet is available under WIAQ@VKNET. QNEWS Text and real audio files available from the web site

Annual Membership Fees. Full \$85.00 Pensioner or student \$72.00. Without *Amateur Radio* \$56.00

VK5 Division South Australia and Northern Territory
(GPO Box 1234 Adelaide SA 5001)
Phone 08 8294 2992
web: <http://www.sant.wia.org.au>
President Jim McLachlan
Secretary David Minchin
Treasurer John Butler

VK5NB
VK5KK
VK5NX

VK5WI: 1827 kHz AM, 3.550 MHz LSB, 7.095 AM, 14.175 USB, 28.470 USB, 53.100 FM, 147.000 FM Adelaide, 146.700 FM Mid North, 146.800 FM Midura, 146.825 FM Barossa Valley, 146.900 FM South East, 146.925 FM Central North, 147.825 FM Gawler, 438.425 FM Barossa Valley, 438.475 FM Adelaide North, ATV Ch 35 579.250 Adelaide. (NT) 3.555 USB, 7.065 USB, 10.125 USB, 146.700 FM, 0900 hrs Sunday. 3.585 MHz and 146.675 MHz FM Adelaide, 1930 hrs Monday.

Annual Membership Fees. Full \$77.00 Pensioner or student \$63.00. Without *Amateur Radio* \$49.00

VK6 Division Western Australia
PO Box 10 West Perth WA 6872
Phone 08 9351 8873
Web: <http://www.omen.net.au/~vk6wia/>
e-mail: vk6wia@omen.net.au
President Neil Penfold
Secretary Christine Bastin
Treasurer Bruce Hedland-Thomas

VK6NE
VK6ZLZ
VK6OO

VK6WIA: 146.700 FM(R) Perth at 0930hrs Sunday relayed on 1.865, 3.564, 7.075, 10.125, 14.116, 14.175, 21.185, 29.120 FM, 50.150 and 438.525 MHz, Country relays 3.582, 147.200 (R) Cataby, 147.350 (R) Busselton, 146.900 (R) Mt William (Bunbury), 147.000 (R) Katanning and 147.250 (R) Mt Saddleback. Broadcast repeated on 146.700 at 1900 hrs Sunday relayed on 1.865, 3.564 and 438.525 MHz : country relays on 146.900, 147.000, 147.200, 147.250 and 147.350 MHz. Also in "Real Audio" format from the VK6 WIA website

Annual Membership Fees. Full \$69.00 Pensioner or student \$59.00. Without *Amateur Radio* \$38.00

VK7 Division Tasmania
PO Box 371 Hobart TAS 7001
Phone 03 6234 3553 (BH)
Web: <http://www.tased.edu.au/tasonline/vk7wia>
also through <http://www.wis.org.au/vk7>
email: batesjw@netspace.net.au
President Phil Corby
Secretary John Bates
Treasurer John Bates

VK7ZAX
VK7RT
VK7RT

VK7WI: 146.700 MHz FM (VK7RHT) at 0930 hrs Sunday relayed on 147.000 (VK7RAA), 146.725 (VK7RNE), 146.625 (VK7RMD), 3.570, 7.090, 14.130, 52.100, 144.150 (Hobart), repeated Tues 3.590 at 1930 hrs.

Annual Membership Fees. Full \$88.00 Pensioner or student \$75.00. Without *Amateur Radio* \$55.00

VK8 Northern Territory (part of the VK5 Division and relays broadcasts from VK5 as shown, received on 14 or 28 MHz).

VK1 Notes

Forward Bias

The guest speaker, at the General Meeting on 25 September 2000, was Mr Bruce McLaughlan. Bruce works for Transact, the company that is going to change the way we communicate with the world. He said that at present, most residential homes receive Television signals via a dish or VHF/UHF antenna, and that the computer and telephone connect through copper wires to the exchange and the rest of the world. Transact will offer something similar to cable television but in a much more expanded way. In fact, a bandwidth of 36 Mbps is offered to customers, making it possible to deliver data, video, and telephone services, all at the same time. Bruce explained that the system for Canberra consists of digital equipment that connects mainly via Fibre Optics, except for the last 300 metres to the customer's home where it terminates in a little black box.. That part uses CAT-5 copper cable. However, any length more than 300 metres would not allow the guarantee of 36 Mbps. The Canberra system is planned to be interconnected

with Nodes and Super Nodes in suburban streets, Hubs in suburbs, and a Gateway at a central point in North Canberra. The advantage of this system with its very wide bandwidth is the speed of delivery and interactivity. Video is available from many different sources as well as Data and Voice services; the latter being virtually free amongst Transact customers.

On a different note: The ACT Technical Advisory Committee (ATAC) got together on October 4, 2000 to discuss the implications for the 70 cm bandplan, now that the ACA has decided to limit access to the first 10 MHz of that band. ATAC, under the chairmanship of Ernest Hocking, VK1LK, discussed the various options that are open to users of the remaining part of the band. A draft proposal - Modified 70 cm Band Proposal (430 to 440 MHz) - was put together and sent to John Martin, Chair of FTAC, for consideration and comments. The discussions included subjects like LIPD channels, links and repeater input/

Peter Kloppenburg VK1CPK

output shifts, channel raster/interleaving, directional antennas, squelch and CTCSS options, and future frequency management. Importantly, the aim was to fit all existing 70 cm activities into the 430-440 MHz slot, with the exception of ATV. Furthermore, to comply with international usage, avoidance of LIPD interference to repeater inputs, and to minimise changes to existing services.

A vacancy is becoming available for a QSL (Outwards) Manager in the Division. Mike Jenkins, VK1MJ, who has performed this task for the last four years, is looking for another challenge and will resign at the end of the year. You can contact Mike on 6295 2220, or Gilbert Hughes on 6254 3266 for details about the job.

The next General Meeting will be held on November 27, 2000 at the Griffin Center, Civic, Canberra City. And, don't forget Folks, this is the last meeting for 2000! It will be celebrated with a Trash & Treasure sale, and a Party. Everyone is welcome. Cheers, Peter K.

VK2 Notes

Well, another big occasion is over, but there is still more to come, and to have gone by the time you read this. This latter is of course the Paralympics. The AX2GAMES callsign will be running during these games.

It is unfortunate that we could not get enough volunteers to man the Parramatta station during the Olympics, but there were amateurs who ran the callsign from their home QTH and club stations. We thank the amateurs from the Manly-Warringah club and those from the Newcastle area, who between them made five and a half thousand contacts in sporadic operation over the period on 10, 15 and 20 metres, with a few on 80 metres. They had good world coverage with satisfactory conditions.

The next Conference of Affiliated

Clubs will be held at Amateur Radio House at Parramatta on Saturday 11th November. The conference is not scheduled to run into the evening so there will be only one meal catered for.

The WIA (NSW) has received a donation of surplus microwave equipment consisting of 5 watt transmitters and receivers in the L microwave band. The transmitter is in two parts, being a 500mW oscillator and a 5W power amplifier with a directional coupler and detector to measure the output power. Initial tests show the transmitter can be tuned to the 23cm band for wide-band FM use such as ATV or data transmission. The oscillator is locked to a crystal with a phase locked loop system. Circuit diagrams should be

from Pat Lesper VK2JPA

available for the transmitter, oscillator and PLL system.

The receiver has a free running pcal oscillator and a 70MHz IF amplifier. Both the transmitter and receiver are a gold mine of SMA connectors and mechanical components suitable for constructing microwave filters. These units will be on sale at bargain prices that will make the purchase worthwhile just for the connectors.

There are also power supply modules with large heatsinks and other modules that are a good source of difficult-to-obtain components such as high quality tantalum capacitors. If you need LEDs or 4000 series CMOS ICs then we have those too in PCBs that will be available at modest prices.

That's all for this month.

VK3 Notes

www.tbsa.com.au/~wiavic email: wiavic@alphalink.com.au

By Jim Linton VK3PC

Membership recruitment and retention

At the WIA Federal Convention held six months ago a major item for discussion was membership recruitment. All WIA divisions left that meeting with a commitment to consider how they could boost membership.

WIA Victoria has for the past 12 months through its promotional efforts targeted both existing (non-member) and prospective radio amateurs, with some positive and measurable results. Our recruitment level, that is new joining members, increased 25% between January and September 2000. At the same time our loss of membership was small when the GST and other external factors beyond WIA Victoria's control are taken into account. A key factor to recruitment and membership retention is our Internet website. It receives more visits than our office in Ashburton. The ability to communicate with individual

members, and a large section of the membership via email, also has its decided advantages. It has also resulted in considerable interchange of communications between WIA Victoria and its members, with most days having at least one new piece of e-correspondence that needs a response.

Inquiries from non-members about how to join WIA Victoria, the closest active radio club, or where to sit an examination, are frequently received. It is pleasing to see the names of those making such inquiries often finding their way into our new members list. They must have gained a positive image of WIA Victoria through the email correspondence and the content of the website. In fact the website is our best single recruitment tool.

VK3BWI broadcast

As previously mentioned in this column, an ongoing shortage of volunteers is causing ongoing difficulties. The Council at its meeting last month reluctantly accepted the resignation of Bill Trigg VK3JTW, who had been on council since 1983. Bill resigned due to personal reasons. His dedicated contributions in servicing the membership included an almost continuous involvement with the VK3BWI broadcast, being its coordinator for a considerable time. With his retirement from council, and no-one else offering their voluntary services, the broadcast now goes to air only on the first Sunday of the month at 8pm. The requirements of a broadcast producer were reported in the VK3 Notes column in May 2000.

New Secretary appointed

The council has appointed John Brown VK3JJB to the position of Secretary. John had previously been the Administrative Officer. Taking on the office of Secretary is an expansion of his previous duties. John has also joined the council as a director. The council stands at five, and efforts are continuing to find other suitable volunteers to join council.

Finding new radio amateurs

In a recent speech I gave to the Eastern and Mountain District Radio Club the topic of the future of amateur radio was

discussed. While the numbers of radio amateurs in Australia is not experiencing a period of growth at the moment, to put it politely, the solution is in the hands of existing radio amateurs. I suggested that if each and every existing radio amateur set a personal goal of generating one new radio amateur every ten years, the hobby would be in a much better position in decades to come. Think about it. It should not be that hard to find, encourage, and assist an individual to join our wonderful hobby. You don't even have to leave the comfort of your home, or even while at work. The trend towards learning on the Internet offers an excellent way for today's radio amateurs to be give a hand up to a budding radio amateur.

JOTA and other activity

"Be radio-active - not radio-passive" is a theme we could perhaps adopt as a new millenium replacement for the old phrase of "use it or lose it". Where are all of those stations heard in the Remembrance Day Contest during the rest of the year? A similar comment can be made about some participants in the 2000 Oceania DX Contest, JOTA, and particularly the creme de la creme of tests, the CQWW Contest. Activity on the bands is good for the hobby! Band occupancy can play a part when the WIA seeks to defend amateur allocations, obtain expansions or even new allocations. While checking scores of QSL cards for the bureau recently I noted that many overseas stations have simple wire HF antenna systems. The DX is good at this time of the sunspot cycle. If you're not radio-active then why not get on and give it a go?

And if VHF and UHF bands are your cup of tea - then the WIA Victoria George Bass Diploma for simplex contracts between the mainland and VK7 may interest you. The diploma proved so popular last year it is available again this summer. Contacts made last summer will also qualify for this seasons diploma. The rules appear on the WIA Victoria website, or can be obtained on request to the WIA Victoria office.

Andrews
Communications Systems
(EST. 1976 - ACN 001 968 752)

ALINCO
AUSTRALIA'S FIRST AUTHORISED
FACTORY DIRECT IMPORTER
MASSIVE SHIPMENTS EVERY MONTH
FULL 3-YEAR WARRANTY ON
ALINCO and ICOM
WE SELL MOST BRANDS
BALUNS, VERTICALS, YAGIS, P/S.
ICOM-KENWOOD-JRC-AOR-EMOTATOR-
MFJ-DIAMOND-TIMEWAVE-KANTRONICS
-THP - GARMIN - TERLIN - UNIDEN - ETC
DX-1600 HF LINEARS FROM \$ 3,799
**HUGE RANGE OF ELECTRONICS,
ICOM and ALINCO Radios.**
Over 22 Years of
Professional Sales and Service.
Instant Repairs Fridays
HF Transceivers & Linears Wanted

(02) 9636 9060 or (02) 9688 4301
SHOP 6, 41 BATHURST ST, GREYSTANES,
N.S.W. 2145. FAX (02) 9688 1995

VK4 Notes

By Alistair Elrick VK4MV

Q News

Free Band In Toowoomba for VK4

In the Toowoomba Chronicle of last Friday, Gary Rizynski the Station Manager for WIN-TV Toowoomba announced that Channel 5a (137-144 MHz) would cease transmissions this month. An engineering spokesman told QNEWS that their channel 0 frequency (45-52 MHz) at Mt Mowbullin (QG62) would still be operational for some time yet. As Terry VK4KTP said "So now all we have to do is wait and see if the '5a' closure actually happens, it has been promised a couple of times before. Then we might be able to use the bottom end of 2 metres, or even make use of some of the weather satellites."

Good Scout!

Scoutings Chief Commissioner of Australia, Dr Bruce Munro has appointed Stephen Watson VK4SGW to the position of National Co-ordinator, JOTA/JOTI. VK4SGW's predecessor Harvey Lennon VK7KSM has resigned following completion of a three year term, the role previously having been fulfilled by Noel Lynch VK4BNL (SK), and Peter Hughes VK6HU. Steve will be continuing as Queensland JOTA/JOTI Co-ordinator, and Joey Scout Leader at Pioneer Park Scout Group. His contact details, Stephen Watson VK4SGW, 7 Landel Ct. Kirwan QLD 4817 Phone: 07 4723 2185 Fax: 07 4723 6372

Email: shwatson @ bigpond.com.au
Look at the Scouting Web Page at <http://jota.scouting.net.au>

Harmonic Production Alert

Announcing the production of 2 new harmonics to the VK4SGW home QTH! At 10am Saturday September 30th, twin harmonics Charlotte and Gillian. Congratulations to XYL Heather for doing all the work and hope Steve/VK4SGW is starting to recover from the midnight shift!

International Links

Rick P29KFS, QNEWS rebroadcaster in Port Moresby, reported a huge radio fadeout during a recent relay, at 2321 UTC. The fade took VK4MU Theo's 20-metre signal from 9 to nothing in about 20 seconds and it stayed at zero for 4-6 minutes, but was still barely detectable. Was the rest of 20-metres also dead?

Wayne VK4NWH, QNEWS 10-metre SSB rebroadcaster, says YJ8WR, Wayne in The New Hebrides is rebroadcasting QNEWS from 10 or 20 metres over their local 2-metre repeater. Callbacks are being conducted in the region, so we'd be pleased to get some regular reports.

Amateur Radio Hour

Hot off the wire from Alan VK4PS. In Townsville, the 4TTT-FM Amateur Radio Hour has moved to a new time

and new day of the month. Listen for the next session on 103.9MHz FM on Wednesday 4th October from 7pm to 8pm!

Funday 2001

Brian VK4BBS is offering your Club in the Brisbane area, the chance to host the FUNDAY 2001. A great opportunity to promote your club in your local area, as part of the greater exposure of Amateur Radio. Expected to be held as usual, sometime early in February. To find out more contact:

VK4BBS Brian Beamish. VK4BBS @ VK4WIE.#BNE.QLD.AUS.OC

WIAQ Ventures Forth

An upcoming meeting of the WIAQ is to be held in the fair City of Rockhampton. On the 25th November, with final arrangements yet to be made, the Council and other interested parties will be in Rockhampton to conduct a meeting. This will hopefully allow the workings of the Council to be seen and heard directly by the members in this region. Also an opportunity to have Councillor Clive Sait VK4ACC sitting in on the proceedings rather than wearing out his ear on the monthly telephone conference hook-up.

73's from Alistair

VK7 Notes

QRM — Tasmanian notes

Last month I reported on the all out war in the southern branch during the weekly foxhunts. The battle was won by the intrepid team of VK7RB, Robert and VK7DG, Dale and their prize? – The dubious honour of being the first fox in the new series that has started on October 12th. More exciting (?) news next month.

All our branches are busy organizing their December end of year celebrations – usually a good "tuck-in" at a worthwhile restaurant. An outing that many people look forward to each year is the "Sewing circle" barbecue at Rosy Vanyan, Forcett on the 11th November.

Bill Donald, VK7AAW, (reckons he's the only one with a 4 letter suffix – double A, double U – get it?) is mine host there and it's always quite a day. The 'sewing circle is tied in with the Tuesday evening Tassie Devil net on 3.59 MHz.

Following some months of classes when the numbers dropped from 10 to four students we hope that exams on the 17th of October will see some new amateurs on air from the south.

We must take this opportunity to remind all members that February/March are the annual meeting months at both branch and Division levels. There are many jobs in all the branches

that need volunteers – how about YOU.

By the time you read this the North/west branch will have been the communications arm of the Challenge 2000 car rally the first of two major car rallies in that part of Tassy. Down south the Saxon Safari participants braved snow rain and ice and the 28 amateurs and helpers had a hard time coping with the wild weather and formidable terrain problems. Their portable repeaters worked well and the southern operators and the Saxon safari management voted it a "Top shelf team effort."

Cheers for now Ron Churcher VK7RN.

John Martin, VK3KWA
FTAC Chairman

2 Metre Band Plan

There has been a change to the 2 metre band plan: a national APRS frequency of 145.175 MHz has been adopted.

Changes to 2.4 GHz Band Plan

The 2.4 GHz band plan has been revised following the withdrawal of the 2302 - 2400 MHz segment from amateur use. The effect of this change will be minimal because this segment had to be cleared several years ago when it was allocated to MDS pay TV. The small segment from 2300 to 2302 MHz has now been tagged for use by repeater links. The band plan for 2400 - 2450 MHz remains unchanged.

Revised 3.4 GHz Band Plan

The 3.4 GHz band plan has been revised to work around the spectrum losses announced by ACA earlier this year. The main change is the loss of the weak signal segment around 3456 MHz. This has been relocated to 3400 MHz, in line with the IARU Region I band plan. Other changes include some shuffling of the ATV and other wideband segments, to make the best use of the 200 MHz of spectrum that we still have.

Please replace your copy of the 3.4 GHz band plan with the one given below.

Australian Amateur Band Plans: 9 Cm Band

Band Allocation

3300 - 3600 MHz	RADIOLOCATION	Primary Service
3300 - 3600 MHz	AMATEUR	Secondary Service
3400 - 3410 MHz	AMATEUR SATELLITE	Secondary Service
3400 - 3600 MHz	FIXED SATELLITE (Space to Earth)	Secondary Service
3400 - 3600 MHz	FIXED, MOBILE	Secondary Service

From January 2000, amateur operation is prohibited in some portions of the band: see Note 6. The weak signal segment has been relocated from 3456 MHz to 3400 MHz.

Band Plan

3300.000 - 3320.000	Wideband Channel 1: Atv Links	(Note 5)
3320.000 - 3340.000	Wideband Channel 2: Voice/Data Links	(Note 5)
3340.000 - 3360.000	Wideband Channel 3: Simplex, Any Mode	(Note 5)
3360.000 - 3380.000	Wideband Channel 4: Atv Links	(Note 5)
3380.000 - 3400.000	Wideband Channel 5: Voice/Data Links	(Note 5)
3400.000 - 3402.000	Narrow Band Modes	(Note 1)
3400.000 - 3400.100	Eme Only	
3400.100 - 3400.400	Terrestrial Cw / Ssb	
3400.100	Calling Frequency: National Primary	
3400.200	Calling Frequency: National Secondary	
3400.400 - 3400.600	Beacons	(Note 2)
3400.600 - 3402.000	General / Experimental	
3402.000 - 3405.000	Fm Simplex	(Note 4)
3402.000	National Voice Calling Frequency	
3403.000 - 3405.000	Digital Data	

3400.000 - 3410.000	Amateur Satellites	(Note 3)
3410.000 - 3425.000	All Modes	
3425.000 - 3492.500	No Operation	(Note 6)
3500.000 - 3520.000	Wideband Channel 6: Atv Links	(Note 5)
3520.000 - 3540.000	Wideband Channel 7: Voice/Data Links	(Note 5)
3542.500 - 3575.000	No Operation	(Note 6)
3580.000 - 3600.000	Wideband Channel 8: Atv Links	(Note 5)

Note 1: Narrow Band Modes

This segment is reserved for modes such as CW, FSK and SSB only. Weak signal operation has absolute priority. Calling frequencies should be used only to make initial contact and then vacated as soon as possible. Please avoid any terrestrial operation within the EME segment.

Note 2: Beacons

Beacon frequencies are allocated on a call area basis, e.g. VK1: 3400.410 - 3400.419, VK2: 3400.420 - 3400.429 etc. Further details are in the paper "Guidelines for Unattended Transmitters". Beacon frequency spacing is 2 kHz. The beacon segment should be kept clear of any other transmissions.

Note 3: Amateur Satellites

There are no amateur satellites currently operating or planned for this band.

Note 4: FM Simplex

Recommended channel spacing is 100 kHz. Channels reserved for special purposes should be kept clear of other operation.

Note 5: Wideband Modes

These segments are for wideband simplex operation or duplex links. Suggested uses are:

ATV: Mode F3F (FM ATV) with +/- 9 MHz bandwidth. Video carrier at centre of channel. Recommended duplex link channels: For 60 MHz offset, channels 1 and 4. For 140 MHz offset: channels 4 and 6. For 200 MHz offset, channels 1 and 6. For 280 MHz offset, channels 1 and 8. Recommended simplex channel: channel 3.

Data or Voice: Recommended channel spacing is 100 kHz, or 1 MHz for high speed data, excluding upper and lower segment edges, with voice links at the lower end of the segment and data links at the upper end. Recommended duplex link segments: For 60 MHz offset, a frequency pair from channels 2 and 5, for example 3321.0 and 3381.0 MHz. For 140 MHz offset, channels 5 and 7. For 200 MHz offset, channels 2 and 7.

Note 6: Restricted Segments

In the band segments 3425.0 - 3442.5 MHz and 3475.0 - 3492.5 MHz, operation is prohibited in and around most major population centres. In the segments 3442.5 - 3475.0 MHz and 3542.5 - 3575.0 MHz, operation is prohibited in most parts of Australia. For full details, refer to the current ACA Amateur Licence Conditions Determination.

ar



Bill Magnusson VK3JT

How Good are your Feedlines?

Now seems to be a good time to reprint this excellent article by Geoff VK2ZAZ. It appeared in 1990 in issue 65 of the Amsat-VK newsletter. The original idea came from an RSGB publication circa 1980. I built up a copy of this little device and it has paid for itself many times over. With satellite downlink and uplink frequencies being pushed higher and higher, the condition of our feed lines is becoming more critical to the overall performance of any satellite earth-station. Wouldn't it be a pity to have good transceivers, good antennas, good computing software and hardware and to find you have a weak link in the

chain in the form of lossy feedlines. As described the simple RF power meter can be used to determine power levels in the range 100mW to 2 Watts. It can thereby be used to check the condition of your co-ax feedlines. A 2 metre or 70 cm hand held transceiver set to low power is an ideal power source and will ensure that you don't inadvertently burn out the device. When applied to co-axial cable it can be used to accurately determine the losses to be expected in your feedlines. If carefully constructed, it will give accurate results up to 500 MHz making it ideal for use up to 435 MHz directly and the results can be

extrapolated to higher or lower frequencies. The circuit and construction details are shown in Fig. 1. I made mine around a BNC plug rather than a socket because I was lucky enough to obtain a tiny concentric 50 ohm resistor about as big as a three-penny bit and that made the construction even simpler and more efficient as shown in Fig-2. Please don't ask me for a source of these concentric resistors. I was given one by a friend and his source has dried up. If anyone knows of a current source *please* let me know. Provided the lead lengths are kept to an absolute minimum the Fig. 1 construction will do nicely. Using two 100 ohm resistors is an attempt to increase the power capability and also to lend some symmetry to the circuitry.

The device is first calibrated by plugging it into the antenna jack of a hand-held radio. With the radio on low power, use a digital voltmeter to get a reading on the output. Record this reading and plug your co-axial cable to be tested into the antenna jack of the hand-held and plug the little device into the other end of the coax. Take another reading. This will be less than the original reading (unless you have some of that "high-gain co-ax" that you hear talked about in certain circles). How much less is a measure of the loss in your co-ax cable plus connectors. To work out the loss in dB we first calculate the power in Watts in each case using the formula:

$$\text{power} = (\text{voltage} + 0.7)^2 / 100.$$

You can then use the normal $\text{dB} = \log P1/P2$ formula to find the loss in the co-axial cable. Geoff included a simple 10 line basic program for doing the calculations. Even if you can only manage to produce test RF on (say) 145 or 435 MHz, the results can easily be extrapolated out to 1200 and even 2400 MHz or down to 50 MHz or HF frequencies. I also have a simple basic program for doing this. I can email these

The AMSAT organisation.

AMSAT (Amateur Radio Satellite Corporation) is a worldwide organisation with its roots in the USA. Its origin can be traced back to 1958, just a year after the launch of Sputnik-1. Since that time AMSAT members have been involved in the design, building, launching, commissioning, upkeep and of course, the day-to-day use of amateur radio communication satellites. The parent body is AMSAT-NA (North America) and many other countries have similar special interest groups operating.

AMSAT-Australia

Our local organisation is known as AMSAT-VK. The National Co-ordinator is Graham Ratcliff VK5AGR.

Membership of AMSAT-Australia.

AMSAT-Australia operates an open membership system. No formal application is necessary and no membership fees apply. From time to time new software, firmware and hardware is developed and distributed through AMSAT-VK channels. Write to the co-ordinator to express your interest or pop up on the HF net.

AMSAT-Australia HF net.

The AMSAT-Australia net meets formally on the second Sunday evening of the month. During the winter months in South Australia (end of March until the end of October) the net meets on 3.685 MHz +/- QRM at an official start time 1000utc with early check-ins at 0945utc. During the summer months when daylight saving is in operation in South Australia (end of October until end of March) the net meets on 7.068 MHz +/- QRM at an official start time of 0900utc with early check-ins at 0845utc. The times and frequencies have been chosen as the best compromise for an Australia-wide net taking into consideration seasonal propagation changes and the various state summer times. The net is open to all amateurs, beginners or experienced who have an interest in amateur radio satellites. Help and information for beginners in particular, no matter how trivial, is freely and cheerfully available on this net.

The AMSAT Journal.

An excellent bi-monthly journal is available with formal membership of AMSAT-NA. It contains details of practical projects and ranges over all aspects of amateur radio satellite operations. As of 01Jul00 the cost of AMSAT-NA annual membership will be US\$45 payable to AMSAT-NA 850 Sligo Ave, Silver Spring, MD 20910-4702 U.S.A. or you can phone, fax or email your subscription using your credit card. The phone number is 0011-1-301-589-6062, the FAX number is 0011-1-301-608-3410 and the email address is martha@amsat.org

All Communications regarding any matters mentioned above should be addressed to:

AMSAT-Australia.

GPO Box 2141, Adelaide, SA. 5001.

email, vk5agr@amsat.org

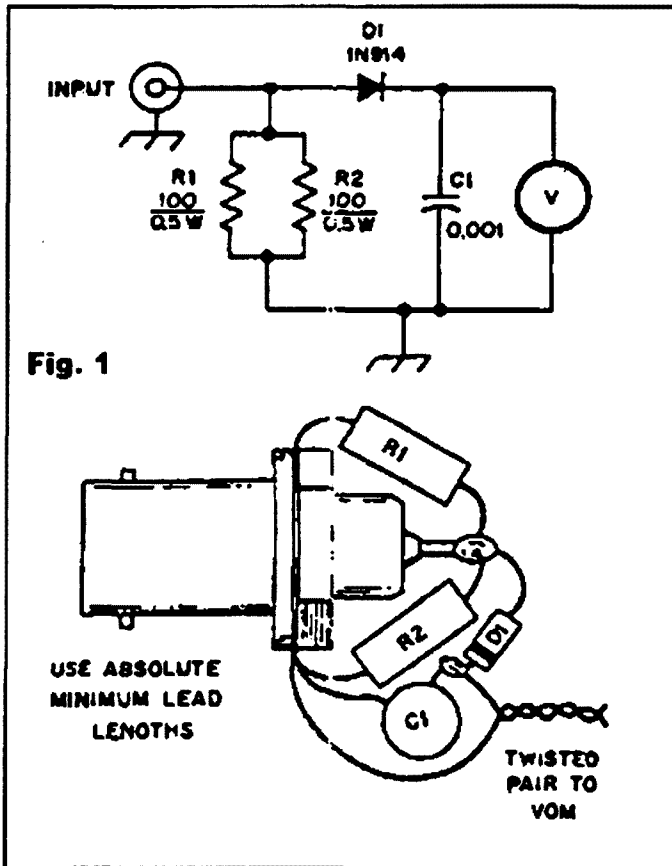


Figure 1

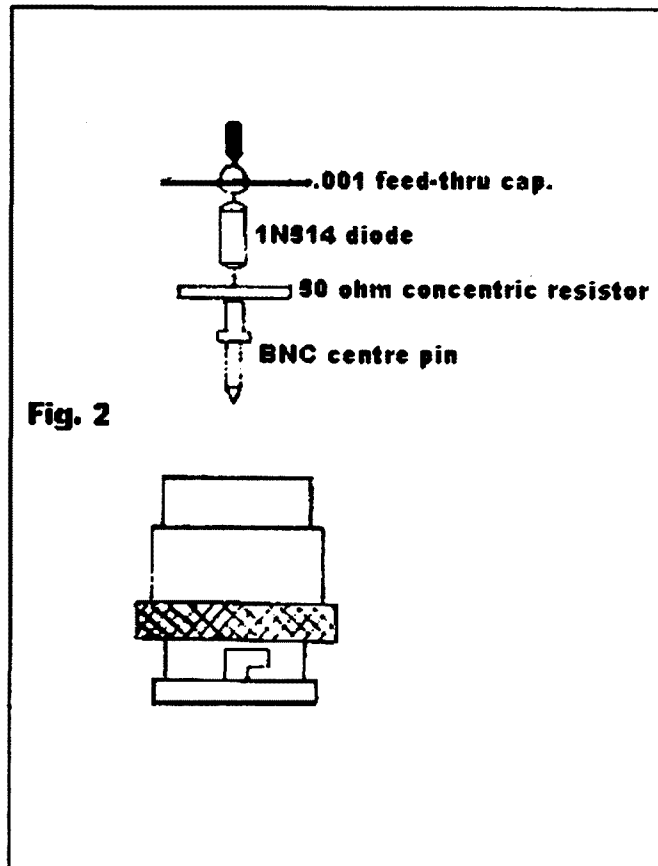


Figure 2

two programs to anyone who needs them. A few key strokes on a calculator can do the same thing of course.

This little device is well worth another look. It has a permanent place in my tool kit and is just as relevant 10 years on in 2000 as it was back in 1990 ... or 20 years on from 1980 for that matter. Thanks Geoff, no excuses now for faulty co-ax in anyone's Phase 3D setup.

Phase 3D Launch Preparations.

The planned mid-November launch of Phase 3D is now looking fairly certain. A short delay of a couple of weeks was due to the non-arrival of one of the other satellites scheduled to be launched with P3D. Peter DB2OS reports that P3D's fuelling operations are now complete. The last chemical to be added in the fuelling process was NH₃, with P3D becoming only the world's second satellite to use ammonia in its fuel, a first for spaceport Kourou! Following the fuelling operations, Phase 3D is ready to be moved into the final assembly building at the European Spaceport. The

next move will be to install the satellite onto the Ariane 5 launch vehicle. The launch team has updated its Internet web site with several new photographs showing the Phase 3D fuelling process. To visit the site, point your browser to: <http://www.amsat-dl.org/launch/>. The next week or two should be very exciting indeed.

Please be patient with Phase 3D.

The latest flagship of the AMSAT fleet will be close to launch or may well be in orbit by the time you read this column. You will still have plenty of time to get your station ready though as the commissioning of this satellite will be a complex and time consuming matter. Peter Guelzow DB2OS has reminded all satellite operators planning to use Phase 3D after launch that it could be a few months before the bird is ready for normal operation. Several things will determine this time frame, including orbit parameters (such as the work that will be needed to slowly nudge P3D into its final elliptical orbit). Peter added,

"satellite operators worldwide can rest assured that every effort will be made to initiate operations at the first possible opportunity consistent with flight operations."

Three New Satellites Successfully Launched.

Three Amateur Radio satellites were launched on September 26, 2000 aboard a converted Soviet ballistic missile. The launch took place from the Baikonur Cosmodrome, placing SaudiSat-1A, SaudiSat-1B and TungSat-1 into low Earth orbit. Reports from the command stations indicate that all is well with these satellites and their commissioning is proceeding normally. SaudiSat 1A and 1B will operate as 9600 baud digital store-and-forward systems as well as having analog FM repeater mode capability. These first ham satellites from the Kingdom of Saudi Arabia were built by the Space Research Institute at the King Abdulaziz City for Science and Technology. AMSAT-NA's Jim White, WD0E, reports that both satellites have been turned on and are running initial housekeeping tasks. The downlink

frequencies are as follows:

SAUDISAT-1A 437.075 MHz

SAUDISAT-1B 436.775 MHz

TiungSat-1 is Malaysia's first micro-satellite and in addition to commercial land and weather imaging payloads will offer FM and FSK Amateur Radio communication. Chris Jackson, G7UPN, reports TiungSat-1 transmitted "excellent telemetry showing that the spacecraft was in good health. By next month we should have complete details on these new birds.

ARRIS News

The ARISS initial station gear is now temporarily stowed aboard the Functional Cargo Block module of ISS.

The initial station will use an existing antenna that will be adapted to support 2-metre FM voice and packet. The ARISS equipment will get a more-permanent home aboard the Service Module in 2001, along with VHF and UHF antennas. Plans call for amateur TV, both slow scan and fast scan ATV, a digipeater and relay stations. Planning for the deployment and use of the ham system aboard ISS has been an international effort coordinated by NASA's Goddard Space Flight Centre. The effort began in 1996 with the formation of the Amateur Radio International Space Station organisation. ARISS is made up of delegates from major national Amateur Radio

organisations, including AMSAT. All previous amateur radio stations aboard MIR and the Space Shuttle have been secondary installations, often using less than optimal antennas which were sometimes partially shaded from Earth. This will be a planned installation having the complete blessing of the ISS authorities from the beginning. We should expect big things from ARISS when the station is completed in a year or two. Our thanks are due to the ARISS team for a job well done, not only in the planning and building of the station but perhaps more importantly in the original and on-going negotiations with the ISS authorities.



News from the Moorabbin & District Radio Club

MDRC displays amateur radio at Hobby Show

The MDRC mounted another display of amateur radio at last month's St Kilda Hobby Show. On show were slow-scan television, PSK-31, satellite operation, QRP equipment, Morse code and two metres FM. HF was not used due to the extreme noise at the site. However contacts were made on VHF/UHF FM and SSTV. The use of a video camera made it possible for us to record pictures and transmit them over the air. This was particularly popular with younger visitors. PSK-31 was demonstrated by running a tape recording of 14 MHz signals into a soundcard-equipped computer to decode the transmitted text. The Morse key and oscillator also got plenty of presses.

An interesting observation is the large number of amateur visitors to the stand. Many were now inactive. It seems that as well as encouraging newcomers to radio, a major role for public displays is to re-ignite interest amongst existing licensees.

MDRC members present included VK3CAT, VK3JED, VK3XOR, VK3YE, VK3CEA, VK3CHK, VK3JEG and VK3KRO. Many other amateurs called

in to lend support during the day. The MDRC has run a stall for three of the four Hobby Shows held.

Club members try PSK-31

Several MDRC members have been experimenting with PSK-31, following a talk and demonstration at our August meeting. PSK-31 is a narrow-bandwidth digital mode similar to RTTY, but provides better results with weak signals. WinPSK software and a simple link between a soundcard-equipped computer and an SSB transceiver is all that's required to get on the mode. A comprehensive article on PSK-31 appeared in *Amateur Radio* for March 2000.

Rapid growth for APC News

The MDRC's weekly *APC News* service continues to grow rapidly, with more frequencies added in the last two months. 1.843 MHz AM commenced in late August, with relays via the VK3RHF 29.640/438.750 MHz crossband repeater being added in September.

APC News bulletins can be heard 8pm Wednesdays on the following frequencies:

- 1.843 MHz AM via VK3YE/VK3TPJ
- 3.565 MHz LSB via VK3JEG
- 29.640 MHz FM via VK3RHF
- 53.575 MHz FM via VK3GRL and VK3RDD
- 146.550 MHz FM via VK3GK/VK3JNB
- 438.750 MHz FM via VK3RHF

Bulletins can also be heard live on the Internet via URL <http://www.qsl.net/vk3jed/repeater.html>. Callbacks are held after all these transmissions. Listeners can also call our listener feedback line on 9544 9545 after the bulletin.

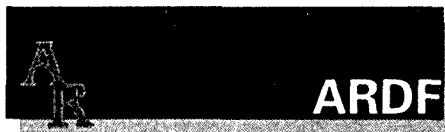
Peter Parker VK3YE
Publicity Officer
Moorabbin & District Radio Club
parkerp@alphalink.com.au
(03) 9569 6751

Redcliffe ARC Competitions

The Redcliffe Radio Club Construction Competition had two entries so they each got a prize of a DSE voucher. They were Don Lainge with a CW Oscillator and Laurie Pritchard with an RF probe.

The closing date for December entries is December 4.

Kevin VK4AKI Media Liaison



VK3WWW Jack Bramham

Email: vk3www@alphalink.com.au

Phone: +61 3 98732459 Fax: +61 3

94281589 Mobile: +61 0408037066

Nanjing hosts 10th World ARDF championships

Many of you may be aware that the WIA had a team competing in the 10th World ARDF championships held in Nanjing China from October 13-18. I know I promised a technical column this month, but I feel it would be better to let Bruce VK3TJN take over and describe the International event. Bruce has been E-mailing a daily report and I may have to edit out some sections but I am sure you will find what is left interesting.

Day 1. Arrival Day.

Bruce here from the Australian ARDF team in China. If you'd like to see future installments of this bulletin, I'll ask you to subscribe to the melb-ardf for the duration (only this first posting will go to foxlist). This is because it is likely to be a very biased account of events, with dollops of parochialism, so I'm now going to subject everyone to it if they don't want to! You can subscribe to melb-ardf by sending message to majordomo@planet.net.au (with the body containing) subscribe melb-ardf. There will be pictures too! They will be uploaded to a web-site somewhere and the reports will point at them. Coming soon.

If you'd like to see future instalments of this bulletin, I'll ask you to subscribe to the "melb-ardf" for the duration (only this first posting will go to foxlist). This is because it is likely to be a very biased account of events, with dollops of parochialism, so I'm not going to subject everyone to it if they don't want to! You can subscribe to "melb-ardf" by sending a message to majordomo@planet.net.au (with the body containing "subscribe melb-ardf"). There will be pictures too! They will be uploaded to a web-site somewhere and the reports will point at them. Coming soon!

Anyway, on with the story; I have just got back from the team-leaders meeting. Australia is first alphabetically so I was first to pick a number out of a paper bag to determine our team start positions for the 2m event. It also meant I was last (had no choice!) for the 80m competition draw. We got 8 and 18 respectively. This doesn't mean a great deal at the end of the day since it only determines the start group for the first competitor of a country. The others are spread through the field. By

the way, there are 26 countries in this world competition. Only the USA team didn't seem to be at full strength, still missing their team leader Dale and some others. There are varying numbers of competitors for each country. We have only a team of 3 in the Senior (Open division 18-40 years). They are Bryan VK3YNG, Adam VK3HDF and myself. Some of you may recall my mention of Kurt, from Belgium, in my previous missives from Korea. Well it turns out I'm rooming with Kurt.

Today it was warm, with occasional rain. We travelled by Bus from Shanghai to Nanjing, a distance of about 400km also on the bus were Yugoslavians, Bulgarians and some of the US team. There will be some photos later, but one thing becomes obvious as you travel: you never really get out in what we'd call the country. Near Shanghai it is dead flat, and only late in the journey did we start to see some hills which surround Nanjing. There is almost always a building (usually a block of flats) to be seen, and usually a continuous row. Otherwise there are rice fields, canals and dams and occasional other crops. Very little ground is left to waste. The Hotel in Nanjing is excellent, and after some teething troubles we now have permanent Ethernet (hey this is better than at home!).

After our arrival here we went out for what turned out to be quite a long walk around the nearby lake. There is an old city wall which circled old Nanjing which borders the lake (see photo soon - :) Caught up with some friends from Korea and Townsville. At the meeting we were shown the electronic tagging system they will be using for the ARDF events. Each competitor has to carry a Smart Card around and insert in the reader when they

find a transmitter. The times are stored on the card. They aren't too worried about rain, but point out sweat might cause problems with the reader. Hmmmm, not quite up to Sport-Ident standards, but we'll see how it goes! Tomorrow we have what is called a Model event. It isn't really, since it will be on completely different terrain to the actual events, but it does give a chance to make sure our gear still works. They have scheduled a team leaders meeting at the same time!! Obviously there aren't too many team leaders like myself who also compete, so I hope there will still be enough time after for me to test my gear.

Day 2. Practice and Opening Ceremony.

Well this morning was a relaxed start; Adam and Bryan were able to do a decent amount of 2m and 80m practice. I was held up in the team leaders meeting (only some of the team leaders actually compete as well) with interminable questions which did seem to go on for hours. I was able to establish that the distances between transmitters will be adhered to in this comp. 750m from the start minimum, and 400m between minimum. What seems a long time limit of 130 minutes has been set. Might be a long course!

Now I did promise pictures. Well I do have them all ready to upload, but for some reason I seem to be having ftp difficulties so not tonight. This afternoon I had a chance to at least test my equipment worked on two transmitters just outside the hotel. After that it was all into a huge queue of buses (22 buses at least) to get to the Opening Ceremony which was on the island in the middle of the lake outside the hotel. There are over 350 competitors at the world

championships from 26 countries, plus team leaders, trainers, referees and organisers. This is a BIG event to stage. I have some good photos of the amazing dancers and acrobats. Some so young (almost pre-school) it seems hard to imagine it is possible. You will just have to wait for the pictures I'm afraid. (If I can't get ftp to work, I might look for a kind volunteer to put them up for me somewhere, tell me where, and I'll send them by email.....anyone ?). As far as I know the link from here is fast. The team leaders were presented with floral arrangements and the whole thing was like a mini-Olympic opening ceremony (complete with marching band). This evening after some preparation for the event tomorrow, I had to go to the team leaders banquet (the others had a normal plebeian banquet -: Actually the hotel food is very good.) Team Leaders banquet was a lavish affair with that evil rice wine, bottomless drinks and a seemingly endless processions of delicacies. Very nice indeed. I have got to know Maurice, the Belgium team leader quite well (you see, Belgium is next from Australia in the alphabet!) since we end up sitting next to each other. Also a university student sat at our table to help translate. She is studying languages, in particular English, so with so many different English accents it would be a good test of her new abilities. Anyway, I must go to bed. Don't want to disturb Kurt too much.

Day 3. 2m Competition.

Today was a 5am wake up (groan), breakfast & hopefully grabbing all the gear we needed & out to the buses. Off we go in a mammoth procession, complete with Police escort and traffic priority provided. There were police holding off traffic, even on a freeway at one point so we could do a strange exit up an entrance lane! All very impressive, and at the same time the scale of it all a bit unnerving. Off the freeways we headed down bumpy roads through small Chinese villages about 1.5 hours out of Nanjing (don't ask me where!). The villagers were all out in force to witness the spectacle of the bus cavalcade. There were even ARDF posters plastered to some of the walls. We arrived at the destination out behind yet another small village. All the local children were out to see the foreigners. Bryan was first out with the 6th group. Groups are let out at 5 minute intervals. I had about a 2 hour wait till I went out,

Adam went last about an hour or so later. The sun came out today and it ended up being quite warm and clear. Lucky I happened to pop the sunscreen in my bag. I was in the same group as my Belgium team leader friend, Maurice. I was number 001, but he lucked James Bond - 007.

The course itself was quite long and hilly. There were areas where it was very slow movement, as well as areas of closely spaced plantation that it was possible to move through reasonably quickly and a number of tracks. Some areas of the map were a bit inaccurate with the location of tracks (some new tracks were there, and of some old tracks shown there was simply no sign and had to be bush-bashed. Every 2m TX was atop a significant hill. Sometimes you could tell the transmitter wasn't far away, but to get there was quite a different matter! Unfortunately I did the transmitters in a non-ideal order, having to backtrack at the end to get one, but in retrospect it wasn't too bad a route choice. It just took me a while. I had about 15 minutes left of the 130, and I decided to abort getting that last transmitter, and turned around to head for the finish. Later I found out I was less than 200m from the transmitter, but at the time I didn't feel I could risk being late (which means instant disqualification). I had some trouble with my smart card at the readers, especially at the last two checkpoints. I personally would not recommend this system! Peter VK3ZPF has kindly offered to put the pictures on his website to view them try the following address:

<http://www.qsl.net/vk3zpf/china/day1.htm> <http://www.qsl.net/vk3zpf/china/day2.htm>, and so on.

Day 4 Rest Day and Local Tours.

Well late last night we got the official results for the 2m competition, and we're quite happy with them! The full results will probably appear on <http://www.crsa.org.cn> at some stage. Here's some highlights: Team Australia 9th in Senior division (18-40 years). China 1st. What is of note is we beat Japan, Kazakstan, Korea, USA (Yay!), France and Yugoslavia. If we count only the truly 'ARDF teams (those who actually have Amateur call signs, we came 3rd !! In individual results, The best China time was 57 minutes for 5 TXs. Nikolay from Kazakstan was 2nd with 57 mins. Adam was 15th with 94 mins (5TX), I was 32nd

with 115mins (4TX) and Bryan 39 with 125mins (3TX). Adam was thrilled he beat the tall Chinese guy from Korea. Kurt (Belgium) was 38th with 113mins. (3TX). Alex (Kazakstan) came 7th in the Old Timers with 74 mins(40-55 years). Best US result was Rob Cooley (an orienteer) who managed 9th in Vets. Some of the comments we have heard about the course: It was long ! Many of the tracks weren't there. You had to read the map and keep track of where you were in order to have a chance of finishing reasonably. It was a good 'navigational' course. Map detail was lacking.

Some titbits of info:

The New Century Hotel turns out to be fully owned by the Phone Company that is sponsoring the event. It is 5 star and otherwise would be costing a fortune. Speaking to a Yugoslavian student who is competing: He was born in Slovenia, but had to move to Yugoslavia in 1991 due to the war because his father was born Yugoslavian. However, the Croatian, Slovenian and Yugoslavian teams are all good friends. They had to get individual sponsorship in order to come here.

Tour day was today. The Mausoleum is what you would expect...a lot of stairs and not much when you get to the top. There was one amazing event today as part of the afternoon tour, we were taken over the Nanjing Bridge across the ChangChang (Yankze) river. The bridge is over 1.5km long. Impressive as it was, it was not nearly as impressive as the lengths the organisation went to ensure smooth passage for the ARDF bus cavalcade. Basically, peak hour traffic was halted over the bridge for us to have exclusive access (we're talking like trying to block the Sydney Harbour Bridge here). We wound from one side of the road to the other, a line of about 15 buses with multiple police car escorts. Traffic was stopped in one direction or the other based on where we happened to be with other squads of police cars. Any cars getting in the way of our official speedy transit were blasted with the extremely serious horn on our bus (we happened to be in the lead bus behind the two police cars). This was amazing enough, but at the far end we left the highway, did an odd U turn in a nearby road, and then proceeded do it all again back over the bridge in the other direction. I have some pictures of all this, but it doesn't really

ICOM Clearly Ahead



"VK3LZ calling!"

More sound information from your friends at Icom.

IC-910H...THE NEW ICOM TRANSCEIVER IN TUNE WITH THE SATELLITE AGE

Our new IC-910H is really arousing the interest of communications buffs right around Australia.

It's a tri band transceiver featuring 2M/70cm/optional 23cm multi mode with 100W 2m, 75W 70cm, and 10W 23cm.

It also features a large display screen, reverse/normal tracking, 9600bps packet operation with optional DSP available. The IC-910H is designed for satellite communication with both main and sub bands displayed. This is a unit in tune with today's communication essentials. Seeing is believing at your nearest Icom Dealer.

POCKET SIZED POWER FROM THE IC-40Jr

It may look small but this CRS handheld unit packs a performance punch.

The new IC-40Jr offers 40 channels including 8 repeater channels, answer back functions, call ring feature, and a smart ring feature.

It's available in either black or yellow and its 'swing down' antenna means a snug 'shirt pocket' fit. See this mini powerhouse at your Icom Dealer today.

2000 DRAWS TO A CLOSE

The first year of the new millennium has flown by and it has been a challenging one for us. We want to thank our Dealers and of course our loyal customers for keeping Icom 'clearly ahead' in the competitive world of radio communications.

"...73"

FreeCall 1800 338 915
290 -294 Albert Street
Brunswick, Victoria 3056
Tel : (03) 9387 0666
Fax : (03) 9387 0022
www.icom.net.au

IBAN 88 006 092 575

ILLUSTRATION: SHARON HILL

capture the amazement we felt about the whole operation. The bridge itself tended to be secondary, the police escort, with sirens blazing, then led us into the middle of downtown Nanjing, the whole caboodle into a pedestrian only zone, into the middle of the market for our dinner in a nearby restaurant.

Day 5. 80m Event and Closing Ceremony

Well today we had, of course, the 80m ARDF event. Again we had the amazing police escorted trip to a remote location. It rained, despite the fine weather forecast. Even so, the villagers lined the streets of the towns and villages as we drove through the misty rain. It seemed every village had a police car there to direct us through. They decided to extend the time limit to 140 minutes due to the rain. I have a picture of the competitors camped at the waiting area. Digital pictures are not allowed in the actual start area due to the risk of someone transmitting an image of the map to a competitor somehow. This is all taken pretty seriously at a World Championship.

Adam headed off first, and despite following a very strange and lengthy route managed a very credible 114 minutes and 26th place. An excellent effort in difficult conditions. Again this was a harder course than we've ever done before (including the 2m event 2 days ago!). Going down steep and muddy hills, you use the bamboo to slow you down, but in the process you shake the wet bamboo resulting in a mini deluge! I was next a couple of hours later (it's a long wait, but we chatted to the US and the Dutch team we were sharing a shelter with. Here's a brief description of my course: Headed out the Woman/Senior corridor to the West. 5 was ahead, 1 to the right, 2 the left and 3 & 4 up the top of the map somewhere. I was planning on doing 5, but after coming down the other side of the big hill around the start decided I was close to 1 and I should do it first. It was near a village in the middle of the map. Went to 5 next in the SW. Lost myself a bit on the map, so I was uncertain to within 100m of where it actually was. Next was #2 for me in the SE. Turned out to be well to the SE and here the tracks didn't do what I expected from the map, so I'm only vaguely aware of where this one was. Not good. Still, doing ok with approx. 1 hour for the first 3 transmitters. 3 and 4 were right up the northern end

of the map so a good long run. Did 4 pretty quickly considering (making up some time), and quickly followed by 3 in a blinding 10 minutes. Now is where things fall apart. I have over 20 minutes to get to the Finish, and it is only an easy 10 minute run away. I pop out on a North-South track and head South. It is a very crappy track, but it is on the map and it should get me to the finish quicker than the road which is harder to get to. I should have learnt from the 2m map inaccuracies, but soon the track became quite indistinct. I could not find a left turn I needed to take and gradually it started to head the wrong way. In an attempt to correct the problem I thought I'd just head through the bush Southwards. Bad Idea! It became impenetrable. It even took me quite a while to back out of the disaster. 10 minutes wasted. Only 7 minutes left. I head the only way I can, on the non-track (sort of a vague passage through jungle) which insisted on taking me West. I ended up on the side of the map, almost further from the Finish than I was at TX3. Time has run out. I walk dispirited back to the distant start. A whole hoard of school children had recently arrived at the Finish so I had to run down the finish to their cheers (too embarrassing to walk). Anyway, that was me, out. Bryan found 3. He didn't have time to get either of the other northern transmitters, but it was a good finish. The Australian team therefore didn't fare as well on the 80m hunt, Oh well!

Speaking to a Norwegian competitor I was encouraged to hear that he took exactly the route as me (4—3 Finish), but he had 30 minutes to throw away on the non-track, which he succeeded in doing in a very similar way to myself. He was also overtime. Team result was 15th out of 18, but we still beat Korea and Mongolia and the best time was 59 minutes from Czech Republic.

Tonight was the award ceremony and banquet (Quite a different affair from Korea). Surprisingly it was very informal and quite brief. Most teams chatted around the periphery during the prize giving. We had adequate gifts this time and of course the little Koalas and Kangaroos are always very well received. Tomorrow is departure day and Individual tours start, I will be staying for a few extra days, but Adam and Bryan will fly home, 73 from Nanjing VK3TJN Bruce.

ar



John Kelleher VK3DP, Federal Awards Officer

4 Brook Crescent, Box Hill South Vic 3128, (03) 9889 8393, email redtoo@rabbit.com.au

The Real Ladies of Amateur Radio

About this time each year, I find my thoughts turning to our precious YL's, the real Ladies of Amateur Radio. These thoughts are purely platonic, otherwise my better Half may have a few words to say. I respect that, because she has kept me on an even keel for nearly 50 years.

One of our best, in Gwen VK3DYL, has only one entity to go to Work All DX countries. I also found out that she is battery-operated these days!

Getting down to YL Awards, I think that I can do no better than to reproduce the awards Which were available in 1999.

AUSTRALIA - The ALARA Award.

VK and ZL contact 10 YL members of The Australian Ladies Amateur Radio Association. Contacts must include 5 VK call areas; others contact 5 in 4 call areas. Contacts on or after June 30 1975. Please, no repeater or net contacts! SWL OK. Endorsements for each additional 10 members. DX only 5. GCR list and fee of 7 Irc for Basic award. The fee for additional endorsements is A\$1.00. The ALARA Award Custodian is :-

Jean Shaw, 10 Huntingsfield Drive, Hoppers Crossing, Victoria 3029 Australia.

NEW ZEALAND - WARO Award.

General requirements: Contact ZL YL's on any mode or band from the same QTH. No Repeater or contest. GCR list and return postage for return to :-

Jeanne Gilchrist ZL4JG, 37 Roy Crescent, Concord, Dunedin 9006 New Zealand.

HF: ZL and VK work 12 WARO members, DX 6. Contacts from June 1 1969. Endorsement seals for ZL and VK for each additional 12. DX 6. Contacts with DX Members of WARO qualify for endorsements, but applications must contain at least 3 ZL contacts.

VHF: 10 VHF contacts with WARO members from Jan 1 1979. Endorsements for each additional 5 contacts.

SWL: ZL and VK list 20. DX list 10; from Jan 1 1979. Endorsements for each additional 10. 5 for DX.

NZWARO Century Award.

Contact 100 NZWARO members (DX members included), from June 1 1987. All modes and bands, but each YL claimed must be a financial member at time of contact, and may be only counted once. Repeaters, nets and contests are OK. Fee is NZ\$2.00.

NZWARO Mountain Buttercup Award.

For contacts with licensed NZWARO members resident, visiting, mobile etc. in the 60 towns named in the official list (sase/irc from manager). All modes and bands, but must have been a financial member at time of contact, and within a 25 km radius of the center of the town named. Repeaters, nets, and contests are OK. Contacts after Jan 1 1989. 30 towns/contacts needed for basic certificate. Stickers for each 5 up to 60. Send SAE and return postage.

CANADA : CLARA Series Awards.

General requirements; GCR accepted. Apply to :-Cathy Hrischenko, VE3GJH, 56 Stockdale Crescent, Richmond Hill, Ontario L4C 3S9 Canada.

CLARA Certificate.

CLARA members work 12 YL in 6 Canadian call areas (limit 5 VE3) other YL or OM In Canada work 10 YL in 5 Canadian call areas (limit 4 VE3). DX stations including USA work 5 YL in 3 Canadian call areas (limit 2 VE3). All bands. Contacts after Sept 12 1972. Endorsements available. Fees: VE and USA \$3.00, all others \$4.00.

CLARA Family Certificate.

Families must reside in Canada. Work two or more members of the same family to get Family status. They need not reside at the same address. Contacts after Jan 1 1975. Log Sheets must show full names and relationships of contacts. You earn one point for the first member of the family, and two points for each additional member worked. It is Necessary to work 2 or more from the same family. 22 points are needed to

earn this Certificate. Endorsements for each additional 22 points. Fees: VE and USA \$3.00, Others \$4.00.

CLARA Ten DX Contacts Certificate.

Work 10 YL in different countries from the approved DX countries list. Open to all YL and OM. Contacts after Jan 1 1990. Fee is \$2.00, and a copy of your extract log book.

YL-DXCC

Work YL in 100 different countries from the approved DX countries list. Open to all YL And OM. Endorsements available for each additional 10 YL countries. Fees: VE and USA \$3.00. all others \$4.00.

JAPAN Ladies Radio Society Series Awards.

General requirements: GCR list and 10 Irc fee is applicable for each award. Endorsement fee for YL-10 is 3 Irc for each group of 10 YL contacts. Member list is available from sponsor for SAE. Please note that fees for all of these awards may have risen since 1997.

YL - Alphabet Certificate.

Contact a minimum of 26 licensed YL operators. The last letter of their callsigns must represent all 26 letters of the alphabet. No time limitations. Class A for contacts with JRLS members only. Class B for YL anywhere in the world including at least five Japanese YL for operators outside Japan. Applications to:-

Kazuko Isiguro JE2EWW, 59-7 Wakinoshima -cho, 7 chome, Tajimi City, Gifu 507 Japan

YL-10 Certificate.

Requires 10 confirmed contacts with licensed YL operators world-wide, including at least one Japanese YL. Contacts after Jan 1 1953. Endorsement stickers for each group of 10, though contact with a Japanese YL is not required for endorsements. GCR list and fee of 10 Irc go to :-

Ayako Inagawa JE3LFH, 1-18-11-701 Minamihorie, Nishi-ku, Osaka 550 Japan.

YL-CW Certificate

For this award and the following 5 awards, GCR list and fee of 10 Irc go to:-

Nobuko Nishigori JA3UPR, Hirosedai, Kaai-machi, Kitakatsuragi-gun, Nara-ken 636, Japan.

YL-CW-AJD.

Contact a licensed YL in each of the 10 districts of Japan. (1 to 0).

YL-CW-WAJA.

Contact a licensed YL in each of the 43 Prefectures of Japan.

YL-CW-JCA.

Contacts with YLs in 10 different Cities in Japan. Endorsements for each group of contacts with 10 additional different Cities.

YL-CW-10 Certificate

10 contacts with different licensed YLs anywhere in the world. Endorsements for each group of 10 additional contacts.

YL-CW-Alphabet Certificate.

26 contacts with licensed YL operators world-wide. The last letter of their call signs must represent all 26 letters of the alphabet.

USA - YLRL Certificate.

General requirements : Contact YLs for a very interesting series of awards. No repeaters. All contacts must be made from the same country. Do not send cards, GCR is encouraged NO CHARGE for any of the certificates, but sufficient return postage for first-class mail Or a stamped legal-sized envelope must accompany the application. The

custodian for each award is shown with the appropriate rules.

DX-YL Award.

Available to licensed YL operators only for working 25 different YLs outside your own country after Apr 1 1958. USA and possessions are counted as separate countries as well As KH6 and KL7. All bands. Contacts do not have to be with 25 countries, just 25 Different DX Yls. GCR list alphabetically by operator's last name. Endorsements for each 10 additional DX Yls. Apply to :-

Phyllis Davis KA1JC, 5282 Boyle Terrace, Pt. Charlotte, FL. 33981. (Oct 10 to Jul 10), P.O. Box 1488, Presque Isle, ME. 04769 (Jul 10 to Oct 10)

Worked All Continents - YL.

Available to all licensed amateurs. Contact a YL operator in each of the six continents. Cross-band contacts are OK. No time restrictions. Apply to :-

Leanna Shaberly KB8RT, 2635 West Sunrise Drive, Phoenix AZ 85041, USA.

Worked All States -YL.

Available to all amateurs. Contact a licensed YL in each of the 50 USA States. DC may Be counted for Maryland. No time or band limitations. GCR list alphabetically by State, and to include the YL's first name. Apply to :-

Richea Brigance KU5L, RR2 Box 197, Booneville AR 72927, USA.

YL Century Club.

Available to all licensed amateurs. Contact 100 different YL amateurs. All bands. Contacts with YLs anywhere in

the world are recognized as long as the stations were operated by licensed women operators. GCR list arranged by last name of operator. Endorsements for each added 50 stations. Gold stickers awarded to applicants who worked their additional contacts from the same country, otherwise Silver stickers will be awarded. Apply to :-

Le Henderson KB6MXH, 857 Tamerack Lane, Sunnyvale CA 94086, USA.

YL-DXCC.

Available to all amateurs. Contact licensed YL operators from 100 countries as recognized by the ARRL DXCC list. All bands may be used, but no cross-band contacts. GCR list in order of DXCC countries list including the Yls name. Endorsements for each added 25 DX countries. Apply to :-

Marty Silver NY4H, 3118 Eton Road, Raleigh NC 27608, USA.

Lastly, and hot off the presses, one for everybody.

The Crimea Award.

Issued for contacting amateur radio operators from the Crimea. (UU,UT#,EM#,EN#,EO#J). It is open to licensed amateurs and SWLs. Cards are not required. For complete, Information please contact Rusty, UU2JQ at uu2jq@packet.crimea.ua
Good luck, and best 73 de John, VK3DP

Now at redtoo@rabbit.com.au

ar



Raymond Harold Kilby VK7RK

Raymond was born in March 1918 and educated at Wellington Square and Launceston Junior Technical Schools. He was apprenticed to his father in the upholstery and bedding firm of H.J. Kilby in 1932. He saw war service for 5 years in Signals with AIF in Australia and New Guinea. He was discharged from the 33 Australian Heavy Wireless in 1946.

He married Jean May Robertson in 1942 and they had two sons Bruce and Terry. Bruce unfortunately died in 1960.

Raymond's interest in radio developed in his teens and he obtained his Amateur

Radio Certificate in 1935. Following his war service he studied further on his own and obtained the Broadcast Operators Certificate in 1958 and then a First Class Commercial Certificate No 1862 7.1/58 which was upgraded to a Radio Commercial Operators General Certificate of Proficiency No T1 in 1977.

He took over his father's business in 1960 but his interest in things radio finally saw him close Kilby's Bedding and Upholstery and take a series of Radio Operator positions. He worked for Australian Offshore Services and AWA. He served on the following ships

Regional Endeavour, Nancy Heath, Brisbane Trader, Cape Hawke, Lake Macquarie, Mt Newman, Lady Jane, Lady Gay and Empress of Australia. He retired from AWA in 1983.

Besides Radio he had a lifetime interest in music and played piano and organ. He played in dance bands and for hotel entertainment.

Ray's key fell silent on 4th October 1999.

The WIA thanks his XYL Jean for the above details of his life.

73 Ray VK7RK, DE VK7AN and the WIA.

ar

Contest Calendar November 2000 – January 2001

Nov	1-7	HA QRP Contest	(CW)	
Nov	4/5	WIA Spring VHF-UHF Contest		(Oct 00)
Nov	4/5	Ukrainian DX Contest	(CW/SSB)	
Nov	5	High Speed CW Club Contest		
Nov	10-12	Japan Int. DX Contest	(SSB)	
Nov	11/12	WAE RTTY Contest		
Nov	11	ALARA Contest	(CW/SSB)	(Oct 00)
Nov	11/12	OK/OM DX Contest	(CW)	
Nov	18/19	LZ DX Contest	(CW)	
Nov	25/26	CQ WW DX Contest	(CW)	
Nov	25/26	CQ WW SWL Challenge		
Dec	2/3	TARA RTTY Sprint		
Dec	2/3	EA DX Contest	(CW)	
Dec	9/10	ARRL 10 Metres Contest	(CW/SSB)	
Dec	16	OK DX RTTY Contest		
Dec	16/17	Croatian CW Contest		
Dec	16/17	Stew Perry 160 metres Distance Challenge	(CW)	
Dec	16/17	International Naval Contest	(CW/SSB)	
Dec	17	RAC Canada Contest	(CW/SSB)	
Dec	26	Ross Hull Memorial VHF-UHF Contest (to Jan 14)		
Dec	30/31	Original QRP Contest	(CW)	
Dec	31/1	15 th Internet CW Sprint	(CW)	
Jan	12-14	Japan International DX Contest Low-bands		
Jan	14	Ross Hull Memorial Contest last day		

Thanks this month to VK5OV ZL2ST ZL1BVK VK4EJ

Results NZART Memorial Contest 2000

VKs only (Call\mode\score)

VK5EMI Mixed 133

VK3JWZ Phone 618

VK7JAB Phone 218

VK7LUV Phone 103

VK3VP CW 267

VK3DID CW 141

Congratulations to Bruce VKK3JWZ who receives an award as highest VK scorer.

Results of AUSTRALASIAN SPRINTS 2000.

From David Box VK5OV, Contest Manager
Entries for the fifteenth (and probably final) series of the Australasian Sprints totalled 8 in the CW Section and 20, including one multi-operator (club)

station and two SWLs, in the Phone Section. These figures are a slight improvement on last year's and are a rather higher proportion than usual of the callsigns recorded on the logs received. Whether this means that the Sprints continue next year will be decided by the AHARS committee but it must be doubtful. I had hoped that some of the familiar callsigns from past Sprints, both from VK and ZL (and indeed a couple of P2s) might have made a final sentimental dash, but it was not to be. The scores in both sections were unusually low and were apparently hard work to achieve; but those who commented also noted that the Sprints were good fun and that it would be a shame to see them go.

The Adelaide Hills Amateur Radio

Society and the SA/NT Division of the WIA congratulate the overall winners, Karol Nad VK2BQQ in the CW Section and John McRae VK5PO, for the second successive year, in the Phone Section. Congratulations also to the leading scorers in the individual call areas and to Ian McGovern of Parkes, NSW, who was again the leading SWL. Lists of the logs submitted with the scores achieved are shown below. Certificate winners are indicated by asterisks.

AHARS thanks the many operators who have taken part in one or more of the Sprints over the last 15 years and who sent in logs, regardless of the size of their scores. Without their support there would have been no Sprints, and to these amateurs we wish "Good Contesting".

CW SPRINT

VK2BQQ 20**
 VK3YE 6*
 VK4UW 9*
 VK5PO 17*
 VK5ET 3
 VK5EMI 2
 ZL1ALZ 15*
 ZL1AIH 5

VK7LUV 26*
 VK7JGD 25
 VK7JAB 5
 ZL1ALZ 24*
 ZL1BVK 21
 I. McGovern 50*
 J. Zinkler 14

VK3DID SO CW 15 3rd VK
 VK3YE SO CW 4
 VK2HDH SWL PH 22 1st VK
 C Elliott SWL PH 12 2nd VK

Results ARRL 10 Metres Contest 1999

from Bernie VK4EJ

PHONE SPRINT*Multi-Op:-*

VK5SR/P 27*

Single-Op:-

VK3YE 9*
 VK5PO 36**
 VK5KCX 31
 VK5YX 30
 VK5UJ 30
 VK5OV 26
 VK5NOS 21
 VK5XY 20
 VK5TY 19
 VK5DUG 18
 VK5EMI 14
 VK5ET 11

Results Waitakere Sprints 2000

(VKs only - Call\cat\mode\score)

VK5NJ	SO	PH	57	Winner
VK5SR	CLUB	PH	53	2nd VK
VK4NEF	SO	PH	46	3rd VK
VK4SN	SO	PH	41	=4th VK
VK7JGD	SO	PH	41	=4th VK
VK1MOJ	SO	PH	39	
VK3JWS	SO	PH	36	
VK3SB	SO	PH	21	
VK7LUV	SO	PH	21	
VK5XY	SO	PH	19	
VK7JAB	SO	PH	18	
VK3YE	SO	PH	8	
VK7LUV/				
VK7JAB	DUAL	PH	39	1st VK
VK4SN	SO	CW	31	1st VK
VK5NJ	SO	CW	24	2nd VK

(Call\score)

VK4EMM	1,400,400
VK2APK	510,752
VK8AV	401,568
VK4UC	1,096,714
VK5GN	803,250
VK4EJ	192,284
VK2ARJ	163,680
VK4NEF	127,296
VK5EMI	56
VK2IA	269,012
VK4TT	135,636
VK4ICU	53,560
VK4XW	1,904
VK4DZ	1,200,960

(Club VK4NM/SN)

WAE RTTY CONTEST

11/12 November, 2000

0000Z Sat - 0000Z Sun

Only 36 hours of operation are permitted and breaks may be taken as one period or no more than three periods.

BANDS: 80 - 10 m with minimum time on band of 15 minutes.

MODE: Baudot (RTTY) only.

CATEGORIES: Single operator all bands; multi-operator single tx; SWL. DX cluster support is permitted.

EXCHANGE: RS(T) plus serial number starting at 001. Stations may be worked once only per band.

SCORE one point for each QSO and one point for each QTC reported to another station not on your continent.

MULTIPLIER is each DXCC/WAE country counted once only per band.

MULTIPLIER BONUS: each multiplier on 80 m is multiplied by 4; on 40 m by three and on 20/15/10 by two.

FINAL SCORE is total QSO + QTC points X total multipliers. Use SEPARATE LOGS for each band, showing band changes and duplicates. Supply DUPE SHEET if more than 100 QSOs on any band.

SEND LOGS by 15 December, 2000, to: WAEDC Contest Committee, Duererring 7, PO Box 1126, D-74370 Serheim, Germany.

Logs may be sent by e-mail to: <waedc@compuserve.com> in plain ASCII with Summary Sheet.

CQ WW DX Contest

SSB: 28/29 October 2000

CW: 25/26 November 2000

0000Z Sat - 2400Z Sun

OBJECT: For amateurs around the world to contact other amateurs in as many zones and countries as possible.

BANDS: 160 - 10 metres (no WARC).

CATEGORIES:: Single operator single band/multi-band; high power (100w +); low power (100w -); QRP (max 5 w o/p); assisted (full power + use of spotting nets permitted). Multi-operator all bands single TX (only one TX and one band permitted during any 10 minute period from first QSO on that band); multi-tx but only one signal per band.

EXCHANGE: RS(T) plus CQ zone.

MULTIPLIERS: Each different zone and country contacted per band. WAZ, DXCC and WAE lists, WAC boundaries are standards. Stations may contact their own country and zone for multiplier credit but zero points.

SCORE three points for contacts between stations on different continents.

FINAL SCORE is total QSO points X zone and country multipliers.

LOGS must show time UTC; exchanges; multiplier FIRST time worked on each band; checked for duplicates and correct scores. Separate log for each band.

SUMMARY SHEET should show name and address in block letters; all scoring information; category and signed declaration. All entrants should submit cross-check sheets.

SEND LOGS on paper or 3.5 inch disk in CT.BIN or N6TR.DAT format by 1 December (SSB) or 15 January (CW) to: CQ Magazine, 76 North Broadway, Hicksville, NY 11801, USA. Various AWARDS available.

NOTE: Contest Organisers please send any material you wish to be published to the Editor.

ar

Ross Hull Memorial VHF-UHF Contest

2000 — 2001

John Martin (VK3KWA), contest manager

The next Ross Hull Contest will be held between December 26 and January 14. The changes to the scoring system in last year's contest resulted in increased activity, so these arrangements will remain the same this year.

In recent years, 6 metre scores have been only a small fraction of what can be obtained on 2 metres and higher bands. This imbalance has been reduced by an adjustment to the 6 metre scoring. However the main source of big scores will still be 2 metres.

The contest has two sections - best seven days and best two days. This means that you can fit your contest activity around other commitments. But please try to get on the air for as many days as possible! You may only need seven good scoring days, but your preferred days may not coincide with someone else's. And good propagation can often come along when you don't expect it.

The Contest

The WIA maintains a perpetual trophy in honour of the late Ross A. Hull and his pioneering achievements in VHF and UHF operation. The name of each year's contest winner is engraved on the trophy, and other awards may be made in the various divisions of the contest. The contest is open to all amateurs.

Duration

0000 UTC Tuesday, December 26, 2000 to 2400 UTC Sunday January 14, 2001. In Eastern Summer Time, that is 11 a.m. on December 26 to 11 a.m. on January 15.

Sections

- Best 7 UTC days as nominated by the entrant.
- Best two UTC days.

Entrants may submit logs for either section. The nominated UTC days need not be consecutive. The overall winner will be the top scorer in Section A. If the overall winner has also entered Section B, his/her log will be excluded from Section B.

General Rules

One callsign and one operator per station. One contact per station per band per UTC day. Repeater, satellite and crossband contacts are not permitted. No contest operation below 50.150 MHz. Band plan calling frequencies should not be used for contest calls, exchanges, or liaison. A contest calling frequency

of .150 on each band is suggested. All rulings of the contest manager will be accepted as final.

Penalties

Minor errors in distance estimates or calculations may be corrected and the score adjusted. Contacts made on calling frequencies will be credited if the entrant provides a satisfactory explanation of why it was not practical to move to another frequency. Otherwise such contacts will be disallowed. Persistent unnecessary use of calling frequencies or false log entries will lead to disqualification.

Contest Exchange

RS (or RST) reports plus a serial number. Serial numbers need not be consecutive. For difficult propagation modes such as meteor scatter, exchange of a total of two digits is sufficient for a valid contact.

Scoring

For 2 metres and above, one point per 100 km or part thereof (i.e. up to 99 km: 1 point, 100 - 199 km: 2 points, etc).

For 6 metres only, contacts below 1000 km: as above. Contacts from 1000 km to 2400 km, 2 points regardless of distance. Contacts over 2400 km, 20 points regardless of distance.

The band multipliers are:

6 m	2 m	70 cm	23 cm	Higher
x 1	x 3	x 5	x 8	x 10

Logs

Logs must cover the full contest period and contain the following for each contact:

- Date and UTC time.
- Station location (if operating portable).
- Specific FREQUENCY (not just band) and callsign of station worked.
- Approximate location or grid locator of station worked.
- Reports and serial numbers sent and received.
- Estimated distance worked and points claimed.

Separate scoring columns for each band would be helpful.

Cover sheet

Logs must be supplied with a cover sheet containing:

- Operator's callsign, name and address.
- Station location (if different from the postal address).
- Section(s) entered, and a list of the UTC days to be scored.
- A scoring table set out as the example below.
- A signed declaration that the station has been operated in accordance with the rules and spirit of the contest, and that the contest manager's ruling will be accepted as final.

Deadline

Paper logs may be posted to the Manager, Ross Hull Contest, 3 Vernal Avenue, Mitcham, Vic 3132. Electronic logs can be e-mailed to jmartin@xcel.net.au. The following formats are acceptable: ASCII text, Office 97 RTF, DOC, XLS, MDB, or PUB, or Works 99 WKS. If you use Office 2000, please save the files in Office 97 format.

Logs must be received by Friday, February 9, 2001. Early logs would be appreciated.

Sample Scoring Table

Band	6 m	2 m	70 cm	etc
Score	xxxx	xxxx	xxxx	xxxx
Band Mult.	x 1	x 3	x 5	x x
Total	xxxxx +	xxxxx +	xxxxx +	
	xxxxx = xxxxx (GRAND TOTAL)			

Note on Calculating Distances

Absolute accuracy is not required. All you need to know is whether the other station is above or below the nearest multiple of 100 km. An easy method is to use a compass to draw 100 km circles around your location on a map. Better estimates can be made from six-digit Maidenhead locators, using a computer program that is available from the contest manager.

Ross Christie, VK3WAC
 19 Browns Road, Montrose 3765, Vic.
 Email vk3wac@aol.com

I have just spent a very enjoyable couple of evenings operating on the 10 metre band. Just a few months ago I was lamenting the fact that 10m was not living up to its reputation from previous sunspot peaks. But I must now rescind those comments.

In the space of just a few hours, on both nights, I worked just about every country in Europe, both on CW and SSB. Signals were solid 59(9) on just about every QSO. Europe may not be 'rare' DX, but distance wise it is about as far as you can get from Australia. Personally, I enjoy working long distance DX, this is what amateur radio is to me, talking to others in far off countries. If the country happens to be a 'rare' and sought after one then all the better. A quick check on the 12 metre band also revealed large numbers of European stations all happily exchanging RST, name and QTH with Asian and some Australian stations. Normally 12m is rather a quiet band, but as with 10m, the coming of the summer months and the longer daylight hours will perhaps encourage more VK stations to get on the band and work some DX. Hope to hear you on the bands.

The DX

3B8, Mauritius. Look for DL7DF and DL7BO to be active from the 3rd to the 17th of November. No callsigns were mentioned, but they will operate from 3B8 with one station, a beam and a vertical for 80 and 160m. QSL via the German QSL bureau DARC to DL7DF or direct to: Sigi Presch, DL7DF, Wilhelmsmuehlenweg 123, D-12621 Berlin, Germany. [TNX OPDX]

3W, Vietnam. "The 59(9) DX Report" reports that Hans, WA1LWS, is planning to be active from here between the 9th and the 26th of November. This will include the CQ WW CW Contest. He has applied to operate on 80, 40, 20, 15 and 10 metres. However, Hans says that 80 and 40 metre operation may

be doubtful. He operates exclusively on CW. [TNX WA1LWS, The 59(9) DX Report and OPDX]

5A Libya. Vladimir, UY5ZZ advises us that George, UY0MF will be operating as UY0MF/5A from near Tripoli "during 2000". George operates on 17 and 15 metres only. QSL via UX5MZ. [TNX 425 DX News]

5B Cyprus. Dez, G0DEZ will be in Cyprus for the next three years until 2003. He hopes to obtain 5B4 and ZC4 licences very soon, but for now he is 5B4/G0DEZ. QSL via G0DEZ whose correct address is Dez Watson, 12 Chadswell Heights, Lichfield, Staffs WS13 6BH, England. [TNX 5B4/G0DEZ and 425 DX News]

5N, Nigeria. Bogdan, 5N3CPR, operates quite a bit on 17 metres CW. He is usually active between 2200 and 0100z around or just below 17080 kHz. He will be heading back to Poland soon for "time off", but will return to Nigeria and resume his 5N3CPR operation. He is running a FT-100 that he finds convenient to carry on airplanes and uses a half-sloper antenna. His home call and QSL route is SP5CPR. [TNX 5N3CPR and 425 DX News]

A3, Tonga Island (Fiji). Hrane/YT1AD and Dragan/Z32AU are active as A35AD and A35AU until the 28th of October. After this time they will be operating as YJ0AD and YJ0AU until the 5th of November. They will return to Fiji to be active as 3D2AD and 3D2AU from the 5th to the 10th of November. Activity will be on CW and SSB on all HF bands including 6 metres. QSL via YT1AD and Z32AU. [TNX OPDX]

D4, Cape Verde Islands. Jose, EA8EE, plans to be active from the 6th to the 12th of November signing D44DX. Jose will also be active on 6m. More details to follow. [TNX The 59(9) DX Report]

VK0, Macquarie Island. The supply vessel "Polar Bird" is due at Macquarie Island on 7 November for the annual re-supply of the station & departs for Casey Station (Wilkes Land, Antarctica) on the 12th of November. Alan, VK0MM will therefore be permanently QRT from 12th of November onwards. Alan does mention, however, that there may be some activity as VK0LD from Casey Station. QSL route will be announced at the end of 2000. QRV times for VK0MM are available at <http://www.geocities.com/vk0ld/1.html> [TNX 425 DX News]

ZL8, Kermadec Island. Jacky, ZL3CW (F2CW) reports he will operate as either ZL8CW or ZD8CW from Kermadec between the 2nd and 15th of November. If you want to contact him before departure to line up a sched or whatever his e-mail address is zl3cw@i4free.co.nz [TNX ZL3CW and 425 DX News]

IOTA Activity

(AF-073) 3V.

The TS7N activity for the Kerkenah Islands (AF-073) is confirmed to take place between the 15th and the 30th of November. A team of 12 German amateurs, plus JH4RHF, I2DLS and IT9ESZ will operate on all bands, including 6 metres, and on all modes. They will participate in the CQ WW DX CW Contest (Multi-Single). QSL via DL6BCF (Britt Koester, Putzstr. 9, 45144

Essen, Germany). The web site for the operation is at <http://qsy.to/ts7n> [TNX DJ7IK and 425 DX News]

AS-049.

Takeshi, JI3DST, will activate the Takara Islands (Kuchinoshima Tosima-Mura, Kagoshima-Gun, Kagoshima, JAPAN) between the 23rd and 25th of November, as JI3DST/8. Activity will be on 17/15/12/10/6 metres. QSL via the JARL Bureau (BUREAU is Best) or direct to (Please don't send US\$): Takeshi "TAKE" Funaki, 2-18-26 Hannan-cho, Abeno-ku Osaka-city, OSAKA 545-0021 JAPAN. [TNX OPDX]

EU-063.

A group under the leadership of Mat, JW5NM, is planning a trip to Axeloya in the Svalbard Archipelago. This is an extremely rare IOTA entity because most of the area is off limits due to environmental concerns. Because it is so remote an expedition to this area will be expensive so the team is looking for some financial support for this venture. Send E-mails to Rag (LA5HE, OZ8RO, JW5HE) at: la5he@yahoo.no [TNX JW5NM and OPDX]

OC-035.

YJ, VANUATU. The Prairie DX Group is pleased to announce their 2nd Dxpeditio to take place between the 18th and 28th of November, from Vanuatu and Efate Island (OC-035). They will be operating at least two stations around the clock and possibly more on 160-6 metres. Modes will be SSB, CW, RTTY, SSTV and PSK31. During the Dxpeditio, they are planning a sub-trip to one or more of the rarer YJ IOTA's. In addition to operating from the other islands, they will be participating in the CQ World Wide CW Contest from Vanuatu. The six members of the traveling team are: Rick/KF9ZZ, Todd/W9YK, Fred/KF9YL, Mike/N9WM, Bill/W8LVN and Tim/KB9QYL. As in their previous Dxpeditio (FP/N9PD September 1998), one of their main goals is to give every amateur the opportunity of working them at least once (and hopefully more often). The QSL route is via N9PD direct (The Prairie DX Group, 1206 Somerset Ave., Deerfield, IL 60035 USA) or via bureau. Please include SASE with postage, IRC or greenstamp. Direct QSL cards received without return postage will be returned via bureau. For further info, check the Web page at: <http://www.n9pd.com> Or send

E-mail to Rick, KF9ZZ at: kf9zz@arrl.net [TNX The Prairie DX Group and OPDX]

AF-086.

D4, CAPE VERDE. Manuel/EA8BYG and Jose/EA8EE will be active near the capital of Mindelo from the Island of Sao Vicente (IOTA AF-086) from the 1st to the 8th of November. They will actually be operating from the QTH of Carlos, D44AC, and will use his callsign. Their activity will be on all HF bands around the IOTA frequencies including 17m, 12m and VHF 50 MHz. The grid locator is HK76KM. Modes will be CW, SSB, RTTY, PSK31, HELL, STREAM, MT63, SSTV and PACTOR. Their equipment will be an IC-706 MKIIG, with vertical antenna and a directional antenna A5S to be assembled on a mast. They will also have a homemade dipole for 6 metres and a TS440 Kenwood. QSL via EA8URL (The Gran Canaria DX GROUP). [TNX OPDX News]

Special Events

HF0POL. Marek, SP3GVX/HF0POL sends us a brief description of his activity from King George Island, South Shetlands. He has been at Arctowski Base since December 1999 and will be there until December 2000. He has also operated as R1/HF0POL from Bellingshausen Base (from the 12th -13th of February and 4th -13th of August, 2000), as LU1ZI/HF0POL from Jubany Base (3rd -7th of June) and as KC4/HF0POL from Peter J. Lenie Base, aka Copacabana (21st -23rd of July). The QSL manager for all his QSOs is SP3WVL either direct or through the bureau. Marek reports both the following addresses for SP3WVL are correct: Tomasz Lipinski, ul. Wodna 7A/6PL, 69-100 Slubice Poland or Tomasz Lipinski, P.O. Box 78PL, 69-100 Slubice Poland. Marek was also active between December 1996 and December 1997, please note that cards for contacts made with HF0POL during this time frame should only be sent to SP3FYM. [TNX SP3GVX/HF0POL and 425 DX News]

A Special event station from Poland, 3Z0MM, will be active until the 30th of November to celebrate the millennium of the historical meeting of Polish King Chrobry with German Emperor Otton III in Szprotawa. QSL via bureau or direct to SP3JHY: Jerzy Ryks, os.B.Chrobrego 3/IV/7, 67-300 Szprotawa, Poland. [TNX SP3JHY and OPDX]

Round up

DX HOLIDAY WEB SITE. Kenny, K2KW, informs OPDX that he has just launched a new Web site called "DX Holiday". The goal of this site is to share information on DX operating locations, and Dxpeditio "how-to" information. He hopes the readers find it helpful, and he especially hopes they will contribute to it! Check out <http://pages.prodigy.net/k2kw/qthlist/> [TNX K2KW and OPDX]

New Israeli 6 metre beacon. Arie, 4X6UO, informed the OPDX that a new 6m beacon is on the air with a temporary callsign and location. The frequency is 50.0802 MHz. The CW beacon text is "vvvvvvvvv 4Z5AY test 4Z5AY test 4X/4Z beacon located in Tel-Aviv km72jb now tx all the characters from memory abcde fghij klmno pqrst uvwxy z1234 56789 0.?- / 15 seconds key down" For more info check the web page at http://www.iarc.org/~4z5ay/htmls/bea_tec.htm [TNX 4X6UO and OPDX]

Pirate operation. Someone who gives either KY6XT or KK6XT as a manager has been pirating AP2JZB's call, using CW, for the past four or five years. Please note that the genuine Bob, AP2JZB does not work CW and still has K2EWB as a QSL manager. [TNX AD5W and 425 DX News]

Another pirate alert. Marcos, LU7BQ, informs us that the station signing Q0X/LU7BQ on 20 CW is a definitely a pirate. He has operated using SSB only for about 40 years and has never gone to XQ0. He is currently receiving a lot of QSLs and he is so sorry for the guys wasting their geenstamps and IRCs. [TNX OPDX]

And yet another pirate (I have had the dubious honour of working this one myself), Jean Michel, F6AJA, reports that a station signing 5R8O is very active and is stating that 5R8FL is his QSL Manager, but unfortunately 5R8FL knows nothing about this station.

Sources

Finally, again this month, special thanks go to the following people and organisations, AD5W, 4X6UO, K2KW, SP3JHY, SP3GVX/HF0POL, The Prairie DX Group, JW5NM, DJ7IK, ZL3CW, 5N3CPR, 5B4/G0DEZ, WA1LWS, The OPDX Bulletin by KB8NW/OPDX/BARF80, 425 DX News and Bernie W3UR & 'The Daily DX'.

ar



David K Minchin VK5KK

Postal: PO Box 789 Salisbury South Australia 5108

E-mail: tecknolt@arcom.com.au, Web page: <http://www.ozemail.com.au/~tecknol>

Phone : 0403 368 066, Fax: +61 8 8234 6396

All times are in UTC

6 Metres .. Ok who has the keys!!

Overall the Spring Equinox, just passed, has been a bit of a fizzer, maybe re-enforcing that this cycle is still yet to perform properly. A lack of Extension propagation modes has kept most of the lower half of VK quiet and I suspect areas further up..

Don VK6HK reports ... "A good day in Perth yesterday, Wednesday 18th - Some log extracts... Band was open earlier than 0400Z but I was out with the XYL. 0407Z KH7L, 0500 - 0615 JA's, 0626 HL1LTC, 0648 7M4BEP/5 (Alarming alternative JA prefix...), 0724 BY9AA, 0745 HL5XF (Hrd), 0748 DS2DKW (Hrd) (Another alternative for Korea...), 0832 4W6UN/B (Hrd), 0647 9V1UV, 0943 YB0AN (Hrd), 1052 EY8CQ, 1153 9M6BAA, 1219 VR2XMT, 1224 9M6BAA (Now 9+10)" ... Don VK6HK

Ron Graham VK4BRG reports ... "Some interesting 6m propagation 0054 to 0107 UTC on 18/9/2000.. commencing with a normal F2 opening to the San Diego area. Then I was called by K7CW in CN87 grid (Washington State). He had a pronounced and rapid auroral flutter on his signal. Some discussion took place and he said he had to beam East to work me. I asked if there was any aurora activity he was aware of and he replied that the aurora had been visible as far south as Nth. Washington State. Four other contacts took place with stations in that general area; as far north as VE7 and as far east as western Montana, all with the same flutter and with them beaming east."

"Immediately following, stations around the Colorado area were worked with what appeared normal F2. That propagation continued for another 20 minutes. I think the stations worked via the aurora were via F2 to somewhere in the US and this linked up with the auroral propagation at that end. I experienced a similar situation last cycle

with a KL7 in Alaska. We both tried various beam headings during that contact but he HAD to beam somewhere close to east to work me. I still remember him saying he was beaming to the Great Lakes area."

And on 25/10/2000 "Well, finally had a reasonable 6m opening to Europe last evening 25/10/00. 0640 YO4BCZ 4-2 KN45, 0703 UT5JCW 5-2 KN64, 0732 YO4FRJ/P 4-2, 0736 UT4IO 5-5 to 5-9 KN88, 0807 OH5CW 5-2, 0809 OH7KM 4-2, 0853 YL3GJ 5-7 KO26. Quite a long opening, and difficult operating conditions!! Wally, VK4DO, had a similar opening over a similar time period." ... Ron, VK4BRG

144 MHz and above

Rob VK3EK has been doing more than most to keep 144 & 432 MHz warm throughout Winter. He reports on activity ... "The 144.150 NET at 9.30 UTC of a Wednesday night it will be warming up in them out door shacks by now so we will be looking for you on the bands below is a list of stations heard or worked from VK3EK on Wednesday 27-09-00. VK3BDL 144.150 VK3YFM 144.150 VK3AXH 144.150 VK3AMH 144.150 VK3WRE 144.150 432.150 1296.150 VK3KAI 144.150 VK3KLO 144.150 432.150 1296.150 VK2MP 144.150 VK1ZQR 144.150 VK3TNW 144.150 VK3BRZ 432.150 VK3XLD 144.150 432.150 1296.150"

"Other contacts at various times ...16-9-00 VK2ZAB 144.2 432.160 and heard 1296.1 VK2MP 144.2 432.150 22-9-00 VK1VP 144.2 VKI2TWR 144.2 432.150 27-9-00 VK3ANP 432.150."

On 11/10/2000...." It was good to see that the activity was about again last night (11/10). REX VK7MO/P Mt Wellington put southern VK7 up for grabs and congratulations to David. VK3XLD and CHAS VK3BRZ on the 2m and 70cm contacts good stuff .I worked Rex VK7MO/P at a sked time of 0915 UTC on 144.180 and also at later times

but didn't make it on 70cm. Other good contacts made from Bairnsdale QF32te as follows VK3WRE 09.31 UTC on 144.150 5x3 with beam at Hobart 0932 UTC VK3AJN 144.150 5x6, 0937 UTC VK3BDL 144.150 5X9, 0938 UTC VK3DUT 5x9, 0943 UTC VK3BDL 5x7 432.150, 0955 UTC VK3BDL 5x1 1296.150, 0901 UTC VK7MO/P 5X2 144.150 Working VK3KLO, 1006 UTC VK3TLW 144.150 5X5/7, 1007 UTC VK3TLW 5x2 1296.150, 1013 UTC VK3TLW 432.150 5X3, 1020 UTC VK3WRE 432.150 5X5, 1022 UTC VK3KLO 5X8 432.160 What a change a 432MHz freq. Busy 1026 UTC VK3KLO 1296.150 5x7/ 5x4, 1032 UTC VK3KLO 144.150 5X9 , 1035 UTC VK3KWA 144.150 5x2 Calling VK7MO/P of the side of his beam." ... ROB VK3EK

Chas VK3BRZ reports ... "Last night 1(11/10/2000) between 09:00 and 10:00 UTC David VK3XLD and I worked VK7MO/P Mt. Wellington on both 2m and 70cm SSB. Signals were very good - at times Rex was up to S9 on 2m and S5 on 70cm, although at the time of my contacts we exchanged reports of 55/53 on 2m and 53/52 on 70cm.

There was clear evidence of aircraft enhancement, especially on 2m where Rex's underlying tropo signal was always audible at S1-2, but came up to S9 with multi-path flutter clearly audible during those times. The enhancement periods lasted about 10 minutes from go to whoa. The 70cm contact was grid No. 45 for me on that band." ... Chas VK3BRZ

Rex VK7MO reports on activity on 25/10/2000 ... "It was great to get through to Robbie VK3EK on both 2 and 70 cms SSB on 25/10/00, considering the poor weather - it was foggy and raining all the time. I did not make any other SSB contacts, but Chris VK3KME did copy my VFSKCW on 2 metres at up to 20 dB above the noise, and David VK3ANP did copy some short segments of VFSKCW at Wangarrata on 6 metres. David

VK3XDR at Geelong copied some PSK31 although I could not hear or see a peep from him."

"You may enjoy this story about what happened when I tried to come home. In trying to adjust the window to keep the rain out, with the feedline coming in the window, I must have somehow got the window winder motor stuck on. I must admit that while I was running the rig there was a slight transformer type smell but I could not find it and wrongly assumed it was imagination. Thus while I have a separate battery for the radio I still flattened the car battery - worse to come was that the radio battery did not have enough left in it to jump start the car. And there I was up the top of Mount Wellington at 10.30 PM in the rain and fog. The little I had in the radio battery did charge the car battery slightly and I did turn the engine over twice but not enough to start it. So I had to call my son out and jump start it from his car." Rex, VK7MO

Microwave Primer Part Six: 10 GHz

Mention 10 GHz and most amateur operators identify this as THE microwave band, the frontier where it all happens. 10 Ghz "Primer" is to be presented in two parts, as this band holds most of the interest, yet is one of the more difficult bands to get going on. Despite this, most 10 GHz operators jumped straight from 1.2 Ghz to 10 Ghz missing all the bands in between What has made 10 GHz the "icon" of the microwave bands?

Our 3 cm allocation stretches from 10,000 MHz to 10,450 MHz. Narrowband operation is concentrated around 10,368 MHz with the satellite allocation being around 10451 MHz (the long awaited Phase 3D satellite). The band was first activated over 50 years ago, our own Des Clift VK5ZO being the first to operate 10 GHz in the UK in the late forties.

Up until the seventies operation on 10 GHz was limited to Klystron technology, the WW2 surplus 2K25 (723A) Radar Klystron being the mainstay of operation. The Klystron provided about 100 mW's of RF and was typically used with a 1N23 mixing diode and a 30 MHz Wideband FM IF. The second station is tuned 30 MHz higher or lower, allowing full duplex operation.

In the seventies the Gunn diode that only required 5 volts to provide 5 – 40 mW's of 10 GHz RF soon displaced the old Klystron. It allowed the same "waveguide mixing" techniques as the Klystron with 30 MHz IF's, later 88 – 108 MHz FM receivers became popular as Wide band IF's giving some flexibility to tune around (30 MHz IF's were fixed requiring the Gunn diode to be tuned). As other "consumer" devices started to use Gunn diodes, e.g. movement detectors, the popularity of 10 GHz grew.

Gunn diode technology is still the easiest way to get going on any of the bands above 1 GHz if you have access to the parts. A commercial Gunnplexer needs little more than a few transistors, a FM receiver, microphone and dish to complete a 10 GHz station. They are also ideal RF sources for Wideband ATV and data links. More recently, DRO's (Dielectric Resonant Oscillators) have made an impact on wide band operations. DRO's offer much better temperature stability (they are typically used as the first LO of satellite down converters)

Wideband direct mixing technology has its limitations. Stability and noise sidebands of Gunn or Klystron RF sources are the prime limitations. Another is the actual noise figure of the receiver, at very best about 10 db. As the mixer has no Filtering in front of it, the DSB noise sideband adds 3 db to the noise figure. A Wideband IF bandwidth has an approximate 15db disadvantage over a normal 2.5 KHz SSB IF. And 5 – 100 mW's of 10 GHz RF isn't much! It is obvious that stable "Narrowband" equipment would be an enormous improvement at any power level!

In the late seventies, several amateurs in Europe started experimenting with "Narrowband" 10 GHz operation. A demonstration by G3JVL of his waveguide based "transverter" to a group of German amateurs in 1977 to started the era of 10 GHz. Even though this still involved "plumbing", the explosion of interest on 10 GHz put Europe at the head of the Amateur microwave world. Yet it was still "mixing only" equipment. Affordable amplifying devices were not available.

By 1986 Gasfet technology had become affordable, as had PTFE based printed circuit board. And some clever work by some amateurs, making resonant cavity filters from common copper plumbing

end caps, provided the necessary filtering to make the first PCB based transverter possible.

The first PCB based transverter design was published by DC0DA, in VHF Communications in 1987, making all waveguide mixers obsolete. The 200mW's and 3-db noise figure changed the game plan, seeing the tropo world record double in distance in short time! The 10 GHz transverter designs that have followed all reflect this design by DC0DA.

Next month, how do you get started on 10 GHz

New 24 GHz Record in USA

A new North American distance record at 24 GHz is being claimed by Ron Smith, K6GZA and Gary Lauterbach, AD6FP. The contact occurred September 16 during the 2000 10 GHz and Up Cumulative Contest between Mt Oso (CM97hm) in Northern California and Mt Frazier (DM04ms) in Southern California. The calculated distance of 375 km is believed to be a new North American record. Both stations used SSB with signals peaking to S7 on the Frazier end and S5 on the Oso end of the path.

At the time conditions on 10 GHz over the path were reported excellent. Signal levels were good enough for K6GZA and AD6FP to converse for several minutes before each went back to working other stations in the contest. (From ARRL Bulletin)

In Closing

Wally VK6KZ reports ... "Good news is that the 1296 MHz VK6RSW Augusta beacon is now 1296.562 MHz. 144 and 432 seem to be propagating in the Perth direction quite well but 1296 has yet to be heard." ... Wally VK6KZ

A short column this month as various work and private commitments has robbed much of the time required for producing the column (special thanks to Colwyn, AR editor for allowance here!). By the time you read this the Spring Field day should be well and truly over, I trust the weather helped with propagation!

I'll leave you with this thought.. "The time to relax is when you don't have time for it"

Till next month

73's David VK5KK AR

Ises Observed And Predicted Solar Indices

Prepared by IPS Radio and Space Services
Predictions Based on Cycle 23 Peak Sunspot Number of 140
Issued on Oct 03 2000

SMOOTHED SUNSPOT NUMBER

Year	Jan	Feb	Mar	Apr	May	Jun	Jul	Aug	Sap	Oct	Nov	Dec
1995	24.2	23.0	22.1	20.6	19.2	18.2	17.0	15.4	13.4	12.1	11.3	10.8
1996	10.4	10.1	9.7	8.4	8.0	8.5	6.4	8.3	8.4	8.8	9.8	10.4
1997	10.5	11.0	13.5	16.5	18.3	20.3	22.6	25.0	28.3	31.8	35.0	39.0
1998	43.7	48.9	53.4	56.5	59.4	62.5	65.5	67.8	69.5	70.5	73.0	77.9
1999	82.6	84.6	83.8	85.4	90.4	93.0	94.4	97.5	102.3	107.7	110.9	111.0
2000	112.8	116.6	119.8	122.4 ^e	123.6 ^e	126.1 ^e	130.4 ^e	133.6 ^e	134.8 ^e	135.4 ^e	136.6 ^e	137.8 ^e
				(1)	(2)	(4)	(5)	(7)	(9)	(10)	(12)	(14)
2001	136.8 ^e	135.5 ^e	136.5 ^e	138.2	137.3	136.2	134.9	133.4	131.7	129.9	128.0	125.9
	(15)	(17)	(18)	(19)	(19)	(19)	(19)	(19)	(18)	(18)	(18)	(17)
2002	123.7	121.4	118.9	116.4	113.8	111.1	108.3	105.5	102.6	99.6	96.7	93.7
	(17)	(17)	(16)	(16)	(16)	(15)	(15)	(15)	(14)	(14)	(13)	(13)
2003	90.6	87.6	84.6	81.6	78.6	75.6	72.6	69.7	66.8	63.9	61.1	58.4
	(12)	(12)	(12)	(11)	(11)	(10)	(10)	(9)	(9)	(9)	(8)	(8)
2004	55.7	53.1	50.5	48.0	45.6	43.2	40.9	38.7	36.6	34.6	32.6	30.7
	(7)	(7)	(7)	(6)	(6)	(6)	(5)	(5)	(5)	(4)	(4)	(4)
2005	28.9	27.1	25.4	23.8	22.3	20.9	19.5	18.2	17.0	15.8	14.7	13.6
	(4)	(3)	(3)	(3)	(3)	(2)	(2)	(2)	(2)	(2)	(2)	(1)
2006	12.6	11.7	10.8	10.0	9.3	8.5	7.9	7.2	6.7	6.1	5.6	5.1
	(1)	(1)	(1)	(1)	(1)	(1)	(1)	(1)	(1)	(1)	(1)	(1)
2007	5.4	5.6	6.0	6.4	7.1	8.2	9.5	11.2	13.3	15.6	18.3	21.3
					(1)	(1)	(1)	(1)	(1)	(1)	(2)	(3)
2008	25.0	29.0	33.2	37.6	42.1	46.8	51.6	56.4	61.3	66.1	71.0	75.8
	(3)	(4)	(4)	(5)	(6)	(6)	(7)	(8)	(8)	(9)	(10)	(10)
2009	80.6	85.2	89.8	94.2	98.5	102.6	106.5	110.3	113.8	117.2	120.3	123.2
	(11)	(12)	(12)	(13)	(14)	(14)	(15)	(15)	(16)	(16)	(17)	(17)

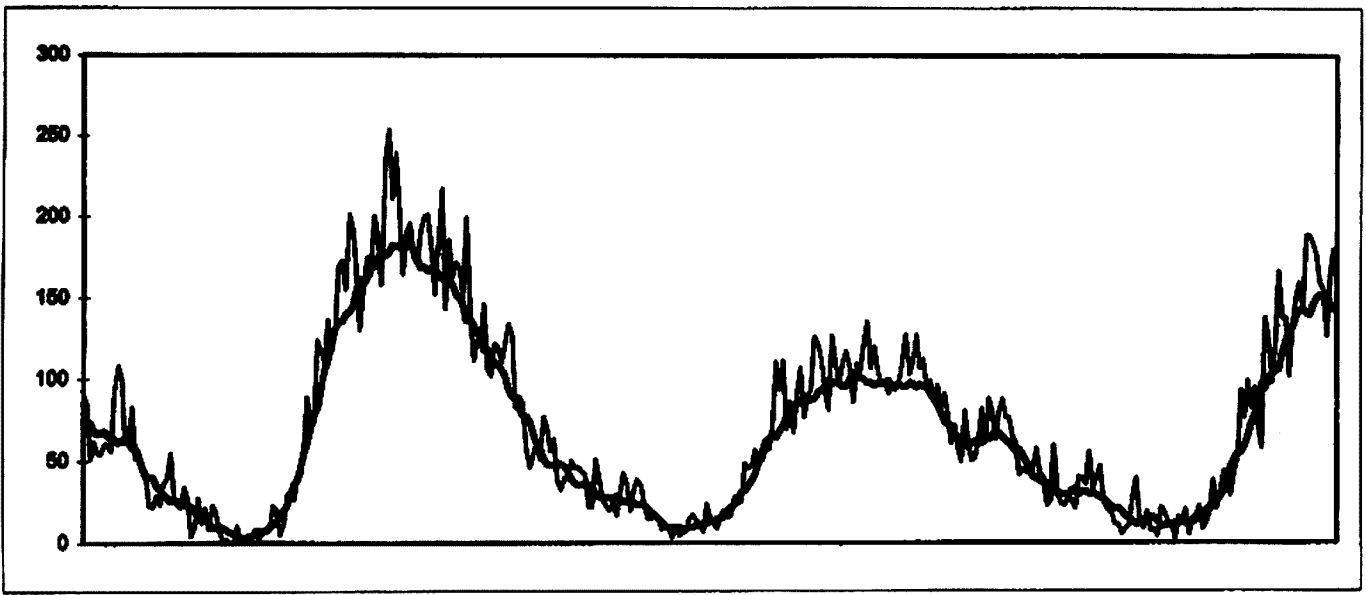
Solar Cycle 23 maximum

The Ionospheric Prediction Service is predicting a peak for solar cycle 23. The smoothed sunspot number is expected to peak at 140 in December 2000. The table on the top left is the Ionospheric Prediction Service table for smoothed sunspot numbers for solar cycles 23 and 24; it is printed with permission.

The graph of the current solar cycle [23] shows that that is now at or near its maximum. As the smoothed sunspot number is a running average, taking in figures six months ahead and six months in the past, we can only be sure of the maximum at least 6 months after it has happened. Past figures predicted this to be about now.

More recent figures were setting the maximum in the range August 2000 through to February 2001. The graph of observations also shows the monthly average of observed T index to be falling. The Ionospheric Prediction Service has revised its table of T indices with the new table showing a peak in August 2000.

This does not mean that conditions for radio are on a downward slide. My experience is that the best conditions are in the year following a solar cycle peak. 2001 is shaping up to be the best year for radio propagation in solar cycle 23.

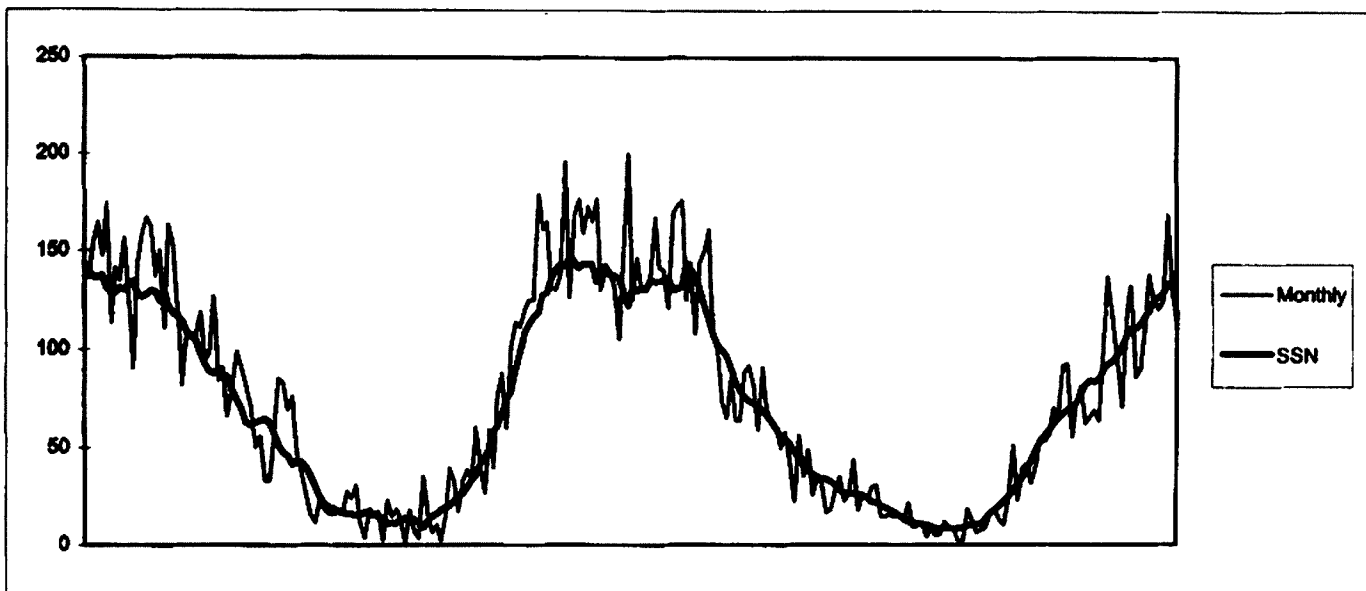
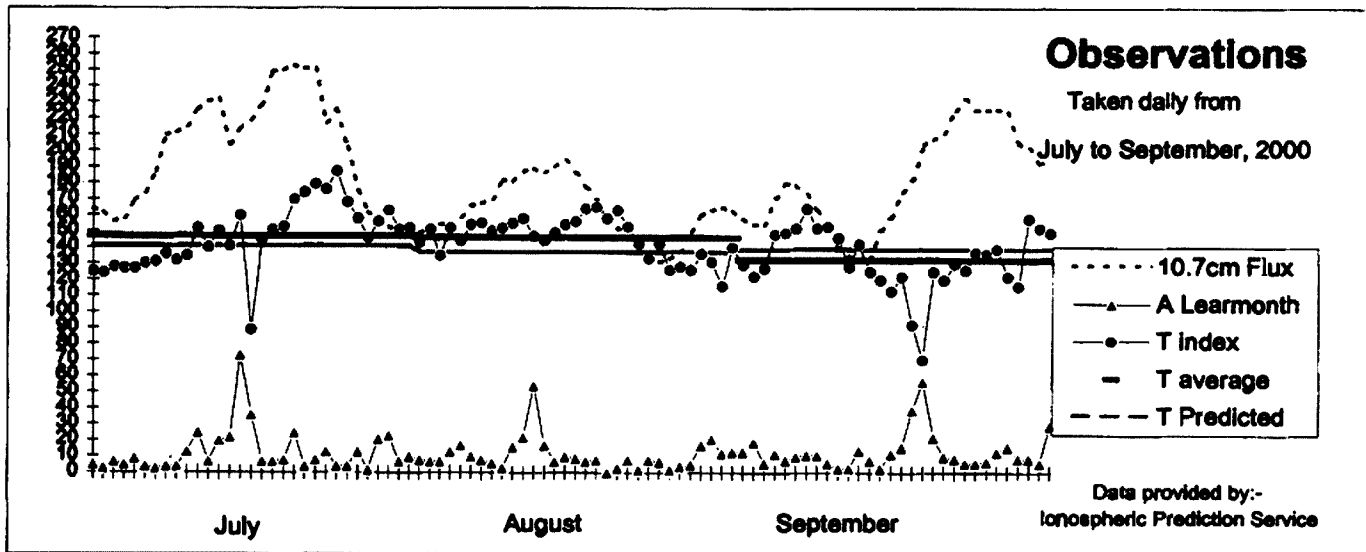
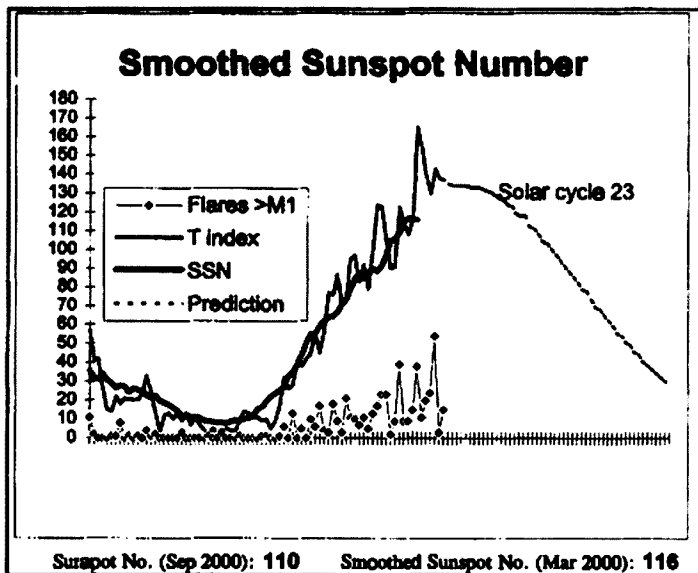


Climatology

At the bottom of these pages is a graph of the last fifty years of monthly sunspot numbers and the underlying smoothed sunspot number

The rise and fall with each sunspot cycle shows the pattern expected but that's where it stops. You can see the variation in the peak values. The length of each solar cycle can also vary, and has done so in the past, but has been close to the standard eleven years for the last half century. It is included to show the variation in the solar cycles and the consequent difficulty in quantifying variation based on past climate. It is designed to cover the operational time of most amateurs. It may equate to the rise and fall of DX or entries in some station logs.

The graph runs from July 1950 where you can see the final decline of cycle 18 to September 2000 which is approaching the peak of cycle 23. The break between pages occurs at June/July 1980 which is near the peak of solar cycle 21.



HF Predictions

by Evan Jarman VK3ANI

34 Alandale Court Blackburn Vic 3130

These graphs show the predicted diurnal variation of key frequencies for the nominated circuits.

These frequencies as identified in the legend are:-

- Upper Decile (F-layer)
- F-layer Maximum Usable Frequency
- E-layer Maximum Usable Frequency
- Optimum Working Frequency (F-layer)
- Absorption Limiting Frequency (D region)

Shown hourly are the highest frequency amateur bands in ranges between these key frequencies, when usable. The path, propagation mode and Australian terminal bearing are also given for each circuit.

These predictions were made with the Ionospheric Prediction Service program: ASAPS Version 4

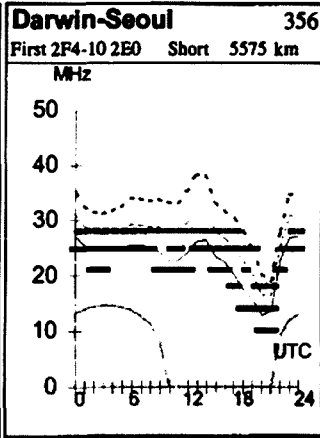
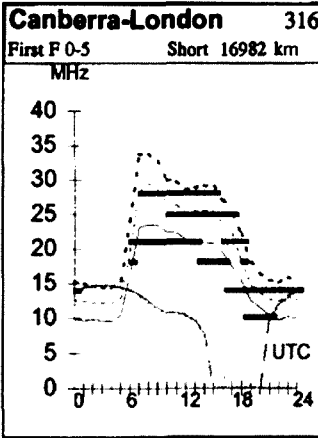
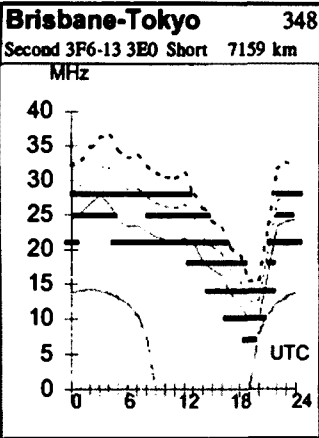
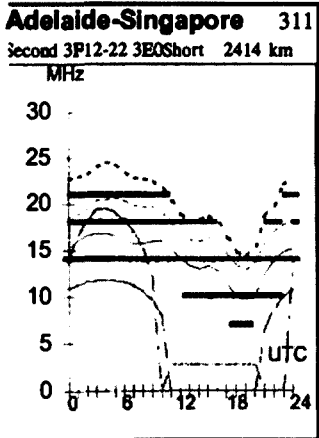
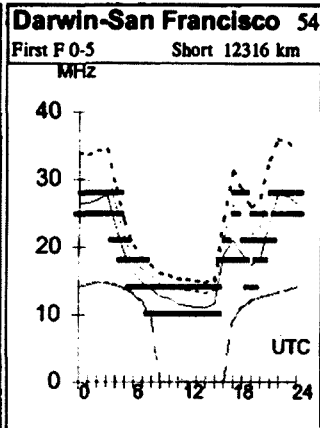
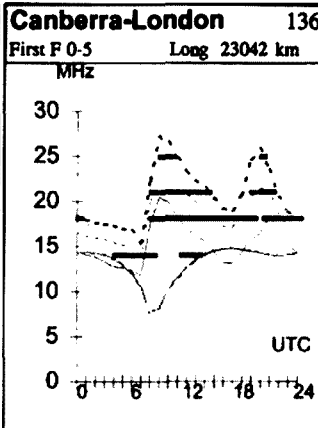
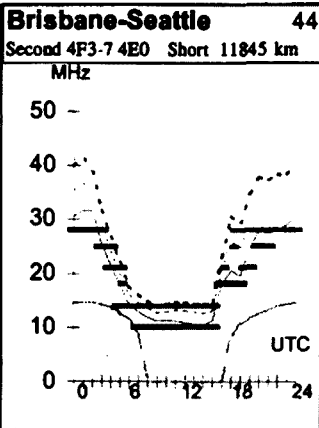
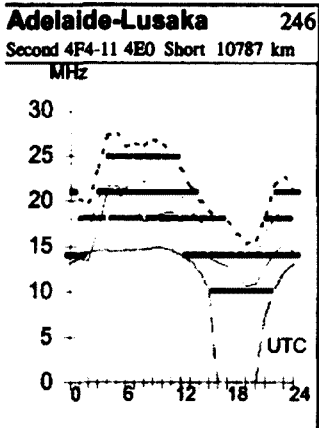
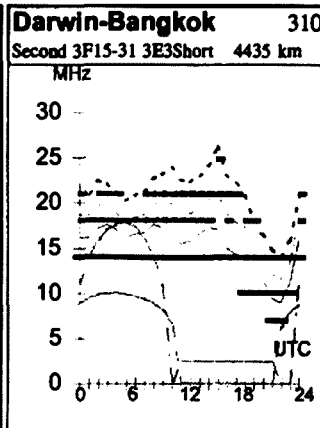
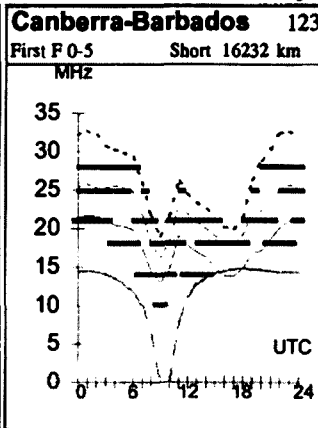
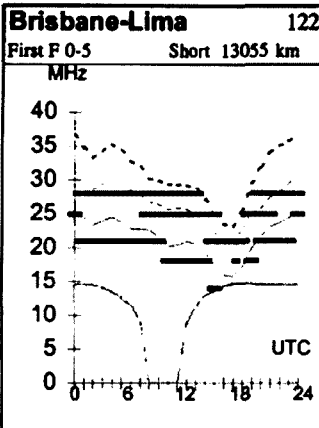
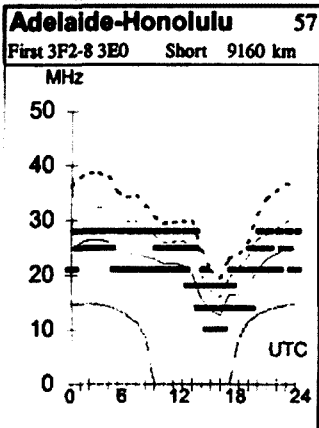
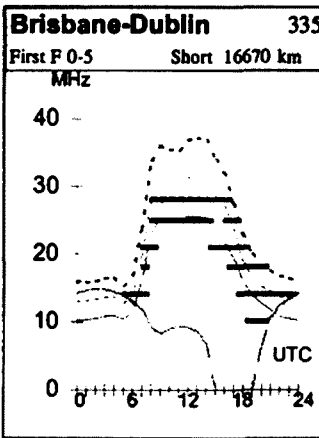
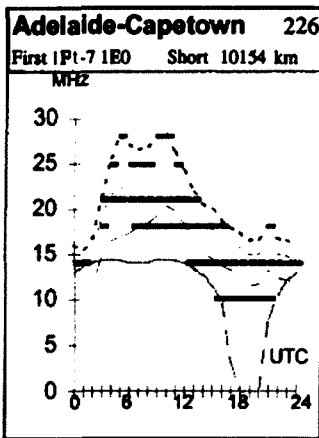
November 2000
T index: 134

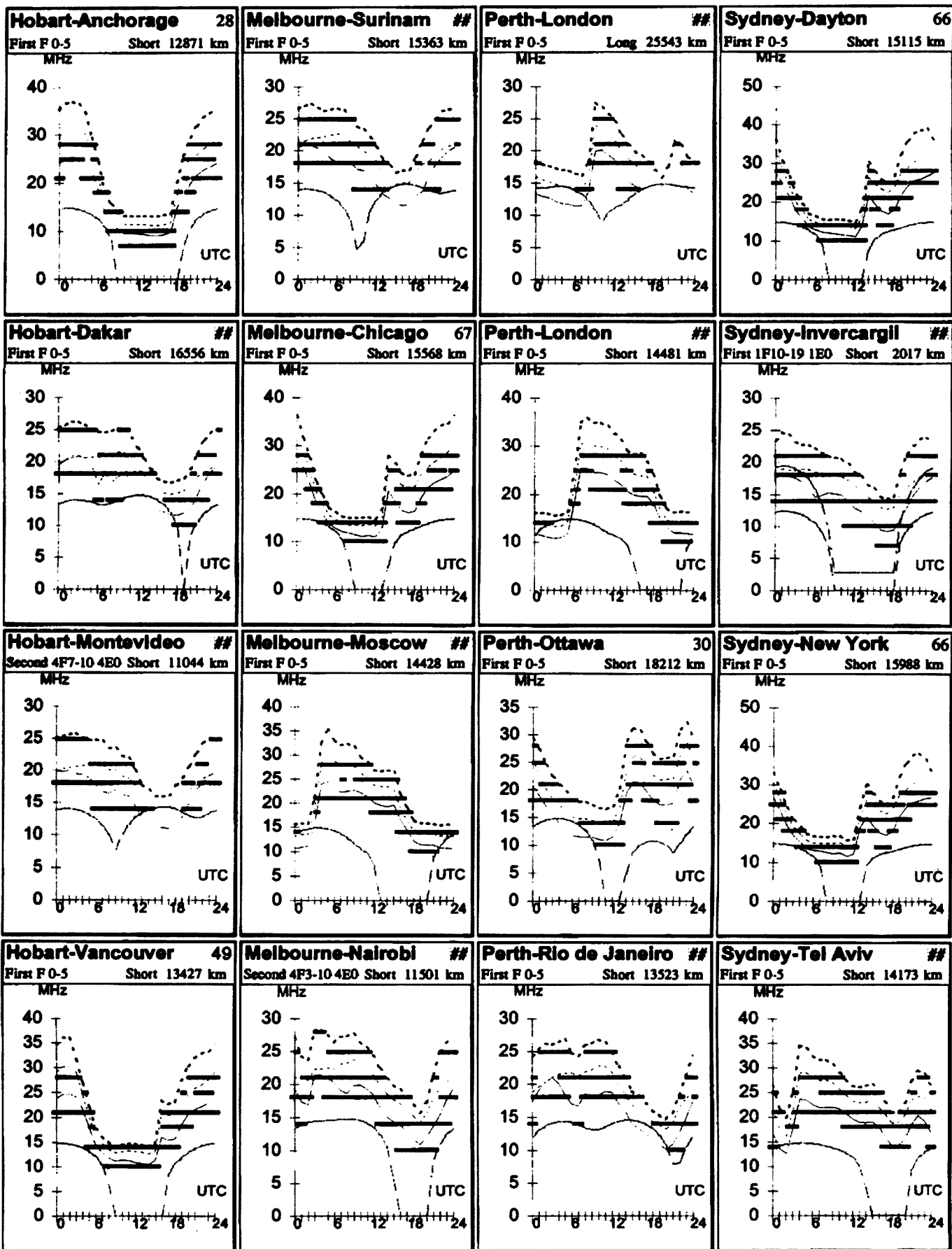
Legend

Frequency scale

- UD
- F-MUF
- E-MUF
- OWF
- ALF

Time





HAMADS

- Hamads may be submitted on the form on the reverse of your current Amateur Radio address flysheet. Please print carefully, especially where case or numerals are critical.
- Please submit separate forms for For Sale and Wanted items, and be sure to include your name, address and telephone number (including STD code) if you do not use the flysheet.
- Eight lines (forty words) per issue free to all WIA members, ninth and tenth lines for name and address. Commercial rates apply for non-members.
- Deceased estates Hamads will be published in full, even if the ad is not fully radio equipment.
- WIA policy recommends that the serial number of all equipment for sale should be included.
- QTHR means the address is correct in the current WIA Call Book.
- Ordinary Hamads from members who are deemed to be in general electronics retail and wholesale distributive trades should be certified as referring only to private articles not being re-sold for merchandising purposes.
- Commercial advertising (Trade Hamads) are pre-payable at \$25.00 for four lines (twenty words), plus \$2.25 per line (or part thereof), with a minimum charge of \$25.00. Cheques are to be made out to: WIA Hamads.
- Copy should be typed or in block letters, and be received by the deadlines shown on page 1 of each issue of Amateur Radio, at:

Postal: Newsletters Unlimited, 29 Tanner Street, Richmond, 3121

Fax: 03 9428 4242 E-mail: news1@webtime.com.au

Please only send your Hamad once

Please send Hamads by mail OR fax OR email (much preferred).

Please do not send by more than one method for any one ad or issue, it is confusing.

FOR SALE - NSW

- Kenwood R-1,000 Communications receiver plus instruction book. Recommended five star rating. Genuine snap. QTHR Newcastle 02 4954 0893
- Kenwood TS8305 xcvr. Remote VFO240. Shure 444 mic. Emtron EAT300A ATU. Big collection of AR and R+C magazines going way back. \$700 dollars the lot. John VK2F0 QTHR phone/fax 02 44571510
- BOOK: "Radiotelegraph and Radiotelephone Codes, Prowords and Abbreviations." 2nd Edition. \$15 posted Australia. 90 Pages. Q,X,Z Codes, 97 Phonetic, 20 Morse Codes. Phillips, Myer, 10,11,12,13 Codes. Much other info. Internet - <http://www.nor.com.au/community/sarc/phonetic.htm> VK2JWA, John W.Alcorn. QTHR. 02-66215217. Email jalcorn@nor.com.au
- INTERNET Connect from Port Macquarie to the Gold Coast from 80c per hour. Summerland Amateur Radio Club. For info - <http://www.nor.com.au/community/sarc/sarc.htm> - John, VK2JWA, QTHR, jalcorn@nor.com.au. 33 Spring St, Lismore, NSW, 2480. Ph 02 66215217
- FT102 Ser no 2n080351, FC102 Ser no 3e070288, FV102 Ser no 3e040122, SP102 Ser no 070288, KP100 Squeeze Key New. L C Baker VK2BVT 1 Payton St Canley Vale NSW 2166 Phone (02) 97264784

WANTED - NSW

- Circuit and service manual for UPS of Australia model MC 1003; Palec valve and circuit tester model vct-c; User manual for Amstrad LQ3500LI printer VK3ZA QTHR
- YC-7B outboard digital frequency display unit for FT7B transceiver. N. Chivers, VK2YO. QTHR 02 6674 2095

FOR SALE - VIC

- ICOM IC271A 2metre all mode with inbuilt pre-amp excellent condition S/N 27401948 with original packaging \$900. ICOM IC471A 70cm all mode with masthead pre-amp excellent condition S/N 21301178 with original packaging \$900. ICOM IC505 6mtr all mode portable \$350. Len VK3AQJ 03 9762 3522
- Tower 35ft galvanised wind up tilt-over, TET 3 element HB33M tri-band antenna, h/duty rotator, all good condition. \$500 the lot. Moving house. Bob VK3CF 03 9361 3242
- Step down transformer rated 500 v/a 110v out at 4.5A input 210/240 50Hz, weighs 25lb, 11.5kg, made by Bland Radio Adelaide. Best offer gets it. Cannot deliver. Allan Doble VK3AMD QTHR phone 03 9570 4610 anytime.
- FT101E 100w TR/RX, FL2100 amplifier, YD844 table mic, YO-100 monitor scope, YE601 digital readout, Dalton speech processor (RF-model). Plus all instruction books, VGC. Sell only in one lot. \$725 VK3BTQ QTHR 03 9578 5701
- Icom IC-751a Transceiver, IC-PS15 power supply, IC-SP3 extension speaker. Fully optioned base station. Also SM-10 base mic and a HM-14 hand mic. Plus a rare RC-10 remote controller to match. Excellent condition. Paul VK3DA 03 5983 1771 or apaulo@vk3da.alphalink.com.au.

WANTED - VIC

- Circuit and manual for 1967 Stoddart field intensity receiver type NM22A. Circuit and manual for VHF heterodyne frequency meter TS323UR/URM32, and for a B41 receiver. Circuit for KYORITSU V.T.V.M K142. Brian VK3WYN QTHR 03 5664 1251

- Original technical manual USA TM-11 300 for SCR211 (BC221) frequency meter. Grateful if anyone can help. VK3HX QTHR 03 9807 9172
- UNIDEN 2020 HF transceiver in any condition, needed for spares only. Lindsay VK3IQ, QTHR Ph [03] 5672 2563, vk3iq@telstra.easymail.com.au

FOR SALE - QLD

- Kenwood TS20S HF transceiver with dynamic microphone, excellent condition, one owner, purchased new, includes spare pair new 6146B power amplifier tubes, 100w output \$395. Kenwood MC43S scanning microphone new \$50. Kenwood PS-52 power supply, new in box. \$425 John Abbott VK4SKY 0417 410 503 benoel@fan.net.au QTHR
- Kenwood TS50 Transceiver all bands plus 6m with power supply, brand new with manuals \$1350 or near offer. Owner ill. Serial Number 60800 810. In first instance ring Ken (07) 5578 2293 QTHR
- Closing down Station: HF Transceiver TS850 incl AT850 \$1950. Power Supply PS50 \$200. Speaker SP230(filters) \$100. TNC PK232MBX Latest Eprons \$300. Diamond X300 (VHF/UHF) \$120 TitanDX HF Antenna \$400 (Bought last year) Tel/Fax: 07 55788052 hama@smarchat.net.au, Post Code Qld 4226
- Two QB3-300 valves, one 4-125A valve, two EIMAC sockets suit 4-1000 valves, one SB200 linear amp. All in very good condition from M.Deakin QTHR phone 0749332646 (AH)

WANTED - QLD

- Case for AT5 transmitter or junked set with intact case. Control box for Emotator 105S or similar model. Wayne Melrose VK4WDM (07) 47888 781. Email Wayne.Melrose@jcu.edu.au
- Wanted Urgently: Grid Dip Oscillator prefer bipolar transistorised (or FET) with multi-coil coverage from 5 MHz to 250 MHz. Calibration accuracy is no consequence; however, sensitivity is! Noel VK4CED 07 40699878 email: thecape@bigpond.com

FOR SALE - SA

- Icom IC730, Yaesu FP 707, Kenwood AT130, Kenwood TH205A 2m b/h, 10 metre freestanding tower, Alinca EMR 400 rotator, Chirnside CE 42 duo-band beam, A248D 3 band trapped dipole, Chirnside CE5SS 5 band vertical, 15 metre steel pole. All manuals, filters, switches, cables, etc. Moving house, must sell together as a complete station. Suit new licence. \$1350 Ted VK5KEW. QTHR 08 8552 3885
- World globe "map" flat, 320 UHF rig, "vertical ant" 60 ohm "balun", four way co-ax switch. Two way two four ohm speaker, 15 watts WNMAR stereo amp. Two ac/dc adaptor, ten metre vertical ant. Dynamic P/A mic. Good condition. Will accept highest offer for everything. VK5AUS QTHR 08 8344 5011

FOR SALE - WA

- Beams (two). Three element tri-band, Moseley and Chirnside \$100 ea. Plus heavy gauge tapered steel light pole with access door, 6.5 metres long, has a piece of straight tube to mount rotator at top \$50. Call John 08 9293 2998 VK6RI QTHR

WANTED - TAS

• JRC NSD 505 transmitter. Must be in good condition. Matches JRC ND 515 receiver. Kenwood MC10, MC30, M35 hand mic, suit TS130S or Shure MC404 mic. Allen VK7AN 03 6327 1171 or 0417 354 410

• Working CW crystal filter to suit Kenwood TS-520 (TRIO YG-3395C). Phone Justin VK7ZTW (03) 6223 1351 (AH) or email: justingc@ozemail.com.au

MISCELLANEOUS

• If you got your licence before 1975, you are invited to join the Radio Amateurs Old Timers Club. A \$2.50 joining fee plus \$8.00 for one year or \$15.00 for two years gets you two interesting Journals a year plus good fellowship. Arthur Evans VK3VQ or Allan Doble VK3AMD can supply application forms. Both are QTHR in any Call Book

• The WIA QSL Collection (now Federal) requires QSLs. All types welcome, especially rare DX pictorial cards, special issue. Please contact the Hon Curator, Ken Matchett VK3TL, 4 Sunrise Hill Road, Montrose Vic 3765, tel. (03) 9728 5350

TRADE ADS

• AMIDON FERROMAGNETIC CORES:

For all RF applications. Send business size SASE for data/price to RJ & US Imports, PO Box 431, Kiama NSW 2533 (no enquiries at office please ... 14 Boanyo Ave Kiama). www.cyberelectric.net.au/~rjandusimports

Agencies at: Assoc TV Service, Hobart; Truscotts Electronic World, Melbourne and Mildura; Alpha Tango Products, Perth; Haven Electronics, Nowra

• WEATHER FAX programs for IBM XT/ATs *** "RADFAXZ" \$35.00, is a high resolution short-wave weather fax, Morse and RTTY receiving program. Suitable for CGA, EGA, VGA and Hercules cards (state which). Needs SSB HF radio and RADFAX decoder. *** "SATFAX" \$45.00, is a NOAA, Meteor and GMS weather satellite picture receiving program. Needs EGA or VGA & WEATHER FAX PC card, + 137 MHz Receiver. *** "MAXISAT" \$75.00 is similar to SATFAX but needs 2 MB of expanded memory (EMS 3.6 or 4.0) and 1024 x 768 SVGA card. All programs are on 5.25" or 3.5" disks (state which) plus documentation, add \$3.00 postage. ONLY from M. Delahunty, 42 Villiers St, New Farm QLD 4005. Ph 07 358 2785.

<http://www.hamsearch.com>
a not-for-profit site that is a
search engine for hams

ADVERTISERS INDEX

Andrews Communication Systems32
Dick Smith.....28, 29, OBC
Tower Communications17
WIA Call Book.....IFC



9A4SP/4W6SP Pero Simundza

The recent deaths of three UN aid workers in West Timor shocked the world. Australian amateur radio operators are perhaps unaware that one of those killed was a radio ham, one Pero Simundza, 9A4SP/4W6SP.

I had the privilege to work Pero while he was in Albania signing ZA/9A4SP and have also heard him in on the air from Timor.

The duties of UNHCR members often expose them to danger when they are operating in hostile territories, but their dedication and skills are prerequisites in conducting their humanitarian mission. Their jobs are often risky, but unfortunately necessary, to humanely relieve the suffering of those who become refugees or displaced during times of violence and unrest.

Unfortunately, Pero met his untimely death at the hands of lawless militia while performing his duties as a radio operator in Atambua, West Timor. His dedication and bravery merits recognition from all radio operators, both professional and amateur.

Our sincerest condolences are extended to his family and friends.

The following letter is from Peter, ON6TT, on the recent death of Pero, 9A4SP/4W6SP in Atambua in West Timor.

"Friends,

"It is with profound sadness and anger I heard today that Pero Simundza - 9A4SP/3W4SP - a UN colleague and fellow ham, was amongst the three UN staff who were killed during a militia assault on the UNHCR office in Atambua, West-Timor yesterday.

"The UNHCR office in Atambua was attacked by a vicious militia mob who overrun and trashed the premises and vehicles, stabbed three UNHCR relief workers who were working in the office at that moment to death. They then dragged the bodies onto the street and put them on fire. Pero was one of them.

"Pero worked for UNHCR in Atambua as an international radio operator. He joined UNHCR years ago, in Sarajevo. Later on, he moved on mission to Albania, where I met him in June last year. He was then on the air as ZA/9A4SP. We spent a most enjoyable evening together, ending with me operating from his station. He struck me as a young, very enthusiastic and true DX passionate ham, and a great person.

"Since then, we kept regular contacts, sending each other news from where we were, and where we operated from.

"After returning from Albania, to work in Sarajevo for a few months, he was appointed to Atambua, West Timor. He was real happy with his international assignment, close to the East Timor border. He regularly crossed the border to be active from the other side as 3W4SP, in a small house where he had arranged his shack. He sent me pictures by Email of his shack and antenna.

"I looked forward to meet him during my current Asia tour, which included West and East Timor. Unfortunately, I had to reschedule my visit to Kupang and Atambua by a few days at the last moment, so Pero and I missed each other by 2 days. He was on R&R when I had meetings in his office in Atambua two weeks ago and I walked passed the radiator room he worked in. Last week we exchanged Emails again saying 'there will always be a next time, people like us always meet again, one side of the earth or another'.

"Unfortunately, Pero, I will not be able to keep my promise. You parted us way too soon, in a senseless death. We all know the risks we face while working in emergency relief activities, but your departure due to inhumane and totally absurd violence shocked many of us.

"Farewell, my friend, we will all miss you. Our thoughts go to your family remaining behind.

"vy 73 Peter, ON6TT"

TRADE PRACTICES ACT

It is impossible for us to ensure that the advertisements submitted for publication comply with the Trade Practices Act 1974. Therefore, advertisers and advertising agents will appreciate the absolute need for themselves to ensure that the provisions of the Act are strictly complied with.

VICTORIAN CONSUMER AFFAIRS ACT

All advertisers are advised that advertisements containing only a PO Box number as the address cannot be accepted without the addition of the business address of the box-holder or seller of the goods.

Note: 1. Views expressed in letters are those of the authors and do not necessarily represent the policy of the WIA
 2. Some of the letters have been shored to allow more letters to be published.
 3. Address letters to: The Editor, Amateur Radio, 34 Hawker Crescent, Elizabeth East SA 5112

The Things That People Do

Hi Fellow DXers,

I would like to air my anger and surprise regarding DX cheating

I would also like to hear from others, about their experiences to gauge how widespread DX cheating is. Before I begin I must impress that *this has nothing to do with the operators of A52A*. In my opinion they did an amazing job, with bad conditions & only 100 odd Watts. I applaud them and hold them in the highest regard. My experience is as follows.

In the recent A52A Dxpediton, I was experiencing difficulties hearing the A52A Station let alone breaking the pileups. I was listening for up to seven hours a day in the usual timeslot that propagation was expected between VK and A5. I heard nothing of them, I was constantly connected to my local DXpacket cluster. It is a linked system with great coverage. I knew exactly where the A5 was by the constant spotting. I was posting announcements on the Cluster often. Announcements like: PSE someone in Europe ask A52A to listen for Pacific or Have any VKs worked A52A, if so Time ? Band? Not heard in VK4 yet. I was getting desperate as I could hear 9N (Nepal) & VU (India) just fine, but no A5. I was getting answers to my packet pleas, like. A52A now listening for VK/ZL etc etc. but I had no copy with my tribander yagi. I could hear VK3s working them but not a whisper in VK4. Finally on the 12th of May 2000 (the last day of the A52A operation) I heard a weak signal on 15 meters SSB, Long Path. I called & worked them. I was elated as it was at 0134Z. I later saw posted they went QRT at 0202Z. So I made the cut by a mere 28 minutes. My patience was rewarded. I also later found out that the location of the A52A dxpediton did not favour Oceania as there was a mountain range between us. Hence the poor showing of Oceania in the log, (2% or so). As I do not have an Internet connection, only a

cheap Email server, I asked a friend to look up my Call in the A52A log on the Internet. I was confident I had a good QSO on 15m SSB but just had to know if I was "in the log". My findings were shocking and angered me. I was in the log 10 times, for bands I don't even operate on, and also for CW QSOs. I do not use CW. I show 3 QSOs on 15 metres alone! (I never knowingly Dupe DX unless I think they might have BUSTED my Call.) My question is this? Who makes these Illegal QSOs, using my Callsign? Is it some guy who feels sorry for me not able to make the QSO ? Is it someone who hears me calling & then later works them with my call? How widespread is this practice? I am not ignorant of the fact that cheating goes on, I am the QSL manager for a DX station and have been sent blank QSLs with only the date and signature on them, for rare IOTAs. I have been asked in the post "Can I get a Mellish Reef QSL from anyone" etc. The station I manage has often mentioned about working the same voice or key with several Callsigns. To me this is a pointless practice, Its like cheating at solitaire, I know every station in MY log has been worked by ME VK4EJ. If and when I reach "Honour Roll" status it will be on my own merits. I had hoped that every DXer could say the same, But now I question it, and it troubles me. I thank you for reading this; it has, if nothing else got it off my chest and maybe, just maybe, might jog someone's conscience and help stamp out this Non Ham Spirit.

Best 73, de Bernie McIvor VK4EJ

Focus on young hams

Dan Bartlett, VK4TDB, wishes to compile a list of current Amateur Radio Operators in Australia, who are under the age of 25 (that is, born in or after 1975). He wishes to start up a club, with a bi-monthly newsletter focusing on youth ham radio issues, and how to get more young people into the hobby. So, if you fit into that category, send an email to vk4tdb@radio.fm, or snail mail to PO Box 8129, Allenstown, QLD, 4700.

WIA QSL bureau: Will It survive?

Firstly, I should perhaps explain that I have been, and still am, a member of the VK2 division, in excess of 10 years. Plus a prior member of the VK5 division.

Many members who participate and enjoy QSLing would agree that a decline in the exchange of cards in recent times is most apparent.

I am not spearheading the VK2 division - heaven forbid!. The problem is worldwide.

Many amateurs I have spoken to recently, one in Spain, have given away the bureau, and will only reciprocate when they are in receipt of the other party's card, and then only by direct mail.

In view of the Institutes battle to increase membership numbers, this problem would be better eliminated.

I dispatch more cards these days than ever before, but the response is down to a trickle.

I would be grateful to read members' comments, particularly those experiencing this problem.

John G Lyons VK2NDR

Intrusion in 70cm allocation

Just as matter of interest, regarding the intrusion of low powered devices into our 70cm allocation I recently purchased a 2 Channel UHF Remote Control Kit from OATLEY ELECTRONICS. The on board receiver module is for 318MHz but has provision for a 433.9MHz receiver. The instructions state that this is to be ignored as this is for a future project currently being developed.

So I guess it is only a matter of time before we start seeing or should I say start hearing other signals on the band.

Best 73's Ian G VK3AQU

Silent Key

The WIA regrets to announce the recent passing of:-

M (Malcolm) CREW VK3BBU

▶ YAESU'S DONE IT AGAIN



FT-920 HF/6m Transceiver with DSP

Now there's no excuse for not taking advantage of the advances in Digital Signal Processing, transceiver design plus the fun of 6m operation. The stunning Yaesu FT-920 is a high performance HF/6m multi-mode base station transceiver that provides 100W PEP output on the 160-6m bands, incredible front-end performance based on the FT-1000MP design, and a huge array of features that make it a pleasure to use.

At first glance Yaesu's renowned Omni-Glow LCD screen is obvious, and its wide-angle view provides a wealth of information about the transceiver's operating status with multi-function metering, dual frequency displays and an Enhanced Tuning scale for DSP bandwidth, CW tuning, FM discriminator and more. Inside, the FT-920 is built around a rugged diecast unibody chassis which provides excellent heatsinking for the low distortion dual MRF255 160-6m FET power amplifier.

For more comfortable operating when weaker signals are present Yaesu's engineers dedicated themselves to enhancement of real-world signal to noise ratios, and after thousands of hours of design and testing have produced an industry-leading 33.3MIPS (millions of instructions per second) processing speed DSP in the FT-920 that provides a two-parameter noise reduction system with 32 steps of front panel adjustment. This amazing system also provides dual control DSP passband tuning, DSP auto-notch filter, an amazing new transmit Digital Speech Processor, DSP mic equalisation, fast acting DSP VOX circuitry as well as a Contest-ready Digital Voice Recorder!

Offers expire 3/12/00

Other features include an all-band (160-6m) auto antenna tuner which also provides greater receiver band-pass protection, Direct Digital Synthesis for clean local oscillators, selectable frequency-optimised receiver front-end pre-amps, and a Shuttle Jog tuning ring for fast QSY.

A Dual Watch receive system allows you to check for band openings, especially handy when monitoring 6m. Also provided are SSB/CW operation (AM and FM optional), 127 memories with alphanumeric labelling, IF Shift and IF noise blanker to fight interference, plus an extensive menu system for selecting most "set and forget" functions. The FT-920 is supplied with an MH-31B8 hand mic, DC power lead and comprehensive instruction manual.
D 3420

**Why not call for a copy of
the Yaesu 6 page FT-920 colour brochure
to learn more about this efficient transceiver
that's without peer in its price class.**

2 YEAR WARRANTY

YAESU

\$2750

HURRY! LAST CHANCE AT THIS PRICE

DICK SMITH
ELECTRONICS

For further information, orders, or the location of your nearest store: Phone 1300 366 644 (local call charge) Or Fax: (02) 9395 1155

MORE

GREAT

GEAR

FROM

ICOM



IC-706MKIIG

The amazing evolution of the legendary 706. Frequency coverage is expanded to the 70cm band and output power is increased for the 2m band. You get base station performance and features in a mobile rig-sized package.

IC-718 A compact HF all band transceiver.

A superior performer with simple, straight forward operation with keypad. Optional AF DSP capabilities, including noise reduction and auto notch function. It's versatile, compact and loaded with features.

NEW!!!



NEW!!!



IC-756PRO The HF & 6mm multimode

professional performer. 100 watts of power, newly designed 32 bit floating DSP for noise reduction and auto notch function, and AGC loop operation for wider dynamic range. Plus digital IF filter, built-in RTTY Demodulator/Dual Peak APF, and a whole lot more.

IC-2800H A totally new approach to dual band mobile.

Powerful performance on 2m and 70cm bands, remote control capability, and a first for mobile rigs... a multi-function colour LCD screen! All your information is right in front of you in colourful 3D-like characters and icons.



IC-T81A A remarkably compact quad bander.

Superb clarity on the 6m, 2m, 70cms and 23cm bands. It's water resistant, with tone squelch and pocket beep functions standard, plus you can change volume and bands even quicker with the 'joy-stick' style multi-function switch.



ICOM

Clearly Ahead

2 YR WARRANTY

See your nearest Icom Dealer, or visit our website at www.icom.net.au

December 2000

Volume 68 No 12



Amateur Radio

Novice Notes:

**The crystal set:
an ideal holiday
project**

MATHS

for Amateur Radio

**Phased Verticals for
10m Mobile Use**

**Fun with a
'Cool Little Mast'
and a Pulsar**



Gil Sones VK3AUI

Technical Abstracts

Lloyd Butler VK5BR

***Antenna Noise and
Signal Cancelling at LF***

Drew Diamond VK3XU

From Circuit to Chassis



**Air, land
or sea....**



**the world is getting
the message**

IN THE WORLD OF COMMUNICATIONS
THERE'S ONE NAME THAT IS
CLEARLY AHEAD... ICOM.

Icom's worldwide reputation for communications excellence has been gained in some of the harshest environments imaginable, from the frozen Antarctic to the searing heat of Australia's red centre.

Icom radios communicate loud and clear in all sorts of situations from sailing to flying, to emergency services, law enforcement, military, the mining industry, and meteorology.

The Icom range includes innovative UHF handheld CBs such as the IC-40S; waterproof VHF marine transceivers like the IC-M1V (the world's smallest marine handheld); the rugged F Series private land mobile VHF & UHF vehicle and portable radios; and the 3 way versatility of the IC-A200 VHF air band transceiver for communication in the air, on the ground, or on the road. And the ultimate handheld receiver, the IC-R3 featuring a world first for a handheld communications receiver... a 2 inch TFT colour TV screen!

When communication is vital, Icom's innovation, performance and durability ensures the world gets the message every time.



2 YR WARRANTY

For the name of your nearest accredited Icom Dealer visit our website at www.icom.net.au

ICOM
RADIO COMMUNICATIONS
Clearly Ahead

IC-R3 h/held

Meet Icom's fantastic new scanner



- Huge TFT colour multi-function TV screen
- High tech Lithium Ion battery
- 450 memory channels
- Covers 0.5 to 2450MHz
- Joystick



IC-756_PRO

- Icom's new HF +50MHz digital performance king
..... *try it and see why*
- fantastic colour multi-function screen

Your best way to get onto HF and six and two metres

- Multi-function high-res display
- Direct frequency entry
- Fabled Icom *Work the World* performance
- Great in the shack or can go portable

IC-746



Icom's great new HF price leader

IC-718

- All bands 160-10 metres plus general coverage receive
- 100 effortless watts output on all bands



TS-50S

- Solid mobile or base HF rig
- Fabulous Kenwood audio
- Matching optional auto ATU



IC-207H

- Affordable dual-bander with no-nonsense Icom quality
- Can be remote controlled



TM-V7A

- Stylish Kenwood dual-band 2m and 70cm
- Plug in 9600 baud TNC convenience
- Can be remote-controlled from the boot



TH-D7A h/held

Nothing else comes close

- Dual bander for effortless two metres and 70cm
- **built in** packet radio TNC. Ideal for use with APRS
- 200 fully alphanumeric memory channels
- Full 6W out from 13.8VDC
- Supplied with NiCd battery and charger



TS-570S

- Frequency range: 1.8 — 54MHz, all HF bands plus six metres
- Great heterodyne zapper
- Industry-best DSP **standard**
- Improved model, now better than ever



TM-G707A

- Kenwood's latest dual-bander
- covers two metres and 70cm
- Outstanding Kenwood audio
- Extended receive frequency coverage
- A Kenwood remote-control masterpiece



STRICTLY HAM PTY LTD

ACN 059 638 407

14 Church Street Bayswater VIC 3153

Tel: (03) 9729 7656

Fax: (03) 9729 7422

sales@strictlyham.com.au

www.strictlyham.com.au



Amateur Radio

The Journal of the Wireless
Institute of Australia
ISSN 0002-6859

Editorial

Editor: Colwyn Low VK5UE
edarmag@chariot.net.au

Technical Editor: Peter Gibson* VK3AZL

Publications Committee Members

Ron Fisher VK3OM
Don Jackson VK3DBB
Evan Jarman VK3ANI
Bill Rice VK3ABP
Gil Sones VK3AUI

Advertising

Mrs June Fox,
Tel: (03) 9528 5962

Hamads

"Hamads" Newsletters Unlimited
29 Tanner Street, Richmond VIC 3121
Fax: (03) 9428 4242
e-mail: newsl@webtime.com.au

Office

10/229 Balaclava Road
Caulfield, Victoria
Telephone (03) 9528 5962
Facsimile (03) 9523 8191

Business Hours 9:30am to 3:00pm weekdays

Postal

P.O. Box 2175
CAULFIELD JUNCTION
VICTORIA 3161
AUSTRALIA
e-mail: armag@hotkey.net.au

Production

Newsletters Unlimited (03) 9428 3458

Printer

Streamline Press, Melbourne (03) 9417 2766

Postal Service

IMS (03) 9291 5888

Production Deadlines

Advertising booking and articles for
publication 10th of preceding month.

Hamads and advertising material deadline
18th day of preceding month

The contents of Amateur Radio are
Copyright Wireless Institute of Australia
C 2000

Our cover this month

The peak of solar sunspot cycle 23 is predicted to occur this month. The cover shows a very active sun photographed with H alpha filter. Inset is a photograph of the Learmonth Observatory (Courtesy of the Ionospheric Prediction Service), part of the network which takes daily observations

General

Fun with a 'Cool Little Mast' and a Pulsar	8
Don't Hang The Washing on The Aerial	26
<i>Peter Brougham VK3PJB</i>	

Technical

Antenna Noise and Signal Cancelling at LF	4
<i>Lloyd Butler VK5BR</i>	
Maths for Amateur Radio	6
<i>Lindsay Lawless VK3ANJ</i>	
Phased Verticals for 10m Mobile Use	7
<i>Kim Rhodes VK6TQ</i>	
From Circuit to Chassis	10
<i>Drew Diamond VK3XU</i>	
Adding CW to Your Repertoire	16
<i>Lindsay Lawless VK3ANJ</i>	
Laptop Mobile Supply Step Up Converter	17
<i>Gil Sones VK3AUI</i>	
The crystal set: an ideal holiday project (Novice Notes)	8
<i>Peter Parker VK3YE</i>	
Save Your Tuner For Two Pence (Technical Abstracts)	24
<i>Gil Sones VK3AUI</i>	
Matching Low Impedance Antennas (Technical Abstracts)	25
<i>Gil Sones VK3AUI</i>	
75 ohm Coaxial Cable (Technical Abstracts)	25
<i>Gil Sones VK3AUI</i>	

Columns

Advertisers' Index	55	Hamads	54
ALARA	22	HF Predictions	52
Awards	37	New Members	2
AMSAT	34	Novice Notes	18
Contests	39	Over To You	56
Club News	23	Pounding Brass	42
WIA Division News		Repeater Link	50
VK1 Notes	31	Silent Key	2,33,36
VK2 Notes	31	Spotlight on SWLing	46
VK3 Notes	32	Technical Abstracts	24
VK4 Notes	32	VHF/UHF - An Expanding World	47
VK7 Notes	33	WIA Comment	3
DX Notes	43	WIA Division Directory	30
Editor's Comment	2	WIA Federal Directory	2
Education Notes	36		

Contributions to Amateur Radio

Amateur Radio is a forum for WIA members' amateur radio experiments, experiences opinions and news. Manuscripts with drawings and or photos are always welcome and will be considered for publication. Articles on disc or email are especially welcome. The WIA cannot be responsible for loss or damage to any material. A pamphlet, How to write for Amateur Radio is available from the Federal Office on receipt of a stamped self-addressed envelope.

Back Issues

Back issues are available directly from the WIA Federal Office (until stocks are exhausted, at \$4.00 each (including postage within Australia) to members.

Photostat copies

When back issues are no longer available, photocopies of articles are available to members at \$2.50 each (plus an additional \$2 for each additional issue in which the article appears).

Disclaimer

The opinions expressed in this publication do not necessarily reflect the official view of the WIA and the WIA cannot be held responsible for incorrect information published.

Amateur Radio Service

A radiocommunication service for the purpose of self-training, intercommunication and technical investigation carried out by amateurs; that is, by duly authorised persons interested in radio technique solely with a personal aim and without pecuniary interest.

Wireless Institute of Australia

The world's first and oldest
National Radio Society
Founded 1910

Representing
The Australian Amateur Radio Service

Member of the
International Amateur Radio Union

Registered Federal Office of the WIA

10229 Balaclava Road
Caulfield North Vic 3161

Tel: (03) 9528 5962 Fax (03) 9523 8191
<http://www.wia.org.au>

All mail to
PO Box 2175 Caulfield Junction VIC 3161

Business hours: 9.30am-3pm weekdays

Acting Federal Secretary

Peter Naish VK2BPN

Federal Office staff

June Fox Bookkeeper
Rita Trebilco VK3IF Examinations Officer

Council

President	Peter Naish	VK2BPN
VK1 Federal Councillor	Glenn Dunstan	VK1XX
VK2 Federal Councillor	Michael Corbin	VK2YC
VK3 Federal Councillor	Brenda Edmonds	VK3KT
VK4 Federal Councillor	David Jones	VK4OF
VK5 Federal Councillor	David Box	VK5OV
VK6 Federal Councillor	Will McGhie	VK6UU
VK7 Federal Councillor	Phil Corby	VK7ZAX

Executive

Peter Naish VK2BPN
John Lottus VK4EMM

Federal Coordinators

AMSAT	Graham Ratcliff	VK5AGR
ARDF	Jack Bramham	VK3WWW
Awards	John Kelleher	VK3DP
Contests		
Education	Brenda Edmonds	VK3KT
FTAC	John Martin	VK3KWA
Historian	John Edmonds	VK3AFU
IARU	Grant Willis	VK5ZWI
Intruder Watch	Gordon Loveday	VK4KAL
ITU Conference and study group	Gilbert Hughes	VK1GH
QSL Manager (VK9, VK0)	Neil Penfold	VK6NE
Videotapes	VK2 Division	
Web/PR	Richard Murnane	VK2SKY

ACA Liaison Team

Peter Naish VK2BPN
Glenn Dunstan VK1XX
Michael Corbin VK2YC
Wally Howse VK6KZ
Canberra Liaison Officer
Richard Jenkins VK1RJ



Editor's Comment

Colwyn Low VK5UE

End of Year One

Well this is the end of my 12th issue of AR. It has had its ups and downs. We have assembled a few very good issues and fortunately no really bad ones. However we have had our moments when articles did not get presented as the authors would have liked and we apologise for that. We have omitted to print a submitted column once or twice and we are doubly sorry for that because the volunteers who write the columns give up a lot of their time to assemble and write the column each month. On behalf of the production team I wish to thank all those who write columns monthly for AR, all those who have taken the time to write articles for AR and those of you who have written to *Over to You*. The magazine is the house journal of the Wireless Institute of Australia and can only continue while members support it. Please continue to contribute. Please write an article once in a while. Please use OTU to let us all know how you feel.

As you can see in the Presidents Notes and the letter from the ACA the Federal WIA is continuously working to protect our stake in the Radio Spectrum. Without the WIA where would we be? I do not see the knockers banding together to produce a competitor, so the WIA has to work for all Amateurs. Let us all thank those in Federal positions and on Federal Committees for their dedication to Amateur Radio. Special thanks are also due to the State Divisions and the Clubs that bind us together.

I had several replies to my request for bearing distance programs. Getting them into a Basic compatible machine here is proving difficult. No compatible drives ! This issue contains a Spreadsheet form of Great Circle bearing and distance calculation. This may be more readily usable these days. Thanks to all those who sent me programs.

I wish you all a Merry Christmas and a Happy New Year. May you enjoy your hobby more in 2001 and every now and again ask "What can I do for Amateur Radio and the WIA?" not "What can the WIA do for me?"

Now just to keep you posted I did get out in the Spring UHF/VHF Field Day and I have got my 1.2GHz transverter built. The transverter component boards all worked first time so I'm now putting it in a box. So thanks to Mark Kilmier VK5EME of Mini-Kits, <http://homepages.picknowl.com.au/vk5eme/minikits/index.html> for a very good kit and to David Minchin VK5KK for helping me check the finished transverter.

NEW WIA MEMBERS

The WIA bids a warm welcome to the following new members who were entered into the WIA Membership Register during the month of October 2000

G4DFV	MR D J WALTERS	VK3DBD	MR D DUNN
L31556	MR S POGATSCHER	VK3HDF	MR A SCAMMELL
VK1TRT	MR T O N ROULSTON	VK3KAY	MR D KAY
VK2EDE	MR W LAKE	VK3RB	MR T MORRISON
VK2JLX	MR P DUDLEY	VK6HGR	MR G ROGERS

Silent key

The WIA regrets to announce the recent passing of:-
M (Malcolm) CREW VK3BBU



WIA Comment

Peter Naish

WIA Federal President.

I would like to clarify the situation regarding the proposed changes to the 70 cms. band. There appears to have been some misunderstanding of what is taking place. In the Perth area the ACA has allocated a significant part of 420-430 MHz to the land- mobile service as co-primary with the Department of Defence. Consequently this sub-band will be withdrawn from the amateur radio service very soon in the Perth area. Although there are no immediate plans for similar land-mobile services elsewhere, the ACA expect that such services will be needed in the not too distant future and thus have advised the WIA that 420-430 MHz may be withdrawn from the amateur radio service nationally before long.

There is no threat to the 430-440 MHz sub-band which is allocated to radio amateurs in the ITU Region-3 band plan as secondary users. Also, the higher sub-band, 440-450 MHz is likely to remain available in Australia to the amateur radio service for some while yet.

With the above in mind the WIA has reviewed the 70 cms national band plan

to permit the various amateur radio services now operating in the full 30 MHz (420-450 MHz) to be accommodated in a 20 MHz band (430 to 450 MHz). The opportunity has also been taken in the revised plan to avoid the Class Licence area around 430 MHz where the LIPD's are operating. This WIA band-plan is still in a draft form but it is expected that a final version will be ready for deployment in time to meet the closure of the 420-430 MHz sub-band. A feature of the new plan will be to minimize where possible the changes needed to fixed links and repeaters. However, it is inevitable that some changes will be necessary.

A full description of the new band plan and the reasons behind it will be available just as soon as agreement on it has been reached by the various users and organisations concerned. The future of 70 cms. is assured albeit with a narrower overall band.

May I on behalf of the WIA wish you all a Happy Christmas and Good Wishes for the New Year.

FEDERAL CONTEST CO-ORDINATOR Job Specification

Applicants for the position of Federal Contest Co-ordinator are asked to consider the following guidelines —

1. To report frequently to the member of the Federal Executive appointed to oversee Contest activity and to keep him fully informed, especially of budgetary costs;
2. to liaise frequently with the Federal Office;
3. to write an Annual Report in February each year for presentation at the WIA's Annual General Meeting;
4. to liaise closely with the NZART Contest Co-ordinator;
5. to liaise closely with other Contest Co-ordinators and Managers, both in Oceania and world wide;
6. to produce a monthly information column in "Amateur Radio";
7. to organise for production and forwarding of trophies at various times each year as appropriate;
8. to keep accurate records of trophy winners and to arrange for engraving of Perpetual Trophies;
9. to oversee the supplies of available certificates and to organise replacements when necessary;
10. to write and post certificates on behalf of individual Contest Managers;
11. to arrange a speaker for the annual Remembrance Day Contest and to produce and distribute tapes of the speech for each Division;
12. to be available via telephone, postal mail and e-mail.

Applications to WIA Federal C/o the Federal Office.

Happy Christmas and a Prosperous

New Year to all

**Amateur
Radio**

readers!



Letter from Australian Communications Authority

to Mr Peter Naish, President, Wireless Institute of Australia

AUSTRALIAN BROADCASTING AUTHORITY DROP-THROUGH FOR UHF TELEVISION CHANNEL 35 (575 - 582 MHz)

The Australian Communications Authority, (ACA) has recently received advice from the Australian Broadcasting Authority, (ABA) about the extension of the drop-through for UHF television channel 35 beyond 31 December 2000.

Under section 34 of the *Broadcasting Services Act 1992*, the ABA has decided that the drop-through for channel 35 at the existing four sites may continue until certain dates in 2001. This decision was made on the condition that licensees accept possible interference from digital television and/or datacasting transmissions. The four sites and their associated drop-through dates are:

LOCATION	UNTIL
Lawson (New South Wales)	30 June 2001 (midnight)
Lane Cove (New South Wales)	30 June 2001 (midnight)
O'Halloran Hill (South Australia)	31 December 2001 (midnight)
Spring Hill (Queensland)	31 December 2001 (midnight)

In addition, all services must operate wholly within the band 575 - 582 MHz (UHF channel 35). The ABA has advised that it will write to each Amateur licensee to advise him or her about the ABA decision.

Yours sincerely

Alan Jordan

Manager, Radiocommunications Licensing Policy Team

27 November 2000

Antenna Noise and Signal Cancelling at LF

Lloyd Butler VK5BR

By using the signals from two antennas, controlling their relative amplitudes and controlling the phase of one of them, unwanted signal or unwanted noise can be phased out. Circuitry is described which uses the signal from a wire antenna to provide selective cancelling against the signal output from an LF loop antenna.

Introduction

The fact that the phasing between a wanted signal and an unwanted signal can be different on different antennas is put to advantage. With this condition, the unwanted signal can be cancelled out by controlling amplitude and phase. The heart of the system is some form of phase control circuitry. I described methods for doing this at HF in AR Sept. 1992 (ref. 1) and AR Jan. 1993 (ref. 2). The second system made use of the 180 degree phase shift which was achieved when two lightly coupled tuned circuits were tuned from one side of resonance to the other by a ganged pair of variable capacitors. It is this system which is again used at LF.

The circuit described provides a phase and amplitude controlled auxiliary signal from a wire antenna. Whilst its output could be used to mix with some other antenna system, it was specifically aimed at mixing in with the signal from the loop antenna in the active loop converter described in AR Jul 2000 (ref. 3).

Circuit Detail

The circuit diagram is shown in figure 1. The auxiliary wire antenna is coupled into the phase control network L1-L2-L3-C1A-C1B via R10. The network is made up of two tuned circuits C1A-L1 and C1B-L2 coupled via inductor L3. The three inductors are miniature chokes obtainable from electronics stores. C1A and C1B with maximum capacities of 450pf are ganged. Using the component values shown, the circuit is tuneable over the range of 160 to 500 kHz. A phase control range of 180 degrees is achieved tuning from one side of resonance to the other with an amplitude variation not greater than 6db.

The phase control network is interfaced with amplifier V1A which is one half of an LM353 twin mosfet op.

amp package. The circuit constants are set for a gain around 25. The other half, V1B, is connected as a phase inverter to provide the second half of the 360 degrees phase range. Switch S1 provides selection of one or the other ranges of 180 degrees.

The amplifiers operate from 12V DC picked up from the loop converter supply. Their operating points are set by 6V derived from R8 and R9.

The output from the auxiliary circuit is mixed in with the output from the loop converter interface amplifier at the NE602 mixer input, pin1. As there is a second input to the NE602 (pin2), I could have fed the auxiliary signal via this second pin. However, I would have had to disconnect the converter circuit board card, remove it from its mounting and modify the board. I found it easier to add circuitry around the loop gain control RV2, as shown in the top right hand corner of figure 1, so that both signals are fed to pin 1.

There is nothing specific about requirements for the auxiliary antenna. The normal radio shack antenna used for HF communications can be connected for this purpose.

Operation

A little bit of practice is needed to set up the system on a station tuned in.

First of all set the auxiliary antenna gain control RV1 to zero and loop gain control RV2 in the converter well advanced or at maximum. Adjust the loop tuning for resonance indicated by maximum signal.

Now set the loop gain control RV2 to zero and advance the auxiliary gain control RV1. Adjust C1 in the phasing circuit for resonance indicated by maximum signal.

Restore loop gain control RV2 to its previous position so that signals from both antenna are feeding the mixer.

Assuming there is unwanted noise or signal, carefully 'fiddle' with the tuning of C1 either side of resonance and the setting of auxiliary gain RV1 to find a null in the unwanted noise or signal. If there is no success, reverse phase with switch S1 and try again.

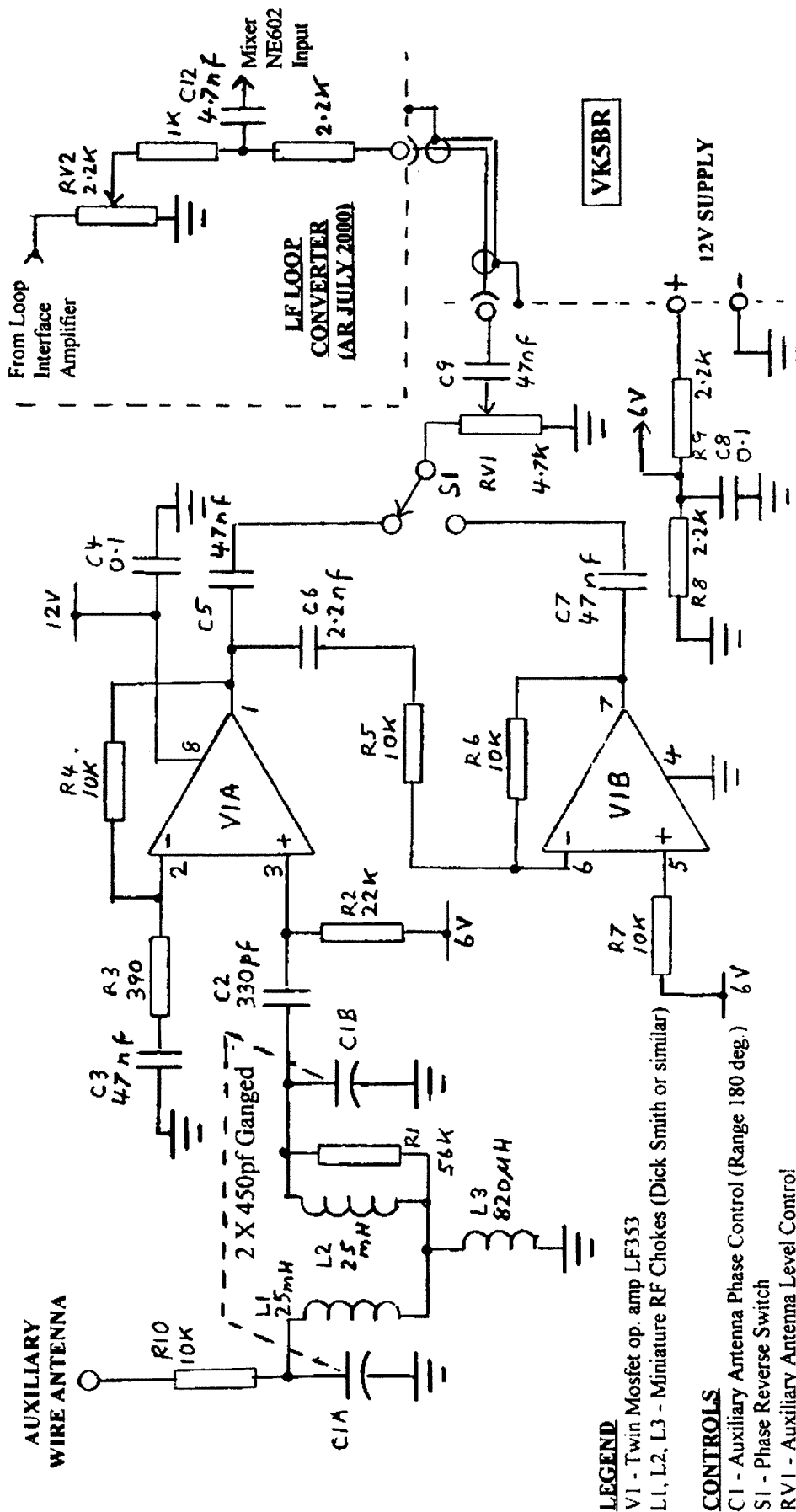
For the cancellation to work, the unwanted noise or signal from the auxiliary circuit must be at least equal in level to that from the loop circuit. If this is not the case, it might be necessary to reduce the loop level (RV2) to achieve this condition.

Performance

Whilst the main purpose in setting up the cancelling circuit was to phase out locally generated noise, it has also proved to be useful in separating signals. There are a multitude of aeronautical NDB signals to be heard above 200 kHz and many of these stations are on the same frequency or very close in frequency. Tune across the band and at many tuned positions more than one station ident. can be heard.

Assuming the signals are from different directions, one way to separate one station from another is to carefully set the loop null in the direction of the signal to be rejected. However, independent of the loop position, the cancelling circuit is also very effective in phasing out the unwanted signal. It is interesting to phase out one or the other of two signals so that each can be heard on its own, one at a time.

If there is no signal or noise to be cancelled, another interesting aspect of having two different types of antenna is that either can be selected to operate in its own right. If the signal from the loop seems better than that from the wire antenna, just set RV1 to shut off the auxiliary signal. If the signal from the wire antenna seems better, set RV2 to shut off the loop.



LEGEND
 V1 - Twin Mosfet op. amp LF353
 L1, L2, L3 - Miniature RF Chokes (Dick Smith or similar)

CONTROLS
 C1 - Auxiliary Antenna Phase Control (Range 180 deg.)
 SI - Phase Reverse Switch
 RV1 - Auxiliary Antenna Level Control
 RV2 (in Loop Converter) - Loop Antenna Level Control

FIGURE 1
LF Noise Cancelling Circuit
Frequency Range - 160 to 500 kHz

Summary

The LF Noise & Signalling Cancelling circuit is a useful addition to the LF receiving system where localised noise is a problem. It is also useful to phase out an unwanted signal near the frequency of the signal being received.

As described, the circuit has been designed to operate in conjunction with the LF Active Loop Converter described in AR, July 2000. In the combined arrangement, the following is achieved:

The advantage of the loop with its properties of directivity and insensitivity to the high level electric

component of localised noise.

The ability to raise the Q of the loop by feedback and limit its bandwidth.

The ability to phase out unwanted noise or signal by using an additional antenna pick-up.

The ability to select loop or wire antennas for best signal condition.

Using components shown in Figure 1, the phase control circuit works over the frequency range of 160 to 500 kHz. No attempt has been made to operate below 160 kHz but this might be achieved by using large values of inductance in the circuit.

References

1. *An Interference Cancelling System for your Receiver or Transceiver* - Lloyd Butler VK5BR - Amateur Radio, September 1992.
2. *More on Interference Cancelling and a New Circuit* - Lloyd Butler VK5BR - Amateur Radio, January 1993.
3. *An Active Loop Converter for the LF Bands* - Lloyd Butler VK5BR - Amateur Radio, July 2000

Maths For Amateur Radio

Great Circle Calculations

Lindsay Lawless VK3ANJ

Calculating great circle distance and bearings using a Microsoft Works spreadsheet might not be as convenient to use as a programmed calculator or dedicated PC programme, but if neither of those are available it is a useful alternative.

There are several equations available for the purpose; I find the following most useful:

$$\text{Distance } D = 60 \cos[\sin L_1 \sin L_2 + \cos L_1 \cos L_2 \cos (l_1 - l_2)] \quad (1)$$

$$\text{Bearing } H = \arccos[(\sin L_2 - \sin L_1 \cos(D/60)) / \sin(D/60) \cos L_1] \quad (2)$$

For spreadsheet calculations we can enter latitudes and longitude across the sheet and do the necessary conversions to radians in the rows below.

The formulae for final calculations can be entered below the conversions to radians.

So proceed as follows :-

L1 = latitude of position 1 entered in 'a1'

L2 = latitude of position 2 entered in 'b1'

l1 = longitude of position 1 entered in 'c1'

l2 = longitude of position 2 entered in 'd1'

D = distance in nautical miles and H = true bearing in degrees

For spreadsheet calculations latitude and longitude in degrees minutes and seconds must be converted to radians using

$$(\text{degrees} + (\text{minutes} \times 60 + \text{seconds}) / 3600) \times \text{Pi} / 180 \quad (3)$$

to get 'a2', 'b2', 'c2', 'd2'

Equation (1) converted to spreadsheet language becomes :

$$D = 'a3' = (60 * 180 / \text{Pi}()) * \text{acos}(\sin(a2) * \sin(b2) + \cos(a2) * \cos(b2) * \cos(d2 - c2)) \quad (4)$$

and equation (2) becomes;

$$H = 'a5' = (57.3) * \text{acos}((\sin(b2) - \sin(a2) * \cos(a4)) / (\sin(a4) * \cos(a2))) \quad (5)$$

$$'a4' = (a2 / 60) * \text{Pi}() / 180 \quad (5a)$$

where a2, b2 etc are the cells containing the radian values of the latitudes and longitudes

Notes

- (1) South latitudes and East longitude must be entered as negative quantities

(2) If H = a4 is negative add 360 deg. to obtain true bearing

(3) a1, b1, b2...etc are the column, row designators.

(4) The expressions 1,2,4& 5 will not compute along lines of equal longitude i.e. if l1 = l2.

(5) Do not use co-ordinates located at opposite sides of the earth (ie antipodes)

(6) Do not use latitudes +90 or -90.

Those readers who prefer to use a calculator, equations 1 & 2 can be entered direct in a HP 32 S or as programmed operations in the HP 32 and the HP 11 C. I have equation 1 as LBL A in a HP 11C and use the result to program equation 2 at LBL B. I also use LBL C for a program to determine the Latitude crossing point of the GC path at a given Longitude. That equation is:

$$Li = \text{atan}([\tan L_2 \sin (l_1 - l_2) - \tan L_1 \sin (l_1 - l_2)] / \sin (l_2 - l_1)) \quad (6)$$

Li is the intermediate latitude and li the intermediate longitude.

The equations are derived from spherical trig. identities, there is a good introduction to that subject and its use in terrestrial and celestial navigation in "Mathematics for the Millions" by Lancelot Hogben. The ITT "Reference Data for Radio Engineers" also has useful information.

Calculating the bearing and distance of Perth from London and the bearing of London from Perth is a useful test of the calculations.

The distance is 7812.49 nautical miles (130.21 degrees).

The bearing of Perth from London is 92.9 degrees.

The bearing of London from Perth is 313 degrees.

ar

Phased Verticals for 10m Mobile Use

Kim Rhodes VK6TQ

Band conditions OK, but solar cycle 23 not all that great and the DX from the car more difficult than expected. Big signal difference between the home antenna (4 element quad) compared to jumping in the car and going mobile. I seem to be the kids' taxi late afternoon, which is the time 10meters is usually open to Europe. I decided to see if I could do something to improve operating 10meters mobile.

I have been operating for some time with a 2 metre tall whip on the front of the car which is top loaded to be a 1/4 wave on 10 metres. I then put a second shorter whip on the roof rack to see how it compared to the one on the roof bar. It seems the height gain of the roof compensates for the shorter antenna OK but no real lift over the front antenna. Both performed about the same with slightly different direction lobes from the car.

However still being the ever busy kids taxi I was not satisfied with the operation of 10 metres mobile. I also work daily to YJ8WR (ex VK6JR) from VK6. Wayne's reports over this distance served as a good yard stick for the antenna tests.

I had been pondering phasing the two antennas together for a while. A measure up and slight moving of the roof rack allowed me to space the two mobile whips 1/4 wave apart. A change of coax to put equal length feed line to both the antennas and arbitrarily choosing to make the feed lines a multiple 1/4 wave in coax for 10 metres.

A small metal box with two cheap relays glued in with the pins facing up. A couple of PL259 chassis mount connectors, 1/4 wave of RG-58, 2 X 1/4 wave of some small 75 ohm coax and a small switch to place near the transceiver to remote control the relays.

By using a centre off type toggle switch to drive the relays it is possible to parallel both antennas (giving a gain of about 3dB to the sides of the car) switch forward or reverse with a gain of about 6dB in the selected direction. It may not sound like much but it is equivalent to bumping up to 400 watts from 100 watts and adds the same to the bloke you are listening to. In many instances it also reduces near by QRN further improving the received signal readability.

I used RG-58 for the 1/4 section for direction change and a small diameter 75 ohm cable (which I do not have a number for) on the impedance raising 1/4 wave sections. RG-59 would be fine for the 75 ohm sections and a BNC 'T' piece could be used as the joiner at the transceiver feed point. A 1/4 wave in coax for this project was 1700mm and the antenna spacing on the car was 2600mm. The relays were small 12DC from a local component store.

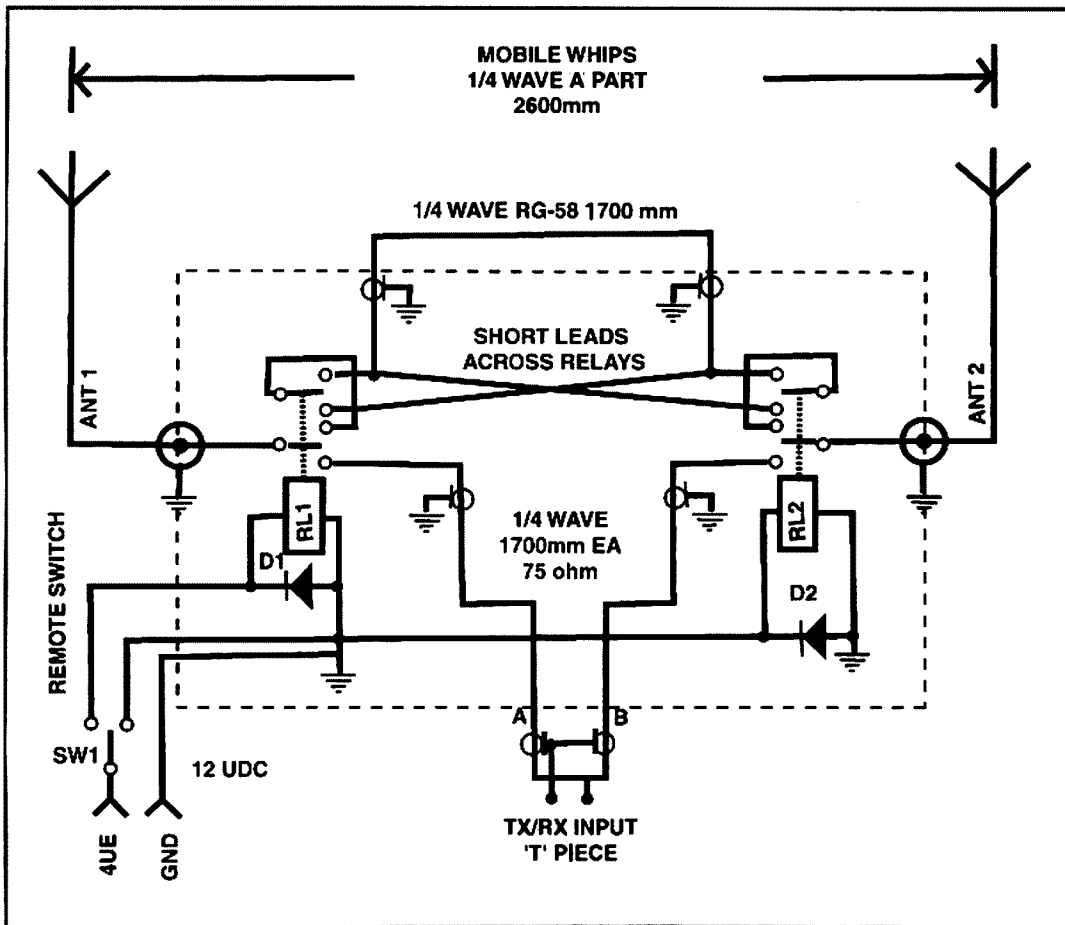


Figure 1

Fun with a 'Cool Little Mast' and a Pulsar

VHF/UHF Spring Field Day 2000

Andrew Scott VK2TWO-QF560D
ascott@bigpond.net.au

I'm not the most organised person in the world, and this Field Day proved that theory. I had organised to borrow the Super mast from work and had collected some lengths of Coax and assorted odds and ends. I then was faced with the challenge of finding some Antennas.

I don't own any horizontal antennas and went about asking people at the local Radio Club. (Manly Waringah Radio Society) I managed to borrow a 5 element Hygain 2m FM beam and a 15 element home made 70cm FM beam. I wish to thank Dom VK2JNA and Tim VK2ETJ for letting me function test their beams, they worked well.

Now neither of the antennas was ideal, but better than a vertical on the car. So I collected these antennas in preparation. This is where I ran into my first problem. I have a Nissan Pulsar. A 15 element 70cm beam is not small. Thus some of the antenna had to stick out the window of the car for the trip. This did not pose a problem, as even though it was raining

for part of my trip. I didn't seem to have any water leaking issues.

So I had collected all the assorted bits and pieces. I required a trip to DSE to purchase an N-SO239 adapter and I was ready to "play radio". I'm not a VK2 local. I have been here for 14 months now but still haven't done much travelling. So where should I go?

Requirement was a good view into Sydney and not too far. I asked around and was told Bilpin was as good a location, as any, so I headed off into the surrounding areas of Sydney.

One thing you learn very quickly about Sydney is that the maps are terrible. UDB don't even include Lat/Long references on their pages. I didn't really have a good map. Oh well, I sort of knew where it was. Dom said I should drive about 4km past Bilpin and there is a turn off to the right that's about 8km to a good mountain. So I passed the Bilpin sign, found a road to the right that looked okay, (it seemed to lead to a mountain). So down this road I went.

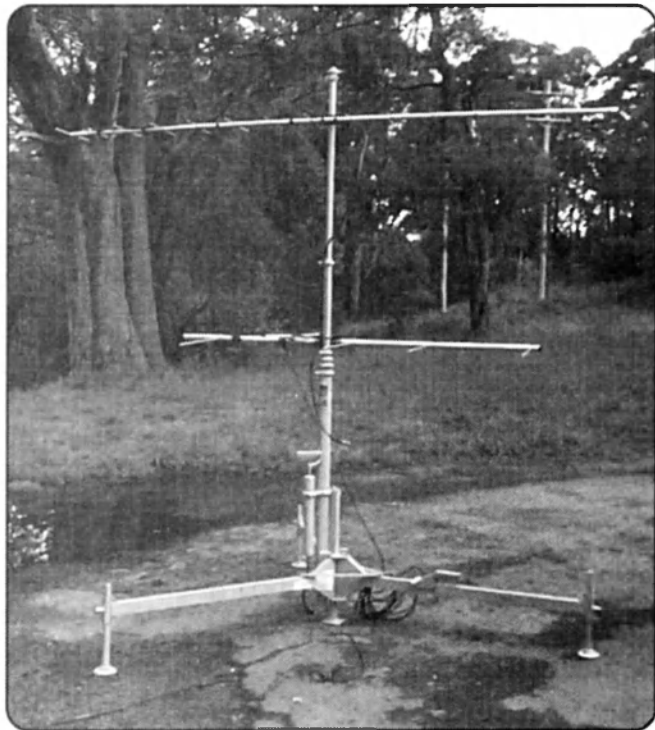


Photo 1

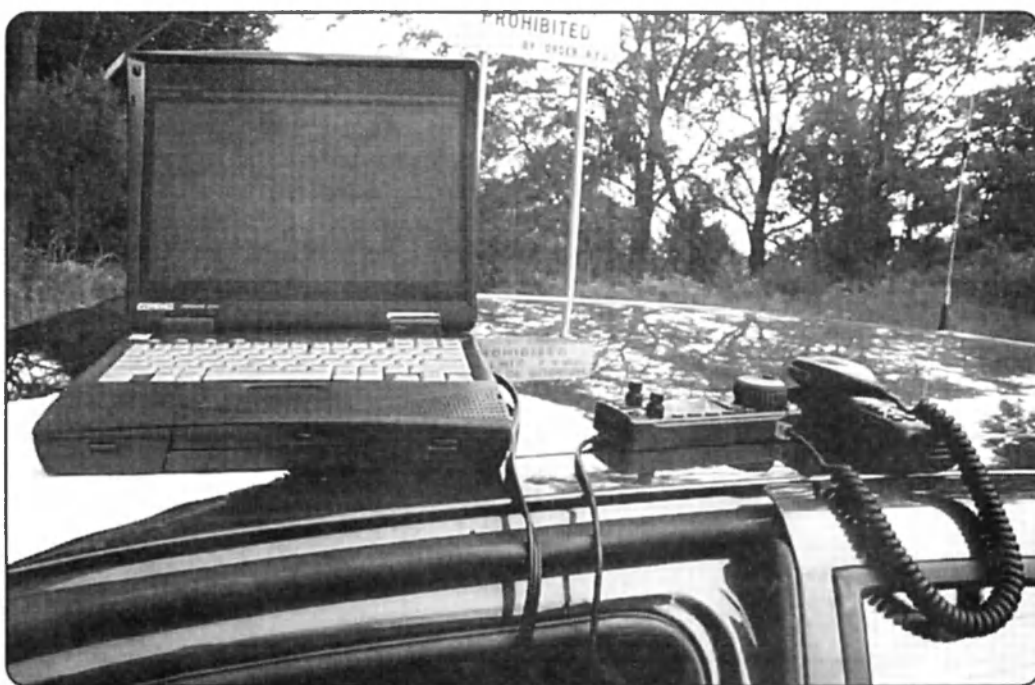


Photo 2

Bitumen turned to gravel so I kept going. Gravel road turned to fire track, but I kept going. It was a mountain. But the road missed the top and the GPS only said 500m ASL. So I turned around and went looking for something better. I ended up at Mt Tomah QF56el at 1006m ASL. This was a good path back into Sydney, about 100km. I worked a number of stations, some on FM.

Photo 1 is the "Cool Little Mast", self supporting, 6.5m high. It has a pump to erect it. Each section locks into place once raised, It also has the option to guy it. Setup with antennas installed is around ten minutes. The ideal portable station. Thanks to work for letting me borrow it.

This is the Mt Tomah Location. QF56el. The path wasn't the best. But it worked. East (Sydney) was between the trees. I also had a good path west towards Bathurst.

The 6m Antenna used was a Terlin Outbacker Perth Plus. This antenna is my station HF antenna. It works okay. Though wasn't enough for a 175km 6m contact. I'm in the process of obtaining a small 6m beam.

My operating station is an Icom IC706G, do-everything radio so this comprised my portable station. This is shown in photo 2 with my Laptop that is used for logging and a GPS. I have the radio installed as a remote unit in the car. I was able to sit the head unit on the roof and operate it this was as seen in the Picture. It worked very well.

I had only worked a handful of stations and was having fun, but my calls from Mt Tomah went unanswered. I looked at the map and decided to go for a drive. If you operate in another Grid Square there are extra points offered. So I headed for Bathurst. I ended up at this mountain (QF49xm at 1306m ASL). I'm

not sure but I think it is Mt Conobolous. It was around 150km from Sydney It had a 360 degree view and I had good paths back to Sydney and also to Young. This is a very good spot to remember. I will be using this spot again for future field days.

Again setting up was a breeze. There are a number of commercial applications on this site. But I did not suffer desensing or any major interference.

As the sun started to set, the clouds drew closer. They had covered the mountain by the time I had packed up. Photo 3 shows the site to the left is the survey marker.

In the end I believe the trip was successful. I didn't work that many stations. I drove nearly 500km and had a ball. It was great to prove that the setup works and learn some tricks to make my next effort much more successful. It was a very good performing setup. Contacts of over 200km on both VHF and UHF. It

would have been nice if there were more people to work with but maybe the Summer Field Day will be better represented. Thanks everyone who I worked with, those who helped me and to Barry VK3BJM for providing me some big scores. See you all at the Summer Field Day.

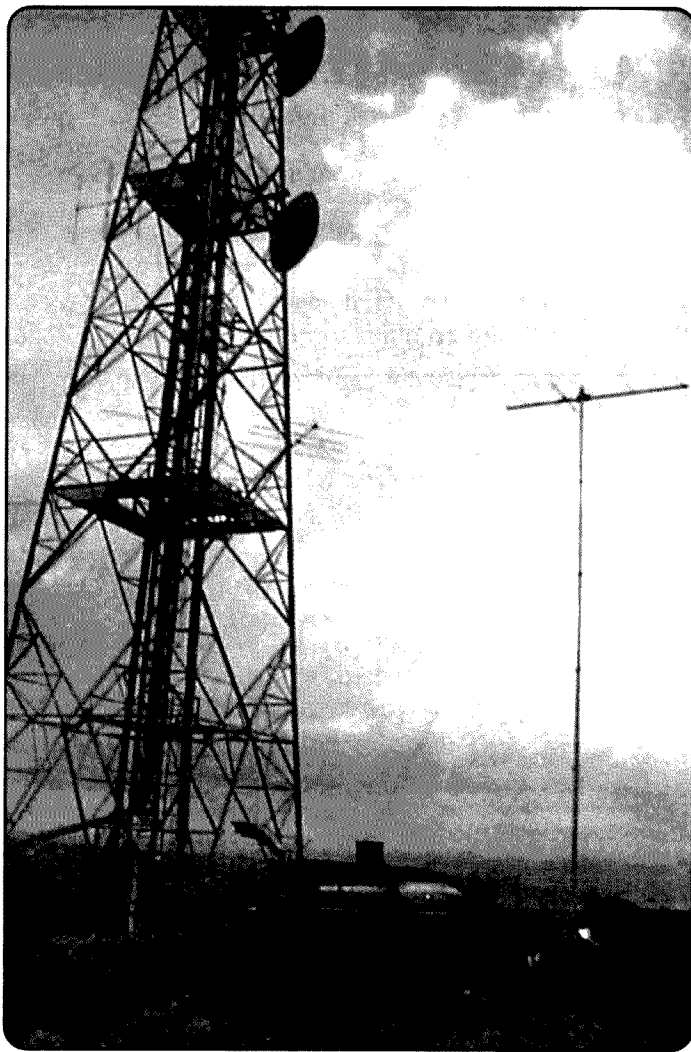


Photo 3

Don't miss out!

**Australia's BIGGEST and BEST exhibition and sale of
NEW AND USED RADIO AND COMMUNICATION EQUIPMENT**

**at the Central Coast Field Day,
Sunday 25th February,
Wyong Race Course,
just 1 hour north of Sydney.
Starts 8.30am.**

- Special Field Day bargains from traders and tons of disposals gear in the flea market.
- Exhibits by clubs and groups with interests ranging from vintage radio, packet radio, scanning, amateur TV and satellite comms.

www.ccarc.org.au

Ph (02) 4340 2500

From Circuit to Chassis

Drew Diamond, VK3XU
45 Gatters Rd., WONGA PARK, 3115

It is probably a safe bet that the most popular home-brew radio projects are power supplies, antenna couplers and linear power-amplifiers. All of these items require some sort of chassis/case assembly to house the device. But for some constructors, it seems that the necessary metalwork job can be rather daunting, with the result that the urge, or desire, to build something is seldom fulfilled.

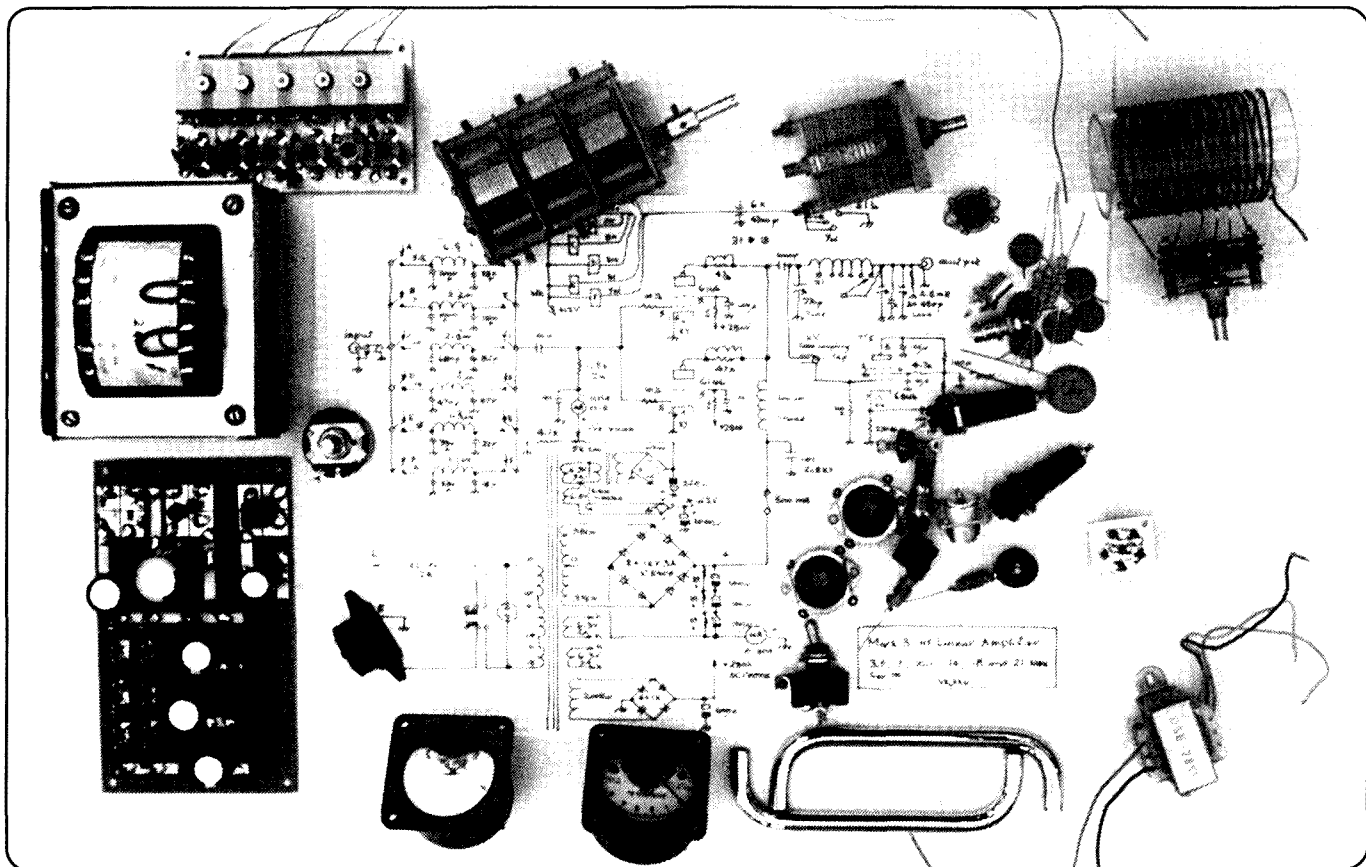


Photo 1: Components and sub-assemblies

Apart from power supplies perhaps, few of the ready-made metal boxes really suit couplers and amplifiers. And factory-made cases are usually quite expensive.

Depending upon available tools, material and experience, there are many ways that an amateur may construct a chassis to suit an application. Let me describe just one method which, with care and practice, yields quite acceptable results using ordinary tools. Front and back panels are of 3 mm aluminium sheet, connected front to back with four 12 mm square-section Al. rods. Good mechanical rigidity is thus obtained by using reasonably thick panel

material in a simple construction. In the example shown here, we see a re-build (to reduce size, and to accommodate new bands) of a small 100 W HF linear amplifier originally made about 20 years ago.

Having decided on a project, and found (or designed) a suitable circuit, it is not a good idea to rush ahead with the metalwork on the assumption that key parts will be available when required. Rather, we should obtain at least those major components whose size have an influence upon the dimensions of the case. And if all the

necessary parts can be acquired before work is started, so much the better. Any sub-assemblies should be fabricated early in order to fully determine the shape and measurements of the chassis. Depicted in Photo 1 are all of the main components for the job, including switched input filter assembly, power supply circuit board and output tank coil/switch assembly. It would be prudent to check, as far as possible, the serviceability of important size-determining parts such as (in this example) power transformer, filter capacitors and meters.

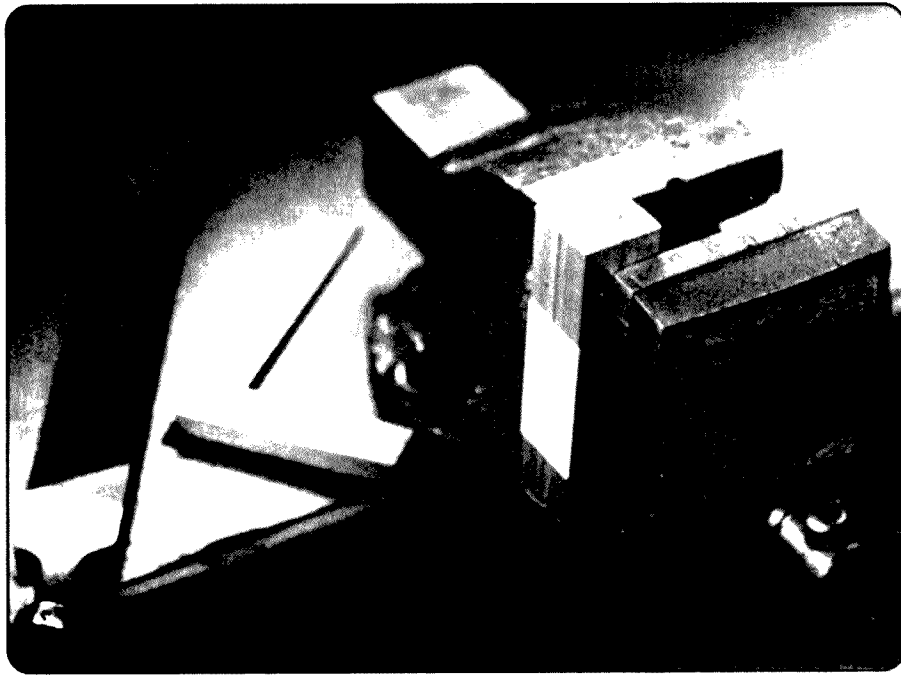


Photo 2: Filing the rod ends

and cut the front and back panels to size using the means available. If you do not have access to a guillotine, use an electric jig-saw (as described in Ref. 1) or scroll-saw or hand-saw. All finished corners must be exactly 90 degrees. Remove burrs and tool marks with a smooth file.

Hack-saw four pieces of 12 mm (or thereabouts) square-section Al. rod about 1 or 2 mm longer than the actual length required. The rod ends must be finished off as squarely as your skills and equipment permit. Best method is by turning (perhaps one of your mates at the radio club has a lathe with 4-jaw chuck). Or they may be filed to square-tape the four rods together as a 2 x 2 bunch, fix vertically in your vice and square off the ends with a smooth file, as depicted in Photo 2. Test for exact squareness with a try-square.

The rod ends must be drilled and tapped to accept 4 BA or 5 mm or 5/32" Wh screws. If you do not know how to drill and tap: Refs. 2 and 6 are suggested as excellent guides (should your local

With all of the parts to hand, the builder should now be able to form a pretty good mental picture of the chassis/case required. With pencil and paper, make a sketch of the envisaged layout, keeping in mind (for an amplifier like this one for instance) which parts must go below chassis, and those above. Obey any special instructions specified by the circuit designer. Be on guard for potential 'clashes'- where the fitting of one part excludes, or interferes with another. Remember to allow for ventilation of heat producing components such as power tubes/valves. Tank coils should have adequate all-round clearance- at least half coil

diameter, and preferably one coil diameter.

With dimensioned sketch and tape-measure in hand, visit your local aluminium merchant. Off-cuts are usually cheaper, so check their rack to see if there is some pre-cut material which suits the job. Also, some scrap-metal merchants/re-cyclers sell quite good factory off-cuts at considerably lower cost.

Accurately mark-out

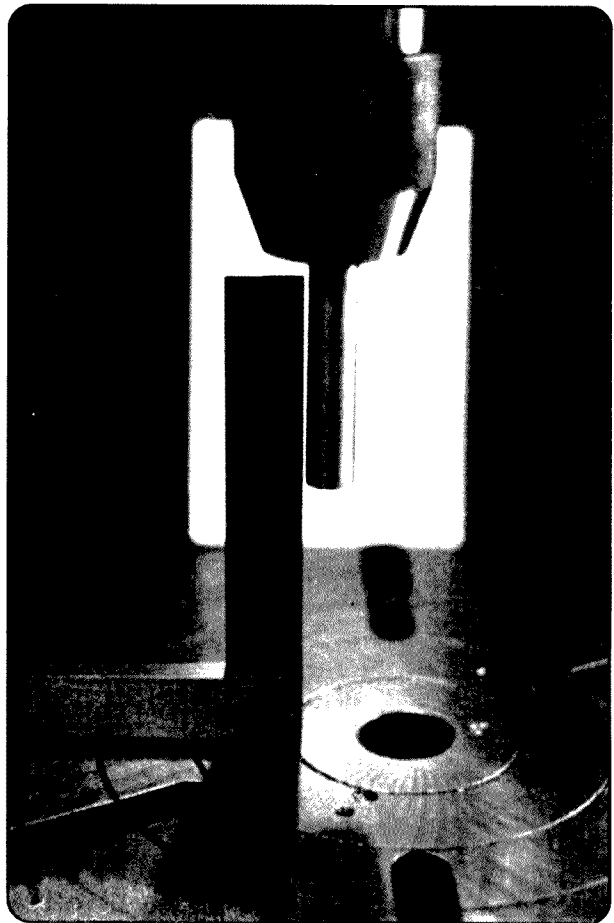


Photo 4: Checking drill table

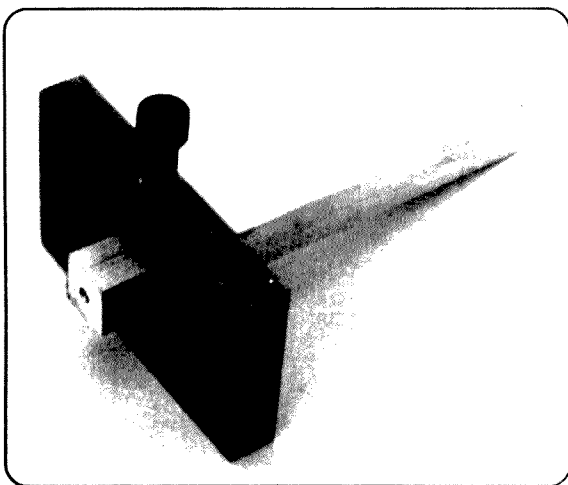


Photo 3: Work-holding jig

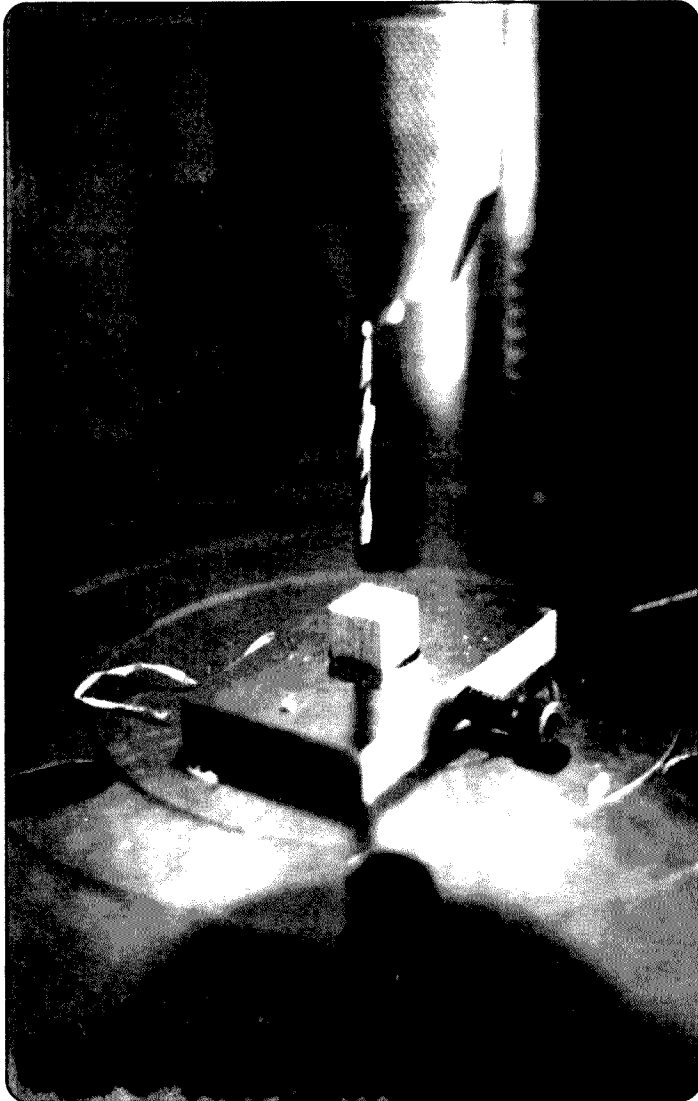


Photo 5: Drilling a rod end

library not have a copy-request an inter-library loan, then practice some drilling and tapping in scrap material first). In order to drill the tapping hole axially using an ordinary bench-drill- and you do not have a vee-block; consider making a work holding jig similar to that shown in Photo 3. A 10 x 40 mm x (say) 70 mm long piece of mild steel is drilled centrally with a 16.5 mm hole to accept the 12 mm sq. rod. A hole for a 1/4" Wh or 6 mm clamp bolt is drilled and tapped in one side of the holder as shown.

Before any drilling is done, it is essential to ensure that the drill table is at right angles to the chuck. Fix a suitable length of round rod in the chuck, and present your try-square to the rod, as illustrated in Photo 4. Adjust the table as necessary (you should find a fixing bolt and graduated scale beneath the drill table).

With your scribe, mark across the diagonals for each rod end, then accurately centre-punch where each tapping hole shall be. Fix the rod(s) in the jig as depicted in Photo 5.

There are various trade cutting fluids for aluminium, but I find that ordinary auto transmission fluid or sewing-machine oil makes a good lubricant for drilling and tapping Al. Using the appropriate tapping drill, bore a shallow hole first, then insert a drop of fluid into the hole, then continue drilling. If the bench-drill has a depth-stop, set it for a drilling depth of about 25 mm- or just a bit longer than your screws. Withdraw the drill periodically to clear the swarf and add more fluid. Don't force the pace, otherwise drill breakage may occur.

Now, with the 8 holes drilled, carefully counterbore each hole to exactly screw diameter to a depth of about 5 mm (depth-stop again), which greatly aids in getting the tap started at right angles, and helps prevent cross-threading when the screws are inserted later.

Having prepared the four rods, the front and back panels may be drilled accordingly. A chassis pan was required in my example. Front and back panels may be temporarily assembled, which then allows an exact measurement to

be made for the chassis pan. To provide support for heavy components, and strengthen the whole assembly, allow for a 12 mm (plus material thickness- say 1.5 mm) 90-degree flange front and back of the pan. The 90-degree flanges may be bent using the methods described in Refs 1 or 3. Remember to allow for the material thickness when bending (Ref. 8).

Drill two or three holes in the 90-degree flange front and back, and two each side. Now use the pan as a template to exactly locate corresponding holes in the front and back panels, and the two side-member rods. My completed chassis components, ready for assembly, are shown in Photo 6.

With the chassis pan temporarily fitted, it is now possible to experimentally position your

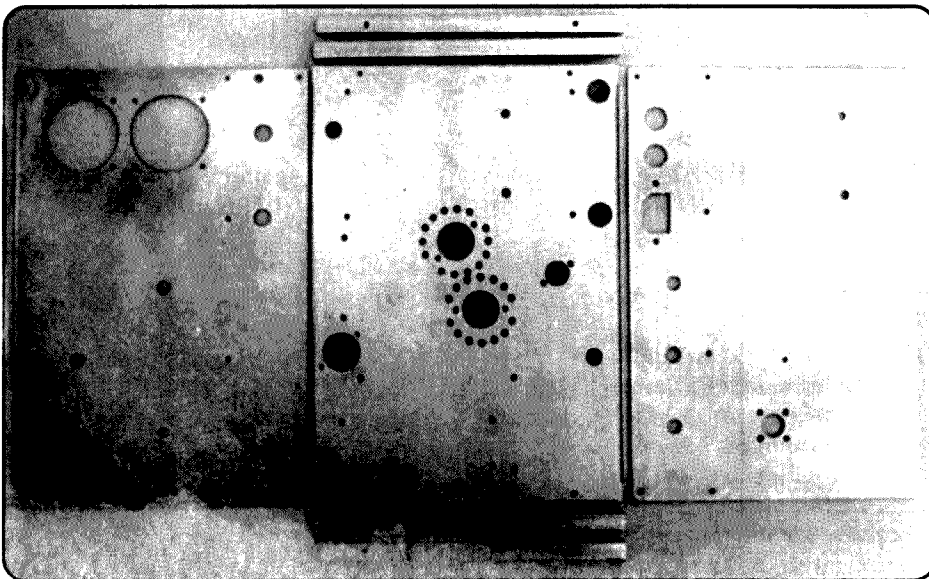


Photo 6: Chassis components

components upon the chassis and determine exactly where each part shall go. The resulting pre-drilled bare chassis is shown in Photo 7. 'D' style equipment handles are recommended for the front panel, which also permit the chassis to be laid face down during assembly and service (Photo 8).

File a slight round upon the top-most corners of the front and back panels- just a few strokes with a smooth file, to permit the top cover to fit snugly. Top and bottom covers may be "made-to-measure" using 1.3 or 1.6 mm Al. sheet. Don't forget to include the thickness of your bottom cover.

For the top cover, allow about 5 mm extra overhang for each side, much of which is "taken up" by the bend. You can always remove surplus metal by nibbling or filing later- putting it back is a bit more difficult. Make one bend, then test for fit upon the chassis, thus permitting any corrections on the second bend. The cover screw fixing holes are drilled in top and bottom covers, which then provide a "template" for you to transfer their positions exactly onto the bottom rod members, which are drilled and tapped accordingly. Using metal-stamps, or by scribing, number or mark the four rods and panels to assign congruence upon final assembly.

A good paint job adds greatly to the appearance of your project. Auto spray paints are ideal for radio case applications. Therefore, if desired, apply a grey undercoat primer, then top-coat to required colour- such as gun-metal or cast-iron.

The metal must first be rubbed back, using fine emery or glass-paper, to remove any tool marks and provide an effective 'key' for the paint (Ref. 1). Nylon feet, or fibre or timber runners should be fitted to the bottom panel. As a nice finishing touch, and to win extra points in your Club's home-brew

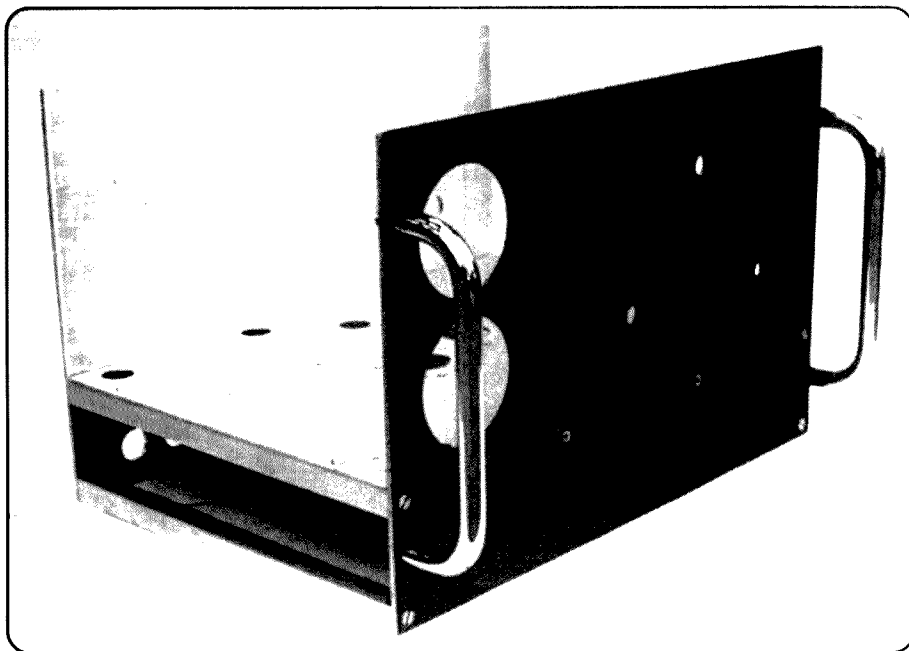


Photo 7: Bare chassis

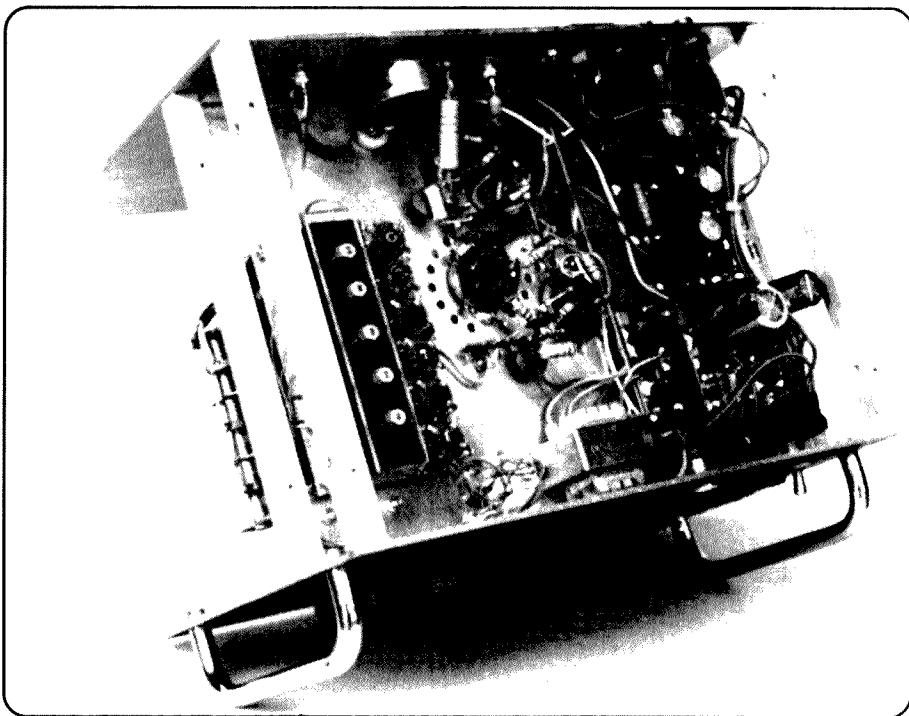


Photo 8: Under chassis view

GEELONG RADIO & ELECTRONICS SOCIETY HISTORICAL RADIO DISPLAY

Portarlington Summer Festival, Saturday 20 January, 2001. Admission FREE

VK3ANR have been invited to set up an Historical Radio display for the Federation theme Portarlington Summer Festival which will be held Saturday 20th January 2001 in the Portarlington foreshore reserve for one day only. Admission is FREE, so come along and enjoy a day out with the family.

Approximately 40 working models from the GRES museum will be on display .

Communications equipment will also be operating and contacts with HAMS will be the work of the day.

An invitation is extended to all to come along and enjoy the day with us.

We also remind all that the GRES Historical Radio Museum is always on display each week-end and public holiday at the HISTORIC Geelong Prison in Myers St. Geelong.

So come along and "Go to gaol" and view our display.

ar

ICOM *Clearly Ahead*



**"VK3LZ
calling!"**

More sound information
from your friends at Icom

OUR GOOD WISHES TO YOU ALL.

As the year 2000 draws to a close we would like to thank all our loyal Icom customers, and to also congratulate our Dealers on a very successful year to kick off the new millennium.

We wish you all a happy and safe Christmas and we look forward to bringing you new goodies in the New Year.

AND SPEAKING OF GOODIES...

Remember the IC-910H tri-band transceiver is about to hit the airwaves from December 2000. It's a superb package in tune with today's communications essentials.

And, for communications among the wider community, the miniature IC-40Jr (Joey) will also be available from December 2000. It's a powerful pocket sized unit that will open up the market to anyone who wants to communicate with Icom clarity and performance.

"...73"

290 -294 Albert Street
Brunswick, Victoria 3056
Tel : (03) 9387 0666
Fax : (03) 9387 0022
www.icom.net.au

APN 88 026 292 575

competition, suitably label all controls and connectors. Photo's 9 and 10 show the completed amplifier.

References and Further Reading

1. "Making Boxes with Ordinary Tools"- Diamond, AR May '98.
2. Drills, Taps and Dies; Tubal Cain- #12 in the Workshop Practice Series. Argus/Nexus Books.
3. "A Simple Sheet-metal Bender"- Diamond, AR Sep. '98.
4. "Homebrewing Equipment- from

Parts to Metal-work"- P. Johnson, W7KBE, Ham Radio (USA) Mar. '88.

5. Radio Communication Handbook, 7th edition, Ch 17. RSGB (excellent).
6. The Amateur's Workshop- Ian Bradley. Argus/Nexus Books.
7. "Try Building Your Own Equipment"- G. Diana, N2JGU, QST Mar. '95.
8. "Designing and Bending Metal Enclosures"- D. Smith, K3LXD, QST Oct. '80.

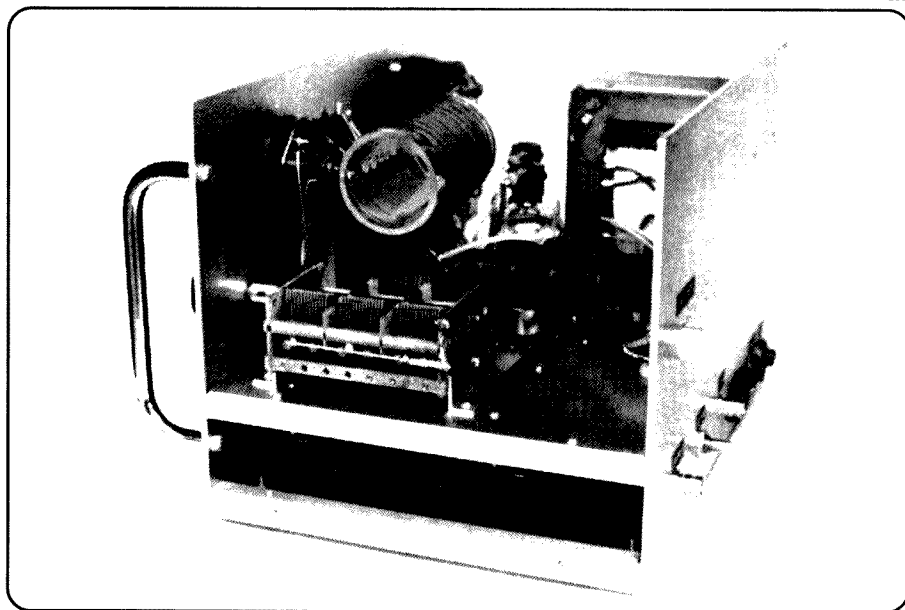


Photo 9: Above chassis view

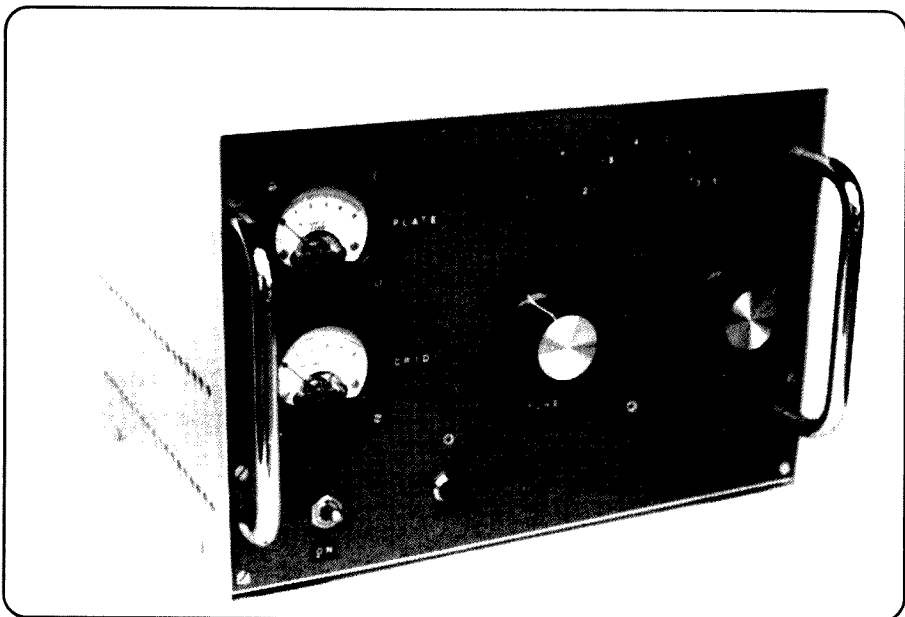


Photo 10: Complete amplifier

PIC Controlled Transmitter

(see Amateur Radio, October 2000, page 22)

Jeremy Lemke VK3TFH

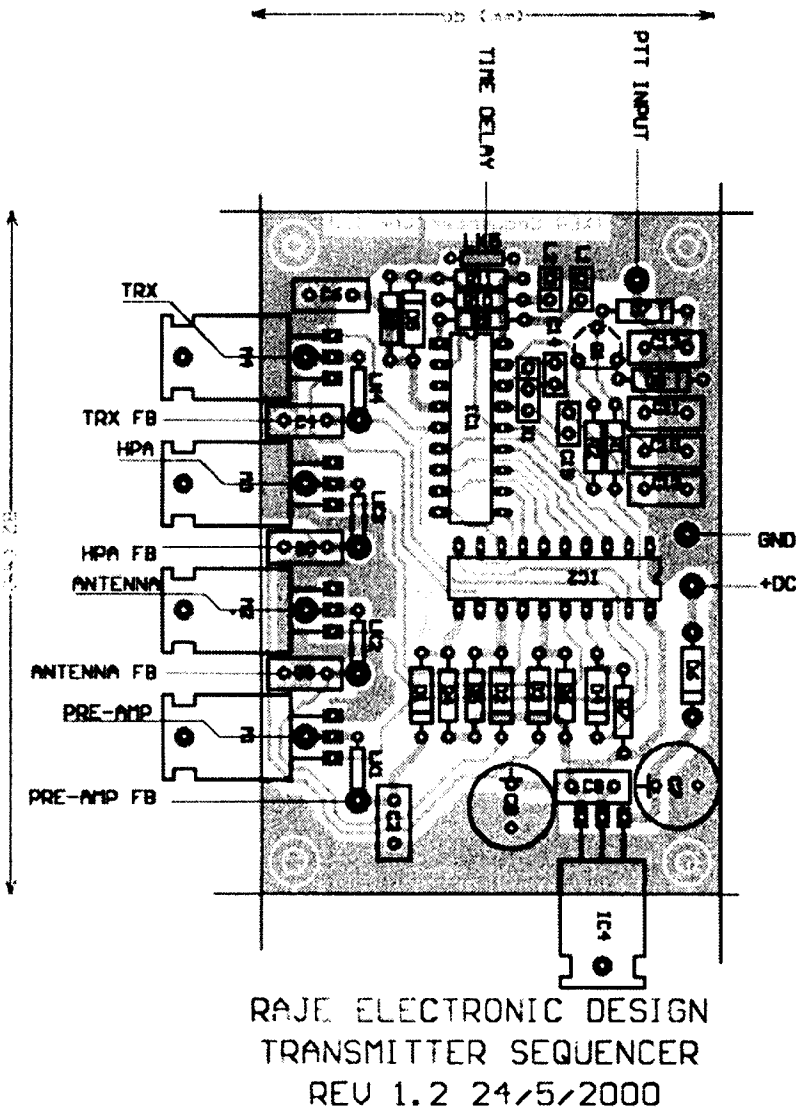
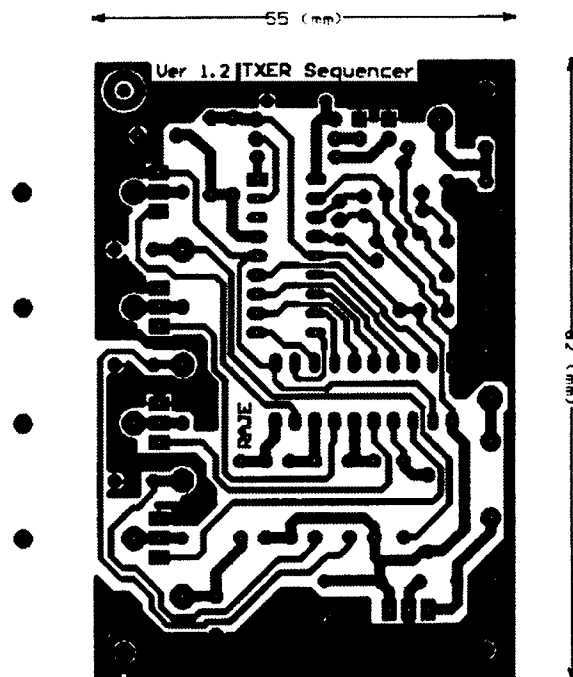


Figure 2

AR apologises to those who wished to make the controller that the board was not printed full size. We also apologise to Jeremy Lemke VK3TFH that some of his diagrams did not reproduce as he would have wished. We now reprint full size, Figure 2 and Figure 3 from Jeremy Lemke's article.

Editor



TRANSMITTER SEQUENCER
REV 1.2 24/5/2000

Figure 3

Adding CW to Your Repertoire

Lindsay Lawless VK3ANJ
Box 760, Lakes Entrance, Vic 3909

Modern CW as a one to one communication mode does not now require expertise at manipulating a "straight" or "bug" key. Those antiquated devices have been replaced by electronic keyers or "elbugs".

Elbugs produce perfect Morse characters at accurate preset speeds, which makes them a valuable aid to learning to read and send the code, and to acquire acceptable operating speed. For that reason alone, newcomers to the art should consider purchasing or constructing an elbug and confining any other keys they might possess to the "gash box".

Another important reason for starting and continuing with an elbug is the fact that many DX stations and satellite Morse transponders use electronic

Morse readers which do not respond satisfactorily to the individual styles of mechanical keying.

The Three Chip Keyer described by Drew Diamond in *Amateur Radio*, January 1998 is as good as others of more sophisticated design and would be a good starting project. At Figure 1 is a duplicate of the circuit used by Drew but with a few modifications that will simplify construction and convert the unit to a 9 volt low current model. Included in the circuit is another transistor for keying a negative keyline

TX. If that is not needed leave it out. It is a good idea to use an external easily accessible 9 volt battery. It can be embarrassing to lose power in the middle of a QSO. The 555 buzzer will not be missed; listening to the TX sidetone is closer to the real sound and helps the learning process.

The PCB supplied by Drew is very convenient but a prototype board similar to DSE part No H5604 is suitable for the purpose. That board is ideal for many one off projects.

ar

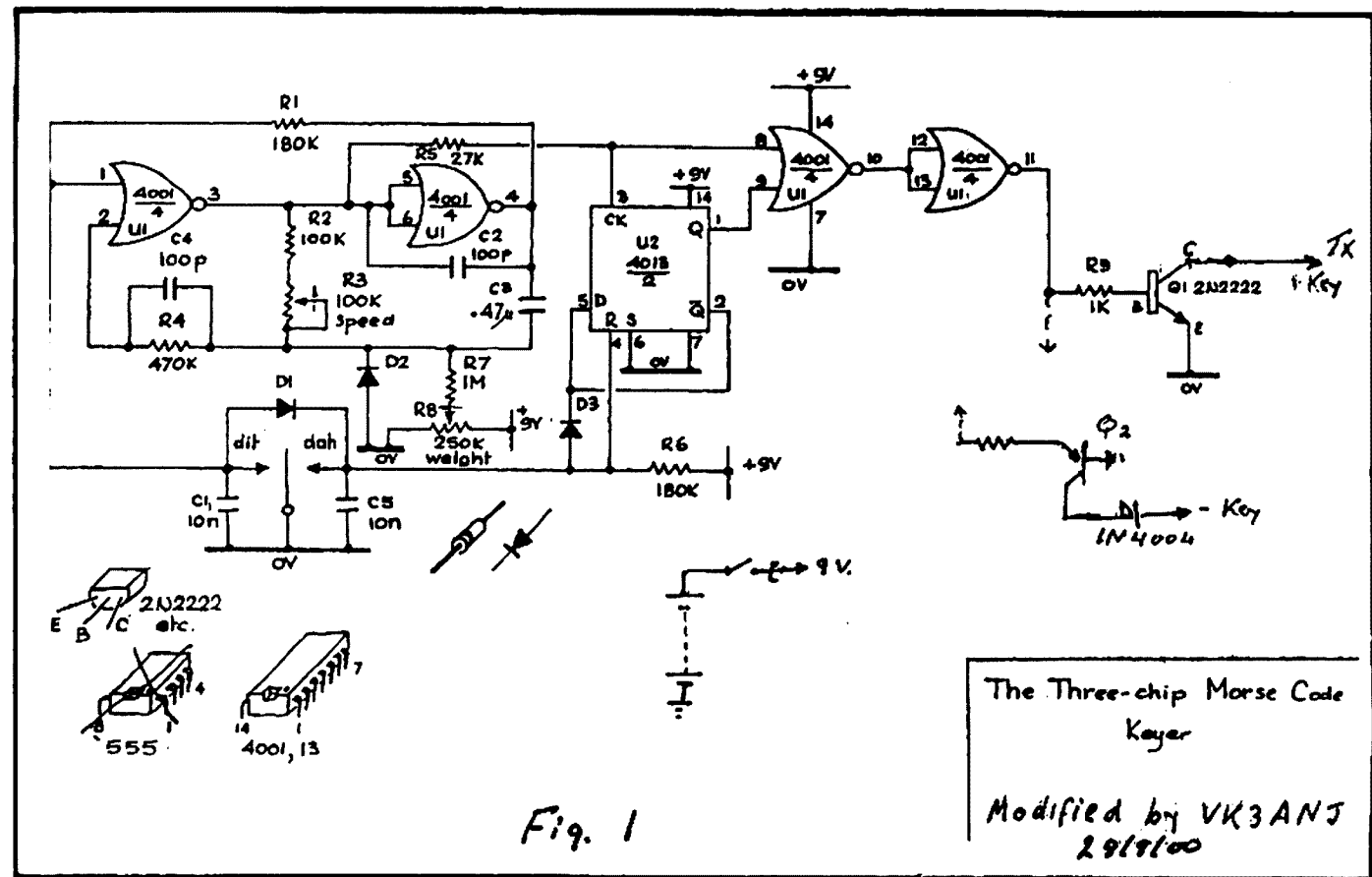


Fig. 1

Figure 1

Laptop Mobile Supply Step Up Converter

Gil Sones VK3AU

Voltages above the standard 12 volt automotive system voltage are sometimes required. Some laptops call for an external supply of 16 to 19 volts. This can be supplied by using a step up converter. This is a form of switching converter.

I have used this type of converter to charge SLA batteries. The device was obtained as a kit and was described in Silicon Chip July 1996. It provides 13.8 volts to charge an SLA battery even when the vehicle battery is down in the region of 12 volts. The kit is no longer available. An earlier circuit with a lower current output is currently available as a kit and uses a circuit published in Silicon Chip July 1992.

The heart of this circuit is a Motorola MC34063 DC-DC converter IC. The voltage output can be set to the voltage desired by adjusting the voltage divider connected to pin 5. In the Silicon Chip article this is made up of a 22k 1% resistor and a 2.2 k 1% resistor. I found that a 10k resistor placed in parallel with the 2.2k resistor provided a 16.5 volt output. Some experimentation would give you the voltage you desire.

The range of output possible is quite large and should meet most requirements. The ratings of the switch device and the diode should be watched. Operating over 20 volts output may tend to stress the MTP3055 switching FET used which has a 60 volt rating. With any switching device you need some head room for spikes. There

are many alternative FETs with higher ratings so a substitute should not be a problem.

However modest changes of output voltage should not be a problem.

While adjusting and experimenting with a kit I observed a rise in noise level on receivers tuned to 6 and 2 meters. This may be untoward if you wish to use the device and operate at the same time. The kit is built in a plastic box and so there is no shielding and the input and output capacitors of the converter are not really capable of limiting signals escaping via the leads.

I built another device using the same circuit in a diecast box with input and output filters on the leads. The noise was reduced to an acceptable level and was not noticeable on 6 or 2 metres. The filters were single section PI using small toroid chokes and 0.47 mF disc ceramic capacitors. Monolithic ceramic capacitors could be used but I had disc ceramics on hand. The toroids were small surplus items but the prewound toroids sold by Jaycar Cat LF-1270 would be suitable. I used a toroid similar to one of these toroids from my junk box for the supply choke and it worked fine at 1.5 amp output of 16.5 volts. The

diecast box was used as the heat sink for the Switch MOSFET and the rectifier diode. I built it using ugly construction where components are direct wired together over a PCB laminate ground plane. This device is shown in Fig 1.

Another modification I made was to provide 470 mF 25 VW electrolytic capacitors in parallel with the 0.68 mF capacitors used as the supply input and output capacitors. These provide reservoirs for the supply and load. They would have little effect on high frequency components. The supply is operating in the 20 to 30 kHz region.

The original converter was built from a kit which is no longer available. However Altronics can supply the toroid used in the Silicon Chip July 1996 design. It is a Neosid 17-742-22 and is Cat L 5120 in the Altronics catalogue. Other parts are available from many suppliers. The prewound toroids used in the filter are a Jaycar stock item Cat LF-1270.

You could also try using the filter with an existing device. For screening just try a metal box which would accommodate both the kit and the filter.

ar

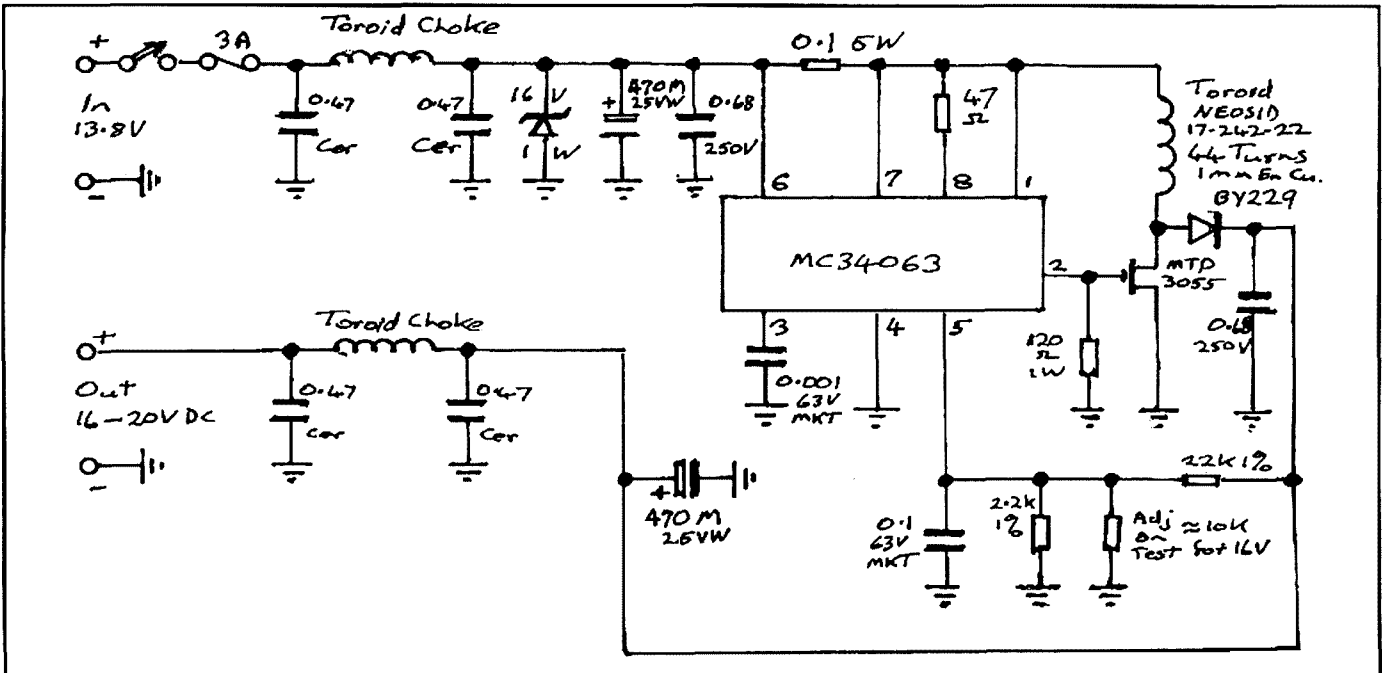


Fig 1. Step Up Converter Skeleton Circuit.

Peter Parker VK3YE

12/8 Walnut Street, Carnegie, Victoria, 3163

E-mail: parkerp@alphalink.com.au

Novice Notes Online: <http://www.alphalink.com.au/~parkerp/nonline.htm>

The crystal set: an ideal holiday project

Of any electronic project, the crystal set would have to rate as one of the most popular. Many amateurs are on the air today because of their early construction of a crystal set. Most practical electronic books for beginners include at least one crystal set project. Unfortunately, some of these circuits take simplicity too far and deliver mediocre performance, often by omitting key components such as the tuning capacitor, or failing to provide coil taps.

This article describes a crystal set of medium complexity. It features coil taps for the antenna and diode to make it useful for both country and metropolitan listeners. The taps allow the set to cover 160 metres if desired. All parts are easily obtainable, making it a good choice for the beginner. The endless possibilities for experimentation also make crystal sets interesting novelty projects for experienced constructors.

Obtaining the parts

Tuning capacitor

A large air-spaced type, covering about 10 to 415 picofarads is preferred. These capacitors were common in valve and early transistor radios and often appear at hamfests. Their long shafts make it easy to attach large tuning knobs. When purchasing one see that the shaft turns freely, but is not loose. Ensure that the plates are straight and do not touch when meshed - use a multimeter (preferably with audible continuity function) to test this. Avoid capacitors with 3/8 inch shafts unless nothing else is available - knobs for these are not obtainable, and an old valve radio dial drum will need to be used instead.

If a large capacitor is unavailable, a small plastic dielectric unit is suitable

(eg DSE R-2970). The lower maximum capacitance (160 pF) means that more coil turns are required to provide coverage of the lower end of the broadcast band. This can be partially overcome by connecting the 60 and 160 pF sections in parallel (link the 'G' and 'O' tabs). The main disadvantage of these capacitors is their short shafts, which makes it harder to attach most types of knobs.

Vernier Drive and dial

The use of a vernier reduction drive is not necessary. However, its inclusion makes tuning easier, particularly on the higher frequencies. A Dick Smith P-7170 or P-7172 is suitable, provided that it fits the variable capacitor's shaft. If your drive lacks a dial, one can be fashioned from a plastic or metal disc, such as a jar lid or salvaged computer hard disc. Glue the dial directly to the skirt of the tuning knob if you lack a vernier drive.

Diode

This is the most easily obtainable and cheapest component in the project. A germanium diode, such as a 1N60, 0A90, 0A91, 0A95 or 1N34A will be suitable. The purists still make their own diode detector with a 'cats whisker' and lump of galena, but modern diodes provide more stable and repeatable performance.

Headphones

The very old high impedance headphones are required for this circuit. A minimum of two kilohms is suggested. Medium impedance headphones (approx 600 ohms) will also work, but are less sensitive.

High impedance headphones have become difficult to obtain. Alternatives include:

1. Crystal earpiece. These are sensitive, easy to obtain and inexpensive.
2. Piezo transducer. Believe it or not, these actually will work as an earphone. Some sizes even fit snugly in the outer ear in a similar manner to modern earpieces, such as used with mobile phones. The main drawback with transducers is their peaky audio response.
3. 1k to 8 ohm audio transformer and standard low-impedance headphones. Works well, but not as sensitive as a crystal earpiece.
4. Cheating! Use a transistor or IC amplifier kit to run a speaker. This approach eliminates the 'free radio' advantage of the crystal set, but provides louder reception in weak signal areas and allows speaker listening.

Coil and Coil former

This needs to be a cylinder about 55 millimetres in diameter and 150 mm long. The length needs to be long enough to accommodate all ninety coil turns used, with enough left over for mounting to the front panel. Plastic pipe, shampoo container or similar will suffice. Though enamelled copper wire can be used for the winding, the prototype used thin plastic-covered stranded insulated wire.

Front panel

All parts are mounted on a 6mm-thick polyethylene chopping board, which forms the front panel. A hacksaw was used to cut the panel to fit inside the wooden case. Use the thinnest chopping board available so that the many screw-mounted sockets used can be fastened properly. The front panel pictured was cut to 240 mm square.

Case and handle

Use non-metallic material for the enclosure. The box used in the prototype was originally a speaker bought cheaply at a school fete. The lid (which held the speaker) was removed, and the rest of the box painted. The top carry handle is optional and came from a hardware store.

Construction

Commence construction once all components have been obtained. Plan how the parts will fit behind the front panel. Figure Two shows the arrangement used in the prototype. The coil is fastened with stand-offs and the variable capacitor is screwed to an aluminium L-shaped bracket. 4mm binding posts with banana sockets are used for the antenna and headphone connections, and 2mm micro sockets for the coil tapping points.

Start by winding the coil. This consists of ninety turns of thin stranded insulated wire close wound on a plastic tube approximately 55 millimetres in diameter. A large number of tapping points are provided so that the user can vary the set's frequency coverage, and antenna and diode coupling. This makes it possible to obtain the best compromise between volume and selectivity for a particular station.

Figure Two shows the coil construction. Start from the earth end (identified as '0' in the diagram). Make

two holes in the former to anchor the end of the wire. Wind six turns and then an extra half-turn. With a knife remove about 1cm of insulation, taking care not to cut the wire. Form the bare wire into a loop and lightly coat with solder. Do not apply excessive heat - the wire insulation easily melts. Wind another five and a half turns and make another tap. Repeat for the remainder of the coil until approximately ninety turns have been wound. Add more turns and taps if using a smaller variable capacitor than specified. Again make two small holes in the former to anchor the wire.

Place the completed coil aside and start work on the front panel. Mount the 4mm banana binding post terminals for the antenna, earth and headphones, as shown in Figure Two. Drill holes and mount the 2mm terminals for the coil taps and the antenna, diode, variable capacitor taps. The tuning capacitor can also be fastened at this time.

Two sets of screws and spacers can be used to mount the coil to the rear of the front panel. A 10mm separation between the coil and the panel is adequate. Solder in the various components and connecting wires as per Fig 2. Use insulated wire for the connections between the sockets and to the variable capacitor. Tinned copper wire can be used for the short links between the coil taps and the 2mm sockets. Use

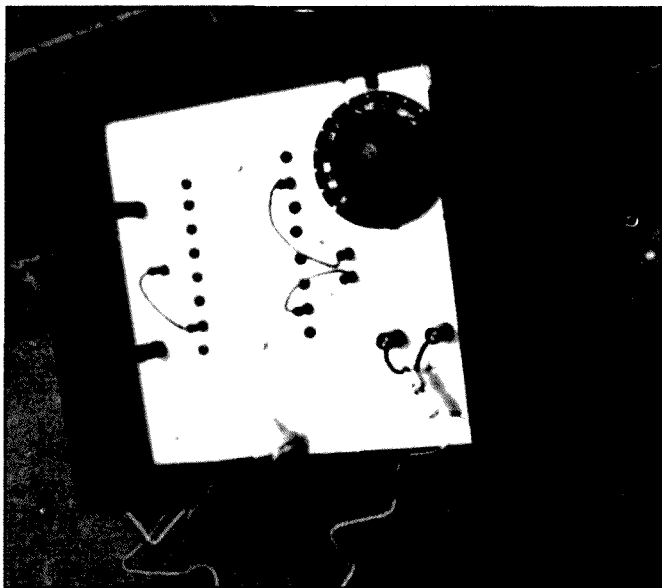


Photo One: Front view of crystal set

insulated wire for the three jumper leads. The jumpers should be sufficiently long to be able to make connections with all taps along the coil.

This completes the construction. The panel can now be inserted into the box. In the unit pictured, the front panel is recessed - this protects the banana sockets and dial and makes the set more rugged. It also allows attachment of a hinged lid if required.

Antenna and earth

A crystal set requires a wire antenna to operate properly. The longer and higher it is the better. A length of at least 10 metres in urban areas, and 20-30 metres elsewhere should provide reception in most cases. The antenna should always be installed away from power lines for safety reasons and to reduce interference pick-up. An existing amateur or TV antenna can also be effective, especially if the coaxial feedline is used as part of the antenna. This is achieved by connecting both the outside and the inside of the coaxial connector to the receiver's antenna terminal.

An earth provides stronger signals, and is essential in remote areas. In homes with copper water pipes, this can simply be a lead to the nearest cold water tap. In newer homes, where plastic pipes are used, an outside ground stake can be used instead.

For long distance reception (hundreds or thousands of kilometres) more than usual effort needs to be taken when installing the aerial and earth. Reference One suggests a length of about 100

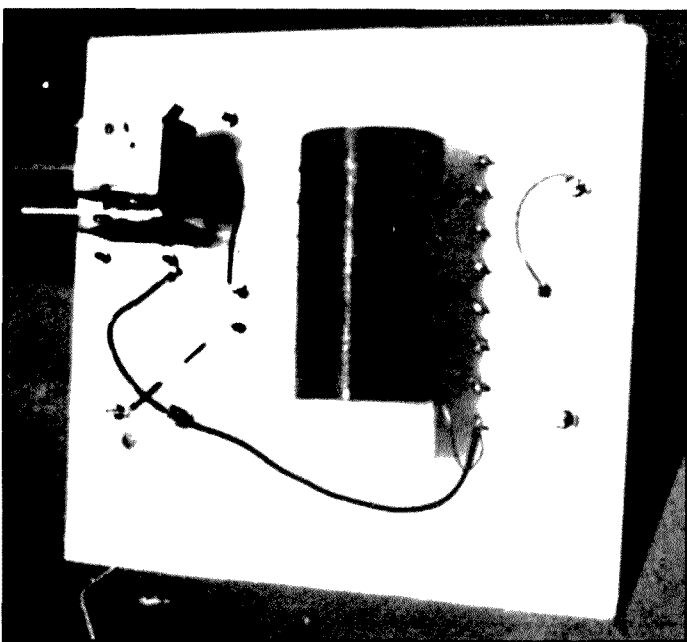


Photo Two: Inside view of crystal set

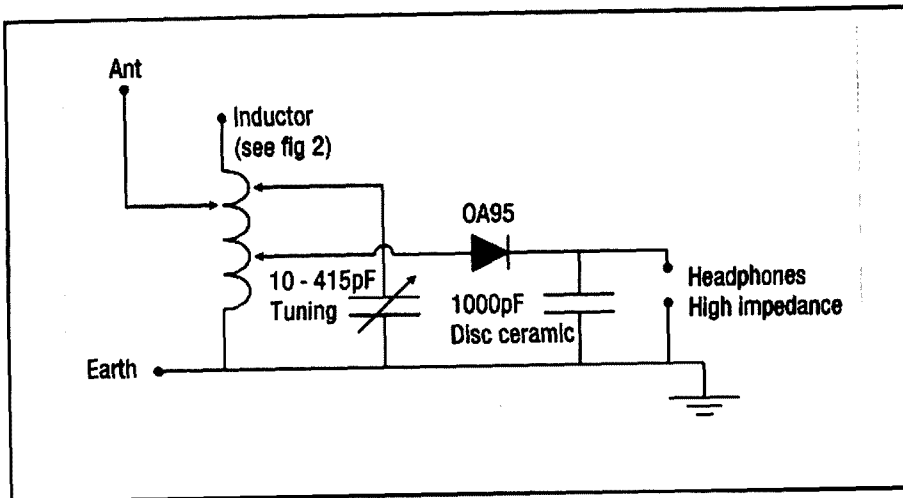


Figure One: Schematic diagram of crystal set

metres and a height of at least 12 metres. A series of buried radials is suggested for the earth, rather than the water pipe suggested above.

Operation

Connect antenna, earth and earphones. Install the three jumper leads. Set the capacitor tap to near the top of the coil (either the 78th or 90th turn) and the diode and antenna taps to approximately midway along the coil.

In a quiet room, adjust the tuning control and listen for a station. If several stations are audible, move the diode or antenna taps nearer the earth end (lower numbered turns) of the coil. This

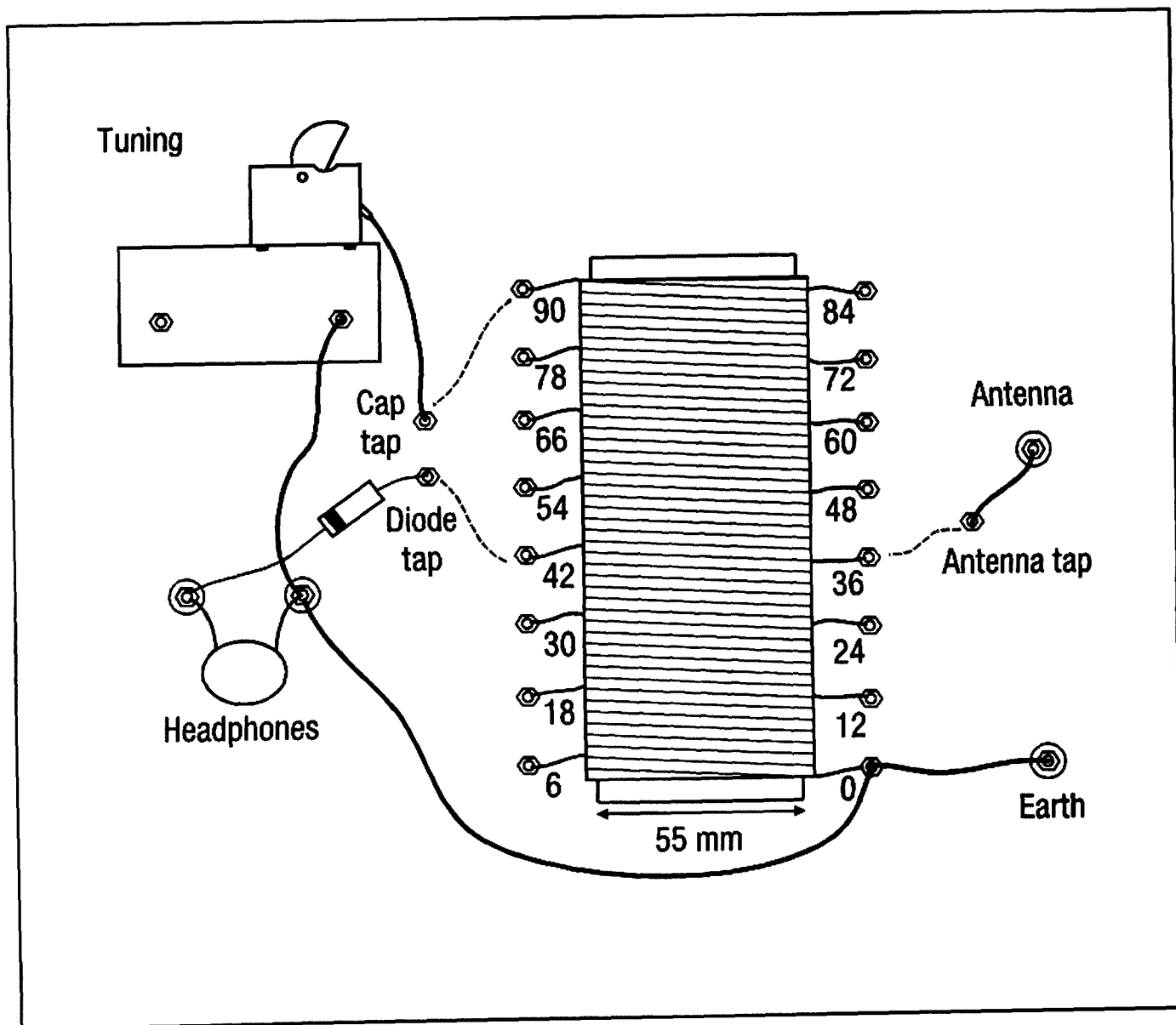


Figure Two: Rear view of front panel, showing coil details

increases the set's selectivity and makes it possible to separate stations. In a capital city it should be possible to separate at least nine or ten stations. Optimum tap settings vary across the broadcast band – lower frequency stations are often best received with higher tap settings. In rural areas volume is normally more important than selectivity, so the taps can be moved near the top of the coil.

Reception of AM operators on the 1.8 MHz (160 metre) amateur band is possible by moving the capacitor tap lower down the coil, to the 54th or 66th turn. Performance will be well down on a superhet or regenerative receiver, and SSB signals cannot be resolved. Whether you hear amateurs or not depends on your antenna system and the extent of activity from nearby operators. Here in Melbourne 160 metre AM activity includes the Sunday to Friday AM morning net and the weekly transmissions of APC News.

In many areas there are narrowcast stations between the top of the official AM broadcast band and 160 metres. Because of their low power these stations will be weaker than the mainstream broadcasters. However these stations are excellent tests of your receiver and antenna system.

Conclusion

A crystal set of moderate complexity has been described. It is the minimum

required to provide good reception of local stations in urban and rural areas. However numerous refinements to increase sensitivity, selectivity or audio output can be made. These include:

1. Double tuned circuits (with variable coupling between them) to improve selectivity
2. Use of a tuned trap to null out interfering signals
3. Attention to the construction of coils to provide the highest possible Q
4. Addition of an impedance matching network to provide efficient power transfer between the antenna and the tuned circuit
5. Use of a large loop antenna for the coil to allow reception of signals without an external antenna and nulling of unwanted signals
6. voltage doubler diode detector circuit using two diodes to increase volume

Should you decide to experiment with these changes, it would be desirable to keep this set as a reference and build a second receiver as a test bed for the experiments.

Further reading

Numerous articles, books and internet websites featuring crystal sets have been produced. Some include:

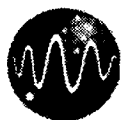
1. Shawsmith A "The Early Days of Wireless – the Crystal Set" Amateur Radio Action, Vol 4, No 13.

2. The Xtal Set Society: <http://www.midnightscience.com/>
3. WB4LFH's Crystal Radio Resources: <http://www.thebest.net/wuggy/>
4. N3FRQ's Skywaves: <http://www.webex.net/~skywaves/home.htm>
5. Crystal Radio Design Page: <http://uweb.superlink.net/bhtongue/>
6. Yahoo Xtal set forum: <http://clubs.yahoo.com/clubs/thecrystalsetradioclub>

Postscript: HamBabble (NN October 2000)

There was a big response to October's column on HamBabble, all of it positive. Several correspondents suggested further items for the list. These include: dBs (dollar bills) – term used by amateurs sensitive about breaching the regulations by discussing matters of pecuniary interest, or involving money; (going) horizontally polarised - going to bed; and OM (Old Man) – amateur version of the formal sir, or the less formal mate. Then there's the throat clearers or over openers such as 'Fine business on all that Tony'. 'OK there Keith', 'All noted Lee', et cetera. As always, more examples of HamBabble would be appreciated.

ar



Australian
Communications
Authority

EMR Compliance Self-assessment Trial

The Australian Communications Authority (ACA) invites eligible radiocommunications licensees to take part in a trial of materials for self-assessing electromagnetic radiation (EMR) compliance

The draft materials will allow licensees of some radiocommunications transmitters to self-assess compliance of their transmitter against the limits in the *Radiocommunications (Electromagnetic Radiation—Human Exposure) Standard 1999* (as amended from time to time).

Although the standard currently applies only to transmitter installations supporting cellular mobile telecommunications services, all radiocommunications transmitters will be subject to the standard by the end of 2001.

When the regulatory arrangements are fully in place, the ACA intends to allow some licensees to determine, for themselves, whether their installations comply with the standard. In anticipation of these changes, the ACA is making the self-assessment materials available to licensees to trial on a voluntary basis.

The trial will assess the effectiveness and user-friendliness of the self-help guidelines by obtaining feedback from the licensees, which will enable the ACA to fine-tune the materials. The trial will also provide licensees with the opportunity to bring their installation into compliance before compliance becomes mandatory.

The self-assessment materials include charts and graphs that will allow trialing for the following radiocommunications services:

- Fixed Link
- Land Mobile Base Station
- Low Power TV and Radio Broadcast
- Paging
- Amateur Radio
- General Radio

The materials are designed to assist licensees to make a simple assessment of whether their transmitting facilities comply with the EMR standard.

The self-assessment materials are available for trial from **15 September 2000 to 15 January 2001**. Licensees using the materials are required to return an evaluation questionnaire to the ACA. Participants may also be offered a free validation of their assessment through measurement by the ACA.

Licensees wishing to take part in the trial may obtain the materials via the ACA's website www.aca.gov.au/standards/emr.htm or by contacting the ACA on telephone: **(02) 6256 5552**.



Christine Taylor VK5CTY
VK5CTY@VK5TTY or geencee@picknowl.com.au

Final Report On Hamilton

The YL2000 International in Hamilton was a credit to everyone involved. It will have gone a long way to fostering friendship among YLs all over the world. Everyone who attended will be keen to go to the next international meet in Palermo on the island of Sicily in June of 2002. The hostess for that meeting will be Ruth IT9ESZ, well known to many amateurs for her DX activities. If you are planning an overseas trip in 2002 consider including Palermo in June on your itinerary. More details will be published, as they become available.

If you are touring Australia in 2002 you could also think about joining us in Murray Bridge (South Australia) at the very end of September. That is the venue for the next ALARAMEET for which pamphlets were handed out to many of the attendees in Hamilton.

Perhaps you could make it all part of a round-the-world trip. Palermo in June and Murray Bridge in September.

Publicity News

Publicity for the YL2000 was very well covered. In the lead up to the gathering a photo and a description of the purpose of it all appeared in the "Auckland Herald". The photo is attached here; it shows Lynn ZL2PQ, Jacqueline ZL1JAQ and Rosemary ZL1WRO with Jacqueline's rig in the background.

During the meeting we were asked if anyone was prepared to speak on the local radio station in Hamilton. Several YLs accepted the offer including Robyn VK3WX, Vice President of ALARA. Unfortunately I was unable to listen to the broadcast but hope to have a copy of it for ALARA's historical records. To have the local station request interviews shows that the girls organising the YL2000 had spread the word wide.

Also, during the weekend Raija SM0HNV passed on to me a copy of a page from a Swedish amateur radio magazine on which there was an article she had written about her visit to the YLRL meeting on the "Queen Mary" at



Lynn ZL2PQ, Jacqueline ZL1JAQ and Rosemary ZL1WRO with Jacqueline's rig in the background. Photo first appeared in *The Auckland Herald*.

Long Beach, California in June and her attendance at the ALARAMEET in Brisbane in October last year.

After Hamilton

Two of the tours arranged by the WARO girls, to follow on directly from the Hamilton weekend were to Rotorua, either for a one day or a two-day tour. Two particular visits were special. For overseas visitors the Farm Show was an eye opener. It started with dogs bringing in a small flock of sheep to be sheared and another small herd of cattle for milking and continued with an excellent demonstration of the procedures, which in New Zealand and Australia occur every day.

The two young people demonstrating were very good and most amusing without being silly. All the steps from sheep's back to knitted jumpers was shown as were all the processes that provide the milk, cream and butter we all buy each day.

For the Asian visitors there was a commentary they could listen to and brochures in many other languages were

available. Then to cap it all off some of the people in the audience (including some of our group) were called down from their seats to participate in turning the handle of a separator or a butter churn or in feeding the baby lambs and goats from a bottle. A well chosen demonstration.

Apart from the sight of the geysers and mud pool of Rotorua which are a must for all visitors to New Zealand, the other very good tour was the hangi (a meal for which the food is cooked in the traditional way, in a pit heated by hot stones) arranged at a Maori maire or village. We were asked to elect a Chief for the evening, (John VK2ZOI, OM of Dot VK2DB), who along with Chiefs from the other tourist groups were "greeted" by the head of the maire with dance intended to frighten us away, if we were there as enemies, before we were allowed into the meeting hall. During the evening, as well as enjoying some beautiful food we were entertained with dances and songs and told something of the Maori culture that

would have greeted the first Europeans.

Again, congratulations are in order to the committee for their choice of tours to illustrate such different aspects of New Zealand life.

Norfolk Island And VK9YL

Fourteen YLs and 4 OMs went to Norfolk Island after the weekend in Hamilton. They took wire aerials and a mast, though the mast could not be brought ashore for several days because the sea was too rough, but they certainly did not operate for the whole of the seven days they were on the Island. Nevertheless they made the amazing total of 3,450 contacts with 111 countries.

Elizabeth VE7YL on CW and VK4SJ on phone probably made the most contacts and coped with the "dog-piles" best but most of the others made some contacts.

Gwen VK3DYL was the organiser with June VK4SJ, Bev VK6DE and Poppy VK6YF representing Australia and Biny ZL1AZY from New Zealand. Scandinavia was well represented by Raija SM0HNV, Brigitta SM0FIB and Eine SM0UQW from Sweden with her OM Lars SM5CA (who, with Doug VK4BP, Merv ZL1AVY and Ted OH1BV mostly looked after the aerials and set up the radios) with Maya OH1MK from Finland, Unni LA6RHA and Ingrid an

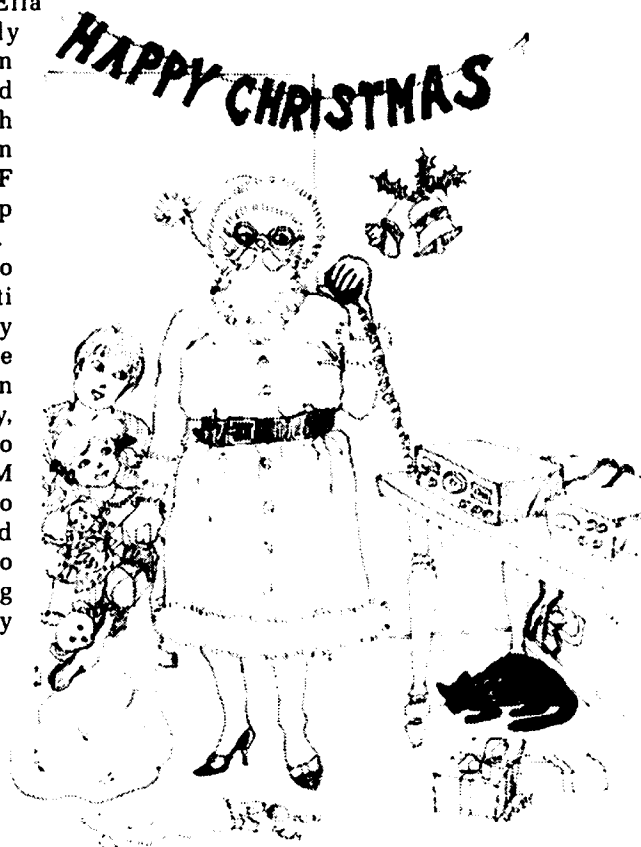
SWL from Norway. Ella GOFIP was the only representative from Britain at Hamilton and on Norfolk Island, with Elizabeth VK7YL from Canada and Mio JR3MBF from Japan to make up the international group.

They were delighted to have a visit from Kirsti VK9 YL (known to many from her articles in the magazines as well as on air and OM Jim one day, and amazed to bump into Val VK4VR and OM Brian who were also visiting the island, and aside from radio everyone enjoyed touring Norfolk Island as widely as possible.

Thanks to everyone who contacted them as a consequence of hearing about it through this column

Season's Greetings

As this will reach you as the Christmas/ New Year period has us all rushing around with family and holiday



commitments please accept greetings to you all from ALARA and pause to enjoy the cartoon drawn by Sally VK4SHE.

ar

AR Club Notes

Adelaide Hills Amateur Radio Society

The President and committee wish members and all amateurs Season's Greetings. May all your radio dreams come true.

The annual Buy and Sell will be over by the time you read this but it is certain to be as successful as ever, as a social occasion and as an opportunity to

exchange your "treasures" for someone else's "treasures" or maybe to buy some new gear just in time to enjoy it during the holidays. A photo taken one year shows the "wall to wall" crowd that is normal for this event December and January are special for members of AHARS. In December they hold the Christmas Dinner, this year on December 2nd so it does not clash with later activities, and in January when members will visit the Elizabeth Radio Club and have an opportunity to tour the water tower. If you don't know what this means, perhaps you had better come along, too.

ar



GEELONG RADIO & ELECTRONICS SOCIETY HISTORICAL RADIO DISPLAY — see page 13

Save Your Tuner For Two Pence

The catchy title refers to the use of cam switches fashioned from old British pennies to switch a T match tuner into the appropriate L configuration in order to reduce losses. Many of the popular tuners use a T match configuration which can result in higher losses in some matching situations and higher stress on the tuner components. The use of an L match in these situations may lead to lower losses and less stress on components. Stress on tuner components can result in arcs or smoke from overheating. The problem together with a way of turning the T match into two types of L network was described by Tony Preedy G3LNP in Rad Com May 2000.

The T network can be represented as two L networks in series. The load is transformed to an intermediate impedance level by the input network.

The intermediate impedance is then transformed to the 50 ohms that the transceiver prefers. The common element of the two networks is the inductor which has to dissipate the losses of both networks. The usual tuning method is to start with maximum capacity in the capacitors and then adjusting the antenna capacitor and inductor for minimum SWR and then to finally adjust the Tx capacitor with tweaking of the other adjustments. This method is an attempt to minimise losses.

Tony G3LNP modified an MFJ989 tuner by adding cam switches which could short out the capacitors and so convert the tuner into either of two L networks. The cam switches were fitted to the capacitor shafts and used cams fashioned from old British pennies. The local ones would probably be similar. The mechanical details of the cam

switches are shown in Fig 1. Other brands of tuner could be treated in a similar fashion.

The cams are fashioned from old pennies. The author recommends a search of old sofas as a source of pennies. The pennies do not have to be mint and should be reasonably easy to find even though they are over 30 years old. The penny is reduced over an arc of 270 degrees to a 5 mm radius with a small indent filed in the outer radius of the larger radius. The cam is soldered to half of a brass shaft coupler for attachment to the capacitor shaft.

The stationary brass contact can be fashioned out of an old telephone relay spring or a piece of springy bronze. Refer to Fig 1. for details. Some ingenuity may be required to adapt available materials.

The idea is that the capacitor has a position close to fully open where it is shorted out. You should be able to have close to the full normal capacity adjustment range as well as the shorted out position.

The tuning procedure is to tune for minimum VSWR in first one L configuration and then in the other. If this fails then resort to the T configuration. The L configuration matches a lower to a higher impedance and so with the two L configurations both low and higher impedances can be transformed to 50 ohms.

The author found that on bands below 14 MHz there was sometimes not sufficient capacity available to use the L configuration. However on bands above 14 MHz the L configuration could be used to advantage. The coil in the L position could generally be operated with more turns in circuit. This means less voltage across each turn. The capacitors in the L configuration were usually working with more capacity in circuit and less voltage across the capacitor.

An interesting and simple modification to reduce tuner losses and it should be especially beneficial when matching to higher VSWR loads.

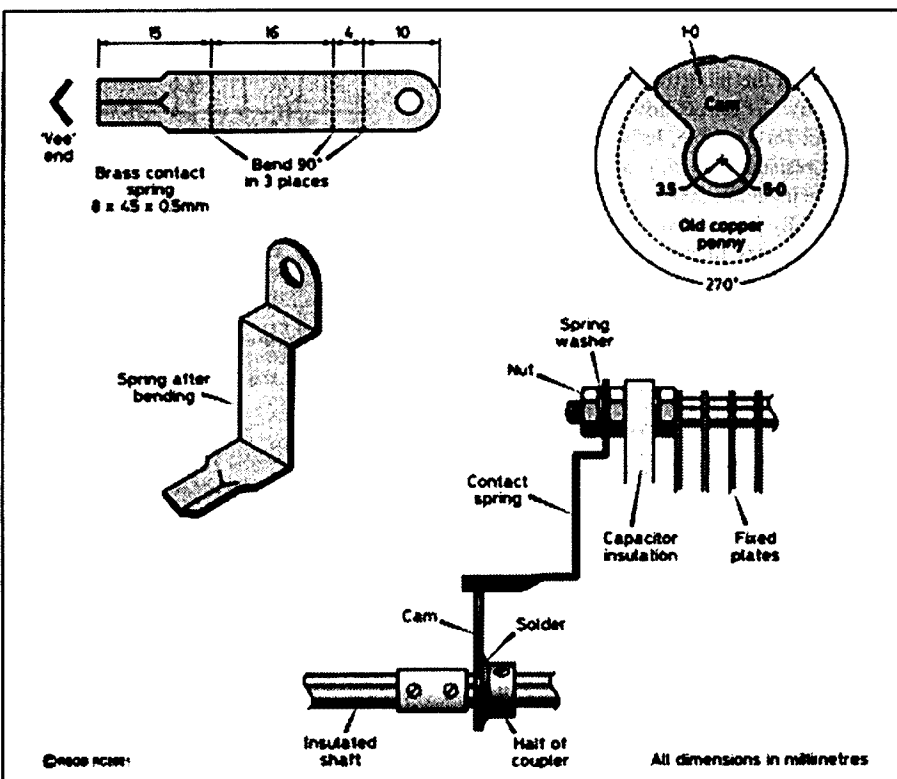


Fig 1. Mechanical Details of the Cam and Contact for Shorting the Capacitors in a T Match ATU.

Matching Low Impedance Antennas

Some interesting techniques for matching low impedance antennas appeared in the Technical Correspondence Column of QST June 2000 edited by Paul Nagel N1FB. The ideas came in a letter from Albert E Weller Jr WD8KBW who proposed a number of alternative ways of matching a yagi with a 13.3 ohm feed impedance. A previous article in QST Oct 99 by Bob Zimmerman NP4B had used the technique of offset feed to match the antenna. This appeared in Tech

Abstracts Aug 2000.

Albert WD8KBW provided four alternative methods to match a 13.3 ohm impedance to a 50 ohm line using a variety of coaxial line transformers. A simple near match could be obtained with a simple quarter wave line transformer using a quarter wave 25 to 26.5 ohm line formed by paralleling two quarter wave lines of 50 to 52 ohm cable. The SWR achievable is 1.06 : 1. This may well be close enough.

A variety of other matching solutions

are shown in Figures 2, 3, 4, & 5. These use a variety of coaxial cables of both 50 and 75 ohm impedance. The lengths are given in degrees. A quarter wave is 90 degrees. The actual lengths of cable need to take into consideration the velocity factor of the cable. These vary due to the dielectric used and for really accurate work may have to be determined for the coax used. Otherwise use the published velocity factors for the coax used..

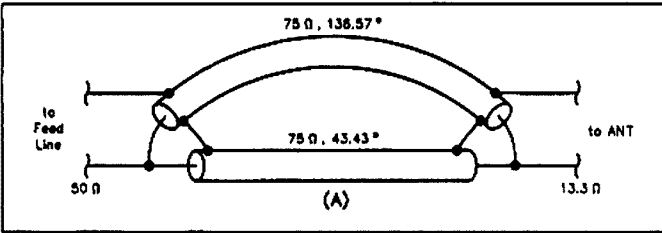


Fig 2. Parallel Line Transformer Using 75 ohm coax to transform 13.3 ohms to 50 ohms.

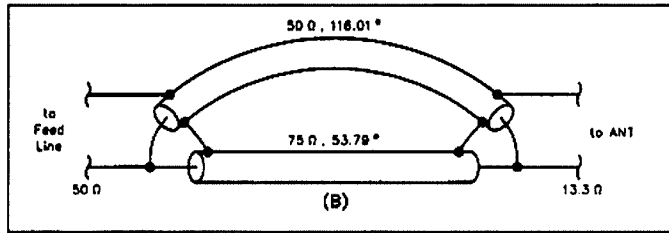


Fig 3. Parallel Line Transformer Using 50 and 75 ohm lines.

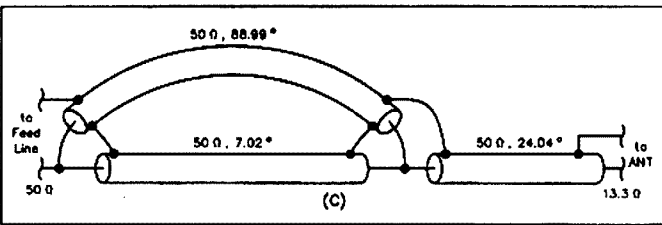


Fig 4. An Alternating Line Transformer with the output line formed by a parallel line transformer.

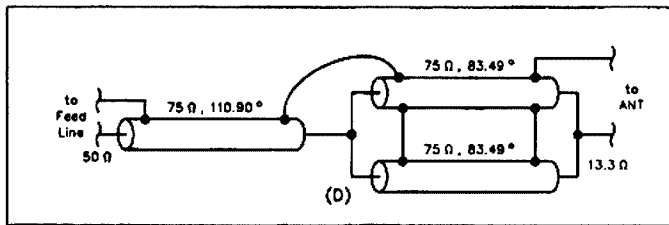


Fig 5. A Series Line Transformer with the Input (37.5 ohm) Line formed by two 75 ohm Lines in Parallel

75 ohm Coaxial Cable

The Long Wire For 6 and 10 published in Tech Abstracts July 2000 from from the original article in QST April 2000 used 75 ohm coax for the matching section. Some constructors have reported difficulty with the 75 ohm coax locally available. The coax has a foil outer as well as a skimpy copper braid and is intended for TV use. Termination is difficult at the antenna end.

The coaxial cable which uses a foil and braid is usually intended for use in TV antenna systems. The connectors used in the TV system are usually clamped or crimped onto the foil and braid to make connection in the connector. Rather than attempting to solder to the foil and braid the use of the TV type connectors is recommended. These can be plugged into a socket where a wired connection is needed such as at a feedpoint. At the

other end there are adaptors available which can be used to connect to the connectors we are used to.

The connectors I have seen for this type of cable are either the Type F or the Belling Lee which seems to be called TV, 75 ohm or PAL. The cable is often loosely called RG59 but is really only a 75 ohm cable which has approximately the same diameter.

One point to watch is that many of the TV cables may deform and cause trouble if they are subject to stress such as holding up the weight of the feedline or being bent around a small radius. They often use a foam dielectric and this should be taken into account where the electrical length is critical. You can avoid undue stress by supporting them from a messenger cable to take the weight.

CHRISTMAS/NEW YEAR BREAK FOR WIA FEDERAL SECRETARIAT

The Melbourne secretariat of WIA Federal will close for the Christmas-New Year break on Friday 22nd December 2000 and re-open on Monday, 29th January 2001.

The WIA Exam Service advises that amateur examination papers for marking and orders for exam material required over the holidays, should have been received in Melbourne by Monday, 4th December to ensure posting before Christmas.

Any material or orders received after that date cannot be guaranteed to be dealt with before the break and may have to wait until the Exam Service re-opens.

Buried Treasure...

This song must not be cut out and sold apart from the "NEWS OF THE WORLD." Anyone disregarding this intimation will be proceeded against.

No. 1,406.
Copyright.

DON'T HANG THE WASH

Written by HARRY EAST. Composed by HARRY EAST

Moderato. Key G.

1. Last week I bought a lit-tle wireless set, Thought I'd like to list-en in when
Till ready.
home I get. When my work was o-ver I thought it would be grand To list-en to a con-cert or a
nice brass band. In the gar-den I put up my aer-i-al, Thinking of the treat I had in
store. When I got home to-day the wife was feel-ing ve-ry glad, She said "This is the fin-cat dry-ing
day I've ev-er had." When I saw the wash-ing hang-ing I got mad, I look'd at her and then be-gan to roar:

f.g.

The musical score is written for voice and piano. It features a vocal line with lyrics and a piano accompaniment. The tempo is marked 'Moderato' and the key signature is G major. The score is divided into systems, each with a vocal line and a piano accompaniment. The lyrics are: '1. Last week I bought a lit-tle wireless set, Thought I'd like to list-en in when Till ready. home I get. When my work was o-ver I thought it would be grand To list-en to a con-cert or a nice brass band. In the gar-den I put up my aer-i-al, Thinking of the treat I had in store. When I got home to-day the wife was feel-ing ve-ry glad, She said "This is the fin-cat dry-ing day I've ev-er had." When I saw the wash-ing hang-ing I got mad, I look'd at her and then be-gan to roar:'. The score ends with a final chord marked 'f.g.'.

This sheet music was found in an old newspaper from England by Peter Brougham VK3PJB

NG ON THE AERIAL.

ASHLEY RICHARDS. Sung by HARRY EAST.

NEXT WEEK

LESLIE ELLIOTT'S MORNING BALLAD,

I SHALL ALWAYS HEAR YOU SINGING IN MY HEART.

CHORUS.

||# :s :l |s :n :r d |d :r d ||,d :r : |s :s |s :n r n |d :s |

Don't hang the wash - ing on my aer - i - al, Mag - gie! I want..... to list - en in;

||n :n |n :f :n :r d :s :d :r n : :f# |s :r :r |r :n r :d |t :s :t :r |s : :s |

When I want to hear the mu - sic, how it hurts, For all I can hear... is the flap - ping of the shirts; You

||l : :l :l |f :f :s :l |s :s |n :s : :s |f :n |r :r :d :d |

cause a dis - turb - ance of the wave - length, Mag - gie,... I seem pun - ish'd for my,

||r : :r : :n :f |s :l :s :n , r :d :n :r |d :r :d :s :t :s :d :r :s : :s |

sins,..... { "Eight - een Twelve" by old Tachai kow - sky makes my cats - whisk - er Pop - puff - ski..... }
And... mu - sic by No - vel - lo sounds as if it's gone 2 L O..... }

a tempo. 1st time. 2nd time.

By - 'ry time a wash - ing day be - gins..... - gins.....

a tempo. 8

complete words on page 51

DON'T MISS THE ACTION!

Uniden 245XLT Trunk-Tracker™ Scanner

Now you too can follow the activity on the "trunked" radio networks used by many Government, business, and emergency services organisations. The new Uniden 245XLT Trunk-Tracker is a specially designed scanner that can read the control channel data on a number of trunked radio systems, allowing the receiver to follow specific users, or groups of users, as their transmissions automatically change frequency through a trunked network. Compatible with many Motorola and EDACS analogue trunking systems, the 245XLT is also supplied with a PC interface cable for use with third-party software. The 245XLT covers 66-88, 108-174, 406-512, and 806-956MHz and provides 300 memories in 10 banks for storing favourite frequencies, 5 pre-programmed Search-bands, Multi-Track scanning that allows you to scan a mix of conventional and trunked systems, and 10 Priority channels (one per memory bank). Super-fast Scanning and Search facilities are also provided (Scan at 100 channels per second for non-trunked services, and Search at either 100 or 300 steps per second), as well as battery-free memory back-up, Data skip to limit reception of data transmissions, an Attenuator to reduce overload from very strong signals, and a Battery Save facility to extend battery life. Each 245XLT is supplied with a NiCad battery pack, AC charger, flexible antenna, PC interface cable, and detailed instructions.

D 2735

Uniden™

\$529



Yaesu VR-500 Multi-mode Scanner

The new VR-500 is more than just a scanning receiver, it's more like a miniature high performance monitoring station! Providing almost continuous coverage of the 100kHz to 1300MHz range, the VR-500 includes reception of narrowband FM, wideband FM (for FM and TV broadcast audio), SSB (for Amateur, CB, and HF reception), CW, and AM (for shortwave and broadcast station) signals. A large backlit LCD screen not only displays the receiver operating frequency, but also displays channel steps and reception mode. For monitoring band activity above and below your current listening frequency, the VR-500 even provides a 60 channel Bandscope to display local activity (within a range of 6MHz max when used with 100kHz steps). A total of 1091 memory channels are provided, with 1000 of these being "regular" memories with alpha-numeric tagging, and the balance being for special features (such as Search band memories, Preset channel memories, Dual Watch memories, and a Priority memory channel). A Smart Search™ function, which sweeps a band and finds in-use channels, allows you to allocate up to 41 memories that can automatically note these active frequencies. The VR-500 operates from just 2 x "AA" size alkaline batteries, and can be connected to an external 12V DC source (such as a vehicle cigarette lighter) using the optional E-DC-5 adaptor. For easier operation, the VR-500 can also be connected to your PC using the optional ADMS-3 interface/software package.

D 2799

YAESU

\$699



PowerHouse stores

A shopping experience like no other!

Dick Smith PowerHouse stores not only offer an expanded range of those original electronics products that have made our stores famous, but now you can experience the fun of using a wide range of communication equipment in our hands-on demonstration area. Called the "Ham Shack", each PowerHouse store has a dedicated area where licensed staff can show you the latest Yaesu, Uniden, or Magellan communications and GPS products, as well as an expanded range of accessory lines that may not be available in other stores.

Not involved in Ham Radio? Staff can also advise on the installation of a CB radio for your four-wheel drive vehicle, how to get involved in listening to Shortwave radio stations from around the world, or assist you in the selection of a suitable accessory for an existing piece of equipment. For bushwalking or boating users, you can also find out about the latest in inexpensive satellite based navigation receivers or emergency beacons, or just browse through an extensive selection of communications related books.

The PowerHouse is also the place to go if you simply need a component to finish that weekend project, to buy tools, or just to while away a few hours while checking out our

in-store technical books, library CD-ROMs, or our dedicated customer use Internet terminals.

With over 20,000 product lines in the electrical, computer, and communications areas, our new PowerHouse stores get the wavelength right!



1890 DP-S/spot.coi

DON'T MISS THE ACTION!

Economy Soldering Station

Affordable quality for the technician or enthusiast. This new soldering station provides variable temperature control from approx. 250°C to 450°C, plus zero voltage crossing circuitry for low noise operation. While not a sensor-compensated temperature-controlled design, it is suitable for a wide range of soldering applications. It features a lightweight soldering pencil with heat-resistant cable, iron holder and a tip cleaning sponge, and is full Energy Authority approved. Supplied with a long-life 1.6mm plated tip.

T 1975

\$78

SAVE \$20



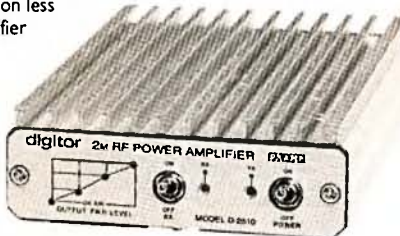
Digitor 2m 30W RF Power Amplifier

If you use your 2m band FM handheld at home or in the car, but find that 2-3W RF output isn't enough for reliable communications, then this compact 30W RF amplifier may be the answer. It works with inputs from 0.5 to 5W and produces up to 30W output with just 3W input. A switchable 12-15dB gain low-noise GaAs FET receiver pre-amplifier can be selected for improved receiver performance on less sensitive hand-helds when being used in RF quiet areas. The amplifier offers a large heatsink for extended duty-cycle transmissions, fused DC power lead, and SO-239 input/output connectors. Frequency range 144-148MHz, FM only. Size: 100 x 36 x 175mm(WHD).

D 2510

digitor

\$99⁹⁰



Rugged HF 5-Band Trap Vertical Antenna

The rugged 58TV incorporates Hustler's exclusive trap design (25mm solid fibreglass formers, high tolerance trap covers and low-loss windings) for accurate trap resonance with 1kW PEP power handling. Wide-band coverage is provided on the 10, 15, 20, and 40m bands (SWR typically 1.15:1 at resonance, <2:1 SWR at band edges), and 80kHz bandwidth on 80m. An optional 30m resonator kit can be installed without affecting operation of other bands. High strength aluminium and a 4mm (wall thickness) extra heavy-duty base section guarantee optimum mechanical stability. At just 7.65m long, the 58TV can be fed with any length of 50 Ohm coax cable.

D 4920

HUSTLER

\$425



Yaesu FT-90R 2m/70cm micro mobile

Another engineering breakthrough from Yaesu – a tiny-dual band mobile rig with high power output, a remoteable front panel, and a rugged receiver front-end. The FT-90R provides 50W RF output on the 2m band as well as 35W output on the 70cm band, a solid die-cast casing with microprocessor controlled cooling fan for reliable operation, and a large back-lit LCD screen, all in a package measuring just 100mm x 30mm x 138mm.

Also includes:

- Wide dynamic range receiver for greatly reduced pager breakthrough.
- Huge receiver coverage – 100-230, 300-530, 810-999.975MHz (Cellular blocked).
- 180 memories and a variety of scanning functions.
- Built-in CTCSS encode/decode, battery voltage metering.
- Designed for 1200 and 9600 baud packet operation.
- Tiny remoteable front panel (requires optional YSK-90 separation kit)
- Includes MH-42 hand mic, DC power lead, and easy to follow instructions.

D 3312 **2 YEAR WARRANTY**

AMAZING VALUE!

\$699
YAESU

YSK-90 Front Panel Separation Kit

D 3317



PHONE FAX AND MAIL ORDERS



PHONE: WITHIN AUSTRALIA: 1300 366 644
(Local call charge)

FAX: (02) 9395 1155 within Australia and (+612) 9395 1155 from outside Australia

Visit our web site at <http://www.dse.com.au>

MAIL: DICK SMITH ELECTRONICS, Direct Link, Reply Paid 160,
PO Box 321, North Ryde NSW 1670 (No stamp required)

Excludes packaging and postage. All major credit cards accepted.

14 Day Money Back Guaranteed if NOT completely satisfied. (Software excluded)

DICK SMITH
ELECTRONICS

That's where you go!

Yaesu transceivers and accessories stocked in selected stores only. Other stores can place orders on a deposit-paid basis. Offers expire 31/12/2000. All prices shown are inclusive of GST.

1890 DPS.spot.col



Division Directory

The Amateur Radio Service exists for the purpose of self training, intercommunication and technical investigation. It is carried out by amateurs who are duly authorised people interested in radio technique solely with a personal aim and without pecuniary interest.

The Wireless Institute of Australia represents the interests of all radio amateurs throughout Australia. National representation is handled by the executive office under council direction. One councillor for each of the seven Divisions. This directory lists all the Divisional offices, broadcasts schedules and subscription rates. All enquiries should be directed to your local Division.

Broadcast schedules All frequencies MHz. All times are local.

VK1 Division Australian Capital Territory,
 GPO Box 600, Canberra ACT 2601
 President Gilbert Hughes
 Secretary Peter Kloppenburg
 Treasurer Ernie Hosking

VK1GH
 VK1CPK
 VK1LK

VK1WI: 3.590 LSB, 146.950 FM each Sunday evening from 8.00pm local time. The broadcast text is available on packet, on Internet [aus.radio.amateur.misc](http://www.aus.radio.amateur.misc) news group, and on the VK1 Home Page <http://www.vk1.wa.ampr.org>

Annual Membership Fees. Full \$77.00 Pensioner or student \$63.00. Without *Amateur Radio* \$49.00

VK2 Division News South Wales
 109 Wigram St, Parramatta NSW
 (PO Box 1066, Parramatta 2124)
 (Office hours Mon-Fri 1100-1400)
 Phone 02 9689 2417
 Web: <http://www.ozemail.com.au/~vk2wi>
 Preecall 1800 817 644
 a-mail: vk2wi@ozemail.com.au
 Fax 02 9633 1525

President Michael Corbin
 Secretary Barry White
 Treasurer Pat Leeper

VK2YC
 VK2AAB
 VK2JPA

From VK2WI 1.845, 3.595, 7.146*, 10.125, 14.160, 24.950, 28.320, 29.120, 52.120, 52.525, 144.150, 147.000, 438.525, 1281.750 (* morning only) with relays to some of 18.120, 21.170, 584.750 ATV sound. Many country regions relay on 2 m or 70 cm repeaters. Sunday at 1000 and 1930. Highlights included in VK2AWX Newcastle news, Monday 1930 on 3.593 plus 10 m, 2 m, 70 cm, 23 cm. The broadcast text is available on the Internet newsgroup [aus.radio.amateur.misc](http://www.aus.radio.amateur.misc), and on packet radio.

Annual Membership Fees. Full \$78.00 Pensioner or student \$61.00. Without *Amateur Radio* \$47.00

VK3 Division Victoria
 40G Victory Boulevard Ashburton VIC 3147
 (Office hours Tue & Thur 0930-1500)
 Phone 03 9885 9261
 Web: <http://www.tbasa.com.au/~wlvic/>
 Fax 03 9885 9298
 e-mail: wlvic@alphalink.com.au

President Jim Linton
 CEO Barry Wilton
 Secretary Peter Mill

VK3PC
 VK3XV
 VK3APO

VK3BWI broadcasts on the 1st and 3rd Sunday of the month at 8.00pm. Primary frequencies, 3.615 LSB, 7.085 LSB, and FM(R)s VK3RML 146.700, VK3RMM 147.250, VK3RWG 147.225, and 70 cm FM(R)s VK3ROU 438.225, and VK3RMU 438.075. Major news under call VK3ZWI on Victorian packet BBS and VIA VIC Web Site.

Annual Membership Fees. Full \$78.00 Pensioner or student \$61.00. Without *Amateur Radio* \$47.00

VK4 Division Queensland
 GPO Box 638 Brisbane QLD 4001
 Phone 07 3221 9377
 e-mail: office@wiaq.powerup.com.au
 Fax 07 3266 4929
 Web: <http://www.wia.org.au/vk4>

President Colin Gladstone
 Secretary David Jones
 Treasurer Bill McDermott
 Office Mgr John Stevens

VK4ACG
 VK4OF
 VK4AZM
 VK4AFS

VK4WIA broadcasts on 1.825 MHz SSB, 3.605 MHz SSB, 7.118 MHz SSB, 10.135 MHz SSB, 14.342 MHz SSB, 21.175 MHz SSB, 28.400 MHz SSB, 29.660 MHz FM (rptr), 147.000 MHz, and 438.525 MHz (in the Brisbane region, and on regional VHF/UHF repeaters) at 0900 hrs K every Sunday morning. QNEWS is repeated Monday evenings, at 19.30 hrs K, on 3.605 MHz SSB and 147.000 MHz FM. On Sunday evenings, at 18.45 hrs K on 3.605SSB and 147.000 FM, a repeat of the previous week's edition of QNEWS is broadcast. Broadcast news in text form on packet is available under WIAQ@VKNET. QNEWS Text and real audio files available from the web site

Annual Membership Fees. Full \$85.00 Pensioner or student \$72.00. Without *Amateur Radio* \$56.00

VK5 Division South Australia and Northern Territory
 (GPO Box 1234 Adelaide SA 5001)
 Phone 08 8294 2992
 web: <http://www.sant.wia.org.au>

President Jim McLachlan
 Secretary David Minchin
 Treasurer John Butler

VK5NB
 VK5KK
 VK5NX

VK5WI: 1827 kHz AM, 3.550 MHz LSB, 7.095 AM, 14.175 USB, 28.470 USB, 53.100 FM, 147.000 FM Adelaide, 146.700 FM Mid North, 146.800 FM Mildura, 146.825 FM Barossa Valley, 146.900 FM South East, 146.925 FM Central North, 147.825 FM Gawler, 438.425 FM Barossa Valley, 438.475 FM Adelaide North, ATV Ch 35 579.250 Adelaide. (NT) 3.555 USB, 7.065 USB, 10.125 USB, 146.700 FM, 0900 hrs Sunday. 3.585 MHz and 146.675 MHz FM Adelaide, 1930 hrs Monday.

Annual Membership Fees. Full \$77.00 Pensioner or student \$63.00. Without *Amateur Radio* \$49.00

VK6 Division Western Australia
 PO Box 10 West Perth WA 6872
 Phone 08 9351 8873
 Web: <http://www.omen.net.au/~vk6wia/>
 e-mail: vk6wia@omen.net.au

President Neil Penfold
 Secretary Christine Bastin
 Treasurer Bruce Hedland-Thomas

VK6NE
 VK6ZLZ
 VK6OO

VK6WIA: 146.700 FM(R) Perth at 0930hrs Sunday relayed on 1.865, 3.564, 7.075, 10.125, 14.116, 14.175, 21.185, 29.120 FM, 50.150 and 438.525 MHz, Country relays 3.582, 147.200 (R) Cataby, 147.350 (R) Busselton, 146.900 (R) Mt William (Bunbury), 147.000 (R) Katanning and 147.250 (R) Mt Saddleback. Broadcast repeated on 146.700 at 1900 hrs Sunday relayed on 1.865, 3.564 and 438.525 MHz : country relays on 146.900, 147.000, 147.200, 147.250 and 147.350 MHz. Also in "Real Audio" format from the VK6 WIA website

Annual Membership Fees. Full \$69.00 Pensioner or student \$59.00. Without *Amateur Radio* \$38.00

VK7 Division Tasmania
 PO Box 371 Hobart TAS 7001
 Phone 03 6234 3553 (BH)
 Web: <http://www.tased.edu.au/tasonline/vk7wia>
 also through <http://www.wis.org.au/vk7>
 email: batesjw@netspace.net.au

President Phil Corby
 Secretary John Bates
 Treasurer John Bates

VK7ZAX
 VK7RT
 VK7RT

VK7WI: 146.700 MHz FM (VK7RHT) at 0930 hrs Sunday relayed on 147.000 (VK7RAA), 146.725 (VK7RNE), 146.625 (VK7RMD), 3.570, 7.090, 14.130, 52.100, 144.150 (Hobart), repeated Tues 3.590 at 1930 hrs.

Annual Membership Fees. Full \$88.00 Pensioner or student \$75.00. Without *Amateur Radio* \$55.00

VK8 Northern Territory (part of the VK5 Division and relays broadcasts from VK5 as shown, received on 14 or 28 MHz).

VK1 Notes

Forward Bias

Peter Kloppenburg VK1CPK

The Education section of the ACT Division can now look back over a year of setting up classes for aspiring radio amateurs, providing tuition in Theory, for both Novice and AOCF, Morse, and Regulations. The exam pass rate through the year was on the average 95%. The exams were held at the Hughes Community Centre in all of these subjects, for a total of 31 candidates. Given the success rate, the Division will continue with the classes next year, beginning on Wednesday, February 7, 2000.

The new Call book for 2001 has arrived! The new edition contains the listings for almost 16,000 amateur radio stations, plus very useful information such as constantly referred to reference data, accredited examiners list, band plans, repeater and beacon list, and DXCC countries listing. From January onwards, members can get a copy at the monthly meetings. Price will be \$20, when collected in person.

Foxhunts are on again in the ACT. If

you are interested, give Neil Pickford (VK1KNP) a call on 6258 7803 at home, or use his URL neil.pickford@aph.gov.au for detailed information.

The Division has received an offer from the Scouts to share their facilities at Farrer. It is there where a partly used building is available for setting up classes, meetings, a radio station, and training facilities. Negotiations are underway regarding building access, security, tenure and other important aspects such as siting of antennas, cable runs, electricity and phone usage, etc. At this stage we are hopeful that sometime in February the Division may have a permanent facility for its activities.

The Division has become the proud owner of two beam type antennas. One is a Hy-gain TH6-DXX "Thunderbird", a six-element, 3-band antenna. The other a Hy-gain HF Log Periodic 7 element beam for the 13 to 30 MHz bands. Both of these antennas will be put up at the facility in Farrer, when it becomes

available to us. The TH6 was bought from Thomas Mann, a local radio amateur, and the log periodic was a donation from the Swedish Embassy in Yarralumla

In September, the WICEN State Coordinator, Phil Longworth (VK1ZPL), arranged for a mailout to all potential participants of organised WICEN exercises. Over 100 letters were sent out to amateurs who had participated in the past, or who were likely, if asked well in advance of the event(s). More than 15 replies were received in response to the mailout, all of whom were keen to join in the exercises.

Lastly, it is with regret that we mention the passing of Dr Thomas Olin Rhymes (VK1BUD). Tom was well known in the amateur radio fraternity around Canberra and in Academic circles. He will be missed by many of us.

The next General Meeting will be held on January 22, 2000 at Room 1, Griffin Centre, Civic, Canberra City, at 8.00 pm.

VK2 Notes

by Pet Leeper VK2JPA
patleep@bigpond.com

Well, the festive season is upon us and the Division would like to wish all members the very best for the holiday period. We hope you receive all those little gifts that make amateur radio such a great hobby.

A final reminder that clubs and individual members can apply to use the AX2000 callsign until the end of the year. It is available in one week blocks and dates can be obtained by ringing the Divisional office. The last week of the year is already booked by the Hunter Brach Group who are intent with finishing the year with a big effort.

By the time you read this, the Conference of Clubs will have been held at Amateur Radio House. These meetings are held twice a year to discuss agenda items from the clubs that are intended to bring to the Council's attention matters needing action. Your club can have a say -- this feedback helps make the Council of your Division aware of your concerns and action to be taken.

The Divisional Office will be closing for the holidays on Friday 22 December. The January date for resuming business has not been finalised as the November Council meeting was put back a week to

coincide with the Conference of Clubs. As you will see in the new call book, the office is no longer open on Wednesdays, but the telephone is diverted to one of the Councillors for your convenience.

But -- don't forget -- if you have any queries or gripes about the way your Division is running matters -- Let us know! Ring, fax or email the Division as per the Divisional page in AR. Country members can use the free call line.

That's all for this month from the VK2 Division.

VK3 Notes

By Jim Linton VK3PC

End of year

The WIA Victoria Office will close for the year on 19 December and reopen on Tuesday, February 6, 2001. Next year it is proposed that the office will only be open on Tuesdays

Although the office is not open during the holiday season, the Treasurer, Secretary and President will be busy during this time with matters relating to annual reports and auditor requirements.

Correspondence including member applications and membership changes will also be handled during the office closure.

The annual general meeting to be held in May, on a date yet to be advised, after the venue is confirmed and annual report requirements completed. Members are advised that any Notices

of Motion for the AGM close with the Secretary at Noon on 27 February, 2001.

May I take this opportunity of behalf of the WIA Victoria Council of wishing all members the compliments of the festive season.

Sandbagging anti-WIA pair on a WIA Victoria two-metre repeater early one morning we heard a couple of radio amateurs making outrageous and mischievous claims about the WIA. One of the themes was that the WIA had resisted reducing the Morse code amateur licence test speeds. The logic to back up this claim was that because the WIA runs the exams it wanted to keep the Morse tests going as a revenue source. But the ACA forced it to change its policy on the code. This is absolute rubbish. Exams are hardly a source of revenue for the WIA and the fees do not

cover the true costs of the exam service. I wondered at the time how many others were listening, and perhaps believed the pair as they bagged the WIA about a range of issues.

A few days later I checked out their callsigns on the WIA Victoria membership database, and was not surprised to find they did not appear on the list.

WIA Victoria Tel: 9885 9261 40G
Victory Boulevard Fax: 9885 9298
Ashburton 3147

Office Hours: Tuesday & Thursday
10.00am to 2.30pm VK3BWI broadcast
1st/3rd Sunday at 2000 hours.

Web site: www.tbsa.com.au/~wiavic
Email wiavic@alphalink.com.au

IARU Region III information page -
www.tbsa.com.au/~wiavic/iaru

VK4 Notes

By Allstair Elrick VK4MV

GPS Stash

VK4's first APRS/GPS stash hunt is on right now in SE VK4 and has been set up by Brian VK4BBS. You need to take your GPS gear to the locations given then search for the "treasure". ALWAYS leave "another" treasure when you take from the stash and sign the logbook also with the stash.

Simple as this! Park your car at 27.38.30 South, 153.04.12 East. The Stash is located at 27.38.34 South, 153.04.37 East.

Weird And Wonderful

This from a recent Qnews broadcast sounds like a great idea for field days and Hamfests.

How often have we been told, "You Radio Hams are MAD... always collecting old junk and building things". Well now you can tell the YL it might make you "rich and famous".

Lock Harry the gadget man, Prof. Miller, Mad Max, and the Monty Python crew in your shack and you'd end up with something close to Junkyard Wars, a televised "engineering entertainment" contest that features strange schemes, odd teams, incredible machines, and lots and lots of duct tape.

In the US it's called Junkyard Wars, in the UK, Scrapheap Challenge. The show takes two teams of gearheads, puts them into a junkyard and gives them 10 hours to create the biggest, fastest, or strongest whatchamacallit with whatever parts they manage to scrounge up.

Well how about a donated pile of junk with the challenge for competitors to make something that works from it during a Hamfest or Field day, could be a great spectator event.

Vk4 Area Special Interest Groups - Radio Scouting

JOTA 2000 went very well in the north of the State with Guide and Scout groups participating in ARDF, Slow Scan TV, Packet Radio (which a lot of them called "the Internet"), disassembly of electronic apparatus, local interstate and international voice contacts. Two groups also deployed 70MHz "LIPD's" to maintain on-demand contact. Stations were set up in Guide and Scout halls, out in the bush at Guide and Scout Camps and even in portable situations under canvas.

Comment Highlights:

AX4SBW: Open Address, It Makes a First! All received here ok! AX4GGF: this is the first year we have heard the opening properly! Received well by 130 girls making up 6 to 7 guide groups with some girls travelling from Ingham and Bowen to participate. AX2XTJ: opening ceremony received nice and clear here at the den. Our scouts are very active on the radio.

AX4PVH: Signals received well here on the beach, 15 scouts in attendance. AX4SCK: Rebroadcast received on handheld and piped to PA amp so 80 joeys/cubs/scouts/venturers could hear the opening in its entirety for the first time. VK4FUQ: transmission quality good. K4SKL: transmission received well at Selheim.

Feedbacks from group leaders so far are that the kids enjoyed themselves immensely and are ready to roll again in 2001. JOTA coordinators in the region remind group operators to dispatch notes about their operation for inclusion in the state JOTA report.

Stephen Watson VK4SGW the National Co-ordinator, JOTA/JOTI through Scouts Australia, sends thanks

to all the JOTA Operators. You can feel deservedly proud of your efforts, which will remain with Youth Members as an important and memorable part of their young lives. I hope that you can share JOTA/JOTI again on the 20th and 21st of October 2001.

Dalby QNews Interrupted

Mike VK4XT says it appears that with the addition of an extra repeater belonging to the Queensland Emergency Services on Mt Kiangarow, the home of the Dalby Amateur repeaters, the Ham services have suffered. The Amateur

setup, connected to the same power supply as QES, closes down at low voltage, the extra drain on the system, by the additional repeater saw this happen last weekend, slap bang in the middle of QNEWS.

Seems some 30 ft + cabling is a bit much for the power supply! But when the sun is shining we bounce back! The panels charge at some 25 amps to a battery that is about 2 feet high and has some 500-ampour capacity.

TREC soon to have a 70cm repeater
A 70cm repeater will be soon

operational on the Atherton Tablelands, initially in test mode from Hallorans Hill and then possibly permanently located at Bones Knob which should give good coverage into the Mareeba and Atherton Tableland area. Frequency will be 439.500 Tx / 434.500 Rx.

TREC wishes to thank the WIAQ Office Manager John Stevens, VK4AFS for his help with this project, as without John's technical expertise this project would not have seen the light of day.

73's from Alistair

VK7 Notes "QRM"

Good news – Tasmanian Amateurs are going to be better off!! Our Divisional Council has decided on a fee decrease of \$3.00. per annum for each grade of membership. Last year the Council was faced with a lot of questions on finance due to many upcoming changes. "Playing safe" we felt was the right thing to do but by careful financial management and also a federal component decrease we reckon that we can still be viable with fees of :-

F grade \$85.00, G grade 72.00, and X grade \$52.00.

Two of our DX stalwarts, Barry VK7BE and Al, VK7AN recently went on an IOTA safari to Flinders Island, logged thousands of calls, had a "wow of a time" and now are planning another to

the newly IOTA listed King Island. We look forward to another good report.

Both the north-west and northern branches enjoyed near record attendances at their November meetings. In the northwest a visit was made to the "Minecom" headquarters in Devonport. This small company is doing business all over the world supplying underground communications and (in co-operation with the CSIRO) developing safety programmes for mining companies. They also supply UHF controlled video street surveillance system for Councils. Tasmanian expertise to the for !.

The northern branch had a very good dinner meeting followed by an illustrated lecture on our solar system

by the resident astronomer at the Launceston museum. He held his audience spellbound for two hours with amazing pictures of solar system space exploration and then explained the "leonid meteor" phenomenon visible each mid-November.

The "Challenge 2000" car rally had the usual assistance of the north-west branch members for communications and 17 members, xyl's etc. spread themselves over the whole northwest area doing a really professional job. We must congratulate Phil Harbeck, VK7PU on his brilliant organizing.

Cheers for now and a Happy Christmas to all from your Tasmanian pals.

Ron. VK7RN



Silent Key

Doug Parish VK7AZ

Tasmania lost one of its grand old men recently with the passing of VK7AZ, well known worldwide from his avid DXing.

He put himself on the map with one of the most impressive antenna arrays one could find anywhere at his Bellerive home. He put himself into the news when he lowered one of them into the high tension hydro lines running past his home, putting the whole suburb off power and destroying everything that was connected to a powerpoint in the house!

Careless? No, you see Doug was blind

and for the most part erected and maintained his antennas personally. With beams on all bands from 40 metres up, he put a big signal around the world.

Not only did he build, maintain and operate his amateur station himself, he also built and crewed a large fishing boat and was active in the fisherman's union area.

He owned several boats, including a yacht, which he, with a little help from his friends, raced successfully on the Derwent.

Nothing came easily but nothing seemed to daunt him. His wife, Edna,

who had been his "eyes" for so many years later became blind herself, and Edna's untimely death a few years ago meant that Doug had to leave his beloved "shack" in Bellerive and live in a retirement home. His health deteriorated until he finally became a silent key in early November at the age of 79.

Doug determined to prove that "nothing is impossible" and Doug, you proved it!

Vale, Mate.



Bill Magnusson VK3JT

Pictures from UO-36 available from the Internet

Even if you do not have the facility for direct downloading of the high speed digital data from UO-36, you can still explore the fantastic images that this satellite is producing almost daily.

Rob, VK3KOS has re-activated his site on the world-wide-web. The address is <http://www.geocities.com/vk3kos/dload/>. A visit to this site is worth considering if you are curious to see what this satellite imaging business is all about.

You will be presented with a menu system that will allow you to browse through all the archived files. They are listed in groups, each group being a complete set of files that go to make up an 'image-set'. Each image set consists of a number of 'thumbnail images' and a number of compressed image files. The thumbnails are identified by their extender (.imt) and the compressed files (.imc). As is the practice when direct downloading from the satellite, it is a good idea to download the thumbnails first and then after viewing them, decide which of the larger compressed image files to download.

A word of warning though. Don't expect to open these images with your favourite picture viewer. They are in Surrey's own format. In order to be able to view the thumbnails or image files you will need the latest version of Colin Hurst's 'CCD Display 2000' program. This is available for download from the AMSAT-NA web site, <http://www.amsat.org>.

Good luck and good viewing. Remember, those of you who enjoy a challenge, these images are available now from UO-36, and soon from TiungSat-1 at a download rate of 38k4 using broadcast protocol and it's faster than my dial-up ISP download rate using TCP/IP.

The image sets on Rob's website are just an example of the wide range available direct from UO-36. So having whetted your appetite, what about making a few station improvements to

get it working on the high speed digital birds. You can also explore the archived files of TMSAT (TO-31) images at the Surrey website. If you point your web-browser to http://www.sstl.co.uk/primages/remote_sensing/Processed/ you will find a directory containing heaps of images from the TMSAT spacecraft. These images have already been processed into jpeg format so any of the common viewers will open them. You do not require the CCD-Display program to view these images. The jpeg compression detracts slightly from the image quality so the results are not quite as spectacular as the direct downloads from TMSAT.

When Chris Jackson returns from his current sojourn of satellite launching he has promised to make another site available for archiving the UO-36 images. These are much more detailed as they exploit the advantages of high speed downloads available on UO-36. The resolution of UO-36's cameras is better than those on TO-31 and the detail in the pictures is amazing. But the price you pay is in file size. One image I downloaded recently of the Tokyo docklands area came out as a .BMP image of over 13 megabytes!

Many thanks to Rob VK3KOS for making his site available for storage of the raw UO-36 files. A visit to either of these sites will hopefully show you what this satellite imaging business is about and perhaps plant the spark of an idea to set up a download station of your own. Baud rates are set to increase in the near future and speeds of up to 116k are mooted. So as I said earlier, if you love a challenge, gird up your loins and become part of this exciting facet of amateur radio.

Phase 3D Launch Date Set

Word has finally been received that Phase 3D will be launched on board Arianespace Flight 135. The time of

The AMSAT group in Australia

The National Co-ordinator of AMSAT-VK is Graham Ratcliff VK5AGR. No formal application is necessary for membership and no membership fees apply. Graham maintains an email mailing list for breaking news and such things as software releases. Members use the AMSAT-Australia HF net as a forum.

AMSAT-Australia HF net.

The net meets formally on the second Sunday evening of the month. In winter (end of March until the end of October) the net meets on 3.685 MHz at 1000utc with early check-ins at 0945utc. In summer (end of October until end of March) the net meets on 7.068 MHz at 0900utc with early check-ins at 0845utc. All communication regarding AMSAT-Australia matters can be addressed to:

AMSAT-VK,
GPO Box 2141, Adelaide, SA. 5001.
Graham's email address is:
vk5agr@amsat.org

launch has been set at 01:07 UTC, Wednesday 15th November (which will be a few days after the deadline for this column). Phase 3D will be launched with three other satellites, the large PAS-1R communications satellite and the smaller STRV-1C and 1D satellites. All four are to be placed in geostationary transfer orbit. Flight 135 is set to be a record-setting Ariane 5 mission, marking the first use of the ASAP-5, a platform that will enable the Ariane 5 launcher to carry auxiliary micro and mini satellite payloads. Ariane 5 will be lifting 6200 kg into geostationary transfer orbit. This includes the mass of the PAS-1R primary payload and the three auxiliary satellites including Phase 3D as well as the weight of the ASAP-5 platform itself and the other payload mounting and interface hardware. If all goes well, Phase 3D will be in orbit and in its commissioning mode when you read this column. Please be patient as the orbit positioning and refining is a tedious, time consuming process requiring lots of very precise work by

the control stations. Rest assured, its transponders and beacons will be turned on as soon as possible. Potential users are advised to watch the AMSAT web site for the latest news or better still, to subscribe to the ANS news service. This can be done via the web site. The latest AMSAT news will then be delivered to your email address.

Telemetry Format Documentation Released for Phase 3D

It will be very important that as many stations as possible monitor the telemetry stream from Phase 3D in the early days. The format is the same as Oscar-13, ie. 400 baud PSK. You will need a suitable demodulator and software to display the engineering data. The most popular demodulator is that designed and produced by James Miller G3RUH. It is available in finished form or kit form. Some of the current batch of DSP demodulators can be configured to deal with the telemetry. Software has been developed and should be available from the AMSAT-NA web site in time for the launch. Known as P3T, it was written by W4SM. It is a Windows 95/98/NT/2000 "telemetry-only" version of P3TC as used by command stations. The telemetry document is a 60 kilobytes long text file and is available for download from the AMSAT-Germany web site at <http://www.amsat-dl.org/p3d/tlmspec.txt>. It's well worth reading.

First Permanent Crew now Resident Aboard ISS

ISS is now permanently occupied. The crew includes expedition commander/U.S. astronaut Bill Shepherd, KD5GSL, Soyuz vehicle commander/Russian cosmonaut Yuri Gidzenko, and flight engineer/cosmonaut Sergei Krikalev, U5MIR. Not a bad start to have two out of three of the inaugural crew with amateur radio call signs.

Amateur radio activity had not started at the time of writing this column. The ARISS initial station gear is now temporarily stowed aboard the Functional Cargo Block module of ISS. The initial station will use an existing antenna that will be adapted to support 2-metre FM voice and packet. The ARISS equipment will get a more-permanent home aboard the Service

Module in 2001, along with VHF and UHF antennas. Plans call for amateur TV, both slow scan and fast scan ATV, a digipeater and relay stations. The Expedition-1 crew's activities are being scheduled around a UTC timeframe. It's expected that their working day will start around 08:00 UTC and end somewhere near 19:00 hours with a lunch break near 12:00 UTC. This means we will have to revise our possible operating times from those we knew on MIR that worked on Moscow time. When the daily routine of the occupants becomes more established we should expect activity in the hour or so before they start work for the day, perhaps during their lunch break but more realistically during their "evening" recreation time. The crew will also have most weekends off, from about mid-Saturday until the end of their day on Sunday. The proposed frequencies for the initial operations are:

- Worldwide packet uplink
145.990 MHz
- Region 1 voice uplink
145.200 MHz
- Region 2/3 voice uplink
144.490 MHz
- Worldwide downlink for voice and packet: 145.800 MHz
- TNC callsign will be RZ3DZR when operations begin but could change soon after.

TiungSat-1 Opens for Business

At the time of preparation of this material TiungSat-1 had successfully survived its commissioning and the PacSat BBS had been turned on. The startup was in 9600 baud mode but a move to 38k4 baud is expected before long. As is the case with UO-36 its prime function will be Earth imaging. If UO-36 is any indication we can look forward to more spectacular images from TiungSat-1. It is yet to be allotted an "OSCAR" number.

InstantTRACK ver. 1.5 is now available from AMSAT-Australia.

Graham VK5AGR has advised that he can supply copies of the updated version 1.5 of the old faithful *InstantTRACK*

program. If you own a licensed version of IT V1.0 and can provide the registration number, then an upgrade for AMSAT members is available for a donation of \$20. A first time copy of IT V1.50 is available to AMSAT members for a donation of \$30 or \$50 for non-members. For this exercise you are deemed an AMSAT member if you subscribed to the AMSAT-Australia newsletter before its demise earlier this year or are currently a member of AMSAT-NA. If you send your donation by cheque or money order made payable to AMSAT-Australia GPO Box 2141 Adelaide S.A. 5001, Graham will email you a copy of the software. *InstantTRACK* version 1.5 has a number of improvements and many new features including:

- More video modes supported (CGA, HGC, EGA, VGA, and up)
- Very fast computers supported
- Year 2000 (Y2K) fixes
- Configuration items to match your system
- Easier Keplerian elements file input
- Support for automated Keplerian elements updates
- Ephemeris table output to a file or printer
- Improved accuracy for the Moon
- More ways to control the real-time screens
- Ground track displays
- Visual magnitude displays
- More control over timezones
- More consistent user interface
- Configuration items to match your personal preferences

This new updated version has been keenly awaited by many people. It brings a sadly outdated old friend right up to date so it can cope with modern hardware and modern methodology. Now is your opportunity to obtain a copy. For those who prefer the QuickTrack program, version 5.0 of this software is also available to AMSAT members for a donation of \$25 or \$40 for non-members.

Hopefully the big news next month will be the successful launch of the long-awaited Phase 3D satellite. It is still scheduled for launch just a few days after the deadline for this copy.

ar

AR Education Notes

Brenda M Edmonds VK3KT
PO Box 445 Blackburn Vic 3130

Christmas Greetings and Best Wishes for 2001 to all readers.

This will be the last issue of Amateur Radio for the 20th century. This means that it is now 90 years since the foundation in Sydney of the organisation which has become the Wireless Institute of Australia. In 2010 we will celebrate our centenary, if there is still a Wireless Institute of Australia.

Radio (or Wireless) has evolved considerably since 1910, both in the technical and the social aspects. But perhaps it has now passed its peak of activity and influence. Other interests and hobbies have supplanted radio in many minds. We have all seen how absorbed the young people have become in computer games, CDs, the Internet and television, and it is not only the young. Is there room or time left for the dedication and commitment required to obtain an amateur licence?

To obtain an amateur licence indeed

requires a commitment. For those starting with no background in physics or electricity, there is a vast amount of theory to be learned and understood, and a massive amount of regulations to assimilate, even without the Morse code. Most courses allow about six months of one-night-a-week classes to cover the novice syllabus. It is possible to cover the course without help, but that makes it much harder.

The amount of material to be covered in a course has expanded considerably over recent years. It has been elaborated and specified since the days when "a knowledge of basic radio theory" was the total syllabus. In particular, the course for Novice Amateur Operators Certificate of Proficiency, which was introduced nearly thirty years ago as a simpler entry path to the hobby, has been extended as Novices have been granted extra privileges. This means that the gap between the standards required for the

two levels of certificate has become smaller, as has the gap between the two levels of operating privileges. To return to the original difference in standards, there are two possibilities:

1. Make the AOCIP a higher standard by including more on "state of the art" technology; or
2. Return the NAOCP to an appropriate level by reducing the knowledge required.

If we wish to continue to attract new amateurs to the hobby, the first alternative is not acceptable. If we do not continue to attract new amateurs, the hobby will die out as the present population ages. It may well be time for a careful review of the whole examination and syllabus situation. I will be interested to receive any comments on this idea.

Once again, Season's Greetings and best wishes to all.

AR Silent Key

Ronald "Graham" Clayton, VK4BGC (1921 -2000)

Graham passed away on the 3rd March 2000, finally succumbing, after a courageous battle with the many complaints and ailments which assailed him in later life. With each setback he would pick himself up and bravely announce that he hadn't yet reached his 'used by date'. Thanks to the love, support and care given by his wife Beverley, VK4NBC, together they managed to stretch out the years of their married life.

They drove all the way to Perth and back to enjoy the ALARA Meet in 1996 and only last year Graham was able to share, with satisfaction and pride, the success of the 1999 ALARA Meet in Brisbane, which Bev convened.

Graham was born on the 21st October 1921 at Mount Gambier, South Australia, one of four children, born of Olive and Horace Clayton.

At the age of 18 Graham joined the RAAF and served as a Wireless Operator

Gunner in the South West Pacific area from 1939 to 1945. During the war years, Graham still found time to court and marry his first wife Gwen, who sadly passed away in 1979. They had four children, Robert, Terry, Shame and John. There are ten grandchildren.

Graham met Bev in Singapore, while in transit from Europe. Bev was also in transit from Singapore to Hong Kong. A friendship started when they became acquainted on a bus tour of Singapore. They were re-acquainted in Brisbane and married in 1981. Graham had a distinguished Air Force career. After graduating from No. 1 WAGS at Ballarat and No. 1 BAGS at Evans Head as a sergeant WAG, Graham travelled overseas to Kenya, where he crewed up at No.70 OTU. In 1942 he joined 60 Sqdn Blenheim. Operating out of India and Burma, Graham completed 64 sorties for a total of 325 op hours. He then moved on to Dakotas with 74 Sqdn,

adding a further 164 sorties to his tally and another 500 op hours to his Log.

Returning to Australia, he joined No.34 Internal Transport Sqdn based at Parafield. Graham was commissioned in 1943 and discharged in 1945, with the rank of Flying Officer.

In civvy life Graham was a Flight Service Officer with the Department of Civil Aviation. He had a job which had much in common with his hobby of Amateur Radio, so he was a lucky man.

Graham joined the Air Forces Amateur Radio Net and held the position of Secretary for several years. With Bev as Treasurer they made a great team.

On behalf of all the members of AFARN I extend to Bev and family our deepest sympathy at the loss of a good man and a good friend to all who knew him. He will be sadly missed.

Roy Mahoney VK4BAY
President AFARN



John Kelleher VK3DP, Federal Awards Officer
 4 Brook Crescent, Box Hill South Vic 3128 (03) 9889 8393

It is with great pride and pleasure that I humbly announce my tenth year as your Federal Awards Manager. From the beginning, the road to success was sometimes very bumpy, as you can assume I was a new broom in the organization. I found that I had to bone up on DXCC in all its forms as well as fitting myself out with all the necessary electronic gear to produce this monthly copy. All the existing files had to be reshaped to produce the bi-annual DXCC listings. I must admit that it was a monumental task. I was working a 16 hour day until finally, everything took shape. Now I can answer all requests in a matter of minutes, even though I have not computerized all the necessary information.

The fees for all WIA awards were raised from \$5 to \$10 almost 12 months ago, but I am still receiving applications with the lower fee included. This is very obviously not enough as postage rates have ballooned to a point where dispatch of awards in tubes is roughly seven dollars US. Therefore, I am working at a disadvantage. Bear in mind also that this operation is carried out on a totally voluntary basis, which I am pleased to do, as I am providing a service to our members, as well as non-members, and overseas applicants.

To date, the following awards have been issued.

WAVKCA-HF	2168
WAVKCA - VHF	50
Antarctic	20
WAS VHF	197
Grid Square	25
Havkca	181
VHFCC	127
DXCC-Phone	459
DXCC-CW	167
DXCC-Open	283
DXCC-RTTY	7

Not bad, when you consider that all this has been carried out by one person, as previous Awards Managers will verify.

CZECH REPUBLIC. Czech Radio Club Programme

General requirements. Fee for all awards is 10 IRC or US\$5.00. Endorsement fee

is 2 IRC or US\$1.00, and indicate number and issue date of basic award. Send cards unless GCR from National level Society has confirmed possession. List for P75P must contain locations of listed stations. Apply to :-

Czech Radio Club
 Awards Manager
 PO Box 69
 113 27 Praha 1
 Czech Republic.

S6S-Worked Six Continents

Work and confirm contacts with at least one station located in each of the six continents since Jan 1 1950. All CW, all Phone, all RTTY, all SSTV. Endorsement stickers for basic certificate are available for 80, 40, 20, 15 and 10 metres.

P75P-Worked 75 Zones

Work and confirm contacts with at least one station located in 50 different ITU zones since Jan 1 1960. Endorsements for 60 and 70 zones. SWL OK.

100 - CSWorked 100 Czech Stations

Work and confirm contacts with at least 100 OK/OL stations since Jan 1 1993. Issued for mixed-mode, all CW, all phone, all 160m, all VHF or SWL. Endorsements available for each additional 100 up to 500.

OK DX Award

Contact at least 40 different Czech counties during the annual OK/OM DX contest held every year during the second week in November.

OM DX Award

Contact at least 15 different Slovak counties during contacts as above.

Logs for the two above awards go to Contest Sponsor :-
 Karel Karmasin OK2FD
 Gen Svobody 636
 674 01 Trebic
 Czech Republic.

SLOVAKIA Slovak Association of R.A. Serles

General requirements. All bands and modes except as indicated. No repeater contacts. SWLs may earn award under same conditions as categories as shown. GCR list and fee of US\$7.00 or 10 IRC to:

Mr Milan Horvath OM3CDN
 Lopenicka 23
 83102 Bratislava
 Slovakia.

Diplom Slovakia.

Issued by the Slovak Association of Radio Amateurs in HF and VHF categories for contacts with Slovak stations after Jan 1 1993 as follows:

HF Shortwave

- Slovak stations: 10 different OM, 3 from Bratislava.
- Europeans: 3 different OM, 2 from Bratislava
- DX: 3 different OM, 1 from Bratislava

VHF Category

- Slovak stations: 5 different OM 2 from Bratislava
- Europeans: 3 different OM 1 from Bratislava
- DX: 1 QSO with an OM station.

OM3KAB and OM9HQ counts as two QSOs.

Bratislava Award

Bratislava, the Capital of the Slovak Republic celebrated its 2000th anniversary of its founding in 1991. This permanent award is available to all amateurs and SWL's for contacting Bratislava stations since Jan 1 1991. Slovak stations need 10 different. Europeans need 5, DX need 3. All bands, including repeaters.

Slovak Century Club Awards

Contact at least 100 different Slovak stations (OM prefix) after Jan 1 1993. SWL OK. Contacts must have been made from same country. All bands and modes. Separate certificates for :multi-band/multi-mode, multi-band/single-mode, single-band/multi-mode, single-band/single-mode, and 5 band in either multi or single mode. Separate certificates issued for each successive 100 stations.

Old Timers Club Award.

This award is issued for contacting at least 3 different old-timers in the Republic of Slovakia. SWL OK. No band

or mode restrictions. A list of eligible stations available from manager for SASE/IRC. GCR list and fee of DM10 to:-

Vilo Kupal OM3MB
Sumracna17
SK-821 02
Bratislava, Slovakia

SLOVENIA - Twin Towns Award.

Sponsored by the MariborARC to publicise it's written agreement and friendship with the 7 towns of Maribor (S5), Kraljevo (YU), Greenwich (G), Marburg/Lahn (DL), Szombathely (HA1), Udine (IV3), and Graz (OE6). For the purposes of this award, only the geographic area has to be worked, not the specific town, except that Europeans need two (2) QSO's from any of the towns, and others need just one (1). The remaining contacts need be made with the call districts noted above: YU S5 G-London County, DL DOK- F, HA1 IV3 and OE6. Contacts after Jan 1 1986. Handsome multi-colour award displays coats of arms of the towns. Send list of contacts and US\$4.00 or 10 IRC to :-

Award Manager
Radio Club Maribor
PP12 62001
Maribor
Slovenia.

South Africa

General requirements. GCR rule applies. Awards are free to SARL members, fees for all others are 10 IRC, US\$4, or R2,00. Apply to :-

Awards Manager
South African Radio League
PO Box 807
Houghton 2041
South Africa.

All Africa Award

Contact 34 different areas in Africa. One contact each with areas 1 to 9 is mandatory, plus any 25 additional ones from the list below. Land stations only, no islands around Africa. Contacts may be with past or present prefixes, but not both.

**Everything else
can wait.
Get on air
today!**

AREA	PREFIX	COUNTRY
1	ZS1	South Africa
2	ZS2	South Africa
3	ZS3/V51	Namibia
4	ZS4	South Africa
5	ZS5	South Africa
6	ZS6	South Africa
7	ZS9/A2	Botswana
8	ZD5/ZS7/3D6/3DA0	Swaziland
9	ZS8/7P8	Lesotho
10	H5/S4/S8/V9	Bophutatswana/Ciskei/Transkei/Venda
11	7X	Algeria
12	D2/3	Angola
13	ST	Sudan
14	9Q5	Zaire
	9U5	Burundi
	9X5	Rwanda
15	6O/T5	Somalia
16	TJ	Cameroon
17	SU	Egypt
18	ET3	Ethiopia
19	TL8	Cent.African Republic
	TN8	Congo
	TR8	Gabon
	TT8	Chad
20	CN	Morocco
21	FL8/J2	Djibouti
22	TU	Ivory Coast
	TY	Benin
	TZ	Mali
	XT2	Birkin Fasso
23	5T5	Mauretania
	6W6/8	Senegal
	5U7	Niger
	3X	Guinea
	3C	Equatorial Guinea
24	ZD6/C5	The Gambia
25	ZD4/9G1	Ghana
26	5Z4	Kenya
27	EL/5L	Liberia
28	5A	Libya
29	C8/9	Mozambique
30	ZD2/5N2	Nigeria
31	9J2	Zambia
32	ZD6/7Q7	Malawi
33	J5	Guinea-Bissau
34	ZD1/9L1	Sierra Leone
35	ZE/Z2	Zimbabwe
36	EA9/S0	West'n Sahara
37	5H3	Tanzania
38	3V8	Tunisia
39	5V4	Togo
40	5X5	Uganda

Best of good luck es 73 de John, VK3DP.

Contest Calendar December 2000 – February 2001

Dec	2/3	TARA RTTY Sprint		
Dec	2/3	EA DX Contest	(CW)	
Dec	9/10	ARRL 10 Metres Contest	(CW/SSB)	
Dec	9/10	SWL 10 Metres Contest		
Dec	16	OK DX RTTY Contest		
Dec	16/17	Croatian CW Contest		
Dec	16/17	International Naval Contest	(CW/SSB)	
Dec	17	RAC Canada Contest	(CW/SSB)	
Dec	26	Ross Hull Memorial VHF-UHF Contest	(to 14 Jan)	(Dec 00)
Dec	30/31	Original QRP Contest	(CW)	
Dec	30/31	Stew Perry 160 metres Distance Challenge	(CW)	
Dec	31/1	15 th Internet CW Sprint	(CW)	
Jan	1	ARRL Straight Key Night	(CW)	
Jan	6/7	ARRL RTTY Roundup (Digital)		
Jan	12-14	Japan International DX Contest Low-bands		
Jan	12/14	Summer UHF/VHF Contest		(Dec 00)
Jan	14	Ross Hull Memorial Contest last day		
Jan	20	LZ Open Contest	(CW)	
Jan	21	HA DX Contest	(CW)	
Jan	26-28	CQ WW 160 Metres Contest	(CW)	
Jan	27/28	REF (France) DX Contest	(CW)	
Jan	27/28	UBA DX Contest	(SSB)	
Feb	3/4	Mexican RTTY Contest	(RTTY)	
Feb	10/11	WW RTTY WPX Contest	(RTTY)	
Feb	10/11	PACC Contest	(CW/SSB)	
Feb	10	Asia-Pacific Sprint	(CW)	
Feb	10/11	RSGB 160 Metres Contest	(CW)	
Feb	17/18	ARRL DX Contest	(CW)	
Feb	23-25	CQ WW 160 Metres Contest	(SSB)	
Feb	24/25	REF (France) DX Contest	(SSB)	(Dec 00)
Feb	24/25	UBA DX Contest	(CW)	
Feb	24/25	RSGB 7 KHz Contest	(CW)	
Feb	25	High Speed Club Contest	(CW)	

Information this month from K7RAT VK6VZ REF UBA LA9HW7

We must congratulate Steve Ireland VK6VZ, who is a dedicated 160 metres operator. Steve won the Stew Perry 160 Metres Challenge for 1999, something that has never happened to any operator in the Southern Hemisphere before.

This event is a challenge rather than a contest, as it is held around Christmas and therefore has to cope with high levels of noise, requires honest reports (not automatic 599s from computer programs), scores points for distances between stations and has bonuses for low power operation.

Steve was lucky enough to get some very good propagation into North America in the last four hours of the contest, working 80 stations out of 111 QSOs and scoring a total of 3,480 points. His nearest American rival was KH7R with 3073 points.

Steve says that in 1998 he was 71st, in 1997 19th and "the great thing about the contest – almost anyone can win from anywhere in the world if they get some good conditions".

A magnificent effort, Steve VK6VZ, and sincere congratulations. Anyone wishing to see the rules for this year may find them

at <http://jzap.com/k7rat/stew.rules.txt>

VHF Time Again

All amateurs are asked to get involved in the Ross Hull Memorial Contest at Christmas, and the Summer VHF Field Day in January. See Calendar for details.

Interesting Comment

A note from David VK2AYD points out that for the Commonwealth Contest this year the majority of logs was received in paper format, something that militates against the cry of many pundits that computer logging programs have replaced older methods.

NOTE: Ian Godsfil, now ex-VK3DID, has ceased to be Federal Contests Co-ordinator. Anyone interested in assisting with this task is asked to contact Mr John Loftus VK4EMM on e-mail: John_Loftus@vettweb.net.au

A job specification is included in this issue on page 3.

Results ANARTS RTTY Contest 2000

From Jim VK2BQS and Colin VK2CTD

(VKs only Place\call\score\award)

3	AX2000	21,558,600	1st VK2
5	VK4UC	16,195,020	1 st VK4
11	VK6GOM	8,929,998	1 st VK6
71	VK2SG	1,257,360	2 nd VK2
129	VK2BQS	348,950	3 rd VK2

10-10 International

We have all heard of the 10-10 International Club. Apparently there are some VK and ZL operators who are active in the club's contests, eg: VK2FHN 111 points Spring CW Contest; VK3AFM 176 points, VK6PP 44 points and VK3MRG 42 points in Winter Phone Contest; VK2FHN 92 points in 1999 Autumn CW Contest; VK2FHN 404 points, VK3AFM 153 points and VK6PP 42 points in 1999 Day Sprint; VK2FHN 91 points in 1999 Sprint CW QSO Party. Many thanks to Phil VK2FHN for drawing attention to these results.

Ross Hull Memorial VHF-UHF Contest 2000 - 2001

from John Martin VK3KWA Contest Manager

In recent years six metre scores have been only a small fraction of what can be obtained on two metres and higher bands. This imbalance has been reduced by an adjustment to the six metre scoring. However the main source of big scores will still be two metres.

The contest has two sections - best seven days and best two days. This means that you can fit your contest activity around other commitments; but please try to get on the air for as many days as possible!

The Contest

The WIA maintains a perpetual trophy in honour of the late Ross Hull and his pioneering efforts in VHF and UHF operation. The contest is open to all amateurs.

Duration

0000 UTC Tuesday, 26 December 2000 to 2400 UTC Sunday, 14 January, 2001

Sections

- Best seven UTC days as nominated by the entrant;
- Best two UTC days.

Entrants may submit logs for either section. The nominated UTC days need not be consecutive. Overall winner will be the top scorer in Section A. If the overall winner has also entered Section B, his/her log will be excluded from Section B.

One callsign and one operator per station. One contact per station per band per UTC day. Repeater, satellite and crossband contacts are not permitted. No contest operation below 50.150 MHz. Band plan calling frequencies should not be used for contest calls, exchanges, or liaison. A contest calling frequency of .150 on each band is suggested. All rulings of the Contest Manager will be accepted as final.

Penalties

Minor errors in distance estimates or calculations may be corrected and the score adjusted. Contacts made on calling frequencies will be credited if the entrant provides a satisfactory explanation of why it was not practical to move to another frequency. Otherwise such contacts will be disallowed. Persistent unnecessary use of calling frequencies or false log entries will lead to disqualification.

RS (RST) reports plus a serial number.

Serial numbers need not be consecutive. For difficult propagation modes such as meteor scatter, exchange of a total of two digits is sufficient for a valid contact.

Scoring

For two metres and above, one point per 100 km or part thereof (ie up to 99 km: one point; 100 - 199 km: two points, etc). For six metres only, contacts below 1000 km as above. For contacts from 1000 km to 2400 km, two points regardless of distance. Contacts over 2400 km, 20 points regardless of distance.

Band multipliers are:

6m	2m	70cm	23cm	higher
x1	x3	x5	x8	x10

Logs

Logs must cover the full contest period and contain the following for each contact

- Date and UTC time
 - Station location (if operating portable)
 - Specific FREQUENCY (not just band) and callsign of station worked
 - Approximate location or grid locator of station worked
 - Reports and serial numbers sent and received
 - Estimate of distance worked and points claimed.
- Separate scoring columns for each band would be helpful. Logs must be supplied with a cover sheet containing:
- Operator's callsign, name and address
 - Station location (if different from postal address)
 - Section(s) entered, and a list of UTC days to be scored
 - A scoring table
 - A signed declaration that the station has been operating in accordance with the rules and spirit of the contest, and that the Contest Manager's ruling will be accepted as final.

Deadline

Paper logs may be posted to the Manager, Ross Hull Contest, 3 Vernal Avenue, Mitcham, 3132. Electronic logs can be sent by e-mail to: jmartin@xcel.net.au in any of the following formats: ASCII text; Office97

RTF, DOC, XLS, MDB or PUB; WORKS99 WKS. If you use Office2000, please save files in Office97 format.

Logs must be received by FRIDAY, 9 FEBRUARY, 2001. Early logs would be appreciated.

Note on Calculating Distances

Absolute accuracy is not required. All you need to know is whether the other station is above or below the nearest multiple of 100 km. An easy method is to use a compass to draw 100 km circles around your location on a map. Better estimates can be made from six-digit Maidenhead Locators using a computer program which is available from the Contest Manager.

REF (France) DX Contest

CW: 27/28 January, 2001

SSB: 24/25 February, 2001

0600 z Saturday to 1800z Sunday

Object: to work as many French stations as possible once per band. Callsigns are: F FG FH FJ FM FO FP FR FS FT FW FY TK TM TO TP2CE

Classes: Single operator; multi-operator one TX; SWL

Bands: 80 – 10 metres (no WARC)

Exchange: VKs send RS(T) plus serial number. French stations will send RS(T) plus own prefix.

Score: one point for QSO with station in same continent; all other QSOs three points.

Multipliers: on each band all departments, 00-99 and overseas prefixes.

Final score is sum of all QSO points X sum of all multipliers.

Send logs by mail by 15 March (CW) or 15 April (SSB) to: REF Contest, BP 7429, 370974 TOURS CEDEX (FRANCE). Logs may also be sent by e-mail to: concours@ref-union.org

Japan International DX Contest 2001

LF CW: 2200z 12 Jan - 2200z 14 Jan 2001

HF CW: 2300z 13 Apr - 2300z 15 Apr 2001

PHONE: 2300z 9 Nov - 2300z 11 Nov 2001

Object is to work as many JA stations + JD1 islands as possible.

Bands: LF CW 160/80/40; HF CW 20/15/10; Phone 80 - 10 (no WARC). **Categories:** Single operator single/multi-band high power (more than 100w o/p); single operator single/multi-band low power (less than 100w o/p); multi-operator; maritime mobile.

General: Operate for maximum of 30 hours only and show rest periods in log; single op must perform all tasks himself; multi-op must remain on band for at least 10 minutes and during this time multi-op may transmit on another band only if new station is multiplier; ops may use spotting networks.

Exchange: RST plus CQ Zone number. JAs will send RST plus Prefecture number (01 - 50).

Score on 160m four points; 80m two points; 40/20/15m one point; 10m two points.

Multiplier is total JA prefectures + JD1 islands worked (possible 50 per band).

Final Score: multiply total points by total multipliers.

Logs (one per callsign) must show times in UTC; exchanges; multiplier first time worked; duplicate QSOs shown as no points; rest periods clearly marked; use separate sheet for each band.

Send Logs and summary sheet to: JIDX Contest, c/o Five-Nine Magazine, PO Box 59, Kamata, Tokyo 144, Japan, by 28 Feb, 31 May or 31 Dec. Logs may be submitted on 3.5 inch disk in ASCII with summary sheet, or by e-mail. For instructions send e-mail to jjdx-info@ne.nal.go.jp with command #get jidxlog.eng or #get jidxlog.jpn

SUMMER VHF-UHF FIELD DAY 2001

John Martin (VK3KWA), contest manager

The next Summer VHF-UHF Field Day will take place on January 13 and 14, 2001. The rules are the same as for the Spring Field Day in November 2000. Please note a minor change in the definition of portable stations under "General Rules".

Duration

VK6 only: 0400 UTC Saturday January 13 to 0400 UTC Sunday January 14, 2001. All other call areas: 0100 UTC Saturday to 0100 UTC Sunday.

Sections

A: Portable station, single operator, 24 hours.

B: Portable station, single operator, any 6 consecutive hours.

C: Portable station, multiple operator, 24 hours.

D: Home station, 24 hours.

Single operator stations may enter both Section A and Section B. If the winner of Section A has also entered Section B, his log will be excluded from Section B.

If two operators set up a joint station, they may enter Section C under a single callsign, or sections A/B under separate callsigns. Stations with more than two operators must enter Section C.

General Rules

One callsign per station. Operators of stations in Section C may not make contest exchanges using callsigns other than the club or group callsign. Operation may be from any location, or from more than one location. You may work stations within your own locator square.

A station is portable only if all of its equipment, including antennas, is transported to a location which is not the normal operating location of any amateur station.

Repeater, satellite and crossband contacts are not permitted. No contest operation is allowed below 50.150 MHz. Recognised DX calling frequencies must not be used for any contest activity. Suggested procedure is to call on .150 on each band, and QSY up.

Contest Exchange

RS (or RST) reports, a serial number, and your four digit Maidenhead locator.

Repeat Contacts

Stations may be worked again on each band after three hours. If the station is moved to a new locator square, repeat contacts may be made immediately. If the station moves back into the previous locator square, the three hour limit still applies to stations worked from that square.

Scoring

For each band, score 10 points for each square in which your station operates, plus 10 points for each locator square worked, plus 1 point per contact. Multiply the total by the band multiplier as follows:

6 m 2 m 70 cm 23 cm Higher
x 1 x 3 x 5 x 8 x 10

Then total the scores for all bands.

Sample Scoring Table

Band	QSO Points	Locator Pts	Multiplier	Total
6 m	100	+ 200	x 1	= 300
2 m	60	+ 120	x 3	= 540
etc.				
Overall Total				= 840

Logs

For each contact: UTC time, frequency, station worked, serial numbers and locator numbers exchanged, points claimed.

The front sheet should contain the names and call signs of all operators; postal address; station location and Maidenhead locator; the section entered; a scoring table; and a signed

declaration that the contest manager's decision will be accepted as final.

Entries

Paper logs may be posted to the Manager, Spring VHF-UHF Field Day, 3 Vernal Avenue, Mitcham, Vic 3132. Electronic logs can be e-mailed to jmartin@xcel.net.au. The following formats are acceptable: ASCII text, Office 97 RTF, DOC, XLS, MDB, or PUB, or Works 99 WKS. If you use Office 2000, please save the files in Office 97 format.

Logs must be received by Friday, February 9, 2001. Early logs would be appreciated.

ar



Pounding Brass

S.P. Smith VK2SPS

4/6 Taranto Rd, Marsfield NSW 2122

(H) 02 9876 8264 (M) 0419 602 520

Early power generation

This month a look at two forms of early power generation as used by telegraphers, these are the "Edison-Lalande Cell" a modification of the Leclanche Cell and the "Fuller Cell" one in which you might not be aware of.

Other forms of power generations were the Chloride of Silver Cell and Gravity Cell as mentioned in an earlier issue.

Edison-Lalande Cell

This type of cell consists of a zinc plate and a copper oxide plate (commonly referred to as a block). The solution of the cell is oxide of potassium, or caustic potash dissolved in water, both plates are suspended from the cover of the cell.

Polarization is prevented by the decomposition of water of the solution, the oxygen of the water combining with

the zinc to form oxide of zinc, which in turn combines with the potash to form an exceedingly soluble double salt of zinc and potash.

Hydrogen liberated from the water combines with the oxygen of the copper oxide, reforming water and depositing pure metallic copper.

E.M.F is about .98v and dropping to about .75v when in use. Internal resistance of the cell is about .025 ohms which drops after a few hours of use.

Fuller Cell

This type of cell was commonly used in Telegraphy where large currents were required.

This type of cell consisted of a zinc and carbon plate. The zinc plate is cone shaped and placed within a porous cup containing a solution of diluted sulphuric acid. The other plate, that is carbon is positioned outside the porous cup but within a glass jar. The carbon plate is placed in a solution of bichromate of potash, water and sulphuric acid. The solution was commonly known as "Electropoison". Two ounces of mercury was added to the bottom of the porous cup for the purpose of amalgamating the zinc, which works by capillary action.

As the zinc becomes decomposed during normal operation the impure particles of the amalgam become detached and fall to the bottom of the cell. The sulphuric acid (the supply of which passes from the outer solution

into the porous cup), attacks the zinc, which forms sulphate of zinc and setting free hydrogen; polarization being prevented by the combination of the hydrogen thus set free with oxygen of the bichromate of potash.

E.M.F is about 2.029v with an internal resistance of about .5 ohms which varies with the size of the plates, normally decreasing as plates get larger to within reason of construction. This type of cell will normally last between 4-6 months and will require very little attention if not worked to full potential.

A good technician can tell the condition of the cell by its colour.

- 1) A working cell will be orange in colour due to the bichromate crystals.
- 2) A Bluish tint - additional crystals required.
- 3) Should the cell become inoperative but retain its orange colour - sulphuric acid is required.
- 4) Should the cell become inoperative and become very bright - replace cell.

I hope everybody has a great Christmas and a safe and happy new year.

Next month a technical look at telegraph equipment, mainline sounders, box relays and pony relays. See you next month.

Stephen P. Smith VK2SPS

Ref: *American Telegraphy & Encyclopedia of the Telegraph* by William Maver Jr - Chap 2.

ar



Silent Key

VK5ZCF Grenville Sawyer

Rob Duncan VK5ZIK

Secretary WICEN SA Inc

It is with deep regret that I have to inform members of the passing away of Grenville Sawyer VK5ZCF in the early hours of Sunday morning (August 6th).

Glen was buried in his WICEN uniform, and WICEN provided a guard of honour as a mark of respect for all of Glen's efforts on behalf of WICEN. It was good to see so many members in uniform at the funeral.

Ross Christie, VK3WAC
 19 Browns Road, Montrose 3765, Vic.
 Email Vk3wac@aol.com

Reviving a hot topic

After my comments last month I have received a few letters of encouragement and appreciation. It's good to know that these notes are appreciated by at least some of the readers. One letter in particular from Les, VK4DA, was gratefully received. He had some nice comments and a short list of some great DX stations that he has worked recently. Details later. Les mentions that he has never used a 'DX Net' to work a DX station, preferring to 'go it alone'. I must admit to having checked into the 'ANZA Net' to work a few rare ones. What do others think of the idea of participating in 'DX Nets' to bag that rare station? This used to be a hot topic many years ago, I wonder if the ideas of the DX community have changed over the years.

There has been a bit of bad news on the DXpedition front this month. Unfortunately the planned DXpedition to Agalega, 3B6RF, has had to be postponed for a couple of weeks due to a change of government in Mauritius. This will pose a bit of a problem for the organisers as transport to the island being limited to two ships per year, one in October and the other in May. Obviously a delay of a couple of weeks will cause them to miss their original operating dates. More news later to the new date, those on the net can visit their website at <http://www.agalega2000.ch> for more news. Hopefully something will be worked out.

The DX

4N8/LZ1BJ, Kosovo. Boyan, LZ1BJ reports he will be working in Kosovo for the next several months and will operate as 4N8/LZ1BJ on SSB and CW. QSL via LZ1BJ either direct (Boycho Hadshiyski, P.O. Box 90, 2500 Kjustendil, Bulgaria) or via the bureau. [TNX 425 DX News]

5T, Burundi. Yannick, F6YD is heading to Nouakchott, Mauritania for six months, maybe longer. He hopes to be active on all HF bands on SSB. QSL via home call. [TNX F6AJA, Les Nouvelles DX and 425 DX News]

6Y, Jamaica. Ron, 4S7RO, will be active on the air with the call 4S7RO/6Y5. He expects to be in Kingston, Jamaica for the next two years. Equipment and some other problems have prevented Ron from getting fully setup, however he is working to overcome all this and hopes to be on the air soon. He plans to be active mainly on 20 metres SSB and CW. As space is tight he does not anticipate any activity on 160 and 80 metres. Ron's wife, VU2MAB, will also be active from 6Y5 shortly. QSL info is not clear yet, but cards should not be sent to Franz, DJ9ZB, as this route is only good for Ron's past 4S7 activities. [TNX 425 DX News]

9X, Rwanda. Charlie, N4XT, will be working at the U.S. Embassy in Kigali in the year 2001 between the 12th January and 12th March. He hopes to be able to squeeze in some activity from this African nation. [TNX The 59(9) DX Report and OPDX]

A5, Bhutan. Jani, 9M6US and Charly, K4VUD will be active from Bhutan from the 1st to the 9th of December. They have obtained permission to run 1kW on all bands. Antennas will be a tri-band beam and wire antennas and possibly a beam for the WARC bands if they can make some repairs. Charly will operate as A52UD on SSB and CW with an emphasis on the low bands, while Jani plans to operate on RTTY as well. QSL requests for A52UD go to K4VUD, preferably direct. Jani will announce his QSL address and policy separately. [TNX K4VUD and 425 DX News]

A9, Bahrain. Gus, K4SXT, is now set up and ready to go in Bahrain, A9. He expects to obtain his license (hopefully A92ZE) around the 14th of October. Gus has erected an HF2-V 40 feet up and just 50 feet from the Arabian Gulf. This should provide a reasonably good a take off for his signals. Expect to see big signals from him on 40, 80 and 160 metres. [TNX The Daily DX]

EP, Iran. Mac, W3HC, has received an email from Iran informing him that there

will be seven stations set up for the "Civilization Talks". Look for the old timers EP2FM, EP2CM and EP2ES and 4 new novices to be active. On October 10th, Hamid/EP3HR and his friend Yar/EP3SP opened their club station EP4PTT. This club is working with a license from Ministry of Post and Telephone of Iran. This club will only be active on 14 MHz as their equipment is all homebrew. Their antenna is a dipole and the output power is only 20 watts. QSL via the Iranian Bureau. [TNX W3HC and OPDX]

HC1, Ecuador. Rick, NE8Z, plans to be active as HC1MD from Ecuador again. This trip he expects to be active from HC2, HC3, HC6 and HC7 from the 25th of November till the 11th of December. Rick will be operating on 40-10 metres CW and SSB running 500 watts, and on 6 metres with 10 watts. QSL via K8LJG, John Kroll, 3528 Craig Drive, Flint, MI 48506, USA. [TNX NE8Z and 425 DX News]

HC, Ecuador. Otto, UA4WAE, informs us that he has been QRT since 30th of August. This was when he relocated to Ecuador. He will be there and operating as HC2/UA4WAE for at least the next two years. QSLs should be requested direct via Alex Otto Ogorodov, Correo Central, Salinas-Guayas, Ecuador, or by e-mail [UA4WAE@qsl.net]. [TNX 425 DX News]

J2, Djibouti. Patrick, J28LP, is now active from Djibouti and will be there for the next 2 years. He will be operating only on 10 metres. QSL via F8UNF. [TNX The Daily DX]

SV/A, Mount Athos. Monk Apollo will be on air with the special callsign SY2A from now until the end of the year. QSL via his CBA (call book address) of SV2ASP. [TNX The DX News Letter and The Daily DX]

TT, Chad. Christian, FH/TU5AX is now active as TT8DX from Moundou, Chad. He is active on all bands from 80 - 6 metres, SSB. He will be in Chad until the end of 2001. QSL via F5OGL either

direct to Didier A. Senmartin, BAS - P.O. Box 19, 35998 Rennes Armees, France, or through the French bureau. [TNX F5OGL and 425 DX News]

ZK2, Niue Island. Bill, W7TVF, will once again be active from Niue Island as ZK2VF from the 19th of November until the 19th of December. Bill hopes to be active on all bands, 160 – 6 metres. Bill will pay particular attention to Europe, Africa and South America on the low bands during periods of grayline propagation. QSL via W7TVF, Bill Dawson, P.O. Box 4049, Pahrump, Nevada 89061, USA. [TNX The Daily DX]

Jim Neiger, N6TJ, will activate his ZD8Z call from Ascension Island from the 21st of November to the 9th of December. He will also be entering a single band 10 metre operation in the CQ WW CW DX Contest. Before and after the contest, Jim will be active on all HF bands on CW and SSB. All QSLs should go via VE3HO via his call book address (CBA) U.S. return stamps are O.K.

Bert, KC4/WA1O, is heading back to Antarctica. He will be there from the 1st of November until the 15th of January. Bert is a researcher with the International Trans Antarctic Scientific Expedition (ITASE). He will use a TS-50 barefoot with wire antennas. Science is the main reason for the trip but he hopes to manage to get on the air most days even if for short periods. QSL via KA1CRP. [TNX The Daily DX]

IOTA Activity

EU 027, Bear Island and EU 063, Hopen Island. Off to the windy wastes is Per, LA3FL, who is expecting to start a six-month work contract with the North Norwegian Weather Bureau on Bear Island and Hopen Island. His stint will commence on the 17th of November. Per will stay on Bear Island (EU-027) for three months. The island has a population of just 9. In January Per will move to Hopen Island (EU-063) which has an even lower population, only 4. He will be returning home in May 2001. Plans are to pack a small rig along for the trip. His call will be JW3FL. Operations will take place during his spare time away from his official duties. [TNX The Daily DX]

AS 013, 8Q, Maldives. Kurt, DF4XX and Holger, DL5XAT will be active on all bands 160-6 metres. Mode will be mainly CW. The call will be 8Q7TX from the Maldives (AS-013). They intend to

be active from the 21st of November till the 3rd of December. Participation in the CQ WW CW DX Contest as 8Q7WW is also planned. QSL via DL5XAT. [TNX DL5XAT and 425 DX News]

OC 129, Guimeras Island, DU. John, G3IZM be active (on 20 and 15 metres SSB and CW) as DU7/G3IZM from Guimeras Island in the Visayan Group (OC-129) between 19 December and 5 January. QSL to home call. [TNX G3SWH and 425 DX News]

OC 009, T8, Palau. Kenji Fujihara, JI3DLI plans to be active on all bands 40 - 6 metres on SSB, CW, RTTY and FM. His call will be T88DX from Palau (OC-009). Activity will take place between the 2nd to the 5th of January 2001. QSL via JI3DLI. [TNX 425 DX News]

OC New. Members of the Surabaya City Club Station YB3ZES will be active from Madura Island, Java coastal islands (OC-NEW) starting from October 21, 2000 using the special call 8A3B. The license issued is good for 1 year, but for the first operation they will only last for 2 days. They plan to operate for 2 or 3 days out of every month until October 2001. Plans are to be mainly QRV on 15 and 20 metres on SSB, CW and RTTY. They will also try PSK31 and SSTV later in the operation. QSL is direct to P.O. Box 4025, Surabaya 60401, INDONESIA. [TNX The Daily DX]

NA 005, VP9, Bermuda. Mark, AA1AC will be active as AA1AC/VP9 from Hamilton Parish, Bermuda (IOTA NA-005) from the 8th till the 12th of December 2000. Operation will be on all HF bands (10-80 metres) CW and SSB. He will also be operating in the ARRL 10-metre contest. QSL via AA1AC. [TNX AA1AC and 425 DX News]

AF 006, VQ9, Diego Garcia. Patrick, W3PO (ex F6DWY) will be active (on all bands, but mainly CW) as VQ9PO from Diego Garcia (AF-006) starting on the 30th of October until February 2001. QSL via W3PO. [TNX The Daily DX and 425 DX News]

EU 063, JW, Prins Karls Forland. Terje, LA3OHA/JW3OHA and a group of others are in the advanced stages of planning an operation from Prins Karls Forland (EU-063). They are aiming at operating between the 31st of May and the 10th of June 2001. They are still looking for members to join the team. If interested, please visit <http://www.dxpediton.org> [TNX LA3OHA and 425 DX News]

Special Events

The special prefixes 4D68 (individuals) and DZ68 (for club stations) are being used in the Philippines to celebrate the 68th anniversary of the Philippine Amateur Radio Association, Inc. [TNX The Daily DX]

SP, Poland. The special event stations SP2000S (SP-two thousand-S) and SN2000C (SN-two thousand-C) will be active on all bands and modes until 31 December 2000 to celebrate the new millennium. QSL route for SP2000S is via SP5ZCC and QSL route for SN2000C is via SP9PKZ. [TNX SP5UAF, SP9XWD and 425 DX News]

PC50, The Netherlands. The 15th of December will see the Radio Agency of The Netherlands celebrating the 50th anniversary of former intercontinental radio reception station "NERA". Amateur radio will be represented during the celebrations. In fact, the weekend before the official celebrations, Saturday and Sunday the 9th and 10th of December, a special event station will be on the air and manned by employees of the Radio Agency. They have applied for the callsign PC-50-N. This is the first time The Netherlands has authorised a callsign from this allocation block. Activity will be continuous 24hrs a day, propagation permitting, on CW, SSB or PSK31 on 70cm and 2m, and all pre-WARC HF bands (10, 15, 20, 40, 80 and 160 metres). A full size inverted vee dipole at 65m over excellent ground will be used for 160m. This should provide excellent signals to DX locations. Special QSL cards will be awarded for all QSOs. SWL reports will be answered too. All QSLs will be forwarded via the Buro. Reports can be sent via the bureau, direct or E-mailed. Send to Ben Witvliet, PA5BW c/o NERA, Radioweg 3, Nederhorst-den-Berg, The Netherlands. Send E-mails to: ben.witvliet@rdnr.nl [TNX OPDX News Bulletin]

80 years ago, the first public radio broadcast in Germany took place on the 22nd December 1920. The station transmitted to air an instrumental concert 'The Koenigs Wusterhausen'. From the 1st to the 23rd of December the Club call DL0KWH will be active from the QTH of the old radio station using the special DOK (for DLD award) "80 Radio". "80 Radio" is good for the DLD AWARD issued by the DARC. DL0KWH is good for the AWARD "Sender K=F6nigs Wusterhausen". The QSL card

will depict the area of the old radio station. For further details visit www.qsl.net/dl0kwh [TNX DL2VFR and OPDX News Bulletin]

DXpeditions

3B6 - The proposed DXpedition to Agalega, 3B6RF, from the 8th to 24th of October has been postponed until May 2001. A note from Hans Peter, HB9BXE explains "Our landing permit for Agalega was cancelled", "due to unexpected elections in Mauritius, which took place middle of September. Officials of the new Mauritius Government have asked us to postpone the expedition for 2 to 3 weeks for security reasons. This creates severe difficulties for us, as there are only two regular ships per year heading to 3B6. These run at the beginning of October and the other at the beginning of May." For the latest information on the DXpedition visit <http://www.agalega2000.ch>

3D2, CONWAY REEF (OC-112), Mats/5X1Z (SM7PKK) and Nils/SM6CAS have announced a DXpedition to Conway Reef in 2001. An international team consisting of operators Nils/SM6CAS, Mats/SM7PKK, Janne/SM0DJZ, Pekka/OH1RY, Siggie/TF3CW and Steve/G4EDG will be active between the 5th and the 24th of April 2001. Three of the operators have already been on Conway Reef, and the majority of team are well seasoned DXpeditioners. The team is also looking for 2 additional members (any takers from VK?) The DXpedition will consist of 4 complete stations running continuously 24 hours a day (one for 20, 15 and 10m SSB; one for 20, 15 and 10m CW; one for 40, 80 and 160m, RTTY and 6m; one for 30, 17 and 12m CW/SSB). All stations will have their own generators, linear amplifiers and Force 12 antennas. The main target of the DXpedition will be Europe but good coverage on all bands to all areas is expected. No callsign/callsigns have been mentioned yet but as soon as they are known they will be posted in the various media. Transport has already been organised in the form of a yacht suitable for the conditions and purpose. [TNX SM6CAS and 425 DX News]

3D2, CONWAY REEF (OC-112). Another DXpedition to Conway Reef is currently being planned by Hrane, YT1AD. Reports are that the operation is planned from the 5th to the 15th of

February 2001. The following operators have been mentioned: YT1AD, YU1RL, YT6A, YU1NR, Z32AU (YU1AU) and Z32ZM and possibly one more operator from Central America. There will be three stations active at the same time each equipped with a 1KW amp. Each station will have two 3 element multiband beam antennas, one vertical and wire antennas for 160 metres. The callsign for the DXpedition will be announced on the 5th of Feb 2001. The licence for the operation has already been issued (October 5th, 2000). [TNX OPDX]

Round up

Les, VK4DA has sent me in a nice list of DX stations that he worked recently.

Call	Freq. kHz	UTC	QSL via
5X1P	14018	2130	G3MRC
KH0T	21016	0615	JA1SGU
T88NK	14002	2130	JA2AAU
8Q7AB	14004	2100	W7MP
TR8XX	14046	0700	Direct
ZP5KO	14021	0630	Direct
JY9NX	14017	0610	JH7FQK
CX3CY	21029	0030	Direct
TA3DD	21022	0620	KB2MS
CE0Y/JA3IG	21021	2340	JA3IG
5V7VJ	14027	0633	G4ZVJ
5H3NK	14024	0715	Direct

In DX Notes for November 2000 I reported 5R8O as a pirate operator who was using 5R8FL as a QSL manager. However, this is not the case. A recent report in The OPDX Bulletin has established that 5R8O is authentic. The operator is Albert whose QTH is Tananarive and QSL route is via 5R8FL. The information has been confirmed by Andreas, 5R8FL himself. This is good news for me as I can now confidently send off a QSL for my contact. [TNX OPDX]

Alain F5LMJ reports A50CDX is a pirate. Alain is receiving cards for A50CDX for contacts during the period of the 1st to 3rd of September 2001, but says this was definitely a pirate and not to waste your money. [TNX NA5G and 425 DX News]

And another, Gene, TZ6YV, reported hearing a station using the callsign TZ1GH who was advising people to QSL via the Bureau! According to Gene, the call TZ1GH has not been issued, and additionally Mali has no QSL Bureau. [TNX OPDX]

And yet another, someone is pirating VU2DED on CW. Please note that the genuine Ajay, VU2DED does not operate

CW and has not been active on HF bands for a couple of years. [TNX VU2TRI]

The Daily DX carried a note from Abubaker, 5A1A, who reports that 5A1A is the only station active from Libya, officially. Any other 5A callsigns are pirates. Abubaker would like to enlist the help of any Amateur Radio operators that hear any pirate stations on the bands using any other 5A callsign. Anyone who hears a 5A station, other than 5A1A, are asked to send the relevant information to one of the following email addresses: assakerclub@hotmail.com, elzo71@yahoo.com or sanacat@netaddress.com. [TNX The Daily DX]

Sources

Again this month thanks and appreciation is extended to the following individuals and organisations. VU2TRI, NA5G, SM6CAS, HB9BXE, DL5XAT, LA3FL, N4XT, K4SXT, W3HC, NE8Z, UA4WAE, F5OGL, W7TVF, KC4/WA1O, The DX Newsletter, The OPDX Bulletin, 425 DX News Bulletin and The Daily DX.

ar

Andrews

Communications Systems

(EST. 1976 - ACN 001 968 752)



ALINCO

**AUSTRALIA'S FIRST AUTHORISED
FACTORY DIRECT IMPORTER**

MASSIVE SHIPMENTS EVERY MONTH

FULL 3-YEAR WARRANTY ON

ALINCO and ICOM

WE SELL MOST BRANDS

BALUNS, VERTICALS, YAGIS. P/S.
ICOM-KENWOOD-JRC-AOR-EMOTATOR-
MFJ-DIAMOND-TIMEWAVE-KANTRONICS
-THP - GARMIN - TERLIN - UNIDEN -ETC
DX-1600 HF LINEARS FROM \$ 3,799

**HUGE RANGE OF ELECTRONICS,
ICOM and ALINCO Radios.**

**Over 22 Years of
Professional Sales and Service.
Instant Repairs Fridays
HF Transceivers & Linears Wanted**

(02) 9636 9060 or (02) 9688 4301

SHOP 8, 41 BATHURST ST. GREYSTANES,
N.S.W. 2145. FAX (02) 9688 1995

Spotlight on SWLing

Robin L. Harwood VK7RH.

Good listening on HF

The year 2000 is rapidly drawing to its conclusion. It has been very interesting listening over this period on the high frequency bands. For example, the formerly exclusive maritime allocations are not as crowded as they were only five years ago. There still is an active HF messaging system still operating under the aegis of Globe Wireless, which has bought the majority of the American HF coast stations, expanding worldwide through acquiring or leasing the remaining HF maritime telecommunications senders or leasing senders, establishing a worldwide network. They do still have SITOR but have developed a variation of PACTOR. The former mode, which is identical to the AMTOR mode, is very much on the way out. Very few hams are using it these days

There are a few remaining HF C/W operators such as the Cubans, Chinese, a few Italians and some Indonesians. I also have been informed that 9VG, Singapore Radio, will be completely leaving HF at the end of March 2001. I do expect that the maritime HF allocations will be pruned when the next WARC is convened. In the interim, there are plenty of illegal SSB operators quickly occupying the vacant channels.

The 2001 edition of Passport to World Band Radio has been out since the end of October. This publication has taken over from the World Radio and Television Handbook for those interested primarily in listening to shortwave broadcasting stations. (The WRTH has become a directory of all radio and television broadcasters and production companies.) Larry Magne is the Executive Editor and is very helpful to the beginner or the more advanced listener. It also has very extensive reviews of former and current shortwave receivers. There is a frequency directory at the rear of the handbook, which is very handy in identifying stations and language blocks.

I obtained my copy direct from the publishers online and the price was \$26.95 American postpaid. The price in Australian dollars will vary with the fluctuating exchange rate. I noted that this time around it was 10 dollars higher than last year. Australia's only surviving DX club submitted a bulk order and by now it may also be available in bookstores.

The ISBN number is 0-914941-51-8 and published by International Broadcasting Services Ltd. Their website is <http://www.passband.com>.

The Korean peninsula has remained divided since the outbreak of hostilities over 50 years ago. It is the one remaining legacy of the Cold War. Last year, the South Korean leader, Kim Dae-Jung, journeyed to the communist North to break the impasse and meet another Mr. Kim, Kim Jong-III. Since then, tensions have eased slightly with the American Secretary of State, Dr. Albright, also visiting Pyongyang.

A clandestine radio war has been ongoing and both sides of the Korean divide, have routinely been jamming each other. The North Koreans are on 3480, 4120, 4440 and 4470 kHz although the audio may be difficult to hear, due to the southern bubble-jammers. Conversely the South Koreans also have clandestine broadcasters on 3880 kHz

and one that is very easily heard around 6397 kHz. It moves around daily to avoid jamming. These stations are best heard from 1000 UTC.

The official Radio Pyongyang external service is on in English at 1300 UTC on 11335 kHz. It is very dry and boring, mostly with reports of meetings or seminars held to study the works of "the Great Leader" in remote corners of the Globe. Their announcers are not native English speakers judging by their pronunciation.

The South Koreans also broadcast in English at 0900 UTC on 9570 kHz. The future of the main transmitting site at Kimje is somewhat uncertain, as the antenna arrays are being replaced. Also some target areas may be dropped particularly Australasia.

Radio Japan also is coming very well on 21775 kHz from 0600 till 1100 UTC with their General Service in Japanese and English. They have moved from 21570 kHz and are the strongest signal on 13 metres.

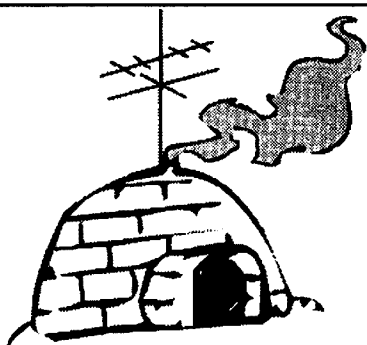
Recently while tuning across the 49 metre band, I came across a very unusual station on 6165 kHz from 1100 UTC.

You may need to use USB because there is a strong VOA transmission in Chinese, emanating from the Philippines on 6160 kHz. The station is broadcasting from Vietnam and is a regional service in the Hmong dialect. What caught my attention was the haunting singing of the Hmong women.

This is in the first half-hour with the remaining half-hour being in Vietnamese. Incidentally Tasmania does have a small Hmong community and they often sell their vegetable produce at Hobart's Salamanca Market. They fled Southern Vietnam in 1975, settling in Tasmania.

Well that is all for 2000. It only remains for me to wish the Greetings of the Season to you and yours and hope that 2001 will be a good year for you.

73- Robin L. Harwood VK7RH.



Meet hams where you live

Join your local club

Addresses appear in

WIA Callbook 2001

OUT NOW



AN EXPANDING WORLD

David K Minchin VK5KK

Postal: PO Box 789 Salisbury South Australia 5108

E-mail: tecknolt@arcom.com.au

Web page: http://www.ozemail.com.au/~tecknolt

Fax: +61 8 82346396

Phone: 0403 368 066

All times are in UTC

50 MHz Equinox comes and goes..

Unfortunately not much to report from the southern areas on Northern Hemisphere DX. There have been, however, some Sporadic E openings on 6m (and 2m as reported later) into most areas. What follows is a broad wrap up of the Spring Equinox. Neville VK2QF reports ... "Not much to report about six metres from this location but what has been lacking in quantity has been corrected by quality! Only two openings of note this season."

Oct 31st, 9A1CMS, I4SJZ, IW0RGN, S59RE, IZ5CMG, I4SJZ, EH3ADW [16,884km], IK5RLP, IW5BZQ, IK5QLO, IK5OEA, IK5YJY, IZ5EME, I4CIL, S59MA, I0AMU, IK0FTA, 9A3RE, I0WTD, I3LDS, IK4DRY, S52AB, I0JX, JA4MBM [hrd only], IZ2AAJ [hrd "JA only"], OM3LO, OM4FF, SP9CCD, OM3CM, SP9CCD, SQ9HYM, OE3WBA, IK2IQC, S59MA, IW2DMN, SP6OUL, OK1KT, IW2JMC, DL1DSW, S53X, IK2IQC, IV3ZOF, IK2OFO, SP9HWY, SP6GWB, IK2GSO, SP6GWB, DF3CB, VK8RAS/B [hrd], DL6UCW, DL9USA, SP6ASD, SP6GZZ/P, DJ2DA, DL6AMI, DL2HWA, DL1DTD, DL6AMI, DL3DXX, DL7AV, DK2EA, DJ3TF, OM3NY, from 0818 to 1013z, 315 deg beam heading and to 599+, 60 QSO's the largest opening ever on six from this location, with 9 entities worked, 62% CW the MAGIC MODE!

Nov 7th, KC8CC, K7JE, K4ZOO [hrd], W7RV, W3ZZ [hrd], N3YDT, W3ZZ [15,832km], WE4N, KA8OHM, W4YV, WZ8D, WB8XX, KC2TX/7, W4TJ], K4ZOO, W4TJ, K4ZOO, W4TJ, N3II, N4MM, K4ZOO, KB4XK, W4MYA, W4MYA, NH6YK, JA2IGY/B [hrd], from 2038 to 2359z, 60deg beam heading to S9. States worked were Ohio, Virginia, Georgia, Arizona, California & Maryland [North of Washington D.C].

"Otherwise the band has shown a few TEP openings to Japan, Korea and Taiwan but not as frequently as expected so far. Sporadic E played a major role in most if not all of the openings especially the US where there was probably an extension at both ends." ... Neville VK2QF,

From Broome Bill VK6JQ reports .. "I have compiled a summary of Countries heard and worked during the last six months from daily records I keep of band conditions on 50 MHz." A total of 41 countries were heard with 25 countries worked as follows through the "winter" period —

APR	MAY	JUN	JUL	AUG	SEP
H44	JA	UR	SP	JA	JY
JA	9M2	EY	OH	BV	JA
EY	9N7	4W6	RU	YB	
5B4	KH6	UN	JA	9M0	
YB	W	DL	VR2		
KH6	V73	SP	EY		
FK8	I	9V1			
ZL	T88				
T88					
JY					
BV					

August was the quietest month, yet consulting another summary provided by Bill the band was open to JA for 23 out of 30 days during August! The multiple occurrences of European openings throughout June & July also perhaps indicate that we further south should look out for Es extensions well outside the traditional equinoxes. Thanks again Bill, VK6JQ.

Ray VK4BLK at Yeppoon reports an unusual event on 50 MHz on 28/29th of October 2000 ... "The band was dead and had been for the previous 48 hours.. even JA's and 49.750 MHz had gone so I set my rig scanning the DX portion of the band. At 0120Z 29/10/00 the rig passed over a very strange sounding CW signal. Tuning to the signal I found it was VE7SL and that the propagation was

Auroral! There was no doubt as to the sound as I had previously worked Auroral several times whilst living in southern VK3."

"I made contact with VE7SL @ 0122Z and went onto work W7HAH at 0130Z, W7JF at 0200Z and VE7SL again at 0201Z. All contacts were made on slow CW, I don't think SSB would have been possible because of the extreme doppler shift. Signals were stronger on my 2 element quad which points North than on a 3 element yagi pointing directly at VE/W7" ... Ray VK4BLK. Scott VK4JSR also reporting hearing some of the above stations along with contacts also being had by VK4KK & VK4CP atleast from 0130Z to 0230Z. Auroral propagation with TEP extension, it does happen! WWV numbers were 182/17/3 with magnetic storm warnings.

Ray's VK4BLK's Log for November 2000 reads (all CW contacts) 5/11 UY1HY @ 0830Z 559, 6/11 UT2IO @ 0648Z 559, 7/11 HK4CZE @ 2332Z 549, 8/11 W5OZI @ 0013Z, AA5XE @ 0013, W3XO/5 @ 0014, W5UN @ 0020, W7RV @ 0034, WA7JTM @ 0040, WA7A @ 0043Z, W7USA @ 0045Z, WA7CJO @ 0047Z KC8CC @ 0058Z, 12/11 KH6ND/KH5 @ 0046 559, 20/11 FO5RA @ 0039 549, 21/11 K6QXY @ 0214Z & 22/11 K6QXY @ 0224Z. The contact with UT2IO was very early for the EU path. Some well-known W calls worked on 8/11/00 also!

Mike VK2FLR reports ... "From 0830 to 1010 on 31 October, I worked 5 SP6, 3 DL, 4 OK, 1 OM, 9 I, S53 and 9A2, all on CW at up to 579, except for a couple of Italians on SSB at up to S5. Best Eu opening I have had. Conditions were ideal - no noise, no video buzz, no loud locals. Others heard working the DX were VK2QF, VK2VC, VK2APG, and VK2EDB. I suspected we were in with a chance yesterday evening when we had good Es into VK4 at around 6pm. During

the opening VK8RAS was a solid 579"
... Mike VK2FLR

144 MHz and above

2 metres has been a bit slower starting than last year, so far no reported VK5 – VK6 contacts although conditions have gone close several times now. Please look out for the VK6 Augusta beacons on 144/432 & 1296 as reported in earlier columns. Locally we have had some conditions to the SouthEast VK5 @ 400km with 55 signals from Colin VK5DK @ 1000Z on 19/11/00. Signals on 432 MHz were well down on 144 MHz though.

During the Spring Field day I managed to go portable with Steve VK5AIM and Colwyn VK5UE (AR Editor) and operated from 4 various grid squares, about 120km north of Adelaide, over the 24 hour period. Contacts were had on 50, 144, 432, 1296 & 3400 MHz. Yes 3400 MHz; the crystals have been changed to suit the new bandplan ready for this summer. (If anyone needs 90.444 MHz xtals for 3400 – 144 MHz I have a few to spare) 10 GHz went out portable as well but unfortunately the nearest station with 10 GHz, Colin VK5DK, was hard enough to work on 50 MHz let alone higher over the 520km path! It was an enjoyable time; a surprise contact was Jim VK3AEF at Nhill 4/11/ @ 1153Z on 50.150 as well as 146.550 FM! Distance just around 500km

Guy VK2 reports .. "Recent contacts on 144MHz from VK2KU: Meteor Scatter 16/11 at 1917 VK3UM, VK3HY, also heard VK7JG. 17/11 at 2023 VK7JG. 17/11 at 2053 VK4KZR, just missed VK4DFE. Sporadic E 20/11 at 0129 VK4FNQ, also heard VK4ABW but no contact 21/11 heard VK4ABW again, no contact. Aircraft Scatter 17/11 at 2036 VK4AML for a new one. I very rarely hear VK4, too much dirt in the path!" ... Guy VK2KU

Neil VK2EI at Pt Macquarie reports on "MS" activity around the time of the "Leonids" ... "Here is what was heard from my QTH: 16/11 Numerous short pings. Only identifiable call was VK3UM. 17/11 Average of about 10 pings/hr 1923 Heard VK7MO off back of my beam working VK4DFE, both 5/2 Swung beam to 220° 1924 Worked VK3UM 5/2 Worked VK3CO 5/2 (In fact both were much stronger!) (There were several others also called during this burn) Heard VK3KEG (didn't log the

time) 2004 Heard VK2YOC/VK3KU full callsigns on one ping 2011 Heard VK3? All the rest were too short to identify. 18/11 Average of about 10 pings/Hr, all short or weak. Beaming 220° 1829 Heard VK7MO 1837 Heard VK3ZL?, missed the last letter of callsign. General propagation below normal. This was my first serious MS attempt and found it very interesting. Looking forward to the next one!" ...Neil VK2EI.

And Chris VK4DFE from Maleny reports ... "Re: Leonids. 2025z this morning heard VK3KEG at 5/2, peaking 5/5. Also hrd by VK4KZR and VK4TZL (Hervey Bay). Many S5-S8 sigs from VK2's. 144.100 very busy." ... Chris VK4DFE

MICROWAVE PRIMER PART SEVEN:

10 GHz Continued

Having discussed the evolution of equipment for 10 GHz, we will turn our attention to making a start. As previously mentioned 10 GHz seems to be the next jump from 1296 MHz for a large number of people, yet the two bands have distinct differences in construction techniques after all one is 9 times the frequency of the other! While you may have got the hint from earlier parts of this primer that some of the intermediate bands perhaps make better training areas, there is still something about jumping into the deep end of the pool! So how do you start?

Step One: The best recommendation is to find someone or a group closeby who shares the same interest. Sometimes you can be lucky, but the time saved in pooling resources reduces such a project from years down to months! You will need to have or have at least access to a reasonable amount of test equipment .. this is where groups really help. It will also help immensely in getting hold of the various magazines and literature

Step Two: Test equipment. Some means of differentiating various signals or frequencies and measuring the various levels makes life so much easier (i.e. possible). A microwave power meter (Bolometer type) is probably the most important piece of equipment. You are able to measure so many variables that otherwise could make or break a system. For identifying signals a Spectrum Analyser is handy, but not essential. A signal source is also handy for antenna

work and tuning amplifiers, but not essential. Old HP 620 Klystron Signal Generators pop up, from time to time or you can make use of a Gunn diode movement detector. A useful signal generator can also be made using ERA series MMIC multipliers and amplifiers ... an ERA1 can give 5 mW or more saturated power on 10 GHz with no tuning. A poor old HP620 is lucky to get better than 1 mW. And then you will need an assortment of various SMA leads and some attenuators for comparative measurements.

Step Three: What do you want to do? Narrowband or otherwise? Maybe you want to experiment with Phase 3D? Or work ATV, or narrowband Tropo work or just to add lots of multipliers for field day work (I had to put that in.. it works!). 85% of all these modes use the same building blocks, i.e. discrete component on Teflon PCB designs. The balance is achieved using simpler technology like Gunn diodes. If interest is there I will address Gunn diodes in a separate section.

Step Four: The design. In the last part I touched briefly on several of the designs that have been published or made available over the last 14 or so years. VK microwave enthusiasts have successfully replicated most of these designs. Which do you pick?

For scratch built designs two of the more popular designs are the DB6NT Mk1 transverter and the G3WDG type transverter. The bare output of both of these transverters is a quite useful 5 – 20 mW. Other designs are around, they all are seemingly based on the original DC0DA 1986 design using plumbing pipe cap resonators.

For modified surplus designs, the Qualcomm satellite transceivers have been a boost to 10 GHz activity. Most in the country were brought in and distributed by Alan Vx3XPD .. it would be safe to say they out number all other types of transverters. There is a bit of work required to get them going but they do work and they will take a lot of abuse, just perhaps a bit harder to tune for a novice when compared to a purpose built 10 GHz transverter. A newer design is available now from the US using a later transmitter PCB but still with the original "discrete PA"

After building four 10 GHz transverters (2 DB6NT's and 2 Qualcomm's) plus helping get a few

others going (including about half a dozen 1 watt amplifiers!) I reckon it comes down to whether you want to scratch build a design or modify a commercial satellite uplink. Surprisingly there is actually little difference in effort between the two options.

DB6NT and others have various amplifier modules to take the transverter output to at least 200mW (more useful) where upon a further single stage will get you about 800mW. Up to 20 watts solid state can be had but some of these devices are worth around A\$800 or worse! The alternative to that is to use a surplus Qualcomm 1watt PA. One of these properly tuned only requires about 0.25mW to get 1-watt output. I run a 15-db SMA pad between my DB6NT and a Qualcomm for portable use. After tuning a large number of these I tend to think they are the better way to get 1 watt of power on 10 GHz. 1 watt is plenty of power!

For home station use that 15 db pad is replaced by a run of RG214 coax up the tower to a masthead mounted 1watt PA. Much better than using waveguide! On receive I have a 30 db gain Preamp up top driving another bit of RG214 running down the tower. The loss of good RG214 (double shielded) is about 1db per metre at 10 GHz. New 9913 coax is also usable (about 0.7db loss per metre) LDF4/50 also works although its bigger internal dimensions make it almost look like waveguide. Single shielded coax RG213 and "no name" coax is next to useless as signal leakage/shield excitation means nearly double theoretical losses. If you want to test how good or bad coax is do it at 10 GHz!

The other source of 10 GHz power is surplus Travelling Wavetube Amplifiers (TWTA). TWTA's are a thermionic progressive wave tube, accidentally discovered in the forties when helix antennas were being played with. They have both high gain (35 - 40 db) and broad bandwidth. A 14 GHz tube can be used on 10 GHz with just a bit of matching. On the downside, they require stabilised 3 - 6 kV HV Helix and collector voltages, as well as being easily destroyed with too much drive power (more than 10mW can kill!). TWTA's do pop up from time to time as surplus 14 GHz satellite links are sold or dumped. I have seen some go for several thousands of dollars at auction or heard

of tales where they have been used as landfill under new runways (true!) They do pop-up so as usual a keen amateur will hunt them down! TWTA's are restricted to serious portable work and EME unless you have a good supply of waveguide to go up a tower!

Next month, Antennas on 10 GHz

In Closing

Phase 3D Launched! A new era in amateur radio communications was ushered in on November 16, 2000 (UTC) as AMSAT-DL Executive Vice President and P3D Mission Director Peter Guelzow, DB2OS, informed AMSAT News Service that the launch of the Phase 3D satellite from the European Spaceport in Kourou, French Guiana was successful — following a spectacular nighttime launch. "It was a textbook launch" said DB2OS, "from the first minute of flight, until P3D separated from the Ariane 5 launch vehicle, all received telemetry indicates the launch went perfectly and our satellite appears to be in very good health." ...courtesy AMSAT.

That's the good news about Phase 3D. The not so good news concerns the eventual coverage of Phase 3D. The elliptical 36-hour orbit of the satellite varies from 4,000km to some where near 40,000km. Japan, Europe & the USA each take their turn at maximum coverage while Australia along with the rest of the Southern hemisphere will see only part of that coverage with, 4000km high passes. While this may not be too much of a problem on the lower bands, it will probably restrict the microwave coverage from VK to just VK/ZL and a bit further. A bonus is perhaps the lower pass loss on 4000km vs 40,000km! And here's hoping they leave some of this stuff turned on for the Southern Hemisphere!

For the next 6 or so months 3D will slowly edge into its final orbit so we will have a better chance to work "further" now rather than later. If anyone is seriously contemplating using on the 2.4 GHz and above facilities please drop me a line and I will put you in touch with others.

I'll leave you with this thought. ... "I can't understand why people are afraid of new ideas. I'm frightened of the old ones." - John Cage

Till next month
73's David VK5KK

*For All Your
Requirements*

AUTHORISED DEALER
ICOM

KENWOOD

AMATEUR COMMERCIAL
MARINE COMMUNICATIONS



14 Mary Street
Hazelmere

Western Australia 6055
Telephone: (08) 9274 1118
Facsimile: (08) 9250 3734

E-mail: tower@com.net.au

www: <http://www.tower.visionimage.com.au>



Australian
Amateur Radio
**Callbook
2001**

Reference Guide

OUT NOW

at your

Divisional Bookstore

See page 30 for contact details



Will McGhie VK6UU
21 Waterloo Cr Lesmurdie 6076
VK6UU@VK6BBR will2@iinet.net.au

RF Safety

How serious do we all take electromagnetic radiation safety and in particular at repeater sites? Hopefully we all know that there is a level of exposure to radio frequencies considered to be safe and take this into consideration when climbing on towers. If your repeater site is a shared site there are other transmissions from the tower that you may know little about and this should be of concern. However in general most sites that are two way radio orientated, have power levels that are moderate, with most transmitters being under 50 watt and only being spasmodic in their operation. Provided your stay within a metre or so of such antennas is under an hour or so, there is little to be concerned about. The real concern is on broadcast structures that radiate high power on a continuous basis. In my work situation this occurs from time to time and as such I have undertaken RF safety courses. These have been interesting and are worth passing on for their oddities if nothing else.

Qualifications

It is to be assumed that those giving the RF safety course know considerable more than you do, but this is not always the case. For example, as happened to me, the RF safety course was an add-on to a tower climbing and tower rescue course, both of which were excellent. However it quickly became obvious that tower riggers, well versed in their field of tower safety and rescue, knew enough about radio to be scary.

Firstly there is a history of stories that are funny, but most often are factually incorrect. I remember one from way back when I was a teenage trainee, about a young technician who climbed a high power medium frequency broadcast tower and needed to relieve himself from near the top of the tower. The liquid stream was fine until a quarter wavelength was obtained and a certain appendage became barbecue meat. Now it all sounded very funny at the time and

as young trainees we all made a mental note to make sure if any live broadcast towers were to be climbed, toileting would be done before climbing began. But the story is just some ones avid imagination. For starters water separates into drops and there is no continuous quarter wave receiving aerial. Secondly most broadcast towers are less than a physical quarter wavelength high.

In more recent times the stories were many to liven up the RF safety part of the course. One referred to a large dish antenna on a city building pointing straight into an adjoining building. People in this building reported being hot from the radiation. Now it might concern you looking straight at a large parabolic antenna less than a hundred feet away, and so it should, but being heated by it! How many watt was this dish putting out was the question? The answer, 50-watt as best could be remembered, but 50 watt can't make you hot was the response. Yes it can because of the gain of the dish, some 30 or 40 dB. This of course equates to an ERP of more than 50,000 watt, more than enough to make you hot, went the logic. Yes but ERP or not it is still only 50 watt, all be it concentrated. Even if you absorbed all the power it would only be 50 watt. No was the reply, you are forgetting the gain of the dish, and so it went. It was time to shut up and flow with the course. It was obvious that the instructors were way out of their depth. They knew enough to pass on considerable misinformation and many more stories with a basis of truth, but enhanced so as to be dangerous. RF safety is very important and there is no room for inaccurate, let alone completely wrong information.

Public Concern and Experts

No wonder the general public can so easily be whipped into a frenzy when a new phone tower appears next door. All this new found concern over phone towers is very difficult for the phone

companies, yet for years there has been all sorts of radio transmissions close to the public. Take for example a medium frequency broadcast mast in a northern suburb of Perth. This tower has houses within 80 metres of the tower and has a combined power output in excess of 100 kilowatt! Sure the frequencies are a lot lower than mobile phone towers, and the higher the radio frequency the greater the danger, but you sure would not get me living within 80 metres of the base of a 100 kilowatt transmitter, 24 hours a day. I even rang the radio station during a listeners call back discussion about the dangers of phone towers and said to the presenter, was she aware that she was being broadcast on a tower emitting 100 kilowatt in a suburban area? The question went right over her head. She had no idea what I was talking about and yet these people help shape public opinion and concern over such issues as phone towers.

Have you noticed the warning signs appearing at petrol stations not to use your mobile phone. Now this one is really right off the planet. For year's taxis and all manner of two way radio transmissions have been occurring at petrol stations, and still occur. Have you ever heard of a petrol station blowing up due to someone using a two-way radio, let alone a mobile phone with one hundred times less power? I also had the chance to ring a radio station during a call back program on just this issue, mobile phones at petrol stations. The expert knew of no instances of a mobile phone causing a petrol station to blow up and knew even less about two-way radios and the relative power levels between them and mobile phones. Yet these "experts" forget public concern and we all end up with yet another regulation. And by the way there is a petrol station within a short distance of the 100-kilowatt broadcast mast, but no concern over it.

RF Levels

In the past couple of years my employer has undertaken considerable

measurements of RF levels from all our microwave equipment. Broadcast microwave equipment used for linking varies in power level from fractions of a watt to 20 watt. Satellite links can be several hundred watt. The results of the tests showed there was risk within a few metres for the 5 to 20 watt levels in line with the antenna. A safe distance of around 10 metres away from the direction of the antenna is a good rule of thumb. This is in the frequency range of 2 GHz to 10 GHz. And it is important to note this is the continuous 8-hour exposure. You would have to stand within a few metres of the antenna for over 8 hours to exceed the safe radiation level at power level of several watt. There is a considerable built in safety margin as well. Also of note is that the radiation levels are different for those working in the industry as compared to the general public. The RF exposure levels are lower for the general public than the industry worker. This may seem the wrong way round, but as I understand it, the logic is that the worker

has knowledge of the situation and as such can take steps to minimise exposure. The general public have no idea what the equipment is and needs an extra level of protection.

One interesting outcome of the RF level measurements was the safe distance from a 7 metre satellite dish. The maximum radiation risk is about 2 kilometres from the dish and not closer in to the dish. Why the radiation level concentrates at this point from the dish is unknown to me.

Us Amateurs

How can we as radio amateurs add something to this debate? Most of us should have knowledge way above the general public. The public gets much of their information from the media and the media know very little about radio. Any chance to beat up a story often results in little relationship to the facts. It is only of recent weeks that the highest radiation levels from phone towers has been reported by the media to be some considerable distance from the phone

tower. If you live right next door to a phone tower you receive less radiation than someone living several hundred metres from the tower. We know it is all to do with antenna patterns designed to concentrate the radio energy at a distance but all the public see is a big tower and the further away from the tower the better. This could even result in a tower being forced to move from a particular location and then causing a greater radiation level at the original point of concern. For us radio amateurs this could well spill over into our own towers. Even though your antennas may only be transmitting 1% of the time, unlike medium wave broadcast towers in suburbs, transmitting considerably more power 24 hours a day, every day.

Hopefully we won't be greatly effected by the issues of mobile phone towers and perhaps this is because our antenna structures don't look like mobile phone towers, but in light of the miss information by the media who knows how we will fair.

ar

Don't Hang The Washing On The Aerial: the words

[Verse 1]

Last week I bought a little wireless set,
Thought I'd like to listen when home I get,
When my work was over I thought it would be grand,
To listen to a concert, a nice brass band,
In my garden I put up an aerial, thinking of the treat I had in store
When I got home today the wife was feeling very glad
This is the finest drying day I've ever had
When I saw the washing I got mad
I looked at her and then began to roar

*Don't hang the washing on the aerial
Maggie! I want to listen in
When I want to hear the music, how it hurts
For all I hear can hear is the flapping of the shirts
You cause a disturbance of the wavelength Maggie
I seem punished for my sins Eighteen twelve by old Tchaikovsky makes my cat's whisker Pop-off-ski Every time a washing day begins*

*Don't hang the washing on the aerial
Maggie! I want to listen in
When I want to hear the music, how it hurts
For all I hear can hear is the flapping of the shirts
You cause a disturbance of the wavelength Maggie
I seem punished for my sins And music by Novelo sounds as if it's gone
2 L O Every time a washing day begins*

[Verse 2]

The wife said, "Your aerial can be used for lots of things
I've put a rope across it, now the kids play swings
On a summer's evening, when all is calm and bright
The cats come around and do a tight rope act each night;
With the pole I've made a lovely clothes prop
The headphones keep the babies ears in place
Fifteen bob a year is very cheap you will agree
For all of these advantages, and now, it seems to me

Wireless in the home is a necessity
I said May be, but still, if that's the case

*Don't hang the washing on the aerial
Maggie! I want to listen in
When I want to hear the music, how it hurts
For all I hear can hear is the flapping of the shirts
In your pegging out the bits and pieces, Maggie
The neighbours stand around with grins
There's lots of fun on Mondays, there's a foxtrot by your undies
Try time a washing day begins*

*Don't hang the washing on the aerial
Maggie! I want to listen in
When I want to hear the music, how it hurts
For all I hear can hear is the flapping of the shirts
In your pegging out the bits and pieces, Maggie
The neighbours stand around with grins
When music's played by Schuman, there's that sound most inhuman
Ev'ry time a washing day begins*

ar

HF Predictions



by Evan Jarman VK3ANI
34 Alandale Court Blackburn Vic 3130

These graphs show the predicted diurnal variation of key frequencies for the nominated circuits.

These frequencies as identified in the legend are:-

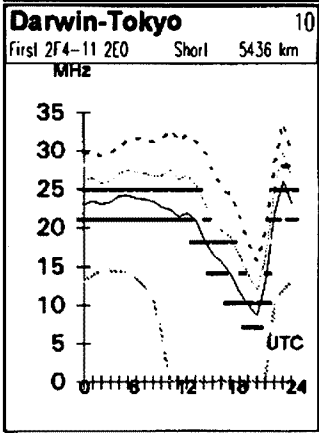
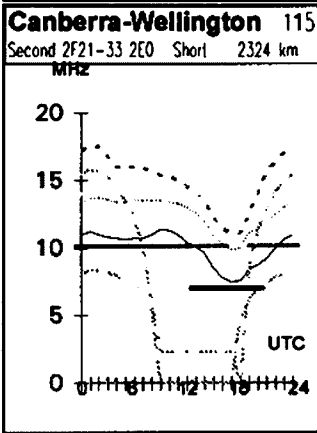
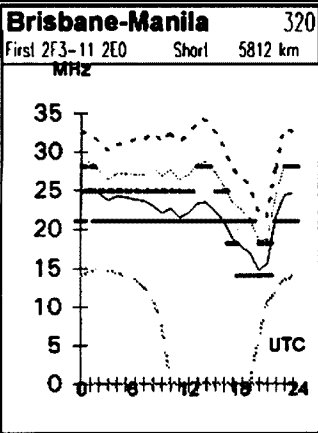
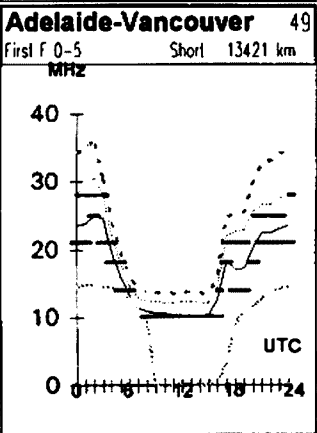
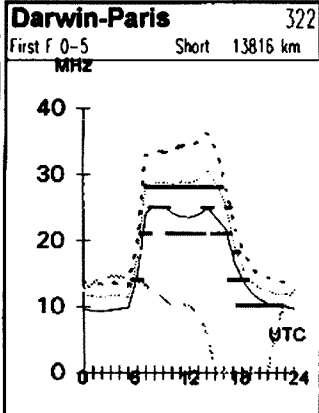
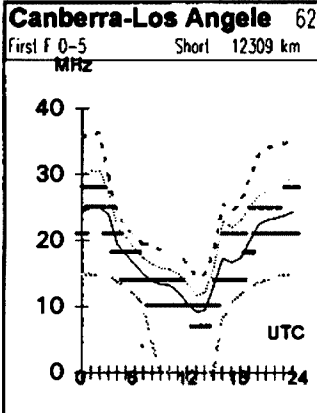
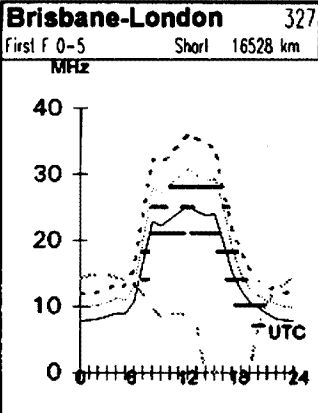
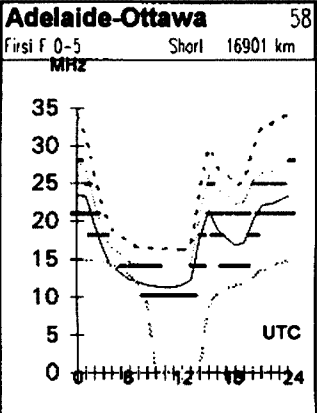
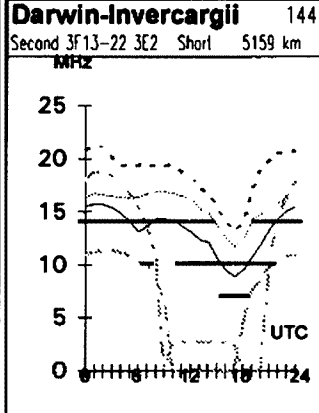
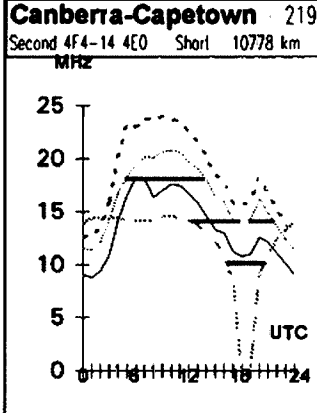
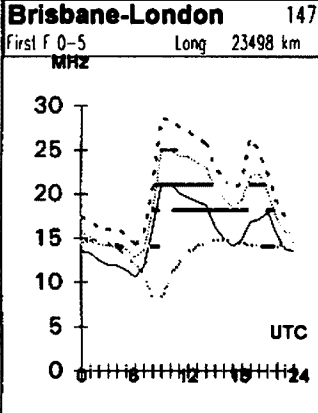
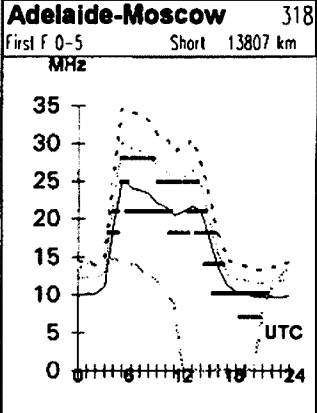
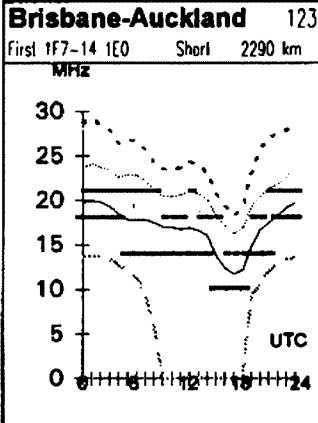
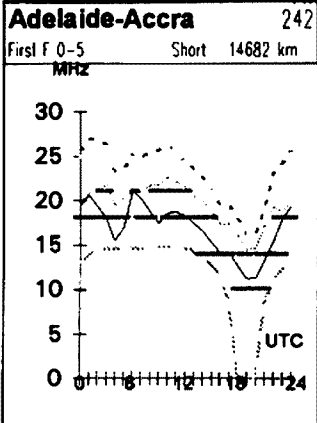
- Upper Decile (F-layer)
- F-layer Maximum Usable Frequency
- E-layer Maximum Usable Frequency
- Optimum Working Frequency (F-layer)
- Absorption Limiting Frequency (D region)

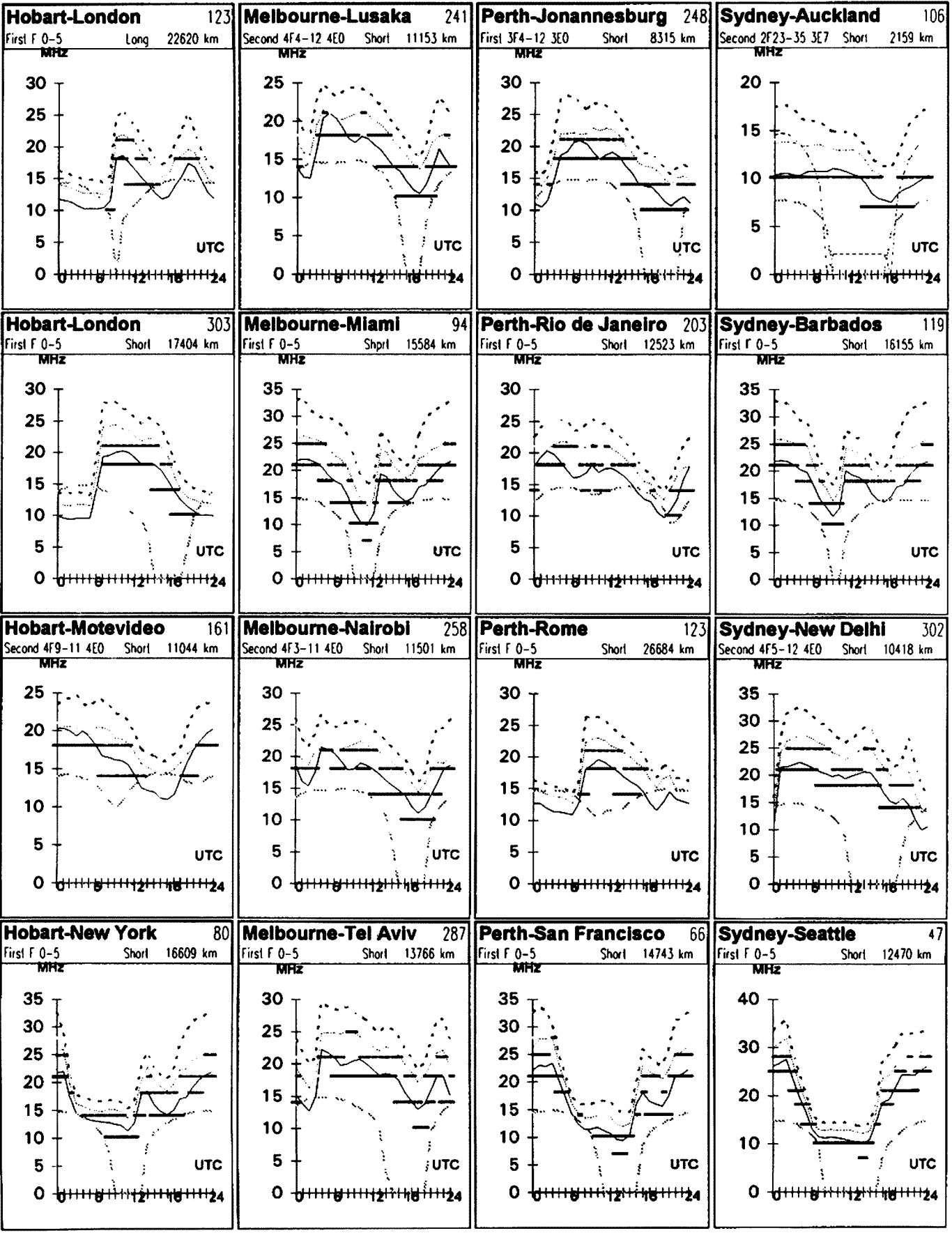
Shown hourly are the highest frequency amateur bands in ranges between these key frequencies, when usable. The path, propagation mode and Australian terminal bearing are also given for each circuit.

These predictions were made with the Ionospheric Prediction Service program: ASAPS Version 4

December 2000
T index: 133

Legend
UD
F-MUF
E-MUF
OWF
ALF
10%-50
50%-80
80%-100
Frequency scale
Time scale





HAMADS

- Hamads may be submitted on the form on the reverse of your current Amateur Radio address flysheet. Please print carefully, especially where case or numerals are critical.
- Please submit separate forms for For Sale and Wanted items, and be sure to include your name, address and telephone number (including STD code) if you do not use the flysheet.
- Eight lines (forty words) per issue free to all WIA members, ninth and tenth lines for name and address. Commercial rates apply for non-members.
- Deceased estates Hamads will be published in full, even if the ad is not fully radio equipment.
- WIA policy recommends that the serial number of all equipment for sale should be included.
- QTHR means the address is correct in the current WIA Call Book.
- Ordinary Hamads from members who are deemed to be in general electronics retail and wholesale distributive trades should be certified as referring only to private articles not being re-sold for merchandising purposes.
- Commercial advertising (Trade Hamads) are pre-payable at \$25.00 for four lines (twenty words), plus \$2.25 per line (or part thereof), with a minimum charge of \$25.00. Cheques are to be made out to: WIA Hamads.
- Copy should be typed or in block letters, and be received by the deadlines shown on page 1 of each issue of Amateur Radio, at:

Postal: Newsletters Unlimited, 29 Tanner Street, Richmond, 3121

Fax: 03 9428 4242 **E-mail:** news1@webtime.com.au

Please only send your Hamad once

Please send Hamads by mail OR fax OR email (much preferred).

Please do not send by more than one method for any one ad or issue, it is confusing.

FOR SALE NSW

- Mobile Two-way manuals, crystals etc. About to be dumped. Collect or pay freight - all are free- between 200 & 300 manuals. Ph (02) 9791 0366 (wk) 9/5 for details. VK2ACV Tony. tonymul@pip.com.au
- Ameritron Linear Amp AL811. Serial no 12391X, Ex. cond., complete with new spare set of final tubes. \$600. Kevin VK2ANT. Ph (02) 4389 2708 3
- Kenwood R-5000 communication receiver plus instruction book, recommended, 5 star rating, genuine snap \$550 QTHR Newcastle Ph (02) 4954 0893
- Alinco DX70TH HF/6m XCVR 100W as new in box with manual and mobile bracket \$1050. Cliff VK2CJL Ph (02) 6972 3788
- BOOK: "Radiotelegraph and Radiotelephone Codes, Prowords and Abbreviations." 2nd Edition. \$15 posted Australia. 90 Pages. Q,X,Z Codes, 97 Phonetic, 20 Morse Codes. Phillips, Myer, 10,11,12,13 Codes. Much other info. Internet - <http://www.nor.com.au/community/sarc/phonetic.htm> VK2JWA, John W.Alcorn. QTHR. Ph (02) 6621 5217. Email jalcorn@nor.com.au INTERNET Connect from Port Macquarie to the Gold Coast from 90c per hour. Summerland Amateur Radio Club. For info - <http://www.nor.com.au/community/sarc/sarc.htm> - John, VK2JWA, QTHR, jalcorn@nor.com.au. 33 Spring St, Lismore, NSW, 2480. Ph (02)-6621 5217
- Audio amplifier valve 6550A made by GE USA \$60 ea. Dieter VK2EDD Ph (02) 4982 9847
- Kenwood TS-811A 70cm all mode base, excellent cond., owners manual, service manual, 25W \$750. Kenwood TS-43X HF 100W, gen. coverage, with manual, FM fitted, good order \$500. Grant VK2VB Ph (02) 4965 8658 ah QTHR or vk2vb@optusnet.com.au

- Fax receiver Alden 9273A solid state 1970's model with spare paper rolls and manual. Never used, too big and heavy. You collect! Price very negotiable. Good condition. Email John at vk2dvw@qsl.net or Ph (02) 9580 6567. Bring a big mate or a trolley, this is hernia territory!
- Kenwood TS-520 HF transceiver, s/n 342042. 3.5 and 7 MHz bands unserviceable \$150. QTHR Ph (02) 9759 1274

WANTED NSW

- Old unloved heavy filthy, receivers, valve stuff for a "nut", that gets them going again, even trashed one's military or commercial receivers, even home brew jobs. Also after any old WRTVH's books, in Sydney will personally collect and will bring a broom to help. Outside of Sydney will make special arrangements. Will pay money or simply collect, your call. But I have 130 sets all set up per previous AR articles. So don't delay call Ph (02) 9533 6261 or email to dxe@fl.net.au WIA L21068 John.
- Quad OP-AMP IC type NE5514N (or SE5514N). Qty required = 4. To use in several receiver and XCVR projects in the 1999 ARRL handbook. Contact Pat Brennan VK2ABE, PO BOX 158 Tamworth NSW 2340
- Wanted for AWA V.O.M. type IA56074, p/n IR56075 probe or body of same, could also use p/n 2R56075 probe. Stan Dogger. Ph (02) 6677 9292 QTHR
- Hills or similar winch-up tower. Will dismantle if necessary. Preferably in VK2. Phone Glen VK2FC Ph (02) 4982 6800
- HY-GAIN medium or heavy duty antenna rotator, BENCHER BY-1 keyer, DRAKE MN-2700 antenna tuner, SWISSLOG logging software. Tom, VK2OE Ph. (02) 9793 2347 (evenings) or vk2oe@arrl.net

• Circuit diagram for Swan 500c transceiver wanted. In particular area around function switch S2. QTHR VK2WF Ph (02) 6775 1080

FOR SALE VIC

- Yaesu FT 101 E transceiver with handbook \$ 375.00. Yaesu FT 7 with DC supply and valve linear \$ 300.00. Peter VK3APO Ph mobile 0428 178 640
- Kenwood TS-711 2m all-modes 25W out, power supplies built in (GC) and MC-60A Desk Microphone \$750. Richard VK3ZCL AH Ph (03) 9729 1947 12
- Icom IC271A 2 metre all mode with inbuilt preamp, excellent condition with full service manual \$700. Icom 735 HF transceiver, excellent condition with full Icom service manual \$700. Charlie VK3FMD Ph (03) 9572 3583

WANTED VIC

- Circuit/Technical manual for STAR SR-700A communications receiver. Photocopy or original will be OK. All costs gratefully reimbursed VK3DBF QTHR. Ph (03) 9796 8982

FOR SALE QLD

- Bencher iambic paddle and home brew Curtis 8044B iambic keyer \$110. Ray VK4BLK Ph (07) 4939 2284
- Spectrum analyzer Hewlett Packard 141T, 0-1.2GHz. 8554B RF and 8552 IF \$1850. Ray. Ph (07) 3299 3819, fax (07) 3299 3821
- Antenna DX 8 band multiband DX manf. by GAP USA. No radials req. \$400. MFJ 564 de Luxe iambic paddle \$45. Ph (07) 5578 8052 QLD 4226 hama@smartchat.net.au

WANTED QLD

- Wanted Urgently: Grid Dip Oscillator prefer bipolar transistorised (or FET) with multi-coil coverage from 5 MHz to 250 MHz. Calibration accuracy is of no consequence; however, sensitivity is! Noel VK4CED Ph (07) 4069 9878 email thecape@bigpond.com

FOR SALE SA

- Large AM valve transmitter PEP 130W finals pair 807s 30"H 16"W 14"D home brew, coax and ladder line connections. One for the real enthusiast. Separate BFO unit. QTHR Ph (08) 8294 6906

WANTED SA

- M5106P Mitsubishi audio amplifier IC needed to replace IC in Sansei Electronics signal tracer Model SE-360. Ivan VK5QV QTHR, Ph (08) 8725 5514 email: ieh@dove.net.au
- Information on source of video on life of Nikola Tesla early radio pioneer shown about two years ago on TV. Rob VK5RG QTHR Ph (08) 8379 1889 gurrrc@picknowl.com.au
- Reasonably priced Yaesu FT101ZD in good to excellent working condition. Preferably with manuals, although not essential. Chris VK5JJJ Ph (08) 8294 0774 or vk5jjj@arrl.net

WANTED WA

- Linear amp IC2KL or similar. Cliff VK6ABF QTHR Ph (08) 9337 1532
- Digital readout for YAESU FT101E. VK6GW QTHR Ph (08) 9298 8489

FOR SALE TAS

- Collins KWM-2 with built-in DX-ENER processor. Matching 75S-3 receiver and power

supply. Unmarked condition, all books. With or without as new D104 mike. Prefer to sell to Collins collector. Jim Davis VK7OW Ph (03) 6426 1520 for details.

MISCELLANEOUS

• Linear amp 2m needs new valves 2 x QQE06/40. Will swap for HF amp. HM, unfinished project O.K. or any HAM junk. Vic VK4AXM QTHR Ph (07) 3287 5655

• Will give away vintage Philips VCR model N1512 s/n W D07 709A/1000 379 with handbook. Yuri VK5ZYS QTHR Ph (08) 8445 8492

• If you got your licence before 1975, you are invited to join the Radio Amateurs Old Timers Club. A \$2.50 joining fee plus \$8.00 for one year or \$15.00 for two years gets you two interesting Journals a year plus good fellowship. Arthur Evans VK3VQ or Allan Doble VK3AMD can supply application forms. Both are QTHR in any Call Book

• The WIA QSL Collection (now Federal) requires QSLs. All types welcome, especially rare DX pictorial cards, special issue. Please contact the Hon Curator, Ken Matchett VK3TL, 4 Sunrise Hill Road, Montrose Vic 3765, tel. (03) 9728 5350

TRADE ADS

• AMIDON FERROMAGNETIC CORES:

For all RF applications. Send business size SASE for data/price to RJ & US Imports, PO Box 431, Kiama NSW 2533 (no enquiries at office please ... 14 Boanyo Ave Kiama). www.cyberelectric.net.au/~rjandusimports

Agencies at: Assoc TV Service, Hobart; Truscotts Electronic World, Melbourne and Mildura; Alpha Tango Products, Perth; Haven Electronics, Nowra

• WEATHER FAX programs for IBM XT/ATs *** "RADFAXZ" \$35.00, is a high resolution short-wave weather fax, Morse and RTTY receiving program. Suitable for CGA, EGA, VGA and Hercules cards (state which). Needs SSB HF radio and RADFAX decoder. *** "SATFAX" \$45.00, is a NOAA, Meteor and GMS weather satellite picture receiving program. Needs EGA or VGA & WEATHER FAX PC card, + 137 MHz Receiver. *** "MAXISAT" \$75.00 is similar to SATFAX but needs 2 MB of expanded memory (EMS 3.6 or 4.0) and 1024 x 768 SVGA card. All programs are on 5.25" or 3.5" disks (state which) plus documentation, add \$3.00 postage. ONLY from M. Delahunty, 42 Villers St, New Farm OLD 4005. Ph 07 358 2785.

<http://www.hamsearch.com>
a not-for-profit site that is a search engine for hams

ADVERTISERS INDEX

ACA.....	21
Andrews Communication Systems	45
Dick Smith.....	28, 29, OBC
Icom.....	14, IBC
Tower Communications	49
WIA Call Book.....	49, IFC

New Associate Membership available to the Old Timers Club

For a number of years the requirement for membership of the Radio Amateurs Old Timers Club Australia has been to have held, or been qualified to hold, an amateur radio licence for a minimum of 25 years.

Bearing in mind the number of operators who have taken up the hobby of amateur radio relatively late in life due to pressure of family or business, it has been decided to create a grade of associate membership of the Club.

The qualifications for Associate Membership are to be aged 60 years or more, and to have held, or been qualified to hold, an amateur operator's licence for a minimum of 10 years.

Associate Members will receive the two issues of the Club's highly regarded magazine, OTN, which is published in March and September of each year, but will not be entitled to vote or hold office in the Club. Full membership will be automatic when the 25 year target is

reached provided, of course, that subscriptions are up to date.

Current subscriptions, which fall due on 1 April each year are a joining fee of \$2.50 and an annual subscription of \$8.00 (or \$15.00 for two years). Life Membership is available for \$100.00.

Application forms, complete with details of the Club's Constitution, are available from the Honorary Secretary, Arthur Evans VK3VQ, 3/237 Bluff Road, Sandringham Vic 3191 on receipt of a stamped, self-addressed envelope.

Telephone enquiries will be welcomed by the Secretary, Arthur Evans VK3VQ, on 03 9598 4262, or by the President, Allan Doble VK3AMD, on 9570 4610

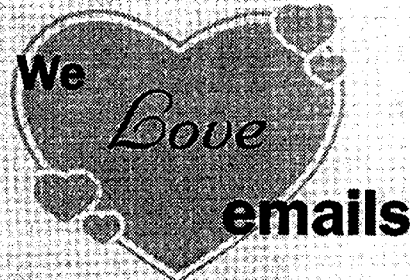
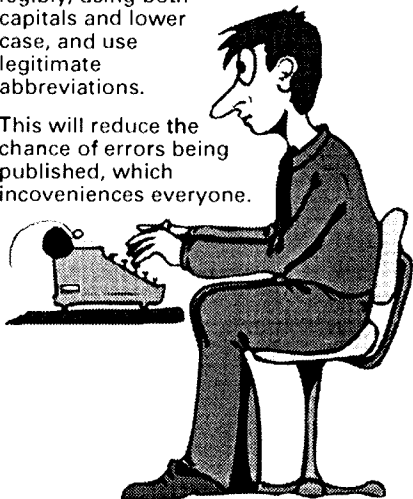
PLEASE BE KIND TO OSCAR

Meet Mr Oscar Goldenboy, our Hamad typist

Oscar is not an expert in your field — he thinks Megahertz is what happens when he stubs his toe on a rock.

To help Oscar, please write your hamad legibly, using both capitals and lower case, and use legitimate abbreviations.

This will reduce the chance of errors being published, which inconveniences everyone.



If you are emailing your Hamad, the method MUCH preferred by our typesetters, could you please assist by following these two guidelines:

- 1) Please use upper and lower case in normal text (not caps please)
- 2) Please enter the words directly into the body of the email

Have you heard this week's Divisional Broadcast?

See page 30 for times and frequencies.

TRADE PRACTICES ACT

It is impossible for us to ensure that the advertisements submitted for publication comply with the Trade Practices Act 1974. Therefore, advertisers and advertising agents will appreciate the absolute need for themselves to ensure that the provisions of the Act are strictly complied with.

VICTORIAN CONSUMER AFFAIRS ACT

All advertisers are advised that advertisements containing only a PO Box number as the address cannot be accepted without the addition of the business address of the box-holder or seller of the goods.



To Morse or not to Morse?

Is that the question?

In the hope that my previous expressions of support for CW would be read in the great spirit of Amateur Radio, I believed that it would not be either necessary or appropriate for an additional one. However, references to arrogance and anachronisms have generated a need for further comment and explanation. I can't understand why those who are opposed to CW seem to have an intense and absolute dislike for it. Therein lies an unhealthy polarisation within our sport/hobby. Those of us who use CW don't get angry at other forms of transmissions. So why does the reverse seem to apply?

When I look at the Olympics and I see Archery, Javelin, Shot put, Rowing and Fencing, to name a few, I see a great parallel in anachronisms which relate to CW. Our anti CW fraternity may well look closely at those activities and question why the Olympic movement keeps them when we are trying to do away with CW. People nowadays are more interested in our heritage than ever before.

I recently conducted a "look see" day for members of my fishing club at my shack. Without exception, the interest was in the CW side of things. It is not a great feat to create a voice communication in this modem age. Clearly, technology has caught up with us and our supporters of a no CW policy are hard to fathom.

Firstly, if the anti CW fraternity have already qualified, why worry. (Maybe some of them struggled a bit and gave it up after the exam) However, that is no reason to take it out of the exam. Is it?

Secondly, it is still the cheapest and most simple form of HF communication. The term "black box operator" can just as easily apply any other form of transmission.

Thirdly, and by far the most important is that there are literally thousands of overseas operators from small countries who do not have the universal language skills nor the sophisticated and powerful equipment to communicate on DX. CW is, and will remain their main, if not major source of a DX outlet. Your only have to listen to the lower end of the band any evening. You certainly couldn't fit the same number of side band stations there, nor could you expect to understand most if you did.

These operators are very genuine and sincere people and CW contact with them is very rewarding indeed. I don't think that is arrogance.

Anachronistic or not, CW should be retained as a qualifying subject for unlimited access to our HF facility. In the meantime, when our communities outlaw some of our older Olympic sports and close down home made pottery activities and their like, I will give further consideration to the CW question.

W. P McCarthy VK4WMC

Re: Morse Code, Amateur Radio and Tripe.

I have no argument with the Morse code and CW comments of your correspondent Allan Madigan VK2OA in the September 2000 AR but when he flippantly dismissed Tripe in favour of fillet steak, my hackles fairly rose.

What right sir, do you take upon yourself to so denigrate this princely dish? I should explain that I am both an Amateur Operator with over 50 years of Ham experience, a member of the Radio Amateur Old Timers Club, a member of the WIA and a Tripe afficianado, currently holding office of Vice President of the Fremantle Tripe Club, which has just celebrated it's 154th monthly meeting. The Club has a membership of about 100 members from all walks of life; Engineers, Doctors, Reverend Ministers, Magistrates as well as Hams, clerical workers etc. We have a brother organisation in Perth, the Perth Tripe Club and often visit one another's luncheon meetings.

Our luncheon meetings on the third Tuesday of each month, are held at different venues, usually hotels or restaurants in the Fremantle area where it is known that the chef is expert in preparing Tripe dishes and the meal is usually accompanied with music from one of our members on violin with his female accompanist on piano. The traditional Tripe and Onions is always on the menu and it is left to the chef to surprise us with additional renditions and variations in Tripe dishes. A few years ago, one of our guest chefs, an ex-submarine RAN cook prepared a seven course luncheon (all Tripe dishes) ranging from Tripe soup as starter through

to Tripe sweets featuring cold (cooked) spiced Tripe served with ice cream. The courses in between consisted of deep fried Tripe, Tripe sweet and sour, Tripe pizza, Tripe sausages, and Tripe and onions. Members always vote on the meal at the conclusion of the luncheon; a vote out of a possible 20 and most meetings have an average vote of 16 to 18. We have had Tripe prepared in the English, French, Italian, Croatian and German styles and it has all been delicious. During the meal, the loyal toast, toast to Australia are drunk and at the conclusion of the luncheon, our Tripe Anthem is sung with gusto, to the tune of the Drinking Song from the Student Prince. Each November the club holds its Christmas meeting in advance on the nearby island of Rottnest and is always a great day out and good tucker as well!

So Allan Madigan VK2OA, bah to your fillet steak! Give me nutritious and flavoursome Tripe any day!

Ray Peterson VK6PW.

mailto:rwpete@ozemail.com.au

Dropping signal reports from contest exchange

If the signal report were dropped from a contest QSO exchange then the contact would no longer be valid for DXCC purposes. For this reason alone I would oppose the suggestion to drop this as part of the contest exchange. Can you imagine how many non-contester dxers would request a signal report from rare expedition style contest stations? It would be detrimental to their score!

Why don't we go the other way and accept or rather provide certificate awards for logs that have only true signal reports? How is this enforceable? It is not, just as enforcing the output power of contest stations is not enforceable. Simply publish the percentage of S9 sent reports for all stations and provide certificates for only those stations who have less than 75% S9. My experience is that less than 50% of QSOs are genuinely S9. Now before you go off the deep end, if you've got such a great station that everyone is S9 plus 20 dB, put the attenuator on so that only the VERY strongest stations are S9!

I certainly would love to get accurate reports during a contest. What a change it would be to know how strong... or weak you actually are.

Tony Burt, VK3TZ



Australian
Amateur Radio

Callbook 2001

and
Reference Guide

OUT NOW!

Callbook Listings • Frequency Listings • Band Plans • Repeater Lists • Beacon Lists • Satellite Lists • Licence Conditions • Examiner Lists • Special Interest Groups • Radio and TV Frequencies and more!

***The "WIA Call Book 2001" is now
available from
Divisional Bookshops
and selected outlets***

For further information contact your local Division, phone numbers on page 30

MORE

GREAT

GEAR

FROM

ICOM



746 A tri-bander packed with power. Powerful and versatile to satisfy all your base station needs, HF + 6m + 2m band coverage, 100 W of output power on all bands, DSP functions standard, large multi-function LCD keeps you totally informed and makes the 746 so easy to use.



2071H Switch to two bands for a single band price...

In-dash versatility, VHF/UHF capabilities (one band at a time) via a band switching system, superb clarity on either operating channel, easily detachable front panel, even a connection to a packet modem supporting speeds of up to 9600bps.



Q7A A mini unit with maximum performance. 2m/70cm transceiver/wide band receiver just 8.6 cms high, wide band receive from 30 to 1300 MHz in FM/WFM/AM modes, simple operation with easy band switching, automatic squelch, crystal clear audio.

PCR100 Cruise the airwaves with your computer. Turns your PC into a sophisticated 0.5 - 1300 MHz receiver (FM/WFM/AM modes) with plug'n play installation. Multi function control panel, wide frequency coverage, and unlimited memory channels.

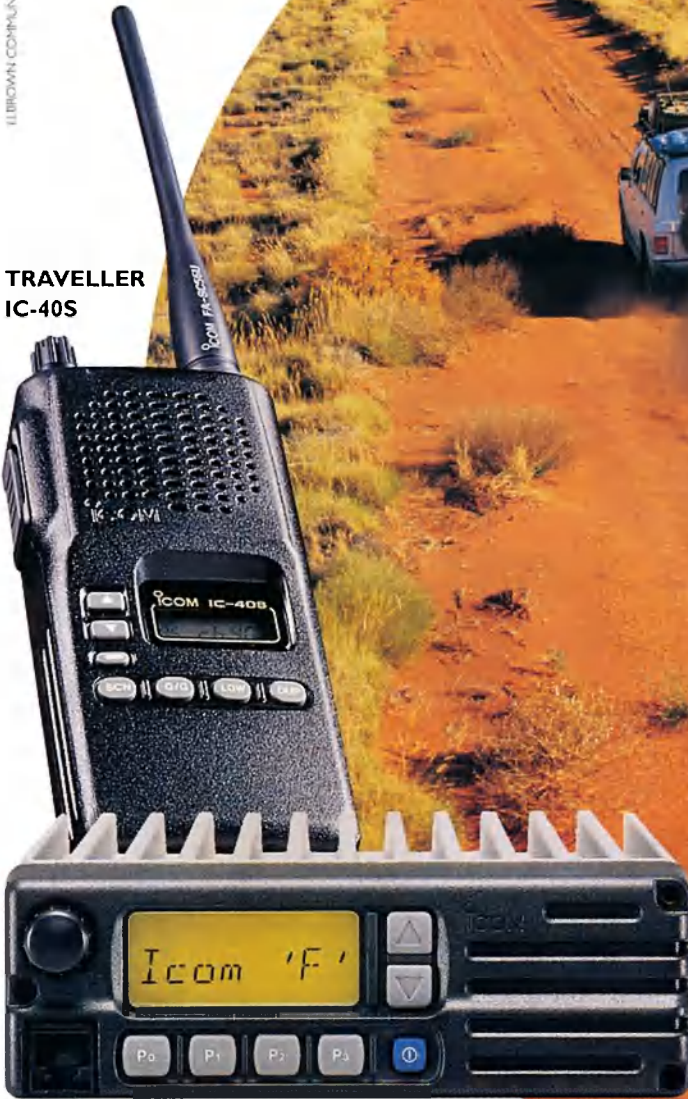
R2 Fit the world's airwaves in your shirt pocket. Just 8.6cm high, 0.5 - 1300 MHz frequency range divided into 9 bands plus FM/WFM/AM, auto squelch for consistent signal strength, 400 memory channels, great sound in rugged water resistant construction.

ICOM
Clearly Ahead

2 YR WARRANTY

For the name of your nearest accredited Icom Dealer visit our website at www.icom.net.au

**TRAVELLER
IC-40S**



Outback Travellers

TRAVELLER II IC-F2010

Icom's Traveller™ IC-40S is the wide band portable CB for the wide open spaces. And now it's joined by the Traveller II™ IC-F2010, a radio built on the same rugged architecture as Icom's legendary F Series. Both radios offer the highest levels of performance – comparable with commercial grade

equipment, and capacity for private channels if you need them (contact your Dealer for details). When you're off the beaten track you can rely on these two Icom Travellers to keep you in touch. They're rugged, reliable, and very affordable. In fact, they make the perfect travelling companions.

2 YR WARRANTY

For the name of your nearest accredited Icom Dealer visit our website at www.icom.net.au

ICOM
CB RADIOS
Clearly Ahead

▶ YAESU'S DONE IT AGAIN



HURRY!
Only 20 pieces
available at this crazy
clearance price!

Yaesu FT-100 Ultra-compact HF/6m/2m/70cm Mobile

AMAZING CLEARANCE VALUE!

Now you can enjoy the fun of operating on all bands from 160m to 70cm, either at home or in your car, and at a fantastic Yaesu price.

The Yaesu FT-100 features HF/6m/2m/70cm transmitter coverage with 100W RF output on HF and 6m, 50W on 2m and 20W on 70cm, plus you can easily mount the detachable front panel using an optional lead (YSK-100) for more convenient mobile installations. Powerful interference fighting features such as a DSP based Bandpass filter, Notch filter and Noise reduction, together with an IF based Shift control, all aid reception quality during tough conditions. A Speech Processor and VOX facility are provided for SSB users and an internal Electronic keyer is provided for CW operation. Also included are Dual VFOs, built-in CTCSS encode, 300 memory channels, all-mode operation (SSB, CW, AM, FM, AFSK, Packet* 1200/9600bps), 100kHz-970MHz receiver (cellular locked-out), and options for additional AM and CW IF filters.

The FT-100 is supplied with an MH-42B6JS hand mic, DC power lead and comprehensive instructions.

D 3285

YSK-100 remote front panel kit.

D 3286

YAESU

Included as standard:

- Digital Signal Processing on both transmit and receive
- Effective IF noise blanker
- Electronic CW keyer with 50 character message memory
- Spectrum Scope function
- Massive receiver coverage (100kHz – 970MHz, less cellular)

\$1998 **SAVE \$348**

2 YEAR WARRANTY

All prices shown are inclusive of GST. Limited stocks. Some units may be ex-demo models with minor marks, but full warranty applies.

DICK SMITH
ELECTRONICS

That's where you go!

* Requires third party TNC
Offers expire 31/12/2000.