

# Amateur Radio

Volume 81  
Number 6  
June 2013  
Price: \$8 incl GST

[www.wia.org.au](http://www.wia.org.au)



## Build a 2-tone oscillator

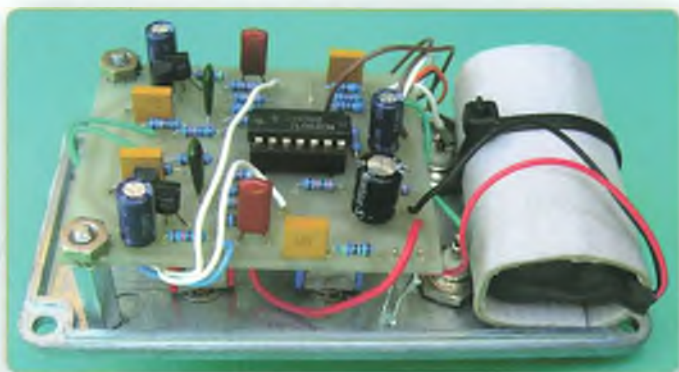

- Make use of a 27 MHz radio
- Ten Tec R4020 reviewed
- Remote operating



**The radio... YAESU**

HF/50 MHz 100 W Transceiver

# FTDX 3000

New Crystal Roofing Filters provide ultimate weak signal receiver performance in crowded, strong signal environments



## The amazing Crystal Roofing Filter performance

The Down conversion 9 MHz 1st IF frequency receiver construction, can realize narrow 300 Hz (optional), 600 Hz and 3 kHz bandwidth roofing filters.

## Outstanding receiver performance, the heritage of the FTDX5000!

The high dynamic range IP3 performance that was realized and proven in the FTDX5000.

## IF DSP provides effective and optimized QRM rejection

## Independent Frequency display

## 4.3-inch Large and wide color LCD display with high resolution

## High Speed Spectrum Scope built-in

## AF SCOPE display and RTTY/PSK encoder/decoder

Specifications subject to change without notice. Some accessories and/or options may be standard in certain areas. Frequency coverage may differ in some countries. Check with your local Yaesu Dealer for specific details.

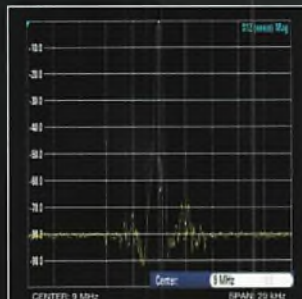

Characteristics of the Crystal Roofing Filter (300Hz)

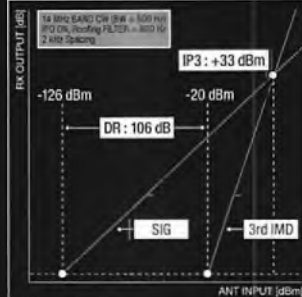

3rd Order Dynamic Range / IP3 (2kHz Spacing)

**YAESU**  
The radio

## YAESU Authorized Dealer in Australia and New Zealand

**Andrews Communications Systems**  
Shop 8, 41-51 Bathurst Street,  
Greystanes NSW 2145  
URL : [www.andrewscom.com.au](http://www.andrewscom.com.au)  
Tel: +61-2-9636-9060

**Strictly HAM Pty. Ltd.**  
14 Church Street,  
Bayswater Vic. 3153  
URL : [www.strictlyham.com.au](http://www.strictlyham.com.au)  
Tel: +61-3-9729-7656

**GEOPLEX DISTRIBUTION LTD**  
Level 1, 60 Cook Street,  
Auckland 1010, New Zealand  
Tel: +64-21 434342

## YAESU Authorized Service Center in Australia and New Zealand

**Andrews Communications Systems**  
Shop 8, 41-51 Bathurst Street, Greystanes NSW 2145  
Tel: +61-2-9636-9060. Fax: +61-2-9636-9955  
E-mail: [radioandrews@hotmail.com](mailto:radioandrews@hotmail.com)

**JNB Electronics Pty Ltd**  
St Kilda Rd Towers, Suite 1138, 1 Queens Rd, Melbourne, VIC 3004  
Tel: +61-3-9465-9399. Fax: +61-3-8682-8748  
E-mail: [yaesu@jnb.com.au](mailto:yaesu@jnb.com.au)





# Amateur Radio

The Journal of the Wireless Institute of Australia

Volume 81  
Number 6  
June 2013  
ISSN 0002-6859

## Editorial

### Editor

Peter Freeman VK3PF  
[editor@wia.org.au](mailto:editor@wia.org.au)

### Technical Editor

Peter Gibson VK3AZL

### Publications committee

Don Jackson VK3DBB  
Evan Jarman VK3ANI  
Bill Roper VK3BR  
Ewen Templeton VK3DW  
Ernie Walls VK3FM  
Peter Hartfield VK3PH

### All circulation matters

[nationaloffice@wia.org.au](mailto:nationaloffice@wia.org.au)

### How to submit material

Secretary  
AR Publications Committee  
PO Box 2042  
BAYSWATER VIC 3153  
or [armag@wia.org.au](mailto:armag@wia.org.au)

### Letters to Editor

Editor AR Magazine  
PO Box 273  
Churchill Vic 3842  
or [editor@wia.org.au](mailto:editor@wia.org.au)

### Hamads

'Hamads'  
PO Box 2042  
BAYSWATER VIC 3153  
[hamads@wia.org.au](mailto:hamads@wia.org.au)

### Advertising

All enquiries to  
Advertising Manager  
AR Publications Committee  
PO Box 2042  
BAYSWATER VIC 3153  
or [admanager@wia.org.au](mailto:admanager@wia.org.au)

### Registered Office

Unit 20 11-13 Havelock Road  
BAYSWATER VIC 3153  
Australia  
Phone: 03 9729 0400  
Fax: 03 9729 7325

### Production Deadlines

All articles, columns, hamads and advertising booking by **first day of previous month.**

The contents of Amateur Radio are Copyright  
Wireless Institute of Australia © 2013

## General

VK5 National & Conservation Parks Award	12
Paul Simmonds VK5PAS	
Remote operation	21
Rob Norman VK5SW	
Will the REAL PL-259 connector please stand up?	23
John McLean VK2KC	
Traps for old players	24
Ron Holmes VK5VH	
Great North Walk 100s –	29
Les Poole VK2APE	
Can a 'small pistol' station offer useful advice to a 'big gun' DXpedition?	32
Ernie Walls VK3FM	



*This month's cover*

*The 7 MHz traps being installed on the HARG HF beam. See VK6 News on page 41. Inset: A view inside the low distortion two tone audio oscillator by VK5JST. See page 14. Main photo by Bill Rose VK6WJ, inset by Jim Tregellas VK5JST.*

## Technical

Receive 7 MHz on a 27 MHz CB radio - make your old AM set useful again	6
Peter Parker VK3YE	
A low distortion two tone oscillator	14
Jim Tregellas VK5JST	
Review: A review of the Ten Tec R4020 QRP CW transceiver	18
Peter Parker VK3YE	
Foundation Corner 23 – Baofeng UV-5R review	25
Ross Pittard VK3CE	

## Columns

ALARA	34
AMSAT	46
Contests	57, 58
DX - News & Views	56
Editorial	2
Hamads	62
Over to You	13
Silent Key	38, 54
SOTA	48, 51
Spotlight On SWLing	55
VHF/UHF – An Expanding World	52
WIA Comment	3, 5
WIA News	4, 5
VK2 News	36
VK3 News	37, 61
VK4 News	38, 39
VK5 News	60
VK6 News	41
VK7 News	44

## Contributions to Amateur Radio



Amateur Radio is a forum for WIA members' amateur radio experiments, experiences, opinions and news. Manuscripts with drawings and/or photos are welcome and will be considered for publication. Articles attached to email are especially welcome. The

WIA cannot be responsible for loss or damage to any material. Information of house style is available from the Editor.

### Back Issues

Back issues are available directly from the WIA National Office (until stocks are exhausted), at \$6.00 each (including postage with n'Austr'a) to members.

### Photostat copies

If back issues are unavailable, photocopies of articles are available to members at \$2.50 each (plus an additional \$2 for each additional issue in which the article appears).

### Disclaimer

The opinions expressed in this publication do not necessarily reflect the official view of the WIA and the WIA cannot be held responsible for incorrect information published.

## Amateur Radio Service

A radiocommunication service for the purpose of self-training, intercommunication and technical investigation carried out by amateurs; that is, by duly authorized persons interested in radio technique solely with a personal aim and without pecuniary interest.

### Wireless Institute of Australia

The world's oldest

National Radio Society, founded 1910.

Representing

The Australian Amateur Radio Service

Member of the International Amateur Radio Union

#### Registered Office of the WIA

Andersson House

Unit 20, 11-13 Havelock Road

Bayswater, Victoria. 3153

Tel: (03) 9729 0400 Fax: (03) 9729 7325

email: [nationaloffice@wia.org.au](mailto:nationaloffice@wia.org.au)

<http://www.wia.org.au>

All mail to

**PO Box 2042 BAYSWATER VIC 3153**

Business hours: 10am - 4pm weekdays

#### National Office staff

Manager	Mal Brooks	VK3FDSL
Examination Officer	Dianne Ashton	VK3FOIZ

#### Board of Directors

President	Phil Wait	VK2ASD
Vice-President	Chris Platt	VK5CP
Directors	Philip Adams	VK3JNI
	Bob Bristow	VK6POP
	Ewan McLeod	VK4ERM
	Trent Sampson	VK4TS
Secretary	David Williams	VK3RU
Treasurer	John Longayroux	VK3PZ

#### Coordinators

AMSAT	Paul Paradigm	VK2TXX
ARDF	Jack Bramham	VK3WWW
Australian AR/ISS	Tony Hutchison	VK5ZAI
Awards	Chris Platt	VK5CP
Clubs	Ted Thrift	VK2ARA
Contests	Craig Edwards	VK6POX
John Mayle Field Day	Denis Johnstone	VK4AE
Editor 'AR'	Peter Freeman	VK3PF
EMC/EMR	Gilbert Hughes	VK1GH
Standards	Gilbert Hughes	VK1GH
	David Wardlaw	VK3ADW
	John Bishop	VK2ZOI
NTAC	John Martin	VK3KM
Historian	Peter Wolfenden	VK3RV
IARU Region 3 Liaison	Chris Platt	VK5CP
Monitoring Service	Peter Young	VK3MV

#### ITU Conference & Study Group

	David Wardlaw	VK3ADW
	Brett Dawson	VK2CBD
	Dale Hughes	VK1DSH

#### QSL Curator

Repeater	National Office	
	Peter Mill	VK3ZPP
	Richard Carveny	VK2AAH
Webpage	Robert Broomhead	VK3DN

#### Emergency Communications Group

Coordinator	Phil Wait	VK2ASD
Members	Ewan McLeod	VK4ERM
	Peter Young	VK3MV



## Editorial

Peter Freeman VK3PF

### Australian amateurs honoured abroad

At its Annual General Meeting on 20 April 2013, the Radio Society of Great Britain honoured two Australian amateurs: Phil Harman VK6APH and Andrew Martin VK3OE. Phil and Andrew were awarded the Wortley-Talbot Trophy for 2012. The Wortley-Talbot Trophy is awarded for outstanding experimental work in amateur radio. In this instance, it recognises the work of Phil and Andrew in developing "Chirp modulation". Readers will recall the outstanding article *Adventures with a bistatic chirp and CW radar* prepared by Andrew which was published in the December 2012 issue of *Amateur Radio*. The technique has already shown unexpected results in investigating ionospheric propagation at 10 and 6 metres and has potential to explore other propagation modes. Readers will be aware that Andrew has previously shared significant insights into tropospheric propagation at VHF and above. Many will be aware of the contributions made by Phil in the sphere of Software Defined Radio, and especially in the *hpsdr* project.

Drew Diamond VK3XU has been inducted into the QRP ARCI Hall of Fame. The induction occurred at the QRP ARCI Awards Banquet at approximately 7 pm EDT on May 18 (0900 on May 19 in Wonga Park) during the Dayton Hamvention. The induction recognises contributions over 40 years in the fields of QRP, home construction and CW operating, and in particular Drew's willingness to share his knowledge through publications, particularly through his articles published in *Amateur Radio*.

All at the WIA, and I am sure all readers of *AR*, congratulate Phil, Andrew and Drew for the recognition of their achievements by prominent amateur radio organisations overseas.

### Advancements in radio technology

We are seeing significant developments in amateur radio technology. The main commercial brands are bringing out new model transceivers, especially in the VHF/UHF arena. There are moves towards different digital modulation methods promising higher performance voice communications, with a variety of largely proprietary components in use in the different systems. We also have the work done largely in VK5 on an open source CODEC for low bit-rate, high quality digital voice communications. At GippsTech last year, we had a presentation on a digital voice SSB mode under development that would allow for the graceful degradation of a communications link as signal to noise ratio declined.

Many readers will be aware of the significant advancements in recent times in the field of software defined radio. We have seen the development of the FunCube Dongle, together with the development of software which allows cheap USB dongles designed for reception of television signals to be used as multi-frequency, multimode receivers across the VHF and UHF spectrum. With the addition of simple up-converter mixers, these units can

Continued on page 5





## WIA comment

Phil Wait VK2ASD

### The Foundation licence – a strategic view

Last year, just before he passed away, Michael Owen wrote a President's Comment about the Foundation licence. He said, "The Directors would like to know the opinion of amateurs generally on the Foundation licence, and whether there should be any changes".

The WIA received a number of comments, mostly arguing for increased privileges for Foundation licensees, especially in relation to power and digital modes. Some suggested that the 4-letter F-call was confusing, especially when contacting overseas stations, and should be changed to a 3-letter call with a different prefix.

Since Michael's comment, the VK-Logger forum has logged 13 pages of posts to the question "Should changes be made to the Foundation licence", and consistent with comments sent directly to the WIA, increased power and digital modes are the most common suggestions. Although, it must be said that is not a unanimous view.

Any discussion about the Foundation licence, and ultimately the entry-barriers to amateur radio, needs to take a strategic approach. The Foundation licence was intended to be, and still is intended to be, an easier entry into amateur radio with the hope that Foundation licensees will eventually upgrade to Standard or Advance licences.

Indeed, quite a large proportion of Foundation licensees have upgraded, but naturally there is also a lot of churn as some drop out of the hobby altogether.

There is no doubt the Foundation licence has been a positive development for amateur

radio in Australia, and it certainly has bolstered the total numbers and encouraged higher levels of on-air activity. However the 'pent-up demand' from the pre-Foundation licence years has probably now been satisfied and, together with the ageing amateur population, I expect we are entering a period where the total numbers of Australian radio amateurs will start to decline. Australia is not alone; this is a likely feature of most western nations.

(Having said that, the good news is we have seen an early pick-up in Foundation courses and assessments so far this year, so hopefully that will continue).

When I was a kid, amateur radio was about the only technically based hobby I could get into, and then only because of a local amateur in my neighbourhood, Muriel VK2AIA. It was simply luck that I found it/her.

Now technically inclined kids have a multitude of hobby options mostly related to computers and the internet, where entry-barriers are very low and networking with like-minded people anywhere is just part of the scenery. Talking around the world via amateur radio must look very passé to them, and it also comes with a significant entry barrier.

Convincing significant numbers of young people to take up amateur radio sounds like a very hard call to me. Things have certainly changed.

However, I do think there are emerging opportunities. The "maker-space" or "do-it-yourself" movement is one area where the benefits of amateur radio could be promoted, especially using some of the new digital modes. A recent news item on the WIA website shows how to

use a \$35 Raspberry Pi computer to generate low power WSPR signals directly into an antenna - with nothing else needed except a good quality low-pass filter.

My personal view is that there is an opportunity for amateur radio amongst technically savvy people wanting to use the capabilities of amateur radio as a tool to do something else that interests them. I'm not saying that amateur radio should move away from its traditional areas we all know well – having a chat, DX and contesting etc. – but I do think the 'scope' of amateur radio needs to expand somewhat to take into account the new types of hobby technologists.

If you share that view, it does seem rather counter-productive to have an entry-level licence intended to attract technically savvy people into amateur radio, which at the same time limits them to old technologies. That's why I'm inclined to think the Foundation licence should include digital modes, but naturally that depends very much on the ACMA.

The obvious question is – how do we attract these new technically savvy people to amateur radio in the first place? Answer, probably not through conventional amateur radio channels like radio clubs, but possibly through social media. That's why we have included a social media group in our new WIA committee system.

One argument against introducing digital modes to the Foundation licence is that the extra study required, to ensure digital transmissions are not over modulated and do not cause

Continued on page 5

## Amateur radio antennas and masts in NSW

On 19 April, Roger Harrison VK2ZRH reported:

For all New South Wales amateurs waiting to hear what the NSW planning department is doing about amateur radio antennas and masts, I have some news for you. Last week I had a discussion with one of our contacts in NSW Planning & Infrastructure. There's some good news and some not so good news.

The good news is: NSW amateurs will get pretty much what was wanted.

That is – antennas and masts up to 10 metres height will be an exempt development within residential zones R1 to R5. There will be no need for a development application to your local council, or a consent certificate, provided the structure meets a few simple parameters – such as complying with Australian Standard AS 1170, footings to comply with Australian Standard AS 3600, the structure positioned at a specified set-back from the nearest boundary depending on its height, and so on.

Because it will be a code within a State-wide Environmental Planning Policy, it cannot be overridden by local councils. We will know more about the detail later, and hope there aren't too many devils in that detail.

You will have to be patient for it to become law – that's the not so good news.

I was informed that, in relation to the planning regulations that affect us (and many other stakeholders as well), the legal branch of the department will be submitting the revisions to the parliamentary counsel – the people who actually draft the legislation – by the end of the second quarter this year. That means June. When the parliamentary counsel completes its work, it will be recommended to the NSW Governor, who will make the legislation, which will then be

gazetted some time later this year.

However, the legislation will not come into effect for another six weeks after that, to allow time for local councils and other organizations to become familiar with it. Maybe, just maybe, amateurs in NSW will have a Christmas present!

Our contact in the planning department said that they had enjoyed the input from the "amateur communications lobby". However, he did say that it would not be productive for you all to continue writing. Further letters to the department, the NSW Minister for Planning, or your local member – even just "thank you" letters – would only necessitate them taking time out to write replies, rather than concentrating on the important work of completing the legislation.

If you want to write or email your thanks or comments, send them to WIA President Phil Wait VK2ASD. The Institute will, at the appropriate time, convey everyone's thanks to the planning department and the minister.

I must congratulate and thank everyone – individual amateurs and radio clubs alike – who went to the effort of making a submission during all the phases of the NSW Planning System Review over the past 18 months and also writing to your local members last year. All the effort has paid off.

I expect that, in a few years, amateur antennas and masts will rise up across metropolitan and regional suburbia like the quills on a feral echidna! Or, to paraphrase a famous misquote: "Let a thousand antenna masts bloom!"

## World Amateur Radio Day – 18 April 2013

As reported on the VK1WIA broadcasts, each year World Amateur Radio Day is celebrated under a theme. This year it was: *Amateur Radio: Entering Its Second Century of Disaster Communications*. The theme for 2013 was chosen by the International Amateur Radio

Union (IARU) to commemorate the first known use of amateur radio in a disaster situation.

A 15-year old student, Herbert V. Akerberg, from Ohio USA, is believed to be the first person to use amateur radio to call for help during a disaster. In March 1913, the Scioto River in Ohio flooded its banks, killing more than 100 people. The flood destroyed bridges and swept away telephone and telegraph lines. The Columbus Dispatch newspaper reported that Akerberg used his home radio transmitter to send SOS calls via Morse code. For about three days and nights he manned his rig, sending out many messages as the area was isolated and damaged.

The ARRL reports that his efforts were "highly commended by the city authorities and his achievement widely heralded over the country as a new contribution to the comparatively new science of radio." Herbert Akerberg passed away in Scottsdale Arizona on November 6, 1964.

A number of special event stations were on the air to mark the occasion, including 4A8DMR, Mexico, QSL via N7RO and LoTW; CR5IARU, Portugal, mounted by REP; Portugal's IARU Member Society, QSL via CT1REP (bureau or direct); KP4FD, Puerto Rico, the Puerto Rico Field Day Group was on-air from the Emergency Management Agency of the city of Cataño, Puerto Rico, QSL via LoTW; and ZL2WARD, New Zealand, the Wellington VHF Group was on-air on The National System and possibly on other bands. The National System is a network of linked 70 cm repeaters, which operate to provide a single voice channel that covers much of New Zealand. Details online at [www.vhf.org.nz](http://www.vhf.org.nz)

## The WIA 2012 financial report online

WIA members can now view the WIA 2012 financial report on the WIA website; it has been placed



on the website as a member's only accessible file. You can view it using your WIA member login. Your member login is your membership number and your chosen password. If you do not yet have a member's login and password all you will need is a copy of your latest AR magazine mailing slip and simply go to the member's registration page accessible at: [https://www.wia.org.au/members/details/first\\_use.php](https://www.wia.org.au/members/details/first_use.php)

A recent change to the Australian Corporations Act 2001 means public companies and associations with less than \$1 million turnover can elect to have

their financial accounts 'reviewed' rather than 'audited' (for details of this change, see [www.asic.gov.au](http://www.asic.gov.au)). Although the process of investigating the accounts is similar, the less formal review process is significantly less expensive. The changes also allow small corporations such as the WIA to make financial accounts available to members on request, rather than having to mail every member a printed set of accounts. These two changes will provide savings of almost \$4,000 annually to the WIA.

The 2012 financial report can be downloaded from the "About

the WIA" information page on the WIA website. It is a "members only" file, so as mentioned above you will need your member's login password. The "About the WIA" web page can be accessed from the "About the WIA" drop down menu on the WIA website and click the "Information About The WIA" menu option. The report was also distributed at the WIA's Annual General Meeting in Perth. Members who would like a printed copy of the financial report should request a copy from the WIA office.



## WIA comment

Continued from page 3

interference, would make it harder to obtain, indeed almost as hard as a Standard grade licence and therefore departing from the original concept of an easy-entry licence. Perhaps that could be addressed by introducing a digital endorsement to the Foundation licence, or a series of endorsements for various licence extensions.

So, what do you think? The Committees and the WIA Board

have been in active discussion for some time about the complex issues and implications of suggesting changes to the Foundation licence. Maybe you have your own suggestions, but discussion alone does need to come to a conclusion by October this year.

Phil Wait VK2ASD

*Other areas where amateur radio can provide a real benefit are for remote-area travellers, 4WD clubs, yachties, grey nomads etc. Amateur radio could also be a very useful tool for students and researchers studying wireless technologies, partly due to its universal access to spectrum. More emphasis needs to be placed on recruitment from these areas.*



## Editorial

Continued from page 2

be used on the HF spectrum. Of course, much of the heavy-lifting technology is down to the PC hardware and software – not cheap, but prices are dropping and at least the hardware can be used for many different tasks.

In previous editorials I have mentioned the *hpsdr* project. The latest hardware recently started shopping from India – a company called Apache Labs has started shipping three different models of SDR radio, all with their roots in the *hpsdr* project: Anan-10 and Anan-100, based on the Hermes SDR transceiver, and the Anan-100D, based on a development of the Hermes board which includes two separate receiver input channels.

The transceivers look odd – they have almost no knobs, dials or displays – these functions are relegated to the controlling PC or similar device.

From what I have been reading, some are having some issues with resolving a variety of issues, many related to the software driving the SDR hardware and firmware combination. Overall, the reports on the Hermes board and its Anan-10 sibling look very promising. Many recipients of the recently shipped Anan-100 and Anan-100D are talking about their satisfaction with their new arrivals. The volunteers behind the *hpsdr* project are continuing to work on the software and the future looks bright.

Of course, there are other

players in the game. We have seen reviews of the FlexRadio SDR transceivers in AR in the past and they are working on new models. Of course, there are other players also in the mix. There are at least a couple of "crowd-funded" projects in the wind, offering broad frequency coverage into the VHF, UHF and low microwave frequencies, but only at low transmitter output powers.

With all these developments, one can only imagine what changes we will see in the near future – for how much longer will we be buying transceivers with lots of buttons, knobs, dials and a single small display?

Until next month.

Cheers,

Peter VK3PF



# Receive 7 MHz on a 27 MHz CB radio - make your old AM set useful again

Peter Parker VK3YE - [www.vk3ye.com](http://www.vk3ye.com)

27 MHz AM CB has had its day. A flick through the channels will reveal only noise and occasional garbled SSB, even in a major city. Everyone's moved to UHF, mobile phones or Skype and sets are rarely seen in shops. Almost the only place you'll find them is at hamfests, where they sit in dusty piles, unloved and unsold, under vendors' tables.

Yet an AM CB contains many useful parts for the builder, such as RF transistors. And if still working, the receiver strip can simplify receiver construction. Performance is passable and a small up-converter will allow HF amateur reception.

This article describes such a converter. It shifts incoming

40 metre (7 MHz) amateur and broadcast signals up to 27 MHz for reception on a standard AM CB. Beginners and Foundationers can readily build it as all parts are obtainable, it's a receiver only and no internal modifications to the CB are needed.

## The CB

The first thing you'll need is a 27 MHz CB. AM sets are cheap and most commonly found, but don't pass up an AM/SSB unit if available. Choosing an SSB set will make the converter simpler to build. 18, 23 or 40 channel sets will all work for 7 MHz amateur reception, with the full 40 channels only needed for shortwave broadcast reception. Get a set with a rotary knob or dial as these are easier to tune than the up/

down buttons on cheaper newer radios.

To test, apply 12 volts, un-squelch, and turn volume to maximum. A few metres of wire in the antenna socket should make the receiver come to life. If not, your set may need the microphone plugged in even for receive. Try to find a radio complete with microphone for this reason. Otherwise you may need to bridge certain microphone socket pins to allow reception.

## How it works

The converter is about the simplest possible. Short cuts are possible because CBs are sensitive and selective enough without much extra amplification or filtering needed.

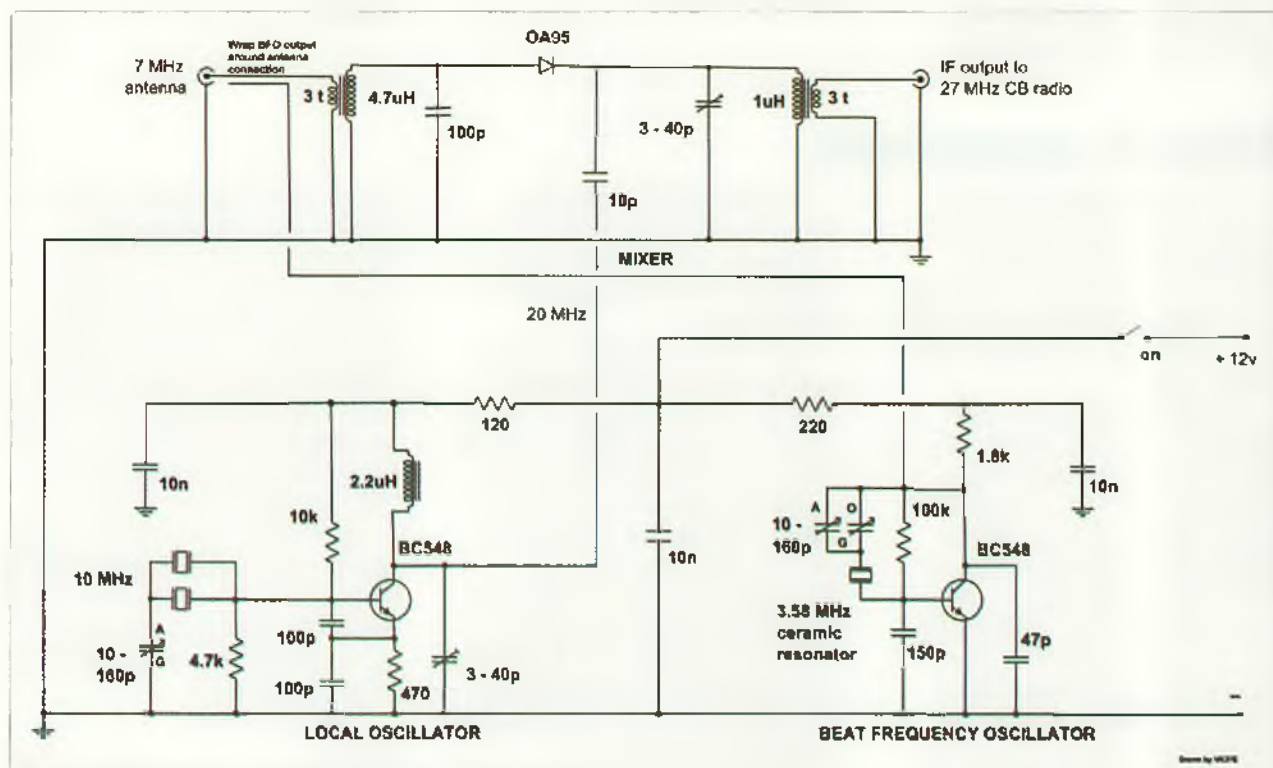

Figure 1: 7 to 27 MHz converter circuit diagram.



## Front end

Incoming signals from the antenna are fed via a primary coupling winding to the front end tuned circuit. This comprises a 4.7  $\mu\text{H}$  RF choke in parallel with a 100 pF capacitor. To prove these values are correct do an internet search for 'tuned circuit calculator' and enter inductance and capacitor values. The result will be a resonant frequency around 7 MHz.

As this is a parallel tuned circuit, signals much different from 7 MHz will be electrically shorted to earth. The 100 pF capacitor reduces signals much about 7 MHz, with the cut increasing with frequency. Whereas the 4.7  $\mu\text{H}$  choke reduces signals much below 7 MHz, with its effect increasing at lower frequencies. Only desired signals around 7 MHz escape this attenuation and proceed at full strength to the RF mixer stage.

## Mixer

The mixer circuit looks a lot like a germanium diode crystal set, with some important differences. The most important is that crystal sets select only one incoming RF signal, with the diode stripping off (or demodulating) the amplitude modulated component to produce an audio frequency signal.

In contrast diode mixers are fed with two incoming signals, with several product signals appearing on the output. All outputs are related to the inputs, with the two main ones being the sum and difference of the input frequencies (in this case 27 and 13 MHz). Just the sum frequency is desired, with the 1  $\mu\text{H}$  and trimmer capacitor tuned circuit presenting 27 MHz only to the CB's receiver.

## Local oscillator

A stable 20 MHz source is needed here. Because 20 MHz crystals are less common than 10 MHz types, this signal is generated with a 10 MHz oscillator whose output is tuned to the second multiple.

The tuned circuit is formed by the 2.2  $\mu\text{H}$  RF choke and the trimmer between collector to earth. The 10 nF capacitor from the top end of the choke effectively earths it (as far as RF is concerned) so it behaves like a parallel tuned circuit. 20 MHz RF to the mixer is tapped off via a 10 pF capacitor.

A fixed frequency oscillator would work if we just wanted to tune forty spot frequencies. However, unlike CBers with set channels, amateurs operate anywhere in the band, so continuous tuning is required. So the 20 MHz needs to be varied slightly to tune the spaces between channels. Most 27 MHz CB channels are 10 kHz apart with a few 20 kHz gaps. A 10 kHz shift will mostly suffice, with 20 kHz guaranteeing full coverage.

20 kHz on 20 MHz requires 10 kHz on 10 MHz. This is a substantial shift for a variable crystal oscillator, so two crystals are paralleled for increased range. The circuit shown tunes 20.000 - 20.020 MHz, though expect some variations between crystals. It doesn't matter

**Electronics  
Enthusiasts**  
**ONE-STOP-SHOP**

**Jaycar**  
Electronics  
Better. More Technical.

### Deluxe Large Screen Power Meter

Monitor the energy consumption of an appliance to see what it is costing you to run.

- Large LCD screen
- Displays wattage, voltage and cost usage
- Supplied with 1m extension cable
- Size: 159(L) x 73(W) x 38(H)mm

**\$29.95**

**NEW  
2013**



### Gas Leakage Detector

Run a quick check over your house or gas powered devices to make sure all outlets are safely sealed. Hold the power button for a few seconds and then place the detector near the suspected leak and visual/audible warnings will sound if the leak is bad, moderate or safe. Red (Hi), orange (Lo), and green (safe) LEDs denote the severity of the leak.

- Requires 2 x AAA batteries
- Sensor detects butane, propane, acetylene, and methane (natural gas)
- Size: 165(L) x 27(W) x 21(D)mm

**\$39.95**

**NEW  
2013**



### 140A Dual Battery Isolator (VSR)

Allows two batteries to be charged from your engine alternator at the same time.

The isolator automatically engages and disengages depending on the charge condition of the start battery, ensuring that you always have enough charge in the start battery to crank your engine.

MB-3686

Two models available:

Isolator only MB-3685 \$79.95

Isolator and Wiring Kit (shown) MB-3686 \$139

**FROM  
\$79.95**

**NEW  
2013**



### Arduino Experimenters Kit

Page 32 of Amateur Radio April described a 'Dead Band Operator' using an Arduino microcontroller. As the article describes the versatile Arduino circuits could also be used to add remote control to antenna systems, beacon, repeater and foxhunt transmitter controllers, etc. A great place to learn about Arduino is with our Experimenters Kit. Complete with instructions and supporting web pages to create projects from flashing an LED to moving things with a servo. See website for more details.

**XC-4262**

**\$89.95**



### Desk Mount LED Laboratory Magnifier Lamp

High quality, all metal frame construction magnifier which features 90 super bright LEDs and handle for quick repositioning. A great tool to assist PCB assembly/inspection, jewellers, stamp/coin dealers, etc.

- Mains powered
- 3 diopetre magnification
- Total extended length 300mm

**\$119**

**NEW  
2013**



Prices valid until 30 June 2013

**Phone Orders 1800 022 888**  
**www.jaycar.com.au**

very much if it tunes a 20 kHz segment slightly lower (say 19.990 – 20.010 MHz) or you only get an 18 kHz range. However there will be implications for dial calibration, discussed later.

### Beat frequency oscillator

The converter described so far tunes 7 MHz, with the variable crystal oscillator allowing all-frequency coverage. In the early morning and evening 7 MHz AM broadcast signals should be audible, with the occasional AM amateur during the day. In eastern Australia most amateur AM is on 7.125 MHz, with the VK2WI Sunday broadcast audible on 7.146 MHz. SSB will sound as 'duck talk', unless your CB is SSB, in which case signals will be readable in the LSB position.

For SSB reception on an AM CB, you'll need a beat frequency oscillator. This locally replaces the carrier signal that was removed in the transmitter when the SSB was generated. The BFO is a one transistor RF oscillator that happens to have a harmonic on 7 MHz. It uses a 3.58 MHz ceramic resonator pulled by a variable capacitor to cover 3.520 to 3.600 MHz. Its harmonic neatly provides a 7.040 – 7.200 MHz beat carrier tunable over the SSB segment.

Because the BFO's output is applied at signal frequency rather than the receiver's fixed intermediate frequency, it will need to be readjusted with every change to receive frequency. It was chosen here as it has the benefit of not needing modifications done to the CB.

### Parts, construction and testing

The converter is too simple to need a printed circuit board. Instead earthed component leads are soldered to the copper side of an un-etched board, with other parts being supported between them. Small pads of circuit board material glued to the main board provide insulated connection



Photo 1: Converter in use with 27 MHz AM CB.

points for input, output and control connections.

Construction is not critical and there is little alignment. The main thing is to observe component polarities and not apply excessive heat as this can damage some parts, such as trimmer capacitors. For this reason it's a good idea to sandpaper the main board until shiny to ensure good solder take-up. Only a general coverage short wave receiver is needed to test oscillator operation.

All parts are commercially available in Australia. Jaycar and Altronics can supply most, with the crystals and ceramic resonator available from Rockby Electronics.

RF chokes that look like fat resistors form the coils. The 7 MHz antenna input and 27 MHz CB output are both three turns of enamelled wire wound over the middle of the choke. The wire can be about 0.5 mm diameter and is commonly found in old transformers.

The transistors can be any small signal general purpose NPN type. Any germanium signal diode (as used in crystal sets) will work in the mixer. All resistors are ¼ watt 5%

tolerance and no values are really critical. Fixed capacitors are all disc ceramic. Only the smaller values need to be exact.

Start building with the 20 MHz local oscillator. The tuning capacitor's G terminal is earthed while the A lead goes to the crystals. Apply power and test that it's operating with a 10 MHz receiver. Its output frequency should vary as its tuning capacitor is moved. There should also be RF output indicated if a metered RF probe is connected to the coupling winding over its choke.

Find the harmonic on a 20 MHz receiver. Adjust the oscillator's collector trimmer capacitor for maximum indicated signal on 20 MHz. It is quite normal for the oscillator frequency to vary slightly when making this adjustment. Next assemble the diode mixer and its two tuned circuits. This won't take long but do be careful not to overheat components, particularly the RF chokes.

Check wiring then apply power, CB antenna and antenna connections. Don't press the PTT as applied RF may damage the diode mixer. Provided it's after dark you



should hear 41 metre broadcast stations as you flick through channels 20 to 40. Adjust the fine tuning control if any sound off tune. 40 metre amateur SSB is most common between about channels 8 and 20.

To make out this SSB with an AM-only set you'll need a beat frequency oscillator, which is the next stage. Construction is similar to the local oscillator. The tuning capacitor's O and A terminals are bridged to ensure both sections are paralleled for optimum coverage.

There is no electrical connection between the BFO output and the rest of the converter. Instead enough RF is coupled into the front-end by a 10 cm length of insulated wire connected to the BFO's collector. This wire is routed near the antenna connection, with a couple of twists if necessary.

To prevent 'hand capacity' making tuning touchy, there must be shielding between the BFO adjustment capacitor and the tuning

knob on the front panel. This will be taken care of if using a metal case or an earthed metal front panel. Alternatively a small piece of earthed aluminium, tinplate or copper circuit board material behind a plastic front panel will suffice.

When power is applied the BFO should produce a carrier signal tunable from about 3.52 to 3.6 MHz, which when doubled covers the 7 MHz SSB segment. A calibrated receiver is useful for this test. If low end coverage is lacking make the 47 and 150 pF capacitors larger values.

Another check is to receive the BFO on the CB and converter. Set it to about channel 15 and adjust the BFO's tuning control. You'll hear the CB go quiet, with almost no noise if the BFO's output wire is tightly wrapped around the antenna connection inside the converter. Flicking to other channels will make the receiver noisy again.

Find the dead spot on other channels by readjusting the BFO.

If its range is sufficient you should be able to hear it between about Channel 8 and Channel 20. If not its range is insufficient for general SSB reception and you'll need to adjust the 47 pF and 150 pF capacitor values to change the range.

Tuning in an SSB signal requires use of three controls. Firstly there's the coarse tuning with the CB channel selector. Then there's finer tuning with the local oscillator adjustment. This is set for maximum volume of 'duck talk' on the signal.

The signal only becomes intelligible when the BFO is correctly set. Turn its tuning control until the receiver goes quiet and very carefully adjust the BFO for an intelligible signal. If the BFO's effect can be heard but its effect isn't much then coupling is too loose and you need to wind more of the BFO's output lead over the antenna connection. Conversely if the receiver goes too quiet then the BFO is over coupled and the lead can be unwound or shortened.

# TET-EMTRON



**Kevlar Wire!!!**

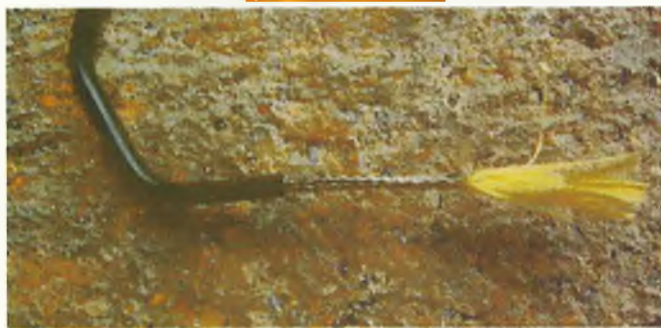

**TET-Emtron**  
**47 Ocean Drive,**  
**PORT DENISON,**  
**W.A. 6525**  
 See our wide range of new parts and  
 products at:-  
**[www.tetemtron.com.au](http://www.tetemtron.com.au)**

Super flexible, strong, Kevlar cored tinned copper wire for making dipoles, OCFeds, G5RVs and any other wire antenna. Can support the weight of a human (well me, anyway) so it will not stretch and will not break. Perfect for portable antennas as it will not kink up or twist when you want to wind it up or lay it out. Will wind easy on to the cable winder or a roll.

Colour: Drab Olive.  
 Jacket O.D. 3.00 mm PVC  
 Radiator: 16 x 3/0.12 mm Flexible  
 tinned copper braid.  
 Filler: 1500D Kevlar x 9c  
 Tensile Strength: Better than 75 kg  
 Weight: 15 grams per metre.  
 Power: 1 kW PEP

**More and more Home Brew parts every month!!!**

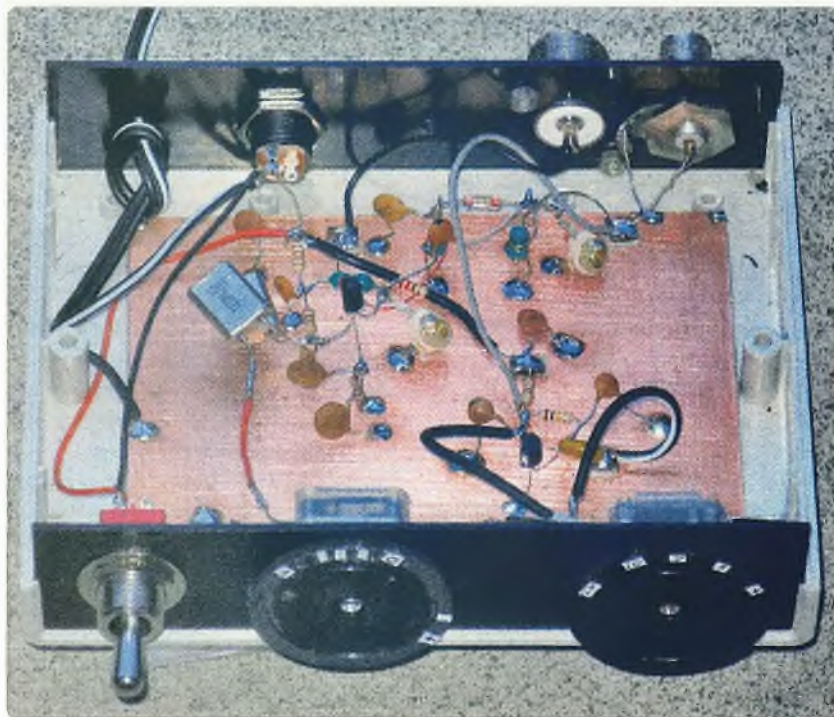

Photo 2: Inside the converter.

There should be a point when, with careful adjustment, the SSB signal is plainly audible. Only a little practice will be needed to master tuning and get good reception.

### Calibration

It's worth calibrating both the converter's tuning controls. This can provide a frequency indication with about 5 kHz resolution – better than the crude dials often found on homebrew receivers. For this job you'll need an HF receiver or transceiver with digital readout.

Ideally your local oscillator should cover 20.005 MHz, with a range of 10 kHz either side. However this doesn't matter very much, and as noted before mine tunes 20.000 – 20.020 MHz.

What's special about 20.005 MHz? Inspect a channel/frequency table for 27 MHz CB. You'll notice all frequencies end in .xx5 MHz. Now compare frequencies with channels above about channel 20. Apart from one or two out of sequence there's a pattern. For instance channel 26 is 27.265 MHz, channel 31 is 27.315 MHz and so

on.

Subtract 20.005 MHz to arrive at the 7 MHz receive frequency. 7.260 MHz will appear on channel 26 and 7.310 MHz on channel 31 respectively. This neat arrangement only happens with 21.005 MHz and breaks down on the lower channels (due to some 20 kHz channel gaps).

Calibrating the local oscillator tuning control allows a better estimate of frequencies either side. The setting that produces 20.005 MHz should firstly be marked as 0. Mark 20.000 MHz as +5, 20.010 MHz as -5, 20.015 MHz as -10 and 20.020 MHz as -15. 19.995 MHz should be +10 if your local oscillator goes this far down.

As normal with VXOs, tuning is non-linear with many frequencies crowded at one end. If this makes it too hard to attach a numbered dial, use thin pieces of paper to mark each five kHz step either side of the 20.005 MHz centre frequency (marked as 0).

To read the frequency look up the frequency that corresponds to the CB's channel and add or subtract according to the local

oscillator's dial. For example, Channel 14 on 27.125 MHz corresponds to a receive frequency of 7.120 MHz. If the local oscillator dial is set to -5 then that means you're monitoring 7.115 MHz. Similarly +5 would be 7.125 MHz. This becomes second nature with practice, though a look up table on the case is helpful for lower channels where it's a little less clear.

### Improvements and modifications

Overall performance is quite good and exceeds that of a regenerative or direct conversion receiver made from the same number of parts. However you may encounter times when strong incoming signals swamp the BFO and sound ragged. At other times the BFO may swamp very weak signals. Either an RF gain control in the antenna lead or a means of varying BFO – antenna lead coupling will allow levels to be optimised.

Substituting other crystals would allow coverage of different amateur and shortwave broadcast bands. The tuning range can be calculated by subtracting the crystal's frequency from the CB's 26.965 – 27.405 MHz range. For example a 12 MHz crystal will tune the 19 metre shortwave band (including WWV on 15 MHz) while 13 MHz will cover 20 metres.

Even better would be the use of a modern DDS RF oscillator kit to provide full coverage reception of the HF and lower VHF range. If you go to this trouble I would suggest better front end filtering and a stronger mixer (for example, a four diode balanced type). Some DDS kits offer the ability to change the display to show the received frequency for a range of intermediate frequencies and would make the receiver more professional.

Transceiver builders can also benefit from this approach. CBs and upconverters greatly simplify construction as most receiver work is avoided.



An appealing project would be an AM transceiver for 1.843, 3.579, 3.686 or 7.125 MHz. The first three are common crystal frequencies while 7.125 MHz is easily generated by pulling up 7.122 MHz crystals cheaply available from the US. The CB's squelch function allows silent monitoring, providing a feature missing from the older HF receivers normally used.

The skilled builder may be able to squeeze everything into the CB's case, but a second box for the receive converter/transmitter will be easier for most. That does not mean that parts from the CB still can't be recycled. For example the driver and power amplifier transistors can be unsoldered and used in the new transmitter. Because it

often shares the receiver's audio amplifier, the modulator circuitry can't be removed but it could still modulate the new transmitter if the connection to the 27 MHz final amplifier stage is opened.

If your CB does SSB, building a linear transverter could provide a useful SSB transceiver for 7 MHz. A transverter comprises the circuit described here plus a transmit mixer, RF power amplifier chain and low pass filter. If you go this way I would suggest using a 20 MHz crystal instead of 10 MHz for the local oscillator to reduce spurious. A transverter on an unmodified CB will work but will be inefficient due to the need to attenuate 12 watts PEP down to a few milliwatts for the transverter.

Builders may wish to take the CB's driver and power amplifier out of the transmitter circuit and use the predriver stage's milliwatt output to more efficiently drive the transverter. Another possible modification is to convert the CB's RIT control into a 'slider' effective on transmit also. This provides frequency agility without needing to adjust the 20 MHz oscillator.

### Conclusion

A converter to permit reception of amateur signals on a 27 MHz CB radio has been described. It's easy to build, brings an old CB to life and can be applied to more ambitious projects. A demonstration can be viewed at [youtube.com/vk3ye](http://youtube.com/vk3ye)



Help us

Contribute to the Weekly WIA News Broadcast. See our website for details.

[www.wia.org.au/members/broadcast/contribute/](http://www.wia.org.au/members/broadcast/contribute/)

**InnoAntennas**  
Performance through Innovation

[www.innovantennas.com](http://www.innovantennas.com)  
Call Us: +44 2033 84 0072  
[info@innovantennas.com](mailto:info@innovantennas.com)

You can buy direct from the UK and save \$\$\$ !! Email us - [info@innovantennas.com](mailto:info@innovantennas.com)

SPID Elektronik



All SPID Rotators are computer-ready and have a USB controller & software supplied as standard.

SPID Elektronik produce very robust worm-drive rotators which take some serious abuse!

If you want to be sure your antennas will stay pointing where they should in any weather, then a SPID rotator is a great option to consider!

Azimuth, Elevation & AZ/EL for EME and satellite work!

From \$795.00 SHIPPED to your door!



**Have you heard of the InnoAntennas LFA Yagi? Search on Google for reviews!!**

A wide range of high performance Yagi antennas - EME & weak signal antennas our speciality - Stacking and Station Consultancy  
More than 250 High Performance Yagis on our website. Contact us via Email, we will call you to discuss your needs

InnoAntennas are a UK Limited company - All major credit cards accepted - Professionally Built Antennas for Ham Radio - British Innovation, Design & Build

# VK5 National & Conservation Parks Award

Paul Simmonds VK5PAS

There is a new amateur radio award originating here in South Australia - the VK5 National and Conservation Parks Award sponsored by the Adelaide Hills Amateur Radio Society.

The aim of the Award is to encourage portable operation by amateur radio operators from within South Australia's 21 National parks and 262 Conservation parks.

The Award is open to activators, hunters (those who work activators) and short wave listeners.

The award is not limited to VK5 operators solely. Applications for the award are welcomed from interstate and overseas amateurs and short wave listeners.

Contacts made after the 14th of April, 2013 are valid for the Award.

There are five levels of the Award: Bronze, Silver, Gold, Platinum and Diamond, with a

*Photo 2: The author's Buddipole 'under test' on Mount Barker in the Adelaide Hills.*



*Photo 1: An example of the VK5 National and Conservation Parks Award certificate.*

certain number of points being required for each level. Separate certificates are available for all five levels and an optional glass etched trophy is also available for those attaining Diamond status.

More information can be found on the Adelaide Hills Amateur Radio Society website at [www.ahars.com.au](http://www.ahars.com.au)

And there is also a VK5 National and Conservation Parks Award Yahoo Group site which can be found at [au.groups.yahoo.com/group/sanpcpa](http://au.groups.yahoo.com/group/sanpcpa). A link to this Yahoo group site can be found on the AHARS website.

## Get on the Air with HF Digital

It is a step-by-step guide that'll get you started in the fascinating world of **HF digital technology**.

Written in an easy to understand, conversational style, this book will show you how to set up and operate your own HF digital station.

The text includes instructions for configuring software programs for popular modes such as RTTY, PSK31 and JT65.

You'll also learn about other digital communication modes such as MFSK, Olivia and PACTOR.

**WIA Member Price: \$30.00 Retail: \$35.00**





## Over to you

### Amateur radio and Gallipoli 2015

Dear Peter,

I was watching the Gallipoli service, a little over 12 months ago, and as I watched the service I realised a couple of things:

Firstly it dawned on me (pun intended) that the 100th anniversary of the Gallipoli landing will soon be upon us (April 2015). I also noticed that at the service at Gallipoli there were a large number of people. These people were packed in fairly tightly in the available space and there seemed to be only "elbow-room". Obviously the 100th anniversary will have even more people in the same space.

That got me thinking and wondering if there was a way that would enable people to experience the 100th anniversary of Gallipoli without actually going to Turkey. I then wondered if it was possible for the Wireless Institute of Australia or an Australian amateur radio club to set up an amateur radio station close to where the 100th anniversary is to be held.

This amateur radio station would serve a number of purposes. It would enable many amateurs, particularly in Australia but also around the world, to join one of Australia's most significant anniversaries, albeit from a distance. It would also serve as a way of promoting the Wireless Institute of Australia, amateur radio and also the club that operates there.

73 and kind regards,

Ross Fraser VK2WNJ

Email: [vk2wn@wia.org.au](mailto:vk2wn@wia.org.au)

*Editor's note: Further email discussion with Ross revealed that his idea is to set up a station as close as possible to the celebration site at Gallipoli. One obvious thought is that we should attempt to encourage a Turkish Club to adopt the proposal, and if there was an Australian Club willing to work with them, develop the idea further.*

*I note that there has already been discussion in the media regarding the anticipated high demand for Australians to attend the 2015 Gallipoli Dawn Service, and the Government has announced a ballot system as the most fair, equitable and transparent process for allocating 'attendance passes'. Further details can be found at: <http://www.gallipoli2015.dva.gov.au/>*

*As there will be a limit of 8000 places for Australians to attend the 2015 Gallipoli Dawn Service, perhaps the WIA should consider the option of contacting the IARU member society in Turkey with a proposal for amateur radio involvement. Perhaps a Turkish station close to Gallipoli and stations at major commemorative sites in Australia? I would suggest that those interested should feed ideas in soon, as such an arrangement may take considerable time to organise.*



[www.ttssystems.com.au](http://www.ttssystems.com.au)

Phone: 03 5977 4808 Email: [info@ttssystems.com.au](mailto:info@ttssystems.com.au)

Your Australian reseller for:



...America's Best!



## YouKits

New Products coming soon

### AVAILABLE NOW

Hard Drawn Copper Wire, Insulators, Dipole Centres  
Open Wire Transmission Line, Spreaders, Kevlar Guy Line  
Spiderbeam Fibreglass Poles, Baluns and Switches



Meanwell power supplies  
Diamond products  
Daiwa products  
Technical books  
Amidon products  
Custom cables made to order

**450 Ohm ladder line now in stock**

# A low distortion two tone oscillator

Jim Tregellas VK5JST

## Introduction

Unlike the ultra-simple two tone oscillator I described in the September 2004 issue of *Amateur Radio* magazine which has a distortion of around 2.5% THD, this unit is of laboratory grade and features oscillators with a THD of around 0.05%. This specification not only allows gross operating defects such as instability, non-linearity, and overdrive to be observed on an oscilloscope, but also allows serious engineering measurements to be done on transmitters. Such tests include those for intermodulation distortion (IMD), and the typical published specifications of between -28 and -35 dB for an amateur transceiver/linear can be easily verified.

Output frequencies of 700 Hz and 1900 Hz are provided. These frequencies are not harmonically related, and are approximately equal distances in from either end of the audio pass band. Both frequencies are available individually for single tone testing, or in combination for two tone testing. The output levels of both test frequencies can be adjusted relative to each other, accommodating for variations in the transmitter audio response, and hence allowing perfect zero crossings to be obtained on the oscilloscope two tone test pattern. If you want 1 kHz spacing between the two tones (700/1700 Hz), all you have to change is two resistors.

## How it works

The Wien Bridge circuit, which is used in the two sine wave generators in this instrument, can be broken into two halves. Looking at the 1900 Hz oscillator we can see that the first half, which provides positive feedback around the

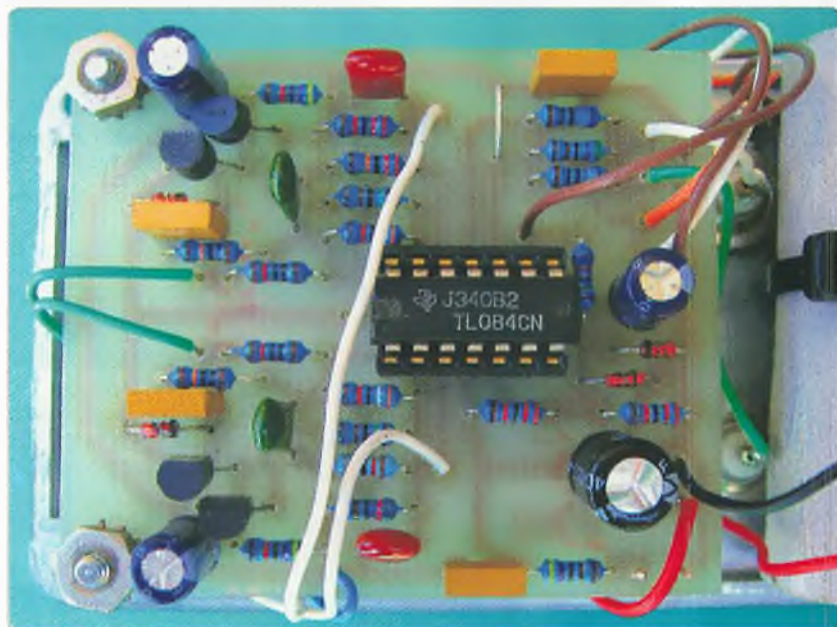

Photo 1: A view of the PCB.

amplifier, is formed from an upper section with a resistor and capacitor in series (R1, C1) and a lower section with a resistor and capacitor in parallel (R3, C2). This network is frequency selective and at the frequency of oscillation, provides a phase shift of zero between output and input of the amplifier.

In a normal realization of the oscillator, equal values of capacitors and resistors are used in each of these bridge sections, and a little circuit analysis will show that an amplifier gain of just three is necessary to maintain oscillation. This in turn means that when the amplitude of oscillation has settled, one third of the output amplitude appears at the non-inverting amplifier input and consequently this same large signal swing must appear at the inverting input too. To provide this signal level at the inverting input (negative feedback) means that the other half of the

Wien Bridge must have a resistance in the upper section (R2) of twice the value of the resistor in the lower section (R4 plus the drain source resistance of the FET). These large signal levels at the two amplifier inputs create distortion, because the transfer characteristics of the op amp inputs are not precisely linear over large voltage ranges, and neither is the drain source resistance of the FET exactly constant under varying voltage conditions. In this circuit, the FET is used as an output amplitude sensitive resistance which sets the negative feedback to precisely that required to maintain a stable amplitude of oscillation. It replaces the thermistor or low current tungsten filament lamp normally used for this function, as both of these components are now very difficult to obtain.

The distortion created by the FET and op amp inputs is overcome



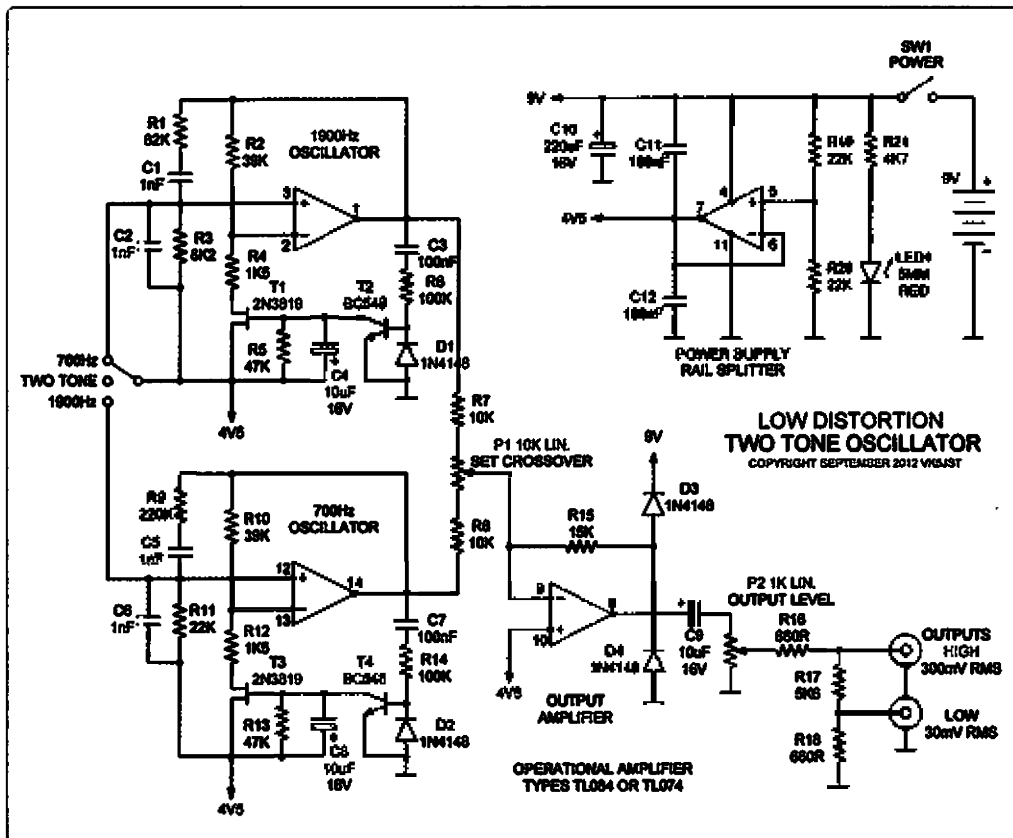

Figure 1: The circuit.

to a very large degree in this design by using a most uncommon version of the Wien Bridge. In this variant, the capacitors and resistors in the frequency selective part of the bridge are in the ratio 10:1, which causes the resistors in the negative feedback section to be in the ratio 20:1. This in turn means the amplifier gain required for steady state oscillation is 21, and also means that the signal swings at the two amplifier inputs are much reduced, relative to the normal oscillator design. It is these low amplitudes of input voltage which give this design its excellent low distortion characteristics, and typically harmonics are at least 65 dB down on the amplitude of the fundamental sine wave (<0.05% THD). This is difficult to measure, and initial attempts using the FFT feature on a Rigol DS1052 digital oscilloscope were disappointing. No matter what was done with instrument settings or the circuit

design, the displayed harmonics were never more than 43 dB below fundamental. Given the oscillator design, this figure could not have been correct, and the distortion was later measured using a HP spectrum analyser, with -65 to -70 dB figures being obtained.

At switch on, the gate source voltage of the FET is zero, and so its drain-source resistance is typically around 180-200 Ω. The gain of the amplifier is thus around 24,  $\{(39k + 1k5 + 200)/(1k5 + 200)\}$  and so oscillation starts to build up. When the amplitude reaches about 1.0 volt peak to peak, D1 and the base emitter junction of T2 turn on, causing collector current pulses to flow through C4 and R5. These components have a large time constant which reduces these current pulses to a smooth DC voltage at the FET gate. Note that both the diode and transistor turn on at around 500 millivolts, not the usual 600 millivolts for a

silicon junction, due to the minute currents being used. As the amplitude of oscillation increases, this smoothed DC voltage takes the gate of the FET negative with respect to source, increasing the drain-source resistance, and consequently also increasing negative feedback. When the drain-source resistance reaches 450 Ω, the gain of the amplifier is lowered to exactly 21, and so this process rapidly stabilizes the level of oscillation. Due to the large voltage gain of T2, it takes very little extra voltage swing at the base of T2 to cause very large changes in

DC voltage at the gate of the FET and so oscillation settles to a level of one volt peak to peak and this is largely independent of the huge spreads which occur in the FET characteristics.

Both oscillators work identically producing one volt p-p of about 700 Hz and 1900 Hz at their outputs. For single tone testing, either oscillator can be turned off by shorting the lower part of the frequency selective arm of the Wien Bridge. The two oscillator outputs are current summed at the virtual earth existing at the inverting input of the output amplifier, via R7, R8, and P1. P1 allows the amplitude of one sine wave to be varied relative to the other, allowing the perfect test patterns mentioned earlier in this article to be obtained. The sum of the two voltages appears at the output of this amplifier, which has both high and low level variable outputs with a 600 Ω impedance level. The low level output is





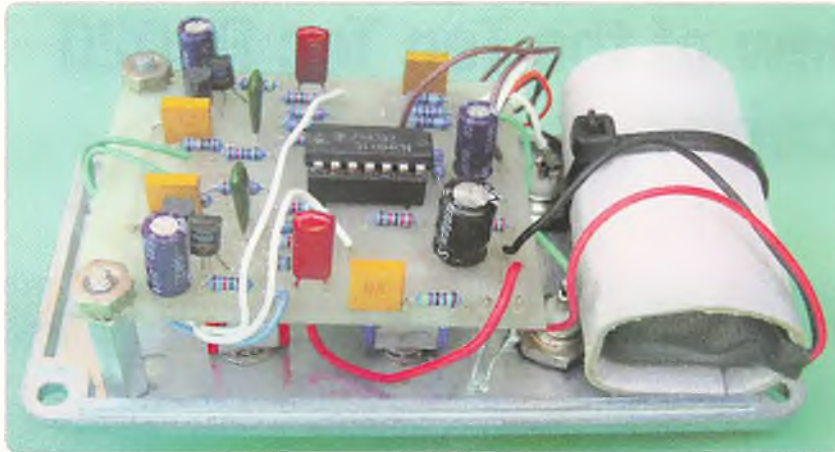

Photo 2: Inside the unit.

The quad op amp can be a TL074 or TL084. Do not use type LM324, which has some unhappy habits. The NPN transistors can be any TO92 package which happens to be handy, and the FETs used should be of the Process 50 type, that is a 2N3819, 2N5485, MPF102 or similar. The PCB has been laid out for Process 50 FETs with the gate terminal in the middle, and one of the great things about these FETs is that they are closely electrically symmetrical. The drain and source are interchangeable, although the manufacturer does not say this, and with the gate in the middle, you simply can't put them in backwards. The 2N3819 which I used has this pin-out but both of the other types have their gate at one end, and so you will have to do a bit of package twisting and lead insulation if you use these alternatives.

The design provides oscillator output voltages fixed to within +/-15% for FETs at either end of the huge characteristic spreads. There is sufficient adjustment range provided in the SET CROSSOVER pot to cancel out these tolerances, but if you want to do a really good

job, then short gate and source together and measure the drain source resistance with ohms feature on your DVM. I checked out 100 odd 2N3819s from various manufacturers, and with  $V_{gs}=0$ ,  $R_{ds}$  varied between 112 and 269  $\Omega$  with the peak of the distribution being at 183  $\Omega$ . Select a couple of FETs with



Photo 3: The finished unit.

drain source resistances within 10% and the two oscillators will behave virtually identically.

Good testing.

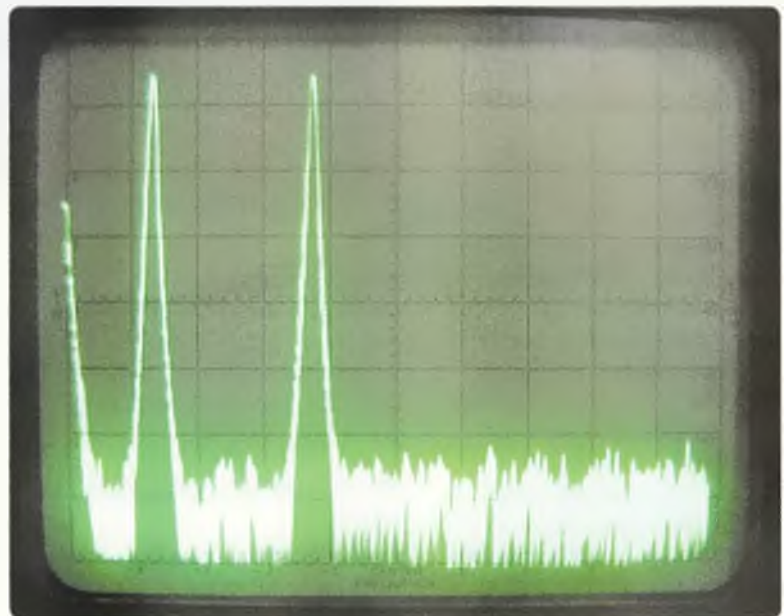

Photo 4: The output spectrum of the two tone oscillator.

Participate

**Albury Wodonga Amateur Radio Club Inc HAMFEST 28 July**

# Review: A review of the Ten Tec R4020 QRP CW transceiver

Peter Parker VK3YE

It started with short wave receivers. Then there were low-end VHF/UHF transceivers. Now HF QRP equipment is the latest area where China is an emerging force in the amateur market.

While other manufacturers, importers and retailers are feeling the pinch, consumers are winning, with equipment too specialised for larger manufacturers now available at reduced prices. Prominent in the Chinese assault is YouKits, which is starting to challenge Elecraft, MFJ and Hendricks in QRP equipment.

What has this to do with a review of a Ten Tec rig? Simple. The Ten Tec R4020 is a rebadged YouKits HB-1A, built to Ten Tec specifications. As happened with consumer goods, we are likely to see more amateur manufacturers exploiting China's lower production costs.

## Description

Having described its origin, what is the R4020? It is a five watt CW only transceiver for 40 and 20 metres only. It has a synthesised VFO with superhet receiver. Notable receiver features include wide coverage (5 – 16 MHz), several bandwidth settings and SSB reception. The transmitter boasts an inbuilt Morse keyer and CQ caller. Also provided are 20 tuneable memories, inbuilt AA battery holders and a digital display showing frequency, relative signal/power and battery voltage.

Like the 'trail friendly' Hendricks and Elecraft, the R4020 is designed for the traveller, hiker or mountaineer. Their requirements include light weight, top facing controls and low power consumption. While an advance at the time, the Yaesu FT-817 drew too



Photo 1: The front of the Ten Tec R4020.

much current (300 mA on receive) for serious use with lightweight batteries. Whereas the R4020 is half its weight and draws just one sixth the current on receive, making it suitable for long trips.

## What makes a practical QRP rig?

Even the best performing set will not satisfy if it misses important capabilities. On the other hand QRP designers often have to omit features to ensure their creations remain small, light and affordable. It is a tough juggle between competing requirements.

Some might scoff at the R4020's two band coverage. Home constructors know that

complexity rises exponentially with the number of bands and commonly build single band radios. However having just one band may make the rig unusable for much of the day. Functionality is much increased if two to four HF bands can be covered, something Heathkit discovered with its forgettable HW7 and classic HW8 models.

Which bands? Many years ago 'Solid State Design for the Radio Amateur' said that 40 and 20 metres were a good combination as they allowed QRP contacts around the clock. We have since gained 30 metres but that advice remains true; those two bands remain the mainstay of QRPers today. 40 metres is low enough to often



provide blanket coverage up to about 3000 km while 20 metres is high enough for easy DX contacts. So the R4020's band choice is perfect, though if you disagree a 40/30 metre version is also available as the R4030.

While homebrewers may skimp, necessities on a commercial product include five watts RF output, superhet receiver with good IF filtering, and smooth transmit/receive switching. Small size, light weight, low power use, frequency agility and RIT are other essentials. Extras like a wide coverage receiver (for WWV monitoring), SSB reception, variable selectivity and an automatic CQ caller aren't strictly necessary but make operating a pleasure.

The R4020 has all these features. Apart from (possibly) an

SWR indicator, nothing major has been left out. And many useful inclusions aren't on other rigs of its type. The designers clearly know what the portable QRPer needs.

### Look and feel

The R4020 is of moderate weight only; it lacks the FT-817's heavy heatsink. Its front panel is the size of a QSL card while its thickness is like an ARRL handbook. Unfortunately the radio is not safely 'chuckable' due to its protruding knobs. Truly robust outdoor and military radios have flat or recessed controls. Otherwise the case was robust, though I'd have preferred rounder corners.

Using a transceiver is a sensual experience. Cheap electronics has made hardware the most expensive part of a radio and that on which

manufacturers are most tempted to skimp. How its controls feel indicates mechanical quality and the R4020 is no Racal, Collins or Elecraft. Some play in the detented tuning knob, made more obvious by the need to press it to change tuning rate, was noted. The tuning mechanism is the hardest working part in a transceiver and time will tell how long it lasts. Received audio quality also contributes to user experience and is discussed later.

### On air

The R4020 was tested from various locations around Port Phillip and Westernport bays. Antennas used included end-fed wires, dipoles and a vertical Moxon beam. Numerous DX stations were worked; mostly Europeans on 20 metres. A good location will add many decibels to

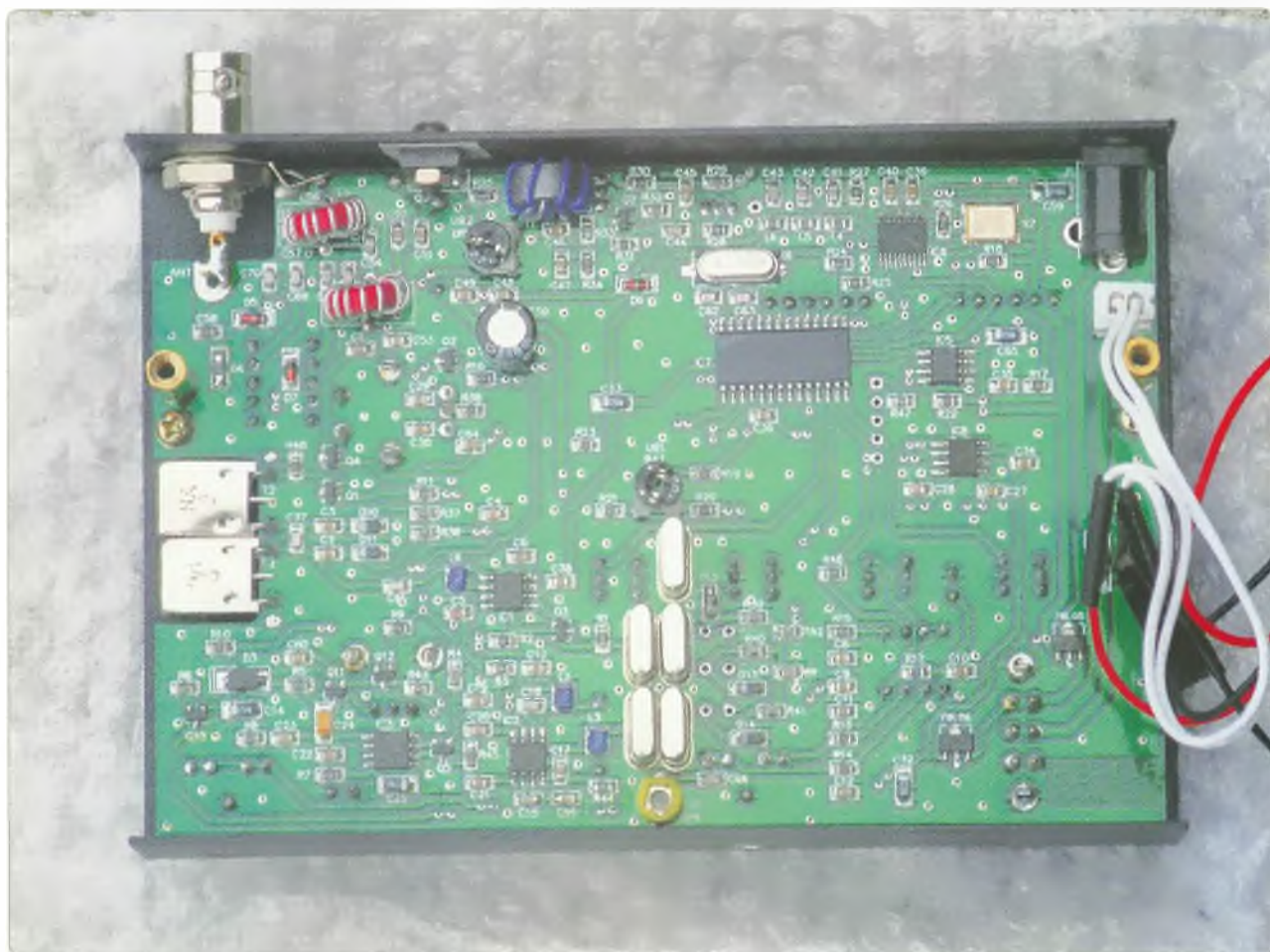

Photo 2: Inside the Ten Tec R4020.

the transmitted signal and a small battery (three to four AH) will last hours per charge.

The first challenge faced, if using a straight key, is keying properly, for the R4020 pretends as if an iambic keyer is connected. To overcome this plug in the key (mono plug) or keyer (stereo plug) before switching on and the rig will detect which is connected. This has sometimes confounded first-time users as it isn't mentioned in the (somewhat skimpy) manual. Other connections (3.5 mm for stereo headphones, 2.1 mm for power and BNC for the antenna) work as expected.

Apart from the tuning and volume knobs, the transceiver's functions are controlled by four buttons. Short and long touches activate different functions. Apart from its main function, the tuning knob is also the RIT control or switches between memories (and thus the band).

Pressing the tuning knob toggles between 1 kHz or 100 Hz steps. 1 kHz is just right for scanning the band and you won't miss anything if one of the wider filter settings

is selected. 100 Hz is fine for operating, though others may find it too coarse. For them a 10 Hz option is available through the RIT. 100 kHz jumps can be selected via the menu for large excursions.

An informative blue display is provided. This shows the frequency, memory channel number, battery voltage and a bargraph relative signal/power indication. Care should be taken not to scratch it; a protective plastic cover would have made the rig more robust.

The receiver is conventional, using the NE602 chips popular with QRP builders. It comfortably drives headphones; more oomph is needed to drive a speaker on weak signals. On CW there are four IF selectivity settings; 400, 500, 700 and 900 Hz. Wider widths are provided for SSB reception.

The receiver performed well on CW. While the NE602 isn't the strongest front-end, no overload was observed during use. Low internal noise made listening from a quiet coastal location a treat. All synthesiser birdies heard disappeared when the antenna was connected.

The RF attenuator is too savage and almost kills the receiver. Luckily this is a minor shortcoming as it is seldom needed. Audio quality on CW was good but not outstanding. Received SSB audio also wasn't top shelf but is adequate for casual listening.

The transmitter has received nothing but complimentary reports. The semi-automatic CQ caller has been particularly handy. Unfortunately a button press is needed for every call; automatic operation after a reasonable pause would have improved it. Flexibility was also limited; only the callsign can be changed. You are stuck with 'pse k' at the end and cannot otherwise customise the call.

### Conclusion

The Ten Tec R4020 is a barrel of fun. Shortcomings are minor and DX has been worked almost every time it's been taken out. The designers know what makes a successful QRP rig and have produced a package that comes highly recommended for the portable operator. The R4020 is stocked by AR advertiser TTS Systems.



**GippsTech 2013**  
will be held on the  
weekend of July  
13 & 14, 2013, a  
date which is fast  
approaching.

**It is time to register!**

### Do you own an amateur transceiver that includes six metres, two metres and/or 70 centimetres in addition to the HF bands?

Have you explored any of the bands above HF? Or do you simply use the two metre and 70 centimetre capability on FM for chatting with the locals or to access the local repeater? If this sounds familiar, you might be surprised at what you can actually work on these higher bands, especially if you tune to the SSB segments or explore some of the digital modes. But how do you discover more information about such operation? For a two-day immersion experience, attend the annual GippsTech conference.

GippsTech has a reputation as a premier amateur radio technical conference. It focusses primarily on techniques applicable in the VHF, UHF and microwave bands, especially for weak-signal contacts.

It is almost that time again: GippsTech 2013 will be happening on the weekend of the 13th and 14th of July, at Monash University Gippsland Campus in Churchill, Victoria, about 170 km east of Melbourne.

A Partner's Tour will be conducted, together with an informal social gathering for dinner on Friday and a Conference Dinner on Saturday.

Those of you who have more experience and have information to share with others are invited to submit titles of presentations to the Conference Chair Peter-VK3PF as soon as possible.

We look forward to seeing you at GippsTech in early July.

Further details are available from the Eastern Zone Amateur Radio Club website: <http://www.vk3bez.org/>



# Remote operation

Rob Norman VK5SW – vk5sw@tpg.com.au



Photo 1: The location of the remote ham radio station.

The advent of the internet has changed our lives. It has definitely impacted the hobby of amateur radio. For me, the prospect of setting up a remote station seemed rather daunting at first but I soon came to realize that it wasn't that difficult. Remote operating basically consists

of two or more computers connected together via the internet with the remote computer also connected to the amateur radio station. With suitable software installed in both computers, the control computer is able to operate the remote radio via the remote computer.

There are variations to this. The software used here is Ham Radio Deluxe running the DM780 program on BPSK31. At this stage, this is the only mode I use while remotely operating the station. In my case, the remote computer is connected to the Internet using a wireless

Photo 2: The remote station which is solar powered.



connection as the available internet server antenna is ten kilometres away. I am lucky enough to have a property in the bush which we use as our getaway QTH. Fortunately my brother in law Greg owns the property next to ours. So when I am at the home QTH in Adelaide, which is about 150 kilometres away, and he is at the property, he is able to turn on the remote computer and

radio and connect to the internet for me. Once Greg has told me the IP address of the remote computer via mobile phone, I am able to connect to it and operate the remote station from the home QTH. The distance between computers doesn't really matter. If the internet connections of both computers are hard wired, then you will not need the assistance like I do to operate a remote station.



Photo 3: The wireless internet modem.

The background noise level on the radio at this remote location is strength zero. The remote station can be seen on my website at [www.vk5sw.com](http://www.vk5sw.com). To actually control the radio from a distance is a great experience. In setting up a remote station, I have found that the program Ham Radio Deluxe, which can be found at <http://www.hrdsoftwarellc.com/> works well. Also, if interested, I recommend that you purchase a copy of the ARRL's 'Remote Operating for Amateur Radio' from the WIA Bookshop.



Photo 4: The wireless internet antenna.



Photo 5: The computer setup at the home QTH.



## WAVERLEY AMATEUR RADIO SOCIETY

**Auction of Radio and Electronic Equipment.  
Saturday, 6th July 2013**

at

**The Scout Hall, Vickery Avenue, ROSE BAY, NSW 2029**

All are welcome to attend this annual event to buy or sell. Entry is only \$2 and there is plenty of free parking nearby. The club is adjacent to Lyne Park and Sydney Harbour. Doors open at 8:30 am and the auction commences at 10:00. Full details, including pictures of some of the items to be sold, can be found on the club's web site at [www.vk2bv.org](http://www.vk2bv.org).

Contact: Simon, VK2UA. Email: [vk2bv-info@vk2bv.org](mailto:vk2bv-info@vk2bv.org)



# Will the REAL PL-259 connector please stand up?

John McLean VK2KC

After being caught out on more than one occasion regarding the incompatibility of the so-called PL-259 and SO-239 threads on connectors, equipment and instruments from Japanese and Asian suppliers, there must be an underlying reason behind the seemingly lookalike threads, but how did the Asians get it so wrong?

As a fitter and machinist, but now retired, with the valuable experience gained in 45 years activity in that trade along with an accumulation of appropriate measuring equipment simplified the extensive research on the subject of the incompatibility of some PL-259/SO-239 threads.

The original PL-259/SO-239 connector was invented in the 1930s by an Amphenol engineer named E. Clark Quackenbush. UHF coaxial connectors are general purpose units developed for use in low frequency systems from 0.6 - 300 MHz invented for use in the radio industry. UHF is an acronym for Ultra High Frequency because in the '30s, 300 MHz was considered ultra-high frequency. Despite the name, today it is rarely used in commercial applications for UHF frequencies as the non-constant impedance (the impedance drops to 30-40  $\Omega$  for a cm or so in the central region of the connector) means they create significant reflections above 300 MHz.

Research has shown that Comet in Japan for their local and Asian markets specify the MJ thread, which is a 'newer' type thread utilised specifically for the aerospace and propulsion industry. The accuracy of screw type fasteners demanded by that

industry was a deciding factor in formulating another thread instead of using the standard that the aviation industry used. The aviation industry uses a closer nut to thread tolerance, and being mainly US based, fractions of an inch are their sizing standard.

Somewhere along the line the standard of the MJ thread was adopted by Comet and I might add the majority of Chinese coax connector manufacturers, and the old standard PL-259 thread which is 5/8" diameter x 24 threads per inch was not used. This thread is called UNEF (Unified National Extra Fine) and on reflection, due to the closeness of the two standard threads, the MJ was I believe mistakenly adopted, and understandably China with a 1.3 billion population, local demand is a priority with the export market a secondary consideration.

The size and pitch of the MJ thread used by Japanese and Chinese manufacturers is 16 mm diameter x 1 mm pitch. It's interesting that the Chinese refer to the real version of the PL-259 as the 'British Thread' but the Japanese call it the 'International Standard Thread.'

The reason why the thread pitch is incompatible is easy to understand when you convert the 1 mm pitch thread (MJ thread) to imperial threads per inch.

1 mm pitch = 25.4 threads per inch, so 24 threads per inch (UNEF) will screw on for about two to three turns, depending on the quality of the fitting; if it is force screwed on to, say, 12 mm at that point the thread is almost 1/2 of one thread out and this misalignment will strip

the thread. An interesting exercise is to compare the two diameters, 5/8" = 0.625" and 16 mm = 0.630"; which is only five thousandths of an inch larger.

Ah you say, but your experience shows that the MJ thread will screw on to an SO-239 connector and this is true in some cases, and I agree if you are ham fisted enough you will make it fit, but the Asians being very a resourceful race have worked out that if you make the female thread larger (sloppler) it will screw on!

The only problem with that easy fix is that the male/female thread flank contact is less than 50%, (75% is considered minimum in general engineering terms, in the aviation industry, 90% minimum contact is the standard) and this excessive play makes it a very weak union. In some cases it will work, but when one is using, for example, a commercial Japanese PL-259 to 3/8" adaptor to mount an 80 metre whip, it's a recipe for disaster. Picture an 80 metre whip becoming disconnected at 100 kph on the freeway! Another scenario is that if the connector unscrews or loosens then the whole load of the connection is then placed on the centre pin of the PL-259, and being brass, will fatigue and snap off, with some interesting effects.

Here is a copy of an email from Comet in Japan after a CAA-500 antenna analyser was purchased from a supplier in the USA. When contact was made to advise them of the SO-239 thread incompatibility, after finding that none of my PL-259 connectors would screw on to the SO-239 connector, and telling them that the CAA-500 utilised the MJ thread instead of the standard

UNEF 5/8" x 24 threads per inch standard, his terse comment was and I quote 'we have supplied over 20 of these units to the local (USA) market and no-one has complained.'

That ill-educated and simplistic response led me to take up the matter with Comet in Japan and here is their response:

*Hello Mr. John McLean,  
Thank you very much for purchasing our CAA-500.  
The CAA-500 first lot does not have*

*international standard connector. From the second lot, which will be released on NOVEMBER 2011, we change the CAA-500 connector so that PL-259 connector will screw onto the CAA-500 M-J connector completely.*

*Would you please so kind as to send your CAA-500 back to us? I will send you the new one with international standard connector, then.  
We deeply apologize for the inconvenience we have caused you.*

*We hope that you will continue to choose COMET products.*

*Sincerely,  
Mika Yagishita  
COMET Co. Ltd.  
TEL: 81-(0)48-839-3131  
FAX: 81-(0)48-839-3136  
m\_yagishita@comet-ant.co.jp  
<http://www.comet-ant.co.jp/english/index.html>*

*Hopefully this information will clear the thread incompatibility issue up! Or at least explain it. 73.*



## Traps for old players

Ron Holmes VK5VH - vk5vhron@gmail.com

Recently I bought a small Italian solid state linear amplifier to help with DX. When running it at about 200 watts it definitely made a difference, and this did not upset the TV in the next room. I use it with a little FT-897D, my regular rig since 'Boat Anchors' became too heavy for me to lift.

But one day it worked exceptionally well for a short time, then stopped working altogether! I fairly quickly turned it off. After checking out the vertical antenna to see if perhaps something had happened to send the SWR sky high, I investigated every connection I could think of, looking for a short circuit or something to explain the stoppage.

Turning the FT-897D on again, I went through the whole process of making sure its RF output **was** the ten watts I always adjusted it to before using the amplifier. Now the

little FT-897D has 90 menus! All are adjusted by bringing them up on a screen the size of a postage stamp. Most of them I have never found need for, but the one controlling RF output has been important since using the amplifier. It is number 75.

I have made the numbers as large as possible and 100 shows up quite clearly when I turn to it, showing my normal output power for frequencies other than 20 metres. This I turn down to 10 when using the amplifier. It was definitely showing ten watts. I turned it up to 100 and back again to 10. Everything was working OK.

But then I noticed something I had missed before. In the small print up in the top left corner it indicated, not RF level, as it usually did, but NB level. I had turned the knob for the menus a quarter of a turn too far it seems! I was on No 63 menu instead of 75. Apparently at some

stage I had turned that up to 100 with the hope that it would work better, but like most noise blankers in my experience (apart from the NES 10-2 noise eliminating speaker) it didn't make much difference and I had left it there. The result was that I thought I was feeding the linear with ten watts but actually it was a hundred watts! Not generally recommended. Fortunately I did not blow the final transistors and the repair bill was not too serious.

How I came to do this could have something to do with the fact that I am 87 years old, but my claim is that the main culprit was that modern gear is just too clever and complicated. I bring the matter to notice in case some other 'old player' may do the same. It is not difficult! Best 73.



### Contribute to Amateur Radio

*Amateur Radio* is a forum for WIA members' amateur radio experiments, experiences, opinions and news. Manuscripts with drawings and/or photos are welcome and will be considered for publication. Articles attached to email are especially welcome. The WIA cannot be responsible for loss or damage to any material. Information on house style is available from the Editor.



# Foundation Corner 23 – Baofeng UV-5R review

Ross Pittard VK3CE - vk3ce@wia.org.au

Following on from the recent review of the Wouxun hand held I thought it a good idea to look at an offering readily available on the internet, in particular from a number of eBay sites. One of these is the Baofeng which can be picked up very cheaply, again with the proviso that as delivered it will not conform to ACMA requirements (more about this later). These are available for around \$50 on eBay, and depending who you buy from some are

postage free, others are not. The fact is you can land one of these rigs in Australia for well under \$100 so they are becoming increasingly popular with Australian amateurs.

The review unit duly arrived in a compact box with a moulded inner to keep everything in place during transit. Included in the box is the radio itself, rubber ducky aerial, instruction manual (in English), belt clip, carry strap, external mike/earpiece and the charging stand

with plug pack. One point to make is the plugpack comes with an adapter for Australian power points but please be aware that the plug pack itself is not type approved by Australian authorities. If you are concerned about this it is possible to replace the pack with a locally purchased one with type approval; obviously this will be at your own expense.

The radio itself has a dual frequency display and what



Photo 1: What's in the box!

is becoming a fairly standard telephone style keyboard which can be used for all programming functions but, as with previously reviewed hand held radios, I prefer to set them up using programming software on a PC. The Baofeng is no exception to this as software is available from their web site to suit this radio and the programming lead

from my Wouxun suits this radio as well.

One word of caution regarding the programming cable and Windows drivers. The Chinese manufacturers of these cables use fake Prolific chips in their leads. A recent problem has arisen where Prolific have altered their driver software to work only with genuine

Prolific chips. The drivers supplied with the programming lead will work without problems however Windows usually goes off into the ether to find the latest driver and this is where you will have problems. What I did to overcome this was to turn off the driver auto update function in Windows 7.

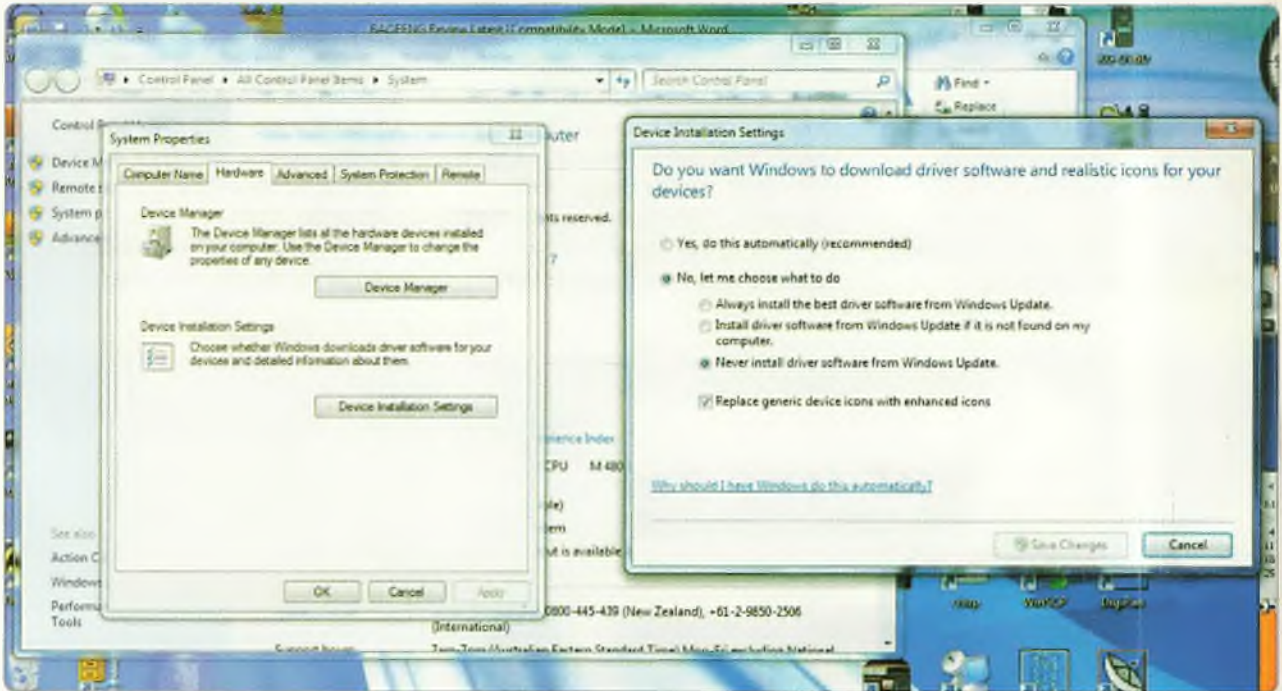

Figure 1: Windows driver settings.

This can be done by:

- first clicking start
- right clicking on computer
- clicking properties
- select advanced system settings
- select hardware tab
- select device installation settings
- Once you are here select 'no let me choose' and make sure to apply and save new settings.

After this is done the supplied drivers can be installed without problems.

The latest version of software for both the Baofeng and Wouxun radios, including the cable drivers can be found at Reference 1.

For the connoisseur of hand held radios there has recently become available an open source (free) program called CHIRP which has the

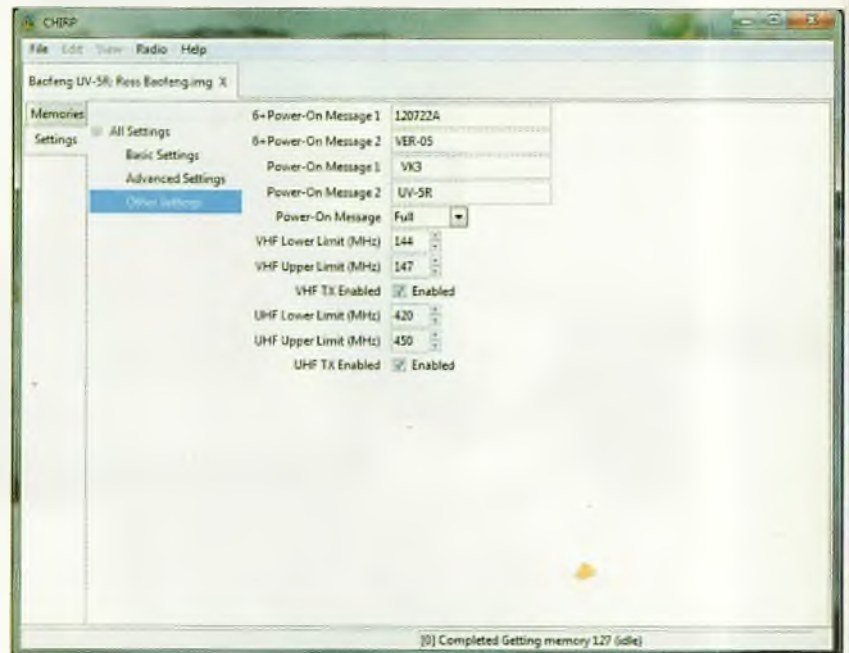

Figure 2: CHIRP band setting screen.



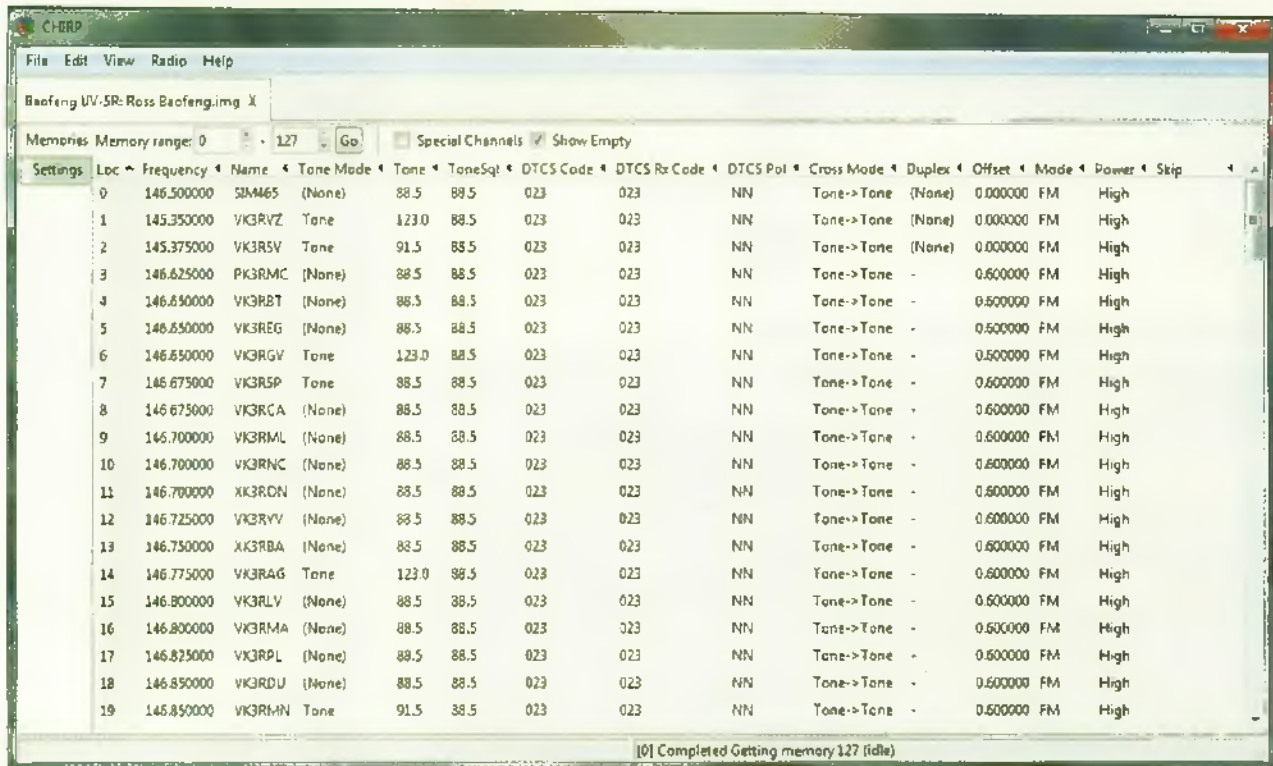

Figure 3: CHIRP memory programming screen.

ability to program the Chinese radios as well as many of the popular amateur rigs available from the major manufacturers. To download the latest version of the software, visit Reference 2. It's available in Windows, Apple and Linux flavours, so should cater for everyone.

One major advantage using this program is the ability to set the band limits of the Baofeng so as to conform to the Australian amateur bands. As I understand it the ACMA are happy with these radios providing they are limited to transmitting on the 2 m/70 cm bands only. I would suggest if you are going to buy one of these rigs the first thing you do is set the band limits to suit Australia. If the ACMA do come knocking on your door, the radio is then legitimately operating only on the ham bands.

I found the radio easy to use and it fits well in the palm of your hand. As with all Chinese radios I have had the opportunity to look at the menu system; it is very basic compared with the big three but I

find this rather refreshing as one can easily get lost in the multitude of screens in some of the modern rigs. The radio performed well with good reports of voice quality and clarity. The results of my power tests were 4.2 watts on two metres and 3.4 watts on 70 cm which is a little down on stated claims but should not be a problem. As can be seen from the charts, the radio has a clean spectrum and sensitivity was -124 dBm on two metres and -122 dBm on 70 cm for a 12 dB SINAD. The radio has a low/high power setting and voice prompts in English as well as DTMF/CTCSS tones which can all be programmed into a memory channel for easy recall.

The Baofeng supplied software works well but I found it easier to get used to the CHIRP software as it will program several radios that I have in the QTH. All in all the Baofeng is a great little radio for the price and I find it hard to see how the big three will be able to compete in the market place with these little rigs, costing as they do well under \$100.

This is the current list (as at time of writing) of radios that the CHIRP software can program, provided you have the necessary interface cable.

<b>AnyTone</b>
AT-5888UV (in daily builds)
<b>Alinco</b>
DR-03T
DR-06T
DR135T
DR235T
DR435T
DJ596T
DJ175T
<b>Baofeng</b>
F-11 (in daily builds)
UV-3R
UV-5R
<b>Icom</b>
IC-80AD
IC-2820H
ID-800H
ID-880H
IC-208H
IC-2200H
IC-91/92AD

IC-V/U82
ID-RPx000V/RP2x
IC-2100H
IC-2720H
IC-T70
IC-T7H
IC-T8A
IC-Q7A

IC-W32A
IC-746
IC-7200
IC-7000
ID-31A
ID-51A (in daily builds)
<b>Jetstream</b>
JT220M

<b>Kenwood</b>
TH-D7A/G
TH-D72
TH-F6A
TH-K2
TK-7102/8102/7108/8108 (in daily builds)
TM-271A/281A
TM-D700
TM-D710
TM-G707
TM-V7A
TM-V71A
<b>Puxing</b>
PX-2R (UHF)
PX-777
<b>TYT</b>
TH-UV3R
TH-UVF1
<b>Yaesu</b>
FT-60R
FT-817/ND
FT-857/D
FT-897
FT-1802M
FT-2800M
FT-7800R
FT-7900R
FT-8800R
FT-8900R
FTM-350R (in daily builds)
VX-3R
VX-5R
VX-6R
VX-7R
VX-8R
<b>Wouxun</b>
KG-UVD1P/UV2D/UV3D
KG-UV6D/UV6X

## The Baofeng specifications at a glance

BAOFENG	UV-5R
<b>General</b>	
Frequency range	65-108 MHz (FM receive only) 136-174 MHz and 400-480 Hz (TX/RX)
Channel number	128
Frequency stability	±2.5 ppm
Antenna	High gain dual band antenna
Antenna impedance	50 Ω
Operating voltage	DC 7.4 V
Mode of operation	Simplex or semi-duplex
Dimensions (W x H x D)	100 x 52 x 32 mm
Weight	250 g (including battery, antenna)
<b>Transmitter</b>	
Output power	4 W/1 W (maximum 5 W)
Modulation mode	16k0F3E / 11k0F3E
Maximum deviation	< 5 kHz (wide) / 2.5 kHz (narrow)
Spurious radiation	<7 μW
Adjacent channel power	≤-65 dB (wide) / ≤-60 dB (narrow)
Pre-emphasis characteristics	6 dB
Current	≤1.6 A (5 W)
CTCSS/DCS deviation	0.5±0.1 kHz (wide) / 0.3±0.1 kHz (narrow)
Intermediation sensitivity	8-12 mV
Intermediation distortion	<10%

The package includes :

- 1 x UV-5R - VHF136-174MHz, UHF 400-480 MHz
- 1 x 7.4 V 1800 mAh Li-ion battery pack
- 1 x antenna 136-174/400-470 MHz
- 1 x belt clip
- 1 x manual – in English
- 1 x desktop charger, 100V – 240V (2 pin USA, or 3 pin UK, or 2 pin EURO, or 2 pin Australia)
- 1 x PTT earpiece

## References

Reference 1: [http://www.wouxun.us/item.php?item\\_id=222](http://www.wouxun.us/item.php?item_id=222)

Reference 2: <http://chirp.danplanet.com/projects/chirp/wiki/Home>



Participate

**2013 Gippsland Gate Radio &  
Electronics Club (GGREC) Hamfest**

**20 July**



# Great North Walk 100s – Friday 9th to Sunday 11th November, 2012

Les Poole VK2APE – RCO, Hunter WICEN

Photos by Irene Hopkins VK2FIRH

Les VK2APE and Heather spent Friday morning packing the gear into the caravan and then at 1300 hours motored out to Somersby Public School in time to arrive prior to the teachers finishing for the day. After backing the van into the car park it was time to set it up as the communications base for the Great North Walk 100s Endurance Race.

What is this event you ask? Well it is actually two endurance foot races, run concurrently, of 100 kilometres and 100 miles (175 km). It is organised by the Terrigal Trotters. Hunter WICEN provides the safety communications and progressive results. The Great North Walk is a scenic 250 km walking trail between Sydney and Newcastle completed in 1988 as a bi-centennial project.

The races start at Teralba, west of Newcastle, at 0600 Saturday, and basically follow the Great North Walk on foot tracks and fire-trails through the Watagan Mountains and Brisbane Water National Park. The 100 km finish is at Yarramalong, west of Wyong, with the 100 mile finish at Patonga, south of Gosford and Woy Woy, on the banks of Broken Bay. Cut off time for the 100 mile race is 1800 Sunday or 36 hours after the start. If all the ups and downs in the course are added up the 100 milers ascend and descend approximately 6,200 metres. It is definitely not an event for the faint hearted.

Over the course there are seven checkpoints that were manned by volunteers from the

Terrigal Trotters and amateur radio operators who passed messages, competitor numbers and their in/out times, so that base could maintain a progressive master sheet and monitor the whereabouts of runners and check for any that were overdue at a checkpoint. Base also maintained an identical Excel spreadsheet which was regularly uploaded to the Terrigal Trotters website for viewing by friends and relatives.

The main radio at Base was a Yaesu FT-857D with Desk Mic to operate on the repeater in use at the time and an Icom IC-2820 to monitor the other repeater and Rural Fire Service Firecoms at Wyong and Gosford in case of bush fire alerts in the event area. A couple of handhelds for backup rounded out the radios.

Antennas consisted of a dual band mobile whip ground plane on the side of the caravan and a

Diamond X50 dual bander and a UHF Yagi at about eight metres on a fibreglass mast cable tied to a fence.

Power was 240 V from the school with 12 V battery backup in case of failures.

Repeaters being used were VK2RNC UHF on Mt Sugarloaf for comms to the start, Checkpoint 1 and Checkpoint 2, and Hunter WICEN thanks the Hunter Radio Group for allowing them to use this repeater. All other checkpoints used linked repeaters VK2RSR VHF Scaddens Ridge and VK2RAG UHF at Somersby and thanks to Central Coast WICEN for these repeaters.

Base operators' nerves were tested when VK2RAG went down but a quick response by Don VK2ZCZ, who dashed up to the repeater site and reset the circuit breaker, solved the problem.

Base went on air at 0530 Saturday morning in time to hear



Photo 1: Base at Somersby School. Photo by VK2APE.



Photo 2: VK2APE at Base.

Fred VK2YF call in from Start. Shortly after 0600 he advised that the runners had started and that there were 140 of them. Dan VK2GG joined Les and Heather at base to complete the trio. This year we also had Inspector Talone H, from Gosford Firecom, with us in the base in case of bushfires and she was of great assistance maintaining the Master Sheet particularly when we had a disastrous crash on the laptop and had to quickly substitute a netbook for the web link.

The weather was overcast and rainy so quick times were anticipated and this proved to be the case with runners arriving at checkpoints earlier than in previous years.

Checkpoint 1 was located at the old ranger station on the top northern end of the Watagan Range and was quite busy with bunches of runners checking in and out fairly quickly. First runner arrived at 0856 and cut-off time was 1200. Dennis VK2XDW and Barry VK2BZ survived the onslaught after which Barry moved south along the range to become a relay point for Checkpoint 3.

Congewoi Public school in the valley south of Cessnock was Checkpoint 2 where family affair Michael VK2OI, Mel VK2FMAI, and Josh VK2FJBC handled the early traffic and Marshall VK2TMM took over later after finishing work in Cessnock. Here the front runner arrived at 1055, cut-off time at 1700.

From here the runners climb back into the Watagans

and head south along the GNW to The Basin Camping Area or Checkpoint 3, first runner 1356, cut-off 2300. This is a notoriously difficult RF location where Dave VK2FDWE and Chris used simplex to Barry VK2BZ, parked beside the road on the ridge in the dark and very lonely, who acted as Relay for reliable communications via VK2RSR.

Runners then proceeded along and down from the Watagans to Yarralong valley and the old school site for Checkpoint 4 and also Finish of the 100 km event. Here Fred VK2YF and Yvonne handled the traffic again via VK2RSR and then camped for the balance of the night after a long stint on duty. First male home in the 100 km was Clarke McClymont at 1558, which equated to an

overall time of 9 hours and 58 minutes at an average speed of 10.4 km/h. First lady was Beth Cardelli in 12 hours 36 minutes, average 8.2 km/h.

After leaving Checkpoint 4, the runners climb Bumble Hill to Kulnura then through Hidden Valley at Ourimbah to Somersby School where base becomes Checkpoint 5. Here the first 100 mile runner appeared at 2013, cut-off 1000 Sunday.

Runners then progress to Mooney Mooney Creek Bridge on the old Pacific Highway for Checkpoint 6 where Shayne VK2XUV and Karen eagerly awaited their customers, the first of which arrived at 2206. Cut-off time for runners here was 1300 Sunday. Shayne used UHF to access the linked repeaters.

It is time to introduce the WICEN event commander



Photo 3: Checkpoint 1 in the Watagan Mountains.



Photo 4: VK2YGM, VK2OI, VK2FJBC and VK2FMAI at CP 2.



Photo 5: VK2YGM, VK2FDWE and Chris at CP 3.



Peter VK2YGM, accompanied by Irene VK2FIRH. During the event Peter and Irene visited each checkpoint in turn, prior to the arrival of runners, to ensure everything was ok and to hand out paperwork or give any last minute information.

Then they went down to Patonga wharf to provide communications at the finish. Unhappily they didn't get much sleep as Brendan Davies, the winner of the 100 mile race, finished at 0127 Sunday morning in 19 hours 27 minutes at an average speed of 9 km/h. In the process he shattered the old record of 22 hours 2minutes. First lady home was Gill Fowler who set a new record of 23 hours 58 minutes, average speed of 7.3 km/h, and also destroyed the old record of 25 hours 3 minutes. Finish checkpoint closed at 1800 Sunday after the last runners had completed the course.

Thankfully there were no major incidents during the event, although one lost runner was eventually located at home in bed after he withdrew from the race but failed to notify checkpoint staff.

The saddest message received at base came in a mobile phone call from 'Old Bill' who said *"this is the call that I didn't want to make but I am absolutely buggered. Can someone pick me up at the top of Bumble Hill"*.

He has previously run the 100 miles each year but just couldn't make it this time. Bill has earned the affectionate title of 'Old Bill' as he is over 80 years of age. When it was suggested that he should enter the 100 km run, he said that it was only for wimps.

Now for some more statistics:

There were 152 entries including New Zealand 5, New Caledonia 2, Malaysia 2, and China, Japan, Indonesia 1 each, and from all areas of Australia, except SA and NT. There were 76 starters in the 100 mile race of which 50 finished and 64 starters in the 100 kilometre race with 54 finishers.

Dave, Race Organiser and Director, expressed his complete satisfaction with the efforts of WICEN and that he looked forward to WICEN involvement in future events.

See also: <http://www.terrigaltrotters.com.au/GNW100s.htm>



Photo 6: VK2YGM, VK2YF and Yvonne at CP 4.



Photo 7: Finish at Patonga Wharf.



Photo 8: Commander Pete and Race Director Dave at Finish.

# Can a 'small pistol' station offer useful advice to a 'big gun' DXpedition?

Ernie Walls VK3FM

## The case for an improved RTTY operational performance from DXpeditions!

I have a propensity for verbose dialogue on my local two metre simplex frequency, the unfortunate ears usually belonging to Dave VK3JMB. One of our favourite subjects is our 'objective' analysis of the operational performance of the many DXpeditions we hear and try to work, and in particular their RTTY operations.

Now, the first thing I want to say is that, in general, almost all<sup>1</sup> DXpeditions do a wonderful job catering for the 'deserving'. That I freely acknowledge, and this is the good news.

However if, like me, if you are a somewhat late-blooming RTTY lover then, when you analyse their RTTY mode operational performance, the result could certainly be interpreted as bad news!

The almost universal use of computers in the typical ham shack has seen a literal explosion of RTTY (and other digital mode) activity on the bands – and this has slowly filtered through to most DXpeditions. Slowly!

However, it seems that many DXpeditions and, yes, DXpeditioners in general do not maximise operational opportunities for the mode and there appear two main reasons for this – firstly and fundamentally, DXpeditions don't place enough resources behind the RTTY mode and secondly, we as DX 'customers' are missing out due to poor operating procedures and techniques, quite often because the DXpedition operator, often brilliantly effective in the CW or SSB mode of operation is relatively inexperienced, and sometimes even appears not terribly interested in, the RTTY operating mode and is thus far less

effective with RTTY operating. So OK, that is the bad news identified.

But perhaps some self-indulgent advice to the DXpeditioner from this small pistol station may see benefits for all stakeholders.

Arguably the use of RTTY is the fastest growing mode on the bands, albeit from a smaller base than either CW or SSB. It could, and should, be even greater if the DXpeditioner was better prepared to 'service' the RTTY deserving!

Why?

Most DXpeditions do not seem to prepare well enough for this mode; in fact, I think they have been caught unprepared for the demand they will face when they reach that far flung DX RTTY rare entity. They have many SSB expert operators, as they do with CW operators, but they either don't realise, or appreciate, or want to acknowledge that it is RTTY where the most demand may well be. Simply, RTTY is far more likely to be a new band/mode fill for most of the deserving. Many of us have worked a lot of DX on SSB and CW, but are now chasing the 'new boy in town', RTTY, on as many bands as we can find them, because it is all new to us.

This is where the planning for all DXpeditions needs an urgent 'tweak'. That is, for them to prepare for, and be capable of servicing, the demand for RTTY QSOs. Yes, there have been RTTY DXpedition 'records' set, and bettered, over recent times, but even these records only reflect a very modest percentage of total QSOs made, when I believe the demand is far, far greater. Perhaps even greater than either CW or SSB! Hmmm!

In fact, an analysis of <sup>~2</sup> 35 major DXpeditions over the past several years, between them totalling more than two million QSOs produced

an RTTY QSO ratio of only 6.7% - a totally inadequate result given all of the circumstances discussed in this note. Only two of those DXpeditions produced a RTTY ratio above 15%, which the author suggests is the already present demand for the mode. And those two DXpeditions were not big, large scale DXpeditions, rather they were closer to being 'boutique' DXpeditions, the first being YJ0VK, in April/May, 2012, and then TO3X in April, 2012. They contributed 28,899 QSOs, but achieved 5,738 RTTY QSOs, or 19.9%. Well done, lads. It can be done!

Secondly, most DXpeditions do not include in their team dedicated RTTY operators. Perhaps there is not yet enough anecdotal history of RTTY operation to determine who our expert operators may be. In any event, DXpeditions tend to use skilled SSB or CW operators to fill the RTTY void, and many do this task with remarkable clumsiness and inefficiency, with poor operating skills as they relate to RTTY operations. Frankly, I think it is time that every well planned DXpedition should select skilled RTTY experts to man their RTTY operations, and give it their best shot, rather than appearing to leave RTTY as an afterthought.

Yes, RTTY is slower than either CW or SSB, thus will not attract as many QSOs over a similar operating timeframe, but perhaps the focus of QSO numbers worked ought now be tempered with thoughts of 'quality' operations rather than just bare numbers! Yes, I know, the dreaded connection between the number of raw QSOs made, and QSL income, need be considered.

So, what is this small pistol's advice?

1. DXpeditions need to accept the current and likely growth of



RTTY as the genuine third major mode. Sounds simple, but for the amateur family, probably will be extraordinarily difficult. But that's the start point.

2. RTTY QSOs as a percentage of total QSOs need to rise to at least <sup>\*3</sup> 15%, to even approximately represent demand.
3. DXpeditions need specialist RTTY operators as part of their selected operational team membership.
4. Adequate air time and other resource management need be made available to ensure that (1) is accepted, and that (2) and (3) can produce appropriate results.
5. Amateurs, despite often self-proclaimed images of modern, up to date thinking, and being readily willing to accept change in a rapidly changing world, in fact quite often fight change to the bitter end, no matter what the issue. The introduction of SSB and the removal of automatic code qualifications before allowing full licencing are but two of the classic 'change' issues bitterly opposed early on, and for protracted periods.
6. A RTTY pile must be worked with a split, and quite a wide split at that. Seems obvious, I know, but many DXpeditions certainly try the simplex approach, or quite small splits, with generally unsatisfactory, if not disastrous results.

To further emphasise the need for improved DXpedition RTTY operations, a look at the most recent (2011) survey of the RTTY most wanted lists on Don AA5AU's website <http://aa5au.com/rtyysurvey.html> indicates that the vast majority of the 50 most wanted entities will only be sensibly serviced by a formal DXpedition effort – so we really need those DXpeditions, when they occur, to perform well in the RTTY mode.

Come on DXpeditions, accept the growth and inevitable progress of RTTY, and the demand there now, and present your DX offering to

cater. Remember, any business that doesn't listen to what its potential customers want, doesn't last (or in this context), fully succeed.

### Notes

- \*1 In this article, the term DXpedition can be readily interspersed with DXpeditioner – the two are mutually inclusive. Both need to service the RTTY demand.
- \*2 Although these statistics were garnered from a number of DXpedition websites, the vast majority were from records available

on the Club Log © website, a wonderful and highly recommended resource for such information. I also need acknowledge the general RTTY information that was gathered from the website of Don AA5AU, my favourite RTTY website.

- \*3 The author acknowledges that demand is rarely met on any mode by any DXpedition, through no fault of the DXpedition. That is simply the nature of the beast. The 15% target figure represents a nominal target percentage for RTTY QSOs of total QSOs made by a DXpedition.

Call	Date		QSOs by mode					RTTY %
	Month	Year	SSB	CW	RTTY	Other	Total	
600CW	May	2012	22789	24810	5529	0	53128	10.4
A5A	May/June	2012	17210	21595	0	0	38805	0.0
5N7M	On going	2009>	29900	82287	5513	10	117710	4.7
1A0C	July	2012	20269	14735	5950	5	40959	14.5
603A	Feb/June	2012	1084	15130	468	0	16682	2.8
708T	Apr/May	2012	72997	80237	8795	0	162029	5.4
YJOVK	Apr/May	2012	4815	8332	3211	57	17415	18.4
JD1BLY	Feb/May	2012	10320	45595	1906	456	58277	3.3
T03X	April	2012	6146	2811	2527	0	11484	22.0
9M0L	April	2012	10578	27335	3763	0	41676	9.0
PJ7PT	Jan/Mar	2012	15799	22663	3442	0	41904	8.2
3B7C	Sept	2007	51718	79221	6545	0	137484	4.8
3W6C	April	2010	7397	10437	324	33	18191	1.8
4W6C	Sept	2011	21196	18955	1216	0	41367	2.9
9M0C	February	1998	28854	34269	2074	295	65492	3.2
ZK2V	Oct/Dec	2011	11076	20976	2147	0	34199	6.3
ZK2C	February	2012	12819	28561	6831	0	48211	14.2
ZD8D	Jul/Aug	2011	10127	13335	1707	0	25169	6.8
ZD8ZZ	Oct/Nov	2010/1	7146	17314	0	0	24460	0.0
ZD7XF	Jun/Mar	2011/2	0	28255	0	0	28255	0.0
YE0M	July	2012	6880	13504	521	61	20966	2.5
Y11PSE	April	2010	22763	24181	3457	0	50401	6.9
9LOW	Nov/Dec	2011	5826	19936	2207	1	27970	7.9
9Q80QN	Jun/Dec	2010	12344	16655	3096	0	32095	9.6
VP80RK	Jan/Feb	2011	17090	41945	4608	0	63643	7.2
XX9E	May	2012	8404	10999	3211	0	22614	14.2
VP8T	May	2012	18898	33098	4295	0	56291	7.6
HK0NA	Dec/Feb	2011/2	91914	87129	18288	0	195331	8.3
TY1KS	August	2011	17055	9888	1857	1	28801	6.4
3C0E	Mar/May	2012	8683	8668	691	0	18042	3.8
3C6A	Feb/Mar	2012	8029	6943	782	0	15754	5.0
VP8DX	February	2008	86140	87294	10252	0	183686	5.6
T32C	Sep/Oct	2011	88367	102152	19201	3286	213006	9.0
T31A	April	2011	12865	17854	1045	0	31764	3.3
TN2T	January	2012	25010	23130	2429	0	50569	4.8
			792508	1101229	135888	4205	2033830	6.7

RTTY QSO analysis by DXpedition.

# ALARA

Margaret Blight VK3FMAB – Publicity Officer

The ALARA contest is again due to be held in July. A suggestion has been made that on the day of the contest, if some YLs held a lunch at their home shack or even at their club shack, this could be a means of encouraging a greater number of participants. This would also provide an opportunity to support the participation of less experienced operators. Many of us remember being encouraged in our early days in radio and this is one way to offer similar assistance to others. There are also operators who may no longer have access to a radio/aerial who may appreciate the chance to make radio contacts again.

## LYL 2014

The next International YL meeting is to take place in Iceland in 2014. Preparations are currently underway. The conference will be held in Reykjavik on 9th – 12th May. We have been informed that May is springtime in Iceland and the weather is usually most pleasant with sunny days and very little rain. So it is hoped YLs will mark their calendars and seriously consider the possibility of joining an Australian contingent to the conference. More information will be given as it comes to hand.

## Calling YLs.

Jeanne Socrates is an Englishwoman sailing single handed around the world. Her call sign is KC210V and she has been running a nightly net starting on 7.144 MHz. This has been changing because of strong northern stations and contests during late evening/early morning hours. She has mentioned in passing that she has not had much opportunity to speak with any YLs. So perhaps you can consider making contact with her. For descriptions of her epic journey check out <http://svnereida.com/>

where you will find her daily log and other interesting details.

## Inter club BBQ

On Sunday 21st April, members of the Shepparton Amateur Radio Club and the Macedon Amateur Radio Club met for a picnic at Nagambie Weir. Jean VK3VIP, President of ALARA, and her OM, John VK3DQ travelled up from Melbourne together with Margaret VK3FMAB to participate once again as they had previously enjoyed earlier BBQs with the clubs.

The weather on the day was beautiful and the sun shone for the duration. This enabled us to sit outdoors in comfort and enjoy a chat and catch up. It was a pleasant surprise to learn that the BBQs in the park were now operating free of charge, without the earlier coin in the slot mechanism, having been completely refitted since our last visit.

Everyone's interest had focused on an unusual looking three wheel vehicle that was brought to the event by Kevin VK3CKC, OM of Monica VK3MON. After lunch he explained to us that it was in fact called a Recumbent Tadpole

Trike that he had built himself and intended to use to raise the profile of amateur radio in his local community. Kevin strongly believes that public interest will be successfully aroused if amateur radio can be seen to be operating in a public environment, as this provides an opportunity to interact directly with members of the community.

The O'Keefe Rail Trail is located near Kevin's home. Initially he considered building a radio into a back pack and using it while walking the Trail where people could see the operation and take the opportunity to ask questions about the hobby. Some problems did emerge with this project, one of which was the building of an appropriate antenna for the backpack. Then in January this year the idea of joining two bikes together to build a conventional trike came to mind. This concept was then developed and the form of a Tadpole Trike was eventually decided upon.

There remained a number of issues to be overcome, such as how to steer one handed as the other hand would be needed to



Photo 1: ALARA members at lunch at the Nagambie Weir.





Photo 2: Kevin VK3CKC demonstrating his recumbent trike.

hold the radio. A VHF/UHF antenna has been fitted to the rear of the trike and other modifications are being worked on. Overall the trike looks comfortable to ride on and the pedals look to be easy to use from the recumbent position. We were all given a demonstration of the trike's versatility as Kevin rode it around the park for us.

Kevin outlined the current plan is for a ride along the O'Keefe Rail Trail to be organised, hopefully involving a local school and other interested community groups. There would be an amateur station set up at either

end of the trail and the public would be encouraged to become involved. We hope to hear that this plan has been successful and look forward to learning the outcome.

Another participant, Luke VK3HJ, then discussed his latest project, a variable inductor that he had developed to enable him to experiment on the 630 metre band. He demonstrated the finished model to us and outlined its component parts.

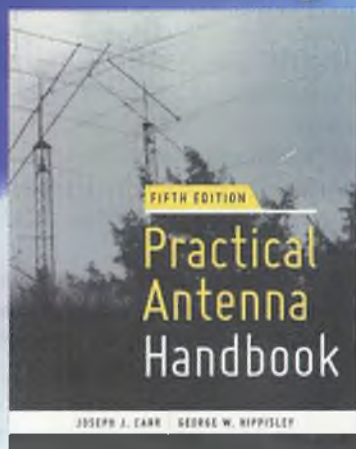

Photo 3: Luke VK3HJ and his variable inductor project.

After enjoying the input from both VK3CKC and VK3HJ we were all rewarded with a sweets course of pavlova, trifle and home baked cookies. This was considered to be a fitting end to a very successful day. We look forward to future events.



## Visit our **Bookshop**



*\*Plus Postage & Packaging*

## Practical Antenna Handbook

Reorganized to flow logically from broad physical principles to specific antenna design and construction techniques, the book begins by covering the fundamentals.

Then the half-wave dipole is discussed both as an excellent antenna in its own right and as a conceptual tool for predicting the performance of other designs. Transmission line impedance matching techniques—and a companion Smith chart tutorial—lead into "must have" accessories for tuning, monitoring, and troubleshooting antenna system performance.

Other tools, such as antenna modeling software and network analyzer add-ons for PCs and Macs, are addressed, and concluding chapters offer fresh insights into support structures and installation techniques.

Antenna topics covered include:

- › Dipoles and inverted-Vs
- › Quads, delta, and NVIS loops
- › Wire arrays (bobtail curtain, half-square, rhombic)
- › Verticals and shunt-fed towers
- › Rotatable Yagi beams
- › MF/HF receiving antennas (flag, pennant, K9AY, Beverage)
- › Mobile and portable antennas
- › VHF/UHF/microwave antennas
- ...and many more!

**Members: \$55.00 \* Retail: \$65.00 \***

**Order your copy today!**

Visit our online bookshop for details. <http://www.wia.org.au/members/bookshop/about/>



## VK2news

Tim Mills VK2ZTM  
e vk2ztm@wia.org.au



Paul VK2APA, on the left, presenting Terry VK2UX with his Life Membership certificate at the ARNSW 2013 AGM.

ARNSW held their AGM on the 20th April on a very wet Saturday morning. 29 members braved the elements to attend. Highlight of the meeting was the bestowing of Life Membership on Terry Ryeland VK2UX. The members soon dealt with the business to hear guest speaker WIA President Phil Wait VK2ASD. An election was required this year. 154 formal votes were cast resulting in the election of Mark Blackmore VK2XOF, John Harper VK2HRK, Al Hirschel VK2KAM, Mathew Magee VK2YAP, Tim Mills VK2ZTM, Terry Ryeland VK2UX, Julian Sortland VK2YJS, Bob Yorston VK2CAN and Peter Zielinski VK2VG. At a subsequent committee meeting Terry VK2UX was again elected as President. Other office bearer positions are to be found on the ARNSW web site. ARNSW has recently added a clothing and merchandise range which can be viewed on the ARNSW web site at [www.arnsw.org.au](http://www.arnsw.org.au)

In a few days' time the annual Oxley Region two day field day is

to be held in Port Macquarie on the long weekend, Saturday 8th and Sunday 9th June. The venue is the Tacking Point Surf Lifesaving Club. There is a dinner on Saturday night at the golf club. You will find all the details on their web site [www.orarc.org](http://www.orarc.org)

or in the May issue of AR on page 40. The club is part way through its Standard course. They are preparing to conduct Foundation and Advanced courses and anyone interested should register by mail to Box 712, Port Macquarie, NSW 2444.

The Blue Mountains ARC held their AGM early in May. The club has advised that it is unlikely that they will be conducting their Winterfest field day, which is normally held towards the end of August. In August however the Summerland ARC out at Richmond Hill, Lismore has their SARCfest. The Manly Warringah RS recently had an interesting lecture on 'MESH Potato', a little box of tricks using Wi-Fi mesh networks to provide a telephony service in remote communities. MWRS meet informally every Wednesday plus a monthly general meeting. They are located in the 1st Terrey Hills Guide Hall in Beltana Avenue, Terrey Hills. The doors open at 7.30 pm for an 8 pm start. Their local repeater is 6875 and the web site is [www.mwrs.org.au](http://www.mwrs.org.au)

Next month WICEN NSW will be taking part in the 25th annual Bush Walkers Search and Rescue Nav Shield exercise on the weekend of 6th and 7th July. Need more contact with NSW WICEN, go to [www.nsw.wicen.org.au](http://www.nsw.wicen.org.au) The Central Coast ARC set up three field stations for the WIA National Field Day in March. HADARC set up an IMD station for the annual event in April. The Illawarra ARS had recent involvement in an ARISS hookup with a local school as reported in AR last month. Lord Howe Island continues to be a DX destination for every few weeks the ARRL DX News lists activity from the VK9 location.

Westlakes ARC who provide QSL facilities on behalf of the WIA advises of changes in postal addresses. The Teralba post office has been closed, so Westlakes have had to move to nearby Boolaroo post office. The club postal address is now Box 5, Boolaroo, NSW 2284. The QSL operation is now Box 66, Boolaroo, NSW 2284. The club telephone is 02 4958 1588. Email contact is [secretary@westlakesarc.org.au](mailto:secretary@westlakesarc.org.au) The club meeting is the 1st Saturday of each month at 13.30 hours.

In north west VK2, in the town of Inverell, there are a couple of towers that belonged to Reg VK2ATS who is now a Silent Key. The family would like to have them removed and are being offered free to anyone with the expertise to remove same. Details are available from ARNSW by an email to [office@arnsw.org.au](mailto:office@arnsw.org.au) 73 – Tim VK2ZTM.



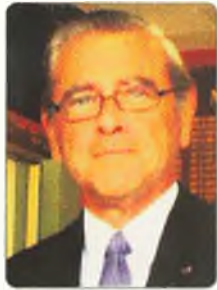

Tony Collis VK3JGC

### The Dereel 'Hilton' survives a fire storm

On Wednesday 27 March TV and radio media announced that a fire storm had hit Dereel, west of Melbourne. This was traumatic news for the GARC as in a remote multi hectare block owned by Dallas VK3DJ was the 'Dereel Hilton', a large shed used as a retreat by GARC members and other amateur radio enthusiasts throughout the year. Whilst the shed has no utility services available, it is equipped with a petrol generator supplying power and lighting, and a water tank. Last year a tower was erected by the side of the shed and a multi band beam installed supplementing several dipoles. On Thursday 28

March a visit by Dallas ascertained that whilst the fire had destroyed adjacent properties the shed itself was not significantly affected; indeed only one dipole antenna had been partially disabled. The fire had come within six

metres of the building which was then surrounded by charred and burning trees.

The survival of the shed was largely attributed to the CFA who did a magnificent job cutting a swathe through the trees providing



Photo 3: The building flanked by charred and burning trees.

a much needed clear access route from the road, whereas previously access was a tricky route around the surrounding trees. The following weekend a working bee was established to start the clear up process and at the same time a collection was taken up for the CFA in gratitude for their tremendous efforts.

### The GARC Annual General Meeting

On 5 April the GARC held its Annual General Meeting at the club house in Storrer Street, Geelong.

Two changes were made to the existing Executive Committee; the first was to replace the retiring President Tony VK3JGC, who had held the office for the last two years, with Nik VK3BA. The second, in line with The Associations Incorporation Act changes, as recommended by Consumer Affairs Victoria, was to confirm that Secretary Jenni VK3FJEN now also takes on the role of the GARC's Public Officer.

### Ray Cowling Award

As is the custom with the GARC, the last order of AGM business was to decide who was to receive the Ray Cowling Award. This award is given to the club member who is deemed, by the members, to have contributed the greatest amount to amateur radio and the Geelong Amateur Radio Club, in particular, throughout the year. This year the award went to Tony VK3JGC and was presented by Treasurer Lou VK3ALB.



Photo 1: Dallas VK3DJ.



Photo 2: President Nik VK3BA.



Photo 4: The burnt block surrounding the 'Dereel Hilton'.

Clive Sait VK4ACC

### Two members achieve 50 years of continuous WIA membership - A life time!



Photo 1: Clive VK4ACC presents Doug VK4DUG with his 50 year medal.



Photo 2: Clive VK4ACC presents Gordon VK4GM with his 50 year medal.

On Wednesday evening, 17 April, 2013 at the Rockhampton and District Amateur Radio Club (RADAR Club) a celebration and presentation was given to two members, Gordon Adams VK4GM and Doug Kraatz VK4DUG, on their achievement of having reached fifty years of continuous WIA membership, to the very day.

They both joined the WIA in 1963, and the club is fortunate to hold copies of both original membership certificates – copies of which will be sent to the WIA.

During the presentation Gordon VK4GM stressed to younger members the importance of being a member of the WIA.

As part of the evening's festivities a few pieces of history dealing with amateur radio in the Rockhampton area were detailed.

In March 1928 the first radio club was formed in Rockhampton. The Central Queensland (CQ) branch of the WIAQ was formed in November,



Figure 1: Gordon VK4GM's original WIA membership certificate.

1960. Yes! Every member had to have WIA membership - and they all were! The Rockhampton and District Amateur Radio Club was founded on 15 May, 1996, due principally to the WIA CQ Branch finding it too difficult to administer for the then state body WIAQ.

Clive VK4ACC, a winner of a WIA 75th Anniversary Medal and Past Alternate Federal Councillor and past member of the WIAQ Advisory Committee made the presentation of the 50 year WIA membership medals on behalf of the WIA.

## Silent Key

### Frederick William Norman (Fred) Ryan BEM VK1RY

It was with deep regret that I learned of the passing of Fred Ryan VK1RY.

Fred and his XYL Allison have been friends of mine since 1978. Fred, like many public servants of his era, started as a Telegraph Messenger at Richmond, Victoria. He gained promotion as a Telegraphist and eventually rose to Supervisor status.

In 1964, Fred was promoted and transferred to the then Department of External Affairs, (now Foreign Affairs and Trade), in which he served in many local and overseas postings. He also served as an ad hoc Diplomatic Courier.

Two of his key appointments were as OIC of the communications centres at Washington and London.

At the end of December 1981, Fred became a recipient of the British Empire Medal for outstanding public service. He retired in 1982.

Fred attained his AOCP in 1965 and became VK1RY, a callsign that he actively used until his sudden demise on 2 November 2012. Fred's main interest in amateur radio was CW. He was a well-known and dedicated member of the "Morsecodians", and when possible would join others at the old Overland

Telegraph Station at Alice Springs around ANZAC Day.

Fred had his final sked with former Telegraphist friend Geoff Butterworth VK3ED just two days prior to his passing.

Fred is survived by his XYL Allison and son Ian.

Submitted by John Clara VK1CJ with much assistance from Allan Moore (ex VK1AL), long time telegraphist friend of Fred and Allison, for over 50 years.



Mike Charteris VK4QS  
 e mikevk4qs@gmail.com

### Club news from Queensland

G'day fellow Queenslanders and welcome to the June edition of QTC. What an exciting first six months of 2013 it has been, with plenty of activity on the bands in the form of propagation as well as contests. Thus far this year we have seen the CQWPX on a world wide scale, and on a more local level the much celebrated Harry Angel Contest on the 80 metre band. One of the highlights of the Queensland amateur calendar, BARCFEST, was conducted on May 11th, and by all accounts it was a great success. On a national level the WIA Annual General Meeting and Conference in West Australia has now come and gone with all its celebration. More on this next month as reports come to hand.

### Ipswich & District Radio Club

In news from Ipswich this month, Bob Beck VK4RJ reports that the club has developed a very interesting net on the subject of slow scan TV. You can find the boys on Wednesday evenings from 7.30 pm on 28.450 MHz, chatting for a while before they fire up the gear and start sending pictures a little further up the band on 28.680 MHz. 'F' calls are encouraged to come up for a listen with their computer sound cards, and a program called MMSSTV. It's a free download that can be utilized by placing your microphone next to the speaker of the HF rig so you can receive and decode the picture file that is being sent. Another club stalwart, Graham VK4GRA, has been very busy coaching candidates for the Foundation, Standard and Advanced licences. Assessments are carried out at the Ipswich Clubhouse on Denmark Hill when required. Please contact the President, Vice President or Secretary via the club website at [www.vk4wip.com](http://www.vk4wip.com) for contact details. Also to hand is news that the boys have been busy



Photo 1: Lockyer Valley ARC members operating in the JMMFD, from the left: Wayne VK4HS, Ken VK4QH, Bob VK4BYX and Peter VK4MN. The photographer was Alan VK4SN.

with a recent construction night in an effort to build some 2 m/70 cm vertical antennas. Thanks again to Graham VK4GRA for the procurement of material for this very worthy project. The Ipswich club are often involved in community activities as well, and the next one will occur in June 2013. This will be the Kilkivan Tom Quilty Endurance Horse Ride which will be conducted over a 24 hour period. If you would like to catch up with the Ipswich club on HF, then tune into their 80 m net each Tuesday night on the frequency of 3.585 MHz, give or take QRM. If you're into wallpaper, then ask about working for their Ipswich 80 m Net award.

### Lockyer Valley Amateur Radio Club

Alan Shannon VK4SN reports that the boys at the Lockyer Valley club went all out for the John Moyle Field Day recently. The team consisted of Al VK4SN, Pete VK4MN, Ken VK4QH, Wayne VK4HS and Bob VK4BYX. The team arrived around 6.30 am and were straight into setting up the tables, chairs, tent and caravan, plus the station equipment. This was followed by the antennas which consisted of a three element tri-band Yagi, perched on a pump

up tower, as well as a ubiquitous G5RV, a 160 m dipole and a five band trapped vertical. Once that was accomplished it was time for a relaxing cup of tea and a well-earned spell before the contest kicked off at 0100 UTC. Power was ably supplied from two generators with a third in reserve, to supply four operating positions. The availability of a fifth operator proved a benefit when one of the guys took a well-earned break. Despite their best efforts, nature seemed to have the last laugh with a coronal mass emission the previous day playing havoc with signals across the bands. To their credit the boys from Lockyer Valley managed a respectable 485 contacts. These ranged from local VKs to ZLs, plus further afield to places like the Philippines, China, and parts of Europe. The photo gives a pretty good idea of what the boys were up to for the John Moyle Field Day.

### Bunya Mountains & District Am Com Inc

On the weekend of June 22 and 23 the club will be conducting two days of courses and exams. So if you are reading this, it might be a good opportunity to step up for that Foundation licence you have

been considering for some time. For details email Neil Holmes, at [holmzie@bigpond.com](mailto:holmzie@bigpond.com) as I am sure he would look forward to hearing from you. Don't forget that you can catch up with Neil and the Bunya Mountains gang on their weekly Sunday evening 80 m net, on 3.650 MHz from 7.30 pm. So pop by and say hello, and you can look forward to a friendly welcome. Well done to Ricky VK4NRL, Peter VK4POP and Rick VK4FRLJ for their efforts in the recent John Moyle Field Day. They put in a very good effort for six hours at the back paddock of Peter VK4POP's QTH. Apparently the local insect population clocked up a considerable score on the boys, but they in turn did pretty well in the John Moyle for the night's efforts. It looks like the club has been enjoying a bit of fundraising in the form of 'Sausage Sizzling' down at their local Dalby Home Hardware store in the months of April and May. If your club can aspire to such promotion of our hobby and make a few new friends at the same time, then more strength to you Gentlemen. And finally, in news just to hand, the Bunya Mountains Club will more than likely have their Club Website up and running by the time you read this report. So contact Neil Holmes for details of the website and join in.

### Darling Downs Radio Club

Make it a date Saturday nights at 7.30 pm on 3.587 MHz to catch up with Theo Moller VK4ESK and the boys from the Darling Downs. Pop in and say hello on a very friendly net, and ask Theo about working for the Club's 80 metre Award as a very nice piece of wallpaper. The club also hosts a very nice website at [www.darci.webs.com](http://www.darci.webs.com) with details of how to join plus club activities and some photos of members.

### Brisbane Amateur Radio Club

The Brisbane Amateur Radio Club has recently moved to the Rochedale Scout Den, located at 21 Rochedale Road, Rochedale. The club meets

on the evening of the second and forth Friday for an informal chat with those who have an interest in all forms of radio communications and electronics. Now that it has a more permanent home, the club hopes to run workshops and talks throughout the year in order to discuss how amateurs can take advantage of new developments in an increasingly connected world. With an annual subscription of only \$20.00, the Brisbane Amateur Radio Club has much to offer anyone with an interest in electronics and radio communications. The club's website can be found at <http://www.qsl.net/vk4ba>. So drop by and catch up with the boys at their new clubhouse, I am sure you will be made most welcome.

### Tableland Radio Group

The Tableland Radio Group decided that the World War 2 Australian General Hospital Rocky Creek Igloo on the Atherton Tablelands, would be an excellent location for amateur radio operation, as part of the AM and CW on the ANZAC DAY national event.

It had the following attributes:

- 1) Is part of our WWII history, as the Rocky Creek AGH was the largest hospital in the southern hemisphere during that time.
- 2) It also had trees ideal for a dipole.
- 3) The Tableland Regional Council was very co-operative towards our plan and, finally,
- 4) Rotary, who are presently responsible for the igloo, was also happy for us to set up nearby.

With no major problems encountered in the initial stages, we settled on an IC-746 transceiver as it was 12 V DC and ideal for portable operations and so it all came together after that. Earlier in the day we were informed by an RSL committee man that the RSL organisation

was well aware of the amateur radio Anzac Day event and thought it was a good idea.

The Townsville Amateur Radio Club, AX4WIT, operated as net control as stations came in from Cooktown to Rockhampton and west to Charters Towers and Mt Surprise areas. In near perfect conditions, it was surprising how well the AM mode worked, as in the previous two years there were a few problems.

It was pleasing also to work ex HMAS Diamantina in Brisbane, with Col VK4RAN running that station on CW and adjusting his speed to the various stations calling in and conditions at the time. Overall it was an excellent opportunity to try the old modes and to experience the idiosyncrasies of them, resulting in a most enjoyable day.

The original idea came from Mike Patterson VK4MIK of the Tableland Radio Group after a talk to an ex Coastwatcher, Lionel Veale, who talked about operating the ATR4A transceiver during various operations in WWII. It appears to be growing in popularity each year worldwide, so well done to Mike for initiating this event and giving amateur radio operators the opportunity to acknowledge the efforts of past service personnel, for their communication skills under the most arduous of conditions.

Pat Edmunds VK4MUY, for the Tableland Radio Group VK4GHL.



Photo 2: The Tableland Radio Group operating at the AGH Rocky Creek Igloo on the Atherton Tablelands.



# VK6news

Keith Bainbridge VK6RK

e vk6rk@wia.org.au

By the time you read this the WIA VK6 AGM and Conference will be over and, I'm lead to believe, it was only the third such similar event to take place in WA. WA is commonly known to stand for 'wait awhile', so I wonder how long it will be till the next one is here? I can only hope it was successful and the hard work put in by Bob VK6POP and Onno VK6FLAB enabled it to run smoothly. Unfortunately, I was not there, my family booked the first 'whole family away trip' for many years and I had no means of escape. Anyway, to business.

First up is the Peel Group.

The Peel Amateur Radio Group (PARG) will be assisting the WIA National conference in May by providing a portable amateur station in Fremantle on Sunday May 26th. The portable station will double as a public display of amateur radio, as well as promoting the WIA.

PARG's mobile communication unit, which incorporates a 12 metre mast, will be operating out the front of the WA Museum - Shipwreck Galleries on the corner of Marine Terrace and Cliff Street, Fremantle. The station will be active from approximately 1000 till 1630 WST. All amateurs and interested parties are welcome to drop by and join in. PARG normally operate using their club callsign VK6ARG, but this weekend they will be operating the special event callsign VI03WIA over those hours, in collaboration with the WIA National conference. Prior to the conference weekend the group will be meeting to fully prepare the mobile communication unit for this special field day/ portable station. Contributed by Paul Gardner VK6LL, Secretary, PARG Inc.

We hope that all went to plan Paul.



Photo 1: Jamie Giddons from Access Hire installing the 40 m traps on the HARG HF Beam.

Next, this month's news from the Hills Group.

## Greetings from HARG - the Hills Amateur Radio Group.

By the time you read this our annual HARGFest will be over for another year. This year we had two commercial sellers. Mark from TET-Emtron was there with his antennas, auto tuners, antenna analysers and everything you need to home brew your own antennas. Heath VK6TWO from Spooktech had a large range of Wouxun products - handhelds, mobiles and bluetooth headsets plus APRS trackers, GPS antennas, solar panels and regulators. Steve VK6IR ran his QSL bureau and Fritz VK6UZ was there with all his useful bits and pieces. The raffle prizes were all donated by local suppliers. First prize was a Wouxun dual band mobile donated by Ian VK6LCT and Kylie VK6XYL of Timberden Plant Hire. Second Prize was a Wouxun two metre handheld donated by Heath VK6TWO of

Spooktech and the third Prize a 500 W 4:1 current balun donated by Mark of TET-Emtron. The door prize was an Iroda professional quality 125 watt gas soldering iron kit donated by Altronics. Please support all four of these suppliers to reward them for their generosity. Next month I can announce the names of the winners.

At our April General Meeting we welcomed two new members, Fred VK6FJJR and Mitch VK6FLEX. Mitch pitched in straight away by offering to get the sausages and bread for the lunchtime barbecue and by assembling our new WARC band rotatable dipole which was donated by Martin VK6ZMS. At that meeting we added the 40 metre traps to the director on our four element TET-Emtron HF beam. Our heartfelt thanks to Ray, VK6ZRW's friend, who supplied a cherry picker for the cost of a carton of soft drinks. Thanks also to Graeme VK6LV who has donated a very nice RF quiet

generator for use on field days. At our General Meeting on Saturday 29 June, Mal VK6LC will be giving us a talk on balloons. In July, thanks to John VK6JGF we will be visiting the Radio Operations Centre at the Fremantle Water Police where maritime rescues are coordinated. In August we will be participating in the International Lighthouse and Lightship Weekend from Fremantle and in September Heath VK6TWO will give us a talk on satellite and ISS communication. Until next time, cheers and 73 from Bill VK6WJ for HARG.

I am/was (so confusing writing a month in advance!) planning to be at the sale, so I hope all went well.

Will VK6UU sent me this segment so I'll let him explain:

### Cross band repeater

The proposal for a cross band repeater is being considered for Perth. A cross band repeater is similar to a normal repeater, the difference is that a cross band repeater repeats from one band to another. A normal repeater repeats in band, for example a two metre repeater receives on one two metre frequency and re-transmits on a different two metre frequency. A cross band repeater is simplex on a given band. Cross band repeaters are easier to construct than an in band repeater, as there is not the need for complicated duplexers. The issue of desensing is not an issue with a cross band repeater. Also there are no duplexer losses, typically 2 dB. A cross band repeater can maximise the receiver sensitivity in a variety of ways often found difficult with a normal in band repeater.

There is a disadvantage with a cross band repeater, in that if two users are on the same band they will only hear each other if they are within simplex range of one another. However the user benefits from a cross band repeater are many, particularly if many bands are used. The proposal for Perth is a six band repeater on 10 m, 6 m, 2 m, 70 cm, 23 cm and 5.8 GHz. Ambitious yes but the complete system does not have

to be completed in one go. Initially a 2 m/70 cm cross band system would be constructed and then other bands added. Where the amateur benefits is in activity. Once several bands are working, a call on say, 2 m goes out on many other bands. The chances of a contact increases with the number of bands the cross band repeater has. The repeater has to comply with the normal repeater regulations, time out and identification.

There is also the licence issue of amateurs not being transmitted onto bands they are not licensed for. An example is Foundation licensees are not licensed for 6 m, so the system

would require other licence holders to encode their transmissions with CTCSS. This then keys up all bands. Without the CTCSS only those bands licensed to the Foundation licence are re transmitted to via the cross band repeater. Foundation holders could only access 10 m, 2 m and 70 cm but they would hear the activity of the other bands and this may act as an incentive to upgrade their licence. Perhaps the most difficult aspect of the project is the licensing, as it is not the normal repeater. This is under way along with choosing suitable frequencies. Some initial design work has started and the 6 m, 2 m and

Photo 2: Repeater sites throughout WA.





70 cm radios will be based on the Hamtronics receivers and transmitters.

You may ask why also include 5.8 GHz. The answer is that it appears relatively easy. One watt transmitters and receivers can be purchased for under \$100. The mode used is wideband FM and has one video and two voice channels. The exact configuration and use is yet to be decided but is an exciting addition to a cross band repeater.

As I was writing this article, an amateur emailed me to put forward the idea of adding an FM analogue input to the cross band repeater, which is connected to an ailstar node and then via the Internet to other world-wide systems. What a great idea! More on this later. Will VK6UUJ.

That's an interesting prospect for future amateur radio repeaters in this state; fingers crossed.

From the land of FIFO comes this report from Jono VK6DF:

Just something for the VK6news: All be it is not very exciting at the moment so just some general info and also a VK6 repeater location map I quickly chucked together. As we see an end of the Cyclone season here in the north-west and the start of tourist season and an influx of travellers we urge them all to stay safe. Be sure to let your loved ones know your plans. Before you set out anywhere, get local advice about conditions and what you should know about where you intend to go. Advise people of your intended trip, where you will be going, when you'll be leaving, when you think you'll be back. We are all well aware of the different types of communications devices available nowadays and the one we rely on the most, the mobile phone, as convenient as it might be in the major cities and highly populated towns, it's not always the case in the country.

The technology behind mobile phones, and especially after the introduction of Next Generation Mobile Networks has improved vastly in the last few years. But be aware! Mobile phone networks might use phrases like '90% of the

Australian population covered', which doesn't mean that the same amount of the landmass is covered. Most of the outback is still out of reach for the mobile phone, and our dear friend Murphy and his Law will guarantee that when you need that phone service you won't have it.

Sat phones can be a great device but sometimes not very cost effective. With expensive monthly access fees as well as quite costly call charges per minute (which can be in excess of \$20 per minute if you happen to call from one Sat phone service provider to another) it's not the ideal choice for everyone. This would be a great time for us to embark on a bit of maintenance on our vehicle radios. Just simple things like checking the power terminations, even the power cable run to make sure it has not started to rub through on bare metal and may short out after driving down the corrugated roads. Check the antenna, the connections and VSWR. Consider packing a 'spares' kit. Include things like a spare microphone or microphone cord. Some appropriate fuses, and maybe some coax and even a spare antenna if room permits. It would also be a good time to familiarise yourself with the radio's features.

Grab the manual and highlight some key operational points. Maybe even get a list of the local repeaters for the area you plan to travel and store them in the memory bank of the radio.

It's no good having a radio in the vehicle if it doesn't work like it should.

There have been many occasions where people are left with egg on their face because of a simple fault which could have been, and should have been, prevented prior to the journey.

If you are travelling we hope you have a safe and enjoyable trip. Jono VK6DF, Amateur Radio Society of Northwest Australia.

Thanks Jono. My youngest daughter is working 200 km inland from Port Hedland, and she has terrible mobile coverage; perhaps I can persuade her to get her licence? Finally, a brief update from the NCRG:

The club put on the Sundowner event at the WIA conference and a marquee, catering requirements and everything else set up for the event at NPSARC in Whiteman Park. Visitors were bussed in and hopefully enjoyed the chance to eat, drink and have a look around the clubs facilities.

All projects are progressing well and a new challenge has been thrown down to provide many towers for an upcoming international event. We need to refurbish some, so work is under way.

That's it for this month, a good input from many of the groups.



Photo 3: Repeater locations in the south west of WA.





## VK7news

Justin Giles-Clark VK7TW

e vk7tw@wia.org.au

w groups.yahoo.com/group/vk7regionalnews/

Last month was eventful! Firstly, a huge congratulations to Rex VK7MO and the crew at OK1KIR in the Czech Republic. A 24 GHz Digital EME world record was set with a distance of 16,383 km with a portable 24 GHz station in VK7. Another event was the analogue TV switch off in VK7. The author captured this event showing the switch off of each station using a spectrum analyser and has posted to YouTube – search 'Analogue TV' and the author's name to view the short video of this historic event. With the closure of analogue TV the CTCSS tone has been removed from the VK7RAD six metre repeater (53.835 MHz) in Hobart. It is nice that the noise floor actually decreases! Another event was the author's 10th anniversary of writing this column. I hope I have brought some smiles to faces who read about this fantastic hobby of ours in VK7.

### SOTA in VK7

In VK7 we have done the preliminary work of regionalising the state and I thank Peter VK3PF who has already mapped three of the regions of the state for us. We have developed instructions on how to map summits using the free mapping resources available and we are looking for VK7 volunteers to map the remaining regions. If you are interested in being involved then please get in contact.

### Cradle Coast Amateur Radio Club

ANZAC Day 2013 saw a great story from Steve VK7BI who has restored his late father's New Zealand army radio, a 1944 ZC1. Steve had it operating on ANZAC day in glorious



Photo 1: Steve VK7BI with the restored ZC1. Photo courtesy of VK7BI.

AM coinciding with what would have been his father's 85th birthday. Steve supplied a great history lesson on the development of the ZC1 during WWII in New Zealand which included sending a team of geologists up into the Westland Alps of the South Island to mine mica for capacitors. The ZC1 saw service in the Pacific at Guadalcanal when the New Zealand troops landed at Vella Lavella in 1943. Post war sets appeared in the Greek, Turkish and Egyptian armed services.

Members of CCARC and NTARC were involved in radio communications for the Tasmanian State Equine Endurance Championship 160/80/40 km fundraiser rides at Sassafrass in NW VK7. Communications was all conducted on two metre simplex. There were 70 riders who participated in the weekend's rides.

This was a prequalifying event for the 160 km Tom Quilty ride which is in Queensland this year. Thanks to all involved and Dave VK7DC for the information.

### North West Tasmanian Amateur Television Group

Tony VK7AX let me know that the vital statistics of the group's repeater VK7RTV are now available on the web at <http://www.vk7ax.id.au/atvgroup/> thanks to work by Jim VK7JH. This information includes received signal strength, battery voltage and heatsink temperature. At the bimonthly group meeting Jim VK7JH took attendees through the analogue TV switch off and the need to restack digital TV frequencies in many areas of Australia to enable the reclamation of spectrum and realise the 'Digital Dividend' that the ACMA has been promoting. Thanks Jim.



## Northern Tasmania Amateur Radio Club

NTARC has moved into its new clubrooms in the Rocherlea Scout Hall in Archer St, Rocherlea. Many working bees and much work has gone into preparing the venue as the permanent home of NTARC. The first general meeting was held on 10 April, 2013 and was well attended and some great discussion about the potential of the venue was forthcoming. The coffee machine is fired up every Monday morning at Rocherlea and the social gatherings continue every Friday morning at the usual coffee venue – Friend's Cafe in Jimmy's Shopping Complex, Charles St., Launceston.

Many items have been donated for the new clubrooms and thanks go to Rick VK7RI, Norm VK7KTN, Oatley Electronics, Bill VK7ZK, Lewis VK7FLPL and XYL Liz, Idris VK7ZIR, Wayne VK7XGW, Tony VK7YBG and XYL Anne VK7FYBG and George Walker formerly VK7GW. Peter VK7PD is assembling the club station with a centre piece of a Kenwood TS-900, matching VFO-900 and the matching PS-900 power supply, thanks to George. Peter is also looking for a dual band VHF/UHF antenna and G5RV for HF for use with the club station.

## Radio and Electronics Association of Southern Tasmania

We congratulate Mary, Susan and Chris for all passing their foundation assessments in the last month. We also congratulate Brian who upgraded to standard level at the same assessment session. We look forward to hearing you all on the

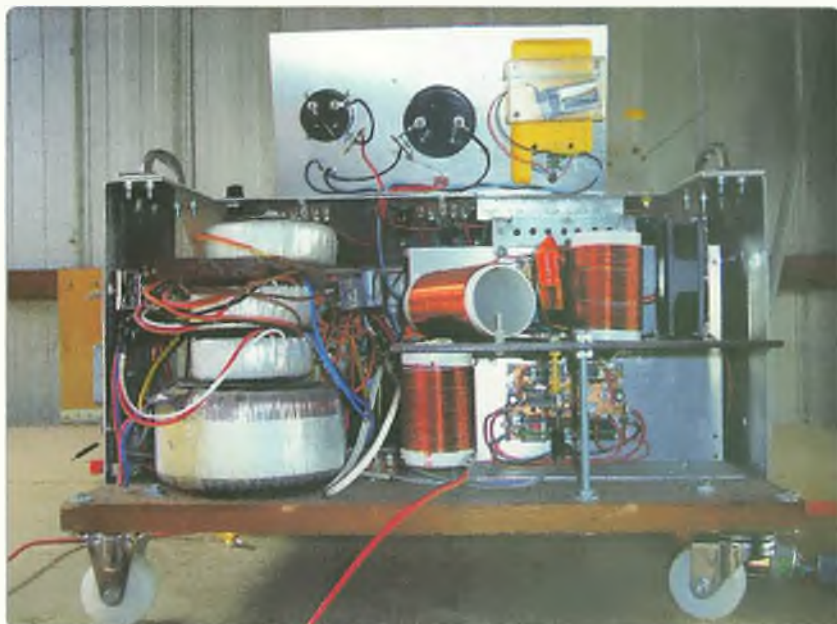

Photo 2: AX2TAR's kilowatt LF transmitter. Photo courtesy of VK7ZL.



Photo 3: Bob VK7ZL explaining the finer points of NDB hunting. Photo courtesy of VK7TW.

air. REAST's April presentation was given by Richard VK7RO and Bob VK7ZL on LF/MF, non-directional beacons and AX2TAR. Richard started with his recollections of

Robert Milne VK7ZAL (SK) who also held experimental LF licence AX2TAR. Robert was a keen experimenter and built all his equipment and received reports from around Australia and New Zealand on 171.5 kHz.

Bob VK7ZL then took the audience through his experimentation with non-directional beacons and improving his reception capability in the LF and MF frequencies. Much interest was shown in the active antenna design from PA0RDT which Bob uses. In the ten years of experimenting he has been listening his range has increased to greater than 3000 km and includes Navtex beacons, DGPS beacons and other beacons. Thanks to Ric and Bob for this presentation.



## Participate

### Winter VHF-UHF Field Day

The Winter Field Day will be held over the weekend **22 and 23 June**. For full details please check the contest web page.



# AMSAT

David Giles VK5DG  
e vk5dg@amsat.org

## April launches

Three successful launches carrying satellites using amateur frequencies were carried out in April. In total ten new satellites of interest to amateurs were put into orbit.

## OSSI-1 news

Blasting off to an elliptical orbit of 250 to 580 km, the first privately built cubesat OSSI-1 successfully made it into orbit. Unfortunately that's the good news; no reception reports have been made since. I heard nothing during the two passes I was able to listen for the beacon on 145.980 MHz. The elliptical orbit will give OSSI-1 a short life as it will drag in Earth's atmosphere at its closest approach [1].

With OSSI-1 on the same launch were BEESAT-2, BEESAT-3 and SOMP. These use amateur frequencies but the BEESATs will only be heard over their ground station in Berlin, Germany. SOMP – the Students Oxygen Measurement Project – was developed by students at the Dresden Technical University in Germany. Its two main missions are to measure atomic oxygen in the Earth's upper atmosphere and test a type of thin film solar cell. It transmits a 12 WPM CW beacon every minute, 1200 baud FSK and BPSK telemetry that requires special hardware. Details are provided on their website. The transmitter emits 0.5 watts on 437.485 MHz [2].

## Phonesats

With the retirement of the space shuttle fleet NASA has been involving private companies to develop ways of supplying the

International Space Station. On the 21st of April a test launch was made from Wallops Island, Virginia of an Antares rocket owned by Orbital Sciences Corporation. The rocket successfully delivered its payloads into a near circular orbit of 250 km. Three of the payloads were 'phonesats'; cubesats based on smartphones. These phonesats had their phone and texting functions disabled but still utilised other functions such as cameras and battery management. They had 1200 baud AFSK downlinks in the 70 cm band and over 200 packets and six pictures were received by amateurs worldwide (pictures can be viewed on their website). Due to the low orbit they only stayed up there for a week. More flights are expected later this year which hopefully will be in higher orbits.

The main payload of the test flight was a mass simulation of the Cygnus spacecraft. But what is a mass simulation? Basically it's a big lump of matter with the same mass distribution as a proposed payload. In this case it was a 3800 kg block of aluminium covered in instruments such as strain gauges, accelerometers and thermometers which were used to represent the Cygnus payload and provide the engineers with data about how it survived the launch. The next flight is intended to launch a Cygnus spacecraft to the International Space Station. No doubt the mass simulator burnt brightly when it de-orbited. Seems a shame in a way! [3]

## Long March

The third launch of the week was the Long March CZ-2D rocket from

Jiuquan Space Centre in China. This sent TurkSat-3USAT, CubeBug-1 and NEE-01 Pegasus into a 680 km circular orbit. Turksat was covered in last month's article. CubeBug-1 is a 2U size cubesat from the Argentinean Ministry of Science. It has a packet digipeater with a one watt downlink on 437.445 MHz at 1200 baud AFSK. The call sign is LU1VZ-11 and it transmits packets every 10 or 30 seconds. CubeBug-1 is a demonstration platform and at some stage the open source hardware and software will be made available to other groups interested in creating their own satellite. All the parts are commercial off-the-shelf [4].

Built by volunteer engineers and with the launch sponsored by the Ecuadorian government NEE-01 Pegasus is the first of two 1U cubesats from Ecuador. It transmits a FM voice/CW/SSTV beacon and high definition digital TV in the 33 cm band (910 MHz) with a power output of 900 mW. This would normally be a bit much to ask of a 1U cubesat but NEE-001 Pegasus has two 30 cm fold out solar panels to give it the extra power needed. The SSTV format is Martin1 and the FM voice beacon also plays the Ecuadorian national anthem [5].

All three satellites were heard soon after launch including a couple of reports of signals through the transponder on Turksat. It was reported that the CubeBug-1 beacon has low modulation so may be difficult to decode. I have heard CubeBug-1's beacon, activating every 10 seconds or so. 10 second intervals means the batteries are charged, 30 second intervals



# AMSAT-VK

AMSAT Co-ordinator  
Paul Paradigm VK2TXT  
email: [coordinator@amsat-vk.org](mailto:coordinator@amsat-vk.org)

Group Moderator  
Judy Williams VK2TJU  
email: [secretary@amsat-vk.org](mailto:secretary@amsat-vk.org)

Website:  
[www.amsat-vk.org](http://www.amsat-vk.org)

Group site:  
[group.amsat-vk.org](http://group.amsat-vk.org)



## About AMSAT-VK

AMSAT-VK is a group of Australian amateur radio operators who share a common interest in building, launching and communicating with each other through non-commercial amateur radio satellites. Many of our members also have an interest in other space based communications, including listening to and communicating with the International Space Station, Earth-Moon-Earth (EME), monitoring weather (WX) satellites and other spacecraft. AMSAT-VK is the primary point of contact for those interested in becoming involved in amateur radio satellite operations. If you are interested in learning more about satellite operations or just wish to become a member of AMSAT-Australia, please see our website.

## AMSAT-VK monthly net Australian National Satellite net

The net takes place on the 2nd Tuesday of each month at 8.30 pm eastern time, that is 0930 Z or 1030 Z depending on daylight saving. Check-in starts 10 minutes prior to the start time. The AMSAT-VK net has been running for many years with the aim of allowing amateur radio operators who are operating or have an interest in working in the satellite mode, to make contact with others in order to share their experiences and to catch up on pertinent news. The format also facilitates other aspects like making 'skeds' and for a general 'off-bird' chat. In addition to the EchoLink conference, the net will also be available via RF on the following repeaters and links.

**In New South Wales**  
VK2RBM Blue Mountains repeater on 147.050 MHz

**In Queensland**  
VK4RIL Laidley repeater on 147.700 MHz  
VK4RRC Redcliffe 146.925 MHz IRLP node 6404. EchoLink node 44666

**In South Australia**  
VK5TRM, Loxton on 147.175 MHz  
VK5RSC, Mt Terrible on 439.825 MHz IRLP node 6278,  
EchoLink node 399996

**In Tasmania**  
VK7RTV Gawler 6 metre repeater 53.775 MHz IRLP node 6124  
VK7RTV Gawler 2 metre repeater 146.775 MHz IRLP node 6616

**In the Northern Territory**  
VK8MA Katherine 146.700 MHz FM

Operators may join the net via the above repeaters or by connecting to EchoLink on either the AMSAT or VK3JED conferences. Past experience has shown that the VK3JED server offers clearer audio. The net is also available via IRLP reflector number 9558. We are keen to have the net carried by other EchoLink or IRLP enabled repeaters and links in order to improve coverage. If you are interested in carrying our net on your system, please contact Paul via email. Frequencies and nodes can change without much notice. Details are put on the AMSAT-VK group site.

## Become involved

Amateur satellite operating is one of the most interesting and rewarding modes in our hobby. The birds are relatively easy to access and require very little hardware investment to get started. You can gain access to the FM 'repeaters in the sky' with just a dual band handheld operating on 2 m and 70 cm. These easy-to-use and popular FM satellites will give hams national communications and handheld access into New Zealand at various times through the day and night. Currently only SO-50 is available.

Should you wish to join AMSAT-VK, details are available on the web site or sign-up at our group site as above. Membership is free and you will be made very welcome.

means they are being charged. As reported by others it was clear out of the noise but modulation was not as sharp as a normal 1200 baud AFSK signal. Hopefully this can be fixed as CubeBug-1 is intended to become a digipeater for amateurs once its primary goals are achieved.

During the initial stages of its mission, the controllers of Turksat have asked amateurs to monitor the beacon and not try the transponder so they can keep the batteries

charged and complete their primary goals. In the two passes I have been able to listen to it so far, I haven't heard the CW beacon.

### Final pass

Cubesats are now becoming a commodity item. Some of those mentioned above were constructed using commercial off-the-shelf components with just the scientific experiments being developed in house. But there is still more to

having a successful satellite than just buying the bits and bolting them together.

### References

- [1] <http://opensat.cc/blog/>
- [2] <http://phpweb.tu-dresden.de/stard/SOMP/?lang=en>
- [3] <http://www.phonesat.org/index.php>
- [4] <http://1.cubebug.org/>
- [5] <http://pegaso.exa.ec/>

## Participate

**Oxley Region ARC 38th Annual  
Field Day Port Macquarie**

**8 and 9 June**

# SOTA

Allen Harvie VK3HRA

## The activator

After chasing SOTA last month, we focus on the all-important activators.

It appears that the SOTA bug has bitten a few recently. Judging by the number of new chasers on air these days, it would be a fair guess that there is more than one person reading this magazine who has thought about activating a summit for themselves.

To assist you in participating in SOTA as an activator, whilst ensuring a valid activation that is both safe and enjoyable, we will detail a few key points drawn from those who have been on the ground. If you have worked a few activations, you will have noticed the different approaches being used by those activators. Several combine years of bushwalking experience with portable radio operations executing multi peak multi day trips that make us tired just watching. Others are amateurs taking a HT with them when walking the dogs up the local peak. The common thread is simply the use of a portable radio on a defined peak. Don't feel you have to go out on a remote peak in the deep bush or that you have to be super

fit. Fitness or physical ability is not a limitation, SOTA has space for all.

At the time of writing this article there have been over 550 activations in VK and we can identify at least three broad styles of activation:

- One band, one mode, single summit.
- Single day, multiple summit activation.
- Multi day, multiple summit remote activation.

For the new activator, let's start simple - one band, one mode, single close summit. You can graduate to more challenging efforts over time and it is worth remembering that there are no prizes for expiring before your licence does.

## One band, one mode, single close summit

Before we go too far, let's quickly re-cap the key rules to ensure that your expedition will be valid.

- The activation zone is an unbroken area within 25 vertical metres of the summit.
- The final 25 metres of the ascent into the activation zone shall be made only by non-motorised means.

- Operation from or near vehicles is not permitted.
- You must operate from a portable power source, that is, batteries or solar cells. Fossil fuel based generators are not allowed.
- All equipment must be carried to the summit.
- At least four QSOs are required to claim your activator points. You should exchange callsigns, reports and the SOTA reference number (see Association Reference Manual).
- QSOs through a repeater do not count nor do QSOs with others on the same summit.
- Activator points can only be claimed by the holder of the callsign that is used on the summit though multiple operators can share equipment.
- You must use legitimate access routes and obtain landowners' permission, if necessary.

For the full details go to <http://www.sota.org.uk/RulesAndGuidelines>

Download and read the specific ARM (Association Reference Manual) for your area of interest. These can be found at <http://www.sota.org.uk/Associations>

## Equipment

There is an ever-increasing range of equipment suitable for portable radio operations. The Yaesu FT-817 is extremely popular, however Elecraft KX3 and K3, Icom IC-703/IC-7000 and even Codan radios are being deployed. Another alternative is a small, lightweight single band QRP rig.

The range of potentially 'essential' accessories is mind boggling as are antenna choices. Remember you are going to be carrying this equipment up a hill and operating under field conditions. Consider what you already have and if you are fortunate

Photo 1: Andrew VK1DA on Isaacs Ridge, where the noise on 40 metres prevented contacts, but the two metre HT came through.







Photo 2: Ron VK3AFW on Mt Gawler with a Wouxun dual band HT with dual band whip.

to have access to portable HF radio and antenna units, then just go for it. For now, we are going to assume that you have access to a five watt two metre handheld or can borrow one from your club.

## Planning, planning and planning

A common aspect in all activations is the planning stage – planning a safe and enjoyable activation. The level of concern for safety will depend on the situation and how familiar the activator is with the area, terrain, roads and the like.

Summits that have good access and two metre potential include:

- VK1 - Mt Ainslie, Mt Taylor and Mt Stromlo
- VK3 - Mt Macedon, Mt Dandenong, Mt Buninyong and Flinders Peak.
- VK5 - Mount Lofty and Mt Gawler.

Use the Summit Search feature on SotaWatch, <http://www.sotawatch.org/summits.php> to find

summits that are local to you, if not mentioned above. Ensure that you understand the access to the summit. This may be as straight forward as checking out the local street directory but could involve downloading maps and preparing GPS devices with waypoints.

Sources of access information also include:

- Google the location for other reports, blogs, hiking trip logs, Forestry Services or Park Services information.
- Read the summit information on SotaWatch. Those that have been before often upload guides/ maps for future activators.
- Check for activator blogs with information and photographs.
- Check [www.geocache.com](http://www.geocache.com) for nearby geocaches with access details. (This is also another hobby that you could easily wrap into the activation.)
- Check interactive maps at web sites such as [www.land.vic.gov.au](http://www.land.vic.gov.au) for roads and contours

- Check Google Earth for visible tracks.

Also ask yourself 'What, if any, dangers will the summit and time of year present?' As the Scouts say 'Be Prepared'. The VK ARMS make it clear that activators need to be fully responsible for their own safety and take whatever precautions they feel are advisable. Factors considered by experienced activators include:

- Fire ban days
- Bad weather and lightning storms
- Notifying others of your intentions
- Roads that your car may be ill prepared to tackle
- Carrying too much stuff, too far

For remote locations, it may be too risky for inexperienced bushwalkers to tackle the activation on their own. Nothing in the rules says it has to be a solo activation, so take your family, friends or a goat (look up "WGOAT"). Get others involved; they might discover a new reason to be out in the fresh air, just like you.

## Trip checklist

We have stated that planning is the key to a successful activation, so here is a quick checklist to help you to have a stress free day:

- Do you have maps of the area? A GPS or compass?
- Have you advised someone of your intentions and when you are expected back?
- Check your equipment. Batteries charged and everything packed?
- Do you have a pen or two or three?
- Do you have the local repeater details in the radio?
- Are you prepared for the weather?
- Do you have enough water and snacks for the duration?
- Do you have insect repellent, sunscreen, a hat and a coat

## Day and time

Decide on the day, the time and the frequency that you will use then add an Alert on SOTAWatch





Photo 3: Allen VK3HRA at Mt Misery. If it's not a national park, Darcie comes along for company.

declaring your intentions: <http://www.sotawatch.org/alerts.php> Also, send an email to the SOTA Australia Yahoo group describing your plans to ensure that you will have chasers ready to answer your CQ SOTA call. The Yahoo groups email address is: [SOTA\\_Australia@yahoogroups.com.au](mailto:SOTA_Australia@yahoogroups.com.au)

As a general rule, Sundays are good. If you can be on the air before 10.00 am EST (0000 UTC) then the chasers will be most appreciative, but there's nothing wrong with an afternoon activation if you are inclined to linger in bed a little longer.

### Activation

Pack your gear, jump in the car and drive up to the summit. Remember the final 25 vertical metres of the ascent has to be non-motorised. There may be locations where the car park is within 25 metres of the summit and thus in the activation zone. In that case you can simply park your car, pick up all of your equipment and walk out of, then back into the activation zone.

Nearly everyone has a camera in their phone these days so use it, or something else to take some photos to remember the event and perhaps share with others.

Once you are setup, put out a couple of calls keeping in mind the courtesy of listening and ensuring the frequency is not in use. Always ask 'Is this frequency in use?' first.

As we are using two metres for the activation, 146.500 MHz is the national simplex calling frequency. If in use you may need to move to one of the nearby simplex frequencies such as 146.475 MHz, 146.525 MHz, 146.550 MHz or 146.575 MHz.

You can even jump on the local repeater and put out calls indicating your simplex frequency but remember that only simplex contacts count for the activation.

Astute chasers will be listening around the advertised SOTAWatch Alert frequency and will also be keeping an eye on the Spots page on SOTAWatch. Once spotted by chasers, you will become the pile-up so have your logbook and pen ready to record the contacts.

Once back home enter your contacts in the SOTA database: <http://www.sotadata.org.uk/logon.aspx?returnurl=AddActivation.aspx>

It is also a great idea to post a reply to the notification sent to the SOTA Yahoo group summarising your adventure. How did it go? What worked? What did not?

### Summary

Even though you can only claim the points for activating a summit once a calendar year, there is no reason why you cannot go out every weekend. Having a nearby hill allows you to work other activators whilst testing your equipment, claiming S2S contacts and allowing chasers to gain points. SOTA has space for all.

Welcome to the world of SOTA activation. Be careful, this is addictive. Soon work becomes a place to print maps and you won't be able to drive anywhere without checking out the summits beforehand and planning a short deviation. Don't ask how I know this to be true...



# SOTA activities

Autumn is upon us in VK with milder weather. Reports coming for the activators include 'It is cold on the hill' and 'hiding out of the wind behind a large rock'. There is also a desire to gain activations before winter hits.

Congratulations go out to VK3YY Glen and VK3ZPF Peter gaining 'Shack Sloth' status. April was a month of milestones with VK1NAM Andrew and VK3HRA Allen gaining 250 S2S points and VK3KAN Rik, VK1MDC Mark, VK1FBIT Brenden and VK1HBB Bruce achieving 100 points as Chasers.

We welcome VK3MRG Marshall as a new activator and note the return of VK3FMDV David, VK3UA Mark and VK5AKH Andrew to activating.

SOTA chasers were in prime position to assist with a medical emergency that unfolded during peak SOTA time. A motorbike rider came off his bike near Mount Disappointment (VK3/VC-014), less than an hour north of Melbourne. Present was Terry VK3UP who drove seven km down to the accident site where he and a mate performed first aid. As there was no mobile phone coverage at the accident scene, Terry also set up

his mobile transceiver on 40 m and contacted VK2UH Andrew, an avid SOTA chaser, and Andrew was able to use the phone system to coordinate emergency services to attend. The casualty was taken to hospital and has since recovered. *(Editor's Note: We plan to publish a full account of this event in the July issue.)*

With SOTA activity dominating the 40 metre band during day discussion indicating a need to formalise a SOTA frequency has resurfaced. I'm sure there will be more on this topic for a while to come.

Special mention goes to VK3WAM Wayne for first place in the 6-hour single operator all mode VHF section of the recent John Moyle Memorial Field Day. This was a SOTA summit activation and demonstrated the skills brought to SOTA. It also shows Wayne's keenness, with two trips up the hill (two kilometres each way, with 300 m climb) to carry all the gear up, with several antennas erected. Then another two trips at the end of the activation to carry all the gear down.

There is increased activity and interest in preparing the paper work for submission of VK2 summits. This is of great interest due to the

highest mountains on the Australian mainland being in the Snowy Mountains region in VK2 (New South Wales) and the presence of the Great Dividing Range.

VK9 was launched on 1 May. There are a small number of remote summits that will attract big interest. No activations as of yet but plans are being formulated.

## Regional Round up

**VK1:** The Canberra lads have maintained the activation rate. The proximity of Canberra to summits has encouraged S2S activations with 2 m and 40 m providing contacts.

**VK2:** Increased activity in the planning stages, so stay tuned.

**VK3:** The weather has allowed activations to continue. Increased chaser and activator activity. Increased 2 m use with VK3WAM Wayne conducting 2 m based multi summit activations.

**VK5:** The milder weather again is allowing activations in VK5 to pick up with VK5PAS, VK5AKH and VK5CZ returning to the hills with multi summit activations.

**VK9:** Launched and activators are planning SOTA expeditions.



## WIA Contest Website

Keep up to date with all of the major Australian contests, including rules and results, at the WIA Contest Website at:

[www.wia.org.au/members/contests/about](http://www.wia.org.au/members/contests/about)



# VHF/UHF - An Expanding World

David Smith VK3HZ

e vk3hz@wia.org.au

## Weak Signal

Only a very short report from me this month as there has not been a great deal of newsworthy activity.

The only propagation of note was reported by Jim VK3II. On the morning of April 10th at about 2300Z, he heard the Esperance VK6REP 2 m beacon, peaking to S3. No contacts were made.

## VK3QM portable ops

David VK3QM has again been out travelling around the state with his portable microwave setup. On ANZAC Day, he headed east to Mt Pinnibar (1750 m) in QF43, just on the Victorian side of the border near Mt Kosciuszko. He had equipment covering all bands from 1296 MHz to 10 GHz. Unfortunately, he had to contend with multiple challenges including fallen trees, blocked roads, howling winds and low temperature.

The team of Chas VK3PY, Ken VK3AKK, Charlie VK3NX and Lou VK3ALB set up at their usual field site in the Barabool Hills near Geelong. Lou reports that due to time constraints and site access, there was no activity on 1296 although Ken VK3AKK remedied that by working David the following morning. All managed to work David on 2.4 GHz although QSB was slow and deep. 3.4 GHz also had some QSB but not as pronounced. The big disappointment was 5.7 GHz where the WiFi noise wiped out any chance of a contact. The path ran over the inner eastern suburbs and there was no getting around the noise. Flat band conditions didn't help the situation. No contacts were made on 10 GHz.

## AX on EME

Australian radio amateurs had the opportunity to operate using the AX prefix on ANZAC Day Thursday April 25th as an amateur radio salute to the servicemen and women in the many conflicts.

Ian AX3AXH used the opportunity to work the rare DXpedition station 9G5EME in Ghana on 2 m – a special AX call for their special log!

Phil AX4CDI was also handing out AX contacts off the moon.

## VK3RLP Beacons

Phil VK3YB reports: *The Frankston 1296.532 MHz and 2403.532 MHz beacons are back on air. Very keen to get reports - including from 'locals' - to ppavey@bigpond.com Thanks to everyone involved in repairing and reinstalling the beacons.*

Please send any Weak Signal reports to David VK3HZ at vk3hz@wia.org.au



## Digital DX Modes

Rex Moncur  
VK7MO

## Meteor scatter reports April 2013 by Kevin VK4UH

In general the early part of April can herald poor or average conditions for 2 m MS. This proved to be the case again this year. The change-over of clock times with daylight savings in the eastern and southern call areas also delays the start of

the Saturday and Sunday morning activity sessions (07.00 - 08.00 local) by an hour. In VK4, which has no daylight saving, it was already after dawn by 2000 UTC and past the optimum time for MS activity.

For those not familiar with MS operating in VK there are two main activity periods in place running from 07.00 to 08.00 on Saturday and Sunday mornings on 144.230 MHz using FSK441 mode. By agreed protocol, in general, stations in the southern call areas VK7, VK3 and VK5 always transmit in the first period (0-30 seconds each minute) and beam northwards on both days. Northern stations in VK4 always transmit in the second period (30-60 seconds each minute) and beam south on both days. Stations in the middle states VK2 and VK1 generally run second period on Saturdays and beam south and first period on Sunday beaming north.

Saturday 5 April – Conditions reported as average, many very short pings detected often too short to decode.

VK4UH QG62 reported contact with VK3AMZ, VK3II and VK3HY.

VK3AMZ QF22 reported contact with VK2DVZ, VK2AMS, VK4UH, VK4RF, VK2XN and VK4AMG.

Sunday 6 April – Conditions reported as 'rollercoaster ride' from previous day with low ping count.

VK4UH QF62 worked/decoded VK3AMZ, VK1WJ, VK5PJ and VK3HY.

VK3AMZ QF22 worked/decoded VK4CDI, VK2DVZ, VK4UH, VK2AMS, VK2EMA and VK2XN.

Saturday 12 April – average conditions reported by all stations.

VK4UH QF62 worked/decoded



VK3AMZ, VK5PJ and VK3II.

VK4AMG QG62 worked/decoded  
VK3AMZ, VK5PJ and VK3II.

VK3AMZ QF22 worked/decoded  
VK2DVZ, VK2AMS, VK4UH and  
VK4AMG.

Sunday 13 April Conditions  
reported as average but rapidly  
deteriorating after 2000 UTC.

VK4UH QG62 Worked/decoded  
VK1WJ and VK5PJ.

VK1WJ QF44 worked/decoded  
VK4UH, VK4JMC and VK2XN.

Saturday 19th April – Conditions  
reported as 'worst remembered'  
meteor count very low with short  
weak pings only.

VK4UH QF62 decodes only  
VK3II, VK3AMZ and VK5PJ but no  
two way completions.

VK3AMZ QF22 worked /  
decoded VK4JMC, VK2AMS,  
VK2DVZ, VK2XN and VK4LHD.

VK3II QF21 reported decodes  
only VK1WJ, VK4UH and VK4JMC.

Sunday 20 April – Conditions  
remained poor.

VK4UH QG62 worked/decoded  
VK3AMZ, VK1WJ and VK5PJ.

VK3AMZ QF22 worked/decoded  
VK4JMC, VK2AMS, VK2DVZ,  
VK2XN, VK4LHD and VK4UH.

Saturday 26 April – conditions  
improved over previous week.

Stations reported receiving many  
loud but short pings often too brief  
to decode.

VK4UH QG62 worked/decoded  
VK3AMZ and VK3HY.

VK3AMZ QF22 worked/decoded  
VK2DVZ, VK4MIL, VK4NWH,  
VK4JMC, VK4UH, VK2AMS and  
VK4LHD.

Sunday 27 April – 'unusual' but  
improved conditions reported. A  
mixture of short pings and frequent  
large meteor returns providing  
burns lasting tens of seconds. The  
results probably represented the  
beginning of the Aquarid meteor  
shower expected over the following  
weekend at the beginning of May.  
This being one of the best expected  
MS operating showers each year.

VK4UH QG62 decoded/worked  
VK1WJ, VK3AMZ, VK3HY and  
VK3AXH.



Photo 1: The VK7MO 24 GHz 1.2 m dish.

VK3AMZ QF22 worked/decoded  
VK4UH, VK2DVZ, VK4LHD,  
VK2AMS and VK4MIL.

### 24 GHz EME world record extended to 16,583 km with JT4F

On 23 April Rex VK7MO worked  
OK1KIR to extend Alan VK3XPD's  
world record for 24 GHz EME to  
16,383 km (see AR for April and  
May 2013 for details of Alan's  
records).

Rex upgraded his portable  
station to a 1.2 metre Mitec dish  
(1.14 metres effective size) and was  
running about eight watts to the  
feed.

OK1KIR was running 20 watts  
to a 4.5 metre dish. The JT4F mode  
was used with WSJT's improved  
decoder in Version 9.5 r3033. Best  
signals were -14 dB as received by  
VK7MO and -17 dB as received by  
OK1KIR. A more detailed report on  
this QSO is available at: [www.vk3hz.net/microwave/24GHz\\_World\\_Record\\_EME\\_QSO.pdf](http://www.vk3hz.net/microwave/24GHz_World_Record_EME_QSO.pdf)

Rex also completed a QSO with  
W5LUA on 25 April. W5LUA uses  
a 2.4 metre dish compared to the  
4.5 metre dish used by OK1KIR  
but he does run 100 watts with a

high power TWT. The problem is  
for W5LUA to receive Rex's eight  
watts on his smaller 2.4 metre dish,  
and while signals were right on the  
margin, a QSO was completed and  
then repeated again on 30 April.  
A more detailed report on the first  
QSO with W5LUA is at:  
[www.vk3hz.net/microwave/24GHz\\_QSO\\_W5LUA.pdf](http://www.vk3hz.net/microwave/24GHz_QSO_W5LUA.pdf)

Please send any Digital DX  
Modes reports to Rex VK7MO at  
[rmoncur@bigpond.net.au](mailto:rmoncur@bigpond.net.au)



### The Magic Band – 6 m DX

John McRae  
VK5PO

Hi fellow six metre enthusiasts.

Sadly, we have lost one of the  
FIRST VK 6 metre 'tragic's'. Eric C.  
Jamieson VK5LP passed away at  
Meningie. His funeral was attended  
by many amateur radio friends.

Steve VK3OT has sent these  
paragraphs for inclusion in this  
month's AR magazine:

# Silent Key

Eric Jamieson VK5LP

I had known Eric for more than forty years, which is over four sunspot cycles, when he passed away this year. During that period there were times when I saw or heard little from him when he moved from being the voice in the hills to the voice by the lake.

When he became seriously ill with the back injury that was to eventually paralyse him, I made a special trip to see him in the Royal Adelaide Hospital, such was the rapport between us. He told me that he really appreciated the effort, as he did my infrequent visits at the Meningie Hospital in recent years, when I flew over the dirt airstrip at Lake Albert and always buzzed his house.

When I applied for a position with ANARE in 1992, his reference was one of two that I sent in and which I am sure was the result of my successful candidacy. Eric only forgave me for pulling out of the position when Mark Spooner (VK0AQ) and I made that initial two way six metre QSO between the Antarctic continent and Australia in 1993.

Eventually Eric was moved to the Meningie Hospital, where he busied himself with books and publications. He had two rooms at Meningie and it was a hive of production.

Collectively we researched and produced "50 Years on 50 Meg's" which circulates on the Internet to this day. Every few months I would cram a manila envelope with QST magazines because I knew he liked following the 'World above 50 MHz' which used to be published by his very good friend, Bill Tynan W3XO. Bill came to visit in the 1990s and made a point at coming to Hamilton then onto Meningie to visit with Eric, and missed seeing Eric because he was receiving treatment for his ailment in the RAH. Both men never got over this meeting denied of them by the circumstances.

Peter VK5PJ and I last visited Eric in the Meningie Hospital late last year and we saw that he was busily into everything and was not slowing down with age.

As soon as I heard of Eric's passing I notified Bill and Mattie Tynan in Kerrville, Texas and VK5PJ of the sad news.

The voice by the lake is silenced but the memory will live on in his books, publications and his two metre award. When I fly over Lake Albert in future and look down from altitude, I will reflect on this man that I knew and respected, and will never forget.

VK3OT  
Vale Eric Jamieson OAM, JP, VK5LP AR SK.



At its AGM on 20 April, the RSGB awarded the Wortley-Talbot Trophy jointly to Andrew VK3OE and Phil VK6APH 'to recognise outstanding experimental work in amateur radio' for the work on chirp modulation. This award is indeed a great recognition by the RSGB for the chirp 'radar' backscatter and forward scatter experiments. Andrew and Phil are very honoured.

That is fantastic recognition of the research and development in this field. Well done to both of you, and we are proud that two VK fellows have made a mark internationally, as reflected by the RSGB in giving this prestigious award.

April activity was not full on. It is fair to say that if you live south of the tropics, DX has been scant.

27 April saw six metres open between various parts of VK3 and JA. At around 0600Z, several

stations were heard and worked.

Northern parts of VK8 are enjoying daily propagation to JA, BY and some parts of the Pacific. KH7Y logs many of the northern beacons and has been worked by stations as far south as Brisbane.

Several Middle East beacons were logged in Darwin also from time to time during April.

South West VK6 had a few openings to most JA call areas during April.

The KH9/WA2YUN/B beacon is heard almost daily in VK4, despite this, it is proving very hard for any stations to actually work Colin from Wake Island!

From a VK5 perspective, the various BY TV video offsets are audible almost daily, but signals are way down. The Russian 'warbler' also continues to be heard from time to time.

ZL3 analogue TV transmitters are now shut down, so 45 MHz usage as an indicator is no more! In a few months, the 'big' ones on the north island will also be defunct.

David, VK3AUU reports:

*Not much to report on the DX front. I worked several JAs, with just five watts! The rest were with my Mirage 1016 amplifier putting out just 100 watts.*

*Antenna: 10 element YU7EF at 14 metres.*

*On the 2nd of April, I snared JR2HCB, JM1IGJ, JL1IHE and JP1LRT. My Flex 1500 SDR with the standard five watts was used.*

*The 5th of April saw another JA opening, and running 100 watts, I managed to get these stations: JR2HCB, JF3VEC, JF3FFJ, JA1QOP and I heard JI2NQR as well as the JR6YBR beacon weakly at 319. On the 15th April, a very brief sporadic E opening into VK4 at 0415Z allowed me to work VK4XE, and at the same time BY TV video was audible on 49.75 MHz.*

*The 27th of April around 0545Z, I worked Hiyo JH2HCB again, and also heard JH1USR.*

A brief summary of activity from Perth. Andy VK6OX writes:

*On 3rd April the band opened to JA from about 0630 UTC to 0800 UTC. Twenty two JA stations were worked during the period with many signals at around the S 9 level. All contacts were via CW but call areas 5, 6 and 9 were not worked.*

*On 13th April, five JA stations from call areas 0, 3, 5 and 9 were worked between 0658 UTC and 0744 UTC, with signals up to S9. JA3OKC was worked with JT65a, others using CW.*

*On 20th April I worked Matteo IW5DHN via EME on my moon-set. Signals were good in both directions however Matteo's very good EME setup with 4 x 8ele LFA Yagis, with full elevation was doing most of the work!*

*The 24th of April saw me complete an EME QSO with N3XX. This brings the number of*



completed EME contacts on six metres to six so far.

Cheers Andy VK6OX.

Peter VK6KXW and I have been trying for months now to complete a meteor scatter QSO using FSK441. Finally on the morning of ANZAC Day we did it. At 400 watts my end, Peter did not get many decodes, so I tried my legal limit of 1,000 watts. That helped nicely. The distance

between us is approximately 2,042 km, and as such is almost at the maximum distance for meteor scatter. The horizon is at one degree at that distance.

Morning meteor scatter operating is still on-going, with the regulars making contacts via SSB and JT65a.

The Mt. Lofty Beacon VK5VF is off air, and whilst on the subject of

beacons, VK5GF reports that he is rebuilding the VK8RAS beacon, and when completed, Jeff, along with Peter VK5PJ, will make the long drive up to Alice Springs to put it all back on air.

Please submit reports, logs or other info you may consider useful to John VK5PO at [vk5po@wia.org.au](mailto:vk5po@wia.org.au)



## Spotlight on SWLing

Robin Harwood VK7RH/VK7002SWL  
e [vk7rh@wia.org.au](mailto:vk7rh@wia.org.au)

It is June and winter has set in, so plenty of time to monitor the frequencies. I am increasingly using various online receivers throughout the world because, quite frankly, it has become much more reliable than my existing home set-up. At the beginning of the a-13 period there were more gaps evident especially on the higher frequencies. For example the 13 metre allocation has few signals, mainly from Kuwait and Iran. Sadly the 16 metre allocation is rapidly going in the same direction. One allocation that has been bucking the trend is the 22 metre allocation. That is from 13550 to 13880. This allocation slowly took off and has become so crowded that broadcasters have stretched out of the allotted band in both directions. Signals are getting closer to our 20 metre amateur band.

I have heard that the BBC World Service hopes to be completely off shortwave by 2015. Severe budgetary cuts have accelerated the process as funding switches from a grant-in aid from the Foreign Office to being part of the receiving licence the citizens pay for all their

radio and television programs. I cannot recall how many decades it has been that receiving licences were abolished here in Australia but this is still common in Europe. Radio Australia depends on government funding as part of the ABC. The external television arm I believe does show commercials, yet I surmise would not provide enough income to be independent of government funding.

Radio Symban is operational after a hiatus and has resumed broadcasting on 2368.5 kHz. It commenced broadcasting in Greek but now seems to mainly be for the Pacific Island community in Sydney. Its 400 watt signal has been heard in California lately but I personally have not heard it yet. Probably because I have been experiencing long distance skip and signals are often inaudible.

There was a brief flurry recently following the decision of Radio Taiwan International to discontinue relaying Radio Free Asia and the Sound of Hope. This led to an outcry, particularly from the Falun Gon Movement which has been

operating small powered illegal senders in addition to the use of one RTI sender. It turned out to be a propaganda misinformation campaign by the Movement, which actively promotes Tai-Chi. The real reasons appear to be that the sender of RTI has passed its use-by-date together with the declining audience within the PRC. There however are other senders still active and presumably will continue with RTI and the American Radio Free Asia. However Falun Gon which is banned within the PRC, has now fallen foul of the Taiwan administration as well. They are annoyed by these illegal senders operating within utility allocations, especially aeronautical channels such as 11300. The Charleville (Qld) WEFAX signals on 13920 also experienced considerable interference from the Chinese Firedrake signals that were designed to block the small SOH illegal senders.

Well that is all for now. Keep listening because surprises always unexpectedly pop up.



# DX-News & Views

Ernie Walls VK3FM - Guest Contributor

*Editor's note: Our regular contributors are off on the VK9NT DXpedition to Norfolk Island. On the island they have limited internet connectivity and one suspects that the draft column was lost in the hectic preparations for the trip. The team comprises 10 VK amateurs*

*and one from the US. Given that I have already worked the VK9NT team on 40 m without much effort AND worked both Chris VK3QB/9 and Brenton VK3CBV/9 today from the recently announced SOTA summit VK9/NO-001, I guess that I must forgive the lack of planning*

*for the regular column. I already knew that I would need to cover the proof reading normally undertaken by Luke! So this month, it is over to the Secretary of the Publications Committee, Ernie VK3FM for a quick roundup of coming DXpeditions plus an opinion piece.*

1 - 7 June	Fiji	3D2WN	AA2WN	DXW.Net 20130426	By AA2WN from Viti Levu Is (OC-016, WLOTA 0055); HF; holiday style operation.
3 - 20 June	Cape Verde Is	D44TWO	M0OXO	DXW.Net 20130420	By DF2WO; HF; holiday style operation.
8 - 15 June	Bahamas	C6ATT	Home Call	K2TTT 20120920	By K2TTT from New Providence Is (NA-001, WLOTA 1115, FL15hb); also N2RFA (C6ABB), K2KJI (C6ALC), KC4PX (C6APX); 80-10 m; SSB, RTTY, SSTV, PSK31, JT65; QRV for ARRL June VHF QSO Party.
11 - 28 June	St Martin	FS (NEW)	LotW	DXW.Net 20130507	By K9EL as FS/K9EL; 80-6 m.
14 - 28 June	Br Virgin Is	VP2V	W9DR	W9DR 20130212	By W9DR as VP2V/W9DR from Anegada I (FK78tr); 6m; SSB; CW beacon on 50115.6 kHz.
22 - 29 June	Guantanamo Bay	KG4	Home Call	K4RX 20130424	By K4RX as KG4RX, AC4TO as KG4TO, N4SIA as KG4AS from FK29kv; HF; CW; KG4RX + KG4TO. QSOs will go to Clublog.
28 June - 7 July	Curacao	PJ2	LotW	ON6DX 20130418	By ON6DX as PJ2/ON6DX; focus on 6m + 15 12 10 m for JA and Asia; QSL also OK via ON6DX, buro or direct.
30 June - 5 July	Luxembourg	LX	ON6ZV	ON6OM 20130228	By ON6ZV, ON6OM, ON7EG, and ON4MW as LX/OO6P; HF; SSB RTTY PSK31 PSK63.

Many thanks to the NG3K website for this information.

Change continues unabated in the DX community, this time surrounding the methodology of acquiring the very valuable confirmation of ones QSO with that most wanted entity. For more years than we can all remember this has been by a request via the amateur radio bureau system, or direct to a designated address accompanied by the equally ubiquitous green stamp and/or IRC coupon.

Well, not much longer one thinks, at least to the extent of the past. A new kid is now on the block, known as the Online QSL Request Service (OQRS) and, in the next few years this method will almost certainly become the preferred way of doing things, for both direct and bureau QSL requests – well, at least for most DXpeditions and,

one suspects, many of those rare individual stations that use some of the better known, and proficient, QSL managers.

OQRS essentially means that you request a QSL for all required QSOs via a nominated website (generally that of the QSL manager concerned) and, if direct, the process allows you to pay an amount either through PayPal or direct from your credit card via PayPal. For bureau cards, you complete the same detail and the QSL manager will dispense your QSLs via his QSL bureau to your bureau. It is worth noting that, in both instances, no QSL cards are required from the DXer. No doubt this new method will greatly relieve bureaus from much of the unnecessary work they currently

suffer from unwanted DXpedition QSLs flooding the system.

The highlight of the DX calendar for May was the DXpedition to Norfolk Island by the Oceania DX Group, comprising Chris VK3QB, Luke VK3HJ, Lee VK3GK, Allan VK2CA, Catherine VK4GH, John VK4IO, Roy VK3GB, Peter VK3IJ, Graeme VK3GL and San K5YY. As this item was being written they had compiled some 16,600 QSOs with 120 entities over nine bands and, for once, perhaps VK and their DXing cousins in ZL enjoyed a propagational advantage. For VKs there was an added 'bonus' in that some lucky DXers even managed to work them on 30 metres SSB mode being, as we are, the only country (the author thinks!) that has SSB authorisation on that band. No doubt our regular



DX contributors will let us know the exciting details in a future column.

There were a number of appealing DXing opportunities available to the keen DXer in May, among them Egypt with Sparky SU9AF, the Galapagos with Daniel

HC2IWM/8, the Australs with Yoshi FO/KH0PR, South Sudan with Pekka and Martti Z81X, Mauritius with Clive 3B8CW and a group of Italians from Tunisia (Djerba Island IOTA AF-083) as TS8TI. And many more, making May a month to be savoured.

Coming up in June are more opportunities to add to one's band/mode totals, a few of which are likely to be keenly sought by many DXers, among them those listed on page 56.



## Contests

James Fleming VK4TJF  
• leartez@bigpond.com

In this month of June there are two Australian contests that should really be fun to operate, the VK Shires Contest and the winter VHF/UHF Field Day, one for HF and one for VHF and UHF.

The VK shires contest goes for 24 hours starting on Saturday 8 June at 0600 UTC. The object here in Australia is to work as many different VK shires as possible and also as many CQ zones as possible, while the rest of the world can only work VK shires. There are no entry categories based on bands or power. And I'm going to make a bet that most of your contacts will be Australian. Now the first breakdown in categories is whether or not you decide to become a rover. That is a portable station that activates more than one shire. The other breakdowns are if you are multi-operator or single, there is a single operator category specifically for foundation licensees and one for DX stations. Thus there are a total of six categories for the contest. For the exchange the DX stations give their CQ zones and the Australian stations supply their shire abbreviations. Multiplies for the DX are the VK shires and for the Australian stations the VK shires and the CQ zones. There is no breakdown for mode, thus it may be advantageous to work SSB and CW. Scoring is simple, a point per QSO and multiply the total by the total of the multipliers.

So that was the raw information on the contest. My thoughts are that the contest is fairly egalitarian, as

it doesn't matter how you operate everyone has a good opportunity to do well in the contest. It would also seem to me that the whole idea here is to have fun. This contest brings to mind many scenarios to achieve the real objective in having fun. I can envision taking your car or ute, that is set up with a mobile HF, and being a rover, or perhaps having a couple of camping sites waiting for you and your camper. Or perhaps you're a DX chaser trying to get all the CQ zones. Yet another possibility is that you like the 40 and 80 metre bands and just have a dipole. The possibilities and different configurations are endless; however one thing is common with all these different operating styles, you got to be in it to win it. Submitting the log is easy again with VK logger. If you are out portable just take your laptop with you to do the logging. All VK shire abbreviations are on a list located on the WIA website under contests along with the complete rules. So hope to hear you in the contest.

The next big Australian contest is the winter VHF/UHF field day held over the weekend of June 22/23. The section breakdown here is portable single or multi-op and 24 hours or eight hours, and home 24 hours and rover 24 hours making a total of six sections. Mode can be FM or SSB. Contest exchange is your RST report, serial number and four digit maidenhead locator. You can work stations on each band every three hours; however

if they are a rover and move to a new location you can work them immediately. Scoring for each band is 10 points for each four digit locator square plus 10 points for each locator square plus one point per contact multiplied by band multipliers – 6 m x 1, 2 m x 3, 70 cm x 5, 23 cm x 8, higher x 10. Again VK logger is the logging software that is the easiest to use.

Now for a bit of personal insight into this contest, I'm by no means a VHF/UHF contester, I'm usually into HF contesting. However I do enjoy the company of a few of my fellow club members that are into VHF/UHF at the Redcliffe radio club, such as Kevin VK4UH and Peter VK4EA. I can almost certain that there will be an open invitation to join them in setting up a microwave station on top a big hill somewhere near Brisbane. A couple of things that I do admire in this group of VHF/UHF operators is the ability to go portable quickly and efficiently, as in emergency communications. Also the idea of using very small antennas with big gain fascinates me. And finally I bet that Peter and Kevin are all too willing to show me their gear and let me have a go at operating. So my advice to newcomers to this type of contesting is to link up with fellow operators for some camping and fun on a mountain top. I may even bring my own little station consisting of my arrow antenna and my Yaesu FT-7800 as well.



# Results John Moyle Memorial Field Day 2013

Denis Johnstone VK4AE/VK3ZUX  
Contest Manager

## 24 Hour Portable Operation – Multiple Operator

Call Sign	Operators	Mode	Band	Contacts	Score	Place /Award
VK3ER	Multi	All	All	825	5,736	1 / 1**
VK2WG	Multi	All	All	397	2,222	2 / 1
VK2AJN	Multi	All	All	206	994	3 / 1
VK2ACH	Multi	All	All	257	512	4 / 1
V100ACT	Multi	All	All	158	322	5 / 1
VK2HZ	Multi	Phone	All	567	1,846	1 / 1
VK4WS	Multi	Phone	All	280	1,582	2 / 1
VK3JNH	Multi	Phone	All	246	1,532	3 / 1
VK3AVR	Multi	Phone	All	255	1,154	4 / 1
VK3CMZ	Multi	Phone	All	223	733	5 / 1
VK4WT	Multi	Phone	All	162	435	6 / 1
VK6SH	Multi	Phone	All	139	290	7 / 1
VK5GRC	Multi	Phone	All	106	220	8 / 1
VK2EH	Multi	Phone	VHF	78	1,686	1 / 1
VK5OM	Multi	Phone	VHF	57	1,252	2 / 1
VK4WE	Multi	Phone	VHF	33	212	3 / 1
VK4Z	Multi	All	HF	957	2,234	1 / 1
VK2AWA	Multi	All	HF	659	1,466	2 / 1
VK4WL	Multi	All	HF	491	966	3 / 1
VK8DA	Multi	All	HF	286	676	4 / 1
VK5LZ	Multi	Phone	HF	963	1,926	1 / 1
VK4XA	Multi	Phone	HF	575	1,150	2 / 1
VK3CNE	Multi	Phone	HF	390	782	3 / 1
VK5BAR	Multi	Phone	HF	230	480	4 / 1
VK6ZN	Multi	Phone	HF	206	410	5 / 1
VK6BRC	Multi	Phone	HF	201	402	6 / 1
VK5KDK	Multi	Phone	HF	181	362	7 / 1
VK1MT	Multi	Phone	HF	179	356	

## Six Hour Portable Operation – Multiple Operator

Call Sign	Operators	Mode	Band	Contacts	Score	Place /Award
VK5SR	Multi	Phone	All	173	1248	1 / 1
VK2MA	Multi	Phone	All	113	340	2 / 1
VK3AWS	Multi	Phone	All	39	197	3 / 1
VK2BOR	Multi	Phone	All	59	126	4 / 1
VK2SF	Multi	Phone	HF	242	484	1 / 1
VK2CL	Multi	Phone	HF	171	342	2 / 1
VK4BRC	Multi	Phone	HF	126	252	3 / 1
VK4WD	Multi	Phone	HF	113	226	4 / 1
VK2GCE	Multi	Phone	HF	42	84	5 / 1

## Comments on John Moyle Memorial National Field Day 2013

This year's entries came from all Australian mainland call areas, as well as from Tasmania and New Zealand. The total number of logs submitted was only 111. This was a significant decrease from the 140 logs received last year. Well done to all who took part. It was good to see some

## 24 Hour Portable Operation – Single Operator

Call Sign	Operators	Mode	Band	Contacts	Score	Award
VK4DE	Single	Phone	All	168	2,151	1 / 1
VK2FAAD	Single	Phone	All	200	1,820	2 / 1
VK3VCL	Single	Phone	All	147	563	3 / 1
VK2PAM	Single	Phone	All	100	208	4 / 1
VK2FERM	Single	Phone	HF	82	164	1 / 1
ZL3AKM	Single	Phone	HF	70	140	2 / 1
VK5QG	Single	Phone	HF	64	128	3 / 1
VK8BM	Single	Phone	HF	52	100	4 / 1
VK2AWJ	Single	Phone	HF	18	36	5 / 1
VK2PN	Single	All	HF	23	60	1 / 1
VK2JUB	Single	All	All	233	4,676	1 / 1
VK1WJ	Single	All	All	94	289	2 / 1
VK4TGL	Single	All	All	11	58	3 / 1

## Six Hour Portable Operation – Single Operator

Call Sign	Operators	Mode	Band	Contacts	Score	Award
VK3WAM	Single	All	VHF	92	1,435	1 / 1
VK3FX	Single	Phone	VHF	29	385	1 / 1
VK3VMC	Single	Phone	VHF	26	340	2 / 1
VK3ZD	Single	Phone	VHF	20	173	3 / 1
VK3FABT	Single	Phone	VHF	1	7	4 / 1
VK4ADC	Single	Phone	All	106	616	1 / 1
VK2ID	Single	Phone	All	56	332	2 / 1
VK2XLJ	Single	Phone	All	21	60	3 / 1
VK5KPR	Single	Phone	All	24	54	4 / 1
VK2BJT	Single	CW	HF	8	32	1 / 1
VK4JAZ	Single	CW	HF	3	12	2 / 1
VK1SV	Single	All	HF	23	54	1 / 1
VK3YSP	Single	Phone	HF	168	336	1 / 1
ZL2AVZ	Single	Phone	HF	97	194	2 / 1
VK4HNS	Single	Phone	HF	53	106	3 / 1
VK3ZPF	Single	Phone	HF	6	12	4 / 1

ZL stations take part again this year, and three stations submitted their log.

I have included in the results all of the logs that I received and if any are missing, they are completely lost. I can only offer my apologies to anyone so affected. I am sorry if your log is missing, but it simply did not get to me despite my most careful procedures and cross checking.

Based upon submitted logs, there were some 18,047 contacts, (a 19.8% decrease from 2012) accumulating some 61,213 points claimed, (a 30.7% decrease from 2012). This was good contesting for an Australian field day contest, but unfortunately it resulted in just 111 logs being received. More than 1,000 individual Australian call signs were logged during the contest.

Unfortunately, the number of stations who went to the considerable trouble of going out and setting



## Home Station – 24 Hour

Call Sign	Operators	Mode	Band	Contacts	Score	Award
VK2LAW	Home	0	All	1139	1496	1 /
VK4VDX	Home	0	All	256	671	2 /
VK3MEG	Home	0	All	318	504	3 /
VK2ACD	Home	0	All	163	457	4
VK2FAJA	Home	0	All	209	411	5 /S
VK2HBG	Home	0	All	251	357	6
VK3BQ	Home	0	All	93	270	7
VK3MPH	Home	0	All	40	209	8
VK2ASY	Home	0	All	111	201	9
VK3KIS	Home	0	All	65	142	10
VK3D	Home	0	All	70	109	11
VK3TDX	Home	0	All	22	79	12
VK4PQ	Home	0	All	32	57	13
VK5LJ	Home	0	HF	330	517	1 /
VK2FADD	Home	0	HF	263	392	2 /
VK4MIT	Home	0	HF	166	251	3 /
VK5TE	Home	0	HF	158	247	4
VK4GH	Home	0	HF	97	170	5
VK4MON	Home	0	HF	100	164	6
VK4JGD	Home	0	HF	90	145	7
VK4FD	Home	0	HF	81	140	8
VK5MK	Home	0	HF	51	85	9
VK5FD	Home	0	HF	48	83	10
VK5FCJM	Home	0	HF	40	68	11 /S
VK3VWW	Home	0	HF	42	64	12
VK6WW	Home	0	HF	5	8	13
VK2WDD	Home	0	VHF	99	1051	1 /
VK3DIP	Home	0	VHF	66	457	2
VK2AGC	Home	0	VHF	39	358	3
VK2BHO	Home	0	VHF	15	115	4

up as a portable station and then not bothering to submit a log as an entry, is still a great disappointment. Some multiple operator stations got very big scores and perhaps that simply reflects the great and varied planning and implementation efforts required to assemble and operate a multi operator station.

Activity was carried out on all bands permitted under the rules. There was not a noticeably increased activity on HF, though there was more activity on the higher HF frequencies as expected by the increasing sunspot cycle. This sunspot cycle is nearing the top of the cycle but conditions did not appear to improve substantially this year. There was a marked six metre reduction apparent in all states.

In the higher UHF and microwave bands there was a very significant decrease in activity; since it obviously follows a weather cycle, rather than the solar cycle? Maybe it only takes a couple of club stations to not operate to make the difference and the weather in VK3 was quite wet?

The scoring in the UHF range was also well down from last year. The scoring in the VHF range and the number of contacts was also substantially lower than for 2013. The absence of many VK2 & VK3 club stations,

## Home Station – 6 Hour

Call Sign	Operators	Mode	Band	Contacts	Score	Award
VK4KLC	Home	0	All	85	252	1 /
VK4NA	Home	0	All	66	138	2
VK4IAA	Home	0	All	41	78	3
VK2TQ	Home	0	HF	204	318	1 /
VK2ND	Home	0	HF	166	247	2 /
VK3VTH	Home	0	HF	135	205	3 /
VK4QD	Home	0	HF	105	158	4
VK3JLS	Home	0	HF	91	144	5
VK2FRKO	Home	0	HF	96	132	6 /S
ZL4RO	Home	0	HF	58	96	7
VK3SMC	Home	0	HF	54	89	8
VK7GM	Home	0	HF	10	18	9
VK2RQ	Home	0	HF	3	12	10
VK3VKJ	Home	0	HF	4	8	11

/ Certificate Awarded

\*/ President's Cup

/S Participation Certificate

because of the miserable weather in some parts certainly reduced activity, with many stations making such comments.

The other major change noticed this year was the decrease in both Portable and Home Station operation. Clearly there were quite a few portable station operators who did not bother to submit a log; they are strongly encouraged to do so next year. However the change in the Home Station scoring last year did not result in increased activity.

The participation across the various call areas was patchy. There was an increase in portable stations in only VK2, while the other states all showed a decrease from last year.

All of the portable stations that went to the effort to send in a log will get a certificate. The WIA believes that those who made the effort to set up and operate a portable station should be acknowledged. In line with previous years, the Foundation License logs who did not achieve a placing were instead awarded a Participation Certificate for encouragement.

There were only seven Foundation operators who submitted a log. (Six from VK2, none were from VK3, none were from VK4, one from VK5 and none from VK6.) There were many more stations than this logged during the contest, but who did not submit a log. All logs submitted by Foundation operators were awarded a certificate. Logs from club stations did show that a few also took part as part of the club station effort, well done.

This year, the rules again stated that EXCEL is the preferred submission format. A sample linked EXCEL logging report was prepared and sent to those who requested this file. (Contact me at [vk4ae@wia.org.au](mailto:vk4ae@wia.org.au) if you would like a copy of my linked spreadsheet in EXCEL for next year.) Other suitable file submission formats are WORD, TXT or the ADI output file from VKCL (VK Contest Log).

PDF format is not acceptable as are JPG and TIF.

All logs submitted in an electronic form this year were fully readable.

The new General rules for WIA contests were issued prior to last year's contest requiring all logs to be submitted in Cabrillo format to fall into line with contests in other countries. There was insufficient time available to prepare a template and revise the contest scoring software. In the event there were no logs submitted in that format. Hence the time spent on creating suitable software by the author was completely wasted. It is viewed that, in Australia, there is negligible interest among most operators to go down this path to follow overseas contests by banning paper logs and only submitting logs in

Cabrillo format. Hence it is unlikely that the rules of this contest will change to follow this model.

There were still only 94% of logs submitted electronically this year, up from last year. This has been due largely to the excellent work by Mike Subocz (VK3AVV) and his worthy program VKCL (VK Contest Log). Those that submitted a log in the VKCL export format were as usual very easy to work with. Those that simply forwarded the text output of VKCL were also rather simpler to work with than any form of posted paper log or a log completed by hand.

Paper logs may also be used. A small log from an individual operator is and will remain completely acceptable. Large paper logs require a very considerable manual workload on the part of the contest

manager to input the data into the contest database and are no longer permitted. It is so much better to forward the computer files used to print the paper log as part of an e-mail as the data can then be easily extracted and used for checking purposes.

**A note for all HF Stations - All HF contacts are valid HF scoring contacts, whether they are from VK ZL or P2 stations or stations from overseas.** Overseas stations cannot submit a log to the contest, but can exchange numbers with stations participating in the Field Day Contest. They are to be scored as a Portable station contact.

*Editor's note: A more complete analysis can be found on the WIA website.*



## VK5news Adelaide Hills Amateur Radio Society

Christine Taylor VK5CTY and Rob Gurr VK5RG

The April meeting was a member's buy and sell at which, as usual, one person's junk became another person's treasure. It was a pleasant social evening as well and as such was appreciated by us all. That meeting was held in a different hall to the one we usually use (the two halls are side by side). Possibly no-one from our group tried out the dancing class next door but we certainly had a few visitors who wanted to know who we were. There are many ways to advertise amateur radio!

Since the halls in this building have been taken over by the council we have been warned that, in the event of a catastrophic fire day, we will need to cancel our meeting that night. This is a good warning and a reminder that the near bush areas around all our cities are vulnerable to bushfires and that it is as well to be aware and prepared 'in case'.

The club Shack on which some members spent many weekends is being used for many different activities. This is what was intended so it is very satisfying to see that all the hard work was worth it.

The fourth Saturday morning at the Shack is now a technical morning. The presentations are by authors with practical experience in a number of subjects, and are supported by demonstrations and displays as appropriate. Subjects presented to date include Jim Tregallas VK5TR on cathode ray oscilloscopes in amateur radio, John Dawes VK5BJE on digital communications programme JT65, and D-STAR systems, and Rob Gurr VK5RG on home brew digital communications interfaces. There are sufficient breaks between the presentations to enjoy a cup of tea/coffee, challenge the authors, or even operate VK5BAR, the club

station.

When there are five Saturdays in the month, we have a Club Breakfast and use the occasion to auction some of the smaller items of equipment we get through deceased estates. Some estates are donated to the club, the proceeds of others are returned to the estate less a small fee for the club.

The club has launched an award for stations operating in, and for contact with stations operating in, VK5 National and Conservation Parks. Full details are on the club website.

All amateurs are welcome to attend our meetings, and full details of future subjects may be found on the AHARS website [www.ahars.com.au](http://www.ahars.com.au) The venue is the Blackwood Girl Guide complex, Hannaford Road, Blackwood.





Jim Linton VK3PC

e [arv@amateurradio.com.au](mailto:arv@amateurradio.com.au)

w [www.amateurradio.com.au](http://www.amateurradio.com.au)

## On-air for ANZAC Day

The permanent station VK3RAN was again activated on board HMAS Castlemaine museum ship at Gem Pier, Williamstown. Luke Steele VK3HJ and Terry Murphy VK3UP used a Kenwood TS-2000 transceiver coupled to a Terlin Outbacker vertical antenna to work stations on 40 metre SSB and CW. Band conditions seemed a little quiet this year. The couple did not make contact with other military-based stations despite calling for some time.

HMAS Castlemaine was gifted to the Maritime Trust in 1973 for preservation as a museum ship and home to a small part of Australia's wartime history. She is now berthed at Gem Pier, close to where she was built and commissioned in 1942. She is a beautifully restored corvette that was used in World War II and is open at weekends.

## Review of our main events

The organisation is reviewing its current involvement in a variety of events to determine whether there needs to be more advanced planning, the involvement in different activities or a refocus of

its efforts. Amateur Radio Victoria already actively supports the WIA public relations event in April, joins in ANZAC Day's memorial event through VK3RAN on HMAS Castlemaine, and the International Lighthouse and Lightship Weekend each August. It directly initiates the Victorian National Parks activity weekend in November tied to the Keith Roget Memorial National Parks Award and the Centre Victoria RadioFest in February. The RadioFest has never been a major fundraising event, but rather is for the enjoyment of the entire community and while also under review it will be held next February.

A question asked occasionally is whether it should branch out to other events. The main thing holding it back is the lack of involvement by the membership. For example, if the organisation is to enter the field of contesting, at a six hour entry level at least, there would need to be a number of members willing to be dedicated to such a task. If you have any ideas to be considered or wish to volunteer yourself for a task then contact our Secretary, Ross Pittard VK3CE.

## Classes taking enrolments

The next training session at the Foundation licence level will be held on Saturday June 22, followed on Sunday June 23 with assessments for all three grades of amateur licences.

These are held at the Amateur Radio Victoria office 40G Victory Boulevard, Ashburton. The entry level Foundation licence continues to be the most popular way of getting into amateur radio. It is attracting those who have had some previous hobby radio communications interest (CB, 4WD, scanner listener) and others attracted to ham radio for the first time. The Foundation licence, introduced in 2006, has been a big change with this entry level licence no longer taking about six months of study to get a basic licence.

All it usually takes is the quality training provided by expert trainers plus the comprehension of the study and operational practice guide book. To enrol or for further information contact Barry Robinson VK3PV 0428 516 001 or [foundation@amateurradio.com.au](mailto:foundation@amateurradio.com.au)



## Timbertown Heritage Park

Timbertown Heritage Park is located in Wauchope on the VK2 mid north coast.

It is a theme park of yesteryear with all sorts of attractions. One of the attractions in the 'Village' is a telegraph office. They are looking for a morse code operator during school holiday periods.

Contact can be made with Judy Lockwood at Timbertown Events, on **02 6586 1941**.

Email [functions@timbertown.com.au](mailto:functions@timbertown.com.au)

You can check out Timbertown at [www.timbertown.com.au](http://www.timbertown.com.au)

# Hamads

## WANTED – NATIONAL

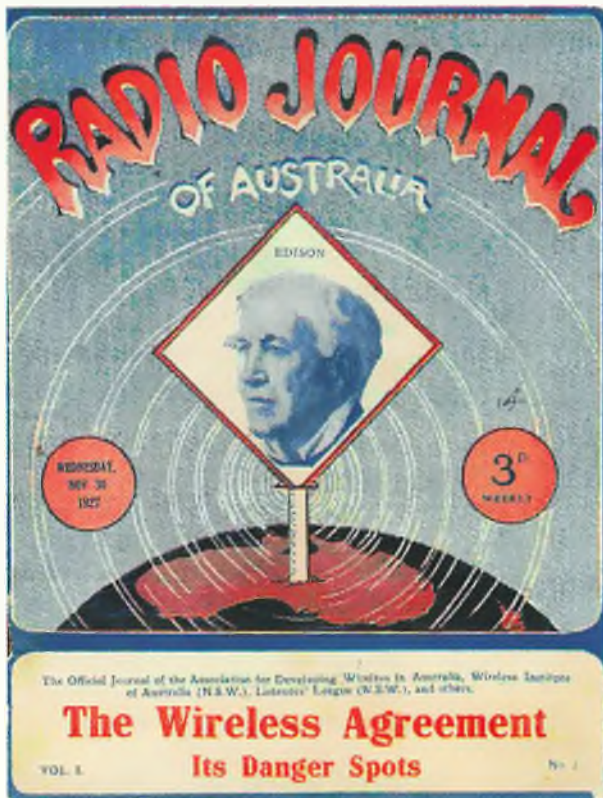

### Copies of Radio Journal of Australia magazine.

The WIA Archive is seeking copies of the Radio Journal of Australia for copying and/or adding to the WIA Archive's shelves.

Little is known about this magazine. The WIA holds one copy only. Volume 1, Number 2 published on 30th November 1927 which contains 64 pages. The magazine claims to be the Official Organ of the Association for Developing Wireless in Australia, the Listeners' League (N.S.W.) and of importance to us, the Wireless Institute of Australia (N.S.W.).

The magazine contains articles of general radio interest, a comprehensive weekly radio guide for stations in N.S.W., S.A. Qld. and Vic. and some notes from the WIA, NSW Division. It was published in Sydney, presumably commencing on 23rd November 1927.

It is of interest to note that the magazine's Editor was George A. Taylor, the person

responsible for calling the first meeting of Sydney wireless experimenters in March 1910 from which the WIA grew. Taylor was never known to be a member of the WIA, rather he returned to his interests in aviation and defence. Later he went on to form the Association for Developing Wireless in Australia, an organisation predominately representing those involved in commercial broadcasting.

There is little doubt that Australia had a colourful and heady start to those early days of radio communication and broadcasting - in

all of its forms and magazines such as this provide a glimpse of that exciting pioneering time past!

Please contact Peter VK3RV via email [vk3rv@wia.org.au](mailto:vk3rv@wia.org.au) or c/o the National Office in Bayswater if you can help us locate copies of this magazine.

### ACKNOWLEDGEMENT

For those who have responded to previous requests for copies of early magazines, thank you. We are gradually building up our collection of important Australian magazines which will be available to future researchers.

I would also like to thank in particular, the following individuals and clubs who have forwarded books, audio recordings and magazines to the archive: Graeme Zimmer, Gordon Bracewell, Ron Fisher, John Paterson, Aub. Topp, Ric. Cole and Keith Strickland (on behalf of the Geelong Radio and Electronics Society) for their recent, important donations. 73, Peter VK3RV

## FOR SALE – VIC

Sell satellite dish, 1.2 metre diameter, to best bid received before 16 June. An email photo is available on request. Purchaser to collect.

Contact Deane [vk3tx@wia.org.au](mailto:vk3tx@wia.org.au) QTHR.

## WANTED – VIC

A circuit drawing for Yaesu FT7 please. I will pay any costs involved.

Contact Laurie VK3BV or email to [shirlau@netbay.com.au](mailto:shirlau@netbay.com.au)  
Phone is 03 5975 0306.

Z-match or swinging link-type antenna coupler, suitable for matching balanced line to 50  $\Omega$  co-ax. This is required by a pensioner amateur. NB: A E F Johnson Matchbox would be great. Please contact John VK3ZK QTHR, mobile 04 6699 4856 or [jlwickham@aapt.net.au](mailto:jlwickham@aapt.net.au)

Circuit or circuit and handbook, or clear copies for a Crammond CTR-55 marine transceiver. Fair price paid.

Please contact Rodney VK3UG, QTHR, phone 03 5825 1354 or email [rodlynn6@bigpond.com](mailto:rodlynn6@bigpond.com)

## FOR SALE – SA

The VK5JST Aerial Analyser (AR May 2006). Over 10,000 built, and still available from the Adelaide Hills Amateur Radio Society. For full details see [www.ahars.com.au](http://www.ahars.com.au)

## WANTED – QLD

Mitsubishi 10 watt VHF power amp chip, RA08H1317M (as used in Bionics Tiny Tracker APRS TX). Or another working APRS TX.

Please contact Steve, on email [VK4KHQ@ozemail.com.au](mailto:VK4KHQ@ozemail.com.au)





## Contributions to Amateur Radio

AR is a forum for WIA members' amateur radio experiments, experiences, opinions and news.

Your contribution and feedback is welcomed.

Guidelines for contributors can be found in the AR section of the WIA website, at <http://www.wia.org.au/members/armag/contributing/>

Email the Editor:  
[editor@wia.org.au](mailto:editor@wia.org.au)

## About Hamads

- Submit by email (MUCH PREFERRED) or if written and mailed please print carefully and clearly, use upper AND lower case.
- Deceased estates Hamads will be published in full, even if some items are not radio equipment.
- WIA policy recommends that the serial number of all equipment for sale should be included.
- QTHR means the address is correct in the current WIA Call Book.
- Ordinary Hamads from those who are deemed to be in general electronics retail and wholesale distributive trades should be certified as referring only to private articles not being re-sold for merchandising purposes.
- Commercial advertising on these pages Contact [admanager@wia.org.au](mailto:admanager@wia.org.au)
- Copy to be received by the deadlines on page 1 of each issue of Amateur Radio.
- Separate forms for For Sale and Wanted items. Include name, address STD telephone number and WIA membership number.

**'Hamads'**  
PO Box 2042  
BAYSWATER VIC 3153  
[hamads@wia.org.au](mailto:hamads@wia.org.au)

## AMIDON FERROMAGNETIC CORES



tts systems

Phone 03 5977 4808. Fax 03 5977 4801  
[info@ttssystems.com.au](mailto:info@ttssystems.com.au)

## VKHAM.COM

AUSTRALIAN AMATEUR RADIO  
Hundreds of pages and links  
related to Amateur Radio  
and radio in general

### HOME OF

- VK Classifieds
- VK Auctions
- VKs on the Internet

Repeater Maps, Software, Prefix Maps and more...

## RM Products Italy

are now available in Australia after the  
appointment of

Hamak Electrical Industries Pty Ltd

as distributor for RM products  
Visit the Hamak website at

**[Hamak.com.au](http://Hamak.com.au)**

for

**Linear amplifiers,  
Power supplies  
and accessories**



## JACKSON BROS

[www.jacksonbrothers.com.au](http://www.jacksonbrothers.com.au)

Highest quality products made by UK craftsmen

Variable and trimmer  
capacitors, reduction drives,  
dia's, ceramic standoffs

CATALOGUES, PRICE LISTS AVAILABLE

## HAMMOND ENCLOSURES



HAMMOND  
MANUFACTURING - Large range of quality electronic  
enclosures for the discerning Radio Amateur.  
Diecast, extruded aluminium and plastic enclosures  
and instrument cases. As seen in many ARRL projects



Cookson Controls CHARLES I COOKSON  
PTY LTD

11-13 Port Rd Queenstown SA 5014

Tel: (08) 8240 3200 Fax: (08) 8240 3233

[sales@jacksonbrothers.com.au](mailto:sales@jacksonbrothers.com.au)

[ccookson@hammfg.com](mailto:ccookson@hammfg.com)

ALL MAJOR CREDIT CARDS ACCEPTED

SOLE AGENTS AUSTRALIA AND NEW ZEALAND

## "Hey, Old Timer..."

If you have been  
licensed for more  
than 25 years  
you are invited  
to join the



## Radio Amateurs Old Timers Club Australia

Or if you have been licensed for  
less than 25 but more than ten  
years, you are invited to become an  
Associate Member of the RAOTC.

In either case a \$5.00 joining fee  
plus \$15.00 for one year or \$25.00  
for two years gets you two  
interesting OTN Journals a year  
plus good fellowship.

### Write to RAOTC

PO Box 107, Mentone  
VIC 3194

Ron Cook 03 9579 5600

or Bill VK3BR on 03 9584 9512,  
[email raotc@raotc.org.au](mailto:email.raotc@raotc.org.au)  
for an application form.

## ADVERTISERS INDEX

Cookson (Jackson Bros)	63
Hamak Electrical Industries	63
Icom	OBC
Innov Antennas	11
Jaycar	7
TET-Emtron	9
TTS	13, 63
Yaesu	IFC

### TRADE PRACTICES ACT

It is impossible for us to ensure that the  
advertisements submitted for publication comply  
with the Trade Practices Act 1974. Therefore,  
advertisers will appreciate the absolute need for  
themselves to ensure that the provisions of the  
Act are strictly complied with.

### VICTORIAN CONSUMER AFFAIRS ACT

Advertisements with only a PO Box number  
address cannot be accepted without the addition  
of the business address of the box-holder or  
seller of the goods.

# Directory

## National Office

Unit 20, 11-13 Havelock Road  
PO Box 2042 BAYSWATER VIC 3153

Contact 10 am to 4 pm weekdays  
Phone **03 9729 0400** Fax **03 9729 7325**  
nationaloffice@wia.org.au  
http://www.wia.org.au



## The Amateur Service

... a radio communications service for the purpose of self training, intercommunication and technical investigation carried out by amateurs, that is, by duly authorised persons interested in radio technique with a personal aim and without any pecuniary interest.

56 ITU Radio Regulations

## Advisory Committees

### New South Wales/ACT Advisory Committee

Email: vk2advisory@wia.org.au

- \* John Bishop VK2BK
- Dominic Dahl VK2YDD
- \* Timothy Mills VK2ZTM / VK2UJ
- Gilbert Hughes VK1GH

### Victorian Advisory Committee

Email: vk3advisory@wia.org.au

- \* Bob Tait VK3XP
- Luke Steele VK3HJ
- Noel Ferguson VK3FGN
- Chris Chapman VK3QB

### Queensland Advisory Committee

Email: vk4advisory@wia.org.au

- Don Wilschefski VK4BY
- Kevin Johnston VK4UH
- \* Michael Charteris VK4QS
- Alan Shannon VK4SN

### South Australian Advisory Committee

Email: vk5advisory@wia.org.au

- \* David Clegg VK5KC
- \* Peter Reichelt VK5APR
- Ben Broadbent VK5BB
- Trevor Quick VK5ATQ

### Western Australian Advisory Committee

Email: vk6advisory@wia.org.au

- \* Heath Walder VK6TWD
- \* Craig Lamb VK6FLAM

### Tasmanian Advisory Committee

Email: vk7advisory@wia.org.au

- Clayton Reading VK7ZCR
- \* Justin Giles-Clark VK7TW
- Peter Rumble VK7Y

### Northern Territory Advisory Committee

Email: vk8advisory@wia.org.au

- \* Peter Blackadder VK8HPB
- Garry Woods VK8GW
- \* Alan Baker VK8AB
- Mark Sellers VK8MS

\*Denotes Committee Chairman

\*Denotes nominated by the WIA Board ("Nominated Member")

## Visit our Bookshop

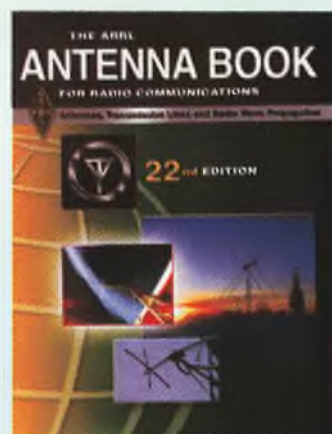

### ARRL Antenna Book

(22nd Edition - Softcover)

#### Antennas, Transmission Lines and Radio Wave Propagation

Build one antenna, and you'll quickly find yourself planning the next. **The ARRL Antenna Book for Radio Communications** is devoted entirely to that pioneering spirit. In this one book, you will find all of the information you need to design complete antenna systems—from

planning, to design and construction. **The Antenna Book** includes treatments for nearly any radio band and operating application: low-band, HF, VHF, UHF and microwave; fixed station, portable, mobile, maritime, satellite and more!

MEMBER PRICE: \$85.00\* RETAIL: \$95.00\*

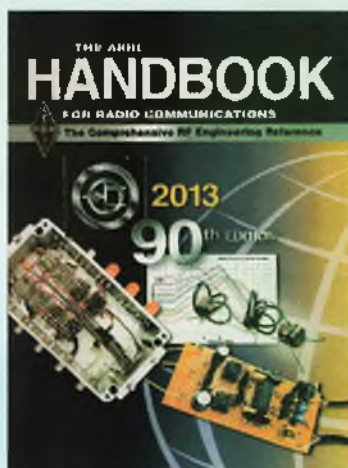

### ARRL Handbook

(2013 - Hardcover or Softcover)

**The ARRL Handbook for Radio Communications** has kept technologists—amateur, professional and student's—immersed in the radio 2:1 for generations. As innovations in wireless communication march (and race!) ahead, **The ARRL Handbook** has maintained its place at the forefront—a single resource covering electronic fundamentals, radio design, and loads of practical treatments and

projects. You'll read it, study it, and turn to it... again and again.

**Updated and Revised!** This ninetieth edition of **The Handbook** includes something for every radio amateur and experimenter.

MEMBER PRICE: \$85.00\* RETAIL: \$100.00\*

Hardcover

MEMBER PRICE: \$80.00\* RETAIL: \$95.00\* Softcover

\* Plus Postage and Packaging

Order your copy today! Visit our online bookshop for details. [www.wia.org.au/bookshop](http://www.wia.org.au/bookshop)





# Join your local radio club today!

## Radio Clubs:

- Are Australia-wide
- Will introduce newcomers to amateur radio
- Run regular meetings and functions
- Provide short training & accreditation courses for people wishing to obtain an amateur radio licence

Further information on clubs can be found on the WIA website

[www.wia.org.au](http://www.wia.org.au)



 ICOM

# Experience Icom technology in analogue & digital



IC-7100

IC-80AD



IC-D31A



ID-51A

IC-2820H



IC-9100



To find out more about our latest products,  
call Icom on 03 9549 7500 or visit [www.icom.net.au](http://www.icom.net.au)