

# amateur radio

JOURNAL OF THE WIRELESS INSTITUTE OF AUSTRALIA

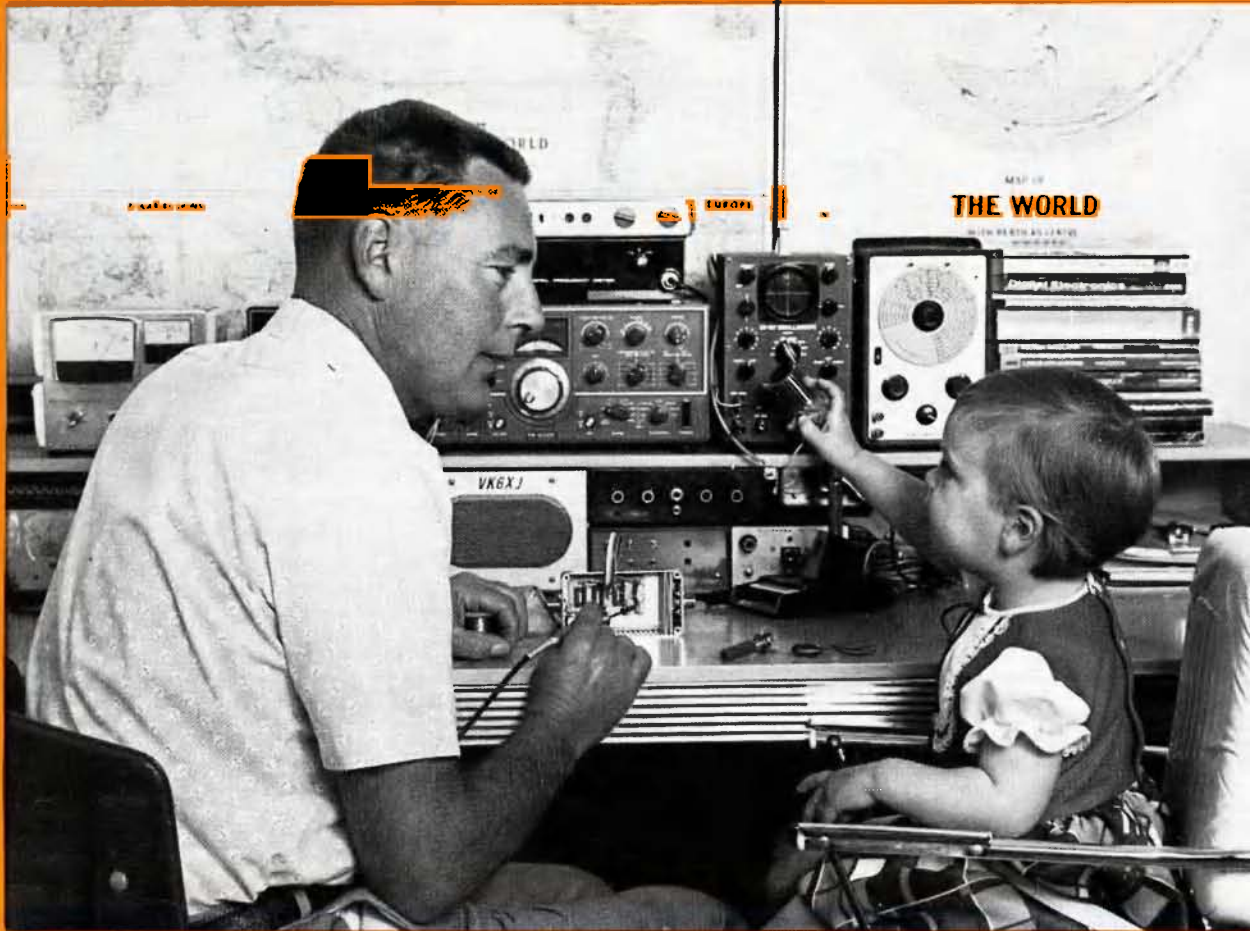

VOL. 48, No. 1

JANUARY 1980

## *FEATURED IN THIS ISSUE:*

- ★ *INEXPENSIVE HIGH IMPEDANCE MULTIMETER*
- ★ *THE EVEN SIMPLER REGULATOR*
- ★ *REPLACING THAT UNUSUAL 'JA' TRANSISTOR*
- ★ *ELECTRONICS—ITS PART IN MY DOWNFALL*
- ★ *JOHN MOYLE MEMORIAL FIELD DAY CONTEST — RULES — 1980*

Registered for posting as a Publication —  
Category "B".

# VICOM: THE ONE STOP COMMUNICATIONS SHOP!

## Daiwa Low Pass Filters

FD30LS 32 MHz, Fc. 200 w. 3 stages — \$2000

## Baluns

AS-BL Asahi 50 ohm for beams — \$34.00  
BL50A 50 ohm 4 KW. 1:1 for dipoles — \$32.00  
BL70A 70 ohm, 4 KW. 1:1 for dipoles — \$32.00

## Leader Test Equipment

LAC 895 Antenna Coupler 3.5 — 28 MHz — \$182  
LPM 885 SWR/PWR Meter — \$97  
LPM 880 RF Power Meter — \$139  
LDM 815 TR Dip Meter — \$89.00  
LBO 310 3" Ham Oscilloscope — \$330  
LA 31 Ham monitorscope adapter — \$26.00  
LSG16 Signal Generator — \$119.00  
LSW250 TV-FM Sweep Generator — \$429.00  
LAG26 Audio Generator — \$166.00

## Tubes

6KD6 Finals for Yaesu linears — \$10.00  
6JS6C Finals for Yaesu transceiver — \$10.00  
12BY7A Driver — \$4.75  
6146B Finals — \$13.00

## CW Filters

FT101E Yaesu — \$39.00  
TS520S YG3395 Kenwood — \$57.00  
TS820S YG88C Kenwood — \$59.00

## Morse Keys

HK702 Deluxe Key with marble base — \$41.00  
HK708 Economy Key — \$23.00  
HK706 Operator's Key — \$25.00  
MK701 Manipulator (side-swiper) — \$45.00  
PALOMAR 1C Keyer — \$149.00

## Jaybeam Antennas

5Y/2m 5el 2m, 7.8 dBd gain, length 1.6 m — \$43.00  
8Y/2m 8el 2m, 9.5 dBd gain, length 2.8 m — \$51.00  
10Y/2m 10el 2 m, 11.4 dBd gain, length 4.4 m — \$84.00  
10XY/2m 10el 2m cross yagi, 11.3 dBd — \$114.00  
DB/70cm Twin 8el, 70 cm, 12.3 dBd, 1.1 m — \$64.00  
PBM 18/70 18 el, 70 cm, 14.9 dBd, 2.8 m — \$96.00  
MBM 48/70 48el, 70 cm, 15.7 dBd, 1.83 m — \$83.00  
MBM 88/70 88el, 70cm, 18.5 dBd, 3.98 m — \$105.00  
PMH/2C Phasing harness — \$20.00  
8XY/2m 2m cross yagi, 8el, 9.5 dBd 2.8 m — \$99.00  
12XY/70 cm 70 cm cross yagi, 12el, 13.0 dBd, 2.6 m — \$139.00

## Nagara

SS56 6 m 5el beam 1 KW — \$159.00  
V5JR 80-10 m trap vertical, 6.7 m high — \$129.00  
V4JR 40-10m trap vertical, 5.2 m high — \$99.00

## Hy-Gain Antennas

204BA 4 el monobander for 20 m — \$259.00  
203BA 3 el beam 20 m — \$199.00

## Scalar

M22T 1/4 wave 2 m mobile whip, top only Qty 1-4 — \$7.00

M25T 5/8 wave 2 m mobile whip, top only Qty 1-4 — \$14.00

BASE B/L for above — \$4.00

## Microphones

VM-1 Noise cancelling, hand ptt low z — \$10.00

## Coaxial Cable

RG58AU mil spec, 30m reels — \$13.91  
RG213/U mil spec per metre — \$1.50

## Kenwood Transceivers

TS520S HF transceiver — p.o.a.  
TS120S Solid state 100w — p.o.a.  
TS120V Solid state 10W — p.o.a.  
TS180S Solid state 10w — p.o.a.  
R-1000 Communications Receiver — \$498.00

## Monitor Receivers

747 Vicom Aircraft Scanner — \$199.00  
210 Bearcat 210, scanner — \$469.00  
HF12 VHF pocket, 12 channels — \$149.00

## Coaxial Relays

CX-2L 1.8 thru 170 MHz, 100w pep — \$45.00  
CX-2H 1.8 thru 450 MHz, 200 w pep — \$69.00

## Coax Switches

CS201 2 position, commercial quality — \$23.00  
CS401 4 position, commercial quality — \$59.00

## Speech Processors

RF660 Phasing type, 6dB gain, dc — \$109.00  
RF440 Phasing type, 6dB gain, dc — \$109.00  
RF440 Phasing type, 6dB gain, ac/dc — \$126.00

## Antenna Rotators

DR7500S Medium duty complete with clamps — \$189.00  
DR7600S Heavy duty model — \$259.00  
Cable for above (6 core) — \$1 per m.

**NEW TONO THETA 7000E COMMUNICATIONS COMPUTER ARRIVING SOON!**



**DAIWA**

**DIRECT-READING SWR/PWR METER  
(NO NEED FOR FREQ. ADJUSTMENT)**

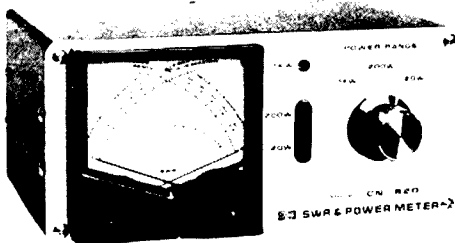

**CN 620 — \$99**

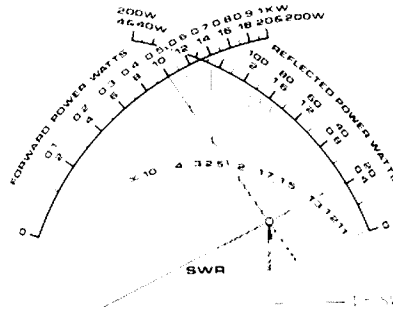

**THE CROSS-NEEDLE DIAL**

## SPECIFICATIONS

Frequency: 1.8—150 MHz  
Input/output impedance: 50 ohms  
Ratio of Forward vs.

Reflected power: 5 : 1  
Power range: Forward 20W/200W/1kW  
Reflected 4W/40W/200W

### INPUT RATING POWER

HF BAND 1kW CW ( 2kW PEP)  
50 MHz BAND 500W CW ( 1kW PEP)  
150 MHz BAND 250W CW (500W PEP)

Tolerance: ±10% at full scale

SWR measurement 1 : 1—1:

SWR detection sensitivity: 5W min

Input/output connectors: SO-239

Dimensions: 165W x 75H x 97Dmm

Authorised dealers throughout Australia

☐ Sydney: 339 Pacific Hwy,  
Crow's Nest  
Ph (02) 436 2766

☐ New Zealand: 10 Lion Court,  
Upper Hutt,  
Ph 287 946

☐ Head Office and Mail Orders:

68 Eastern Road,  
Sth Melb. Vic. 3205.  
Ph (03) 699 6700  
Telex 36935

**VICOM**

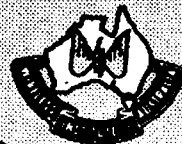

# amateur radio

Published monthly as its official journal by the Wireless Institute of Australia, founded 1910.

**JANUARY 1980**

**VOL. 48, No. 1**

**PRICE: \$1.20**

Registered Office:  
3/105 Hawthorn Road,  
Caulfield North 3161.

**EDITOR:**  
MARK STEPHENSON\* VK3NOY

**MANAGING EDITOR:**  
BRUCE BATHOLS\* VK3UV

**TECHNICAL EDITORS:**  
BILL RICE\* VK3ABP  
EVAN JARMAN\* VK3ANI  
RON COOK\* VK3AFW  
GIL SONES\* VK3AUI

**CONTRIBUTING EDITORS:**  
BOB ARNOLD VK3ZBB  
MIKE BAZLEY VK6HD  
ROD CHAMPNESS VK3UG  
ROY HARTKOPF\* VK3AOH  
RON FISHER\* VK3OM  
ERIC JAMIESON VK5LP  
PETER MILL VK3ZPP  
LEN POYNTER\* VK3ZGP  
BILL VERRALL VK5WV  
WALLY WATKINS VK2DEW

**DRAFTING:**  
NEIL OSBORNE\* VK3YEI

**BUSINESS MANAGER:**  
PETER DODD VK3CIF

\*Member of Publications Committee

Enquiries and material to:  
The Editor,  
PO Box 150, Toorak, Vic. 3142

Copy is required by the first of each month. Acknowledgement may not be made unless specially requested. All important items should be sent by certified mail. The editor reserves the right to edit all material, including letters to the Editor and Hamads, and reserves the right to refuse acceptance of any material, without specifying a reason.

Advertising: Material should be sent direct to P.O. Box 150, Toorak, Vic., 3142, by the 25th of the second month preceding publication. Phone: (03) 24 6652.—Hamads should be sent direct to P.O. Box 150, Toorak, Vic., 3142, by the 1st of the month preceding publication.

Trade Practices Act: It is impossible for us to ensure that advertisements submitted for publication comply with the Trade Practices Act 1974. Therefore advertisers and advertising agents will appreciate the absolute need for themselves to ensure that the provisions of the Act are complied with strictly. Readers are reminded that, when buying, obtaining or receiving goods from overseas including goods listed in advertisements by overseas organisations in this Journal, Customs import duties and Sales Tax may be levied on the goods at the time of importation. These amounts, if any, are payable by the purchaser unless the terms of sale state otherwise and the seller has made specific provision to this effect in his quotation to the buyer or unless other prior arrangements are in force between the buyer and the seller.

Typesetting: MUELLER INDUSTRIES  
1a Levenswell Road, Moorabbin, 3189  
Tel.: 553 0292

Printers: EQUITY PRESS PTY. LTD.  
50-52 Islington Street, Collingwood, 3066  
Tel.: 41 5054, 41 5055

## CONTENTS

### TECHNICAL

Commercial Kinks	29
Inexpensive High Impedance Multimeter	9
New Developments for the Morse Enthusiast	17
Replacing that Unusual "JA" Transistor (amp. mod. to Kyokuto 2m Txcvr)	15
Some Improvements to the Eddystone 888A Receiver	20
Sunspot Cycle 21 — To Date	26
The Even Simpler Regulator	12

### GENERAL

Amateur Radio Satellites — An Opportunity for Education	21
CW and Redundancy	16
Electronics — It's Part of My Downfall	18
John Moyle Memorial Field Day Contest — 1980 Rules	27
Review — The SX100 Scanning Receiver	25
Sunspot Activity Increases	40
WIA Federal Video Cassette Library	28
WIA 1980 Subscriptions	28

### DEPARTMENTS

Amateur Satellites	29
Around the Trade	39
Awards Column	36
CARE	38
Contests	36
Divisional Notes	47
Editor's Desk	6
Hamads	42
Ionospheric Predictions	40
Letters to the Editor	38
QSP	31, 42
Silent Keys	42
VHF/UHF — An Expanding World	30
WIANEWS	4
WICEN	40
You and DX	39
20 Years Ago	42

**ADVERTISERS' INDEX** 42

## Cover Photo

John Tuppen VK6XJ and his youngest daughter Ann discuss a few of the finer points of amateur radio. See John's article "Electronics, It's Part of My Downfall!" on page 18.

# WIANEWS

## 6m BAND

This is the text of a letter sent to the P. & T. Department in October —

"On 18th August 1977 a letter was addressed to you in connection with the use of the 50-52 MHz band in Australia on a non-interference basis by the Amateur Service. A copy of this letter is attached for ready reference. This subject has been discussed with Departmental officers on numerous occasions, both before and after the above letter was sent, especially at Joint Committee meetings.

Having regard to the rising solar activity of Cycle 21 there are many licensees involved, and becoming involved, in the observation of extended propagation at VHF frequencies. The fact that amateurs in many countries enjoy the use of the full ITU Regions 2 and 3 amateur exclusive allocation of 50-54 MHz places Australian operators at a great disadvantage, being limited only to 52-54 MHz.

Propagation has already occurred one way on several occasions over such unusual paths as Hawaii-Perth and Los Angeles-Perth on 50.1 MHz but not only does the frequency disparity of 2 MHz present operational difficulties it is evident that propagation performance differs considerably between 50 and 52 MHz.

These factors are an almost insurmountable handicap in achieving two-way communication which is considered essential to the ultimate confirmation that a circuit has been completed between the terminals of interest.

Delay beyond a few months or even weeks will limit the amount of first hand experience of unusual propagation that may be gained.

Application is now made for the immediate use by the Amateur Service in Australia on a year to year basis of at least the segment 50.0 to 51.0 MHz of the Region 3 allocation except

- (a) where interference would be caused to operational TV Channel 0 stations (i.e., amateurs be allowed this segment outside the service areas of TVO transmitters and translators);
- (b) on spot frequencies already assigned to, and in use by, the Secondary Service in any particular service area.

The technique at (b) above is one which is used in many countries on various frequency bands but more specifically in relation to Hong Kong on 52.025-52.100 MHz and the USA on the 1.8 MHz band.

Operators licensed in the Amateur Service traditionally have been to the forefront in bringing to light new factors in propagation phenomena; factors which of course have properly been the subject of later intensive examination by those engaged professionally in the field. We refer to examples such as tropospheric propagation beyond the horizon at VHF and VHF Trans-Equatorial Scatter propagation via the ionosphere, Radio Astronomy, etc.

By reason of their numbers and geographic distribution amateur stations are in a specially favourable position to observe and record details of unusual propagation phenomena on usable frequencies of reasonable commonality with other countries.

It might be difficult to provide an Australia-wide concession but the request is made that this question be discussed with you

## COMPUTERISED 2 METRE FM RIG NDI HC 1400



HC-1400

ALL FOR  
ONLY **\$399**

*Microprocessor controlled  
PLL circuitry  
Repeater Offset  
Tone Burst  
800 Channels with 5KHz  
Spacing 144-148MHz  
3 Memory channels  
LED Displays both TX &  
RX frequencies  
25 Watts Power Output (5 watts on Low)*

**MOST YAESU HF PRODUCTS IN STOCK**

**SPECIAL FT101E's with fan, DC-DC converter  
& mic for only **\$829.00** (no hidden price extras)**

**I M A R K**

Pty. Ltd., 167 Roden St., West Melbourne, Vic. 3003  
Phone (03) 329 5433

Available in South Australia from — Watson Communications, 75 Prospect Rd., Prospect. S. A. 5082 Phone (08) 2694744

at the very earliest opportunity, particularly in reference initially to specific areas or States, such as Western Australia and Northern Territory."

No response having been received the following reminder was despatched on 7th November —

"I am instructed to refer to my letter dated 12th October to which no response has been received.

Information has now been received that in New Zealand the amateur service is allegedly authorised the use on a restricted basis of the segment 50 to 50.15 MHz during hours when no television stations are operating.

It is therefore requested that a very early discussion with the Department on this matter be authorised."

Despite telephone enquiries no response to either letter was to hand by the 3rd week in November when this was written.

It is reliably reported that the Minister for Post and Telecommunications recently wrote to an M.P., in response to enquiries, that the W.T. Act does not provide for control over the importation and sale of radio communications equipment but the proposed new legislation, to be introduced as soon as possible, will provide such controls.

Apparently the Minister conferred with Business and Consumer Affairs for the possible use of the Trade Practices Act and the Customs Act. Nothing eventuated under the former, but the latter could be used to prevent the importation of unlicensable equipment and action is being taken under the Customs (Prohibited Imports) Regulations to prohibit the import of unlicensable 27 MHz CB transceivers.

For equipment already in Australia the only practicable control over sales appears to be the proposed new radio regulations.

At the Executive meeting in November it was observed that, in relation to the suppression of address or other call sign details as requested by holders of call signs, this was in fact a prerogative of the P. and T. Department having regard to the contract the Institute possesses for printing the call book.

It has been reported that an amateur received a solicitor's letter about interference with a neighbour's TV, radio and stereo. The amateur concerned apparently had done all the right things not only to assist with filters but also had his own gear checked and cleared, apparently as satisfactory. Nonetheless the neighbour appears to have taken legal advice, hence the solicitor's letter which stated that the nature of the interference was most substantial and was really an invasion of privacy for which they were prepared to obtain an injunction from the Supreme Court to prevent him from transmitting during certain hours. This matter is being pursued as it is of great concern to all amateurs.

Definite news has come to hand that the morse code exam markings would be split for the November exam onwards. This means, for example, that anyone obtaining a pass in the sending part would not be required to pass this part again within the ensuing 12 months — he would only be required to obtain a pass in the receiving part to be given a pass in morse within that one year.

This resulted from a firm request to the Department by the Institute and may well be in the Department's favour too in relation to the number of candidates at future examinations. The principle applies to both novice and full call speeds and credits back to November 1978 will be given at the November 1979 exam.

The Executive wishes to acknowledge with grateful thanks the receipt of the following donations from members towards the expenses of WARC 79 —

**LIST No. 9**

VK3PE .....	\$2.00
VK2BHO (accidentally omitted from earlier lists)	10.00
VK4ALE .....	5.00
VK6FS .....	25.00

# SC22DX

Scalar's Great New 5 Band Vertical

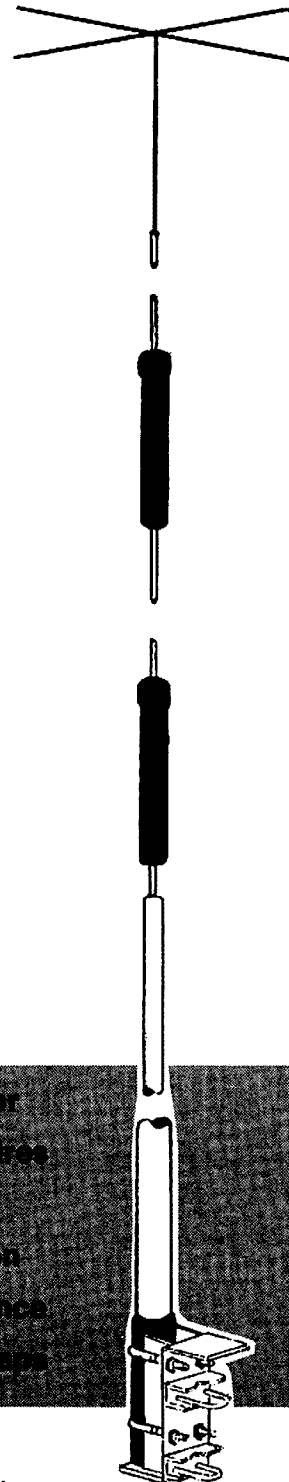

**FEATURES:**

- ★ 1/2 wave operation for
- ★ 10, 15, 20, 40, 80 metres
- ★ self supporting
- ★ low angle of radiation
- ★ superb DX performance
- ★ built in SWR meter

**"A QUALITY AUSTRALIAN MADE PRODUCT"**  
Recommended Retail Only \$129.00

**CONTACT YOUR LOCAL  
HAM GEAR RETAILER OR  
THE MANUFACTURERS...**



**SCALAR INDUSTRIES PTY. LTD.**  
20 Shelley Avenue, Kilsyth, Vic. 3137 (03) 725 9677  
N.S.W.: 20 The Strand, Penshurst, 2222 (02) 570 1788  
QLD.: 969 Ann St., Fortitude Valley, 4006 (07) 52 2594

# WIRELESS INSTITUTE OF AUSTRALIA

Federal President: Dr. D. A. Wardlaw VK3ADW

Federal Council:

VK1 Mr. R. G. Henderson VK1RH

VK2 Mr. T. I. Mills VK2ZTM

VK3 Mr. G. A. G. Williams VK3ZXW

VK4 Mr. A. R. F. McDonald VK4TE

VK5 Mr. C. J. Hurst VK5HI

VK6 Mr. N. R. Penfold VK6NE

VK7 Mr. R. K. Emmett VK7KK

Staff: Mr. P. B. Dodd VK3CIF, Secretary.

Part-time: Col. C. W. Perry, Mrs. J. M. Seddon and Mr. Mark Stephenson (AR advertising).

Executive Office: P.O. Box 150, Toorak, Vic. 3142.

2/517 Toorak Rd., Toorak, Ph. (03) 24 8652.

Divisional Information (all broadcasts are on Sundays unless otherwise stated).

ACT:

President — Mr. A. Davis VK1DA

Secretary — Mr. F. Robertson-Mudie VK1NAV

Broadcasts— 3570 kHz and 2m Ch. 6 (or 7): 10.00Z.

NSW:

President — Mr. F. S. Parker VK2NFF

Secretary — Mr. T. I. Mills VK2ZTM

Broadcasts— 1825, 3595, 7146 kHz, 28.32, 52.1, 52.525, 144.1, 145.6, 146.4, Rptr. Ch. 3— Gosford, Ch. 4— Lismore, Ch. 5 Wollongong, Ch. 8— Dural 11.00h local (Evening 0930Z). Relays on 160, 80 and 10m, VHF and Repr. Ch. 3, Ch. 5, Ch. 8, and Hunter Branch, Mondays 0930Z on 3595 kHz, 10m, and Ch. 3 and 6. RTTY Sunday 0030Z 7045, 14090 kHz, Ch. 52, 0930Z 3545 kHz, Ch. 52.

VIC.:

President — Mr. E. J. Buggee VK3ZZN

Secretary — Mr. G. F. Atkinson VK3YFA

Broadcasts— 1840, 3600, 7135 kHz— 53.032 AM, 144.2 USB and 2m Ch. 2 (5) repeater: 10.30 local time.

Gen. Mtg. — 2nd Wed., 20.00.

QLD.:

President — Mr. A. J. Aarsse VK4QA

Secretary — Mr. W. L. Giells VK4ABG

Broadcasts— 1825, 3580, 7146, 14342, 21175, 28400, kHz; 2m (Ch. 42, 48): 09.00 EST.

Gen. Mtg. — 3rd Friday.

SA:

President — Mr. I. J. Hunt VK5QX

Secretary — Mr. W. M. Wardrop VK5AWM

Broadcasts— 1820, 3550, 7095, 14175 kHz; 28.5 and 53.1 MHz, 2m (Ch. 8): 09.00 S.A.T.

Gen. Mtg. — 4th Tuesday, 19.30.

WA:

President — Mr. Ross Greenaway VK6DA.

Secretary — Mr. Peter Savage VK6NCP.

Broadcasts— 3560, 7075, 14100, 14175 kHz. 28.485, 52.290 MHz. 2 metres Ch. 2 Perth, Ch. 6 Wagln. Time 0130Z.

Gen. Mtg. — 3rd Tuesday.

TAS.:

President — Mr. I. Nicholls VK7ZZ

Secretary — Mr. P. T. Blake, VK7ZPB

Broadcasts— 7130 (AM) kHz with relays on 2m Ch. 2 (S), Ch. 8 (N), Ch. 3 (NW), 09.30 EST.

NT:

President — Mr. T. A. Hine VK8NTA

Vice-Pres. — Barry Burns VK8DI

Secretary — Robert Milliken VK8NRM

Broadcasts— Relay of VK5WI on 3.555 MHz and on 146.5 MHz at 2330Z. Slow morse transmission by VK8HA on 3.555 MHz at 1000Z almost every day.

Postal Information:

VK1 — P.O. Box 46, Canberra, 2600.

VK2 — 14 Atchison St., Crows Nest, 2065 (Ph. (02)

43 5795 Tues & Thurs (10.00-14.00h).

P.O. Box 123, St. Leonards, NSW 2065.

VK3 — 412 Brunsworth St., Fitzroy, 3065 (Ph. (03) 41 3535 Weekdays 10.00-15.00h).

VK4 — G.P.O. Box 638, Brisbane, 4001.

VK5 — G.P.O. Box 1234, Adelaide, 5001 — HQ at West Thebarton Rd., Thebarton.

VK6 — G.P.O. Box N1002, Perth, 6001.

VK7 — P.O. Box 1010, Launceston, 7250.

VK8 — (Incl. with VK5), Darwin AR Club, P.O. Box 37317, Winnelie, N.T., 5789.

Slow morse transmissions — most week-day evenings about 09.30Z onwards around 3550 kHz.

VK QSL BUREAUX

The following is the official list of VK QSL Bureaux, all are inwards and outwards unless otherwise stated.

VK1 — QSL Officer, G.P.O. Box 46, Canberra, A.C.T. 2600.

VK2 — QSL Bureau, C/- Hunter Branch, P.O. Teralba, N.S.W. 2284.

VK3 — Inwards QSL Bureau, Mr. E. Trebilcock, 340 Gillies Street, Thornbury, Vic. 3071.

VK3 — Outwards QSL Bureau, Mr. R. R. Prowse, 83 Brewer Road, Bentleigh, Vic. 3204.

VK4 — QSL Officer, G.P.O. Box 638, Brisbane, Qld., 4001.

VK5 — QSL Bureau, Mr. Geo. Luxon VK5RX, 203 Belair Road, Torrens Park, S.A. 5082.

VK6 — QSL Bureau, Mr. J. Rumble VK6RU, G.P.O. Box F319, Perth, W.A. 6001.

VK7 — QSL Bureau, G.P.O. Box 371D, Hobart, Tas. 7001.

VK8 — QSL Bureau, C/- VK8HA, P.O. Box 1418, Darwin, N.T. 5794.

VK9, 0 — Federal QSL Bureau, 23 Landale Street, Box Hill, Vic. 3128.

## Editor's Desk

Bruce Bathols VK3UV

At this time of the year, most people pause for a moment to reflect on the year's performance.

What have we as amateurs achieved in 1979?

Let us have a look at our hobby first, then the WIA and AR.

As far as the hobby is concerned one would have to be honest and say "Virtually nothing new or different from last year".

Why is this?

Certainly many new amateurs have joined our ranks and some further advances have been made in technology.

It is apparent that we amateurs are content to plod along with our "black boxes" and take things as they come.

What has happened to home-brew? Apart from a few isolated cases from the die-hards, if anything, it has taken a decline.

With the high cost of components and the specialities required to build "state of the art" equipment, for most of us it is more economical to purchase equipment "off the shelf". Yes! I even fall into that category myself — a "black box" operator.

To keep the record straight, perhaps it should be stated what it is that we actually do with our "black boxes".

Apart from some basic experimentation with antenna systems and investigations into the VHF spectrum, etc., we have evolved into a race of "specialist communicators".

Our techniques and abilities are second to none and we are always willing and organised to handle

any civil emergency communications network should the need arise. (Strange though! I seem to hear the same claim from NDO, CES, State Police, and even CREST!!)

Perhaps it is time that we took stock of ourselves?? Certainly I do not have the answers, but amateurs collectively and working together through the WIA have a much better chance of improving our public image.

We become "ambassadors" each time we speak into a microphone — whatever we say on the air becomes instant "public property". The countless ears of the world monitor us.

It therefore behoves us to conduct ourselves with decorum, and to stop and think for a moment before polluting the air waves with waffle. We should encourage and teach new amateurs correct procedures before any bad habits become established.

The future of amateur radio is in our own hands — let us all make the most of it.

Let us now look at the WIA and Amateur Radio magazine.

1979 has shown a steady growth, with membership only a few short of the 8,000 mark. Approximately 55 per cent of Australian amateurs are WIA members, this compares most favourably with other overseas amateur societies where membership is voluntary and not a condition of an amateur licence.

Naturally we would like a much higher percentage, as this would give the Institute extra "teeth" to complete negotiations with the authorities more effectively.

One of the greatest efforts of the WIA is the WARC preparation, and member representation at Geneva. This was a very costly exercise but vital to our survival. The full result will not be known for a little time yet, but we are always very optimistic.

We thank all members and supporters for their efforts in helping us with the WARC preparations and costs.

A lot of work goes on behind the scenes and this is primarily done by volunteers in the various Divisions and Executive office.

The Executive office is becoming overloaded with daily enquiries, but progression is all around us, and this includes your magazine "Amateur Radio" — affectionately known over the years as AR.

Since the first issue of AR was published, it has been under the direction of a hard working volunteer committee.

Of late, the work involvement of the editorial staff has reached such proportions as to become quite a personal burden for several members.

At the last Federal convention a long range plan was devised to centralise all aspects of AR production. As a result, Executive have appointed Mark Stephenson VK3NOY as a permanent salaried Executive staff officer. Mark's main duties will be the publication of AR, and he will take over effective control of all aspects of our magazine from 1st January, 1980.

Naturally producing a magazine the quality of AR requires much assistance from our members.

We require photographs and novice material in particular.

We look forward to our members' full support and wish Mark well in his new venture.

VK3UV. ■

## Are you checking our bands for INTRUDERS

### AND REPORTING SAME TO THE INTRUDER WATCH CO-ORDINATOR?

# THE PHILIPS FM321

A 70CM 40 CHANNEL  
FULLY SYNTHESISED  
AMATEUR RIG

Australian Designed  
Australian Made



FOR ONLY  
**\$299** \*

**With these features** ● 40 synthesised channels with electronic channel change and LED readout. ● Channel selection up or down from front panel or hand microphone. ● A LED each for power on, transmit and receive. ● 5 watt RF and 1 watt audio power. ● Combined signal strength and RF power meter. ● Single or two frequency simplex operation on any of the 40 channels. ● Instant selection of these modes plus any one nominated repeater channel. ● 5MHz TX/RX separation on repeater mode. ● PL259 antenna socket. ● 6 pole crystal filter combination for improved selectivity. ● High sensitivity.

## and this performance

Typical data at 22°C 13.8V  
Frequency Range: TX 433.025MHz to 434.000MHz  
438.025MHz to 439.000MHz  
RX 438.025MHz to 439.000MHz  
Frequency Stability: Better than 6ppm 0°C to +60°C  
Supply Voltage: 11 to 16.2Volts—Ve earth

### TRANSMITTER

Power Output: 5Watts  
Spurious Output: -63db(out of band)  
Audio Response: 6db/octave pre-emphasis  
300Hz to 2KHz

### RECEIVER

Audio Output: 1.0Watt at 10% THD into 8Ω  
Selectivity: 50db at ±25KHz  
Sensitivity: 0.3uvpd (12db SINAD)



# PHILIPS

Please send me an FM321  
by registered mail.

To: **Philips - TMC**  
Radio Communication Division AUSTRALIA  
P. O. Box 105, Clayton,  
Victoria, Australia, 3168.

NAME ..... ADDRESS .....

..... STATE ..... POSTCODE .....

CALL SIGN .....

CHEQUE No/MONEY ORDER No..... IS ENCLOSED FOR

\$ .....

OR

PLEASE DEBIT MY BANKCARD No.....

EXPIRY DATE .....

FOR \$..... SIGNATURE .....



\* Add \$4.00 for packing and postage

# CHIRNSIDE ELECTRONICS

## CHIRNSIDE ANTENNAS.

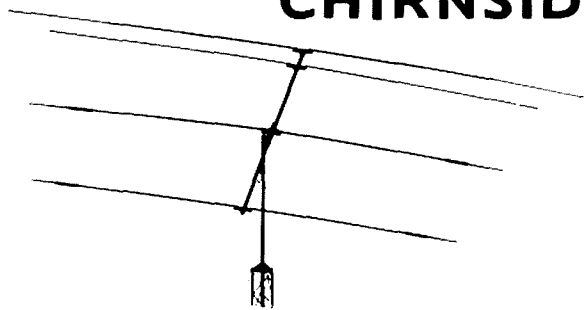

Duoband CE 4-2 15-10M 8dB gain .... \$139.

### YAESU GUTTERMOUNT HF ANTENNAS

RSL base mast inc. 2 metre stub .....	\$29
80 M. Resonator .....	\$19.
40 M. Resonator .....	\$19.
20 M. Resonator .....	\$19.
15 M. Resonator .....	\$19.
10 M. Resonator .....	\$19

### ANTENNA TUNERS



HC-75. Tokyo Hy-Power Labs. Transmatch	75W PEP .....	\$69
HC-250. Tokyo Hy-Power Labs. Transmatch	250W PEP .....	\$85.
HC-500A. Tokyo Hy-Power Labs. Transmatch	500W PEP. inc. 160M. ....	\$115.
AT-200. Kenwood. 200 Watts. ....		\$159.



### MONO BAND BEAMS.

APPROX. GAIN.

CE3-10. 3 el. 10M. 12' boom. 8 dB. ....	\$59.
CE4-10. 4 el. 10M. 15' boom. 10 dB. ....	\$74.
CE5-10. 5 el. 10M. 19'6" boom. 12 dB. ....	\$89.
CE6-10. 6 el. 10M. 24' boom. 13 dB. ....	\$105.
CE3-15. 3 el. 15M. 16' boom. 8 dB. ....	\$89.
CE4-15. 4 el. 15M. 20' boom. 10 dB. ....	\$114.
CE5-15. 5 el. 15M. 24' boom. 12 dB. ....	\$139.
CE3-20. 3 el. 20M. 8 dB. ....	\$139.
CE4-20. 4 el. 20M. 10 dB. ....	\$189.



trapped verticals.

**\$99.**

### CHIRNSIDE TRAP VERTICAL

CE5-5B 80-10 M. 30' long ..... \$99.

### CHIRNSIDE MOBILE HELICAL WHIPS.

Adjustable Tip Rod for easy SWR

80M. 7' long. ....	\$22.
80M. 6' long. ....	\$21
40M. 6' long. ....	\$20
20M. 6' long. ....	\$20.
15M. 6' long. ....	\$19.
10M. 6' long. ....	\$19.

Bumper mounts to suit. .... \$9.  
SET OF ALL FIVE FOR ONLY \$95 INCLUDING BUMPER MOUNT.



It is worth coming a little further to get a lot better quality and service

## ROTATORS

The high quality professional "EMOTATOR" Powerful rotation with independent braking systems.



1031BX. Medium Duty. ....	\$164.
502CXX. Heavy Duty. ....	\$249.
1102MXX. Extra Heavy Duty. ....	\$349.
1103MXX. Extra Extra Heavy Duty. ....	\$395.
502 Mast Clamp. ....	\$32.
103 Mast Clamp. ....	\$20.
VCTF-7. 7 Core Cable. per Metre. ....	\$1.20
VCTF-6. 6 Core Cable. per Metre. ....	\$1.00.

### DIAWA

DR-7500S. Medium Duty. ....	\$175.
OR-7600D. Heavy Duty. ....	\$248.



### FRG7 Synthesized Receiver.

For amateurs novices and shortwave listeners Electronic band changing with 0.5 - 29.9 MHz continuous coverage Uses Wadley Loop to derive synthesized heterodyne oscillator signal LSB USB AM and CW Frequency readout better than 10KHz. stability within 500Hz. Write for full details

**\$309.--**

### MISCELLANEOUS ACCESSORIES.

"Tono" 0-7000 communication computer. ....	\$839.
Leader dip meter. ....	\$89.
Leader ham oscilloscope. ....	\$299.
Other Leader test equipment available.	
Diawa antenna coupler CNW-217. ....	\$155.
Diawa 5WR meter. CN-620. ....	\$95.
Diawa Speech processor. RF-660. ....	\$105.
TSW-120 2 pos. coax switch. ....	\$15.
590G 5 position coax switch. ....	\$38.
LP-42. Drake low pass filter. 200W. ....	\$16.
Bumper mounts 3-8" x 24 thread. ....	\$10.
RG-58U thin coax. ....	40c. per M.
Porcelain egg insulators. ....	50c.
HI-Q balun 1:1 .....	\$15.95.

## YAESU.

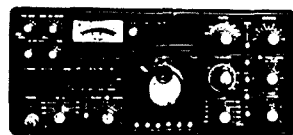

FT-101Z. 160-10M Transceiver. analog dial. ....	\$750.
FT-101ZD. 160-10M Transceiver. Digital. ....	\$898.
optional digital display for FT-101Z. ....	\$148.
optional Fan. ....	\$39.
optional DC-DC converter. ....	\$79.
YE-7A Hand mike. ....	\$21.
YD-148 Desk mike. ....	\$45.
FT-901DM. 160-10M Transceiver. ....	\$1322.
FV-901. ext. VFO for FT-901 & FT-101Z. ....	\$429.
YO-901. Panoramic adapter monitorscope. ....	\$475.
FC-901. Antenna coupler. ....	\$248.
FTV-901. Converter. 6M. 2M. 70 cm. all inc. ....	\$765.
FTV-901. Converter. 6M. 2M. only. ....	\$539.
YR-901. Morse reader. ....	\$TBA.
SP-901. ext. speaker. ....	\$53.
FRG-7. Communication receiver. ....	\$309.
FRG-7000. Digital communication receiver. ....	\$559.
LF-2A Narrow band filter for FRG-7. ....	\$20.
FT-7B. 80-10M Transceiver. ....	\$599.
FP-12. 12 Amp. power supply for FT-7B. ....	\$159.
YC-7B. Digital display for FT-7B. ....	\$139.
QTR-24 24 hr. World clock. ....	\$33.
QTR-24D. Deluxe 24 hr. World clock. ....	\$49.
FT-227RA. 2M. Scanning digital transceiver. ....	\$379.
FT-227B. 2M Digital programable transceiver. ....	\$POA.
YP-150. Dummy load/Watt meter. ....	\$109.
FF-50DX. Low pass filter. 2kw. ....	\$38.
NEW FT-107 & FT-107Drange. ....	\$TBA.

equipment sold by Chirnside Electronics is pro-sales checked and covered by 90 day warranty and expert after sales service.

All prices include Sales Tax. Freight and Insurance extra.  
Prices and specifications are subject to change without notice.

We handle and stock most Yaesu. Kenwood. Icom. Equipment.

CHIRNSIDE ELECTRONICS, 26 Edwards Road, Chirnside Park, Lilydale, 3116. Phone (03) 726 7353



# INEXPENSIVE HIGH-IMPEDANCE MULTIMETER

G. J. Hunt VK3ZIX  
19 Menzies Close, Frankston 3189

In this age of digital devices it is reasonable to ask whether the construction of an analogue multimeter is still justified. A quick look around would seem to indicate a definite yes. You can buy small ones from about \$10, very good ones cost hundreds. The unit described here can be built for approximately \$35 (allowing \$13 for a good quality movement) and has features found on instruments costing twice as much. These are:

- Sensitivity 100,000 ohms/volt, all ranges.
- Single linear scale for all voltage and current ranges, AC and DC.
- 8 volts ranges. 0.1 to 500V, AC and DC.
- 7 current ranges. 10 uA to 10A, AC and DC.
- 5 ohms range. 1 ohm to 10 megohms approx.
- "Automatic" meter protection (explained later).
- Uses inexpensive and readily available parts. No complicated switching arrangements.
- AC response 3 dB down at 12 kHz.

## OPERATION

The design centres around a 1 mA meter movement driven by a 741 op amp such that 100 mV input will cause 1 mA to flow through the meter. Under these conditions the current through the input resistor R1 is 10 uA; hence we have a basic movement with a sensitivity of 100k ohms per volt. (If R1 is made 100k then 1 megohm/volt is possible but this was rejected due to zero offset and noise problems and the need for excessively large multipliers, e.g. the 500V range would require 500M ohms which is difficult to obtain.)

The op amp will also pass AC, so for these readings the meter is switched across a diode bridge. Any non-linearity in the diodes will be compensated for by the feedback circuit of the amplifier. (This bridge could be left in circuit for DC readings but then it would not be possible to determine whether the voltage being measured was AC or DC.) The output voltage is developed across R2. To read true RMS (AC) this must be reduced to 90.03 ohms. This is done by switching in the compensation trimpot RV3.

The two diodes from the amp input to COMMON afford some protection in the event of a severe overload. The current through the meter itself is limited by R3 to about 3 mA under the worst conditions.

The 18V supply comes from two small 9V rectangular transistor radio batteries. A modest consumption of 800 uA plus the meter current should ensure long life. Accuracy of reading was maintained until either or both battery voltages fell to less than 6.3 volts.

## CONSTRUCTION

All the components for the meter amp and also the ohms ranges resistors are mounted on a PCB which bolts directly on the meter terminals. The board layout is reproduced here, but note that the hole spacing is for a 4½ inch panel meter and

may not suit the one you use. Use a socket for the 741, for reasons to be explained later.

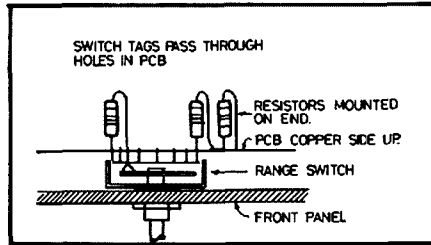

FIG. 1: Switch Details.

In the prototype a separate PCB was made to fit over S1, S2 and S4. The multipliers and shunts were then mounted on this board, see Fig. 1. However due to the possible variations in switch types, layouts and case sizes it was considered pointless reproducing this. The general principle only is shown here.

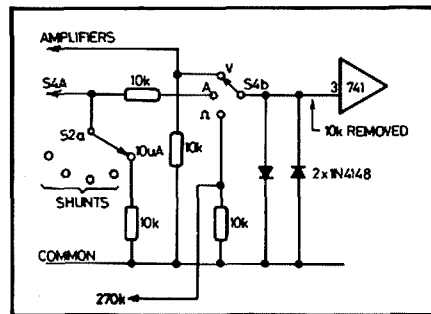
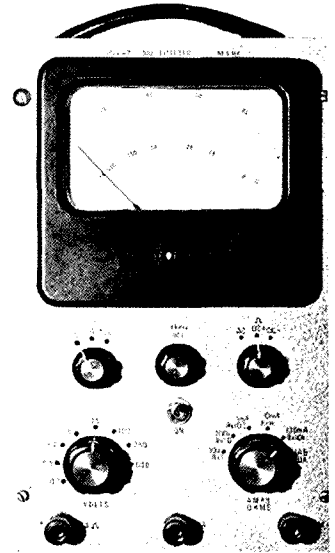

FIG. 2: Input Circuit.

If you use a PCB like this, make it of fibreglass (to reduce capacitive effects) and leave plenty of "pads" around the volts range switch to allow series connection of the multipliers. The 50M resistance for the 500V range consists of



High Impedance Multimeter.

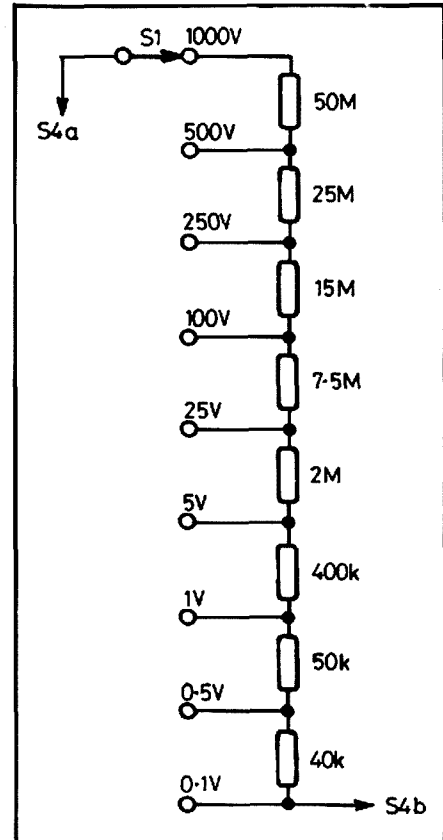

FIG. 3: DC Divider.

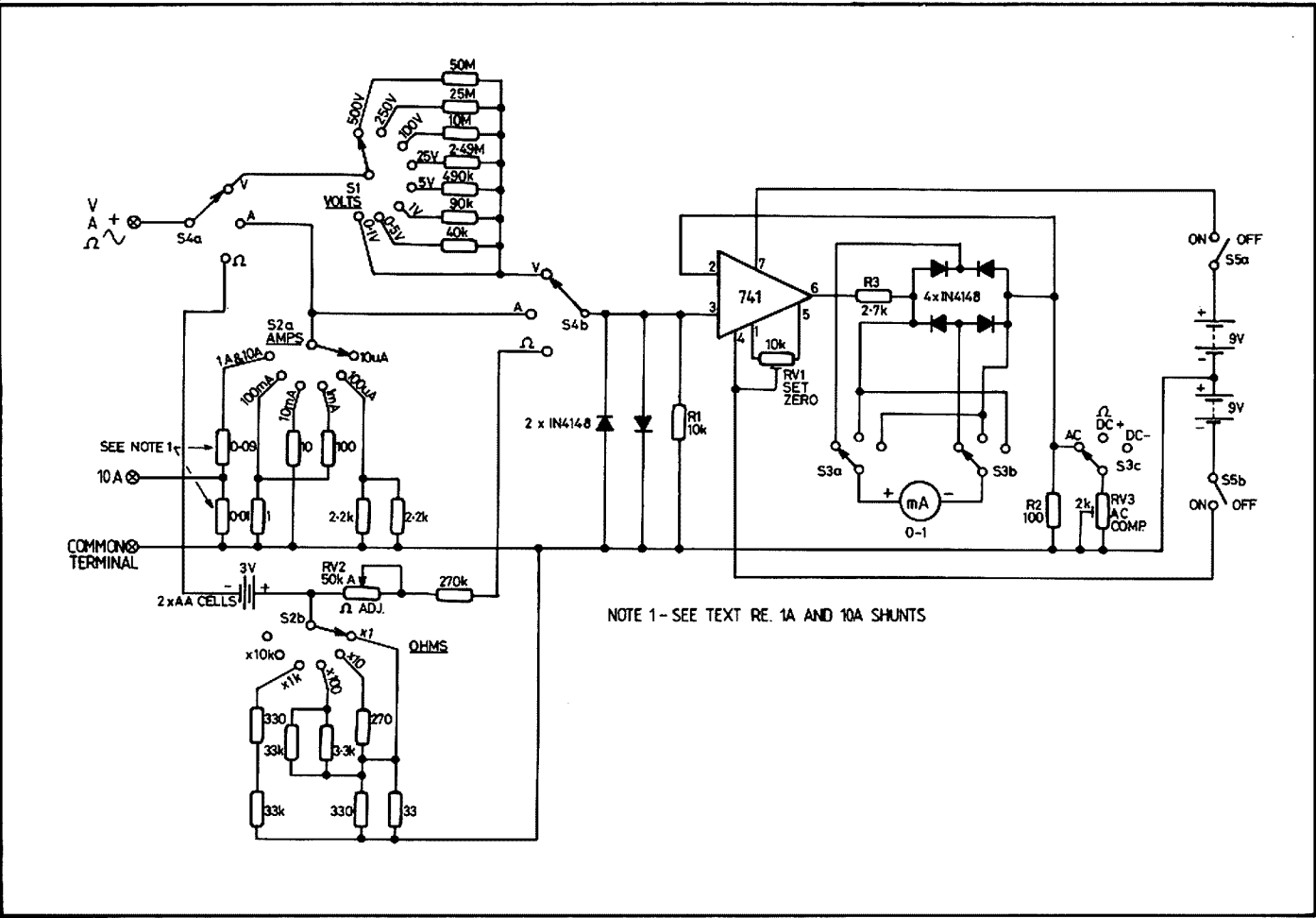
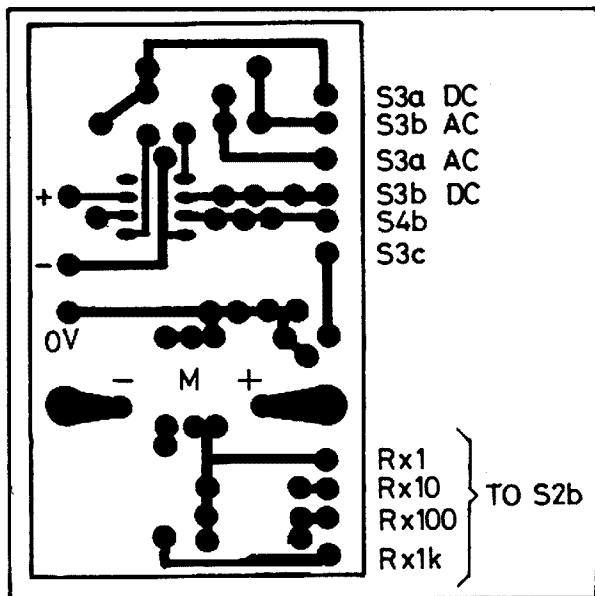

FIGURE 4: Multimeter Circuit Diagram.

5 x 10M + 3.3M in series, the latter because the 10M resistors were ± 10 per cent tolerance and all measured low! Some trimming of values will be necessary if accuracy is to be realised. We used a Digital Multimeter on the ohms range to get them as close as possible then checked the working unit against the same DMM on volts and amps. Accuracy and linearity were surprisingly good, the main limiting factor being the meter itself. The 1A shunt was made from several strands of electric jug element and is best worked out by experiment. The 10A shunt consists of 440 mm of 15 amp fuse wire, doubled (to make it 220 mm long), wound on a 2 watt carbon resistor and connected directly across the 10A and COMMON terminal posts.

All the switches except S3 were obtained from Tandy Electronics. S2a is modified by removing the insulation between contacts to make it bridging; this prevents the shunts going open if ranges are changed during a current reading. It will be noticed that on the 1A range this current actually flows through S2a and S4a. No problems have occurred in practice, but if this is felt undesirable then the solution is to either use heavy duty



Amplifier PCB, Copper Foil Side.  
 Scale: Full Size.

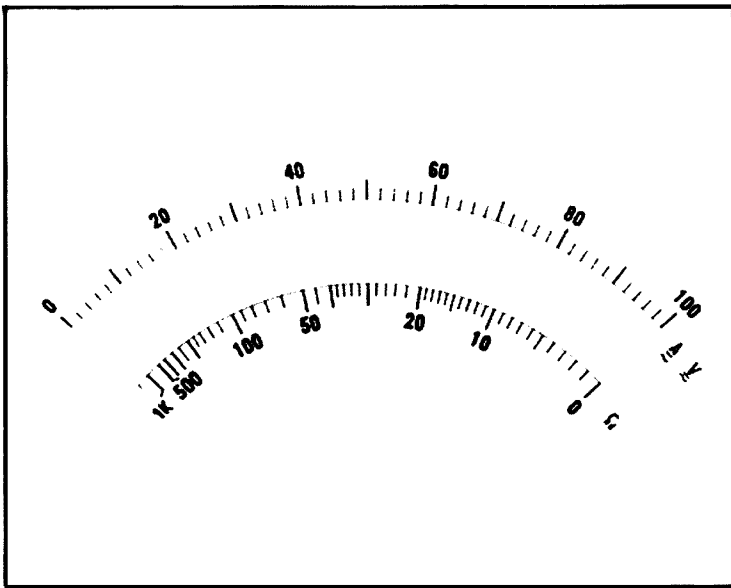

ABOVE  
Meter Scale.  
Scale: Full Size.

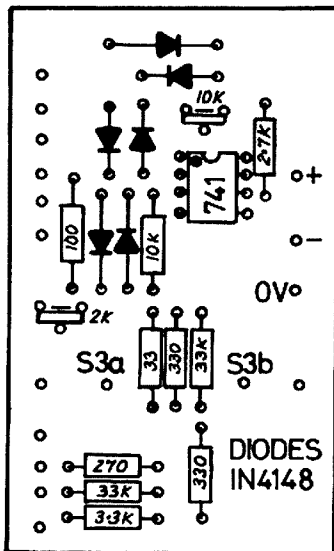

RIGHT  
Component  
Placement  
on PCB.

**PARTS LIST**

Case to suit meter (ours measured 235 x 145 x 65 mm to house a 4 1/2 In. (120 x 110) meter).

0-1 mA meter.

**SWITCHES**

1 1-pole 12-position rotary (8 positions only used).

2 2-pole 6-position rotary (3 positions only used on S4).

1 3-pole 3-position rotary.

1 DPST miniature toggle.

**SEMI-CONDUCTORS**

1 741 op amp (see text).

6 1N4148 diodes.

**RESISTORS (all 1/4W)**

1 x 270k, 2 x 100 ohm, 1 x 2.7k, 1 x 10k, 2 x 2.2k, 1 x 10 ohm, 1 x 1 ohm, 1 x 33 ohm, 1 x 270 ohm, 2 x 330 ohm, 1 x 3.3k, 2 x 33k, 8 x 10M, 1 x 2.2M, 2 x 470k, 1 x 22k, 1 x 82k, 1 x 8.2k, 1 x 39k, plus various values for trimming.

1 50k linear potentiometer.

1 Trimpot 10k.

1 Trimpot 2k.

15 amp fuse wire.

**MISCELLANEOUS**

Printed Circuit Board.

2 x 1.5V Penlight Cells. 1 Battery Holder to suit.

2 x 9V Batteries. S-006P or equivalent.

Battery clips, PCB pins, hookup wire, solder, knobs, test leads, etc.

3 Terminals, 2 red, 1 black.

1 x 8-Pin DIL socket.

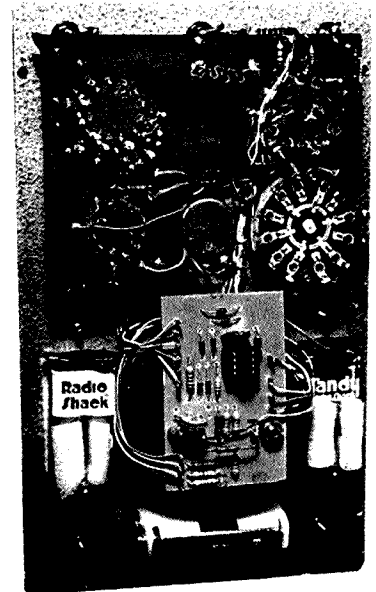

Inside the Multimeter.

switches or bring the 1A range out to a separate terminal. In the interest of cost cutting this was not done on our version.

**SETTING UP**

Switch on, select volts and adjust RV1 for zero. Set S2 to one of the higher AMPS ranges and switch S4 to AMPS. If there is any change in the zero reading, try another 741. We found a wide variation in the amount of offset between different ICs. The best one of all was labelled 741CP and the variation with this was negligible. Type 741K was also good. Several 741CNs had enough offset to cause a reading error of nearly 3 per cent. If you cannot obtain the better type, the circuit mod. (Fig. 2) should cure the problem on all but the 10 uR range.

Some final remarks about the design. As an ohmmeter the unit feeds out negative on the positive lead as is the convention. But testing of semi-conductors is less of a hassle if the potentials agree with the lead colours. This can be done quite simply by reversing the connections

to the 3V "ohms" battery and using the "DC minus" setting of S3 for ohms.

The ohms adjust pot. RV2 is provided to compensate for the internal resistance of the 3V battery. If a regulated supply capable of 100 mA at 3 volts were built in then this control could be omitted from the front panel.

The meter was basically intended for low voltage work and so a 1000V range is not shown. Individual multipliers for each range are used because this way it is possible to trim one range without changing any other. If a 1000V position is needed, it would be better to use series multipliers; Fig. 3 shows this arrangement.

**NOTES ON THE PHOTOGRAPHS**

All components are mounted on the inside of the front panel, making it possible to lift the entire unit out of its box without any connecting lead problems. The 3 volt battery holder (above the meter) attaches to the panel with a small hinge and will fold down flat for removal of the cells.

The 1A shunt is in the foreground between the 10A pad and S2. The 10A shunt can just be seen under the board at the bottom of the picture.

The meter turned out to be 900 uA, so there is an 820 ohm resistor across the terminals.

The scale (copy included) was photographically produced from a text book; it was then masked out and enlarged to the required size.

# "THE EVEN SIMPLER REGULATOR"

Denzil Roden VK2BXF  
7/169 Herring Rd., N. Ryde 2113

A large percentage of amateurs attempt construction of power supplies. However, from reports heard "on-air" or via other lines of communication, many run into strife. This is avoidable, as the author shows.

Most circuits published are based on the uA723 Integrated circuit regulator and it is around this device that most construction problems occur: confusion regarding pin numbering, incorrect orientation of package on PC board, wrongly cut tracks on Vero board, accidental assassination by short circuiting with meter probes, are the most common.

From commercial experience with vast quantities of uA723 chips of various manufacture, the writer has found them to be not the most reliable of beasts, being prone to self-oscillation, noise generation or simply suicidal. On a production line it is convenient to stamp such rogue components into the floor but the tighter budget of Mr. Amateur does not allow such flexibility.

Consequently the writer decided to attempt production of a regulator design to overcome such difficulties. The objectives were:—

1. Simplicity of construction: eliminate need for printed circuit board or similar sub-assembly.
2. Low cost.
3. Versatility: adaptable for various output voltages or as a variable supply.
4. Wide dynamic range: with minimal, if any, circuit change.
5. Reliability: capable of continuous operation at full design current rating.
6. Regulation: equal to or better than previous designs.

With the circuit described, all the above aims have been met or bettered.

The regulator shown in Fig. 1 will deliver up to 6 amps at 13.8 volts, suitable for most needs such as powering the popular VHF transceivers to about 30 watts output.

Higher current capacity can be obtained simply by adding more 2N3055 transistors, with emitter resistors, in parallel with the two shown. For example, six additional transistors will raise the output capability to 20 amps, with no other circuit changes whatever. (Obviously transformer, rectifier,

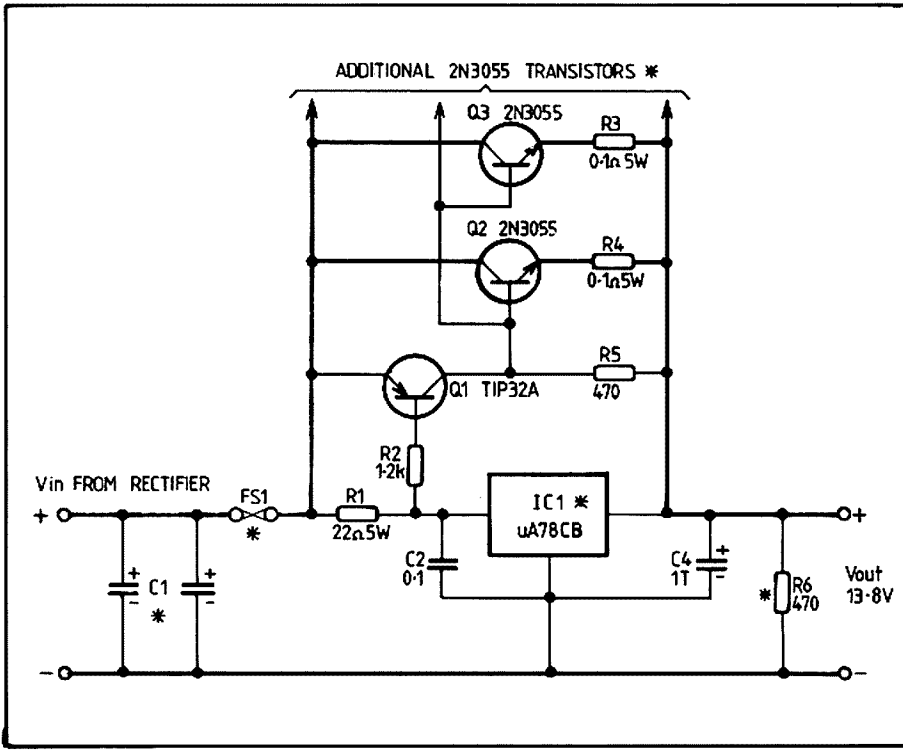

filter capacitors, wiring, etc., must be upgraded too.)

The current ratings are continuous and not intermittent, as in many commercial regulators sold for amateur applications.

Transformer and rectifier connections follow standard circuitry so have been omitted from Fig. 1. However details of suitable components are given in the text, together with some useful performance information.

The heart of the circuit is a three terminal 1 amp regulator integrated circuit, which defines the output voltage. C3 bypasses R7 to reduce ripple modulation of the IC common terminal, D1 routes the discharge path of C3 around the IC. C2 and C4 should be mounted as close to the IC terminals as is convenient. The 2N3055s driven by the PNP transistor, provide current amplification. R6 defines a minimum load current required by this particular circuit for reliable operation.

Several regulators have been built in 6 amp and 20 amp versions and have been extensively tested with no problems. 20 amp regulators have been run at full output for over 24 hours, with no sign of

FIG. 1: 6A (to 20A) DC Regulator.

- (a) For LM317  
 R7 4.7k lin carbon pot.  
 R8 220 ½W carbon.  
 \*C2 1 uF tantalum.
- (b) For LM 340-12 to produce 13.8V output  
 R7 150 ½W carbon. SOT.  
 R8 1.8k ½W carbon. May need adjustment.  
 \*C2 0.1 polyester.

<b>POSITIVE FIXED</b>		
TO-220	uA78XXCP	
	LM340T-XX	Pin 1 Input
TO-3	uA78XXKC	Pin 2 Output
	LM340K-XX	Pin 3 Common
<b>POSITIVE ADJUSTABLE</b>		
TO-220	LM317T	Pin 1 Adjustment
TO-3	LM37K	Pin 2 Input
		Pin 3 Output
<b>NEGATIVE FIXED</b>		
TO-220	uA79XXCP	
	LM320T-XX	Pin 1 Common
TO-3	uA79XXKC	Pin 2 Output
	LM320K-XX	Pin 3 Input
<b>TIP32</b>		
	Pin 1 Base	
	Pin 2 Emitter	
	Pin 3 Collector	

stress. Test results are given later, together with additional circuitry "options".

**CURRENT LIMITING**, or foldback protection was considered not necessary, for most amateur applications and was rejected for the sake of simplicity. The most common application for this regulator design will be for mains operation of mobile equipment. Most such gear is designed for use on automotive battery supplies. Protection in such installations is limited to an in-line fuse.

In this circuit, over-current protection is by fuse. Plenty of circuits are available where more sophisticated protection is warranted.

**FUSE (FS1)** ratings need some mention. Fast-blow cartridge types should be used, though it should be noted that they are capable of carrying currents up to 25 per cent greater than their marked values and for considerable time. For example, several 7.5 amp fuses tested, passed 10 amps for over two hours, but at 10.5 amps such fuses failed after between ten and twenty seconds.

So where precise current protection is required, it can be achieved by selection of fuse values about 25 per cent less than the current level desired.

However, when fuses are used in this manner they run decidedly hot and under mechanical stress, thus their useful life is very limited, especially if the current is repeatedly switched on and off.

For continuous operation the marked value of the fuse should be as specified by the transceiver manufacturer.

**OUTPUT VOLTAGE.** Three terminal 1 amp regulators are available in a wide range of output voltages, any of which may be used. The Fairchild uA78CB is a long awaited addition to the range and provides  $13.8V \pm 5$  per cent, in either TO-3 or TO-220 (plastic) packages.

The same voltage may alternatively be obtained using a 12V output device, with the common terminal lifted a couple of volts, as shown in Fig. 2(b), without degrading the regulation significantly. This method enables the voltage to be set precisely and may be preferable when exactly 13.8 or any other voltage is required.

If a variable voltage is wanted, the LM317 regulator is used with the circuit additions shown in Fig. 2(a).

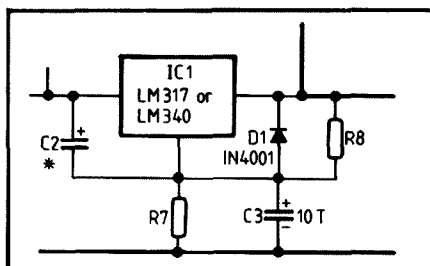

FIG. 2: IC Options.

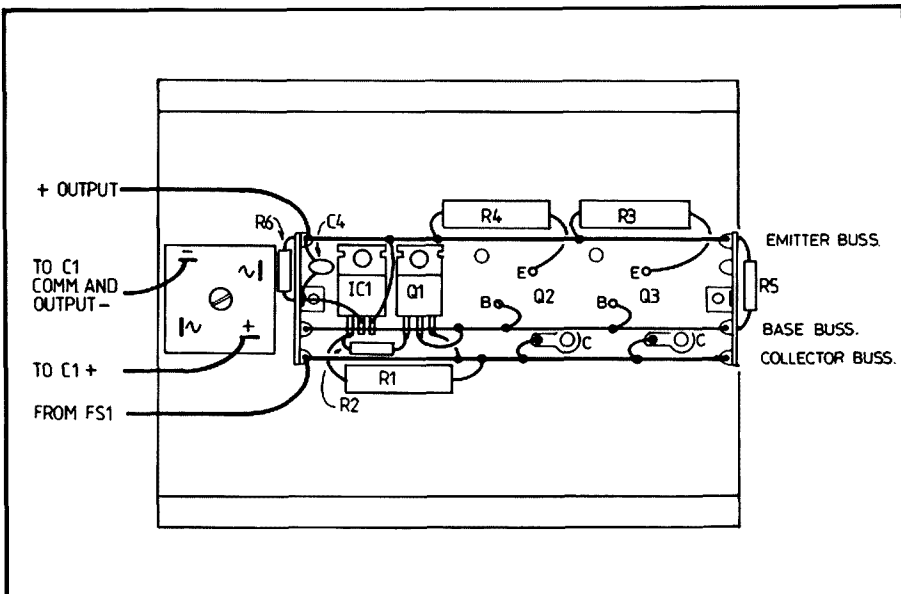

FIGURE 5: 6 amp Regulator Layout.

**INPUT VOLTAGE**, measured across C1, is determined by the transformer used. This voltage must be kept below the Absolute Maximum specified for the particular regulator used. For the LM340/LM78XX series up to 18 volts output, the maximum is 35 volts and for the LM340-24/LM7824 it is 40 volts.

This rating is given in a different form for the LM317 variable regulator, where the maximum difference between input and output voltages is specified at 40 volts, which means, for the device adjusted to give minimum output (1.2V) the input voltage must be kept below 41 volts.

For the 13.8 volt circuits described, the lower input voltage limit for good regulation is 17 volts for 6 amps and 20 volts for 20 amps.

**SEMI-CONDUCTOR CONNECTIONS** are illustrated in Fig. 4. It should be noted that even though the LM340 and LM317 are both positive devices, their connections differ. (Negative regulators are different again.) This circuit may be adapted for negative voltages by making the necessary polarity inversions.

The LM340 can be bolted directly on to the heatsink but the LM317 needs to be insulated with a mica washer as does the TIP32.

Plastic TO-220 devices were used because they are much cheaper and require only one mounting hole, but there is no other reason why TO-3 packages should not be used.

**BRIDGE RECTIFIERS** churn out considerable heat so require thought regarding heatsinking. The case temperature of a PB60, without a heatsink, runs at the limit at 6 amps, but with 1½ inches of 4 inch width heatsink it is quite happy. The same type, on a near infinite sink self-destructs at between 15 and 20 amps continuous.

For the 20 amp regulator a type MDA3501 bridge on 3 inches of heatsink is adequate; these are rated at 35 amps and can cope with 20 amps joyfully and, incidentally, can be obtained at less cost.

**FILTER CAPACITOR C1.** 12000 uF was used with the 6 amp version. This value is somewhat higher than usual, probably because the transformer specified is being stretched. For 20 amps 2400 uF is suitable.

Increasing the value has no significant effect on the output regulation; however it will reduce the ripple voltage amplitude. In some cases a worse ripple may be tolerated, so it is worth trying reduced capacity, down to half the recommended value, in order to cut costs. Capacity can always be added until the ripple becomes acceptable.

**TRANSFORMERS** are the most expensive consideration. The type M2000, obtained

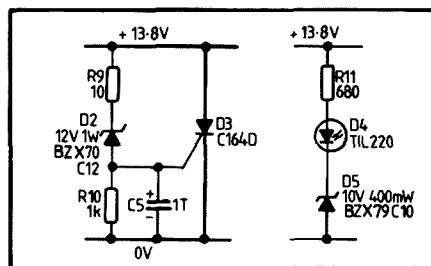

FIG. 3: Crowbar and Indicator Circuit.

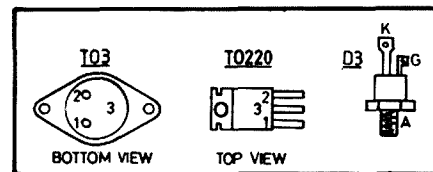

FIG. 4: Semiconductor Connections.

from Dick Smith, is used in the 6 amp version, at a quite good price. Though the regulator itself is capable of continuous operation, this transformer will only provide a continuous 6 amps for limited periods, and will be satisfactory at this current for the usual FM transmit-receive duty cycle. Run at 5 amps for longer than one hour the transformer becomes too hot to be picked up with bare fingers.

Alternatively Ferguson Transformers have type PF3788 rated at 15 volts, 8 amps, at a few dollars more. It has not been tested by the writer so it is not known whether the rating is continuous or peak.

Douglas Transformers, who advertise in ETI, have a range of up to 15 volts at 10 amps continuous, however transformers rated higher than that are not usually stock items. A single 20 amp unit can be made for some \$40, so a bulk order from a club or group would be worth while. Even so a 20 amp supply can be made at a good saving over a commercial brick. If one has the facilities, a home spun transformer would be ideal.

**CONSTRUCTION.** A suitable layout is given in Fig. 5, for a 6 amp unit, all components are mounted on a 6 inch hunk of heatsink. At maximum ratings, 2 inches of heatsink should be allowed for each 2N3055. The integrated circuit and the TIP32 do not create much warmth. It may be more convenient to mount the components on the assembly box, but choice is up to the constructor.

In any case the load-bearing wiring, shown in heavy line on the diagrams, must be kept as short as possible and must be of sufficient cross sectional area to carry the peak currents.

The emitter and collector busses each consist of two lengths of 14 B & S tinned copper wires in parallel, supported by tag strips. Where multiple heatsinks are used, the busses can be paralleled with flexible wire of suitable size. The base bus is a single 14 B & S.

The transformer secondary wiring should be kept short too. The heavy current path in the negative (0V) line, is from rectifier to C1 negative terminal and to the output. There is no need for heavy duty wiring to the common side of the regulator. The IC common terminal is connected with 14/0076 size wire to the rectifier negative post via the heatsink earth point as shown.

Often otherwise good regulation is degraded, even in commercial supplies, simply because wiring has been skimped. Instead of using a single heavy duty wire, with which neat solder connections are hard to make, the writer finds that several smaller wires run in parallel, giving the same total rating, produce a better looking job. Otherwise layout is not critical.

#### PERFORMANCE

Input and output voltages measured are listed over the range of load currents.

**6A.** Output ripple at 6 amps was 12 millivolts peak to peak or 0.03 per cent. Regulation at the same current is 0.22 per cent. Variation of the main supply voltage by  $\pm 6$  per cent has no noticeable effect.

Load Current	V in	V out
amps	volts	volts
0	25.4	13.80
0.5	23.8	13.80
1.0	23.0	13.80
2.0	21.9	13.80
3.0	21.0	13.79
4.0	20.2	13.79
5.0	19.5	13.78
6.0	18.7	13.77

These results were obtained with a M2000 transformer.

With V in equal to 18 volt, 9 amps can be drawn loading the output to 12.0 volts. Of course this is impossible with the M2000. Results using an LM340-12 as in Fig. 2(b) were virtually identical.

**20A.** Output ripple at 20 amps was 40 millivolts peak to peak or 0.1 per cent. Regulation is 0.72 per cent and again  $\pm 6$  per cent change in mains voltage had no measurable effect.

Load Current	V in	V out
amps	volts	volts
0	35.0	13.80
2.0	32.8	13.79
4.0	31.5	13.79
6.0	30.8	13.77
8.0	30.0	13.76
10.0	29.3	13.75
12.0	27.8	13.74
14.0	26.5	13.73
16.0	25.8	13.72
18.0	25.3	13.71
20.0	24.8	13.70

With V in equal to 20 volts, the output is loaded down to 12.0 volts at a current of 29 amps.

These results should be more than adequate for most requirements. Ripple can be further reduced as stated earlier but this action should not be needed.

**OPTIONS.** Additional circuitry is detailed in Fig. 3. In all similar regulators, there exists the possibility of breakdown in the series control transistors. In such a situation the full value of V in can appear across the output terminals, with expensive results in the equipment being supplied.

**THE OVERVOLTAGE CROWBAR** in Figure 3(a) is suitable for an 8 amp or less regulator. With the component values shown, voltages exceeding about 15 volts will cause the SCR to fire, placing a very low impedance across the output, thus reducing the output voltage to zero and pulling a hefty enough current through the fuse to take it out very quickly.

The same circuit can be used with higher rated regulators, using suitably proportioned SCRs.

The efficiency of such crowbars is dependent upon very low wiring resistance, so the wiring shown in heavy line should be up to the job.

When other SCR types are used, component values may need to be changed to give the right firing voltage and of course the circuit can be adapted for any fixed output voltage.

R6 should be omitted if a crowbar is installed.

**THE UNDERVOLTAGE INDICATOR** in Fig. 3(b) gives an indication that the output voltage is at or below a minimum level. With the values given, the LED will glow just perceptibly at 12.5 volts and will be dark at 12.0 volts. At full output the LET will be bright.

R11 or the zener diode, which has a voltage tolerance, may have to be selected to give the required results.

**CURRENT METERING.** Most designs published in amateur magazines have one falling, in that when a current meter is included, it is usually badly positioned, after the regulator in the output leg. This has the result of degrading the regulation. At 5 amps, the internal resistance of the meter will cause a voltage drop in the order of about half a volt.

The regulation of our 6 amp unit, at full output, works out at 0.22 per cent, but with the drop across the current meter, the regulation is degraded to about 4 per cent.

If a current meter is required, it would be better placed between the fuse and the regulator, where it would not affect the regulation. The meter would carry the quiescent current of the regulator and any additional circuitry, but even as much as 50 milliamps would barely register on a meter of higher than 2 amps full scale deflection.

**COMPONENT SOURCES** of the heavy components have been mentioned in the text already. All semi-conductors may be obtained from Silicon Valley, the outlet of Cema Electronics. Miniature 5 way tag strips and heatsinks from Davred Electronics. The 0.2 ohm 5 watt wire-wound resistors, type ASW5, are obtainable from Radio Parts, George Brown, etc.

At the time of writing this design still represents the lowest cost for high current applications. In a year or so the prices of integrated and hybrid regulators may come down sufficiently to allow an "even more simple regulator project". ■

Technical Articles  
Always Needed

# REPLACING THAT UNUSUAL 'JA' TRANSISTOR

## — Amplifier Modification for the Kyokuto 2m Transceiver

Ian Hunt VK5QX

8 Dexter Drive, Sallsbury East 5109

**Following fixing of the DC supply which had apparently suffered from a mains "bump" whilst left running in the shack I was able to check out the transceiver. Result! No. RF output. They don't like having about 30 volts DC fed to them at all. It did not take long to ascertain that the RF transistors in the Power Booster Unit had blown up.**

I am about to fit a crowbar protection circuit to the output of my 12 volt 10 amp regulated power supply. On two occasions, having left the supply plugged in with the mains turned on, I have connected my Kyokuto transceiver to the output only to find the "S" meter dial shining much too brightly. The first time I was lucky and the regulators in the transceiver must have worked overtime protecting the circuitry, however, on the second occasion I stupidly pressed the transmit switch before turning off.

So what to do? According to the circuit the unit uses a type 2SC1169 as the driver transistor, however the device actually in the unit was marked 2CS1965. The output transistor was a 2SC1605A. None of these types were immediately available as replacements, particularly for the driver transistor which is housed in a TO37 case with the emitter connected to the case. The case of this transistor is screwed to the underneath side of the amplifier unit chassis for heat sink purposes.

Replacement of the final transistor was fairly simple as the set already used a stud device in this position. Here a type 2N6082 (25 watt, 6.2 dB minimum gain device) was pressed into service. Fitting of this transistor did not present very much of a problem and was achieved simply by cutting short the wings of the transistor, which is designed for stripline use. The associated components were soldered directly on to the short length of wing left for the base and collector connections and the two reduced length emitter wings bent down and soldered directly to the printed circuit board on either side of the transistor.

The physical nature of the original driver transistor is, however, such that direct replacement appears to be a little difficult to obtain. The problem can be overcome by the following method based on a suggestion by Steve VK5ZSD, who actually carried out the work in my shack involved

in the first replacement, with yours truly looking over his shoulder urging him on.

A sort through the spare transistor drawer brought to light a Motorola type 2N5641 (7 watt, 8.4 dB) which was also designed for stripline type construction and had narrow leads for connection. Removal of the original driver transistor is relatively easy. The two holding screws underneath the chassis are taken out and the collector and emitter leads are unsoldered from the pads on the printed circuit board together with the leads from other associated components. The aid of a solder-sucker is invaluable here. Do not be fooled by the appearance of this driver transistor because as well as the emitter connection being via the case clamped to earth, there is a third lead from the transistor soldered on to the board and initially a little hard to see.

Incidentally, it is a simple matter, the removal of four screws and unsoldering of two light coaxial cables and two other wires, to completely remove the entire amplifier chassis from the transceiver, which makes it much easier to work on.

To replace the driver transistor with a more readily available type the following procedure was necessary.

First of all the small tinplate shield across the amplifier compartment had to be removed. The use of a short length of coaxial cable braid wet with liquid flux, in the absence of "solder-wick", to soak up the holding blobs of solder while heated with the iron allowed this feat to be performed without too much trouble.

A hole to allow passing the stud of the replacement transistor was then drilled through the chassis and a large drill used to cut away the printed circuit board to permit the replacement transistor to fit down snugly on the board. Again, cutting back the leads of the replacement and a similar connection scheme as for the final transistor allowed a neat job to be performed. The pads on the printed circuit

board for base and collector connection for each transistor were not used as the transistor wings are sufficiently stiff to act in a self-supporting fashion and allow direct connection and easier soldering of the components. The cut-out in the tinplate shield to be replaced in the compartment was slightly enlarged so that the shield would clear the head of the replacement transistor and was then soldered back into place with little difficulty and not too much solder to allow easier removal later, which approach proved fortuitous in the light of further happenings.

Then came the matter of tuning up the unit following the replacement of one of the transceiver power supply unit transistors which had also suffered. Fortunately a general purpose replacement type of sufficient rating can be used here if you have a problem in this section.

I might also comment that with "JA" type transistors it is quite common for the first two identification numbers or letters of the transistor type marking to be left off, e.f. 2SA495 marked as A495 or 2SC1605A marked as C1605A, so don't be fooled by this and think you have a peculiar transistor type number on your hands.

The first problem encountered when commencing tune up was the fact that the trimmer capacitor across the input (base) circuit of the driver transistor came to the fully meshed position for maximum RF output and would not actually peak. Experimentation proved that an additional 15 pF (approx.) was required across this trimmer, and a small disc ceramic soldered into place solved this problem. A check of Steve's (5ZSD) Kyokuto transceiver in original condition showed that just such a value had been fitted by the factory, so obviously these tuned circuits are not as precisely made as you may think.

It was then found that no amount of tuning up of the circuits in the RF amplifier plus a check and peaking up of

circuits on the exciter board would produce more than about 6 watts at the output. Some head scratching and puzzlement followed, as to all intents and purposes the new driver transistor should have performed the job very well.

A little further thought and consultation of the data books showed that a much better transistor to use would be the Motorola Type 2N6080 (4 watt, 12 dB), which is designed as part of a set of transistors 2N6080 to 2N6084 specifically for the purpose of RF power build-up in circuits of this nature, the latter type (2N6084) being capable of about 60 watts output at these frequencies and used by me in an outboard power amplifier sometimes driven by the Kyokuto transceiver.

The process of replacing the driver transistor was undergone again with much less difficulty than before, probably due to the experience already gained.

With this complement of transistors now in the amplifier a tune up produced almost 15 watts of RF output power, which was considered to be satisfactory. No problems were encountered with the tune up, which

was done at 146.50 MHz, and the output remained constant over the band from 145 to 148 MHz, with a drop off in output at 144 MHz.

One other word of warning when working on this unit. When soldering in the amplifier compartment be careful not to let your soldering iron touch against the plastic bodied trimmer capacitors as they will melt very easily. It is probably better to remove them altogether and replace them later when rebuilding the stages if you are in any doubt as to the steadiness of your hand.

Now to summarise:

1. If you are using a regulated DC supply for your solid state transceiver without a suitable warning or voltage metering system on its output, don't leave it plugged into the mains and turned on so that mains surges can do damage and catch you napping. (In my case, twice.)
2. You would be well advised to fit a "crow-bar" over-voltage protection system on any such supply so as to protect your prized expensive transceiver.

3. The Kyokuto RF Power Amplifier stages can be satisfactorily replaced with more readily available and conventional stripline RF power transistors, and the job is not beyond the average amateur. This probably applies to some of the other popular transceivers as well.
4. Check the data books carefully when undertaking a project of this nature and choose the most suitable type devices for the job. It is not true that almost anything will do when replacing transistors, particularly in the area of RF devices. They are certainly not all much the same as one another.

I trust that this information has been of interest to you and that it may also be an encouragement for you to overcome a problem should you also, God forbid, be unlucky to have a similar blow up and not be sure whether or not you can do much about repairing the gear.

I would also like to acknowledge the encouragement and assistance I received from Steve Dench VK5ZSD in getting my unserviceable unit into operating condition again. ■

## CW AND REDUNDANCY

Dick Goslin VK3SV

In recent years, opposition has been expressed to the retention of **CW** in the examination syllabus on the grounds that it is "old-fashioned". But it is still the most reliable method of radio communication, and under difficult conditions may be the only one available to us. We are officially recognised as the amateur **SERVICE**, which implies an obligation to provide communication by the most effective means. We should therefore try to improve our skills rather than reject one of them simply because it happens to be the oldest.

This article follows an earlier one (December 1977) which dealt with the use of abbreviations. Other means of obtaining a "speed-up" are available to us, one of the more significant being the elimination of unnecessary (redundant) words. The English language contains many words which, although desirable for grammatical reasons, may be left out without reducing the sense of the message. For instance, we ask "Where is the house?". A Russian would ask "Where house?". The question is still clear and understood, but the reduction in words is 50 per cent and in elapsed (transmitting) time 33 per cent. (10 morse characters in place of 15.)

As such a simple example may not be a reliable guide to redundancy, suppose we look at an extract from a daily newspaper. I have chosen a newspaper report because in general terms these are probably closer to our usual way of expression than other forms of printed matter. "It appears that a ladder left in the recreation area was used by the prisoners to climb over the bakehouse roof and make their way to a car waiting for them in an adjacent street." The passage contains 144 letters or morse characters. At 10 w.p.m., or to be precise, 50 characters per minute as per paragraph 15 of the Handbook, it would take 2 minutes 53 seconds to transmit.

If the redundant words are removed, being careful to retain the sense of the message, the passage is reduced to—"Appears that ladder left in recreation area used by prisoners to climb over bakehouse roof make way to car waiting in adjacent street", a total of 111 characters, which at 10 w.p.m. would require 2 minutes 13 seconds to transmit. So whilst maintaining a keying speed of 10 w.p.m. we have improved our rate of communication to the equivalent of 13 w.p.m. I have not mentioned abbreviations as these can be learned by reference to journals or by listening around the bands. Their use will further increase the communicating rate.

The application of redundancy comes only with experience and practice, as with

most other forms of skill whether mental or manipulative. A starting point could be the writing down of a sentence which you expect to use on air, and then striking out any word not necessary for the message to be understood. "(My) name is Bert (es) QTH (is) Hobart OG (on) ur rig wx (hr) (Is) cold windy raining." He knows you are describing *your* weather, not his. The benefit may seem marginal but over a five or ten minute transmission (with call signs repeated at the required intervals) can be quite substantial. For those interested in examining the transmission from "Bert", the reduction in sending time is 22 per cent.

In time, the practice of eliminating unnecessary words becomes so automatic as to require no conscious effort. Instead, the operator's mind may be several words ahead of his keying, "dropping" those that are not essential, substituting short ones for long ones, and transposing others to avoid the use of prepositions.

A final note on use of call signs. Having established a Q5 contact, restrict subsequent identification to his call sign sent once, followed by yours sent once. He expects you to call and is listening to you. Repeating call signs wastes his time as well as yours.

I am indebted to Don VK3AKN for many valuable comments on "redundancy". ■



# NEW DEVELOPMENTS FOR THE MORSE ENTHUSIAST

Geoff Thompson VK3AC

Not a great deal has yet been heard here about some ham equipment which now sets new standards, particularly for the CW-morse enthusiast.

Full break-in has always been the goal for the ardent "smoke signaller", but it has been something which has been completely ignored by most of the manufacturers of ham gear. In fact, even with some of the most expensive transceivers, fiddling with key filters to eliminate clicks and thumps and to improve keying shape has been almost mandatory.

In 1968, the American Electrovoice Company merged with a conglomerate. The company will be well remembered by professionals for its high quality microphones. I have used them in sound film production for many years.

Albert Kahn K4FW was President of Electrovoice at the time of the takeover and he resigned to form a company of his own. On a ten acre block he and his associates built a modern factory complete with tool and die shop, plastic moulding facilities, turning and fitting workshop and provision for the production of components, including power and audio transformers, etc., forming the basis for the production of a little three watt QRP three band transceiver designed to interest youngsters in radio communication. However the greatest sales were to old-timers who became interested in the idea of QRP after having inhabited "kilowatt alley".

Out of this little rig, of which 4000 units were sold, grew the Argonaut, a small five band CW-SSB transceiver which could be powered by a lantern battery.

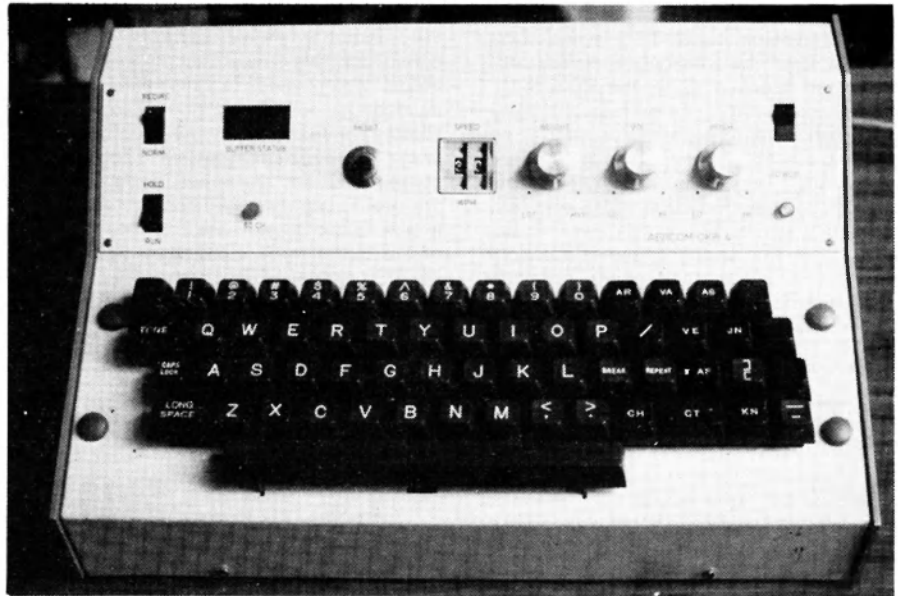

PHOTO 1: The VK2BF Morse Keyboard.

Then came the Triton which was the forerunner of the totally solid state medium power transceiver, a system which has since been widely imitated.

Albert Kahn and his boys have now produced the Century 21, a 70 watt CW transmitter-receiver which has the full break-in facility and optimum keying characteristics. This little box containing its own power supply is an ideal unit for the ham who is interested exclusively in CW-morse.

Now have come the Omni series of SSB-CW solid state transceivers complete again with full QSK at speeds up to and

exceeding 50 words per minute. With his background in the audio business and his hobby interest in ham radio, Albert Kahn has combined these skills to produce the Ten Tec range of ham gear which has set new standards for SSB audio quality and dynamic range and for perfect morse keying characteristics without external filters being required.

Having had the opportunity to use both the Century 21 and the Omni D rigs on the air for some months, I have enjoyed the experience of full break-in. Previously it had required several relays and a relay



PHOTO 3: The Omni D Ten Tec.



PHOTO 2: The Ten Tec Century 21.

control system to achieve full break-in using a transmitter and a separate receiver. This was an unreliable system when using a keyboard at speeds up to 55 words per minute. So it was a real pleasure to have TR switching which would permit high speed sending which could be broken by a single dash from the station at the other end. When two hams are using this gear the full break-in feature is at its best and short overs add a new dimension to a QSO using CW-morse. Most of the transceivers today provide limited break-in using the VOX relay. The slow make time of this relay in many cases spoils the first character each time the relay closes.

The Ten Tec rigs are particularly amenable to the morse keyboard and will key cleanly up to 100 words per minute. On the CRO, the keying shape is identical with the CRO photograph of the optimum attack and decay times published in the ARRL handbook. A 12 volt storage battery

floating across a ten amp charger provides an effective power supply for the Omni series of rigs.

Graham Stallard VK5ES is Albert Kahn's representative in Australia. Graham has full facilities for a back-up service, including any modifications which may come to hand for Ten Tec gear.

Allan Appleby VK2BF also has an Omni D and will be happy to demonstrate to VK2s at his Dural QTH. Allan has led the VK interest in morse keyboard communication, and his latest design puts his keyboard well ahead in this field of communication. Allan's keyboard embodies a number of features, including a recirculating memory system which can be very useful. The keyboard has a digital read-out indicating the number of characters in the buffer at any instant. The capacity of the buffer is 64 characters, but a warning LED lights up at 60 characters, giving time to slow down and avoid over-filling the memory.

To read morse at 50 w.p.m. plus, it is essential that the "weight" should be optimum. Too heavy and copy can become very difficult. It also becomes unpleasant if the weight is too light, so there is a dot length and dot-dash spacing which is just right for the speed being used and for clear cut copy of QRQ morse. So with the full QSK facility and one of Allan's keyboards, morse isn't as old-fashioned as many hams might think. With the Americans hitting speeds of 80 words per minute plus, we still have some way to go to match that sort of performance. But even if we don't, it's still a new ball game and a very interesting one because it becomes a new language when reading high speed morse in the head. Who was the American General who said "When the balloon goes up, the frequency spectrum will be so full of signals and counter signals that it could be the little guy with the morse key who will get the message through"—hi. ■

## ELECTRONICS — ITS PART IN MY DOWNFALL

John Tuppen VK6XJ

Be patient, dear reader, as my tale could be long in the telling. Settle down, turn off the gear, lock the kids out.

My father was an ex-military man of English extraction, just old enough to play a very small part in the first big bunfight, and just young enough to play a larger part in the second.

In the interim, he had come to Western Australia and tried his luck on the land, but due to sundry catastrophes, not least of which were the results of the Wall Street crash, I think everyone was relieved when the British requested his presence to assist with the troublesome little German painter.

Yes, we will get round to wireless in a moment.

Father had just a little spare time in the initial stages of this business and took himself a wife, which explains why, during some difference of opinion my father was having with a chap called Rommel, he received a communication telling him of my arrival, and that I bore an uncanny resemblance to him. It is said he spent quite some time searching for a mirror in order to see what misfortune had befallen him.

In 1949, father having concluded his business in Europe, we all emigrated to WA, where he was this time most determined to succeed in obtaining his own farm.

"It's not going to be easy," said father. He was not wrong.

Yes, yes — Wireless!

It was during the early 1950s. We were living on a rather isolated wheatbelt farm, at the time resident, together with the property's original owner (an elderly Irishman), in an old unlined Nissen hut, aptly called the Igloo in winter and something quite different during summer. I had very little in the way of toys, and the old Irishman, feeling sorry for me, cast about among his possessions and discovered a very old, completely defunct Batyphone receiver. "Here lad," he said. "Pull 'er ter bits an' see if yer can get 'er goin' agen."

What joy! Never had anyone given me anything like that before. Carefully I separated its various parts. What peculiar secrets could they hold? Even more carefully (I had nothing else to do) I separated the parts of its various parts. Resistors were broken in half to see what discoveries I could make therein. Paper condensers were disassembled and their yards of tinfoil and wax paper studied most intensely. What hidden mysteries could it all contain?

I couldn't wait to get to school next day, and having done so, went to the meagre collection of books, they had there (it couldn't be called a library) and, glory be, a textbook on wireless. It was dated 1930, did not look as if it had ever been read, and I'm blown if I can remember its title. There amongst the bright emitters, dull emitters and variometers (hands up all

those who knew what a variometer is), was all the information I required. Quickly I requested that I borrow it for a while. The teacher was puzzled why a 10-year-old should request such a thing, but conceded.

I read it from cover to cover. Numerous times. Most of it meant nothing to me but by then I was hooked. I contracted the disease then, from which I have never fully recovered.

I found from my perusals that, with the remnants of Batyphone, a telephone ear-piece from an old wall type phone which had fallen into my possession and a thing called a cat's whisker, I could build a crystal set. But where could I get a cat's whisker? I gathered up my meagre savings, which amounted to 2/6d. and during school lunch hour, went into the local radio serviceman whose name was Vic Trobe. (Are you still out there somewhere, Vic?) I demanded a cat's whisker. Vic smiled, went to his bench and returned with a point contact germanium diode. "It's the very latest thing, much better than a cat's whisker," he said. "It's 2/6d."

Home became a hive of activity. I erected a "long and well elevated" length of fencing wire, bashed in an earth stake, wound my first coil, and with sundry bits of Batyphone, suddenly found myself listening to 6MD, the local broadcasting station.

The old Irishman came in about that time and saw my contrivance. He smiled. Turning to Mum he said, "By God Missus,

yer'd think 'e knowed what 'e was doing with all them bits". He turned to me. "Well, yer got 'er goin' yet lad?"

"Yes, it's working now, Mr. Dwyer," I said. "Would you like to listen to the news?"

Determined to humour this small boy, the old man gravely placed the receiver to his ear, listened briefly, turned a ghastly shade of pale, then staggered to his room for the comfort of a bottle of old Irish he kept secreted there for such occasions.

Time passed and, flushed with my success with the crystal set, I progressed on to greater things. We had moved out of the Nissen hut into something slightly more resembling a house and I soon had a new wire antenna up.

Further reading of my book showed the way towards regenerative receivers, and I found I had in my possession (doubtless from the Batyphone) a type 30 triode, which became the heart of my first such receiver.

I soon found that there were other places in the spectrum than the broadcast band, and one memorable night I discovered some people talking on a band they called 80 metres. It was AM of course, and there was little activity, so I had no trouble hearing them.

To me, they were gods, discussing so blithely such exotic things as dipoles, 807s, high level plate modulation and a host of sundries too numerous to mention.

I swore then, there in the dark, illuminated only by the soft glow of the type 30 filament (we had no electric light), a solemn oath that one day I, too, would join their ranks and speak so knowledgeably about such things.

Time moved on. I constructed a miniature broadcast receiver in a ounce tobacco tin using a 1T4 valve (the A and B batteries I carried in my school satchel) and gained many points with the girls in my class—until someone's incredibly rich dad returned from Japan with the latest pocket sized transistor radio. I took an instant dislike to semi-conductors.

When I was 14, it was decided that I was having trouble holding down two jobs (school and farm work), and anyway it was a well known fact that too much learning was not good for you. There was concern that I was not doing myself any good, what with all this wireless business and all. (There had been some trouble about oscillations getting into father's wireless while he was listening to weather reports.) Thus it was decided I join the workforce as a farm labourer.

By the time I was 15, I had built a 6 valve superhet receiver, resplendent with BFO, using 2 volt filament tubes, and by scrounging around various rubbish heaps I could generally pick up enough discarded B batteries to hook up in series and enable me to listen to Wally Coxon VK6AG, putting on the Sunday morning WIA news.

If I was particularly lucky the batteries would hold out long enough to hear a bit on 80 during the week.

Around this time father, being a kindly man, decided that the age of the kerosene lamp was about done, and one memorable day arrived home with a 32 volt generating plant and lots of wire, fittings and batteries.

"You know about such things," he said. "You'd better wire up the house and get 'er going. Make sure you're finished tomorrow night so you can get on with farm work next day though."

Never has a house been so carefully wired. Every joint spliced and soldered. Every cable insulated from its mate in exemplary fashion. But we had power the next night, and I was already planning a vibrator HT supply . . .

One day father had roused me for "fiddling with that damn wireless", and gave me a list of instructions to be carried out whilst he made his weekly visit to town. He went into the bathroom to shave off a seven day growth with his newly acquired 32 volt electric razor and, seizing the opportunity, I went out to the engine room. Estimating the best possible moment, I pulled the fuses out of the board. I am told it took father quite some time to remove the jammed cutters from his face, but can't verify this fact as I was by then heading for elsewhere at a fair rate of knots.

I have never known my father to use an electric razor from that day to this.

I could go on with anecdotes regarding the older farmers and their electrical misadventures for some time, but, dear reader, the story is long enough now. I will content myself with observing that I am sure Dad and Dave lived round here somewhere—they just took on different names and faces at times.

During the next few years the disease really took hold, and my exploits in electronics continued. I discovered that there were two amateurs living in our local town (Merredin) at the time, and one day nervously knocked on the door of the local broadcasting station, which was opened by a large man I came to know as Mai Urquhart (VK6MU). Mai taught me many things about radio transmission and though he has long joined the silent keys, I remember his teachings well. I also met Bob Elkin (VK6RE), the other amateur in town, and he also was most helpful, particularly on the operating side of amateur radio. Bob is now in Sydney, his call is VK2ASH.

I obtained a commercially built receiver. Having acquired the sum of £15, I went to see Jack Burrows (VK6BU), who was running a small business in Perth at the time, and boldly telling him of my vast hoard, requested his advice on the purchase of a receiver. To Jack's credit, he neither laughed nor kicked me out—he went out the back and returned with a

thing I later learned was a 3BZ. It remained with me for a long time and taught me a lot—particularly about replacing paper capacitors . . .

By 1962 I had a Marconi CR100 receiver, had constructed a modulator using a pair of 807s, and was fronting up at the local post office for the full AOCPE examination.

Grimly I awaited the arrival of the buff envelope with the results. I knew it would be touch and go.

It arrived. Total devastation! I had failed by two miserable marks. Just 68 per cent in the theory. I was shattered. Next time, I swore, next time there will be no mistake. If I had known then that it was going to be 15 years before I again had the opportunity to sit at the examination table, the devastation would have been complete.

I was at this time equally determined to get established on my own farming property and this, together with other Interests (well, I was a young healthy country boy), gradually drew me away from radio.

It was not until August 1977 that, in one of those quirks of fate that make truth stranger than fiction, I suddenly found myself in the shack of Mick Cole VK6TV.

I had achieved most of the aims I had set for myself years ago, I was master of my own land and doing well, was married with a family, and probably unconsciously casting around for a new challenge.

Mick showed me his gear. It didn't look much like the gear I remembered, but as he turned on the TS-820 I saw the digital display showing 14.250 and heard a K6 coming through at good strength. "Well, twenty metres is open to the west coast of W land," I said. Mick picked himself up off the floor and rightfully demanded, "If I was so damn smart, why wasn't I doing something about it?"

It was a good question. Mick told me about a new class of licence called the Novice, and said there was an examination due in a few weeks time. With the help of Mick I got my brain working along such lines again and in early November found myself in front of my own brand new TS-520S, with a brand new Novice call sign. It was so strange—very few of the calls I remembered were still around, the gear was so different and although many people spoke about 807s, very few (particularly the Novices) even knew what they looked like!

However, it was great and I enjoyed the few months of Novice operation while waiting for the next full call examination in February 1978, and this time (I was right!) there was no mistake, and the vow I made as a small boy so many years ago was at last completed.

When I first came up on air, a few operators asked me how I came to be interested in amateur radio. Was it via CB? Good grief!

Others asked which technical school I had attended in order to acquire such knowledge as required to pass the AOCPE examination. I wish I could think of a name for it! But I wouldn't swap the experience for quids (well, perhaps not), and it's all been worth the effort.

There is still some concern in my mind

though.

My youngest daughter, Ann, although she is only 14 months old, is even now taking an uncommonly unhealthy interest in all things electronic. Whenever any home brewing is being done she requests — nay, insists — most vocally to be sat in her high chair next to the work bench.

Each resistor as it is inserted in the PCB is most carefully studied. Each capacitor scrutinized thoroughly.

Yer'd almost think she knowed wot she was doing with all them bits.

Remind me to go back to the old safety razor in a few years time. ■

# SOME IMPROVEMENTS TO THE EDDYSTONE 888A RECEIVER

A. G. Loveday VK4ZBI  
Avlemore, Rubyvale 4702

Here is an article for the owners of old receivers.

These fine receivers of the 1950s were much sought after until the transistorised transceivers became common. The writer recently purchased one and although it was found to be excellent for AM signals it left much to be desired on SSB.

The results of considerable investigations are described here. Firstly it was decided to stick with valves. All the old 0.1 uF capacitors were replaced. A product detector, Fig. 1, was added. This is a circuit devised by W6SAI and shown in the Radio Handbook, but now has an audio amplifier stage added. An audio derived AGC circuit, Fig. 2, was included. I also disposed of the 6AL5 noise limiter/S meter blocking diode.

Next the audio filter was replaced by one with switched bandwidths from 60 to 3,500 Hz. A uA741 IC was used; this circuit is on page 113 of the 5th Edition of the RSGB Amateur Radio Techniques. The power supply was relocated on a separate chassis to reduce drift.

I now have a fine receiver which is more sensitive than before, especially on 15 and 10m. ■

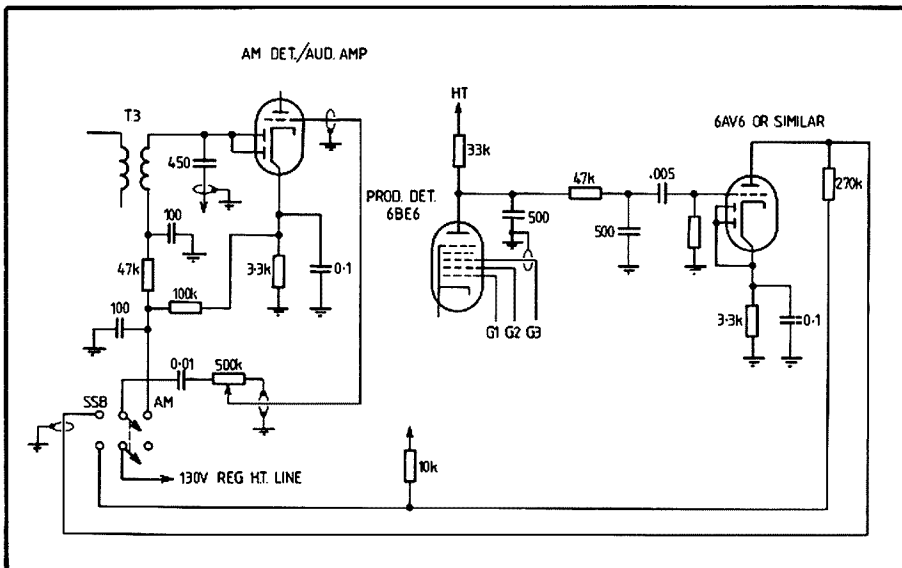

FIGURE 1: The new Detector Circuit.

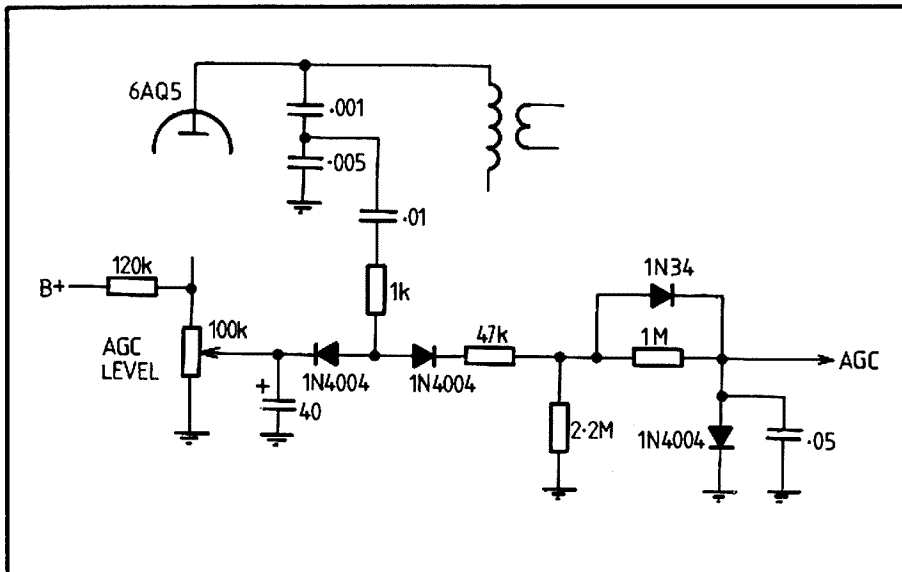

FIGURE 2: The new AGC Circuit.

**Photographs  
Required  
NOW for AR**

Join a New Member

# AMATEUR RADIO SATELLITES: AN OPPORTUNITY FOR EDUCATION

Stephen C. Place WB1EYI,  
ARRL OSCAR Education Programme Manager  
AMSAT Phase III Education Special Service Channel Co-ordinator  
Submitted by Bob Arnold VK3ZBB

**With AMSAT-OSCARs 7 and 8 and the Soviet's recent RS-1 and RS-2 Amateur Radio Communications Satellites, and with the upcoming AMSAT-Phase III-A long range, high elliptical orbit communications satellite, AMSAT-United Kingdom's University of Surrey scientific and educational UOSAT, and several other Amateur Radio space-bound projects still in their infancy, the future of the Amateur Radio satellite programme looks very bright indeed. Opportunities for a variety of applications in educational programmes throughout the world are greater than ever before as newer and more exciting programmes arise with every new launch. The following is a paper explaining the OSCAR Education Programme and how it can become an invaluable resource to the educational system and students.**

The Amateur Radio Service has been well respected through the years for its service in the international community. Always probing, exploring, pushing the cutting edge of technology; always ready to assist in times of natural disaster and emergency when other lines of communication are out; always willing to educate the uninitiated in electronics technology and communications techniques. The opportunity for education which may be considered among the more valuable contributions of Amateur Radio, is often overshadowed by news of floods, fires, and earthquakes which stir the emotions, and developments in slow scan television and narrow band voice modulation that excite the imagination. Nonetheless, today's young men and women aspire to careers in space communications technology, or those who wish only to prepare themselves better to prosper in the technological age now upon us, can do no better than to become involved in our Amateur Radio hobby.

One of the areas holding great promise for our students is the OSCAR Education Programme. Our OSCAR satellites offer the student a chance to actively participate in his studies of space science and communications: a chance he most likely would not otherwise have. This programme in its many variations has served countless thousands in recent years, from very young students to college and university classes, from well equipped science centres to poorly equipped inner city school systems and from classes in North America and Europe to the Far East and Africa. Today we are on the threshold of an even more exciting future. We strongly urge you to investigate the possibilities: for your hobby, your country's students and your enjoyment.

## AMATEUR RADIO SATELLITES

Why have amateurs become involved in the satellite field? Ever seeking more re-

liable and effective ways to communicate with one another, amateurs have utilized state-of-the-art technology in expanding the usefulness of their frequency allocations. High frequencies (HF), though their reliability has been enhanced over the years through technological development, are still subject to the vagaries of propagation. The large segments of very high and ultra high frequencies (VHF and UHF) to which amateurs have access do enable predictable, reliable communication, but only within slightly greater than line-of-sight ranges under normal conditions. Orbiting high above the earth, however, a satellite is simultaneously within the line of sight of many earth stations dispersed over a comparatively wide range. Equipped with a transponder (receive-retransmit unit), such a satellite would greatly extend the reliable communications range at VHF and UHF.

Our Amateur Radio satellites have done just that. Routine daily VHF communications up to 7500 km have become commonplace during the past five years. But amateurs have not been the sole beneficiaries of this effort. OSCAR users have demonstrated the practicality and effectiveness of using satellites for such innovative applications as locating downed aircraft quickly and accurately, remote store and forward data transmission, the transmission of electrocardiogram information in transit from the scene of an accident, and, of direct concern here, in teaching physics, space science and related subjects to students at all levels.

The OSCAR (Orbiting Satellite Carrying Amateur Radio) satellites we use today have evolved over the past twenty years. The OSCAR series was born in 1961 with the launch of OSCAR 1, only four years after Sputnik 1, the first man-made orbiting satellite of any kind, achieved orbit. The small battery-powered box built by the Project OSCAR group of radio amateur

hobbyists in California represented the amateurs' first venture into the space age. Four satellites and several years later, the Radio Amateur Satellite Corporation, AMSAT, was formed in the Washington, DC, area to continue the work. Volunteers, many with absolutely no prior experience in the field, designed, built and secured launch opportunities for a very successful series of communications satellites. Though these have gained wide notoriety for having been built in garage and basement workshops by unpaid volunteers at absolutely minimum expense, the record has been nothing less than outstanding. Often exceeding their life expectancies by years, the spacecraft in the AMSAT-OSCAR series have been recognized for their reliability and quality. This and imaginative applications in scientific, educational and public service areas have led NASA to continue its generosity in providing "secondary payload" launch opportunities. AMSAT's record was recently exemplified in the launch of OSCAR 8: AMSAT's proposal was selected first by NASA from 80 world-wide applicants. And with the upcoming Phase III OSCAR, AMSAT's acceptance has spread: Phase III-A will be launched as a secondary payload by the European Space Agency.

As the satellite programme has grown in sophistication from the early short-lived orbiting beacons to the present long-lived, multiple transponder communications vehicles, it has also grown in international involvement. AMSAT now has nine active affiliate national organizations, over thirty countries with official organizational representation, and satellite users in over 100 countries. Many countries, including Australia, Canada, the Federal Republic of Germany, Japan, the United Kingdom and the United States, have contributed to the design and construction of the AMSAT-OSCAR series and continue their involvement in several upcoming projects. An open invitation exists

to any country to become involved in the satellite programme, if not through technical contribution, then through operations participation. Countries that are now developing a base of technical expertise might consider using the satellites in gaining direct space technology experience for their students. Students in both Kenya and Sierra Leone are preparing to use the AMSAT Phase III-A satellite in their studies and we enthusiastically welcome others with a similar interest.

### THE OSCAR EDUCATION PROGRAMME

Recognizing the potential of the OSCAR satellites in educational settings, the American Radio Relay League in conjunction with the Radio Amateur Satellite Corporation sponsors the OSCAR Education Programme. With OSCAR as the focus, students from a wide range of curriculum areas spanning many grade levels are introduced to modern space technology. What are the benefits of OSCAR Education? Active involvement, hand-on experience and personal participation, are all parts of this dynamic approach to learning. As their studies come to life, students will become more motivated and gain a familiarity, a comfortable rapport with space science that would not be theirs from traditional, passive study alone. The programme (a curriculum guide, suggestions and ideas for experimentation) is extremely versatile and may be adapted in any number of ways: from a closely structured and supervised course of study to a loosely structured approach that draws heavily on students' initiative. There is no charge for the programme and the only requirement is having access to a very modest ground receiving station to monitor the satellites' activity.

What will a class likely do with the OSCAR satellites? How will it begin? To use the satellites for any programme of study or experimentation, the students will have to understand its orbit, locate its position at any time and predict when it will be accessible to the class. Thus, the typical first step will be an introduction to *basic* orbital mechanics. For younger students, understanding a simple graphic tracking device using previously calculated orbit schedules may suffice. Such concepts as altitude, range, period and incremental progression will become familiar. A more demanding approach will have the students derive all of the orbital parameters through careful observation over time. Using the change in received frequency, resulting from the Doppler Effect, students will plot beacon frequency versus time, determine the times of closest approach over several consecutive orbits and derive other orbital parameters, Kepler's Laws, or even the mass of the earth. The key here, though, is involvement. The students will learn by interacting with their environment; their experience will teach them basic space science as they see the laws of nature at work. Refining their calculated parameters with

further observation over time, the students will be able to predict with fair accuracy when the satellite will again be in range. What better test of success than actually to hear the satellite rise above the horizon at the appointed time? Such direct personal experience and immediate feedback are very strong teaching techniques.

Using OSCAR as a remote laboratory tool will similarly help in teaching radio electronics. Few if any elementary or secondary schools have orbital hardware at their disposal, nor do they have access to sophisticated electronic technology. OSCAR ground receiving stations need not be very complex; construction of a ten metre receiver and two metre receive converter are projects well within the grasp of many secondary school classes. Regardless of the receiver used, however, constructing antennas of various types and subsequently comparing their effectiveness, are inexpensive tasks that can easily involve entire classes. With these simple devices the students will gain the access to sophisticated technology they would not otherwise have had.

The opportunity for students to participate in meaningful scientific experimentation is constrained only by the imagination. Routine "experiments" such as determining whether the satellites are in sunlight or darkness, electronically measuring the slant range to the satellite and observing how it changes throughout the orbit, calculating the seasonal effects on the satellite's temperature and voltage, calculating satellite spin rates or even observing the patterns of performance degradation over the lifetime of the satellite will give students an inside view of space science and satellite communication. And students may make a real contribution through propagation studies; it was through an amateur radio satellite that anomalous or inverted Doppler was noticed. Furthermore, utilizing the Morse encoded telemetry that is transmitted on OSCAR's beam, students will gain a personal insight into the concept of integrated systems and interdependent units. Students test their world for the answers, again learning through experience.

### FUTURE OPPORTUNITIES

We feel that the OSCAR Education Programme has much to offer progressive school systems today, and the thousands of students who have learned with OSCAR agree. But we have barely scratched the surface. Some inner city schools such as those in Camden, New Jersey, are using OSCAR to acquaint their students with space science in preparation for an experiment that will ride aboard one of the first NASA Space Shuttle missions. A special programme in Newark, New Jersey, uses OSCAR as a motivation technique for their under-achieving students, while Talcott Mountain Science Center in Connecticut has used the programme as a supplementary experience in their academically talented students. Programmes

similar to these are possible in your school system as well, and with the launch of Phase III early in 1980, the possibilities expand tremendously.

Phase III will be launched into a high elliptical orbit that will simultaneously cover most of the Northern Hemisphere at its apogee and extend access times up to ten continuous hours. Though the communications range and times of availability will be less in the Southern Hemisphere at first, after several years the apogee will precess to a point over the equator and the Southern Hemisphere will benefit from the long-duration, long-range use. With AMSAT-Phase III-A the OSCAR satellites will become as much tools for study as objects of study. Present plans are to incorporate a Special Service Channel scheduled for educational use only, while the telemetry beacons and the rest of the passband will still be available to the student with other specific needs. Also planned for launch in the next year or so is the University of Surrey's UOSAT, a satellite intended solely for educational use. It will carry beacons in several of the amateur frequency allocations to facilitate propagation studies, and will contain devices (cloud cover camera, magnetometer, etc.) to facilitate new experimentation. From low altitude, nearly circular orbit and high altitude elliptical orbit satellites to geostationary orbit amateur radio satellites, the possibilities are many and the future very bright indeed.

How may you get involved? AMSAT, all of its international affiliate organizations and the ARRL welcome your active involvement in the OSCAR Education Programme and pledge our assistance in whatever ways may be possible. We strongly suggest that you locate an interested person or group within your society to serve as Education Programme Co-ordinator for your country. He would serve as liaison to AMSAT's and ARRL's Education Programme Co-ordinator and would be responsible for co-ordinating local efforts. He would be the contact for us as well, and would receive information on upcoming programmes, and, in turn, be the source of information to Radio Amateurs and educators in your country. Meanwhile, please let us know your needs and desires so that we may better plan for the educational use of AMSAT-Phase III-A. We urgently request your ideas and suggestions as well as those of interested educators. OSCAR satellites are truly an international co-operative effort, and we want the educational benefits likewise to be world-wide.

Please share news of the OSCAR Education Programme with educators in your country and please convey our eagerness to serve them. The OSCAR satellites and education programme are here for *your* benefit; Amateur Radio Satellites are truly an exciting opportunity for education. ■

# HAM HEADQUARTERS FOR S.A.!

**IC22S**



22 Channels Synthesised  
Australia's most popular FM Rig

**STILL ONLY \$299**

**IC280**

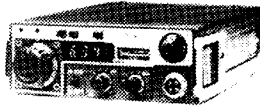

**2M REMOTABLE!**  
Ideal for small cars

**\$450**

**IC551D**



**6M 100 WATTS!**

**\$850**

10W Model **\$799**

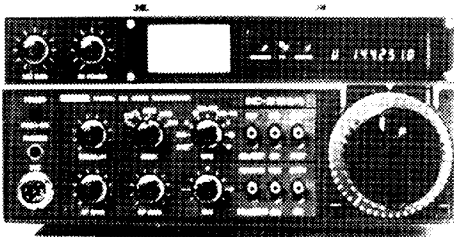

**NEW IC251A**

All-mode 2m FM with exciting new features!

**Price \$847**

## OTHER ICOM GEAR

IC701	HF transceiver	<b>\$1199</b>
IC502A	6m portable	<b>\$289</b>
IC215	2m FM portable	<b>\$229</b>
IC402	70cm FM portable	<b>\$439</b>
IC255A	2m FM mobile	<b>\$425</b>
IC202S	2m portable	<b>\$318</b>

# ICOM



## DAIWA

**CL67A**

**ANTENNA COUPLER**

\*500W PEP  
\*1.8-30 MHz

**PRICE \$135**



## QUALITY DAIWA ACCESSORIES

Automatic antenna tuner	<b>\$269</b>
Medium duty Rotator	<b>\$189</b>
Heavy duty Rotator	<b>\$259</b>
Direct reading SWR Bridge	<b>\$99</b>
RF Speech Processor	<b>\$109</b>
Coax Switch (2 position)	<b>\$23</b>
Coax Switch (4 position)	<b>\$59</b>
Low Pass Filter	<b>\$20</b>

**PORTABLE VIDEO CAMERA**

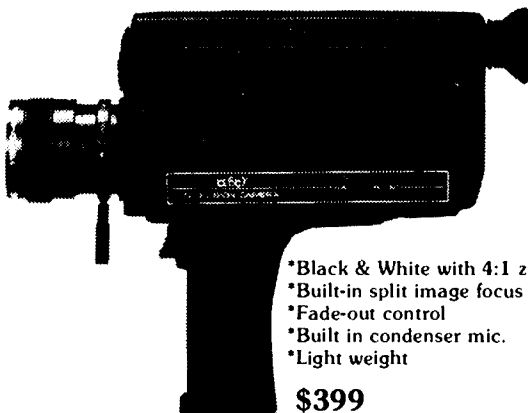

\*Black & White with 4:1 zoom  
\*Built-in split image focus  
\*Fade-out control  
\*Built in condenser mic.  
\*Light weight

**\$399**

**PLUGS & SOCKETS**

**COAX**

**AIRCRAFT RECEIVERS**

**SCANNING RECEIVERS**

**LEADER TEST INSTRUMENTS**

**TONO COMMUNICATIONS COMPUTER**

**JOSTY KITS**

**PERSONALISED SERVICE**

**graham e. stallard**

27 WHITE AVE LOCKLEYS 5032  
SOUTH AUSTRALIA PHONE 43 7981

**AUTHORISED  
DEALER**

**VICOM**

## NOW COMBINE AMATEUR RADIO AND COMPUTERS WITH A SOUTH WEST TECHNICAL PRODUCTS COMPUTER FROM GFS

We have a system to suit you, from hobby level all the way up to a business level system with 2.4 Mega-Byte of on-line disk memory. Also available is a comprehensive range of software packages including many that are orientated to amateur radio. Write or call us for full details of SWTPC's products.

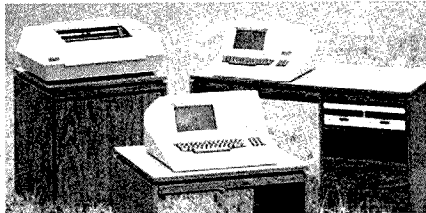

## GFS FOR RECEIVERS

STANDARD C-6500.....\$359.

HF Wadley Loop Communications Receiver.

Manufactured by Marantz Japan the C-6500 is a state-of-the-art HF receiver covering 0.5-30 MHz in 30 x 1 MHz band segments. Its sensitivity is extremely high at 0.5uV and selectivity is 4 KHz on SSB and 7 KHz on AM.

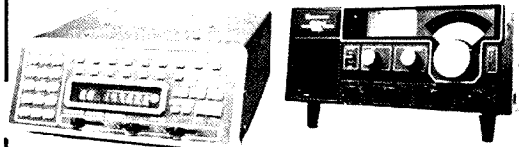

J.I.L. SX-100 16 CHANNELS VHF/UHF SCANNING RECEIVER.....Price \$407.

Still the best value in Programmable Scanners, the SX-100 covers the 6.2 and 70 cms Amateur Bands plus over 32,000 other Frequencies including Channel 0 and Channel 5A TV Sound.

Amateurs can use the SX-100 to monitor band conditions using beacons etc. Firemen can keep informed by listening to firebrigade frequencies. CBers can monitor UHF CB Channels. Fishermen can monitor VHF marine and Emergency frequencies. Servicemen can use the SX-100 to check virtually any commercial two-way frequency with its 32,000 channel coverage.

- Covers 30-54, 140-180, 410-514 MHz.
- 5KHz Channel Spacing.
- Built-in Digital Clock & Date.
- 240V AC and 12V DC operated.
- Frequencies are programmed using built-in keyboard.

SEE REVIEW ETI NOV. '79

SKY ACE R-517... \$104.



The monitoring of aircraft communications has long been a requirement for emergency service organizations, flying schools and clubs, aircraft operators, aviators themselves as well as a band of communications enthusiasts. GFS has a range of airband receivers that should suit all these requirements.

Designed for the enthusiast, the R-517 is a Palm Sized Receiver which features Full 118-144 MHz Tuning plus the 3 Crystal Locked Channels.

- Active inbuilt AGC System.
- Excellent Selectivity.
- High Sensitivity.
- Built-in Telescopic Antenna.
- VFO main tuning with FINE control and 3 crystal channels.

NEW!! COMNI R-1010 AIRBAND RECEIVER. The R-1010 is a Professional Receiver that uses frequency synthesis thus giving the following outstanding performance.....\$529.

- Frequency range 108-136.975 MHz.
- Channel Spacing 25 KHz.
- Digital Frequency Readout.
- 12 VDC or 240 VAC operated.
- Co-Axial Channel Selector.
- Squelch and IF Noise Blanker. Weight 3 Kg. Size 16 cms x 5.6 cms x 25 cms.



### SCANNER BASE ANTENNAS

- Scan-X 65-520 MHz, 3dB Gain ..... \$35.00
- GD-X-1 85-480 MHz, Heavy duty ..... \$69.00

Write for a comprehensive price list and Catalogue of the complete GFS Product Range. Trade Enquiries Welcome.



ATLAS RADIO INC.

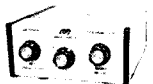

## TRANSCEIVER OF THE DECADE

NEW  
215XLE  
LIMITED  
EDITION

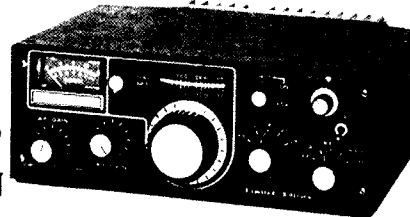

- 80-100 METRE.
- 250 WATTS.
- SEMIBREAK-IN CW.
- BUILT-IN SIDETONE.

Includes all the outstanding features of 215X plus new 250 Watts Input, new R.I.T. control and update frontpanel design.

- 215XLE Transceiver \$795.00
- 220CS Console/P.S. \$170.00
- 210X Transceiver \$795.00
- 200PS Power Supply \$139.00
- DD8-C Digital Readout/Counter \$245.00
- VX-5M Vox \$78.00
- MT-1 Matching Transformer \$44.00
- DMK Plug Mobile Mount \$62.00
- 10xB Crystal control Adapter \$78.00
- DCC Power Cable Kit \$14.00
- MBK Mobile Bracket Kit \$14.00
- DL-300 300W Dummy Load \$32.00

## NEW PRODUCTS FROM MFJ

Now a very wide range of Antenna Tuners

- MFJ-984 3KW Ant. coupler/Dual Meter type SWR/Power Meter/Co-Ax switch for Bal and Un Bal Line (Inc. Balun) \$419.00
- MFJ-982 3KW Ant. coupler/SWR/Power Meter for Bal and Un Bal Line (Inc. Balun) \$279.00
- MFJ-982 1.5KW Ant. coupler/SWR/Power Meter 6 Pos. Co-Ax SW for Bal and Un Bal Line (Inc. Balun) \$233.00
- MFJ-951 1.5KW Ant. coupler/6 Pos Co-Ax SW for Bal and Un Bal Line (Inc. Balun) \$199.00
- MFJ-949 300W Ant. coupler/SWR/Power Meter/200W Dummy Load/Co-Ax SW for Bal and Un Bal Line (Inc. Balun) \$186.00
- MFJ-941B 300W Ant. coupler/SWR/Power Meter Co-Ax SW for Bal and Un Bal Line (Inc. Balun) \$145.00
- MFJ-943 300W Ant. coupler for Bal and Un Bal Line (Inc. Balun) \$115.00
- MFJ-901 200W Ant. coupler for Bal and Un Bal Line (Inc. Balun) \$97.00
- MFJ-900 200W Ant. coupler for Unbal Line (No Balun) \$83.00

### Tunable Active SSB/CW Filters

- MFJ-752 Dual TUNABLE ACTIVE SSB/SW FILTER inc. Peak/Notch, Noise Limters, and two Variable Frequency Filters. \$145.00
- MFJ-751 Tunable Active SSB/CW Filter. \$115.00

### Electronic Keys

- MFJ-481 THE GRANDMASTER MEMORY KEYP, stores 2 x 50 character messages 8-50 WPM \$145.00
- MFJ-402 Econo Keyer, built-in Paddle, Weight and Speed control, 8-50 WPM, solid state keying \$83.00

### Other Accessories

- LSP-520BX II Super Logarithmic speech processor 30dB dynamic range and 3 Active Filters \$97.00
- MFJ-202 Antenna Noise Bridge, wide range 0-250 Ohms, 150 pF Xcc, 1-100MHz \$83.00
- MFJ-1030 BX 10-30MHz Preamp, 25dB gain. \$83.00

## INSTALL YOUR OWN TOWER

AND SAVE \$\$\$s  
GFS now have a range of easy to install Self Supporting Towers

- G201/ 6 m Single Section Tapered ..... \$79
- G202/ 6 m Double Section Tapered ..... \$89
- G203/ 3 m Heavy Duty Base for G201/2 ..... \$135
- G204/ 6 m Heavy Duty Base for G201/2 ..... \$175
- G120/ 6 m x 5 cm Tubular Mast for G201/2 ..... \$25

\*\*\*\*\*  
GREAT CIRCLE  
MAP

THIS POPULAR MELBOURNE CENTRED MAP IS STILL AVAILABLE FROM GFS

PRICE \$1.00 + 75c P&P

## TET SWISS QUADS

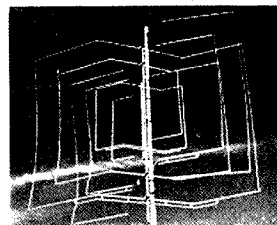

This antenna is a PHASED QUAD and well known as a HB9C QUAD. Its concept is to drive the Radiator and Reflector at the same time with phase differences to obtain more gain and better front-to-back ratio than the conventional quads.

- SO-22 2m x 2 Stacked 16dB Gain \$99
- SO-24 2m x 4 x Stacked 18dB Gain \$219
- SO-61 6m x Standard 12dB Gain \$119
- SO-10 10m x Standard 12dB Gain \$159
- SO-15 15m x Standard 12dB Gain \$169
- SO-20M 20m x Loaded 10dB Gain POA

## ATN ANTENNAS

Write to us for a catalogue and price list on ATN's large range of VHF/UHF & HF antennas.

## DSI COUNTERS

GFS are Melbourne agents for the comprehensive range of DSI FREQUENCY COUNTERS. Drop us a line or just give us a call for your DSI counter.

## SPECIAL!! METAL DETECTORS

Limited Stocks Only, available at the special low price of \$38 + \$3 P&P

## ANNOUNCEMENT

TEN METRE OPERATORS. NOW ENJOY FM OPERATION WITH THE COMTRONIX FM-80.

Enjoy the thrill of FM operation that has been so popular amongst 2 Metre operators for years, but with the advantage of being able to work OVERSEAS DX (10 metre FM is very popular in the US with over 70 repeaters already operating). With the FM-80 you have the choice of 80, 10KHz spaced channels, 28.91-29.7 range can easily be changed to 28.01-28.80 MHz), power output is 10-15 Watts, deviation is ±3KHz, receiver sensitivity is 0.5uV for 20dB quieting.

Don't miss out on experiencing this exciting new form of communication. Call or write to us for your FM-80 now. SPECIAL INTRODUCTORY PRICE \$289.

NEW 1980 CALLBOOKS EXPECTED SOON  
US Callbook, over 395,000 listings ..... \$19.95  
Foreign Callbook, 300,000 listings ..... \$18.95



# USER REVIEW: THE SX100 SCANNING RECEIVER

Mark Stephenson VK3NOY

## INTRODUCTION

Many old-timers may remember the SX 100 as a general coverage HF receiver made by Hallicrafters many years ago, but this unit manufactured by the Japanese JIL company is also a receiver but any similarities then end.

The SX 100 is a solid state scanning receiver designed to receive FM transmissions in 5 kHz steps within the ranges 30-53.995 MHz, 140-179.995 MHz and 410-513.995 MHz. The unit requires no crystals as frequency selection is controlled by a single LSI chip and basically the design of the receiver is modelled on the standard concept double conversion super-heterodyne using 10.695 MHz as the first IF and 455 kHz as the second IF. This is followed by the second IF amplifier, FM detector and audio amplifier.

## OPERATION

No time at all was taken to master the operation of the unit. The front panel design is straightforward and pleasing in appearance, although operationally, as with most "calculator type" keyboards, the wrong button pressed led to some undesirable results. With careful placement of fingers when pushing the rather small keys errors can be avoided. The entry board keys for frequency selection are located to the left of the unit adjacent to the seven figure green fluorescent indicator board. The keys are arranged in 5 rows of three keys, the first ten being numerals from one through to zero and the other five being "specialist" keys enabling entry, scanning and memory of desired frequencies.

The specialist function keys are marked ST, FR, SW, MW and SP. Above the digital display are 16 keys marked M1 through to M16. Each key is a memory function and at any one time any or all of the 16 frequencies desired may be stored in the unit's memory. To enter a wanted frequency in any memory position the desired frequency is dialled up using the numerical keyboard and using the ST key for decimal places indicating the division of MHz and kHz. Having then pressed the MW key (memory write) the frequency is now ready to be stored in the position wanted, i.e. M1-M16. This process can be completed any number of times until the memory bank is full. At any time frequencies may be changed in any position in the memory.

To the right of the digital display are three keys marked "SEEK", SCAN A and SCAN B. These when used in conjunction with the specialist keys described before provide a variety of scanning and seeking capabilities. With all 16 memory positions filled by pressing Scan A all will be scanned at the rate of 4 channels per

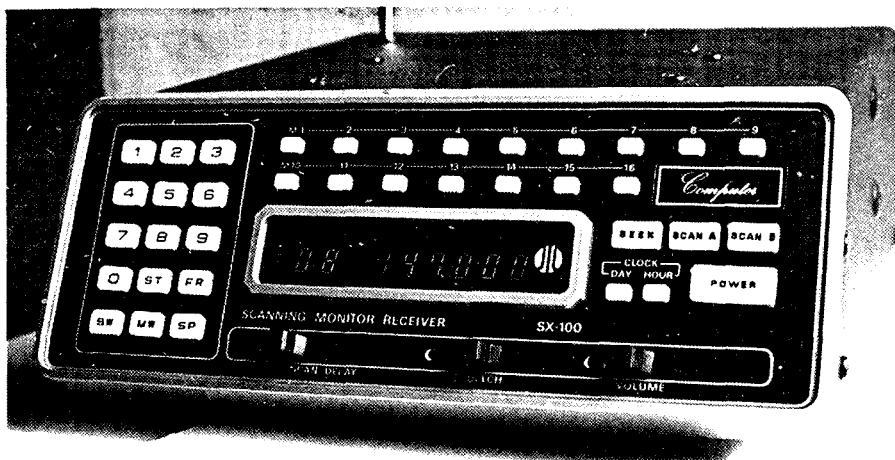

The SX 100 Scanning Monitor Receiver.

second until a signal activates a locking circuit. Similarly, the scanning can be stopped on any frequency by depressing the ST key. By depressing the SP key the scanning speed will double to 8 channels per second. If at any stage it is desired to only scan say, for example, three of the sixteen already programmed into the unit then by pressing SW followed by those required and then Scan B, only those channels required will be monitored, the rest will be "SKIPPED".

The SEEK function enables the unit to start at a frequency and search for a signal. When a signal appears the unit will pause and then continue scanning. The search rate can be improved from 5 channels per second (5 kHz split) to 10 channels per second by utilising the SP key.

Although the main interest in the unit is the receiver, it also incorporates a clock showing the day and month. This can be set by depressing the four keys representing the date wanted, i.e. November 24 would enter as 11 24. The display will then show 11 24 which is the normal way of showing the date in the USA but not here. Amateurs may find the clocks a little disappointing, aside from the reverse date process in that the clock will only read in 12 hour periods, not good for the hardened GMT man.

## ROAD TEST

The unit is adaptable to both AC and DC and is supplied with leads for a pure DC source at 12-16 volts and a step down unit enabling use from a normal 240 volt source.

Because of its versatility the unit was first tested in a vehicle mounted beside the driver using only the telescopic 4 to 22 inch whip which screws into a connecting hole at the top of the unit. The external antenna uses a Belling Lee plug

and as no antenna with a suitable plug was available, the supplied telescopic whip which measures from 4 to 22 inches long (depending on the frequency of operation) was used.

Results were excellent. With the unit sitting on the floor beside the driver the Mount Macedon repeater VK3RMM, the Geelong repeater VK3RGL and stations on simplex channel 6500 (146.500) at ranges varying from 10 to 15 miles away were audible and relatively noise free. Ignition interference was negligible. On UHF commercial services were extremely strong and no difficulty was experienced in hearing base stations talking to mobile units and vice versa. The scanning facilities made listening on various amateur frequencies simultaneously enjoyable and undesired frequencies could be easily locked out and the remaining scanned effectively. The instruction manual supplied with the unit quotes sensitivity as 0.5 uV without giving details on signal/noise ratio or quieting, nonetheless the receiver's performance with a meagre antenna and location was very impressive.

As a base station with a good quality antenna the receiver performed, as expected, very well indeed. Mobile units on simplex could be heard over large distances and repeaters mentioned above were fully quieting strength nine plus many dB.

As this is the first unit we have received it would be interesting to compare the SX 100 with similar units on the market. For the avid VHF/UHF listener and for those wishing to listen to amateur operators on VHF or UHF the SX 100 would be a worthy unit to consider.

The SX 100 is distributed by GFS Electronics of 15 McKeon Road, Mitcham. ■

# SUNSPOT CYCLE 21 - TO DATE

Len Poynter VK3ZGP/NAC

Cycle 21 started in March 1976 when the previous cycle went out with a minimum of 12.2. Predictions for the peak of the new cycle ranged from a mere 50 to a

massive 230. The more conservative predictions was for a peak of around 150 late 1979 or early 1980.

Here are the figures to date.

## SUNSPOT MONTHLY MEANS

	Jan	Feb	Mar	Apr	May	Jun	Jul	Aug	Sep	Oct	Nov	Dec
1976	8.1	4.3	21.9	18.8	12.4	12.2	1.9	16.4	13.5	20.6	5.2	15.3
1977	16.4	23.1	8.7	12.9	18.6	38.5	21.4	30.1	44	43.8	29.1	43.2
1978	51.9	93.6	76.5	99.7	82.7	95.1	70.4	58.1	138.2	125.1	97.9	122.7
1979*	165.8	138	137	102.8	134.6	150.5	159.6	143.5	188.7			

\*Provisional means.

## SMOOTHED SUNSPOT NUMBERS

	Jan	Feb	Mar	Apr	May	Jun	Jul	Aug	Sep	Oct	Nov	Dec
1976	15.2	13.2	12.2	12.6	12.6	12.2	12.9	14	14.2	13.4	13.4	14.8
1977	16.8	18.2	20	22.2	24.2	26.4	29	33.4	39.2	45.6	51.8	56.9
1978	61.3	64.5	69.6	76.9	83.2	89.4	97.4	104	108.4	111	113.4	117.8
1979	123.8	131	136.7									

The running smoothed mean is always six months behind.

At this stage the peak of cycle 20 of 110.6 in November 1969 has been exceeded. Also the highest monthly mean

of cycle 20 of 135.8 in March 1969 has also been exceeded.

The other solar activity indice—the 2800 MHz solar flux looks like this:

	Jan	Feb	Mar	Apr	May	Jun	Jul	Aug	Sep	Oct	Nov	Dec
1976	74	71	77	76	71	71	68	75	73	76	73	77
1977	77	82	77	78	80	92	81	84	100	97	94	102
1978	110	146	142	149	147	142	131	114	138	158	152	175
1979	203	204	186	175	166	185	169	165	202	219	(212)	(214)
1980	(215)	(214)	(211)	(208)								

In brackets (215) predictions.

Of interest to many are the OHL/SARGENT predictions for the running smoothed sunspot number. It uses the relations of geomagnetic activity in the de-

clining year of a cycle to project the run of the oncoming cycle. They were made back in 1977.

	Jan	Feb	Mar	Apr	May	Jun	Jul	Aug	Sep	Oct	Nov	Dec
1978	58.6	64.4	69.6	75.0	80.0	85.1	89.5	93.6	97.6	99.7	103.3	107.1
1979	110.8	114.6	116.8	120.3	124.5	127.8	131.1	136.1	138.2	140.8	145.0	148.1
1980	151.5	153.4	151.4	152.0	153.6	152.2	150.9	149.8	146.2	145.4	143.7	141.2

Generally they equate well with the Zurich numbers but on the low side at this time. It will be interesting to see how they compare fully with observed data. Even at this stage it looks like quite a lot will be made of these predictions in future sunspot cycle predictions.

It still looks good for a few years yet. The VHF scene for 1980-81 looks good, perhaps even through until 1982. The 6 metre fraternity will be happy.

Time you settled down to charting geomagnetic activity before the next equinox in March 1980. The recurring phenomenon due to solar rotation, approximately 26-27 days, is well worth watching. Start charting daily Solar Flux and A indices to be one of the best informed operators. Saves a lot of time listening to nothing in an otherwise dead period.

A new service available from our Ionospheric Prediction Service is worth a phone call to (02) 269 8614 on half price STD at night.

The recorded message is updated daily around 2330 UT, or more often if events dictate. Take particular note of the critical frequency observation at the end.

IPS are to be commended for their excellent service which commenced on October 1, 1979. Perhaps it could be added to VNG like WWV?

Well 1979 is now over. What will 1980 hold in store? It should give plenty of service to the ardent DXer. Just listen on any of the bands.

73. Lots of DX in 1980.



Len VK3ZGP/NAC, Len also prepares our Prediction Charts each month.

# JOHN MOYLE MEMORIAL FIELD DAY CONTEST — RULES — 1980

**Amateur operators and Short Wave Listeners are invited to make this contest, held in the memory of the late John Moyle, a huge success. Contestants may participate either as individuals or as part of a group. There are two divisions in this contest. The first is for 24 hours continuous operation, and the second for any continuous period of 6 hours. Either period must be within the 26 hours available.**

## CONTEST PERIOD

From 0400Z 9 February 1980 to 0600Z 10 February 1980.

## OBJECTS

The operators of portable field stations or mobile stations within the VK and P2 call areas will endeavour to contact other portable, mobile or fixed stations in VK, P2, ZL and foreign call areas on all bands.

## RULES

1. In each division there are 8 sections.

- (a) Portable field station, transmitting phone.
- (b) Portable field station, transmitting CW.
- (c) Portable field station, transmitting open.
- (d) Portable field station, transmitting phone, multi-operator.
- (e) Portable field station, transmitting open, multi-operator.
- (f) VHF portable field, or mobile station, transmitting.
- (g) "Home" transmitting stations.
- (h) Receiving portable and mobile stations.

2. In each division, 24 or 6 hours, the operating period must be continuous.

3. Contestants must operate within the terms of their licence.

4. A portable field station must operate from a power supply which is independent of any permanent installation. The power source must be fully portable, i.e., batteries, motor generators, solar panels, etc.

5. No apparatus may be set up on site more than 24 hours before the contest.

6. All amateur bands may be used, but cross band operation is not permitted.

7. Cross mode is permitted, but note Rule 21.

8. All operators of a multi-operator

station must be located within approximately an 800 metre diameter circle.

9. Each multi-op. transmitter should maintain a separate log for each band. A 2 FM rig may be separate from 2 AM or SSB rig, but note Rule 11. A separate QSO number series is required for each band.

10. All multi-op. logs should be submitted under one call sign.

11. Only one multi-op. transmitter may operate on a band at any one time.

12. RS or RST reports should be followed by serial numbers beginning at 001 and increasing by one for each successive contact.

**13. SCORING FOR PORTABLE FIELD STATIONS AND MOBILES.** Portable field stations and mobiles, outside entrant's call area — 15 points. Portable field stations and mobiles within entrant's call area — 10 points. Home stations outside entrant's call area — 5 points. Home stations within entrants' call area — 2 points.

**14. SCORING FOR HOME STATIONS.** Portable field stations and mobiles outside entrant's call area — 15 points. Portable field stations and mobiles within entrant's call area — 10 points.

15. Portable field stations may contact any other portable field station twice on each band and mode (10-160) during the period of the contest provided that at least 4 hours elapse after the previous contact with that station on that band and mode.

16. Stations may be worked repeatedly on 52 MHz and above providing 2 hours have elapsed since the previous contact on that band and mode. Note that FM, AM, SSB and any other voice modes are grouped together as PHONE.

17. Operation via active repeaters or translators is not acceptable for scoring.

18. All logs shall be set out under head-

ings of date-time in GMT, band, emission, call sign, RST sent, RST received, and points claimed. List contacts in correct sequence. There must be a front sheet to show — name, address, division, section, call sign, call signs of other operators, location, points claimed, equipment used and power supply. You must also certify that you have operated in accordance with the rules and spirit of the contest.

19. Certificates will be awarded to the highest scorer of each section of the 6 hour and 24 hour division. The 6 hour certificates cannot be won by the 24 hour entrants. Additional certificates will be awarded for excellent performance.

20. Entrants in sections a, b, c, d, e and f must state how power for transmitting is derived.

21. All CW-CW contacts count double. Cross mode contacts count single.

22. Logs to be postmarked no later than 28 February 1980 and sent to FCM, Box 1065, Orange 2800.

## RECEIVING SECTION

This section is open to all short wave listeners in VK and P2 call areas. Rules are as for transmitting stations, but logs do not have to show report and serial number of the second station. Logs must show the call sign of the portable or mobile station heard, the report and serial number sent by that station, and the call sign of the station called. Scoring is as shown in Rule 14 for home stations. A station calling CQ does not count. Portable and mobile stations, which must be listed in the left hand call sign column of your log, alone count for scoring. Stations in the right hand column may be any station contacted. A certificate will be awarded to the highest scorer of each of the 6 and 24 hour divisions, individual or multi-operator entries. Certificates will be issued for excellent performance. ■

# WIA FEDERAL VIDEO CASSETTE LIBRARY

J. Ingham VK5KG

Since its inauguration over a year ago the WIA Federal Video Cassette Library has grown to the extent where rationalisation of its operations has been necessary. The following tells how your radio club can take advantage of this free service offered in the interests of promoting Amateur Radio.

There are three categories of programme.

**Group A** are those programmes for which the WIA does *not* hold copyright and which are available for loan **ONLY** and are not to be copied or transmitted. These are available on loan from the WIA Federal Videotape Co-ordinator upon receipt of —

1. Stamps to cover postage of the videocassette to you, and
2. A statement signed by a responsible officer of your club to the effect that the videocassette will be returned promptly upon use and that while it is in his care it will not be copied or transmitted over the air.

**Group B** are programmes for which the WIA holds copyright. As it is impractical to hold sufficient numbers of each of these to cater for every request for loan, these are available **ONLY** by supplying your own videocassette on to which the programme of your choice will be copied for you to do with as you wish.

**Group C** are programmes which are not intended as formal, permanent programmes. They are simply videotaped lectures, mostly recorded at the VK5 WIA monthly meetings. These will be of particular interest to country clubs which may have had until now difficulty gaining access to the same standard of technical lectures as their city cousins. Group C videocassette masters will be held for no longer than a year, so if you see a title that may interest your club don't hesitate to send in your request.

Both Groups B and C are ordered in the same way — send your request to the Federal Videotape Co-ordinator together with —

1. A blank videocassette of acceptable format, and
2. Stamps to cover the return postage of the videocassette to you.

## GENERAL POINTS

The only acceptable videocassette formats at present are the ¾ in. Umatic and the Philips ½ in. N1500. Regrettably, we cannot as yet supply programmes on the

Group	Title	Approx. Duration	Colour/ B & W	Availability		
				WIA Fed. VTR Co-ord.	Fed. Exec.	Emerg. Loan
A	"G6CJ Aerial Circus"	1½ hrs	B & W	✓	—	✓
A	"7J1RL DXpedition"	1 hr	Colour	✓	—	✓
B	"Official Opening of Burley Griffin Building" (VK5 HQ)	50 m	Colour	—	✓	✓
B	ARRL Films —					
	"This is Amateur Radio"	15 m	Colour	—	✓	✓
	"Moving up to Amateur Radio"	15 m	Colour	—	✓	✓
	"The Ham's Wide World"	30 m	Colour	—	✓	✓
B	"This Week Has 7 Days" looks at Amateur Radio	25 m	Colour	—	✓	✓
B	"Amateur Radio — The National Resource of Every Nation"	6 m	Colour	—	✓	✓
B	"The VK5 ATV History"	20 m	Colour	—	✓	✓
B	"ATV in Aust. 1978" (made for British ATV Club)	30 m	Colour	—	✓	✓
C	Lecture on "Long Wire Antennas" (VK5RG)	40 m	B & W	—	✓	—
C	Lecture on "RTTY" (VK5QX)	40 m	B & W	—	✓	—
C	Lecture on "Tracking Oscar" (VK5HI)	40 m	B & W	—	✓	—
C	Lecture on "The Signal to Noise Story" (VK3ATY)	45 m	Colour	—	✓	—
C	Lecture on a "Hamshack Microcomputer" (VK3AHJ)	10 m	Colour	—	✓	—
C	Lecture on the "Apollo 13 Disaster" (VK5ZJB)	1½ hrs	Colour	—	✓	—
C	(Coming Soon — "Microprocessors") (VK5SPE)	?	Colour	—	✓	—

VHS or Betamax formats. Although this service is free *all* requests must include prepayment of return postage in stamps. As a guide a 60 minute Umatic videocassette and box weighs 900 g, a 30 minute 775 g, both plus wrapping. An extra 50c should be allowed for a padded post bag.

Order in plenty of time, at least one month ahead, to allow time for processing

and mail delays. Urgent requests involving "air parcels post" or "priority paid" are much more expensive!

In "emergencies only" Federal Executive WIA have available for loan one copy of each Group A and B programme. However, don't rely on this as the programme you want may already be on loan or booked for Federal Executive use. ■

## WIA 1980 SUBSCRIPTIONS

These are the 1980 WIA subscription rates:

	\$	Grades
VK1	24.00	All
VK2	22.00	Full
	20.00	Associate
	17.00	Student*
	12.00	Pensioner*
	12.00	Family†
VK3	23.00	Full
	20.00	Associate

12.00	Student*
12.00	Pensioner*
15.80	Family (full)†
12.80	Family (associate)†
20.00	Full & Assoc. Metropolitan
18.50	Full & Assoc. Country
7.50	Student*
13.00	Pensioner*
9.00	Family†
17.00	Club (with AR)
9.00	Club (no AR)
23.00	Full City
21.50	Full (Country) & Associate

# AMATEUR SATELLITES

R. C. Arnold VK3ZBB

	11.50	Student*
	11.50	Pensioner*
	4.50	Family†
VK6	22.00	Full
	21.00	Associate
	12.50	Student*
	12.50	Pensioner*
VK7 Zone 1	20.00	Full & Associate
Zone 2	22.00	Full & Associate
Zone 3	22.00	Full & Associate
Zone 4	23.00	Full & Associate
All Zones	12.00	Student* and Pensioner*
Zone 1	12.00	Family†
Zone 4	15.00	Family†
Others	14.00	Family†

(Note VK Zones: Zone 1 members outside VK7; Zone 4, Postcodes 7256, 7305 to 7331, 7466 to 7470; Zone 2, S & 3, N.)

\* Only for members as approved by the Division concerned.

† No AR.

## NEW MEMBERS

Add joining fee — VK2 \$2.00, VK5 \$1.00, VK7 \$1.00.

The Federal part of subscriptions, included in the above rates, as appropriate, are —

AR .....	\$7.95
IARU .....	0.30
Federal .....	8.25
<b>Total .....</b>	<b>\$16.50</b>

# COMMERCIAL KINKS

With Ron Fisher VK3OM

3 Fairview Avenue, Glen Waverley 3150

## MORE ON THE YAESU FT-75

It seems that every few months our Assistant Editor, Ron Cook VK3AFW comes up with a new modification to his FT-75 transceiver. Always popular with novices and full calls alike, these rigs can often be purchased at most reasonable prices on the secondhand market.

But on with the modifications and over to Ron.

"The external VFO as used with the FT-75 sometimes causes RF feedback when operated on 10 metres. Experience shows that a number of 'cures' either singly or all together are effective. They are listed in the order that they should be administered.

(1) Reduce the length of the transceiver to VFO connecting lead. 300 mm is not too short.

(2) Connect a good RF ground to the back panel under the wing nut provided. If a good ground is not available, use a 2.4m long radial instead. Keep the distant end as far from the rig as possible.

(3) Re-arrange the placement of the VFO so that it and its leads are as far as possible from the aerial coax and/or ATU.

(4) Check the neutralisation of the PA on 28 MHz.

(5) Modify the VFO circuit as follows:

1. Replace TR5, the emitter follower, with a 2N3866.
2. Replace the 22k base resistor for TR5 with a 1.8k resistor.
3. Wire a 2k trim pot across the 470 ohm resistor in the collector circuit of TR2.
4. Remove the 50 pF coupling capacitor from the collector of TR2 and connect it to the wiper of the 2k trim pot.
4. Set the trim pot for 0.25 volt RMS at the output socket with the FT-75 connected.

These modifications reduce reverse coupling back into the oscillator."

With all of this completed you should have the cleanest sounding FT-75 on ten metres with the exception of Ron's of course. ■

## REVERSE REPEATER MODIFICATION FOR THE YAESU FT-227R

The Yaesu FT-227R two metre FM transceiver appears to be rather popular with FM enthusiasts at the moment. It of course offers full coverage of the entire two metre band in effectively 5 kHz steps. It however lacks one important feature, that of instant reverse repeater operation. It's a fairly simple procedure to dial up the required frequency, but under mobile conditions this would involve a short distraction from driving concentration. However all is not lost. Don Moyle VK3YOG has come up with a simple modification to provide instant reverse operation by selecting the +600 kHz position on the mode switch. No other facilities are changed. Now over to Don to tell the story.

"This simple modification can be carried out utilising the plus 600 position, which is of little use at the present time. If you have been using the memory to provide reverse receive on a particular repeater it can now of course be used on a simplex channel. In the new +600 position, the display will read as dialled but this will now be the transmit frequency, receive being 600 kHz below.

It is all accomplished at switch S8, by cutting away one wire, transposing two others and by adding two new links. As this involves getting at all sides of S8 start by removing the front panel from the transceiver and then free S8. By following the 'Before and After' circuit diagrams you will have no trouble, however a small fine tip soldering iron is necessary.

In conclusion It might be of interest to point out that the FT-227R instruction books do not always give correct alignment data. In several cases alignment points are incorrectly identified. Check carefully TC-302 through TC307. In my book, an early one, they are all identified one number lower than they actually are. It appears that later books have corrected this particular one but that other errors are possible." ■

1. As from January 1980 AMSAT will publish a new quarterly magazine called "ORBIT". This would seem a must for all those seriously interested in amateur satellites.

2. Those contemplating joining AMSAT are advised that subscriptions will be substantially increased in July 1980. Present subscriptions are \$US10.00 p.a. (plus \$3.00 for airmail magazine) of \$US100 for Life membership. The address again is PO Box 27, Washington DC, 20904, USA.

3. Jim P29ZFB has now qualified for membership of Mode "J" Club.

4. The Orbit Predictions for January 1980 are based on the following parameters:

Time per orbit	114.944753 min.	103.117202 min.
Increase-ment	28.737804°W	25.804622°W

For newcomers, I should explain that the tables give the estimated time and position of the satellite's first crossing of the equator each GMT day.

To convert these figures to local acquisition times, references are —

OSCAR 7 — "Amateur Radio", October 1972.

OSCAR 8 — "Amateur Radio", October 1978 and January 1979, or at Dick Smith shops a copy of the AR October 1978 "Insert" is available. ■

## ORBIT PREDICTIONS — JANUARY 1980

OSCAR 7				OSCAR 8		
Date	Orb. No.	Eqz Z	Eqz °W	Orb. No.	Eqz Z	Eqz °W
1	23456	0003	69	9295	0037	65
2	23469	0058	82	9309	0041	66
3	23481	0151	94	9323	0044	67
4	23494	0051	78	9337	0048	68
5	23507	0145	92	9351	0052	70
6	23519	0045	77	9365	0055	71
7	23532	0138	90	9379	0058	72
8	23544	0038	75	9393	0103	73
9	23557	0132	89	9407	0106	75
10	23569	0032	74	9421	0110	76
11	23582	0125	87	9435	0113	77
12	23594	0025	72	9449	0117	79
13	23607	0119	86	9463	0121	80
14	23619	0019	71	9477	0125	81
15	23632	0112	84	9491	0128	83
16	23644	0012	69	9505	0132	84
17	23657	0106	83	9519	0135	85
18	23669	0006	87	9533	0139	86
19	23682	0100	82	9547	0143	87
20	23695	0155	95	9560	0003	62
21	23707	0054	79	9574	0007	63
22	23720	0148	93	9588	0011	64
23	23732	0047	78	9602	0014	65
24	23745	0142	92	9618	0018	67
25	23757	0041	76	9630	0021	68
26	23770	0135	90	9644	0025	69
27	23782	0034	75	9658	0029	70
28	23795	0129	88	9672	0032	72
29	23807	0028	73	9686	0036	73
30	23820	0122	87	9700	0039	74
31	23832	0022	72	9714	0043	75

# VHF-UHF

An expanding world

Eric Jamieson,  
VK5LP



Forrester, S.A. 5233

- \* Denotes attended operation.
- † Denotes new listing.
- ‡ Denotes change of frequency or call sign.

Bill W3XO, conductor of "The World Above 50 MHz" in QST responded to my invitation to have a mutual upgrading of the beacon list in both hemispheres, with the result there are some additions and changes to frequencies and call signs as shown above. We hope the list is accurate, but the 6 metre listings are difficult to keep correct owing to pressures in some areas for spectrum space.

The North West Branch notes in "QRM" for November briefly mention a new beacon frequency of 144.470 MHz; I wonder if this means a new beacon on the north or west coast, if well located, could be heard over a wide area.

## SIX METRES

It's been a bit quiet considering we have been passing through the latter stages of the spring equinox. From the VK5 viewpoint the last of the JA openings occurred on 30-10 about 0100Z, and on 13-11 0000Z to JA2, JA3. On 15-11 band opened to VK7JG at 0000Z when VK5SV and VK5ZBU worked him. Later 0745 to 1200Z open to VK7 again with 11 stations on from there, and at least 16 VK5s. Signals to 5 x 9 plus. Short skip into Victoria noted, with VK3CCM from the Gippsland area on. Garry VK5AS at Cowell on the west coast working stations in Melbourne, though not very strong here. VK7RNT noted also.

On 16-11 VK4 to VK5 from 0000 to 0630Z, starting with stations in Townsville and then coming down the coast. Later VK5ZBU worked VK2VC and VK2ZAY briefly. VK7 also available from 0830Z onwards. Ch. 0 from Brisbane strong. On 18-11 noted and worked Eric VK5ZAG from Kapunda in the north after an absence of some years on 6 metres. His 100 watts very strong indeed at my QTH.

## SIX METRES OVERSEAS

On 29-10 JA worked XE on 50 MHz. On 27-10 JA7 and 9 worked the Lorde Howe Island DX-pedition; during the period 30-10 to 18-11 there have been consistent workings from JA to W6, VE7, KL7, W7, etc. On 4-11 VE1ASJ worked KG6JDX, whilst on 2-11 HL9TG had his first stateside contact to K6FV, followed on 4-11 by working K7KV and 25 others in W6 and W7.

On 5-11 W6 worked KX6 and DU, whilst JA4, 5 and 6 worked HP2. Big day on 8-11 when JA worked W1, 2, 3, 4, 8, 9, and 0 which are all comparatively rare, plus the easier W6, W7 and VE1! It was also reported on the same day in Jaapn that for the previous two weeks they had worked nothing below the equator, and hadn't heard and VKs at reasonable strength for some time. Same day VE1, 4, 5, 6 and 7 worked Japan, whilst of some significance to those involved was the reception on AM in Japan of a contact between a W4 and W7!

KZ5NW is now signing HP2XPW, while ZB2BL should be returning to 6 before long. According to QST the WAS 50 MHz Award is still being regularly issued in USA. Reports filtering through the northern hemisphere indicate a tremendous equinox there, hopefully we shall have some details soon. Significantly, on 11-11 the solar flux peaked to a record of 383, the highest recorded since Cycle 18, when in 1946-47 it was very high. On 10-11 it was 325, and the day after the peak, on 12-11, the high was 340.

## VK0JM SIX METRE OPERATION

Steve VK30T writes saying John VK0JM is now set to receive and transmit on 52 MHz using a crystal converter, Collins receiver and a homebrew transverter using a 6/40 in the output. Antenna a vee beam with 100 foot legs centred on Adelaide.

He listens at 0800 plus or minus 30 minutes on 52.050, also at 2400Z plus or minus 30 minutes to VK. So far on 27-10 VK7 beacon heard in noise at 0800Z for a few minutes, also Ch. 0 Melbourne. He has a chart recorder running on 6 metres and can see noise increases around his lunch time of 0800Z.

Liaison is via 21.195 at 0500Z, he will check into the VK3PA net just before this on 21.202

MHz. Anyone interested should look him up on 21 MHz as he has tried 28 MHz without result. John is at Davis Base under India in longitude and will be there until late February—should be a good chance for VK stations to obtain another country/continent.

Steve also mentions he hopes to go to Cocos and Christmas Islands after Christmas, signing VK9YT and VK9XT, and to Norfolk Island for next CQWW contest. Good luck, Steve, and thanks for writing.

## 1979 FACT SYMPOSIUM

The 1979 Future Amateur Communications Techniques symposium held in North Sydney on 29-9 to 1-10 and arranged by Roger VK2ZTB drew attendance from VK1, 2, 3, 4, ZL and P29. Nine papers were presented covering propagation methods and predictions, amateur microwaves, use of microprocessors and computers, and solid state amplifier design.

Des VK2AHC, amongst other things, described how to set up a 10 GHz station, and had a large amount of equipment on display. Des apparently regards 1296 MHz as one of the DC bands!

From the report in "The Propagator" it looked like a very worthwhile symposium, and I only wished I lived closer. Subsequent details of the various papers will no doubt be published and should make good reading. Good work, Roger.

## FROM CARNARVON AREA

Andy VK6OX sends along some further information on activity from Carnarvon. This is about the only information available these days from anywhere above the 30th parallel, perhaps everybody is too busy working exotic DC to worry about informing the southern States!

6-10 JA1 0930Z 5 x 9. 7-10 JA5EWQ. 8-10 JA1 2, 3, 4 and 6. 9-10 JA1, 2, 3, 4, 6, 7 and 9, 18 contacts. 0445 to 0930Z, included were 8J4ITU and 8J7ITU. 10-10 JA1 to 7, 5 x 9, 0425 to 1300Z. 11-10 JA1, 3, 7, 8, 9 and 0. At 0450Z worked JF1UMK on FM, full quieting both ways. Andy used his PRC10 into the A50-12 linear, output 6 watts! 13-10 JA7, 8, 9 weak. 16-10 JA2BZY 5 x 7 0845Z. Yoshi reports YBOX should be operating around the end of 1979 or early 1980, possibly as YBOX/9, but not certain yet. 19-10 JA1, 7, 9. Not strong. 0927Z. 26-10, 27-10, 29-10 and 5-11, all JA districts at varying times between 0900 and 1000Z, up to 5 x 9. Similar conditions in Perth also.

On 27-10, Wayne VK6WD had a crossband contact 10 metres to 6 metres with Gary W6XJ at 0440Z. Wayne read Gary's CW at 529 for about 1½ minutes just below 52 MHz. Problems occurred due to the sudden inrush of JAs, causing lots of QRM. This is the closest that VK6 have come yet to making a two-way 6 metre contact with W.

Andy also reports on the reported hearing of the beacon VK6RTV by G4BPY (reported in this column last month), and then goes on to say he has at MMT 144/28 transverter and a 16 element beam at 25 feet for two metres.

Aided by a number of troughs the results on two metres have been most rewarding, as indicated: 6-10 VK6RTV 559 at 1005Z, VK6RTW 509 1135Z, VK6WD 5 x 7, 144.1, 1250Z, VK6HK 5 x 5 both ways, each running 10 watts, 1255Z. 16-10 VK6ZT, VK6ZEL and VK6WD, from 1250 to 1540Z. 19-10 VK6WD 559 at 1305Z. VK6XY 569 out, 519 in, 1350Z. Both Aub and Andy were excited about this one as it is possibly the longest 2 metre SSB QSO in VK6, about 1150 km.

24-10: Good opening up and down the western coast, working VK6ZEL, VK6HK, VK6WD, VK6ZKO, VK6ZFY, VK6ZGG. 6 metres was tried and Jack VK6ZEL worked 5 x 7, 144.1, both ways. Tried with VK6ZFY at 1437Z 5 x 5 both ways. Also worked VK6ZKO and VK6WD. 25-10: Ducting conditions continue, Geraldton repeater Ch. 8 about 300 miles south was accessed with a 2W handbag and 16 element beam (that's cheating you know! . . . 5LP). Contacts also with Perth, also on 144.100. 30-10: Another trough, worked VK6FM at 0027Z 5 x 9 out, 5 x 4 in, on 144.100, also VK6ZZ and VK6IQ. From 1210Z worked VK6ZKO, 6WD, 6XP, 6VG, 6ZEL and 6BV. At 1437Z Tony VK6BV tried simplex Ch. 40 with Andy, contact easily made with low power. At 1507Z access to Ch. 2 repeater in Perth. 1-11: VK6XO, VK6OA in Geraldton and VK6HK in

## AMATEUR BAND BEACONS

Freq.	Call Sign	Location
50.005	H44HIR	— Honiara
50.008	PY1RO	— Brazil ‡
50.010	HL9TG	— Seoul *
50.023	HH2PR	— Halli
50.025	6Y5RC	— Jamaica
50.030	ZS6PW	— South Africa *
50.035	ZB2VHF	— Gibraltar
50.036	HC1JX	— Guillo, Ecuador ‡
50.038	KL7CDG	— Anchorage, Alaska * ‡
50.040	ZS6VHF	— Edenvale, South Africa †
50.040	WA6MHZ	— San Diego, California
50.048	VE6ARC	— Alberta, Canada †
50.050	K6FV	— San Francisco †*
50.050	ZS3E	— South West Africa †
50.050	ZS6LN	— South Africa *
50.050	VE6NAB	— Alberta †
50.055	WA9FEF	— Illinois †
50.060	PY2XB	— Sao Paulo, Brazil †
50.065	WB5ZRL	— New Orleans *
50.073	W7KMA	— Arizona * ‡
50.075	HK3/4	— Columbia (repeaters)
50.080	W1AW	— Connecticut †
50.080	T12NA	— Costa Rica
50.088	VE1SIX	— New Brunswick
50.090	WA6JRA	— Los Angeles * ‡
50.093	WA8FTA	— Ohio *
50.098	K7IHZ	— Arizona *
50.100	ZS6HVB	— South Africa *
50.101	F08DR	— Tahiti †
50.103	N8AJD	— Ohio †*
50.104	KH6EOI	— Pearl Harbour
50.110	KG6JIH	— Guam *
50.110	JD1YAA	— Marcus Island
50.110	KX6??	— Marshall Islands *
50.110	KG6RO	— Salpan *
50.110	AL7C	— Anchorage, Alaska *
50.498	5B4CY	— Cyprus
51.002	ZL1BPW	— Auckland *
51.999	YJ8PV	— New Hebrides
52.100	VK0BC	— Casey Base
52.200	VK8VF	— Darwin
52.300	VK6RTV	— Perth
52.350	VK8RTU	— Kalgoorlie
52.400	VK7RNT	— Launceston
52.440	VK4RTL	— Townsville
52.450	VK2WI	— Sydney
52.500	JA2IOY	— Nagoya
52.500	ZL2VHM	— Palmerston North
52.510	ZL2MHF	— Mt. Clifmie
52.800	VK6RTW	— Albany
52.900	VK6RTT	— Carnarvon
53.000	VK5VF	— Mt. Lofty
144.010	VK2WI	— Sydney
144.400	VK4RTT	— Mt. Mowbrallan
144.475	VK1RTA	— Canberra
144.500	VK6RTW	— Albany
144.600	VK6RTT	— Carnarvon
144.700	VK3RTG	— Vermont
144.800	VK5VF	— Mt. Lofty
144.900	VK7RTX	— Ulverstone
145.000	VK6RTV	— Perth
145.100	ZL1VHF	— Auckland
145.150	ZL1VHW	— Walkato
145.200	ZL2VHF	— Wellington
145.250	ZL2VHP	— Manawatu
145.300	ZL3VHF	— Christchurch
145.400	ZL4VHF	— Dunedin
432.400	VK4RBB	— Brisbane
432.475	VK7RTW	— Ulverstone
433.000	ZL2UHF	— Wellington
433.150	ZL1VHF	— Walkato
433.200	ZL3UHF	— Christchurch
433.250	ZL2VHP	— Manawatu
10370	ZL2UHF	— Wellington

Perth, all via the Geraldton repeater 8. 2-11: Many Perth stations and Tony VK6BV in Northern worked 144.100. At 1302Z worked VK6XY in Albany 5 x 6 in, 5 x 1 out, on SSB. Colin VK6ZCC also in Carnarvon joined in at times.

Present plans are to increase power on 2 metres and hopefully to try and work Adelaide! Almost nothing seems impossible on VHF these days. However, the foregoing indicates once more that when even one operator starts up on 2 metres in a more remote area, it is surprising what interest can be stirred up in other areas. What has happened between Carnarvon, Geraldton, Perth and Albany is similar to what happened up and down the east coast of Australia a year or two ago, between various points in Queensland and NSW. The full details of Andy's contacts are included in the hope they will stir up further activity and get the two metre band really going throughout the whole country. Contacts have been made both ends of the continent, it seems time to try and upgrade the situation in the middle, between Alice Springs or Darwin and Adelaide, it only needs someone dedicated enough in either of those centres for something to happen when conditions are right.

#### OF GENERAL INTEREST

Mick VK5ZDR sent word that VK2ZDI will be unable to make the journey to Norfolk Island due to a back injury. Sorry to hear that, as such injuries can persist for a long time . . . Ron VK5GM passes along a message from Stan ZL4MB indicating the New Zealand allocation recently made is 50.000 to 50.150 MHz until December 1980, except in the case of Channel 1 TV areas . . . Good tropo on six to western Victoria on 2-10 from VK5 with VK3AXV, VK3OT and VK3AOS at good strength . . . Re working Okinawa stations, Col VK5RO advises having QSL cards from JD1MO/JR6, KA6HF and JR6HJD twice.

The multi-million dollar storms on 14-11 took a very heavy toll of buildings, property and crops in South Australia. I cannot ever recall hearing and observing such howling winds and hailstones. The trees around my property suffered quite a lot, but miraculously the antenna farm survived! Perhaps the recently erected "with storm-in-mind" system paid off, but they are standing, undamaged.

Not so lucky were Keith and David Minchin VK5SV and VK5KK, at Wasleys, 35 miles north of Adelaide, who were right in the path of the storm on its way to the Barossa Valley — they lost their pair of 8 element antennae on 6 metres, and the pair of 16 elements on 144 MHz, plus sundry other smaller antennae. The towers are standing, but the masts have all been bent. We all regret this damage, chaps, and hope the setback will not daunt your spirits too much — I know what it's like. I have been through something similar myself some months ago — but at the very least you may have sufficient time to get the systems going again in time for the autumn equinox. Good luck.

I am sure we are all waiting for a change of heart by P. and T. to allow us an opportunity of working on the 50 MHz end of six metres with the probable peak of Cycle 21 approaching in March. Much has been written and spoken about this, some indication of a change would be most welcome now.

The Editor requires this information a lot earlier this time to allow for publication prior to Christmas, hence not so much to report. Best wishes for the New Year, and may 1980 be a great year for DX. Thought for the month: "It is a pity, but owing to the pull of gravity, it takes less energy to open the mouth than to close it."

73. The Voice in the Hills. ■

## LATE NEWS

Bill W3XO of OST has sent a small letter to say that things really exploded on 6 metres during October. He reports: "Many many crossband contacts with G, GM, GW, SM, DJ, some with LA, OE and OK. EI2W has been on and worked as far as the US Midwest (WO area). The West Coast of USA has had days of JA openings. During one of

these WA7RTA, Portland, Oregon, worked 80 JAs. 6th November the East Coast had its first good KL7 opening in 20 years. I finally worked my last State after being on the band for 30 years! I worked seven KL7s, including WA4TNV/KL7 at Shemya, Alaska. Yesterday K3HFV locally worked KX6AQ. I am looking forward to working VK, ZL as well as JA, etc. 73, Bill W3XO." It's enough to make your mouth water!

#### CHANNEL O RECEIVED IN AUSTRIA

I have received a letter from the Australian Broadcasting Commission, Federal Engineering Division, which refers to a letter from Vienna outlined below. The ABC letter reads —

"You may be interested to learn that a transmission by ABC-TV Ch. O Wagga has been picked up in Vienna.

"Enclosed is a letter from Walter Ertelt OE1WEB, whose claim was accompanied by a cassette recording of the sound reception which, although very noisy at times, has been verified by the ABC as the end of 'Anna and the King' and the start of 'The Ghost and Mrs. Muir' broadcast 1830 local time in Wagga Wagga. Signed D. R. Mackay VK2ZMZ."

It's a continuing saga of 6 metres and the unexpected. This may be one of the few if any actually verified reception reports over such a distance. The Australian autumn equinox will hopefully be something really worth being around for, and if we can use 50 MHz what a great unfolding of world-wide activity there will surely be for us . . . 5LP.

#### RECORDS

##### NEW AUSTRALIAN 6m BAND RECORD

Confirmation of an Australian record has been given for the two-way CW contact between VK5KK near Wasleys and XE1GE in Cuernavaca on 20th April 1979. The former was on a frequency in the 52 to 54 MHz segment and the latter was on a frequency between 50 and 52 MHz. The distance is 8,747.8 miles or 14,078.2 km for this split frequency QSO of 599 both ways.

##### NEW VK2 70 cm BAND RECORD

Confirmation has been given of a VK2 record for the two-way SSB contact between VK2BQJ in Oyster Bay and ZL1TAB in Sheffield on 9th January 1979 on 432.25 MHz. The distance is 1,339.7 miles or 2,156.1 km.

#### WAGGA TV IN VIENNA

Vienna, 25 October 1979

This is a copy of a letter received from the Australian Broadcasting Commission, Federal Engineering, which may be of interest to 6m ops.

I received your TV transmission on channel 0, vision 46.25 MHz and sound on 51.75 MHz today, 25 October 1979, from 0820 GMT (1820 Sydney time) to 0835 GMT (1835 Sydney time) both vision and sound, and until 0900 GMT (1900 Sydney time) vision only. Referable to the World Radio Handbook, I suppose it was your transmitter in Wagga Wagga. The programme contents:

0820 GMT: TV serial cast.

0830 GMT: Announcement "ABC".

0831 GMT: Supp. "Western Movie", starts with a lot of shooting.

Vision quality was very poor to me, due to "plastic". I was unable to tune my set down to the low of 46 MHz, European channels start on 48 MHz. Signal strength was approximately 20-30 dB/uV with unexpected long fading periods of approximately 20 seconds. This leads me to the assumption that not multi-hop F2 propagation was involved, it may have been a sort of "Super-Paddington-Ray". Antenna here is a simple vertical dipole.

I detected your signal while searching for OX signals in the 6 metre amateur band, due to the present extraordinary solar activity. Enclosed an audio cassette with recorded sound channel, partly destroyed by local electrical engine noise. Also enclosed my report in form of my amateur QSL card.

So I hope you can confirm and yet your QSL for that event, such things happen only once in a lifetime. Distance is approximately 16,000 km. I remember well 1957 press headlines: "British TV received in Australia". If we consider the distance by frequency product, it may be a new world record of VHF propagation.

Yours sincerely,

Walter Ertelt OE1WEB. ■

## QSP

#### EXPOSURE TO RF

In his Technical Topics article in Radio Communications November 1979 Pat Hawker reviews the "so-called" safe limits recommended for exposure to radio frequency generating equipment. "Nothing that I have read" he writes "has indicated that there is any real danger to the public at large, or to a prudent operator, from amateur radio radiation — but if we may increasingly be called upon to convince the public of this, we need to understand at least what the debate is all about. At the heart of the problem is the question of how safe is the safe limit (for continuous exposure) of 10 mW/cm<sup>2</sup>? This is the officially recommended standard used in the UK, USA and many other countries. Although set many years ago, and based rather pragmatically on the thermal effects of HF/VHF/UHF radiated energy, the vast majority of engineers working in this field are satisfied that it has, in fact, provided entirely effective protection against all biological damage resulting from localised heating, even of sensitive organs such as the eyes. However, again many years ago, the USSR and some E. European countries adopted a figure lower by a thousand times 0.01 mW/cm<sup>2</sup>." WA2UNY, a doctor, writing in Ham Radio September 1979 comes up with what appears to be balanced and sensible advice to amateurs —

- (1) Avoid HF, high power equipment with antennas in the shack within 3m of living areas.
- (2) Avoid direct radiation to the eye by a Tx in the microwave region (looking into a horn antenna or down a waveguide, etc.).
- (3) Avoid prolonged close contact with any antenna radiating more than minimal amounts of energy.
- (4) Women in early months of pregnancy, or those who may become pregnant, should avoid contact with strong HF, VHF and UHF fields.

Somewhat vague and unprecise though these may, nevertheless, writes Pat Hawker, one feels that they reflect the current uncertainty and would avoid any possible future recriminations from the public. ■

#### LICENCE FEES

A new radio licence fee schedule is expected for non-broadcasting stations in Canada from 1st April, quotes a news item in May 1979 Telecommunication Journal. The new schedule introduces the concept of variable fees more representative of the size and complexity of the licensees' communications system. More than 1 million general radio service (CB) and amateur licences will not be affected, although these represent 70 per cent of radio station licences in force. The revenue from the new fees is expected to cover the costs of spectrum management in accordance with the principle that the cost of licensing radio stations should not be borne by taxpayers generally. ■

## Photographs for AR

DON'T KEEP THEM  
TO YOURSELF

Send them in — NOW

# BRISBANE HAM TASTES BETTER!

CW ELECTRONICS GETS RID OF THE NORTHERN AMATEUR RADIO OPERATOR'S BLUES.

One of the best and most comprehensive stock displays of transceivers, test gear, communication computers etc. is housed at CW Headquarters in Tarragindi, Brisbane.

CW Electronics is looking to offer the northern amateurs a service and selection that has never been available in Queensland before.

- Inhouse warranty and servicing
- Managed and staffed by experienced amateurs
- mail order
- wide stock selection
- enquiry service
- Bankcard and terms -- and more

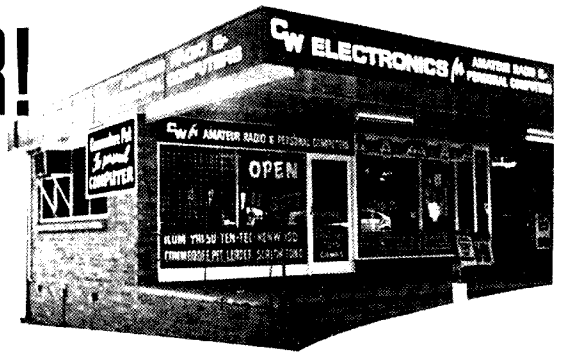
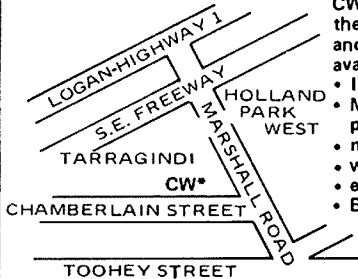

TURN THE KNOBS, LOOK AT THE METERS, READ THE HANDBOOKS OR JUST COME IN AND DREAM - IT IS ONE OF THE FEW PLACES IN AUSTRALIA THAT YOU CAN.

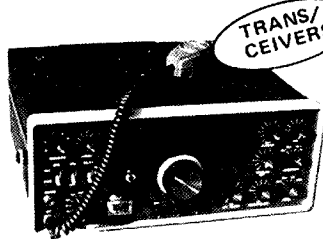

TRANS/CEIVERS

## CW

**ELECTRONICS**

Cnr. Marshall Road and Chamberlain Street  
TARRAGINDI, Brisbane  
Ph: (07) 48 6601  
PO Box 274  
SUNNYBANK, Qld 4109

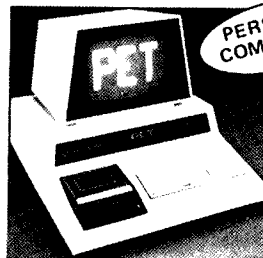

PERSONAL COMPUTERS

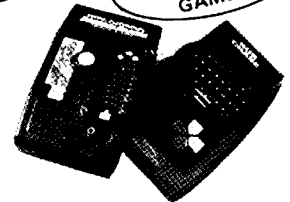

ELECTRONIC TOYS & GAMES

ICOM ◦ YAESU ◦ TEN-TEC ◦ KENWOOD ◦ COMMODORE PET  
SCALAR ◦ LEADER ◦ JAYBEAM ◦ HAL ◦ HY GAIN

OPEN THURSDAY NIGHTS AND SATURDAY MORNINGS

## FREE TRIAL

Send No Money

See offer below!

ONLY \$4.95

Cat B-2600



Electronics - the fun and the easy way! This 72 page book is great for beginners from 6 to 106! - it could be the start of a fascinating hobby or a rewarding career.

Just write or phone us (address below) and we'll send you a copy. If you like it, keep it: we'll bill you \$4.95 (we pay postage!). If you don't wish to keep it, send it back within 14 days. It's that easy!

PHONE OR WRITE NOW!

**DICK SMITH ELECTRONICS**

MAIL ORDER CENTRE.

PO Box 321, North Ryde, 2113

PHONE (02) 888 3200

ALSO AVAILABLE AT NEWSAGENTS AND BOOKSTALLS - (SORRY, NO TRIAL OFFER)



## AT LAST!

THE TYPE 610 BRITISH POST OFFICE designed MORSE CODE KEY

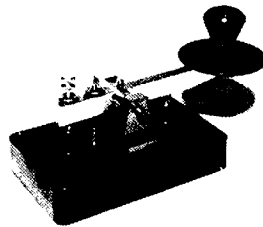

There has never been a better designed Morse Code Key - SOLID, ROBUST and BEAUTIFULLY BALANCED.

**\$26.50** (Post Paid)

"LEARNING THE MORSE CODE" - Cassette Album Training Course. You will progress rapidly using this modern training system.

**PRICE \$20** (Per Album of 3 Cassettes)

**WILLIAM WILLIS & Co. Pty. Ltd.**

77 CANTERBURY ROAD, CANTERBURY, VIC. 3216  
PHONE 836 0707

A Call to all holders of a

## 'NOVICE LICENCE

Now you have joined the ranks of Amateur Radio, why not extend your activities?

**THE WIRELESS INSTITUTE OF AUSTRALIA (N.S.W. DIVISION)**

conducts a Bridging Correspondence Course for the AOCF and LAOCF Examinations.

Throughout the Course, your papers are checked and commented upon to lead you to a **SUCCESSFUL CONCLUSION.**

For further details write to:

**THE COURSE SUPERVISOR, W.I.A.**

P.O. BOX 123,  
ST. LEONARDS, N.S.W. 2065



# SIDEBAND ELECTRONICS ENGINEERING

P.O. BOX 23, SPRINGWOOD, N.S.W. 2777  
 WAREHOUSE 213 HAWKESBURY RD., SPRINGWOOD  
 TELEPHONE (047) 54 1392

We have lowered our prices on many items and regret the necessity to increase prices on Hy-gain antennas. However our new antenna prices are still below wholesale replacement cost on these items. Rotators and cables still hold at very attractive prices, good stocks on most lines. Send a stamped, self-addressed envelope for a more detailed price list.

ROY LOPEZ

**HENRY RADIO** — A famous brand, new linear amplifier 1KD-5 10-80M 1200W PEP linear .....\$850

## HY-GAIN ANTENNAS

TH6-DXX 10-15-20M 6-el yagi .....\$300  
 TH3-MK3 10-15-20M 3-el yagi .....\$280  
 TH3-JR 10-15-20M 3-el yagi .....\$180  
 18-AVT/WB 10-80M vertical .....\$110  
 204-BA 20M 4-el Tiger Array .....\$220  
 BN-86 balun for beam buyers .....\$20

HY-Q (USA) 50-ohm 1KW balun .....\$15  
 HY-Q (USA) multiband 10-80M dipole kit, wire, balun insulators, spreaders, etc .....\$45

## ROTATORS & CABLES

All rotators now come with bottom brackets and control-indicator boxes wired for 28V AC operation  
 KEN KR-400 medium duty .....\$110  
 COR BT-1A light duty 4 position push-button programmable .....\$85  
 CDR Ham III heavy duty .....\$175  
 CDR tail-twister extra H.D. ....\$225  
 RG-8U foam coax cable, per metre .....\$1.00  
 8-cond. rotator cable, per metre .....75c

## ACCESSORIES

Voltage regulator 18V AC input 12V DC 3A output .....\$18  
 240/18V AC transformer .....\$10  
 Mobile bumper mounts 3/8" 24 thread.....\$2

**KYOKUTO FM-2016A** 800 channel 2 meter FM transceiver with 4-channel memory & scanner 15W .....\$355

## TRIO-KENWOOD PRODUCTS

VFO 820 for TS 820S .....\$140  
 VFO 520 for TS 520S .....\$130  
 LF 30A low pass filter .....\$30  
 SP 120 for TS 120 series .....\$32  
 DK 520 adaptor TS 520 to DG 5 .....\$10  
 All further Trio-Kenwood accessories and transceivers at competitive prices

## YAESU MUSEN PRODUCTS

FRG-7.5 to 30 Mhz receiver, still .....\$300

## CO-AX CONNECTORS

PL-259-SO-239-cable joiners ea. ....60c  
 Right angle & T connectors, ea. ....\$1.00  
 GLP right angles RG-58U to SO-239 w/lock nut and cap, ea. ....\$1.50  
 Double female connectors, ea. ....60c  
 MLS right angles RG-58U to PL-259, ea. ....75c  
 In-line mike sockets 3 & 4 pin, ea. ....60c  
 Mike sockets 3 & 4 pin, ea. ....60c

## NOVICE SPECIALS — TRANSCEIVERS

10M Sideband SE-502 USB/AM 15W PEP-240V AC 12V DC-inbuilt SWR/RF meter 28.3-28.6 mhz-clarifier tuning transmit and receive .....\$90  
 10M Universe 224-M USB/AM 15W PEP 12V DC 24-ch. 28.480 to 28.595 mhz, 5-khz steps-clarifier tuning transmit and receive ....\$95  
**CONVERSION CRYSTALS** for amateur licence holders — set of 8-crystals to convert 23-ch. 27-mhz CB units to 28-mhz. Suitable for Kraco, Sideband, Universe, Hy-range V etc., converts as per Universe 10M above — CRYSTALS and instructions .....\$32  
 Set of 4-crystals converts to 28.3-28.6 mhz. ....\$15

All Prices are NET, ex Springwood, NSW, on a pre-payment with order basis. All risk insurance is free of charge, allow for freight charges by air, road, rail or postal, excess will be refunded. Prices are subject to change without prior notice. All orders cleared on a 24-hour basis after receipt of order with payment.

Roy Lopez (VK2BRL) Manager

# CUSTOM COMMUNICATIONS

SHOP 11 PARRAMATTA ARCADE  
CNR. CHURCH AND DARCY ST., PARRAMATTA. 2150

TEL. 635 6399  
A/H 674 1719

## LEADER TEST INSTRUMENTS

LPM-880

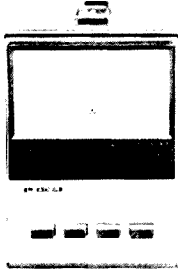

120w DUMMYLOAD  
**\$135.00**

LPM-885

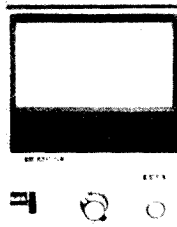

INLINE SWR/WATT  
1kw  
**\$89.00**

LDM-815

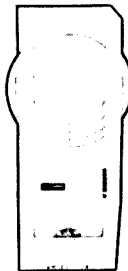

GRID DIP OSCIL.  
**\$89.00**

LAC-895



250w ANT. COUPLER  
**\$182.00**

LBO-310

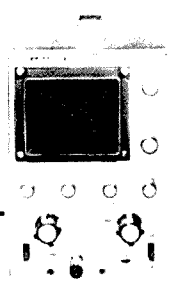

HAM SCOPE  
**\$310.00**



**\$189.00**  
**\$259.00**

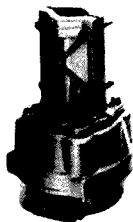

DR-7500S HD  
DR-7600S HD

### COUNTRY DEALERS

DIGITRONICS — NEWCASTLE  
DX — ENGINEERING — PT MACQUARIE  
WILF · MURRELL — HILLSTON  
MACALEC — WOLLONGONG  
ARMIDALE—ELEC — ARMIDALE  
STOCKMAN & HIGGINS — INVERELL  
ROD PIKE-TRADING — COONAMBLE

### INTERSTATE DEALERS

HARVEY SCEGG — GILSTON BAY TAS  
CULT COMM — FORTITUDE VALLEY OLD

DUE TO THE FACT THAT SWAN HAS CHANGED FROM VALVES TO SOLID STATE TRANSCEIVERS. WE HAVE VERY FEW MODELS AVAILABLE WHICH WE HAVE DISCOUNTED BELOW COST PRICES. THE MODELS ARE THE HF700S X 2 500w DC IN 350B X 1 ANALOG 300w DC IN 350D X 1 DIGITAL 300w DC IN ALSO 1200w LINEAR 2kw LINEAR.

**SERVICE FACILITIES AVAILABLE**  
We repair any equipment at reasonable prices.

### Valves Finals

	Each
8950 Swan —	\$13 50
6HF5(6LQ6) Swan —	\$13 50
6MJ6 Swan —	\$13 50
6KD6 Linear Yaesu —	\$13 50
6JS6 Yaesu —	\$13 50
6146B Kenwood —	\$12 50

### Driver Valves

12BY7A K Wood Yaesu —	\$3 95
6GK6 Swan —	\$3 95
12B26 Swan —	\$5 50

AND MANY OTHERS

### Rak Antennas

AL24DXN	20-40 m trap dipole —	\$70 00
A4VPN	40 m dipole kit —	\$27 00
LISTENER 3	Short wave Rx antenna —	\$49 00
LISTENER 1	Short wave Rx Antenna —	\$22 00

### Nagara

SS56	6 m 5el beam 1 KW —	\$159 00
V5JR	80-10 m trap vertical, 6 7 m high —	\$129 00
V4Jr	40-10m trap vertical, 5 2 m high —	\$99 00

### Hy-Gain Antennas

HYOUAD	10/15/20 m, 2 element quad —	\$279 00
204BA	4el monobander for 20m —	\$259 00
TH60XX	6 el tribander —	\$310 00
TH3MK3	10/15/20 m 3 el beam —	\$249 00
TH3JR	10/15/20 m 3 el beam —	\$229 00
203BA	3 el beam 20 m —	\$199 00

### Daiwa Low Pass Filters

FD30LS	32 MHz, Fc, 200 w, 3 stages —	\$20 00
--------	-------------------------------	---------

### Baluns

AS-BL	Asahi 50 ohm for beams —	\$34 00
BL50A	50 ohm, 4 KW, 1:1 for dipoles —	\$32 00
BL70A	70 ohm, 4 KW, 1:1 for dipoles —	\$32 00

### Leader Test Equipment

LAC 895	Antenna Coupler 3.5 — 28 MHz —	\$182 00
LPM885	SWR/PWR Meter —	\$97 00
LPM 880	RF Power Meter —	\$139 00
LDM 815	TR Dip Meter —	\$89 00
LBO 310	3" Ham Oscilloscope —	\$330 00
LA 31	Ham monitorscope adapter —	\$26 00

### Radio Teletype Terminal

0-7000	Tono RTTY CW/Baudot/ASC11 —	\$839 00
--------	-----------------------------	----------

### Jaybeam Antennas

5Y/2m	5el 2m, 7.8 dBd gain, length 1.6 m —	\$43 00
8Y/2m	8el 2m, 9.5 dBd gain, length 2.8 m —	

### CW Filters

FT101E	Yaesu —	\$39 00
TS520S	YG3395 Kenwood —	\$57 00
TS820S	YG88C Kenwood —	\$59 00

### Morse Keys

HK702	Deluxe Key with marble base —	\$41 00
HK708	Economy Key —	\$23 00
HK706	Operator's Key —	\$25 00
MK701	Manipulator (side swiper) —	\$45 00
PALOMAR	1C Keyer —	\$149 00

### HF — Helical Mobile Antenna with adjustments

10mtr	\$24 00	40mtr	\$26 00
15mtr	\$24 00	80mtr	\$28 00
20mtr	\$24 00	B Mount	\$15 00

### ICOM Gear

IC701	transceiver NOW —	\$1199 00
IC22S	2m transceiver —	\$299 00
IC551	6m transceiver —	\$799 00
IC280	2m fm remotable —	\$450 00
IC502	6m ssb portable —	\$239 00
IC202S	2m, ssb portable —	\$318 00
IC211	2m all mode —	\$847 00
ICRM3	Remote control unit —	\$159 00

### Coaxial Cable

RG58AU	mil spec 30m reels —	\$13 00
RG213 U	mil spec per metre —	\$1 40

### Kenwood Transceivers

TS520S	HF transceiver —	
TS120S	Solid state 100w —	
TS120V	Solid state 10w —	
TS180S	Solid state 10w —	

Call us today for a good deal

### Monitor Receivers

747	Vicom Aircraft Scanner —	\$199 00
210	Bearcat 210 scanner —	\$469 00
HF12	VHF pocket 12 channels —	\$149 00
220	Bearcat incl air —	\$530 00
250	Bearcat 50 channels —	\$560 00
FT-101E	10 mth old —	\$500 00
TS-820S	10 mth old —	\$800 00
HF700S	New Swan 500w Pep incl P S —	\$690 00
Atlas 210	Incl Power Console in mint condition —	\$550 00
M-75	Info Tech RTTY to Video Converter —	\$200 00
Model 150	Info-Tech RTTY Keyboard to suit M 75 —	\$200 00

ASK FOR THIS MONTHS SPECIAL

# SUMMARY OF CURRENTLY AVAILABLE ICOM TRANSCEIVERS:

Model	Band	Modes	Features	Price \$
IC701	160-10M	SSB/CW/RTTY	Solid-state deluxe	1199.00
IC22S	2M	FM	Popular mobile unit	299.00
IC280	2M	FM	Mobile remotable	450.00
IC215	2M	FM	Portable	229.00
IC402	70CM	SSB/CW	Portable	439.00
IC251A	2M	SSB/CW/FM	AC/DC, base station	847.00
IC551	6M	SSB/CW	Microprocessor control, 10 watts	799.00
IC551 D	6M	SSB/CW/FM	100 watt output	850.00
IC255A	2M	FM	New, digital, 25 watts	425.00
IC202S	2M	SSB/CW	Portable	318.00
IC502A	6M	SSB/CW	Portable	289.00
IC260A	2M	SSB/CW/FM	Mobile, digital	tba

## ICOM



### IC22S FM TRANSCEIVER

- \* The most popular 2m rig, thousands sold.
- \* Ideal for mobile as there is no digital display to worry about.

### GET WITH THE STRENGTH!

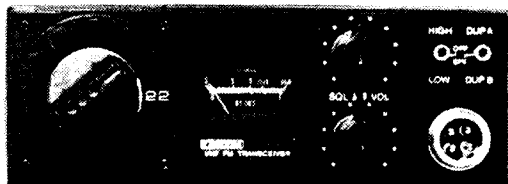

So well known that it is hardly necessary to say much about it!

- \* Easy to use on the move without looking.
- \* 22 programmable channels — 10 popular ones already done and 12 for you to program to your own choice
- \* Full reverse repeat at the flick of a switch.
- \* Superb quality and performance — as thousands of owners will confirm.
- \* Excellent value for money.
- \* Rugged, ideal for mobile.
- \* Complete with mobile mount.
- \* Low receiver noise, excellent sensitivity.
- \* Backed by VICOM 90 day warranty.

**STILL ONLY \$299**

## ICOM

**— SIMPLY THE BEST!**

## ICOM



### IC701 HF TRANSCEIVER

ICOM's superior LSI technology takes the lead in Amateur HF. The extremely compact **IC-701** delivers 100 watts output from a completely solid state, no tune (broad band design) final, on all modes and all bands, from 160-10 M. With single knob frequency selection and *built-in-dual VFO's*, the LSI controlled **IC-701** is the choice in computer compatible, multi-mode Amateur HF transceivers.

The **IC-701's** single frequency control knob puts fully synthesized instant tuning at a single finger tip. **WIDE** bandspread, with 100 Hz per division and 5 KHz per turn, is instantly co-ordinated between the smooth turning knob and the synthesizer's digital read-out with positively no time lag or backlash (no waiting for counter to update: less operator fatigue). And at the push of the electronic high speed tuning button, the synthesizer flies through megacycles at 10 KHz per step (500 KHz per turn).

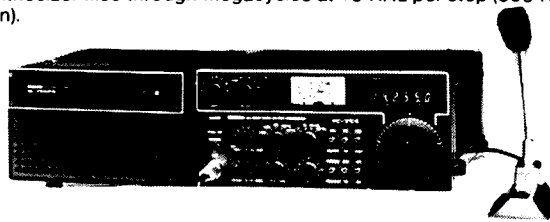

The computer compatible **IC-701** LSI chip provides input of incremental step or digit-by-digit programming data from an external source, such as the microprocessor controlled accessory which will also provide remote band selection and other functions.

Full band coverage of all six HF bands, and continuously variable bandwidth on filter widths for SSB, RTTY, and even SSTV, help to make the **IC-701** the very best HF transceiver ever made. **IC-701** include two CW widths, all of this standard at no extra cost.

Sold complete with the high quality electret condenser base mic (SM-2), the **IC-701** is loaded with many ICOM quality standard features. Standard in every **IC-701** are *two independently selectable, digitally synthesized VFO's at no extra cost*. Also standard are a double-balanced schottky diode 1st mixer for excellent receiver IMD, and RF speech processor, separate drop times for voice and CW VOX, optionally continuous RIT, fast/slow AGC, efficient IF noise blanker, fast break-in CW, and full metering capability.

Price \$1199 (AC power supply extra)

# VICOM

Available from authorised VICOM dealers  
throughout Australia.

# AMATEUR RADIO ACTION

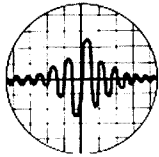

is the **NEW GENERATION**  
amateur magazine.

- ★ Comprehensive DX notes
- ★ Propagation forecasts
- ★ Very technical - and not so
- ★ Technical articles
- ★ Useful projects

Here are just a few of the arti-  
cles which have appeared in  
recent months

- ★ Fixed wire beams
- ★ Case for UHF beacons
- ★ 80W linear for 6m
- ★ Wilson System Three review
- ★ Spratly DX exclusive
- ★ Backyarders - good or bad?
- ★ A.T.V. Special
- ★ SWL notes

Average page content is 80  
pages - at \$1.20 an issue that's  
good value.

Please put me down for 12 editions of  
Amateur Radio Action, starting NOW-

Rates In Australia - \$14.40. Surface  
mail overseas - \$18.40 Air mail: To  
New Zealand - \$A28.70; Malaysia -  
\$A32.60; Japan - \$A38.45; USA -  
\$A42.35; UK - \$A46.25

Herewith enclosed cheque/postal  
note/money order to the value of:

\$A .....

Name.....

Address.....

Postcode.....

Post to: Amateur Radio Action Sub-  
scriptions, Box 628E, Melbourne,  
3001.

## AWARDS COLUMN

Bill Verrall VK5WV  
7 Lilac Ave., Flinders Park, S.A. 5025

### BLUE MOUNTAINS LAGOON AWARD (VK2)

Here are the details of another 10/10 award which is available from the Blue Mountains Lagoon Chapter of the 10/10 International net. This award is only available to 10X members for contacts on the 10 metre band.

Net Frequency 28.585 MHz.

Basic Award requires 15 points.

Kookaburra Bar endorsement requires 35 points.

Koala Bar endorsement requires 65 points.

Kangaroo Bar endorsement requires 150 points.

Points may be aggregated to achieve the 150 points required.

You are required to work one committee member and one local member. Each award can be applied for separately if desired.

The cost of the basic award is \$2.00 plus an extra \$1.00 for airmail to overseas stations. The bars cost \$1.00 each, which includes airmail posting.

Chapter membership is available for a fee of \$2.00 and this is worth 1 point.

Note: For the third bar, you may work all or any stations at 24 hour intervals. Up to the Kangaroo bar, stations may be worked once only.

### DESCRIPTION

The award measures 300 mm x 220 mm printed in three colours on high quality gloss paper. The border is in dark blue, background in light blue and printing in red.

### APPLICATIONS

Applications should be submitted to the Awards Manager, Mr. A. McGrath VK2APD, Mountain Lagoon Road, Bilpin 2758, NSW, Australia.

### THE GARDEN CITY AWARD

This award is available from the Darling Downs

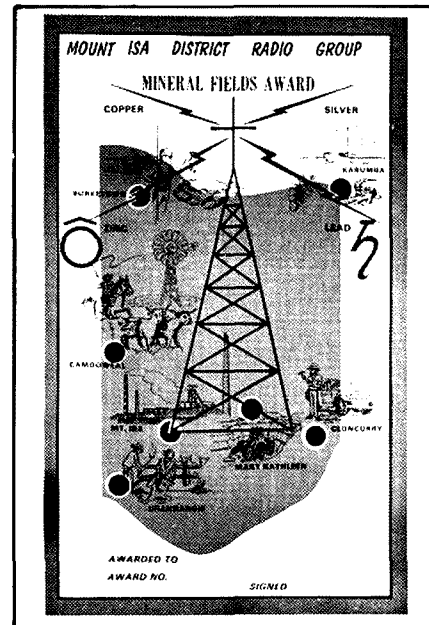

Mineral Fields Award.



QUEENSLAND  
THE SUNSHINE STATE

10-X CHAPTER

NET FREQUENCIES  
28.510MHz  
0930 Z Wednesday  
0130 Z Sunday

BRISBANE  
VK4  
SUN VALLEY

Certificate No. 4CH

This is to Certify that Amateur Radio Station **VK4 NES** operator **LIN** 10-X  
has submitted evidence of having conducted two-way communication with the required number of member stations.

*And in recognition of these contacts is awarded this Certificate.*

VK4 NCB *[Signature]*  
Chapter Head

VK4 NEN *[Signature]*  
Certificate Manager

Date Issued 3-9-78

Brisbane Sun Valley Award.

Radio Club for working stations in Toowoomba, Queensland. The award is available to Australian and overseas amateurs and will also be issued to SWLs.

This award is on a points attained basis as follows:

VK and ZL: 10 points required by working or hearing DDRC members.

All others: 5 points required by working or hearing DDRC members.

Each phone/SSB contact is worth 1 point. Contacts on CW, RTTY or the club station are worth 2 points.

Only one contact per band per member each 24 hour period is permitted for point scoring purposes.

Only contacts made on or after 1st October 1979 will count.

The cost of the award is \$1.00 for Australian applicants and \$AUST2.00 or equivalent in IRCs for ZL and overseas operators.

OSL cards are not required. Send details of a log extract only.

Applications for the award should be directed to the Awards Manager, Darling Downs Radio Club, PO Box 715, Toowoomba, Queensland 4350.

The award measures 335 mm x 230 mm printed in two colours on matt finish white parchment type paper. The outline of the map of Australia is in black and all other printing in red.

Good hunting. ■

# CONTESTS

Wally Watkins VK2DEW  
Box 1065, Orange 2800

## January:

- /13 ROSS HULL VHF/UHF CONTEST
- 12/13 ARRL VHF SWEEPSTAKES
- 12/13 YU 80m CW
- 12/13 DL QRP CW
- 19/20 N and S AMERICA RTTY
- 25/27 CQ WW 160m CONTEST
- 26/27 FRENCH CW CONTEST

## February:

- 9/10 JOHN MOYLE FIELD DAY
- 16/17 ARRL DX CW CONTEST
- 23/24 FRENCH PHONE CONTEST

## March:

- 1/2 ARRL DX PHONE CONTEST
- 9/10 EUROPE AND AFRICA RTTY
- 22/24 BARTG RTTY SPRING CONTEST
- 29/30 CQ WW WPX SSB CONTEST

The French contests should provide some hard to get prefixes from various French possessions around the world. SASE for full details. In the 1979 contest two locals featured in the results — A1 — VK3XB 7,750 points, 31 contacts, and A3 — VK5YY, 12,090, 41. ■

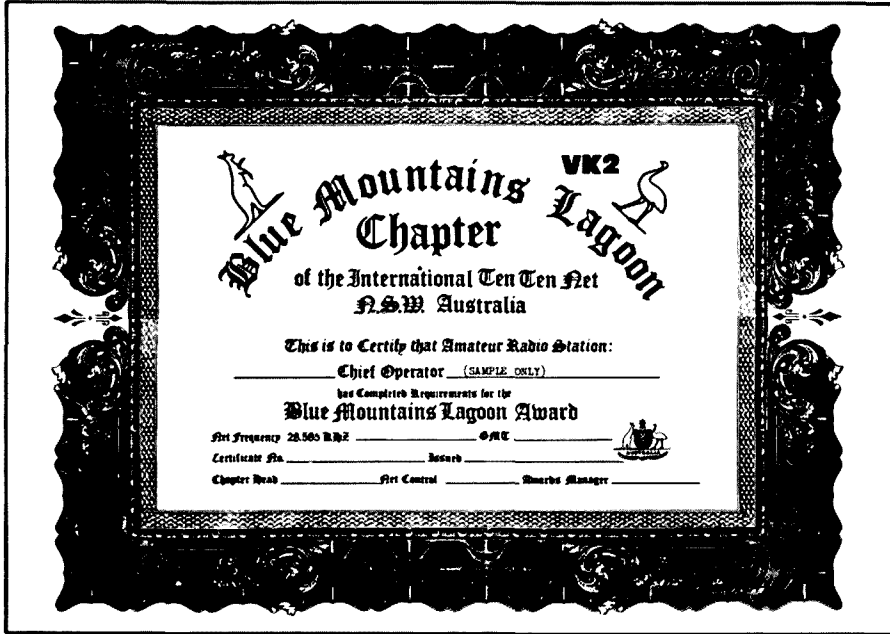

Blue Mountains Lagoon Award.

## SUPPORT OUR ADVERTISERS

## DIVISIONAL NOTES

### VK2

Members of the WIA (NSW Division) are asked to note that their annual subscription to the Division becomes due on the 1st January 1980 and is payable within one calendar month. The notices have already been sent by separate mail during December. The subscription is to be returned to the Federal Office at PO Box 150, Toorak 3142 (Clause 27 — Articles of Association).

Members, various sub-groups and suppliers are notified that the Division's financial year (1979) ends on 31st December 1979, and the Treasurer requests that any accounts be finalised as soon as practical. Various groups are advised that your annual report should be in the hands of Council by early February.

Nominations for the 1980 Divisional Council will close at 2 p.m. on Thursday, the 14th February, 1980, at the Registered Office — 14 Atchison Street, Crows Nest (Clause 48).

Any business/agenda items for the Annual General Meeting should be lodged at the office before 2 p.m. on the 19th February in time for the next Minibulletin.

The Annual General Meeting of the Division will be held at the Registered Office, 14 Atchison Street, Crows Nest, on Friday, the 28th March, 1980. Business to include the presentation of the report of Council, the Balance Sheet, the election of Council for the incoming year and any other business of which due notice has been given. The meeting is scheduled to commence at 7.45 p.m. (Clause 28).

Further details about the above matters will be included in the various Minibulletins.

T. I. Mills, Secretary, WIA (NSW Division), 14 Atchison Street, Crows Nest NSW, 3rd December 1979. ■

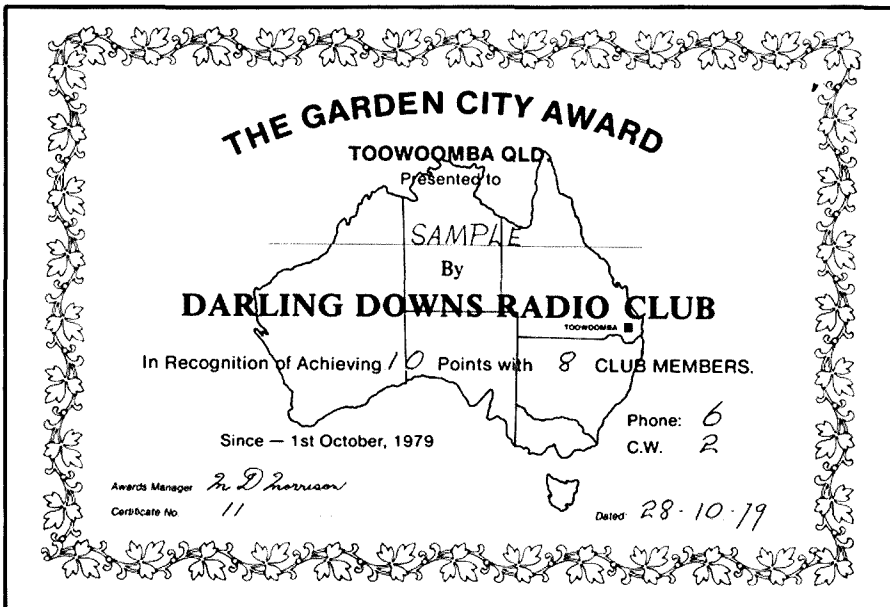

The Garden City Award.

# LETTERS TO THE EDITOR

Any opinion expressed under this heading is the individual opinion of the writer and does not necessarily coincide with that of the publisher.

72 Church St., Morwell 3840  
17-11-79

The Editor,  
Dear Sir,

I would like to comment on the article in the QSP column on page 47 of the November issue of AR. The article contained an extract from a letter by "JP" to the Queensland Division of the WJA complaining about the operation of the "Rendezvous Group", which it is claimed is run by the Jehovah's Witness Organisation.

I have on occasions come across this group while tuning over the band and have listened casually for a while before tuning elsewhere. I have heard nothing to imply that the group is run by, or for the benefit of, the Jehovah's Witness Organisation, by which I suppose JP means the Watchtower Society. I would like to state at this point that I am not a member of the above organisation or ever likely to be, as their teachings are anathema to me.

The group seemed to be comprised of people with a common interest and the matters discussed were of a personal nature, involving their work, families and friends, and I accept JP's point that they were all Jehovah's Witnesses. However, JP implied that the group was run as part of the operations of the Watchtower Society. Presumably this means that the group was used for propaganda, evangelism, or to conduct the administrative details of the Society, so avoiding mail and cable costs.

I have heard nothing to support this view and the operations of the group seem to be no different to that of any other group of people with a common interest. The regulations allow amateurs to discuss matters of a personal nature, there is no prohibition on the subject matter of these discussions so long as it is not obscene or otherwise objectionable. Apparently it is Regulation 80(e) that concerns JP, but I can only repeat that the matter I have heard transmitted on this net only concerned the operators in the group.

I can only conclude that JP's observations were coloured by a prejudice against this particular organisation. The group is no more offensive than any other minority group such as bushwalkers, horse breeders or rugby players, who meet regularly on air to discuss a common interest. It is a very dangerous attitude when representations are made at an official level to halt the operations of an on air net, just because the majority of people may not agree with the philosophies of the group concerned.

Yours faithfully,

Kevin L. Feltham VK3ANY.

The Editor  
Dear Sir,

I would like to take the opportunity through your pages of thanking Mr. McKibbin for his comments on my previous letter on the subject of International Correspondence.

I wish to ensure, however, that no misunderstanding exists in either Mr. McKibbin's or anyone else's mind for that matter.

I am surprised at the description intimating narrow-mindedness on my part, and I would like to direct Mr. McCubbin's attention to the last portion of the last sentence of my letter. Quote, "Just ponder as to how you would manage to write a business letter to someone in Japan in Their Own Language". Perhaps he missed reading that portion of my letter.

I would therefore deny the charge of narrow-mindedness.

Whilst I do speak a little German and can get by with a QSO in the French language, I don't

consider any language, other than one's mother tongue, to be necessarily easy to learn. I could well imagine, and indeed expect, even a small French child to be amused at my poor efforts in his native tongue, neither would I take offence at his amusement.

My XYL comes from the north of England and I was born here in Australia. With her accent, the existence of which she so strenuously denies, and my local understanding of pronunciation and expressions, just imagine the "fun" we sometimes have in communication in our own language, English. Thus my first hand experience in problems of this nature.

So Mr. McKibbin or any others who may feel like you about my letter, I must apologise if I conveyed in any manner any semblance of pedantry or egocentricity. I can assure you that such is not the case nor was in fact the intention.

We should all be capable of laughing at ourselves whoever we may be. I often suspect the Irish of being the ones who make up all those jokes about the Irish anyway!

By the way, I think that Victor Harbour is a beautiful place and have always enjoyed visiting there, so please why can't I take any more trips to that lovely area?

Ian Hunt VK5QX.

4 Quinn St., Penguin, Tasmania  
19th November, 1979

The Editor,  
Dear Sir,

I was concerned recently when advised that a practice I had engaged in was not permitted on the amateur bands.

In the north-west area of VK7 a branch activity was to encourage a Sunday morning on the air "get together". This involved novice, limited and full call members. Two main frequencies were used, one on ten metres and the other on repeater 3.

Many stations took part and enjoyed the opportunity to "rag chew" with other stations along the coast. We soon found that most novice operators could listen to repeater 3, but several full call stations had trouble receiving on 10 metres due to local terrain, etc. Being set up for relaying the VK7WI broadcast from HF to repeater 3, I occasionally patched a novice station, after he had given his call sign, on to the repeater for the benefit of all stations in the net.

This turned out to be quite a smooth operation and greatly increased the flexibility of our net.

I had checked the current Regulation Handbook and although there was no direct reference to relaying another station (apart from replaying a recording of another station) I used my common-sense in ensuring that both the novice and myself operated within the terms of our licences, i.e. each giving our respective call signs on our respective bands before and after a patch. I have been advised that this practice is NOT PERMITTED.

This raises several points which I feel need clarification. Firstly, my XYL who has no active interest in amateur radio is allowed to talk on VHF on my transmitter in my presence. Why not a novice via an RF link? Secondly, if the novice also has the limited call but is operating on 10 metres is he, with his permission, allowed to be relayed on to a repeater or is relaying as such just not permitted?

It is understood in the branch that repeaters are primarily for mobile use and any mobile traffic will take priority over "rag-chewing" but the whole exercise was to increase the general local activity.

Surely when we are not causing any interference to any person outside the amateur service or to any station within our bands we should be able to conduct an experiment such as this.

I have heard on the grapevine that the regulation concerning "Third Party Traffic" is involved. "What next?"

Yours faithfully,

Winston Nichols VK7EM.

## EDITOR'S NOTE:

This is a "grey" area at the moment; we know of other novices in the same situation. The P. and T. Department is aware of these activities and so far have forbidden novices being relayed on to bands they are not licensed to use, same with limited licensees.

The matter of dual licence holders will be referred to the Department for further information.—VK3UV.

## C.A.R.E.

(COMMUNITY AMATEUR RADIO EVENTS)

### SEA RESCUE

Ron Fisher VK3OM, a member of the Publications Committee and Federal Tapes reader, was tuning across the 20m band about 22.00h local time on 11th November when he heard ZL4HI, Fin in Dunedin, taking a Mayday call from TIBUF. At the time VK2NHC happened to be visiting Fin and was in his shack.

The Mayday call emanated from a survival raft from the yacht Dauntless, which had been attacked three times by a whale and had sunk about 15.30h NZ time. All the people aboard the yacht were in the raft—Mr. Innis Jones with his wife and two children. By dead reckoning they had estimated their position east of Norfolk Island.

Ron could read signals from the raft and also ZL4HI till 22.30h local time, by which time copy from the raft became difficult. Den Kelly VK7DK broke in to report good copy from the raft but could not copy ZL4HI. Ron then acted as a relay to ZL4HI who contacted the NZ Search and Rescue Service, which arranged the despatch of an Orion aircraft to the raft's area from Auckland and contacted a Dutch freighter "Freetown" to divert to the area to pick up survivors.

By this time ZL4HI faded out on 20m but did receive advice to QSY to 3.8 MHz, after which

# SAVE \$\$\$ ON BATTERIES!

3.6V  
at 200mA!

WAS \$9.50

NOW

\$6.90

(SAVE NEAR 30%!) Cat M-9525

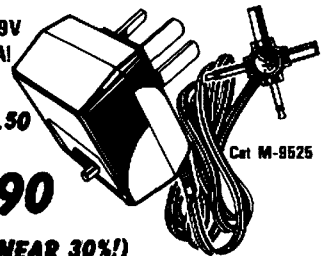

Why waste money on batteries? This superb 'plug-pack' battery eliminator suits most small battery operated appliances with its 3, 6 and 9 volts output — radios, cassettes, toys, calculators, etc etc. At our budget price, it will pay for itself in no time at all! Fully approved; comes with 4-way power plug and reversible polarity. Ideal for the home, office, shack, etc. Start saving money today!

## DICK SMITH ELECTRONICS

SYDNEY 439 4111 MELBOURNE 67 9834 CANBERRA  
RC 4944 ADELAIDE 212 1962 BRISBANE 191 6233  
PERTH 328 1944 WOLLONGONG 26 3800

MAIL ORDERS PO Box 321 North Ryde NSW 2113

(Please include \$1.00 extra for packing & postage.)



contact with VK3OM was re-established and continued. The relay through VK7DK on 20m continued with advice to them about the Orion search and they should release their EPIR beacon, which they did at 17.15Z. The Orion found them about 17.30Z and the freighter picked them up around 22.30Z and dropped them off on Norfolk Island.

The Australian Coastal Surveillance in Canberra was informed by the NZ Search and Rescue and were aware of the situation. Any similar occurrences should always be reported direct to them, as soon as possible, on telephone (062) 47 5244, reverse charges accepted.

One more example of the enormous value of amateur radio to seafarers. ■

## AR ADDRESS LABELS

Please check your call sign, name, initials, address, grade and other details on your address labels.

Advise any corrections NOW to your Division or direct to WIA, Box 150, Toorak, Vic. 3142.

- The coding on the label reads: Letter Numeral Two digits One digit Two digits Grade Division Unused Distribution Zone.
- The Call Book data derives from the same EDP file.

## AROUND THE TRADE

### LEADER LSG16

Leader's popular range of instruments for the Hobbyist is most famed for the RF Generator model LSG16, covering the RF spectrum from 100 kHz to 300 MHz in six ranges, 100 MHz to 300 MHz on harmonics. The LSG16 is available from the sole Australian Agent, Vicom International Pty. Ltd., and distributors. ■

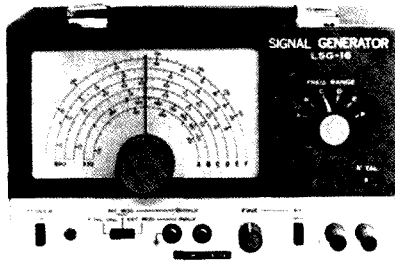

### NEW 10m FM TRANSCEIVER

GFS Electronic Imports of Mitcham, Victoria, have just announced the release in Australia of a new 80 channel FM transceiver, the Comtronix FM-80.

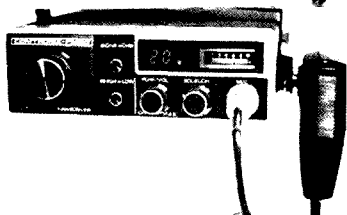

The FM-80 is a fully synthesized transceiver that runs 10-15 watts output over the frequency range 26.91 to 29.70 MHz (also it can easily be made to operate 28.01 to 28.80) in 10 kHz steps. FM deviation is  $\pm 3$  kHz. Channel number is indicated by a bright LED readout. Other features include Hi-Lo power switch — one watt (for local conversations) or full output, adjustable squelch for muted standby operation and an illuminated meter reading "S" units and transmitter power.

The price of the FM-80 is \$289. For more information contact the Australian distributors, GFS Electronic Imports, 15 McKeon Road, Mitcham, Vic. 3132. Phone (03) 873 3939. ■

### NEW ICOM POWER SUPPLY IC-PS20

ICome have released a new power supply to be used with the new high power 6 metre transceiver IC551D and other matching Icom transceivers such as the IC701.

This new fully regulated supply eliminates heavy power transformers and offers a variation in technique over the usual methods. A switching regulator IC is used containing a reference voltage circuit, OP-amp, comparator and current limiting circuit.

The oscillating frequency of the regulator is around 50 kHz and this high frequency, high voltage AC is rectified and filtered to produce 13.8V DC at a maximum load current of 20 amps.

The circuit also provides short circuit protection and automatic shut-off when the current exceeds 25 amps.

Weight of the unit is only 4.2 kg, a useful saving of 4 kg over the older type. An optional fan is available if continuous operation of RTTY is contemplated. Further information is available from Vicom (03) 699 6700 or their dealers. ■

## YOU and DX

Mike Bazley VK6HD

8 James Road, Kalamunda W.A. 6076

One of the reasons that people take notice of rumours is that on occasions a rumour turns out to be true. The part of amateur radio which covers DX chasing, rumours add spice, interest and the possibility of truth. A good example would be the recent 8Z4A operation. The DXpedition had been rumoured for approximately six months prior to the operation and then all of a sudden, there was the pile-up. The moral is to note all you hear on the air, add your own value judgement and then play by ear. Don't worry too much if you missed the 8Z4, "rumour" has it that this neutral zone will not exist much longer!!!

### DX NEWS, RUMOURS, FACT AND FICTION

Heard Island is in the news again. An interesting note from Peter VK3DU quotes the following from the Brisbane "Courier Mail" of 30-10-79: "An Australian party will land on Heard Island this summer for the first time in nine years. Its mission will be to reinforce Australia's claim to the Island's known fishing grounds and suspected mineral resources. The expedition also will search for signs that other parties have been to the Island since the last known visit by a Franco-Australian team in the summer of 1970-71.

The National Mapping Division has chartered the lighthouse supply ship, Cape Pillar, from the Transport Department for the six week mission from late February to early April. The 16 men in the working party will be drawn from the Mapping Division and the Science and Environments Department's Antarctic Division."

There we have it! Someone is going to Heard Island but will there be amateur activity? There must be a radio operator on the ship so there could be hope. The interesting thing from all the above is that it is fuel for the rumour game. Up to the present I have personally heard of four possible ways of some Heard Island amateur activity. These are:

1. P29 JS plus other operators are hoping to join the ship at Perth.

2. A VK6 is hoping to be allowed to travel on the ship and is looking for WIA support and approval.

2. The ship's wireless operator has been offered \$1,000 to take out an amateur licence, make as many QSOs as possible and request all QSLs via his sponsor!

4. A part of DX-minded Ws are prepared to fly down to Perth and pay for their passage on the ship, if permission can be obtained.

There you are, four rumours, and no doubt there will be more before the end of February arrives. As the headlines says, DX News, rumours, fact or fiction?

January is the month when one looks to the future with hope and perhaps I may be allowed to indulge in a few predictions for 1980. I expect H5, S8 and T4 will be added to the DXCC listing, there will be an all time new country\* from the Caribbean. Someone will manager to operate from 70 and BY.

Unfortunately copy for the January AR has to be in the hands of the printer during mid-November and as this is only a couple of weeks since I last put pen to paper there is very little DX news. Those chasing DX on 80m should be able to grab VQ9KK, who seems to appear every evening at 1300Z around 3514 or 3502. Bill puts a couple of CQ calls out and if no takers goes QRT. He has also been heard here in VK6 between 2030 and 2130Z.

If you worked Y1BIF recently, this was a special call from the Baghdad International Fair. QSLs via PO Box 5864. Incidentally Y14SC QSLs are now turning up.

The proposed trip to CR3 land by C5ABK and W4MGN has been postponed. Rumour has it that this may be activated some time in February.

TN8AJ is QRV on 15m (QSL via DM2XLO) and will be in the Congo Republic until July 1980. A list is sometimes taken on 21155 on Saturdays at 1400Z.

T3KC is ex VR1BD, T3PA is ex VR1PJ and T3LA is ex VR3AR, no change in DXCC status. Checking the suffixes, K is for Kiribati, P for Phoenix Islands and I for Line Islands.

Lloyd and Iris Colvin are once again QRV from around the Caribbean area. During the CQ Phone test they were heard from J3ABV and recently were copied signing VP2SAX. QSLs via YA5ME, PO Box 2025, Castro Valley, California 94546.

There will be operation from Kingman Reef during January. (It may be over by the time you read this.) All bands SSB and CW are planned with several operators. It is rumoured that this could be the last operation for some time from this spot as the Palmyra Islands could be used as a nuclear waste dumping ground.

I'm afraid that's all for this month. A Happy and Prosperous New Year to you all. 73 Mike VK6HD.

### QTHs YOU MAY HAVE MISSED

A4XHI — PO Box 8530, Salafian, Sultanate of Dman.  
 DF4NW/A7 — via DARC.  
 C5ABK — via G3LQP  
 FG0DYM — via W3HNK.  
 HK8GM — Box 777, Pato, Colombia.  
 J28AP — Box 814, Djibouti.  
 KG6SW — via W7OM.  
 KV4AA — via K6PBT (change of manager).  
 KH6LW/KH7 — via KH6JEB.  
 LU3ZY — via LU2CN.  
 S8AAT — Box 750, Umtata, Rep. of Transkel, Southern Africa.

VP1RX — via W4SME.

VP2E — via WA4MAV.

VP2EEG — via W3HNK.

VP2EY — via W3HNK.

VP2MBA — via W7FP.

VP2VDH — via N6CW.

VP2VFK — via N6CW.

VP5MRX — via K8MR.

XF4MDX — via XE10X.

ZF2BB — via N4IZ.

ZF2BN — via W4HET.

ZF2CD — via W3ODJ.

ZK2VE — Box 100 Niue.

3B9RS — via DJ6QT.

5N0SID — via G4GTQ.

7P8BQ — via K9KXA.

9Q5DH, 9QWH — via WB4CSW. ■

# IONOSPHERIC PREDICTIONS

Len Poynter VK3ZGP/NAC

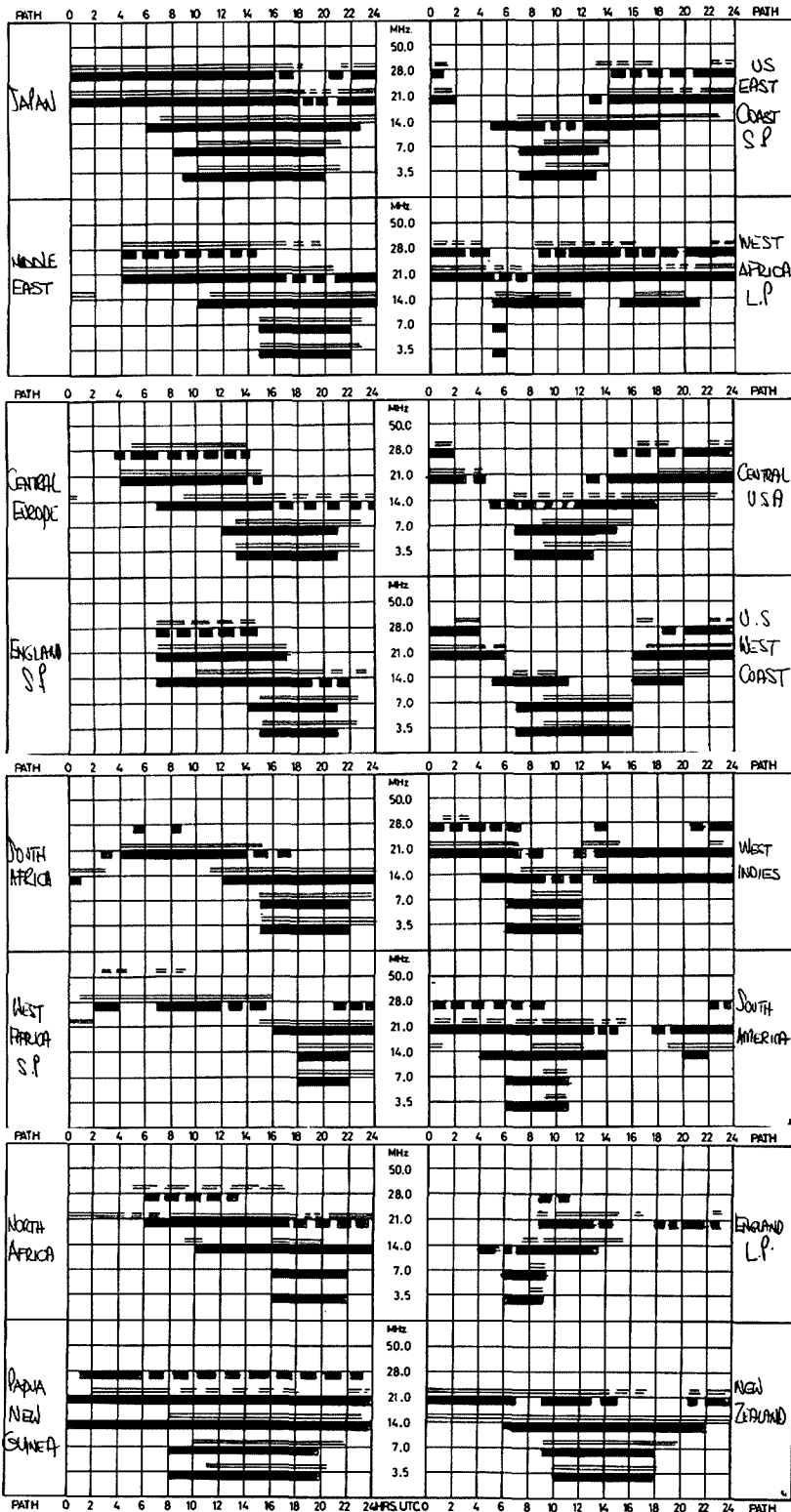

**LEGEND**

- FROM WESTERN AUSTRALIA.
- FROM EASTERN AUSTRALIA.
- BETTER THAN 50% OF THE MONTH, BUT NOT EVERYDAY.
- LESS THAN 50% OF THE MONTH.

PREDICTIONS COURTESY I.P.S. SYDNEY.

ALL TIMES UNIVERSAL UTC (GMT).

# SUNSPOT ACTIVITY INCREASES

Below is a photograph of the sun taken on 10th November 1979 at 0957 daylight saving time by Grahame Sprott, Director, Solar Section, Astronomical Society of Victoria. The number of sunspots visible is quite high and most should be visible again in the first and last weeks in January. Note the two bands of spots above and below the solar equator. These bands will move closer to the equator as the cycle peaks. For a safe viewing method refer to p. 10 July AR.

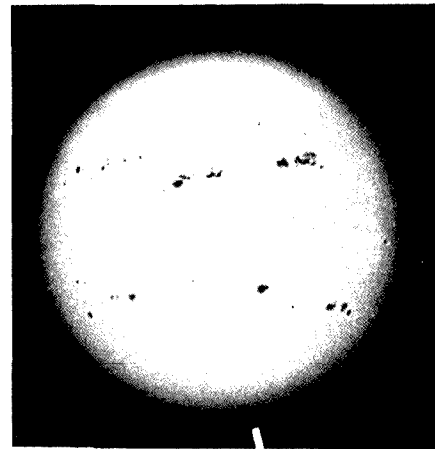

## WICEN

Ron Henderson VK1RH  
Federal WICEN Co-Ordinator,  
53 Hannaford St., Page ACT 2614  
Ph. (062) 54 2059, A.H.

### EMERGENCY SERVICES COMMUNICATIONS PROCEDURE

This issue we continue with the second part of the Emergency Services Communications Procedure paper.

#### 11. PHONETIC ALPHABET

(a) The standard phonetic alphabet is:

Letter	Spoken as	Letter	Spoken as
A	Alfa	N	November
B	Bravo	O	Oscar
C	Charlie	P	Papa
D	Delta	Q	Quebec
E	Echo	R	Romeo
F	Foxtrot	S	Sierra
G	Golf	T	Tango
H	Hotel	U	Uniform
I	India	V	Victor
J	Juliett	W	Whiskey
K	Kilo	X	X-Ray
L	Lima	Y	Yankee
M	Mike	Z	Zulu

(b) Difficult words or groups within the text of plain language message may be spelled using the phonetic alphabet, and preceded by the proword "I SPELL". If the operator can pronounce the word to be spelled, he will do so before and after the spelling to identify the word. Unless block capital letters are difficult, I SPELL is not used.



**EXAMPLE A (a pronounceable word):**  
"Catenary . . . I SPELL Charlie Alfa Tango Echo November Alfa Romeo Yankee-Catenary."

**EXAMPLE B (an unpronounceable abbreviation):**  
"Moving to NSW State HQ" is transmitted as:  
"Moving to I SPELL November Sierra Whiskey-State I SPELL Hotel Quebec."

## 12. PRONUNCIATION OF NUMERALS

- (a) To distinguish numerals from words similarly pronounced, the proword "FIGURES" may be used preceding such numbers.
- (b) When numerals are transmitted the following rules for their pronunciation will be observed:

Numerals	Spoken as	Numerals	Spoken as
0	Zero	5	Fi-yiv
1	Wun	6	Six
2	Too	7	Seven
3	Thuh-ree	8	Ate
4	Fo-wer	9	Niner

- (c) Numbers will be transmitted digit by digit except that exact multiples of hundreds and thousands may be spoken as such.

Number	Spoken as
44	Fo-wer-Fo-wer
90	Niner Zero
136	Wun Thur-ree Six
500	Fi-yiv Hun-dred
1478	Wun Fo-wer Seven Ate
7000	Seven Thow-zand
16000	Wun Six Thow-zand
812681	Ate Wun Too Six Ate Wun

- (d) The figure "zero" is written "ϕ".  
(e) The Decimal Point is written as "pt" and transmitted as "point".

## 13. MIXED GROUP

In giving a mixed group of letters and figures, the prowords FIGURES and I SPELL are used as in the following examples:

The mixed group 31AB7 is sent as follows:

FIGURES three one—I SPELL Alfa Bravo—FIGURE SEVEN.

## 14. PUNCTUATION

In sending capital letters or punctuation, the following phrases are to be used:

- (a) "Blocks on" and "Blocks off".  
(b) "Slop".  
(c) "Brackets on" and "Brackets off".  
(d) "Oblique" (/).  
(e) "Quote" and "Unquote".  
(f) "Hyphen".  
(g) "Point" (written as "pt").

## 15. NET DISCIPLINE

TRANSMISSIONS ARE TO BE AS SHORT AS POSSIBLE, CONSISTENT WITH CLARITY.

- (a) The procedure described in this paper should be followed. If the procedure does not cover a specific operating requirement, use common sense to deal with the situation.

(b) Departures from the standard procedure invariably create confusion and reduce accuracy and speed.

(c) The following basic rules are essential for simplicity and efficiency.

- (1) No transmission is to be made which has not been authorised by proper authority.
- (2) The following practices are to be avoided:
- Unofficial conversations between operators.
  - Transmitting in a directed net without permission.
  - Excessive tuning and testing.
  - Use of plain language in place of appropriate prowords.
  - Speaking faster than the receiving operator can be expected to write.

## 16. OPERATING RULES

(a) To save circuit time, all messages should be written down prior to transmission. Messages preceded by the proword "MESSAGE" are to be written down by the receiving operator.

(b) Transmissions must be kept as short as possible and the use of prowords enhances brevity. Every transmission must be concluded with the proword "OVER" or "OUT" as appropriate.

(c) Transmission should be clear with natural emphasis on each word and should be spoken in natural phrases, not word by word.

Special care must be taken with the transmission of numerals.

(d) To avoid interfering with other traffic, a user should listen on the circuit before transmitting.

(e) When it is necessary for a station to indicate test signals, either for the adjustment of a transmitter before making a call, or for the adjustment of a receiver, the signals are not to continue for more than 10 seconds and will be composed of spoken numerals (1, 2, 3, etc.) with the call sign of the station transmitting the signals.

## 17. RADIO NETS

Radio nets may be "Free" or "Directed". Under conditions of light traffic and well-trained and disciplined operators, a net may be termed "Free", and Control will not intervene in direct communication between substations. Where traffic is heavy however or the standard of training and discipline is suspect, Control must exercise control over the net and all messages between substations will be offered. Control will be the first to answer these offers and will be able to regulate all traffic on the net.

## 18. NET LOGS

- (a) Net logs are to be maintained, when ordered.
- (b) The net log normally shows a complete and continuous record of operating conditions and all transmitted and received traffic. The log should include such data as the following:
- (1) The time of opening and closing of the station(s), etc.
  - (2) Causes of delays on the net.
  - (3) Frequency adjustments and changes on radio channels.
  - (4) Unusual occurrences such as procedure violations, equipment faults, etc.
  - (5) Signal Strength Reports.

(c) When opening a new net or starting a new day's log or the operator is relieved or closes the net he is to sign the log. The oncoming operator is to then write his name on the log.

## 19. LOG SHEETS

Log sheets should contain spaces for date, time, call to, call from, and event or text or message identity.

## WICEN INVOLVEMENT IN NDO EXERCISE COMCOORD 2

The annual Natural Disasters Organisation exercise for the Natural Emergency Operations Centre (NEOC) was held from 7 to 9 November 1979. The simulated emergencies were a cyclone in Darwin and an earthquake in Adelaide. The Darwin and Adelaide Emergency Operations Centres were manned and in contact with the NEOC in Canberra.

WICEN was involved in passing typical prepared messages from Darwin and Adelaide to Canberra over the period 0900Z 7 November until 1000Z 8 November 1979.

The Darwin circuit was worked on RTTY and showed a 92 per cent availability, however this was reduced to 79 per cent workability due to operator unfamiliarity with RTTY.

The Adelaide circuit was scheduled for SSB from 0200Z until 1100Z and achieved a 56 per cent availability due in the main to a late path being established. A check of the propagation predictions showed a daytime ALF of 6.9 MHz, together with an E layer MUF of 13.7 MHz and F layer MUF of 12.5 MHz. In retrospect this difficulty should have been anticipated and relay stations alerted or put on stand-by.

The message rate was low, only four or five messages were passed from each outstation, but they were designed to be representative of the type of traffic that would occur.

The WICEN involvement demonstrated the need for operator training and circuit planning, also the value of RTTY when a good path exists. It is our only national WICEN exercise. It demonstrates our abilities to NDO and state SES and provides us with necessary experience.

Thanks are due to the roster of operators who worked from South Australia and manned VK1W1, also to VK8HA, who "went it alone from the top".

## WICEN-WA ACTIVITIES REPORT

1. The year of 1979 to present date has been fairly active for WICEN-WA. Listed below are the activities we have been involved in:

24 February, 24 March, 28 April, 26 May: Half-day field exercise with LVES and German Shepherd dog tracker team.

30 June: Full day as above, including simulated aircraft crash.

2-3 July: Operation search for lost youth, Yancheep.

3-4 August: 24 hour Regional exercise "Long Stop" based on earthquake situation, with at least 350 incident reports.

15 September: Day Regional HQ internal exercise "Home Base", similar to CP telephone battle.

21 October: Communications task for the Neurological Foundation of Australia during a Fun-Run.

All activities applied for and approved by P. and T., Perth, with no difficulty.

2. The WICEN-WA Group has been integrated into the HQ Metropolitan (Perth) Region, State Emergency Service and is responsible for the manning and operation of the Communication Room. Members operate the Control Set of the Metropolitan Command Net (Voice). The ability is there to use the Communications Room for State-wide operations.

3. The somewhat small RTTY Group in WA has also accepted a role within WICEN structure and there are current plans to install a permanent terminal in the Communications Room. Hopefully this may be achieved before the Christmas 1979 holidays.

4. A small reconnaissance detachment has been formed with the object of not only being used for back-up communications but to act as the eyes of the Area Co-ordinator (Metropolitan). We will have to do more work on this plan and obviously try it out.

5. It is my intention to curtail the training programme over the summer months. Naturally we would have to cope with school holidays and I feel we must retain some resources as the summer months usually bring out a share of search operations.

6. I believe that WICEN-WA is firmly established, though not large in active strength. State Emergency Service Officers appear to be quite satisfied with the situation and we are information for a lot of the writings.

S. A. Jenkins, Co-ordinator WICEN-WA.

## WICEN NORTH QUEENSLAND ACTIVITIES REPORT

The WICEN plan for North Queensland has recently been revised.

Since preparing the original plan several years ago the organisation has grown considerably, especially with the introduction of the novice licence and the migration of amateurs from other areas.

Effective coverage has also increased and more remote areas now have one or more permanent amateur operator residents.

All these factors necessitated a change in the planning and operation of WICEN networks within the Zone.

The plan has been approved by the P. and T. Department (Queensland).

Reproduction has been carried out by the Cairns office of the SES and the plan is incorporated in their local disaster plans for North Queensland.

You may be interested to know that the Cairns Club has been successful in negotiations with Telecom for the installation of the Club's 2 metre repeater (VK4RCA Ch. 8) at the TV station on Mt. Bellendenker (5200 ft. AMSL), and a proposal has been put to the Townsville Club for linking through their repeater on Mt. Stuart.

Also this Club has been donated a model 15 teletype machine, and as several local amateurs, including myself, are becoming active on RTTY, this gives WICEN another useful model for handling emergency traffic.

Ted Gabriel VK4YG.

# 20 YEARS AGO

Ron Fisher VK3OM

JANUARY 1960

A new decade and the Editorial page takes a look at the possible outcome of the just completed ITU Conference. It seems that we might be in the same situation at the present time. It was suggested that we would lose 100 kHz off the top end of 80 and 50 kHz off the top end of 40. We did. The final words are worth repeating, "Put your transmitter on the air regularly; encourage others to do the same; encourage young people to take up Amateur Radio as a hobby and encourage your friends to join the WIA". On the technical side, SSB was starting to show up as the thing to be in. The AR7 and SSB. C. Cullinan VK3AXU described the addition of a product detector to this still popular receiver.

Transistorised equipment was the in thing in the early sixties, but many were trying to resist the change. We went through a period where many tried to run tubes with 12 volts HT. In fact a special series was brought out designed with just this in mind. Several commercial car radios were marketed using these, often with transistor audio output. Taking the reverse approach V. Kerr VK4LK described a valve audio system working with a 12 volt HT. Many were building SSB transmitters about this time and most used the phasing method. Lining the thing up was always a problem but Stan VK2EL described a simple method using a receiver as the main piece of test gear.

ATV was in the news in 1960. Flying spot scanners were the in thing. Call signs mentioned were VK2AWW, VK5AO, VK3AUX and the late VK3BU of Geelong Short Wave Listener groups were very active and an action packed page of notes was a feature of AR. Maurice Cox L3055 was the driving force behind this informative section. ■

## QSP

### THOUGHT FOR THE MONTH

"Those who persistently trigger repeaters without saying anything perhaps would rather have people wonder why they don't say anything rather than come out with a comment and then leave people wonder why they bothered to say anything."—Break-In. ■

## ADVERTISERS' INDEX

AMATEUR RADIO ACTION	36
CHIRNSIDE ELECTRONICS	8
CUSTOM COMMUNICATIONS	34
CW ELECTRONICS	32
DICK SMITH ELECTRONICS	32, 38
GRAHAM STALLARD	23
GFS ELECTRONIC IMPORTS	24
IMARK	4
PHILIPS	7
SIDEBAND ELECTRONIC IMPORTS	33
SCALAR INDUSTRIES	5
TRIO-KENWOOD	44
US IMPORTS	42
VICOM	2, 35, 43
WIA NSW DIVISION	32
WILLIAM WILLIS & CO. PTY. LTD.	32

## EXECUTIVE OFFICE HAS MOVED

NEW ADDRESS:

**3/105 HAWTHORN ROAD  
CAULFIELD NORTH**  
Tel. No. not yet known

Postal address unchanged:  
**P.O. BOX 150, TOORAK 3142**

## HAMADS

- Eight lines free to all WIA members. \$9 per 3 cm for non-members.
- Copy in typescript please or in block letters to P.O. Box 150, Toorak, Vic. 3142.
- Repeats may be charged at full rates.
- Closing date: 1st day of the month preceding publication. Cancellations received after about 12th of the month cannot be processed.
- QTHR means address is correct as set out in the WIA 1979 Call Book.

### FOR SALE

Kenwood TS-520S Transceiver, mint cond., \$565, ONO. VK3OM, QTHR. Ph. (03) 560 9215.

Yaesu FRG-7 Rx, little use, good cond., digital clock, price \$150, ONO. Rob L50355, QTHR.

Yaesu Linear FL2100B, new cond., \$400; Swan mobile whip, all bands, 1 kW, \$100. Bill Hempel VK1BH, QTHR. Ph. (062) 88 6002 A.H., (062) 65 5385 Bus.

ICOM IC701 HF Txcvr and IC701 PSU, mint cond., mic., manuals, no mods., \$1300; Yaesu FRG7 comm. recvr., .5-30 MHz, late model, slow reduction drive and narrow filter for SSB as per AR mods., exc. cond., \$250. B. Bathols VK3UV, QTHR. Ph. (03) 90 6424 A.H.

Yaesu Tcvr FDX400 with adjust. effective noise blankers, spkr., set of 19 valves and manual, clean, in original working order, \$340, ONO. VK2AOU, QTHR. Ph. (02) 53 9789 A.H., (02) 807 0484 Bus.

FT200, complete with power supply and microphone, \$350. VK3BVK, 50 Ficher St., Torquay. Ph. (03) 329 0160 Bus.

TS-520S, with mic., SWR meter and ant. coupler, with instr. manuals and orig. boxes, \$560; portable double conversion Rx, 5 bands, MW plus 3.8-28.5 MHz, with BFO, xtal freq. marker, band spread dial and carrying case, \$86; both in excellent cond. VK3VBF, QTHR. Ring Ken (03) 857 7261 evenings.

Drake SSR1, complete with orig. packing box, book and accessories, \$165. Contact David Deerman, 222 Parry St., Charleville, Q. 4470. Ph. 278.

Multi-Palm II Hand-held 2m Tcvr, rptr, 2, 3, 5 and 8, simplex 40 and 50, as new cond., also nicads, charger, leather case, \$230, ONO. VK3BNJ, Ph. (03) 743 6708.

Drake TR4C Txcvr, complete with noise blanker fitted, 240V AC, 12V DC PSU and set of spare final tubes and driver tubes, exc. cond., \$750 the lot; MFJ SSB filter, \$15.00; Quasi-Logarithmic speech Proc. by New England Eng., \$30. Alf Chandler, QTHR. Ph. (03) 99 5344.

## SILENT KEYS

It is with deep regret that we record the passing of —

Mr. A. P. BALTHASAR  
Mr. R. J. LENNON

VK2IH  
VK1TV

Yaesu FT101E with matching speaker, mic., manual, exc. cond. Trevor VK3NMJ, QTHR. Ph. (03) 789 3129.

Eddystone General Coverage Rx, model 1830/1, 9 bands, continuous 120 kHz-31 MHz, 6 xtals fitted, fully solid state, extension plinth spkr. fitted, owner's manual, very stable, perfect cond., model used by many comm. orgs., \$1,500. L30605, QTHR.

HC500A ATU, 500W, with book, as new, \$100; Micronta SWR/PWR meter, 10/100/1000W, as new, \$30; EA electronic keyer, wired and tested OK, \$35; 13.8V. 2A reg. power supply, \$20. VK1KV, QTHR. Ph. (062) 88 1767 AH, (062) 45 3522 Bus.

Hy-Gain Quad, 20, 15, 10m, single coax feed, exc. cond., need the space on the tower for VHF array, \$180. B. Bathols VK3UV, QTHR. Ph. (03) 90 6424 after 7.00 p.m.

SB200 2m Transverter, \$125; FT75 HF transceiver, with ext. VFO, xtals, 240V and 12V supplies, \$295. VK3AFW, QTHR. Ph. 579 5600 AH.

Contents of VK1 Div. Parts Box, incl. light dimmer kits, ST5 RTTY demod. PCB and photo neg., misc. PCBs for keying monitor and FM alignment osc., PN3565 xtrs, pot cores, small neosid coil formers with F25 slugs and other hardware, 3 x 5 in. reels Apex rec. tape, ¼ in. x 600 ft., misc. pots. Please send for list to Box 46, Canberra, ACT 2600, or John Tilley VK1FT, QTHR.

Yaesu FT200 with matching PSU, mic., hand-book, FT200 club notes, exc. cond., \$400. P. Willmott L31159, QTHR. Ph. (03) 772 1802.

RTTY Gear, model 15 printer, \$65; model 14 reprocessor, \$35; both 45 baud and v.g.c. VK3YLH, QTHR. Ph. (03) 754 4974.

TS820/S, CW filter, spkr., MC50, mic., \$750; TS120/V, CW filter, HH mic., \$460; TR7400, mic., but damaged mobile bracket, \$350; Dentrone ML2500/B, modified for 28 MHz, \$800; home-brew 100W in broad band linear, suit TS120/V, \$75; home-brew ant. tuner, with SWR and power meter, bal. or unbal. feeder, \$130; AT-120 tuner, suits TS-120, \$70; home-brew electronic keyer with memory and MK701 paddle, \$150; FRG-7 Rx, \$200; Hansen RMS-PEP power meter FS-600A, \$60; most items under 1 year old, cartons and manuals; will sell to licenced amateur only. VK2BOT, QTHR. Ph. (02) 623 4858 AH.

### WANTED

VHF Radio, AN/ARC 49 HF radio 618S-1A, UHF radio AN/ARC51BX, DME control panel VAN 5, intercommunication control panels AN/A1C 18 (3 if possible), radio compass indicator I-75-A, panels or complete units if possible. Information to Mark VK3NOY. Ph. (03) 478 8726 AH.

Heathkit SB-620 Spectrum Analyser, offering \$100. Bruce Hedland-Thomas VK600, 27 Parsons St., Embleton, WA. Ph. (09) 271 0649.

Uriden 2020 or Tempo 2020 Tcvr., working or not, with or without accessories, pay up to \$350; freight paid. VK8ZOO, QTHR. Ph. (089) 27 2003 AH.

VFO-520S External VFO for Kenwood TS520S. VK2DDS, was VK2NPS, QTHR. Ph. (065) 52 3464 after 6.30 p.m.

Yaesu FT221 2m Tcvr. Details to Mark Ph. (08) 389 1204 after 800 GMT.

### TRADE HAMADS

Amidon Torolds, refer ARRL Handbook. T200-2 \$6 ea., T106-2/6 \$3 ea., T50-2/6/10/12 \$1.20 ea., T25-2/6/10/12 70c ea. Orders over \$10 less 10%. P & P 80c. SAE for information. US Imports, Box 157, Mortdale, NSW 2223. Tel. (02) 579 3848.

# 2m ALL-MODE! IC251A

# ICOM



## Features:

### \* 2m ALL-MODE TRANSCIVER INCORPORATING A MICROCOMPUTER

CPU control with ICOM's original programs provides various operating capabilities. No-backlash dial controlled by ICOM's unique photo-chopper circuit. Band-edge detector and Endless System provides out-of-band protection. No variable capacitors or dial gear, giving problem-free use. The IC-251A provides FM, USB, LSB, CW coverage in the 143.8-148.2MHz frequency range. Thus the IC-251A can be used for mobile, DX, local calls, and satellite work.

### \* MULTI-PURPOSE SCANNING

Memory Scan allows you to monitor three different memory channels. Program Scan provides scanning between two programmed frequencies. Adjustable scanning speed. Auto-stop stops scanning when a signal is received, in all modes.

### \* DUAL VFO'S

Two separate VFO's can be used either independently or together for simplex operation, and any desired frequency split in duplex operation.

### \* CONTINUOUS TUNING SYSTEM

ICOM's new continuous tuning system features a luminescent display that follows the tuning knob movement and provides an extremely accurate readout. Frequencies are displayed in 7 digits representing 100MHz to 100Hz digits.

Automatic recycling restarts tuning at the top of the band, i.e., the high edge when the dial goes below the low edge. Recycling changes the high edge to the low edge as well. Quick tuning in 1KHz steps is available, and fine tuning in 100Hz steps in the SSB and CW modes, and 5KHz steps and 1KHz steps in the FM mode, is provided for trouble free QSO.

### \* EASIER OPERATION AND LIGHTER WEIGHT

The most compact, lightest weight all-mode 2m transceiver. First to use a pulse power supply in communication equipment, for lighter weight. 50 mm-diameter large tuning control knob for smooth and easy tuning. Trouble-free controlling knobs for both receiving and transmitting. LED indicator for transmit and receive modes.

### \* MOST SUITABLE FOR BOTH FIXED AND PORTABLE STATIONS

Built-in 240V AC and DC power supplies. Convenient Dial Lock switch for mobile operation. Easy-carry handle. Effective Noise Blanker to reduce outgoing pulse noise. IC-SM5 high quality stand microphone is suitable for fixed station operation. Powerful audio output, 1.5 watts at 8 ohm, for easy listening even in noisy surroundings.

### \* OUTSTANDING PERFORMANCE

The RF amplifier and first mixer circuits using MOS FET's, and other circuits provide excellent Cross Modulation and Two-Signal Selectivity characteristics. The IC-251A has excellent sensitivity demanded especially for mobile operation, high stability, and with Crystal Filters having high shape factors, exceptional selectivity.

The transmitter uses a balanced mixer in a single conversion system, a band-pass filter and a high-performance low-pass filter. This system provides distortion-free signals with a minimum spurious radiation level.

### \* BACK-UP SUPPORT

Backed by Vicom spares and technical support, together with 90 day warranty.



**IC-251A Typical Technical Characteristics:** General. Numbers of semi-conductors: Transistors 99, FET's 12, IC's 37, Diodes 132. Frequency coverage: 143.8000 - 148.1999MHz. Frequency resolution: SSB 100Hz steps FM 5KHz steps. 1KHz steps with TS button depressed. Frequency Control: Microcomputer based 100Hz step Digital PLL synthesizer. Independent Transmit-Receive Frequency Capability. Frequency Readout: 7 digit LED 100Hz readout. Frequency stability: Within  $\pm 1.5$ KHz. Memory channels: 3 channels, any inband frequency programmable. Usable conditions: Temperature: -10 C - 60 C (14 F - 140 F). Operable time: Continuous. Antenna impedance: 50 ohms unbalanced. Power supply requirement: 13.8V DC  $\pm 15\%$  (negative ground) 3A Max. or 240V AC  $\pm 10\%$ . Current drain (at 13.8V DC): Transmitting: SSB (PEP 10W) Approx. 2.3A. CW, FM (10W), Approx. 2.3A. Fm (1W), Approx. 1.0A. Receiving: At max audio output. Approx 0.6A. Squelched Approx 0.4A. Dimensions: 141mm (h) x 241mm (W) x 264mm (D). Weight: Approx. 5.0 Kgs. Transmitter: Output power: SSB 10W (PEP). CW 10W FM 1 - 10W (Adjustable). Emission mode: SSB (A3J, USB/LSB), CW (A1), FM (F3). Modulation system: SSB Balanced modulation, FM Variable reactance

frequency modulation. Max. frequency deviation:  $\pm 5$ KHz. Spurious emission: More than 60dB below peak power output. Carrier Suppression: More than 40dB below peak power output. Unwanted Sideband: More than 40dB down at 1000Hz AF input. Microphone: 1.3K ohm dynamic microphone with built-in preamplifier and push-to-talk switch. Operating mode: Simplex, Duplex. (Any inband frequency separation programmable). Receiver: Receiving system: SSB, CW Single conversion super-heterodyne. FM Double conversion superheterodyne. Receiving Mode: SSB A3J, USB/LSB, CW (A1), FM (F3). Intermediate Frequency: SSB, CW 10.7MHz, FM 10.7MHz, 455KHz. Sensitivity: SSB, CW Less than 0.5 microvolts for 10dB S+N/N. Fm More than 30dB S+N+D/N+D at 1 microvolt. Less than 0.6 microvolts for 20dB Noise quieting. Squelch sensitivity (FM only): Less than 0.4 microvolts. Spurious response rejection ratio: More than 60dB. Selectivity: SSB, CW More than  $\pm 1.2$ KHz at -6dB point. Less than  $\pm 2.4$ KHz at -60dB point. FM More than  $\pm 7.5$ MHz at -6dB point. Less than  $\pm 15$ MHz at -60dB point. Audio output power: More than 1.5W. Audio output impedance: 8 ohms.

# VICOM

Check it out at your VICOM dealer.

# KENWOOD

## GET UP AND GO KENWOOD IN 1980

### TS-120S Mobile Station

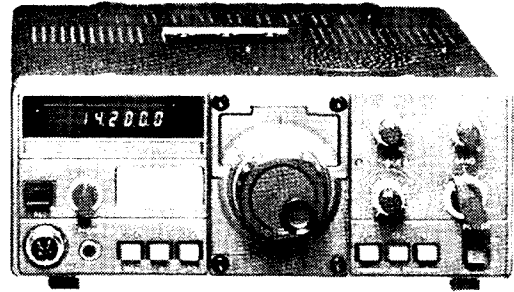

#### RECOMMENDED RETAIL PRICE

TS-180S ...	\$1240	SP-180 ...	\$63	TS-120S ...	\$735	MC-35S ...	\$26
AT-180 ...	\$161	VFO-180 ...	\$169	AT-120 ...	\$96	TR-7625 ...	\$455
PS-30 ...	\$205	MC-50 ...	\$55	MA-5 ...	\$136		

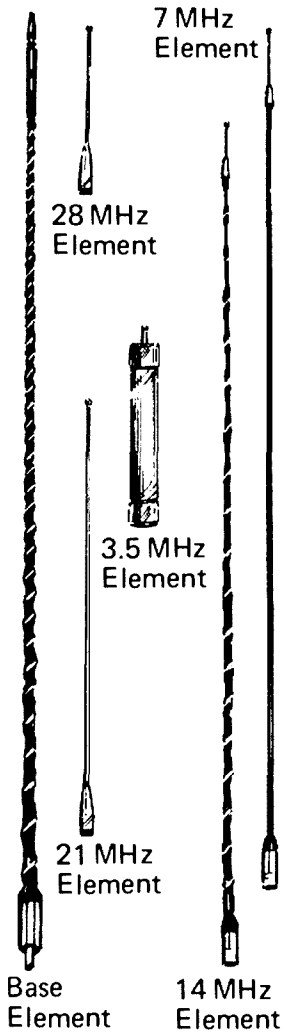

### MA-5 5 BAND HELICAL TYPE HF MOBILE ANTENNA

### TS-180S Base Station



MC-50



AT-180

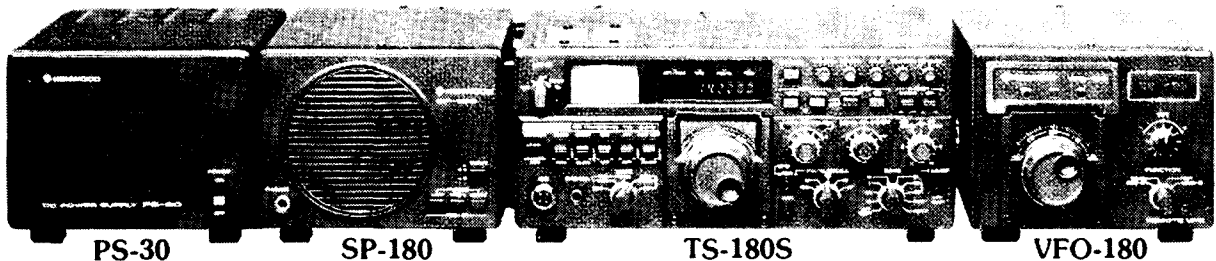

PS-30

SP-180

TS-180S

VFO-180

## TRIO-KENWOOD (AUSTRALIA) PTY. LTD.

31 Whiting Street, Artarmon, Sydney, N.S.W. 2064. Telephone (02) 438-1277

#### Authorised Distributors:

**N.S.W.:** SIDE BAND ELECTRONICS SALES. (02) 438-4191. — EMTRONICS (02) 398-6378 •  
**VIC.:** VICOM IMPORTS PTY. LTD. (03) 699-6700 • **QLD.:** MITCHELL RADIO CO. (07) 57-6830 •  
**S.A. & N.T.:** INTERNATIONAL COMMUNICATIONS SYSTEMS PTY. LTD. (08) 47-3688 •  
**W.A.:** WILLIS ELECTRONICS (09) 321-7609 • **TAS.:** ADVANCE ELECTRONICS. (003) 31-5688 •  
**PLUS MANY OTHER REGIONAL OUTLETS THROUGHOUT AUSTRALIA**

Call into  
your nearest  
authorised  
distributor  
and ask to see  
these and other  
high performance  
Kenwood units

# amateur radio

JOURNAL OF THE WIRELESS INSTITUTE OF AUSTRALIA



VOL. 48, No. 2

FEBRUARY 1980

## ***FEATURED IN THIS ISSUE:***

- ★ 1979 RD CONTEST RESULTS
- ★ Review: KENWOOD R1000 GENERAL COVERAGE RECEIVER
- ★ Review: YAESU FT207R SYNTHESISED 2m HAND-HELD
- ★ THE WEE WILLIE WONDER ANTENNA COUPLER
- ★ AN 80 METRE VERTICAL

# THIS IS A YAESU PRICE TICKET.

## Notice the price?

There isn't one! Or if there is, it represents only the **maximum** you will have to pay. If anyone advertises, in Australia, a lower price than we show, we will guarantee to beat it! Our list prices are very competitive as they are – but we will guarantee to lower them if our prices are undercut!

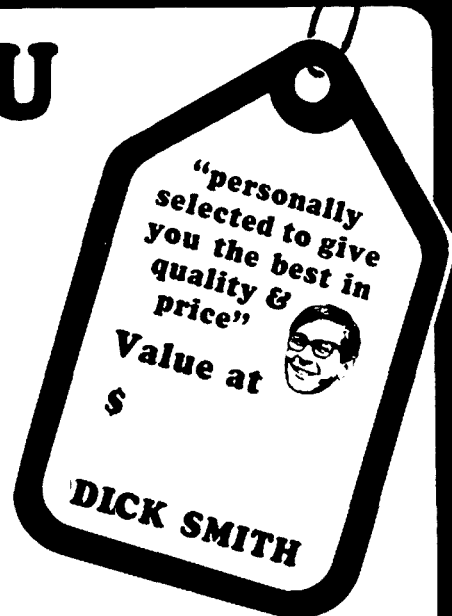

**Please take these prices with a grain of salt . . .**



**WHY TAKE CHANCES?  
BUY YOUR YAESU GEAR  
FROM THE AUTHORISED  
AUSTRALIAN YAESU  
AGENTS!**

### HF TRANSCEIVERS:

- FT-901D: Superb all-mode HF transceiver with digital readout. 6146B finals: 180 watts. The ham's dream! ..... CatD-2854 **\$1266.00**
- FT-101Z: Up-graded version of the famous FT-101E. Suits the FT-901 accessories, same smart styling ..... CatD-2862 **\$849.00**
- FT-7B: Mobile or base, all HF bands. AM/SSB/CW, 12 volt operation. Easy controls for safer mobiling, too. .... CatD-2868 **\$649.00**

### LINEAR AMPLIFIERS:

- FL-2100B: 1.2kW of muscle (drive it at 400 and it's coasting!) Tunes all HF bands: 240 volt operated. .... CatD-2546 **\$599.00**

### VHF TRANSCEIVERS:

- FT-625R: The new all mode 6m rig for DX chasers. .... CatD-2886 **\$795.00**
- FT-207R: The 21st century microprocessor-controlled hand held for 2 metre operation. Complete with NiCads. .... CatD-2888 **\$358.00**
- CPU-2500RK: 800 channels from 144-148; 25 watts. .... CatD-2889 **\$549.00**
- FT-227RB: 2 metre mobile, dual power out, built-in memorizer. .... CatD-2891 **\$399.00**

### RECEIVERS:

- FRG-7: Probably the most popular receiver in the world! ) 0.5 to 30MHz, famous Wadley Loop circuit. Mains or 12V. .... CatD-2850 **\$395.00**
- FRG-7000: Up-graded FRG-7, with digital readout, dual clocks & timer, etc. A superb receiver for the serious listener. .... CatD-2848 **\$625.00**

### ACCESSORIES:

- FC-901 Antenna tuner: Suits most transceivers; tunes into virtually any load (almost a wet piece of string) ..... CatD-2855 **\$265.00**
- DC/DC Converter: Suits both the 901 & 101Z. .... CatD-2856 **\$75.00**
- MEMORY UNIT: For both the 901 & 101Z. .... CatD-2858 **\$149.50**
- YE7A Mic: 500 ohms imp; with p.t.t. Suits most transceivers. .... CatD-2863 **\$14.50**
- Cooling Fan: For the 101Z (or replacement on 901). .... CatD-2865 **\$39.00**

### TEST EQUIPMENT:

- YC-500S Digital Frequency Counter: 1ppm accuracy, 500MHz. .... CatD-2892 **\$475.00**

**WE OFFER EASY TERMS THROUGH BFC FINANCE \***

*For us to better any price, simply show us the advertisement from an Australian company. After checking that they have stocks available at that price, we will sell it for a lower price. Offer open while stocks last.*

# DICK SMITH ELECTRONICS



**NSW** 125 York Street, SYDNEY. Phono 290 3377  
147 Hume Highway, CHULLORA. Phono 642 8922  
162 Pacific Highway, GORE HILL. Phono 439 5311  
30 Gross Street, PARRAMATTA. Phono 693 1133

**ACT** 96-99 Glodstano Street,  
**VIC** 399 Lonedale Street,  
666 Bridge Road,  
**QLD** 166 Logan Road,  
**SA** 203 Wright Street,  
**WA** 414 William Street,

**FYSHWICK.** Phono 80 4944  
**MELBOURNE.** Phono 67 9934  
**RICHMOND.** Phono 429 1614  
**BURANOA.** Phono 391 6233  
**ADELAIDE.** Phono 212 1962  
**PERTH.** Phono 329 6944

**SHOPS OPEN 9AM to 5:30PM**  
(Saturday: 9am till 12 noon)  
**BRISBANE:** Half hour earlier.

**ANY TERMS OFFERED ARE TO APPROVED APPLICANTS ONLY**  
**RE-SELLERS OF DICK SMITH PRODUCTS IN MOST AREAS OF AUSTRALIA.**

263 Keira Street, WOLLONGONG Phono 29 3800  
EXCEPT WHERE NOTED, ALL ITEMS SHOWN IN STOCK AT PRICES GIVEN AT TIME OF GOING TO PRESS.  
**MAIL ORDER CENTRE: PO Box 321, NORTH RYDE NSW 2113. Ph 888 3200. PACK & POST EXTRA.**

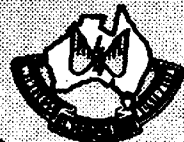

# amateur radio

Published monthly as its official journal by the Wireless Institute of Australia, founded 1910.

**FEBRUARY 1980**

**VOL. 48, No. 2**

**PRICE: \$1.20**

Registered Office:  
3/105 Hawthorn Road,  
Caulfield North 3161.

**MANAGING EDITOR:**  
BRUCE BATHOLS\* VK3UV

**PRODUCTION MANAGER:**  
MARK STEPHENSON\* VK3NOY

**TECHNICAL EDITORS:**  
BILL RICE\* VK3ABP  
EVAN JARMAN\* VK3ANI  
RON COOK\* VK3AFW  
GIL SONES\* VK3AUI

**CONTRIBUTING EDITORS:**  
BOB ARNOLD VK3ZBB  
MIKE BAZLEY VK6HD  
ROD CHAMPNESS VK3UG  
ROY HARTKOPF\* VK3AOH  
RON FISHER\* VK3OM  
ERIC JAMIESON VK5LP  
PETER MILL VK3ZPP  
LEN POYNTER\* VK3ZGP  
BILL VERRALL VK5WV  
WALLY WATKINS VK2DEW

**DRAFTING:**  
NEIL OSBORNE\* VK3YEI

**BUSINESS MANAGER:**  
PETER DODD VK3C1F

\*Member of Publications Committee

Enquiries and material to:  
The Editor,  
PO Box 150, Toorak, Vic. 3142

Copy is required by the first of each month. Acknowledgement may not be made unless specially requested. All important items should be sent by certified mail. The editor reserves the right to edit all material, including Letters to the Editor and Hamads, and reserves the right to refuse acceptance of any material, without specifying a reason.

Advertising: Material should be sent direct to P.O. Box 150, Toorak, Vic., 3142, by the 25th of the second month preceding publication. Phone: (03) 24 8652.—Hamads should be sent direct to P.O. Box 150, Toorak, Vic., 3142, by the 1st of the month preceding publication.

Trade Practices Act: It is impossible for us to ensure that advertisements submitted for publication comply with the Trade Practices Act 1974. Therefore advertisers and advertising agents will appreciate the absolute need for themselves to ensure that the provisions of the Act are complied with strictly. Readers are reminded that, when buying, obtaining or receiving goods from overseas including goods listed in advertisements by overseas organisations in this Journal, Customs Import duties and Sales Tax may be levied on the goods at the time of importation. These amounts, if any, are payable by the purchaser unless the terms of sale state otherwise and the seller has made specific provision to this effect in his quotation to the buyer or unless other prior arrangements are in force between the buyer and the seller.

Typesetting: MUELLER INDUSTRIES  
1a Levenswell Road, Moorabbin, 3189  
Tel.: 553 0292

Printers: EQUITY PRESS PTY. LTD.  
50-52 Islington Street, Collingwood, 3065  
Tel.: 41 5054, 41 5055

## CONTENTS

### TECHNICAL

An 80 metre Vertical	16
Calculation of Great Circle Distances	14
Simple Antenna Coupler	6

### GENERAL

C.A.R.E. (Community Amateur Radio Events)	17
RD Contest Results 1979	26
Hooray (for none of the above)	20
NOVICE NOTES — Beware the SWR Meter	29
Reviews —	
The FT207R 2m Transceiver	11
The R1000 General Coverage Receiver	8
Western Zone Convention	20

### DEPARTMENTS

Amateur Satellites	24
Around the Trade	40
Awards Column	38
Contests — Commonwealth Contest 1980	33
Divisional Notes	40
Hamads	41
Ionospheric Predictions	34
International News	39
Intruder Watch	39
Letters to the Editor	33
Obituary	42
QSP	4, 19, 26, 32, 39
VHF-UHF — An Expanding World	30
WIANEWS	5
You and DX	36

**ADVERTISERS' INDEX** 42

## Cover Photo

### AMATEUR RADIO ASSISTS RUNNERS

The "Sun" City to Surf Race held in Sydney during August 1979 attracted some 21,000 runners. Amateur Radio provided communications consisting of a radio link in the lead vehicle, numerous check-points along the route and portable man-pack links. Eric Van de Weyer VK2ZUR seen here relaying a message for a race official at Bondi Beach, the race finish.

2 metres FM via a repeater was used as the primary system with a HF network

back-up. The lead vehicle relayed up to the minute positions of the front runners. Numerous fixed check-points provided information for medical assistance to exhausted runners. This is the second year that Amateur Radio has provided communications and it has proved to be a worthwhile contribution, bringing to the attention of the public what Amateur Radio can do.

Photo: VK2ATU

# WIRELESS INSTITUTE OF AUSTRALIA

Federal President: Dr. D. A. Wardlaw VK3ADW

**Federal Council:**

VK1 Mr. R. G. Henderson VK1RH  
 VK2 Mr. T. I. Mills VK2ZTM  
 VK3 Mr. G. A. G. Williams VK3ZXW  
 VK4 Mr. A. R. F. McDonald VK4TE  
 VK5 Mr. C. J. Hurst VK5HI  
 VK6 Mr. N. R. Penfold VK6NE  
 VK7 Mr. R. K. Emmett VK7KK

Staff: Mr. P. B. Dodd VK3CIF, Secretary.  
 Part-time: Col. C. W. Perry, Mrs. J. M. Seddon and Mr. Mark Stephenson (AR Production).

Executive Office: 3/105 Hawthorn Rd., Caulfield North, Vic. 3161. Ph. (03) 528 5962.  
 Divisional Information (all broadcasts are on Sundays unless otherwise stated).  
**ACT:**

President — Mr. A. Davis VK1DA  
 Secretary — Mr. F. Robertson-Mudle VK1NAV  
 Broadcasts— 3570 kHz and 2m Ch. 6 (or 7): 10.00Z.  
**NSW:**

President — Mr. F. S. Parker VK2NFF  
 Secretary — Mr. T. I. Mills VK2ZTM  
 Broadcasts— 1825, 3595, 7146 kHz, 28.32, 52.1, 52.525, 144.1, 145.6, 146.4, Rptr. Ch. 3—Gosford, Ch. 4—Lismore, Ch. 5 Wollongong, Ch. 8—Dural 11.00h local (Evening 0930Z). Relays on 160, 80 and 10m, VHF and Repr. Ch. 3, Ch. 5, Ch. 8, and Hunter Branch, Mondays 0930Z on 3595 kHz, 10m, and Ch. 3 and 6. RTTY Sunday 0030Z 7045, 14090 kHz, Ch. 52, 0930Z 3545 kHz, Ch. 52.

**VIC.:**  
 President — Mr. E. J. Buggee VK3ZZN  
 Secretary — Mr. G. F. Atkinson VK3YFA  
 Broadcasts— 1840, 3600, 7135 kHz—53.032 AM, 144.2 USB and 2m Ch. 2 (5) repeater: 10.30 local time.  
 Gen. Mtg. — 2nd Wed., 20.00.

**QLD.:**

President — Mr. A. J. Aarsee VK4QA  
 Secretary — Mr. W. L. Giells VK4ABG  
 Broadcasts— 1825, 3580, 7146, 14342, 21175, 28400, kHz; 2m (Ch. 42, 48): 09.00 EST.  
 Gen. Mtg. — 3rd Friday.

**SA:**

President — Mr. I. J. Hunt VK5QX  
 Secretary — Mr. W. M. Wardrop VK5AWM  
 Broadcasts— 1820, 3550, 7095, 14175 kHz; 28.5 and 53.1 MHz, 2m (Ch. 8): 09.00 S.A.T.  
 Gen. Mtg. — 4th Tuesday, 19.30.

**WA:**

President — Mr. Ross Greenaway VK6DA.  
 Secretary — Mr. Peter Savage VK6NCP.  
 Broadcasts— 3560, 7075, 14100, 14175 kHz. 28.485, 52.290 MHz. 2 metres Ch. 2 Perth, Ch. 6 Wagin. Time 0130Z.  
 Gen. Mtg. — 3rd Tuesday.

**TAS.:**

President — Mr. I. Nicholls VK7ZZ  
 Secretary — Mr. P. T. Blake, VK7ZPB  
 Broadcasts— 7130 (AM) kHz with relays on 2m Ch. 2 (S), Ch. 8 (N), Ch. 3 (NW), 09.30 EST.

**NT:**

President — Mr. T. A. Hine VK8NTA  
 Vice-Pres. — Barry Burns VK8DI  
 Secretary — Robert Millikan VK8NRM  
 Broadcasts— Relay of VK5WI on 3.555 MHz and on 148.5 MHz at 2330Z. Slow morse transmission by VK8HA on 3.655 MHz at 1000Z almost every day.

**Postal Information:**

VK1 — P.O. Box 46, Canberra, 2600.  
 VK2 — 14 Atchison St., Crows Nest, 2065 (Ph. (02) 43 5795 Tues & Thurs (10.00-14.00h), P.O. Box 123, St. Leonards, NSW 2065.

VK3 — 412 Brunswick St., Fitzroy, 3065 (Ph. (03) 41 3535 Weekdays 10.00-15.00h).  
 VK4 — G.P.O. Box 638, Brisbane, 4001.  
 VK5 — G.P.O. Box 1234, Adelaide, 5001 — HQ at West Thebarton Rd., Thebarton.  
 VK6 — G.P.O. Box N1002, Perth, 6001.  
 VK7 — P.O. Box 1010, Launceston, 7250.  
 VK8 — (incl. with VK5), Darwin AR Club, P.O. Box 37317, Winnellie, N.T., 5789.

Slow morse transmissions — most week-day evenings about 09.30Z onwards around 3550 kHz.

**VK QSL BUREAUX**

The following is the official list of VK QSL Bureaux, all are Inwards and outwards unless otherwise stated.

VK1 — QSL Officer, G.P.O. Box 46, Canberra, A.C.T. 2600.  
 VK2 — QSL Bureau, C/- Hunter Branch, P.O. Teralba, N.S.W. 2284.  
 VK3 — Inwards QSL Bureau, Mr. E. Trebilcock, 340 Gillias Street, Thornbury, Vic. 3071.  
 VK3 — Outwards QSL Bureau, Mr. R. R. Prowse, 83 Brewer Road, Bentleigh, Vic. 3204.  
 VK4 — QSL Officer, G.P.O. Box 638, Brisbane, Qld., 4001.  
 VK5 — QSL Bureau, Mr. Ray Dobson VK5DI, 16 Howden Road, Fulham, S.A. 5024.  
 VK6 — QSL Bureau, Mr. J. Rumble VK6RU, G.P.O. Box F319, Perth, W.A. 6001.  
 VK7 — QSL Bureau, G.P.O. Box 371D, Hobart, Tas. 7001.  
 VK8 — QSL Bureau, C/- VK8HA, P.O. Box 1418, Darwin, N.T. 5794.  
 VK9, 0 — Federal QSL Bureau, Mr. N. R. Penfold VK6NE, 388 Huntriss Rd., Woodlands, W.A. 6018.

After all those years of preparation it is now time to look back on the results of WARC 79.

Results that have given the amateur service three new high frequency bands and access to many more bands by the amateur satellite service.

These results did not just happen, they were the result of a co-ordinated and concerted effort.

After the 1959 conference, John Moyle made a few very pertinent comments in his article in AR of March 1960 about the future of amateur radio in its relationship with and preparation for ITU conferences. Those lessons of 1959 were well learnt.

Firstly, our WARC 79 ground work preparation started many years before the conference with the development of an international amateur radio position formulated by the representatives of amateur radio societies in each of the three ITU regions.

This position, having been refined, was then presented to many administrations thus indicating a consistent amateur requirement. There was also an effective international organisation providing the back-up for national societies.

In Australia there was amateur participation from the very beginning of the Australian Government preparation for WARC 79. The importance and value of membership of the national delegation cannot be over-emphasised.

In view of the complexity of the WARC agenda the ability to have two amateur representatives on the Australian delegation was a godsend; particularly as there were many simultaneous working group meetings discussing amateur matters.

It was in these working group meetings that the decisions were made and delegates had the opportunity of putting their cases in order to influence these decisions.

Every stage in the WIA preparation for WARC 79 on behalf of Australian amateurs was vitally essential: None could have been bypassed —

- (a) The preliminary preparation;
- (b) The complete participation in the Australian preparatory group;
- (c) The attendance at preliminary ITU meetings particularly the special preparatory meetings of the CCIR culminating in the acceptance of two members on the Australian delegation.

Notwithstanding the heavy cost in time and money, all this has proved to have been well worthwhile in results obtained.

**D. A. WARDLAW,**  
 Federal President.

**QSP —**

**WARC  
 79  
 IN  
 RETROSPECT**



# WIANEWS

## 6 METRE BAND

The text of the latest letter from the P. and T. Department reads: "Reference is made to your letter of the 12 October and 7 November 1979 concerning use of the 50-52 MHz band in Australia by the Amateur Service.

"The use of this portion of an Australian Television band outside of normal viewing hours is presently studied following the recent decisions made at the World Administrative Radio Conference.

"It is therefore considered that the appropriate time for the discussions you have requested will be after clear guidelines are established".

This question is being pursued as urgently as possible, especially as Melbourne's TV Channel 0 will move to Channel 10 near the end of January.

## INTRUDER WATCH

Alf Chandler VK3LC, the Federal Intruder Watch Co-ordinator, having relinquished this post at the end of 1979, has handed over to Graham Fuller VK3NXI and this has been confirmed. Graham's address is P.O. Box 156, Healesville, Vic. 3777.

## OFFICE

As shown in January AR the Executive office news address was notified. The telephone number is (03) 598 5962. The postal address is unchanged.

## 1980 FEDERAL CONVENTION AGENDA ITEMS

Item 80.121 from VK5 reads:

"That the P. and T. Department be requested to include on the 'application for an amateur station licence' the right to suppress publication of the licensee's name and address from the Australian Call Book".

Item 80.122 received from VK2 reads:

"That the WIA makes representations to the Department that the authorised maximum FM deviation on the 29 MHz band be increased from  $\pm 3$  kHz to  $\pm 7.5$  kHz".

Item 80.091, also from VK2, reads:

"That higher operating requirements for new HF bands be discussed".

The Executive will also be introducing several Agenda Items mainly of a procedural nature to permit discussion, and arisings, on WARC 79, IARU and continuing action from previous conventions. The 1980 Federal Convention (the 44th) will be held in Melbourne (Brighton Savoy Hotel) from 25th to 27th April 1980. Agenda Items should be sent to your Division as quickly as possible so that they can be published in AR beforehand to allow members to make comments on them to their Divisions.

## AR

The print run for AR reached 8000 for the first time. A WIANEWS Special, reporting on WARC 79, was issued as an insert into January AR.

## WARC 79 DONATIONS

The accounts for 1979 show that donations towards the expenses of WARC 79 received in that year from WIA members totalled \$5049 and from non-members (including AR advertisers) \$4330. As will have been noted from the Federal accounts (see AR July, page 30) the amount brought forward, including investments which have since been encashed, was \$13,956. The magnificent response for funds means that the expenses of this very important costly representation was just about covered. The Executive wishes to acknowledge the receipt with grateful thanks of further donations from members —

# WIA (FEDERAL) DIRECTORY

## MEMBERS OF EXECUTIVE

Dr. D. A. Wardlaw VK3ADW, Federal President.  
Mr. P. A. Wolfenden VK3ZPA, Exec. Vice-Chairman.  
Mr. K. C. Seddon VK3ACS, Member.  
Mr. H. L. Hepburn VK3AFQ, Member.  
Lt.-Col. J. McL. Bennett VK3ZA, Member.  
Mr. C. D. H. Scott VK3BNG, Hon. Treas.  
Secretary: Peter B. Dodd VK3CIF.  
Amateur Radio: Mark Stephenson VK3NOY

IARU LIAISON OFFICER AND  
IMMEDIATE PAST FEDERAL PRESIDENT  
Mr. M. J. Owen VK3KI.

INTRUDER WATCH CO-ORDINATOR  
Mr. G. J. Fuller VK3NXI

FEDERAL REPEATER SUB-COMMITTEE  
Mr. K. C. Seddon VK3ACS, Chairman.  
Mr. J. J. L. Martin VK3ZJC.  
Mr. P. B. Mill VK3ZPP.

MANAGING EDITOR AND  
CHAIRMAN OF PUBLICATIONS COMMITTEE  
Mr. B. Bathols VK3UV.

FEDERAL BROADCAST TAPE CO-ORDINATORS:  
Mr. R. Fisher VK3OM.  
Mr. W. Roper VK3ARZ.

FEDERAL EDUCATION CO-ORDINATOR  
Mr. G. F. Scott VK3ZR.

FEDERAL HISTORIAN  
Mr. G. M. Hull VK3ZS.

FEDERAL CONTESTS MANAGER  
Mr. W. A. Watkins VK2DEW

FEDERAL AWARDS MANAGER  
Mr. W. D. Verrall VK5WV.

## FEDERAL VHF/UHF ADVISORY COMMITTEE

Mr. K. G. Malcolm VK3ZYK, Chairman.  
Mr. P. A. Wolfenden VK3ZPA.  
Mr. I. W. Cowan VK3BGH.  
Mr. L. Janes, VK3BKF.  
Mr. J. J. L. Martin VK3ZJC.  
Mr. K. L. Phillips VK3AUQ.  
Mr. W. M. Rice VK3ABP.

## FEDERAL RTTY COMMITTEE

Mr. H. P. Mulligan VK2ABH, Chairman.  
Mr. J. J. Lupton VK2BVJ.  
Mr. R. E. Taylor VK2AOE.

## PROJECT ASERT COMMITTEE

Mr. R. C. Arnold VK3ZBB, Chairman.  
Mr. P. A. Wolfenden, VK3ZPA/NIB.  
Mr. K. G. McCracken VK2CAX.  
Mr. L. Janes VK3BKF.  
Mr. G. C. Brown VK3YGB.

## AMATEUR SATELLITES

Mr. R. C. Arnold VK3ZBB.

## FEDERAL WICEN CO-ORDINATOR

Mr. R. G. Henderson VK1RH.  
VK/ZL/O CONTEST MANAGER (VK)  
Mr. N. R. Penfold VK6NE.

FEDERAL VIDEOTAPE CO-ORDINATOR  
Mr. J. F. Ingham VK5KG.

FEDERAL COUNCILLORS  
Please see main Directory.

## ALTERNATE FEDERAL COUNCILLORS

VK1 — Mr. A. Davis VK1DA.  
VK2 — Mr. P. B. Card VK2ZBX.  
VK3 — Mr. A. R. Noble VK3BBM.  
VK4 — Mr. D. T. Laurie VK4DT.  
VK5 — Mr. C. J. Hurst VK5HI.  
VK6 — Mr. P. J. Savage VK6NCP.  
VK7 — Mr. P. D. Frith VK7PF.

## LIST No. 10

	\$
Hornsby & Dist. ARC	125.00
VK5WO	25.00
Darwin ARC (VK8DA)	50.00
plus —	
VK8NTA	10.00
VK8DI	10.00
VK8NRM	10.00
VK8ZJM	10.00
VK8JW	10.00
Brisbane DX Club	20.00
VK3SO	7.00
VK4PS	10.00
VK4NFG	5.00
VK2AFU	10.00
VK6YD	10.00
L60132	2.00
VK2AZF	8.00
VK6ZGY	1.50
VK6WV	2.20
VK3BFQ	10.00

## QSP

### JANUARY AR

In the hiatus caused by holidays the quantity received of the January issue was a little short unfortunately. A few people near the end of the labels missed out in the mailing. The missing copies will be sent out as soon as possible after the printers return from the annual shut-down.

# SIMPLE ANTENNA COUPLER

M. N. O'Burtill VK3WW  
3 Maxwell Street, Lalor

A simple and effective antenna coupling unit for the novice and low power operator.

Like most operators I like to explore new fields and of necessity have to adapt equipment to particular needs. In this case it was portable operation from my caravan using an FT7 with a helical antenna and a Marconi 300 ohm ribbon antenna.

I soon decided that an aerial coupling unit was needed. The design, apart from electrical considerations, demanded that the unit be physically small, easy to tune and calibrate and be inexpensive. As the FT7 is a lower power rig, small tuning capacitors could be used.

I chose the Robian single gang broadcast tuning capacitor which retails for about \$5 each. I had on hand a Toroid core, which was red and marked G 29SW479 U142. This core measures 20 mm outside diameter, 13 mm inside diameter and 6 mm deep. I think any toroid of about this size which is capable of working in the range 3 to 30 megahertz would be suitable. The Neosid type part No. 28-023-34 should be suitable also.

Winding the coil on a small toroid can be difficult, particularly when it comes to making taps every 3 turns. My method in this case was to wind on 3 turns of 20 gauge wire and leave a half inch lead on each end. I then removed this winding and straightened it out, next I cut 9 other pieces of wire of exactly the same length. Clean the enamel for half an inch on each end of each wire and carefully tin each end. Now wind 3 turns with the half inch ends pointing across the toroid. Wind another 3 turns and lightly solder one end of the first coil to the start of the second coil, continue like this until you have 30 turns wound round the toroid. Spread or compress the turns so that the coil is fairly evenly spaced around the toroid.

Now starting at the first tap, unsolder the join and twist the half inch ends together to make a good mechanical join and then resolder. Repeat this process at each tap point and leave the two ends of the coil free.

Carefully solder each tap point to the ten position switch. You will find that this method holds the coil quiet rigidly and no further mounting is required. The earth end of the coil is connected to a convenient chassis point using as short a lead as possible. The tuning capacitors are in series with the antenna and therefore are at RF potential. It is essential that they

be completely insulated from the chassis and that insulated knobs be used. A scrap of perspex sheet is a good insulator in this case. I mounted the capacitors on a piece of perspex then laid another piece under this and bolted the lot to the chassis. Of course the holes in the front plate through which the capacitor tuning shafts pass must be large enough to avoid the possibility of the shafts touching the metal plate. Likewise do not mount the capacitors too close to the front plate, the shaft is long enough to allow this.

## TUNING UP

From the circuit, Fig. 1, you will note that I have included a switch to allow direct feed. This is handy for testing the effectiveness of the aerial coupling unit. Hook up the rig, SWR meter and aerial coupling unit as in Fig. 2 and tune in the signal with the aerial coupling unit switched out (direct feed). Note the S metre reading and switch the coupling unit in. Set C1 and C2 to maximum capacity and L1 to maximum inductance.

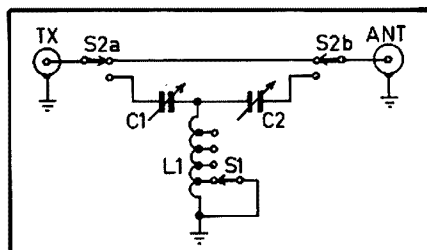

FIG. 1: Circuit diagram C1 and C2 Robian 10-415 pF single gang. S1-10 position rotary switch. S2-DPT switch. L1 — 30 turns tapped every 3 turns on ferrite toroid, Neosid Part No. 28-023-34 or similar.

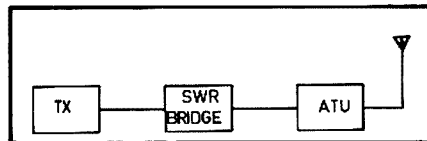
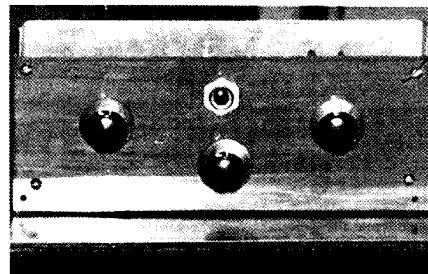

FIG. 2: Block diagram of coupler in use

Switch the taps on L1 and see if you get an increase in received signal. Now tune C1 and C2 alternately to peak the signal and note the settings of L1, C1 and C2. Switch the coupler out and apply power from the transmitter and note the SWR reading. Of course you should tune clear of the received signal a few kilohertz so that you don't cause interference. Now switch the coupler back into circuit and note the SWR reading.

At this stage I should explain that you don't always get a really good indication



The completed unit

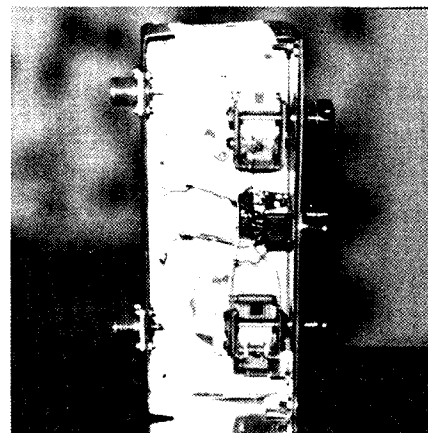

Inside view

on received signals. If the SWR is too high or not improved from direct feed, switch the coil one tap each side of its present setting. What you are looking for is a drop in reflected power and an increase in forward power. A twin meter bridge is very useful in this situation. The meter indications are quite dramatic and show clearly when the correct tap is found. After this, alternately adjust C1 and C2 to obtain maximum forward and minimum reflected power. You should be able to achieve virtually one to one SWR on any reasonable antenna.

Once you have found the correct settings for an antenna on one band make a note of them, as they will be a good starting point for that band on any other antenna.

## WHAT ABOUT HIGHER POWER?

Yes this circuit will work with higher powered rigs. Larger capacitors must be used, that is ones with greater plate spacing, and to avoid excessive heat loss a larger toroid is recommended. I am indebted to Charlie VK3BIT for bringing this circuit to my notice. It really works well, is easy and cheap to build and with low power rigs can be quite a small size which will fit in anywhere. ■



## CALL SCALAR



MELBOURNE (03) 725 9677

SYDNEY (02) 570 1788

BRISBANE (07) 52 2594

**OR CONTACT YOUR HAM GEAR RETAILER**

**SC22DX 5 Band Vertical**  
**SC00R Series; HF Mobile Resonators**  
**Quad Kits • SC33DX; 3 Band Beam**  
**Mobile HF Helicals • W2AU Baluns**  
**Reyco Antenna Coils • Strain Insulators**  
**UHF & 2 Metre Gain and Unity Whips, Beams**  
**Gain Colinear Base Antennas • Magnabase**

FRANK WELSH VK3BPV  
MIKE KILPATRICK VK2NMO  
RON SMITH VK2DCK  
BRIAN ROBINSON VK4NQG

**Professionally Designed  
with Amateurs in Mind.**

# SCALAR GROUP

20 SHELLEY AVENUE, KILSYTH, VICTORIA. 3137.

20 THE STRAND, PENSHURST, NEW SOUTH WALES, 2222.

969 ANN STREET, FORTITUDE VALLEY, QUEENSLAND. 4006.

## EQUIPMENT REVIEW:

# THE KENWOOD R1000 GENERAL COVERAGE RECEIVER

Ron Fisher VK3OM

**Trio Kenwood have a long history in the manufacture of general coverage receivers. Many hundreds of 9R59D/DE and DS's are still in use. The later R300 series did not reach the popularity of the earlier receivers. It seems now that Kenwood have produced a receiver that could lead the field for some time to come.**

The R1000 is a fully solid state general coverage communications receiver with all required facilities but at the same time offering simple operation. It is obviously aimed at short wave listeners and at the growing market of people interested in overseas reception to keep up with current affairs. It is also the in-thing for amateur operators to have a general coverage receiver handy.

### CIRCUITRY AND TECHNICAL DESCRIPTION

The R1000 tunes from 200 kHz to 30 MHz in thirty bands each one MHz wide. An analog dial with 10 kHz calibration divisions is supplemented with a LED digital readout with one kHz resolution. This readout is also switchable to a crystal controlled clock with facilities for preset switching on and off both the receiver and auxiliary equipment such as a cassette recorder. Selectivity is taken care of with three Murata ceramic filters. These provide for wide AM, 12 kHz, narrow AM, 6 kHz and SSB with 2.7 kHz selectivity. A first for this type of receiver is the inclusion of a noise blanker. Other features include an RF attenuator for the receiver front end, a dimmer switch for both the digital display and dial and S meter illumination and an audio tone control.

The R1000 is the first receiver of its type to get away from the Wadley Loop principle and yet still have the advantages of this type of operation. The PLL synthesizer provides a heterodyne signal to the first mixer to up-convert to 48.0 MHz. The second mixer converts to 455 kHz and this is also fed from the synthesizer. Both first and second mixers are balanced. The synthesizer output is also used to switch in appropriate band pass filters for the receiver front end. This of course eliminates the need for separate front end tuning and the need to follow main tuning with the preselector to maintain sensitivity. As if

this was not enough, the synthesizer also drives the digital readout.

The R1000 has a built-in AC power supply designed to operate from 100 to 234V. There is no provision for any in-built battery supply — but a DC connector allows for externally supplied 12 volt DC operation.

### APPEARANCE AND IMPRESSIONS

Kenwood have carried through the general appearance of the 120 series transceivers to the R1000, although the front panel dimensions are slightly larger and the cabinet depth slightly less. The R1000 weighs in at 5.5 kg. Overall the appearance would have to be rated as very good and the only criticism possible is the analog dial and 'S' meter. The faces of both are completely opaque and finished in a bright silver. The calibration points are rear illuminated in bright green, but under conditions of high ambient light, reflection from the silver makes the dial and 'S' meter hard to read. With low external light both are very legible.

Controls are in general easy to use. The only exception to this is the tone control which is concentric and to the rear of the volume control. As its diameter is only slightly larger than the volume control it is hard to operate. Perhaps the next model will have a small lever extending from it to help.

The unusual carry handle seems to be either liked or completely disliked, however it does serve a useful dual purpose. As well as being a carry handle it also acts as a variable tilt angle support for the receiver when installed on a desk.

Another feature is the rear panel. This is recessed and set at an upward facing angle, and allows connections to be changed easily with the set in situ. Connections can also be routed into the back panel with the set pushed hard against a wall.



**PHOTO 1: Good appearance — the R1000 and a TS520**

### THE R1000 IN USE

For comparative tests we set up the R1000 alongside a TS820S, with a two position coax switch to feed both from the same antenna. The antenna for low frequency reception was at first a parallel connected 80 metre dipole. It was soon obvious that this was a bit too much. Even with the RF attenuator at the 40 dB point there was quite a bit of cross modulation. We finished up with about 10 metres of wire stretched out on the floor and this gave excellent broadcast and long wave reception. Aircraft NDBs were audible at good strength over distances of 100 km or so. Quality of broadcast reception was outstanding. With a Hi-Fi speaker plugged into the extension speaker output, the high frequency response was superior to my AM/FM Hi-Fi outfit. This was of course using the wide AM mode of the R1000.

However, over to the short wave bands and naturally the first part we checked were the amateur bands. Anything audible on the 820 was equal in every way on the R1000. It was only under the most difficult QRM conditions that the superior selectivity of the 820 made a slight difference. But mark this, the difference was slight and this applied to all bands including ten. The turning rate, although somewhat faster than the TS820S was still good at

50 kHz per knob revolution and a very smooth dial drive made tuning of SSB easy. It should also be noted that SSB resolution is made considerably easier with the 2.7 kHz bandpass as compared with receivers with similar tuning rates but wider selectivity. The calibration of the digital readout proved to be quite accurate in the AM mode and a plus or minus one kilohertz error on SSB depending on the sideband selected. One of the highly rated points of the R1000 is the noise blanker, however we found its action rather disappointing. In fairness, it was no worse than the blanker in the 820S but I have never considered that one very good either. It did reduce ignition noise to some extent and appeared more effective on the higher frequencies above 20 MHz.

The quartz controlled clock was extremely accurate for the duration of our test. It is of course independent of the mains, so that even when the R1000 is run from a battery supply the clock will still operate. On a personal point, I would have preferred a 24 hour type to the 12 hour one. AM and PM indicators however overcome this to some extent.

Output to a cassette recorder is made via a 3.5 mm phone socket and audio level proved excellent for the aux. socket on my AIWA recorder. This output is at a constant level and is not affected by

the setting of either the volume or tone control.

While on the subject of the tone control, I thought that its effect was too small and more top cut would have been useful in many cases.

However, most criticism would have to be mild in view of the overall superb performance of the receiver. The R1000 is well ahead of any other comparable receiver on the market at the present time.

Overall stability proved most impressive with total drift not exceeding one kilohertz over several hours of operation.

**INSTRUCTION BOOK**

The receiver tested was an early sample and did not come with an instruction book and in fact it was to be several weeks before one came to hand. When it did, I was delighted until I opened it and found not one, but several instruction books all in different languages. This means that instead of one large (at first sight) book, there is one rather small book. The information contained is completely directed at a non-technical user. Apart from the block diagram and the circuit diagram there is no technical description at all.

It seems a pity in this age when equipment is getting better all the time, general instruction books are steadily getting worse.

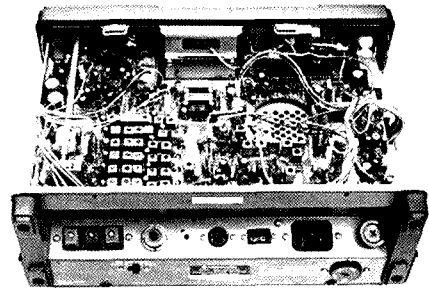

**PHOTO 2: Rear view of the R1000. Note easy access to connections.**

In conclusion, I am collecting all the old bottles I can find to rake up a down payment on an R1000. Our test model was supplied by VICOM International of Melbourne and all enquiries regarding price and delivery should be directed to them.

**FIGURE 1 (below): Schematic diagram of the R1000. Of special interest is the PLL synthesiser unit.**

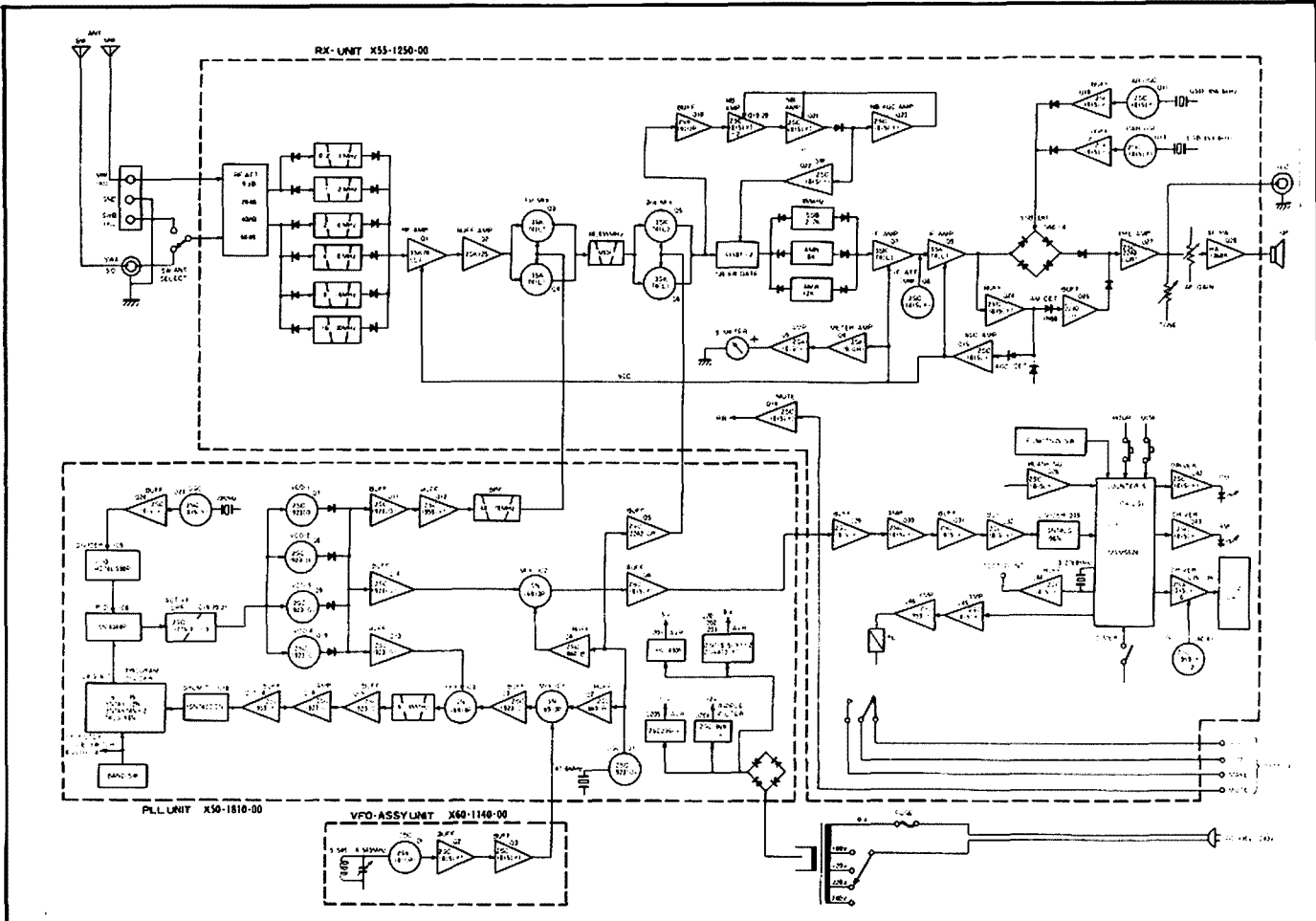

# CHIRNSIDE ELECTRONICS

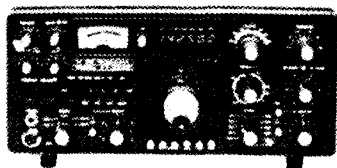

**All-New FT-101ZD Series:**  
High-performance HF Transceiver with today's technology backed by a proud tradition. This rig includes variable IF bandwidth, digital plus analog frequency display, a built-in RF speech processor and wide receiver dynamic range.

## YAESU.

- FT-101Z. 160-10M Transceiver, analog dial. .... \$750.
- FT-101ZD. 160-10M Transceiver, Digital. .... \$898.
- optional digital display for FT-101Z. .... \$148.
- optional Fan. .... \$39.
- optional DC-DC converter. .... \$79.
- YE-7A Hand mike. .... \$21.
- YD-148 Desk mike. .... \$45.
- FT-901DM. 160-10M Transceiver. .... \$1322.
- FV-901, ext. VFO for FT-901 & FT-101Z. .... \$429.
- YO-901. Panoramic adapter monitorscope. .... \$475.
- FC-901. Antenna coupler. .... \$248.
- FTV-901. Converter. 6M, 2M, 70 cm. all inc. .... \$765.
- FTV-901. Converter. 6M, 2M. only. .... \$539.
- YR-901. Morse reader. .... \$TBA.
- SP-901. ext. speaker. .... \$53.
- FRG-7. Communication receiver. .... \$309.
- FRG-7000. Digital communication receiver. .... \$559.
- LF-2A Narrow band filter for FRG-7. .... \$20.
- FT-7B. 80-10M Transceiver. .... \$599.
- FP-12. 12 Amp. power supply for FT-7B. .... \$159.
- YC-7B. Digital display for FT-7B. .... \$119.
- QTR-24 24 hr. World clock. .... \$33.
- QTR-24D. Deluxe 24 hr. World clock. .... \$49.
- FT-227RA. 2M. Scanning digital transceiver. .... \$379.
- FT-227RB. 2M Digital programmable transceiver. .... \$POA.
- YP-150. Dummy load/Watt meter. .... \$109.
- FP-50DX. Low pass filter. 2kw. .... \$38.

**QTR-24D. Deluxe 24 hr. World clock. \$49.**

### EMOTATOR ROTATORS



- 103L BX. Medium Duty. .... \$164.
- 502CXX. Heavy Duty. .... \$249.
- 1102MXX. Extra Heavy Duty. .... \$359.
- 1103MXX. Extra Extra Heavy Duty. .... \$395.
- 502 Mast Clamp. .... \$32.
- 103 Mast Clamp. .... \$22.
- VCTF-7. 7 Core Cable. per Metre. .... \$1.20
- VCTF-6. 6 Core Cable. per Metre. .... \$1.00.

### DIAWA

- DR-7500S. Medium Duty. .... \$175.
- DR-7600D. Heavy Duty. .... \$249.

**FT-207R. 2M Hand held transceiver. . .**  
Fully programmable. . . **\$335.**

AMPHIBIOUS  
DEALER

VICOM



## CHIRNSIDE MOBILE HELICAL WHIPS.

Chirnside Helical Whips feature an all adjustable stainless steel tip rod for easy tuning.

Finished in heavy PVC heatshrink tubing and chrome plated fitting, will fit any 3-8 x 24 TPI thread base.

80 M. ....	\$21.
40 M. ....	\$20.
20 M. ....	\$20.
15 M. ....	\$19.
10 M. ....	\$19.
Bumper mount to suit. ....	\$9.

**SET OF ALL FIVE FOR ONLY \$95 INCLUDING BUMPER MOUNT.**

### CHIRNSIDE TRAP VERTICAL

Chirnside Vertical Antenna Type CE-5B Features.

Long length and high Q traps makes the CE-5B more efficient than similar types of antennas especially on 80 Metres.

It is also very easy to tune and its construction is very rugged.

- Easy to tune.
- Rugged construction.
- Easy to assemble.
- 12 month guarantee on parts and workmanship.
- **ONLY \$99.-.**

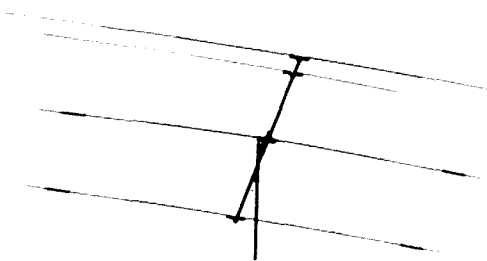

**\$139**

CHIRNSIDE CE-42 rugged duo band beam features 4 elements and uses independent reflectors for optimum results.

3 elements on 15 M.

3 elements on 10 M.

Director and driven elements have hi-q traps.

Forward gain is 8 dB and front to back ratio is in excess of 20 dB.

Dozens of reports have indicated F/B ratios in excess of 28 dB.

CE-42 15-10 M. Duo-Band ..... \$139.

CE-5B 5 Band Vertical ..... \$99.

CE-4B 4 Band Vertical ..... \$85.

Compare our antennas with other brands and see that it is of a better quality.

Ask about our rotator - antenna package deal and save \$\$\$\$\$\$.



welcome here

FAST MAIL ORDERS.

## EQUIPMENT REVIEW:

# THE YAESU FT-207R

Ron Fisher VK3OM

**It is often said that good things come in small packages. The new Yaesu FT-207R is a hand held two metre FM transceiver and even for one used to using hand held equipment the 207R would have to be rated as very small. When it is considered just what this rig will do, the whole thing becomes quite remarkable. However, back to the beginning.**

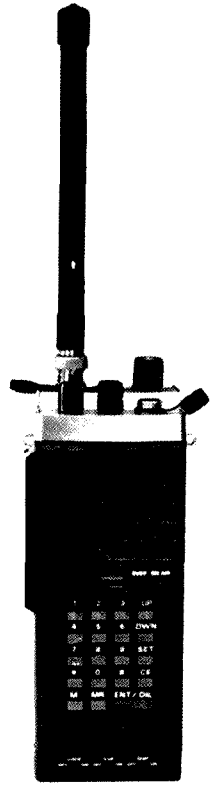

PHOTO 1: Front view of the FT207R

Two metre hand held transceivers go back quite a few years in the history of FM in Australia, but strangely cover only a very few models. Yaesu were rather late into the hand held field with the FT-202R announced a year or so ago. I am not certain if any of these were actually imported into Australia. These were six channel devices of apparently conventional electrical design with normal crystal control. Transmitter output was rated at one watt. The new FT-207R uses the same case but from there on, apart from the fact that they both operate in the two metre band there is very little in common. The FT-207R has more electronics built into its 68 x 181 x 54 mm case than almost any other mobile size package. Lets look at what it offers.

It has full microprocessor control with keyboard dial up frequency control. It covers the entire two metre band in ten kilohertz steps with a switch selected 5 kHz upshift. Four memory frequencies can be entered via the keyboard and scanning of either the four memories or the entire band is available with the scan stepping on either a busy or clear channel. Operating frequency is indicated with a LED readout and of course the usual 600 kHz offset for repeater operation can be selected with the function switch. In addition any other desired offset can be programmed into the system. Once a memory is programmed it is held even if the transceiver is switched off, for as long as the in-built nicad battery retains its charge. As the memory uses about 5 milliamps, this is limited to about 80 hours assuming no actual operation of the transceiver.

Transmitter output is rated at a generous 2.5 watts and on test actually produced just over three watts.

The FT-207R as supplied for test was complete with a nicad charger/AC adapter, external microphone/speaker, flexible antenna and adaptor to charge the battery when removed from the transceiver.

At least some of these are optional extras and it would be well to contact the distributors for all-up prices.

An interesting point is that the nicad battery is rated at 10.5 volts and the manual states that the transceiver should not be operated on a voltage in excess of exactly 12 volts. It would seem therefore that operation should not be attempted from a standard 12 volt car system which would rise to about 14 volts. Strangely, Yaesu do not have any sort of adaptor or regulator for such operation.

### CIRCUIT DESCRIPTION

As could be imagined the little box contains a large number of semiconductor devices. There are in fact 31 transistors, 5 FETs, 10 ICs, 35 diodes plus 2 LEDs and a LED display. The receiver circuit is a standard double conversion with 10.7 MHz and 455 kHz IFs. However it comes as a surprise to find bipolar transistors in the RF and first mixer stages, but in practice sensitivity was first class.

The transmitter starts off at 10.7 MHz and is mixed directly with the 133.3 to 137.3 MHz output of the synthesized frequency control to produce the 144 to 148 MHz output. This same synthesized output is also injected into the receiver first mixer to convert the two metre signals to the first 10.7 MHz receive IF. Reference to the block diagram indicates the operation of the synthesizer and its control from the 4 bit microprocessor chip. An interesting point is that when the VCO is in an unlocked condition, voltage is removed from both the transmitter and receiver and the frequency display indicates 'E' for error condition. Transmitter output is switchable from the nominal 2.5 watts down to 200 mW simply by inserting a resistor in series with the voltage supply to the final and driver stages.

Diode switching is employed for transmit receive changeover which allows for normal push to talk operation with the external microphone. A microswitch is employed in the PTT switch on the transceiver which gives very positive and light control.

### THE YAESU FT-207R ON AIR

This is one transceiver where it is absolutely necessary to read the instruction manual before trying to go on the air.

The transceiver was used in turn by four experienced amateurs and all found that the set had unexplained "faults". However the fault turned out to be the operators' and not of the set. In each case the manual had not been fully digested. But back to the start with a look at the controls and their functions. The top panel has the volume/on/off, squelch, mode switch for simplex or repeater operation, a 3.5 mm socket for external ear-phone or speaker, a BNC antenna connector and a multi pin miniature connector for the external microphone speaker unit. On the front of the set is the frequency selection keyboard, the LED frequency readout, the two LEDs to indicate transmit condition and incoming receive signal. Three miniature slide switches select the 5 kHz up condition, frequency display off and keyboard lock. The two latter require some additional explanation. The display off switches the display off once a frequency has been selected after a three second delay. If a new frequency is dialled up the display operates again for three seconds. While scanning the display operates and switches off three seconds after scanning stops. The keyboard lock switch retains the dialled frequency even if a new one is dialled up either accidentally or purposely.

The remaining control, the transmitter power selector switch is mounted on the bottom of the case. Rather badly placed, not from an operational point of view but the set will not sit firmly when placed on a flat surface. Four small rubber pads would fix this and at the same time protect the table top from scratching.

All operators testing the 207R found that small fingers would have been a decided advantage. Also good eyesight is handy to read the control designations. It's not a rig to use on a dark night unless you take a torch along. First few times the transceiver was operated without the external mike/speaker and transmit quality was clean but somewhat woofy in quality. It also appeared to have excess mike gain. Plugging in the external mike unit fixed all of these problems which indicates that the user would need to set the internal mike gain to suit either the internal or the external mike — one setting will not suit both. Another interesting point with the external mike/speaker unit is that when in use, the internal mike is muted but the internal speaker isn't.

Transmit capability with the flexible antenna was about as good (or bad) as other sets tested using these antennas. The radiation efficiency of stubby antennas seems dependent on just how much metal is under them to provide a ground plain, and most of these small transceivers just are not big enough. If you want to get out even into the local repeater a better antenna is needed.

Receiver sensitivity when checked against a selection of 2m FM units was as good and in fact the mute opened easily on very weak signals that would not open the mute on some of the others. The selectivity is designed for narrow band operation and the local channel eight repeater which tends to have rather wide deviation sounded somewhat distorted, however most local simplex signals were clean.

To get full use of all the keyboard facilities takes quite a bit of practice, hence my earlier remarks on unexplained "faults". It was discovered that changing the mode switch while the set was switched off produced some odd and unexpected results. This is covered in the instruction book, we just hadn't read it. The scanning position will either scan the whole band or the four memories. It is also possible to listen on one frequency and monitor a second frequency on a one second in five basis — very handy to listen to the local repeater while waiting for a friend to show up on simplex. The display shows the operating frequency at all times, so that if a transmit repeater offset is selected, the readout will show the transmit frequency. Many synthesized transceivers with digital readout do not have this feature and continue to display the receive frequency when actually transmitting 600 kHz away.

The FT-207R was supplied with the optional NC-2 quick charger/AC adapter.

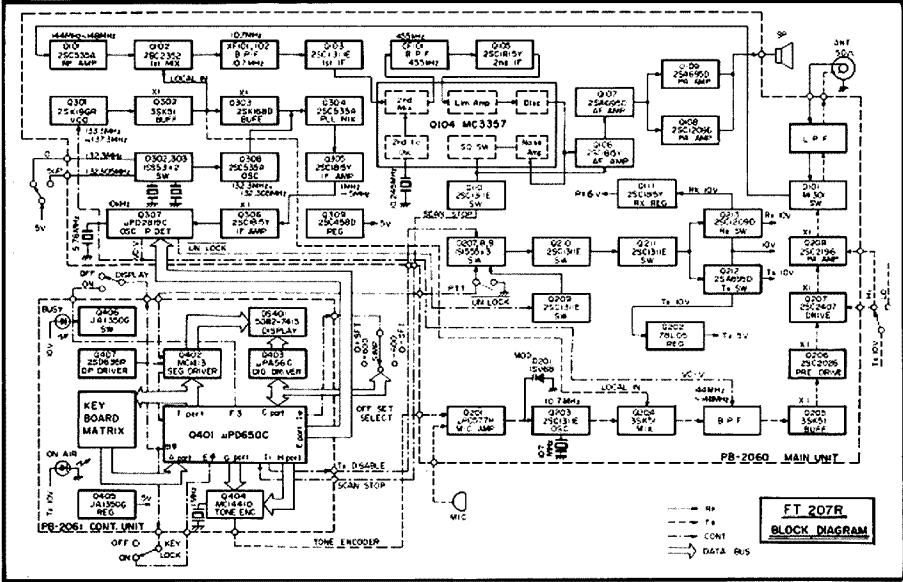

FIGURE 1 (above): Schematic diagram for the FT207R

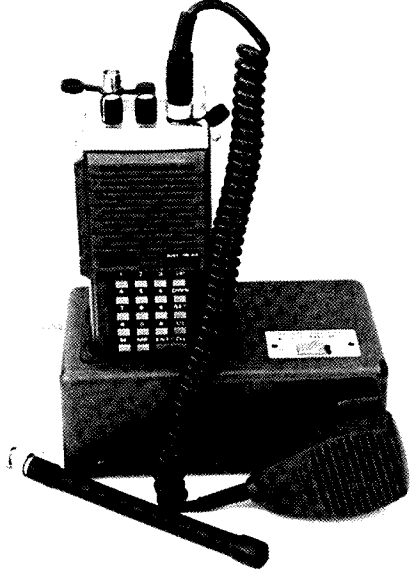

PHOTO 2: The unit complete with speaker/microphone, NC2 quick charger/AC supply and antenna.

The transceiver plugs into this either for quick battery charge in as little as three hours, or can be used to power the transceiver for base station use. In the charge mode, the initial charging rate is 450 milliamps which is automatically reduced to a pulsed 45 milliamps as the state of charge increases.

**INSTRUCTION MANUAL**

This came as quite a surprise as it is much smaller than the usual Yaesu manual (but then so is the transceiver). Its 40 pages cover operation, circuit description and basic maintenance and alignment. A full circuit diagram is included as well as a complete parts list. Several photos show

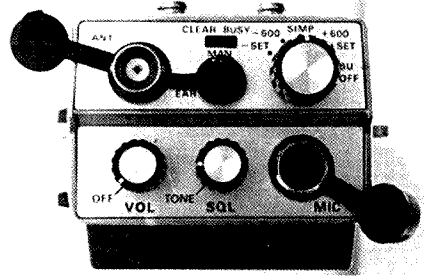

PHOTO 3: Control functions on the unit

the position of the main components and adjustment points. The book covers all needed points and is well written.

**CONCLUSIONS**

This little rig is superbly constructed and finished but where does it fit into the scheme of things? Well, if you travel either interstate or overseas and you need a rig with all facilities that will fit into a small overnight bag and still room for all the other things you need to take, then the FT-207R is for you. It would also make a wonderful toy for the amateur who "has everything". Beyond this, I am not sure. If you decide to buy one, drop a note to AR and let us know what your application for this rig is.

The FT-207R and NC-2 used in our review was supplied to us by Bail Electronics of Box Hill, Victoria, to whom all enquiries of price and delivery should be directed. ■

Technical Articles  
 Always Needed



FROM



ELECTRONICS

# The Little Handie ... with the big features FT-207R

## CPU controlled synthesized Handie

The "horse-and buggy" days of crystal-controlled handies are gone! Yaesu's engineers have harnessed the power of the microprocessor, bringing you 800 channels, digital display, memory, and scanning from a hand-held package. Only with Yaesu can you get these big performance features in such a compact package:

- \* 4 bit CPU chip for frequency control. \* Keyboard entry of all frequencies. \* Digital frequency display. \* 800 channels across 144—148 MHz. \* Up/Down manual scan, or auto scan for busy/clear channels. 10 kHz or 12.5 kHz scanning step models available. \* Four channels of frequency memory. \* Priority channel with search-back feature. \* Keyboard lock to prevent accidental frequency change. \* Two-tone input for autopatch. \* Memory backup. \*  $\pm 600$  kHz or odd repeater splits. \* Display ON/OFF switch for battery conservation. \* 2.5 watts (min.) RF output. \* Equipped with rubber flex antenna and one NiCd battery pack.

### OPTIONS FOR FT-207R

- \* NC-2 Quick Charger. \* YM-24 Remote Speaker/ Microphone. \* Leather Carrying Case. \* Extra NBP-9 Battery Packs.

### SPECIFICATIONS: FT-207R

#### GENERAL

**Frequency coverage:** 144—146 or 144—148 MHz (per local regulations)  
**Emission type:** F3  
**Batteries:** NiCd battery pack  
**Voltage requirement:** 10.8 VDC  $\pm 10\%$ , maximum  
**Current consumption:**  
 RX 150 mA (35 mA squelched)\*  
 TX 800 mA (Hi), 250 mA (Low)  
**Mem backup:** Approx. 4 mA  
**Case dimensions:** 68 x 181 x 54 mm HWD  
**Weight (with batteries):** 680 g

\* Display OFF

#### TRANSMITTER

**Power output:** 2.5 watt RF/200 mW RF  
**Deviation:**  $\pm 5$  kHz  
**Spurious radiation:** -60 dB or better  
**Microphone:** Condenser type, 200 ohms impedance

#### RECEIVER

**Circuit type:** Double conversion superheterodyne  
**Intermediate frequencies:**  
 1st IF = 10.7 MHz  
 2nd IF = 455 kHz  
**Sensitivity:** 0.32  $\mu$ V for 20 dB quieting  
**Selectivity:**  $\pm 7.5$  kHz at 60 dB down  
**Audio output:** 200 mW at 10% THD

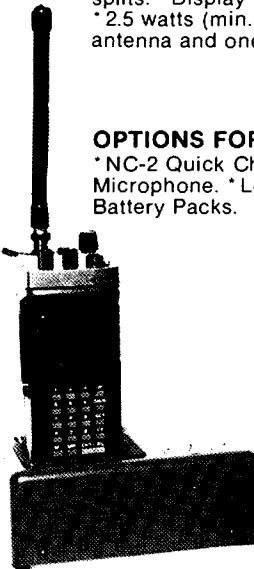
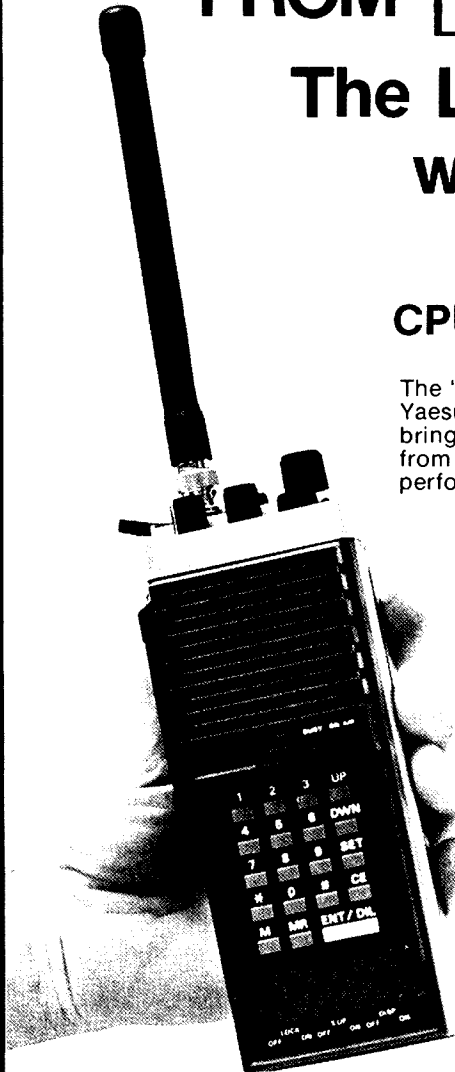

60 Shannon St., Box Hill North, Vic., 3129. Phone 892213  
 Distributors in all states and N.T.

STAN ROBERTS VK3BSR  
 JIM BAIL VK3ABA

AGENTS & REPS.— W.A. COMO (09) 450 4379. PERTH (09) 321 7609. KALGOORLIE (08) 211 1906. S.A. FLYNNPTON (08) 293 2155. TAS. LAUNCESTON (003) 44 5000. N.S.W. MASCOT (02) 667 1630. SEVEN HILLS (02) 624 2691. NEWCASTLE (049) 692040. WAGGA WAGGA (069) 212125. COFFS HARBOUR (066) 54 3206. TAMWORTH (067) 66 1363. INVERELL (067) 22 1300. QLD. ALBION (07) 57 6830. TOWNSVILLE (077) 798173. CAIRNS (070) 514826. BRISBANE (07) 486601. N.T. DARWIN (089) 815411. VIC. SOUTH WANGARATTA (057) 662359

# CALCULATION OF GREAT CIRCLE DISTANCES

C. K. Maude VK3ZCK  
2 Clarendon St., Avondale Heights 3034

Over many years radio amateurs and others have tried to calculate the distance between two known points on the earth's surface using mathematical tables or slide rules. These methods can be quite time consuming and frustrating.

The basic equation used is

$$D = \arcsin(\sin(\text{lat I}) \times \sin(\text{lat II}) + \cos(\text{lat I}) \times \cos(\text{lat II}) \times \cos(\text{lon I} - \text{lon II})) \cdot M$$

where —

lat I is the latitude of the first point and lon I is the longitude of the first point and lat II is the latitude of the second point and lon II is the longitude of the second point, all of these being in decimal degrees, and where M is the multiplier for kilometres, miles or nautical miles.

For those having scientific calculators, one of the programmes shown here can be used. There are programmes for fully programmable types and simple models, for reverse polish notation and for algebraic models.

The only information that is required to obtain the great circle distance between any two points is the latitude and longitude of both points in degrees, minutes and seconds. The latitudes and longitudes must first be converted to degrees and decimals, remembering that 60 seconds make one minute and 60 minutes make one degree. Answers can be calculated in kilometres, miles, or nautical miles by using the appropriate value of M as shown.

For kilometres use M = 111.12  
For Miles (statute) 69.047  
For Miles (nautical) 60.00

## NOTE:

When longitudes are East change the sign to -ve.

When latitudes are South change sign to -ve.

If both are East or both are South no change is necessary.

Example:

Melbourne Airport: Lat 37 40 30, long 144 50 32.

Launceston Airport: Lat 41 32 45, long 147 12 49.

lat I = 37.675, lon I = 144.842.  
lat II = 41.547, lon II = 147.214.  
Distance: 475.72 km, 295.6 miles, 256.87 nautical miles.

Note that if only degrees and minutes are used the accuracy is still better than 0.5 per cent for this example. ■

## LISTING OF PROGRAMMES

CALCULATOR TYPE				
	RPN		Algebraic	
Step	HP45, HP35, HP55, etc.	Novus 3500, NS 4510	With store — TI59, etc.	With brackets — TI25, etc.
1	Clear all functions	Clear all functions.	Clear all functions.	Clear all functions.
2	lon I <b>ENTER</b>	lon I <b>ENTER</b>	lon I —	lon I —
3	lon II —	lon II —	lon II =	lon II =
4	<b>COS</b>	<b>COS</b>	<b>COS X</b>	<b>COS X</b>
5	lat I <b>COS X</b>	lat I <b>COS X</b>	lat I <b>COS X</b>	lat I <b>COS X</b>
6	lat II <b>COS X</b>	lat II <b>COS X</b>	lat I <b>COS =</b>	lat I <b>COS =</b>
7	lat I <b>SIN</b>	<b>STO CLR</b>	<b>STO CLR</b>	+ (
8	lat II <b>SIN X</b>	lat I <b>SIN</b>	lat I <b>SIN X</b>	lat I <b>SIN X</b>
9	+	lat II <b>SIN X</b>	lat II <b>SIN</b>	lat I <b>SIN</b>
10	<b>ARC X COS</b> or <b>COS<sup>-1</sup></b>	<b>RCL +</b>	<b>= + RCL =</b>	) =
11	M X	<b>ARC COS</b> or <b>COS<sup>-1</sup></b>	<b>ARC COS</b> or <b>COS<sup>-1</sup></b>	<b>ARC COS</b> or <b>COS<sup>-1</sup></b>
12	Answer	M X	X	X
13		Answer	M = Answer	M = Answer

Calculator function and operation keys are shown in bold type.

# CW ELECTRONICS PROCESSED HAM

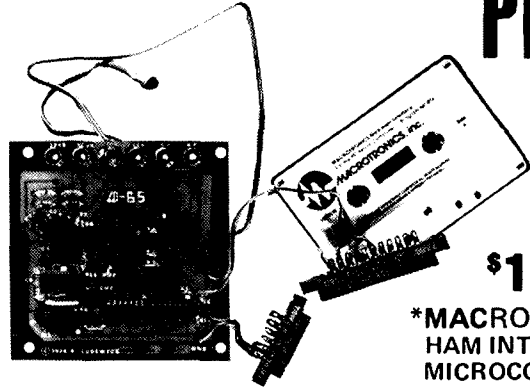

**\$149**

**\*MACROTRONICS M65  
HAM INTERFACE FOR PET  
MICROCOMPUTERS.**

The M-65 is a complete Morse Code and RTTY system for the PET microcomputer. It is made up of two parts: the hardware and the software consists of one PC board which is connected to your rig and to your PET user port. No modifications are required to either your radio equipment or to the PET - everything plugs into existing jacks. No external power supply is required. The software consists of two computer programs - MORSE and RTTY - supplied on one audio cassette. Both pro-

grams are written in BASIC with machine language subprograms. Each requires 8K bytes of RAM. Program MORSE allows continuous speed adjustment from one to 100 words per minute in any of three modes of operation: Receive, Send, and Code Practice.

In addition, up to ten programmable message memories (2550 characters total) allow "brag tapes", pictures, etc. direct from the keyboard. A special feature allows sending the time automatically at the press of a single key!

**\$269**

Other MACROTRONIC modules include the M650 Deluxe RTTY and Morse system Interface with software cassette.

MLK-1 loop Keyer module.

MSK-1 Solid State Keyer module.

FSD-1 Phased-locked loop de-modulator. **\$149**

especially for the RTTY enthusiast. If you have a TSR-80 or a Sorcerer, we can help you too!



**\$309**

TR 128

**RTTY REGENERATIVE  
SPEED CONVERTOR**

TTL compatible connections for direct hook-up to the Felscher TU-170, also adaptable to other terminal units.

- 60, 67, 75, 100 WPM and 110 BAUD ASCII.
- Stable crystal-controlled oscillator.
- 128 Character storage capacity with storage status meter to show buffer fill.
- Pre-loads and repeats up to 128 characters.
- Continuously variable character rate
- Low power CMOS circuitry.
- One-board (total circuitry) construction.
- Power requirement: 115V 60Hz, 5W

**\* FLSCHER CORP.**



TU-170  
AUTO START **\$299**

State of the art design features make the TU-170 ideal for HF and VHF autostart operation at an unchallenged price.

- SIZE: 7¼"W x 3¼"H x 7½"D.
- Proved 170 Hz shift active filter demodulator.
- Lighted tuning meter for easy tuning.
- Current regulated loop keyer and power supply.
- Autostart with threshold control and solid state relay.
- Stable audio frequency shift oscillator produces phase coherent sine wave tones.
- TTL compatible inputs and outputs for auxilliary equipment.
- High level output for scope tuning.
- 100 Hz shift CW keying input.

\*DEALER ENQUIRIES WELCOME

**CW ELECTRONICS**

**CNR MARSHALL RD & CHAMBERLAIN ST.  
TARRAGINDI - BRISBANE PH. (07) 48 6601  
P.O. BOX 274, SUNNYBANK, OLD, 4109.**

# 80 METRE VERTICAL

M. N. O'Burtill VK3WW  
3 Maxwell St., Lalor, Vic. 3075

Here is a 23 foot antenna that is cheap, effective and easy to build. It is the answer for 80 metre operation when you can't erect a 136 foot flat-top.

The antenna is made from  $\frac{5}{8}$  in. aluminium tubing for the lower section and part of the upper section, which is tuned by telescoping  $\frac{1}{2}$  in. and  $\frac{3}{8}$  in. tubing.

The loading coil is wound with 14 SWG enamel covered wire and is probably the hardest part of the whole project.

I mounted the antenna on a 30 foot oregon pole and have the base of the antenna about 10 feet above the ground but there is no reason why it should not work with the base at ground level.

Using a wooden mast is an easy way of erecting a vertical, and providing it is insulated from the mast the antenna is not affected in any noticeable way.

I used a series of wooden blocks and shelf brackets to hold the vertical in place. Each block measured  $4\frac{1}{2}$  in. x  $2\frac{1}{2}$  in. x  $\frac{3}{4}$  in. and had a  $\frac{3}{4}$  in. hole positioned as shown in Fig. 1. 3 in. lengths of clear plastic tubing were then slid on to the aluminium tubing and positioned so as to insulate the antenna from the mounting blocks. Ordinary hose clips were used to hold the tubing in place once the blocks were mounted on the mast and the plastic tubing of course insulated the aluminium tubing from the hose clips.

If you have any trouble sliding the plastic on to the tubing, boil up some water and let the plastic lie in it for a few minutes; it softens very quickly.

The loading coil manufacture and mounting was the hardest part of the project, yet it seems quite simple at first. All you need is about 20 feet of 14 SWG wire, 3 pieces of perspex or similar insulating material, a coffee tin, a co-operative XYL, and lots of patience.

The aim is to finish up with a coil  $4\frac{1}{2}$  in. diameter with 38 turns spaced to take up about 10 in.

My method was to carefully mark out the three pieces of perspex and then drill 38 holes in each, spaced one diameter of 14 SWG apart. Two perspex pieces measured 9 in. x 1 in. and the third 10 in. x 2 in., which provided the method of mounting to the mast. I also used two more pieces to join the two 9 in. x 1 in. pieces across the coil to stiffen the mounting. It is hard to put into words, but the photograph should get the message across.

I first close-wound the coil on a 4 in. diameter coffee tin. As soon as tension was released the coil expanded to  $4\frac{1}{2}$  in. diameter.

The next job is the hardest. Starting from one end of the coil thread the three perspex spacers on to the coil. You cannot do this single-handed, so be nice to your XYL or recruit some unsuspecting local amateur to help you. An hour or so later you will have a nice coil and/or a divorce case pending—no matter, it's all in the cause of science or something.

## GETTING IT ALL TOGETHER

Mount the stand-off blocks on the mast as shown in Fig. 2, being careful to keep the holes in line. Next mount the coil using the large perspex spacer as the mounting to the mast. Next slide the tubing into position and tighten the hose clips to hold it firmly in place.

Carefully bare the wire at each end of the coil and tin about  $\frac{1}{2}$  in. Now wrap a couple of turns around the tubing at each end of the coil and solder the wire to a lug held in place by a self-tapping screw. Use the same method at the base of the antenna to connect to the coax socket.

## TUNING

At this stage I should mention that my mast is hinged to an extended barge-board and can be easily tilted to horizontal. This is necessary as all adjustments are made by sliding the  $\frac{3}{8}$  in. tubing at the top of the antenna.

I find the best method of getting any antenna on frequency is to use a noise bridge and a general coverage receiver. If you don't have a noise bridge you can buy or build one. A good article on building one appeared in AR for July 1971, with modifications in AR October 1971.

There are two reasons for using a general coverage receiver.

One is that your first try could well have the antenna out of band limits. Also most modern transceivers are too sensitive and selective and make finding the null hard work. In any case adjustments are small, say 1 in. or 2 in. at a time, so you have to be prepared to do a lot of climbing up and down the ladder.

I selected 3.6 MHz as centre frequency and SWR checks show a bandwidth of at least 50 kHz each side of centre.

The test of any antenna is how it works under all conditions. Previously I have used a G5RV in inverted V configuration, so I ran checks against this antenna. The table shows the results—generally over longer paths (200 miles or more) the vertical won every time.

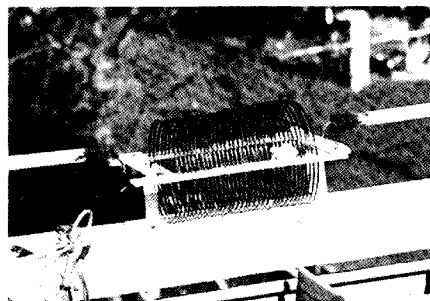

Coil close-up showing construction detail

All verticals are noisier than horizontals and this one is no exception. However, the increase in noise was not too bad, perhaps because an inverted V has some vertical properties anyway.

It would be great to have an 80 metre dipole and a vertical but this isn't on for the average suburban block, so I think this vertical is quite an efficient antenna under the circumstances.

## MULTI-BAND AS WELL

After satisfying myself that the vertical was working well on 80m I tried loading it on other HF bands.

I fed it through an aerial coupling unit (Willy Willy's Wonder, AR January 1977) and found I could load it quite well on 40m, 20m and 10m.

Of course on these extra bands it does not perform as well as a full size dipole, but is suitable as an emergency antenna capable of working all VK and ZL at least.

All things considered, this antenna is cheap, fairly easy to build and tune and performs well on 80m. With a little imagination it could be made to fit most houses.

No radials were used but an earth spike at the base is essential. My vertical is fed with 70 ohm coax because I had some available. It would probably perform better with 50 ohm and even better with a 2:1 RF transformer, so there is room for improvement if you have the bits and pieces available.

All soldered connections were covered with DENSU 510 tape to provide weather-proofing. This tape is covered in wax, which enables moulding by hand once it is wrapped around the tubing.

This article is written mainly for the amateur with limited space, and it is hoped that it will enable more amateurs to enjoy 80m operation. ■

## TEST TABLE

Distance	G5RV	Vertical
2-10 NM	0	+ 10 dB
Melbourne-Sydney	0	+ 2 S points
Melbourne-ZL2	0	+ 2 S points
Melbourne-Wagga	0	+ 1 S point
Melbourne-Adelaide	0	+ 1 S point
Melbourne-Hobart	0	No Difference
20-200 NM	0	+ 1 S point
10-20 NM	0	+ 2 S points

# C.A.R.E.

(Community Amateur Radio Events)

In times of emergency amateurs often provide the only communication link. One recent occasion was on February 15, 1979, when the US Embassy in Teheran was occupied by Iranian nationals. Charles (Chuck) Watter W4RHE had been keeping in touch with his sister and her family in Teheran via a local amateur. After the US Embassy's communication facilities were shut down Charles became the official relay station for the State Department in Washington and kept the link operating until the Iranian amateur station was closed down. The information passed via the link gave the US its only information in relation to the safety of its embassy staff during the initial stages of the occupation.

Letters of thanks from the White House and the House of Representatives were sent to Charles.

Charles, who from 1960 to 1962 held the call VK8TB, has been licensed for 31 years and welcomes VK QSOs and VK visitors.



Charles W4RHE (left) presented with letter by Congressman Nelson

THE WHITE HOUSE  
WASHINGTON

June 22, 1979

To Charles Watters

I want to express my appreciation for your valuable work in maintaining communications between the United States Government and Iran during the recent upheaval last winter.

Your help was of great benefit to the personnel of our Embassy and the interests of our Government.

Sincerely,

Mr. Charles H. Watters  
Post Office Box 8401  
Orlando, Florida 32806

Letter signed personally by President Jimmy Carter

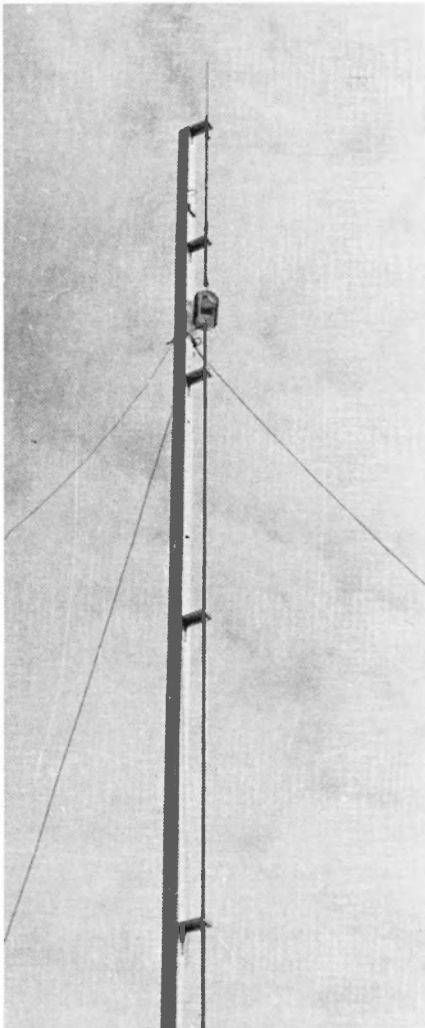

The 80 metre vertical

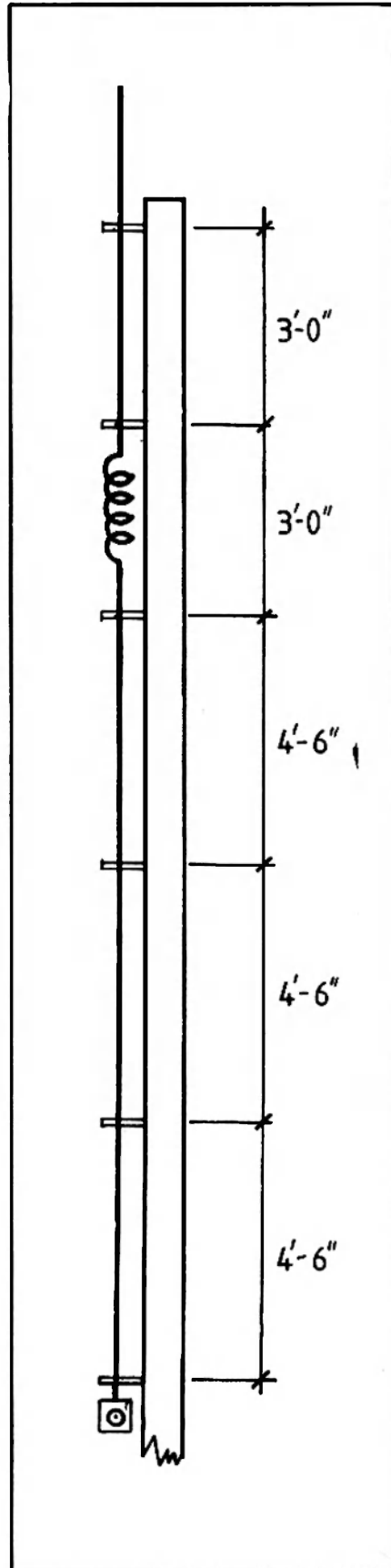

FIG. 2: Stand off mounting positions

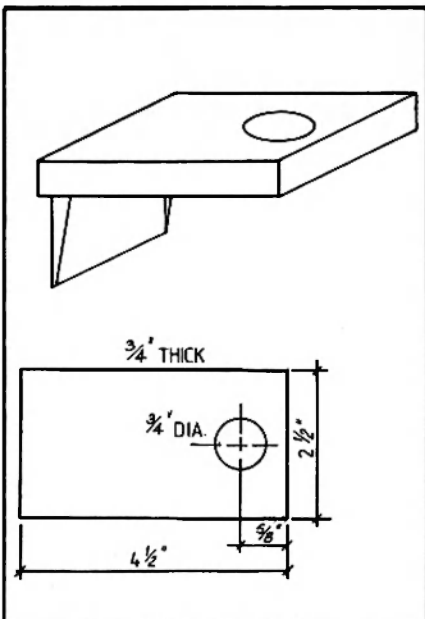

FIG. 1: Wooden blocks stand off construction.

# THE PHILIPS FM321

A 70CM 40 CHANNEL  
FULLY SYNTHESISED  
AMATEUR RIG

Australian Designed  
Australian Made



FOR ONLY  
**\$299** \*

**With these features** ● 40 synthesised channels with electronic channel change and LED readout. ● Channel selection up or down from front panel or hand microphone. ● A LED each for power on, transmit and receive. ● 5 watt RF and 1 watt audio power. ● Combined signal strength and RF power meter. ● Single or two frequency simplex operation on any of the 40 channels. ● Instant selection of these modes plus any one nominated repeater channel. ● 5MHz TX/RX separation on repeater mode. ● PL259 antenna socket. ● 6 pole crystal filter combination for improved selectivity. ● High sensitivity.

## and this performance

Typical data at 22°C 13.8V

Frequency Range: TX 433.025MHz to 434.000MHz  
438.025MHz to 439.000MHz  
RX 438.025MHz to 439.000MHz

Frequency Stability: Better than 6ppm 0°C to +60°C

Supply Voltage: 11 to 16.2Volts-Ve earth

### TRANSMITTER

Power Output: 5Watts

Spurious Output: -63db(out of band)

Audio Response: 6db/octave pre-emphasis  
300Hz to 2KHz

### RECEIVER

Audio Output: 1.0Watt at 10% THD into 8Ω

Selectivity: 50db at ±25KHz

Sensitivity: 0.3uvpd (12db SINAD)



# PHILIPS

Please send me an FM321  
by registered mail.

To: **Philips - TMC**  
Radio Communication Division AUSTRALIA  
P. O. Box 105, Clayton,  
Victoria, Australia, 3168.

NAME ..... ADDRESS .....

..... STATE ..... POSTCODE .....

CALL SIGN .....

CHEQUE No/MONEY ORDER No. .... IS ENCLOSED FOR

\$ .....

OR

PLEASE DEBIT MY BANKCARD No. ....

EXPIRY DATE .....

FOR \$ ..... SIGNATURE .....



\* Add \$4.00 for packing and postage

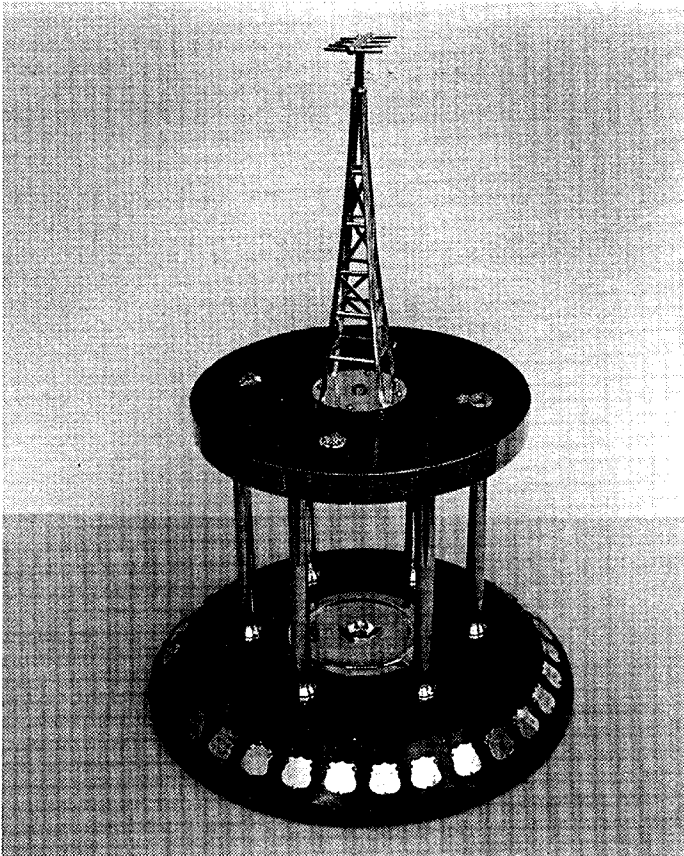

**PHOTO 1: The much sought-after RD Contest Trophy — a reminder of those amateurs who became Silent Keys during World War II. (See page 27 for last year's results.)**

## **QSP**

### **10 GHz DX RECORD**

According to Ham Radio of Oct. '79 a new 3 cm band record was set on 27th July by I4CHY/7 and I2FZD/2. The distance of 633 km was from a mountain top NE of Milan by the latter station to Testa del Gargano on the Adriatic Coast by the latter. Both used Gunnplexers and 1m dish antennas. ■

### **ALL AIRWAVES ARE NOT FREE**

An article, so entitled, appeared in Oct. '79 QST and gives much food for thought. It is too lengthy to quote in full but deals with MDS (Multi-Point Distribution Service) systems in the 2.15 GHz region which are over-the-air relay systems for premium movies and other specialised TV fare received on a monthly rental basis and providing receiving system equipment (typically around \$60 per installation) and interception of geostationary (common carrier programmed) satellites channels. ■

### **PHILATELISTS' NOTE**

West Germany has issued a 60 pfennig WARC commemorative postage stamp which shows the front panel of a Collins KWM-2 transceiver tuned to the 21 MHz CW band. Plans for a separate amateur radio commemorative stamp have been dropped resulting from this issue. Ham Radio, Oct. '79. ■

### **HISTORIC "JUNK"**

In his editorial to Oct. '79 Ham Radio Jim Fisk W1HR bemoaned his inability to attend an auction recently of surplus electronic equipment dating back to the 1920s built into custom-made wooden cases which were then in fashion. Most of the buyers, he said, were antique dealers who were interested only in the finely crafted cabinets — the priceless radio equipment inside was destined for the trash heap. He quoted another earlier opportunity missed for acquiring old gear for his collection from a sale of a local deceased amateur's collection of "junk" which filled four large warehouses. He recommends amateurs to talk to their heirs and clue them in as to what items, if any, belong in a museum. Put the details down in the will and give your executor the names of trusted amateur friends to help dispose of more modern gear at a fair market value as the equipment's value would be meaningless to most executors. ■

### **MARITIME EMERGENCY**

The following is pieced together from articles in the Toowoomba Chronicle of 11th, 14th and 29th December, received from Steve St. George VK4SE, all acknowledged with thanks. Stephen Zadkovich with his wife Jenny VK4NXV/MM and his brother Gary set sail from Brisbane aboard the 32 ft. Toowoomba-built steel sloop "White Wave" in August '79 on a round-the-world trip. Daily skeds were kept between VK5SE and the sloop which ran into cyclone Albert some 500 miles south-east of Rodrigues Island in the Indian Ocean. Before the storm reached its peak on 3rd December, VK4SE received a relayed position faintly from the sloop and several other amateurs in Australia, South Africa and Mauritius joined in a listening watch. VK4SE also reported the details to "Marine Operations" in Canberra. The sloop was rolled four times during the storm. The life raft went overboard on the first roll, the mast went in the second capsized next day, but throughout the radio was saved and when dried out, Jenny was able to transmit morse for a contact with a ZS station on 8th December using a makeshift antenna rigged up on 6th December. By that time the batteries were nearly flat, they had no fuel and no mast but were making two knots under jury rig. The ZS authorities were ready to mount a search and rescue operation but before they could act, clearance was required from Canberra. However the Mauritian authorities did act and the sloop made harbour for shipment to Toowoomba for repairs. All the occupants were safe and had returned home. ■

## **EMPLOYMENT OPPORTUNITY**

### **- Brisbane -**

The Company; a young energetic business with high growth possibilities in the area of Amateur Radio, Micro Computers and Commercial test and communications equipment.

#### **POSITION 1 - Service Technician.**

A qualified technician to manage our service centre. Previous experience in communications equipment and digital technology essential. A pre-requisite is an Amateur Radio licence and some sales experience an advantage.

#### **POSITION 2 - Sales Engineer**

To handle our quality range of products (as above). The market area includes government and commercial bodies. A pre-requisite is an Amateur Radio licence or willingness to obtain one at the earliest opportunity. Some service experience would be an advantage. The position involves some travel.

**Salary & conditions negotiable.**

#### **APPLICATIONS**

Initial applications should be in writing stating work experience, qualifications and other relevant details.

**Mark Confidential**  
**Att: Mr. Brian Beamish**

**CW ELECTRONICS**

**P.O. BOX 274, SUNNYBANK QLD 4109**

# HOORAY FOR

(NONE OF THE ABOVE)!

Submitted by  
Bruce Saxon VK3NSB  
77 Edithvale Road, Edithvale, 3196

This concoction is dedicated to all those hard working amateurs who so generously give of their spare time to present courses and lectures to aspiring students of NAOCP and AOCF.

The idea was taken from the Educational Magazine, Vol. 36, No. 5, 1979, titled, Hooray for (None of the above).

The time is set as some time in the future.

I wasn't aware of the awesome changes sweeping through our educational system until I visited the Henry Radio School the other day and had a little chat with its Principal, Dr. Homer P. Dantic. "How are you?" inquired Dr. Dantic, shaking my hand. "(A) Just fine, (B) not too bad, (S) so-so, (D) not too hot, (E) at death's door?" "(A) thank you," I said, "and you?" "(B)" said Dr. Dantic, "But let me tell you I certainly was (D) last month when our Novice grade students scored in the thirty second percentile of the seventh stanine at the Novice grade level on the Standard Webley-Vickers Radio Theory Test." "Good grief," I cried, "What an indictment of your educational methods. Did you discover a solution?" "Well it was clearly a multiple choice problem," said Dr. Dantic. "Tell me, do you think we should have (A) purchased one of the 1156 other sample tests now on the market, with the hope that there would be at least one test that would make our faculty look good; (B) attempted to attract a better calibre of student through a recruitment programme; (C) drastically revised our teaching methodology; (D) burned down the school; (E) none of the above?" "Let's see," I said. "I think . . ." "Sorry, your time is up," said Dr. Dantic, clicking his stop watch. "Actually, after much thought, we took the plunge and decided to (C)." "You mean you have drastically revised your methodology for teaching Radio Theory?" I asked. "No, we have drastically revised our methodology for teaching our students how to score well in multiple-choice tests," said Dr. Dantic.

"Would you like to see one of our new dynamic instructional modules in action?" I said I would, indeed. It was a most enlightening experience. The module we visited contained 32 students and Miss Ann Tenna, an enthusiastic young teacher. As we entered the room Miss Tenna was reviewing a homework assignment. "Who can tell me the name of the assistant who polished Marconi's ebony rod with catskin?" she asked. "Adrian?" "The name," said Adrian, "is (B)." "Very good, Adrian," said Miss Tenna. "Now, Peter, please tell the class the age of the pilot of the first communication satellite." "It is (D)," said Peter. "Wrong, wrong, wrong," shouted the class, "it is (E)."

Miss Tenna regained control and continued with the probing questions. "What is the square root of 15 712?" (Answer (C)) "Does Mr. Diode still work for Telecom?" (Answer (A).) And so the lesson continued.

"I didn't know you taught the historical aspect of Radio Theory," I remarked to Dr. Dantic. "We don't," he replied. "Then how can Miss Tenna test the students on it?" I asked. "She's not testing on that," explained Dr. Dantic, "She's testing their ability to take tests."

Well, I wish you could have seen the crackjack way in which those students performed. When Miss Tenna cried "Go", all the students had their papers flipped over in a millisecond and their pencils flashing away as they ruled the little marks on the answer sheet. By the time Miss Tenna blew her whistle Peter was only half way down the page. Miss Tenna looked at him and sighed "How often do I have to tell you, Peter?" she admonished, "When you see that you won't have time to finish a test, simply slash a vertical line down the page, hitting as many boxes as possible. If each question has five alternative answers, you will thereby increase your score by an average of 20 per cent. Adrian will you read your answers to the class?" "Yes," said Adrian, "(B), (B), (B), (B), (B) . . ." "I take it you answered (B) to every question," interrupted Miss Tenna, "Can you tell us why?" "Simple," said Adrian, "I recognised the format of the Hispano-Suzu Multiphasic Norm-Referenced Scholastic Evaluation Test. I immediately recalled that the computer readouts we studied last week indicated (B) was the correct answer 28.8 per cent of the time in Hispano-Suza multiphase, as compared to 16.9 per cent for (A), 18.3 per cent for (C), 19.7 per cent for (D) and only 16.3 per cent for (E)." "Very good," said a beaming Miss Tenna. "Class dismissed."

Miss Tenna's admiration for Adrian was echoed by Dr. Dantic when we were out in the corridor. "Adrian is the brightest student we've had here at Henry Radio School in years," he said. "He has already single handed raised our faculty performance record 1.3 per centiles on the Standard Webley-Vickers Intermediate Placement Test. And thanks to his score of 799 on the Academic Aptitude test, he will move directly to AOCF classes next year." "Most impressive," I said. "Yes," he said, "We are predicting a brilliant academic future for this young chap as he seeks the answers to those all-important questions." "In which facet of amateur radio would he specialise?" I asked. "Multiple-choice testing, of course," he replied. ■

## PENSIONERS

**ONLY YOUR DIVISION CAN APPROVE RE-GRADING TO PENSIONER STATUS — PLEASE APPLY TO YOUR DIVISION IF YOU BELIEVE YOU CAN NOW QUALIFY.**

## WESTERN ZONE CONVENTION

Jack Thomas VK3NTR  
1 Stevens Crescent, Ararat 3377

The Annual Convention of the Western Zone of the Wireless Institute, Victorian Division, was held at Halls Gap on the 10th and 11th of November 1979 and was a great success. The Saturday venue was held with a dinner at the Mountain Grand Guest House with 94 attending. Guest of honour was the President of the Victorian Division, Mr. Eric Buggee VK3ZZN and his lovely wife, with many visitors from many parts of Victoria and interstate visitors.

Sundays venue was slightly marred by an opening of the heavens but this was only a minor setback as the proceedings were carried out in the Halls Gap Hall. Forty-six ladies plus a couple of wandering OMs took advantage of the day to have a memorable sightseeing tour of the Halls Gap area.

Trade exhibits were excellent and many an amateur left with an empty pocket. Imark, Vicom, Wecam, Hamilton Electronics and the Moorabbin Club contributed to the draining of funds and provided excellent displays of various gear.

The convention was a unanimous success and many people have pledged to return to the Halls Gap area again, independent of any conventions. I wish to thank sincerely all those who attended and those whose help effort made the convention worthwhile. Special thanks to Sylvia Rose and her son and the trophy donors for the various events. We hope those who attended left satisfied and those who could not attend can make it to our next convention. ■

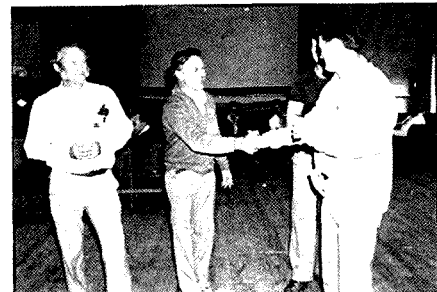

PHOTO 1: Jack VK3NTR congratulates Gordon VK3NO (right) who won the lucky entrance, Brian VK3ZBS looks on.



PHOTO 2: Laurie VK3NDL (c) presents Jack VK3NTR with an award.



# VICOM: THE ONE STOP COMMUNICATIONS SHOP!

## Daiwa Low Pass Filters

FD30LS 32 MHz, Fc, 200 w, 3 stages — \$20.00

## Baluns

AS-BL Asahi 50 ohm for beams — \$34.00  
 BL50A 50 ohm, 4 KW, 1:1 for dipoles — \$32.00  
 BL70A 70 ohm, 4 KW, 1:1 for dipoles — \$32.00

## Leader Test Equipment

LAC 895 Antenna Coupler 3.5 — 28 MHz — \$182  
 LPM 885 SWR/PWR Meter — \$97  
 LPM 880 RF Power Meter — \$139  
 LDM 815 TR Dip Meter — \$89.00  
 LBO 310 3" Ham Oscilloscope — \$330  
 IA 31 Ham monitorscope adapter — \$26.00  
 LSG16 Signal Generator — \$119.00  
 LSW250 TV-FM Sweep Generator — \$429.00  
 LAG26 Audio Generator — \$166.00

## Tubes

6KD6 Finals for Yaesu linears — \$10.00  
 6JS6C Finals for Yaesu transceiver — \$10.00  
 12BY7A Driver — \$4.75  
 6146B Finals — \$13.00

## CW Filters

FT101E Yaesu — \$39.00  
 TS520S YG3395 Kenwood — \$57.00  
 TS820S YG88C Kenwood — \$59.00

## Morse Keys

HK702 Deluxe Key with marble base — \$41.00  
 HK708 Economy Key — \$23.00  
 HK706 Operator's Key — \$25.00  
 MK701 Manipulator (side-swiper) — \$45.00  
 PALOMAR 1C Keyer — \$149.00

## Jaybeam Antennas

5Y/2m 5el 2m, 7.8 dBd gain, length 1.6 m — \$43.00  
 8Y/2m 8el 2m, 9.5 dBd gain, length 2.8 m — \$51.00  
 10Y/2m 10el 2 m, 11.4 dBd gain, length 4.4 m — \$84.00  
 10XY/2m 10el 2m, cross yagi, 11.3 dBd — \$114.00  
 D8/70cm Twin 8el, 70 cm, 12.3 dBd, 1.1 m — \$64.00  
 PBM 18/70 18 el, 70 cm, 14.9 dBd, 2.8 m — \$96.00  
 MBM 48/70 48el, 70 cm, 15.7 dBd, 1.83 m — \$83.00  
 MBM 88/70 88el, 70cm, 18.5 dBd, 3.98 m — \$105.00  
 PMH/2C Phasing harness — \$20.00  
 8XY/2m 2m cross yagi, 8el, 9.5 dBd, 2.8 m — \$99.00  
 12XY/70 cm 70 cm cross yagi, 12el, 13.0 dBd, 2.6 m — \$139.00

## Nagara

SS56 6 m 5el beam 1 KW — \$159.00  
 V5JR 80-10 m trap vertical, 6.7 m high — \$129.00  
 V4JR 40-10m trap vertical, 5.2 m high — \$99.00

## Hy-Gain Antennas

204BA 4 el monobander for 20 m — \$259.00  
 203BA 3 ei beam 20 m — \$199.00

## Scalar

M22T 1/4 wave 2 m mobile whip top only Qty 1-4 — \$7.00  
 M25T 5/8 wave 2 m mobile whip top only Qty 1-4 — \$14.00  
 BASE B/L for above — \$4.00

## Microphones

VM-1 Noise cancelling, hand ptt, low z — \$10.00

## Coaxial Cable

RG58AU mil spec, 30m reels — \$13.91  
 RG213/U mil spec per metre — \$1.50

## Kenwood Transceivers

TS520S HF transceiver — p.o.a.  
 TS120S Solid state 100w — p.o.a.  
 TS120V Solid state 10W — p.o.a.  
 TS180S Solid state 10w — p.o.a.  
 R-1000 Communications Receiver — \$498.00

## Monitor Receivers

747 Vicom Aircraft Scanner — \$199.00  
 210 Bearcat 210, scanner — \$469.00  
 HF12 VHF pocket 12 channels — \$149.00

## Coaxial Relays

CX-2L 1.8 thru 170 MHz, 100w pep — \$45.00  
 CX-2H 1.8 thru 450 MHz, 200 w pep — \$69.00

## Coax Switches

CS201 2 position, commercial quality — \$23.00  
 CS401 4 position, commercial quality — \$59.00

## Speech Processors

RF660 Phasing type, 6dB gain, dc — \$109.00  
 RF440 Phasing type, 6dB gain, dc — \$109.00  
 RF440 Phasing type, 6dB gain, ac/dc — \$126.00

## ICOM

IC701 HF transceiver — \$1199  
 IC280 2m Remotable — \$450  
 IC251A 2m All-mode — \$847  
 IC551 6m 10 watts — \$799  
 IC551D 6m 100 watts — \$850  
 IC255A 2m Digital — \$425  
 IC502A 6m portable — \$289

## QUALITY ANTENNA ROTATORS



### Typical operating characteristics:

	DR7500S (medium duty)	DR7600S (heavy duty)
Power consumption	40VA	40VA
Motor	24V split phase	24V split phase
Rotation time (approx)	50 sec	64 sec
Rotating torque	500kg/cm	600kg/cm
Braking Torque	2000kg/cm	4000kg/cm
Vertical load	200 kg	200 kg
Weight	4.5 kg	4.6 kg
Cable	6 core	6 core
PRICE: (cable \$1 per m)	\$189.00	\$259.00

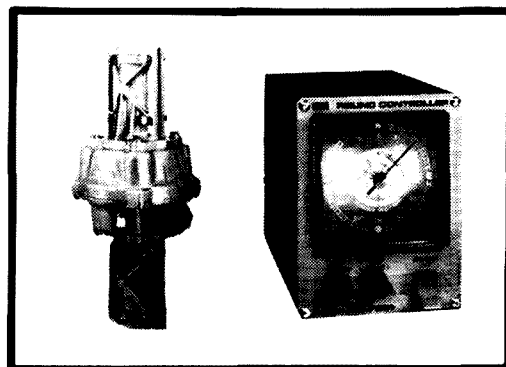

### Available from your VICOM dealer

Authorised dealers throughout Australia

↓ Sydney: 339 Pacific Hwy,  
 Crows Nest  
 Ph (02) 436 2766

↓ Brisbane 48 6601  
 ↓ Perth 321 3407  
 ↓ Adelaide 43 7981

↓ Head Office and Mail Orders:  
 68 Eastern Road,  
 Sth Melb. Vic. 3205.  
 Ph (03) 699 6700  
 Telex 36935

# VICOM

# ANNOUNCING A NEW COMMUNICATIONS COMPUTER!



## TONO

### THETA 7000E

**NEW IMPROVED MODEL  
FEATURING  
STACKS OF EXTRA TRICKS!**

The new Theta 7000E has all the features of the popular 0-7000, plus a lot more! Now every Amateur can enjoy the visual display of CW, RTTY, and ASCII in both transmit and receive modes. Just connect the TONO to any TV set via the antenna terminals or to a page printer from the parallel port provided. Bring up your CW speed in receiving or sending by either watching receiver-sent or from recorded cassettes.

## SOME OF THE OUTSTANDING FEATURES:

### THETA 7000E COMMUNICATIONS COMPUTER

Due to the most up-to-date computer technology, just one piece of equipment can now handle both transmitting and receiving in CW, RTTY and ASCII.

#### VHF and Composite video output provided:

Both home TV set and video monitor outputs are provided for display purposes.

#### Printer interface.

Centronics. Compatible interface enables easy connection of a low-cost dot printer for hard copies.

#### Wide range of transmitting and receiving speeds.

10 communication speeds for transmitting (with automatic CW speed adjustment on receive) and 8 communication speeds for transmitting and receiving in RTTY and ASCII. The multiple speed feature makes the Theta-7000E ideal for Amateur, business and commercial use.

#### Built-in demodulator for high performance.

Three-step shift (either 170Hz, 425Hz, 850Hz) can be obtained in High Tone and Low Tone by the switch. Manual adjustment is available by FINE TUNING control.

#### Crystal controlled modulator.

A transceiver without AFSK function can transmit in RTTY mode by utilising the high stability crystal-controlled modulator controlled by the computer.

#### Convenient ASCII key arrangement.

The keyboard layout is the same as a regular typewriter and automatic insertion of LTR/FIG code makes operation a breeze.

#### Large capacity display memory.

The two-page display memory contains 32 characters x 16 lines per page. Page selection is operated via the keyboard.

#### Split-screen.

With a keyboard command, the same page can be divided in two; the upper half for transmit and the lower half for receive. Sentences can be edited whilst receiving.

#### Automatic Transmit/Receive switch.

The transmit/receive switch is controlled by the microprocessor. (Manual operation is also available). Built-in remote control key function controls the transmit/receive switch of the transceiver.

#### Anti-noise circuit.

A new anti-noise circuit prevents garbled messages when there is no signal.

#### Battery backed-up memory

Data in the battery backed-up memory is retained when the external power source is removed. The Theta-7000E has provision for 64 characters x 7 channels in the non-volatile memory. Data in this memory can be repeated 1-9 times from a keyboard instruction. Every channel can read out continuously. The channel number in use is displayed on the screen.

#### SEND function

The SEND function sends the whole data displayed on the screen, including the stored data in channels, with an instruction from the keyboard. The message can be stopped and easily restarted.

#### Buffer memory.

A 53-character-buffer-memory is displayed on the 17th and 18th. lines on the screen. The characters move to the left erasing one by one as soon as they are transmitted. Data in the channels can be displayed in the buffer.

#### Rub out function.

Mistakes can be erased whilst the information is still in the buffer memory. If the mistake has already been sent correcting code will be transmitted.

#### Simultaneous access of the memory.

Whilst receiving, it is possible to write into the channel memory and the buffer memory from the keyboard. When sending from the channel memory or the screen it is possible to write into the buffer memory.

#### Pre-loading function.

The buffer memory can momentarily store data and release it on an instruction from the keyboard.

#### Channel No., Page No., and Case No.

Channel No., Page No., and Case (FIG/LTR) in RTTY are displayed in the 17th line of the screen.

#### CR (Carriage return)/LF (line feed) cancel function.

When receiving CR or LF, they are replaced by = (equal) and (underline) respectively for effective use of the screen.

#### Cursor control function.

Full cursor control (up/down — left/right) is available from the keyboard.

#### WORD MODE operation.

Characters can be transmitted by word groupings.

#### Automatic CR/LF

While sending, CR/LF are automatically inserted once every 72 (60 or 80) characters.

#### Echo function.

With a keyboard instruction, received data can be read and sent out at the same time. A cassette tape can be used as the source data.

#### WORD-WRAP-AROUND function.

In receive mode word-wrap-around prevents the last word of line from splitting in two.

#### Transmit/receive in ASCII mode in RTTY.

On instruction from the keyboard, the same AFSK signals as used in RTTY are transmitted in ASCII mode.

#### CW Identification function.

Keyboard controlled CW identification is available if required.

#### MARK-AND-BREAK (SPACE-AND-BREAK) system.

Either mark or space tone can be used to copy RTTY.

#### Monitor circuit.

A built-in monitor circuit with an automatic transmit/receive switch enables checking of the transmitting and receiving state. In receive mode it is possible to check the output of the mark filter, the space filter and AGC amplifier prior to the filters.

#### CW practice function.

The Theta-7000E reads data from the key and displays the characters on the screen.

#### Variable CW weights.

For CW transmission, weights (ratio of dot to dash) can be changed within the limits of 1.3-1.6.

#### Cross-pattern checking output terminal.

Provision has been made for attachment of an oscilloscope to aid tuning. This supplements the tuning LED and audio monitor provided in the system.

#### Log-computer output provided.

The Theta-7000E has an output terminal for connection to a log-keeping computer.

#### Test message function.

"RY" and "QBF" test messages can be repeated with this function.

#### VICOM Back-up

Supported by VICOM 90 day warranty and technical service.

**\$899 incl. S. Tax**

Distributed by:

Available from VICOM dealers  
throughout Australia

# VICOM

□ Melb: 68 Eastern Rd. □ Syd: 339 Pacific Hwy. □ Bris. 48 6601  
Sth. Melb. □ Crow's Nest □ Perth 321 3407  
Ph. 699 6700 □ Adel. 43 7981

# THE FAMOUS 2M FM MOBILE IC22S

## ICOM



## 1000'S SOLD IN AUSTRALIA

STILL ONLY \$299

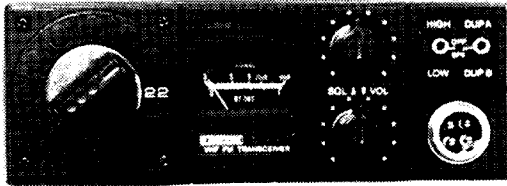

## SYNTHESISED

- \* **IDEAL FOR MOBILE**  
No digital display, easy to use on the move without looking.
- \* **STACKS OF CHANNELS**  
22 programmable channels — 11 popular ones already done and 11 for you to program to your own choice.
- \* **REPEATER REVERSE**  
Full reverse at a flick of a switch.
- \* **SUPERB QUALITY AND PERFORMANCE**  
The ICOM name is synonymous with reliable communications, as thousands of happy owners will confirm.
- \* **COMPLETE**  
Comes complete with mic, mobile mounting brackets, dc lead and comprehensive instruction manual. Backed by Vicom 90 day warranty.
- \* **LOW RECEIVER NOISE**  
The IC22S uses a FET front end and high-Q helicalised cavity resonators. Signal gain of 90dB or more up to second mixer.
- \* **PROGRAMMABLE DIODE MATRIX**  
It's easy to add extra channels. Just solder in the diodes!

## SIMPLY THE BEST!

### Typical Technical Characteristics

General: (Australian Model). Number of semiconductors. Transistors 41. FET 7. IC 13. Diode 33 (Except Matrix Board). Frequency Coverage. 146-148 MHz. Antenna Impedance. 50 Ohms unbalanced. Power Supply Requirements. DC 13.8V  $\pm$  15% Negative Ground 2.5 A Max. Current Drain. Transmitting. Approx. 2.0A. Receiving. At Max. Audio. Approx 0.7 A. Squelched Approx. 0.4A. Dimensions: 58mm(H) x 156mm(W) x 218mm(D). Net Weight. 1.9 Kg. Channels Installed: R1-8, 40, 50, 51. Transmissions: Transmitting Frequency. 22 Channels in the 2m Band. Programmable by a diode matrix for any channels on 25KHz spacing. Emission Mode 16F3. Output Power. 10W. Max. Frequency Deviation. 5KHz. Modulation System. Variable

reactance phase modulation. Spurious Emission. More than 60dB below carrier. Microphone. Impedance: 600 Ohms. Input level: 10mV typical. Dynamic or optional Electret condenser microphone. Reception: Receiving Frequency. 22 Channels in 2m Band. Modulation Acceptance. 16F3. Receiving System. Double super heterodyne. Intermediate Frequency. First IF 10.7MHz. Second IF 455KHz. Sensitivity. Less than 0.5u V for 20dB Noise quieting. More than 30dB S+N+D/N+D at 1 u V. Squelch Sensitivity. Less than 0.3u V. Spurious Response Rejection Ratio. More than 60dB. Selectivity.  $\pm$ 7.5KHz at the -6dB point.  $\pm$ 15KHz at the -60dB point. Audio Output Power. More than 1 Watt. Audio Output Impedance. 8 Ohms.

Available from authorised dealers  
throughout Australia

# VICOM

Check it out at your VICOM dealer.

□ Melb: 68 Eastern Rd. □ Syd. 339 Pacific Hwy. □ Bris. 48 6601  
Sth. Melb. Crows Nest □ Perth 321 3407  
Ph. 699 6700 Ph. 436 2766 □ Adel. 43 7981

# AMATEUR SATELLITES

R. C. Arnold VK3ZBB

## OSCAR 7

Efforts to maintain AMSAT OSCAR 7 on its old schedule of operation have been successful in recent months. For those who may not remember, Mode A operates on odd days of the year with Mode B on the even days. Wednesday is experimental day on Mode X.

The tentative launch date of the British UOSAT Amateur Satellite is 13th September, 1981.

Probably the most "up to the minute" and comprehensive notes on satellite activity are found in the newsletter of the Mode "J" Club. I can only repeat some snippets from this newsletter as they are rather dated by the time they appear in AR, but I am sure many OSCAR fans must have qualified for membership of the Club and could receive their own copy — details have been published in recent editions of these notes.

Congratulations are due to Larry Roberts W9MXC, the editor of Mode "J" Newsletter, for a job well done.

Have you ever thought of exchanging your AMSAT membership during a satellite contact? If you work a station not possessing a membership number, give details of AMSAT and suggest he should join this elite organisation. The same suggestion goes for Mode "J" contacts.

## LOOKING AHEAD

1980 May — AMSAT Phase III satellite.

1980 Sometime — Two more Russian Amateur satellites.

1981 September — UOSAT.

1984 A French Amateur Satellite is expected to be launched from Kouron in French Guiana on an Ariane Mission. It will probably carry two transponders, one on Mode J (up 145 down 435 MHz), the other with uplink 435 MHz and downlink 1260 MHz (this seems to conflict with the latest WARC information — Bob).

Do you realise the AMSAT OSCAR 7 has completed five years of operation? It is interesting to note that the prime load with which AO7 was launched only lasted about 1½ years.

## OSCAR IN THE CLASSROOM

Bill Magnusson VK3JT who is vitally interested in the use of amateur satellites for educational purposes, has agreed to act as Phase III OSCAR Education Programme Co-ordinator in Australia. Bill has asked me to include the following notes:

"With the imminent launch of Phase III and the general upturn in interest in VHF, UHF and satellite communication, an attempt will be made in 1980 to tie together the very considerable educational possi-

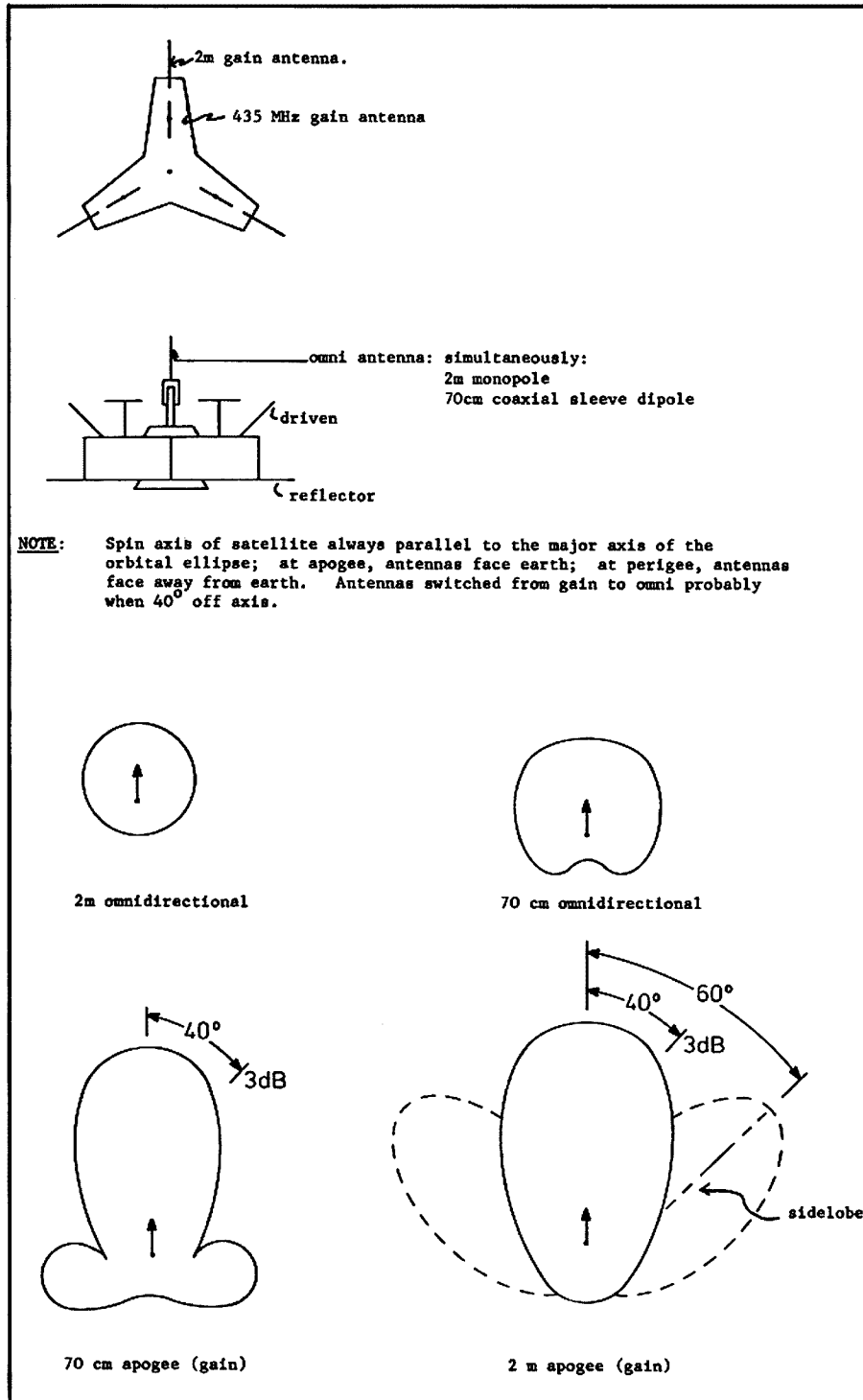

**SCHEMATIC 1: Spacecraft antenna placement and pattern AMSAT OSCAR Phase III-A.**

bilities of the AMSAT programme in this country.

"I have been asked to act as education co-ordinator and one of my first priorities will be to compile and distribute a register, hopefully as complete as possible, of all school-based radio clubs or groups with an interest in the amateur satellite programme. A considerable amount of in-

formation of interest to such groups is already available from AMSAT and ARRL and I will be in a position to disseminate this and to act as a central source for collection and distribution of such information. I will also be making approaches through the various State education departments for advertising space in gazettes and journals and through standing com-

mittees in the physics, general science and electronic practices areas. I'm sure many secondary schools have radio clubs. Many such clubs are run by or have available a licensed radio amateur. I will be trying to show these clubs that it really is quite easy to become involved in OSCAR and that the educational spin-off is immense. It should be well within the grasp of even the most modest club to take part.

"Should anyone reading this feel they could contribute or require information, or would like to be placed on a register, they could write to me, care of Footscray Technical School, Ballarat Road, Footscray, Vic. 3011".

The following updated information on AMSAT OSCAR Phase III-A has been received from Steve Place WB1EYI and should be of value to those contemplating monitoring this satellite:

"AMSAT OSCAR Phase III-A, as all previous OSCAR satellites, will receive a numerical designator once it successfully achieves orbit. At that time it will be referred to as either AMSAT OSCAR X (probably AMSAT OSCAR "9") or AMSAT X (AMSAT 9), NOT OSCAR X. The proper abbreviation will be A-O X (probably A-O 9).

The latest updates on the projected orbital parameters (these figures are still tentative) are shown in Table 1.

#### Revised Maximum access time

The projected maximum access time has changed. Given the new period of about 10 hours and 28 minutes, a station at 30° N latitude, for example, will have about 9½ hours of continuous access. This, of course, would be for the ideal pass for a particular station at this latitude; stations at different latitudes will have differing times. Also, certain orbits may not be accessible at all. Apogee latitude will very gradually shift North, increasingly favouring higher N latitudes, and access times for a given location will change. Eventually, apogee drift will swing south and occur over the equator and below, favouring S latitudes.

#### Rate of change in apogee latitude

Immediately after firing, the projected initial latitude of apogee will be about 24.8° N lat., and of perigee will be about 24.8° S lat. The rate of change of apogee, and perigee, latitude (drift) will not be constant. The initial argument of perigee (angle in the orbital plane from the line of nodes to perigee — measured counterclockwise) will be about 210°; its rate of change will be constant at about 0.07° per day.

To determine the change in the latitude of apogee and perigee, use the following relationship (angle of inclination = 57°) (Wo = argument of perigee)

$$\text{perigee latitude} = \arcsin((\sin i) \times (\sin W\omega_0))$$

For example, ten days after firing, assuming the projected values are correct, the argument of perigee will have changed to:

$$210^\circ + (10 \text{ days} \times 0.07^\circ/\text{day}) = 210.7^\circ$$

and from this, we calculate that perigee will occur at:

$$\begin{aligned} \text{perigee lat.} &= \arcsin((\sin 57^\circ) \\ &\quad \times (\sin 210.7^\circ)) \\ &= -25.35^\circ \text{ ("—" means S lat.,} \\ &\quad \text{apogee is "+" Or N)} \end{aligned}$$

In other words, in ten days, perigee will occur about 0.5° further South, and apogee 0.5° further North. Again, the rate of change of the argument of perigee is constant, the rate of change of apogee/perigee latitude is not.

#### Firewheel — the primary payload

AMSAT OSCAR Phase III-A will ride piggyback", or as the secondary payload aboard the European Space Agency Ariane LO2 mission. The primary payload is an experiment called Firewheel which will be mounted atop what ESA calls the "CAT" or Application Technology Capsule. Phase III will be mounted below Firewheel, affixed to the side of the CAT. Firewheel comprises a series of cannisters, arranged around the top circumference of the cylindrical CAT, containing explosives, lithium, barium and other compounds. When exploded, these will form a visible, "glowing", steam-like cloud, enabling scientists to study the patterning of the earth's magnetic field. Phase III will be clear of the experiment before the explosive charges are fired.

#### Transfer orbit bulletins

During the transfer orbit, AMSAT engineers will make precision ranging measurements to determine the actual orbital parameters as accurately as possible for the critical kick motor calculations. One-way bulletins

will occasionally be transmitted near apogee to explain the status of the mission, but the satellite will not be available for general use until a short time after firing. All are urged not to interfere with this work.

#### Special Service Channels

Included in the Phase III bandplan are six SSCs; the correct sequencing, placement, focus and co-ordinators follow:

- L1 Scientific (formal, scheduled) N1DM — 17 kHz up from General Beacon
- L2 AMICON (computer) WA2LQQ — 21 kHz up from General Beacon
- L3 NTS (formal, record CW traffic) K1XA — 25 kHz up from General Beacon
- H1 CW/RTTY Bulletin, CW Practice W1EH — 17 kHz down from Engr. Beacon
- H2 Education (schools and ham) WB1EYI — 21 kHz down from Engr. Beacon
- H3 Phone Bulletin (international) G3IOR — 25 kHz down from Engr. Beacon

All SSCs are 4 kHz wide. Send all comments, inquiries and suggestions to the co-ordinators via AMSAT headquarters.

#### General Beacon format

The General Beacon, located at about 145.81 MHz, will contain much useful information. Each hour will be formatted the same so that listeners will know exactly when to listen to get the information they need.

A suggested format appears in Table 2.

TABLE 1:

Parameter	Transfer Orbit	Final Orbit
inclination	17.5°	57°
apogee altitude	34,385 km	34,385 km
perigee altitude	200 km	1,500 km
argument of perigee	190.587°	210°
drift rate (arg. of per.)	0.7838°/day	0.07°/day
anomalistic period	603.78 minutes	628.8 minutes
perigee latitude	about 3.2° S lat.	about 24.8° S lat.

weight of spacecraft: 75 kg (165 lbs.)

TABLE 2:

Time	Interval (minutes)	Duration (minutes)	Content
T0	0-1	1	CW i.d. and preamble
T1	1-3	2	basic orbital data
T2	3-6	3	CW telemetry data
T3	6-21	15	CW bulletin board
T4	21-26.5	5.5	RTTY rescan of above
T5	26.5-30	3.5	CW telemetry
T6	30-31	1	CW i.d. and preamble
T7	31-33	2	basic orbital data
T8	33-36	3	CW telemetry data
T9	36-51	15	CW bulletin board
T10	51-56	5	RTTY week's orbits
T11	56-60	4	fill to the hour with CW telemetry

CW code speed will be 15 words per minute.

### Telemetry formatting

With previous OSCARS, telemetry was transmitted as raw data — numbers that were in themselves meaningless and which had to be "translated" by equations or graphs into meaningful data such as voltages and currents. Phase III, however, will transmit meaningful data that has been processed in its flight computer. During the 3 minute telemetry transmissions, 20 channels out of a possible 64 will be sent in a five number format. The first two digits will be the decimal channel number, followed by the three digit value. The user will look up a given channel number in a table in which he will be told where to place the decimal point and what the unit of measurement is. For example, 32498 would be channel 32 (decimal) with a value of 498. From the table, you would find that the value should be multiplied by 0.1 and was a measure of watts: transponder power out. The transponder was putting out 49.8 watts (this is strictly an example and channel assignments may change).

AMSAT calling frequency: 28.880 MHz (no scheduled activity but excellent source of information if individuals are monitoring. All are encouraged to check in).

The following diagrams illustrate the antenna arrangements in AO Phase III-A together with their patterns for 70 cm and 2m.

OSCAR 8 orbital parameters are forever changing and it has been difficult to predict what they may be at the time of

publication of these notes. It is surprising what a significant effect  $10^{-3}$  seconds per orbit has when estimating times some 2½ months ahead. The predictions for February are submitted with "fingers crossed" and I hope they will turn out to be reasonably accurate — at least any inaccuracy should be consistent. ■

### ORBIT PREDICTIONS — FEBRUARY 1980

OSCAR 7				OSCAR 8			
Date	Orb. No.	Eqx Z	Eqx °W	Orb. No.	Eqx Z	Eqx °W	
1	23845	0119	87	9728	0046	53	
2	23657	0018	72	9742	0050	54	
3	23870	0112	86	9756	0053	55	
4	23882	0012	70	9770	0056	56	
5	23895	0106	84	9784	0100	57	
6	23907	0005	69	9798	0103	58	
7	23920	0100	82	9812	0107	58	
8	23933	0154	96	9826	0110	59	
9	23945	0053	81	9840	0113	60	
10	23958	0147	94	9854	0117	61	
11	23970	0047	79	9868	0120	62	
12	23983	0141	93	9882	0124	63	
13	23995	0040	78	9896	0127	64	
14	24008	0135	91	9910	0130	64	
15	24020	0034	76	9924	0134	65	
16	24033	0128	90	9938	0137	66	
17	24045	0028	75	9952	0141	67	
18	24058	0122	88	9965	0001	42	
19	24070	0021	73	9979	0004	43	
20	24083	0116	87	9993	0008	44	
21	24095	0015	72	10007	0011	45	
22	24108	0109	85	10021	0015	46	
23	24108	0109	85	10021	0015	46	
23	24120	0009	70	10035	0018	46	
24	24133	0103	84	10049	0021	47	
25	24145	0002	68	10063	0024	48	
26	24158	0056	82	10077	0027	49	
27	24171	0151	96	10096	0031	50	
28	24183	0050	80	10105	0034	51	
29	24196	0144	94	10119	0038	51	

## QSP

### CW REQUIREMENT

The editorial in Oct. '79 QST seeks expressions of opinion by U.S.A. amateurs that there should be no change in Article 41 of the ITU Radio Regulations. This is the article dealing with the Amateur Service. The ARRL makes it clear that no change should be made to this Article — a position maintained by ARRL for some years. Despite this, the FCC proposed that the Morse Code requirement below 144 MHz be eliminated, "a change which is not wanted by the Amateur Radio Service it affects, and we don't like it". "Nearly everyone is concerned over the possibility that one of the strengths of the Amateur Radio Service would be eroded if these rumours are true". Well, as everybody now knows, WARC 79, dropped the minimum frequency requirement for morse code to 30 MHz from 144 MHz. ■

### INDUCTION COOKING RANGES

An article in Oct. '79 QST draws attention to a new technological development in cooking appliances to come onto the market soon. AC at a frequency between 20 and 40 kHz is circulated in a coil under a smooth ceramic cooking top. When an Iron pot is placed on the top (which is in the induction field of the coil) eddy currents are induced in the pot causing it to become hot and cook the food within it. It is stated that the induction range is much more economical and there is no danger of fire from oil spillage because the ceramic cooking top remains cold, moreover it is easy to clean, being smooth. However, these ranges are a potential source of serious RF interference and the FCC in the U.S.A. has adopted regulations from 1.2.1980 which will apply to any induction cooking range using a frequency of 10 kHz or higher. Before any such range is put on the market certification is required that it meets certain radiation and conduction limits. ■

**JOIN A NEW MEMBER — NOW!**

# BELCOM LS707 UHF ALL MODE TRANSCEIVER

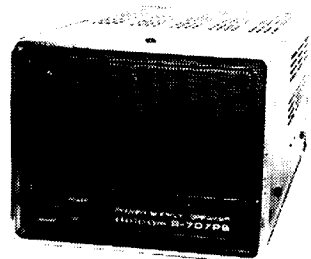
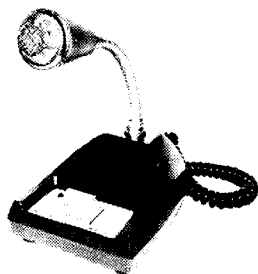

### BRIEF FEATURES

- ★ All solid state devices
- ★ All modes — AM, USB, LSB, CW, FM
- ★ Continuous band coverage from 430-440MHz
- ★ Provision for up to 100 fixed crystal channels

- ★ Power Out-Put SSB, FM, CW 10 Watts  
AM 4 Watts
- ★ Double/triple conversion receiver
- ★ 5 Amp Power supply available as option
- ★ Stand microphone available as option.

**NOW AVAILABLE DUTY FREE AT ONLY \$895.00**

**I M A R K**

**Pty. Ltd., 167 Roden St., West Melbourne, Vic. 3003  
Phone (03) 329 5433**

# 1979 REMEMBRANCE DAY CONTEST RESULTS

## WINNER - VK5 DIVISION

	a.	b.	c.	d.	e.	VK2 PHONE					ZJ	262	YFZ	156	AJR	80	
VK1	65	160	38892	40.6	15800	DDS	2327	WT	324	NAW	119	YLD	259	AIE	150	RN	73
VK2	132	2035	66438	6.5	4309	ARX	2256	BDH	323	FM	118	ZYL	255	XH	138	ZFI	66
VK3	93	1545	56941	6.0	3428	DO	1824	HD	320	XT	116	AVJ	253	BAX	137	AWZ	65
VK4	103	655	52147	15.7	8200	BYF	1735	NHD	317	DEW	116	NWH	245	YRP	136	BIS	63
VK5&	175	616	98990	26.8	28539	NVT	1689	NRB	299	NJU	116	BRL	243	AMW	134	VCE	62
VK8	6	60	7599			DM	1590	WW	296	AJH	115	YIW	241	VAN	132	BER	60
VK6&	93	462	68434	20.3	14395	NMY	1540	OH	294	QC	112	BJM	238	AAJ	131	ZBB	59
VK9	1					BTZ	1320	DAI	287	DAB	107	BOU	237	APZ	110	YQI	57
VK7&	63	184	46724	35.3	16936	WI	1236	BMX	286	NMX	103	ZI	227	NLT	103	ACS	50
VK0	2		1218			NQL	1163	VJH	268	NBD	102	BKN	220	NZ	101	BJV	44
						BPK	1058	CN	266	NUK	101	BJU	202	AER	101	AVV	34
						BDN	995	AGM	264	CF	99	BKU	182	NOV	94	YLC	29
						DCL	931	VB	263	DDQ	87	NRW	177	J1	89	VKR	21
						BXD	928	AJL	261	VCO	86	NMX	167	Bi1	84	YCU	18
						VRW	901	WA	252	VEO	84	NZW	157	BGS	81		
						VKM	884	BRF	246	BDT	80						
						BAM	879	VIE	231	WB	78						
						DFI	856	AIC	227	LE	70						
						VDF	814	TK	226	NHA	69						
						VDJ	780	AZR	221	NNF	69						
						AWI	773	VIE	217	HZ	67						
						ATZ	767	VJM	213	SW	66						
						BPR	754	VJN	205	RJ	62						
						DFA	731	VDN	194	BBO	62						
						BDB	724	AHH	192	VBX	62						
						VAO	627	APP	191	BLK	61						
						QV	613	CU	190	NYU	46						
						BFS	588	NWW	186	BYD	46						
						LF	581	BUT	183	VHC	46						
						SS	577	NWL	182	WG	40						
						AGS	576	NUA	176	ZVN	40						
						ASH	576	ALZ	175	ZLX	40						
						VAB	558	VBU	174	BCC	39						
						BVJ	557	VJB	171	ASY	36						
						VNJ	552	DED	168	NVD	36						
						ASU	529	DEV	168	BSG	37						
						BFF	497	AQ	160	DBK	36						
						VEM	478	AIM	159	VOH	36						
						DEO	462	VKZ	159	ZTD	35						
						NZ	431	VOK	157	BHM	33						
						AOA	420	NV	155	AWX	30						
						BYS	417	VBF	152	BXQ	30						
						EY	364	AXV	144	WD	26						
						BIP	347	VCU	144	AJO	24						
						BVR	370	PT	143	DDN	24						
						PN	359	DDD	143	DR	22						
						BB	352	CI	135	ZI	13						
						ABC	347	NNI	131	YNM	13						
						HQ	337	AKY	130	ZMY	13						
						NTF	333	VPK	125	YHU	10						
						VQW	330	VRJ	122	IV	7						
						DEE	328	VNA	119								

- Column.
- a. Full call logs received
  - b. Full call licences issued (31 March 1979)
  - c. Total points score
  - d. Percentage participation of full calls
  - e. Trophy score (a x c / b = e).

The following details show the section and the points scored:

**VK1 CW**

PG	1408	CDR	98	PM	68
DH	928	RP	86	8SU/P	54
DA	442	RC	82	DS	54
FT	372	8GG/P	80	J1	42
MW	252	BP	78	AYL	22
8DB\$P	192	KA	76		

**VK1 PHONE**

GB	2604	RK	170	RP	436
JN	1945	AC	165	KA	435
TD	1864	ZBJ	162	BP	428
DA	1349	NCF	158	XU	416
NAV	1156	NAQ	153	VW	405
GM	1057	ZAR	148	KP	370
NBM	1029	AVM	131	NCE	370
KB	947	ACA	118	AYL	312
DV	940	ZCB	113	ZAH	309
MX	751	DS	112	PM	276
NBK	736	ZWP	95	RJ	271
NAT	726	MF	94	NAL	269
BR	625	JH	63	VP	264
RC	621	BJ	60	NBF	263
KV	601	DG	58	J1	260
NAS	575	EF	52	NCP	258
NCL	565	EP	52	LF	252
FT	538	ZAG	52	ZT	250
RH	514	YS	50	DH	228
AW	481	8GG/P	37	8DB/P	227
RM	471	CDR	23	WI	207
NCN	471	8SU/P	10	BC	193
NAM	453	ML	9	NBS	182

**VK1 RECEIVING**

LF0035	R. M. Pillifeant	1312
L10042	P. Zarew	1194
LF0082	G. J. Berger	918
	J. Galea	678
L10016	K. Ray	473

**VK2 CW**

SX	1214	IC	248	BYF	66
AQF	1116	ZC	222	BCC	56
EL	892	DBA	220	NAW	54
CBF	822	ABB	212	DEW	50
QL	810	NMX	158	ASY	42
BAT	718	VM	152	BHM	38
BHO	628	BLK	128	DR	36
II	514	JM	120	AOA	34
QF	508	PN	102	BSG	20
BWI	434	BNL	100	ZMY	14
GT	400	BBB	74		
DO	340	IV	72		

**VK3 CW**

XB	1178	AMD	378	YL	134
AEW	1060	AJB	348	ARB	128
YF	788	ANI	322	AOK	98
FC	786	MJ	304	NEA	80
YK	638	AMG	290	ABA	76
DG	578	BOD	244	BKU	58
BDH	518	LV	220	AFW	54
J1	480	RJ	180	FA	24
VF	438	SV	178	BYA	22

**VK3 PHONE**

WP	2554	BJQ	907	NEA	449
AQZ	2053	AUQ	862	BPN	436
BSH	1761	NAW	819	BRR	412
BPF	1707	G1	739	LP	386
WW	1624	BRM	688	VAH	363
NMI	1362	SM	673	NEV	361
BQB	1350	AF	650	AFW	357
NLO	1327	XF	641	BHU	337
BIR	1275	BDL	590	ARV	315
NYO	1243	EF	586	AZA	299
BHC	1187	BOD	580	AH	295
DS	1085	NAF	567	NCQ	288
ANA	1056	BSR	553	BGG	280
ADW	1028	AMA	542	BLY	279
OF	999	NSQ	542	BYA	274
NLS	936	ZY	463	BIT	266

**VK3 RECEIVING**

L30042	E. Trebilcock	788
L31203	P. Barclay	694
	N. Blake	579
L31158	K. Brown	403

**VK4 CW**

LV	1276	UA	408	OD	78
KX	1242	XA	386	XJ	76
GH	608	LH	280	QY	40
HH	608	JT	200	ZA	32
ARC	462	UC	186		
CJ	480	YG	182		

**VK4 PHONE**

UX	2088	LZ	324	ZBV	103
QO	1770	ADW	324	SF	101
NOD	1732	NXL	323	NWH	101
WIZ	1699	UG	315	DH	95
AMH	1262	NAP	315	UJ	94
AOA	1254	OX	305	NVS	94
YG	1236	RP	305	AEK	90
AYL	1236	AEM	287	AF	8

VK5 CW			
UM	1284	NLC	300
BN	1016	QR	216
OR	938	QQ	194
FM	836	RT	180
SW	804	FX	174
XD	656	ABB	130
LI	654	KU	116
HO	386	RG	94

VK5 PHONE			
QX	2562	VV	349
GH	2123	ASA	347
MM	1987	ZAT	345
KK	1866	OL	343
WV	1697	ABW	338
LP	1388	NEB	333
NTB	1347	NLS	324
ARC	1345	NCO	316
NX	1278	ZCM	316
ABP	1275	NAJ	314
ZH	1263	NHB	314
DV	1152	AZ	312
OU	1100	NHO	309
AGO	1090	NDG	307
DK	1089	ZBI	304
NN	1084	AJJ	301
BI	1081	LQ	300
TY	1057	RV	294
ZK	1017	VG	294
FD	968	ZE	284
LZ	932	ZF	278
DR	928	NBG	275
TS	921	NTK	274
NJE	914	SW	271
ADD	887	NRZ	269
DI	848	NPF	269
TZ	841	RX	267
NNC	839	NXY	265
XT	833	ZPE	263
AIC	827	ZVK	262
EN	745	NCE	251
XZ	723	OM	246
NOF	719	ABS	241
NKA	716	NGP	241
SN	698	AKS	237
LN	694	OT	234
SU	688	UW	222
AMW	668	ZZ	220
BW	654	ADC	219
IN	642	NMY	208
KR	623	ARV	205
NBN	615	EF	200
FO	576	HN	198
ATW	571	NVW	194
ON	568	ZRJ	193
ZJG	554	RI	188
NCL	551	SG	182
HI	544	NGA	180
ZG	539	PK	177
OI	533	AQ	175
FX	528	AVQ	174
CGR	528	YV	173
NJ	510	LC	171
NLV	499	NB....	167
GL	492	NKW	167
NPC	488	ZJE	166
NBY	482	RK	161
NBJ	472	NSA	157
ATM	470	VE	156
LM	447	ZBC	156
NMO	445	HM	150
NXT	434	KH	149
IZ	429	NGQ	149
NCB	427	NEH	145
BP	410	NGC	144
NCX	407	NSW	142
SS	402	NNE	142
LL	400	EV	140
NHG	399	RR	139
IT	396	ZQ	137
ND	379	ZB	136
NEN	379	WN	134
NWT	378	NRO	133
AIM	376	BG	129
EA	359	NCK	129
FL	359	OZ	128
XI	359	JK	125
NHM	358	TW	125
NYD	358	WC	124
ALM	356	NAT	124
NTU	356	NMS	122
DH	355	YY	121
NDW	352	NHC	121

VK5 RECEIVING			
R. Whitford	.....	.....	2690
L50340 R. A. Cunningham	.....	.....	536
BBC30785 D. Nelson	.....	.....	344
R. Dayman	.....	.....	344
D. Warrington	.....	.....	112
L50122 G. Edmeades	.....	.....	65

VK6 CW			
RS	826	PD	316
RU	792	RM	292
ED	642	GW	246
VK	486	NFA	104
AJ	470	GA	66
HX	418	VG	64

VK6 PHONE			
NBU	2863	EV	523
PD	2604	AN	520
JP	2276	HU	505
FS	2214	EB	503
NFI	2111	TP	502
RG	2054	LP	493
AO	2047	FC	420
MF	1771	EO	401
ER	1744	NEY	401
YL	1721	FI	400
IC	1673	YG	398
ED	1633	RL	393
KG	1147	BD	375
NGA	1145	SH	374
WV	1053	XC	362
GW	1041	GA	342
NGV	1012	OX	337
UN	672	YE	336
IW	858	NGC	334
UT	834	CN	322
NGR	631	LV	321
WT	810	NAG	289
NFA	810	ZIT	268
XJ	801	CR	270
DY	800	HE	259
XP	754	ZZ	256
JX	748	UX	244
NGH	726	UH	243
JK	711	NGB	220
PG	627	BE	219
FE	610	TU	216
WL	599	QR	211
VG	592	DC	198
YF	568	NGX	179
NHA	568	NDV	178
NHK	579	ZGA	176

VK6 RECEIVING			
L60030 F. H. Price	.....	.....	1702
D. Robson	.....	.....	1635
L60038 K. Dean	.....	.....	770
L60213 L. Baxter	.....	.....	367
L60228 G. Mann	.....	.....	283
J. Greenaway	.....	.....	163
D. Handscombe	.....	.....	174

VK7 CW			
RO	1330	GB	288
CH	858	ZO	280
BC	766	GV	244

VK7 PHONE			
KJ	1985	NHA	713
NJD	1847	NDP	711
KZ	1711	MX	707
KZ	1711	DK	680
HK	1630	EB	675
HD	1429	SG	661
NRC	1080	JU	656
NVH	1038	NJC	644
GD	961	BC	630
NSA	955	EM	612
AW	899	WI	612
NRH	884	OH	596
NPC	878	NHT	575
KC	800	BH	572
NEA	784	NPV	559
KH	746	NDY	539

BP	322	DG	143	NAD	59
ZZ	307	JG	139	ZPB	58
LH	302	LR	139	IC	54
NXB	295	DL	138	RP	49
NFR	275	ZAT	137	ZBY	36
NJX	246	NOW	136	KS	35
NGR	228	NAM	124	AX	35
PS	224	ZLB	118	ZAJ	28
NOA	201	ZTA	102	NB	26
FT	199	NBI	96	MK	24
GF	178	KK	88	AO	18
YY	165	ZAO	88	ZLD	16
NRJ	149	ZJG	78	ZSU	13
CF	146	CT	74	ZAK	12
NSA	145	NKD	73	RR	12
AL	145	IL	68	GB	5

VK7 RECEIVING			
L70107 G. Mutton	.....	.....	2226

VK8 CW			
HA	960		

VK8 PHONE			
LD	1784	NJN	739
NRF	1749	NXX	363
DA	1478	BE	274
			NDZ 107
			GB 103
			RP 42

VK9 PHONE			
XW	2314		

VK0 PHONE			
JM	750	AB	468

CHECK LOGS			
ZL PHONE			
1ACL	2038	2AJB	324
1AFE	1012	2MM	271
			4MG 1305
			4IJ 181
ZL CW			
1GQ	1576	2BDC	176
2AJB	184	2MM	100
P2 PHONE			
9NPS	4360	9EJ	1358
9DJ	2010	9NDC	157

P2 CW			
9EJ	474		

**LATE ENTRIES**  
 VK — 2HC, 2AGZ, 2AUX, 3QG, 3ANM, 3APP, 3NHA, 3NNX, 4DT, 4LP, 4MS, 4QT, 5FH, 5MS, 5UB, 5NJW, 5NSL, 6MU, 6SM, 6NGO, 6NHX, 6ZGO.  
 ZL — 1AGO, 4BE.

**COMMENTS FROM CONTEST MANAGER**  
 Participation in the annual "Friendly" Contest was well up with 1068 valid logs received.  
 VK5/8 put in a sterling effort to once again take out the trophy, generously supported by Novice and Limited entrants.  
 The new formula has been applied and for statisticians the difference between first and second is only 25 average logs, and between first and third 26 average logs and if they were from Full Calls the result would have been different.  
 Some Divisions did not take advantage of the separate phone and CW logs being counted as two entries for column (a). Also for the first time SWL logs counted for their respective divisions.  
 Some confusion was caused due to the misprinting of the rules and also the late delivery of July 79 Amateur Radio in some States, but the majority of participants entered into the spirit of the "Friendly" contest.



Log presentation has improved dramatically this year ably supported by some divisions distributing well designed iron sheets to entrants.

Especially noteworthy was an entry from Frank VK2Z1 who is totally blind. His log was a verbal one on tape and I was delighted to be able to score his entry for him. All but one contact was through an Oscar satellite.

From my own observations during the contest there was a very friendly atmosphere evident but this did not flow through with all entries! The comments and threats I received, with a small minority of logs, showed some amateurs in a very poor light. I cannot accept any blame where an entrant fails to read the rules before entering a contest.

I will, however, apologise for being a little late with the results but I was absent from Orange due to work commitments for the best part of three months from September.

The 1980 "Friendly" contests will be even better and bigger than before and I am looking forward to an even larger number of entries. Thank you for supporting your divisions and the memory of those who paid the supreme sacrifice. ■

## NOVICE NOTES

### BEWARE THE SWR METER

For many years standing wave ratio has been the yard (or is it metre) stick when antennas are discussed. This has been accentuated since the advent of CB. Many CBers would be happy with a piece of wet string if it showed an SWR of 1.1 at the end of a 50 ohm line.

The only thing that an SWR meter will tell you is how close the match between the feeder line and the antenna feed points is, it will not necessarily tell you if the antenna is resonant. If the antenna feed point happens to be the same as the impedance of the feeder line, the SWR meter will give you the right answer, i.e. that the antenna is resonant.

However, in practice, the antenna may have anything but the right feed point impedance. Indeed the rule is generally that it is not. Let us consider the quarter wave vertical for a moment fed with 50 ohm coaxial cable. With a very good ground plane, this antenna will have a feed point impedance of about 35 ohms at resonance. This will exhibit an SWR of 1.4 to 1. Often the SWR is lower, around 20 ohms or so resulting in an SWR of 2.5 to 1. Altering the length of the antenna to get the SWR down will shift its resonant frequency and decrease its efficiency.

You will ask: what about losses due to high SWR? A study of a chart in the ARRL Handbook in the chapter on transmission lines showing losses against SWR, will reveal that the SWR has to be quite high, 6 to 8 to 1, before these losses will cause concern.

Your next question is: how else do I do it if I can't trust my sacred SWR meter? The answer lies in three instruments. The

# THE MAN BEHIND THE MICROPHONE



first is a tape measure. If you are erecting an 80 metre dipole, measure it, first of course, find the correct length and here again, there are charts in ARRL Handbook. The second instrument is that sadly neglected field strength meter. After all, you are only really interested in making your antenna radiate the best signal strength that can be achieved. The lowly field strength meter will do just this, indicate the relative radiation directly on the meter — and with no ifs or buts.

The third instrument is an antenna impedance bridge. This will tell you two vital values — the resonant frequency and the feed point impedance of your antenna. There are a couple of instruments on the market for about the same price. The Palomar RX noise bridge is the better of the two as it will also give the inductive or capacitive reactance of the antenna. With this instrument we can also determine the impedance.

Submitted by  
Dennis Breitreuz VK4ZEW/NMK ■

### CQDX GROUP REFORMED

Owing to internal problems the CQDX Club has been reformed. Irresponsible and selfish behaviour on the part of a minority of the members, and the fact that the hams in the group have now found that they have little in common with the CB element, caused the whole concept of the club to be reviewed.

It must be pointed out that though the CBers in the club were amongst the most responsible of the members, there was little to offer them once those who wished to attain amateur status had done so.

### MAN BEHIND THE MICROPHONE

Many stations recently worked VK2DFM alias Konrad HB9ARQ on his recent visit to Australia. Konrad hails from a small village in the eastern part of HB9 near Lake Constance and the Austrian border. He is QRV with an FT200 and tri-band beam on 10-15-20 metres and on RTTY with a modified model 25 teleprinter. Konrad enjoys activity on VHF and UHF with 15W SSB into a 10 element yagi on 2 metres and on 432 MHz using a 28/432 MHz transverter into a 19 element long yagi. ■

We have issued a new certificate and an honorary committee comprising VK3s NDY, NNR, NOA, NNY, NAC, VEW, VGQ, NDO.

So far these amateurs are the only members of the new club. Three or four former members are being approached to rejoin, and a couple of others have been excluded.

The group is now strictly an amateur DX group. I am acting as honorary secretary but there are no other official officers and no dues other than THE WILDLINGNESS TO CO-OPERATE WITH EACH OTHER.

The new rules are simple . . . go all out for DX by all means, but never forget to help others whilst you are doing it. The code set down by Paul M. Segal still applies.

In short . . . give your mates a go . . . an old Australian tradition that seems to be less in evidence these days.

From Trevor C. Reid VK3NNR. ■

# VHF-UHF

An expanding world

Eric Jamieson, VK6LP



Forrester, S.A. 5233

433 250 ZL2VHP — Manawatu  
10370 ZL2UHF — Wellington  
\* Denotes attended operation.

No changes to the beacon list this month, other than to include the attended operation beacon provided by David VK5KK. This has been heard over a wide area on 52.150 MHz, currently it is signing VK5KK with FSK, about 25 watts to a 3 element beam pointed north, and is located at Wasleys about 60 km north of Adelaide, at David's QTH.

There are a number of other attended beacons operating in the U.S.A. but I don't propose listing these unless important. Full time beacons will be given priority in the very large list now being provided.

The correct frequency of the Geelong beacon when in operation will be 52.330 MHz, call sign VK3RGG. According to the Geelong ARC Newsletter, the frequency was determined with the WIA "Band Plan" in mind, which has been so arranged for beacons to operate between 52.3 and 52.5 MHz. The second figure after the decimal point is to indicate the State, e.g. VK3RGG on 52.330, the second 3 represents VK3. VK2 would be 52.32, VK7 52.37 etc.

## NEWS FROM HONG KONG

Also from the Geelong ARC Newsletter is news of a recent QSO between Mike VK3ASQ and Tony VS5ES on 10 metres during which the following information was obtained: The Hong Kong allocation is 50.050 to 51.150 plus 52.025 + 10 kHz (CW) and 52.100 + 10 kHz (SSB). Power: Max. 133.3 watts PEP (50 watts AM). VS6FX runs low power to a GP aerial. VS6BF 50.110 low power. VS6EZ calls CQ (Voice via VOX) for 1 minute, listens for 1/2 minute when conditions are good, and monitors 28.490 MHz when on 6 metres.

## NORTHERN HEMISPHERE ON SIX

Bill W3XO sends a lot of information from his column in QST re six metres. Despite the approaching winter in the north, the band seems to have remained open almost continuously to exotic places. What follows is a condensed version of Bill's information, which is too vast for this column!

What took place between 15-10 and 15-11-79 as this is being written, all but eclipses those outstanding records from 20 years ago. Started 18-10 when VE's worked JAs. A big day was 20-10 when VE1AVX lists 14 OSOs via the 28-50 MHz route to Europe, as well as a two-way contact with EI2W, confirming he was still able to use 50 MHz. On 21-10 WB2WK worked 22 stations in Europe crossband, including SM7PU with Gs and DLs making the rest. It has been noted as a result of these contacts that the strongest signals on 10 metres are not necessarily the strongest signals on 6 metres!

"But that was only the beginning! Almost daily a path existed to Europe from about 1300Z, followed a few hours later with transcontinental openings right across U.S.A. EI2W and ZB2BL are the only ones on 50 MHz in Europe, and these have worked right across U.S.A. to W6! Not bad for a barefoot FT620B! Active European countries include G, GM, GW, DL, EI, ZB2, SM, LA, HB, PAO, OK and EA. 5B4CY beacon heard, but no sign of 5B4AZ.

"Another beacon that has been driving everyone crazy is that of FY7THF in French Guiana. The 50.038 MHz FSK signal from this station has been received many mornings, to over S9, but the operator is seldom available for contacts. Other than to HC1JX north-south contacts have been rare, thus HP2XPW (KZ5NW) failed to work all U.S. states before departing the Canal Zone on 12-11. John HC1JX has 45 States to his credit!

"If 6 metre stations are scarce in Europe because of allocations, and in South America because of lack of propagation, there is no scarcity in the direction of Japan, e.g. between 2310Z on 2-11 and 0120Z on 3-11 N6CT worked 83 JAs plus HL9TG! At the same time at least one U.S.A. station has worked more than 700 JAs and going for the WAJA Prefecture Award! Reports of working 40 to 60 JAs are common, 5-11 and 6-11 provided a great opening to Alaska and many stations got their 50th State. The opening was so wide spread that WL7ACY contacted 270 stations in 45 States! The following day propagation opened to

KH6 from as far away as VE1. KH6IAA notes working over 100 stations, some using his IC502 and whip antenna! KX6AO was worked from the Washington area to provide a new country. KG6DX at Guam also worked.

"The conditions were so good during mid November that stations like WA2EAH worked several west coast stations with his IC502 and whip, while W3IP worked a W6 with 20 milliwatts and a dipole, and WA1UOC made a mobile crossband contact with G3FXB! In summary, it's been wild, and continues to be, and will possibly surpass even 1958. We're having fun."

It certainly reads like it. Our only hope is that something akin to these conditions will come to the Southern Hemisphere during March and April, if it doesn't it will set another pose in the history of propagation as to the differences between the two hemispheres. Our misfortune is that we have no land areas akin to that of the Japan to U.S.A. path with large masses of interested six metre operators. We have Africa to the west with limited six metre interest, and South America to the east, further away and with interests unknown, particularly on the west coast. Most interest from that continent seems to be the north-south path to the U.S.A. and that from the eastern area of the continent. But let us not give up hope yet!

## SIX MONTHS ON SIX

John VK5ZBU has done some researching and provides the following to sum up the six metre activity during the last six months of 1979.

"June and July provided a few weak signals, the 'drought' broke briefly on 13-8 when VK3AMK, VK3VD and VK3ZTK were worked, between 0300 and 0350Z. August and September were not very productive, only brief and weak openings to VK4.

"Things improved a little in October, Roger VK8ZRT in Alice Springs was 5 x 9 at 1240Z on 26-10, also Graham VK2ZVV earlier 5 x 9. Considerable solar activity was noted between 1-11 and 4-13-11 with lack of signals, JA2ODM and VK4ZAA in Brisbane being only brief contacts until 15-11, when a good opening to VK7 occurred, 5 x 9 contact's taking place with VK7MC, VK7ZJG, VK7ZTY, VK7TW, VK7AE, VK7BC, VK7LZ and others, from 0800Z.

"The following day 16-11 VK4ZAY and VK4ZNG announced their presence from Townsville at 0300Z, they followed VK2ZAY, VK4UX, VK2VC, plus another group of VK7s, plus ZL2CD and ZL2BFC. Conditions mainly unstable with considerable QSB. Quiet until 25-11 when Neville VK2QF at Mudgee was worked 5 x 9 at 0424Z, then Claud VK4UX. On 27-11 Townsville stations again 5 x 9 into Adelaide. VK4ZAY, VK4ZNG and VK4XZ around 0700Z, later VK4ABP (ex VK4ZBB) at Longreach was 5 x 8 at 0726Z, then at 0730Z band opened again to Townsville. Barry VK4ZBJ reports an increase in 6 metre activity in Townsville, with about 12 stations able to work on the band, at least 7 of whom have already been worked. Strangely this year, the usual 'pipe-line' to Rockhampton has not been in good shape during the openings to the more northerly areas, perhaps it is undergoing repairs or cleaning!

"Seemingly improved conditions due to less solar activity produce some good signals on 28-11 — opening at 0320Z and continuing until 0850Z available were the following: Gary HL9TG, Noel P29GA, Bill ZL2CD, Brian ZL2BFC, JA7MEV, Barry VK4ZBJ, Joe VK4JH, Ian VK2ZIO, Adrian VK2YHU, Phil VK2ZZY. Also on this day Col VK5RO let his hair down and worked 52 Japanese stations! YJ8PD was reported as hearing VK5ZJG and VK5ZBU though YJ8 not worked in Adelaide.

"Following two quiet days, on 3-12 good signals from VK7 and VK2 preceded an interesting opening on 4-12 starting at 0700Z with VK2BHO, and VK1RK, plus many other very strong VK2s. At the same time extremely strong signals received from Gippsland VK3 stations into Adelaide, VK3CCM and VK3YKA. During this opening Andy VK6OX could be heard on backscatter from Carnarvon working into Sydney and areas east of VK5, finally at 1100Z he worked into VK5.

"On 5-12 VK2ZZV, VK2ZKT and VK2ZIE were worked, then VK4ACE. Denis, a new station at Mt Isa called in around 0800Z. At 1250Z it opened

## AMATEUR BAND BEACONS

Freq.	Call Sign	Location
50.005	H44HIR	— Honiara
50.008	PY1RO	— Brazil *
50.010	HL9TG	— Seoul *
50.023	HH2PR	— Haiti
50.025	6Y5RC	— Jamaica
50.030	ZS6PW	— South Africa *
50.035	ZB2VHF	— Gibraltar
50.036	HC1JX	— Guito
50.038	KL7COG	— Anchorage *
50.038	FY7HF	— French Guiana *
50.040	ZS6VHF	— Edenvale
50.040	WA6MHZ	— San Diego
50.048	VE6ARC	— Alberta
50.050	K6FV	— San Francisco *
50.050	ZS3E	— South West Africa
50.050	ZS6LN	— South Africa *
50.050	VE6NAB	— Alberta
50.055	WA9FEF	— Illinois *
50.060	PY2XB	— Sao Paulo
50.065	WB5ZRL	— New Orleans *
50.073	W7KMA	— Arizona *
50.075	HK3/4	— Columbia (repeaters)
50.080	W1AW	— Connecticut
50.080	TI2NA	— Costa Rica
50.088	VE1SIX	— New Brunswick
50.090	WA6JRA	— Los Angeles *
50.093	WA8FTA	— Ohio *
50.098	K7IHZ	— Arizona *
50.100	ZS6HVB	— South Africa *
50.101	F08DR	— Tahiti *
50.103	N8AJD	— Ohio *
50.104	KH6EOI	— Pearl Harbour
50.110	KG6JH	— Guam *
50.110	JD1YAA	— Marcus Island
50.110	KG6RO	— Saipan *
50.110	AL7C	— Anchorage *
50.498	5B4CY	— Cyprus
51.002	ZL1BPW	— Auckland *
51.999	YJ8PV	— New Hebrides
52.100	VK0BC	— Casey Base
52.150	VK5KK	— Wasleys *
52.200	VK8VF	— Darwin
52.300	VK6RTV	— Perth
52.350	VK6RTU	— Kalgoorlie
52.400	VK7RNT	— Launceston
52.440	VK4RTL	— Townsville
52.450	VK2WI	— Sydney
52.500	JA2IOY	— Nagoya
52.500	ZL2VHM	— Palmerston North
52.510	ZL2MHF	— Mt. Cilmia
52.800	VK6RTW	— Albany
52.900	VK6RTT	— Carnarvon
53.000	VK5VF	— Mt. Lofly
144.010	VK2WI	— Sydney
144.400	VK4RTT	— Mt. Mowbrall
144.475	VK1RTA	— Canberra
144.500	VK6RTW	— Albany
144.600	VK6RTT	— Carnarvon
144.700	VK3RTG	— Vermont
144.800	VK5VF	— Mt. Lofly
144.900	VK7RTX	— Ulverstone
145.000	VK6RTV	— Perth
145.100	ZL1VHF	— Auckland
145.150	ZL1VHW	— Waikato
145.200	ZL2VHF	— Wellington
145.250	ZL2VHP	— Manawatu
145.300	ZL3VHF	— Christchurch
145.400	ZL4VHF	— Dunedin
432.400	VK4RBB	— Brisbane
432.475	VK7RTW	— Ulverstone
433.000	ZL2UHF	— Wellington
433.150	ZL1VHF	— Waikato
433.200	ZL3UHF	— Christchurch

to the regulars in VK7. On 6-12 and 7-12 only opened to VK4ACE and the Townsville gang, and on 8-12 to VK7 again, plus VK3CCM. On 10-12 very quiet during day but open to the VK7s again at 1230Z, with just enough time to say "Good evening" before the band shut for the night! With few exceptions conditions were such that signals would reach 5 x 9 then disappear quickly. The Japanese stations have been weaker, though fairly consistent at times.

"On 11-12 daylight hours very quiet, one pleasant contact was with Lance VK5ZBC, the first in many years, the QSO jointly with VK5RO was on "Adult Modulation" with excellent signals all round!

12-12 0510Z VK4ACE followed by VK4JH, plus others, band staying open until 0742Z to VK4. At 0850Z Graham VK8GB heard in QSO with VK4 but weak in Adelaide. VK4 working VK3, and VK4RO's RTTY good copy on 52.085, 0915Z VK5ZDR worked VK7ZLB, at 0940Z Ray ZL2KT worked several VKs at 5 x 6/9. At 1030Z VK4 to VK7.

"11-12 Townsville beacon 0500Z, followed by Hal VK4DO chasing Ross Hull numbers, at 0636Z to VK2ZFX, 0736Z VK4ZTV, then Bill VK4ZWH and John VK4AJT, VK4ALM and VK4ZAA. At 0918Z Geoff VK8GF heard calling L, then he was worked in Adelaide 5 x 9 0948Z, and attempts made to hear Geoff's two metre signal. Considerable activity between eastern States and ZL.

"14-12: Nothing until 0900Z, then VK5AMK worked Tony VK5BV at Northam, then band opened to VK4ZBC at Mt. Isa, then back to VK6WD, VK6OX, VK6OM, VK6ZED, VK5KZ and others. Beacons from VK2, 4 and 6 during opening".

Thanks for the fill-in up to this date John, which now allows me to continue with some information to conclude the chapter from my own log.

18-12: VK4ZBW at 0443Z and VK4ZBJ at 1129Z, nothing else. 19-12: 2305Z VK4ACE 5 x 9. Continued to fiddle the fingers until 23-12 when VK4ZLB came in really early at 2237Z, followed by a string of other VK4s and VK2s, but the VKs mainly confined to the far north areas. At 0120Z VK8GF 40 dB over 9, so strong in fact we just had to try 2 metres with him, but the absence of any short skip stations indicated the MUF was not high enough. At 0516Z JJ1ERG heralded the first opening to JA for some time, this time assisted by Es. JAs were mainly 5 x 9 and covered JA1, 2, 7, 8, 9 areas.

Of particular note on 22-12 were very strong (well over S9) signals from Japanese stations on 50 MHz but not reaching 52 MHz. The JAs were working themselves via a strong Es opening in their own country — it was interesting to hear them calling their own call areas. Hal, VK4DO reported working 1657 JAs from February to November 1979! Incidentally, the JAs on 23-12 worked in VK1, 2, 3, 4, 5, 6, 7 and 8 as far as we know, with signals into VK6 being the strongest. Not many call areas left for them to work that day!

24-12: JA1 to 9 areas, VK4ZAZ, and VK8GF, plus VK2BXT advising he will be shifting to Sydney from Moree in 1980. Speaking to Graham VK8GB on 28885 liaison frequency, he advised Brian VK8VV lost his four 2 metre beams in a recent storm, and that Brian would be going to P29 (Rabaul) for a period of 3 years during 1980. Graham advised ZL1, 2, 3 and 4 had been worked from Darwin this year, plus P29 twice. He was hoping to work the Bali DX-pedition during the next few days up to 5-1-80. The VK8VF beacon is at present running low power since the storm.

25-12: Started off a bit slow, probably everyone eating Christmas meals! At 0736Z opened to VK4, then VK3ATN backscatter at 0805Z. At 0847Z VK4ZGJ, 0858Z VK6KZ, 0924Z VK2ASZ plus others, 1104Z VK3ATN again on backscatter, also VK3BHS, then just to complete the day Aub VK6XY in Albany worked on 144.090. Also noted that H44PT worked VK4JB at 1645Z for first H44 to VK4 contact I am told.

28-12: Early start at 0135Z to VK4DO, still chasing numbers, gave me 58674! At 0142Z VK8GF so strong again that 2 metres had to be tried! 0204Z VK4ZBI and VK4 stations interspersed throughout the day until 1031Z. Report received that Les VK3ZBJ had heard a VK8 (8GF7) in Melbourne on 2 metres. 27-12: Open to VK4ZNG at 2333Z 5 x 9. We then had a spell until 29-12 when Joe VK4JH

came through 5 x 9 at 0025Z, then VK4ZBJ, the remainder of the day was a rest period from Es!

30-12 opened early with VK4ZLS at 0047Z, then an interesting set of conditions produced very strong signals from VK3 northern areas from 0050Z, with VK3ANP, VK3YNV, VK3OT and VK3ATN predominating. Later Ken VK3AKK was heard at 0139Z at 5 x 4. These short skip conditions caused the VK5 stations to scurry on to 2 metres because Es were bringing in strong signals from VK4 at the same time, but no success. Ted VK2ARA was grabbed at 0145Z 5 x 9. Open to VK4 for most of the day, at 0942Z VK8GF 5 x 9 again, followed by 5 x 9 signals from VK6ZKO, VK6ZED, VK6BV, VK6RO, VK6ZZ and others. At 0930Z observed VK4ZJB working VK6WD and others, 5 x 9 reports. Tony VK6BV advises he could be on 432 MHz soon.

2-1-80: Probably the last of any worthwhile Es for this period, opening at 2316Z to VK2ASI, VK2ZRU and VK2BHO. John VK2BHO almost always alerts us the band is open because his strong CW signals herald the opening! At 1149Z VK7ZIF and VK7ZTA, and the same two stations again at 1223Z just long enough to say "Good-night". Lance VK4ZAZ worked VK2BXT, and reports came through during the opening that W6XJ had worked ZL on 31-12. Also a report from Gerry VK5ZZZ that the DX-pedition to Ball, YB9X/9 had worked 160 JAs on 6 metres up to 2-1 but no VKs — that's not surprising considering the lack of Es from the Darwin plus area this year.

#### SIX METRES FROM BUNBURY

A newcomer to six metres, Graham VK6ZGS, has been thrilled with his workings to date, and I can understand why. On 10-10 he obtained an IC502, and the following day had his first contact to JA from his car, using the IC502 barefoot to a whip antenna! When I think of the years to take me to work my first JA . . . 5LP. At home Graham runs the 502 into a 25 watt linear and a bow-tie antenna with 6 dB gain. On 24-11 mobile between 0640 and 0643Z worked VK5YA, VK5ZDR, VK5RO and VK5ZPE the latter up to 5 x 8 on the handbag! From the home shack on 3-12 worked a string of VK2s plus heard VK3OT and others. 4-12 VK4 barefoot. And so it goes on.

Good luck Graham, hope you passed the CW in November, and also hope this won't mean you will forsake the VHF bands!

#### A LOOK ON TWO METRES

One might be forgiven for thinking there is no two metre activity with so much happening on six metres, but this is not the case. Looking around the country, I now confirm via the VK6 VHF Group Bulletin that a new two metre internal record has been established there between Andy VK6OX in Carnarvon and Aub VK6XY in Albany, on 144.100, during October on CW, and later to be repeated on SSB on 2-11-79. Distance 1195 km. Perth stations are reporting reception of the Carnarvon beacon VK6RTT on 144.600 MHz.

#### VK5CK STIRS THE VKs

From his hilltop location near Piccadilly in the Mt. Lofty Ranges, Dave VK5CK using a pair of stacked 13 element beams (a la 5LP) and about 50 watts has certainly been stirring up the VK3s in all directions. The following details are given in the hope that VK3 won't despair that their efforts go un-noticed, but do remember there are other VK5s available too, but not from such a super location, therefore, they will probably be weaker!

18-11 starts off this saga, most contacts unless otherwise noted have been on 144.1 or thereabouts, and signal reports mostly the same both ways. So our old friend Roy VK3AXV hits the receiver at 5 x 9 + + +, and the same again on 19-11. 21-11: VK3YII 5 x 6, VK3ZHP 5 x 2. 26-11: VK3ZHP 5 x 2, and heard a VK7 working a VK3. 27-11: VK3AXV 5 x 9, same again 29-11. 1-12: VK5XY 5 x 9, VK3TN, VK3AXV both 5 x 9, VK6ED 5 x 1, VK6NL 5 x 1, heard VK3ARM. 6-12: VK3YII 5 x 9. 18-12: VK3AXV 5 x 9, 21-12: VK3AKP 5 x 7. 22-12: VK3ZSQ 5 x 5, VK3BFY 5 x 4, VK3ZHP 5 x 1, VK3ZHE 5 x 1, VK3YNV 5 x 5, VK3YRY 5 x 1, VK3YLV 5 x 7, VK3AXV 5 x 9, plus a brief CW contact with K3AUV 5 x 1.

25-12: VK3ATN 5 x 5, VK6WG 5 x 5, VK6BE 5 x 5, VK3AXV 5 x 9, VK3ATN 5 x 7, VK5DK 5 x 5. 26-12: VK3YPD 5 x 1, VK3AXV 5 x 9, VK3YII 5 x 2,

VK3ZBJ 5 x 8, VK3ZE 5 x 7, VK3BFY 5 x 5, VK3ATN 5 x 5, VK3YLH 5 x 6. 29-12: VK3ATN 5 x 3, same on 30-12. And that sort of thing is still continuing!

It is interesting to note that daily contacts both early morning at 2100Z and at night 1100Z have been made between a number of VK5 stations and VK3ATN on 144.100. Signals for some reason or other have not been very strong, but they are always there. Those participating have been VK5CK, VK5RO, VK5ZDR and VK5LP, occasionally others. Most reports have been from 4 x 1 to 5 x 3, with somewhat stronger signals at 5CK. 432 MHz signals have been heard from lime to time between VK3ATN and VK5LP, but only weak, on CW.

#### OTHER TWO METRE NEWS

Perth beacon VK6RTW copied in Adelaide 1000Z on 18-12 at S1. New Albany stations on 2 metres are VK6EO, VK6ZKJ and from Denmark further west VK6NL . . . On 14-12 Wayne P29ZWW worked into the 2 metre repeater at Townsville, later made contacts via Ch. 50 and on SSB . . . 25-12 VK6MZ heard VK5VF beacon on 144.800 on 0630Z, so it looks as though the path on 2 metres to Perth could be just around the corner once more . . . 29-12 VK3ATN worked four VK3s on 432, and also VK3ACH on 1295 MHz, CW both ways. This latter contact a bit difficult as VK3ACH was keying his FM carrier! . . . 2-1-80: VK3ATN worked VK2DGM in Griffith who had an IC202 to 5 element beam at 15 feet! . . . Roy VK3AXV runs 80 watts on 2 metres, very fine signal at VK5LP QTH . . . Continuing to find the pair of 13 element beams here at 5LP do very well on 2 metre working — backed up with the masthead pre-amplifier I can work anything or anyone I can hear!

#### TROUBLE DOGS REPEATER

From the "Propagator" comes this months bad luck story: "The Wollongong repeater is on Ch. 5. First a savage storm caused damage to the receiver, transmitter exciter, and the control unit. Five transistors had to be replaced; amazing damage had not been worse considering some grass in the vicinity of the transmitter cubicle had been burnt by lightning. A large tree nearby had been burnt on one side.

"Two weeks later, another storm took its toll of transistors, this time in the control unit.

"Last week's hailstorm which hit Sydney had its epicentre in Robertson. The force of the hail tore holes in the top of the transmitter cubicle, allowing water to penetrate. The water got into the decoder for the auxiliary receiver used for the relay of the Sunday broadcast. A special ground stake has been installed in an effort to reduce currents in the landline due to surge currents from the lightning".

Apart from a gale smashing the whole assembly there doesn't seem much more could wrong with the installation. Let's hope your troubles are now behind you, boys.

#### SECOND ARRL EME COMPETITION

Gerry VK5ZZZ sends me a copy of the results of the above competition, conducted on 144, 432 and 1296 MHz, with world-wide participating stations. It was won by K1WHS who scored 70,200 points, heard 47 EME stations and contacted 39 of them, on 144 MHz only and using a 160 element collinear. 103 stations from everywhere participated, the average QSO for single operator stations was 13.1. The set-up at the winning station consists of the 160 element collinear fed with 7/8" heliax, a 3N211 MOSFET preamp mounted at the antenna with a 1.4 dB noise figure, homebrew converter and 75A3. Homebrew transmitter used 6360-4CX350A-8877 running 1000 watts. Next year they plan a bigger and better antenna!

Number two position went to WB5LUA, one of the few with 144 and 432 capabilities. His preamps both use OXL 3501A GaAs FETs with 0.5 dB noise figure. The top 432 MHz honours went to 9F9T who used sixteen 21 element yagis, an HP HFET1101 GaAs FET pre-amp with 0.3 dB noise figure, and a pair of 4CX250Rs.

Pleased to see Chris VK5MC was able to participate, using his 6.6 metre dish to run up 3600 points with 6 stations heard and worked.

Some stations are very well set-up when one peruses the list, I note ZE5JJ has the 10 metre dish working, whilst JA6DR has a 12 metre dish.

# OPPORTUNITY to obtain back copies of AR

To make space in the new executive office it is proposed to deliver for paper recycling all EXCESS COPIES of AMATEUR RADIO accumulated from MARCH 1972 to DECEMBER 1977 inclusive.

Anybody interested in specific issues should apply at once to

PO BOX 150,  
TOORAK, VICTORIA 3142  
with lists of requirements and  
PAYMENT OF 30 CENTS  
per copy to cover postage and  
packing.

Regrettably some issues of these ARs will not be available, being out of print. Orders will be processed as time permits so some delay in despatch must be accepted.

## "WILLIS" AIR-WOUND INDUCTANCES

Take the hard work out of Coil Winding, use — "WILLIS" AIR-WOUND INDUCTANCES

No.	Turns			B & W Equiv.	Price
	Dia. Inch	per Inch	L'gth Inch		
1.08	½	8	3	No. 3002	99c
1.16	½	16	3	No. 3003	99c
2.08	¾	8	3	No. 3006	\$1.16
2.16	¾	16	3	No. 3007	\$1.16
3.08	¾	8	3	No. 3010	\$1.40
3.16	¾	16	3	No. 3011	\$1.40
4.08	1	8	3	No. 3014	\$1.56
4.16	1	16	3	No. 3015	\$1.56
5.08	1¼	8	4	No. 3018	\$1.75
5.16	1¼	16	4	No. 3019	\$1.75
8.10	2	10	4	No. 3907	\$2.52

Special Antenna All-Band Tuner Inductance

(equivalent to B. & W. No. 3907, 7 inch)

7" length, 2" dia., 10 TPI Price \$4.36  
Reference: A.R.R.L. Handbook, 1961

Willis Pi-Coupler Unit — \$23.95

Stockists of Transmission Cables, Insulators  
and Hard Drawn Copper Antenna Wire

Write for range of Transmission Cables

**WILLIAM WILLIS & CO.**

PTY LTD

Manufacturers and Importers

77 CANTERBURY RD. CANTERBURY  
VIC. 3126 Phone 836-0707

A Call to all  
holders of a

## 'NOVICE LICENCE

Now you have joined the ranks of Amateur Radio, why not extend your activities?

**THE WIRELESS INSTITUTE  
OF AUSTRALIA  
(N.S.W. DIVISION)**

conducts a Bridging Correspondence Course for the AOCF and LAOCF Examinations.

**Throughout the Course, your papers are checked and commented upon to lead you to a SUCCESSFUL CONCLUSION.**

For further details write to:

**THE COURSE SUPERVISOR,  
W.I.A.**

P.O. BOX 123,  
ST. LEONARDS, N.S.W. 2065

One wonders at the mechanical problems that must confront stations like YU2RCC who uses sixteen 23 element yagis on 432 MHz — and the complexity of feeding the monster. Even K2QR heard one station on his single 15 element yagi on 2 metres! And what about W4WD who ran up 12000 points using sixteen 46 element J meams!

### ROSS HULL CONTEST

A few stations around with some very high scores, but the facility of being able to commence at any number up to 1000 makes some of the early high numbers rather suspect. I note VK3ATN has been making a good effort to gather numbers and using several bands to do it. He has managed to stir up some interest in VK5 to get some stations on night and morning at least on 52 and 144 to exchange numbers, but the conditions have been fairly poor so it has been a struggle at times.

In an effort to ensure the Contest continues I hope those operators with lower scores will send in a log particularly as the Contest Manager has suggested a photocopy of your log will be acceptable — this to me is a very sensible departure from previous requirements.

### THE EQUINOX

Those keenly interested in six metres will be looking forward to the March/April period in particular in the hope we may have a chance to share in some of the outstanding conditions already enjoyed by stations in the Northern Hemisphere. It is clear that March/April last year was better than September/October last year, and in the Northern Hemisphere it is the other way round, September/October seems to have been superior to the earlier equinox. This seems to suggest conditions are more favourable during the autumn than the spring, but only time will tell.

Just a few suggestions which might help to pave the way for an increase in exotic contacts:

(1) If you can monitor between 30 and 50 MHz watch for a rising MUF which will be shown by overseas commercials becoming apparent in that

area. Even two-way radio stations are audible from U.S.A. and elsewhere, and are a good guide to possible contacts. These will mostly be heard during our mornings, say from 2300Z through to perhaps 0200Z or even later.

(2) If the 40 MHz+ area is active, keep a close watch on 50 MHz with the beam to the north east, in this position you will also hear the JAs if they are strong enough to work. But hearing signals on 50 MHz doesn't always mean they will be on 52 MHz, the MUF sometimes does not rise that high! And don't cheat, wait and work stations on 52 MHz, not 50 MHz. Remember, most overseas areas are dead set against out of band contacts and wide publicity about the VK position has been given in overseas publications — you may not care to have your name on the ARRL and SMIRK blacklist!

(3) When the band is quiet operate on 52.050 by all means — that was the purpose of originally deciding on a calling frequency and it is known overseas. BUT, please do leave a few seconds break between overs to allow another station, perhaps from an exotic area, to call in. If the band is in good shape, then after establishing contact on 52.050, move away to allow others to monitor the frequency. The worst thing you can do is to use 52.050 for a crossband contact and so block the frequency for lengthy periods, the only exception might be if you are using VOX so there will be periods when you and your listening station will have a chance to hear another station.

(4) Perhaps most importantly, if you are lucky enough to get a contact with a rare station, keep the contact SHORT, remember there will be many other stations wanting to work him, and the conditions may only remain for a few minutes. All you need for a contact is to exchange signal reports, plus names, a request for a QSL, then sign off, the whole exchange need only take 1 to 2 minutes. This way you won't have other stations breaking in and generally frustrating others and getting a bad name on the band. There is absolutely

no justification for ANY station to have a prolonged contact with a rare station — do the right thing and share him with the multitudes!

So I feel if you bear all of the above in mind there could be many stations sharing some good contacts, particularly if PAT see fit to join with other administrations and recognise the need for Australian amateurs to be able to share in some way the 50 MHz area at least by 1st March 1980!

Closing with the thought of the month: "In the game of life, as in other sports, you can pick out the winners — they're the ones who aren't complaining about the officiating".

73, The Voice in the Hills. ■

## QSP

### AMATEUR LICENCES

As at 30th June, 1979, there were 12,062 licensed VK amateur stations of which 2,974 were Novice, 3,108 Limited and 5,956 Full Calls. For States, NSW led with 4,043 and Victoria 3,425. NT showed 65 per cent as Full Calls, ACT 63 per cent and the national total 49 per cent — the lowest being Queensland with 44 per cent of the national total. Novices were 25 per cent with the highest percentage of 29 per cent in Queensland and the lowest in the NT of 8 per cent. Limited calls showed up as 26 per cent of the national total, ranging from 31 per cent of the Victorian total down to 16 per cent of the ACT total. At the same date licensed CB stations on HF totalled 173,507. ■

### TF LAND

In a letter to AMSAT (September 1979) Kristian TF3KX briefly outlined the level of activity in Iceland. There are approximately 100 members in the national society, of which 20 to 30 are active on HF, VHF or in special fields of amateur radio such as RTTY, etc. It may pay to also keep a listening watch on OSCAR satellite frequencies from time to time, as Kristian and fellow amateurs are becoming active using OSCAR. ■

# LETTERS TO THE EDITOR

Any opinion expressed under this heading is the individual opinion of the writer and does not necessarily coincide with that of the publisher.

Lot 92, Russell Ave., Woodend 3442  
9th January, 1980

The Editor,  
Dear Sir,

I am writing to you with an appeal. The appeal is to ask if there is any radio amateur reading this who might be able to help me in learning about RTTY. Just recently I obtained a Model 15 teleprinter and I set it up to the point where I can copy reasonably well. However I do need some more help in getting it all to work very well. I am at a disadvantage in that I live in a remote location and have no effective means of contacting anyone else except by letter. There is no Wireless Club where I can see other amateurs and learn from them. This is also one of the reasons that I have lacked the confidence and the knowledge to go for my ticket.

Whilst I have visited the "shacks" of some amateurs I have had virtually no contact with any amateurs for some time now and I have never had an amateur come here and visit me.

Terry Robinson L31105

5 Lyle Ave., Lindfield, N.S.W. 2070  
26th November, 1979

The Editor,  
Dear Sir,

Would you kindly publish in our magazine this note of appreciation.

I have just returned from a yachting trip in which I was navigator/radio operator. Just before typhoon Tip commenced to build up we lost our engine due to mechanical failure and when the storm started we ripped our mainsail and later our backstay bracket failed so we were without propulsion.

I would like to thank all those hams who assisted by passing messages to the captain's XYL to obtain replacement parts for the engine and to my XYL to advise her of the details of our rescue by the United States Navy and Coastguard. I am especially grateful to the operator who rang the Marine Operations Centre in Canberra to advise them of our "Mayday" calls and who also rang a well known amateur friend of mine in Sydney.

My only disappointment was to find that an amateur I "knew" from previous contact did not know how to react to a mayday call but casually remarked to the station he was working that he had heard a "mayday" which appeared to be coming from New Zealand and then went on rag chewing.

This contrasted to the American hams who kept watch on my frequency and chased off anyone who started transmitting within 5 kHz of me. (Oh to have ten kilohertz all to myself now that I am back!) The principal amateur in our rescue was KG6JBX who remained on watch for 48 hours except for the period from 0200 to 0900 LMT on our first night.

Thank God for the radio amateurs.

Yours faithfully,

Gordon H. Sanders VK2DGS

"Bonnie Braes", Wattamondara, N.S.W. 2741  
21st December, 1979

The Editor,  
Dear Sir,

I am writing in support of Mr. R. J. Somerville's letter in December AR suggesting that past articles of an instructional nature should be made available in book form.

Having recently gained the AOCIP after studying on a-d off for some years via the WIA course, which was until recently about the only guide as to the scope of knowledge required, I find that there seems to be a great lack of really comprehensive basic training material. To some this may seem strange since there are many books of basic this and elementary that, but unfortunately most are trying to cover a complete radio course

in a couple of hundred pages or less — an impossible task.

Many may argue that it's all in the RSGB or ARRL Handbooks but to me they leave far too much reading between the line to be classed as satisfactory training texts. I would have hoped that the continual issue of new editions would have done much to remove those vague old explanations that have been rehashed for many many years.

The ARRL is however to be commended for many of its other publications, an outstanding one of which is "Understanding Amateur Radio". This practical little book is a taste of what the Handbook should be and is an invaluable aid for AOCIP candidates. Another fine book with a much fuller treatment of electronics but not radio is "Basic Electronics" by Grob.

Undoubtedly the best general text I have seen is "Electronic Communication" by Shrader. I thoroughly recommend this book to all such as myself who have not had the good fortune to be able to collaborate with someone trained in communications radio and have had to learn it all from books.

Judging from the number of novice calls filling up the callbook, there should be plenty of incentive for those better informed WIA members to get together and do something about this situation. I can think of no better way to justify those membership fees and enhance the reputation of the WIA at home and abroad than to put out a really worthwhile training textbook. Why leave it to the Yanks, they may have thirty times the numbers but are they thirty times as smart? Why not simply ask or offer a small incentive to members for submissions of suitable material — the results may be surprising. Remember, all those call signs have had to pass an exam.

Perhaps a good starting point for those contemplating doing something would be to give some credit to men like Gaivani, Ampere, Faraday and Hertz. Their discoveries have laid the foundations for a massive part of the technology that has made our age unique.

I would also like to take this opportunity to thank those unsung heroes that have devoted their time and talents to produce the slow morse practice session. Without their help my AOCIP would have been extremely hard to get. In terms of simplicity of equipment, width of spectrum and communications effectiveness, CW still seems unchallenged. With this excellent service provided each night I wonder at that long list of limited calls. Is the modern amateur to be merely an extravagant CBER or someone with some knowledge and understanding of the privileges he enjoys.

The RF spectrum is a natural resource and with a sound standard of knowledge to indicate a genuine interest in radio. I see no reason to provide further evidence to justify our occupation of the amateur bands, especially since forward looking Governments should be looking at satellites and that massive undeveloped microwave segment for domestic and international communications.

Yours faithfully,

Graham L. Dun

5th December, 1979

The Editor,  
Dear Sir,

I would like to strongly support the sentiments expressed by VK6ED in his letter in November AR.

Like VK6ED I am not interested in entering EITHER Phone OR CW, I wish to enter both and meet as many of my old friends as possible, a number of whom served with me during 1939-45. The abolishing of an Open section does appear to be influenced by the "Down with CW" group, but I can well remember contacting many of those amateurs, who later paid the supreme sacrifice, on CW during 1938-39 era, probably because I could not afford to go on phone anyway.

Other factors annoyed me regarding this year's contest. If one relied on AR for rules concerning the RD contest, it would have been difficult as my July copy of AR arrived on August 21st and having arrived back from overseas on August 6th I had no idea when the contest was to be held; I listened to the pre-contest broadcast from

VK2AWI and little significance was attached to the true meaning of the contest; the roll of honour in whose memory the contest is conducted, was not even read out, in fact, from what I heard, let us change the name of the Contest — say, "The Friendly Contest".

Might I suggest that in future years details are not left to the last minute — we could well have some strike to blame again for late advice of details — an outline be given of what the RD contest is all about, that an open section be included, that Novices be encouraged to enter the open section, even a low power section be encouraged.

We owe a lot to those amateurs — and many others — who died during the 39-45 conflict, let us remember them on this occasion each year and give those members who participate the opportunity to enter those sections and modes that give them most enjoyment. If they choose to have the minimum permissible contacts and put in a log (as I did this year) — good thing — if they want to go flat out for 24 hours for a large score (as I have done in the past) — all the better. But let us encourage and advertise the RD Contest.

Yours sincerely,

Jim Andrews VK2BO

8th December, 1979

The Editor,  
Dear Sir,

## ENDEAVOUR AWARD — ROYAL NAVAL AMATEUR RADIO SOCIETY

Our award, the "Endeavour Award" has also been going nicely, thanks to AR, and I have been advised we have issued 52 awards since Easter. There have been a couple of minor changes to the rules of the award to permit QSOs on VHF and to award double points for VK2BNR, HMAS NIRIMBA. Also VK2BNR counts double points for the "Mercury Award" as do the two other stations operating from Naval establishments:— GB2RN/G4HMS — HMS BELFAST and GB3RN/G3BZU — HMS MERCURY.

To gain an idea of the size of RNARS we are currently allocating numbers in the 1420 series.

We hope to gain a few more members and also interest a few YLs, especially those who were in the WRANS.

If anyone has a Creed transmitter for sale we would be grateful if you could let us know.

Terry R. Clark, VK2ALG, RNARS 1196,  
Australian Branch Manager — RNARS  
P.O. Box 537, Albury, N.S.W. 2640.

EDITOR'S NOTE: Please see "Awards Column" for the updated rules.

# CONTESTS

Wally Watkins VK2DEW  
Box 1065, Orange 2800

## February:

9-10 John Moyle Field Day  
16-17 ARRL DX CW Contest  
23-24 French Phone Contest  
23-24 RSGB 7 MHz CW Contest

## March:

1-2 ARRL DX Phone Contest  
9-10 Europe and Arlic RTTY  
22-23 BARTQ RTTY Contest  
29-30 CQ WW WPX SSB Contest

## April:

26-27 Helvetia Contest

## May:

24-25 CQ WW WPX CW Contest

ARRL DX Contests, full rules and specimen front sheet and log sheet available from FCM for SASE.

Watch for W2BBK/PJ7, CW and SSB on 10, 15 and 20 during March 10-24, 1980.

COMMONWEALTH CONTEST 1980 — "BERU" — RULES

## TIME

1200 GMT Saturday, 8th March to 1200 GMT Sunday, 9th March.

**MODE**

CW only, 3.5 to 28 MHz. Call is CQ BERU.

Eligible entrants are radio amateurs licensed to operate in British Commonwealth call areas as listed below.

**SCORING**

5 points per contact exchange (RST 001 etc.), 20 points for 1st, 2nd and 3rd contact with each call area other than one's own, on each band.

G, GW, GD etc. are counted as one area. Contacts with one's own area do not count at all. Penalties are imposed for unmarked duplicate contacts, incorrect calls and reports.

**LOGS**

Separate logs are required for each band showing columns:—

1. Date and time GMT.
2. Station worked.
3. NR sent.
4. NR received.
5. Band.
6. Leave blank (for checking).
7. Contact points claimed.
8. Bonus points claimed.

Each band log should be separately totalled and should include at the end a check list showing areas worked and number of contacts per area. Separate band totals should be added together and the total claimed score entered on a cover sheet giving particulars of station, QTH, equipment, power, antenna, and a declaration that the rules and spirit of the contest have been observed.

Entries may be single or multiple band. Single band entries should claim contacts on one band only, but submit details of contacts on other bands for checking only.

Entries should be addressed by AIR MAIL to D. J. Andrews G3MXJ, 18 Downsview Crescent, Uckfield, East Sussex, England, TN221UB. Closing date: 12th May, 1980.

**COMMONWEALTH CALL AREAS**

The following call areas are recognised for the purposes of scoring in the 1980 Commonwealth Contest:

- A2 Botswana, A3 Tonga Is., A5 Bhutan.
- C2 Nauru, C5 Gambia, C6 Bahamas.
- G/GB/GD/GI/GJ/GM/GU/GW.
- H4 Solomon Is.
- J3 Grenada, J6 St. Lucia, J7 Dominica.
- P2 Papua New Guinea.
- S2 Bangladesh, S7 Seychelles.
- T2 Tuvalu, T3 Kiribati.
- VE1, VE2, VE3, VE4, VE5, VE6, VE7, VE8, VK1, VK2, VK2 Lord Howe Is., VK3, VK4, VK4 Willis Is., VK5, VK6, VK7, VK8, VK9 Christmas Is., VK9 Cocos Is., VK9 Norfolk Is., VK0 Heard Is., VK0 Macquarie Is., \*VK0/VP8 Antarctic, V0, VP1, VP2A, Antigua Barbuda, VP2E Anguilla, VP2K St. Kitts Nevis, VP2M Monserrat, VP2S St. Vincent, VP2V British Virgin Is., VP5 Turks & Caicos, VP8 Falkland Is., VP8 S. Georgia, VP8 S. Orkney Is., VP8 S. Sandwich Is., VP8 S. Shetland Is., VP9, VQ9 Chagos, VR1 British Phoenix Is., VR6, VS5, VS6, VX9 Sable Is., VY1 Yukon, VYO St. Paul Is., VU India, VU Laccadive Is., VU Andaman & Nicobar Is.

- YJ.
- ZB2, ZC4/5B4, ZD7, ZD8, ZD9, ZE, ZF, ZK1 Cook Is., ZK1 Manihiki, ZK2 Niue, ZL1, ZL2, ZL3, ZL4, ZL Auckland and Campbell Is., ZL Chatham Is., ZL Kermadec Is., ZM7.

- 3B6/3B7 Agalega and St. Brandon, 3B8 Mauritius, 3B9 Rodriguez Is., 3D2 Fiji, 3D6 Swaziland.
- 4S7.
- 5H3, 5N2, 5W Samoa, 5X5, 5Z4.
- 6Y5.
- 7P8, 7Q7.
- 8P, 8R.
- 9G1, 9H Maltese Is., 9J2, 9L1, 9M2 W. Malaysia, 9M6/9M8 E. Malaysia, 9V1, 9Y4.

\*All calls operated from Commonwealth controlled areas of the Antarctic (VK0, VP8, ZL5 etc.) count as one call area.

Results of the 1979 Contest in which 41 VKs submitted logs appeared in December 1979 Amateur Radio.

# IONOSPHERIC PREDICTIONS

Len Poynter VK3ZGP/NAC

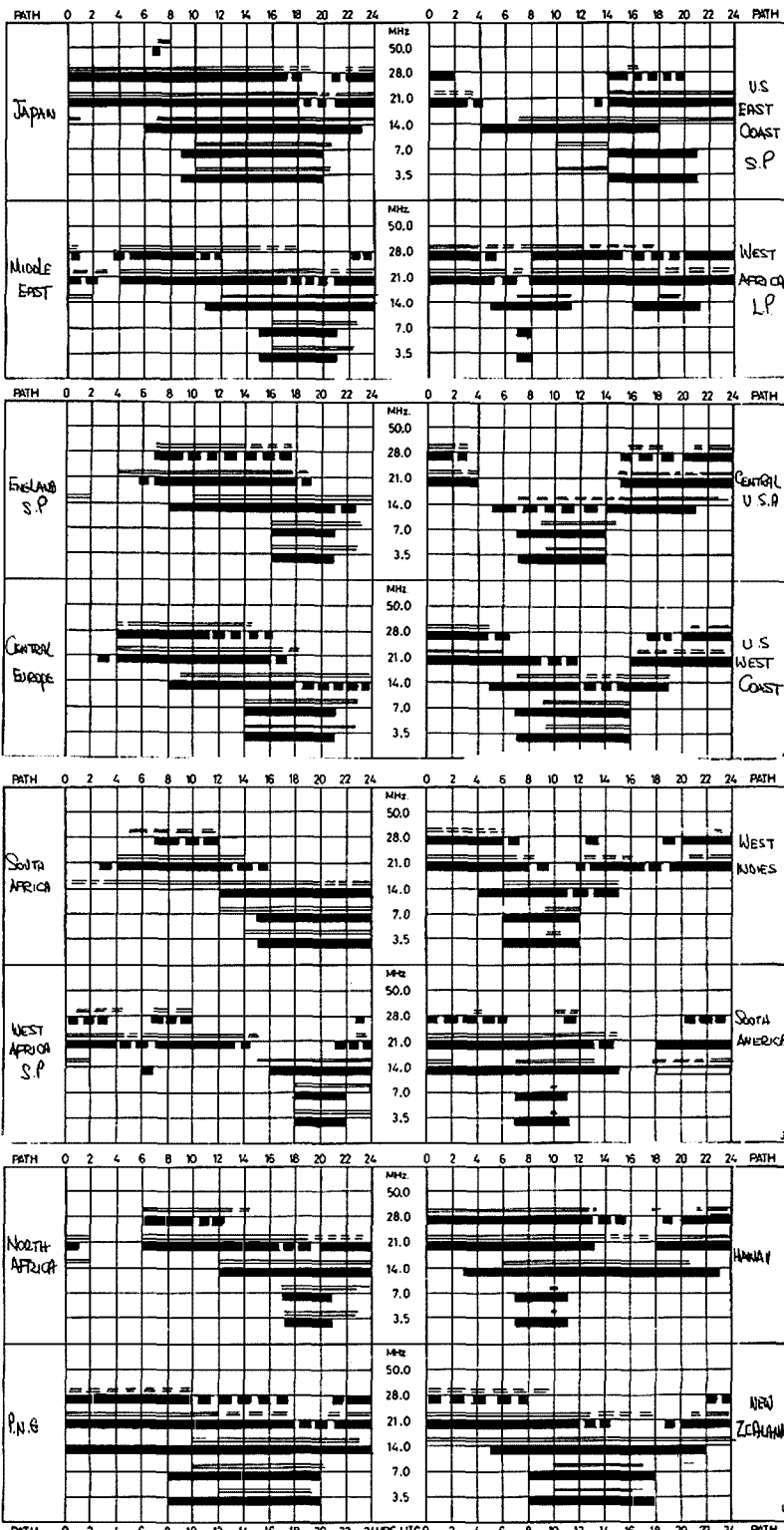

**LEGEND**

- ===== FROM WESTERN AUSTRALIA.
- ===== FROM EASTERN AUSTRALIA.
- ===== BETTER THAN 50% OF THE MONTH, BUT NOT EVERYDAY.
- ===== LESS THAN 50% OF THE MONTH.

PREDICTIONS COURTESY I.P.S. SYDNEY.

ALL TIMES UNIVERSAL UTC (GMT).

**IF  
YOU'RE  
NOT  
BUYING  
AMATEUR  
RADIO  
ACTION**



(IT'S AUSTRALIA'S BEST  
SELLING AMATEUR MAGAZINE)

**THEN  
YOU'RE NOT  
KEEPING  
UP WITH  
THE LATEST  
NEWS, VIEWS  
AND REVIEWS**

Please put me down for 12 editions of Amateur Radio Action, starting NOW!

**Rates In Australia - \$14.40 Surface mail overseas - \$18.40 Air mail: To New Zealand - \$A28.70; Malaysia - \$A32.60; Japan - \$A38.45; USA - \$A42.35; UK - \$A46.25**

Herewith enclosed cheque/postal note/money order to the value of:

\$A.....

Name.....

Address.....

.....

.....

Postcode.....

Post to: Amateur Radio Action Subscriptions, Box 628E, Melbourne 3001.

# WICEN

Ron Henderson VK1RH  
Federal WICEN Co-Ordinator,  
53 Hannaford St., Page ACT 2614  
Ph. (062) 54 2059, A.H.

## EMERGENCY SERVICES COMMUNICATIONS PROCEDURE

This issue we continue with the third part of the Emergency Services Communications Procedure Paper.

### 20. SIGNAL STRENGTH AND READABILITY

A station that wishes to inform another of its signal strength and readability will do so by means of a short and concise report of actual reception such as "Weak, but readable", "Strong, but distorted", "Loud and clear", etc. A station desiring to know how its transmission is being received will transmit "How do you hear me?"

### 21. SYNCHRONISING TIME

(a) When a net has been established, Control should announce the time so all operators can synchronise their watches. To do this Control will say, for example:  
"All stations THIS IS (Call Sign). When I say time it will be exactly 1500 hours. 15 seconds — 10 seconds — 5-4-3-2-1 — Time 1500. OVER".

(b) Control will use the same procedure if a request for the time is received from a substation.

### 22. OFFERING MESSAGES

(a) An offer is a short transmission made to warn the receiving station concerned that a message follows. All messages will be offered. The prowords used in the exchange of calls in the offer of a message are "MESSAGE" or "LONG MESSAGE" or "UR MESSAGE".  
"SEND"

(b) When the sending operator has a long message he warns the receiving operator by offering the message as a "LONG MESSAGE".

### 23. RECEIPTS

The transmission of a message is not completed until the receiving station gives a receipt for it. This is done simply by using the proword "ROGER".

Example:  
"VK1BAA THIS IS VK1BAC send vehicle for mail — OVER".  
"VK1BAA — ROGER — OUT".

### 24. TYPES OF CALL

There are three types of call which can be used on a net. They are "Single, Multiple and All Stations".

(a) Single Call: Used by Control to substation, substation to control or substation to substation.

Example: Control to substation (or substation to control, VK1WI is control).

Control: "VK1BFA THIS IS VK1WI UR MESSAGE — OVER".

VK1BFA: "THIS IS VK1BFA — SEND — OVER".

Control: "THIS IS VK1WI — fresh batteries have arrived — OVER".

VK1BRA: "VK1BFA — ROGER — OUT".

Example: Substation to substation (Directed Net).

VK1BFA: "VK1WI — THIS IS VK1BFA — UR MESSAGE FOR VK1BFC — OVER".

Control: "THIS IS VK1WI — SEND — OUT".

VK1BFC: "VK1BFA THIS IS VK1BFC — SEND — OVER".

VK1BFA: "VK1BFA — request loan of a new battery — OVER".

VK1BFC: "VK1BFC — ROGER — OUT".

(b) Multiple calls: Used by Control to two or more substations but not used when calling all substations.

EXAMPLE:  
Control: "VK1BFA, VK1BFB THIS IS VK1WI — UR MESSAGE — OVER".

VK1BFA: "VK1BFA — SEND — OVER".  
VK1BFB: "VK1BFB — SEND — OVER".

Control: "VK1WI — Collect fresh batteries from me — OVER".

VK1BFA: "VK1BFA — ROGER — OUT".  
VK1BFB: "VK1BFB — ROGER — OUT".

(c) All Stations Call: Used by Control to all substations on the net. (All Stations on the Net reply in alphabetical order.)

EXAMPLE:  
Control: "ALL STATIONS — THIS IS VK1WI — UR MESSAGE — OVER".

VK1BFA: "VK1BFA — SEND — OVER".  
VK1BFB: "VK1BFB — SEND — OVER".

VK1BFC: "VK1BFC — SEND — OVER".

Control: ALL STATIONS — THIS IS VK1WI — Have you received fresh batteries — OVER".

VK1BFA: "VK1BFA — YES — OUT".  
VK1BFB: "VK1BFB — NO — OUT".

VK1BFC: "VK1BFC — YES — OUT".

### 25. SENDING A LONG MESSAGE

A long message is one of more than 30 words of text. The following procedure is then adopted:

(a) The message will be offered, using the proword LONG MESSAGE.

(b) It will be sent in sections.

(c) After about 15 groups, the sender confirms progress by saying "ROGER SO FAR — OVER".

(d) Receiving stations answer "ROGER" in turn or, if necessary, ask for repetitions.

(e) After obtaining acknowledgements from all receiving stations the sender pauses for five seconds. This is to allow any other station to transmit an urgent message.

(f) If there is no interruption the next section of the message is transmitted.

This procedure is continued until the message is cleared.

EXAMPLE:  
VK1BFC is sending a LONG MESSAGE to VK1BFX. He sends it in two sections.

VK1BFC: "VK1BFX — THIS IS VK1BFC — LONG MESSAGE — OVER".

VK1BFX: "THIS IS VK1BFX — SEND — OVER".

VK1BFC: After sending the heading of the message says:

"BREAK — following accommodation stores required — by one six hundred hours today — stop — blankets figures five hundred — stretchers figures two live zero — ROGER SO FAR OVER".

VK1BFX: "VK1BFX — SAY AGAIN WORD AFTER Accommodation — OVER".

VK1BFC: "VK1BFC — I SAY AGAIN WORD AFTER Accommodation stores — I SPELL — Sierra Tango Oscar Romeo Echo Sierra — stores — OVER".

VK1BFX: "VK1BFX — ROGER — OVER".

VK1BFX pauses for 5 seconds to allow any station with urgent traffic to call in.

VK1BFC goes on sending the rest of the message:

"VK1BFX — THIS IS VK1BFC — pillows figures two five zero — cutlery sets figures two five zero — cooking sets type Delta figures two — MESSAGE ENDS — OVER".

VK1BFX: "VK1BFX — ROGER — OUT".

### 26. WORDS TWICE PROCEDURE

When communication is difficult, call signs, phrases, words, or groups are transmitted twice and indicated by use of the proword "WORDS TWICE". Reception may be verified by use of the proword "READ BACK".

EXAMPLE A:

VK1BFX: "VK1BFC — VK1BFC THIS IS VK1BFX VK1BFX — UR MESSAGE — UR MESSAGE — OVER — OVER".

VK1BFC: "VK1BFX — VK1BFX — THIS IS VK1BFC — CK1BFC — SEND — SEND — OVER — OVER".

VK1BFX: "VK1BFC — VK1BFC — THIS IS VK1BFX — VK1BFX — WORDS TWICE — WORDS TWICE — PRIORITY — PRIORITY — TIME ONE TWO TWO ONE SIX THREE ZERO — TIME ONE TWO ONE SIX THREE ZERO — BREAK — BREAK — CONVOY has arrived — Convoy has arrived — over — over".

VK1BFC: VK1BFX — VK1BFX — THIS IS  
VK1BFC — VK1BFC — SAY AGAIN — SAY AGAIN  
— WORD AFTER BREAK — WORD AFTER BREAK  
— OVER — OVER".

VK1BFX: "VK1BFC — VK1BFC — THIS IS —  
I SAY AGAIN — I SAY AGAIN — WORD AFTER  
BREAK — WORD AFTER BREAK — convoy — con-  
voy — over — over".

VK1BFC: "VK1BFX — VK1BFX — THIS IS  
VK1BFC — VK1BFC — ROGER — ROGER —  
OUT — OUT".

EXAMPLE B:  
The text consists of code groups.

VK1BFX: "VK1BFC — VK1BFC — THIS IS  
VK1BFX — VK1BFX — WORDS TWICE — WORDS  
TWICE — PRIORITY — PRIORITY — TIME One  
Two Zero Eight One Zero — BREAK — BREAK  
— Alfa Mike Lima Quebec Delta — Alfa Mike  
Lima Quebec Delta — Romeo Oscar Charlie Zulu  
Yankee — Romeo Oscar Charlie Zulu Yankee —  
etc., — OVER — OVER".

VK1BFC: "VK1BFX — VK1BFX — THIS IS  
VK1BFC — VK1BFC — ROGER — ROGER —  
OUT — OUT".

## 27. REPETITIONS

When words are missed or are doubtful, repetitions are requested by the receiving stations before saying ROGER. The proword "SAY AGAIN" used alone or in conjunction with "ALL AFTER", "ALL BEFORE", "TO", "WORD BEFORE" is used for this purpose. In complying with requests for repetitions, the transmitting station will identify that portion which is being repeated.

### EXAMPLE:

VK1BFC has been told to "SEND" by two stations for whom he has traffic. He then says:

VKIABA — VK1BFB — THIS IS VK1BFC —  
TIME ZERO Eight One Zero Five Two — FROM —  
BRAVO Foxtrot Charlie — To — Bravo Foxtrot  
Bravo — INFO — Bravo Foxtrot Alfa — BREAK  
— at Zero Eight One Seven Ztro Zero — FIG-  
URES One Thousand — blankets — for BRAVO  
FOXTROT BRAVO — arrive Murrundi railroad —  
STOP. Blocks on ACK — MESSAGE ENDS —  
OVER".

VK1ABA having missed "BREAK" to "THOU-  
SAND" transmits:

VK1BFC — THIS IS VK1ABA — SAY AGAIN —  
BREAK to thousand — BREAK — at Zero Eight  
One Seven Zero Zero — FIGURES One Thousand  
— OVER".

VKIABA now having received the message satis-  
factorily transmits:

"VK1ABA — ROGER — OUT".

VK1BFB having received message satisfactorily  
transmits:

"VK1BFB — ROGER — OUT".

## 28. CORRECTION DURING TRANSMISSION

When an error is made by a transmitting operator, the proword "CORRECTION" is transmitted followed by the last word, group, proword or phrase correctly transmitted. Transmission then continues.

### EXAMPLE A:

VK1BFC: "VK1BFX — THIS IS VK1BFC — TIME  
One Zero One Five — CORRECTION — TIME One  
Zero Zero One Five Five — OVER".

VK1BFX: "VK1BFX — ROGER — OUT".

### EXAMPLE B:

When an error in transmission is discovered and the transmission is concluded, the word, group, proword, or phrase must be properly identified and the correct version given.

VK1BFC: "VK1BFC — THIS IS VK1BFX — TIME  
Zero Six Three Zero — BREAK — Convoy will  
arrive — supplies will be available — CORREC-  
TION — TIME — Zero Six Four Zero — OVER".

VK1BFX: "THIS IS VK1BFC — ROGER — OUT".

## 29. CANCELLING MESSAGE DURING TRANSMISSION

During the transmission of a message and prior to the transmission of the ending proword "OVER" or "OUT", the transmission may be cancelled by use of the proword "DISREGARD". A message which has been completely transmitted may be cancelled only by another message.

### EXAMPLE:

During the transmission of a message, station BFX discovers that the transmission is in error and

cancels it by transmitting the proword "DISRE-  
GARD".

VK1BFC: "THIS IS VK1BFX — ROUTINE —  
TIME Zero Six Zero Two Three Five — commence  
unloading at dawn — sixteenth — proceed —  
DISREGARD — OUT".  
30. READ BACK

If it is desired that a message or a portion thereof be read back, the proword "READ BACK" and identify data will be transmitted immediately following the call.

### EXAMPLE:

VK1BFX: VK1BFC — THIS IS VK1BFX — READ  
BACK text — TIME One Six One Two Three Zero  
— BREAK — convoy has arrived — OVER".

VK1BFC: "VK1BFC — I READ BACK text —  
convoy has arrived — OVER".

VK1BFX: "VK1BFX — CORRECT — OUT".

Note: When READ BACK is employed, the pro-  
word ROGER is not necessary to indicate receipt  
of the message.

VK1BFX: "VK1BFX — ROGER — OUT".

(To be continued) ■

# YOU and DX

Mike Bazley VK6HD

8 James Road, Kalamunda W.A. 6076

The past decade has been good to the DX chaser. True we have seen a sunspot minimum with poorer conditions on the HF bands, though I wonder how many are aware of the DX activity of the past ten years? Looking at the present DXCC list nearly all the countries itemised have been active. The only notable exceptions this writer is aware of were: BY, YZ, VS9K and 70. How many did you miss out on? One thing should be fairly certain, those countries which have not been activated during the past ten years stand a reasonable chance of being so during the next ten years. Something to look forward to.

List operations cause a lot of ill-feeling on the DX bands particularly if you need that country and you are sure he would like to work a VK! One of the main causes of annoyance is that one is never told how to get onto the list in the first place. Full marks must go to the DM gang who organise the lists for TN8AJ, who is QRV every Saturday from 1400Z to 2115Z. The list is taken from about 1410/15Z a few kHz from the TN8s frequency. During the time the list is going through one of the DM master of ceremonies will regularly state on the frequency when and where the next list will be taken. This approach certainly solves a lot of QRM problems and reduces blood pressure!

## DX NEWS, RUMOURS, FACT AND FICTION

One of the problems of Christmas is that copy for this February issue has to be in the hands of the publishers early therefore only a short time has elapsed since pen was last put to paper. For what it is worth, let's dispense with some of the rumours first. Those, like me, who still need 5A may take some comfort in the rumour that a group of European DXers will be trying to activate this one for the WPX SSB contest. Also talk has been heard on the air of possible 70 operation by a group of DLs. Finally don't write off the chance of some XZ operation, rumour has it that VE3FXT is still trying for that one.

Evan VK3ANI advises that JW5FD is active from Baer Island, which is in the Svalbard Group. This station is scheduled to be active until June 1980. The antenna at present is only a dipole but plans are in hand for a beam. The station was heard on 14 MHz SSB from 1900-2000 GMT.

The "DX Bulletin" advises that on-the-air Bulletins are made by W0JRV at 1200 GMT on Mondays, frequency 1400Z. Need to brush up the CW for this one.

Those of you chasing WAZ or 5BWAZ and looking to QSO U0Y on one of the bands should direct their QSLs via UK0AAA. This station must have run up an enormous QSO total as it was active for over six weeks and this period covered both the phone and CW contests. The station was re-

ported as having OSO'ed VK on all bands except 160m. A7XA and A7XB are both active at present, usually found on 28550/28620 from 0900 GMT at weekends.

LUTX, who was active during the CQ/CW contest was operating from Staten Island, QSL via LU6EF.

The N2KK Expedition has been held up due to problems in obtaining the necessary visas and licences. By the time this is being read the Expedition should be under way.

There are quite a number of VU stations active on 80 metres. VU2DPK and VU2BX have been reported on SSB and this writer has recently QSO'ed VU2UH on CW.

604LS recently caused a stir on the 15m band. If you worked him I regret to tell you that he was operating from aboard the Panamanian ship "Judy" in Mogadischu harbour.

Did you miss the 3C1 Expedition? Well take heart 3C1AC, who is a TV technician, is active on 14, 21, 28 SSB. QSL via EA7FY.

D68AM, Alain is being heard again on 14 and 21 SSB. QSL via Box 501, Moroni, Grande Comore.

100 Moscow stations and 25 stations from each city where the Olympic Games are to be held will use special prefixes from Jan. 1 to Aug. 3. UA stations with 2 suffix letters will use RX, those with 3 suffix letters will use RZ, UK stations will use RK, UV RV, UW RW, UC2 RZ2, UR2 RU2, UB5 RZ5, UT5 RT5, UY5 RY5. From July 1 to Aug. 3 special station RM30 will be QRV from Moscow, RT20 from Tallinn. From July 15 to Aug. 3 special station RL10 will be QRV from Leningrad, RK50 from Kiev, RM20 from Minsk. An Olympiada-80 Award will be available for a maximum of 40 points as follows: — 5 points each for working RM30 RT20 RK50 RM20, 1 point for working other special prefix stations, 1 point for working all stations from Oblast 170. One QSO per station. Send log data plus your QSLs for the USSR stations worked to P.O. Box 88, Moscow.

N4HX/TT8 is reported active from Chad. He has been worked/heard in VK on 14, 21 and 28 SSB. QSL via ON5NT, P.O. Box B-9880 Aalter, Belgium.

Well, that's the lot for this month. Thanks to G. Watts News Sheet and VK3ANI, VK4AX, VK6AJ, VK6LK and L30853.

73 es DX Mike, VK6HD

## QTHs YOU MAY HAVE MISSED

A7XB — via DJ9ZB  
A9XCV — Box 14, Manama Bahrain  
C6ACY — via WB4LIB  
CT2QN — via W2KF  
FP8AA — via K2RW  
H223M — via W7RQ  
HK0BBF — Box 133 San Andres Island  
HP1XOJ — via WB3KGY  
HK0EFE — via K4TXJ  
H21AV — via K8PYD  
JW5FD — via LA5NM  
KH6GB/KH9 — via KHJJO  
OY9J — via K2JUL  
S2BTF (for non W QSOs) — via LA5NM  
TG9GI — via K8HV  
N4HX/TT8 — via ON5NT  
TU4AQ — via F6FPF  
T4GN — via ZS6GN  
VK0KH (Macquarie) — via VK5UW  
VP1KS — via DL1KS  
VP2EY — via W3HNN  
VP2SAX — via YA5ME  
VP8SU — via G3ZCA  
VP8YN — via G4CHD  
YN1JCC — Box 52 Managua  
ZL5AC — via ZL2VF  
3C1AA — via EA4MY  
5T5JD — P.O. Box 477 Nouakchott  
N2RM/6Y5 — via N2MM  
9Y4DR — via KA2RFK

## QSP

### CONGRATULATIONS

To Mr. E. J. Wilkinson ISO, upon being elected President of the IREE Australia for 1979-80 as announced in the Dec. '79 issue of "Monitor". ■



# SIDEBAND ELECTRONICS ENGINEERING

P.O. BOX 23, SPRINGWOOD, N.S.W. 2777  
 WAREHOUSE 213 HAWKESBURY RD. SPRINGWOOD  
 TELEPHONE (047) 54 1392

Overseas prices again show an upward trend. If you are in need of new equipment it makes sense to purchase now. Prices must increase once current stocks are sold. How about **KENWOOD** transceivers at the right price, or a **YAESU FT-1012Z** fitted with fan at **\$850 -**, **HENRY** linears **\$850 -** and **\$1050 -**, **TH6-DXX** **\$300 -**, **18-AVT/WB** **\$110 -**, Rotators, cables and Co-ax connectors all at the right price. Check and compare our prices with others before you buy!

## HENRY RADIO — A Famous Brand —

### NEW LINEAR AMPLIFIERS —

2KD-5 — 2KW PEP, 80 - 10m SSB/CW/RTTY/AM  
 ..... **\$1050**  
 1KD-5 — 1200W PEP, 80 - 10m SSB/CW/RTTY/AM  
 ..... **\$850**

## GAIN ANTENNAS

TH6-DXX 10-15-20M, 6-el. yagi..... **\$300**  
 18-AVT/WB 10-80M vertical..... **\$110**  
 204-BA 20M, 4-el. Tiger array..... **\$220**  
 BN-86 balun for beam buyers..... **\$20**  
 HY-Q (USA) 50-ohm 1KW balun..... **\$15**

## ROTATORS & CABLES

All rotators now come with bottom brackets and control-indicator boxes wired

KEN KR-400 medium duty..... **\$120**  
 KEN KR-500 vertical rotator..... **\$140**  
 KEN KS-065 stay/thrust bearing..... **\$25**  
 CDR BT-1A light duty 4 position push button programmable. Plus normal operation 120V AC..... **\$85**  
 CDR am III heavy duty 120V or 28V AC..... **\$178**  
 CDR tail-twister extra H/D 120V or 28V AC..... **\$225**  
 RG-8U foam coax cable, per metre..... **\$1.00**  
 8-cond. rotator cable, per metre..... **75c**

## ACCESSORIES

Voltage regulator 18V AC Input, 12V DC 3A output **\$18**  
 240/18V AC transformer **\$10**  
 Mobile bumper mounts 3/8" 24 thread **\$2**

## KYOKUTO FM-2016A

800 channel, 2 meter FM transceiver with 4-channel memory and scanner 15W..... **\$355**

## TRIO-KENWOOD PRODUCTS

VFO 520 for TS 520S..... **\$130**  
 LF 30A low-pass filter..... **\$30**  
 SP-120 (TS-120 series) SP-100)..... each **\$32**  
 DK 520 adaptor TS 520 to DG 5..... **\$10**

*All further Trio-Kenwood accessories and transceivers at competitive prices.*

## YAESU MUSEN PRODUCTS

FT-1012D 10-16M digital transceiver w/cooling fan fitted..... **\$850**  
 SIDEBAND brand microphone to suit..... **\$10**

## CO-AX CONNECTORS

PL-259, SO-239, cable joiners, each..... **60c**  
 Right angle and T-connectors, each..... **\$1.00**  
 GLP right angles RG-58U to SO-239, w/lock nut and cap, each..... **\$1.50**  
 Double female connectors, each..... **80c**  
 MLS right angles RG-58U to PL-259, each..... **75c**  
 In-line mike sockets 3 & 4 pin, each..... **60c**  
 Mike sockets 3 & 4 pin, each..... **60c**  
 M-ring body mount w/lock-nut..... **\$1.50**

## NOVICE SPECIALS-TRANSCIVERS

10M sideband SE-502 USB/AM 15W PEP-240V AC, 12V DC, inbuilt SWR/RF meter, 28.3-28.6 MHz clarifier tuning transmit and receive..... **\$80**  
 10M Universe 224-M, USB/AM, 15W PEP 12V DC, 24-ch. 28.480 to 28.595 MHz, 5-Khz steps-clarifier tuning transmit and receive..... **\$85**  
**CONVERSION CRYSTALS** for amateur licence holders - set of 8 crystals to convert 23-ch, 27-MHz CB units to 28 MHz. Suitable for Kraco, Sideband, Universe, Hy-range V etc., converts as per Universe 10M above — **CRYSTALS & INSTRUCTIONS..... \$32**  
 Set of 4 crystals converts to 28.3-28.6 MHz..... **\$15**

All prices are NET, ox Springwood NSW, on pre-payment with order basis. All risk insurance is free of charge, allow for freight charges by air, road, rail or postal, excess will be refunded. Prices are subject to change without prior notice. All orders cleared on a 24-hour basis after receipt of order with payment.

**ROY LOPEZ (VK2-BRL) Manager**

# AWARDS

## COLUMN

Bill Verrall VK5VV

7 Lilac Ave., Flinders Park, S.A. 5025

### WORKED GERMAN LARGE CITIES AWARD

This award is available for working stations in West Germany. It is available in three (3) classes and there is no restriction on the mode used. No band endorsements are made as more than one band may be used in qualifying for the award. Each city may be listed once only in the claim. The three classes are:—

Class	DX Stations
3	10 Cities
2	20 Cities
1	30 Cities

QSLs are not required for this award, but a list certified by two other radio amateurs or an officer of a National Radio Society should be submitted together with 10 IRCs. The Award is also available to SWLs on a "Heard" basis.

Claims should be sent to: Karl-Heinz Kummerie, DL2JB, 694 Weinheim, Postfach 23, Germany.

German Large Cities are: Aachen, Augsburg, Berlin, Bielefeld, Bochum, Bonn, Bottrop, Braunschweig, Bremerhaven, Darmstadt, Dortmund, Dusseldorf, Duisberg, Essen, Frankfurt/Main, Freiburg, Gelsenkirchen, Göttingen, Hagen, Hamburg, Hannover, Heidelberg, Hellbronn, Herne, Karlsruhe, Kassel, Kiel, Koblenz, Köln, Krefeld, Leverkusen,

Ludwigshafen, Lubeck, Mainz, Mannheim, Monchengladbach, Mulheim/Ruhr, München, Münster/Westf., Neuss, Nürnberg, Oberhausen, Offenbach/Main, Oldenburg i., Osnabrück, Recklinghausen, Regensburg, Rheydt, Saarbrücken, Salzgitter, Solingen, Stuttgart, Trier, Ulm, Wanne-Eickel, Wiesbaden, Wilhelmshaven, Witten, Wuppertal.

### "100 X" AWARD

This award is issued by the Mexico DX Club to licensed radio amateurs and SWLs for confirmation of QSO with stations that have in its call sign one or more "X" letters (XE1OW, W4LXX, EA3AX, I2XYZ, etc.).

To apply for this award you must have at least 100 points.

Each letter X of stations of any country outside Mexico counts 1 point.

Each letter X of Mexican stations count 2 points.

Each letter X of Mexico DX Club members counts 3 points.

QSO with the club station of the Mexico DX Club "XE1MDX" counts 10 points.

Only contacts after January 1st of 1973 are valid.

Application and OSL cards must be sent to P.O. Box 21-167 in Mexico City 21.

For safe return of the QSL cards and award, please include 15 IRCs (or 3 dollars U.S.A.).

### CENTRAL COAST AWARD (VK2)

The Central Coast Amateur Radio Club issues an award to stations who meet the following requirements:—

#### 1. Overseas Stations:

Overseas stations must work Two (2) stations

resident on the Central Coast of N.S.W. OR one of the Club stations VK2EH or VK2AFY.

#### 2. VK Stations:

VK stations must work Four (4) stations resident on the Central Coast of N.S.W. plus either of the Club stations VK2EH or VK2AFY.

#### 3. Central Coast of N.S.W. Stations:

Central Coast stations must work Ten (10) stations resident on the Central Coast of N.S.W. plus either of the Club stations VK2EH or VK2AFY.

4. The Central Coast of New South Wales is defined as that area within the Shires of Gosford and Wyong.

5. After the necessary number of stations have been worked send a copy of the log extracts to:

The Awards Manager, P.O. Box 238, Gosford, N.S.W. 2250, Australia.

After verification of the OSOs the Award will be issued.

Good Hunting. ■

### UPDATED ENDEAVOUR AWARD RULES

(See also AR, February 1979 and July 1979)

#### Rules

1. The name of the award shall be the "ENDEAVOUR AWARD" and shall be open to all radio amateurs and short wave listeners.

2. Applicants must establish two-way amateur communications with RNARS Members residing in Australia. SWLs must monitor Australian RNARS Members.

3. Points will be awarded on the basis of one point per VK RNARS Member worked/heard per band, regardless of mode. Only contacts after January 1st 1979 will count towards the award. Contacts on the VHF bands will count double points. All contacts with HMAS NIRIMBA club station, VK2BNR, count double. To qualify the following is required:—

For amateurs/SWLs residing inside Australia — 15 points.

For amateurs/SWLs residing inside Oceania — 10 points.

For amateurs/SWLs residing outside Oceania — 5 points.

In addition, for amateurs residing outside Oceania, contacts with VK RNARS Members on the 3.5 MHz band will count double points. For the purposes of this award, any RNARS Maritime Mobile Member when located inside Australian waters may be counted as a VK Member.

4. The Award will be endorsed ONLY at the request of the applicant and the following endorsements are available:

ALL CW — ALL SSB — ALL NOVICE — ALL 3.5 MHz — ALL 28 MHz — ALL VHF — FIVE-BY-FIVE. The last endorsement being for gaining at least five points on each of the five high frequency bands.

5. A special sticker is available to add to existing certificates for gaining 100 POINTS. However, any previous MODE endorsements on the original must hold true for all 100 points, or a second award claim for mixed mode must be made. The sticker is issued free of charge to existing award holders. A SASE or 2 IRCs would be appreciated to cover return postage.

6. To claim the Award, no QSLs are required. Full log details showing the VK member (or /MM+QTH) claimed, their RNARS number, date, time, frequency, mode, plus an application fee of \$1.50 Australian or 7 IRCs are to be sent to the Endeavour Award Custodian:—

Mr. R. Baty, 43 HMAS Australia Road, Henley Beach South, SA 5022, Australia. Please ensure all cheques are in Australian currency and made payable to "R. Baty". Clearly state what endorsements are claimed. Certificates to successful applicants will be forwarded by air-mail. ■

Join the IW net at 2300Z on Thursdays on 14165 kHz when you have intruder information.

# THE CENTRAL COAST AWARD

Presented by

## Central Coast Radio Club

Jo SAMPLE ONLY

WHO HAS MADE RADIO CONTACT WITH THE REQUIRED NUMBER OF AMATEUR RADIO OPERATORS WHO ARE MEMBERS OF THE CENTRAL COAST RADIO CLUB

Award No.

Date

Stations Contacted

President

### CENTRAL COAST - THE HOLIDAY COAST

The Central Coast, which has been called the Holiday Playground of two cities, embraces more than 725 square miles of the finest and most varied scenery. The area has a great diversity of interests including 30 of the most beautiful beaches in the State, more than 100 square miles of shark-free lakes, mountain lookouts and scenery, heavily-timbered forests and more than 300,000 acres of wonderful national parks and reserves. The Central Coast is a water wonderland controlled by the Shire Councils of Gosford-Wyong. Gosford is the hub of the coast and the terminus of a fast and modern electric train service from Sydney. Situated midway between Sydney and Newcastle, 50 miles from each, with excellent shopping facilities and a population of 78,000, it is a wonderful area in which to live or spend a pleasant holiday.

The Central Coast Radio Club — operating station VK2AFY — is a branch of the Wireless Institute of Australia which is the oldest amateur radio organisation in the world.

This Award has been sponsored by The Central Coast Tourist Authority

### The Central Coast (VK2) Award

# ALARA

AUSTRALIAN LADIES' AMATEUR RADIO  
ASSOCIATION

Results of the elections which were held at the Annual General Meeting of ALARA: President — Heather Mitchell VK3AZU, Vice President — Raedl Fowler, Secretary — Daurel Coolidge VK3ANL, and Treasurer — Mavis Russell VK3BIR. Last year's officers were given thanks for the work they did and the time they contributed. The group gave special thanks to Mavis VK3BIR for all the contributions in time and energy she has made this past year to amateur radio and ALARA.

The next meeting of ALARA will be held at the home of Mavis Stafford VK3KS, 16 Byron Street, Box Hill, on 9 February, 1980. There is no meeting in January.

## YL ACTIVITY DAY

Aims: For YLs to meet and get to know other YLs without contest pressure, to have more personal QSOs than occur in a YL net, and to help QMs who may need a quick contact for a YL award.

Date: the 6th day (GMT) of every month.

Frequencies: 3.688, 7.088, 14.288, 21.188, 21.388, 28.688 MHz ± QRM.

Times: on the hour, every hour. If you don't hear any YLs, please call CQ YL.

(Thanks to Diana G4EZI for this information.) ■

## CAMEO OF MAVIS RUSSELL VK3BIR, PRESIDENT OF ALARA, 1979

Mavis has had her full call for 2½ years now. She became interested in amateur radio when her husband, Earl VK3BER, received his ticket. She took a correspondence course, but her interest waned. Mavis had heard about the formation of ALARA on the WIA broadcasts, but it was the ALARA sked on 80m that really piqued her curiosity. So, in July 1975, she took classes at the Eastern and Mountain District Radio Club. In 1977, she received the news that she had passed the full call exam. Mavis remembers that it was a "tremendously exciting moment", and it was followed by much celebrating.

Since then, Mavis has been active in many aspects of amateur radio. She has participated in WICEN activities, in particular the canoe race on the Murray. She was on the steering committee of the Frankston and Mornington Peninsula Amateur Radio Club and has been on various committees since its inception four years ago. Presently she is the QSL manager for the club.

Her involvement with ALARA began with the skeds and the monthly meetings in 1975. In 1979 she served as President. Her efforts have brought forth the ALARA Award, newly printed but not yet publicised, and an expanded membership base. She wants to have more YLs involved in the sked (Mondays 1030 GMT 3.56 MHz ± QRM). With the help of State Co-ordinators, she has been experimenting with moving it into the novice section in the hopes of fuller participation.

Mavis enjoys working DX and has worked the 100 countries needed for the DXCC but has yet to apply. Her goals for the coming year are to improve her CW and to get involved with satellite operation. In fact, the whole family is interested in satellites. Mavis says that one of her sons, aged 18, will be sitting for his novice exam in February. That may result in competition for the use of the rig, with three amateurs in the household.

Mavis is quite active on SSB, especially on 20m and 2m. Early in the morning before work, she can be heard on 10m, sometimes chatting with Erin YJ8NEM. It was her on air friendship with Erin that helped Mavis travel to Port Vila and operate there with YJ8 call last October. Her special QSL cards have been printed and are being posted.

The Victorian Division held a pre-Christmas picnic in Woodend at the home of Janet VK3BTU. Among those attending were Norma VK3AYL and Frank VK2AKG, who were married only a week previously. Congratulations and best wishes to the

both of you! Norma was the foundation president of ALARA in 1975.

YLRL, ALARA's sister organisation in the US, celebrated its 40th birthday. A YL Anniversary Contest was held and a few VK YLs participated. No news yet about the results.

YL Activity Day is the 6th of every month. Look for YLs on the hour, every hour, at the following frequencies: 3.688, 7.088, 14.288, 21.188, 21.388, 28.688 ± QRM. Geraldine VK2NOI and Helene VK2HD did call "CQ YL" last month but they were unsuccessful in making contacts. Mavis VK3KS hopes to give it a try next month when repairs to her antenna should be completed.

If you are a YL and would like to join ALARA, the only requirement is an interest in amateur radio. For more information, please contact the Secretary, Box 110, Blackburn, Victoria, 3130.

Maggie VK3NRR ■

# INTRUDER WATCH

All Chandler, VK3LC

## FEDERAL INTRUDER WATCH CO-ORDINATOR REPLACEMENT

As denoted in November AR I have relinquished the position of Federal IW Co-ordinator, and have been fortunate in finding a replacement.

Graham VK3NXI is your new Co-ordinator as from January 1980, and it is very fitting that a Novice should take over the co-ordination.

With the conclusion of WARC 79 there is a completely new era commencing for Amateur Radio as a whole, and for Australian Amateurs, too. With the above in mind I am of the opinion that the IW should be handled by new and enthusiastic members, and Novices fall into that category. The old-timers have done a very good job in the past and it is up to the newcomers to do likewise in the future. The future destiny of Amateur Radio is in their capable hands.

Co-ordinators as at the time of writing are —

VK1NBB R. Chorley, 42 Gouger Street, Torrens 2607.

VK2AFG Las Weldon, 11 Raymond Avenue, Northmead 2152.

VK3 —

VK4NMJ Gordon Loveday, "Aviemoore", Rubyvale 4702.

VK5LG Leith Cotton, 64 Weroona Avenue, Parkholme 5043.

VK6WT Dave Couch, 9 The Grove, Wembley 6014.

VK7NJC Jeff Cordell, 323 Lenah Valley Road, Lenah Valley 7008.

VK8HA Henry Andersson, PO Box 1418, Darwin 5794.

Federal, VK3NXI Graeme Fuller, PO Box 156, Healesville 3777.

All Chandler VK3LC,  
IARU Region 3 IW Co-ordinator. ■

# INTERNATIONAL NEWS

## H44

A note has been received about the formation of a new society in the Solomon Islands — SIRS, the S. Island Radio Society. The inaugural general meeting was held on 10th October 1979, and a call sign — H44SI has been obtained. The President is H44DX and Dr. G. W. Hughes is the Secretary. The address is P.O. Box 418, Honiara, Solomon Islands which also serves as their inward QSL bureau address.

## RECIPROCAL LICENSING

Details were published in AR, Jan. 1978, p.25. ■

# MAGAZINE INDEX

Roy Hartcopl VK3AOH

From this issue onwards it is proposed to make some alterations to the Magazine Index Department of AR. The title of an article can often be misleading and it is disappointing if one goes to a lot of trouble to hunt up a magazine and then find that the article has — for instance — no constructional information. Therefore it is proposed in future to add a key letter to the various titles listed: G for general; C for constructional; P for practical where there are no actual constructional details; T for theoretical and N for anything of particular interest to the Novice. Any comments from readers as to whether they find this new format helpful would be greatly appreciated.

## 73 MAGAZINE August 1979

Converter for 2 GHz TV Channels (P); History of Ham Radio (G); The Potted J, Weatherproofed Antenna (P).

## September 1979

History of Ham Radio (G); Remote Control for the IC22S (P).

## RADIO COMMUNICATION June 1979

Improving the FT101 (C).

## August 1979

CMOS Keyer with Memory (C).

## CQ August 1979

The People's Temple Net (G); Foreign Morse Codes (G, N).

## October 1979

DX World Records (G); Crystal-transistor Tester (C, N).

## HAM RADIO July 1979

UHF Local Oscillator Chain (C); 40 Metre Beverage Antenna (C); Test Equipment Mainframe (C).

## August 1979

12V 10A Power Supply (C); Ground Systems (G).

## QST June 1979

AR in Tonga (G); 5/8 2 Metre Antenna (C).

## September 1979

Printed Line Techniques for VHF (C, G); Ionospheric Ducting (G); Mono-Loop Delta Antenna (C).

These are a few highlights. More next time. ■

# QSP

## CB AGAIN

According to reports in CQ for October 1979 Japan has recently approved a CB service which will operate in a band consisting of 110 channels. Channel 1 is identical to that in the USA CB service, with the highest channels extending to just under the 10 metre amateur band. ■

## USA REPEATERS

How many amateur repeaters are there in the U.S.A.? ARRL Repeater Directory lists 4872 in 1979, which excludes some private and closed repeaters mainly in the 70 cm band. There were 3438 on 2 metres, and 728 on 70 cm, with others on 10 (36) and 6 (193) metres, 220 MHz (446) and 1215 MHz band (7) and 24 ATV repeaters. If the growth rate continues there would be over 10,000 in 1982.—OST July 1979. ■

## VALVE (TUBE) PROBLEMS

Writing in Technical Topics in November 1979 Radio Communications Pat Hawker quotes the growing scarcity (and consequent rising cost) of many once-familiar valve types now that new TV receivers (the last mass market for valves) are virtually entirely solid-state. Some valves for TV sets, not being designed for RF applications, may or may not neutralise satisfactorily depending on the make. Inter-electrode capacitances seem to vary widely between different brands of the same valve type, e.g. 12BY7A. ■

# AROUND THE TRADE

## ICOM RELEASES MICROPROCESSOR 2m RIG

Following the tradition of the earlier IC211 2 metre multi-mode transceiver, the IC251A has improved performance and facilities, apart from introducing new power supply technology. In common with the 6m version, a pulse type (50 kHz) power supply is used on AC allowing a reduction in weight and heat.

Using micro computer control, a multi-purpose scanning facility allows monitoring of three different memory channels, a program scan giving scanning between two programmed frequencies, and an adjustable scanning speed that stops scanning when a signal is received — on all modes!

Continuous coverage over the complete 2m band is provided with either 1 kHz steps on FM or 100 kHz steps on SSB, with a fast tuning facility also provided.

Further details and prices are available from Vicom at their Melbourne and Sydney addresses or their interstate representatives.



CW Electronics, Brisbane, has commenced selling and distributing a range of morse code and/or RTTY interfaces for the Commodore PET computer. These components are marketed under the brand name Macrotronics and are imported from USA.

The interfaces link the worlds of the computer enthusiasts and amateur radio operator.

The Macrotronics M650 interface comes complete with relevant software cassette. The manufacturers claim the interface offers a number of interesting features:

- Split screen display with the top six lines for the transmit buffer, middle two showing actual characters transmitted to air and bottom twelve displays the incoming signals.
- Message library functions, you could record the RTTY news service for future reference. The interface offers Auto CWID, eight message memories and enables you to send UTC at a push of a key.
- Select ASCII at 110 Baud or Baudot at 60, 67, 75, 100 w.p.m.
- Other features include word orientated editor, instant replay, auto transmitter control from the keyboard plus more.

If you require to drive a model 15 teletype simultaneously then there is a Macrotronics MLK1 Loop Keyer module or with a FT101Z a MSK1 Solid State Keyer module to handle the reed relay keying.

The M65 ham RTTY/morse interface is also available which offers phase locked loop demodulator, LED tuning indicator, built-in side tone oscillator, auto time sending, ten message memories and a morse code trainer.

The RTTY enthusiast's Macrotronics FSD-1 RTTY modulator uses a phase locked loop demodulator and provides RS232 output. It allows reception of 170 Hz or 850 Hz shift RTTY signals at the flick of a switch. Tuning is achieved by an 0-1 mA meter that is supplied.

Owners of TRS 80 or Sorcerer computers can easily use some of the range.

For further information contact CW Electronics, Cnr. Marshall Road and Chamberlain Street, Tarragindi, Brisbane, Qld. 4109. Tel (07) 48 6601.

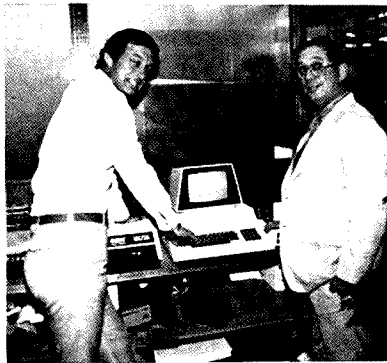

Nigel Sheppard (l) and Brian Beamish (r) discuss the Commodore PET.

## NEW COMMUNICATIONS MONITORS

Instrument Flight Research (IFR Inc.) have released, through their newly appointed agents, Vicom International Pty. Limited, Professional Products Division, their communications monitor FM-AM 1000A and FM-AM 1000S. The instrument covers 100 Hz-999.9999 MHz as a generator and as a receiver 300 Hz-999.9999 MHz with accuracy quoted as  $1 \times 10^{-6}$  ppm. The instrument covers all functions as standard, and this includes spectrum analysis (S Model), audio synthesis, two tone generation, BFO for single sideband measurements, power measuring to 100 watts and field strength measurements as well. Indeed, all modes of measurement are available at the flick of a switch.

The instrument is powered by mains voltage (either 240V AC or 110V AC) or by its own built-in Nicad battery pack. Because the instrument is small and light it is well suited to field operation.

Further information and specifications may be obtained from the authorised Australian agents, Vicom International at 68 Eastern Road, St. Melbourne, Phone (03) 699 6700 or 339 Pacific Highway, Crows Nest, Phone (02) 436 2766.



## IC22S MAKES 2k

Over 2000 units of the current Icom Model IC22S 2m FM transceiver have been sold in Australia, according to the distributors, Vicom International Pty. Limited. This is in addition to the popular IC22A and IC20 series.

## LEADER LDM170

As part of the vast range of Leader test equipment, Vicom International are pleased to announce the release of their noise and distortion meter (model LDM170).

The instrument is available from Vicom International Pty. Ltd. and distributors.

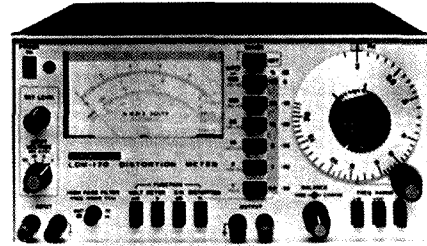

## DAIWA RELEASE NEW SPEECH PROCESSOR

Daiwa Corporation have released the new model RF660 RF Speech Processor designed for amateur radio transceivers.

The retail price is \$109 and it is available from the Australian distributors, Vicom International Pty. Ltd., 68 Eastern Road, South Melbourne.

The RF660 is shown below with the popular Kenwood TS120V.

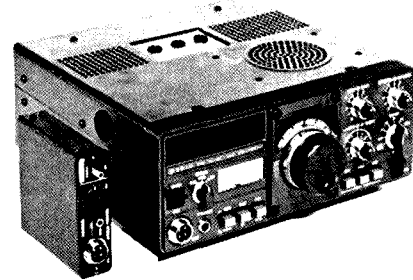

# DIVISIONAL NOTES

## VK2

34th URUNGA CONVENTION AND FIELD DAY, EASTER 1980

April 4th, 5th and 6th

Friday 4th: 2000 hrs Ocean View Hotel, Urunga. Ragchew and Registration. OM \$7, XYL \$5, Family \$15. Includes maps and tourist information, all events, morning and afternoon tea, Saturday and Sunday, supper Saturday and Sunday.

Saturday: Urunga opposite Ocean View Hotel.

Sunday: Bellingen Show Ground. Coming from Highway turn right at Bellingen Post Office — follow signs.

Car trips have been arranged to local cottage industries for those who are interested. Details will be available at the Registration table.

Trade displays, disposals — bring and sell — lucky registration, amateurs displays, cottage industry displays, quizzes.

7100 MHz-28.5 MHz-146 MHz monitored for talk-in.

Further information can be obtained from the Coffs Harbour Club Net each Monday at 2000 hrs Aust. summer time on 3610 MHz or from Urunga Convention Secretary, Max Francis, Dowle St., Bellingen 2454.

BUYING OR SELLING GEAR?

# HAMADS

MAKE IT HAPPEN FAST

# HELP WITH INTRUDER WATCHING

## TRADE HAMADS

For a very long time commercial advertising has not been accepted in AR Hamada, but as the result of discussions at the 1978 Federal Convention a decision was made to open up a "Hamads-Trade" section. The rate will be \$10 for 4 lines plus \$2 per line (or part thereof), minimum charge \$10, pre-payable. Copy is required by the first day of the month preceding publication. This will mean that in future ordinary Hamads submitted from members who are deemed to be in the general electronics retail and wholesale distributive trades should be certified as referring only to private articles not being re-sold for merchandising purposes. ■

## HAMADS

- Eight lines free to all WIA members. \$9 per 3 cm for non-members.
- Copy in typescript please or in block letters to P.O. Box 150, Toorak, Vic. 3142.
- Repeats may be charged at full rates.
- Closing date: 1st day of the month preceding publication. Cancellations received after about 12th of the month cannot be processed.
- QTHR means address is correct as set out in the WIA 1979 Call Book.

## FOR SALE

Kenwood TS120V HF Tcwr, g.c. (working A1), with manual and orig. packing, 4 mths. old, little use, but slightly soiled on sides of cabinet, \$510, ONO. Phil VK3NAY/ZAU. Ph. (03) 221 6591 A.H.

Teletype Model 15 for RTTY, adjusted to 45.45 baud, good working order, \$50; transformer, 240/110V, for above, \$15. VK2NXP. Ph. (02) 521 2637.

BC-348 Rx with P/S, spare valves and manual, \$50; Gelooso G-209 Rx, needs repair, dial mechanism perfect, \$50; air variable capacitors, 40-300 pF, 7 kV, brand new, \$20; 6 position rotary S/W, 13 kV, 20A, compact size, brand new, \$20. John VK2PI. Ph. (02) 522 4865.

Collins Commun. Rx 51J4, with manual, full set of spare valves, \$300; Kenwood TR7400A, as new, 35W output, \$350; Chess Challenger 10, unwanted gill, \$299. VK2AVP (ex VK2NKN), QTHR. Ph. (047) 21 4373.

IC551D 6m Tcwr., 100W, IC211, 2m tcwr. 6m 5 el. yagi, IC225 2m tcwr., FM mobile, Hustler vertical 4-BTV, 13.8V 12A, regulated DC, HD supply. Ph. (03) 240 1231 A.H., (03) 509 8637 Bus.

Hy-Gain 14 AVT Vert. Antenna, 10-40m, as new, complete with instruction sheet and carton, \$50. VK2ATP, QTHR. Ph. (02) 98 7151.

Drake Comm. Rcvr R4A, ham and ten SW 500 kHz bands, Drake NB, four Drake filters installed, notch filter, exc. selectivity and sensitivity, 1 kHz frequency readout, matching Drake MS-4 comm. speaker, manual, mint cond., \$225. James VK2JO, GPO Box 5076, Sydney 2001, NSW. Ph. (02) 36 7756.

Yaesu FT7, little use, orig. carton, complete, works like a charm, \$350; Drake W-4 meter, 0-200W, a must for every shack, \$40+. L. Wade VK2AQW. Tel (02) 358 3995 A.H.

FT2FB 2m Transceiver (rep. 2, 5 and 8 and simplex Ch. 40) and matching FP2 AC power supply, \$160, ONO. M. Evered VK3AVO, QTHR. Ph. (03) 544 4109.

TH3JR Tribander, 6 mths. old, \$120; FT7 xcvr, \$400; FL110 Yaesu linear, \$180; YO301 Yaesu minitorscope, \$280; IC202 2m SSB xcvr, \$120; Phillips R/C bridge GM414, \$25. VK3CCE, QTHR. Ph. (03) 509 1687 A.H.

Icom IC211 all mode, 2m, Tcwr, very little use, faultless, as new cond. and operation, \$670. VK3SB, QTHR (03) 550 3521.

FTDX 400, just re-aligned, good cond., \$350. VK1MP, QTHR.

Complete Station: Yaesu FT101E, good cond., with manual and carton, \$600; Kenwood TR7600 2m tcwr., complete, \$350; RM76 microprocessor, c/w TR7600/7625 for keyboard entry of frequencies, scanning, six memories, etc., \$95; SX100 scanning rcvr., 2 mths. old, \$330. Richard Cowles. Ph. (02) 699 9403.

Unden 2020, \$535; V5JR 80-10m trap vert. ant., \$90; 4 el. 6m beam, \$40; CS201 coax switch, \$15; Hansen SWR bridge and FS meter, \$20. David VK3ZCR/NKG. Ph. (03) 460 5270 A.H., (03) 379 9468 Bus.

Trio CO-1303D Oscilloscope, \$190; Yaesu FT7 Tx, \$395; Yaesu FRG7 with narrow filter and slow motion drive, \$260; 5 "bandit" quad hubs, never used, \$10 ea. Bruce VK5NBA, QTHR. Ph. (087) 64 7545.

Superb Icom 701, brand new, only removed from carton for checking, completely solid state, no tune (broad band design) final, from 160 to 10m, built in dual VFOs, \$1,000 without 240V power supply/speaker, or \$1,200 with. I need the money. Len Shaw VK3NLS. Ph. (03) 60 0421, ext. 2066, Bus.

F1UX 400, plus home brew linear, \$400 the lot. Ph. (058) 69 3283 evenings.

Trio JR60U gen. cover. Rx, 0.55 to 30 MHz and 144 to 148 MHz, bandspread on amateur bands, Q mult. 100 kHz crystal calib. (needs xtal), recently re-aligned, \$125. VK3ZTA, QTHR. Ph. (03) 560 1157.

1956 Army Tcwr A-510, good cond., incl. morae key, headset, handset, four aeriels, covers to lit webbing and also carrying case, best offer. Glenn VK4NUX, QTHR.

LAC 895 ATU, built-in SWR/power meter, 0-20-250W, manual, \$150; Heathkit cantenna dummy load, 1 kW and oil cable. Will VK3BTQ. Ph. (03) 758 5701.

B47 6m FM Tunable Transceiver, ex army, \$25, ONO. VK3YSQ. Ph. (03) 67 4105 Bus.

FT101B, works perfectly, AC, has faulty DC-DC inverter, causes low output transmitting from 12V, very good condition, original packing, \$500 NONO. TR2200G, 2m FM portable, Ch. 40, 50, R42, R48, nicads, original packing, as new condition, \$150 ONO. VK4VU. Ph. (07) 52 7239 Mon-Fri. after 6 p.m.

Yaesu FT301S Tcwr, Yaesu FP301 power supply, Hadaka 10/15m VS22 Yagi, Emotator 103 LBX rotor and cable; all items in new cond., tcwr has full coverage on 10 and 11m, complete station as above, \$1000. Genuine reason for selling. Kevin Cocks VK3NPC, QTHR. Ph. (051) 52 4632 bus., (\*51) 57 1492 AH.

Heathkit SB101 Tcwr, up-dated to SB102, CW filter, 10 to 60m, like new; Heathkit 640 ext. VFO; Heathkit HP23A 240V AC power supply, solid state; Heathkit 12V DC power supply for mobile; connecting cables, manuals — \$650 the lot. VK2DA, QTHR. Ph. (02) 94 1039.

TH6DXX Hy-Gain Tri-Band Beam, completely refurbished, new boom section, new SS clamps, new trap covers, small elements, traps assembled, aluminized, taped and sealed, tuned for 14,170 MHz, tested, beam to mast assembly etc., \$200. VK2DA, QTHR. Ph. (02) 94 1039.

Atlas 210X SSB Transceiver with Shure 404C mike, POA. Icom IC22A VHF transceiver, POA. Ian VK2AVV. Ph. (02) 653 2341 or (02) 406 5666 ext. 258 bus.

Yaesu Gullermont HF Ant, base, 2m stub, 80m and 40m resonators, \$55. VK2DET, Corimal, N.S.W. Ph. (042) 83 3509.

Yaesu 301D, 160-10m, 200W, PEP, all solid state, digital readout, exc. cond., \$620. Alex VK2NNO, QTHR. Ph. (02) 772 2645.

F1200 Yaesu Tcwr, with FP200 mains power supply, as new, cooling fan, inbuilt audio filter for CW, instruction manual, 2L FT200 club workshop man., \$380. VK3ASM, QTHR. Ph. (03) 754 4194.

Multi Quariz 16 Transistorised 2m FM Tcwr, 25 ch. capability, xtals inc. rpters. 1 to 8, 40 and 50, complete w. usual extras, \$180. IGL 432 MHz strip-line transistor converter, 28 MHz IF with Hy-Q xtal, neatly boxed, \$20. VK4Z21, QTHR. Ph. (07) 224 6875 bus.

Kenwood R-598D Comm. Rx, complete with all accessories, 4 select. filters, aux. bands, VHF converters, matching speaker, 240V AC and 12V DC, Kenwood DG-5 dig. display factory installed, can be used as ext. remote VFO for Kenwood 520 and 820 series tcwrs, brand new in factory cartons, \$700 firm. Manfred Meyer, Box 120, Vaucluse, 2030. Ph. (02) 371 8854.

Hygain trapped vert. ant. for 10, 15 and 20m, \$50. VK2AXR, QTHR. Ph. (02) 44 1389 alter 18.00h.

Kyokuto 2m FM Tcwr, synthesised 800 channels, dig. readout, mic., handbook, no mods., exc. cond., \$280. M. Glover VK7MG, Franklin St., Swansea 7275. Ph. (002) 57 8220.

Yaesu FTDX 560 Transceiver, good condition, recent re-alignment, \$450. VK6BD, QTHR. Ph. (09) 294 1991.

FT101B AC-DC Tcwr, 160-10m, SSB-CW-AM, mint cond., little used, complete, \$525. 14AVQ-WB 40-10m vert. ant., complete, good cond., \$45. VK5YX, QTHR. Ph. (08) 74 2350.

Shack Clearance. ICOM 21A/DV21, 2m FM synthesised, digital readout, full scanning and memory facilities plus several fixed channels, full metering, inbuilt AC P/S or 12V DC operation, all as new, \$350. Ken KP12A RF speech processor, \$100. DAIWA RF440 RF speech processor, \$90. Digital freq. counter to 250 MHz, \$100. 40m helical whip, \$10. 160m helical whip, \$15. Matching speaker for TS520, \$25. Nicad charger for Ken KP202, new, \$12. VK3OM, QTHR. Ph. (03) 560 9215.

Yaesu FL/FRD400, matching Tx and Rx, good condition, new final tubes, \$500 ONO. VK3ZNC, QTHR. Ph. (051) 47 2368.

Yaesu FL110 Linear Amplifier, brand new in carton, with accessories, \$200 ONO. VK3ZNC, QTHR. Ph. (051) 47 2368.

Yaesu FT-301 100W, power supply FP301, and ext. VFO FV301, complete with 10W link for Novice use, excellent cond., with cartons, \$1,100 firm. VK3NRI, QTHR. Ph. (051) 34 5058.

R1Y1 Equipment in working condition, Model 15 (new), Model 14 repairs. and TDs, Model 19 c/w auto CR/LF and downshift on space, also Siemens Tape Teletype punches and repairs. Belcome Satellite UHF tcr and sundry gear. Reasonable offers accepted. VK2ZN, QTHR. Ph. (32) 76 9547.

Ken KP202 handheld 2m FM Tcwr, ch. 2, 4, 6, 8, simplex 40 and 50, exc. cond., c/w charger, nicads, helical and 1/4 wave whips plus PL259 adapter, all only \$175. Mark. Ph. (03) 528 6962 bus.

Yaesu F120U/FP200 (black front panel), plastic cover still attached, good working order, some mods., handbook, \$350. VK2ABC, QTHR. Ph. (02) 451 1313.

2 Sockets suit 4Cx150 and 4Cx250 Sers. SK600, \$20 each. Comm. Rx. Drake SPR4 (160-10m) 0.15-30 MHz, NB fitted all 23xts vty. good wkg. order, sol. state 12V DC plus 240V mains, \$450 ONO. VK3YNB, QTHR.

TS520S Tcwr with digital display (needs small repair), mic., key (all in orig. cartons), \$650. Also IC22S 2m FM Tcwr, power supply, mounting bracket, whips, \$280. Selling for financial reasons. Simon VK5ZJX, 322 The Boulevard, City Beach, WA 6015.

Radio Tower, triangular self-supporting 2 section, height 48 ft., 60 ft. with 2 inch tubing, base size 4 ft. triangle, top section (23 ft.) hinges over, maintenance platform at the top, completely rust proofed and galvanised, filled with commercial heavy duty bearing thrust race, rotor and 140 ft. of rotor cable, dismantled and ready for transport, \$450. David Rosenfield VK3ADM, QTHR. Ph. (03) 592 2168 alter 5 p.m.

FT221, complete with YC221 digital freq. display, very good condition, \$700. VK2K1, QTHR. Ph. (02) 78 4237.

Yaesu FTDX560, 160-10m, 560W, PEP, also spare set valves, \$460. Trio 2200 2m FM port. ch. 1-8, rpt., ch. 40, 50, 51 simplex, new nicads, \$210. Atlas 215 160-15m inc. mobile cradle, AC PS, fixed xtal osc., dig. readout, \$656. Video cassette recorder JVC VHS syst., 6 months old, \$930. Also \$300 worth cassettes for \$100. All prices ONO, will freight free. VK3BEJ, QTHR. Ph. (050) 24 5814.

FRG-7 Rx, switched SSB filter in addition to normal filter installed, \$250. DAIWA Model CL-66 antenna coupler transmatch lype 500W PEP, \$75. Roy VK3XY, QTHR. Ph. (03) 557 1265.

**WANTED**

Urgently, Model 15 Teleprinter, am willing to pay up to about \$60 for machine in fairly good cond., set to speed 45.45 bauds, teleprinter transformer also needed. T. Robinson L31105, OTHR.

Morse Keyboard, Aercom or similar, with memory. VK3AE, QTHR. Ph. (03) 211 7965 A.H.

Mod Demod Unit and power supply for model 15 teletype. VK8BE, QTHR. Ph. (089) 85 4664.

Two 6B8G Valves and two 5Z4s. Price, etc., to VK4NUY, 14 Cooradilla Street, Jindalee 4074.

Help! Urgently need circuit for PSU/batt. charger type PP6245 (032V, 0-60A, General Dynamics). Also, amplifier type 1925/1926 for Synestron-Donner counter type 1034. "Deltahet" valve or transistor Rx built, broken or in bits (will consider other 1-30 MHz Rx). Please write VK3ANC, QTHR, will defray all costs.

Radio and Hobbles, May 1939 (Vol. 1, No. 2), August 1940 (Vol. 2, No. 5), November 1940 (Vol. 2, No. 8). Jim Gordon, 6 Graeme Ave., Ringwood, Vic. 3134. Ph. (03) 870 1745.

Yaesu FT221R 2m all mode lcvr, good condition, also IC22A, TR7100 or FT 2m mobile, will pay current market price. Details for 6m conversion of Cybernet CB rig. Jeff VK8GF, QTHR. Ph. (089) 52 2967.

Service Manual for R5223 Rx, made by TCA for Australian Army. Lionel L. Sharp VK4NS, QTHR. Ph. (07) 59 1945.

Icom IC3PS Power Supply to suit Icom 202E and linear, will exchange brand new IC3PE supply which matches IC22S. Bill Jamieson VK3ZXX, QTHR. Ph. (03) 277 9172.

Home for Memorabilia Items free to collector — Kingsley radio Type K/S9 signal booster with 14 and 28 MHz coils, and KF/C5 tuneable 50 to 54 MHz converter, both as advertised AR 1947/48. Roy VK3XY, QTHR. Ph. (03) 557 1265.

Headphones, early Brown's type, adjustable diaphragms. Details to VK2KI, QTHR. Ph. (02) 78 4237.

Yaesu FT201 Xcvr (not FT200), top price paid, or exchange FT101. Details to VK3OM, QTHR. Ph. (03) 560 9215.

Solid State High-Band Commercial Transceiver, suit conversion to 2m repeater. Two solid state UHF transceivers, suit conversion to 438 MHz for repeater control, good money for good gear. VK2ADZ, QTHR. Ph. (069) 62 3718.

Automatic Keyer. Send details and price to VK2AYR, QTHR. Ph. (02) 44 1389 after 18.00h.

**WANTED KNOWN**

OSI Superboard 2 or C1P users interested in swapping programs and/or information contact Frank VK4AVE on 21.175 at 2330 GMT (Sunday a.m. local time after the VK4 WIA news), or on 14.133 MHz at 0030 GMT.

**TRADE HAMADS**

High Gain Beams for 40, 20, 15, 10, 6, 2 and 70 cm, also UHF CB and ATV repeaters, DSI frequency counters and kits, Mirage PWR/SWR meters, also 2m amps with preamp. Write ATN Antennas, Box 80, Birchip 3483, for catalogue.

ETO ALPHA high power 1-30 MHz linear power amplifiers in stock now, model 76PAE with 3 Eimac 8874 tubes, manual tuning, heavy duty power supply, \$2,195; model 374AE, 2 Eimac 8874 tubes, no tune up, and manual tune if required, \$2,395; export versions all feature 10 meters factory installed; Eto Alpha appointed sole Australian importer and distributor; after sales service. James Goodger VK2JO, Australian Sound and Signal Research, GPO Box 5076, Sydney 2001, NSW. Ph. (02) 389 0428, 389 7786; A.H. (02) 36 7756.

**A REMINDER**

**A WIA MEMBERSHIP CERTIFICATE IS OBTAINABLE ONLY FROM YOUR DIVISION.**

**SILENT KEYS**

It is with deep regret that we record the passing of —

- |                    |         |
|--------------------|---------|
| Mr. A. C. LORD     | VK3BE   |
| Mr. R. G. J. HORNE | VK3BLH  |
| Mr. A. J. WARD     | VK2VH   |
| Mr. W. S. LANE     | VK2LY   |
| Mr. K. J. COLLINS  | VK2ANY  |
| Mr. K. W. HELEY    | VK5ZKW  |
| Mr. T. WOODFORTH   | L50480  |
| Mr. BEN WALLICH    | ex G6BW |
| Mr. A. O. MARKS    | VK3NVG  |
| Mr. A. M. MCGREGOR | VK4KX   |

**SAM LANE VK2LY**  
The death occurred on 20.12.79 of Sam Lane VK2LY after a short illness. Until taken ill, Sam was an employee of Tamworth Base Hospital, starting work there as a tradesman in early 1942. Soon after he joined the RAAF as a Wireless Air Gunner and served in Australia and overseas. On demobilisation he returned to his former employment, finally becoming Hospital Engineer and later Regional Engineer. To his wife Joan, son Alan and daughter Susan, also his mother. I am sure all amateurs extend their heartfelt sympathy in their great loss.

G. H. Simpson VK2WY

**OBITUARY**

**RONALD HORNE VK3BLH**  
Ron Horne, of Maryborough, Victoria, suffered a fatal heart attack on 4th December, 1979. He was previously VK3AGR and VK4RR, and was a well known former member of No. 3 Squadron, RAAF. At the time of his demise he was 61 years of age.

From "Bill" Holland VK3XC.

**HAROLD BOAST VK3AX**  
With the passing of VK3AX (AR Oct.) the ranks of real old-timers thin further. Licensed before the issue of the VK prefix, Harold lived at Frankston as a youngster and was one of 3DB's pioneers. This station opened its country relay at 3LK, Lubeck, in 1936 and Harold moved there shortly afterwards becoming Chief Technician — a post he held continuously until his retirement. Those who visited 3LK will recall what a showplace it used to be, the station and equipment positively gleaming, with the surrounding gardens and lawns neatly kept, a tribute to Harold's management and a great deal of personal effort. Harold and his XYL, Maldie, were deeply involved in district sporting and community affairs, tennis being their favourite sport, at which they both excelled. Harold was an A1 CW op, his main interest being 20m, a band from which he rarely strayed. With his trusty BC348, home brew Tx and 150 ft. near vertical antenna, his patient and methodical approach netted a formidable DXCC tally which I doubt he ever claimed. Harold and Maldie retired to Frankston in 1972, unfortunately illness overtook him in early 1979 and he passed away 1st July, just a few weeks after the last time I spoke with him. Sadly I reflect to what extent my own links with the past in radio both amateur and professional have now been severed. Deepest sympathy is extended to his wife, Maldie, and son Roger and family.

Chas. Hawker VK3IB.

**ANDREW CHARLES LORD VK3BE**  
It is with deep regret we record the passing of Andrew Charles Lord (Andy) VK3BE after a long illness. Andy was first licensed on the 26th October, 1938, and was a very active ham on most bands. He served in the AIF as Lieutenant during World War 2. His occupation was firstly with the Ballarat City Council as a rates collector officer and later resigned this position to take his final position as Shire Secretary of the Buninyong Shire. Ill-health forced his retirement earlier than anticipated. Andy will be missed not only by amateurs but people in many walks of life. Deepest sympathy is extended to his sister, Winifred, and brother-in-law, Bert, and other members of the family.

Stanley E. Widgey VK3SE.

**TOM SCOTT VK2NPK**  
It is with deep regret that I record the passing to Tom Scott VK2NPK on the 26th November 1979. Since serving with the Signal Division in New Guinea in WW II Tom maintained an interest in electronics. At the age of 58 he gained his Novice licence. He was not only an active operator but was a person who was committed to helping others obtain their Amateur licences. He was a tireless worker for YRS Education Service personally packing and despatching over a thousand Novice Study Kits. He was an outstanding example of a person who put back into Amateur Radio something in return for the fulfillment he gained from it. His efforts and his warm and generous personality will be sadly missed by all those associated with him.

Dave Wilson VK2ZCA/NMW

**ARNOLD GILBERT MARKS VK3NVG**  
It is with deep regret that I inform you of the passing of a great friend in Gil Marks who passed away on December 24th with microphone in hand.  
Gil spent all his life in radio and TV servicing. He was a radar operator in the RAAF during World War 2. He operated a business for many years in Portland and shifted to Geelong where he formed the Geelong Radio Club. He was extremely popular with all he met and highly respected by all for his electronics knowledge and friendly bearing.

He will be sadly missed and I wish to convey to his wife, daughter and son on behalf of all his friends our deepest sympathy. The last entry in his log book was: "Jack said he has not received his results as yet". (I received the result on Dec. 27th — VK3VNG).

John E. C. (Jack) Heaner

**ADVERTISERS' INDEX**

AMATEUR RADIO ACTION	35
BAIL ELECTRONICS	13
CHIRNSIDE ELECTRONICS	10
CW ELECTRONICS	15, 19
DICK SMITH ELECTRONICS	2
GFS ELECTRONIC IMPORTS	43
IMARK	26
PHILIPS	18
SIDEBAND ELECTRONIC IMPORTS	37
SCALAR INDUSTRIES	7
TRIO-KENWOOD	44
VICOM	21, 22, 23
WIA NSW DIVISION	32
WILLIAM WILLIS & CO. PTY. LTD.	32

**NOW COMBINE AMATEUR RADIO AND COMPUTERS WITH A SOUTH WEST TECHNICAL PRODUCTS COMPUTER FROM GFS**

We have a system to suit you, from hobby level all the way up to a business level system with 2.4 Mega-Byte of on-line disk memory. Also available is a comprehensive range of software packages including many that are orientated to amateur radio. Write or call us for full details of SWTPC's products.

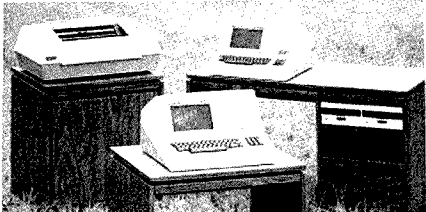

ATLAS RADIO INC.

**TRANSCEIVER OF THE DECADE**

**NEW 215XLE LIMITED EDITION**

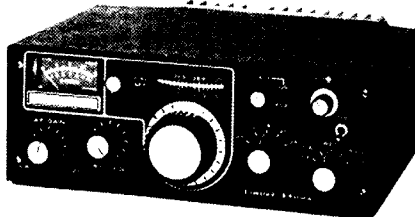

- 80-100 METRE.
- 250 WATTS.

- SEMIBREAK-IN CW.
- BUILT-IN SIDETONE.

Includes all the outstanding features of 215X plus now 250 Watts Input, new R.I.T. control and update frontpanel design.

- 215XLE Transceiver \$795.00
- 220CS Console/P.S. \$170.00
- 210X Transceiver \$795.00
- 200PS Power Supply. \$139.00
- DD6-C Digital Readout/Counter \$245.00
- VX-5M Vox \$78.00
- MT-1 Matching Transformer \$44.00
- DMK Plug Mobile Mount \$62.00
- 10xB Crystal control Adapter \$78.00
- DCC Power Cable Kit \$14.00
- MBK Mobile Bracket Kit \$14.00
- DL-300 300W Dummy Load \$32.00



**GFS FOR RECEIVERS**

STANDARD C-6500.....\$359.

HF Wadley Loop Communications Receiver.

Manufactured by Marantz Japan the C-6500 is a state-of-the-art HF receiver covering 0.5-30 MHz in 30 x 1 MHz band segments. Its sensitivity is extremely high at 0.5uV and selectivity is 4 KHz on SSB and 7 KHz on AM.

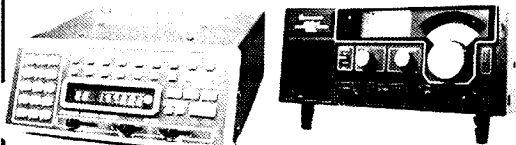

J.I.L. SX-100 16 CHANNELS VHF/UHF SCANNING RECEIVER.....Price \$407.

Still the best value in Programmable Scanners, the SX-100 covers the 6,2 and 70 cms Amateur Bands plus over 32,000 other Frequencies including Channel 0 and Channel 5A TV Sound.

Amateurs can use the SX-100 to monitor band conditions using beacons etc. Firemen can keep informed by listening to firebrigade frequencies. CB'ers can monitor UHF CB Channels. Fishermen can monitor VHF marine and Emergency frequencies. Servicemen can use the SX-100 to check virtually any commercial two-way frequency with its 32,000 channel coverage.

- Covers 30-54, 140-180, 410-514 MHz.
- 5KHz Channel Spacing.
- Built-in Digital Clock & Date.
- 240V AC and 12V DC operated.
- Frequencies are programmed using built-in keyboard.

SEE REVIEW ETI NOV. '79

SKY ACE R-517... \$104.



The monitoring of aircraft communications has long been a requirement for emergency service organizations, flying schools and clubs, aircraft operators, aviators themselves as well as a band of communications enthusiasts. GFS has a range of airband receivers that should suit all these requirements.

Designed for the enthusiast, the R-517 is a Palm Sized Receiver which features Full 118-144 MHz Tuning plus the 3 Crystal Locked Channels.

- Active inbuilt AGC System.
- Excellent Selectivity.
- High Sensitivity.
- Built-in Telescopic Antenna.
- VFO main tuning with FINE control and 3 crystal channels.



NEW!! COMNI R-1010 AIRBAND RECEIVER. The R-1010 is a Professional Receiver that uses frequency synthesis thus giving the following outstanding performance..... \$529.

- Frequency range 108-136.975 MHz.
- Channel Spacing 25 KHz.
- Digital Frequency Readout.
- 12 VDC or 240 VAC operated.
- Co-Axial Channel Selector.
- Squelch and IF Noise Blanker. Weight 3 Kg. Size 16 cms x 5.6 cms x 25 cms.



**SCANNER BASE ANTENNAS**

- Scan-X 65-520 MHz, 3dB Gain ..... \$35.00
- GDX-1 85-480 MHz, Heavy duty ..... \$69.00

Write for a comprehensive price list and Catalogue of the complete GFS Product Range. Trade Enquiries Welcome.

**NEW PRODUCTS FROM MFJ**

Now a very wide range of Antenna Tuners

MFJ-984 3KW Ant. coupler/Dual Meter type SWR/Power Meter/Co-Ax switch for Bal and Un Bal Line (Inc. Balun) \$419.00

MFJ-982 3KW Ant. coupler/SWR/Power Meter for Bal and Un Bal Line (Inc. Balun) \$279.00

MFJ-962 1.5KW Ant. coupler/SWR/Power Meter 6 Pos. Co-Ax SW for Bal and Un Bal Line (Inc. Balun) \$233.00

MFJ-961 1.5KW Ant. coupler/6 Pos Co-Ax SW for Bal and Un Bal Line (Inc. Balun) \$199.00

MFJ-949 300W Ant. coupler/SWR/Power Meter/200W Dummy Load/Co-Ax SW for Bal and Un Bal Line (Inc. Balun) \$186.00

MFJ-941B 300W Ant. coupler/SWR/Power Meter Co-Ax SW for Bal and Un Bal Line (Inc. Balun) \$145.00

MFJ-943 300W Ant. coupler for Bal and Un Bal Line (Inc. Balun) \$115.00

MFJ-901 200W Ant. coupler for Bal and Un Bal Line (Inc. Balun) \$97.00

MFJ-900 200W Ant. coupler for Unbal Line (No Balun) \$83.00

**Tunable Active SSB/CW Filters**

MFJ-752 Dual TUNABLE ACTIVE SSB/SW FILTER inc. Peak/Notch Noise Limiters, and two Variable Frequency Filters \$145.00

MFJ-751 Tunable Active SSB/CW Filter. \$115.00

**Electronic Keys**

MFJ-481 THE GRANDMASTER MEMORY KEYS, stores 2 x 50 character messages 8.5 WPM \$145.00

MFJ-402 Econo Keyer, built-in Paddle, Weight and Speed control. 8.5 WPM, solid state keying \$83.00

**Other Accessories**

LSP-520XB II Super Logarithmic speech processor 30dB dynamic range and 3 Active Filters \$97.00

MFJ-202 Antenna Noise Bridge, wide range 0-250 Ohms, 150 pF Xcc. 1-100MHz \$83.00

MFJ-1030 BX 10-30MHz Preamp, 25dB gain \$83.00

**INSTALL YOUR OWN TOWER AND SAVE \$\$\$'s**

GFS now have a range of easy to install Self Supporting Towers

G201 6 m Single Section Tapered ..... \$79

G202 6 m Double Section Tapered ..... \$89

G203 8 m Heavy Duty Base for G201/2 ..... \$145

G204 6 m Heavy Duty Base for G201/2 ..... \$175

GM20 6 m x 5 cm Tubular Mast for G201/2 \$25

\*\*\*\*\*

**GREAT CIRCLE MAP**

THIS POPULAR MELBOURNE CENTRED MAP IS STILL AVAILABLE FROM GFS

PRICE \$1.00 + 75c P&P

**TET SWISS QUADS**

This antenna is a PHASED QUAD and well known as a HB9CV QUAD. Its concept is to drive the Radiator and Reflector at the same time with phase differences to obtain more gain and better front-to-back ratio than the conventional quads.

SO-22 2m x 2 Stacked 15dB Gain \$99

SO-24 2m x 4 Stacked 18dB Gain \$219

SO-61 6m x Standard 12dB Gain \$119

SO-10 10m x Standard 12dB Gain \$159

SO-15 15m x Standard 12dB Gain \$169

SO-20M 20m x 1 loaded 10dB Gain POA

**ANNOUNCEMENT**

**TEN METRE OPERATORS. NOW ENJOY FM OPERATION WITH THE COMTRONIX FM-80.**

Enjoy the thrill of FM operation that has been so popular amongst 2 Metre operators for years, but with the advantage of being able to work OVERSEAS DX (10 metre FM is very popular in the US with over 70 repeaters already operating). With the FM-80 you have the choice of 80, 10KHz spaced channels, 28.91-29.7 (range can easily be changed to 28.01-28.80 MHz), power output is 10-15 Watts, deviation is ±3KHz, receiver sensitivity is 0.5uV for 20dB quieting.

Don't miss out on experiencing this exciting new form of communication. Call or write to us for your FM-80 now. **SPECIAL INTRODUCTORY PRICE \$289.**

**NEW 1980 CALLBOOKS EXPECTED SOON**

US Callbook, over 395,000 listings ..... \$19.95

Foreign Callbook, 300,000 listings ..... \$18.95

**ATN ANTENNAS**

Write to us for a catalogue and price list on ATN's large range of VHF/UHF & HF antennas.

**DSI COUNTERS**

GFS are Melbourne agents for the comprehensive range of DSI FREQUENCY COUNTERS. Drop us a line or just give us a call for your DSI counter.

**SPECIAL!! METAL DETECTORS**

Limited Stocks Only, available at the special low price of \$38 + \$3 P&P



**SAVE \$65\*** — with every SM-220 Monitor, purchased during February, March and April from your authorised Kenwood distributor, you will receive absolutely **FREE** a BS-5 or BS-8 Adaptor.

This adaptor will allow your Kenwood H.F. Transceiver to display signals on each amateur band as selected by the transceiver.

\*This offer ends on 31st April, 1980.

## SM-220 Station Monitor

Provides efficient station operation and also serves as a high-sensitivity, wide frequency-range oscilloscope for various adjustments and experiments.

Recommended  
Retail Price  
\$375.

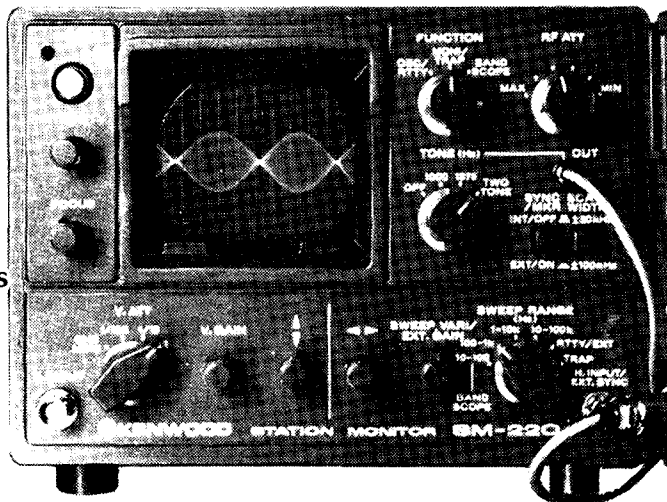

## TS-520S 1.8 to 29.7 MHz SSB TRANSCEIVER

Amateurs throughout the world acclaim this rig which was specially engineered for the serious enthusiast.

Recommended  
Retail Price  
\$650.

## TS-120S 3.5 to 29.7 MHz SSB TRANSCEIVER

Ideal front panel layout gives simple operation for all users — novice or advanced, fixed station or mobile. A marvellous combination of high performance and low cost.

Recommended  
Retail Price  
\$735.

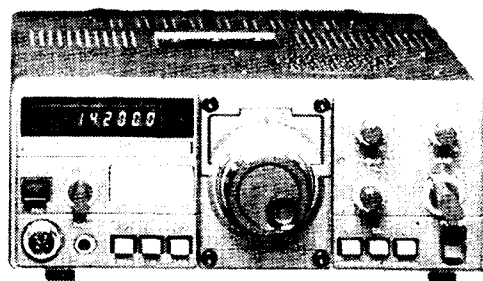

## TRIO-KENWOOD (AUSTRALIA) PTY. LTD.

31 Whiting Street, Artarmon, Sydney, N.S.W. 2064. Telephone (02) 438-1277

### Authorised Distributors:

**N.S.W.:** SIDE BAND ELECTRONICS SALES (02) 438-4191 — EMTRONICS (02) 398-6378 •  
**VIC.:** VICOM IMPORTS PTY LTD (03) 699-6700 • **QLD.:** MITCHELL RADIO CO (07) 57-6830 •  
**S.A. & N.T.:** INTERNATIONAL COMMUNICATIONS SYSTEMS PTY LTD (08) 47-3688 •  
**W.A.:** WILLIS ELECTRONICS (09) 321-7609 • **TAS.:** ADVANCE ELECTRONICS (003) 31-5688 •  
**PLUS MANY OTHER REGIONAL OUTLETS THROUGHOUT AUSTRALIA**

Call into your nearest authorised distributor and ask to see these and other high performance Kenwood units



# amateur radio

JOURNAL OF THE WIRELESS INSTITUTE OF AUSTRALIA



VOL. 48, No. 3

MARCH 1980

## ***FEATURED IN THIS ISSUE:***

- ★ **WORLD ADMINISTRATIVE RADIO CONFERENCE — GENEVA 1979**
- ★ **RON WILKINSON AWARD AND AR AWARDS**
- ★ **A FIVE BAND VXO FOR THE FT75**
- ★ **ADDING RIT TO THE FRG-7**
- ★ **BINDING CONTEST LOGS**

Registered for posting as a Publication —  
Category "B".

# FOR A **BIG** SIGNAL

## STEP UP TO A CHIRNSIDE DUO-BAND

### MONO BAND TRAP VERTICALS MOBILE HELICALS

Chirnside Vertical Antenna Type CE-5B Features.  
Long length and high Q traps makes the CE-5B more efficient than similar types of antennas especially on 80 Metres.  
It is also very easy to tune and its construction is very rugged.

Specifications of the CE5B.  
Bands: 80-40-20-15-10 M. Operation.  
Power handling: 2 kW PEP.  
SWR: 1.5 to 1 or better.  
Length: 30' (approx)  
Weight: 9KG. Packed.

**\$99.--**

The CE-4B is approx. 8' shorter than the CE-5B.

CE-42 15-10 M. Duo-Band ..... \$139.  
CE-5B 5 Band Vertical ..... \$99.  
CE-4B 4 Band Vertical ..... \$85.

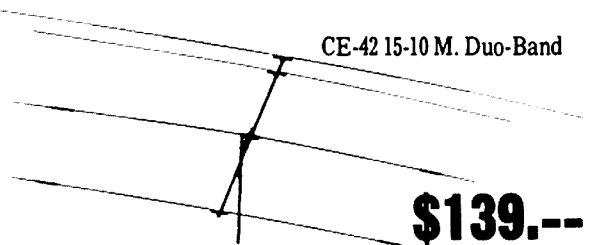

**\$139.--**

CHIRNSIDE CE-42 rugged duo band beam features 4 elements and uses independent reflectors for optimum results.  
3 elements on 15 M.  
3 elements on 10 M.  
Director and driven elements have hi-q traps.  
Forward gain is 8 dB and front to back ratio is in excess of 20 dB.  
Dozens of reports have indicated F/B ratios in excess of 28 dB.

WRITE OR GIVE US A CALL TODAY!

MELBOURNE'S LEADING AUTHORIZED YAESU DISTRIBUTOR.

# BIG DISCOUNTS ON YAESU NOW!

## YAESU.



FT-101Z. 160-10M Transceiver. analog dial.  
FT-101ZD. 160-10M Transceiver. Digital.  
optional digital display for FT-101Z.  
optional Fan.  
optional DC-DC converter.  
YE-7A Hand mike.  
YD-148 Desk mike.  
FT-901DM. 160-10M Transceiver.  
FV-901. ext. VFO for FT-901 & FT-101Z.  
YQ-901. Panoramic adapter monitorscope.  
FC-901. Antenna coupler.  
FTV-901. Converter. 6M, 2M, 70 cm. all inc.  
FTV-901. Converter. 6M, 2M.  
SP-901. ext. speaker.  
FRG-7. Communication receiver.  
FRG-7000. Digital communications receiver.  
LF-2A Narrow band filter for FRG-7.  
FT-7B. 80-10M Transceiver.  
FP-12. 12 Amp. power supply for FT-7B.  
YC-7B. Digital display for FT-7B.  
FT-227RB. 2M Digital programable transceiver.  
YP-150. Dummy load/Watt meter.  
FF-50DX. Low pass filter. 2kw.  
QTR-24D Deluxe 24 hr. World clock.  
FT-207R Handheld.  
Base charger.

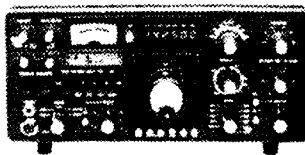

We also stock:

ICOM IC22S ..... \$289.  
LEADER Ham scope ..... \$309.  
LEADER Dip meter ..... \$89.  
TONO 7000E Computer ..... \$895.  
DIAWA CN620 SWR meter ..... \$95.  
DIAWA Ant. Coupler CN217 ..... \$155.  
AUTO Ant. coupler CN1001 ..... \$259.  
KENWOOD R-1000 Communications Receiver..... \$489.

Low pass filters, baluns, co-ax and connectors.

MANY MORE!!!!!!!

## ROTATORS.

EMOTATOR



103LBX. Medium Duty ..... \$169.  
502Cxx. Heavy Duty ..... \$249.  
1102MXX. Extra Heavy Duty ..... \$349.  
1103MXX. Extra Extra Heavy Duty ..... \$395.  
502 Mast Clamp ..... \$32.  
103 Mast Clamp ..... \$20.  
VCTF-7. 7 Core Cable per metre ..... \$1.20  
VCTF-6. 6 Core Cable per metre ..... \$1.00

## DIAWA

DR-7500S. Medium Duty ..... \$175.  
DR-7600D. Heavy Duty ..... \$248.



FAST MAIL ORDERS.

CHIRNSIDE ELECTRONICS, 26 Edwards Road, Chirnside Park, Lilydale, 3116. Phone (03) 726 7353



# amateur radio

Published monthly as its official journal by the Wireless Institute of Australia, founded 1910.

**MARCH 1980**

**VOL. 48, No. 3**

**PRICE: \$1.20**

Registered Office:  
3/105 Hawthorn Road,  
Caulfield North 3161.

**MANAGING EDITOR:**  
BRUCE BATHOLS\* VK3UV

**PRODUCTION MANAGER:**  
MARK STEPHENSON\* VK3NOY

**TECHNICAL EDITORS:**  
BILL RICE\* VK3ABP  
EVAN JARMAN\* VK3ANI  
RON COOK\* VK3AFW  
GIL SONES\* VK3AUI

**CONTRIBUTING EDITORS:**  
BOB ARNOLD VK3ZBB  
MIKE BAZLEY VK6HD  
ROD CHAMPNESS VK3UG  
ROY HARTKOPF\* VK3AOH  
RON FISHER\* VK3OM  
ERIC JAMIESON VK5LP  
PETER MILL VK3ZPP  
LEN POYNTER\* VK3ZGP  
BILL VERRALL VK5WV  
WALLY WATKINS VK2DEW

**DRAFTING:**  
NEIL OSBORNE\* VK3YEI

**BUSINESS MANAGER:**  
PETER DODD VK3CIF

\*Member of Publications Committee

Enquiries and material to:  
The Editor,  
PO Box 150, Toorak, Vic. 3142

Copy is required by the first of each month. Acknowledgement may not be made unless specially requested. All important items should be sent by certified mail. The editor reserves the right to edit all material, including Letters to the Editor and Hamads, and reserves the right to refuse acceptance of any material, without specifying a reason.

Advertising: Material should be sent direct to P.O. Box 150, Toorak, Vic., 3142, by the 25th of the second month preceding publication. Phone: (03) 528 5962. Hamads should be sent direct to P.O. Box 150, Toorak, Vic., 3142, by the 1st of the month preceding publication.

Trade Practices Act: It is impossible for us to ensure that advertisements submitted for publication comply with the Trade Practices Act 1974. Therefore advertisers and advertising agents will appreciate the absolute need for themselves to ensure that the provisions of the Act are complied with strictly. Readers are reminded that, when buying, obtaining or receiving goods from overseas including goods listed in advertisements by overseas organisations in this Journal, Customs import duties and Sales Tax may be levied on the goods at the time of importation. These amounts, if any, are payable by the purchaser unless the terms of sale state otherwise and the seller has made specific provision to this effect in his quotation to the buyer or unless other prior arrangements are in force between the buyer and the seller.

Typesetting: MUELLER INDUSTRIES  
1a Levanswell Road, Moorabbin, 3189  
Tel.: 553 0292

Printers: EQUITY PRESS PTY. LTD.  
50-52 Islington Street, Collingwood, 3066  
Tel.: 41 5054, 41 5055

## CONTENTS

### TECHNICAL

Adding RIT to the FRG-7 and other Receivers	18
A Five Band VXO for the FT75	21
Another AF Filter	28
Modifications and Improvements to Kyokuto VHF Transceiver	27
Try This with the Technical Editors	29

### GENERAL

A Peep into the Past	29
AR Awards	14
Binding Contest Logs	16
Data Transmission and how Computers do it	19
Fingertip Soldering Iron	17
Ron Wilkinson Award	14
Winnie the War Winner	20
World Administrative Radio Conference — Geneva 1979	7

### DEPARTMENTS

Amateur Satellites	32
Around the Trade	45
Awards Column	38
Commercial Kinks	33
Contests	37
Divisional Notes	44
Hamads	47
International News	43
Ionospheric Predictions	37
Letters to the Editor	43
Magazine Review	44
QSP	4, 31, 37
Radio Amateurs Old Timers Club	44
Silent Keys	47
VHF/UHF — An Expanding World	35
WIANEWS	5
WICEN	41
You and DX	40

## Cover Photo

This month we feature our Federal Contest Manager, Wally Watkins VK2DEW (ex VK2ZNW, VK5ZWW and ZL2TCW). Wally mainly operates solid state RTTY and CW on HF and VHF, using a Xitex and 2650 microprocessor.

# WIRELESS INSTITUTE OF AUSTRALIA

Federal President: Dr. D. A. Wardlaw VK3ADW

Federal Council:

VK1 Mr. R. G. Henderson VK1RH  
 VK2 Mr. T. I. Mills VK2ZTM  
 VK3 Mr. G. A. G. Williams VK3ZXW  
 VK4 Mr. A. R. F. McDonald VK4TE  
 VK5 Mr. C. J. Hurst VK5HI  
 VK6 Mr. N. R. Penfold VK6NE  
 VK7 Mr. R. K. Emmell VK7KK

Staff: Mr. P. B. Dodd VK3CIF, Secretary.

Part-time: Col. C. W. Perry, Mrs. J. M. Seddon and Mr. Mark Stephenson (AR Production).

Executive Office: 3/105 Hawthorn Rd., Caulfield North, Vic. 3161. Ph. (03) 528 6962.

Divisional Information (all broadcasts are on Sundays unless otherwise stated).

ACT:

President — Mr. A. Davis VK1DA  
 Secretary — Mr. F. Robertson-Mudle VK1NAV  
 Broadcasts— 3570 kHz and 2m Ch. 6 (or 7): 10.00Z.

NSW:

President — Mr. F. S. Parker VK2NFF  
 Secretary — Mr. T. I. Mills VK2ZTM  
 Broadcasts— 1825, 3595, 7146 kHz, 28.32, 52.1, 52.525, 144.1, 145.6, 146.4, Rptr. Ch. 3 — Gosford, Ch. 4 — Lismore, Ch. 5 Wollongong, Ch. 8 — Dural 11.00h local (Evening 0930Z). Relays on 160, 80 and 10m, VHF and Repr. Ch. 3, Ch. 5, Ch. 8, and Hunter Branch, Mondays 0930Z on 3595 kHz, 10m, and Ch. 3 and 6. RTTY Sunday 0030Z 7045, 14090 kHz, Ch. 52, 0930Z 3545 kHz, Ch. 52.

VIC.:

President — Mr. E. J. Buggee VK3ZZN  
 Secretary — Mr. G. F. Atkinson VK3YFA  
 Broadcasts— 1840, 3600, 7135 kHz — 53.032 AM, 144.2 USB and 2m Ch. 2 (5) repeater: 10.30 local time.  
 Gen. Mtg. — 2nd Wed., 20.00.

QLD.:

President — Mr. A. J. Aarsee VK4QA  
 Secretary — Mr. W. L. Gielis VK4ABG  
 Broadcasts— 1825, 3580, 7146, 14342, 21175, 28400, kHz; 2m (Ch. 42, 48): 09.00 EST.  
 Gen. Mtg. — 3rd Friday.

SA:

President — Mr. I. J. Hunt VK5QX  
 Secretary — Mr. W. M. Wardrop VK5AWM  
 Broadcasts— 1820, 3550, 7095, 14175 kHz; 28.5 and 53.1 MHz, 2m (Ch. 8): 09.00 S.A.T.

Gen. Mtg. — 4th Tuesday, 19.30.

WA:

President — Mr. Ross Greenaway VK6DA.  
 Secretary — Mr. Peter Savage VK6NCP.  
 Broadcasts— 3560, 7075, 14100, 14175 kHz. 28.485, 52.290 MHz. 2 metres Ch. 2 Perth, Ch. 6 Wagin. Time 0130Z.  
 Gen. Mtg. — 3rd Tuesday.

TAS.:

President — Mr. I. Nicholls VK7ZZ  
 Secretary — Mr. P. T. Blake, VK7ZPB  
 Broadcasts— 7130 (AM) kHz with relays on 2m Ch. 2 (S), Ch. 8 (N), Ch. 3 (NW), 09.30 EST.

NT:

President — Mr. T. A. Hine VK8NTA  
 Vice-Pras. — Barry Burns VK8DI  
 Secretary — Robert Milliken VK8NRM  
 Broadcasts— Relay of VK5WI on 3.555 MHz and on 146.5 MHz at 2330Z. Slow morse transmission by VK8HA on 3.555 MHz at 1000Z almost every day.

Postal Information:

VK1 — P.O. Box 46, Canberra, 2600.  
 VK2 — 14 Atchison St., Crows Nest, 2065 (Ph. (02) 43 5795 Tues & Thurs (10.00-14.00h), P.O. Box 123, St. Leonards, NSW 2065.

VK3 — 412 Brunswick St., Fitzroy, 3065 (Ph. (03) 41 3535 Weekdays 10.00-15.00h).  
 VK4 — G.P.O. Box 638, Brisbane, 4001.  
 VK5 — G.P.O. Box 1234, Adelaide, 5001 — HQ at West Thebarton Rd., Thebarton.  
 VK6 — G.P.O. Box N1002, Perth, 6001.  
 VK7 — P.O. Box 1010, Launceston, 7250.  
 VK8 — (incl. with VK5), Darwin AR Club, P.O. Box 37317, Winnellie, N.T., 5789.

Slow morse transmissions — most week-day evenings about 09.30Z onwards around 3550 kHz.

VK QSL BUREAUX

The following is the official list of VK QSL Bureaux, all are inwards and outwards unless otherwise stated.

VK1 — QSL Officer, G.P.O. Box 46, Canberra, A.C.T. 2600.  
 VK2 — QSL Bureau, C/- Hunter Branch, P.O. Teralba, N.S.W. 2284.  
 VK3 — Inwards QSL Bureau, Mr. E. Trebilcock, 340 Gillies Street, Thornbury, Vic. 3071.  
 VK3 — Outwards QSL Bureau, Mr. R. R. Prowse, 83 Brewer Road, Bentleigh, Vic. 3204.  
 VK4 — QSL Officer, G.P.O. Box 638, Brisbane, Qld., 4001.  
 VK5 — QSL Bureau, Mr. Ray Dobson VK5DI, 16 Howden Road, Fulham, S.A. 5024.  
 VK6 — QSL Bureau, Mr. J. Rumble VK6RU, G.P.O. Box F319, Perth, W.A. 6001.  
 VK7 — QSL Bureau, G.P.O. Box 371D, Hobart, Tas. 7001.  
 VK8 — QSL Bureau, C/- VK8HA, P.O. Box 1418, Darwin, N.T. 5794.  
 VK9, 0 — Federal QSL Bureau, Mr. N. R. Penfold VK6NE, 388 Huntriss Rd., Woodlands, W.A. 6018.

## QSP —

# AN INVESTMENT IN OUR FUTURE

This issue of Amateur Radio contains a report on the World Administrative Radio Conference. The report is written in a broader context than many of the reports appearing in other Amateur Journals.

WARC 79 was a conference marked by many issues. The Amateur Service was only one. Our success must be judged in relative terms. The result was highly favourable, coming after so many years of effort by so many people in so many countries.

Our Federal President, David Wardlaw, attended the IARU (International Amateur Radio Union) Presidents' International Working Group which was held concurrently with the Aeronautical (R) WARC in Geneva during February 1978. He also participated in the ITU, CCIR Special Preparatory Meeting and, together with Michael Owen, participated in the WARC as members of Australia's official delegation.

Michael Owen, Immediate Past President of the WIA, was a member of the IARU Presidents' International Working Group. He attended the SPM as a member of the Australian delegation and would have been a member of the IARU Observer Team to WARC had he not been invited to be a member of the Australian delegation together with David.

The WIA, with the help of radio clubs, commercial interests and numerous individual amateurs, financially supported our representatives on the Australian delegation. In a sense, this represented in absolute money terms the largest speculative investment that has ever been made by Australian amateurs. This was justified by the importance of this Conference for the future of amateur radio. To all those who contributed — thank you.

The fact that we were successful was the result of similar efforts in many countries.

It is appropriate that we record an account of the proceedings in Geneva during October and November last year. I recommend that you take the time to read the report carefully.

PETER WOLFENDEN VK3ZPA, Vice-Chairman.

# WIANEWS

The "Australia Table of Frequency Allocations 10 kHz-275 GHz" published by the PMG's Department in 1974 is still the frequency table adhered to by Government until it becomes superseded in due course arising out of WARC 79.

This table shows Broadcasting (TV) in the segment 45-52 MHz with Fixed and Mobile as sending services. The band 52-54 MHz is shown as Amateur.

The band 520-585 MHz is allocated to "Broadcasting" with a note (59) that "the band 576-585 MHz is allocated to the Amateur service until required by the Broadcasting service".

In the existing Radio Regulations the band 50-54 MHz is allocated to the Amateur service in Regions 2 and 3 with 4 footnotes of variations by 9 countries, all in Region 3.

The outcome of WARC 79 shows that when the provisions of this Conference are implemented (from 1-1-1982) the band 50-54 MHz continues to be allocated to the Amateur service in Regions 2 and 3. However, there are now fresh footnotes, one of which (3543A) shows the additional allocation in Australia, China and North Korea that the band 50-54 MHz is also allocated to the Broadcasting service on a primary basis. Eleven other countries in Region 3 also have footnotes but 11 countries in Region 1 will allocate 50-54 MHz to the Amateur service on a primary basis — there was no previous amateur allocation on 6 metres in Region 1 except by footnote for 6 "countries" in Southern Africa.

A letter has been written to the Minister of P. and T. relating to the reported use of TV Ch. 0, including use for IMBC.

1980 Federal Convention Agenda Items will include an item to permit discussions to take place on the Amateur Advisory Service and allied questions arising therefrom.

Members will remember reading a QSP in January AR (p. 31) relating to radiation hazards. This is a subject currently under study by a Standards Association of Australia sub-committee headed by Professor Huey (VK2AHU). The Institute has requested Jim Lloyd VK1CDR, already a member, to look after amateur interests.

At the January meeting of the Executive discussions took place on a wide variety of on-going and current subjects. In a few matters it is expected that answers will be forthcoming at the next Joint Committee meeting due to be held later in February.

The Executive wishes to acknowledge with grateful thanks the receipt of further WARC 79 donations from members:—

## LIST No. 11

	\$
Orange ARC	
per VK2DEQ .....	50.00
VK6NBN .....	8.00
VK5VV .....	2.00
VK4SP .....	3.00
VK4XN .....	5.00
VK3YTO .....	4.00
VK6AH .....	2.50
L50518 .....	6.42
VK3ANX .....	6.95
VK2NPB .....	8.00
L50909 .....	8.50

# SC22DX

## Scalar's Great New 5 Band Vertical

### FEATURES:

- ★ 1/4 wave operation for
- ★ 10, 15, 20, 40, 80 metres
- ★ self supporting
- ★ low angle of radiation
- ★ for top DX performance
- ★ high Q resonant traps

"A QUALITY AUSTRALIAN MADE PRODUCT"

Recommended Retail Only \$129.00

**CONTACT YOUR LOCAL  
HAM GEAR RETAILER OR  
THE MANUFACTURERS...**

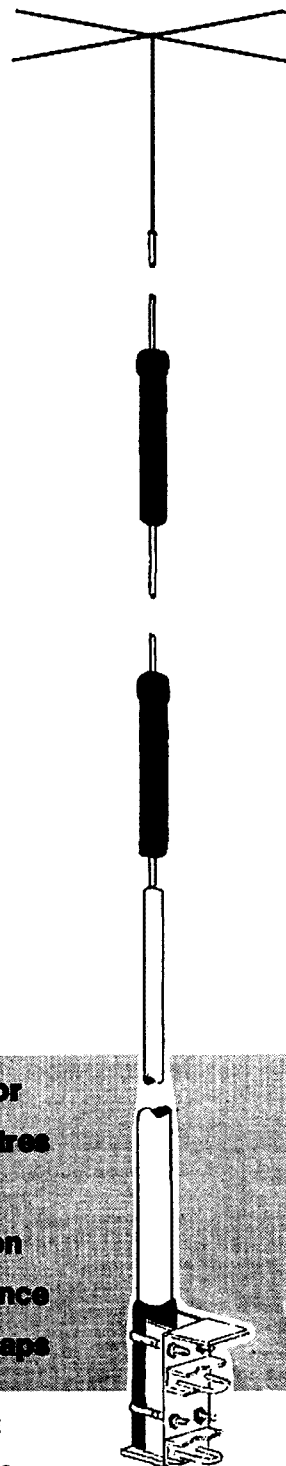

**SCALAR INDUSTRIES PTY. LTD.**  
20 Shelley Avenue, Kilsyth, Vic. 3137 (03) 725 9677  
N.S.W.: 20 The Strand, Penhurst, 2222 (02) 570 1788  
QLD.: 969 Ann St., Fortitude Valley, 4006 (07) 52 2594

set your sights on this ...



# YAESU **The radio.**

now presents you the all new

## **FT-107** SERIES SOLID STATE HF TRANSCEIVER

The FT-107M is the rig you've been waiting for. The versatility of all solid state construction is teamed with the time-proven design techniques from the FT-901 and FT-101Z transceivers to give you—today's active amateur—the competitive edge under the demanding conditions of the next decade.

### Features

- PA protection; 75% rated output at 3:1 SWR
- Variable IF bandwidth
- 12 channels of memory with optional unit
- Scanning microphone option
- Ivory or Grey colour face
- Selectable AGC
- Offset tuning

LSB, USB, CW, FSK, AM  
PA DC Input  
240W on SSB, CW  
80W on AM, FSK.

### Specifications

160m-10m plus 2 aux. bands  
13.5V DC 20A, 234V AC PSU options

*P.S. You can add -  
external VFO,  
VHF/UHF/OSCAR  
transverter and  
antenna coupler...*

ELECTRONIC SERVICES

STAN ROBERTS VK3BSR

38 Faithful St., WANGARATTA 3677

Telephone: (057) 21 6260 Telex: Teletra AA 56880  
Distributors in all states and N.T.

AGENTS & REPS:— W.A. COMO (09) 450 4379; PERTH (09) 321 7609; KALGOORLIE (090) 21 1906;  
S.A. PLYMPTON (08) 293 2155; TAS. LAUNCESTON (003) 44 5000; N.S.W. MASCOT (02) 667 1650;  
SEVEN HILLS (02) 624 2691; NEWCASTLE (049) 69 2040; WAGGA WAGGA (069) 21 2125.

COFFS HARBOUR (066) 54 3206; TAMWORTH (067) 66 1363; INVERELL (067) 22 1300;  
QLD. ALBION (07) 57 6830; TOWNSVILLE (077) 79 8179; CAIRNS (070) 51 4826; BRISBANE  
(07) 48 6601; N.T. DARWIN (089) 81 5411;

# WORLD ADMINISTRATIVE RADIO CONFERENCE — GENEVA, 1979

## A PERSONAL NOTE

The Wireless Institute of Australia, many individual Amateurs, clubs and commercial organisations supported two Amateurs as members of the delegation of Australia to the World Administrative Radio Conference.

Naturally, the first question that is asked relates to the Frequency Table. This question has already been answered. However, simply looking at the Table tells little of the Conference itself. So much time, effort and money has been spent in preparing for this Conference by observing the Aeronautical (R) WARC, participating in the Special Preparatory Meeting of the CCIR, participating in the ITU Seminar in Sydney and participating in the Australian preparation as well as in the WARC itself that we believe a full report should be published. However, any report to be meaningful rather than interminable must incorporate many generalisations and many value judgments.

In reporting here and elsewhere on the events that have culminated in the new Radio Regulations, we have generally avoided reference to particular individuals. So many people from so many countries contributed in so many ways to the outcome of the WARC, in many cases quietly and in the background, that we feel that it is not appropriate to attempt to identify individuals who should be particularly recognised. This is certainly true of dele-

gates who were always bound by their administration's position but who could either influence that position or influence others.

We have always avoided, we hope, over-emphasising the role of Australia—it is sufficient for us that others have seen Australia as a strong supporter of the Amateur Service.

We do, however, wish particularly to note the fact that on Amateur matters the delegates of Australia and New Zealand worked in close mutual co-operation throughout the Conference.

We stress that the judgments are ours. Our interpretation of the WARC may not necessarily accord with the views of the Australian delegation or the Australian administration. Our reports are from the perspective of the Amateur Service but in the years of preparation for the WARC and in the course of the WARC we have become acutely conscious of the differing priorities expressed by different countries and the enormous pressure on the spectrum from so many radio services both existing and planned. The Amateurs of today and of the future cannot ignore these pressures or the fragility of the forum of nations that determines the balance to be given to those conflicting pressures.

This is the important lesson of the WARC.

DAVID  
WARDLAW

MICHAEL  
OWEN

On the 6th December, 1979, the Final Acts of the World Administrative Radio Conference were signed, at the conclusion of the Conference that had commenced on the 24th September and had thus worked for 74 days.

In addition to reviewing the Frequency Table, the Conference had reviewed and revised many of the fundamental provisions which are also part of the Radio Regulations. These Regulations form part of the International Telecommunications Convention and have the force of a treaty between nations. In addition, the Conference adopted many new Resolutions and Recommendations. The 1979 Conference was the first general conference since 1959 and has been said to be the most important conference ever organised by the ITU.

The ITU Secretariat published numerous statistics relating to the Conference. These statistics give an idea of the magnitude of the Conference, and some are worth quoting.

There were 2,000 delegates or observers from 142 Member Countries of the ITU and 30 International Organisations. The texts of the Final Acts which include the

new Radio Regulations and numerous Resolutions and Recommendations, covered 1,150 pages.

There were 894 plenary meetings, meetings of committees and meetings of working groups. This number does not include the smaller meetings.

There were a large number of proposals. For example, there were 12,832 proposals affecting the Frequency Table and certain terms and definitions and other provisions relating to the Frequency Table. 2,634 of those proposals related specifically to proposals for allocations in the band 4-27.5 MHz. In all Committee 5 and its working groups, which were responsible for this part of the Agenda, held 151 separate meetings.

The Conference was held in the International Conference Centre of Geneva (the CICG), which has a series of large conference halls that by a system of moving walls can be opened into a single much larger hall or subdivided into smaller halls. With the use of microphones and headphones the delegates are able to speak or listen, either directly to the person speaking, or to the simultaneous interpretation into either English, French,

Russian, Chinese, Spanish or Arabic.

The size of delegations varied considerably. The United States had a delegation of some 65, which was supported by a substantial back-up staff. Australia had a delegation that for a time effectively numbered 24. Other countries had delegations of 2 or 3. One consequence of the interest of countries with small delegations in covering as many areas as possible was the adoption of a conference structure that restricted the number of working groups and the number of meetings held simultaneously to enable the smaller delegations to participate as fully as possible.

The Committees and their terms of reference, established by the first Plenary (together with their Chairmen), were:—

### COMMITTEE 1 Steering Committee

#### Chairman:

Mr. Roberto J. P. Severini (Argentina), Chairman of the Conference.

#### Vice-Chairmen:

Messrs. A. L. Badalov (USSR), J. Jipguep (Cameroon), H. Kieffer (Switzerland), Li Linchaun (China), A. Petti (Italy), G. O.

Robinson (United States), Vice-Chairmen of the Conference.

*Terms of Reference:*

To co-ordinate the work of the Committees, fix the timetables of meetings, etc.

## **COMMITTEE 2**

### **Credentials Committee**

*Chairman:*

Mr. C. J. Martinez (Venezuela).

*Vice-Chairman:*

Dr. Amer Jorhaid (Iraq).

*Terms of Reference:*

To verify the credentials of delegations and to report on its conclusions to the plenary meeting within the time specified by the latter.

## **COMMITTEE 3**

### **Budget Control Committee**

*Chairman:*

Mr. Z. Kupczyk (Poland).

*Vice-Chairman:*

Mr. K. P. R. Menon (Malaysia).

*Terms of Reference:*

To determine the organisation and the facilities available to the delegates and to examine and approve the accounts for expenditure incurred throughout the duration of the Conference.

## **COMMITTEE 4**

### **Technical Regulations Committee**

*Chairman:*

Mr. N. Morishima (Japan).

*Vice-Chairman:*

Mr. M. Cisse (Senegal).

*Terms of Reference:*

To consider proposals concerning the following articles:

Article N1, Terms and definitions; Section V, Space, orbits and types of objects in space; Section VI, Technical characteristics;

Article N2, Nomenclature of the frequency and wavelength bands used in radiocommunication;

Article N3, Designation of emissions;

Article N4, Technical characteristics;

Article N16, Interference;

Article N17, Tests;

and the related Appendices 3, 4, 5 and B.

To consider proposals concerning technical provisions included in the following Articles:

Article N25, Terrestrial radiocommunication services sharing frequency bands with space radiocommunication services above 1 GHz;

Article N26, Space radiocommunication services sharing frequency bands with terrestrial radiocommunication services above 1 GHz;

Article N27, Special rules relating to space radiocommunication services;

Article N33, Radiodetermination service and radiodetermination-satellite service; Section IVB, Radiobeacon stations;

and the related Appendices 28 and 29.

To consider as appropriate to the work

of the Technical Regulations Committee the resolutions and recommendations adopted by previous administrative radio conferences and to take such action as may be considered necessary including the adoption of any new resolutions and recommendations and also to consider Appendix Z.

## **COMMITTEE 5**

### **Frequency Allocations Committee**

*Chairman:*

Mr. M. Harbi (Algeria).

*Vice-Chairman:*

Mr. J. J. Hernandez (Mexico).

*Terms of Reference:*

To consider proposals concerning the following articles:

Article N1, Terms and definitions (Sections III-V); Section II, Radio systems, services and stations; Section III, Terrestrial radio systems, services and stations; Section V, Space radio systems, services and stations and radio astronomy;

Article N5, General rules for the assignment and use of frequencies;

Article N6, Special arrangements;

Article N7, Frequency allocations;

Article N8, Special rules for the assignment and use of frequencies;

Article N28, Section I, Broadcasting service;

Article N29, Fixed service;

Article N47, Special rules relating to the use of frequencies in the aeronautical mobile service; and the related Appendix 24.

To consider as appropriate to the work of the Frequency Allocations Committee the resolutions and recommendations adopted by previous administrative radio conferences and to take such action as may be considered necessary including the adoption of any new resolutions and recommendations.

## **COMMITTEE 6**

### **Regulatory Procedures Committee**

*Chairman:*

Mr. M. Joachim (Czechoslovakia).

*Vice-Chairman:*

Mr. E. J. Wilkinson (Australia).

*Terms of Reference:*

To consider proposals concerning the co-ordination, notification and registration of frequency assignments, and the activities of the IFRB and, in particular, proposals concerning the following articles:

Article N9, Co-ordination, notification and registration of frequencies—International Frequency Registration Board, general provisions;

Article N10, Internal Regulations of the International Frequency Registration Board;

Article N11, Co-ordination of frequency assignments to stations in a space radiocommunication service except stations in the broadcasting-satellite service and to appropriate terrestrial stations;

Article N12, Notification and recording in the Master International Frequency Register of frequency assignments to terrestrial radiocommunication stations; Article N13, Notification and recording in the Master International Frequency Register of frequency assignments to radio astronomy and space radiocommunication stations except stations in the broadcasting-satellite service; and the related Appendices 1, 1A and 1B.

To consider proposals concerning regulatory measures against harmful interference covered by the following articles:

Article N18, International monitoring;

Article N19, Reports of infringements;

Article N20, Procedure in the case of harmful interference;

and the related Appendices 6, 7, 8 and 9.

To consider as appropriate to the work of the Regulatory Procedures Committee the resolutions and recommendations adopted by previous administrative radio conferences and to take such action as may be considered necessary including the adoption of any new resolutions and recommendations.

## **COMMITTEE 7**

### **General Administrative Committee**

*Chairman:*

Mr. P. O. Okundi (Kenya).

*Vice-Chairman:*

Mr. H. L. Venhaus (Federal Republic of Germany).

*Terms of Reference:*

To deal with proposals on general administrative matters not covered by other Committees and, in particular, to consider proposals concerning the following articles:

Article N1, Terms and definitions; Section 1, General terms;

Article N21, Secrecy;

Article N22, Licences;

Article N23, Identification of stations;

Article N24, Service documents;

Article N30, Amateur service and amateur-satellite service;

Article N31, Standard frequency service and time signals service;

Article N32, Experimental stations;

Article N33, Radiodetermination service and radiodetermination-satellite service, Sections I, II, III and IVA;

Article N39, Special services relating to safety;

Article N73, Effective date of the Radio Regulations;

and the related Appendices C, 9, 10 and 23.

To consider proposals on the technical aspects for the use of radiocommunications for making, identifying, locating and communicating with the means of medical transport protected under the 1949 Geneva Conventions and any additional instruments of these Conventions.



To suggest to the plenary meeting, taking account also of the advice of the other Committees, a programme of future administrative radio conferences to deal with specific services with a view to presenting advice on such a programme to the ITU Administrative Council for subsequent submission to the Plenipotentiary Conference.

To consider Resolution No. Sat-4 of the World Broadcasting-Satellite Administrative Radio Conference (Geneva, 1977), and to take such action as may be considered necessary.

To consider as appropriate to the work of the General Administrative Committee the resolutions and recommendations adopted by previous administrative radio conferences and to take such action as may be considered necessary including the adoption of any new resolutions and recommendations.

CCITT studies carried out in accordance with Resolutions Nos. Mar2-22 and Mar2-23 and to take such action as may be considered necessary.

**COMMITTEE 9**

**Editorial Committee**

*Chairman:*

Mr. P. Bassole (France).

*Vice-Chairmen:*

Mr. V. Quintas (Spain).

Mr. D. E. Baptiste (United Kingdom).

*Terms of Reference:*

To perfect the form of the texts of the Final Acts without altering the sense.

The work of the main committees was spread between various working groups and Figure 1 shows the broad structure of the Conference. In addition to the working groups a considerable number of sub-working groups, ad hoc working groups,

The Amateur and Amateur Satellite Services were only a small part of the Conference, even though matters affecting those Services were constantly arising in one committee or working group or another. The Conference was concerned with the allocations to all Services, specific regulations affecting a small number of Services (including the Amateur Service) and the fundamental provisions of the Radio Regulations, including those relating to the international co-ordination of radio communications as well as definitions and other general provisions.

Some foresaw this Conference as likely to be the forum for a massive political confrontation between the developed and developing countries. To an extent, the Conference was marked by such a conflict. The so-called non-aligned group of countries was a significant voice on a number of issues. Some of the contro-

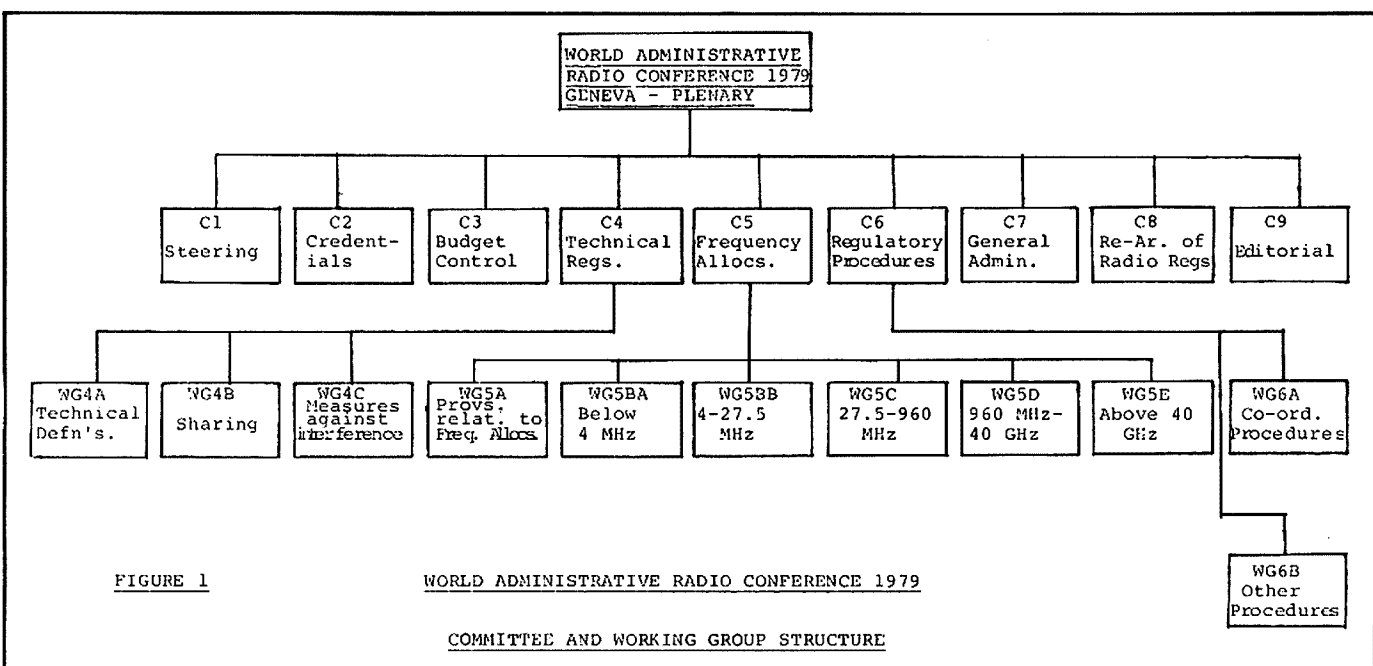

FIGURE 1

WORLD ADMINISTRATIVE RADIO CONFERENCE 1979

COMMITTEE AND WORKING GROUP STRUCTURE

**COMMITTEE 8**

**Restructure of the Radio Regulations and the Additional Radio Regulations**

*Chairman:*

Mr. O. Lundberg (Sweden).

*Vice-Chairman:*

Mr. G. I. Warren (Canada).

*Terms of Reference:*

To consider the specific proposals concerning the basic re-arrangement of the Radio Regulations and the Additional Radio Regulations, and the further refinement and deletion of superfluous or redundant provisions in Articles N34-N38, N40-46 and N48-N72, as well as any consequential amendments concerning those articles, related appendices, resolutions and recommendations including the adoption of any new resolutions and recommendations.

To consider proposals based on the

drafting groups and editorial groups were formed from time to time.

In addition to Mr. E. J. Wilkinson (leader of the Australian delegation), who was the Vice-Chairman of Committee 6, Australia provided a number of other Chairmen. Both the deputy leaders of the Australian delegation were Chairmen of working groups. Mr. Peter Barnes was Chairman of Working Group 5BB, which was responsible for the Frequency Table between 4-27.5 MHz and Mr. Eric Craig was Chairman of Working Group 4B (Technical). In addition, other members of the Australian delegation were from time to time Chairmen of various sub-working groups and ad hoc working groups. These appointments effectively reduced the numbers of the Australian delegation during the period the people concerned were occupied with their duties on behalf of the Conference.

versial issues were resolved during the WARC, but some were simply side-stepped and will become the subject of future specialised conferences.

The opening of the Conference was delayed for some three days whilst the choice of the Chairman of the Conference was agreed. Ultimately Mr. Roberto Severini of Argentina was chosen. This was the first of many compromises that resolved the conflicting interests of different Member Countries of the ITU. Many will have left WARC 1979 disappointed. The real pressure for a substantial increase in HF bands allocated to broadcasting was largely unsuccessful. There was no extension for HF broadcasting below 9 MHz though an additional 725 kHz of spectrum will become available in bands between 9 MHz and 22 MHz. Some additional spectrum was allocated to the Mari-

time Mobile Service but again far less than was sought.

Any expansion to Services in the HF bands was inevitably to come from bands now allocated to the Fixed Service. The developing countries argued that broad Fixed Service bands were essential for them to provide communications to areas where they could not, at their present stage of development, provide communications by alternative means, and thus strongly opposed any reduction at all of those bands.

Indeed, one country, Algeria, proposed a division of all HF Fixed Service bands so that, of these bands, 70 per cent would be specifically reserved for use by the developing countries. This proposal was not adopted, though new procedures to remove outdated assignments and to enable special assistance to be given to developing countries in seeking new fixed assignments were developed and adopted.

Another example of the differing philosophies of different countries arose in relation to the question of whether or not there should be planning for the Fixed Satellite Service. As in the case of assignments in the HF Fixed bands, the developing countries strenuously attacked the concept of "first come first served". The geostationary satellite orbit is recognised by the International Telecommunications Convention as a limited resource. Many developing countries argued for planning so that they should be guaranteed access to this resource; a priori planning may involve nations being able to reserve a position for their future use. It was said by those administrations that opposed this approach that this would be to the detriment of those countries which have a requirement for present use, in order to leave space for countries that may not have either the ability or interest to put up satellites. Some countries argued in favour of regulatory procedures designed to take advantage of developing technology and to provide means of facilitating co-ordination procedures to enable, they argued, maximum utilisation of the orbit satellite resource. In the end the Conference decided on a resolution calling for a further Conference in two parts, the first part to be held in 1984 to resolve these issues.

The Conference was marked by divisions and suspicion. The results were not always logical. The Frequency Table now has far more footnotes than it had before and far more countries in those footnotes. Footnotes provide for additional or alternative locations for virtually every part of the spectrum. The effective co-ordination of services in accordance with the International Regulations will become extraordinarily difficult if all the services allocated by footnote are, in fact, established in the countries entitled by footnote to do so. Many of the Regulations, formulated in sub-working groups or draft-

ing groups, incorporate amendments proposed at working group or committee level (with perhaps several hundred delegates participating) that contain ambiguities or inconsistencies that will bedevil their interpretation for many years to come.

Yet in the end agreement was reached within 11 weeks, subject to very few reservations. This was, perhaps, the real achievement of the Conference.

It is against this background that the decisions of the Conference affecting the Amateur Service must be viewed. Amidst all the very real needs of so many Services to use the radio frequency spectrum amidst the vastly different needs and aspirations of different countries, the Amateur Service fared well. In the most general terms it can be said that the Amateur Service had the benefit of a general sympathy and considerable support. The debate was not whether there should be an Amateur Service, but how much spectrum it should have and to what extent it should be restricted by regulations.

The area of disagreement was generally based on differing perceptions of priorities. No matter how important we may think our use of the spectrum is, others, with different national requirements, must be expected to take a different view.

Turning now to the actual decisions of the Conference that directly affect the Amateur Service, attention must be directed in the first instance to the Frequency Table. In this context it must be stressed that nothing happens as a result of the conclusions reached at the WARC. Each administration (including Australia) will be formulating its own National Table and therefore what is here said should

not be regarded as necessarily representing the ultimate position in this country.

The question of the timing of any changes is dealt with separately.

#### 1800-2000 kHz

So far as Region 3 was concerned, the Amateur Service remains co-primary with Fixed Mobile and Radionavigation though Radiolocation has been made a secondary service. In Region 1 there is a new exclusive band between 1810-1850 kHz though by footnote the Amateur Service can only use 1830-1850 in some countries and by other footnotes it will be shared in other countries. In Region 2 an exclusive allocation was made between 1800-1850 kHz with a shared allocation from 1850-2000 kHz. Attempts to obtain an exclusive segment within the shared band for the Amateur Service in Region 3 failed because of the continued use of Loran A on small vessels operating in part of the Region. The new Region 1 allocation is a significant step forward and, so far as Australia is concerned, no change detrimental to the Amateur Service is likely.

#### 3500-3900 kHz

Again no changes took place in Regions 1 and 3. In Region 2, the band 3500-3750 kHz is allocated exclusively to the Amateur Service, and the band 3750-4000 kHz remains shared. The previous footnote referring to the Amateur Service restricting Amateurs to the band 3500-3700 on an exclusive basis was deleted on the philosophic basis that, as it is a shared band, the administration is free to split the band in any way it chooses and the footnote was therefore unnecessary. Again, no change should be anticipated in this band so far as Australia is concerned.



PHOTO 1: WARC 79, Australia at Committee 5B. L. to r.: David Wardlaw, V. A. Caturia, P. Trost, W. Pike and P. J. Chapman.

#### **7000-7100 kHz**

Proposals for a world-wide band 6950-7100 (Australia), 6900-7100 (Canada), were defeated and the existing allocation, by the Table, of 7000-7100 remains in Regions 1 and 3 with an additional 200 kHz being allocated in Region 2. It is of course open for administrations to allocate an additional segment on a non-interference basis to the Amateur Service. Australia has in the past, and will no doubt continue to do this, in the band 7100-7150 kHz. Again, no change can be expected so far as Amateur operation is concerned in Australia. A consequential effect of the debate in this area is referred to subsequently.

#### **10100-10150 kHz**

This band is a new allocation to the Amateur Service on a secondary basis to the Fixed Service. It is a smaller band than proposed by the many administrations that proposed an exclusive band 100 kHz wide. Despite its small size and the secondary status, the band is of considerable interest, and in the end the major regret is that a further 50 kHz on a secondary basis could not be allocated. Of course, administrations will have the option of relocating any Fixed stations presently operating in this small segment, and perhaps such a course will be attractive in view of the likely intensive Amateur use of the band.

#### **14000-14350 kHz**

The band at 14000-14350 kHz was not changed, though the footnote allocating the band 14250-14350 to the Fixed Service in the USSR now includes Afghanistan, China, Ivory Coast and Iran though subject to a power limitation that fixed stations shall not use a radiated power exceeding 24 dBW (250 watts).

Broadcasting has been allocated a new band between 13600-13800 kHz. A proposal to move that band to the lower edge of the Amateur allocation was defeated, leaving, in effect, a "guard band" of lower powered Fixed stations between the Amateur band and the Broadcasting band.

#### **18068-18188 kHz**

A new world-wide exclusive Amateur allocation has been made, subject to a footnote allowing Fixed Service operation in the USSR, on a primary basis, subject to a power limit and for use only within the boundary of the USSR.

#### **21000-21450 kHz**

There was no change in this band.

#### **24890-24990 kHz**

A new Amateur and Amateur Satellite band allocated on a world-wide exclusive basis.

#### **28-29.7 MHz**

There was no change.

#### **50-54 MHz**

In Regions 2 and 3 the bands remain allocated to the Amateur Service on a primary basis with a number of footnotes making either additional or alternative

allocations to broadcasting, including an additional allocation to broadcasting in Australia. So far as Australia is concerned, the ultimate position will be determined in the formulation of the National Table. The current adjacent use by some television stations will continue to remain a problem to the Amateurs in this country. The ultimate position will depend on national policy decisions as to television broadcasting. In the short to medium term the possibility of time and/or geographic sharing cannot be overlooked.

Strong pressure, led by Norway, to make available, when it was possible, a small segment to the Amateur Service in Region 1 was not successful.

#### **144-148 MHz**

The band 144-146 MHz remains exclusive and world-wide subject to a footnote permitting fixed and mobile on a primary basis in Singapore of systems in operation on the 1st January, 1980. The use shall terminate on the 31st December, 1995. In Region 2 the band 146-148 remains allocated exclusively to the Amateur Service though in Region 3 the band is also allocated to fixed and mobile on a co-primary basis. In Region 1, the band 146-149 remains allocated to Fixed and Mobile. No change is likely in Australia.

#### **420-450 MHz**

In 1959 this band was allocated, in Regions 2 and 3, to Radiolocation primary and Amateur secondary. Now the band has been split and in all Regions the bands 420-430 MHz and 430-440 MHz are allocated to Fixed and Mobile primary and Radiolocation secondary. In Region 1 the band 430-440 is allocated to Amateur and Radiolocation co-primary, and in Regions 2 and 3 the band is allocated to Radiolocation primary with Amateur secondary.

There are numerous footnotes affecting this part of the spectrum. The band 435-438 remains allocated, by footnote, to the Amateur Satellite Service on the same basis as at present, that is, on a non-interference basis to other Services operating in accordance with the Table.

The band 430-440 MHz is allocated to the Fixed Service by footnote to over 40 countries and that band except 435-438 MHz is also allocated by the same footnote to Mobile other than aeronautical mobile also on a primary basis. It was only through a last minute agreement in Committee 5 that mobile was excluded from the Amateur satellite segment. Even that agreement was subject to a Final Protocol by Thailand reserving the right to operate Mobile except aeronautical mobile in the Amateur satellite segment though the final protocol stated that Thailand "shall take necessary steps to ensure that services operating according to the Frequency Allocation Table in other countries shall suffer no harmful interference . . .".

However, by a footnote Australia, the United States of America, Jamaica and the Philippines also allocated the bands 420-430 and 430-450 MHz to the Amateur Service on a secondary basis.

It would seem likely that in Australia we will see no change so far as the Amateur Service is concerned.

#### **1215-1300 MHz**

As was anticipated, the band 1215-1240 MHz has now been re-allocated to Radiolocation and Radionavigation Satellite (space-to-earth) in order to provide for Global Positioning radionavigation satellite systems. The band 1240-1300 MHz remains allocated world-wide to Amateur on a secondary basis, with the band 1260-1270 MHz allocated to the Amateur Satellite Service in the earth-to-space direction only, on the basis of non-interference to other Services. This is a new Amateur satellite allocation.

#### **1300 MHz to 40 GHz**

There has been no change in allocations to the existing bands in this part of the spectrum. However, additional Amateur satellite bands have been allocated on a non-interference basis at 2400-2450 MHz, 3400-3410 MHz (Regions 2 and 3 only) and 10.45-10.50 GHz. In addition to those allocations, the band 5650-5670 MHz is allocated to the Amateur Satellite Service in the earth-to-space direction only and 5830-5850 MHz has been allocated in the space-to-earth direction only.

#### **Above 40 GHz**

In the new bands above 40 GHz the following bands have been allocated exclusive to Amateur and Amateur satellite:—

47.0-47.2 GHz,  
75.5-76.0 GHz,  
142-144 GHz,  
248-250 GHz.

In addition the following bands have been allocated to the Amateur and Amateur Satellite Service on a secondary basis, shared with other Services:—

76-81 GHz,  
144-149 GHz,  
241-248 GHz.

The band 119.98-120.02 GHz is allocated on a secondary basis to the Amateur Service only.

It will be observed that in the case of new bands above 40 GHz exclusive Amateur and Amateur Satellite allocations are generally made adjacent to wider shared allocations. There are 2 bands below 40 GHz where the same philosophy has been applied.

It is tempting to understate the importance of the new Amateur satellite bands throughout the spectrum and the new bands above 40 GHz. Prior to WARC 1979 the band 435-438 MHz was the highest band on which Amateur satellite operation was permitted other than 24-24.05 GHz. Access to new bands throughout the spectrum is essential if the Amateur Satellite Service is to continue to

provide experience of varying conditions and access to all parts of the spectrum is essential if the Amateur and Amateur Satellite Services are to continue to move with new technology.

Turning now to non-frequency table matters, Working Group 5A considered certain definitions, including the definition of the Amateur Service and the Amateur Satellite Service. A number of proposals were made to amend the definition of the Amateur Service, some of which had no real significance. For example, because the Spanish word "radioaficionados" is equivalent to "radio amateur", it was proposed to change the terms, in English, to "Radio Amateur Service" and "Radio Amateur Satellite Service", which would have then required numerous consequential changes in Article N30. This was rejected.

Other proposals were clearly designed to provide a basis for greater control by administrations of the Amateur Service by changes to the definitions. Some of these changes could have inhibited the granting of reciprocal permits, and in any event were not necessary as, of course, an administration has total control of all licences under its jurisdiction. In the end only one change was made—a change proposed by Australia namely, rather than being "a service of self training intercommunication and technical investigation . . .", the Amateur Service becomes a "radiocommunication service of . . .", etc. The desirability of this amendment lay in the definition of "harmful interference", which is defined in terms of an effect on either a safety service or "a radiocommunication service". Elsewhere the Regulations provide that the only other service not categorised as a "radiocommunication service", the Radio Astronomy Service, shall, for the purpose of resolving cases of harmful interference, be treated as a radiocommunication service. In short the amendment, small as it is, makes more clear that the Amateur Service can complain of harmful interference from stations not operating in accordance with the table of frequency allocations or the provisions of the Regulations.

Article N30 is the Article specifically governing the Amateur and Amateur Satellite Service. It was considered in Committee 7, in the early stages of the Conference. In fact very little change was made. The most significant was that the morse code requirement, which may now be waived by administrations in the case of stations making use exclusively of frequencies above 144 MHz, was lowered to 30 MHz. This proved to be the most contentious issue arising from the consideration of this article. The United States had proposed that administrations be given a discretion as to requiring a morse code qualification at all, arguing that this would enable administrations to have regard to their own particular needs and also that this would facilitate handicapped persons

becoming Amateurs. This proposal was supported by Japan but opposed by many other administrations. The Federal Republic of Germany, for example, argued that it placed considerable value on its Amateur Service, it believed that its Amateurs should be highly qualified and were concerned that radio Amateurs could, for example, understand a morse code distress call. In the end 30 MHz was substituted for 144 MHz as a "compromise".

Now the Australian limited licensee's operation on the 6 metre band will, with the coming into force of the new Radio Regulations, be in accordance with those Regulations.

The provision of the Regulations requiring administrations to take such measures as they judge necessary to verify the "technical" qualifications of a person operating an amateur station was amended to include both "operational" and "technical" qualifications—a realistic amendment having regard to the fact that the definition of the Amateur Service incorporates not only the object of "technical investigation and self training" but also the object of "intercommunication".

Other minor changes were made to express the qualification requirement in terms of a condition precedent to obtaining a licence, rather than as a continuing obligation, an amendment of no practical significance though a little hard to follow in terms of logic.

A further provision was added to make it quite clear that the general provisions also applied, as appropriate, to stations operating in the Amateur Satellite Service.

The right of administrations to modify, by special arrangement, the prohibition against the transmission of international communications on behalf of third parties was maintained.

The debate on Article N30 highlighted the concern of a number of countries to restrict the freedom of, and exercise greater control over the Amateur Service. These administrations, of course, can do that now; what they were really seeking to do was to impose on other administrations an obligation to do the same. The end result preserved completely the existing concept of the Amateur Service.

In addition to these regulatory changes there are a number of resolutions that affect, directly or indirectly, the Amateur Service. Undoubtedly the most important of these is the resolution identified in the Final Acts as Resolution BN—"Relating to the international use of radiocommunications, in the event of natural disasters, in frequency bands allocated to the Amateur Service". This resolution arose from the proposal by a number of administrations that specified sub-bands within the HF Amateur bands be set aside for emergency communications.

Whilst on a philosophic basis the Amateur Service cannot reject the proper

use of its bands for emergency communications, there are inherent difficulties in the specification of sub-bands. A sub-band may not, in a particular situation, be the most appropriate frequency—the existence of other nets may need to be taken into account. The inherent disadvantage of a specified small sub-band is that it is likely to be precisely the part of the band where it is difficult to attract attention, simply because the Amateur stations would ordinarily not operate on the sub-band.

Other factors, too, also had to be taken into account. In providing communications in the case of a natural disaster stations operating at the scene may not necessarily be licensed Amateur stations. The national regulations of many administrations prohibit stations in the Amateur Service communicating with stations in other Services. Further, emergency communications necessarily involves the transmission of third party traffic. Article N30 requires special arrangements to be made between administrations before communications on behalf of third parties can be transmitted internationally.

All these factors were taken into account in the formulation of this resolution. The resolution may be paraphrased as follows.

The WARC considered that, in the event of natural disaster, normal communications systems may be overloaded, damaged or completely disrupted and that rapid establishment of communication is essential to facilitate world-wide relief, and that the Amateur bands are not bound by international plans or notification procedures and are suitable for such short term use, and that where international disaster communications would be facilitated by the temporary use of certain frequency bands allocated to the Amateur Service the stations of the Amateur Service, because of their widespread distribution, "and their demonstrated capacity in such cases" can assist.

The existence of national and regional Amateur emergency networks using frequencies throughout Amateur bands was also to be taken into account. It was recognised that the responsibility for communications in the event of a natural disaster rests with the administrations involved.

The WARC therefore resolved, firstly, that the bands allocated to the Amateur Service specified in a particular Footnote may be used by administrations to meet the needs of international disaster communications. Secondly, that the use of these bands shall only be for communications in relation to relief operation in connection with natural disasters. Thirdly, that such use shall be limited for the duration of the emergency and to the area defined by the responsible authority of the affected country. Fourthly, that the communications should take place within that area and between that area and the



**PHOTO 2:** WARC 79, general view of half of the meeting room at a session of Committee 5. Australian delegation (from l. to r., behind "Australie"): P. Barnes, R. Davies, P. Trost, J. Foggon, F. Shephard, David Wardlaw.

permanent headquarters of the organisation providing relief. Fifthly, that such communications require the consent of the administration of the country concerned. Sixthly, that relief communications provided from outside the country in which the disaster has occurred shall not replace existing national or international Amateur emergency networks, and seventhly, that close co-operation is desirable between Amateur stations and the stations of other radio services which may find it necessary to use Amateur frequencies in these circumstances and finally, that such international relief communications shall avoid, as far as practicable, interference to the Amateur Service networks.

The Conference invited administrations to provide for the needs of international disaster communication and to provide for the needs of emergency communications within their own national regulations.

This resolution is of considerable significance. It recognises the value of the Amateur Service in providing emergency communications. The resolution is not directed to replacing Amateur stations in Amateur bands by stations of other services for the purpose of providing emergency communications in the case of a natural disaster. It does contemplate non-Amateur stations working in co-operation with Amateur Stations. The stress on natural disasters is important—the Amateur Service has no role in the case of a civil emergency. The legitimate interest of the Amateur Service in the proper use of its own bands has been taken into account.

It will be now up to administrations to re-examine their own national regulations to ensure that in the case of a natural disaster their Amateurs are not restricted in their ability to provide essential emergency communications.

A further resolution affecting the Amateur Service relating to the use of the band 7000-7100 kHz did not receive the strong support of the previous resolution—in fact this resolution was finally adopted at a Plenary meeting by 38 votes in favour to 37 votes against. This resolution provided that the Broadcasting Service shall be prohibited from the band 7000-7100 kHz and that the broadcasting stations operating on frequencies in this band shall cease such operation, the resolution noting that band is allocated on a world-wide basis exclusively to the Amateur Service. In fact this resolution is not new—it replaces Resolution 10 of the Administrative Radio Conference of 1959 and has been amended to delete the previous obligation of broadcasting stations in Regions 1 and 3 not to cause harmful interference to Amateur stations in Region 2 in the band 7100-7300 kHz.

A further resolution related to the bringing into use of earth stations in the Amateur Satellite Service. This resolution arose because the procedures of Articles N11 and N13 relating to the advance publication, notification, co-ordination and registration of satellite systems apply to the Amateur Service. The procedures are inappropriate in respect of earth stations in the Amateur Satellite Service simply because of their diversity in characteristics and the inability of an administration

to identify every station that may, at some time during the life of an Amateur satellite, wish to operate through that satellite. The resolution was based on a resolution originally proposed by the USA.

The Conference was of the view that, in respect of the space station, full particulars should be notified. It accepted that this should not be required in the case of Amateur earth stations.

Whilst the requirements of Articles N11 and N13 may not have, in fact, caused difficulties in the past, this resolution makes it clear that the International Frequency Registration Board should not reject the information supplied by an administration responsible for the launching of an Amateur satellite as incomplete on the basis that it contains insufficient information relating to earth stations in the Amateur satellite system. The resolution provides that the administration intending to establish such a system and wishing to publish information with respect to earth stations in that system may communicate all or part of the information listed in the relevant appendix. The IFRB shall publish such information in a special section of its weekly circular with a request for comments to be communicated within a period of four months after the date of publication. The information notified shall be recorded in a special list. The resolution does, however, require that if an administration wishes to publish that information, it shall include at least the characteristics of a typical Amateur earth station having the facility to control the space station.

So far as the new Amateur bands are concerned at 18 and 24 MHz a transfer procedure will apply, though there is no specific reference to the Amateur Service. The effect of these proposals is to provide for a preparatory or administrative stage that will terminate on the 1st July, 1984, and a transfer phase which requires the changeover to be effected by administrations by not later than the 1st July, 1989, in the frequency bands above 10 MHz. At this stage it is impossible to predict when, within that time, the final transfer to the Amateur Service will take place, though it should be pointed out



**PHOTO 3 (l. to r.):** Mr. Jim Wilkinson (leader of the Australian delegation), Bob Eldridge VE7BS (member Canadian delegation), David Wardlaw and Michael Owen.

that operation at an early date is possible if an administration is prepared to permit such operation on a non-interference basis.

A different situation exists in the case of the new band at 10.1-10.15 MHz. There the Amateur Service has been allocated the band on a secondary basis and accordingly the transfer procedure is not applicable. As the Final Acts of the World Administrative Radio Conference come into force on the 1st January, 1982, administrations can be expected to allocate that band to the Amateur Service from at least that date.

The late John Moyle attended the 1959 World Administrative Radio Conference as an observer to the Australian delegation. His report was published in Amateur Radio in March of 1960. That report makes fascinating reading for anyone who attended the 1979 Conference. He wrote "I only wish every Amateur could have been present at least part of the time. He would have learned about the enormous pressures on frequency space which have literally made portions of the spectrum unworkable; he would have seen how Amateur problems, important though they are to us, are only a small part of the incredibly complicated pattern of modern communication."

Those words were written when the ITU had 96 member countries. Today it has 154. Those words were written before the advent of the communications satellite. How much more apposite are they today!

John Moyle also made a number of comments and criticisms. He pointed out that it is far too late to initiate action at the Conference itself. He suggested that, in 1959, the Amateur Service fell down because its preliminary work over the years had not been good enough. In 1979 the gains that were made by the Amateur Service arose principally from the preparatory work of the IARU and its member societies throughout the world.

Closer to home we were helped by the enlightened attitude of our administration, and particularly the fair and open-minded approach of Mr. Jim Wilkinson, the First Assistant Secretary, Radio Frequency Management Division, and leader of the Australian delegation to WARC. He encouraged participation in the Australian preparation.

John Moyle, in 1959, commented that the IARU was an ineffective body, pointing to the fact that then there was little international co-operation except in Region 1. There was no IARU representation of Region 3. In 1979 this too had changed. In 1959 John Moyle suggested that the

IARU was preoccupied with their own local problems. On this occasion, perhaps with the exception of the issue of the 40 metre band which affected Amateurs in Region 2 differently from Amateurs in Regions 1 and 3, the IARU effectively promoted a global approach.

There is no question that the observation of John Moyle, that the most important thing was to have Amateur delegates, was more than justified by this Conference.

Finally, John Moyle felt it necessary to criticise the lack of awareness on the part of the Wireless Institute of Australia in 1959 of the fundamental issues of that Conference. The Federal Body of the Wireless Institute of Australia has been preoccupied with WARC 79. A substantial part of Federal conventions in recent years has been devoted to the discussion of the issues that were finally resolved in Geneva.

In short, both within Australia and internationally, the lessons of 1959 have been learnt, and applied successfully.

It is true that the Amateur Service had disappointments but overall the Amateur Service and the Amateurs of Australia have come from the 1979 World Administrative Radio Conference with much to be thankful for.—MICHAEL OWEN. ■

## THE RON WILKINSON ACHIEVEMENT AWARD FOR 1979

Details about this annual Award appear in AR March 1978, page 17. The Award is funded from interest received from a most generous donation received from Mrs. Mary Wilkinson, widow of the late Ron Wilkinson VK3AKC. Previous recipients were:—

1977

Wally Green VK6WG.  
Reg Galle VK5QR.

1978

Winston Nichols VK7EM.  
Aif Chandler VK3LC.

After the most careful and searching consideration the Executive came to the conclusion that few amateurs could better qualify for the 1979 Award than David Wardlaw VK3ADW and Michael Owen VK3KI. 1979 was the culmination of intensive and extensive work leading to and at WARC 79. Whilst it was recognised that WARC was not so much the end as the beginning of continuing work for amateur radio, nevertheless the enormously valuable effort put into preparations for this Conference by these two prominent amateurs on behalf of the Amateur Service as a whole, together with the genuine sacrifice both of them endured at the Conference, must merit recognition by all amateurs.

For these reasons the benefits to the Amateur Service cannot be recorded strongly enough, and all members will most surely join in congratulating them upon receiving another of the WIA's highest Awards. ■

### THANK YOU

to

everyone who supported  
the Australian Amateur  
Delegates to WARC 79 —  
their presence WAS worth  
the effort.

To ensure continuity  
support the WIA —

All Membership enquiries to:  
WIRELESS INSTITUTE OF AUSTRALIA  
P.O. BOX 150, TOORAK, 3142

## AR AWARDS

The Publications Committee has pleasure in advising the names of the recipients of awards for 1979

### HIGGINBOTHAM AWARD

Mr. Syd Clark VK3ASC for loyal and meritorious service to Amateur Radio for over 20 years. Worth \$50.

### TECHNICAL AWARD

Mr. Lou De Stefano VK3AQZ, for his article entitled "40 Channel Digital Synthesiser with 25/50 kHz Steps for 2m FM" in AR August 1979. Worth \$25.

### ASJA

(AI Shawsmit Journalistic Award)

Mr. Terry Clark VK2ALG for his article entitled "The Living Legend" in AR December 1979, being adjudged the best piece of amateur radio journalism for the year. Engraved plaque plus \$15. ■

### 'A' REMINDER

A WIA MEMBERSHIP CERTIFICATE  
IS OBTAINABLE ONLY FROM YOUR  
DIVISION.

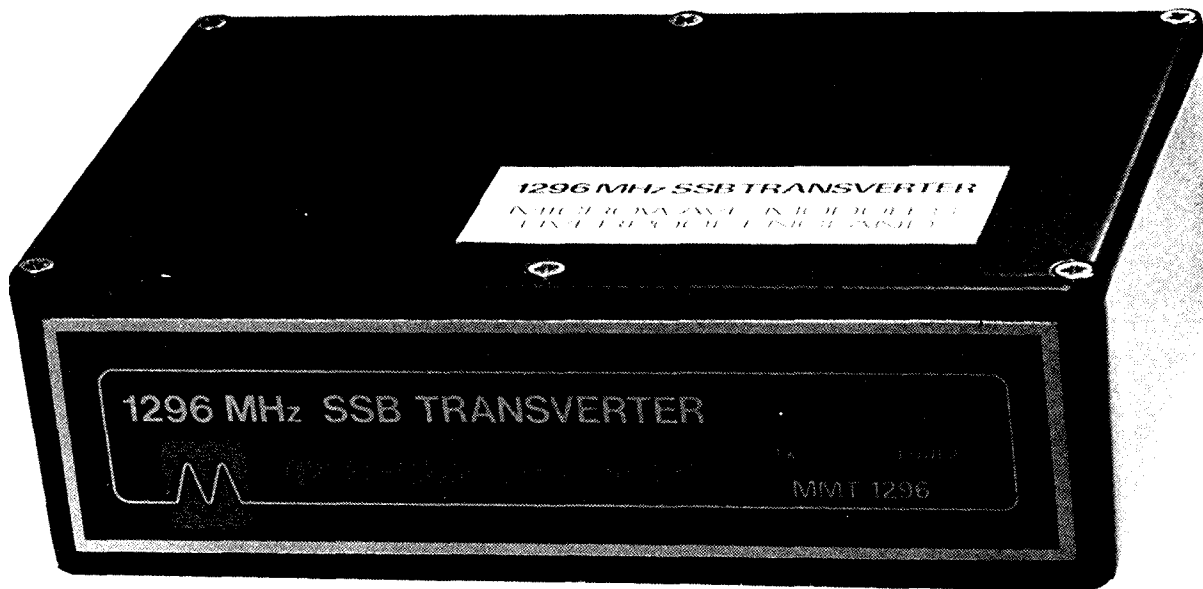

# See You Upstairs!

**NOW for 1296 MHz** LINEAR TRANSVERTER SSB. CW. FM. AM.

**NEW...** 1296 Receive Pre Amp. Low noise, better 2.9dB, Gain 18dB Two stage Microstrip, Teflon PCB Price: \$ 69.00

**NEW...** TRANSVERTER, Linear MMT50/144, coverage 50 to 54MHz Price: \$240.00

TRANSVERTER, Linear MMT144/28, coverage 144 to 146MHz Price: \$235.00

TRANSVERTER, Linear MMT432/28'S', coverage 432 to 436 MHz Price: \$325.00

LINEAR AMPLIFIER. MML144/25 & MML50/25. 25 Watts out for 3 Watts drive, includes RX pre amp. Price: \$105.00

LINEAR AMPLIFIER. MML432/50. 50 watts, RX pre Amp. Price: \$280.00

LINEAR AMPLIFIER. MML144/100. 100 watts. Price: \$340.00

Our Extensive Range includes: Converters MMC432/28'S' & 432/144'S' dual range 432 - 436MHz Price: \$67.00, MMC1296/28 & MMC1296/144MHz Price: \$77.00, MMC144/28 Price: \$53.00, Varactor Tripler MMV1296 & MMV 1152 Price: \$94.00, 500MHz, 6 digit Frequency Counter MMD050/500 Price: \$175.00.

Amateur Electronic Imports is the exclusive Australian distributors for these precision British made units from Microwave Modules, Ltd.

**MMT1296/144**  
1296MHz LINEAR TRANSVERTER  
Available with an IF input of 144 - 146MHz  
Price: TBA

Features include:—

- \* 1.3 watts TX output
- \* RF VOX changeover
- \* All mode operation
- \* RX gain, 25dB
- \* RX N.F., better than 2.9dB
- \* Pin diode aerial c/o relay
- \* 13.8 V DC operation
- \* Supplied with attenuator to allow operation with 10 - 15 watt prime movers

All prices subject to change without notice.

Onwards forwarding please add sufficient for freight or postage. Excess will be refunded.

## Amateur Electronic Imports

P.O. BOX 160, KOGARAH, N.S.W. 2217  
TELEPHONE: (02) 547-1467  
CABLE: "AMATEURIMPORT, SYDNEY"

# BINDING CONTEST LOGS

John Anderson VK2ZXU

In the February 1979 issue of AR I read a complaint by the Contest Manager that one of the logs submitted to him was held together with solder. This surprised me as the use of solder in bookbinding has been extensive for some time.

As Broken Hill is a mining town we are naturally interested in increasing the use of lead, and have as a result developed many methods of binding using solder which should be more widely known. Being soft and easily worked with tools normally available to the active amateur, there is no reason why most of these methods could not be universally adopted.

I will not go into all the possibilities as some are quite complicated and have only limited specialist application. Those presented here however should be useful for those wishing to present thin contest logs or to file their experimental notes for future reference.

## 1. SINGLE HOLE PUBLIC SERVICE METHOD

In this method a single hole is punched in the top left-hand corner of each page. A short length of solder, e.g. 16 SWG rosin cored, is then looped once or twice through the hole and fastened. A simple knot will do but a better job is obtained if the ends are matched up and fused with a touch of a soldering iron (Fig. 1).

A better job is obtained using a copper rivet. While rivetting is quite satisfactory with paper, a certain amount of skill is necessary so one can use a technique originally used in the days of sealing wax.

A rivet of appropriate length is passed through the hole and an asbestos washer placed over the end to protect the paper.

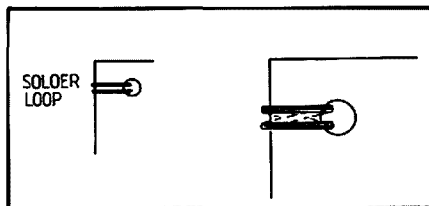

FIGURE 1

A blob of solder is then melted over the end of the rivet fixing the whole assembly firmly together (Fig. 2). If some individuality is desired one can press a seal carrying the station logo and call sign into the solder before it hardens (Fig. 3).

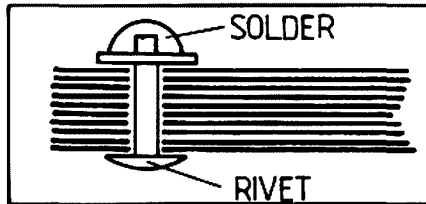

FIGURE 2

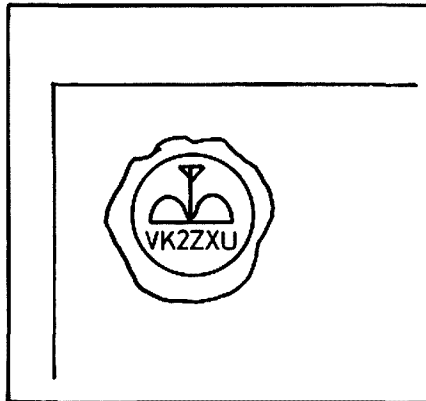

FIGURE 3

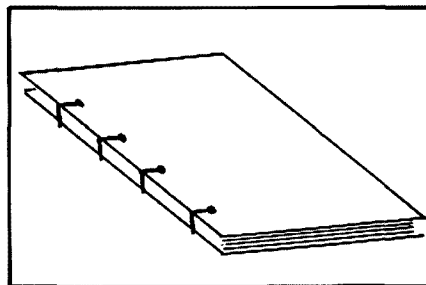

FIGURE 4

## 2. MULTI-HOLE METHOD

Here the standard 2 hole perforations are used or as I saw more frequently during my Sabbatical year in France 4 holes. Pages can be bound together using the same method as for the single hole case, i.e. a loop of solder through each hole

(Fig. 4), or each pair can be sewn together by a long solder loop with the ends neatly tied or fused together (Fig. 5). When this method is used a cover can be incorporated. Suitable covers made of cardboard and already punched are available at all stationery suppliers.

## 3. FULL BINDING METHOD

This is the preferred method for large numbers of pages such as would be the case with RD logs or VHF DXCC submissions. It is the required method for our students presenting their end of session reports and design thesis. While more complex than the previous two methods the degree of difficulty is not beyond the average amateur constructor.

First one obtains a reel of thin spring copper or brass about 5 mm wide. This is cut into lengths equal to the long side of each page. A strip is then glued to the left-hand (spine) side of each page with the paper overlapping the strip by some 2-3 mm. PVC glue or a proprietary product such as Aquadhere is most satisfactory, although simple office paste or mucilage can be quite successful.

Next, one prepares a cover in a similar manner, using a piece of blank printed circuit board the same or a little larger than the page size. The copper or brass strip is in this case soldered on to the copper side of the board using the same overlap as for the pages. The pages and covers are then assembled neatly, with

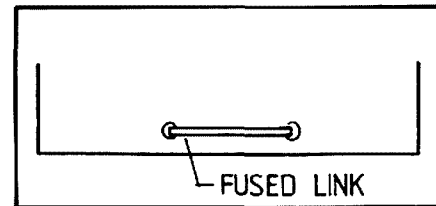

FIGURE 5

the cover overlapping top, bottom and right-hand side if this has been allowed for. The whole assembly is then clamped and arranged so that the spine is on top. Solder is then run lightly down the spine to firmly join the whole assembly together. A quick rub down with a file will smooth



down the spine and remove any irregularities.

It should be noted at this point that inserts such as sample circuit boards can be inserted providing a spacer is provided on the outer edge of the spring strip (see Fig. 6). Such inserts can readily be removed for copying or duplication of equipment and soldered back in after use.

Finally the whole job is finished off by wrapping the spine with a strip of electrical tape, running the excess width over the cover boards. If a quarter binding effect

is required, a wide strip of coloured packaging tape can be used which will extend 2-3 cm over the cover boards. Small pieces of tape across each corner completes the effect.

For a really professional appearance, Letraset can be applied to the spine and front cover giving title, author, etc. Figures 6 and 7 show a cross section of construction and the final job respectively.

Any report or submission is the better for a high quality of presentation. I hope that this article will show that sound book-

binding techniques can be applied using standard materials normally found in the amateur shack, and that the use of solder is far from being an anachronism in the preparation of items such as contest logs.

FIG. 6 (below): Binding Incorporating spacing bars.

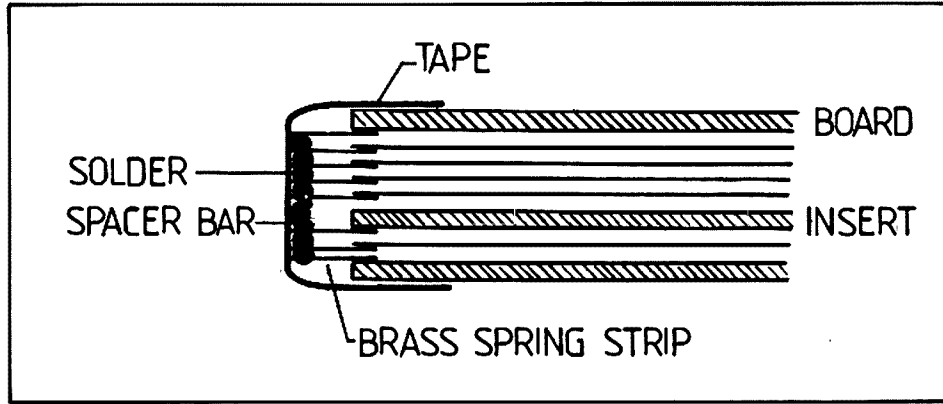
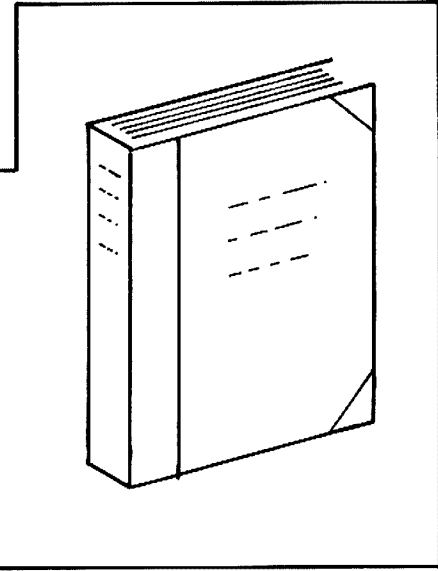

FIG. 7 (below): The completed product.



## FINGERTIP SOLDERING IRON

I have a friend who is interested in electronics and who has as a result of a serious car accident lost much of the use of his hands and arms.

In spite of these disabilities he retains his interest and fortunately he can still use his index finger as a pointer almost normally. Having seen him struggling to perform a simple soldering job I got the idea of a soldering iron that could be attached to the index finger and controlled by a foot operated switch.

The finger stall is a piece of 1 in. diameter plastic conduit which, when suitably slotted, can be heated and compressed if necessary to be a neat fit on the finger.

The bit is a "WAHL" cordless iron tip, quite adequate for most electronic work. The transformer is a small 6.3 volt fila-

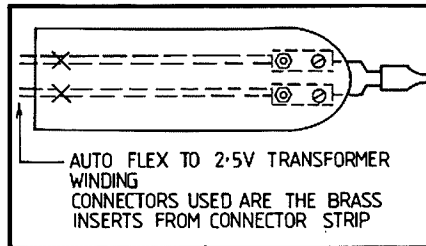

FIG. 2: Connections for the filament transformer.

ment transformer with its secondary re-wound for 2.5 volts. This was mounted in a wooden box with the actuator of a micro-switch projecting through the top to permit foot operation. The leads from the transformer to the iron were made from 10 amp auto flex. As a safety precaution the

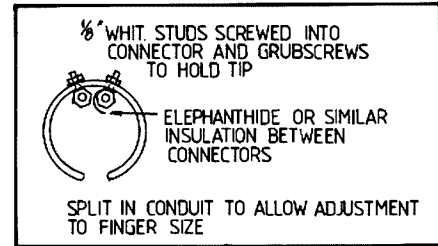

FIG. 3: Finger stall connections.

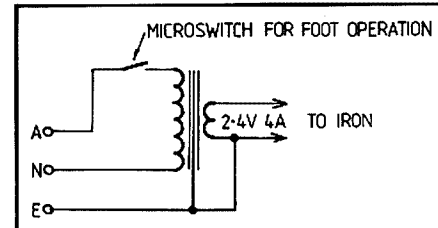

FIG. 4: Transformer with microswitch.

mains earth was connected to one side of the secondary as well as the frame of the transformer.

I see this little gadget as being of interest to other similarly handicapped people and place no restriction on the idea being used commercially or being published by other magazines.

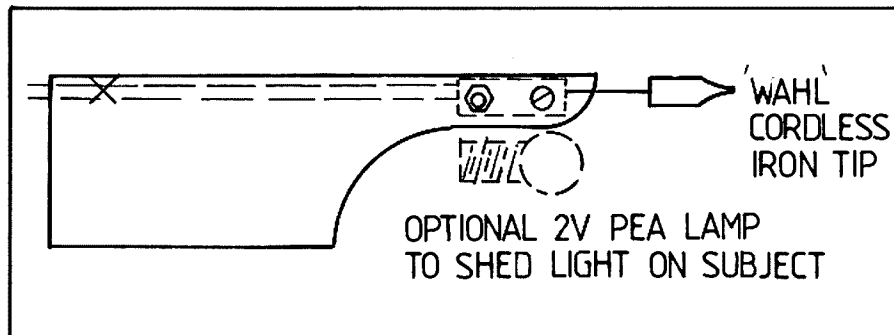

FIGURE 1: Side view of iron.

Join a New Member

# ADDING RIT TO THE FRG-7 AND OTHER RECEIVERS

M. Glover VK7MG  
17 Mona St., Battery Point, Tas. 7000

Although this article describes a modification for the author's FRG-7 receiver it would be a valuable addition to any receiver that does not have Receiver Incremental Tuning (RIT), sometimes called a fine tuning control or a clarifier.

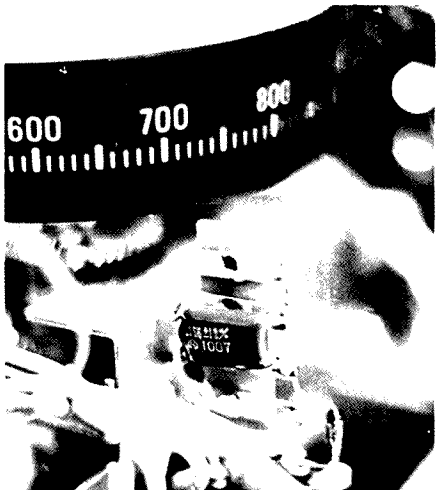

Photo shows position of tag strip mounted behind drum dial of the tuning control.

I recently bought the latest model of the FRG-7 but quickly became dissatisfied with the fine tuning control. This model apparently has greater selectivity than earlier models but still uses the same 5 pF variable capacitor wired in parallel with the main VFO tuning capacitor to provide the fine tuning. (If you too feel that the fine tuning coverage is a little generous there are alternative modifications previously described in AR, e.g. fitting a small 2.2-4.7 pF capacitor in series with the 5 pF variable, adding a reduction drive or a larger knob.—Ed.)

The circuit used is shown in Fig. 1. It provides a frequency swing of about 4 kHz spread over 270 degrees, thus making the tuning of SSB smooth and easy. It can be seen that the modification involves replacing the mechanical tuning with electronic tuning which consists of a varicap diode controlled by a 5k ohm linear potentiometer.

All the components are mounted on a tag strip which is drawn in Fig. 2. I used a shielded cable with two wires to connect to the 5k ohm potentiometer and a single shielded wire to connect the VFO pin TP401 on circuit board IFAF, which is mounted behind the loudspeaker. (These references apply to the FRG-7 only. Constructors modifying other receivers should connection C2, the 10 pF capacitor, to the "hot" side of the VFO tuning capacitor. Screened lead should be avoided if possible for this connection by placing the tag strip as close as possible to the main tuning capacitor and using a short length of stout wire. The shunt capacitance of of the screened cable may cause excessive detuning and prevent proper alignment of the tuning.—Ed.)

The two black wires running from TP401 and TP402 on circuit board IFAF to the fine tuning capacitor on the front panel were removed. The fine tuning knob was removed from its shaft and the tuning capacitor carefully removed with the

aid of a pair of long-nosed pliers. The spindle of the 5k ohm potentiometer was cut to length and, as I wished to use the original knob, the shaft was filed to fit. The hole in the front panel was carefully drilled out to 3/8 inch diameter after covering the circuit board with a piece of paper to catch the metal particles. I ran a spare nut well back on to the potentiometer, placed it in the hole and screwed on a nut from the front. The rear nut was then tightened up after setting the potentiometer to give a symmetrical swing either side of the centre when the knob was fitted.

At the rear of the drum dial there is a metal bracket or plate formed from the chassis. The top screw in this bracket nearest the IFAF board was used to secure the tag strip which holds the extra components. Connections were made as shown in Fig. 2 to complete the modification.

The capacitance across the main tuning capacitor will be a little different to the original arrangement so a slight realignment is necessary. Set the receiver controls so as to receive VNG on 7.500 MHz, that is bandswitch to C, preset dial to 7 MHz, MHz dial to 7 and main tuning to 500. Select LSB and centre the RIT knob. Tune up and down until VNG is heard and peak the preset control. Set the index on the main tuning dial to dead centre by means of the dial set knob on the front panel.

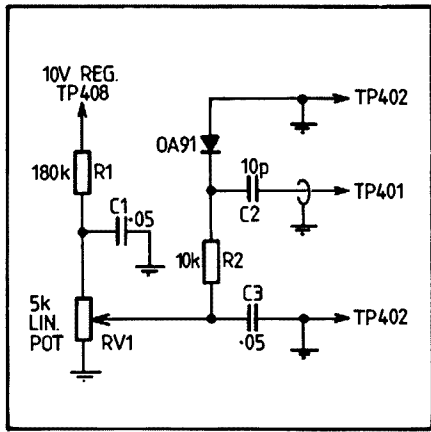

FIG. 1: RIT Circuit

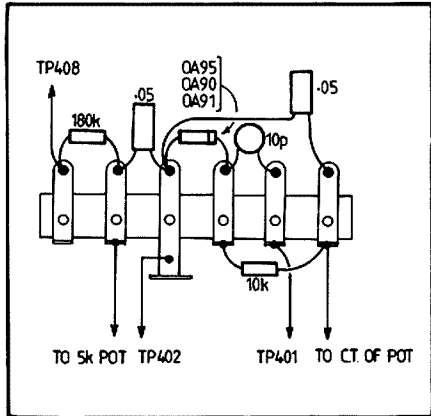

FIG. 2: Layout of RIT components

Unless you are very lucky the tuning will not indicate exactly 500. Locate trimmer capacitor TC403 on the IFAF board. There are three trimmers in a row and TC403 is the closest to the edge nearest the front panel. Adjust the tuning slightly so that the dial reads a little closer to 500 but still allows VNG to be heard. Turn TC403 so that VNG is again zero beat. Note the direction of adjustment. Set the main dial to 500 and tune VNG in exactly by turning TC403 in the direction noted. A pair of headphones will allow the most accurate zero beating of the signal.

Tune off VNG and peak trimmers TC402 and TC401 for maximum background noise. These two trimmers are next to TC403. This completes the adjustments.

I hope you are as happy with the RIT as I am. ■

# DATA TRANSMISSION — AND HOW COMPUTERS DO IT

Barry Ross VK6IF

Nowadays, communications are becoming more complex and none so much as in the area of computers. At one time a computer was a "black box" lucked away in a back room away from the public gaze, known only to an elite few. Now Visual Display Units or VDUs and other terminals are springing up everywhere and more people are being exposed to the power of the computer. But how do we connect a VDU to a computer miles away and perhaps in another country? This article will, I hope, help to explain how it's done.

If the VDU is in the same building or complex then it is usually cabled directly to the parent computer. But if the VDU is remotely placed we must use the telephone network to connect it to the computer. The telephone system will transfer the data from computer to VDU and back again, but in a form that is not compatible with the computer or VDU, so it is converted at either end by a device known as a Modem. In its simplest form the Modem is a big brother to the well known ST-5 and similar in operation. The name Modem stands for MO-dulator-DEM-odulator.

Computers use the transmission codes known as ASCII or EBCDIC. ASCII stands for the American Standard Code for Information Interchange and is an 8 bit code having 7 data bits and one check bit called a parity bit. The EBCDIC code has 9 bits, 8 data and one check bit. The check bit is to ensure that if the character is corrupted it can be detected at the other end, error recovery can be started to re-transmit the characters so the VDU operator sees only correct data on the screen. In the higher speed transmission such as 2400 or 4800 baud another check method also is used as well as a parity bit. It is called a Block Check Character (BCC) and is made up of an addition of all the bits in a block of characters such as 256 characters and is sent at the end of the block. The VDU or computer which is receiving the block of data generates its own BCC and then compares it with the BCC received to see if the block contains any errors. By this means all error characters can be caught before they reach the screen or are printed no matter how bad the line is.

The low speed Modem sends tones down a telephone line in response to the computer making an input to the Modem +6 volts for a space or -6 volts for a mark just like an RTTY machine drives an AFSK generator. However, a telephone circuit has a response of 300 to 3300 Hz and if we keep the speed of transmission and therefore the bandwidth down it is possible to fit two sets of mark/space tones into one telephone line. This means we can have data going in both directions at the same time and this is called FULL

DUPLEX. However this is limited to speeds up to 300 bauds so to have Full Duplex at faster speeds we must use private lines and they cost a whole lot more. So for faster speeds on normal telephone lines a system called HALF DUPLEX is used. In this system we only use one set of tones and one Modem is in receive and the other is in transmit when data is sent and the Modems "turn around" to send any replies. If no data is being sent both Modems are in receive mode. The direction of transmission is controlled by the computer or VDU, depending on which one wants to transmit. This is a faster version of an RTTY contact. Fig. 1 shows Full and Half Duplex.

On faster speeds such as 2400, 4800 and 9600 bauds the bandwidth is too great to use two tones even on private lines, so we must use a different method of encoding our data. The data we are sending is formed of marks and spaces. If we say a space is represented by a 0 and a mark by a 1 we can write the condition of two consecutive bits as 00, 01, 10 or 11. If we send a single tone down the telephone line we can change its phase to represent

one of the four states of the two bits. Fig. 2 shows this. As we are sending two bits for one phase change we are halving the transmission speed down the telephone line so a 2400 baud computer link actually runs at 1200 baud to the remote end where it becomes 2400 baud again. At 4800 baud we encode 3 bits for one phase change and at 9600 we encode 4 bits. 9600 baud is the fastest speed that can be sent on normal telephone lines and even then they must be very high class lines.

There are three basic character timing methods to ensure that the computer and its terminal stay in time. At low speeds the same method as used in RTTY is popular, that is a start bit and a stop bit surrounding the data. At higher speeds this is a large overhead so we do away with the start and stop bits, and use a special character called SYN repeated up to four times at the start of each transmission which the VDU or computer recognises. As there are a number of marks and spaces in the character we can decide not only the first bit of the first data character but also the centre of each bit so that we can tolerate distortion. This timing is kept for the duration of the block and is re-established for each transmission. The third method is similar to the second in that we still use the SYN character to tell us where the data characters starts but the bit timing is formed by the Modems which synchroise each other by sending bit patterns when no data is being sent. The Modem provides a clocking signal to the computer and VDU to tell it when to put a bit on the line. The data throughout is the same for the last two methods but the latter one seems to be preferred by the industry.

Well, that may have explained basically how it is done. It is not the full story as we have not covered items such as Polling, Multi-drop, Paket System, and the like, but that would take much more space. I hope it may make those VDUs seem simpler.

Reproduced by courtesy of AARTG No. 12.

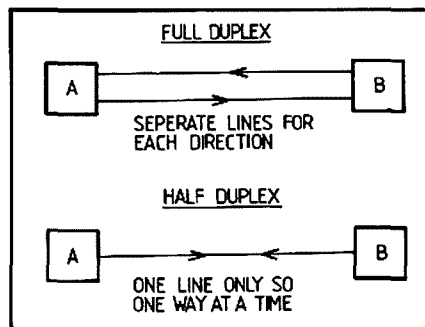

FIGURE 1

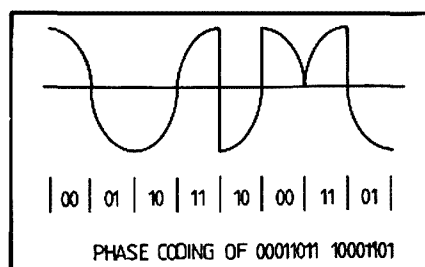

FIGURE 2

**PHOTOGRAPHS FOR AR**  
Don't keep them to yourself  
**SEND THEM IN — NOW**

# "WINNIE" THE WAR WINNER

Reproduced from "Army" August 30 edition. Grateful appreciation is acknowledged to Major J. Hancock, OC/Editor, in allowing us to use this article.

In 1942, when the tide of Japanese success had engulfed the Pacific almost to Australia's shores, a tiny Aussie force was engaged in a ceaseless war against 15,000 Japanese troops on Portuguese Timor.

Its communication with the mainland was severed in February and, for almost two months, the fate of the 400-strong group was unknown.

Then, on April 18, Darwin received a transmission from Timor, and all Australian stations were warned to keep off the air and listen for more signals the following night.

They did not know that they were listening for transmissions from a conglomeration of salvaged and stolen radio equipment — including a Dutch power-pack, a Japanese battery charger, pieces of bamboo, and part of a metal can.

When the Japanese landed at Dili, Portuguese Timor, on February 10, 1942, 20 men of 2/2nd Independent Company managed to blow up the airstrip and fight their way back into the hills.

There they joined the Australian garrison of 400 commandos, known as "Sparrowforce", who were fighting a bitter guerilla war against the enemy—in spite of the fact that contact with the mainland had been severed.

It was vital for them to re-establish communications with Australia.

Soldiers of Independent Company, the Fortress Signals Section, and men of Signals, 8 Aust. Div., therefore pooled their resources to build a wireless set—their target would be Darwin.

They began their task, working from scratch without spare parts or batteries.

Sets they possessed were too weak, so a system of scrounging and raiding was organised.

The scroungers recovered buried and damaged equipment, while raids were made by fighting sections into enemy camps.

Both played their part in the construction of a set which would be nick-named "Winnie the war-winner" by its creators.

First plan was to build an oscillator with a stage of amplification necessary to work on the frequency previously used in communication with Australia.

With no receiver or instruments, this was a tall order.

But Capt. George Parker, with four men, Cpl. John Sargent, L.cpl. Max Donovan, Sig. Max "Joe" Loveless, and Sig. K. Richards, tackled the job.

Sig. Loveless, in civilian life, was a technician with 7ZL, Hobart.

He began by building a transmitter with a crystal which, by luck, was close to the required frequency.

Power supply was a problem and the two available accumulators were nearly flat.

News was received that there was a charging plant in a nearby village, and the accumulators were carried there under escort to be charged.

The method of charging was quite novel.

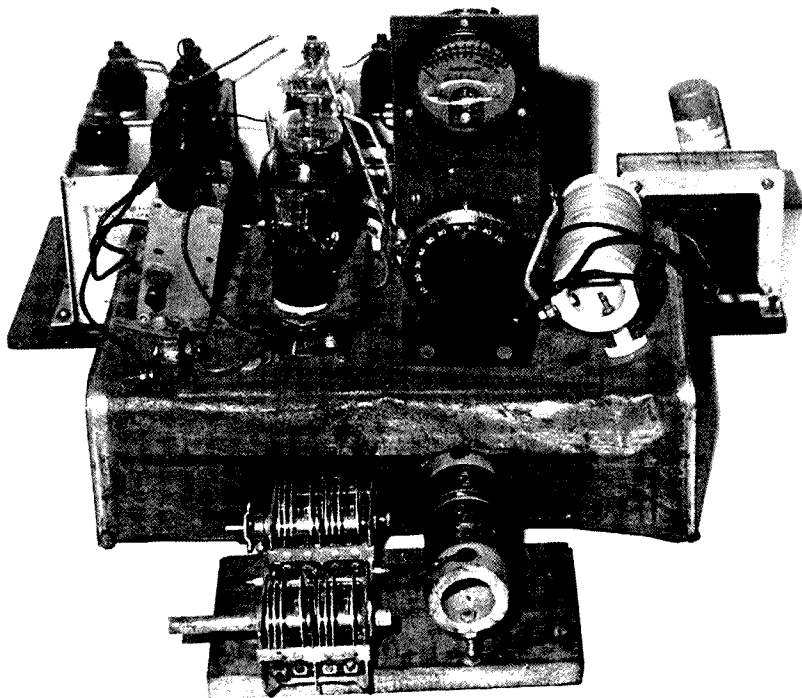

"Winnie" as she appears in the Australian War Memorial, Canberra, today

A procedure which was adopted quite a few times eventually became known as the "boong charger".

A system of wheels, and a belt driving a car generator, was turned by natives.

As their enthusiasm for the job fluctuated, so did the charging rate.

Later, a broken-down 109 set was discovered, and the transmitter was stripped for parts to provide another amplifier for the oscillator — giving more punch, stronger signals, and a better chance of being heard.

Sig. Loveless planned the circuit and asked the commandos to keep their eyes peeled for useful parts.

Cpl. Donovan went on a scrounging trip to Attambooa, on the north coast, and returned with a power pack from a Dutch transmitter, two aerial tuning condensers,

20m of aerial wire, and a receiving set.

The task of building "Winnie" went ahead without delay.

Coils were wound on to bamboo formers, accumulators were recharged, points were soldered and valve sockets were made.

In the absence of precious tools and instruments, guesswork was a major ingredient.

A battery charger was recovered from the enemy when 14 commandos went through the Japanese lines to the old Australian HQ at Villa Maria.

The commandos, while only 100 m from the Japanese, dug up a charger which was buried when the HQ was forced to move.

On April 13, it was all systems go.

The operator tried to raise Australia, but no reply was received.

As the dial of the receiver turned, sounds of music floated through the small radio shack.

Some troubadours were entertaining their audience with "The Last of the Hillbillies".

On April 18, after the transmitter was revised, another attempt was made to contact the mainland.

Again no reply was received, but the men's disappointment would have been allayed had they known that their signals were picked up and passed on to Darwin.

All Australian stations were warned to keep off the air, and to listen for Timor on the following night.

A few days before April 19, "Sparrow force" HQ had given the operators two coded messages "just in case".

"Joe" Loveless tuned up the rig, and a group of soldiers bunched around the set.

The "brass was pounded" and the call was given highest priority.

Although the operator was prepared to continue for a number of hours, a strong signal replied almost immediately.

With suppressed excitement he tapped out his answer.

A tin of tobacco, kept for such an occasion, was opened in celebration and a toast in coffee was drunk to "Winnie".

On the following night, contact was established again, but this time Darwin was suspicious and demanded proof of the guerillas' identity.

Messages flashed across the Timor Sea: "Do you know Jack Sargent?"

"Yes, he is here."

"What rank? Answer immediately."

"Corporal."

"Bring him to the transmitter."

"What is your wife's name, Jack?"

"Joan."

"What is your street and house number?"

The correct answer was given, and the Australian mainland knew that Aussies were alive and fighting in Timor.

On April 27 an Allied plane flew over and dropped parachutes with precious food and stores.

Bush wireless received the news and men who had been bare-footed to save their boots for active work were issued with new pairs.

"Winnie" had done her job.

No time was wasted in asking for bombing targets—which were promptly supplied.

Allied bombers passed overhead on their way to giving the Japanese a taste of their own medicine.

On one occasion a convoy of three enemy ships was sighted, and a message dispatched to the mainland.

The RAAF sank all three ships.

As a fitting climax to her career, "Winnie" guided the rescue party which eventually took the guerillas out of Timor.

"Winnie" now resides in the Australian War Memorial, Canberra—a symbol of Australian ingenuity in the face of great difficulty.

# A FIVE BAND VXO FOR THE FT 75

Ian Berwick VK3ALZ  
107 Loongana Ave., Glenroy 3046

**The FT75 is a handy little unit. On a watts per dollar basis it is hard to beat. The main disadvantage is its limited coverage with the internal VXO. An external VFO can be used, however this can be prone to vibration induced frequency excursions when mobile. The solution adopted by the author is a VXO with some novel features.**

which is filtered before being presented to the transceiver.

The specification of the VXO is as follows:

Band (MHz)	VXO output (MHz)
3.5	8.6724 - 9.1724
7.0	12.1724 - 12.6724
14.0	8.8276 - 9.3276
21.0	15.8276 - 16.3276
28.0	11.4138 - 11.9138

Compared to an LC VFO a VXO is several orders of magnitude better for frequency stability under all conditions. Experiments showed that the frequency swing required—100 kHz—could be obtained using HC-25 crystals in the 26 to 28 MHz region if they were subsequently doubled to 53 MHz. For a 500 kHz range five crystals were required, plus one heterodyning crystal per band or ten in total.

Now since the frequencies for 3.5 MHz and 14 MHz are almost the same and the frequencies for 7 MHz and 28 MHz are reasonably close only, three frequency converters were used to cover the five bands.

The block diagram of the system is shown in Fig. 1. The basic VXO covers 26.550 to 26.800 MHz in five ranges. Then the output is doubled to give a continuous range of 53.100 to 53.600 MHz which is filtered to reduce spurious signals that could be generated. A switch is used to select a converter and associated heterodyne carrier generator. This provides the required signal frequency for the FT75

Note that because the FT75 doubles the external VFO frequency internally for 28 MHz operation on this band the VXO covers 1 MHz in five 200 kHz sweeps. The output voltage is in the range of 250 to 700 mV RMS which matches the requirement of the FT75 mixer. The spurious product frequencies were calculated by Alan VK3ZHU and Ron VK3AFW, and only one of significance was predicted. This was in the 21 MHz band and is well attenuated in practise by the filters, and the screening employed.

The VXO was built in three separate compartments, one containing the VXO and associated doubler, one the carrier generator and the third the converter units. Each of these compartments are 7 1/4 in. x 3 1/2 in. x 4 3/4 in. diecast boxes. The carrier filter units are built into small tinplate enclosures external to the main boxes. This makes the VXO rather bulky, however there is plenty of scope to make a more compact arrangement.

The VXO has been in use now for several years at home and in the vehicle while mobile with excellent results. The stability is excellent and no report of frequency shift has been received.

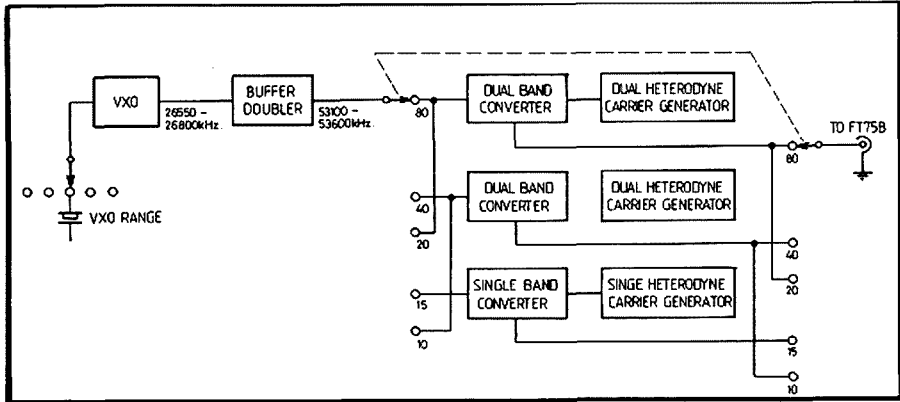

FIG. 1: FT75B VXO Block Diagram.

FIG. 2: 26 MHz VXO.

X1 = 26590 kHz  
 X2 = 26640 kHz  
 X3 = 26690 kHz  
 X4 = 26740 kHz  
 X5 = 26790 kHz  
 (All crystals HQ GC25A)  
 RFC = Single wire through F29 slug  
 L2 = 7.5 uH  
 L1 = 30t 32 B and S on single neosid  
 F29 slug  
 C1 = 2-10 pF concentric ceramic trimmer  
 C2 = 5-100 pF polar single gang  
 L3-L4 — dual neosid 20th each 32 B and S F29 slug

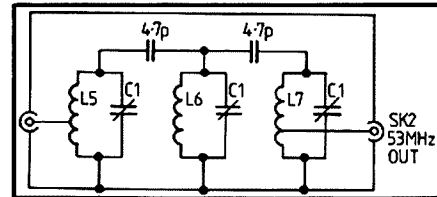

FIG. 3: VXO Doubler and 53 MHz Filter.

C1 = 2-14 pF Ceramic disk Trimmer.  
 RFC1 = 100 uH.  
 L3, L4, L5, L6, L7 7 turns 1/2 in. diam.  
 16 B and S.  
 L4, L5, L7 tap 1 turn.  
 L1, L2 11t on Aegris 3/8 in. slug tuned former.  
 L2 tap one turn from cold end.

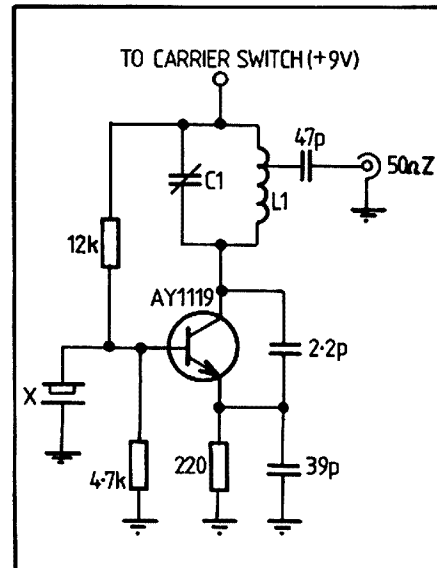

FIG. 6: Single Carrier Generator.

X = 3723.0 kHz (QC 25A3 — HiQ)  
 L1 = 6 turns 1/2 in. ID tap 1 turn 16 B and S.  
 C1 = 2-14 pF ceramic disk trimmer.

**NOTES ON THE CONSTRUCTION AND ALIGNMENT**

**VXO**  
 The 26 MHz VXO should be built first and aligned as follows:

(1) Tune L3 and L4 to give 200-500 mV RF output at the emitter of the 2N3563 with any crystal selected. If no oscillations occur set C2 mid-range and tune L1 for

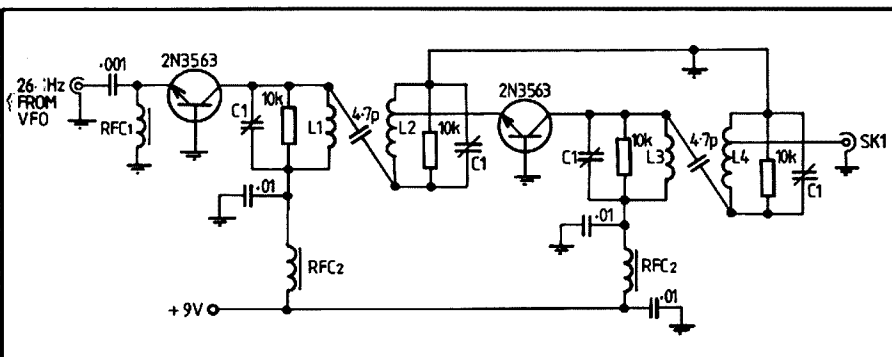
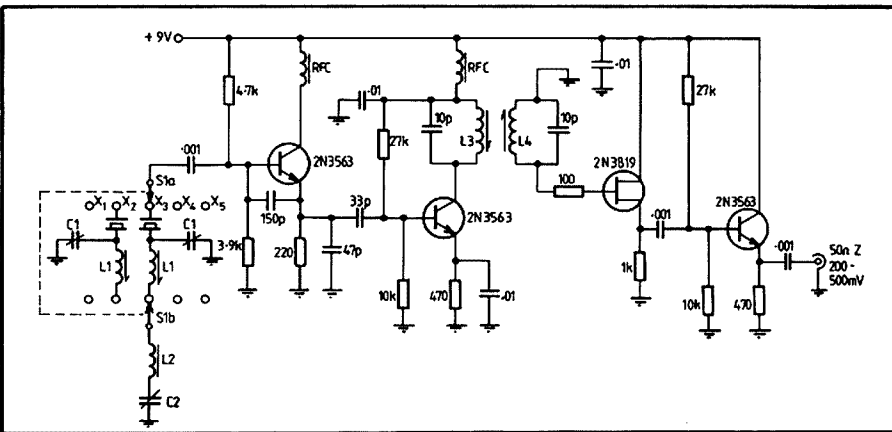

FIG. 4: Converter Unit.

**NOTE:**  
 One each converter for 80/20m.  
 One each converter for 40/10m.  
 One each converter for 15m.  
 RFC = Single wire through F16 slug.  
 T1, T2 dual neosid.

TABLE 1: Table of Values — Converter Unit.

Band	T1 Turns	T2 Turns	Tertiary	C1	C2	Slug
80/20	P 30t CT	P 30t		47 pF	47 pF	F16
	S 30t	S 30t	4t			
40/10	P 29t CT	P 29t		47 pF	47 pF	F29
	S 29t	S 29t	4t			
15	P 25t CT	P 25t		33 pF	33 pF	F29
	S 25t	S 25t	4t			

Wire Gauge 32 B and S enamel.

\* If output volts for converter is not in the range 300-700 mV change number of turns on tertiary winding of T2.

This Tertiary winding is over the cold end of T2 Secondary.

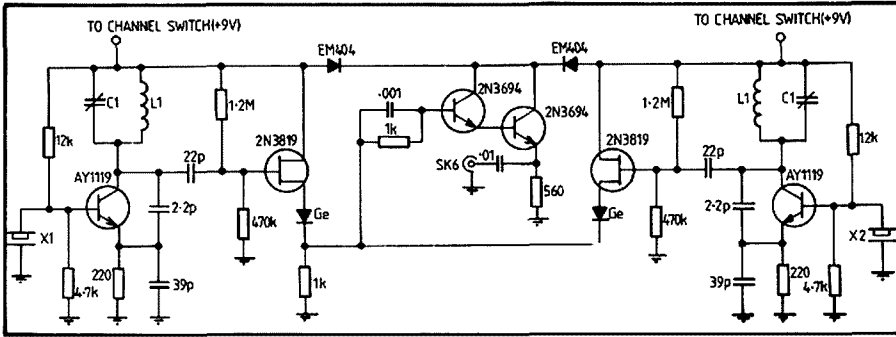

**FIG. 5: 2 Channel Carrier Generator (2 off required)**

	xtal	Band
X1	= 44428.0 kHz	80m
X2	= 40928.0 kHz	40m
X3	= 44273.0 kHz	20m
X5	= 41686.0 kHz	10m

(All crystals — QC25A3 — HiQ)

C1 = 2-15 pF Trimmer (Ceramic).  
 L1 = 6 turns ½ in. ID  
 16 B and S enamel.

the appropriate crystal until oscillations are obtained.

(2) Connect a frequency meter and check that approximately 50 kHz tuning range can be obtained. Adjust L1 and C1 until a linear sweep of 50 kHz is obtained for 0 to 95 per cent of the dial sweep.

The dial can then be marked for, say, 10 kHz steps or a tabulation made of frequency against the dial's arbitrary scale.

Repeat the procedure for the remaining ranges.

**VXO DOUBLER**

Tune the various capacitors C1 to obtain a constant output at skt 1 over the range 53.1 to 53.6 MHz.

**53 MHz FILTER**

Adjust the capacitor C1 for constant output from 53.1 to 53.6 MHz at skt 2. The output should fall rapidly outside this range.

**CARRIER GENERATORS**

There is only one adjustment for each crystal — tune C1 for maximum level of oscillation at skt 6.

**CARRIER FILTERS**

Align the filters for maximum throughput of carrier energy by adjusting C1.

**CONVERTER UNITS**

With appropriate carrier generator plus filter connected and the VXO doubler and filter also connected attach a sensitive RF detector to the output of the converter. Adjust T1 and T2 to give a constant output over the range applicable. An output of 250-700 mV should be obtained.

**FREQUENCY CALIBRATION**

The VXO setting up procedure has already been described. If five scales are provided these can be used for individual calibrations for each 100 kHz range. With a good dial, readout accuracy to 1 kHz is achievable. The next step is to set the carrier oscillators so that the VXO readout is accurate for each band. Select 3.5 MHz and set the VXO dial to 0 (53.100 MHz) and check the output frequency. If it is not 8.6724 MHz adjust the 44.428 MHz crystal by adding shunt C or series L. It is assumed that the carrier generator in the FT75 is on 5.1724 MHz. It would be wise to check the CW output frequency of the rig. The adjustments for the other bands are made in a similar manner. Note

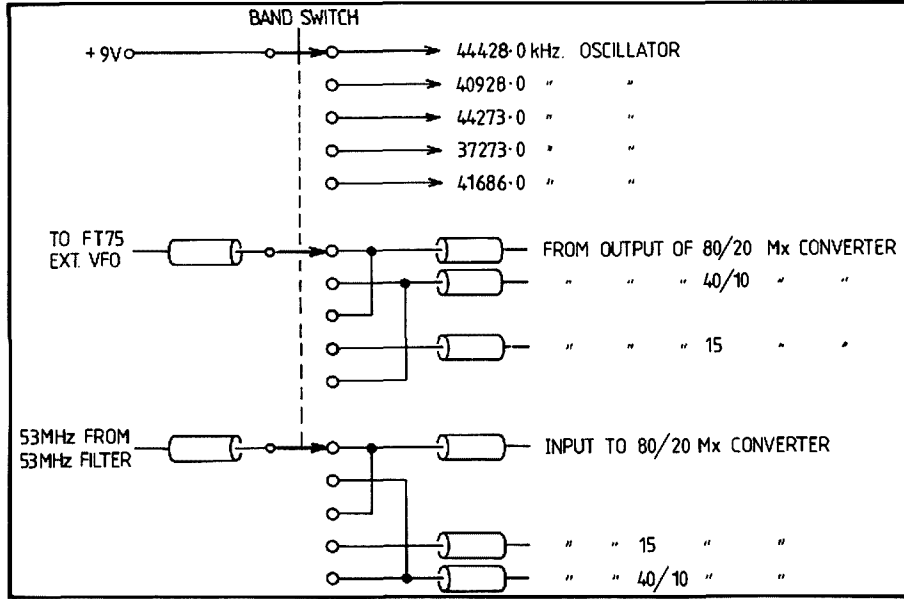

**FIGURE 7: Band switching**

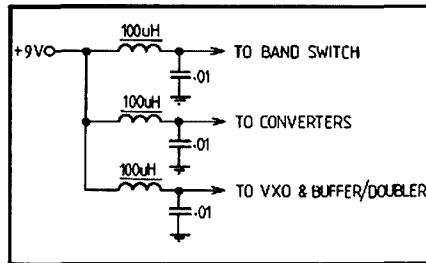

**FIG. 8: Supply filters**

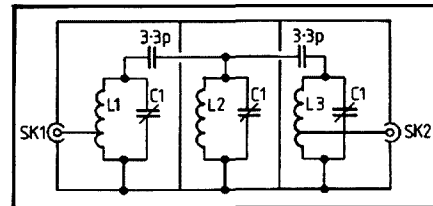

**FIG. 9: Carrier filters**

L1, L2, L3, 7 turns 5/8 in. ID tap L1, L3 one turn C1 2-14 pF ceramic disk trimmer. One filter required between each carrier generator and band switch.

that 500 kHz needs to be added to the dial reading for 3.5 MHz only.

The band-switched heterodyne VXO principle of frequency synthesis is, as far as the author is aware, a new development and therefore copyright is reserved on the following circuits and drawings:

1. 26 MHz VXO unit.
2. Block diagram.
3. Two band carrier generator circuit.

No restriction is placed on use of these by groups or individuals for hobby purposes. ■

**REPORT ALL  
INTRUDERS TO  
THE INTRUDER  
WATCH  
CO-ORDINATOR  
IN YOUR STATE**

# AT VICOM WE'VE GOT THE BALANCE OF POWER!

## \* MORE OUTLETS

We've over 250 outlets scattered throughout

## \* PRODUCT & DEALER QUALITY

The Vicom product line-up and our dealers are carefully selected to provide the best possible service.

## \* TECHNICAL BACK-UP

At Vicom all transceivers sold are pre-delivery checked and backed by our 90-day warranty.



### MAJOR VICOM DEALERS

#### NEW SOUTH WALES

Sydney 635 6399  
Wagga 21 2125  
Newcastle 69 1222

#### VICTORIA

Melbourne 836 8635  
Shepparton 21 9760  
Bacchus Marsh 67 2244  
Horsham 72 2156  
Ouyen 3490  
Yarram 86 1254  
Wangaratta 25 7207

Ballarat 32 7234  
Benalla 62 1376  
Geelong 78 9660  
Bendigo 43 1977  
Ballarat 39 2808  
Swan Hill 32 2253  
Kyabrum 52 2253

#### SOUTH AUSTRALIA/

N.T. Adelaide 43 7981  
Adelaide 272 8417

Darwin 81 3491  
W. AUSTRALIA  
Perth 321 3407  
Perth 446 3232

#### QUEENSLAND

Brisbane 48 6601  
Brisbane 38 4480  
Gold Coast 32 2644  
Bundaberg 72 3288  
Mackay 57 5918  
Rockhampton 28 2843

Cairns 54 1035  
Ipswich 288 8535  
Townsville 72 2633

#### TASMANIA

Hobart 43 6337  
Launceston 44 3882  
Launceston 31 3945

#### NEW GUINEA

Lae 42 4999

#### NEW ZEALAND

Wellington 287 946

### OFFICES AT:

- \* Melbourne
- \* Sydney
- \* New Zealand

### Daiwa Low Pass Filters

FD30LS 32 MHz Fc. 200 w. 3 stages — \$20.00

### Baluns

AS-BL Asahi 50 ohm for beams — \$34.00  
BL50A 50 ohm 4 KW. 1.1 for dipoles — \$32.00  
BL70A 70 ohm 4 KW. 1.1 for dipoles — \$32.00

### Leader Test Equipment

LAC 895 Antenna Coupler 3.5 — 28 MHz — \$182  
LPM 885 SWR/PWR Meter — \$97  
LPM 880 RF Power Meter — \$139  
LDM 815 TR Dip Meter — \$89.00  
LBO 310 3" Ham Oscilloscope — \$330  
LA 31 Ham monitor scope adapter — \$26.00  
LSG16 Signal Generator — \$119.00  
LSW250 TV-FM Sweep Generator — \$429.00  
LAG26 Audio Generator — \$166.00

### Tubes

6K06 Finals for Yaesu linears — \$10.00  
6JS6C Finals for Yaesu transceiver — \$10.00  
12BY7A Driver — \$4.75  
6146B Finals — \$13.00

### CW Filters

FT101E Yaesu — \$39.00  
TS520S YG3395 Kenwood — \$57.00  
TS820S YG88C Kenwood — \$59.00

### Morse Keys

HK702 Deluxe Key with marble base — \$41.00  
HK708 Economy Key — \$23.00  
HK706 Operator's Key — \$25.00  
MK701 Manipulator (side-swiper) — \$45.00  
PALOMAR 1C Keyer — \$149.00

### Jaybeam Antennas

5Y/2m 5el 2m 78 dBd gain, length 16 m — \$43.00  
8Y/2m 8el 2m 95 dBd gain, length 28 m — \$51.00  
10Y/2m 10el 2 m 114 dBd gain, length 44 m — \$84.00  
10XY/2m 10el 2m cross yagi, 113 dBd — \$114.00  
D8/70cm Twin 8el. 70 cm, 12.3 dBd, 1.1 m — \$64.00  
PBM 18/70 18 el. 70 cm, 14.9 dBd, 2.8 m — \$96.00  
MBM 48/70 48el. 70 cm, 15.7 dBd, 1.83 m — \$83.00  
MBM 88/70 88el. 70cm, 18.5 dBd, 3.98 m — \$105.00  
PMH/2C Phasing harness — \$20.00  
8XY/2m 2m cross yagi, 8el. 95 dBd, 2.8 m — \$99.00  
12XY/70 cm 70 cm cross yagi, 12el. 130 dBd, 2.6 m — \$139.00

### Nagara

SS56 6 m 5el beam 1 KW — \$159.00  
V5JR 80-10 m trap vertical, 6.7 m high — \$129.00  
V4JR 40-10m trap vertical, 5.2 m high — \$99.00

### Hy-Gain Antennas

204BA 4 el monobander for 20 m — \$259.00  
203BA 3 el beam 20 m — \$199.00

### Scalar

M22T 1/4 wave 2 m mobile whip, top only Qty 1-4 — \$7.00  
M25T 5/8 wave 2 m mobile whip, top only Qty 1-4 — \$14.00  
BASE 8/L for above — \$4.00

### Microphones

VM-1 Noise cancelling, hand ppt. low z — \$10.00

### Kenwood Transceivers

TS520S HF transceiver — p.o.a  
TS120S Solid state 100w — p.o.a  
TS120V Solid state 10W — p.o.a  
TS180S Solid state 10w — p.o.a  
R-1000 Communications Receiver — \$498.00

### Monitor Receivers

747 Vicom Aircraft Scanner — \$199.00  
210 Bearcat 210 scanner — \$469.00  
HF-12 VHF oocket 12 channels — \$149.00

### Coaxial Relays

CX-2L 1.8 thru 170 MHz, 100w pep — \$45.00  
CX-2H 1.8 thru 450 MHz, 200 w pep — \$69.00

### Coax Switches

CS201 2 position, commercial quality — \$23.00  
CS401 4 position, commercial quality — \$59.00

### Speech Processors

RF660 Phasing type, 6dB gain, dc — \$109.00  
RF440 Phasing type, 6dB gain, dc — \$109.00

### ICOM

IC701 HF transceiver — \$1199  
IC280 2m Remotable — \$450  
IC251A 2m All-mode — \$847  
IC551 6m 10 watts — \$799  
IC551D 6m 100 watts — \$850  
IC555D 2m Digital — \$425  
IC252A 6m portable — \$289

# VICOM

SYDNEY: 339 PACIFIC HWY, CROWS NEST  
PH 436 2766

MELBOURNE: 68 EASTERN RD, STH MELBOURNE.  
PH 699 6700



QUALITY ACCESSORIES FROM **DAIWA** **D'AIWA**

**NEW!**

## AUTOMATIC ANTENNA TUNER

CNA 1001 200W \$269  
CNA 2002 2.5 KW \$569

A new concept in antenna tuning.  
Patent pending. Write for details.

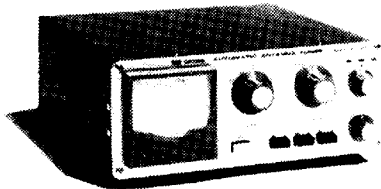

### SWR & POWER METERS

Model	Freq.	PWR	Cross-Needle	Price
CN620	1.8-150 MHz	20/200/1KW	yes	99.00
CN630	140-450 MHz	20/200	yes	135.00
CN650	1.2-2.5 GHz	2/20	yes	169.00
SW210A	1.8-150 MHz	20/120	no	99.00

Cross-needle type offer DIRECT readings.

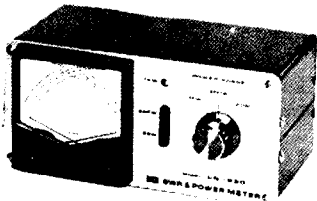

### ANTENNA COUPLERS

CL67A	1.9-28 MHz, 500 wpep	135.00
CNW217	Includes SWR/PWR Meter, 200W	165.00
CNW417	Includes SWR/PWR meter, 500W	199.00

High quality couplers, 2 models includes cross-needle SWR/PWR meters.

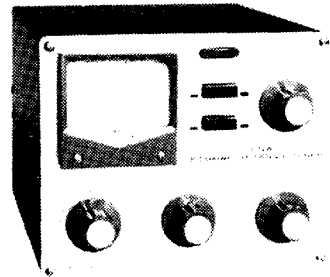

### SPEECH PROCESSORS

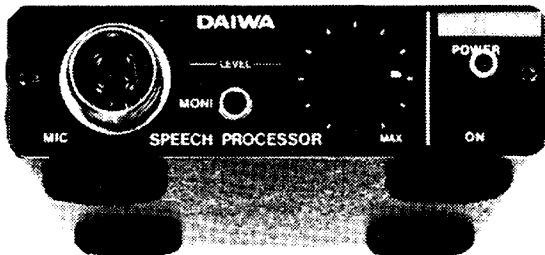

RF660	Phasing type dc	109.00
RF440	Phasing type ac/dc	126.00
RF550	Fitter type, ac/dc	169.00
MC330	Speech compressor	99.00

Increase talk power with splatter free operation. RF clipping (not in MC330) assures low distortion. Simply install between microphone and transmitter.

Typical specs RF660:  
Talk power: Better than 6dB  
Freq. Response: 200Hz-3000Hz at 12dB down  
Distortion: less than 3% at 1 KHz, 20dB clipping.  
Power Req.: 13.8 Vdc at 50mA.

### ROTATORS

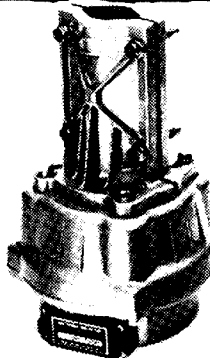

DR7500S	Medium Model	189.00
DR7600S	Heavy Duty Model	259.00

- \* High dependability: weather sealed
- \* Quiet operation
- \* Complete with attractive controller

Rotation Torque	DR7500S 500 Kg-cm	DR7600S 600 Kg-cm
Braking torque	2000 Kg-cm	4000 Kg-cm

### COAXIAL SWITCHES

2 Position model CS201	23.00
4 Position model CS401	59.00

Professionally engineered cavity construction, high isolation.

Power rating: 2.5 KW pep, 1 KW CW  
Impedance: 50 ohm  
Insertion loss: less than 2dB  
Maximum frequency: 500 MHz  
Isolation: Better than 60dB at 300MHz.

### COAXIAL RELAYS

CX2L 100W pep max model	45.00
CX2H 200W pep max model	69.00

Quality change-over relays use 10-15 vdc.  
Frequency Range: CX2L 1.8-170 MHz.  
CX2H 1.8-450 MHz.

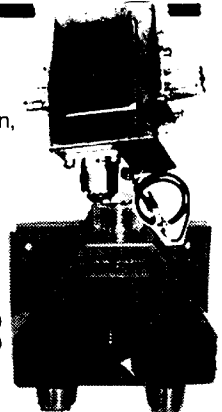

# VICOM

**SYDNEY:** 339 Pacific Hwy, Crows Nest  
Ph. 436 2766

**MELBOURNE:** 68 Eastern Rd, Sth Melb.  
Ph. 699 6700

# HANDY 2M FM/SSB MOBILE!



## IC260A



### FEATURES

#### \* 2m ALL-MODE TRANSCEIVER INCORPORATING A MICROCOMPUTER

CPU control with ICOM's original programs provides various operating capabilities. No back-lash dial controlled by ICOM's unique photo-copper circuit. Band-edge detector and Endless System provides out-of-band protection. No variable capacitors or dial gear, giving problem-free use. The IC-260A provides FM, USB, LSB, CW coverage in the 143.8 — 148.2MHz frequency range. Thus the IC-260A can be used for mobile, DX, local calls, and satellite work.

#### \* MULTI-PURPOSE SCANNING

Memory Scan allows you to monitor three different memory channels. Program Scan provides scanning between two programmed frequencies. Adjustable scanning speed. Auto-stop stops scanning when a signal is received, in all modes.

#### \* DUAL VFO'S

Two separate VFO's can be used either independently or together for simplex operation, and any desired frequency split in duplex operation.

#### \* CONTINUOUS TUNING SYSTEM

ICOM's new continuous tuning system features an LED that follows the tuning knob movement and provides an extremely accurate readout. Frequencies are displayed in 7 LED digits representing 100Hz digits.

Automatic recycling restarts tuning at the top of the band, i.e., 145.999.9MHz when the dial goes below 144.000.0MHz. Recycling changes 148.199MHz to 143.800.0MHz as well. Quick tuning in 1 KHz steps is available, and fine tuning in 100Hz steps in the SSB and CW modes, and 5KHz steps and 1KHz steps in the FM mode, is provided for trouble free QSO.

#### \* OUTSTANDING PERFORMANCE

The RF amplifier and first mixer circuits using MOS FETs, and other circuits provide excellent Cross Modulation and Two-Signal Selectivity characteristics. The IC-260A has excellent sensitivity demanded especially for mobile operation, high stability, and with Crystal Filters having high shape factors, exceptional selectivity.

The transmitter uses a balanced mixer in a single conversion system, a band-pass filter and a high-performance low-pass filter. This system provides distortion-free signals with a minimum spurious radiation level.

#### \* ADDITIONAL CIRCUITS

The IC-260A has a built-in Noise Blanker, CW Break-in, CW Monitor, APC, and many other circuits for your convenience. The IC-260A has everything you need to really enjoy VHF operation, in an extremely compact, rugged transceiver. Comes complete with mic, mobile mounting bracket and English manual.

#### \* BACKED BY VICOM

90 day warranty and technical/spares support.

### Typical Technical Characteristics (Australian model)

**GENERAL.** Number of semi-conductors: Transistor 72, FET 9, IC 44, Diode 90. Frequency coverage: 143.8000 — 148.1999MHz. Frequency resolution: SSB 100Hz steps FM 5KHz steps, 1KHz steps with TS button depressed. Frequency Control: Microcomputer based 100Hz step Digital PLL synthesiser. Independent Transmit-Receive Frequency Capability. Frequency Readout: 7 digit LED 100Hz readout. Frequency stability: Within  $\pm 1.5$ KHz. Memory channels: 3 channels, any inband frequency programmable. Usable conditions: Temperature:  $-10^{\circ}\text{C} - 60^{\circ}\text{C}$  ( $14^{\circ}\text{F} - 140^{\circ}\text{F}$ ) Operable time: Continuous. Antenna impedance: 50 ohms unbalanced. Power supply supplement: 13.8V DC  $\pm 15\%$  (negative ground) 3.5A Max. Current drain (at 13.8V DC). Transmitting SSB (PEP 10W) Approx 2.2A. CW, FM (10W) Approx 3.1A. FM (1W) Approx 1.6A. Receiving At max audio output Approx 0.8A. Squelched Approx 0.6A. Dimensions: 64mm (H) x 185mm (W) x 223mm (D). Weight: Approx 2.7Kgs. Warranty: 90 days when purchased from authorised dealers. **TRANSMITTER.** Output power: SSB High 10W (PEP) Low 1W (PEP), CW High 10W Low 1W, FM High 10W Low 1W. Emission mode: SSB (A3J, USB/LSB), CW (A1), FM (F3). Modulation system: SSB Balanced modulation; FM Variable reactance frequency modulation. Max. frequency deviation:  $\pm 5$ KHz. Spurious emission: More than 60dB below peak power output. Carrier Suppression: More than 40dB below peak power output. Unwanted Sideband: More than 40dB down at 1000Hz. AF input: Microphone: 1.3K ohm dynamic microphone with built-in preamplifier and push-to-talk switch. **RECEIVER.** Receiving system: SSB, CW Single conversion superheterodyne. FM Double conversion superheterodyne. Receiving Mode: SSB (A3J, USB/LSB), CW (A1), FM (F3). Immediate Frequency: SSB, CW 10.75 MHz, FM 10.75MHz, 455KHz. Sensitivity: SSB, CW Less than 0.5 microvolts for 10dB S+N+D/N+D at 1 microvolt. Less than 0.6 microvolts for 20dB Noise quieting. Squelch sensitivity: Less than 0.4 microvolts. Spurious response rejection ratio: More than 60dB. Selectivity: SSB, CW More than  $\pm 1.2$ KHz at  $-6$ dB point. Less than  $\pm 2.4$ KHz at  $-60$ dB point. FM More than  $\pm 7.5$ KHz at  $-6$ dB point. Audio output power: More than 2W. Audio output impedance: 8 ohms.

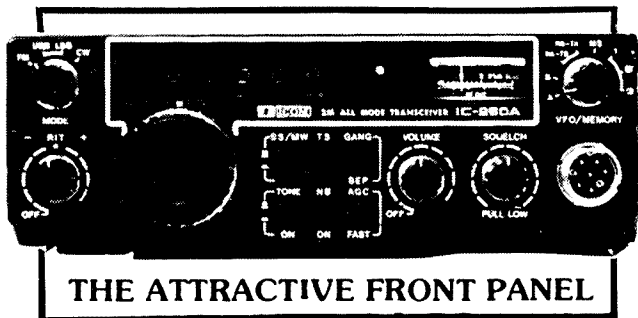

THE ATTRACTIVE FRONT PANEL

# VICOM

Check it out at your VICOM dealer.

# MODIFICATIONS AND IMPROVEMENTS TO KYOKUTO VHF TRANSCEIVER

C. Maitland VK5ZAW  
 10 St. Albans Ave., Toorak Gardens 5065  
 N. Abraham VK5ZJA  
 Unit 5, 50 Vule St., Magill 5072

This article has been adapted from an article originally printed in the WIA SA Division.

## IMPROVING 1st IF RESPONSE

This modification is aimed at improving the receiver section with respect to weak, off-frequency, or heavily deviated signals. As with many other modern narrow-band units the standard Kyokuto mute and audio system can be susceptible to "popping" under the above conditions, the severity depending on the way the receiver was aligned. Most amateurs tend to tune their newly-acquired units to ensure maximum sensitivity. The way this is done is to get a weak, steady signal source and peak the receiver for maximum signal strength or maximum quieting. Whilst this may improve the basic sensitivity for an unmodulated carrier, in the Kyokuto any reasonably high modulation now causes the mute to close, as the IF bandwidth is

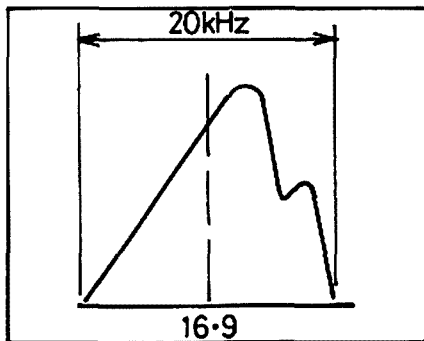

FIGURE 1

now very narrow, with shape likened to a church steeple as in Fig. 1. Notice also that the peak is not on centre frequency due to mismatch of the 16.9 MHz filter.

The factory has partially overcome this problem by their method of alignment, which can only be described as a fiddle to cover up a basic design fault. They do not tune the receiver for maximum sensitivity, but for minimum distortion on a Noise and Distortion Meter, with the required deviation applied from a Signal Generator. This has the effect of broadening the IF response to detuning associated transformers to match the filter, but the sensitivity decreases. A standard Kyokuto, as received from the factory, was swept on a spectrum analyser and gave a picture

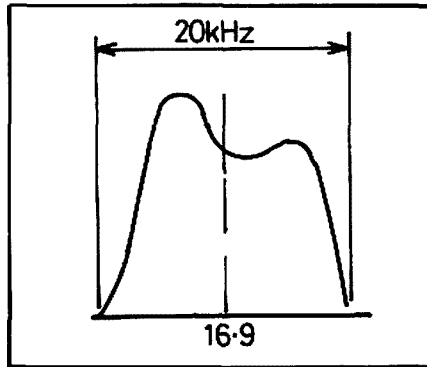

FIGURE 2

as in Fig. 2. Still obviously not good. If the IF is swept carefully with a good spectrum analyser or sweep generator whilst aligning it is possible to get a symmetrical response as in Fig. 3, but as you see it is still far from satisfactory, having somewhere near a 10 dB hole in the middle. All these problems are due to the incorrect matching of the mixer drain coil to the first IF filter (16.9 MHz). By correctly matching this filter to the mixer output a response as in Fig. 4 can be obtained. This shape is ideal as you can see, with 20 kHz passband, less than 2 dB ripple and very symmetrical.

Matching of the filter can be done in several different ways, all achieving similar results. We believe the easiest, quickest effective way is to fit a small active match-

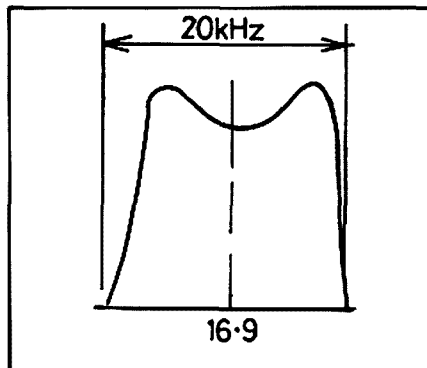

FIGURE 3

ing circuit. Simply a source-follower circuit, it allows the filter to "look" into a low impedance source, while the drain of the mixer can operate into a "high Z" load, enabling this coil to be peaked for maximum gain. This modification has been carried out with pleasing results.

## KYOKUTO IF FILTER MODIFICATIONS

Slip cover off Kyokuto, undo 4 screws securing the receiver board and tip the board over to expose the tracks. Cut track between Q2 drain and filter input circuit. Solder the Fig. 5 modifications coupling capacitor, FET and resistors to the underside of the PCB, keeping all leads as short as possible. Check that you have the correct pin connections for the FET which you use as they are not all identical. The +9 volt rail is picked up from one of the

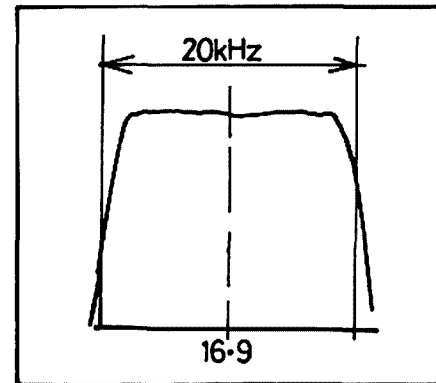

FIGURE 4

47 ohm decoupling resistors. Replace the board after very careful checking of all work. Turn on, find a weak but steady signal and reapeak coils L5, L6 and L7. No fancy test equipment is required.

The increase in gain due to this modification is about 10 dB. You will now have a flat bandpass, a receiver as sensitive as the best and be far less troubled by heavily deviated signals. If any popping now exists, it is purely over-deviation from the transmitting station. Unfortunately, rigs received in VK are not adjusted to a standard deviation, but vary from one brand to another. If the deviation is too

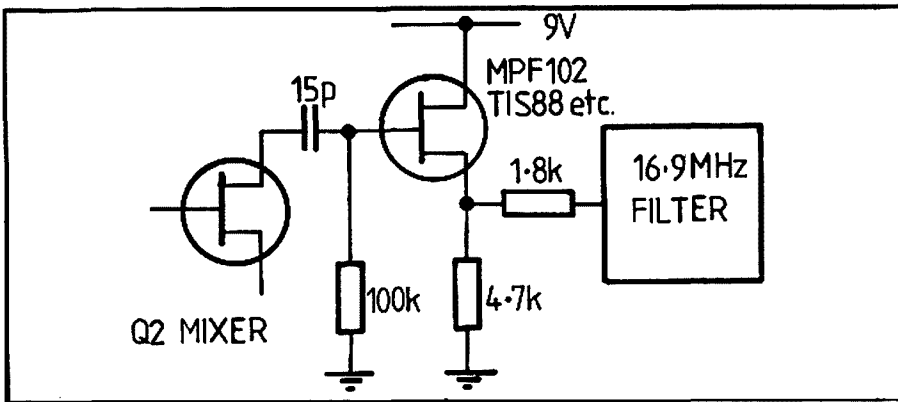

FIGURE 5

high, speaking back from the microphone is no cure. This also must be adjusted.

**INCREASING OUTPUT POWER**

To improve output power and reliability of units such as the Kyokuto and others, some attention must be placed on the output stage. Look for a small 30 pF variable capacitor in parallel with the series output tuning trimmer, in the PA section under a small clip-on lid. Many of these capacitors have failed in service and why they are fitted is a real mystery. Removal of this partly-meshed capacitor immediately permits a rise in output power which indicates that the capacitor is slightly lossy.

Reproduced from Westlakes Radio Club Monthly Newsletter May 1979.

# ANOTHER AF FILTER

Jim Jones VK8ZJJ

This simple circuit endeavours to improve the performance of a receiver that lacks the desired band-pass parameters.

No claim is made for the originality of this circuit; in fact, it is adapted from a well known British circuit originally published in the RSGB Handbook. However, it has been modified to operate on a rail voltage of 12, and has selectable bandwidth characteristics.

This circuit has been incorporated into a number of FRG-7 receivers, replacing the original passive tone control circuits.

**OPERATION**

A twin "T" network is used with two field effect transistors to obtain the desired characteristics. The gain of the circuit, at the centre of the passband, is approximately one.

**CIRCUIT**

The bandwidth of the circuit, with the 820 pF capacitor in the gate circuit of the second FET switched out, is:

	F (lower)	F (upper)
— 3 dB	520 Hz	2.5 kHz
—20 dB	230 Hz	6.6 kHz
(Wide bandpass)		

With the capacitor switched in:

	F (lower)	F (upper)
— 3 dB	520 Hz	1.3 kHz
—20 dB	230 Hz	4.0 kHz
(narrow bandpass)		

The field effect transistors are general purpose types and may be replaced by equivalents.

**CONSTRUCTION**

The circuit may be constructed on Vero board or a simple printed circuit made.

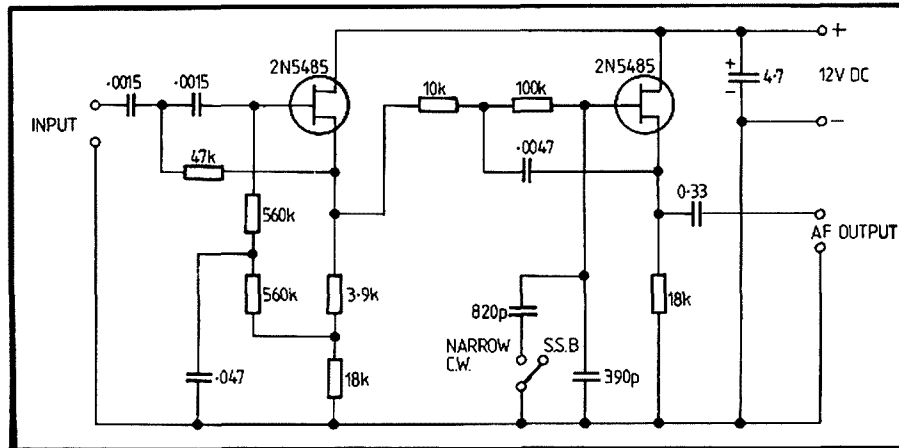

FIGURE 1: Circuit diagram.

The layout is not particularly critical, but the leads should be kept short and normal solid state circuit techniques followed.

**CONCLUSION**

As with many of these circuits the actual results achieved in an operational situation will largely depend on the operator's perceptions of the improved performance or otherwise.

As the circuit is relatively simple it is suggested that the unit be built and the appropriate operational tests made, before the circuit is hard-wired into the station receiver.

In the receivers I have tested with this modification, noise and interference were reduced. In my opinion, this would reduce the stress on the operator, especially in a contest situation, or when endeavouring to resolve those marginal DX signals.

## QSP

**CAR ELECTRONICS INTERFERENCE**

Is there not a possibility that RF from mobile transmitters may affect the often unscreened electronic systems in modern motor vehicles? For example a flasher unit (traffic Indicator) fitted in a Volvo did strange things whilst transmitting 40W out on 2m—ranging from no flashing to flashing at 2 or 3 times normal rate. This was cured by interlinking the three terminals of the flasher unit with 1000 pF disc ceramics. Other examples of the risk of RF interference to vehicle electronics were the possibilities of RFI to electronic fuel-injection systems and anti-skid devices of trucks. Tech. Topics, Radio Communications, November 1979.

**BREAK-IN**

The WIA maintains reciprocity with NZART about subscriptions to their magazine Break-In published every month, of which the June Issue is their call book. If you would like to keep in touch with trans-Tasman affairs send \$12 to WIA Magpubs, Box 150, Toorak, Vic. 3142, for a direct subscription to Break-In.

# A PEEP INTO THE PAST

Eric Trebilcock L30042  
Thornbury Vic.

Through the good offices of Mr. Keith Leonard, a mutual friend of mine (of Kew, Vic.), I recently perused 200 or so QSL cards which came the way of his late father in the mid-20's (Mr. Leonard senior was, at the time A3EN, Drouin, Vic.).

As a result of the aforementioned browse, I had my memory refreshed in more ways than one (I got SWL "started" in 1926). I thought it would interest oldies and newies alike to learn of some of the things I discovered as I read each card's content. Such things as:—

- A3BQ (Max Howden) had a Tx "mast" 80 feet high; A3WM (now VK3BCM) (Bill McAuley) was, like A3BQ, one of the busier of the Australian stations of the era.
- Many "W" stations (they had the prefix "U" in 1925) used 3000 volts on the plate of the final stage tube!
- It was 104 degrees F in Adelaide (VK5) on 3-12-26.
- Both VIB and VIM (coastal radio stations in Brisbane and Melbourne respectively) caused endless QRM to stations using the amateur frequencies!!
- A5BG (the late Harry Kauper) appeared to be one of the few users of crystal control in those days in Australia.
- The two most popular records legally played by amateurs in the 100 to 200 metres band were "The Grandfather's Clock" and "Oh Them Golden Slippers".
- QSL card sizes in 1925-1926 were slightly smaller than in 1979.
- The three most popular Tx circuits were split Colpitts, loose coupled Hartley and Meisner.
- The front line antennae were vertical, 4 wire cage and counterpoise, 60 feet umbrella, half wave Zepp.
- In the Rx area, 2 valve detector and 1 audio, Schnell special, Armstrong and Zenith Reinartz led the way.
- Many of the CW reports contained reference to "chirpy" and "wobbly" signals, and to the fact that the other fellow's signal suddenly took off for an adjacent frequency!

# TRY THIS WITH THE TECHNICAL EDITORS

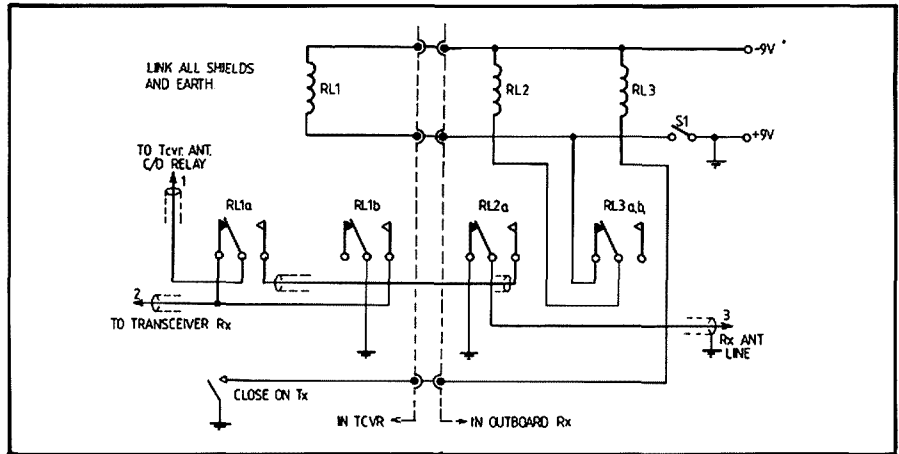

FIGURE 1: Change-over wiring

## USING A SECOND RECEIVER

Often a separate receiver is used by the author in conjunction with the station transceiver. The circuit, Fig. 1, shows how this is done.

The transceiver antenna lead was cut between the transceiver changeover relay and the receiver input circuit. Connections were made to points 1 and 2 as shown. RL1 was installed in the transceiver. RL1a changes the antenna from the transceiver receiver to the outboard receiver when S1 is closed. RL1b grounds the transceiver receiver when S1 is closed. With S1 open, transceiver operation is normal.

It was felt that the outboard receiver antenna lead, point 3, should be grounded during transmission and as a spare contact that closed on transmit was available, RL3 was added to open the supply to RL2 on transmit.

The 9V supply to the relays was obtained between the receiver. S1 may be the "on/off" switch in the receiver, suitably rewired. All relays are DPDT of miniature construction. The contacts of RL3 are connected in parallel. A 5 pin plug and socket system could be used for connections between the receiver and transceiver.

John Taylor VK3AJT. ■

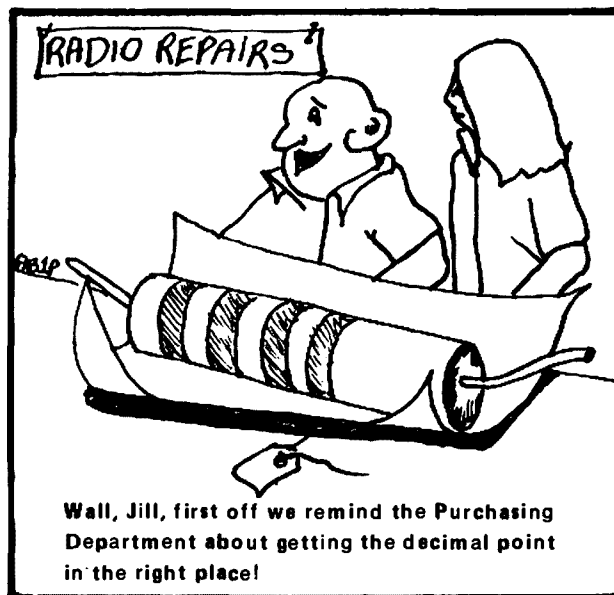

From ARRL  
Instruments  
Newsletter  
No. 13

Wall, Jill, first off we remind the Purchasing Department about getting the decimal point in the right place!

# “Listening across the world”

WHY FLY NOW AND PAY LATER? D X LISTENERS  
HAVE THEIR CAKE AND EAT IT AS WELL!



## YAESU

**GENERAL COVERAGE COMMUNICATION RECEIVER FRG-7**  
.05-29.9 MHz Coverage with 10Hz Readout

The FRG-7 is a precision-built all purpose communications receiver, featuring all solid state construction for long life and high performance. Utilising the Wadley Loop drift cancellation system, in conjunction with a triple conversion superheterodyn circuit, the FRG-7 boast high sensitivity along with excellent stability. It provides broadcast listeners with such features as a 3-position tone selector, an RF attenuator, and an automatic noise suppression circuit. For many of satisfying reception, the FRG-7 is the receiver for you.



## YAESU

**DIGITAL DISPLAY COMMUNICATIONS RECEIVER WITH CPU  
DIGITAL CLOCK AND TIMER FRG-7000**  
.025 thru 29.9MHz Coverage with 1kHz Readout

Computer technology and convenience features are brought together in the FRG-7000, a digital-display general coverage receiver for the discriminating SWL. The digital clock and timer, controlled by a CPU (Central Process Unit) chip, will readout both local and GMT time, and will control peripheral station equipment such as a tape recorder. Improved SSB selectivity, ease of operation, and rugged construction are yours with the new FRG-7000 from YAESU.



## KENWOOD

**COMMUNICATIONS RECEIVER R-1000**  
PL synthesizer covers 30 bands from 200kHz  
to 30 MHz

The R-1000 is a high class general coverage receiver covering 30 bands from 200kHz to 30MHz with a PLL synthesizer that incorporates a variety of KENWOOD'S sophisticated electronic technology acquired over many years. Both a digital display readout (1kHz step) and analog dial are provided for more convenient operation.

The R-1000 also boasts a quartz digital clock with timer, 3-stage IF filters, RF ATT and TONE control, etc. to make the best receiving conditions for each mode.

Due consideration has been given to innovative design and compactness, making the R-1000 an indispensable sub station for amateur radio operators, semi professionals, BCL's and SWL's, etc.

## SERVICE Dept.

CW ELECTRONICS HAS A FULLY STAFFED AND EQUIPPED SERVICE DIVISION.

WE CAN SERVICE ALL YOUR AMATEUR RADIO GEAR EFFICIENTLY AND AT A REASONABLE COST.

WHOLESALEERS, AGENTS, MANUFACTURERS AND RETAILERS CONSIDER US FOR YOUR QUEENSLAND SERVICE CONTRACTS, IN THE ENTHUSIAST AND COMMERCIAL ELECTRONICS MARKET.

CONTACT BRIAN BEAMISH, Manager

(07) 341 5377, AH: (07) 341 4767

*Aust. Distribution agents for:*

- FLESHER RTTY and MORSE GEAR
  - Regenerative speed units
  - Terminal Units with Loop Supply etc.
- MACROTRONICS RTTY and CW
  - Amateur Radio/ Mini Computer interfaces and software

SA Agents: Golf Communications,  
Whyalla (086) 45 0208  
Dealer enquiries welcome

## CW ELECTRONICS

CNR. MARSHALL RD & CHAMBERLAND ST.,  
TARRAGINDI - BRISBANE PH (07) 48 6601  
PO BOX 274, SUNNYBANK, QLD. 4109  
AH: BRIAN (07) 341 4767

## QSP

### A STORY ABOUT FOUR PEOPLE

This is the story about four people named Everybody, Somebody, Anybody and Nobody.

"There was an important job to be done and Everybody was asked to do it. Everybody was sure that Somebody would do it. Anybody could have done it, but Nobody d'd it. Somebody got angry about that, because it was Everybody's job. Everybody thought Anybody could do it, but Nobody realised that Everybody wouldn't do it. It ended up that Everybody blamed Somebody when actually Nobody accused Anybody". ■

### ASCII

In the editorial of QST December 1979 the ARRL was pleased to note that their FCC are formulating rules for allowing USA amateurs to use ASCII in their transmissions. The comment was made that the FCC would be taking notice of the problems which would arise if amateurs themselves (and the FCC) must or should retain the ability to police itself. This could arise if non-standard forms of amateur radioteletype codes were to be authorised. ■

### NZ VHF CONVENTION

Break-In December 1979 contains details of the VHF Convention to be held at the Shedwood Motor Inn, Palmerston North, New Zealand, from 4th to 7th April (Easter), 1980. Registration before 1st March and details available from Conference Committee, PO Box 1718, Palmerston North, NZ, for anyone likely to be across the Tasman at that time. ■

### AMATEUR NOTABILITIES

In August last Prof. Francesco Cossiga was elected Premier of Italy. He is IOFCG, a well known radio amateur and a member of ARI for many years.—QST November 1979. ■



## QSY

## BAIL ELECTRONIC SERVICES

## QTH

Authorised Australian Yaesu agents since 1963, are moving our warehouse to more modern premises in Wangaratta on 1st March 1980.

We will continue to provide complete sales, after sales and spares service to our authorised dealers throughout Australia and to the Amateur Radio fraternity at large — the same traditional service and back-up which was established by the Bail brothers over past years.

Melbourne hams will be able to see and purchase Yaesu and other equipment handled by Bails from our authorised dealers in the metropolitan area:—

### G.F.S. ELECTRONIC IMPORTS

15 McKeon Road, Mitcham ..... 873 3939

### CHIRNSIDE ELECTRONICS

26 Edwards Road, Lilydale ..... 726 7353

### IMARK PTY. LTD.

167 Roden Street, West Melbourne ..... 329 5433

Mail Orders sent to Bails will be despatched within 24 hours, subject to availability of required items.

Authorised Bail dealers are located in Brisbane (07) 341 5105, 57 6830; Townsville (077) 79 8179; Cairns (070) 51 4826; Darwin (089) 81 5411; Coff's Harbour (066) 54 3206; Inverell (067) 22 1300; Newcastle (049) 69 2040; Wagga Wagga (069) 21 2125; Adelaide (08) 43 7981, 293 2135, 272 8417; Mt. Gambler (087) 25 7176; Perth (09) 321 7609; Kalgoorlie (090) 21 1906; Launceston (003) 44 5000; Bendigo (354) 43 1977.

STAN ROBERTS VK3BSR

## BAIL ELECTRONIC SERVICES

38 FAITHFUL STREET, WANGARATTA 3677

Tel: (057) 21 6260

Telex: Teletra AA 56880

SERVICE TO AUSTRALIAN HAMS IS OUR MOTTO

# BELCOM LS707 UHF ALL MODE TRANSCEIVER

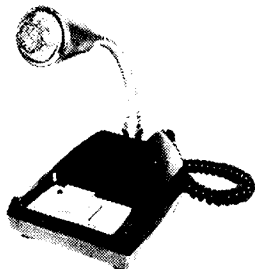

### BRIEF FEATURES

- ★ All solid state devices
- ★ All modes — AM, USB, LSB, CW, FM
- ★ Continuous band coverage from 430-440MHz
- ★ Provision for up to 100 fixed crystal channels

- ★ Power Out-Put SSB, FM, CW 10 Watts  
AM 4 Watts

- ★ Double/triple conversion receiver
- ★ 5 Amp Power supply available as option
- ★ Stand microphone available as option.

**NOW AVAILABLE DUTY FREE AT ONLY \$895.00**

# IMARK

Pty. Ltd., 167 Roden St., West Melbourne, Vic. 3003  
Phone (03) 329 5433

# AMATEUR SATELLITES

R. C. Arnold VK3ZBB

Our working satellites, AMSAT OSCARS 7 and 8, continue to perform satisfactorily on all modes and many interesting contacts have been heard. A welcome newcomer to the OSCAR scene has been Peter H44PT, in the Solomon Islands.

As I forecast, some of the predictions for January and February have been incorrect and I note that AMSAT will not publish advance predictions for the satellites for 1980. I suggest the best way to keep up to date is to become a member of AMSAT and receive the new magazine "Orbit" which will carry predictions in each issue. The cost of joining AMSAT, until July, is \$US10.00 per annum plus \$US3.00 for airmail postage of "Orbit". Amateurs engaged in other interests such as moonbounce, meteor scatter as well as satellite operations, will be catered for in the new magazine. If you are interested in joining AMSAT please write direct to them at Post Box 27, Washington, DC 20044, USA.

Last month I mentioned that Bill VK3TT had agreed to act as Educational Co-ordinator for the Phase IIIa spacecraft, and I am looking for a volunteer to act as Co-ordinator for the CW/RTTY transmissions. Please let me know if you would be prepared to undertake the monitoring of transmissions for the spacecraft and forwarding the information you obtain to AMSAT.

I have now received my first communication from Pat Gowen G3IOR, the overseas Co-ordinator of AMSAT, and his first AMSAT Phase III countdown report is reproduced below.

The main news of this issue is that of the successful launch of the LO-1 mission from Kourou, with its payload now in the nominal 635.3 minute, 17.55° inclination, 0.73 eccentricity orbit, with a 36,010 km apogee and 202 km perigee. Following two delays, the first due to a faulty sensor, the second caused by bad weather, the perfect launch resolved on 24th December, 1979, and was broadcast by AMSAT on 28.880 MHz. Our congratulations go to all involved with our thanks for such a wonderful Christmas present!

All is now set for the launch of LO-2, carrying both the FIREWHEEL and AMSAT Phase III satellites, between 1500 and 1800 UTC, with 1700 optimum on 30th May.

Work continues on the preparation of the spacecraft, with action by WD4FAB in

applying the 1/8 in. thick CAPTAN blankets for thermal insulation, held by VELCRO fasteners and wedding lace. W3PK is working on the Telemetry encoder, and the interface between the sensor electronics and the computer. The computer is almost de-bugged, and is running well. The final antenna parts are being machined in California, whilst further work on the 435 MHz uplink receiver with its new front-end has produced a better than 3 dB NF. The transmitter exhibits 49.5 per cent efficiency at 25 per cent drive, and 54 per cent efficiency at 100 per cent drive, and is giving 54 watts PEP from its DOHERTY amplifier. Work progresses with the command receiver, and the motor ignition circuit is being checked out. The battery charge regulator has been received from HG5BME, and the solar panels are attached. Three Telefunken and three Solarex panels will be flown.

Final tests on the antennas show a smooth pattern from the low-gain Omni system but a measurable lobar pattern is exhibited from the high-gain apogee antennas on both 70 cm and 2m that would cause a 1.5 kHz "ripple" from the spinning satellite to linearly polarized ground stations. For this reason users should plan for right-hand circularly polarized (e.g. conventional screw-thread) both for uplink and downlink, particularly on 435 MHz.

The projected orbital parameters for AMSAT OSCAR 9, once in orbit, have been changed back to that originally projected, and following the firing of the kick motor some 21-24 days after insertion into the transfer orbit, the planned orbit will have a 656.2 minute period, a 35,786 km apogee, and a 1,500 km perigee. Inter-communication between all continents will be possible without the problem associated with skip differential and variable solar conditions as evidenced on the HF bands.

Replies to our invitation to societies to utilize the special service channels are still arriving, and at 1st January we have had interest from ARRL, RSGB, RSF, EDR, SRJ, SARL, NRL, VERON and Puerto-Rico. AMSAT are seeking continental and national co-ordinators to collate the needs of their own areas, and to inter-communicate these with the special channel co-ordinators as listed in "Phase III Countdown" No. 2. Regional aid is sought for the scientific and educational channels, and stations with Phase III capability are sought in the USSR and in Japan to cover the 7 p.m. to 11 p.m. local time slot allotted to their areas to put out messages in their own language, and to give advice and information whilst the transponder is on for special periods during the transfer orbit. Tapes in the major languages are needed to carry information via ground stations to assure wide coverage of information. AMSAT need some gold-plated piano wire for the antennas,



PHOTO 1: Bob VK3ZBB in the shack

and need new members to support the project with donations.

Many excellent Phase III articles are available from G3AAJ, which may be translated and printed in any IARU Society magazine free of charge. Updated news on Phase III may be found on the 21.280 MHz 1900 UTC Sunday AMSAT net and between 1400-1700 each weekend day on 28.880 MHz where AMSAT members gather to meet.

Special thanks to Steve Place WB1EYI, who following editing this information sheet is now concentrating upon the educational aspects, and from AMSAT best wishes to all in 1980, which promises to be an exciting year for the amateur radio fraternity.

Pat Gowen G3IOR. ■

## ORBIT PREDICTIONS — MARCH 1980

OSCAR 7				OSCAR 8			
Data	Orb. No.	Eqx Z	Eqx °W	Orb. No.	Eqx Z	Eqx °W	
1	24208	0044	79	10132	0025	56	
2	24221	0138	93	10146	0030	57	
3	24233	0037	78	10160	0035	59	
4	24246	0131	92	10174	0040	60	
5	24258	0030	76	10188	0045	61	
6	24271	0124	90	10202	0050	62	
7	24283	0024	75	10216	0055	64	
8	24298	0188	88	10230	0100	65	
9	24308	0017	73	10244	0105	66	
10	24321	0112	87	10258	0110	68	
11	24333	0011	72	10272	0115	69	
12	24346	0105	85	10286	0120	70	
13	24358	0004	70	10300	0125	71	
14	24371	0059	84	10314	0130	73	
15	24384	0153	97	10328	0135	74	
16	24396	0052	82	10342	0140	75	
17	24409	0147	96	10355	0001	51	
18	24421	0048	81	10369	0006	52	
19	24434	0140	94	10383	0011	53	
20	24446	0039	79	10397	0016	54	
21	24459	0134	03	10411	0021	56	
22	24471	0033	78	10425	0026	57	
23	24484	0128	91	10439	0031	58	
24	24498	0027	76	10453	0036	59	
25	24509	0121	90	10467	0041	60	
26	24521	0020	74	10481	0046	62	
27	24534	0115	88	10495	0051	63	
28	24546	0014	73	10509	0056	64	
29	24559	0108	87	10523	0101	66	
30	24571	0007	71	10537	0106	67	
31	24584	0102	85	10551	0111	68	

Join a new Member  
— NOW —



# COMMERCIAL KINKS

RON FISHER  
VK3OM

3 Fairview Avenue, Glen Waverley 3150

## REVERSE REPEATER MODIFICATION FOR THE YAESU FT-227R

The Yaesu FT-227R two metre FM transceiver appears to be rather popular with FM enthusiasts at the moment. It of course offers full coverage of the entire two metre band in effectively 5 kHz steps. It however lacks one important feature, that of instant reverse repeater operation. It's a fairly simple procedure to dial up the required frequency, but under mobile conditions this would involve a short distraction from driving concentration. However all is not lost. Don Moyle VK3YOG has come up with a simple modification to provide in-

In January 1980 Issue, the text of this article was printed without diagrams. Murphy apologises — the complete article is now presented.

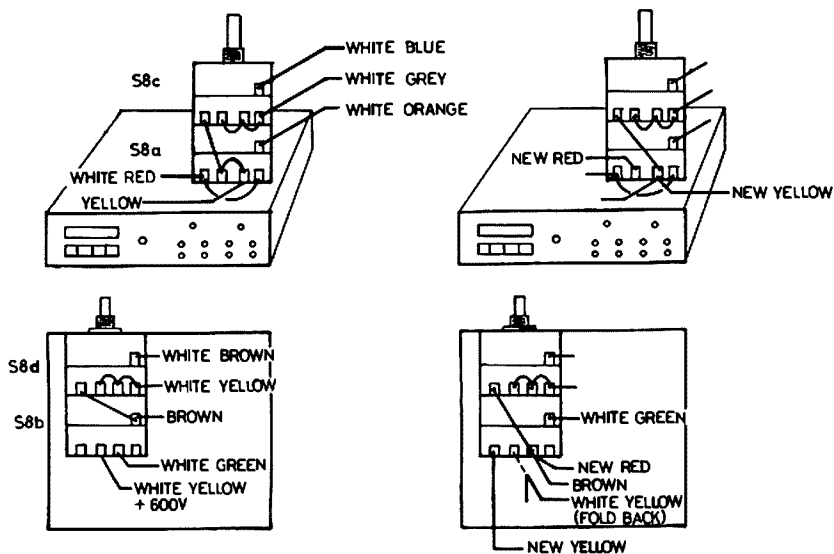
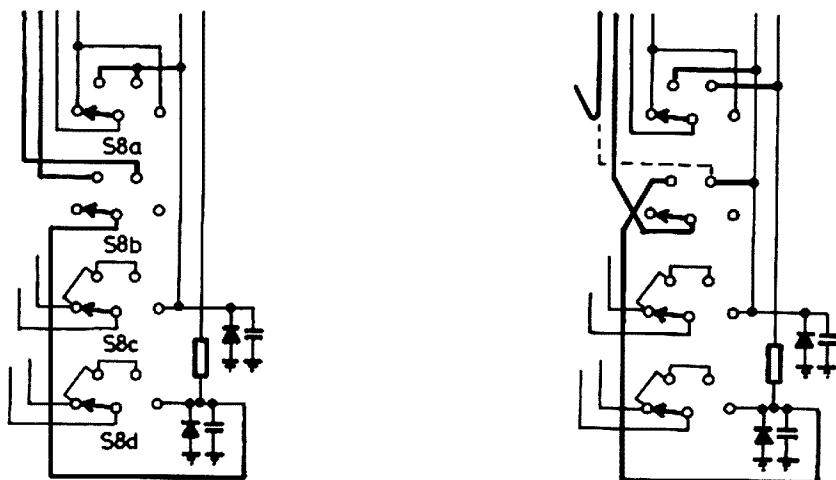

FIG. 1(a) and 2 (left top and bottom) show the 227R as standard, while FIGS. 1(b) and 3 (right top and bottom) show the modified version.



stant reverse operation by selecting the +600 kHz position on the mode switch. No other facilities are changed. Now over to Don to tell the story.

"This simple modification can be carried out utilising the plus 600 position, which is of little use at the present time. If you have been using the memory to provide reverse receive on a particular repeater it can now of course be used on a simplex channel. In the new +600 position, the display will read as dialled but this will now be the transmit frequency, receive being 600 kHz below.

It is all accomplished at switch S8, by cutting away one wire, transposing two others and by adding two new links. As this involves getting at all sides of S8 start by removing the front panel from the transceiver and then free S8. By following the 'Before and After' circuit diagrams you will have no trouble, however a small fine tip soldering iron is necessary.

In conclusion it might be of interest to point out that the FT-227R instruction books do not always give correct alignment data. In several cases alignment points are incorrectly identified. Check carefully TC-302 through TC307. In my book, an early one, they are all identified one number lower than they actually are. It appears that later books have corrected this particular one but that other errors are possible."



**MODEL 444**



**SHURE**

**CONTROLLED MAGNETIC<sup>®</sup>**

**COMMUNICATIONS**

**MICROPHONE**

**GENERAL:** The Model 444 is a pressure-operated CONTROLLED MAGNETIC microphone. It is specifically designed for radio communication applications and provides optimum performance from single sideband transmitters as well as AM and FM units. The response cuts off sharply below 300 and above 3,000 Hz, with a rising characteristic to 3,000 Hz. This special response characteristic results in optimum speech intelligibility and audio punch to cut through noise and interference.

**MICROPHONE FEATURES:** ● A response tailored for single sideband transmissions ● A switch for instantaneous selection of Press-to-Talk or VOX (voice-operated relay control) operation ● Finger-tip control bar (locking or non-locking action) to actuate microphone and an external relay or control circuit ● Long-life switch to satisfy severe requirement of communication systems ● Adjustable microphone height ● A sturdy, high impact ARMO-DUR<sup>®</sup> base and microphone case ● Dependability — under all operating conditions.

The "SHURE" MODEL 444 has one of the best "sounds" on the amateur bands.

**IT'S THE BASE STATION MICROPHONE FOR YOUR STATION**  
**PRICE: \$76.00**

Amateur Nett (Incl. Sales Tax and Postage)

ALSO AVAILABLE — THE WELL KNOWN SHURE 401-A (Hi Z) & 401-B (Low Z) HAND MIKE FOR MOBILE (OR STATION) USE — PRICE: \$82.00.

**WILLIAM WILLIS & Co. Pty. Ltd.**

MANUFACTURERS AND IMPORTERS  
77 CANTERBURY ROAD, CANTERBURY, VIC. 3216  
PHONE 836 0707

# SIDEBAND ELECTRONICS ENGINEERING

P.O. BOX 23, SPRINGWOOD, N.S.W. 2777  
 WAREHOUSE 213 HAWKESBURY RD. SPRINGWOOD  
 TELEPHONE (047) 54 1392

Here is an exciting new tri-band antenna that will out-perform conventional yagis such as the TH6-DXX yet uses only 5 elements and a 4M (13') boom. It's the Japanese TET version of the excellent German Periodic-5 (VK2AOU) 10-15-20M yagi.

SPECIFICATIONS: longest element 10.6M (35'), turning radius 5.67M (19'), VSWR 1:1, weight 21Kg, F/B ratio is 25db or better, handles 3KW and has a gain of 10db on each band. Priced at \$350 (new price on TH6-DXX close to \$500 and TH3-JR close to \$300), it's sure to be a winner.

Increased prices on Ham-3 and T2X Tail Twister rotators are the result of increased prices in USA and increased shipping costs.

**ROY LOPEZ**

## HENRY RADIO — A Famous Brand —

### NEW LINEAR AMPLIFIERS —

2 KD5 — 2KW PEP, 80 - 10m SSB/CW/RTTY/AM.....	<b>\$1050</b>
1 KD5 — 1200W PEP, 80 - 10m SSB/CW/RTTY/AM.....	<b>\$850</b>

## ANTENNAS

TET HB35C Periodic-5 yagi 10-15-20M.....	<b>\$350</b>
TH6-DXX 10-15-20M, 6-el. yagi.....	<b>\$300</b>
204-BA 20M, 4-el. Tiger array.....	<b>\$220</b>
18-AVT/WB 10-80M vertical.....	<b>\$110</b>
GPV-5 2M vertical collinear 2 x 5/8 wave.....	<b>\$48</b>
OSCAR-2-2M mobile 1/4 or 5/8 wave complete with gutter mount, cable & plug.....	<b>\$27</b>
BN-86 balun for beam buyers.....	<b>\$20</b>
HY-Q (USA) 50-ohm 1KW balun.....	<b>\$15</b>

## ROTATORS & CARLES

All rotators now come with bottom brackets and control-indicator boxes wired

KEN KR-400 medium duty.....	<b>\$120</b>
KEN KR-500 vertical rotator.....	<b>\$140</b>
KEN KS-065 stay/thrust bearing.....	<b>\$25</b>
CDR BT-1A light duty 4 position push button program- mable. Plus normal operation 120V AC.....	<b>\$85</b>
CDR am III heavy duty 120V or 28V AC.....	<b>\$200</b>
CDR tail-twister extra H/D 120V or 28V AC.....	<b>\$250</b>
RG-8U foam coax cable, per metre.....	<b>\$1.00</b>
8-cond. rotator cable, per metre.....	<b>75c</b>

## ACCESSORIES

Voltage regulator 18V AC Input, 12V DC 3A output	<b>\$18</b>
240/18V AC transformer	<b>\$10</b>
Mobile bumper mounts 3/8" 24 thread	<b>\$2</b>

## KYOKUTO FM-2016A

800 channel, 2 meter FM transceiver with 4-channel memory and scanner 15W.....	<b>\$355</b>
---	--------------

## TRIO-KENWOOD PRODUCTS

VFO 520 for TS 520S.....	<b>\$130</b>
LF 30A low-pass filter.....	<b>\$30</b>
SP 120 — SP 100 Remote Speakers.....	<b>\$32</b>
DK 520 adaptor TS 520 to DG 5.....	<b>\$10</b>

*All further Trio-Kenwood accessories and transceivers at competitive prices.*

## YAESU MUSEN PRODUCTS

FT-101ZD 10-16M digital transceiver w/cooling fan fitted.....	<b>\$850</b>
SIDEBAND brand microphone to suit.....	<b>\$10</b>

## CO-AX CONNECTORS

PL-259, SO-239, cable joiners, each.....	<b>60c</b>
Right angle and T-connectors, each.....	<b>\$1.00</b>
GLP right angles RG-58U to SO-239, w/lock nut and cap, each.....	<b>\$1.50</b>
Double female connectors, each.....	<b>60c</b>
MLS right angles RG-58U to PL-259, each.....	<b>75c</b>
In-line mike sockets 3 & 4 pin, each.....	<b>60c</b>
Mike sockets 3 & 4 pin, each.....	<b>60c</b>
M-ring body mount w/lock-nut.....	<b>\$1.50</b>

## NOVICE SPECIALS-TRANSCEIVERS

10M sideband SE-502 USB/AM 15W PEP-240V AC, 12V DC, inbuilt SWR/RF meter, 28.3-28.6 MHz clarifier tuning transmit and receive.....	<b>\$90</b>
10M Universe 224-M, USB/AM, 15W PEP 12V DC, 24- ch. 28.480 to 28.595 MHz, 5-Khz steps-clarifier tuning transmit and receive.....	<b>\$95</b>
CONVERSION CRYSTALS for amateur licence holders - set of 8 crystals to convert 23-ch, 27-MHz CB units to 28 MHz. Suitable for Kraco, Sideband, Universe, Hy-range V etc., converts as per Universe 10M above — CRYSTALS & INSTRUCTIONS.....	<b>\$32</b>
Set of 4 crystals converts to 28.3-28.6 MHz.....	<b>\$15</b>

All prices are NET, ex Springwood NSW, on pre-payment with order basis. All risk insurance is free of charge, allow for freight charges by air, road, rail or postal, excess will be refunded. Prices are subject to change without prior notice. All orders cleared on a 24-hour basis after receipt of order with payment.

**ROY LOPEZ (VK2-BRL) Manager**

# VHF-UHF

An expanding world

Eric Jamieson,  
VK5LP



Forrester, S.A. 5233

## AMATEUR BAND BEACONS

50.038 FY7THF — French Guinea  
50.100 KH6EQI — Pearl Harbour †  
52.100 VK0BC — Cassy Base †  
52.150 VK5KK — Arthurton \*  
52.250 ZL2VHM — Palmerston North †  
52.500 JA1IGY — Nagoya  
433.150 ZL1VHW — Waikato

\* Denotes attended operation.

† Denotes frequency change.

‡ See notes.

Full beacon list appeared in AR February 1980, page 30.

Advice has been received from Harry Wiggins ZL2BFR, Beacon Trustee, that the ZL2VHM beacon on 52.500 has had a frequency change to 52.250 MHz, to enable the beacon JA2IGY in Nagoya, Japan, to be monitored. The location of ZL2VHM remains the same. The Manawatu Branch also operates the beacons on 145.250 and 433.250 MHz and reports of any of the three beacons would be welcome, and a OSL card is available for such reports. Reports should be sent to: Beacon Trustee, PO Box 1718, Palmerston North, New Zealand.

The VK5KK beacon on 52.150 is to be located at Arthurton on York Peninsula, where David will be taking up residence, distance about 110 km north-west of Adelaide.

The Beacon and Repeater Co-ordinator for the North-West Branch of the WIA in Tasmania, Tony VK7AX, advises the 70 cm beacon VK7RTW has been taken out of service for the time being due to some technical problems. It is anticipated the whole beacon will be restructured to a solid state device. Tony also mentions the "new" beacon I spoke of in the January issue will in fact be the old beacon VK7RTX coming out as an updated version, and the new frequency will be 144.70 MHz in accordance with the VHF/UHF Advisory Committee suggestions for beacon frequencies. I am to be advised when the change is to be made.

The VK0BC beacon will probably be in some doubt. Plans to have Brian VK0BC operate a new beacon supplied from Australia came unstuck to a degree when it was learned Brian would be returning to Australia at the end of January 1980. So currently we are still holding a fully set-up piece of equipment here in VK5 for use as a beacon if we can find a custodian!

## SIX METRES IN THE WEST

Tony VK6BV has written outlining how the past few months have treated his area on six metres. What does stand out most dramatically in his report is the number of occasions JAs were observed on 50 MHz but not 52 MHz! Between 21-8-79 and 23-11 JAs were evident on 50 MHz on 27 different days between about 0500 and 0900Z, but only available on 52 MHz on 9 days of the 27! This gives some idea of the large number of contacts we are missing out on as a result of our 2 MHz separation from the other Pacific areas.

First JAs were worked by Tony in Northern on 5-9 with JA2 and 3. Then on 22-9 JA1, 3, 4, 6 and 0 from 0633Z. 2-10 JA2 0935Z. 3-10 JA1 and 2, plus HL9TG 0510 to 0603Z. 6-10 JA1 and 2 from 0851 to 0910Z. 8-10 JA6 at 0646Z. 11-10 JA1, 2, 4, 6, 7, 8 and 0 from 0418 to 0624Z. 13-10 JA1 and 7, 0730Z. 27-10 JA1, 2 and 4 0840Z. Then on 25-11 first Es to VK5, VK6WD and VK6ZKO worked to ZL. 26-11 JA signals. VK6ZKO worked to Alice Springs at 0220Z. On 2-12 Tony

worked VK6OX at Carnarvon on 6 and 2 metres as d'd the Perth stations.

The Es season at Norlham was in keeping with other VK areas, contacts being made only on 4-12 to VK1, 2, 3 and 4, 5-12 VK3, 5 and 7, 14-12 VK3 and 5, 16-12 VK4 and 8 (Alice), 23-12 JA1, 7 and 9, heard 2, 3, 4 and 6. On 30-12 worked VK2, 3, 4 and 5. He hopes 1980 may be a little kinder! Thanks Tony.

## NEWS FROM CARNARVON

Andy VK6OX in a letter advises some Es activity kept the six metre band going after the closure of the TEP. His first Es opening occurred on 4-12 when at 0803Z VK2W1 beacon was 579, and TV audio from VK1 and ZL was very strong, and worked into VK1, 2, 3 and 5 from 0805 to 1240Z! 42 stations were worked but no ZLs. 5-12 TV audio 51.740 S7 at 0400Z, worked VK3OT 5 x 9 both ways at 0430Z. 6-12 VK3OT and VK2LM, plus VK2 and 4 beacons. 7-12 Wagga TV audio, then VK6RTU beacon from Kalgoolie at 559 (thanks for that bit, I was beginning to wonder if it was still operational so long since it was heard here . . . 5LP). 12-12 TV audio only from Tamworth, VK2W1 529, etc. 13-12 0648 to 0750Z worked four VK4s in Townsville, VK8VF beacon 519 at 0515Z. 14-12 VK5SV. 16-12 VK4s in Townsville 0610Z. 20-12 0245Z TV audio from Wagga and Melbourne at S7. 22-12 VK6RTU 579. 23-12 0200 VK3OT, 0230Z VK3ATN, Melbourne and New Zealand TV audio! 30-12 worked 11 stations from VK2. 10-1-80 0440Z VK3OT, 0827Z VK3ZQB. 14-1 worked four VK2s. 17-1 0825 to 1045Z many VK3s plus VK7ZIF at 0830Z, being Andy's first VK7.

I guess those who have been complaining about the poor Es season in the southern areas could not have had it much worse than Andy, if you care to tote up his contacts and days of working. It seems the distance to Carnarvon is not too good for VK5 and I never heard Andy at any time, and it appears his only contact to VK5 was VK5SV on 14-12.

Andy d'd make amends, however, when on 3-1-80 he worked YB9X, the JA DXpedition to Bali. He explains thus: "On said date, I had beam SE looking for signs of Es. When none was forthcoming, I was about to turn the rig off, when I recalled a QSO with VK2BA on 6 metres a week or so before when David asked if I had heard anything of YB9X, the answer being negative.

"I decided to swing the beam north on the off chance, really expecting to hear nothing but noise. A few minutes later at 0840Z I listened on 50.110 heard a station signing YB9X in OSO with JA whom I couldn't hear and YB9X was 5 x 5 at the time. I went (rushed) to 52.00, fired up the PA and started calling YB9X. Time 0845Z. He replied after my first call! He was 5 x 6 here and gave me 5 x 9. After our contact he went to CW on same frequency and called CQ for 45 minutes with no other replies being received! At 0937Z I called him on CW, sent 579, received 559 (I was running 8 watts, forgot to take PA out of standby!). After this contact he continued calling CQ until disappearing in the noise at 1000Z. The contact may have been Es but not sure."

Andy also mentions two metres has been interesting with frequent openings to the south. Areas worked to date include Perth, Northam, Albany, Busselton and Bunbury. Ray VK6XQ, at Geraldton, has been bitten by the bug again and has SSB on six and two metres.

On the lighter side, Andy reports his XYL is enjoying the summer Es with TV DX giving extended viewing periods of Ch. 11 at Geraldton, and lesser viewings from Ch. 9 Perth and Ch. 3 Bunbury.

## GEELOG BEACON PROJECT

Peter VK3AWY writes to advise the beacon project for six metres is progressing, a licence has been applied for and the frequency to be 52.330 MHz in accordance with the Band Plan. It is intended initially to run 25 watts output to a pair of stacked crossed dipoles. Ident will be once every 15 seconds at 8 w.p.m. Modulation FSK with 850 Hz shift. At time Peter wrote the letter (1-1-80) the antenna, keyer, power supplies and transmitter are either being constructed or modified. The call sign applied for is VK3RGG. A further report later. Thanks Peter.

## TOWNSVILLE BEACON

Some confusion seems to arise at times with reception of this beacon. I was asked by a number of stations during the Es period what the beacon was on 52.438 MHz (the frequency I was given) which was signalling ST6NANU! To help identify the renegade, it is really VK4RTL, the Townsville beacon, with frequency shift keying, being received backwards! To receive the ident correctly, tune your receiver a little higher in frequency when all will be well. This is one problem of FSK of course, if you are not aware of what is going on.

## THAT ICOM IC502

I received a note from Ray K5ZMS of SMIRK asking if I would be custodian of an IC502 left in Australia by Jack W6AHZ, who was injured whilst here in Australia and was unable to make use of it for a DXpedition. Jack has left the IC502 here in Australia for it to be used for DXpeditions or similar ventures by responsible amateurs. The offer is a very generous one and I am quite prepared to look after the equipment, and make it available as required, providing it comes back to me each time after use.

Under this arrangement I am pleased to make it available to Steve VK3OT, who will be going to Christmas Island in the Indian Ocean from 12-3 to 26-3-80. Steve proposes using it in conjunction with a PA and hopes to have enough 6 metre contacts to put Christmas Island on the map. He is also planning to see what can be done about 2 metres to Indonesia which is not a great distance away. I don't have a lot of information at this stage, but I guess the most important thing is that Steve will be mounting the DXpedition between the dates mentioned and will certainly be looking for contacts back to Australia as well as the other areas. Being the early part of the equinox, long distance contacts may well be possible. Good luck Steve.

## THE NORTHERN HEMISPHERE ON SIX

Anyone would think it was summer time in the North rather than winter, there seems no abatement of the incredible six metre conditions. When one considers quite a number of Pacific coast stations in USA have had two-way contacts with EI2W in Ireland, it's a very long path! However, these contacts may end soon as I understand EI2W's permit to operate expires on 31-1-80.

Bill W3XO says TV signals from Europe have been so strong as to be a nuisance as high as 51.500 MHz which is a long way from their source in the 40 to 45 MHz area.

But contacts have not been confined to east-west, the north-south path to South America has been very active. Such glorious call signs as YV8ASU, FY7AS, FY0HI, JA1PIG/PZ, TI2NA, HC1JX, HP2XPW, HP2XRK, HH2MC and HH2HA are being worked in various parts of the USA. Almost daily openings to KL7 from Central and Eastern areas. Even so, there are some areas missing out. It appears the Washington area is short on JAs, looks like WA7RTA will have to start sharing some of his 1000 JA contacts with the unlucky operators!

17-11 was a particularly good day when VE1ASJ worked ZL1AVZ and ZL1AUM, both making use of 50.105 under their new ZL privileges. 5B4AZ in Cyprus is hoping to get a spot frequency at 50.110 in addition to the one they already have at 50.050.

H44PT is still elusive in VK5, and YJ8 also very rare! Others not so far reported as being worked in VK include 4S7EA, HS1WR, DU1GF, VS6BF, KC6IN, etc. But the exotic call signs being worked from USA and Japan and points between include KY6PF, VY1AU, HP1XDS, VY4AGL, HC1JX, KL7WE, NP2AE, HH2MC, TI2HL, DU7EG, VP9WB, VO2AG, ZK1AA, FO8DR, ZB2BL, VO1JN, 5B4AZ, PY1RO, FM7AD, FW0FIL, KV4FZ, CE3OK, PJ2DW, LUZFA, VP2ML and plenty of others. Add to this the W, KP4, VE, KL7, EI, YV, XE, etc., etc., and you have some idea what is being worked.

## SIX METRES FROM ARGENTINA

Let me quote you some lines from SMIRK Newsletter No. 22 just to give you an idea what is really happening elsewhere, and I have selected the report of Alfredo LU3EX, who is well known for his six metre operating over many years.

# WIA MEMBER INFORMATION

## • AR ADDRESS LABEL CODES

January AR's note on page 39 was not too clear so here is a clarification by example —

"F 3 00 1 00 VK3YYY"

F — Membership grade.

3 — Division.

00 — Unused at present.

1 — Postal distribution code.

00 (when used) — Zone.

VK3YYY or L12345 — Call sign (space for only one) or SWL number.

Please advise corrections to Box 150, Toorak.

## • PENSIONERS

Resolve pensions status with your Division please. Executive office cannot arrange re-gradings as this is a Divisional matter unless you change from Associate to Full member at subscription time. ber near subscription time.

## • MEMBERSHIP CERTIFICATES

These are issued by Divisions not by Executive office.

## • ADDRESS CHANGES, ETC.

Please notify all such changes promptly to Box 150, Toorak. When AR envelopes are returned to sender "left address", "not known", etc., a tag is inserted into your entry in the EDP file to suppress all future address labels until the tag is removed for reasons of a new address forth coming, etc. Missed ARs may not be available later to replace any not received.

• Please remember that the Executive office is the centralised processor of Divisional records for lists, subscriptions and the like.

• Please see advertisements for Mag-pubs supplies inserted in AR from time to time. WIA, PO Box 150, Toorak, Vic. 3142.

**REPORT ALL  
INTRUDERS TO  
THE INTRUDER  
WATCH  
CO-ORDINATOR  
IN YOUR STATE**

the contact to VK6BO in 1952. This time it seems the whole of the south-western area of VK6 was open, which is very unusual. The band was still open to a degree next morning, 24-1, when I worked VK6KJ, VK6KZ/6 and VK6ZFO, but conditions were fading rapidly and little was heard after 2330Z.

To say that Les VK5ALW was a lucky man would be an understatement surely. Full credit for working into Perth, but the chain of events leading up to the contacts is interesting. Les received his full call on Monday, 21-1. He went back to work on 24-1, the day after making the contacts, having then completed his leave. He normally keeps an ear on Ch. 5 repeater, the one Aub VK6XY was working on! And what about poor old Bob VK5ZRO — he really started everything by working Aub whilst going to work in his car, using Ch. 5 repeater! He had to continue to work and leave the pickings for Les.

## 1296 MHz RECORD BROKEN

Apart from the 1296 MHz record separately mentioned, it appears Wal VK6KZ/6 also worked Reg VK5QR on 1296 MHz, with Reg using AM, but no details of this contact are available. And whilst on the subject of 1296 I believe Ray VK3ATN managed a few points from working into Melbourne during the Ross Hull; value, 120 points for the first contact per day anyway!

## THE 70 cm BAND

This band may seem to be neglected at times, but this is not really so. I have had no reports of what Wal VK6KZ/6 did on that band, but it would not surprise me if he didn't work into Melbourne on 23-1. Certainly, Ray VK3ATN has been using the band; I note he worked VK2ZDJ, a distance of 448 km, on at least two occasions with good signal reports. VK2ZDJ runs 10 watts. I also worked Ray on 15-1, 16-1 and 17-1 on 432 with best signals to S7 on 18-1. However, my attempt to work VK6KJ on 20-1 failed, the 144 MHz signals were only 5 x 4, so it's probably no wonder! My 60 dB attenuator (hill) reduces signals somewhat to the west! Roy VK3AOS will shortly be operating on 432 and it seems this band will receive more attention in the future when Ch. 5A starts operating in western Victoria.

## MAINLY ON TWO METRES

Bill VK4ZWH reported on 11-1 that signals were 5 x 9 into Brisbane at 0640Z, distance about 30 km, and worked VK2BXT at 5 x 5 on Ch. 50 FM, distance about 550 km. Bill reports that when the Mt. Mowbrillan beacon is weak at Bundaberg, good conditions prevail to Springsure and Rubyvale, but when the beacon is S9 contacts to those places are poor. Generally conditions are better inland than on the coast too. Good 2 metre conditions generally prevailed on 14-1 between VK5 and VK3, with a big opening to Melbourne and plenty of contacts. The good conditions continued next day, starting with good coverage by the mid-northern repeater Ch. 2 to Peterborough, Whyalla, Cowell, etc. Later in the evening the band opened to Melbourne again with both VK3ZBJ and VK3YII being worked here after 1300Z.

Finally, I note Daniel VK7DA has a 6 foot dish on 1296 MHz up 45 feet, so he must mean business!

## WORLD RECORD ON 1296 MHz BROKEN

On 23-1-80 at 1204Z a two-way contact on 1296 MHz was made between VK5MC at Hatherleigh near Millicent and VK6KZ/8 at Cape Leeuwin. VK5MC received 519, VK6KZ/6 4 x 2 on SSB with 4 watts. Distance approximately 2260 km or 1403 miles. This is a new world record, and extends the former world record held by the same operators established on 29-12-78 over a distance of 2107 km or 1309 miles. Chris VK5MC reports conditions were not as good as on the previous occasion, and no VK6 beacons were audible on any band. Chris first heard Walter VK6KZ/6 at 1004Z, then again at 1100Z, and contact finally made at 1204Z. Congratulations to you both for another outstanding effort . . . VK5LP. ■

"6-9 and 7-9-79 6Y5RC and FY7 beacons, W4, W5, same for 8-9 plus T12NA. 11-9 PY. 12-9 PY KV4 FM7AD. 13-9 PY2 KP4 FY7 YV4AGL and LU. 14-9 KP4 PY KH6 T12 FM7 and YV4. 16-9 PY KP4. 17-9 LU PY YV4 FY7 6Y5 KP4. 18-9 PY KH6 KP4 FY7 T12HL FM7AD FY7AS. 20-9 KP4 PJ2DW FY7 beacon YV4 KH6 KZ5NW T12 and 6Y5 beacon, HK on FM, PY6ABA KH6IAA KH6NS XE1GE. 22-9 PY XE1 FY7 W5 VY T12ZB2BL. 23-9 PJ2DW FY2AS KH6 YV4 XE1GE KZ5NW KP2A KV4 PY1 YV4 T12 FY7 JA. 24-9 FY7 and T12 beacons. 25-9 heard PY2XB/O on CW. 27-9 PY2XB FM7AD KV4 KP2AE PY FM7AB. 28-9 PY2XB FM7AB KZ5NW PY YV XE1GE T12NA. 29-9 KP4 T12 YV4 CX8 BE QP4 KZ5NW T12 HK on FM LU7FA. 30-9 FM7AB KP4 PY2 T12 NP2AE PJ2DW. And this sort of contacting goes on right through October, and that's a station located in South Africa — just imagine how that list could be increased if you lived in KP4 or similar places."

I suppose we will now have to leave the DX on six metres and hope for something worthwhile to happen in the Pacific regions in March and April; the November, December and January period hasn't produced much in the way of exotic call signs in Australia.

## THE AUSTRALIAN SCENE

Probably the best that can be said from our viewpoint is that quite unexpectedly Es produced lots of openings throughout January 1980, making that month quite a bit better than December, which is unusual. From the VK5 area anyway, the 6 metre band was open 2-1 4, 11, 12, 13, 14, 15, 16, 17, 18, 19, 20, 24 and 26. Not a bad effort. Best days were 2-1 with VK2, 3, 4, 5 and 7; 11-1 a big opening to VK7; 14-1 open for 6 hours to VK2 and 4; 17-1 best of all, opening at 2242 to VK4DO and continuing to be open at least until 1100Z, nearly 13 hours! Areas worked were VK1, 2, 3, 4, 5 and 7, with a massive opening to VK3. Many tried 2 metres, looking towards Brisbane, during the VK3 short skip opening but to no avail, the MUF wasn't quite high enough. On 12-1 ZL TV was in at S9 for half an hour from 0300Z and ZL4LV was worked 5 x 6. On 13-1 H44PT worked VK4QO amongst others, plus VK2 and VK7 I was informed. Same day VK2ZAY worked H44PT at 0444Z, and at 0653Z worked VK6OX (that's a long haul).

Working Kerry VK2BXT on 13-1 he informed me he will be going to Sydney late February after a stay at Moree of four years. Kerry also worked VK4RO on RTTY on 14-12 599 both ways! 15-1 Ivan VK4QO working VK1RK and VK3AUR. On 17-1 worked Keith VK2ZER after absence of many years. YJ8PD worked VK2ZDY 0840Z on 15-1. On 19-1 worked Rod VK2BQJ first time this season, says he has 10 watts on 1296 now. 21-1 VK3AXV working ZL. The rest you probably know!

## TWO METRES ACROSS THE BIGHT

It had to happen. There had been a number of small openings between Adelaide and Albany during January, at times with very strong signals. First noted on 20-1 when VK6XY and VK6KJ were worked 1130Z, the Albany beacon continued to be heard on and off over the next couple of days, then on 23-1 it happened. A good high pressure system across the southern areas produced the right conditions which started as follows.

Les VK5ALW (5ZVU) was working John VK5MG on 160 metres (!) when John asked Les to check a trap vertical antenna, and to facilitate this they went on to the Ch. 5 repeater and there was Aub VK6XY signing with VK5ZRO mobile! Les and Aub then went to 144.1 and had a contact, time 2356Z. After this contact Les worked Wal VK6KZ/6 at Cape Leeuwin on the south-west tip of the Continent, then followed contacts with VK6FM, VK6WD, VK6KJ, VK6NL, VK6ZEL, VK6ZFO, VK6EO, VK6ZKO, VK6ZGF, VK6BE and tried valiantly to work VK6HK but to no avail. This was unfortunate for Don as he was the one who alerted the stations in Perth. The last contact was made at 0332Z, which is 1402 SA summer time, an unusual time of the day for two metre contacts to say the least. Two other stations to work some of the VK6s were VK5QR and VK5RP. Being a working day, the usual 2 metre gang were at work.

The above contacts would probably be about the first ever into Perth via tropospheric means, previous contacts having been via Es starting with

# IONOSPHERIC PREDICTIONS

Len Poynter VK3ZGP/NAC

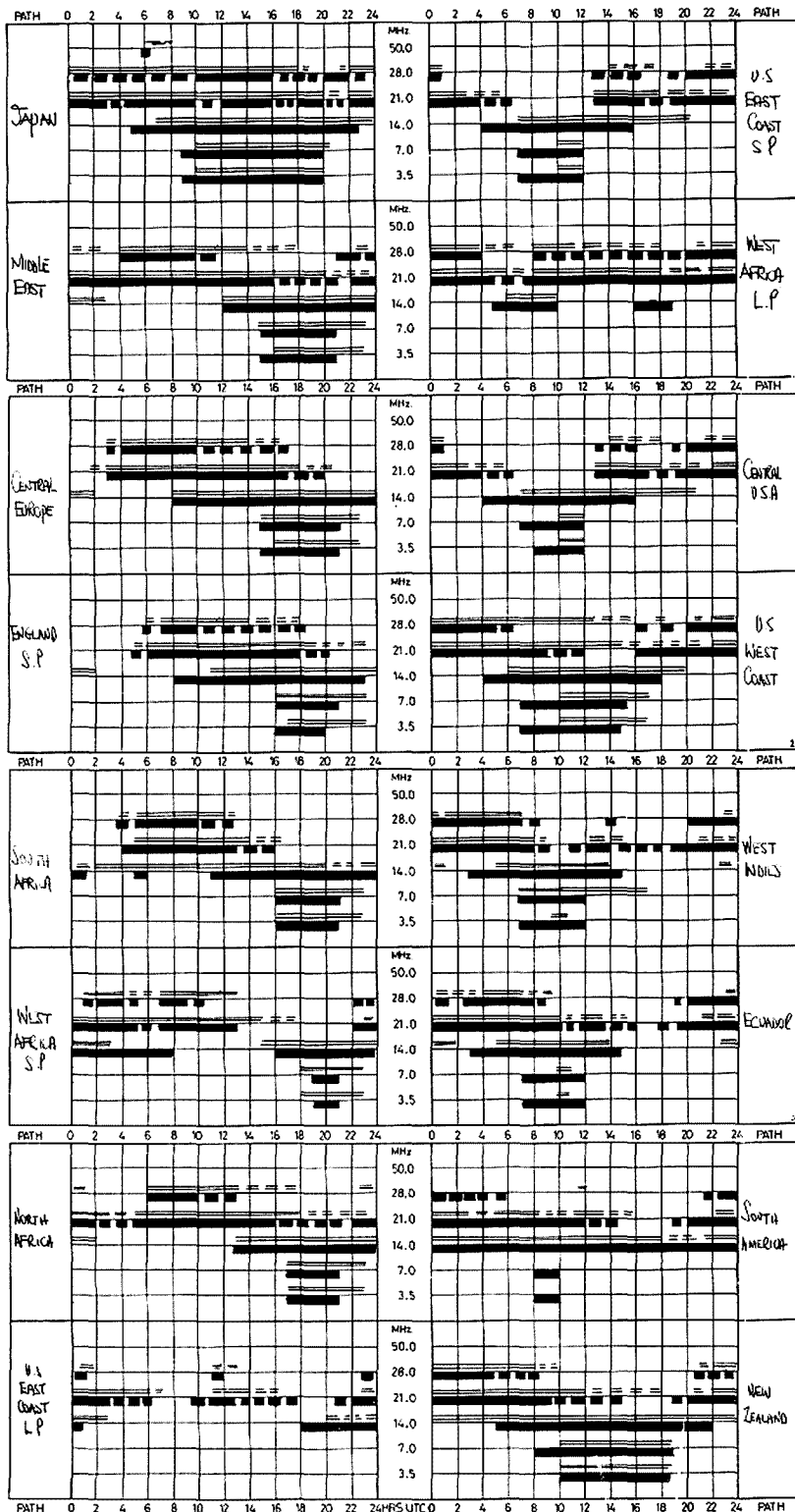

**LEGEND**  
 FROM WESTERN AUSTRALIA (dashed line)  
 FROM EASTERN AUSTRALIA (solid line)  
 BETTER THAN 50% OF THE MONTH, BUT NOT EVERYDAY (thick solid line)  
 LESS THAN 50% OF THE MONTH (thin solid line)

PREDICTIONS COURTESY IPS SYDNEY ALL TIMES UNIVERSAL UTC (GMT)

## QSP

### CURRENCY FOR RETURN QSLs

Most amateurs will be aware that currency (notes) may not be exported by individuals except under written approval from the Reserve Bank. A further problem arises if this is ignored. In many countries the import of currency is strictly controlled. Thus, if a currency note is enclosed with a QSL, the recipient could face severe penalties even if he did not solicit it. Much more tactful to use IRCs instead.

### EVER BEEN HAD?

This is Alpha Paper Figure one Romeo India Lima. QSL via Foxtrot Figure zero Oscar Lima.

### USA LICENCE PERIODS

The FCC is stated to be issuing all amateur licences for a new five year term.—Worldradio November 1979.

### PHILATELISTS

The Swiss PTT issued a series of special stamps on 8th September last to honour USKA on the 50th anniversary of the Union of Swiss Radio Amateurs.—Worldradio November 1979.

### STAMP FANS

Like many amateurs, do you have other hobbies besides radio? Jack K2SHZ is now a keen stamp collector, particularly Australian and Pacific stamps. He would be interested in exchanging stamps with other amateurs and can be contacted at 8 Linden Court, Clifton Park, New York, USA, 12065.

## CONTESTS

Wally Watkins VK2DEW  
 Box 1065, Orange 2800

### March:

- 8/9 COMMONWEALTH CW CONTEST
- 9/10 EUROPE/AFRICA RTTY CONTEST
- 22/23 BARTG RTTY CONTEST
- 29/30 CQ WW WPX SSB CONTEST

### April:

- 5/8 POLISH "SP" CW CONTEST
- 8/9 DX YL TO W/VE YL PHONE CONTEST
- 15/16 DX YL TO W/VE YL CW CONTEST
- 19/20 POLISH "SP" SSB CONTEST
- 26/27 HELVETIA "H-26" CONTEST

### May:

- 24/25 CQ WW WPX CW CONTEST

### CQ WW WPX CONTEST

Starts 0000 GMT Saturday, ends 2400 GMT Sunday. SSB — March 29-30, CW — May 24-25.

Complete rules are published in January "CO" and are the same as in previous years. Briefly the rules are as follows: Contacts between stations on different continents count 3 points on 14, 21 and 28 MHz and 6 points on 7, 3.5 and 1.8 MHz. Contacts between stations on the same continent but not the same country 1 point on 14, 21 and 26 MHz and 2 points on 7, 3.5 and 1.8 MHz. Contacts are permitted between stations in the same country for the purpose of obtaining a prefix multiplier but have no QSO point value.

The multiplier is determined by the number of different prefixes worked. Each prefix may be counted once only not once per band. The exchange is RS(T) report plus a progressive contact number starting with 001.

Only 30 hours out of the 48 hour contest period may be used for scoring. The 18 hours of non-operating time may be taken in up to 5 periods for single operator stations who must show 12 hours of operating time to be eligible for an award.

There is no time limit for multi-operator stations, who must show a minimum of 24 hours of operating time.

Mailing deadline is May 10 for SSB and July 10 for CW. Send entries to CQ WPX Contest, 76 N. Broadway, Hicksville, NY 11801, USA, and indicate whether SSB or CW on the envelope.

### RESULTS OF 1979 AUSTRALIAN NOVICE CONTEST Section A:

VK4NUL/8	601	VK2ATZ-C	143
VK2BHV-C	433	VK5NTV	124

VK2AOA-C	369	VK3VHF	92
VK2NYL	352	VK5NLC	66
VK2NBZ	200	VK2BQS	60
VK6NGO	199	VK3KS	59
VK7NHA	160	VK7NFR	45
VK2VQW-C	151	VK4NIK	25
VK2VPY	148		

Section B:  
VK3XB 83 VK3NIL 65

Section C:  
No entries.

From comments received it would appear that the time of year for this contest is not the best, both from the point of propagation (or lack of it) and pre-Christmas activities. It is difficult to pick a free weekend for contests as there are many throughout the world, but a more suitable time will be sought for the 1980 contest.

#### CONTEST CHAMPION TROPHY

The following are the points to date for 1979 with the 1979 VK/ZL points yet to be allocated.

20 points: 3XB, 5QX.

18 points: 2EL, 3AEW, 5OR.

16 points: 3AUQ.

11 points: 1RP, 3VF.

10 points: 1PG, 1GB, 2CX, 2DDS, 2HZ, 2JM, 3WP, 3YLD, 3AVJ, 4LV, 4UX, 4DO, 5UM, 6RS, 6NBU, 7RO, 7KU, 7BD, 8HA, 8LD, 9XW, 0JM.

The amateur with a "VK" call sign and the highest allocated points will be awarded the trophy but he/she must have entered at least three of the nominated contests and also be a member of the Wireless Institute of Australia.

Nominated contests for 1980 are: John Moyle Field Day, VK/ZL Oceania, Remembrance Day and Australian Novice Contests.

# AWARDS COLUMN

Bill Verrall VK5WV

7 Lilac Ave., Flinders Park, S.A. 5025

Here is a summary of WIA Awards Issued during the period 1st July, 1979, to 31st December, 1979, and the top DXCC scores, new members and amendments as at 31st December, 1979.

#### HAVKCA AWARD

Cert. No.	Call Sign	Cert. No.	Call Sign
781	JA7AMA	786	S8AAP
782	JA7HMZ	787	WB7BFK
783	JH0HWP	788	G3HTA
784	JA1GLT	789	VE2AFU
785	J11NOY		

This is the WIA Award which is only available to overseas amateurs. The award blanks became exhausted last year and I have now received stocks of a reprint from Federal Office. Those of you who have seen this award would agree that it is a very attractive multi-coloured document which would command a prestige position on the wall of any amateur shack. I congratulate the Federal Office and their printer on the high standard of the reprint but the cost was quite high. If any member wishes to know the cost, ask your Federal Councillor! This may discourage some of us from complaining sometimes about our WIA membership fees and would explain "where the money goes".

By the time you read this, the approximate 40 award applications which were held up pending receipt of the reprint will have been issued.

#### WAS (VHF) AWARD

Cert. No.	Call Sign
129	VK5ZGZ plus 4 additional countries.
130	VK4ZEZ plus 8 additional countries.
131	VK2BAE plus 2 additional countries.

#### VHFCC AWARD

Cert. No.	Call Sign
101	VK7MC
102	VK4ZEZ

#### HAVKCA AWARD

Cert. No.	Call Sign
44	L31111, M. A. Martin
45	UA2-125-183

#### DXCC — TOP LISTINGS PHONE

VK6RU	318/362	VK4VC	293/303
VK5MS	318/359	VK4RF	292/301
VK4KS	316/347	VK4PX	291/306
VK6MK	311/347	VK3JF	289/300
VK5AB	308/338	VK4AK	282/290
VK4FJ	303/339	VK5WV	281/292
VK6LK	296/310	VK7DK	278/292
VK3AHO	294/326	VK6HE	274/277
VK2APK	293/313	VK3AKK	274/275
VK4UC	293/306	VK3ACD	269/282

#### CW

VK2EO	309/346	VK4KX	258/270
VK2QL	302/340	VK3YD	250/281
VK3YL	302/333	VK3RJ	246/272
VK3AHO	299/331	VK3TL	241/260
VK4FJ	298/340	VK3KS	235/254
VK2APK	283/304	VK3JF	212/226
VK3XB	272/300	VK7LZ	206/236
VK4RF	271/291	VK4DO	204/228
VK3NC	261/297	VK5RX	202/231
VK6RU	258/297	VK4SD	186/206

#### OPEN

VK6RU	318/362	VK4PX	298/317
VK4KS	316/351	VK4UC	296/310
VK6MK	311/347	VK3AHO	294/326
VK3YL	312/343	VK7LZ	294/325
VK4FJ	309/352	VK2SG	293/311
VK4SD	309/339	VK4AK	282/291
VK2VN	302/336	VK3XB	278/306
VK2APK	301/329	VK2AHL	275/301
VK4RF	301/324	VK3TL	272/293
VK3JF	299/318	VK3ACD	269/283

#### DXCC — NEW MEMBERS

Cert. No.	Call Sign	Tally
180	VK5LA	114/115
181	VK6FS	198/199
182	VK6NEX	140/141
183	VK5OU	162/163
184	VK3AHG	108/111
185	VK2BVQ	112/113
186	VK2NHV	99/100
187	VK6NBU	100/101
188	VK2NQL	102/103
189	VK2BMX	104/105
190	VK4ABM	111
191	VK4AMB	124
192	VK2FD	119/120
193	VK6YL	158
194	VK2BAE	95/102
195	VK3NAC	137/138
196	VK3RF	191/193
197	VK5XN	260/273
198	VK6NDH	103/104
199	VK7GD	103/104
200	VK3BRM	108/109
201	VK2NTF	111/112
202	VK3ABH	225/226
203	VK7BC	237/239
204	VK2NRR	109/110

#### CW

105	VK3ABH	126/131
171	VK2AAC	134/137
172	VK3NLS	126/127
173	VK2AAB	97/104
174	VK5RD	137/139
175	VK4LG	112/113
176	VK3ABH	234/240
177	VK2NOG	103/104

#### DXCC COUNTRIES CONFIRMED ON RTTY

VK5RY, Tally 62;	VK5WV, Hally 33.		
PHONE	CW		
VK2YO	133	VK2AHH	136/150
VK2AAC	134/137		
VK2AHH	267/289		
VK3DS	139/145		
VK3OT	228/229		
VK3SM	171/227		
VK3ALM	237/243		
VK3NAC	137/138		
VK3NDY	171/172		
VK4DO	258/278		
VK7LZ	229/243		
Phew! Good hunting.			
OPEN			
VK3AVO	104/106		
VK3NAC	141/142		
VK3NDY	172/173		
VK3NLS	129/130		
VK4BG	221/234		
VK4DO	266/293		
VK7BC	258/261		

# SAVE \$\$\$ ON BATTERIES!

3 ● 6 ● 9V  
at 200mA!

WAS \$9.50  
NOW

\$6.90

(SAVE NEAR 30%!) Cat M-9525

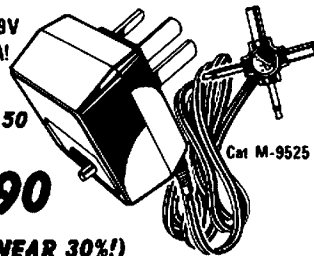

Why waste money on batteries? This superb 'plug-pack' battery eliminator suits most small battery operated appliances with its 3, 6 and 9 volts output — radios, cassettes, toys, calculators, etc etc. At our budget price, it will pay for itself in no time at all! Fully approved; comes with 4-way power plug and reversible polarity. Ideal for the home, office, shack, etc. Start saving money today!

## DICK SMITH ELECTRONICS



SYDNEY 439 5311 MELBOURNE 67 9834 CANBERRA 80 4944 ADELAIDE 212 1962 BRISBANE 391 6233 PERTH 328 6944 WOLLONGONG 28 3800

MAIL ORDERS: PO Box 321, North Ryde, NSW 2113

(Please include \$1 00 extra for packing & postage)

#### SMIRK LIST — UPDATE

JAPAN			
JE1CZV	3459	JE3BRS	3449
JE1DYH	3496	JF3HSI	3499
JE1IJQ	3460	JF3KVI	3439
JJ1KIB	3461	JG3GXU	3472
JJ1PEU	3452	JR3GPP	3497
JK1CBX	3463	JR7BKL	3473
JK1PPD	3437	JA8HKM	3423
JL1PIB	3462	JA8SSE	3431
JR1DLX	3416	JA9UBE	3401
JR1EYS	3436	JA9USX	3403
JR1OCY	3471	JA9WUJ	3402
JE2UFU	3465	JA0SSU	3495
JF2MBF	3490		

AUSTRALIA			
VK5ZGZ	3482	VK7MC	3477
OTHER			
DU1GF	3464	P29ZFS	3454
KX6QC	3466	EI2W	3484

To join SMIRK, the Six Metre International Radio Klub, send details of three foreign to foreign contacts with SMIRK members, together with US\$4, to the Secretary, Ray Clark K5ZMS, at 7158 Stone Fence Drive, San Antonio, Texas, 78227. You will receive your number and certificate by return airmail.

SMIRK also produces a newsletter which is sent to all SMIRK members who keep a supply of self-addressed envelopes with the Secretary. For Australia \$1 per envelope will cover airmail postage. The newsletter will help keep you in touch with what is going on around the world on six metres. List compiled by Lionel VK3NM.

Readers may recall the "Gemfields Centenary Award", details of which appeared in April 1979 Amateur Radio, page 40. As a sequel to this award, the Gemfield Radio Group will hold a draw on March 1, 1980. The prize will be a valuable sapphire donated and cut by group members. The numbers for the draw will be taken from the Gemfields Centenary Certificates. The winner will be notified by post and the results published in AR.



# CUSTOM COMMUNICATIONS

SHOP 11 PARRAMATTA ARCADE  
CNR. CHURCH AND DARCY ST., PARRAMATTA. 2150

TEL. 635 6399  
A/H 674 1719

“IT IS HERE NOW” THE ASTRO 150 FROM SWAN

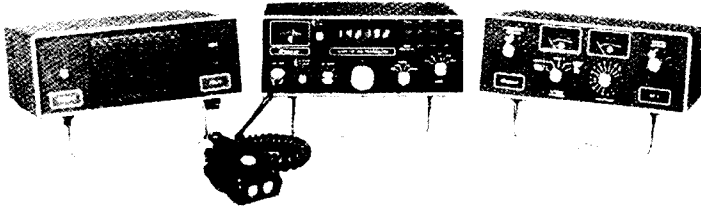

Matching power supply (PSU-5) and antenna tuner (ST-3) provide the necessary additional units for a complete base station.

### Frequency Range:

- 160 Meter Band . . . . . 1.8- 2.4 MHz\*
- 80 Meter Band . . . . . 3.0- 4.5 MHz
- 40 Meter Band . . . . . 6.0- 8.3 MHz
- 20 Meter Band . . . . . 13.8-16.0 MHz
- 15 Meter Band . . . . . 20.8-23.0 MHz
- 10 Meter Band . . . . . 28.0-30.0 MHz\*\*

\*Model 151 only  
\*\*Model 150 only

**SERVICE FACILITIES AVAILABLE**  
We repair any equipment at reasonable prices.

## ASTRO 150/151

- Mode: . . . . . CW, CWN, LSB, USB  
CW Break-in, Full and Semi
- RF Input Power: . . . . . 235 watts all modes, all bands
- Carrier Suppression: . . . . . Better than 50 dB
- Side Band Suppression: . . . . . Better than 60 dB
- Microphone: . . . . . 47 K ohms with push  
button tuning
- AF Response: . . . . . 300 to 3000 Hz

**INTRODUCTORY OFFER \$825**

## Performance Specifications

- Spurious Radiation: . . . . . Harmonics: > 45dB below peak power  
Other: > 55dB below peak power
- Receiver Sensitivity: . . . . . 10 dB  $\frac{S+N}{N}$  or better at .35 $\mu$ V
- Image Ratio: . . . . . Better than 60 dB
- Frequency Stability: . . . . . 10 Hz/Hr. after warm-up
- Receiver Selectivity: . . . . . SSB & CW 2.7 KHz (8 pole filter)  
Shape Factor 1.6:1  
CWN 300Hz (Xtal)
- Audio Output Power: . . . . . Greater than 3 watts into 4 ohms
- Power Requirements: . . . . . 13.8 VDC @ 18A peak (Xmit)

## ASTRO 102BX Performance Specifications

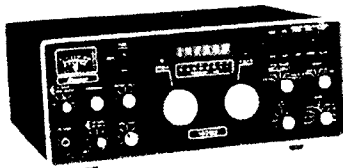

**INTRODUCTORY OFFER**  
**\$1050**

**THE OLD BIRD WITH NEW  
“FEATHERS”**

- General:**
- Frequency Range\* . . . . . 160M Band . . . . . 1.8-2.0 MHz
  - 80M Band . . . . . 3.5-4.0 MHz
  - 40M Band . . . . . 7.0-7.5 MHz
  - 20M Band . . . . . 14.0-14.5 MHz
  - 15M Band . . . . . 21.0-21.5 MHz
  - 10M Band . . . . . 28.0-29.999 MHz

- \*approximate 50 to 100 KHz overrange on each band
- Readout: . . . . . Six digit LED from internal counter
- Frequency Stability: . . . . . Within 100Hz during any 30 minute period after warm up
- Power Requirements: . . . . . 13.6VDC (11 to 15VDC range) at 1.8 amp receive, 19 amp peak transmit

- Transmitter:
  - RF Input Power . . . . . 235 Watts all modes, all bands
  - RF Output Power: . . . . . 100 Watts all bands — limited by ALC to 100 Watt output PEP or CW
  - VSWR Shutdown: . . . . . Full power up to VSWR = 1.7:1  
Approximate limit ratio as follows:
- | VSWR     | Percent Power |
|----------|---------------|
| 1.5      | 100%          |
| 2.0      | 80%           |
| 3.0      | 60%           |
| $\infty$ | 25%           |

- Carrier Suppression: . . . . . Better than 50dB
- Sideband Suppression: . . . . . Better than 60dB
- Spurious Radiation: . . . . . Harmonics > 45dB below peak power  
Other > 55dB below peak power

- Audio frequency Response: 300-3000Hz
- Microphone Impedance: . . . . . 47K ohms
- Receiver Sensitivity: . . . . . 10dB  $\frac{S+N}{N}$  Typ. at .35  $\mu$ V

- Image Rejection: . . . . . Better than 60 dB
- Receiver Selectivity: . . . . . SSB and CW - 2.7 KHz bandwidth, two 8-pole crystal filters with shape factor 1.4; 6dB to 100dB

- CWN - 300 Hz bandwidth, IF crystal filter in series with one 8-pole SSB filter
- Bandpass Tuning: . . . . . SSB and CW eight-pole cut-off continuously variable highpass or lowpass. LED readout shows approximate audio bandpass.

- CWN — IF crystal filter continuously tunable over 300-3000Hz with passband control
- Dynamic Range: . . . . . AGC greater than 100dB  
Third order intercept + 15 dBm

- Audio Output Power: . . . . . Greater than 3Watts into 4 ohms

## Valve Model Runout

Ask for Special Prices

CUSTOM COMMUNICATIONS (SYDNEY) as an independent business accepts **NO RESPONSIBILITY** for actions by the non-related Custom Communications (Brisbane).

# YOU and DX

Mike Bazley VK6HD

8 James Road, Kalamunda W.A. 6076

What is a QSO? The reason for raising this question again is that both CQ and the ARRL are considering dropping the RS or RST exchange requirements from their contests. They argue that, in an international contest, the "Big Guns" only give out 59 or 599 reports regardless of signal strength or clarity. If reports are to be dropped what is the position of a net QSO where the M/C puts across the call sign? Does he say, "These are the stations checking in so please put them in your log!"? Alternatively we can get an exchange that goes "I confirm your good morning, it is good evening here!!!" How about the skeds made with a DX station for a QSO on another band? Here the station knows the call sign, does he only have to think he hears you to put the QSO in the log? A report used to mean something, without it how does one have a two-way contact or net QSO?

## DX RUMOURS, FACT AND FICTION

K1MM, who was recently in the Indian Ocean signing FROMM, will be in S2, Bangladesh, around the 1st March and will be hoping to be active, possibly from S2BTF's (Peter's QTH). S2BTF is very active most days on 21345 kHz from 0100Z. If conditions are not good to the USA, on 15 metres, Peter often QSYs up on to 28595 kHz, plus or minus QRM.

Those chasing an HZ1AB QSL might try ZL3FM as a route. It is reported, via VK3YL, that at present ZL3FM is out of QSLs but will reply to all cards as soon as new supplies are received.

Those who worked VP1KS recently may be interested to know that Klaus DL1KS was using battery power into an FT7 driving a small transistorized linear (50 watt). The antenna on 10-20 was a TH3DXX at 30 feet fixed on Europe. 80 and 40 was covered by inverted vees. Even so over 3500 QSOs were made on the live bands, including one to VK. Klaus will be returning to VP1 in May/June 1980. All QSLs via his home QTH.

In a recent QSO with VE3FXT, George told this writer that he expected to be QRV from Burma in the very near future. Possibly this one will have already taken place by the time this appears in print.

Chatham Island ZL2UW/C is often found on 14220 or 14265 kHz at around 0600 to 0800 GMT.

Tonga A35SM is active but you need sharp ears for this one. He runs 5 watts of CW, usually on 14202 at 0800 GMT. QSL via Box 111, Nuku'alofa. (Last two items from DX notes in November "Break In" by ZL2HE.)

An interesting sidelight to my comments in the January AR, regarding Heard Island, brought forth the following letter from a reader:

"The Cape Pillar is only 2160 tons, and has very limited excess accommodation; the chances of any extra personnel to operate on Heard Island getting a berth are pretty remote; all spare accommodation will be taken by those in the working party.

The Radio Officer, ham or not, will not be allowed ashore as Heard Island is an unprotected anchorage, and the ship will be on permanent standby there, ready to up anchor and head out to sea if the weather deteriorates. The Radio Officer will be required to stay on board and be available for any communication requirements. He will not be able to operate from the ship of course, as antenna space is at a premium, and the DC mains on the ship makes operating modern transceivers a bit of a problem, unless they can operate from 24 volts DC, which the R/O could obtain from his emergency battery (although using the ship's radio installation for amateur operation is illegal).

So Heard Island may be on the air, but personally I doubt it, and certainly the Radio Officer can be counted out."

That letter is certainly thought provoking. Even so the pundits are suggesting that there will be

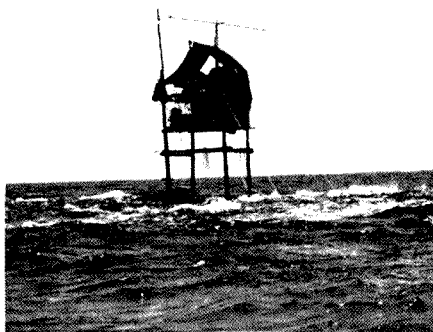

This is a country! The recent 7JL expedition site at low time (bottom) and high tide (top).



OT Jean F8EX, 75 years young. Jean runs a R4C and T4X with a 2 el. quad on HF and long wire for LF.

operation from Heard Island during March and it will be a well known W who will be the operator. May I suggest the best bet would be to check the usual DX frequencies, VK0 operation or not, only time will tell.

Jacques W4LZZ is at present making several trips to 3V8-land on business. Chances are that he could be posted to Tunisia for a two year spell. If this eventuates it should take 3V8 off many wanted lists, as Jacques is a very active amateur.

A note from 10DUO, passed via Jill VK6YL, provides the following information:—

"I'm pleased to inform you that the station from Vatican City, HV3SJ, is active once again after many months of QRT. Myself—home call

10DUD—is the operator. I will be operating from Vatican City almost every Saturday and Sunday from 0600 to 0900 GMT and from 14.30 to 17.30 GMT, mainly SSB 14, 21, 28 MHz. Sometimes a list is made by 10MPF. QSL manager: 10DUD."

Ever thought of going on a DXpedition? The recent Palmyra, King Reel, trip highlights what can go wrong. Departure was delayed one day due to engine trouble. On landing at Palmyra their plane burst a tyre and crashed into trees. Jan Could WA6UQW was injured and taken by US Coast Guard helicopter to Honolulu. It was reported she had two fractured legs and pelvis and ruptured spleen. If you would like to write a get well note, etc., to Jan it could be sent via W6ORD.

VK6HD was told over the air that in spite of bad weather they did make their landing on Kingman and even though one of the rigs had modulation problems they made 5500 QSOs from the Reel. QSL information in the QTH list.

An interesting letter from Peter VK3NYY asks for a section on Novice DX Notes. I am quite happy to do this providing others come to the party with information. Peter would be pleased to hear any QSL information on JL1FFL/JD1, WD4CVK/KH4 and TA2FM. Of further note from Peter comes the information that WD4HQB has been posted to Bangui, Central African Republic, and hopes to operate from TL8JM's QTH. He will be especially looking for Novices at weekends on 21,140 kHz. Finally a list of some of the CW goodies appearing in the 21 MHz Novice section. CX4AQ, HK0AZW, KCSJJ, KG6SL/KH0, KV4BQ, KG4WM, HZ1AB, FY0BE, WD4SCJ/SU, PJ2CC, TA2FM, YN1HFC, TJ1AB, 8P6BZ, 9Y4VT, 9Y4W. If that list doesn't make you brush up your CW then you are not a Dixer.

VE3BVD/ST2 very QRV SSB HF band as is DJ1US/ST3 QRV on CW. 4U1UN QRV 14030 Thursdays from 2100 GMT. 9N1MM very ORV 21 and 28 MHz SSB weekends. Tim BV2A has been very active lately on 14, 21 and 28 CW. He is usually found between 025 and 030. QSL to his home QTH.

Well, that's the lot for this month. Thanks to BERS 195, VK3AQZ, VK3NYY, VK4KX, VK6AJ, VK6LK, Geoff Watts' New Sheet. 73 es DX Mike VK6HD.

## STOP PRESS!!

ET3PG has been reported as very active on 15 metres. Usual frequencies around 21245 plus or minus. Has a few QSOs and when the pile up gets heavy QSYs up or down a few kHzs. QSL PO Box 5327, Addis Ababa.

## QTHs YOU MAY HAVE MISSED

- A4XIK — via I8YCP.
- C3IKJ — via DJ9NT.
- C6ACY — via K4ZGB.
- DJ1US/ST3 — via DF2RG.
- EL2T — via K4BAI.
- FC0FHK — via DL1RK.
- FM8OM — via F6ESH.
- FM7WO — via W1ULE.
- W0BB — via FK8DG.
- HV3SJ — via 10DUD.
- HZ1TA — via 18CYP.
- D4CBS/J5 — via D4CBS.
- JW0EM — via LA5X.
- KH3AA — Box 69 APO, San Francisco, California 96305, USA.
- K6LPL/KH5 — via K6LPL.
- WA2F1J/KH5K — via WA2F1J.
- W8NMK/KH0 — via K4AVU.
- PJ9EE — via WA7UTA.
- S2BTF — via LA5NM.
- TZ4AQS — via ON6BC.
- VE1A1/I — via VE1A1.
- VE3BVD/ST2 — via VE3FRA.
- VK9DM — via K1BZ.
- AA7A/VP2A — via AA7A.
- VP2MEC — via K4TVE.
- VP5DM — via WA4CXZ.
- ZD8RL — via G4DRW.
- ZF2CL — via DK7PZ.
- ZK1DR — via W0WP.
- 3B6CD — via WD5BIF.
- 5W1AB — via DJ9ZB.
- 3D6AR — via WA6AHT.
- 5Z4YP — Box 40601, Nairobi.
- 8Q7AL — via SM3CXS.



# WICEN

Ron Henderson VK1RH  
Federal WICEN Co-Ordinator,  
53 Hannaford St., Page ACT 2614  
Ph. (062) 54 2059, A.H.

## EMERGENCY SERVICES COMMUNICATIONS PROCEDURE

This issue we continue with the fourth part of the Emergency Services Communications Procedure paper.

### 31. VERIFICATIONS

When verification of a message has been requested by the addressee, the sending station will verify with the originator, and send the correct version.

#### EXAMPLE A:

VK1BFX: "VK1BFC — THIS IS VK1BFX — VERIFY message — TIME One Zero Zero Eight Zero One — ALL BEFORE text — OVER".

VK1BFC: "VK1BFC — WILCO — OUT".

VK1BFC, after checking with the originator, finds that the heading as previously transmitted is correct, transmits:

"VK1BFX — THIS IS VK1BFC — I VERIFY — MESSAGE — TIME One Zero Zero Eight Zero One — ALL BEFORE text — PRIORITY — TIME One Zero Zero Eight Zero One — FROM — VK1BFC — TO — VK1BFX — INFO — VK1BFA — OVER".

VK1BFX: "VK1BFX — ROGER — OUT".

#### EXAMPLE B:

VK1BFX: "VK1BFL — THIS IS VK1BFX — VERIFY message — TIME One Zero Zero Eight Four Five — word after — proceed — OVER".

VK1BFC, after checking with originator, finds that originator meant MOREE instead of BOREE as word "proceed" transmits:

"VK1BFX — THIS IS VK1BFC — CORRECTION — message — TIME One Zero Zero Eight Four Five — WORD AFTER proceed — MOREE — OVER".

### 32. RELAYING MESSAGES

(a) It may be necessary for a Signal Centre to re-transmit a message from another Signal Centre. This is "THROUGH" message and the prosign "T" is included in the "FOR COMMSIG/CEN USE" line of the Message Form by the Signal Clerk of the originating Signal Centre.

(b) Relaying of messages may also occur in a radio net, however, without reference to the Signal Clerk, if conditions are difficult and the Sending Operator decides to relay the message via another station. In this case the proword "RELAY" used alone indicates that the station called is to relay the message to all addressees.

#### EXAMPLE:

VK1BFB: "VK1BFX — THIS IS VK1BFB — RELAY — PRIORITY — TIME — ZERO NINE One Five One Zero — FROM Bravo Foxtrot Bravo — To — VK1BFC — PROCEED on mission assigned — OVER".

VK1BFX: "VK1BFX — ROGER — OUT".

VK1BFC: "VK1BFC — THIS IS VK1BFX — PRIORITY — TIME Zero Nine One Five One Zero — FROM — VK1BFB — TO — VK1BFC — proceed on mission assigned — OVER".

VK1BFC: "VK1BFC — ROGER — OUT".

(c) The proword "RELAY TO" followed by an address designation indicates that the station called is to relay the message to the station indicated. When more than one station is called, the call sign of the station designated to perform the relay will precede the proword "RELAY TO". At times it is necessary to relay a message originating on a radio-telephone circuit by some other means of communication. When such relay is necessary, it is the responsibility of the station relaying the message to place the message in the proper form for the means of communication employed for relay.

#### EXAMPLE:

VK1BFB: "VK1BFX — VK1BRC — THIS IS

VK1BFB — MESSAGE — VK1BFC RELAY TO — VK1BFA — TIME One Five Zero One Two Two — FROM — VK1BFB — BREAK — etc. — OVER".

VK1BFX: "VK1BFX — ROGER — OUT".

VK1BFC: "VK1BFC — ROGER — OUT".

VK1BFC: Transmits (relay to VK1BFA).

VK1BFA: "THIS IS — VK1BFC — MESSAGE — TIME One Five Zero One Two Two — FROM VK1BFB — TO — VK1BFA — INFO — VK1BFX — BREAK — etc. — OVER".

VK1BFA: "VK1BFA — ROGER — OUT".

### 33. THROUGH ME

Because of changing condition on a radio net cases may occur when a station to which a call is addressed is having difficulty hearing the calling station, but a third station can hear both stations well, in this case the third station would invite the calling station to relay the call through him.

#### EXAMPLE:

VK1BFX cannot hear VK1BFC too well but VK1BFB can hear both stations loud and clear. After several calls VK1BFB says:

"VK1BFC — THIS IS VK1BFB — THROUGH ME — OVER".

VK1BFC: "VK1BFC — WILCO UR MESSAGE FOR VK1BFX — No further aid required — OVER".

VK1BFB: "VK1BFB — ROGER — OUT TO YOU — VK1BFX this is VK1BFB UR MESSAGE from VK1BFC — No further aid required — OVER".

VK1BFX: "VK1BFX — ROGER — OUT".

VK1BFB: "VK1BFC — THIS IS VK1BFB — message passed — OVER".

VK1BFC: "VK1BFC — ROGER — OUT".

Note: The use of this system depends, of course, on a high standard of net discipline.

### 34. BREAK-IN PROCEDURE

A station having a message of higher precedence than the transmission in progress may break-in and thus suspend that transmission in the following circumstances:

- Flash: Break in at one.
- Priority: Only long Routine messages should be interrupted.
- Routine: Break-in procedure may not be used.

#### EXAMPLE:

VK1BFA is transmitting a long PRIORITY message to VK1BFC and VK1BFX receives a FLASH message for transmission to VK1BFB. When VK1BFA pauses, VK1BFX transmits:

"FLASH — FLASH — FLASH — VK1BFB — THIS IS VK1BFX — FLASH — OVER".

VK1BFA, hearing VK1BFX break-in, ceases his transmission.

VK1BFB: "VK1BFX — THIS IS VK1BFB — SEND — OVER".

VK1BFX: "VK1BFX — text, etc. — OVER".

VK1BFB: "VK1BFB — ROGER — OUT".

(d) After VK1BFB has transmitted his acknowledgment of receipt, VK1BFA pauses for five seconds to permit any station with higher priority traffic to transmit, before resuming the transmission of his message.

(e) Immediately on being offered the FLASH message the operator at VK1BFB should warn his Signal Centre Superintendent, who in turn warns the Operations Room, that a FLASH message is coming in.

### 35. BROADCAST TRANSMISSIONS

(a) The "Broadcast" method of transmission is used to send a message in the event that, although he has not replied to the offer, there is a reasonable chance that the receiving station may be able to receive it.

(b) When using the Broadcast Method, the sending operator transmits the whole message at dictation speed and, at the end of the first transmission says, "I SAY AGAIN — I SAY AGAIN", and continues to transmit the whole message a second time, at dictation speed.

### VK2 WICEN AND THE RED TERROR

During the afternoon of Monday, 17th December, three Emergency Fire Controllers were appointed under Section 41F of the NSW Bush Fires Act in respect of three major bush fires burning in the Shire of Hornsby, the Shire of Warringah and in the Ku-Ring-Gai National Park. These fires were located on an arc roughly 22 km (13 miles) to the

# AMATEUR RADIO ACTION

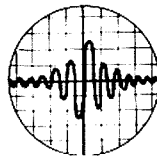

is the NEW GENERATION  
amateur magazine.

- ★ Comprehensive DX notes
- ★ Propagation forecasts
- ★ Very technical - and not so
- ★ Technical articles
- ★ Useful projects

Here are just a few of the articles which have appeared in recent months

- ★ Fixed wire beams
- ★ Case for UHF beams
- ★ 80W linear for 6m
- ★ Wilson System Three review
- ★ Spratly DX exclusive
- ★ Backyarders - good or bad?
- ★ A.T.V. Special
- ★ SWL notes

Average page content is 80 pages - at \$1.20 an issue that's good value.

Please put me down for 12 editions of Amateur Radio Action, starting NOW-

Rates in Australia - \$14.40. Surface mail overseas - \$18.40 Air mail: To New Zealand - \$A28.70; Malaysia - \$A32.60; Japan - \$A38.45; USA - \$A42.35; UK - \$A46.25

Herewith enclosed cheque/postal note/money order to the value of:

\$A .....

Name.....

Address.....

Postcode.....

Post to: Amateur Radio Action Subscriptions, Box 628E, Melbourne, 3001.

north of the centre of the City of Sydney.

Numerous other fires of lesser magnitude were burning in other areas simultaneously, but one particular fire, some 100 km (30 miles) north-west of Sydney in the rugged mountainous country near Clarence, was considered to be a potential threat to settlements to the east and south if the prevailing winds continued.

An Emergency Fire Controller for the Clarence fire was appointed that same afternoon.

#### BUSH FIRE BRIGADE COMMUNICATIONS

All Local Government Councils in the County of Cumberland, which is the area surrounding Sydney, and adjoining areas, operate a VHF FM radio network on their own particular frequency for Bush Fire communications and all Bush Fire vehicles are suitably equipped.

Each Council has a Bush Fire Control Centre in radio contact with their Brigades and has a sub-base on the NSW Bush Fire Council's emergency channel. This latter facility links all Fire Control Centres with the Bush Fire Council's operations room and the NSW Fire Brigade's operations room, both in Sydney.

This channel provides "hot line" links for the Emergency Fire Controllers to the various authorities involved and fire-line links to the tankers moved from distant areas to assist the threatened area.

#### NSW WICEN ACTIVITIES

The Sydney North WICEN organisation, under Regional Co-ordinator Barry White VK2AAB, was activated at 1400 hours, December 17th. By 1500 hours, Sydney North WICEN had established 2 metre VHF (primary) and 10 metre HF (secondary) bases at the Hornsby Shire fire control centre, which was the operational headquarters for two of the three Emergency Fire Controllers.

For the next 52 hours Sydney North WICEN provided continuous fire-line communications with WICEN mobile units attached to the tankers and crews of Bush Fire Brigades from distant areas who were not fitted with the Bush Fire Council's emergency channel.

Mobile canteens proceeding into the fire areas to feed the bush fire crews were accompanied by a WICEN vehicle which ensured that all crews were fed despite the limited visibility resulting from the heavy smoke pall and the continuous movement of the Brigades.

A WICEN 2 metre base was established at Warringah Fire Control Centre during the afternoon of the 17th with a direct link to the Hornsby WICEN base.

There was no requirement for a WICEN mobile force at Warringah but there was a pressing need for operators on the Bush Fire Council's emergency channel which could not be met by the staff of the Warringah Bush Fire Centre due to their complete commitment to their own channel.

By late afternoon of the 17th WICEN was operating the emergency channel and did so continuously for the next 48 hours.

Simultaneously with the above, and located well away from the Fire Control Centres, a WICEN Roster Officer and assistants came on duty to handle the offers of assistance from WICEN members, to roster personnel on and off duty and to record such details and to handle the myriad of things that need attention during emergency situations.

The roster crew had their own 2 metre calling channel and telephones and their location became the rendezvous point for WICEN personnel thereby relieving the operational channels of all administrative matters.

Additionally, throughout Tuesday 18th, WICEN supplied a competent operator for the Bush Fire Council's emergency channel base station in Sydney.

By 1800 hours on Wednesday, 19th December, the three major fires were under control, the emergency declarations were revoked and WICEN was stood down to a standby alert status.

On Saturday, 22nd December, the Clarence fire, to the north-west of Sydney, under the influence of strong north-westerly winds, jumped the control lines. By Sunday the 23rd it was moving south

and east on a broad front, threatening many small settlements and creating a potentially serious threat to the comparatively populated line of towns dotting the Blue Mountains area—some 60 to 80 km west of Sydney.

Sydney North WICEN was again activated on the Sunday afternoon and rapidly established VHF and HF bases at the Baulkham Hills Shire Fire Control Centre with links to two WICEN communications vehicles at the village of Bilpin, some 50 km (30 miles) distant, which was on the most easterly edge of the fire.

The WICEN vehicles became the communications centre for the Bush Fire Brigades from the Sydney area which had been despatched to assist the Blue Mountains and Colo Shire Bush Fire Brigades.

These assisting Brigades could communicate with each other but due to terrain and distance could not maintain reliable communications with their parent base stations.

WICEN could, and did, provide the links continuously which resulted in the relief crews, spare parts, etc., arriving at the fire ground as necessary to maintain the operational efficiency of the fire fighting force.

About 2100 hours on the 23rd the Emergency Fire Controller for this fire urgently requested a Radio Teletype (RTTY) link from his headquarters at Katoomba to the Colo Shire Council Fire Control Centre, about 50 km (30 miles) east.

Bearing in mind that it was 9 p.m. on a Sunday night at the start of the major holiday season of the year, this was not an easy request to meet.

The request was put to the Sydney RTTY Group who, by midnight, had transported two operators and RTTY gear some 50 km (30 miles) and had established RTTY and VHF voice links from the Colo Fire Control Centre to the Katoomba Centre.

Whilst this action was in progress the Blue Mountains Regional WICEN Co-ordinator, Stuart Brown VK2RY, was activated and had proceeded to Katoomba to establish that RTTY terminal.

The RTTY facility was provided with the minimum delay possible and at great personal inconvenience to all participants, and though it was utilized, it was not used to its full capacity.

The arrival of south-easterly winds and cooler conditions during the late afternoon of Christmas Eve stabilised the fire situation and permitted a stand down of WICEN by 1800 hours.

However, that was not the end of WICEN's activities. During Christmas Eve afternoon an Emergency Fire Controller was appointed in respect of a fire in very rugged terrain some 40 km (24 miles) north-west of Gosford. Gosford is a major centre some 50 km (30 miles) due north of Sydney City.

The Central Coast WICEN group, under Regional Co-ordinator Ray Wells VK2BVO, was put on an immediate alert.

The Emergency Controller deferred full scale containment action until 0600 hours on 27th December, when WICEN went into the field providing VHF and HF communication links from the Brigades to the Gosford Fire Control Centre and liaison communications with the Australian Army units engaged on the fire line.

The terrain was such that only four-wheel-drive vehicles could safely negotiate the tracks around the fire and it was taking an hour or more in some places to travel 10 km (6 miles). Central Coast WICEN was in the field continuously from 0300 hours on the 27th until 2200 hours on the 28th, when the fire was declared safe and WICEN reverted to a standby status.

Standby rosters of WICEN personnel were maintained throughout the New Year holiday period and until appreciable rains early in January considerably eased the bush fire situation.

From records maintained throughout the period 17th to 28th December, inclusive, some eighty-six (86) WICEN personnel were activated—either on duty or on standby—during the Sydney, Clarence and Gosford fires. This does not include the non-amateur personnel who provided assistance in the transport and catering fields. Without those services the operations would have been more arduous.

It is estimated that WICEN personnel spent over 1750 manhours in the field, but it is almost impossible to estimate the manhours spent on standby by relief crews except that they must run into several thousand hours.

WICEN responded to the emergency situations rapidly and efficiently without materially depleting the organisation's reserves of manpower and equipment.

#### FIRE DAMAGE

It is provisionally estimated that the Hornsby, Warringah and Ku-Ring-Gai fires burned 15,000 hectares (37,000 acres) of predominately urban land. Fourteen houses were gutted and an undetermined, as yet, number were damaged.

The Clarence fire is estimated to have burned some 116,650 hectares (288,000 acres) of mainly rural country as it travelled some 50 km (30 miles). One weekender holiday house was destroyed and several sheds or outhouses.

North-west of Gosford the fire consumed 22,000 hectares (54,000 acres) of rugged, isolated terrain. No houses or sheds were lost.

Remarkably, no lives were lost at any of the fires, which is a tribute to the efficiency of the Bush Fire Brigades and other organisations on the fire fronts. Several volunteer Brigade members were injured—some seriously.

#### SCALE OF OPERATIONS

Practically every volunteer Bush Fire Brigade in the County of Cumberland and adjacent areas was engaged on one or other of the fires—well over 100 Brigades with a strength in excess of 1000 men, plus every tanker and crew that could be supplied by the NSW Fire Brigade, plus large contingents of the NSW Police Force manning road blocks as well as being on fire lines.

Several hundred Australian Army, Navy and Air Force personnel were involved, together with military and civilian heavy earthmoving vehicles. Military and civilian helicopters and light aircraft were used extensively for observation duties.

The Salvation Army and the Seventh Day Adventist organisations provided continuous assembly point and fire-line catering, whilst the State Emergency Service handled welfare problems.

In total it was a massive community operation involving several thousand persons over an operational period of twelve days.

The contribution by the NSW WICEN organisation has been appreciated and acknowledged by the Statutory Authorities concerned and the amateur fraternity as a whole can be justifiably pleased with, and proud of, their efforts.

#### "VERBUM SATIS SAPIENTI"

(Pidgin Latin for "A word to the wise")

These fires have emphasised and confirmed the answer to the persons, amateur and non-amateur, who decry and criticise the WICEN organisation.

They reiterate, ad nauseum, the theory that the continual build-up of communications facilities by the Statutory Authorities negates any requirement for amateurs to provide additional communications during a Civil Emergency.

When a particular emergency situation reads and abides by the rules, regulations, etc., that the Statutory Authorities must adhere to and presents only the problems that pre-planning procedures have foreseen then, and only then, will the particular communications systems cope with all the requirements. Until that day arrives there will always be a need for a viable WICEN organisation to assist with the perverse, ad hoc demands of a sustained emergency situation.

There is no glory or kudos in being a member of WICEN—just the satisfaction of providing a specialised community service which no other organisation, be it voluntary or Statutory, can provide.

Every WICEN group in the Commonwealth needs mature, responsible amateurs and, irrespective of location or grade of licence, your local WICEN Co-ordinator will be pleased to hear from you.

From Howard Freeman VK2NL, NSW State WICEN Co-ordinator.

# LETTERS TO THE EDITOR

Any opinion expressed under this heading is the individual opinion of the writer and does not necessarily coincide with that of the publisher.

PO Box 93, Toongabbi, NSW 2146.  
7th December, 1979.

The Editor,  
Dear Sir,

I know that it is bad practice to include more than one subject in a letter such as this, however I crave your indulgence since by so doing I will reduce the volume of correspondence and hopefully be a little more economical in the use of words.

## ITEM A

We often see references to the tendency for Australian radio amateurs to become "Appliance Operators".

It is unfortunate that this accusation has a fair measure of truth in it, but I would like to suggest that it is not entirely the fault of the amateur.

From personal experience as one who enjoys attempting to build up items of interest, I suspect that the equipment retail outlets must accept much of the blame. To read the advertisements in any radio journal one would gain the impression that 98 per cent of amateur activity is based on pre-built commercially available items. In fact, any attempt to obtain parts which do not fall into the realm of everyday usage is doomed to failure if one patronises businesses which deal largely in the ready built. Investigation of stocks held by "second-hand" stores often produces results but the time and mileage expended becomes disproportionate to the result.

Without expounding the facts in greater detail, I just wish to make the statement that the "Appliance Operator" is being created largely by the retailers for reasons which must be apparent to all. If there is a solution to this problem I wish someone the very best of luck in any attempts to have the message learned by those responsible for the present situation.

## ITEM B

In December AR VK3UG made a suggestion that the WIA Divisions be dissolved in favour of Club/Zone — Federal body type of organisation.

I would like to express my disagreement with such a proposal, mainly because in a country the size of Australia it is impossible for a centralised body, probably based in a major centre of population, to have a knowledge of the problems and activities associated with the more remote parts of the country. I mean remote in terms of distance from the controlling body — not just outback! It would also be impractical in terms of time and expense for the number of delegates required to efficiently represent remote areas to attend on a voluntary basis the more frequent and extended meetings which would be necessary for such a Federal body to deal with all the regional problems as well as national problems.

Clubs have their use, but their problems, solutions and ideas are normally too fragmented to be of great use to a body dealing at a national level. There must be a filtering system to ensure that matters of national importance are properly represented to a national body, and that more localised matters are dealt with at a more local level.

The difficulties which are apparent and which probably prompted the letter under reference, can be overcome by the standard of representation at Divisional level. Whether or not an improvement is desired or necessary is a matter for each amateur to decide personally, and the solution is equally in the hands of the same amateurs, and this without making major structural changes to an organisation which has demonstrated that it can in fact work.

## ITEM C

In the same issue of AR VK2JO made some comments on the community usefulness of amateur radio.

Despite the editorial comment on "Hamagrams", which I believe was intended to be derogatory, I must support some of the ideas expounded.

During one or other of my many communication industrial disputes, I became aware how some amateurs did in fact put their head on the block and provide some community assistance, largely in the area which could have well been described as "using hamagrams".

Because of the obvious benefit, I made a fairly detailed submission to the Minister of P. and T., setting out how the amateur could, with certain limitations regarding responsibility, take over the role of communications within the country of items which could not be handled by the telephone system, which required more rapid handling than through the mail system, and which by the admission of the Minister, were not desired by his Department. This must of course refer to "telegrams", a communication which has been stated as being a loss to P. and T., and a system which is being phased out as much as possible by discouragement of the user.

My original proposal was followed up some time later in a second letter, however are you really surprised to know that I did not even receive the courtesy of an acknowledgement — not a lesson in good manners at all!

You will gather from these remarks that I do support the idea of community service, even if the word Hamagrams is a little . . . well, unusual.

Yours faithfully,

J. M. Swan VK2BQS.

1 Lines St., Holder 2611, ACT.  
12th December, 1979.

The Editor,  
Dear Sir

With WARC 79 all over bar the shouting, it may be too late to change things. However, if we as amateurs have lost anything, we should consider the following report before we try to lay the blame. The following comments were made at the 1971 World Administrative Radio Conference for Space Communication, and was reported in "Amateur Band News and Notes" in the December 1971 Electronics Australia:

"You fellows aren't amateurs any more. An amateur is supposed to be primarily an experimenter, to build his own equipment, to try out new circuits, to develop new ideas. You did this years ago, but no longer. All you do is lay out a few hundred dollars on station equipment entirely commercially made. When something goes wrong, you even send it back to the manufacturer for repair. You aren't amateurs; you are just communicators. We can't afford frequencies for such activities."

It is not a case of "Amateur Bands — Use Them or Lose Them" as some would have us believe. We must be able to justify our existence as amateurs and experimenters, and not just as glorified CB operators. Just think next time you use your local repeater or have your next HF rag-chew — how much you, or the other people you are communicating with, an experimenter, rather than just a communicator.

Yours sincerely,

Kenneth Ray VK1ZKR.

The originator of the comments was not identified. The outcome of WARC 79 relating to the Amateur and the Amateur Satellite Services speak for themselves in refutation of misinformation or misguidance so freely aired and believed prior to the event — Ed.

13 Salisbury Ave.,  
Bexley 2207.  
11-12-79.

The Editor,  
Dear Sir,

Thank you for publishing the article on Mrs. F. V. McKenzie in December AR.

This distinguished lady has had little publicity in her lifetime and her interests in radio cover such

a span as to exceed that of most living hams.

I well remember as a very young budding ham going to her shop in The Royal Arcade to buy parts and her very helpful manner.

Your journal can do a lot to build up a sense of history in present and future hams by printing articles on "old-timers", and also old equipment, as you have been doing, and I hope you will keep such material regularly before us readers.

Yours faithfully,

J. A. Mead VK2JM.

LIVERPOOL AND DISTRICTS  
AMATEUR RADIO CLUB  
c/- Anthol Tilley,  
6 Belmore St., Villawood, NSW 2163.

December 3, 1979.

The Editor,  
Dear Sir,

We would appreciate publication of the following letter in the Letters to the Editor section, preferably the next possible issue of AR.

"On Sunday, March 23, 1980, the Liverpool and Districts Amateur Radio Club is conducting a Field Day at Catherine Fields, 16 km west of Liverpool. It is worth noting this is the first Sydney Metropolitan area Field Day for some 10 years.

All areas of interest will be catered for, as events include the usual 2 and 10 metre mobile fox hunts, pedestrian hunts, trade displays and activities for wives and children.

Full programme details should be included in EA, ETI and ARA, as well as the VK2 Mini-bulletin.

Persons seeking assistance with accommodation bookings, information, or simply eager to obtain advance copies of the programme can contact Lloyd Anderson at 105 William Drive, Cartwright 2168, NSW."

Yours faithfully,

Anthol Tilley VK2BAD, Treasurer LADARC.

# INTERNATIONAL NEWS

## RECIPROCAL LICENSING

An effort will be made to include in this column the address of licensing authorities likely to be of interest to VKs travelling abroad.

The list this month begins with ZSland. Applications should go to "Telecommunications Dept., Private Bag X74, Pretoria, Rep. of S. Africa".

Another is the Kiribati Republic, "Controller of Telecommunications, Ministry of Communications and Works, PO Box 487, Betio, Tarawa Atoll, Gilbert Is., Kiribati Rep.". Licences cost \$A10.

Further news comes from the "Guest Licence Co-ordinator", Box 35461, Northcliff 2115, South Africa, that short term permits to operate amateur radio stations by visitors whilst in South Africa will now be considered. This apparently does not apply, as everywhere else, to Novice licensees. Also it was stated that Australian visitors can get permission to work from T4, H5, S8, 3D6, A22 and ZE.

During WARC 79 IARU President Noel Eaton VE3CJ convened an informal meeting to discuss the future of the IARU. Twenty top ranking amateurs from all the regions (including VK3QV and VK3ADW) attended.

Join a new Member  
— NOW —

# RADIO AMATEURS OLD TIMERS' CLUB

Bob Cunningham VK3ML

Founded only in 1975 this Club enjoys over 400 members residing in all States of VK plus a number of overseas members. As the membership certificate states, the objects of the Club are to maintain the interests and good fellowship among older members in the common cause. The only qualification for membership is that an applicant must have held an Amateur licence for at least 25 years. At the present time there is a special sticker for attachment to the certificate indicating "50 years", if that is applicable. If any other Amateur is interested in joining the RAOTC send a SAE to Harry Cliff VK3HC, QTHR, for an application form.

A monthly net hook-up is now being conducted under the baton of Fred VK3OL at 1000 hours EAST on the first Monday in each month on 7120 kHz. The next call will be on March 3.

The 1980 annual dinner and get-together will be held at the usual location, i.e. Clunes Ross Science Centre, Melbourne, on Thursday, March 6th, when some 100 members are expected to forgather. Our President Max Hull VK3ZS will welcome members and any visiting hams.

Congratulations are due to the VK6 Division, where the membership at this time of writing was 42. Lee Hitchens is the driving force in that area.

Since the last dinner the committee has come up with a lapel membership badge for the RAOTC. It looks good and is well worth having. Those members who have not yet applied for an issue should apply to VK3HC enclosing money order or cheque for \$1.20 to cover the cost of the badge and postage. ■

## COMING SOON!



From a heated toilet seat to telephone diallers, from boat radios to computers, from hi fi to components - you'll find them all in the 1980 Dick Smith Electronics Catalogue - 104 pages packed with over 3,000 items. Get yours FREE with the April issues of Electronics Today International and Electronics Australia, available from your newsagent or from a Dick Smith store. If you have difficulty in obtaining your catalogue send for the catalogue direct from our Mail Order Centre, price 75c

Call in to one of our stores or by Mail Order  
**DICK SMITH ELECTRONICS**  
Mail Order Centre, PO Box 321 NORTH RYDE  
NSW 2113 Ph: (02) 888 3200



## MAGAZINE REVIEW

Roy Hartkopf VK3AOH

(Coding used: G — General, C — Constructional, N — Novice, P — Practical (no constructional information), T — Theoretical.

### QST October 1979

Better Results with Indoor Antennas (PC); Micro-processor Based Morse Keyboard (T); Log Periodic V Array (TC).

### HAM RADIO October 1979

50 MHz SSB Exciter (TC); Compact Loop Antenna 40 and 80 Metres (T); VLF Antenna Coupler (P); Cross Guide Coupler for 10 GHz (TC).

### 73 MAGAZINE October 1979

2 Metre Synthesiser (C).

### INDIA AMATEUR RADIO February 1979

List of VU Call Signs (G).

### BREAK IN November 1979

Yagi Antennas (T); Old Timers' Club (G).

### CQ November 1979

40-80 Metre VFO (C); Chatham Island DXpedition (G); 160 Metre Vertical (C).

### CQ December 1979

Two Band Vertical Monopole (C); Battery Saving Blinkers (C); W310A Multiband Antenna (GC); Horn Speakers (Historical).

### INDIA RADIO April 1979

Wiring by Touch. A Blind Operator's Achievements (G).

### QST November 1979

"J" Driven 2 Metre Beam Antenna (C); Morse Readout for Your Digital Dial (C).

### 73 MAGAZINE November 1979

Vertical Whips Design (TC); Long Yagis for UHF (G); Index 1963-1978. ■

## DIVISIONAL NOTES

### VK3

#### VK3BWI BROADCASTERS LINDSAY SMITH VK3QX

Lindsay was first licensed in December 1973 and received his full call in May 1975. He joined the team in September 1976.

Lindsay enjoys the fun value in doing the broadcasts each six weeks. He sees them as a small way to do something for the WIA apart from operating. It is a good way to meet the other people in amateur radio and to get an idea of how things run.

He feels that the broadcasts are to allow amateurs to tell other amateurs about what they are doing. It is a funnel for information rather than a collector of information. It is also a display for the public.

He dislikes the tendency for people to waffle. He also dislikes the tendency for people to take the broadcasts for granted. People, he feels, too often "pass the buck" and expect "someone else" to get the news in. It is easy to ring the stop press announcer with a news item.

Lindsay's other interests are 160 metres, Hi-Fi, studying medicine.



#### KEVIN WHITE VK3ZI

Kevin joined the team of announcers about two years ago on the urging of Graham Clements. Kevin has had his full call for about 5 1/2 years. He converted it to a two letter call in 1976.

**PLEASE SUPPORT  
OUR ADVERTISERS**

Kevin thinks of the broadcasts as a service to the members of the WIA. He enjoys the task of making the broadcast have a professional presentation. It is also something to do on every sixth Sunday morning.

Kevin feels that the broadcasts are to communicate with other amateurs. Their purpose is to inform and entertain rather than bore people. Call-backs allow amateurs to present their views on matters in the broadcast.

Kevin dislikes the people who knock the WIA without being prepared to have a go at running the show; people who sit on the fence and criticise rather than contribute.

Kevin's other interests are school teaching, study of a professional radio course, announcing production course, mid-1960s music.



## AROUND THE TRADE

Vicom International Pty. Limited have announced the appointment of Mr. Laurie Wade as Branch Manager, New South Wales operations; responsible for all sales and marketing functions of professional and amateur products in Vicom's recently established NSW office.

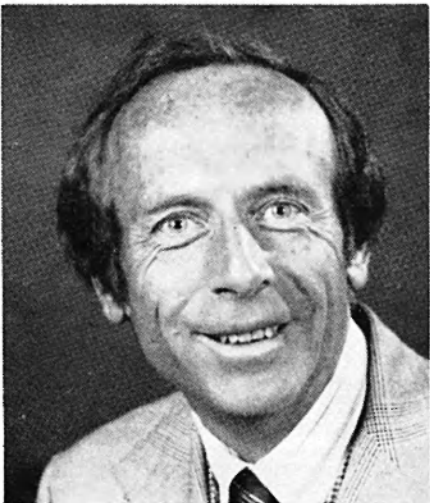

Mr. Wade, a chartered electronics engineer, is well known in the Australian electronics industry, and a respected member of the amateur radio fraternity.

### NEW TRAPPED VERTICAL ANTENNAS

Chirms:de Electronics have recently released their own brand vertical antenna Model CE-5B and Model CE-4B. The CE-4B is a trapped vertical antenna which operates on 80, 40, 20, 15 10m and is approximately 30 ft. long, impedance is 50 ohms and an SWR of 1.5:1 or better can be expected on each of the bands. The power rating is 2 kW PEP.

The CE-4B is basically a 4 band version of the CE-5B, covering 40, 20, 15, 10m, omitting 80m for those who don't require it. Both antennas come

complete with easy to follow instructions and are well packed in a plain carton.

The CE-5B retails for \$99 and the CE-4B for \$85.

For further information contact Chirms:de Electronics, 26 Edwards Road, Chirms:de Park, Lilydale 3166. Phone (03) 726 7353.

### WORLD TIMES ALARM SOLAR WATCH

GFS Electronic Imports have just announced the release of a Solar World Times Alarm Watch. The watch is known as the Model 1700S and allows its user to easily read the time anywhere in the world. The 1700S is also a 12 function 6 digit watch. These functions include Alarm, Day, Date, Seconds, Stop Watch, Dual Standard Time, etc.

Readout is of the Liquid Crystal Type and the watch has a small battery installed which is automatically charged by light reaching its solar cell.

For information on the 1700S contact GFS Electronic Imports, 15 McKeon Road, Mitcham 3132, Victoria, Australia. Ph. (03) 873 3939.



### TRADE HAMADS

For a very long time commercial advertising has not been accepted in AR Hamads, but as the result of discussions at the 1978 Federal Convention a decision was made to open up a "Hamads-Trade" section. The rate will be \$10 for 4 lines plus \$2 per line (or part thereof), minimum charge \$10, pre-payable. Copy is required by the first day of the month preceding publication. This will mean that in future ordinary Hamads submitted from members who are deemed to be in the general electronics retail and wholesale distributive trades should be certified as referring only to private articles not being re-sold for merchandising purposes.

## HAMADS

- Eight lines free to all WIA members. \$9 per 3 cm for non-members.
- Copy in typescript please or in block letters to P.O. Box 150, Toorak, Vic. 3142.
- Repeats may be charged at full rates.
- Closing date: 1st day of the month preceding publication. Cancellations received after about 12th of the month cannot be processed.
- QTHR means address is correct as set out in the WIA 1979 Call Book.

### FOR SALE

2650 Microprocessor Morse Sending Programme, 5-30 w.p.m. with punctuation and abbreviations, easily interfaced to keyer. For listing, instructions and Kansas City 110 baud tape send \$10 to Watkins, Box 1117, Orange 2800.

TS820S MC50 Mic., \$750; AT 200 ATU, \$120; SM220 monitor and 820 pan adaptor and service manual for all items, \$250; BC221 frequency meter with 240V power supply, \$40. VK2 VCO, QTHR. Ph. (02) 570 2042.

Yaesu FT7 Txcvr, as new, \$400, ONO; Yaesu FL110 linear, unused, suit FT7 or FT301, \$180, ONO; Universal HC75 antenna tuner, as new, \$50, ONO. Vicom VC2 SWR/RF/power meter, as new, \$20. VK3NWX. Ph. (03) 467 1503.

Kenwood TS820 dig. display, DC/DC power supply, installed with aux. band, 4 fix xtals, high gain FETS, mic. socket for headset mic, comb. and "Phantom" DC supply for preamp mics., add rear outlets for access 12V foot PPT recorder, factory mods. done, owner's and workshop manual, with bulletins, cables access, factory carton, \$925; D104M pre-amp mic., \$20. VK2BXU. Ph. (02) 57 4648.

ICOM IC 211 2m Base-Mobile, as new, in orig. carton, \$650 (no offers); ICOM IC SM2 desk mike, new, \$40. VK2BYS, QTHR. Ph. (069) 47 1988.

Kenwood R599D Ham Band Comm. Rx, provision for aux. band, four filters, VHF converter, 240V or 12V DC, with Kenwood matching speaker, can be used as remote VFO for TS205E, 820 series Txcvrs, brand new in box, \$400. John (02) 389 6455 BH, or Box 505, Bondi Junction 2022, NSW.

Yaesu FL1000 Linear, new tubes fitted, \$280; Kenwood TR7200 FM Txcvr with bracket and manuals, fitted ch. 2, 3, 5, 8, 40, 50, \$175; TS820S/TS205 DC-DC power unit, \$50. Mick Trickett VK3ASQ. Ph. (052) 78 1043 Bus., or PO Box 444, Geelong 3220.

AR 240 Service Manual, full circuit diagrams and board layouts, plus advice on fixing ping and receiver birdies, \$5 for copying and postage. Ray VK1ZJR, QTHR.

Sweep Generator, Telonic SM200, with plug-in units and markers to 500 MHz, professional unit, c/w handbook, \$400; Rode and Swartz field strength meter, model "HUZ", covers 47 to 225 MHz, c/w handbook and leather carry case, \$150; Oskerblock SWR-200, SWR meter and in-line power meter, 3 MHz to 200 MHz, suit 50 or 75 ohm line, new, still in carton, retails for over \$75, will sell for \$50; Radio Corporation square wave generator, variable output level, impedance and symmetry, \$30. Ian Foster VK3ST. Ph. (051) 52 4027.

Monoband 10m Beam, wide spacing .2 .2, 14 ft. boom gamma matched, solid construction, mast support gusset strengthened, \$50. VK3BIT, QTHR.

Yaesu FT901 DM, \$1000. VK3AIF, QTHR. Ph. (03) 857 5401.

ICOM 202, as new, complete with 10 watt linear amp., has COR and metal case, \$220. VK3AGG, QTHR. Ph. (058) 21 3272.

EMI Fully Interlaced and xtal Controlled Monochrome Pattern Generator, has TV waveform monitor, RF/video picture monitor with reduced scan and half frame facilities, RF modulator and up-converter to TV 0-13 with 5.5 MHz FM sound carrier modulator, dual p/s with metering and crow-bar protection, system also includes sweep gen. for 8/C RF and IF, TV IF with provision for markers, all mounted in a double 19 in. rack cabinet with rear access doors as an operational/standby system originally a factory signal source, board extenders and circuits included, will not break up into individual units, \$250. Ring for more details. G. F. Hughes VK2ZNY, QTHR. Ph. (02) 80 3589.

Hustler Trap Vert. Ant., 4-BTV, never been erected, unsuitable present QTH, \$75; txcvr, Yaesu FT227R, unused, \$310; also old receiver AMR 101 with power AC240, working OK, what offers? VK2IS, QTHR. Ph. (066) 52 3376.

Maroni TF801A Sig. Gen., 10-300 MHz, 0-100 dB attenuators, CW or mod. CW in working order, \$110, ONO. VK3UJ, QTHR. Ph. (03) 874 5632.

Digital Panel Meter, volts and ohms, teletype distortion measuring set, type 68V.6 metre aerial, ATN 51-53-8, log periodic, 12 dB gain, any reasonable offers. VK3BOB, QTHR. Ph. (03) 578 7441.

Yaesu FT101 Txcvr, good cond., complete with manual mic., power cords and original carton, can work you for demo, \$525; Kyoritsu VTVM model PV202, AC-DC, 0-1500 volts, 0-1000 megohms, 7 ranges, good cond., complete with manual, \$50; Grundig GDO, 1.7-250 MHz, 6 ranges, good cond., \$40. VK4XY, QTHR. Ph. (07) 225 8690 Bus., (07) 355 7051 AH.

Yaesu FRQ7 Rx, perfect cond., 12 mths. old, \$250. Andrew Roy VK3BXT. Ph. (03) 489 5752.

Kenwood TS-520S Transceiver, good cond., 12V power pack, \$565, ONO. VK3BLE, QTHR. Ph. (03) 725 0353.

Healthkit SB100 HF Transceiver, good cond., \$300. VK3KD, QTHR. Ph. (03) 221 1458 AH.

Electronics Australia, complete set 1968-1979, excellent cond., \$150 complete set or \$15 per year. Contact K. Cocks VK3NPC, QTHR. Ph. (051) 57 1492.

Tektronix Type 525 Waveform Monitor, complete with orig. instruction manual, 240V AC operation, can be used for station monitorscope or converted to oscilloscope, exc. cond., \$80. VK3NPC, QTHR. Ph. (051) 57 1492 AH.

RTTY Terminal Unit plug-in type printed circuit boards, several sets, for ST-6 demodulator (orig. unmodified), set of 8 boards, \$28; AK-1 modulator, one board, \$3.50; UT-4 regenerative repeater/speed converter with memory set of 4 boards, \$21.20; monitorscope, set of 2 boards, \$7; automatic CW Identifier, one board, \$3.50; automatic frequency control, one board, \$3.50. Steve VK3ZY, QTHR. Ph. (03) 277 4748 AH.

10m SSB, AM, CW Cybernet Tcwr., cont. cov. 28 to 29.3 MHz, proven performer, tuned to perfection, complete with handbook, rocking armature, mic., details of modifications, etc., can't miss, \$150. VK4NZB, 80A Pratién St., Dalby. Ph. (074) 62 1177.

TS120S, immac. cond., used 1 hr. only, matching AT120 ATU, brand new, set Yaesu mobile whips, 80-10m, most unused, Icom 215, 6 ch. fitted, also Icom 370 UHF 400 ch. synth., twin to IC280 remote, etc., all above at lower prices. Ph. (049) 2 3835 AH.

Kenwood TS120S 100W HF Mobile Tcwr, \$650, ONO; Yaesu FL110 100W HF mob. linear, \$210, ONO; Hygain 204 BA 20m 4 el. beam with BN-86 balun, \$150, ONO; Lafayette micro P100A, 147-174 MHz FM mob. Rx, \$150, ONO; Vinten 6 FM plus Realistic patrolman 50 plus B47 army rig, \$50 for the three; 10m Swiss quad ant., \$100, ONO; Kriesler 26 in. colour TV, \$350, ONO. VK3NM, QTHR. Ph. (03) 538 2733 Bus., (03) 88 3710 AH.

Kenwood TS-520 Tcwr, AC-DC, good cond., with mic., handbook, original carton, \$400; matching SP-520 speaker, \$25; AT-200 antenna tuner, \$140; Yaesu FT-7 mobile Tcwr, as new, \$295. Laurie VK2AQW. Ph. (02) 436 2766 Bus., (02) 358 3995 AH.

RTTY Test Set, type TDMS 5A and 6BV, \$45 pair; AWA AF oscillator, 3A51042, \$25; AWA AF oscillator, A5731, \$25; AWA noise and distortion meter, 51932, \$25; QY3-125 valves, Siemens equiv., unused, with glass chimney, \$15 each. VK4CB, QTHR. Ph. (07) 202 6565.

FT101 FT200 Europa 28/144 Transverter, R7 Rcvr., crystals, valves, etc., SSAE for list. VK2AHH, QTHR. Ph. (065) 62 4760 AH, or 62 1287 Bus.

Kenwood TR-7500 2m FM Tcwr., synthesised 40 ch., \$250; Nagara 6m yagl SS-55, \$50. Contact VK4ZRO, QTHR. Ph. (07) 343 5139.

Barlow Wadley Rx XLR30, mk. 2, in working order, \$150. Jack VK3EB, QTHR. Ph. (03) 82 1769.

Collins "S" Line 75S3B/32S3, late round badge model, with matching Collins power supply, all in mint cond., suit Collins enthusiast, \$1250. VK3OM, QTHR. Ph. (03) 560 9215.

Icom IC701 Sol'd State Tcwr, excellent cond., \$1050. VK3BAY. Ph. (03) 570 4371 AH.

#### WANTED

UHF Equipment, converters, triplers, etc., need not be "state of art" but must be g.w.o., super pro or similar Rx, 2m arm trans suitable for driving UHF triplers, etc. W. Melrose VK7WD, 89 Roslyn Ave., Kingston 7150. Ph. (002) 38 8432 Bus., (002) 29 4586 AH.

Remote VFO for TS520, good cond., R. Miller VK2RN/4, 2/2 Glen Parade, Ashgrove, Brisbane, Qld, 4060, or c/- BTQ7. Ph. (07) 36 0111.

AMR300 Circuit, service manual or any information. Mark Haseman, Box 315 PO, Biloela 4715. Ph. (079) 92 2491.

Circuit Diagram of B & D 420 Oscilloscope, have photocopy facilities, will fully reimburse all costs involved. VK3ZUP, QTHR.

Does anyone have an IF strip for a Collins R390A/URR they wish to sell? Price and particulars to VK3ZRV, QTHR. Ph. (03) 435 9386 AH.

Microphone Mixer for Rapar stereo amp RP424. Information to VK3CB, QTHR. Ph. (03) 24 4154.

## OBITUARY

VIOLET NIEDECK VK3BAK

Vi Niedeck, of Bethlehem, Pennsylvania, was first licensed as K3RAG not long after her husband Jim had become active in 1957 as W3MRW. Their only child, Lorraine, came to Australia in 1957 and soon after was licensed as VK3AGO, so that all three members of the family were then active amateurs. After Jim retired in 1964, he and Vi also migrated to Australia and obtained the VK3 calls AIC and BAK. Jim became a Silent Key in 1971, but Vi carried on the family tradition, mainly on 20 metre phone, until only a few months before her death, aged 80, in January 1980. She had a wide range of interests, both within and without the amateur scene, and would have been possibly the most senior member of ALARA. Nevertheless, she was a YL in the true sense, remaining young in spirit to the end. The Institute extends its sympathy to her daughter Lorraine, son-in-law Harry, and their family.

W. M. Rice VK3ABP.

REG SMITH VK1JS

Reg was well known by DX operators as G2DCI from Sutton Coldfield in the UK.

He started in radio when most components were hand made, and he even made his own loudspeakers. He was first issued with a receiving licence in 1921, with instructions that his valve set must not cause interference with other station reception (must have been a regen.). He was taking out his amateur radio licence in 1939, when the war came and all equipment was impounded. He had to wait until 1945 to get his gear back, and Call G2DCI.

He moved to Australia in 1979, and the VK1JS Call was waiting for him, and he has been very active until late December 1979, when he passed away very quickly with a heart attack.

Reg. will be missed by his many friends around the world, and by members of the Ex-G. Radio Club here in VK.

Steve VK5ZB, Sec. Ex-G. Radio Club

## SILENT KEYS

It is with deep regret that we record the passing of—

Mr. K. J. COLLINS VK2ANY  
Mr. F. S. SUTHERLAND L40483  
Mr. J. L. BUBB VK2AOI  
Mr. R. S. SMITH VK1JS  
Mrs. V. H. NIEDECK VK3BAK  
Mr. K. V. ROGET VK3YQ/YJ8KR

MURRAY MCGREGOR VK4KX

Murray McGregor VK4KX, aged 57, died suddenly of a heart attack on 9th January, 1980. Murray will be remembered as an active Radio Amateur in the years since World War 2. During the war Murray served with an A.I.F. Signals Unit, and shortly after his return he joined the Merchant Marine as a radio operator, having qualified from the Marconi School of Wireless. After some 20 years of service with the Merchant Marine Murray was retired due to ill-health and thereafter devoted much of his time to Amateur Radio. Murray gave up a lot of his time to the task of co-ordinating the Intruder Watch for the Queensland Division of the WIA, and his untiring efforts in this work will be remembered by all who knew him. Murray, always a keen CW operator, for many years conducted one of the "slow Morse" sessions each week on 80 metres. A quiet man of great sincerity, Murray will be sorely missed by his many friends in the ranks of Amateur Radio.

Submitted by Norm VK4NP.

KEVIN COLLINS VK2ANY

Kevin Collins VK2ANY passed away on Christmas day. First licensed as VK2ZFC, Kevin became a keen CW operator when he upgraded to VK2ANY. He lived at Epping in Sydney but during the 70s spent some years on a country posting with Telecom at Denilquin in the Southern Riverina.

On behalf of the Amateur Radio Service we extend our sympathy to Kevin's family.

de WIA, NSW Division.

Telescopic Tower, 40 to 60 ft., 2m transceiver, good working order, reasonable price, need only have channel 2 and 40. VK2UJ, QTHR.

Collins Radio Equipment, KWM-2A txcvr, 516F-2 power supply, 312B5 VFO console or Collins separate Tx/Rx combinations, prices asked must be reasonable. Contact VK2JO, GPO Box 5076, Sydney 2001, NSW. Ph. (02) 36 7756 evenings.

Free-930a Movie Equipment, projectors, cameras, films, etc., any gauge or condition, also wind-up gramophones or Edison cylinder players. Mike Trickett VK3ASQ, PO Box 444, Geelong 3220, or Ph. (052) 78 1043 Bus.

Matching VFO FV101B for FT101E. VK6NEP, QTHR. Ph. (09) 279 4069.

Information required for conversion of AWA MR6A carphone junior (70-85 MHz model), to 6 metres, manuals, data, etc., postage costs refunded and manuals returned after 1 photocopy, also xials for above. Info to Richard VK2BIU, QTHR.

Yaesu FV-301 External VFO and FC-301 antenna coupler, SWR, etc, price and cond, reverse charge phone call, quote No. 995, ask for Denis. Ph. (087) 33 8808 Bus., (087) 33 3942 AH.

Yaesu FV-301 External VFO, first class condition only, plus manual. PO Box 135, Parkville 3052.

Joining Members for PET Users' Club formed especially to assist in making more effective use of the PET Commodore microprocessor. Write or phone VK2NNB, QTHR. Ph. (02) 666 5853 AH.

4 Valve Sockets for Siemens valves RS1003, valve sockets have a group of 5 pins and 4 pins opposite. Jack VK3EB, QTHR. Ph. (03) 82 1769.

Mullard No. 7 Tank Antenna Tuner or similar. Details to Gordon VK3NVO, QTHR, or 3.585 ± Thursdays 1230 GMT.

#### TRADE HAMAOS

Amdon Cores, refer to 79 ARRL Handbook. T200-2, T106-2/6, T68-2/6, T50-2/6/10/12, FT50-43/61, beads and sleeves FB43-2401, S43-625-1, large SASE with 35c stamp for info. R.J. and U.S. Imports, Box 157, Mortdale, NSW 2233.

High-Gain Beams for 40, 20, 15, 10, 6, 2 and 70 cm, also UHF CB and ATV repeaters, DSI frequency counters and kits, Mirage PWR/SWR meters, also 2m amps with preamp., 10W in 80W out, amp. with Rx preamp., suit 50-54 MHz. Write ATN Antennas, Box 80, Birchip 3483, for catalogue.



IMPORTANT NOTICE



# ANNOUNCEMENT

In the past we have always tried to bring you the best in Amateur Radio Products.

Following these same lines we are proud to announce that we have recently been appointed

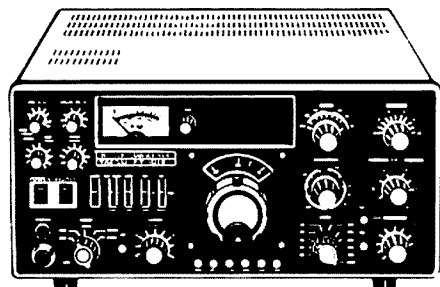

YAESU high performance  
FT-101Z HF transceiver

AUTHORISED  
**YAESU**  
DEALERS

To back this tremendous range of Yaesu transceivers we are also proud to announce that the full range of

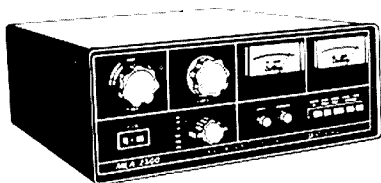

DENTRON MLA-2500  
linear amplifier

**DENTRON**  
**EQUIPMENT**

DENTRON  
Big Dummy  
load

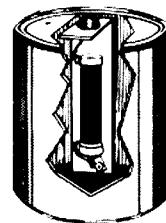

is available from GFS Electronic Imports.

*Dentron*

GFS - EXPERT SERVICE  
MANY YEARS OF EXPERIENCE IN THE  
AMATEUR RADIO AND COMMUNICATIONS  
SERVICE INDUSTRY PROVIDES US WITH  
THE BACKGROUND AND KNOWHOW TO  
OFFER YOU THE BEST IN SERVICING





**SAVE \$65\*** — with every SM-220 Monitor, purchased during February, March and April from your authorised Kenwood distributor, you will receive absolutely **FREE** a BS-5 or BS-8 Adaptor.

This adaptor will allow your Kenwood H.F. Transceiver to display signals on each amateur band as selected by the transceiver.

\*This offer ends on 31st April, 1980.

**SM-220 Station Monitor**  
Provides efficient station operation and also serves as a high-sensitivity, wide frequency-range oscilloscope for various adjustments and experiments.

Recommended  
Retail Price  
\$375.

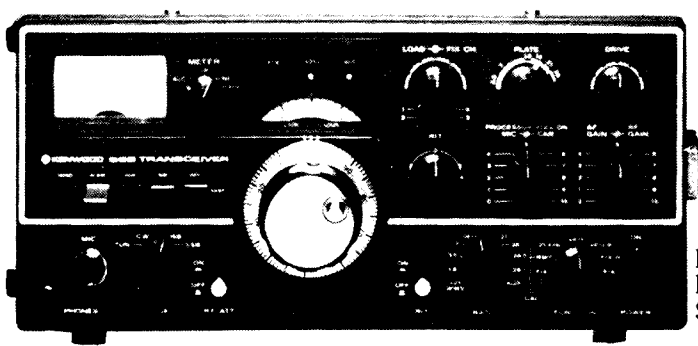

**TS-120S 3.5 to 29.7 MHz SSB TRANSCEIVER**

Ideal front panel layout gives simple operation for all users — novice or advanced, fixed station or mobile. A marvellous combination of high performance and low cost.

Recommended  
Retail Price  
\$650.

**TS-520S 1.8 to 29.7 MHz SSB TRANSCEIVER**

Amateurs throughout the world acclaim this rig which was specially engineered for the serious enthusiast.

Recommended  
Retail Price  
\$735.

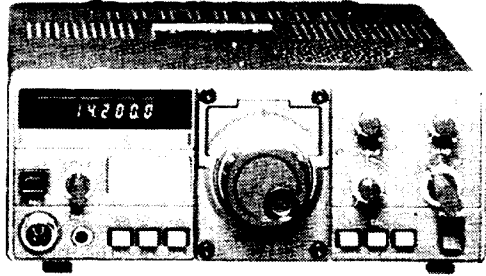

**TRIO-KENWOOD (AUSTRALIA) PTY. LTD.**  
31 Whiting Street, Artarmon, Sydney, N.S.W. 2064. Telephone (02) 438-1277

**Authorised Distributors:**  
**N.S.W.:** SIDE BAND ELECTRONICS SALES (02) 438-4191 — EMTRONICS (02) 398-6378 •  
**VIC.:** VICOM IMPORTS PTY LTD (03) 699-6700 • **QLD.:** MITCHELL RADIO CO. (07) 57-6830 •  
**S.A. & N.T.:** INTERNATIONAL COMMUNICATIONS SYSTEMS PTY LTD (08) 47-3688 •  
**W.A.:** WILLIS ELECTRONICS (09) 321-7609 • **TAS.:** ADVANCE ELECTRONICS (003) 31-5688 •  
**PLUS MANY OTHER REGIONAL OUTLETS THROUGHOUT AUSTRALIA**

Call into your nearest authorised distributor and ask to see these and other high performance Kenwood units



# amateur radio

JOURNAL OF THE WIRELESS INSTITUTE OF AUSTRALIA

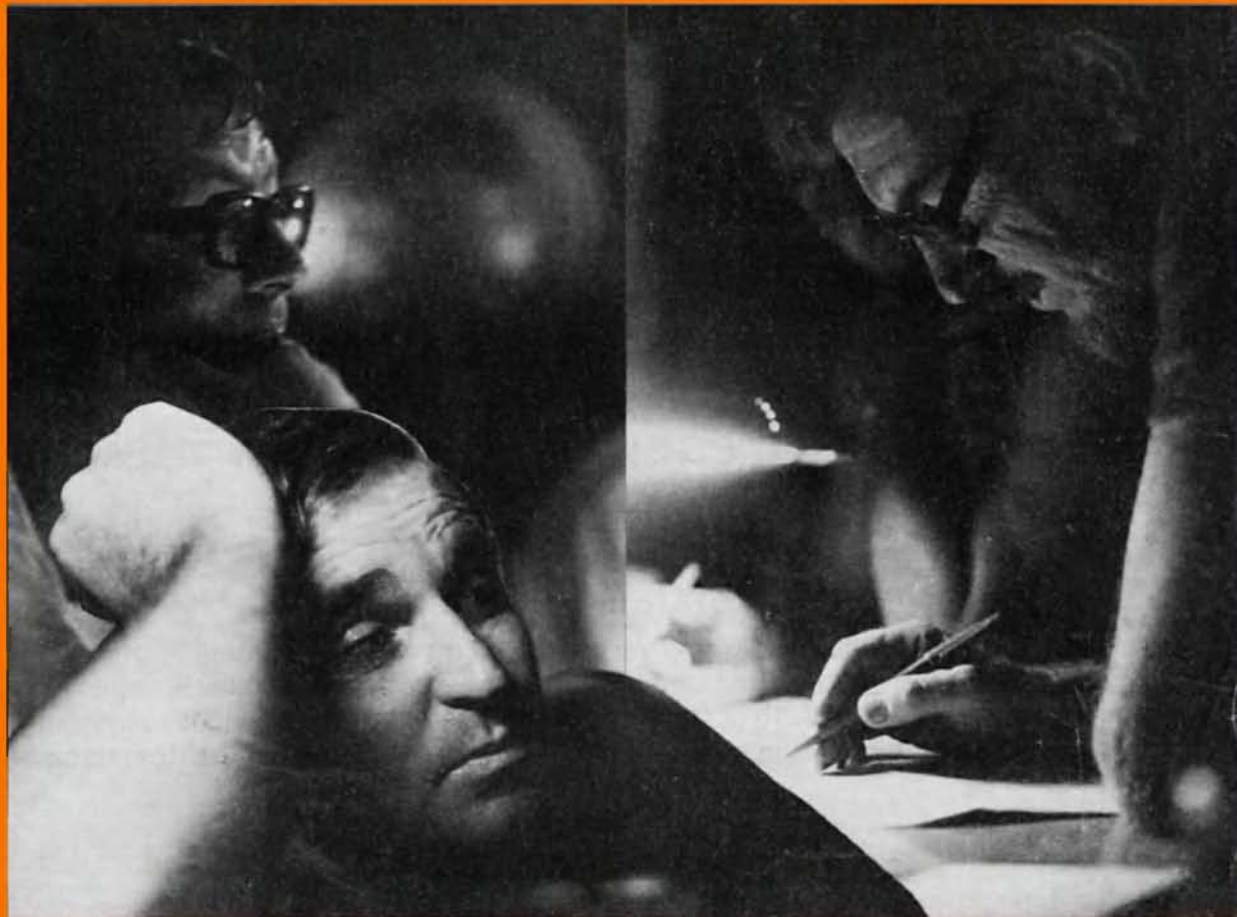

VOL. 48, No. 4

APRIL 1980

## ***FEATURED IN THIS ISSUE:***

- ★ **THE DJ4LB ATV TRANSMITTER AS A BASIS FOR A 70 cm SSB TRANSVERTER**
- ★ **A 40 WATT 432 MHz LINEAR AMPLIFIER**
- ★ **A CURE FOR UNWANTED HIGH LEVEL MIXING WITH THE TS600**
- ★ **THE SEVERITY OF AN EARTHQUAKE**
- ★ **VK-ZL CONTEST 1979 RESULTS**

Registered for posting as a Publication —  
Category "B".

set your sights on this ...



YAESU  
**The radio.**

now presents you the all new

# FT-107 SERIES

SOLID STATE HF TRANSCEIVER

The FT-107M is the rig you've been waiting for. The versatility of all solid state construction is teamed with the time-proven design techniques from the FT-901 and FT-101Z transceivers to give you—today's active amateur—the competitive edge under the demanding conditions of the next decade.

### Features

- PA protection; 75% rated output at 3:1 SWR
- Variable IF bandwidth
- 12 channels of memory with optional unit
- Scanning microphone option
- Ivory or Grey colour face
- Selectable AGC
- Offset tuning

### Specifications

160m-10m plus 2 aux. bands  
13.5V DC 20A, 234V AC PSU options

*P.S. You can add -  
external VFO,  
VHF/UHF/OSCAR  
transverter and  
antenna coupler ...*

# baïl

ELECTRONIC SERVICES

STAN ROBERTS VK3BSR

38 Faithful St., WANGARATTA 3677

Telephone: (057) 21 6260 Telex: Teletra AA 56880

Distributors in all states and N.T.

AGENTS & REPS:— W.A. COMO (09) 450 4379; PERTH (09) 321 7609; KALGOORLIE (090) 21 1906; S.A. PLYMPTON (08) 293 2155; TAS. LAUNCESTON (003) 44 5000; N.S.W. MASCOT (02) 667 1650; SEVEN HILLS (02) 624 2691; NEWCASTLE (049) 69 2040; WAGGA WAGGA (069) 21 2125

COFFS HARBOUR (066) 54 3206; TAMWORTH (067) 66 1363; INVERELL (067) 22 1300; QLD. ALBION (07) 57 6830; TOWNSVILLE (077) 79 8179; CAIRNS (070) 51 4826; BRISBANE (07) 48 6601; N.T. DARWIN (089) 81 5411;

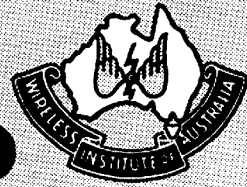

# amateur radio

Published monthly as its official journal by the Wireless Institute of Australia, founded 1910.

**APRIL 1980**  
**VOL. 48, No. 4**

**PRICE: \$1.20**

Registered Office:  
3/105 Hawthorn Road,  
Caulfield North 3161.

**MANAGING EDITOR:**  
BRUCE BATHOLS\* VK3UV

**PRODUCTION MANAGER:**  
MARK STEPHENSON\* VK3NOY

**TECHNICAL EDITORS:**  
BILL RICE\* VK3ABP  
EVAN JARMAN\* VK3ANI  
RON COOK\* VK3AFW  
GIL SONES\* VK3AUI

**CONTRIBUTING EDITORS:**  
BOB ARNOLD VK3ZBB  
MIKE BAZLEY VK6HD  
ROD CHAMPNESS VK3UG  
ROY HARTKOPF\* VK3AOH  
RON FISHER\* VK3OM  
ERIC JAMIESON VK5LP  
PETER MILL VK3ZPP  
LEN POYNTER\* VK3ZGP  
BILL VERRALL VK5WV  
WALLY WATKINS VK2DEW

**DRAFTING:**  
NEIL OSBORNE\* VK3YEI

**BUSINESS MANAGER:**  
PETER DODD VK3CIF

**\*Member of Publications Committee**

Enquiries and material to:  
The Editor,  
PO Box 150, Toorak, Vic. 3142

Copy is required by the first of each month. Acknowledgement may not be made unless specially requested. All important items should be sent by certified mail. The editor reserves the right to edit all material, including Letters to the Editor and Hamads, and reserves the right to refuse acceptance of any material, without specifying a reason. Advertising: Material should be sent direct to P.O. Box 150, Toorak, Vic., 3142, by the 25th of the second month preceding publication. Phone: (03) 528 5962. Hamads should be sent direct to P.O. Box 150, Toorak, Vic., 3142, by the 1st of the month preceding publication.

**Trade Practices Act:** It is impossible for us to ensure that advertisements submitted for publication comply with the Trade Practices Act 1974. Therefore advertisers and advertising agents will appreciate the absolute need for themselves to ensure that the provisions of the Act are complied with strictly. Readers are reminded that, when buying, obtaining or receiving goods from overseas including goods listed in advertisements by overseas organisations in this Journal, Customs import duties and Sales Tax may be levied on the goods at the time of importation. These amounts, if any, are payable by the purchaser unless the terms of sale state otherwise and the seller has made specific provision to this effect in his quotation to the buyer or unless other prior arrangements are in force between the buyer and the seller.

Typesetting: MUELLER INDUSTRIES  
1a Levenswell Road, Moorabbin, 3189  
Tel.: 553 0292

Printers: EQUITY PRESS PTY. LTD.  
50-52 Islington Street, Collingwood, 3066  
Tel.: 41 5054, 41 5055

## CONTENTS

### TECHNICAL

A Cure for Unwanted High Level Mixing with the TS600	12
A 40 watt 432 MHz Linear Amplifier	8
A Two Element Quad for 28 MHz	10
Modifications to the Weston HF1000 Transceiver	28
<b>NOVICE NOTES—</b>	
Peak Envelope Power Measurement	36
The DJ4LB ATV Transmitter as a Basis for a 70 cm SSB Transverter	16

### GENERAL

How Much Electrical Current Can Your Heart Tolerate	27
<b>NOVICE NOTES—</b>	
In the OM's Footsteps	36
Outback Australia Travellers	36
Observations of a Beginner in Amateur Radio	26
Pick of the Pics from VK6	34
What is Amateur Radio?	13
The Mole	9
The Severity of an Earthquake	32
VK-ZL Contest 1979 Results	44

### DEPARTMENTS

Afterthoughts	9
ALARA	42
Awards Column	41
Coming Events	43
Contests	41
Divisional Notes	43
Hamads	46
Intruder Watch	43
Ionospheric Predictions	45
Letters to the Editor	40
Main QSP	5
Magpups	27, 40, 42
Obituary	5, 46
QSP	31, 33
Silent Keys	46
Spotlight on SWL-ing	33
Stolen Radio Equipment	39
WIANEWS	6
VHF-UHF — an Expanding World	39
You and DX	45

<b>ADVERTISERS' INDEX</b>	<b>46</b>
---------------------------	-----------

## Cover Photo

A montage, pictured during business proceedings, of a few of those behind the Wide Bay Burnett 2 metre repeater, R44. Shown (left to right) are Bob VK4AZE, Geoff VK4GI, and Rusty VK4JM. The repeater is now operating from Mount Goonanamin, 155 miles north of Brisbane, by the Bundaberg Amateur Radio Club.

Photography: Bob Wright VK4UD

# WIRELESS INSTITUTE OF AUSTRALIA

Federal President: Dr. D. A. Wardlaw VK3ADW

Federal Council:

VK1 Mr. R. G. Henderson VK1RH

VK2 Mr. T. I. Mills VK2ZTM

VK3 Mr. G. A. G. Williams VK3ZXW

VK4 Mr. A. R. F. McDonald VK4TE

VK5 Mr. C. J. Hurst VK5HI

VK6 Mr. N. R. Penfold VK6NE

VK7 Mr. R. K. Emmett VK7KK

Staff: Mr. P. B. Dodd VK3C1F, Secretary.

Part-time: Col. C. W. Perry, Mrs. J. M. Seddon and

Mr. Mark Stephenson (AR Production).

Executive Office: 3/105 Hawthorn Rd., Caulfield

North, Vic. 3161. Ph. (03) 528 5962.

Divisional Information (all broadcasts are on Sun-

days unless otherwise stated).

ACT:

President — Mr. A. Davis VK1DA

Secretary — Mr. F. Robertson-Mudle VK1NAV

Broadcasts— 3570 kHz and 2m Ch. 6 (or 7): 10.00Z.

NSW:

President — Mr. F. S. Parker VK2NFF

Secretary — Mr. T. I. Mills VK2ZTM

Broadcasts— 1825, 3595, 7146 kHz, 28.32, 52.1, 52.525, 144.1, 145.8, 146.4, Rptr. Ch. 3 — Gosford, Ch. 4 — Lismore, Ch. 5 Wollongong, Ch. 8 — Dural 11.00h local (Evening 0930Z). Relays on 160, 80 and 10m, VHF and Repr. Ch. 3, Ch. 5, Ch. 8, and Hunter Branch, Mondays 0930Z on 3595 kHz, 10m, and Ch. 3 and 6. RTTY Sunday 0030Z 7045, 14090 kHz, Ch. 52, 0930Z 3545 kHz, Ch. 52.

VIC.:

President — Mr. E. J. Buggee VK3ZZN

Secretary — Mr. G. F. Atkinson VK3YFA

Broadcasts— 1840, 3600, 7135 kHz — 53.032 AM, 144.2 USB and 2m Ch. 2 (5) repeater: 10.30 local time.

Gen. Mtg. — 2nd Wed., 20.00.

QLD.:

President — Mr. A. J. Aarsaa VK4QA

Secretary — Mr. W. L. Glallis VK4ABG

Broadcasts— 1825, 3580, 7146, 14342, 21175, 28400, kHz; 2m (Ch. 42, 48): 09.00 EST.

Gen. Mtg. — 3rd Friday.

SA:

President — Mr. I. J. Hunt VK5QX

Secretary — Mr. W. M. Wardrop VK5AWM

Broadcasts— 1820, 3550, 7095, 14175 kHz; 28.5 and 53.1 MHz, 2m (Ch. 8): 09.00 S.A.T.

Gen. Mtg. — 4th Tuesday, 19.30.

WA:

President — Mr. Ross Greenaway VK6DA.

Secretary — Mr. Peter Savage VK6NCP.

Broadcasts— 3560, 7075, 14100, 14175 kHz. 28.47, 53.1 MHz. 2 metres Ch. 2 Perth, Ch. 6 Wagin. Time 0130Z.

Gen. Mtg. — 3rd Tuesday.

TAS.:

President — Mr. I. Nicholls VK7ZZ

Secretary — Mr. P. T. Blake, VK7ZPB

Broadcasts— 7130 (AM) kHz with relays on 2m Ch. 2 (S), Ch. 8 (N), Ch. 3 (NW), 09.30 EST.

NT:

President — Mr. T. A. Hine VK8NTA

Vice-Pres. — Barry Burns VK8DI

Secretary — Robert Milliken VK8NRM

Broadcasts— Relay of VK5WI on 3.555 MHz and on 146.5 MHz at 2330Z. Slow Morse transmission by VK8HA on 3.555 MHz at 1000Z almost every day.

Postal Information:

VK1 — P.O. Box 46, Canberra, 2600.

VK2 — 14 Atchison St., Crows Nest, 2065 (Ph. (02) 43 5795 Tues & Thurs (10.00-14.00h). P.O. Box 123, St. Leonards, NSW 2065.

VK3 — 412 Brunswick St., Fitzroy, 3065 (Ph. (03) 41 3535 Weekdays 10.00-15.00h).

VK4 — G.P.O. Box 638, Brisbane, 4001.

VK5 — G.P.O. Box 1234, Adelaide, 5001 — HQ at West Thebarton Rd., Thebarton.

VK8 — G.P.O. Box N1002, Perth, 6001.

VK7 — P.O. Box 1010, Launceston, 7250.

VK8 — (Incl. with VK5), Darwin AR Club, P.O. Box 37317, Winnelie, N.T., 5789.

Slow Morse transmissions — most week-day evenings about 09.30Z onwards around 3550 kHz.

VK QSL BUREAUX

The following is the official list of VK QSL Bureaux, all are Inwards and outwards unless otherwise stated.

VK1 — QSL Officer, G.P.O. Box 46, Canberra, A.C.T. 2600.

VK2 — QSL Bureau, C/- Hunter Branch, P.O. Teralba, N.S.W. 2284.

VK3 — Inwards QSL Bureau, Mr. E. Trebilcock, 340 Gillies Street, Thornbury, Vic. 3071.

VK3 — Outwards QSL Bureau, Mr. R. R. Prowse, 83 Brewer Road, Bentleigh, Vic. 3204.

VK4 — QSL Officer, G.P.O. Box 638, Brisbane, Qld., 4001.

VK5 — QSL Bureau, Mr. Ray Dobson VK5DI, 16 Howden Road, Fulham, S.A. 5024.

VK6 — QSL Bureau, Mr. J. Rumble VK6RU, G.P.O. Box F319, Perth, W.A. 6001.

VK7 — QSL Bureau, G.P.O. Box 371D, Hobart, Tas. 7001.

VK8 — QSL Bureau, C/- VK8HA, P.O. Box 1418, Darwin, N.T. 5794.

VK9, 0 — Federal QSL Bureau, Mr. N. R. Penfold VK6NE, 388 Huntriss Rd., Woodlands, W.A. 6018.

## WIA (FEDERAL) DIRECTORY

MEMBERS OF EXECUTIVE

Dr. D. A. Wardlaw VK3ADW, Federal President.

Mr. P. A. Wolfenden VK3ZPA, Exec. Vice-Chairman.

Mr. K. C. Seddon VK3ACS, Member.

Mr. H. L. Hepburn VK3AFQ, Member.

Lt.-Col. J. McL. Bennett VK3ZA, Member.

Mr. C. D. H. Scott VK3BNG, Hon. Treas.

Secretary: Peter B. Dodd VK3C1F.

Amateur Radio: Mark Stephenson VK3NOY

IARU LIAISON OFFICER AND

IMMEDIATE PAST FEDERAL PRESIDENT

Mr. M. J. Owen VK3KI.

INTRUDER WATCH CO-ORDINATOR

Mr. G. J. Fuller VK3NXI

FEDERAL REPEATER SUB-COMMITTEE

Mr. K. C. Seddon VK3ACS, Chairman.

Mr. J. J. L. Martin VK3ZJC.

Mr. P. B. Mill VK3ZPP.

MANAGING EDITOR AND

CHAIRMAN OF PUBLICATIONS COMMITTEE

Mr. B. Bathols VK3JUV.

FEDERAL BROADCAST TAPE CO-ORDINATORS:

Mr. R. Fisher VK3OM.

Mr. W. Roper VK3ARZ.

FEDERAL EDUCATION CO-ORDINATOR

Mr. G. F. Scott VK3ZR.

FEDERAL HISTORIAN

Mr. G. M. Hull VK3ZS.

FEDERAL CONTESTS MANAGER

Mr. W. A. Watkins VK2DEW

FEDERAL AWARDS MANAGER

Mr. W. D. Verrall VK5VV.

FEDERAL VHF/UHF ADVISORY COMMITTEE

Mr. K. G. Malcolm VK3ZYK, Chairman.

Mr. P. A. Wolfenden VK3ZPA.

Mr. I. W. Cowan VK3BGH.

Mr. L. Janes, VK3BKF.

Mr. J. J. L. Martin VK3ZJC.

Mr. K. L. Phillips VK3AUQ.

Mr. W. M. Rice VK3ABP.

FEDERAL RTTY COMMITTEE

Mr. H. P. Mulligan VK2ABH, Chairman.

Mr. J. J. Lupton VK2BVJ.

Mr. R. E. Taylor VK2AOE.

PROJECT ASERT COMMITTEE

Mr. R. C. Arnold VK3ZBB, Chairman.

Mr. P. A. Wolfenden, VK3ZPA/NIB.

Mr. K. G. McCracken VK2CAX.

Mr. L. Janes VK3BKF.

Mr. G. C. Brown VK3YGB.

AMATEUR SATELLITES

Mr. R. C. Arnold VK3ZBB.

FEDERAL WICEN CO-ORDINATOR

Mr. R. G. Henderson VK1RH.

VK/ZL/O CONTEST MANAGER (VK)

Mr. N. R. Penfold VK6NE.

FEDERAL VIDEOTAPE CO-ORDINATOR

Mr. J. F. Ingham VK5KG.

FEDERAL COUNCILLORS

Please see main Directory.

ALTERNATE FEDERAL COUNCILLORS

VK1 — Mr. A. Davis VK1DA.

VK2 — Mr. P. B. Card VK2ZBX.

VK3 — Mr. A. R. Noble VK3BBM.

VK4 — Mr. D. T. Laurie VK4DT.

VK5 — Mr. G. Preston VK5PI.

Mr. W. M. H. Wardrop VK5AWM.

VK6 — Mr. P. J. Savage VK6NCP.

Mr. B. Hedland-Thomas VK6OO.

VK7 — Mr. P. D. Frith VK7PF.

## QSP

STOLEN EQUIPMENT

A note in March 1980 OTC Bulletin (VK4) deserves a universal reminder. It reads "Is your equipment covered by insurance? Have you the serial numbers of all your equipment — is your shack secure? Recently there have been a number of robberies of amateur equipment. Beware of buying equipment with defaced or missing serial numbers. It may belong to one of your friends. Find out as much about the seller as you can, and contact the police."

Another suggestion, do not say, on over-the-air contacts, when and for how long you will be away from home — others listen in on your QSOs, especially on the repeater. ■

EPOXY EYE DAMAGE

A hint to those who use epoxy resins, and I use several varieties for bedding rifles — take great care with liquid hardeners, if any gets in the eyes you have just 5 seconds to get it out with water. The damage is irreversible, even the fumes are toxic and irritant. — Jim VK2BBO in the Lyrebird. ■

RFI

"Work by the RSGB Propagation Studies Committee has shown that many (possibly all) of the curious sweeper and creeper signals on about 27 MHz that we reported in TT in January 1978 appear, after all, to be "man made" and could come from the spurious emissions of Industrial RF devices (although not all those who have investigated sweepers accept this view, and the professional research papers in which the phenomena were first reported have apparently never been challenged). But if they are man made then their source is often located many thousands of miles away from the receiver." — TT in Radio Communication, January 1980. ■

Naturally, of course, we are very disappointed that the Government has apparently bowed to pressure and will introduce "Ethnic TV" on the vacated channel 0 frequency, rather than commencing on UHF as originally stated.

We have communicated our concern to the Government in the strongest terms.

It is to be hoped that all concerned members have also expressed their views to their Members of Parliament.

However, while this is a very important issue which required immediate concerted action, we must not be completely distracted by any one issue from the many others which also affect us presently or may affect us in the future from both an operational and organisational point of view.

As we go into a new decade, and with WARC 79 behind us, the Institute must gear itself for the future. How may it best serve the interests of Radio Amateurs:

1. In providing for the needs of its members,
2. In assisting the potential amateur to obtain his goal,
3. In its interface with the licensing authority and Government, and
4. In its relationship with the Amateurs outside Australia through the IARU.

All these facets are important, all can be subdivided and there is a complex relationship between them all.

The Federal Council Meeting at the Annual Federal Convention consider all these things in determining the Institute's current policies.

As you all know, the Federal Council meets this month. I sincerely hope all those with a view on any of the numerous agenda items have expressed this at the Divisional level (grass roots) in order that the Federal Councillor is aware of the majority view of his Division. This is the very important first stage in decision-making by the Institute not to be neglected.

Once a decision has been made after reasonable debate, the best interest of the Institute is served by us all working to a common cause; however, this should not mean an issue cannot be re-opened later if circumstances change.

DAVID WARDLAW VK3ADW  
Federal President

## OBITUARY

## KEITH ROGET VK3YQ/YJ8KR

Those who knew him were deeply shocked to learn of the sudden death on February 13th of Keith Roget VK3YQ/YJ8KR in Port Vila, New Hebrides, where he had been living for the past sixteen months as manager of Normans Overseas Ltd.

Keith was first licensed in the early fifties, having served during the Second World War as a navigator wireless operator with the RAAF. He saw service in the Mediterranean area, having done his basic training in Kenya.

A staunch supporter of the WIA, Keith became Treasurer of the Victorian Division in 1960 — a position he held for a number of years. He also held the Office of President of the Division and on another occasion was Secretary.

Keith's expertise as an accountant was freely made available to the Institute. He was a leader in the formation of Amateur Radio Ltd.

During his time on the Victorian Divisional Council he was particularly aware of the importance of the country members. He attended many a Zone Convention.

He was one of the instigators of the Victorian National Parks Award. As a keen portable operator he participated in many National Field Days and WICEN exercises.

Keith's business also took him to the Solomon Islands where he was active on the air as VR4AV/H44AV.

Keith joined the Executive in 1973 to act as Treasurer, but even prior to this, as representative of the Victorian Division, he had been very much involved in the formation of the new Federal Company and was also deeply involved in the planning for and employment of a full time Secretary Manager for the Federal Body.

Keith was Federal Treasurer of the Institute up until the time of his departure for overseas.

This was a critical period in the history of the Institute with the expansion of the Federal responsibilities of the Institute, the introduction of the EDP system and very serious monetary inflation. Under Keith's guidance, we were able to ride out an extremely rough storm.

Keith worked in such an unassuming manner that much of his effort went without notice by the general membership. However, if it was not for Keith's contribution, many of the successes of the Institute would not have been so easily gained.

In Keith's death the Institute has lost one of its most untiring workers who well deserved the Honorary Life Membership accorded to him last year.

To his wife Jean and children Judy and David we extend our deepest sympathy.

VK3ADW

# WIA NEWS

## JOINT COMMITTEE

The meeting of the Joint P. and T./WIA Committee was held on 20th February after a lapse of six months caused by concentration on WARC 79 on both sides.

Final proofing of the new Handbook nears completion, it was stated. This related to editorial proofing only. It was hoped that the new edition would be printed and distributed some time in April, depending on other work ahead of it in the Government Printer's Department. The May examination would be based on the old Handbook, the August exam would be set in such a manner that either applied and the November exam would be based on the new Handbook. These proposals depended upon the delays in printing the new. Pressures for more frequent examinations could not be met owing to staff shortages, and, it is suspected, costs involved.

The Department categorically refused to make copies available of the actual examination papers. Instead, they recommended reference material for candidates to study, particularly the 500 questions and answers book for AOCIP candidates, published by the WIA NSW Education Service (as reviewed in AR for Nov. 1979, p.45). The Departmental problem is understood to relate to staffing difficulties allied with the necessity to prepare separate exam papers for candidates in places distant from the usual examination centres.

The possibilities of permitting F5 transmissions on a part of the 23cm band appear hopeful on a trial period basis. If this eventuates, it will then be possible to evaluate the results thereafter to determine whether F5 could be considered for higher bands (e.g. 5 cm) for which surplus equipment is becoming available.

Nothing fresh can be reported concerning the application for amateurs to use the 50 to 52 MHz part of the 6m band except that it is being investigated on a similar basis to the recent New Zealanders use of 50-50.15 outside the hours of programmes of the TV station in that part of the spectrum.

A short discussion took place in relation to instances noted of amateur stations breaching on air the prohibition on advertising, for example, that certain specific items of equipment could be obtained from a named supplier.

It was noted that the principle of local Joint Committees in each State had been accepted and would be fostered. It was also noted with approbation that one particular post had been created in Central Office to handle amateur radio matters and that this post had now been filled.

## 1980 CONVENTION

The 1980 Federal Convention is scheduled to be held in Melbourne (Brighton Savoy Motel, as usual) from 25th to 27th April inclusive.

At the time of writing many Agenda Items have been received from various Divisions. A few more are expected.

One item which may generate considerable interest is the subject of the Amateur Advisory Committee system. There is little doubt that the "explosion" of interest in radio communications during the past few years has brought with it a number of undesirable aspects, one being the presence of pirates on amateur bands. Who, except an experienced amateur, could detect these people? A pirate well grounded in amateur communications is even more difficult to detect until the OSL cards begin rolling in for bogus QSOs. This is not only an Australian problem. Read some of the overseas DX columns.

Some amateurs might ask why anyone should get disturbed about all this. Hopefully such lamentable ignorance is rare. Basically, pseudo-amateur pirates white-ant the whole foundation of amateur radio quite apart from a genuine amateur being unaware of what "he" said during "his" contacts!

What can be done by genuinely licensed amateurs to combat this menace? Nothing useful can be gained by confrontation. In some situations confrontation could be dangerous. What machinery exists or can be used to detect pirates? Almost in the same breath can be mentioned intruders because both occupy band space and both should not be there. Much has been achieved world-wide by Intruder Watchers (despite the "woodpecker" still going strong in the face of highest level diplomatic representations) but the lack of interest in IW by the vast majority of Australian amateurs can only be explained by apathy or misplaced tolerance.

Then there is the situation where an amateur transgresses the Regulations or is suspected of having done so. This is what the Amateur Advisory Committee system was designed to handle — a buffer state between the spectrum policeman and the individual amateur. In the old days it was normal practice for one amateur to draw the attention of another to poor signal intelligibility, rough notes, harmonics, spurious and many other sub-standard occurrences. This was carried out in the friendliest possible way and has done a lot towards self-regulation. Unfortunately not every recipient takes advice in a friendly manner.

Are all these things, pirates, intruders, sub-standard occurrences, capable of being channelised through one system? And how are they processed in overseas countries? Does the amateur service here want a separate system for each? These are the kinds of things this Agenda Item is all about.

## BAND PLANS

A VK1 Agenda Item calls for re-affirmation of conformity with VHF and UHF band plans. Another, from VK5, seeks a means to encourage amateurs to respect the gentleman's agreement on band segments devoted to CW and telephony parts of the bands.

This last Agenda Item ties in with another from VK5 proposing that the Department be asked to drop the lower limit for Novices on 80m to 3500 kHz instead of 3525 kHz. Comments were that Novice licensees have great difficulty in working DX on "their" 10 kHz CW segment and the ratio of 2 to 1 between full calls and Novice calls according to statistics; also that many Novices cannot up-grade for various different reasons.

## 70 cm

VK2 propose that channel numbers in the FM portion of 70 cm ending in 25 or 75 should be classified as secondary repeater channels and that the secondary simplex channels should be altered to 438.5 and 439.5 MHz. Also proposed was that all the other channels ending in 00 or 50 in the 433 to 435 and 438 to 440 MHz windows should be classified as secondary simplex channels.

Another Agenda Item from VK2 proposes that the WIA should seek alternative channels in the 500 to 900 MHz (approx.) region for ATV if the present 50cm temporary allocation is withdrawn. The comments thereon suggest there are practical difficulties in transmitting a signal with sufficient useful power on the next band up (i.e. 23cm) which is outside the range of UHF tuners and that post-WARC 79 ZLs will have the band 610-620 MHz on a secondary basis by footnote in the frequency tables.

## MICROWAVES

VK2 also asks for a progress report on the policy to use F5 on amateur microwave bands, especially 5cm for which surplus equipment has become available.

## CHANNEL 0 AND 5A (6m)

No recent Convention would be complete without an Agenda Item calling for reports on the Channel 0 and 5A situation. This from VK2. In 1978 it was decided to seek approval in principle from the Department for 6m repeaters. VK2 now suggest an investigation of a single test channel for evaluation purposes.

**NEW BANDS**

VK2 has two Agenda Items relating to the projected new bands out of WARC 79 on 10, 18 and 24 MHz. One wants pressures to have them allocated as soon as possible and the other proposes higher operating requirements be considered for them because of being so narrow — for example, SSB be limited to a few stations where the operators should possess higher theory qualifications. Also that CW of 20 w.p.m. or a special RTTY exam be discussed in connection with CW or RTTY segments.

**10m FM**

For FM stations in the 29 MHz part of the 10m band VK2 proposes representations to the Department to permit 7.5 kHz as the authorised maximum deviation. This part of the band is becoming used in the USA for FM where deviations in excess of 5 kHz have been observed, so it is stated. 7.5 kHz deviation conforms with VHF practice whilst the existing 3 kHz FM deviation on HF offers little, if any, noise reduction benefit over A3 and makes contacts with stations using greater deviations difficult — also that equipment for this is becoming readily available.

**VARIOUS**

VK5 wants the Department to advise new licensees of the right to suppress publication in the WIA Call Book of the licensee's name and address. VK1 proposes cancellation of the 1946 policy that the Federal Executive should be located in the same State as the Central Office of the Department on the grounds that a small Division would be hard pressed to find enough amateurs for both Federal and Divisional office bearers. Also that modern communications — along with a small local Committee (perhaps assisted from Sydney) for liaison — renders the old policy outdated and unworkable.

The Executive will introduce a number of Agenda Items, mainly procedural. These relate to IARU and WARC 79, standardisation of the WIA membership application form and the Federal Constitution. Of two others, one asks for progress reports, and if necessary re-evaluation, of the educational material to be prepared using the \$3500 special donation received from the sale of equipment from Dick Smith Electronics some 18 months ago. The other proposes that the Department be asked to remove from amateur licence application forms the requirement to list the equipment it is proposed to use.

Another procedural item, from VK2, asks for a report on recruitment and publicity activities of the Institute whilst another proposes frequency details for 6m band repeaters. It is believed that some other Agenda Items have been formulated but have not yet been submitted. The 30 day notice for Agenda Items expires on 25th March.

**MEETINGS**

At an Executive Meeting on 25th February the lateness of mailing out the February edition of AR was discussed and it was noted that this occurred for reasons outside WIA control. It was also noted that over 6000 subscriptions for 1980 had been received and processed and that a telex had been sent by the Victorian Division about Channel 0 to the Prime Minister and Minister for P. and T. This meeting received visitors in the persons of Alan Noble VK3BBM, Alternate Federal Councillor for VK3, Geoff Atkinson VK3YFA, VK3 Secretary, and Trevor Pitman VK3YTP/NMJ, who has agreed to co-ordinate Federal Contests and Awards.

One meeting of the VHFAC on 14th February discussed TV Channel 0 and 5A matters. Confirmation was also given to VK4ZEZ/NFR for a VK4 distance record of 11857.3 km on 6m for his QSO on 2nd March last year with N6CT.

At the Publications Committee meeting on 5th February the future of AR was discussed in detail. It was agreed to review this again at the April meeting.

The Executive wishes to acknowledge with grateful thanks the receipt of WARC 79 donations from members —

<b>LIST No. 12</b>	
VK2ZJC .....	\$8.00
VK5FO .....	\$10.00

# WAG OR WAZ

here's the antenna jazz — **SCALAR** — they work anywhere

**1. W2AU ANSULATOR**

Unadilla/Reyco with built-in lightning arrester. Hang up hook. Weatherised. Rugged 600lb. pull. Use on Vees, Doubles, Quads, Yagis, Folded Dipoles.

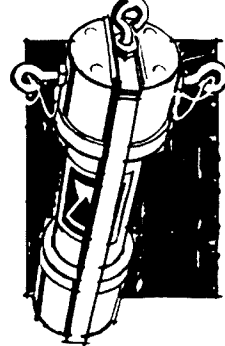
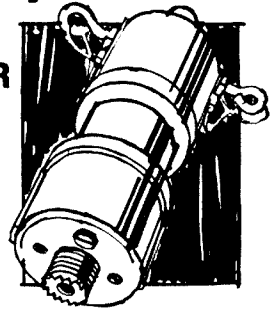

**2. W2AU BALUN**

From 50-70 ohms to 200-300 ohms balanced Broadband 3-40 MHz. 1Kw plus. Weatherproof. Lightning arrester. Balances antenna current. Restores full gain.

**3. MULTIBAND ANTENNA COILS**

Reyco reliable from 7MHz to 28 MHz. Standard five band coils operate on 10, 15, 20, 40 and 80 with wire length of 108ft. Provide perfect dipoles and used together obtain five band operation with total wire length of 95ft.

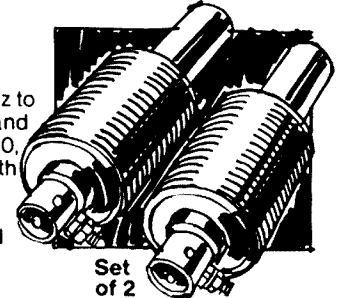

**Power House or Ham Shack — 10.2 on Scalar**

Whip this coupon back Q.R.Q. to Scalar

Please send  order form  
 Or  literature giving more information.  
 Please print.

NAME .....

ADDRESS .....

STATE ..... POSTCODE .....



**73's from SCALAR INDUSTRIES PTY. LTD.**  
 20 Shelley Avenue, Kilsyth, Vic. 3137 (03) 725 9677  
 N.S.W. 20 The Strand, Penhurst, 2222 (02) 570 1788  
 QLD. 969 Ann Street, Fortitude Valley, 4006 (07) 52 2594

# A 40 WATT 432 MHz LINEAR AMPLIFIER

This amplifier is based on a design that appeared in QST for July 1977. The board dimensions have been retained but the transistors altered to 2N5946 and MRF646 to give it 12V capability. It will produce in excess of 40 watts PEP when driven with 3 watts PEP.

Ian Gianville VK3AQU  
23 Falcon Rd., Macleod 3085

For those of you who already have 10 watt excitors the section to the right of the dotted line could be produced. I should mention at this stage that the transistors are not cheap. The MRF646 is about \$28 and the 2N5946 is \$17 approximately.

**CONSTRUCTION**

The entire unit is made of PC board with double sided board as the base, one side having the lines etched on it. The walls of the box are 1 1/2 in. high with a partition as shown. The board size and lines are shown full size in the diagram with the other components drawn in to give you an idea as to their placement, but not to scale. As it was unlikely that more than just the one of these units would be made I simply covered the PC board with clear contact adhesive and traced the outline on to the board. The areas to be etched were then cut out with a sharp knife and the board dropped into the ferric chloride etchant. Remember to cover both sides of the board.

Next drill and file to shape the holes for the transistors. Where the emitter leads will be located solder some very thin copper shim between the top and bottom of the board. Do the same with a piece of wire where the diode and capacitor leads will be grounded one 1/2 in. or so from the etched landing. Now fix the board to the heat sink using plenty of brass bolts. Once this is done and all the other components are in place the transistors can then be soldered in. Be sure you use plenty of heat sink and then some if you intend running the full forty watts for ATV.

**ALIGNMENT**

Check all your work very carefully. If you make a mistake now it will cost money.

Disconnect all power to the MRF646 stage and place an ammeter between RFC5 and the feed through feeding the collector of the 2N5946. Switch on. The collector idle current should be around 100 mA. Now place the meter in a similar position in the collector circuit of the MRF646 and check for 300-400 mA idle current. If everything checks out okay then apply drive power and tune for maximum into a wattmeter or dummy load SWR bridge combination. When you have determined that the output appears to be clean and linear, put it to air for a report.

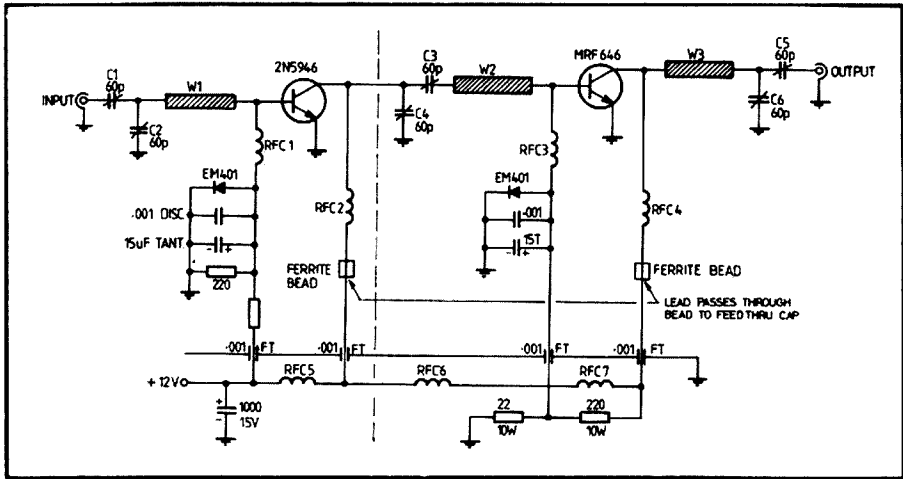

FIGURE 1: Circuit diagram

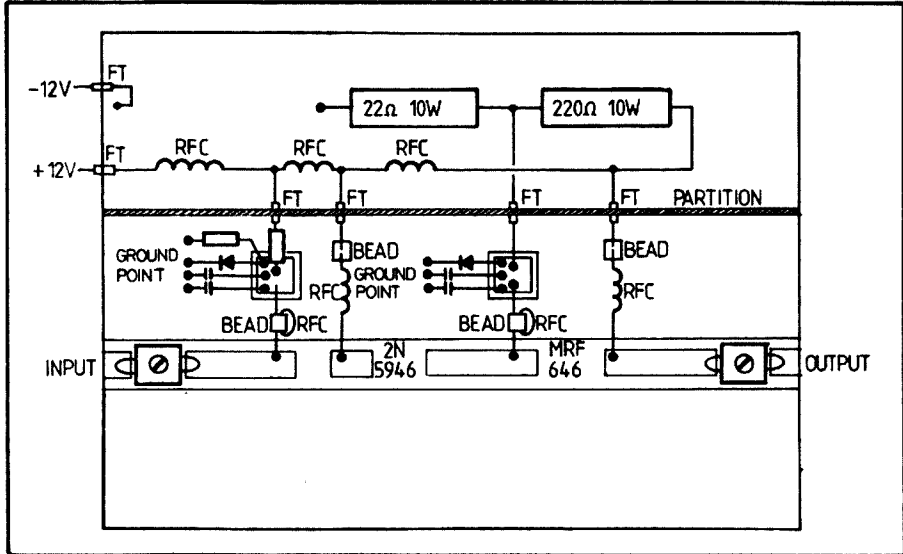

FIGURE 3: Layout of the printed-circuit board. Glass-epoxy board 1/32 inch thick is used, with one-ounce copper on both sides.

RFC 1, 3, couple of turns through ferrite bead, 24g enam.

Capacitors are 60 pF ceramic compression type.

RFC 2, 4, 5, 6 and M, 170 mm 5/32 in. diam. 18g wire, close wound.

C1 and C5 mounted between Input and output coax connectors W1 and W3 respectively.

The power output may be increased by bumping up the supply voltage to 15-16 volts DC.



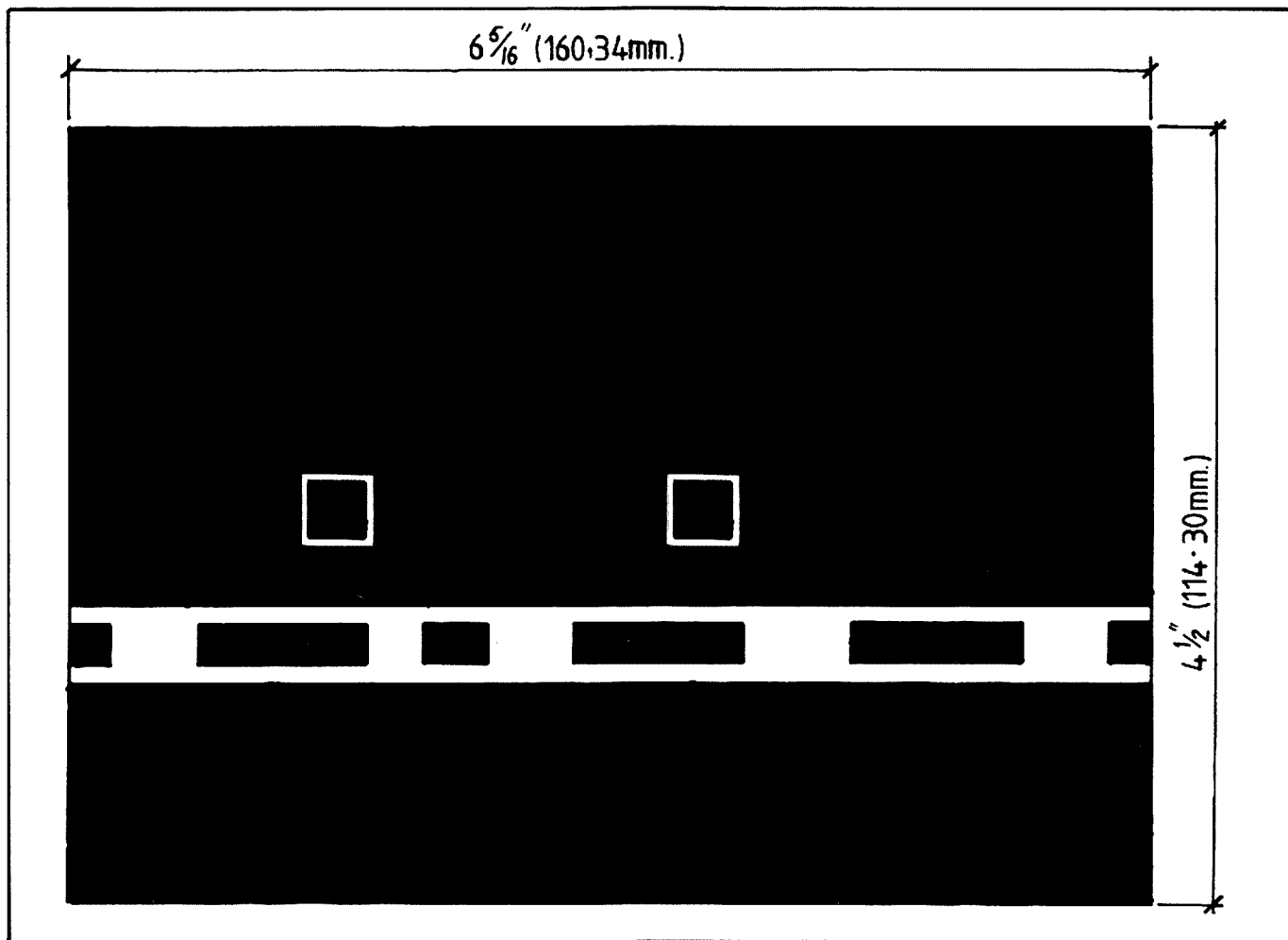

FIGURE 2: Printed circuit board — copper side, full size

## THE MOLE

Hey Dads — here's something from the New Yorker magazine of 13-8-1979 for the wall of your shack (Tnx VK3OB —

"There goes The Mole!" Mother cried. "You children look quick or you'll miss him!" It was Father, disappearing down the cellar stairs. Every day he'd retreat to his radio shack, stay past midnight. He'd built a rig others envied, came from miles around to see. Every day he'd jam the airwaves, ruin the blocks TV. Every day we'd hear him sit before the mike calling "CQ, CQ, calling CQ" to whoever listened at the other end. He once claimed to reach Moscow. "Ralph's the handle, calling from W3CAT, the Old Cat Station — W-3-Cat-Alley-Tail." He was a handsome cat; Mother once adored him, I know.

But what I'll never know is: Why he'd talk to any stranger far away and not once climb back up the stairs to the five of us to say, "Hello . . . Hello . . . Hello . . . Hello".

Robert Phillips. ■

## SALES PERSON

**A WELL MOTIVATED SALES PERSON IS REQUIRED FOR OUR EXPANDING SYDNEY OPERATION AT CROWS NEST.**

THE POSITION INVOLVES SELLING OF A QUALITY RANGE OF POPULAR AMATEUR RADIO EQUIPMENT.

THE APPLICANT SHOULD BE AN ENTHUSIASTIC INDIVIDUAL, WHO IS IN POSSESSION OF AN AMATEUR CERTIFICATE OF PROFICIENCY.

APPLICATIONS SHOULD BE IN WRITING IN THE FIRST INSTANCE AND INCLUDE DETAILS OF WORK EXPERIENCE, EDUCATION ETC. —

TO: MR. L. WADE  
VICOM INTERNATIONAL PTY. LIMITED  
339 PACIFIC HIGHWAY,  
CROWS NEST, 2065.  
PHONE: 436 2766.

## AFTERTHOUGHTS

In the February 1980 issue of Amateur Radio, page 9 (Review — R1000 Receiver), it was incorrectly stated that all enquiries regarding the Kenwood R1000 Receiver should be directed to Vicom International — This is not the case. All enquiries should be directed to Trio Kenwood Pty. Ltd., 31 Whiting Street, Artarmon, Sydney N.S.W. 2064. Telephone (02) 438 1277. ■

# A TWO-ELEMENT QUAD FOR 28 MHz

Ron S. Beames VK5NSB  
2 Wheadon St., Osborne, SA 5017

This quad was originally built by Sid VK3CI and the author has his permission to give details of it for those interested. Recorded tests on various signals have shown between 3 and 6 S-points stronger signal from the front of the quad than the back.

The element spacing is 2 ft. 6 in. The reflector element is 36 ft. 4 in. long, formed into a square loop with the ends joined and soldered together (after fitting). The radiator element is 34 ft. 8 in. long, terminated on a 3 in. x 2 in. x 1/4 in. thick polystyrene block with 2 in. spacing between the ends of the element. (Both elements are 7/029 bare copper wire.) The quad is fed with 75 ohm coax cable to the terminal block. The balun is a length of 75 ohm coax cable, cut to exactly 5 ft. 8 in. long; at one end the inner conductor and braid are soldered together and sealed up. The other end of the balun is connected on to the terminal block with the feeder cable, but connected in reverse to the feeder cable so that conductor and braid are joined together on one side and braid and conductor joined together on the other side of the terminal block.

The construction is easy. The centre section of the quad is a piece of marine plywood 18 in. x 18 in. x 3/4 in. thick, well painted after all holes were drilled. The element arms use four 12 ft. 6 in. lengths of 1 in. orange PVC conduit. First cut off the coupling ends on the conduit and then cut each length exactly in halves. These are saddled across each corner of the centre section on both sides, using 1 in. galvanized conduit saddles and 1 1/2 in. x 1/4 in. galvanized gutter bolts and nuts.

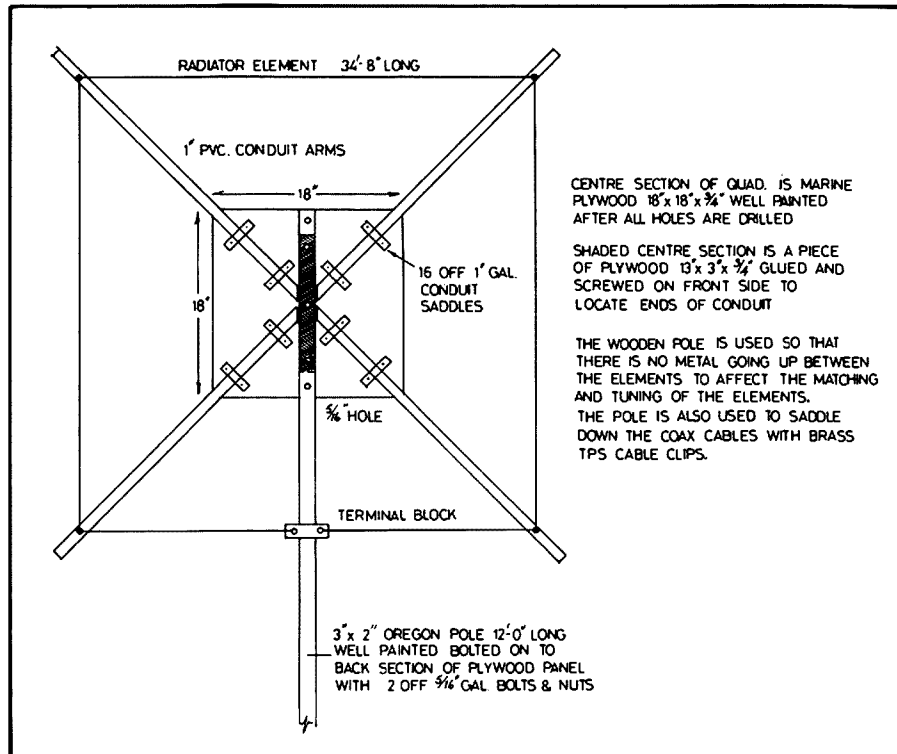

FIGURE 2: Radiator. Galvanised gutter bolts and nuts 1 1/2" x 1/4" used for securing conduit saddles. Drill 3/32" hole in spreaders 6" from end. 1" PVC conduit arms butt up against pole on back of centre section for reflector element.

The spreaders use four lengths of 3/4 in. orange PVC conduit cut to 2 ft. 6 in. long. The ends of the 1 in. conduit saddled across each corner of the centre section are spread out and the 2 ft. 6 in. conduit spreaders are clamped on to the ends of the 1 in. conduit. This gives the 2 ft. 6 in. spacing between the two elements. Note that orange PVC conduit was used because the grey conduit goes very brittle in the weather. The clamps are U-strips of 24g galvanized iron 3/4 in. wide x 5 1/2 in. long bolted to the 3/4 spreaders with 1/8 in. x 1 in. brass bolts.

The 18 in. x 18 in. x 3/4 in. thick centre section is bolted on to the end of a 3 in.

x 2 in. oregon wooden pole, 12 ft. long, which is well painted. A wooden pole is used so that the tuning and matching of the elements is not affected by having a metal pole running up between them. The pole is also used to saddle down the coax cables with brass TNS cable clips. The bottom end of the wooden pole is bolted on to a length of 2 in. galvanized water pipe with two holes drilled in the pole, one 6 in. from the end and the second 4 ft. in from the end.

Two mild steel plates 5 in. x 3 in. x 1/4 in. thick were welded on to the galvanized water pipe where the timber pole bolts on, so that the timber is bolted to a

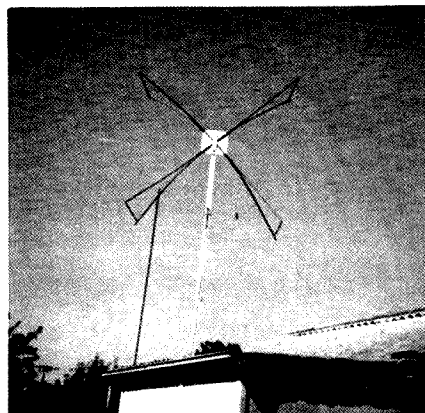

28 MHz Quad

flat surface, using two galvanized bolts and nuts 5 in. x 1/2 in. The pipe at this QTH is mounted on the end of the shack, saddled at the bottom and at the top on to the fascia board with the saddles left slack enough so that the quad can be rotated.

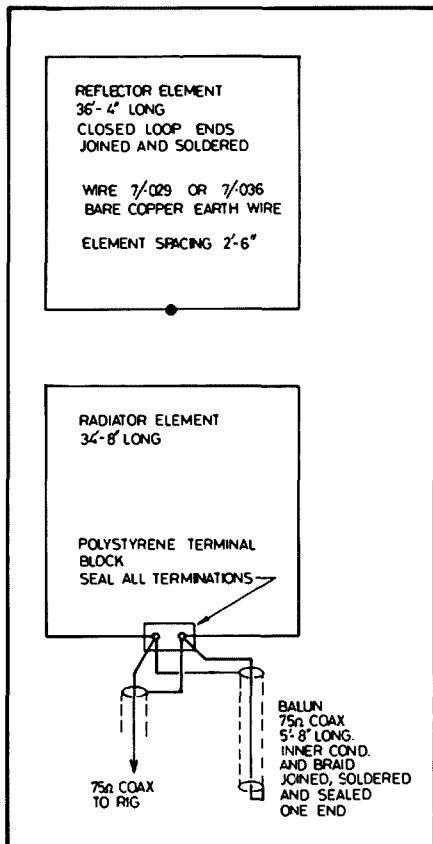

FIG. 1: Wire used — 7.029 or 7.036 bare copper earth wire. Terminal block — polystyrene 3" x 2" x 1/4", drill terminal holes 2" apart.

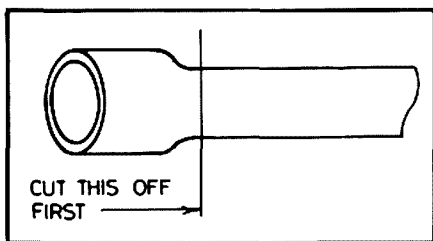

FIG. 4: Material required — 4 lengths of 1" PVC orange conduit 12'6" long (grey conduit becomes brittle in weather). First cut off the coupling ends, then cut each length exactly in half. 4 lengths 3/4" PVC conduit 2'6" long for spreader end supports. 4 lengths 3/4" PVC conduit 12" long to insert in ends of 1" PVC conduit to take reflector element.

**SUPPORT OUR ADVERTISERS**

WHEN PURCHASING GOODS,  
SAY YOU SAW THEM ADVERTISED IN AR

For the radiator element four 5/32 in. holes were drilled 6 in. in from the ends of the 1 in. conduit arms.

For the reflector element, four lengths of 3/4 in. PVC conduit, 12 in. long, were inserted in the ends of the 1 in. conduit and held in position with two brass metal

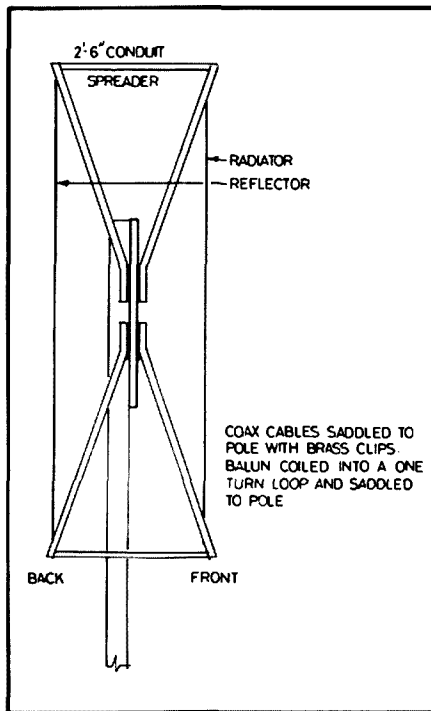

FIG. 3: Side view of quad. 2 x 5/16" galv. bolts and nuts through pole and centre section, conduit spreader arms approx. 6'3" long. End supports 2'6" long 3/4" PVC conduit, clamped to tips of spreaders. Clamps constructed from strips of galv. iron 5 1/2" x 3/4" and wrapped around spreader lips and end supports, and held in position with 1/2" brass threads. (See Figs. 7 and 8.)

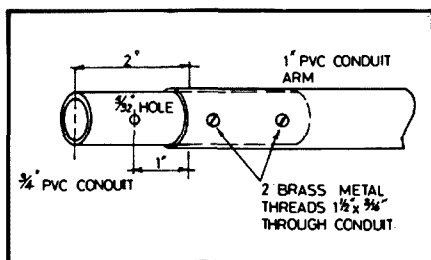

FIG. 5: Details for mounting reflector element.

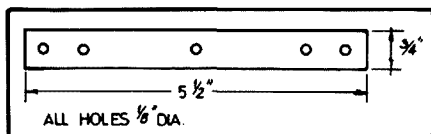

FIG. 8: Clamp construction; strap wrapped around 1" PVC conduit on to 3/4" PVC conduit and held in position with 1/2" brass metal threads in 3/4" conduit, and a long 1/2" PK screw into the 1" PVC conduit.

threads 1 1/2 in. x 3/16 in. through the conduit, leaving 2 in. of 3/4 in. conduit protruding out from the ends of the 1 in. conduit. A 5/32 in. hole is drilled in the 3/4 in. conduit one inch out from the end of the 1 in. conduit for the reflector element.

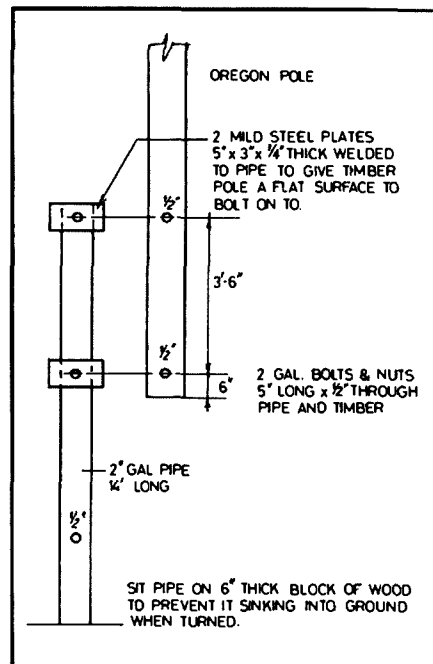

FIG. 6: Mounting details of quad. The quad at the author's QTH is mounted at the end of the shack, saddled at the bottom and at the top on the fascia board, with the saddles left slack enough to enable the quad to be rotated (by hand). — (Mounting naturally can be left to the discretion of the constructor, perhaps utilizing various systems of rotators etc. — Ed.)

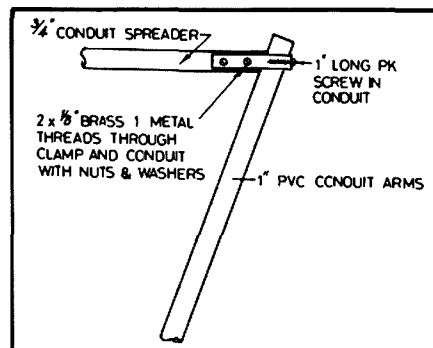

FIG. 7: Side view of quad arrangement for clamping PVC conduits together. 24 gauge galv. iron or brass strips for clamps, see Fig. 8.

**HELP**

WITH INTRUDER  
WATCHING

# A CURE FOR HIGH LEVEL MIXING WITH THE TS600

D. Minchin VK5KK  
 Tamplers Road, Wasleys 5400.

Like most equipment from time to time small deficiencies in design pop up and create varying degrees of displeasure in operation. The Kenwood TS600 while one of the more reliable and popular 6 metre rigs ever does have a small problem with very strong in-band and out-of-band signals mixing to produce unwanted signals within the tuning range.

First a small description of the circuit. The signal on entering the antenna terminal passes through an extensive low-pass filter unit which is primarily intended to filter out transmitter harmonics and spuri. This then goes via the coaxial relay to the receiver front end board. On the Trio TS600 intended for the Japanese market quite a few appeared with a pre-amp stage. But most Kenwood export models have omitted this and the front end looks like that shown in Fig. 1. You will note that D1 and C51 form a division circuit across the front end circuit (T1) and the antenna is fed via a 100 pF capacitor to the centre of the two components. In effect it could be said that the incoming signal is fed via D1 to the first input circuit and this is where the problem starts. It is not too hard to see that with strong signals being passed by the low-pass filter (up to 65 MHz) there is no further preselection until after the diode (D1 = 1SV50 Varicap). Hence the following observations.

Two examples are given and results vary due to the variable nature of some factors. Firstly mixing between a very strong 6 metre signal and broadcast stations. Resultant mixing varies due to MW pickup of certain antenna types, earthing, and proximity to broadcast stations. In Adelaide several TS600 owners experience mixing between VK5VF on 53.0 MHz and almost every local and interstate broadcast station at night! This generally occurs when directly beaming at the beacon which runs 25 watts. If medium wave signals are directly fed to the antenna the situation is quite noticeable with 6 metre stations. Secondly mixing with TV signals from Channels 0, 1 and 2. Even though my QTH is some 40 miles from a Channel 2 transmitter it is quite possible to get mixing with the 64.25 MHz video. The most graphic description of the mixing is when you are suddenly confronted with LSB around 50.0 to 50.1 MHz, usually not very strong. CW may appear above 50.2 MHz and various other strange HF signals above there especially at night. It is helped a bit if your antenna

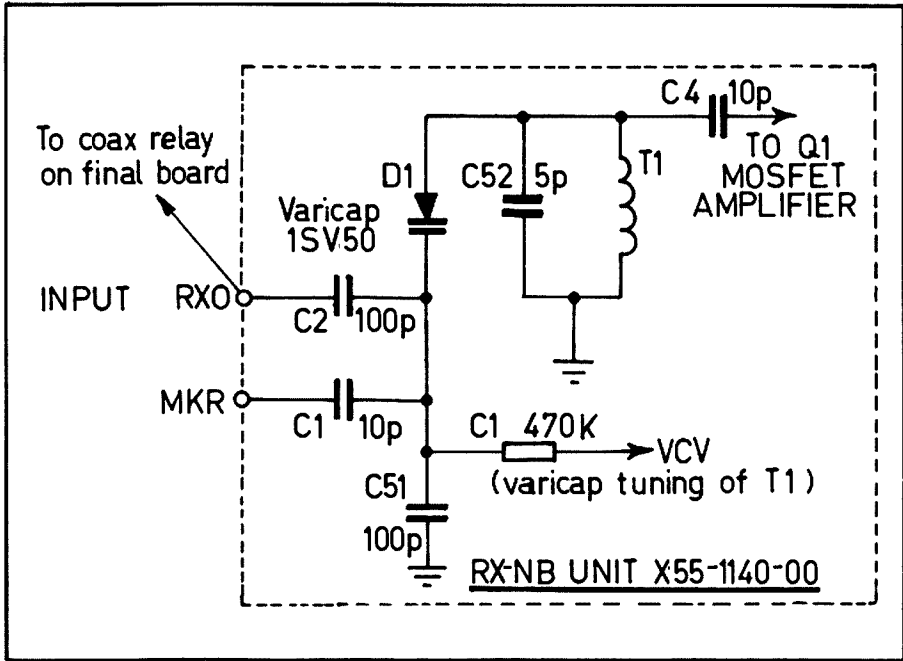

FIG. 1: TS600 Input Circuit.

somehow works well on 64.25 MHz. A lot of good 6 metre beams give enough Channel 2 to mix. By now it should have been realised that 64.25 minus 50 leaves you with 14.250 MHz, etc.!

Fortunately a cure is not very hard to find and it is rather an addition to the circuit rather than a modification. A simple 3 element Butterworth high-pass filter with a fc of about 25 MHz is installed in the

press the both parts of the mixing, hence above 25 MHz no filtering other than the original low-pass filter is used. In theoretical calculations using the formula  $A = 10 \log [1 + (f_c/f)^2 k]$ , the attenuation should be as follows in Table 1. 15 dB attenuation on 14.25 MHz was confirmed with a signal generator. Below 1.6 MHz no attenuation checks were taken but a simple test ensured that the attenuation was quite sufficient. A 15 watt 52 MHz transmitter was fired into a 6 element beam directed to the home station antenna 100 metres away. Without filtering the TS600 could receive all broadcast stations within 200 km at S9 or over. With filtering no audible signals whatsoever. This partially confirms the theoretical results at least. The reduction by 15 dB of 14 MHz seemed all that was necessary as the strength of the mixed signals resulting from here was not great. Should more attenuation be required a more complex filter may be employed. Theoretical loss on 6 metres is less than 0.1 dB and in practice no observable difference occurred. No allowance was made for the 100 pF capacitor feeding the input circuitry in calculation of capacitance values in the filter. When the filter was checked out using 50 ohm terminations the performance was close to that while installed in circuit.

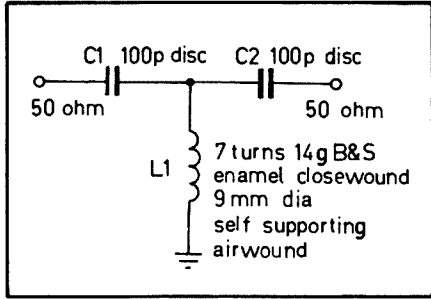

FIG. 2: Filter.  
 fc = 25 MHz  
 k = 3 (No. of elements)

receive line running from the coaxial relay on the PA board under the top cover. 25 MHz was chosen as the majority of unwanted signals seemed to occur below 15 to 20 MHz. It is not necessary to sup-

Installation is simple. Locate the main "Final Unit X56-1220-00". On some TS600s the receive connection consists of an RCA connector close to the coaxial relay whilst in others the coax to the receive board is simply soldered to wire-wrap stakes. Above this point a screw is located on a plated metal partition. This is used as an earth point for the filter. The filter is placed in line with the receive coax coming from that board. No shield-

ing is used and the components are mounted between the board and the earthing point.

In all cases, so far, the filter has been sufficient to cure mixing problems of the type outlined. However should the problem be associated with oxidation of the antenna, etc., then obviously the transmitter is not to blame. The same goes for any other receiving set-up on 6 metres but here's something to try.

TABLE 1

Frequency	Attenuation (Theoretical)
1.6 MHz	51 dB
3.5 MHz	51 dB
10 MHz	24 dB
14.25 MHz	15 dB
25 MHz	3 dB
52 MHz	0.1 dB

# WHAT IS AMATEUR RADIO?

(With acknowledgment to SARRL, Durban Branch)

Amateur Radio is not a new phenomenon but it is a hobby and pastime which is little understood by the general public.

Amateur Radio can trace its origins back to before the turn of the century, to the days of the great pioneers of Hertz, Marconi and others.

THE AMATEUR RADIO SERVICE has no formal champion or spokesman in most countries.

Therefore it falls to radio amateurs themselves, through their national societies, to perform this function on behalf not only of existing amateurs but of all those who will one day elect to enter the field of future generations of radio amateurs and — most importantly — of the larger society which becomes the ultimate recipient of the enormous benefits provided by a strong amateur radio service.

In stating the needs of amateur radio to our respective administrations, it is important to emphasize that we are presenting the case for a vitally important community resource — not merely seeking selfish ends.

Amateur radio constitutes a privilege available to the citizens of each progressive nation.

It provides valuable training, produces international good will, and yields a variety of public service benefits. Amateur radio enhances both the national image and the quality of life of its citizens.

The dimensions of its contribution are many and, depending upon local regulations, vary somewhat in nature and emphasis among the members of the world's family of nations.

Briefly amateur radio:

- Develops a national source of electronics expertise.

- Contributes and demonstrates electronics innovations.

- Explores propagation phenomena and develops efficient spectrum utilization techniques.

- Provides emergency communications resources.

- Promotes international friendship and understanding.

Is available to all citizens, including the young, the old, and the physically handicapped.

Is a disciplined and self-regulating service.

Is a rapidly growing service.

Amateur radio is a self-teaching tool of proven effectiveness.

It offers the opportunity for learning electronics and communications technology at home in one's spare time, while affording ready access to assistance and counsel from experienced teachers in every area from electronics.

Amateur radio training develops a vital supply of electronics expertise and communications resources for the heightened demands for skilled manpower that arise from national and international emergencies of all kinds, to lack these is to be vulnerable.

Perhaps best of all, amateur radio offers a challenging enriching, productive and socially-constructive activity for young people in our increasingly complex society.

Amateur radio provides almost unlimited opportunities for live experimentation in a wide variety of communications disciplines, and has yielded developments and breakthroughs in many specialised areas including, but not limited to, the following:

- Propagation research below 30 MHz and currently in the microwave region.
- Superiority of long distance single sideband voice transmissions.

- Low cost, high performance satellite transponders and ear terminals.

- High efficiency VHF repeater systems.

- Slow-scan long distance television systems.

- Directional antenna design and application.

- Long distance communication employing very low power devices.

- Ultra narrow band voice and code transmission and reception.

- Procedures and techniques for improved spectrum utilization.

- Low power, extended range, narrow-band microwave communication.

A widely recognised aspect of amateur radio activity is the provision of emergency communications services in time of local, national or international disaster. From the earliest beginnings, amateur radio has responded swiftly and effectively to the call for communications assistance when normal channels are lost as the result of calamity.

The greater society's dependence upon communication services becomes, the more sorely these are missed when disruptions occur. Amateur radio has, time and again, been the vital link in bringing first word of disasters such as floods, hurricanes, earthquakes, fires, tidal waves, volcanic eruptions and tornados.

Because radio amateurs tend to be distributed evenly among the populations in most countries of the world, they are at or close to the scene wherever serious emergencies occur, and thus are usually the source of first news and the most active in providing communications services for early relief efforts.

Radio amateurs take pride in their ability to render this unique public service and work at maintaining a state of readiness through a variety of training exercises that include the operation of efficient and widely publicized networks, formalized operating competitions which lead to improvement of equipment and operating efficiency, and well-supported field exercises employing independent sources of electrical power for their equipment.

Amateur communications circuits are tested daily and extend into almost every region in the civilized world, around the clock.

Furthermore, radio amateurs typically maintain close ties with government and relief agency officials to assure prompt availability of their emergency communications resources in the event of need, whether this be a major disaster affecting the lives of hundreds of thousands of people, or locating a special medicine for an ailing child in some remote outpost.

And it is totally a volunteer resource, costing the public nothing.

# Vicom's got it!

## Australia's largest range of Ham Gear

Base or Mobile - we've got the gear to get you on air and keep you there! And all our sales are supported by technical back-up that's unequalled in the industry.

Count on VICOM for personalised service every step of the way. Give us a call today.

### ICOM GEAR

- IC225A 2m FM 25watt synthesised - \$425 00
- IC502A 6m SSB portable \$289 00
- IC251A 2m all mode ac/dc - \$847 00
- IC551 8m, all mode all options - \$59 00
- IC551D 6m all mode, 10w, PBT & VOX - \$849 00
- ICPS20 240V pwr supply - \$230 00
- ICSP2 matching speaker - \$56 00
- IC2A 2m FM synthesised handheld - \$279 00
- IC260A 2m FM/SSB 10w mobile - \$599 00
- IC701 HF solid state 160m-10m transceiver \$1195
- IC225 2m FM synthesised transceiver - \$299 00
- Quantity 5 - 10 - \$299 00
- IC280 2m FM remotable cpu controlled - \$450 00
- IC402 70cm ssb portable, 3 watts - \$439 00
- IC202S 2m ssb portable, 3 watts - \$318 00

### MICROPHONES

- VM-1 Noise cancelling hand plt, dynamic low Z Qty 10-15 - \$10 00

### MORSE KEYS

- HK702 Deluxe Key with marble base - \$41 00
- HK708 Economy key - \$23 00
- HK706 Operator's key - \$22 00
- MK701 Manipulator (side-swiper) - \$45 00

### TONO 2m BI-LINEARS

- MR900E 80-90W, incl RX preamp - \$289 00
- MR1300E 120-130W, incl RX preamp - \$350 00

### RADIO TELETYPE TERMINAL

- O-70000E Tono TRRY CW/Baudot/ASC11 - \$899 00
- O-350 Theta 350 Tono receiver terminal - \$599 00
- HC-800 Tono Dot matrix printer - \$999 00

### TUBES

- 6DK6 Finals for Yaesu linears - \$10 00
- 6JS6C Finals for Yaesu transceiver - \$10 00
- 12BY7A Driver - \$4 75
- 6146B Finals - \$13 00

### VICOM ANTENNAS

- VAR/2 Ringo 2m 6dB gain 135-170MHz - \$55 00
- VAH/80 80m helical whip - \$28 00
- VAH/40 40m helical whip - \$28 00
- VAH/20 20m helical whip - \$28 00
- VAH/15 15m helical whip - \$28 00
- VAH/10 10m helical whip - \$28 00
- VAB/7/5 5el yagi 8dBd gain 500W pep 2m - \$35 00
- VAB/2/10 10el yagi 12dBd gain 500W pep 2m - \$74 00
- VAB/7/16 16el yagi 15dBd 1KW pep 70cm - \$53 00
- VAB/6/5 5el yagi 9dBd gain 1KW pep 6m - \$89 00

### RAK ANTENNAS

- LISTENER 3 Short wave Rx antenna - \$49 00
- LISTENER 1 Short wave Rx antenna - \$22 00

### HY-GAIN ANTENNAS

- 204BA 4el monobander for 20m - \$259 00
- 203BA 3el beam 20m - \$199 00

### JAYBEAM ANTENNAS

- 5Y/2m 5el 2m 7.8 dBd gain, length 1.6m - \$43 00
- 8Y/2m 8el 3m 9.5 dBd gain, length 3.8m - \$51 00
- 08/70cm Twin 8el, 70cm, 12.3 dBd, 1.1m - \$64 00

## NEW TONO 7000E COMMUNICATIONS

### COMPUTER RTTY/CW

send /receiver

# NOW ONLY \$899



- PBM 18/70 18el, 70cm, 14.9 dBd, 2.8m - \$96 00
- MBM 48/70 48 el, 70cm, 15.7 dBd, 1.83m - \$83 00
- MBM 88/70 88el, 70cm, 18.5 dBd, 3.98m - \$105 00
- PMH/2C Phasing harness - \$20 00
- 8XY/2m 2m cross yagi, 8el, 9.5 dBd, 2.8m - \$99 00
- 12XY/70cm 70cm cross yagi, 12el, 13.0 dBd, 2.6m - \$139

### NAOARA

- V4JR 40-10m trap vertical, 5.2m high - \$99 00

### SCALAR

- M22T 1/4 wave 2m mobile whip, top only 1-4 - \$7 5-9
- M25T 5/8 wave 2m mobile whip, top only 1-4 - \$14 5-9
- BASE B/L for above - \$4 00

### COAXIAL SWITCHES

- CS201 2 position, high pwr, to 500MHz - \$23 00
- CS401 4 position, high pwr, to 500MHz - \$59 00

### BALUNS

- AS-BL Asahi 50 ohms for beams - \$34 00
- BL50A 50 ohm 4Kw 1.1 tor dipoles - \$32 00
- BL70A 70 ohm 4Kw 1.1 tor dipoles - \$32 00

### COAXIAL CHANGE-OVER RELAYS (OAIWA)

- CX-2L 1.8 thru, 170MHz, 100W pep max - \$69 00

### AIRCRAFT RECEIVERS

- 747 16ch, ac/dc scanning, inc 4 xtals - \$199 00 Qty 10-20
- XTALS Additional crystals - \$7 50

### BEARCAT SCANNERS (PROGRAMMABLE)

- BEARCAT 210F VHF/UHF 10chs, ac/dc - \$412 00
- BEARCAT 220BF 20chs incl aircraft AM - \$556 00
- BEARCAT 250BF VHF/UHF, 50chs, ac/dc with 68-88 MHz - \$556 00

### KENWOOD

- TS120S ..... poa
- TS180S ..... poa
- R1000 ..... poa

CALL US FOR A GOOD DEAL ON KENWOOD PRICES!

### AMATEUR RADIO EQUIPMENT

- LDM-815 Dip meter, 1.5MHz-250MHz - \$89 00
- LPM-885 SWR/Wattmeter, 1W-100W - \$97 00
- LAC-895 Antenna coupler, 3.5MHz-28MHz - \$182

- LBO-310HAM 3" oscilloscope for HAM use, 20mV/4MHz \$330 00
- LA-31 HAM scope adaptor - \$28 00

### SWR/PWR METERS AND DUMMY LOADS

- VC-2 Twin meters 3-15MHz with cal. chart - \$35
- SW110A Daiwa 1.8 thru 150MHz - \$79 00
- SW210A Daiwa 1.8 thru 150MHz 20/120W direct \$99
- CN620 Daiwa Cross-needle, 1.8 - 150MHz direct \$99 00
- CN630 Daiwa \$140-450MHz, 20/200W direct read \$135 00
- CN650 Daiwa 1.2 - 2.5GHz, 2/20W, direct read \$169
- LPM-885 Leader SWR/PWR meter - \$89 00
- LPM-880 RF Power meter - \$135 00
- RW-155D Kuranshi RF Power meter - \$185 00
- RW-151D Kuranshi RF Power meter - \$185 00
- RW-1002L Kuranshi RF watt meter - \$139 00

### MAST HEAD DIVIDER

- AD103X Mast-head splitter 70cm/2m/HI - \$59 00

### RF MATCHING TRANSFORMERS

- PALOMAR 500W, switchable 6 impedances - \$96 00

### LOW PASS FILTERS (DAIWA)

- FD30LS 32MHz, Fc, 200W, 3 stages Qty 1-10 - \$20

### ANTENNA COUPLERS

- CL67A Daiwa 1.9 - 28MHz 500w pep - \$135 00
- CN217 Daiwa incl SWR/PWR meter, 200W - \$165
- MFJ901 MFJ Matches everything 1.8-30MHz - \$119
- MFJ16010 MFJ Random wire tuner \$160-10M - \$71
- LAC-895 Leader 3.5 thru 28MHz - \$169 00
- CNA-1001 Daiwa, automatic, 200W - \$269 00
- CNA-2002 Daiwa, automatic, 2.5KW - \$569 00

SYDNEY: 339 Pacific Hwy,  
CROWS NEST Ph 436 2766  
MELBOURNE: 68 Eastern Rd. Sth Melb.  
Ph 699 6700

Sydney: 635 6399, 436 2766  
Adelaide: 272 8417, 43 7981  
Brisbane: 48 6601, 38 4480  
Perth: 321 3407, 446 3232  
Hobart: 43 6337  
DEALER ENQUIRIES INVITED

# VICOM

The Question we seem to get most often from our customers:

# “WHEN IS ICOM COMING OUT WITH A HANDIE-TALKIE!”

## ICOM IC-2A SYNTHESISED 2 METRE HANDIE TALKIE

### FEATURES YOU'VE WANTED

- 800 T/R Channels. synthesised.
- 1.5 Watt Output High/Low Power Battery Saving Switch to .15 Watt.
- Separate built in Speaker & Mic. Excellent audio quality.
- Compact. About the size of a \$2 note.
- Variable size Nicad Power Pack, 3 sizes available to suit your needs. (250 MA standard). Makes the IC-2A the most compact synthesised HT on the market.
- ICOM level Receiver Performance-ICOM Quality Receiver in a compact package (.2uv/20db typical)
- Optional Desk Charger, Speaker/Mic available.
- With slip on/slip off Bottom Nicad Pack, you can vary the size of the HT from about 116 mm high to 175 mm high. Easy to carry extra Snap-on packs with you for extended trips.
- Backed by **VICOM** 90 day warranty.

### TYPICAL TECHNICAL CHARACTERISTICS (Australian model)

**GENERAL:** Frequency Coverage 144.000 - 147.995 HMz, Power Supply Requirements DC 8.4V with attendant batteries, Current Drain Transmitting: High (1.5w) approx. 600mA, Low: (0.15W) approx. 200mA, Receiving: At max audio approx. 140mA Squelched approx. 20mA, Dimensions 116.5mm(H) x 65mm (W) x 35mm(D) without battery case, Battery case: 49mm(H) x 65mm(W) x 35mm(D), Net Weight 450g including batteries and flexible antenna

**TRANSMISSION** Transmission Power High: 1.5w (at 8.4v) Low: 0.15w, Max. Frequency Deviation 5 KHz, Modulation System Variable reactance frequency modulation, Spurious Emission More than 60dB below carrier, Microphone Built-in electric condenser microphone optional 600 ohm dynamic microphone can be used.

**RECEPTION** Sensitivity Less than 0.4uV for 20dB Noise quieting, Selectivity #7.5KHz At the -6dB point, #15KHz At the -60dB point, Audio Output, More than 300mW.

actual size: Cut out along the dotted line and put the ICOM IC-2A in the palm of your hand.



TOP VIEW

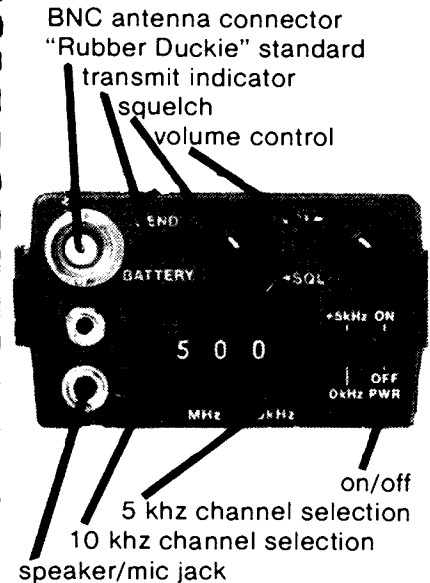

 **ICOM**

only \$279

# THE ANSWER IS: NOW!

## ALL 800 channels of it!

Distributed in Australia by **VICOM**

**VICOM**

# THE DJ4LB ATV TRANSMITTER AS THE BASIS FOR A 70 cm SSB TRANSVERTER

Ian Glanville VK3AQU  
23 Falcon Road, Macleod, 3085

The DJ4LB ATV transmitter has proved very popular in amateur television circles for some time. But its usefulness is not restricted to TV. Some sub-assemblies can be used for 70 cm SSB.

The modular design of the DJ4LB makes it very easy to construct, and the single-sided board layout will help eliminate a lot of the fear that some people have for UHF construction. The two units we are interested in are the DJ4LB 003 oscillator chain and the DJ4LB 004 transmit mixer. Both boards measure 135 mm x 50 mm. In the original article quite some time was devoted to technical explanation of these units. Here, however, we will concentrate on the practical aspects for the construction of a 70 cm SSB transverter. For the receive converter we have used the VK2ZIM converter modified for 28 MHz output and fixed oscillator injection.

The oscillator generates a crystal controlled frequency of 404 MHz. The 67.333 MHz crystal is firstly tripled, then doubled in the output of T303 and further amplified by T304 to a level of around 10 mW. Two outputs are provided. Pt 303 gives about 20 per cent of the total output power and is used to drive the receiver converter. BF199s were used throughout instead of the BF224s specified as these were easier to obtain and cost less than 30 cents at present.

The transmit mixer is again relatively simple. The SSB input (we used 28 MHz) is wed to Pt 402 via the input bandpass filter (Fig. 1), whilst the oscillator is fed to Pt 401. 2N5245 FETs were used in one author's rig while the other used a modification suggested by Peter VK3ZPA consisting of BF180s instead of FETs (Fig. 3). Both work equally as well. Transistors T405, T406 and T407 amplify the 432 MHz signal to approximately 25 mW. Although more power output was claimed in the original article we could not obtain this,

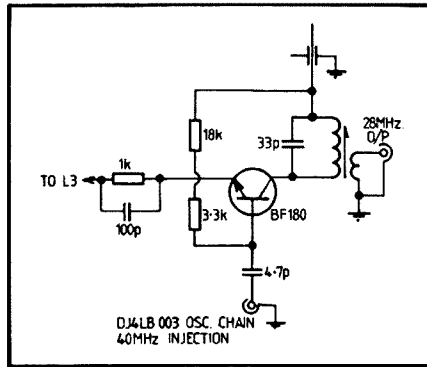

FIG. 2. Modification to VK2ZIM ATV Converter.

28 MHz output wound on neosid former 16Ts 24g. 33 pF, with 5Ts for coupling link.

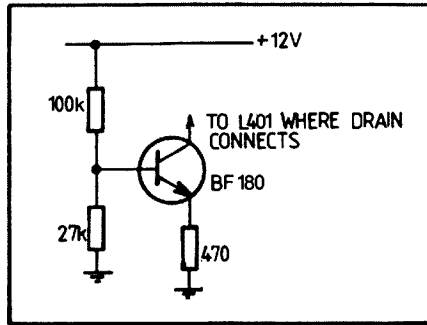

FIG. 3. Alternative to FET Mixer.

100k mounted under board to 12 volt rail at connection of R415 and C429. 27k mounted in place of R401 and R404. 470-2 in place of R402 and R403.

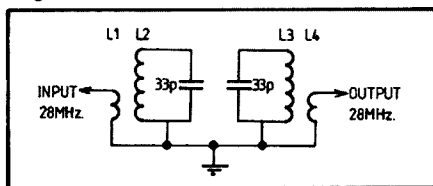

FIG. 1. 28 MHz Bandpass Filter.

L1, L4, 5T, 28g. L2, L3, 16T, 24g. Wound on neosid former inside double can F-29 slugs.

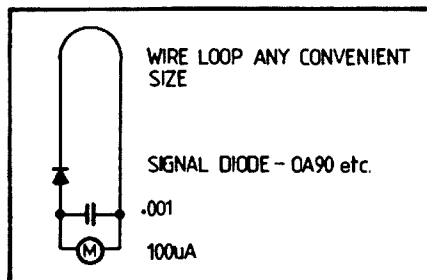

FIG. 4(a). RF Indicator.

nor do we know of anyone who has. This is more than enough power for a 5 x 9 contact over a mile or so. Distances in excess of twenty miles have been worked from the output of the DJ4LB 004 board.

The VK2ZIM ATV converter has proved to be very popular over the years. We have re-printed it here as originally featured for those who may want an ATV converter. The modifications are shown in Fig. 2. It is suggested that the converter be made of PC board. If the Neosid 28 MHz output transformer is mounted on top of the box scrape the copper away from under it. The old oscillator will no longer be required. The 1k resistors shown in the collectors of the first two stages should be connected to 1,000 pF feed-through capacitors before passing through the box to the 12 volt supply and not as shown with them mounted vertically through the top. Remember, KEEP THOSE LEADS AS SHORT AS POSSIBLE.

## ALIGNMENT OF THE OSCILLATOR

Most dip oscillators will tune up to 200 MHz and can be used as indicators for the alignment of the 67.333 MHz and 202 MHz stages. Thereafter use a simple RF indicator (Fig. 4), or better still make yourself a wave-meter using a miniature variable capacitor and hairpin loop (Fig. 4(a)). This can be calibrated, after the completion of the oscillator chain, for 404 MHz at least. It is suggested that the final adjustments to both units be done using a wave-meter. Couple your dipper to L301 and tune the slug for an indication of RF at 67 MHz. Tune for maximum then back off a little to ensure reliable starting. Now

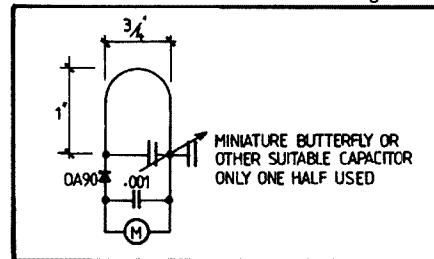

FIG. 4(b). Wave Meter L1 Hairpin Loop 16g. tinned.

\* Dimensions of L will depend on C.





### ALIGNMENT OF THE TRANSMIT MIXER

Connect the local oscillator to Pt 401 and your 28 MHz input to Pt 402 via your *bandpass filter*. Remember that this board is broad-banded for TV so any nasties from your prime mover *WILL* appear in the output! The output Pt 405 should be connected to a dummy load and some sort of indicating device if possible, although the output will only be small. If you haven't made your wave-meter yet then you will have to rely on the simple RF indicator. Couple your indicating device to L401. Now you can do one of two things. Either tune trimmers C404, C405 for the 404 MHz oscillator in which case you will know that the 432 MHz SSB signal must peak at a value of capacitance less than for 404 MHz, or apply a small amount of 28 MHz carrier, peaking the trimmers for maximum. Switch to the SSB position and the output should drop to zero until you speak. On the FT101B used, the mike and carrier controls were set to the first indicator mark or about the seven o'clock position for full output. So as you can see only a very small amount of drive is needed. Residual carrier may also become evident at these low levels. With 432 MHz output from the mixer tune the following stages for maximum output. Output from this board feeding the linears described will produce at least 3 watts.

### THE LINEAR AMPLIFIER

This linear amplifier is quite straightforward. No problems should be encountered in its construction. It will produce at least half a watt when driven direct with the DJ4LB 004 output. Alignment procedure can be followed from the 3 watt linear.

### 3 WATT LINEAR

There are several proven linear amplifier designs that will suit this transverter. One was detailed in VHF Communications some time ago, specifically designed for the DJ4LB series of TV modules. Three such units have been constructed successfully by the authors. In fact the transverter pictured uses such a linear. The construction techniques involved are complicated by elaborate biasing and a DC path to the antenna.

Because of this it was decided to develop a linear of less complicated design. To date two units have been constructed, one for SSB and the other for 440 MHz ATV. Both linears performed well. In ATV use, colour signals were handled with no noticeable degradation of picture quality (a good test for a linear).

The circuit is conventional, using diode bias and is similar to the linear mentioned earlier. The diode biasing does not prevent thermal effects to any great extent. However, at the power levels involved and with generous heat sinking this is not a problem.

The board layout for this linear is designed to use a PCB type coax change-over relay. However the relay is quite expensive (available from Dick Smith Elec-

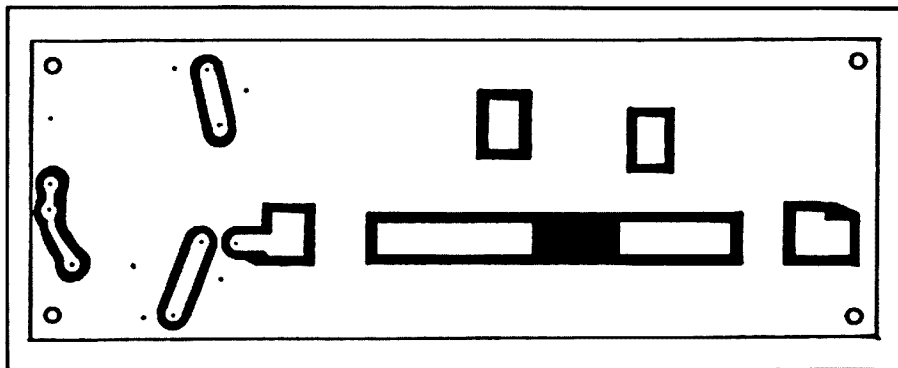

FIG. 9. 3W Linear PCB.

tronics). If another type of relay is used (coax relays only please) then the board layout would have to be altered to suit. This linear is capable of between 4 and 6 watts output.

Alignment is simple. Use the absorption wave-meter and a dummy load. Peak all trimmers for maximum output. Re-tweaking the trimmers using different settings will then provide the best matching.

### ALTERNATIVE RECEIVE CONVERTER

Elsewhere in this article mention is made of the VK2ZIM converter and the modifications necessary for SSB use. Another converter is available ready made. That is the ATV converter manufactured by Microlink. Les VK3ZBJ suggests that the wide band output balun be replaced by a 28 MHz coil.

The authors used a converter similar to that manufactured by Microlink. The free running oscillator FET was removed and drive from the crystal-controlled chain fed by coax to the point where the gate had been connected.

Peaking the trimmers and the mixer output coil is the only alignment required.

The addition of a 28 MHz IF amplifier seemed worthwhile. By careful arrangement of the circuit the IF amplifier can be made to fit above the input section of the Microlink board. The circuit of the receive converter includes the pre-amp.

Our thanks go to Microlink Pty. Ltd., 12 Rosella Street, Frankston 3199, and also Ross French VK3ZFU and the many others who made this unit before us, proving that it is a good, simple, workable transceiver.

### APPENDIX 1 "ELECTRONICS AUSTRALIA" CONVERTER FOR AMATEUR TV

The following is based on an article published in Electronics Australia, January, 1972.

The converter design shown was originally described by Ian McKenzie VK2ZIM in the monthly newsletter published by the VHF and TV Group, Wireless Institute of Australia, NSW Division.

As may be seen, the converter consists of two RF amplifier stages, a mixer stage and a free-running local oscillator, all using BF180 or similar UHF bipolar transistors. The RF stages use the ground-base configuration, with signal tuning per-

### REFERENCE FIGURE 7

- Q1—CTC C12-12\* or 2N5946.
- \* Used if following low power linear.
- C1—4.5-20 pF trimmer.
- C2—As C1.
- C3—70 pF mica compression trimmer.
- C4—As C3.
- Capacitors \* tantalum 1-10 uF value unimportant.
- Change-over relay CX120P to TSU Electric Co. available from Dick Smith Electronics.
- RFC 1—1 turn 16 B & S tinned copper wire.
- D1—IN4001 or similar.
- D2—As D1.
- Single sided board. All components on copper side mounted 3 mm above ground plane (heat sink) shown full size.

formed by trough lines. Output from the second RF stage is fed into the emitter circuit of the mixer, while the local oscillator signal is fed into the base. The IF output circuit in the mixer collector circuit and the local oscillator frequency may be adjusted so that the converter output appears on any suitable unused channel. The output of the converter connects directly to the aerial terminals of the TV receiver, via a suitable balun if necessary.

Although quite suitable for TV reception, the stability of the free-running local oscillator would probably not be good enough for reception of AM or FM phone signals. However a crystal-locked oscillator chain could be substituted if desired.

The physical construction of the converter should be fairly clear from Fig. 11. Each trough-line consists of a 2½ in. length of 1/8 in. brass brazing rod, centred in the 1 in. x 1 in. troughs formed by the partitions in the brass or tinplate box. Suitable trimmers for the tuning would be the Philips type COO4-AA, or the similar types of COO4-BA, COO4-CA, COO4-JA, all of which are available in 0.8-6.0 pF.

Note that the trough partitions are notched to accommodate TR1 and TR2.

### APPENDIX 2 FURTHER DETAILS OF THE DJ4LB ATV TRANSMITTER

The following information is based on the original article which was published in VHF Communications.

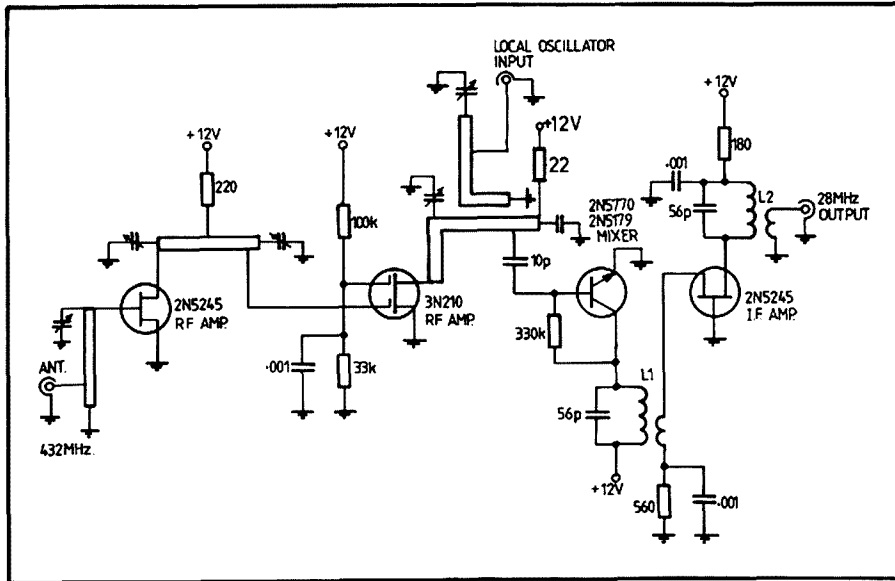

FIG. 11. Converter Layout.

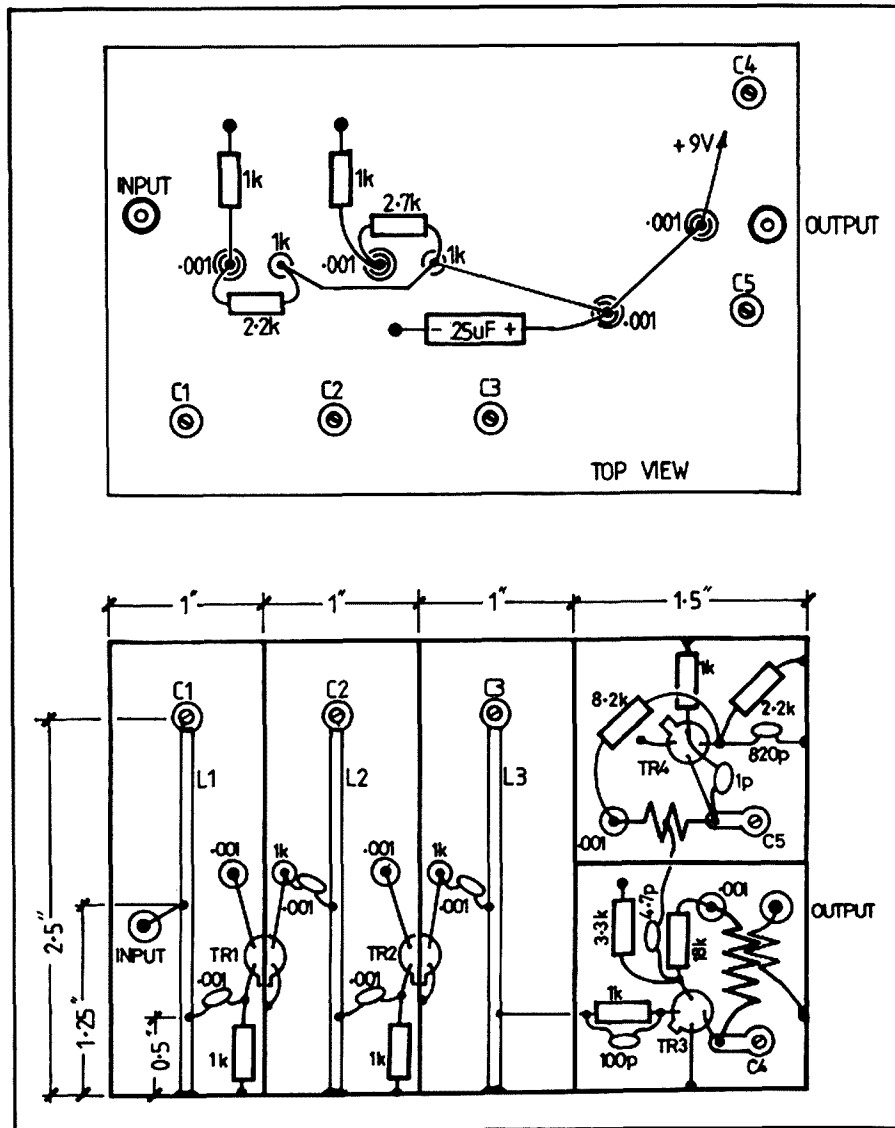

FIGURE 10 (left):  
Converter for Amateur TV.

**LOCAL OSCILLATOR MODULE**

Module DJ4LB 003 generates a crystal-controlled, local oscillator frequency of 473.15 MHz for the transmit mixer DJ4LB 004. A connection is also provided for a receive converter (transceive operation).

As can be seen in the block diagram (Fig. 13), the crystal-controlled frequency of 67.333 MHz is multiplied by six. The bandpass filters at the output of the tripler and doubler stages efficiently suppress spurious signals which are always generated during the frequency multiplying process. The subsequent amplifier stage provides an output power of approximately 10 mW to 15 mW and ensures an isolation between the output socket and the band-pass filter.

**CIRCUIT DETAILS**

Fig. 14 gives the circuit diagram of the local oscillator module. Transistor T301 operates as crystal oscillator and the resonant circuit comprising L301/C303 is tuned to the overtone frequency of the crystal (in our case 67.333 MHz for SSB or 78.8 MHz for ATV). The subsequent transistor T302 generates strong harmonics when operating in Class C and the band-pass filter comprising inductances L302 and L303 filter out the required frequency of three times that of the crystal oscillator frequency. This signal is now fed to the doubler stage equipped with transistor T303 which operates in class AB and therefore generates mainly even harmonics. The bandpass filter comprising inductances L304 and L305 filters out the doubled frequency which is then six times the original crystal-controlled frequency. This signal is then fed to the amplifier stage comprising transistor T304. The output circuit of this stage is in the form of a Pi-filter which transforms the output signal to an impedance of 60 ohms at Pt 304. Connection Pt 303 is an additional RF output having approximately 20 per cent of the output power for driving a receive converter. The crystal-controlled oscillator (T301) and the subsequent tripler stage (T302) are fed via transistor T305 (and D301) with a stabilized voltage of approximately 8.5V so that no frequency variations are caused by fluctuations of the operating points.

**MECHANICAL CONSTRUCTION**

The described local oscillator module DJ4LB 003 is accommodated on a single-coated PC board having the dimensions 135 mm x 50 mm. Fig. 5 shows this PC board and the associated component location plan. The only soldered connection to be made on the component side of the board is the soldering of the ceramic capacitor C319 to the coil tap on inductance L305. It is advisable to also mount this module in a TEKO-box 4B in order to



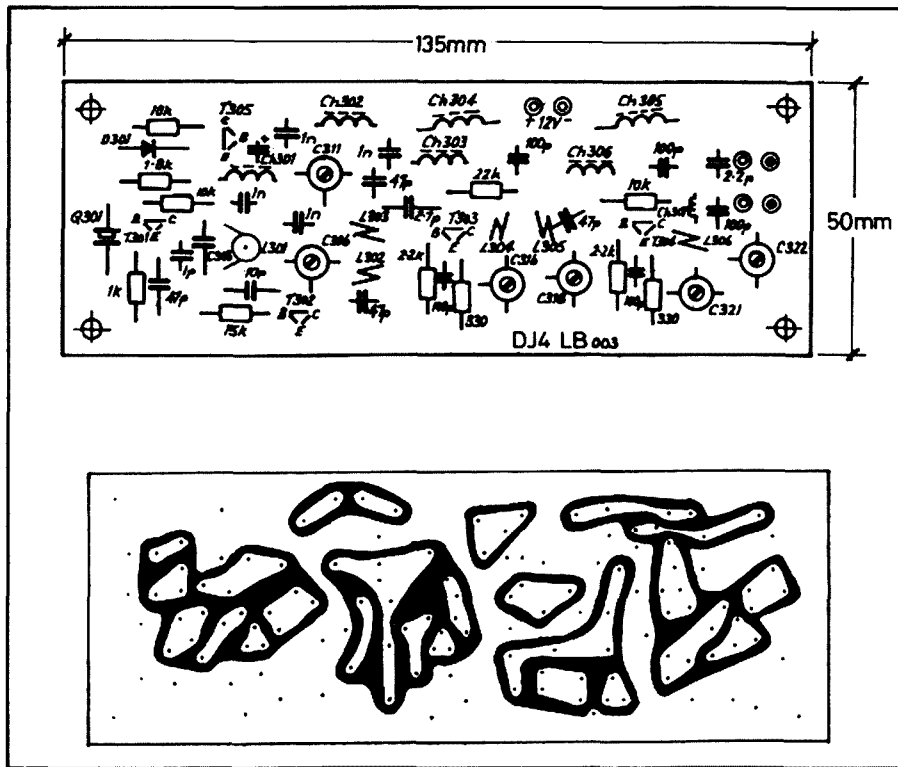

FIG. 15. Printed Circuit Board and Component Location Plan of the Local Oscillator Module.

to resonance by adjusting the variable capacitors. This can also be checked by loosely coupling the RF-voltmeter to the resonant circuit in question.

The described preliminary alignment is repeated until the reflectometer at the output indicates a reading. All resonant circuits are then aligned for maximum reading on the reflectometer and the alignment is repeated until no increase of the output

power is possible. For reasons of stability, the core of inductance L301 should then be slightly extracted until the output power is reduced slightly.

The module is checked by removing the crystal from the holder and ensuring that the circuit no longer provides any RF voltage. In addition to this, the 60 ohm terminating resistor should be removed in order to obtain any required mis-match

conditions with the aid of various un-terminated coaxial cables. If no spurious oscillations occur, the module will be ready to operate even when the output termination is not exactly obtained. Any tendency to oscillation with the version with a higher output power can be neutralized by increasing the coupling and inductances L304 and L305 to another (decreasing the distance between them).

**TRANSMIT MIXER AND AMPLIFIER MODULE DJ4BL 004**

As can be seen in the block diagram given in Fig. 16, module DJ4LB 004 is provided with the local oscillator frequency of 473.15 MHz and the combined video and sound-intermediate frequency of 38.9 MHz and 33.4 MHz. The required output frequency is obtained by conversion of the frequency differences 434.25 and 439.75 MHz which is amplified in a three-stage linear amplifier to approximately 100 mW.

A push-pull mixer stage equipped with field effect transistors is used which virtually completely suppresses the push-pull local oscillator signal. This is especially important due to the relatively small frequency spacing between the local oscillator and required output frequency.

The FET push-pull mixer is driven via a differential amplifier which has been dimensioned as a phase-reversal stage so that two equal-amplitude IF voltages are formed that are phase-shifted by 180° to another. Since this phase-reversal stage and the input circuit for the local oscillator frequency do not contain any resonant circuits, the module DJ4LB 004 can be used for mixing other frequency combinations without modification, such as 28 to 30 MHz and 404 MHz to 432-434 MHz.

Fig. 17 gives the circuit diagram of the mixer and linear amplifier module.

**PHASE-REVERSAL STAGE**

Resistor R409 forms, together with the input impedance of the differential amplifier (T403, T404) the 60 ohm termination for the IF-signal at connection Pt 402. Since the IF input level of approximately 0.6V (peak-to-peak) is already sufficient for driving the mixer, the voltage gain of the differential amplifier is adjusted to a value of approximately 1.5 by the emitter resistors R411 and 413. This feedback increases the linearity of the amplifier and reduces the influence of component tolerances on the balance and driveability of the circuit. Two virtually equal-amplitude IF voltages of maximum 1V (peak-to-peak) each is available at the collectors of the two transistors which are phase-shifted by 180° to another.

**PUSH-PULL FET MIXER**

The two phase-shifted IF-signals are fed via capacitors C401 and C406 to the high impedance gate connections of the field effect transistors T401 and T402. The parallel-connection of the source connections represents the low-impedance termination for the local oscillator voltage. The

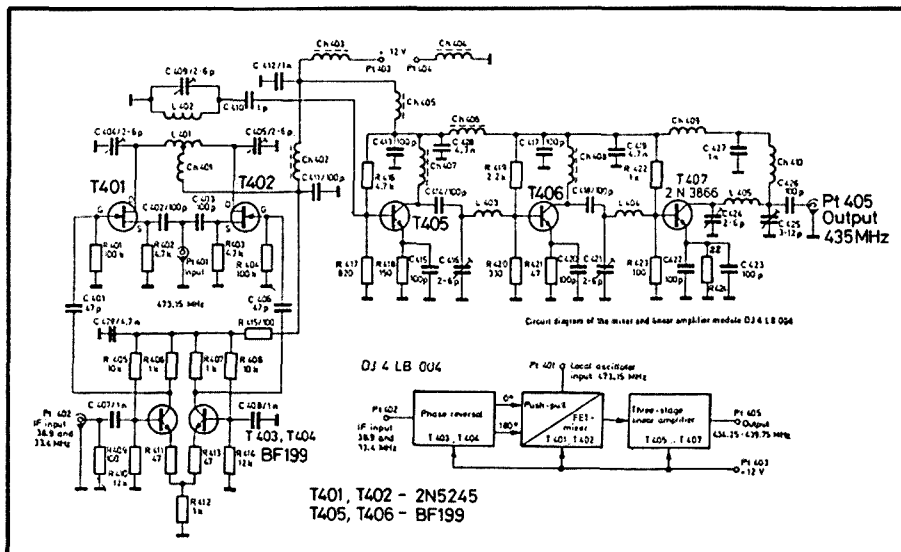

FIG. 16. Block Diagram of the Mixer and Linear Amplifier Module DJ4LB 004.



# NEW QUALITY ROTATORS WITH WORLD MAP CENTRED ON AUSTRALIA!



- \* Safe to operate with low voltage 24VAC
- \* High brake torque with the newly designed brake mechanism.
- \* Specially designed reduction gear train for minimal power loss and dependable long-life operation.
- \* The mast clamp guide (patent pending) eliminates any alignment problems.
- \* Rotator is weather sealed and factory lubricated. Housing is die-cast aluminium with melamine - resin coating to prevent oxidisation.

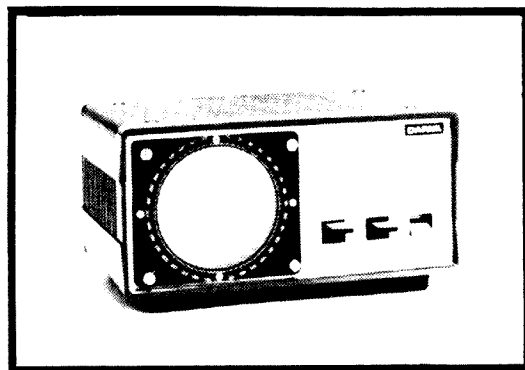

THE "R" TYPE CONTROLLER

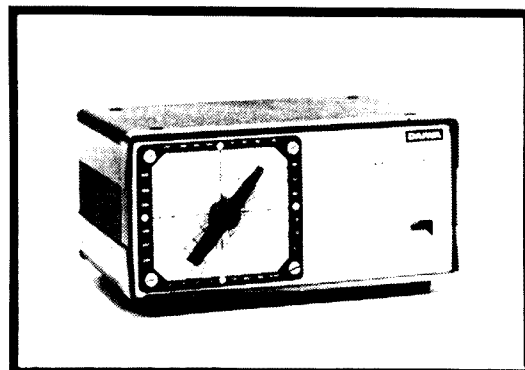

THE "X" TYPE CONTROLLER

## Typical operating characteristics:

	DR7500 (medium duty)	DR7600 (heavy duty)
Power consumption	40VA	40VA
Motor	24V split phase	24V split phase
Rotation time (approx)	50 sec	64 sec
Rotating torque	500kg/cm	600kg/cm
Braking Torque	2000kg/cm	4000kg/cm
Vertical load	200 kg	200 kg
Weight	4.5 kg	4.6 kg
Cable	6 core	6 core

## Prices:



	Controller	Price
DR7500R Medium duty	"R"	189.00
DR7500X Medium duty	"X"	172.00
DR7600R Heavy duty	"R"	269.00
DR7600X Heavy duty	"X"	239.00

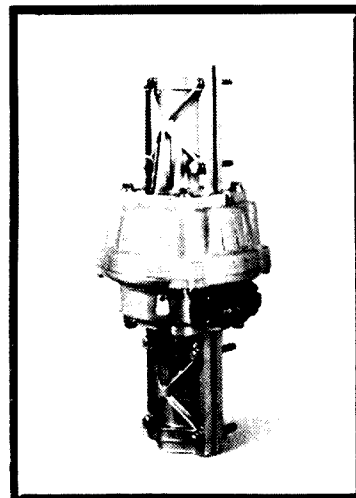

MEDIUM DUTY ROTATOR

Available at your VICOM DEALER

VICOM



# CW ELECTRONICS

**FLESHER CORP.**

TR128  
RTTY  
REGENERATIVE  
SPEED CONVERTOR

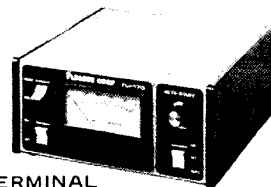
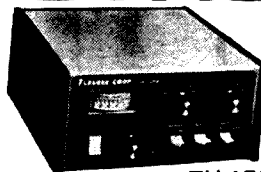

TU-170  
RTTY TERMINAL  
UNIT WITH LOOP  
SUPPLY ETC.



**MACROTRONICS, inc.**

**AMATEUR RADIO/MINI COMPUTER INTERFACES WITH SOFTWARE**

MACROTRONICS M650 DELUX RTTY AND MORSE SYSTEMS



for ● Apple  
● TRS 80  
● Scorerer  
● Commodore

NEW AGENT IN SOUTH AUSTRALIA  
GOLF COMMUNICATIONS, WHYALLA  
(086) 45 0208

VICOM		ATN	
ICOM	Transceivers and accessories	ATN	Antennas, HF, VHF, UHF Australian Made at the right price
DIAWA	Antenna Tuners, Rotators, VSWR/Power Meters, Co-Axial Switches, Low Pass Filters, Voice Compressors and Processors	DSI	Frequency Counters and accessories
LEADER	Oscilloscopes, Signal Generators, Grid Dip Meters, Regulated Power Supplies, Wow and Flutter Meters, Antenna Couplers, Power Meters	MIRAGE	Linear Amplifiers and SWR/Peak reading Watt Meters.
ELBEX	Video Camera	OFFICIAL QUEENSLAND DISTRIBUTOR.	
JOSTY KITS	Amplifiers, Tuners, Generators, Hi-Fi, Relays, Timers, Decoders, etc.  VHF and Aircraft Scanning and Crystal Controlled Receivers, Commercial and Industrial Test and Communications Equipment. OFFICIAL QUEENSLAND WHOLESALE DISTRIBUTOR.	EMTRONICS	LUNAR-HF and VHF linears DATONG Morse Tutors DENTRON Linears and Tuners BEARCAT Scanning receivers.  OFFICIAL QUEENSLAND DISTRIBUTOR.
BAILS:		SCALAR	Multi-band Vertical and Mobile Antennas
YAESU	Transceivers, Receivers and accessories, the fabulous FT 1207R Hand Held, Monitorscopes, Antenna Tuners, Mobile Antennas, Hand Books, RTTY and Morse Readers.	HYGAIN	Antennas and Baluns, TH3Jnr and TH6DXX now in stock
EMOTATOR	Rotators, Mast Clamps, Thrust Bearings etc. <u>CW keys and much much more . . .</u>	WELLER	Soldering irons
GFS		FLUKE	Multi-meters
IMPORTS	MFJ Antenna Tuners, SWR/Power Meters, Filters, Speech Processors and Keyers.	Electronic toys and games, Metal detectors, Tools, Batteries, Cable, Calculators, Morse Tapes, Text books, Log books . . . books, books, books . . . Second hand gear, etc. etc. etc . . .	
KENWOOD	Transceivers, Receivers, Dummy loads, Antennas, Headphones, Power Supplies, clocks etc.	HAMINEX	
		COMMODORE	Personal Home and Small Business Mini-computers (PET 8k, CBM 16k and 32k), Twin Intelligent Floppy Disc Drives, Traction and Pressure Fed Printers, Software, Service, Books, Cassettes, Discs, etc.
		DATASOFT	Coming soon — Well over 100 programmes for wide range of popular mini-computers

AND MORE . . .

*\*Dealer enquiries welcome*

# CW ELECTRONICS

CNR. MARSHALL RD & CHAMBERLAND ST.,  
TARRAGINDI — BRISBANE PH (07) 48 6601  
PO BOX 274, SUNNYBANK, QLD. 4109  
AH: BRIAN (07) 341 4767



# ATN ANTENNAS



be  
on top  
of  
the pile

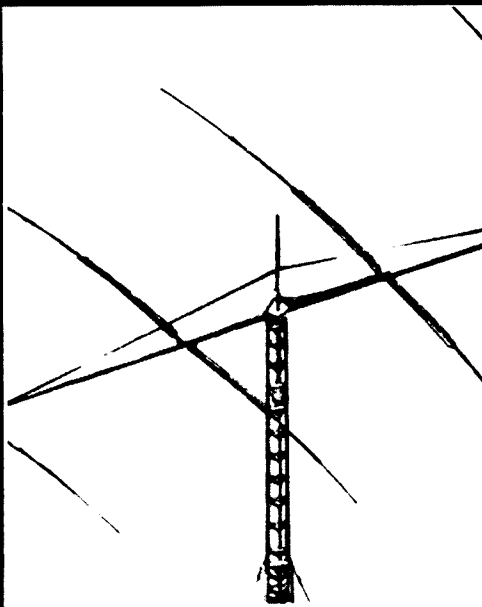

ALL ANTENNAS LISTED  
INCLUDE BALUN FOR  
SYMMETRICAL AND CLEAN  
PATTERN, AND USE "N" CONNE  
FOR 70 cm UP.

15/11/10 mx		
ATN 20-30-1 rotary dipole . . . . .		
11/10 mx model	Gain dbi	Boom
ATN 28-30-3 . . . . .	9.7	3.5M
ATN 28-30-5 . . . . .	12.0	6.5M
ATN 28-30-6 . . . . .	13.2	8.3M
6 mx		
ATN 51-53-5 . . . . .	11.9	3.5M
ATN 51-53-8 . . . . .	14.2	5.5M
ATN 51-53-11 . . . . .	16.2	9.0M
2 mx		
ATN 144-148-8 . . . . .	12.7	2.2M
ATN 144-148-11 . . . . .	14.6	3.8M
ATN 144-148-16 . . . . .	17.0	6.3M
Radio Astronomy		
ATN 220-228-11 . . . . .	14.6	2.5M
ATN 220-228-14 . . . . .	16.2	4.7M
70 Cm Model		
ATN 420-470-6 . . . . .	10.2	0.6M
ATN 420-470-14 . . . . .	13.7	1.5M
ATN 432-11 . . . . .	16.7	1.85M
ATN 432-16LB . . . . .	17.2	3.7M

Ferrite Baluns.	Ratio	Freq. Range
200W Encapsulated	1:1	3-150 MHz
200W Encapsulated	1:1	100-600 MHz
200W Encapsulated	4:1	3-150 MHz
1 KW Encapsulated	1:1	3-100 MHz
1 KW Encapsulated	4:1	3-100 MHz
Insulators Heavy Duty		
No. 1 5/8 element on 2" boom		
No. 2 large 3/8 element on 1" boom		
No. 3 small 3/8 element on 1" boom		

## SERVICE Dept.

CW ELECTRONICS HAS A FULLY STAFFED AND EQUIPPED SERVICE DIVISION.

WE CAN SERVICE ALL YOUR AMATEUR RADIO GEAR EFFICIENTLY AND AT A REASONABLE COST.

WHOLESALE, AGENTS, MANUFACTURERS AND RETAILERS CONSIDER US FOR YOUR QUEENSLAND SERVICE CONTRACTS, IN THE ENTHUSIAST AND COMMERCIAL ELECTRONICS MARKET.

CONTACT BRIAN BEAMISH, Manager

(07) 341 5377, AH: (07) 341 4767

Prices and Models are subject to change without prior notice

DSI

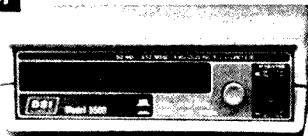

### MODEL 5500 50Hz-512 MHz FREQUENCY COUNTER

More Counter For Less Money

The outstanding sensitivity of the 5500, the result of its unique engineering design, and built-in preamp assures stable, accurate readings every time.

FEATURES:

- Two BNC Inputs
- 1 Meg and 50 Ohm Input
- Factory Wired and Tested in USA
- 8 Large Digits
- 1 PPM TCXO
- Resolution 1 Hz at 50 MHz
- Resolution 1 Hz at 450 MHz

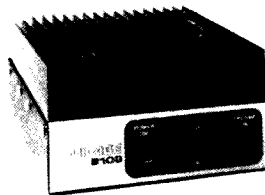

### MODEL BI08 2 METER AMPLIFIER

IOW (in) — 80 (out)

MIRAGE by name — Miracle by performance. A top quality amplifier with a 1 year warranty on RF Power Transistors and 5 years on all other parts and labour.

FEATURES:

- Built-in receiver preamp
- Adjustable delay for SSB
- Remote control operation with optional RC-1 control head
- Heat sink providing more than adequate cooling
- Automatic internal change over relay keyable from external transmitter

Also 160W versions available

6 METRE VERSION DUE MARCH/APRIL

SOLE ATN QUEENSLAND DISTRIBUTOR

**CW ELECTRONICS**

CNR. MARSHALL RD & CHAMBERLAND ST.,  
TARRAGINDI — BRISBANE PH (07) 48 6601  
PO BOX 274, SUNNYBANK, QLD. 4109  
AH: BRIAN (07) 341 4767

# OBSERVATIONS OF A BEGINNER IN AMATEUR RADIO

By Ernie V. Bigg G-16384  
(With acknowledgment to ISWL, England)  
Submitted by Eric Trebilcock L30042

Towards the end of March last year I retired at the age of 69 years as a Service Manager to the Motor Trade. I had delayed my retirement by some four years because I feared boredom through having no hobbies and a dislike for gardening.

Just before my retirement, however, one of my senior technicians collapsed and subsequently died from heart failure and it was my duty to contact his widow regarding affairs connected with the Company. During this contact I discovered that the deceased was a radio SWL and was invited to inspect his equipment, which consisted of a CR100, two speakers, numerous valves and magazines and a pair of headphones. Out of sympathy I elected to purchase all these and well remember carrying the CR100 down a narrow flight of stairs—weight 81 lbs. At this time my knowledge of SW radio was NIL.

Most amateurs are familiar with the CR100, but to me it was a large metal box with knobs and a queer kind of calibration—as I turned them, so stations came on the air and I logged the positions, and within a week had located some 100 stations which I could regularly tune in to—Luxembourg, Monaco, Paris, Melbourne, Dublin, and so on, but the mode marked CW and SSB was and remained until I sold it—a mystery. At this stage I became somewhat interested and a few listeners in the area advised me to sell the CR100 and buy a modern communication receiver. The first person to answer my advert tuned in on lower SS band and obtained clear sound from an amateur station in West Bromwich and settled for purchase on the spot—much to my regret following my advancing knowledge on the subject. About this time I spoke to G8CA of Axminster, who persuaded me to purchase a Yaesu FRG 7000, and this literally provided the "Open Door" and introduced me to the world of amateurs. Various books on the subject were now bought and I even searched the local library for information. After obtaining the RSGB Call Book I discovered that many close friends were operators.

Advice was accepted to join RSGB, International SW League and WDXC; these clubs are more than a must and no question remains unanswered by them. By now my amateur friends were informing me of all the intricacies of the profession—antennas, SS band limits, CW, favourite

times for listening. I was also advised to buy a Z Match for my antenna straight wire, 66 ft., 10 metres high—my experiments with added pieces of wire are amusing and sometimes they work. The FRG 7000 is excellent on all bands.

Recently I contacted the local education authority who are including a night study course for the "B" Certificate ARL Examination—if this is successful then I hope soon to speak to my friends on 2 metres—with the necessary equipment, of course. If the education authorities do NOT obtain enough support for a night study course then the Rapid Results College in London will be asked to accept me for tuition. At the time of writing this article only four weeks have passed, so progress is good and I am fulfilling a promise to ISWL NOT to be a sleeping member.

The following points of view are now recorded and I hope readers will accept them by remembering my lack of experience—at least I can give a newcomer's view.

- (a) The "Q" language—a lot to learn and remember, and I wonder if all of them are needed—although I suppose amateurs from another country need them to convey their meaning. Very often I wish they'd use plain English when they can speak English.
- (b) Too much importance seems to be attached to QSL cards and method to obtain them spoils listening. A few evenings ago I listened to the Falkland Islands and amateur stations were literally lining up to exchange necessary data for a card. It follows that instead of a description of the Island, its culture, family, etc., all that was heard each minute was a description of the transceiver, antenna and report—I was bored.
- (c) It is hard to believe that after all these years the phonetic alphabet is not universal.
- (d) I cannot understand the enormous interest there is in the tropical bands, where, except for the music, you must speak or understand at least three languages.
- (e) To me it is unbelievable to read of the progress made by amateurs since Hertz and Marconi started the ball rolling and discovered radio waves, etc.

- (f) My investigation shows that most licence holders are ex electrical trades, ex signals regts., ex radio and ships' operators, and makes me wonder whether I can ever reach a stage of proficiency to join their selective ranks. Electrons, protons, resistance, Ohm's Law, sine waves, Morse code—it seems a lot to digest at the moment and frightens me a little.
- (g) What a boon this amateur radio is, and source of satisfaction to the disabled, bedridden, retired persons, those who are lonely and/or living on their own—the amateurs have surely contributed well toward a solution to happiness for these types.
- (h) Whilst a strict code of conduct must be followed by licence holders for obvious reasons, I deplore criticisms I have heard of personalities, especially in the arena of politics.
- (i) I believe that all those who are privileged to join this band of clever and dedicated men and women should always try to contribute to it, by giving opinions, spreading new knowledge and, where possible, endeavouring to improve on technical matters and/or research. I hope to do some of this.
- (j) Why are female licence holders in such a minority?
- (k) The amateurs are a dedicated, skilled and professional body of people, helpful, kind, and the world of radio has much to thank them for; their ranks include Kings, professional men, artists, the sick and disabled, and the DIY expert, and I feel privileged and honoured to be part of them and to be called not a Radio Ham, but a DXer.

Finally, I conclude this article by expressing my own type of listening, and that is the 15 and 80 metre band—it's all talking for me and I am interested and very amused sometimes at the conversations I hear on them—good descriptions of the station environment—light protracted arguments, and skeds which you can set your clock to each evening and know you're in for some real pleasure. My FRG 7000 is worth every penny. ■

Join the IW net at 2300Z on Thursdays on 14165 kHz when you have intruder information.



**UKW-BERICHTE  
VHF-  
COMMUNICATIONS**

The magazine for amateurs interested in VHF and upwards:

- Quarterly — February, May, August and November.

1 year surface mail \$8.20  
1 year airmail \$12.40

Whenever in the year you subscribe you will receive that year's issues.

- Issue 3/1979 included:—

Meteosat reception and display system

13 cm doubler

9 cm SSB

3 cm dish radiator

2m 20W PA

Quadrature demodulators

Xtl circuit design

- Write now to:—

**WIA MAGPUBS**

BOX 150, TOORAK 3142

# AT LAST!

## THE TYPE 610 BRITISH POST OFFICE designed MORSE CODE KEY

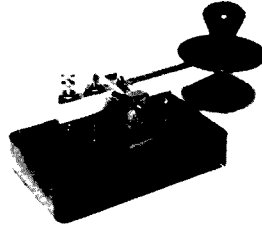

There has never been a better designed Morse Code Key — SOLID, ROBUST and BEAUTIFULLY BALANCED.

**\$27.50** (Post Paid)

"LEARNING THE MORSE CODE" — Cassette Album Training Course. You will progress rapidly using this modern training system.

**PRICE \$20** (Per Album of 3 Cassettes)

**WILLIAM WILLIS & Co. Pty. Ltd.**

77 CANTERBURY ROAD, CANTERBURY, VIC. 3218  
PHONE 836 0707

# IT'S HERE!



This is the latest Dick Smith 1980 Catalogue packed full of interesting items from boat radios to computers, from hi fi to components, from telephone diallers to heated toilet seats. It's all in this 104 page catalogue. Get yours NOW, supplied FREE with the April issues of Electronics Today International and Electronics Australia. If you have difficulty getting your catalogue send for it direct from our Mail Order Centre, price 75c.

Call in to one of our stores, or by Mail Order:  
**DICK SMITH ELECTRONICS**  
Mail Order Centre, PO Box 321 NORTH RYDE  
NSW 2113 Ph: (02) 888 3200



## HOW MUCH ELECTRICAL CURRENT CAN YOUR HEART TOLERATE?

Most of us don't usually think about it any more than we have to, but the typical amateur is exposed to several risks peculiar to his hobby. He or she may forget, once in a very great while, to shut off the house current before probing the innards of a transceiver. And because an amateur may very well be a middle-aged or older male, the ogre of coronary artery disaster can be lurking nearby.

Only 0.2 mA (AC) applied directly to the heart may cause a series of wild, irregular, ineffective movements. Instead of squeezing down rhythmically like a fist clenching and unclenching, the heart quivers like a bag of worms. Circulation stops. In about four minutes the cells of your brain and spinal cord begin to die because they are extremely sensitive to lack of oxygen normally carried in the blood. This unhappy state is the result of one form of cardiac arrest—ventricular fibrillation. 1 or 2 mA at 50 Hz can just be felt by the moistened finger. 16 mA causes pain and spasm, but at that level you can still let go if you want to. 100 mA is enough, if it passes through the heart en route from one hand to the other, to

create the same "bag of worms" problem as the 0.2 mA applied directly. Larger currents tend to stop the heart completely—no movement at all; not even the bumbling bag of worms. This complete lack of muscular contraction is called asystole. It is the other kind of cardiac arrest. Of course it, too, requires immediate treatment.

Alternating current is meaner than direct. Even in small doses it causes muscles to contract. When you are zapped by a suitable alternating current, your heart stops beating, your breathing stops and you can't let go! The muscle contraction holds you there while the current builds up to an evermore effective dose. If anyone else is around (you can't call them) to flip the switch and pull you free, your only help is that your wife forgot to pay the power bill. Just maybe they'll disconnect you in time. Electricity can damage your body in other ways too, causing selective damage along major blood vessels because of their high conductivity, electrothermal burns to skin and other areas of high resistance, and widely spread nerve defects caused by lack of

oxygen. However, these generally don't call for emergency treatment of the same urgency as cardiac arrest.

Very sedentary or arthritic hams may take some small comfort from this statistic (others be careful!): Falls kills about 17 times as many as do electric currents, and cardiac arrest may follow the complication of a bad fall. But the real "hit man" is artery disease. He carries off as many as 17 times the number resulting from falls and electricity combined.

Much dying is, tragically, not necessary. Death commonly occurs only after a period of cardiac arrest; and cardiac arrest could be treated effectively by millions of persons who don't realise how simple it is to learn. You can learn how to save some from death. You can learn in one evening.

Cardiopulmonary resuscitation (CPR) is a skill, just as learning to send code—only easier. It is a simple skill. Check with your local first aid group, ambulance or doctor.

—From QST and "The Lyrebird". ■

# MODIFICATIONS TO THE WESTON HF-1000 TRANSCEIVER

Gareth Davey VK2ANF  
29 Wyuna Rd., West Pymble 2073

The Weston HF-1000 is a 27 MHz AM 1-watt hand-held transceiver and is very similar to other brands, e.g. Midland, Contact. This article should be of particular interest to the Novice who may wish to convert such a unit to 28 MHz.

Because of the similarities between the Weston HF-1000 and some other brands, the details below may serve as a basic guide for conversion of several other models beside the Weston.

In a note which follows, information is provided regarding the availability of low-cost crystals for some channels in the 28 MHz band.

The work is based directly on personal experience with the set pictured, and therefore has been proven in practice. The four modifications are:

## MOD. 1 — EXTERNAL ANTENNA CONNECTOR

Operation of the transceiver will be possible on an antenna other than the in-built Telescopic Antenna (ROD ANT), and will also provide easier test equipment connection for maintenance and adjustments.

## MOD. 2 — NEGATIVE CHASSIS EARTH

The transceiver has NPN transistors in all RF stages, and PNP transistors in the audio and squelch circuits. The circuit board earth has been made positive. This modification will give a negative chassis earth so that operation will be possible (for example) in a negatively-earthed vehicle using external battery and antenna.

## MOD. 3 — BATTERY CHARGER CURRENT LIMIT

Damage due to excess current can be caused to rechargeable batteries (where fitted) by chargers having no current limiting resistors, as is common practice with many commercially available units. This modification will reduce the current to the recommended level when this type of charger is used.

## MOD. 4 — TRANSCEIVER OPERATION ON THE 10 METRE (28 MHz) AMATEUR BAND

While the unit will operate on 28 MHz without retuning from 27 MHz, there is some degradation in performance. Some component changes and realignment are required to restore normal operation.

## COMPONENTS REQUIRED

Mod. 1 — 1 x BNC bulkhead receptacle, type UG-1094/U or similar.

Mod. 2 — 2 x insulating washers, as used on TO3 transistor packages. 1 x 0.01  $\mu$ F ceramic capacitor.

Mod. 3 — 1 x 47 ohm  $\frac{1}{2}$  watt resistor. 1 x 1N4004 diode or similar.

Mod. 4 — 1 x 18 pF ceramic capacitor. 2 x 39 pF ceramic capacitors.

## MODIFICATION NOTES

All four modifications as outlined above should be performed at the same time. The following procedures have been organised with this in mind.

Some components identified in capital letters refer to the designations on the Schematic Diagram supplied with the transceiver.

Standard printed circuit board techniques should be used: temperature-controlled fine-pointed soldering iron, fine solder, and note that too much heat will lift the PCB tracks.

It is important to use non-metallic tools in the alignment procedure to prevent detuning and breaking ferrite slugs. The following test equipment is required: RF Signal Generator, AF Voltmeter, RF Dummy Load and Power Meter, Field Strength Meter. This is standard equip-

ment for any HF transmitter/receiver alignment, but for those without access to such gear, alternative tuning methods have been given.

## MODIFICATION PROCEDURE

1. Undo screws A and B and remove the Printed Circuit Board (PSB) from the chassis (see Photo 1).

## EXTERNAL ANTENNA CONNECTOR

2. Mark the transceiver cabinet for the BNC socket in line with the other holes on the side panel. Position it midway between the CHG jack bracket and the top of the battery compartment, so that the BNC retaining nut will not interfere with either.
3. Drill the hole in the side panel carefully. To avoid damaging the PCB, crystals and slugs, etc., keep the PCB away from the cabinet during drilling. Brush away all metal residue.
4. Mount the BNC connector and securely tighten the retaining nut.
5. Solder a wire from the centre terminal of the BNC connector to the Antenna Loading Coil terminal (LD-C) connected to TP-1. See Circuit 1 and Photo 2. This wire must not go to the ROD ANT side of LD-C.

## NEGATIVE CHASSIS EARTH

6. Unscrew the 2 PCB stand-offs from the inside of the case (see Photo 3).
7. Remove the spacers on the bottom of both PCB stand-offs.
8. Screw both PCB stand-offs back inside the case without their spacers.
9. Very carefully drill out the 2 Board mounting holes on the PCB so that the insulating sleeves on the TO3 washers will just fit through. See Photo 2.
10. Place the TO3 insulating washers over the Board mounting holes on the copper side of the PCB, with the insulating sleeves through the holes towards the component's side.
11. Unsolder the wire between the PTT switch (S1-A changeover contact)

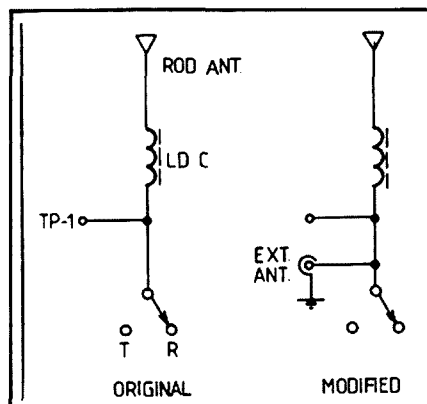

FIG. 1: Schematic Diagram. Refer to MOD. 1 and Photo 2 — External Antenna Connector.

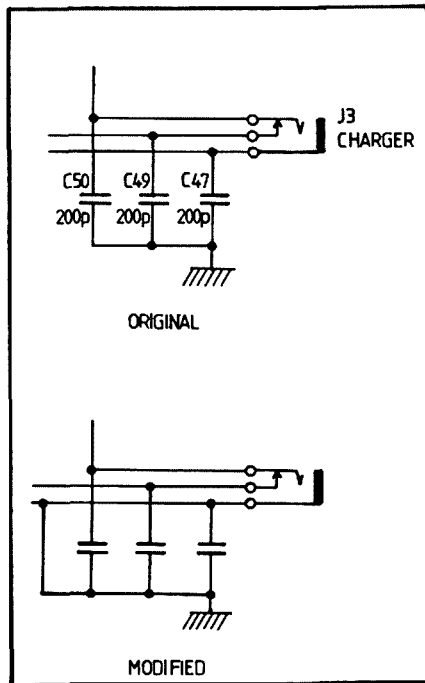
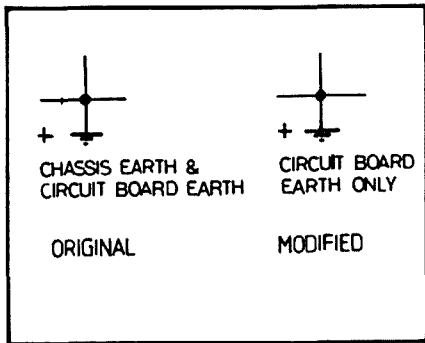
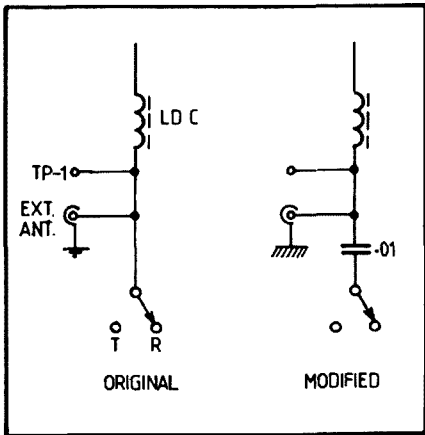

FIG. 2: Schematic Diagrams. Refer to MOD. 2 and Photo 2 — Negative Chassis Earth.

and the Antenna Loading Coil (LD-C). Replace the wire with a 0.01 uF ceramic capacitor (insulate the leads with spaghetti). See Circuit 2 and Photo 2.

- Connect a wire from the negative terminal on the CHG jack to some part of the chassis where good electrical contact can be made, e.g. the body of the BNC receptacle—you may have to lightly file part of the chamber so that the solder will take. See Photo 2.  
Note: For floating DC, not negative, chassis earth, insert a 0.01 uF ceramic capacitor in series with the wire in Step 12.

#### BATTERY CHARGER CURRENT LIMIT

- Solder the leads of a 1N4004 diode on to the leads of a 47 ohm ½ watt resistor, so that the diode and resistor are in parallel.
- Unsolder the wire connecting the centre terminal of the AC jack to the unswitched contact of the CHG jack.
- Solder the diode/resistor combination in place of the wire removed in Step 14, with the diode anode (A) connected to the centre terminal of the AC jack. The diode cathode (K) must connect to the unswitched contact of the CHG jack. See Circuit 3 and Photo 2.

#### TRANSCIEVER OPERATION ON THE 10 METRE (28 MHz) AMATEUR BAND

- Remove capacitor C20 (40 pF) in the Rx Oscillator, and replace with a 39 pF ceramic capacitor.
- Remove capacitor C29 (20 pF) in the Tx Oscillator, and replace with an 18 pF ceramic capacitor.
- Remove capacitor C27 (40 pF) in the Tx PA Stage, and replace with a 39 pF ceramic capacitor.
- Insert the 28 MHz channel crystals in the appropriate sockets. See Photo 1.

#### RE-ASSEMBLY

- Remount the PCB on the 2 stand-offs. Ensure that the TO3 insulating washers are in position so that the copper tracks on the PCB around the Board mounting holes are insulated from the metal stand-offs.

- Secure the PCB with screws A and B (see Photo 1).

#### DC TESTS

- With the battery pack connected, switch the transceiver on and increase the volume control to maximum. If no sound is heard from the speaker, a fault may exist in the Battery Charger Current Limit wiring — recheck Steps 13 to 15.

#### Rx TESTS

- Connect an RF signal generator capable of a stable output on 28 MHz to the BNC External Antenna socket. If a generator is not available extend the inbuilt Telescopic Antenna (ROD ANT) and use a signal off air from another transmitter on the same channel.
- Set the RF signal generator to the channel frequency on 28 MHz, as de-

termined by the Rx crystal frequency plus the IF frequency. This should equal the Tx crystal frequency.

- Modulate the output signal of the RF signal generator with a constant-amplitude audio frequency tone; for example: 85 per cent modulation by a 1 kHz tone.
- Adjust the 28 MHz output signal level from the RF signal generator until it can be heard weakly from the transceiver's speaker. The volume control should be at setting 10 (maximum output).\*

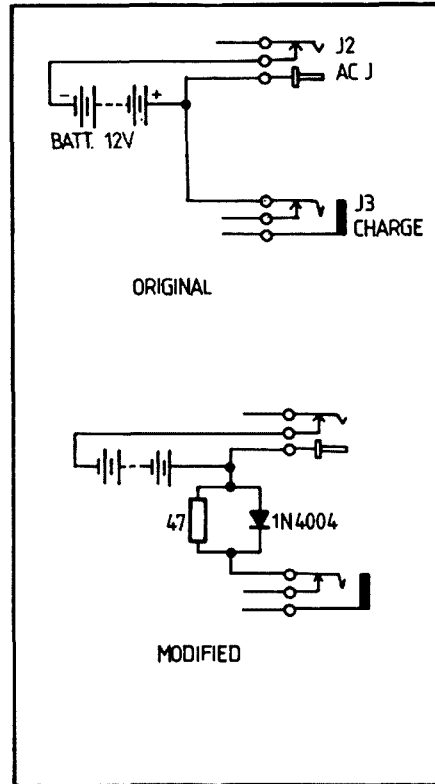
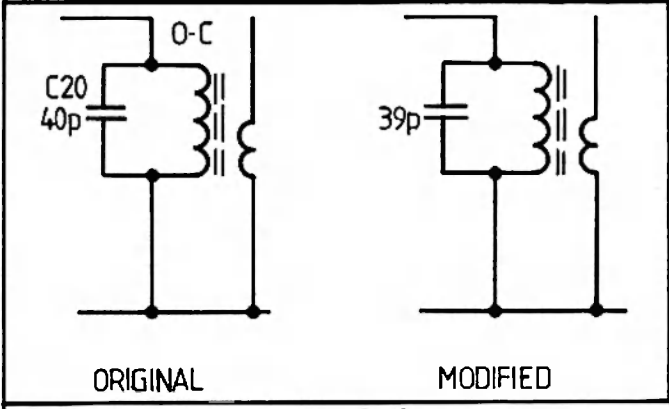

FIG. 3: Schematic Diagram. Refer to MOD. 3 and Photo 2 — Battery Charger Current Limit.

- Plug an audio (AC) voltmeter into the EAR jack on the transceiver. A multi-meter on its lowest AC scale may be suitable. With the RF signal generator set as per Steps 24 to 27, a reading should be apparent on the audio voltmeter; if not, a more sensitive meter will have to be used. (Tuning by ear is not recommended, but is possible if nothing else is available.)

- Adjust Rx Oscillator Coil O-C for maximum received signal, as indicated on the audio voltmeter. The 28 MHz output signal level from the RF signal generator may have to be reduced during the adjustment to prevent AGC action in the receiver affecting the increase in audio output level.

\* If no signal can be heard after tun-



Receiver Oscillator Section.

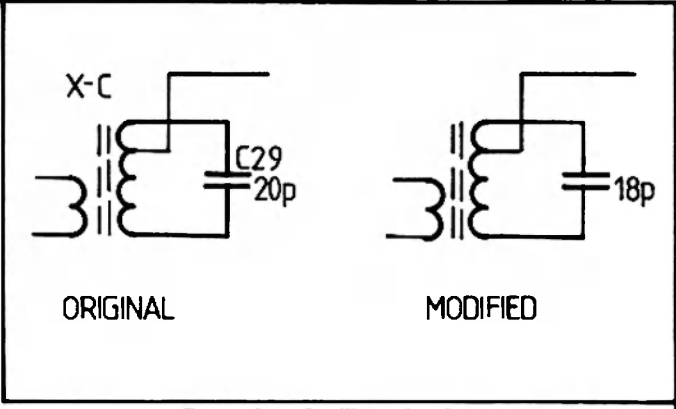

Transmitter Oscillator Section.

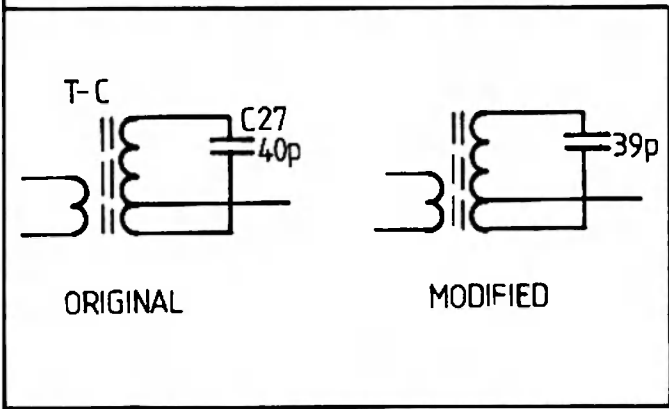

Transmitter PA Section.

FIG. 4: Schematic Diagrams. Refer to MOD. 4 and Photo 1 — 10m 28 MHz Amateur Band Operation.

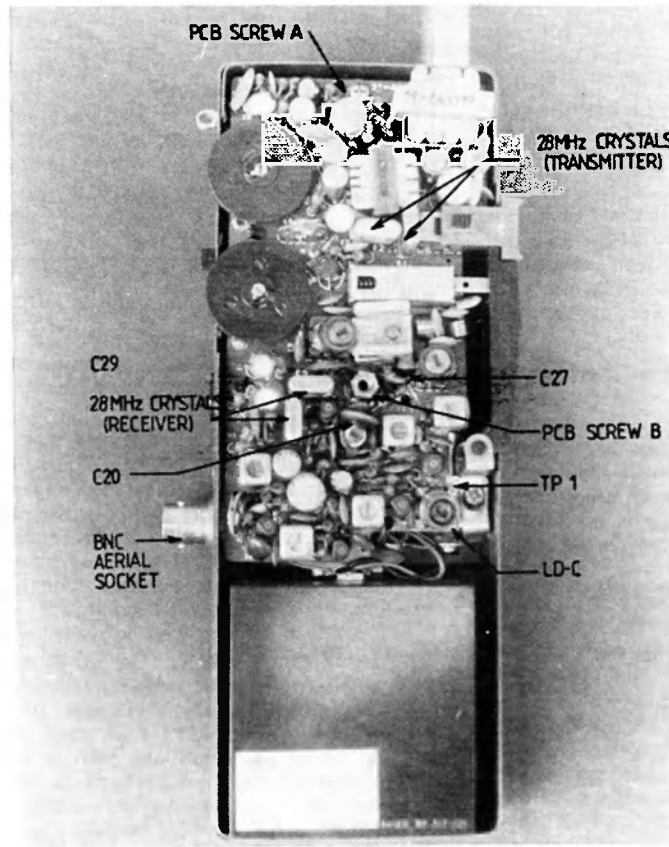

PHOTO 1

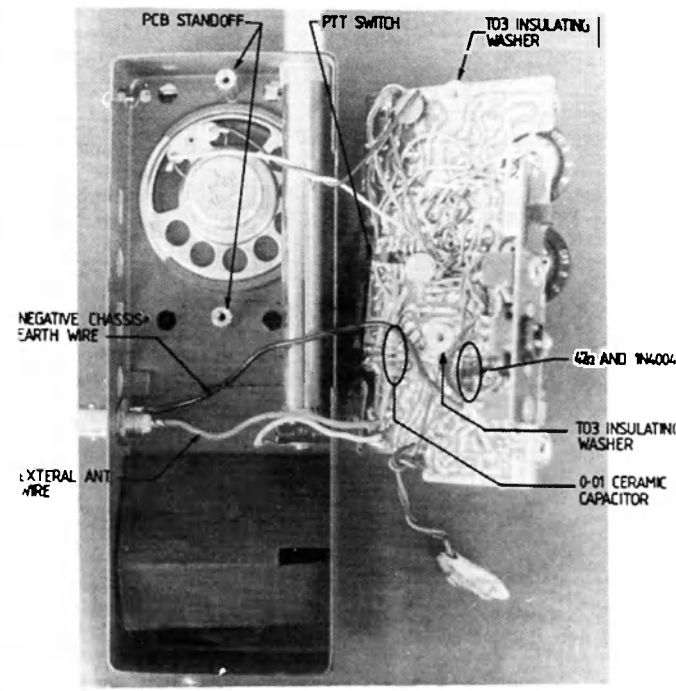

PHOTO 2

ing O-C, a fault may exist in capacitor C20 in the Rx Oscillator — check Step 16.

29. Unplug the audio voltmeter from the EAR jack. Adjust the 28 MHz output signal level from the RF signal generator until it can be heard weakly from the transceiver's speaker. Plug the audio voltmeter into the EAR jack.
30. Adjust Rx front end coil A-C for maximum received signal, as indicated on the audio voltmeter. The 28 MHz output signal level from the RF signal generator may have to be reduced during the adjustment to prevent AGC action in the receiver affecting the increase in audio output level.
31. Perform Steps 26 to 30 again to finely adjust the Rx tuning. Where 2 channels are fitted, change the CHANNEL SELECTOR and the RF signal generator frequency during Steps 28 and 30, and adjust O-C and A-C for equal received signal on both channels.
32. Once the Rx tests have been performed successfully, disconnect the RF signal generator and the audio voltmeter.

#### Tx TESTS

33. Connect an RF Power Meter and a 50 ohm RF Dummy Load to the BNC External Antenna socket. Fully retract the inbuilt Telescopic Antenna (ROD ANT).
34. Operate the PTT switch on the transceiver, and hold in for short periods only during Steps 35 to 37.
35. Adjust Tx Oscillator coil X-C for maximum power output, as indicated on the RF Power Meter.\*
36. Adjust Tx PA coil T-C for maximum power output, as indicated on the RF Power Meter.

\* If no power output is indicated on the RF Power Meter after tuning X-C and T-C, a fault may exist in capacitors C27 or C29 in the Tx circuit — check Steps 17 and 18.

37. Finely adjust X-C and T-C for maximum power output. Where 2 channels are fitted, change the CHANNEL SELECTOR and adjust X-C and T-C for equal power outputs on both channels.
38. Release the PTT switch on the transceiver, and disconnect the RF Power Meter and the 50 ohm RF Dummy Load from the BNC socket.
39. Fully extend the inbuilt Telescopic Antenna (ROD ANT).
40. Operate the PTT switch on the transceiver, and hold in for short periods only during Step 41.
41. Using a Field Strength Meter located nearby, adjust the Antenna Loading Coil LD-C for maximum indication on the Field Strength Meter. Where 2 channels are fitted, change the CHANNEL SELECTOR and adjust

LD-C for equal indication on both channels.

If a Field Strength Meter is not available, the S-meter on a nearby transceiver can be used, provided that it is operated in the lowest part of the S-meter scale where the greatest sensitivity usually exists.

42. Release the PTT switch on the transceiver.
43. Replace the back cover on the cabinet. The unit is now ready for normal 28 MHz operation.

#### A NOTE ON 28 MHz CHANNEL CRYSTALS

In modifying 27 MHz transceivers to 28 MHz, the availability of suitable crystals has always been an expensive proposition. However, depending on the frequency required, 28 MHz channel crystals for AM hand-held transceivers can be cheaply obtained either new or second-hand.

#### Rx CRYSTALS

A good source of 28 MHz Rx crystals is from the 27 MHz Marine Band. These are readily and cheaply available on the following frequencies: 27.880 MHz (most popular), 27.890 MHz, 27.900 MHz and 27.910 MHz.

When these are plugged into the Rx oscillator of a hand-held transceiver having a 455 kHz IF, it will be able to receive the following frequencies: 28.335 MHz, 28.345 MHz, 28.355 MHz and 28.365 MHz respectively.

#### Tx CRYSTALS

The receiver can be readily accommodated for 28 MHz crystals, but it would appear that the transmitter is somewhat more difficult.

One of the more popular distributors of electronic components has had specially made 27 MHz Marine Band crystals, which he calls "HI-SIDE" crystals. For Marine Band users, these are used in their Rx oscillator and are on frequencies above the signal frequency (on the high side), not below the signal frequency as is usually the case.

The intention of this was to change the receiver's image frequency from the CB portion of 27 MHz up to the amateur portion of 28 MHz — strange logic when you compare the power levels normally used on 27 MHz and 28 MHz, but we can use these Hi-Side crystals to our advantage.

Hi-Side crystals are available on the following frequencies: 28.335 MHz, 28.345 MHz, 28.355 MHz and 28.365 MHz. Conveniently, and not by accident, these match the Rx crystals as indicated previously, and thus give the necessary transmit capability.

#### RESULTANT 28 MHz CHANNEL FREQUENCIES

Rx crystal: 27.880 MHz, 27.890 MHz, 27.900 MHz, 27.910 MHz. Tx crystal: 28.335 MHz, 28.345 MHz, 28.355 MHz, 28.365 MHz.

Since 27.880 MHz crystals are the most popular and readily available, it is suggested that 28.335 MHz become a net frequency for 10 metre AM hand-held transceivers. Several stations in Sydney are already fitted with this frequency. ■

## QSP

#### USA BAND SEGMENTS ON HF BANDS

January 1980 QST lists the following for stated modes (max. stated for Extra level) (in parenthesis are others).

kHz	Mode
1800-1810	CW, DX calling
1825-1830	DX window (no W/VEs)
3500-3775	A1 and F1
3610-3630	RTTY
3845	SSTV
3775-4000	A1 and Voice
7000-7150	A1 and F1
7090-7100	RTTY
7150-7300	A1 and Voice
14000-14200	A1 and F1
14080-14100	RTTY
14200-14350	A1 and Voice
(14210	Int. NBVM calling)
14230	SSTV
21000-21250	A1 and F1
21090-21100	RTTY
21090-21.100	RTTY
21250-21450	A1 and Voice
28000-28500	A1 and F1
28090-28100	RTTY
28500-29700	A1 and Voice
28680	SSTV
28300-29500	Satellite downlinks
29520-29580	Repeater inputs
29600-	FM simplex
29620-29680	Repeater outputs
(50.50.1 MHz	A1 and F1
50.1-54.0	A1 and Voice
144-144.1	A1 and F1
144.1-148.0	A1 and Voice)

The low end of the US phone segment is reserved for DX, the high end for traffic — 14 MHz band especially — no definite dividing lines. SSTV is limited to the low ends of the phone segments except for 28 MHz band upwards, where it is the same as the phone segments. The bandwidth for F3 below 29.0 MHz and between 50.1 and 52.5 MHz shall not exceed that of an A3 emission having the same audio characteristics. Below 50 MHz the bandwidth of an A5 or F5 shall not exceed that of an A3 single sideband emission. From 50 to 225 MHz single or double sideband A5 may be used but the bandwidth shall not exceed that of an A3 single or double sideband respectively. For F5 the bandwidth shall not exceed that of an A3 single sideband emission. ■

#### CONTROL OVER AR Tx

According to Worldradio November 1979 the USA's FCC denied petitions requesting the FCC to institute a rule-making proceeding to limit the sale of amateur transmitting equipment to licensed amateur operators. One petitioner suggested point of sale control by registration procedures. One reason given for the refusal was, it is said, the lack of FCC staff and funds to enforce such an operation. Another note was that the form of record-keeping caused a proliferation of paper work which was undesirable because of the low cost effectiveness of the proposals. Also the FCC is stated to have doubts about effectiveness and difficulty in implementing such a programme due to the large number of radio equipment dealers. Meantime the FCC would continue to evaluate the problem and study the effectiveness of the type acceptance programme adopted in Docket 21117 (refers to external RF power amplifier operating below 144 MHz). ■

#### JOTA

A reminder for your diary. 1980 JOTA will be 18th-19th October, 1980. ■

# THE SEVERITY OF AN EARTHQUAKE

The severity of an earthquake can be expressed in terms of both intensity and magnitude. However, the two terms are quite different, and they are often confused by the public.

Intensity is based on the observed effects of ground shaking on people, buildings, and natural features. It varies from place to place within the disturbed region depending on the location of the observer with respect to the earthquake epicentre.

Magnitude is related to the amount of seismic energy released at the hypocentre of the earthquake. It is based on the amplitude of the earthquake waves recorded on instruments which have a common calibration. The magnitude of an earthquake is thus represented by a single, instrumentally determined value.

Earthquakes are the result of forces (deep within the Earth's interior) that continuously affect the surface of the Earth. The energy from these forces is stored in a variety of ways within the rocks. When this energy is released suddenly, for example by shearing movements along faults in the crust of the Earth, an earthquake results. The area of the fault where the sudden rupture takes place is called the focus or hypocentre of the earthquake. The point on the Earth's surface directly above the focus is called the epicentre of the earthquake.

## THE RICHTER MAGNITUDE SCALE

Seismic waves are the vibrations from earthquakes that travel through the Earth; they are recorded on instruments called seismographs. Seismographs record a zig-zag trace that shows the varying amplitude of ground oscillations beneath the instrument. Sensitive seismographs, which greatly magnify these ground motions, can detect strong earthquakes from sources anywhere in the world. The time, location, and magnitude of an earthquake can be determined from the data recorded by seismograph stations.

The Richter magnitude scale was developed in 1935 by Charles F. Richter of the California Institute of Technology as a mathematical device to compare the size of earthquakes. The magnitude of an earthquake is determined from the logarithm of the amplitude of waves recorded by seismographs. Adjustments are included in the magnitude formula to compensate for the variation in the distance between the various seismographs and the epicentre of the earthquakes. On the Richter Scale, magnitude is expressed in whole numbers and decimal fractions. For example, a magnitude of 5.3 might be computed for a moderate earthquake, and

a strong earthquake might be rated as magnitude 6.3. Because of the logarithmic basis of the scale, each whole number increase in magnitude represents a ten-fold increase in measured amplitude; as an estimate of energy, each whole number step in the magnitude scale corresponds to the release of about 31 times more energy than the amount associated with the preceding whole number value.

At first, the Richter Scale could be applied only to the records from instruments of identical manufacture. Now, instruments are carefully calibrated with respect to each other. Thus, magnitude can be computed from the record of any calibrated seismograph.

Earthquakes with magnitude of about 2.0 or less are usually called micro-earthquakes; they are not commonly felt by people and are generally recorded only on local seismographs. Events with magnitudes of about 4.5 or greater—there are several thousand such shocks annually—are strong enough to be recorded by sensitive seismographs all over the world. Great earthquakes, such as the 1906 San Francisco earthquake and the 1964 Good Friday earthquake in Alaska, have magnitudes of 8.0 or higher. On the average, one earthquake of such size occurs somewhere in the world each year. Although the Richter Scale has no upper limit, the largest known shocks have had magnitudes in the 8.8 to 8.9 range.

The Richter Scale is not used to express damage. An earthquake in a densely populated area which results in many deaths and considerable damage may have the same magnitude as a shock in a remote area that does nothing more than frighten the wildlife. Large-magnitude earthquakes that occur beneath the oceans may not even be felt by humans.

## THE MODIFIED MERCALLI INTENSITY SCALE

The effect of an earthquake on the Earth's surface is called the intensity. The intensity scale consists of a series of certain key responses such as people awakening, movement of furniture, damage to chimneys, and finally—total destruction. Although numerous intensity scales have been developed over the last several hundred years to evaluate the effects of earthquakes, the one currently used is the Modified Mercalli (MM) Intensity Scale. It was developed in 1931 by the American seismologists Harry Wood and Frank Neumann. This scale, composed of 12 increasing levels of intensity that range from imperceptible shaking to catastrophic destruction, is designated by Roman

numerals. It does not have a mathematical basis; instead it is an arbitrary ranking based on observed effects.

The Modified Mercalli Intensity value assigned to a specific site after an earthquake has a more meaningful measure of severity to the non-scientist than the magnitude because intensity refers to the effects actually experienced at that place. After the occurrence of widely-felt earthquakes, questionnaires are sent into the disturbed area requesting the information so that intensity values can be assigned. The results of this canvass and information furnished by other sources are used to assign an intensity value, and to compile isoseismal maps that show the extent of various levels of intensity within the felt area. The maximum observed intensity generally occurs near the epicentre.

The following is an abbreviated description of the 12 levels of intensity.

- I. Not felt except by a very few under especially favourable conditions.
- II. Felt only by a few persons at rest, especially on upper floors of buildings. Delicately suspended objects may swing.
- III. Felt quite noticeably by persons indoors, especially on upper floors of buildings. Many people do not recognize it as an earthquake. Standing motor cars may rock slightly. Vibration similar to the passing of a truck. Duration estimated.
- IV. Felt indoors by many, outdoors by few during the day. At night, some awakened. Dishes, windows, doors disturbed; walls make cracking sound. Sensation like heavy truck striking building. Standing motor cars rocked noticeably.
- V. Felt by nearly everyone; many awakened. Some dishes, windows broken. Unstable objects overturned. Pendulum clocks may stop.
- VI. Felt by all, many frightened. Some heavy furniture moved; a few instances of fallen plaster. Damage slight.
- VII. Damage negligible in buildings of good design and construction; slight to moderate in well-built ordinary structures; considerable damage in poorly built or badly designed structures; some chimneys broken.
- VIII. Damage slight in specially designed structures; considerable damage in ordinary substantial buildings with partial collapse. Damage great in poorly built structures. Fall of



chimneys, factory stacks, columns, monuments, walls. Heavy furniture overturned.

- IX. Damage considerable in specially designed structures; well-designed frame structures thrown out of plumb. Damage great in substantial buildings, with partial collapse. Buildings shifted off foundations.
- X. Some well-built wooden structures destroyed; most masonry and frame

structures destroyed with foundations. Rails bent.

- XI. Few, if any (masonry) structures remain standing. Bridges destroyed. Rails bent greatly.
- XII. Damage total. Lines of sight and level are distorted. Objects thrown into the air.

Another measure of the relative strength of an earthquake is the size of the area over which the shaking is noticed. This

measure has been particularly useful in estimating the relative severity of historic shocks that were not recorded by seismographs or did not occur in populated areas. The extent of the associated felt areas indicates that some comparatively large earthquakes have occurred in the past in places not considered by the general public to be regions of major earthquake activity.

Reprinted from International Civil Defence, October 1979. ■

## SPOTLIGHT ON SWL-ING

Mark Stephenson VK3NOY/L30848

This month we start a new column for AR, and in forthcoming issues Short Wave Listeners will have the chance to introduce themselves to other readers and offer hints and advice for those interested in the art of Short Wave Listening.



Although a keen breeder of Border Collies, Mr. A. J. Harrison L30698 also finds time to send many QSLs to unwary amateur and broadcast stations. The main station receiver is an FRG-7 with digital readout and two 2.4 K/c filters in series for SSB. The receiver has been greatly improved through modifications performed

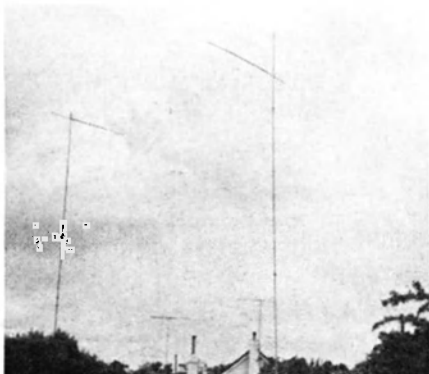

The antenna system in use.

after reading past copies of Amateur Radio. (See December 1977 Amateur Radio, page 22.)

Country count at the moment is 200 confirmed with over 2000 cards sent. The antenna system is a dipole mainly used on 20 metres coincidentally 20 metres above the ground. ■

### “SHORT” POEM

In the little old township of Kenwood,  
Way out beyond Anode Bend,  
There's the grave of an Amateur Full Call  
Who lies earthed at his positive end.  
Let us give him his due in all fairness —  
He was good with the key; he had brains;  
But he once was a little too careless  
When connecting his rig to the mains.  
There's a moral in this little story —  
A moral a novice could see;  
If you don't want short-circuits to Glory  
Don't monkey about with HT

Anonymous: Submitted by P. D. Thomas  
VK5ZPT. ■

### ‘AMATEUR RADIO’ — 1980

I've got a new transceiver  
It's synthesised of course,  
It sends all modes and RTTY  
And generates the Morse.

It's got a micro in it  
Which calls and logs them too.  
It prints the QSL cards,  
There's nothing left to do.

And so I'll lock the shack up  
And let it have a ball.  
And I'll go weed the garden.  
IT WON'T NEED ME AT ALL!

Roy VK3AOH ■

### QSP

#### WPX

Seems to be a peculiar abbreviation. It is the CQ Magazine's Worked All Prefixes Award and currently for mixed CW/Phone the top listing goes to W4WV with 1805 different prefixes confirmed. No VK is listed. Another of CQ's awards is WAZ — worked all zones (40). ■

#### QSL MANAGERS

At the January 1980 meeting of the VK5 Division the President announced the “retirement” of George Luxon VK5RX from the position of Divisional QSL Manager after a term of 50 years. Is this a world record? Another long-time QSL Manager was Ray Jones VK3RJ. He retired last year as Federal QSL Manager after a total of 50 years in the QSL post for VK3 and then Federal. ■

#### PREFIXES

According to October 1979 Ham Radio the ITU has allocated prefixes Y2-Y9 to the East German Republic. Under the new call sign system DM2AAO would become Y2IAO, while DM2CAO would become Y2IAO. Club stations will become Y3 (Y31AA for example) and contest teams will hold call signs within the block Y31A-Y39Z. ■

#### AMATEUR RADIO PHILATELISTS

The Radio Amateurs' column in the December 1979 issue of the Telecommunication Journal reviews the postage stamps issued to honour amateur radio. The first was the USA 5 cent postage stamp issued in 1965 on the occasion of the 50th anniversary of the ARRL. The second was an 0.85d stamp in 1966 by Yugoslavia to mark the 20th anniversary of SRJ. Colombia issued a 60 peso stamp in 1973 to mark the 40th anniversary of the LCD. Also in 1973 the USSR issued a 4k stamp paying homage to Ernst Krenkel, a prominent amateur. Poland issued a 1.50z stamp in 1975 for the IARU Conference in Warsaw that year. In the same Year Costa Rica issued three separate air-mail stamps of 1.00, 1.10 and 2.00c values to recognise the 16th annual meeting of FRACAP. In 1977 the Dominican Republic issued two stamps of 6c and 12c for the 50th anniversary of RCD. Brazil issued a 1.30 Cr dollar stamp carrying the words “Day of the Radio Amateur” and Japan issued a 50y stamp commemorating the 50th anniversary of JARL. In 1979 the Dominican Republic issued a 10c stamp relating to the Beata Is. amateur competition, Bolivia issued a 3p stamp carrying the insignia of RCB, West Germany a 60p stamp honouring WARC 79 and finally Switzerland issued a 70c stamp for the 50th anniversary of USKA. Article by Vic Clark W4KFC. ■

#### PRIORITIES

“The Amateur Radio priority comes so far down the list it is practically invisible.” Comment by an FCC District Officer in California about illegal interference on the amateur bands as reported in Worldradio News February 1980. Another comment about getting attention was the old saying “The barking dog gets the biscuit”. ■

**HELP** WITH INTRUDER  
WATCHING

# PICK OF THE PICS FROM VK6

During the latter part of 1979 the West Australian Repeater Group ran a raffle to acquire funds for a wind generator/tower combination to be used at a more suitable location for the existing Channel 4 Repeater.

We would like to thank all those who participated, especially the Amateurs from the Eastern States of Australia. The results are as follows:—

First prize was won by Harry Stephens VK6ZZ who is shown in photo 1 with the Icom IC22S which was donated by WILLIS ELECTRONICS and presented by Adrian Kelly, the Director. Adrian is shown in photo 2 presenting the unit to Harry.

Gregor Cox VK3ZCG of ZCG ANTENNAE, Lindenow Victoria (via Alyn VK6ZGA) donated a 5/8 2m antenna with base and coax which now proudly resides on the roof of the VK6FC mobile owned by Chris Carter, the winner of the second prize.

The West Australian Repeater Group donated three years subscription to the group as third prize. This was won by Jack Cowles VK6EJ of Geraldton.

Photo 3 shows (from left to right) — Trevor Solomon VK6ZCB, the President of the WARG, Adrian Kelly of WILLIS ELECTRONICS, Harry Stephens VK6ZZ happily clutching his first prize, Gill Weaver VK6YL, Secretary of the group and Alyn Maschette VK6ZGA, a member of the group who worked very hard to make the raffle a success.

The members of the WA Repeater Group would like to thank WILLIS ELECTRONICS of 993 Hay Street, Perth, for their generous donation of the IC22S which made the selling of the 500 tickets a very easy task. We would also like to extend our appreciation to Frank Taylor VK6JK for taking the presentation photographs at the January meeting of the Wireless Institute of Australia WA Division. ■



PHOTO 3



PHOTO 1



PHOTO 2



## THE WIRELESS HILL MUSEUM — FOR OLD-TIMERS AND NEW

Wireless Hill Photos by John Kitchen VK6TU

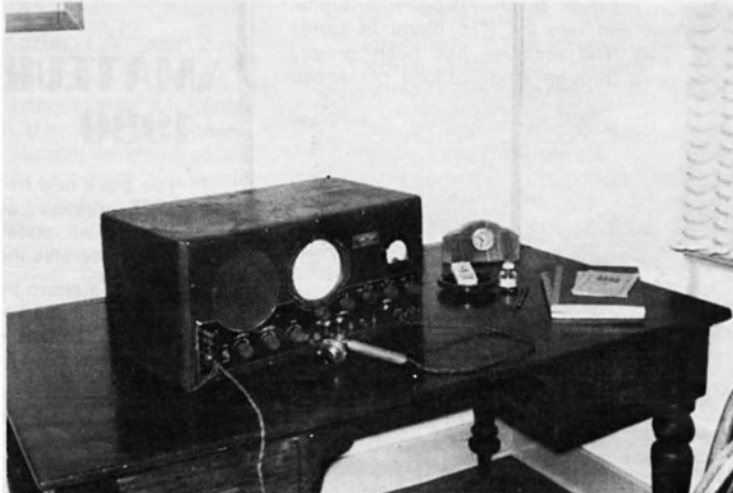

PHOTO 8



Ship's Emergency Transmitter

PHOTO 4

PHOTO 5

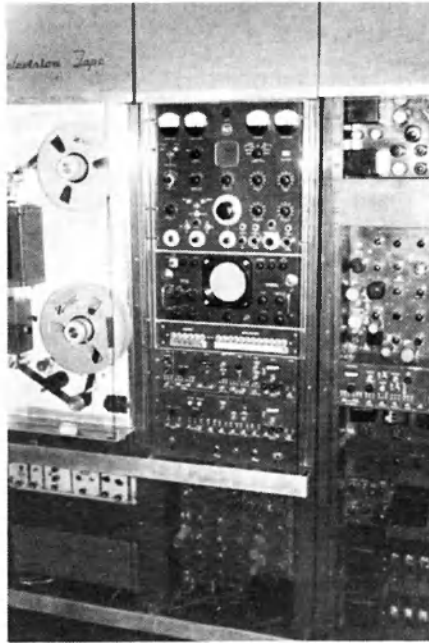

PHOTO 7

The Wireless Hill Museum is situated on a large hill (of course!) in the Perth suburb of Melville. The antique and younger pieces of equipment were originally collected by the West Australian VHF Group but now are maintained and exhibited by the Melville City Council. The museum is open on Saturdays and Sundays from 2-5 p.m., and admission is only 40 cents — a small price to pay to ensure the history of amateur and commercial radio is there for all to see.

PHOTO 10



PHOTO 9

PHOTO 4: AWA 250W Spark Tx.

PHOTO 5: Collins ART 3 Tx.

PHOTO 6: Transcription Turntable and Rounder Disc.

PHOTO 7: Television Tape Recorder TCA-TRT-18.

PHOTO 8: Traeger Pedal Transceiver.

PHOTO 9: Colour Camera Marconi Mk. VII and Monochrome Marconi 1957.

PHOTO 10: Cyril VK6CR on right receives the Amateur of the Year Trophy and Certificate from Ross VK6DA, VK6 Divisional President, at a recent WA Institute Meeting.

PHOTO 6



# NOVICE NOTES

## PEAK ENVELOPE POWER MEASUREMENTS

The measurement of Peak Envelope Power (PEP) of an HF radio transmitter is made as follows:—

1. Connect the transmitter to a monitorscope. Connect the monitorscope to a 50 ohm dummy load. Either measure the RF current into the dummy load with an accurate RF ammeter or measure the voltage developed across the dummy load with a VTVM having an RF probe.

The best way of measuring RF voltage if a VTM is not available is to build the RF probe described in ARRL Handbook, 1974, page 535 and feed it into a Digital Voltmeter having an input impedance of 10 megohms. It will then read accurate RMS volts. In the absence of a monitorscope, a conventional oscilloscope can be used if the pick-up and tuning units described in ARRL 1974, page 399, are built.

2. Tune and load the transmitter.
3. Feed a two tone test signal (two non-harmonically related audio sine waves, typically 1300 Hz and 2300 Hz) into the microphone socket of the transmitter. Adjust the two tone signal level so that, with the microphone gain control in its usual position, the transmitter indicates its allowable continuous cathode current.
4. Adjust the monitorscope for a stationary trace. Adjust the microphone gain until flat topping is observed just to commence. Read the RF ammeter or voltmeter and calculate RMS power from:

$$W = I^2R \text{ or } W = E^2/R \\ \text{where } R = 50 \text{ ohms}$$

Then peak envelope power is given by  $2 \times W$ .

Note the amplitude of the trace on the monitorscope graticule.

Disconnect the two tone generator and re-connect the microphone. Speak. Adjust the microphone gain so that the peaks of the speech envelope do not exceed the amplitude of the two tone trace noted in (3). The peak envelope power will then equal  $2 \times W$  and the transmitter will be saturated on speech peaks without flat-topping on splatting.

Watch the monitorscope constantly while transmitting.

5. Alternatively, where the facility exists to exceed the maximum legal power, proceed as follows. With the two tone generator connected, advance the microphone gain until the RMS power

given by  $I^2R$  or  $E^2/R$  is 200 watts, (i.e.: 2 amps or 100 volt, 50 ohms). Note the amplitude of the two tone trace on the monitorscope. This amplitude should not be exceeded on speech peaks as it corresponds to 400 watts PEP output.

6. If the SWR of the aerial is less than 2:1, the input impedance is in the range 25-100 ohms. If it is 100 ohms, the voltage developed and hence the monitorscope trace will be doubled in amplitude. Decreasing the microphone gain to restore the trace to the same level as on the dummy load will ensure PEP is within the legal limit. If the aerial input impedance is 25 ohms, the possibility exists of emitting twice the legal maximum PEP when the speech envelope peaks are at the correct level on the monitorscope.

For this reason, it is advisable to use an ATU if necessary to ensure the SWR seen by the transmitter is close to 1:1. Clearly the ATU should be connected downstream of the monitorscope.

*Reproduced from a WIA Division Education Bulletin.*

### REFERENCES:

The Radio Amateurs' Handbook, ARRL 1974, chapters 13 and 17.

Test Equipment for Radio Amateurs, Gibson.

The Amateur Operators' Handbook, P. and T. Department.

### INSTRUMENTS REQUIRED

Monitorscope OR oscilloscope, pick-up unit, tuning unit; VTVM with RF probe OR RF probe, DVM with 10 meg impedance, 50 ohm dummy load. Two tone generator OR two equal amplitude audio sine waves.



### IN THE OM'S FOOTSTEPS

VK3NEM is again being heard on the novice bands after a long absence. The operator now is Bob Dickinson, son of Mervyn, the "original" VK3NEM, who qualified for his full call (VK3BGZ) in August 1978. Mervyn took up amateur radio as a retirement interest, and made his presence known in July 1977 using a homebrew rig as described by Rodney VK3UG in a series of articles for AR. He soon became well known in the CW section of 80 metres, where his RAAF background stood him in good stead. Occasionally he could be persuaded to switch his rig to 7 watts AM.

Bob's work situation made it difficult for him to attend classes on a regular basis, and FAMPARC members went out of their way to assist him in his theory studies. He is most grateful for their help and encouragement, and also for the "family" assistance with CW.

Bob operates a modified FT101E from his QTH at Frankston, and although not a real enthusiast for CW, his OM hopes to rectify this in due course! Bob's XYL, Marge, also sat for the November 1979 novice examinations, but failed by only a few marks to pass the theory. Looks like 1980 will see amateur radio becoming a

Dickinson "family business". Which raises an interesting question — are there any other instances where a novice call sign has been re-allocated to a grown-up son? ■



Bob Dickinson VK3NEM with OM Mervyn VK3BGZ, ex VK3NEM.



### OUTBACK AUSTRALIA TRAVELLERS

George Hombsch VK2NXY and Warwick Schofield VK2VBZ hope to continue their successful outback four wheel drive expeditions into the 1980s. Operating FT7s mobile and with inverted Vs at night they welcome anyone to drop in and say hello or just to listen to the progress of their trip this May to Sturt's Stony Desert in the northern part of South Australia. They hope to continue their search for the rare Night Parrot and will also be recording aboriginal ceremonial ground sites.

During their crossing of the Simpson Desert in 1978 many contacts were made on the novice bands, and an interested group of supporters helped us across Sturt's Stony Desert twice in 1979. These included Doug VK5NWT, Peter VK5NWP, Viv VK2VFM, Les VK2NSG, Merv VK7NMP, Bernie VK4NOM, VK5SG and Col VK2CC, among many others.

During the September crossing of Sturt's Stony Desert last year, George had regular contacts from 9.30 a.m. onwards throughout most days with VK7NMP in Launceston on 15 metres mobile.

We know that some SWLs follow these trips also. The next expedition starts on the 3rd May and the most reliable contact is in the evenings on 80m (3.570-3.585 MHz) and on 15m daytime (21.180 MHz), when the driving is not too tough!!

Warwick Schofield VK2UBZ. ■



Outbacking with the Four-Wheel Drive

# SIDEBAND ELECTRONICS ENGINEERING

P.O. BOX 23, SPRINGWOOD, N.S.W. 2777  
 WAREHOUSE 213 HAWKESBURY RD. SPRINGWOOD  
 TELEPHONE (047) 54 1392

*We have cleared our stocks of many lines, and as previously stated it makes sense to buy now from current stocks as due to rising prices overseas and rising import costs, prices are again on the increase. We still have a few Henry Linears and 18-A4T/WB Hy-Gain Antennas in stock at the old prices. Also the Tail-Twister Rotator at \$250 and the BT-1A Big Talk Rotator at \$85 are good value. We regret the necessity of increasing the price of the new TET HB35C Antenna to \$375, however we sold our original order of these antennas at our previously advertised price of \$350 merely to keep faith with our customers - ROY LOPEZ.*

## HENRY RADIO — A Famous Brand —

### NEW LINEAR AMPLIFIERS —

2 KD5 — 2KW PEP, 80 - 10m SSB/CW/RTTY/AM .....	<b>\$1050</b>
1 KD5 — 1200W PEP, 80 - 10m SSB/CW/RTTY/AM .....	<b>\$850</b>

## ANTENNAS

TET HB35C 5el. Full size Tri Band 10 - 15 - 20m Periodic Yagi 13' boom.....	<b>\$375</b>
Hy-Gain 18AVTWB 10-80m Vertical .....	<b>\$110</b>
6'HF Mobile Helical antennas, full range 80m — <b>\$30</b> , 40m — <b>\$28</b> , 15m — <b>\$28</b> , 10m — <b>\$28</b> , 20m — <b>\$28</b> .	
GPV-5 2m vertical collinear 2 x 5/8 wave .....	<b>\$48</b>
OSCAR-2-2m mobile ¼ or 5/8 wave complete with gutter mount, cable & plug .....	<b>\$27</b>
BN-86 balun for beam buyers.....	<b>\$20</b>
HY-Q (USA) 50-ohm 1KW balun.....	<b>\$15</b>

## ROTATORS & CABLES

All rotators now come with bottom brackets and control-indicator boxes wired

KEN KR-400 medium duty.....	<b>\$120</b>
KEN KR-500 vertical rotator.....	<b>\$140</b>
KEN KS-065 stay/thrust bearing.....	<b>\$25</b>
CDR BT-1A light duty 4 position push button programmable. Plus normal operation 120V AC.....	<b>\$85</b>
CDR Ham III heavy duty 120V or 28V AC.....	<b>\$200</b>
CDR tail-twister extra H/D120V or 28V AC.....	<b>\$250</b>
RG-8U foam coax cable, per metre.....	<b>\$1.00</b>
8-cond. rotator cable, per metre .....	<b>75c</b>

## ACCESSORIES

Chrome base and spring for mobile antennas.....	<b>\$20</b>
Chrome Asahi bumper mount.....	<b>\$8</b>
240 18V AC transformer.....	<b>\$10</b>
Mobile bumper mounts 3/8" 24 thread.....	<b>\$2</b>

## KYOKUTO FM-2016A

800 channel, 2 meter FM transceiver with 4-channel memory and scanner 15W..... **\$340**

## TRIO-KENWOOD PRODUCTS

TS180S 10-160m HF solid state transceiver.....	<b>POA</b>
TS820 and TS520S HF 10-160m transceivers .....	<b>Special POA</b>
TS120S and TS120V 10-80m transceivers.....	<b>POA</b>
TS700SP 2m all mode transceiver.....	<b>Special POA</b>
TR7200G 2m mobile transceiver.....	<b>Special POA</b>
TR7625 and RM762m transceiver plus scanner .....	<b>Special POA</b>
VFO 520 for TS 520S .....	<b>\$130</b>
LF 30A low-pass filter .....	<b>\$30</b>
SP 120 — SP 100 Remote Speakers .....	<b>\$32</b>
DK 520 adaptor TS 520 to DG 5 .....	<b>\$10</b>

*All further Trio-Kenwood accessories and transceivers at competitive prices.*

## CO-AX CONNECTORS

PL-259, SO-239, cable joiners, each.....	<b>60c</b>
Right angle and T-connectors, each.....	<b>\$1.00</b>
GLP right angles RG-58U to SO-239, w/lock nut and cap, each.....	<b>\$1.50</b>
Double female connectors, each.....	<b>60c</b>
MLS right angles RG-58U to PL-259, each .....	<b>75c</b>
In-line mike sockets 3 & 4 pin, each.....	<b>60c</b>
Mike sockets 3 & 4 pin, each.....	<b>60c</b>
M-ring body mount w/lock-nut.....	<b>\$1.50</b>

## NOVICE SPECIALS-TRANSCIEVERS

CONVERSION CRYSTALS for-amateur licence holders - set of 8 crystals to convert 23-ch, 27-MHz CB units to 28 MHz. Suitable for Kraco, Sideband, Universe, Hy-range V etc., converts as per Universe 10M above — CRYSTALS & INSTRUCTIONS.....	<b>\$32</b>
Set of 4 crystals converts to 28.3-28.6 MHz .....	<b>\$15</b>

**All prices are NET, ex Springwood NSW, on pre-payment with order basis. All risk insurance is free of charge, allow for freight charges by air, road, rail or postal, excess will be refunded. Prices are subject to change without prior notice. All orders cleared on a 24-hour basis after receipt of order with payment.**

**ROY LOPEZ (VK2-BRL) Manager**

# VHF-UHF

An expanding world

Eric Jamieson, VK5LP



Forreston, S.A. 5233

Freq.	Call Sign	Location
50.005	H44HIR	Honiara
50.023	HH2PR	Haiti
50.025	6Y5RC	Jamaica
50.035	ZB2VHF	Gibraltar
50.036	HC1JX	Quito
50.038	FY7THF	French Guiana
50.040	WA6MHZ	San Diego
50.040	ZS6VHF	Edenvale
50.048	VE6ARC	Alberta
50.050	ZS3E	South West Africa
50.060	PY2XB	Sao Paulo
50.080	W1AW	Connecticut
50.080	TI2NA	Costa Rica
50.088	VE1SIX	New Brunswick
50.100	KH6EQI	Pearl Harbour
50.110	JD1YAA	Marcus Island
50.498	5B4CY	Cyprus
51.999	YJ8PV	New Hebrides
52.200	VK8VF	Darwin
52.250	ZL2VHM	Palmerston North
52.300	VK6RTV	Perth
52.350	VK6RTU	Kalgoorlie
52.400	VK7RNT	Launceston
52.440	VK4RTL	Townsville
52.450	VK2WI	Sydney
52.500	JA1IGY	Nagoya
52.510	ZL2MHF	Mt. Climie
52.800	VK6RTW	Albany
52.900	VK6RTT	Carnarvon
53.000	VK5VF	Mt. Lofy
144.010	VK2WI	Sydney
144.400	VK4RTT	Mt. Mowbullian
144.475	VK1RTA	Canberra
144.500	VK6RTW	Albany
144.600	VK6RTT	Carnarvon
144.700	VK3RTG	Vermont
144.800	VK5VF	Mt. Lofy
144.900	VK2RTX	Ulverston
145.000	VK6RTV	Perth
147.400	VK2RCW	Sydney†
432.400	VK4RBB	Brisbane

The beacon list has been modified this month, and includes only 24 hours a day operational beacons, i.e. permanent beacons. The full list was published in February 1980 AR, and March carried some alterations. Bill W3XO advises of a beacon YV5ZZ in Caracas, Venezuela, believed operating on 50.070, but no other details whether 24 hours a day.

Barry VK2AAB writes to affirm that VK2RCW is still operating as a beacon on 147.400, running 8 watts to a 5/8 wavelength ground plane on a 40 foot mast 600 feet a.s.l. Except for a few brief periods, the last one due to a lightning strike, it has been a continuous operation for about a year. They look for reports on the coverage given, and find it a very useful training facility. The beacon is therefore relisted this month.

It seems there is still some confusion over the VK5KK beacon running on an attended basis on 52.150. The Geelong Amateur Radio Newsletter speaks very severely about the VK5s not conforming to the proposed band-plan for beacons! Let me assure all and sundry there are no immediate plans to fiddle with the existing VK5VF beacons, the VK5KK beacon is purely an experimental beacon utilising a beam antenna with no particular pattern of beam headings, but which has proved useful for overseas stations because it runs more power (ERP) than VK5VF and is thus being heard over greater distances. I suggest those in doubt refer to the reference in last issue re this particular beacon!

## OPERATIONS FROM HONG KONG

Anthony VS6EZ writes from Hong Kong with some corrections to previously published information regarding operations in that country. The following from his letter should be of interest to readers.

VS6HK is the club call sign of the Hong Kong Amateur Radio Transmitting Society, and is being used as a Morse ident on their own 2 metre repeater in Kowloon, operating channel RO, 145.000 MHz input, plus 600 kHz output.

The Microwave Module Transverter 2 metre input and 6 metre output was made at Anthony's suggestion, and has worked very successfully on his usual frequency of 50.150 MHz, giving 10 watts PEP or 10 watts FM. However, the prototype power output drops to 2 or 3 watts at 52.100 MHz which is the highest out of band spot frequencies they are permitted. He occasionally runs a cassette tape which has one minute of CQ, advising he is listening on the frequency he is transmitting on, almost always 50.150, occasionally 52.100, and that he is also listening on 28.490 MHz. After the one minute there is a ten seconds silence to let the VOX drop out and for him to listen, then the call starts again.

Procedure is to switch the rig on at 2300Z and set the RM3 scanning and go back to bed with an ear open for any signals. Switch off is at 0030Z when he leaves the office. Evening operation whenever possible. For VK operators Anthony suggests listening for an opening up north, then look for him on 28.490 or 21.150 which are the two preferred frequencies. He is prepared to work cross-band 6m to 10 or 15m, or between 50.150 and 52.150, or if it is at all possible direct on 52.100, but with only 3 watts it will be difficult.

In Hong Kong there are only a few 6 metre stations, VS6FX with a 551, VS6BF with a 551, VS6EG and VS6GW also have equipment but have not been heard on. Anthony appears to be the only station using a beam, a 5 element, while the other two stations listed use groundplanes. At the time of writing Anthony had not worked any further south than KG6DX and KH6JSG, lots of JAs on 25-11, less on 5-12, 6 JAs on 23-12 and nothing since!

What all the above means simply is that VS6 will be a rather difficult place for VK to contact, but we will live in hope!

## CAIRNS REPEATER

Ted VK4YG writes to advise the Cairns Amateur Radio Club's 2 metre FM repeater VK4RCA on Ch. 48 is now operational at the TV station site on Mt. Bellenden Ker, coverage so far has exceeded expectations, with contacts to Mackay, mobile/mobile, Cairns/Townsville, etc. The site is about 30 miles south of Cairns and the antenna is about 5200 feet ASL.

Technical direction for the project was by Ian Champion VK4AWB (ex VK5WB), who having completed the project is now moving to Brisbane!

## QUEENSLAND 2 METRE RECORD

In October 1979 AR I mentioned receiving advice of a contact between Ken VK4VC and an unnamed station to set a Queensland 2 metre record. Ken has written to say the other station was ZL2BFC, so we can now give due recognition to the record making contact, conducted over 2571.628 km. Congratulations to both parties.

## MOONBOUNCE REPORT

Lyle VK2ALU reports in "The Propagator" that it is two years since VK2AMW had to cease EME operation due to vandalism of equipment. Further details for re-location were finalised with the University before Christmas, and it is hoped 1980 will see the station at its new EME site.

The additional receiving and feed equipment needed for the dish to be also used as a radio telescope is well on the way to completion. Some sections have been tested.

Tests were carried out on the dual band disc feed system at the antenna test range in December and confirmed it is a viable arrangement. The focal point relationship of each of the 432 MHz and 1296 MHz feeds proved to be coincident, a few centimetres in front of the 1296 MHz radiating disc. The polar diagrams showed the average

radiation pattern most suits a dish of approximately 1/d of 0.55. Details are being forwarded to interested EME groups who operate or plan to operate on both 432 and 1296 MHz.

## MICROWAVE NEWS

Lyle VK2ALU also reports that VK2 lost its most competent and enterprising microwave experimenter when Des Clift VK2AHC moved to Adelaide in December. His new QTH is believed to be a very good UHF site!

An over-the-water 3 cm propagation test was recently made between VK2ALU at Currarong (Jervis Bay) and VK2YCN, some 200 km north at Norah Head. Bad weather, with wind and cloud prevented the necessary duct forming to support propagation. However, valuable information was gained on the special problems associated with an over the horizon path over water. The equipment was located at the water's edge at both ends of the path.

## DISRUPTIONS TO COMMUNICATIONS

"Technical Review" No. 65 mentions the US National Oceanic and Atmospheric Administration predicts major disruptions to radio communications particularly in the 3 to 30 MHz band, in 1980, due to an upcoming intense period of sunspots. The sunspot activity is expected to peak in March 1980. Related geophysical disturbances such as solar flares and ionospheric storms can also be expected. If the prediction is accurate, the 1980 cycle will be equal to the second most severe cycle observed over the past century.

If the above proves to be correct, then it looks like the March/April equinox for 1980 will be a good DX period for VHF and 6 metres, so with the final closure of Ch. 0 on Sunday, 24th February, maybe the powers that be will be farsighted enough to allow VK amateurs to use all or some portion of the 50 MHz band, thereby giving us an opportunity of working a greater proportion of the 6 metre DX so readily available in the northern hemisphere.

## GEELONG BEACON

Daryl VK3AQR has advised some details of the Geelong 6 metre beacon which it is hoped will be an indicator for openings to VK3, is likely to be fully operational by the time you read this, operating on 52.330 MHz from Mt. Anakie, 20 miles north-west of Geelong. Antenna two crossed dipoles stacked, running 25 watts initially, but eventually 80 watts, call sign VK3RGG. Now that Ch. 0 has disappeared from the Melbourne scene we will need something to alert the clan of possible openings! It is understood the beacon will FSK ident 850 Hz shift at 9 w.p.m.

## PORT LINCOLN NEWS

Tim VK5ZEV sends some news indicating a good VHF site by the range of workings both via repeaters and direct. On 14-1-80 at 0955Z Ch. 47 Mt. William provided contacts to VK3YEE Melbourne, VK3ATN Birchip and VK3BJ/P Phillip Island. The latter station was heard direct but too noisy to work.

On the same day from 1230Z again via Mt. William VK3AGD, VK3NK, VK3BFF, VK3YND, VK3ZAU and VK3ZQB, signals 8 uV from repeater. Tim's signals were also triggering the Canberra repeater at the same time. On 15-1 VK3AGD and VK3NK via Ch. 42 Pt. Pirie; 24-1 VK6WG via Ch. 48 Adelaide; 23-1 VK3ZRV/5 first on Ch. 45 Adelaide, then direct on Ch. 50 and finally via Ch. 42 Pt. Pirie. Distance from Pt. Lincoln to Adelaide 270 km and the same to Pt. Pirie.

The Pt. Lincoln area is not one to be well represented on VHF and I hope Tim will be able to operate on SSB as well as FM in the future as there will surely be some good opportunities to work from there.

## VHF/UHF RECORDS AGAIN BROKEN

For the fourth successive year Dr. Walter J. Howse VK6KZ has continued his exploration of the VHF/UHF propagation between south-eastern Australia and the south-west of Western Australia. Commencing in December 1976 in Albany on 144 and 432 MHz, his tests have taken him in December 1977 to Torbay Hill, 20 km west of Albany; in January 1979 to Walpole—a further 65 km west, and now in January 1980 to Cape Leeuwin—the most south-western point of WA.

During this time a world record was established by him on 432 MHz from Torbay Hill — but this in turn was broken six weeks later by Aub Keightley VK8XY in Albany, and that in turn was exceeded more recently by contacts between Hawaii and California; the world record on 1296 MHz was extended from Walpole and now further contacts from Cape Leeuwin are the basis of claims for a new world record. The latest expedition also resulted in contacts on 144 and 432 MHz to be submitted for new Western Australian and Australian records respectively.

Following a close study of synoptic weather patterns and liaison with the Perth Meteorological Bureau, Dr. Howse set forth from Perth on Tuesday afternoon, 22nd January, 1980. At that time, the long wave pattern in the Southern Hemisphere comprised four waves with features of importance in the Australian region, being troughs located near 85 degrees east and 170 degrees east and a ridge near 130 degrees east. The Melbourne Bureau stated that these features, along with other elements of the long wave pattern, appeared to be oscillating about these positions and that continued anti-cyclonic activity at central to eastern longitudes was expected.

On arrival at Cape Leeuwin at 1230Z, the Adelaide 144.8 MHz beacon was audible at good strength but no contacts were made (apart from successful QSOs with Don Graham VK6HK in Perth over a 271 km path on 144 and 432 MHz) until 1426Z when VK5NX and VK5ZB — both mobile — were worked via the VK5RHO repeater in Adelaide on 146.85 MHz.

At 2032Z two-way SSB communication was established with Reg Galle VK5QR on 144 MHz. Thirteen minutes later, VK5QR was heard on 1296 MHz SSB but a two-way contact did not eventuate until 0057Z when signal reports of 53/53 were exchanged. This contact over a 2145 km path with two-way SSB exceeded the previous world record distance of 2107 km. In the interim, contacts were made by VK6KZ with VK6WG and VK6KJ in Albany (250 km east), VK6QA and VK6XQ in Geraldton (816 km north), VK6HK in Perth, and with Ken Yates VK5RP in Adelaide. Ken's 1296 MHz SSB signal was also copied at Cape Leeuwin but no reports exchanged.

Also at about 0000Z Wednesday, 23-1, VK6KZ became aware of the opening between Perth and Adelaide on 144 MHz, which was the first to result in contacts since February 1952. The circumstances of these contacts are themselves very interesting and gave evidence of the advantages and disadvantages of the calling frequency of 144.100 MHz. In summary, at 2300Z on 22-1 (0700 Wed.), VK6KZ told VK6HK on of the strong 2 metre signals from Adelaide. VK6HK looked carefully for the Adelaide 2 metre beacon and heard it. Don alerted a number of other Perth amateurs by telephone and together they frantically sought activity from Adelaide. Several phone calls to Adelaide went unanswered. Aub VK6XY in Albany was contacted by Wayne VK6WD and Aub triggered the Adelaide FM repeater. The net result was the emergence of a new licensee, Les Wood VK5ALW. The honour of the first Adelaide-Perth contact for nearly 30 years went to VK6WD, who worked Les at 0003Z. Contacts were also made by Jack VK6ZEL, Ron VK6FM, Phil VK6ZKO. Ironically, Don VK6HK did not copy his report from VK5ALW due primarily to QRM on 144.1 from stations in Albany and Denmark. Here was an occasion where stations with a favourable path would have helped by shifting away from the calling frequency to leave that free for stations trying the more difficult path.

The opening to Perth appeared to close at 0110Z and to VK6FM 45 km south of Perth at 0230Z. The Perth-Adelaide distance is 2129 km. Ken VK6ZFQ, at Katanning, 250 km south-east of Perth, worked into Adelaide also. At 0025Z on 23-1 he worked VK5ALN on SSB over a 1933 km path. (Ken had two further contacts during the opening, viz., at 1255Z with VK5RO and 2305Z with VK5LP.) He reported hearing VK6KZ/P working VK5s without hearing the other end of the QSOs.

In the meantime VK6KZ/P at Cape Leeuwin ceased operating at about 0230Z in order to have breakfast — anyway the Adelaide beacon was fading! Activity was resumed at 0800Z with VK5VF

at good strength. A number of 144 MHz contacts were made with stations in locations as diverse as VK5MC in Mt. Gambler (actually Hatherleigh, near Millicent), Adelaide, Albany, Perth, Geraldton, and at 1035Z with Andy VK6QX, 1056 km north at Carnarvon. At 1000Z Chris VK5MC was heard on 1296 MHz and VK6KZ/P was heard by VK5MC. An exchange of reports, however, was not achieved until 1200Z with reports of 519 to VK5MC at 43/42 received from Chris. This distance of 2290 km is being claimed as the world record for the 1296 MHz amateur band.

At 1036Z the first VK3 station was heard on 144 MHz and worked were VK3QT, VK3BPM, VK3AXV, VK3YLR/P, VK3YII and VK3ZBJ. The contact with Andrew VK3YLR/P at Ross Hill, 80 km east of Melbourne, is the basis of claims for new Western Australian and Victorian records for 144 MHz. Distance 2785 km. Although Andrew heard VK6KZ/P on 432 MHz no contact resulted. However, at 1337Z VK3ZBJ was worked on 432 MHz over 2717 km for a new claimed Australian record.

The following morning saw band conditions deteriorate with the last DX contact by VK6KZ/P being one with Eric VK5LP at 2212Z on 23-1, i.e. 0621 hours local time on Thursday, 24-1-80.

Equipment used by VK6KZ included a modified Kenwood TS120V transceiver at 28 MHz with microphone transverter for 144 and 432 MHz and 10 watt power levels on these bands. The 1296 MHz SSB was obtained by processing a 21 MHz SSB source as described by Reg VK5QR in AR for October 1979. Power output on 1296 MHz was about 4 watts fed to a 1 metre parabolic dish mounted above the car. The receive converter comprised two BFR91 RF amplifiers head of a microwave modules converter. Antennae for 144 and 432 MHz were 5 and 7 element yagis respectively.

This opening to the Eastern States was one of the few to be observed simultaneously from such diverse locations in the south-west portion of Western Australia. It rekindled hope in Perth amateurs that the path to Adelaide will be accessible to them. It also showed that the summer ducting in the Bight can extend as far west as Cape Leeuwin. It now appears that it will be up to Victorian amateurs to explore the extent of the ducting at the eastern end of the path, or will the optimism of Brian Tideman VK5TN expressed in 1958 of the possibility of a VK5/6 path to South Africa on 144 MHz be borne out by systematic tests? . . . Anyone wanting to explore 576 MHz across the Bight please contact VK6KZ!

I thank Walter VK6KZ for the fill in of complete information on the extensive openings across the Bight this summer; the details so given should surely whet the appetite of many an amateur, and hopefully spur him on to share in these great experiences. When one considers that only 10 watts was being used by VK6KZ it shows the extent and strength of the ducting — it seems incredible I should work him through my 30 dB attenuator (hill) at the time when conditions were failing. Just incredible! If nothing else it proves the pair of stacked 13 element yagis are working!

#### MORE NEWS FROM HONG KONG

Graham VK8GB has sent a note confirming the information already mentioned in regard to Hong Kong activity, but adding further that Tony VS6EZ on 20-8-79 contacted on 144.120 FM YD3KJ, YD3BEV and YD3BJN between 1408 and 1502Z. He ran the IC211 via along length of RG58 to a vertical dipole! The stations are located in Surabaya, Indonesia.

Tony VS6EZ is keen to work VK on 6 metres, so it will pay to keep a lookout during March-April at least. Graham also mentions VS6BF, who has an IC55f and ground plane and is soon to sell his gear to VS6CW!

#### THE NORTHERN HEMISPHERE

From Bill WX3O and "The World Above 50 MHz" comes news of continuing 6 metre activity in their hemisphere. Some drop off was recorded during the second half of December 1979, but the last few days of 1979 saw an improvement to the extent FY7AS was worked by many eastern US stations, plus contacts to HC1JX and JA1PIG/PZ,

all around 1300Z. In early January Es conditions prevailed with numerous double hop contacts across the USA. What is unusual is that the Es was so intense it allowed contacts to be made on 144 MHz as well, with 13 US States being worked. Similarly, on 70 cm band conditions between 27-12 and 29-12 were so good that many extreme distance QSOs took place, reminiscent of summer type tropo openings.

With the continuing lengthening out of distances in the USA it looks like the VK3 gang are going to need to make special efforts soon to work to Albany and further west on 1296 MHz and higher bands so as to ensure the world records stay in Australia; there are no places left in VK5 to make contacts much longer, so it's over to VK3 and possibly VK7.

That's all for this time, the bands have been relatively quiet so news becomes scarce under such conditions. Closing with the thought for the month: "In the game of life, as in other sports, you can pick out the winners — they're the ones who aren't complaining about the officiating."

73. The Voice in the Hills.

#### FOOTNOTE

The KH6 EQ! beacon on 50.099 was heard in Melbourne (2-3-80) in the evening for approximately one hour. KH6NS was worked from both VK7 and VK3 on 52.05. Openings also occurred from W and ZL on the weekends of 23-24 of February and 1-2 of March.

## STOLEN RADIO EQUIPMENT

Amateur Radio Equipment stolen from G. Lee-Manwar VK4AML, 4 Webb Street, Stafford, Brisbane 4053. Ph. (07) 356 3807 AH, (07) 275 7483 Bus.

1. YAESU FT101E transceiver S/N 6K211310 (plus Philips microphone).
2. ICOM IC-701 transceiver S/N 8003943.
3. ICOM IC-701PS power supply S/N 7804238.
4. ICOM IC-211 transceiver S/N 6805458.
5. ICOM RM-2 remote control unit S/N 02785.
6. KEN KP-12 RF speech processor S/N TK603200.
7. PALOMAR 2M50 2m linear amplifier, no S/N but can be recognised internally by additional receiver preamplifier board and relay mounted inside.
8. Power supply, DC regulated 10-20V DC, 0-20A, built-in light grey rack mounting box with heavy aluminium front panel with chromed handles. Fits 19 inch rack. Distinguished by large 0-30V meter and 0-25A metres on front panel and 3 pairs of red and black output sockets on bottom of front panel. Two large 6 inch black anodized "Minifin" heatsinks containing four 2N3055 transistors mounted (insulated) on top of box.

If any of the above items are seen, please inform the nearest police station and ask them to contact the Fortitude Valley CIB (Brisbane).



Amateur Radio Equipment stolen from Barry Wilton VK3NXX, 30 Melby Avenue, Balaclava, Victoria 3183. Ph. (03) 697 6230 Bus., (03) 527 4029 AH.

1. FT200 Tcvr, Serial No. IF 320354.
2. FV200 Ext. VFO (Internal mods, 2 xtals fitted).
3. FP200 Power Supply.
4. Turner Desk Mike (Internal mods — Hi, Imp XFR, etc.).
5. CFI Preamp (27-28 MHz — mod. 3.30 MHz).
6. Digital Clock, home-brew (Tandy case MA 1003 chip).
7. Home-brew 6/20V 30A Power Supply (C & V meters 2 in., 2 outputs, Horwood case, black).
8. Diawa Rotator Control Unit.
9. Linear Amp, home-brew, not complete. 2 3/500Z, PS, minus 2 RF chokes and ant. relay, single cabinet.

If any of the above items are seen, please notify your nearest police station or Senior Detective Murray Aldred, Elsternwick CIB. Ph. (03) 528 5986.

# LETTERS TO THE EDITOR

Any opinion expressed under this heading is the individual opinion of the writer and does not necessarily coincide with that of the publisher.

PO Box 11, Woomera, S.A. 5720.  
24th November, 1979.

The Editor,  
Dear Sir,  
Hoping not to bore anyone with the details, may I add a final postscript to the saga of the DXpedition which never came off, the Ghan Railway Mobile DXpedition?

I am prompted to do this as a result of people still asking me over the air what happened—really happened, that is!

Frankly I am appalled at bureaucracy's lack of courtesy, as I have written to them twice and they have seen fit to ignore both letters, although they could legitimately have been written in much stronger language.

As far as I am concerned, the matter is now closed. I would like to thank the VK5 and VK4 divisions of the WIA for printing my comments on the non-event, and the VK2-VK7 divisions for putting to air the tapes which I sent them afterwards explaining in a cool, calm and collected manner (which was not the way I felt!!!) the reasons for cancellation.

In closing it would appear that I may have erroneously conveyed the impression in my letter to the Editor published in October (AR) that the local radio club had, as an organised body, approved the canvassing of support. Although the matter was in fact tabled at a meeting, and discussed informally with individual members and officers, and the draft of the item printed was on the club notice board for a couple of weeks before I sent the other copies out, it appears that it could be interpreted that I had said that they endorsed my comments as a club. I would like to make it clear this was not so, and not the impression I wished to convey.

Yours faithfully,

C. R. W. Ashton VK5DQ.

17-12-79.

The Editor,  
Dear Sir,  
It would be appreciated if this text, or an edited version, is included in the next possible issue of AR.

Unfortunately, in the early hours of 14th December, the Gold Coast Amateur Radio Society's VHF/UHF repeater VK4GC was struck by lightning during a violent electrical storm. In this strike: (1) The mains power lead earth wire vapourized; (2) The mains power plug blew out of the wall; (3) The transistors in the power amplifier melted and their caps blew off. I could go further but suffice to say that the repeater is not expected to be operational until February-March when a new repeater is completed. Any donations towards the construction of the repeater would be very appreciated. Donations may be sent to GCARS Secretary, PO Box 588, Southport 4215, Qld., and are payable to the "Gold Coast Amateur Radio Society".

Yours faithfully,

Glenn Wallace VK4NUX, GCARS Secretary.

340 Gillies Street, Thornbury 3070.  
24-12-79.

The Editor,  
Dear Sir,  
The story published in December 1979 AR concerning Australia's first qualified woman electrical engineer and the first licensed woman amateur radio operator, Mrs. Florence McKenzie, O.B.E., brought to my mind recollections of another "upfront" female Mac, viz., Miss Madeline Mackenzie ex-VK4YL (prewar). Like ex-VK2FV, Madeline, in my opinion, has a claim to fame also, because when she obtained her AOCPP in the early thirties, she was only 11 years of age, and as far as I

am aware, is the youngest Australian licensed amateur radio operator ever. She specialised in CW and was a leading DX and contest operator as such. By post-war she had married and never returned to the amateur radio scene thereafter.

Yours faithfully,

Eric Trebilcock L30042.

71 Lonsdale Avenue, Berowra Heights 2082.  
26-1-80.

The Editor,

Dear Sir,  
Apparently there is a group of amateurs who do not wish to have their call sign and OTH listed in the "Call Book".

The accuracy and completeness and, of course, the usefulness of the Call Book will be considerably reduced if it doesn't contain all amateur call signs. How is an operator to determine if a station is not a pirate if it's unlisted?

If the objection is based on organisations using the book as an advertising mailing list so what, no obligation exists on the recipient to acknowledge, read or purchase or other act on the received material.

I'm sure fellow amateurs would appreciate the Editor compiling a summary of the argument(s) submitted by this group supporting their case, as obviously they would wish to remain anonymous.

73. Stan Dogger VK2VFW/ZRD.

P.O. Box 151, Mannum, 5238, S.A.  
29-1-80.

The Editor,

Dear Sir,  
I was talking to a very good "DX friend" on air before Christmas who said he would be travelling abroad as a representative of his firm.

Imagine the surprise and delight on receiving a picture postcard—very cosmopolitan—a German card, posted in England, by a Japanese, to a Pomme, living in Australia!!

My very good friend is Shiro JE2EFQ.

It really makes one stop and think. What a nicer world this would be if world leaders could be like "Hams"—no colour, religion or politics—just good communications between everyone regardless of who you are, where you live or what language you speak.

88s from Pat Edmunds VK5NPA.

10 David Street East, Springwood 2777.

The Editor,  
Dear Sir,  
17th February, 1980.

I understand that WARC 79 has produced suggestions for additional Amateur Service bands on 10 and 18 and 24 MHz. I believe that 24 MHz is already subject to invasion and usage by illegal stations that have "spilled over" from the chaotic 27 MHz CBRS on the specious grounds that sensible users of CB have been forced to move to unauthorised channels because of overcrowded conditions and "Idiot usage" by 27 MHz CBers.

I support any move that would confine Amateur Service operating on 24 MHz to either "FULL AOCPP" holders only OR to any "above AOCPP" category that may be introduced. The almost certain "struggle for 24" would require capable and experienced Amateur Service members, who could be organised by Institute leadership to present the maximum opposition to illegal occupancy and invasion by "CB pirates". I suggest, too, that the Institute should take urgent steps to counter the present NCRA campaign to retain 27 MHz in 1982 and to frustrate the Federal Government's stated intention to move CB to UHF and to return the 11 metre band to the Amateur Service.

Most amateurs with whom I have discussed these matters are quite apathetic about the whole business, necessitating STRONG Federal and State leadership to get our members motivated to slogging out the issue toe to toe with the CBers, who have made an appalling mess of the 11 metre "loan". However, what they lack in technical competence and worthwhile usage of our former band, they seem to compensate in insatiable demands, financial interests, captive media, vote-seeking politicians and irresponsible business support. Many amateurs are willing to "let 27 go"

and to accept the successful CB CONSPIRACY as a "fait accompli". However, the methods used by the pirate invasion and BIG BUSINESS machinations suggest that the WIA should be committed to pushing hard to regain our ill-lost frequencies and not to pursue a policy of lying whimpering in the corner. The politicians sold us "down the river" and should not be allowed to forget it. The Amateur Service, with its long and proud record of public service and community advantage SHOULD have been protected by our political leaders from the incursion of the pirates and the conspiring of the Big Business Interests foisting the CB MONSTER on to the community.

Yours faithfully,

R. C. Black VK2YA.

"Bonnie Braes",  
Wattamondara, NSW 2741.  
18th February, 1980.

The Editor

Dear Sir,  
I have read with interest recent letters and comments in other publications regarding the plight of "home-brewers" and I am glad to learn that my problems finding parts are not unique.

What is the WIA doing about this situation?

Apart from the unadvertised (WHY?) "Magpubs", which shows considerable savings can be made, I know of no service to provide amateurs with parts, equipment or even those illustrious "Black Boxes".

Do we prefer to see others make the killing?

We have a QSL Bureau. Why not a parts and equipment Bureau?

How about a survey on amateurs' needs?

There is much that can be said on this issue but—what do YOU think?

Yours faithfully,

Graham L. Dun.

EDITOR'S NOTE:

1. We certainly would appreciate our members assistance in compiling such a register/bureau. Do we have any offers? Please write to your Division if you can be of any assistance in this regard.
2. Magpubs details are published at regular intervals in AR.—VK3UV.

## MAGPUBS

A WIA MEMBERSHIP SERVICE

### OVERSEAS MAGAZINE SUBSCRIPTIONS

(One year only)

QST .....	\$19.00
Radio Communications .....	\$19.00
Break-In .....	\$12.00
Ham Radio .....	\$15.50
(\$28.50 for 2 years)	
CQ .....	\$13.50
(\$21.50 for 2 years)	
CQ-TV .....	\$5.50
VHF Communications —	
Surface mail .....	\$8.20
Airmail .....	\$12.40
(Binders \$2.75, plus 50c P & P)	
AR — Overseas surface mail subscription .....	\$14.40

Write to

## MAGPUBS

P.O. BOX 150  
TOORAK, VIC. 3142



# AWARDS COLUMN

Bill Verrall VK5WV  
7 Lilac Ave., Flinders Park, S.A. 5025

Here are the details of two new awards which are now available for working amateur stations located at Alice Springs, Northern Territory.

**THE REVEREND JOHN FLYNN MEMORIAL AWARD**  
This award has been instigated by the Alice Springs Community College Radio Club in memory of the Reverend John Flynn, who was the founder of the Australian Inland Mission, the Royal Flying Doctor Service and radio communications in general in "Outback Australia". Today, thanks largely to the efforts of John Flynn, every cattle station and settlement in the Outback has radio communications.

Flynn spent his whole working life in the Outback helping others, no matter what nationality or colour.

This year, 1980, is the 100th year since the birth of John Flynn and the Alice Springs Community College Radio Club has printed 2,000 certificates in memory of this great man.

The conditions for obtaining this special award are as follows:

VK Stations: 3 contacts with Alice Springs Club members.

Overseas Stations: 2 contacts with Alice Springs Club members.

All SWLs: 3 reports of OSOs undertaken with Alice Springs Club members.

**ALL BANDS — ALL MODES.**

The award commenced at 0001Z on 1st January, 1980.

Each certificate will be individually numbered and signed by the Awards Manager of the ASCCRC.

The cost will be \$3 Australian or equivalent in IRCs (10), which includes return of the certificate by airmail.

Log details only are required and shall include the date, Time (GMT) and stations worked, signed by two other licensed amateurs. Contacts 24 hours apart with the same stations are permitted.

**ALL FUNDS GENERATED BY THIS AWARD WILL BE DONATED TO CHARITY.**

This award is one of a kind and the ASCCRC hopes that it will be treasured by the 2,000 people lucky enough to obtain it.

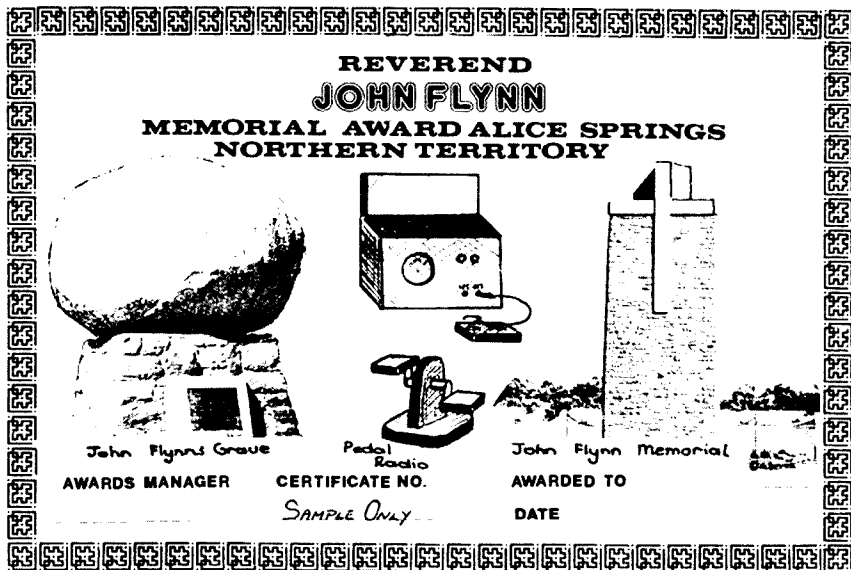

Applications for the award should be addressed to:—Awards Manager, ASCCRC, PO Box 2953, Alice Springs, Northern Territory, Australia 5750.

The award measures 255 mm x 175 mm, printed on high quality white card with surround and "John Flynn" in gold and the remainder in blue.

### OUTBACK AUSTRALIA AWARD

This is a perpetual award also issued by the ASCCRC. The rules of the award are:—

1. The award is available to all amateurs and SWLs.
2. Any band, any mode.
3. The commencement date for this award was 1st December, 1979.
4. Stations contacted for this award must be members of the ASCCRC.
5. GCR rules shall apply, i.e. log details certified by two other licensed amateurs.
6. Requirements: VK stations and VK/SWLs — contacts with 6 stations. Overseas stations and overseas SWLs — contact with 3 stations. Endorsements are available for contacting extra

stations as under — VK and SWL, 4 extra stations (total 10); overseas and SWL, 3 extra stations (total 6).

7. The cost of the award and endorsements for VK applicants is \$2 and for overseas applicants is \$2.50 (or equivalent in IRCs).
8. Instant qualification for this award can be obtained provided a station can show proof of contact with one ASCCRC member operating portable from Ayers Rock, OR alternatively, you can contact one ASCCRC member in Alice Springs if you are operating portable at Ayers Rock.
9. The award is available on behalf of the Northern Territory Tourist Bureau.
10. Certificates will be numbered consecutively.
11. Applications for this award should be sent to the same address as for the "John Flynn" award.

The award measures 250 mm x 200 mm and features a multicolour print of Ayers Rock with lettering in white on a black background. High quality card has again been used and this award would be an attractive addition to the ham shack wall paper.

Good hunting.

## OUTBACK AUSTRALIA

**VK8**  
Alice Springs  
Northern Territory

President  
**VK8GF**

Awarded to  
Sample for **VK5WV**

## CONTESTS

Wally Watkins VK2DEW  
Box 1065, Orange 2800

### April:

- 5/6 POLISH "SP" CW CONTEST
- 8/9 DX YL TO W/VE YL PHONE CONTEST
- 15/16 DX YL TO W/VE YL CW CONTEST
- 19/20 POLISH "SP" SSB CONTEST
- 26/27 HELVETIA "H-26" CONTEST

### May:

- 24/25 CO WW WPX CW CONTEST

Results of the 1979 IARU Radiosport championships are to hand and "down under" was at the top of the Phone list; ZL1ADI with 2,015,384 points took out the Phone section as top scorer. In the multi-operator section VK8BG (8NCT, 8NPC and 8NTG) with 2,847,564 points was just nosed out by CK7WJ (N6KT, WA6s DGX and VEF) with 2,870,544 points. Other VKs taking part were 4VU, 6IE, 6NE, 3AEW, 5ARR, 1NBQ, 2ATZ and 2AOI.

There is a lot of interest this year in the CO WW WPX, especially the CW section on May 24-25. This is a good chance to smarten up your contest CW in readiness for this year's RD CW section. Remember also that if you are interested in hard to get zones or countries then participation in a contest is rewarded by those rare prefixes that are only activated during contests.

# ALARA

AUSTRALIAN LADIES' AMATEUR RADIO  
ASSOCIATION



## DX-YL TO NORTH AMERICAN YL

Phone: Start Tuesday, 8 April, 1980, at 1800 UTC;  
end Wednesday, 9 April, 1980, at 1800 UTC.

CW: Start Tuesday, 15 April, 1980, at 1800 UTC;  
end Wednesday, 16 April, 1980, at 1800 UTC.

Eligibility: All licensed YL operators throughout  
the world are invited to participate. Contacts with  
OMs do not count. Net contacts do not count.

Procedure: Call "CO DX YL".

Operation: All bands may be used. Crossband  
operation may not be used. Stations may be worked  
and counted once on each band and mode. (Bands:  
10 through 180 only.)

Exchange: QSO number, RST reports, country or  
State. Entries in logs must show band worked at  
time of contact, time, date and transmitting power.  
Please print or type.

### Scoring:

- Phone and CW contacts will be scored as  
separate contests. Please submit separate logs.
- DX-YLs, including Hawaii, may contact all North  
American Continents which include the States  
and Canadian Provinces. Alaska YLs will be  
counted as DX, but may not contact the Western  
Canadian Provinces to include VE5, VE6, VE7  
or VE8 as DX. Alaska YLs may contact Hawaii  
or the States or Eastern Canadian Provinces.  
Contestants in the North American area may  
score contacts with DX stations to include  
Hawaii and Alaska except as noted above.  
The Western Canadian Provinces VE5 and VE8  
may not contact or count Alaska as DX.
- A station may be counted once on each band  
for credit and one (1) point is earned for each  
station worked once on each band.
- Multiply the number of OSOs by the number of  
States or countries worked.
- Contestants running 150 watts input or less on  
CW, and 300 watts SSB PEP or less on Phone  
may multiply the results of D by 1.25 (low  
power multiplier). Your log MUST show the input  
power you are running.

Logs: Copies of all Phone and CW logs showing  
claimed scores and signed by the operator must be  
postmarked no later than 3 May, 1980, and received  
by the current YLRL Vice-President no later than  
17 May, 1980, to qualify.

Please remember to file separate logs for each  
portion of the contest (Phone or CW). Contestants  
claiming 100 points or more MUST SEND DUPE  
SHEET with log. Send logs and dupe sheets with  
log.

Awards: Trophy to 1st place DX Phone; Trophy  
to 1st place NA Phone. Trophy to 1st place DX CW;  
Trophy to 1st place NA CW. Plaque to highest com-  
bined DX score; Plaque to highest NA combined  
score. 2nd and 3rd place DX and NA winners will  
receive certificates.

No logs will be returned. Your log must be  
legible. Be sure your logs contain all the necessary  
information for the Vice-President to count your  
scores.

—From YL Harmonics, July-August, No. 4, page 8  
(USA).

## NEWS FROM VK YL

The ALARA award has been published and the  
rules are forthcoming. Heather VK3AZU devoted  
many hours to designing and hand painting the  
award which, in our opinion, is quite beautiful.

Congratulations to Mavis VK3KS, who achieved  
second place in the YL Anniversary Contest, CW  
section; Maggie VK3NQQ, who came through for  
second place in Australia in the same contest;  
Pamela VK3WP for building a 35 ft. steel cruising  
ketch which hopefully will have radio equipment  
aboard; Daurel VK3ANL for completing her first  
home-brew rig, which is a CW transmitter with 5  
watts output.

## NETS

YL nets are growing more popular. Contacts on all  
but the ALARA net can count toward the ALARA  
award.

Open House Net: Tuesdays and Thursdays,  
1030-1300Z, 14.332 ORM.

ALARA Net: Mondays, 0930Z, 3.562 QRM. Net  
controller Geraldine VK2NOI.

YL Activity Day: 6th day of every month, every  
hour on the hour, call CO YL if no YLs are heard,  
14.288, 21.188, 21.388, 28.588, 28.688.

Mavis VK3KS says that in February on 14.288,  
YLs from quite a few countries were heard, includ-  
ing VE, LZ, DL, G, GW and VK.

If you are interested in joining ALARA, please  
write to the Secretary, Box 110, Blackburn, Victoria  
3130. Meetings in the Victorian Division are held  
every six weeks in the homes of ALARA members.

Maggie VK3NQQ.

## QSP

The Standard Association of Australia has recently  
published a report on the "Effect of electricity on  
the human body". The report, numbered MP30, is  
available from the office of the Association in all  
State capitals for \$2.10 post paid.

## 4U1TU

On 27th September last the President of the  
Deutscher ARC, Philipp Leasig D3LP, presented  
several items of equipment to the IARC in Geneva.  
The items consisted of a tower with a Fritel 3 el  
yagl for 14, 21, and 28, a RTTY converter and a  
special amateur radio globe. The gifts were  
accepted on behalf of IARC by the President,  
Heinz Robig HB9QC.—IARU R2 News December  
1979.

# MAGPUBS

## ● A Service to Members



- Books and other items are normally  
available direct from your Division  
or write to Magpubs, Box 150,  
Toorak, Victoria 3142. Always add  
extra for postage.

- Here is a small selection:—

	\$	Wt(g)
1980 ARRL Handbook	12.00	1000
RSGB H'book, Vol. 1	16.95	1200
RSBG H'book, Vol 2	14.50	920
Understanding AR	5.70	420
NZ Basic Training Manual	3.30	250
Course in Radio Fundamentals	4.70	260
Int. DX Call Book 1980	15.20	1100
Int. US Call Book 1980	16.10	1300
RSGB VHF/UHF Man.	11.95	1020
Prefix World Map	1.50	100
Solid State Basics	5.70	350
Hints and Kinks	4.40	200
AR Techniques	6.75	520
Beam Antenna H'book	4.55	270
SSB for RA	4.95	380
RFI	3.70	150
FM and Repeaters	4.95	330
Test Equip. for RA	7.55	520
RA Data Book	5.20	400
TVI Manual	3.50	300
WIA Stickers	0.20	—
WIA Badges	2.00	—
WIA Call Book	2.45	250
WIA Log Book	2.50	220

and many more normally in stock  
— ask for list.

- Ask your Division or write to—

MAGPUBS —

P.O. BOX 150, TOORAK, VIC. 3142

**IF  
YOU'RE  
NOT  
BUYING  
AMATEUR  
RADIO  
ACTION**



(IT'S AUSTRALIA'S BEST  
SELLING AMATEUR MAGAZINE)

**THEN  
YOU'RE NOT  
KEEPING  
UP WITH  
THE LATEST  
NEWS, VIEWS  
AND REVIEWS**

Please put me down for 12 editions of Amateur Radio Action, starting NOW!

**Rates In Australia - \$14.40 Surface mail overseas - \$18.40 Air mail: To New Zealand - \$A28.70; Malaysia - \$A32.60; Japan - \$A38.45; USA - \$A42.35; UK - \$A46.25**

Herewith enclosed cheque/postal note/money order to the value of:

\$A.....

Name.....

Address.....

.....

.....

Postcode.....

Post to: Amateur Radio Action Subscriptions, Box 628E, Melbourne 3001.

## DIVISIONAL NOTES

### VK4

At last year's Queensland Division Convention held at the Ipswich Showground many people experienced their first taste of amateur radio. Among the enthusiastic amateurs displaying facets of amateur radio were the happy gang behind the ATV gear (photo 1). Pictured from left are Noel VK4KP, Peter VK4ZWP, Graham VK4ZCL and Geoff VK4AG with home-brew and commercial bits and pieces. Roy O'Malley VK4ZQ (photo 2) took delight in exhibiting another facet of amateur radio — microprocessor systems. Roy's gear is home-brew and very professional. ■



PHOTO 1



PHOTO 2

## INTRUDER WATCH

There have been many reports of the Russian "Woodpecker" signals. In the spring of 1977 there was only a single station, apparently located between Kiev and Kharkov in the Ukraine. In early August of 1979 a new radiating source appeared in the Kamchatka area of eastern Siberia, and another on the Black Sea in south-western USSR. The pulse repetition frequency of the "woodpecker" signals transmitter is 10 per second, although there has recently appeared another system using about a 25/second pulse repetition frequency. This has been studied in some detail by VK3XB of the Australian Watch, and by G5XB/GB2IW of the British Watch. Australian observers reported a bearing of 0600 in July, and more recently have submitted reports with bearings for both long and short paths. In recent months, a number of spurious signals have been reported, one of which appeared on nearly every 10 kHz in the 14 MHz band. UMS, which has outlets to merchant ships, continues

to use 7212 kHz and also both A1 and narrow-shift (250 Hz) F1 RTTY on 14,248 kHz. Radio Tirana has been transmitting on several frequencies, settling down on 14,320 kHz at 0400Z and 0500Z, and more recently at 1300Z to 1405Z.

Monitoring systems have been kept busy with all the A9 (or A7) phase-modulated-pulse multi-channel transmissions from the USSR. These sound like a buzz saw and are about 3 kHz wide, with one or possibly two guard carriers at the sides spaced 3.3 kHz apart. One in Northern Egypt on 14,145 kHz has two guard carriers, although all of the Asian and European transmitters appear to have been changed over recently to the use of the single guard carrier.

On occasion one hears a single guard carrier on the low frequency side. This may indicate a spurious signal not intended to be on that frequency. As many as 15 of these systems have been heard at one time on the 14 MHz band, consuming a large part of the band. Some of these obviously are spurious signals from other systems. The pulse contains 12 channels for communication, each channel being about 250 Hz in width. The 14,145 kHz channel in Egypt operates almost 24 hours per day. These systems do not follow the USSR practice of using frequencies which divide by 8 (or, in some cases, by 4).

There are a number of A-1 groups in the 14 MHz band, other than the 14,248 kHz UMS frequency, such as those to and from RJS, a probable Russian navy shore station communicating with ships at sea.

A number of broadcasting harmonics appear in the 14 MHz band, and some of these are accompanied by the harmonics of jammer stations operating on the fundamental frequency of the broadcast station. For example, a jammer operating on 7150 kHz also appears on 14,300 kHz. Highly distorted Mayak programme transmissions from Radio Moscow to various regions appear on 14,040, 14,070 and 14,280 kHz. These are apparently employed for jamming purposes using transmitters with high harmonic output.

Five hundred or 1000 Hz shift F1 RTTY frequently appear on 14,096 kHz, these being common shift frequencies for USSR stations. Two noisy signals about 1 kHz apart often are heard on 14,180 kHz: presumably these are very fast F1 RTTY, possibly from RYD. This station also uses Morse code on occasion.

China transmits both 850 Hz shift RTTY and F1 Morse code in the 15 and 20 metre bands. These include BJZ20 on 21,300 kHz, BCK about 14,067/14,073 kHz, BEA2 about 14,132/14,137 kHz (at times with a 5 kHz shift spurious around 14,300 kHz) and BRN1 about 14,298/14,306 kHz, or one 14,320 kHz. BAA6, BAA7 and BAA8 and BABJ at Peking Airport are heard daily around 0001, 0210 and 0520Z.

HMH25, Korean Central News Agency, Pyongyang, assigned 14,350 kHz, is often heard around 14,348-14,349 kHz sending RYR tape at 1252Z to 1407Z.

The intruder picture does change, seasonally and otherwise. But this review of the highlights will be of interest to many users of the bands which are open to USSR and China.

K6KA.

From IARU R2 News, December 1979. ■

## COMING EVENTS

22 APRIL

VK5 Annual General Meeting. Burley Griffin Building, W. Thebarton Road, Thebarton, 20.00h. ■

BUYING OR SELLING GEAR?

# HAMADS

MAKE IT HAPPEN FAST

# VK-ZL CONTEST 1979: RESULTS

## 8 HOUR SECTIONS — CW

Call	10	15	20	40	80	Total
<del>VK6BQ</del> <i>VK6AJ</i>	—	—	<del>29028</del>	—	—	<del>29028</del>
VK3RJ	11700	—	—	—	—	11700
VK3PL	—	—	6984	—	—	6984
VK3AMD	744	483	1904	—	—	3131
<del>VK6AJ</del> <i>VK4SF</i>	8208	—	—	—	—	8208
<del>VK6AJ</del>	11088	—	14507	—	—	25595
<b>PHONE</b>						
VK1LF	30	—	256	—	—	286
VK2NZL	—	10199	—	—	—	10199
VK2BOS	3150	1311	1110	—	—	5392
VK2BIP	—	4692	446	—	—	5132
VK3BQA	—	29028	—	—	—	29028
VK3AFW	546	1485	—	—	—	2031
VK3NKN	1792	—	—	—	—	1792
VK3NEA	340	546	—	—	—	886
VK3AIE	120	224	340	—	—	684
VK3NIH	468	—	—	—	—	468
VK5RX	—	—	23005	—	—	23005
VK5RK	—	—	360	—	—	360
VK5NLC	4	208	—	—	—	212
VK7NFR	—	360	—	—	—	360
VK9XW	15876	21392	418	—	—	37686
ZL1BCG	—	—	165044	—	—	165044

## 24 HOUR SECTION — PHONE

Call	10	15	20	40	80	Total
VK1FT	17088	17407	9	—	—	52546
VK2XT	—	204022	—	—	—	204022
VK2APK	40698	35784	—	—	—	178119
VK2NDK	92713	73500	—	—	—	166213
VK2NVC	—	54426	—	—	—	54426
VK2VRW	54353	48	—	—	—	54401
VK2VAO	41104	12506	—	—	—	53610
VK2VPG	21976	5355	—	—	—	27331
VK2NXH	—	16716	—	—	—	16716
VK2BAM	2087	80	4189	—	—	6336
VK2VHP	660	4320	—	—	—	4980
VK2ABC	—	—	4930	—	—	4930
VK2VCU	—	2352	—	—	—	2352
VK2VKP	120	196	—	—	—	316
VK3ABH	1666	44380	149820	—	—	195866
VK3XB	18423	45752	126363	—	—	<del>195866</del> <i>90538</i>
VK3BRM	109484	<i>19594</i>	30888	—	9	159975
VK3ANA	—	—	51997	—	—	51997
VK3SM	—	14304	6825	—	—	21129
VK3VF	900	896	306	—	—	2102
VK3YF	—	—	399	—	—	399
VK4QK	29252	12870	42245	—	—	84367
VK4LT	32248	19844	23052	—	—	75144
VK4SF	64326	—	—	—	—	64326
VK4VU	180	11097	49770	—	—	61047
VK4UR	23144	759	25651	—	—	49554
VK4NFJ	16800	11890	—	—	—	28690
VK4PJ	—	88	5885	—	—	5974
VK5MS	165088	144882	265408	—	—	575778
VK5ABW	3402	15128	7038	—	—	161968
VK5OU	2030	5100	72625	—	—	79755
VK6NBU	96768	93101	—	—	—	189869
VK6NAT	120960	—	—	—	—	120960
VK6FS	3819	6500	31734	—	—	42053
VK6NEN	32686	—	—	—	—	32686
VK6NAG	—	1040	—	—	—	1040
VK7BC	4601	41182	148060	—	—	193843
VK7NFB	—	360	—	—	—	360
ZL1ADI	163831	2832	555138	—	—	721798
ZL1BOD	119808	298452	187592	—	—	605852
ZL1ANH	—	—	398469	—	—	398469
ZL1AKY	90288	—	—	—	—	90288
ZL1BHR	—	—	—	—	170	170

Call	10	15	20	40	80	
ZL2AH	28710	127000	98512	—	—	254222
ZL2ACP	3015	11169	10248	—	—	217194
ZL2BGJ	—	—	—	713	—	713
ZL2ADP	—	4	240	—	—	244
ZL4MG	588	621	32718	—	—	33931

## 24 HOUR SECTION — CW

Call	10	15	20	40	80	
VK1FT	13800	1564	1794	42	—	17200
VK2APK	40415	37674	48900	—	—	126989
VK2AQF	9443	16376	28448	—	—	54267
VK3XB	9248	49742	64848	—	—	123839
VK3AEW	1376	18300	28440	—	—	48116
VK3VF	3266	25585	1610	—	—	30461
VK3AZW	357	2432	3692	—	—	6481
VK3AMD	744	483	1904	—	—	3131
VK3YF	—	—	1365	—	—	1365
VK3SV	—	—	—	—	20	20
VK4XA	56316	64740	40469	—	—	162097
VK4UR	8288	—	638	—	—	8926
VK4SF	8208	—	—	—	—	8208
VK5KO	18540	—	—	—	—	18540
VK5OR	42	1872	10112	16	1	12043
VK5RX	—	—	9906	—	—	9906
VK5QQ	2660	—	35880	—	—	35880
VK5NLC	100	132	—	—	—	232
VK6HD	—	—	—	—	396	396
VK7BC	7344	378	32004	—	—	39720
VK7ZZ	2298	5858	648	—	—	8804
VK7RY	16	3213	2028	—	3	5261
VK7MC	—	—	—	—	551	551
ZL1ADI	78069	8262	244335	—	—	330666
ZL1AXB	—	—	125967	—	—	125967
ZL1AMO	—	—	—	55692	—	55692
ZL1AFW	16789	4674	2436	—	—	23899
ZL1HV	4860	5056	12584	210	24	22734
ZL2BR	81748	—	85540	—	—	167288
ZL2AGY	—	100744	—	—	—	100744
ZL2TX	2380	1092	24640	1015	—	29127
ZL2KR	—	—	110495	—	—	110495
ZL4MG	1230	—	2790	—	—	4020

## TOP BAND SCORERS

### 8 HOUR SECTION — CW

Call	10	15	20	40	80
VK3RJ	11700	—	—	—	—
VK3AMD	—	483	—	—	—
VK3BQA	—	—	29028	—	—
PHONE	—	—	—	—	—
VK9XW	15876	—	—	—	—
VK3BQA	—	29028	—	—	—
VK5RX	—	—	23005	—	—
ZL1BOD	—	—	165044	—	—

### 24 HOUR SECTION — CW

Call	10	15	20	40	80
VK4XA	56316	64740	—	—	—
VK3XB	—	—	64848	—	—
VK1FT	—	—	—	42	—
VK7MC	—	—	—	—	551
ZL1ADI	<del>78069</del>	—	244335	—	—
ZL2AGY	—	100744	—	—	—
ZL1AMO	—	—	—	55692	—
ZL1HV	—	—	—	—	24
ZL2BIR	—	81748	—	—	—
PHONE	—	—	—	—	—
VK2XT	—	204022	—	—	9
VK5MS	—	165088	—	—	—
ZL1ADI	—	—	265408	—	—
ZL1BOD	—	298452	555135	—	—
ZL2BGJ	—	—	—	713	—
ZL1BHR	—	—	—	—	170

VK5RX, not a huge entry, but not bad for a 71-year-old operator. VK2VPG, good to see so much overseas interest, had chronometer trouble, has anyone a simple method of identifying dupes? VK3AIE, I prefer the old method of scoring. VK7ZZ scored 8804 on CW, not bad for a totally blind operator (by VK6FS). VK3RJ, hope 8 section is continued. VK3NIH, my first contest. VK4KX, contestants should submit a full log, not just a summary. ZL2AGY, I don't envy you the task of checking all the logs one little bit, but your efforts are certainly appreciated by those of us involved

and I think the amount of activity during the contest is also a good indication of its popularity. VK2VHP, this was the second time I've taken part in the VK/ZL contest, first time was in 1938 as an amateur SWL in YR (now YO).

And that completes another contest; winners will receive their certificates within a short time of the results being published, and I hope to see you all again in 1981. Overseas results will be approximately one month after these.

### VK/ZL KONTEST KOMMENTS

My thanks to all those operators who submitted

logs for the Contest, and also to the many who gave serial numbers to overseas participants but d'd not enter a log.

Conditions were not very kind, although some operators managed quite high scores. However, that was the first and last contest that I will accept a summary sheet only, instead of logs. The logs were all checked and the overall picture emerged of entrants not removing duplicates or scoring correctly. This was also evident in those logs called up by the Manager from some operators who only submitted summary sheets.

From our checks, about three hundred VK/ZLs gave numbers to overseas operators.

Let's have more from the novice ranks, as their numbers were well down. However, some good scores were entered by "N" calls, and I hope to see more of them in future contests.

For contest most of the work was done by Hugh VK6FS, and my thanks go to him for his efforts. "Six Flying Saucers" made these comments about the logs:—They sign the declaration that the rules have been observed, but it appears in some instances that they haven't even read them. Please impress on contest operators (as per rules) a SEPARATE LOG for EACH BAND IS REQUIRED. One declaration was signed by two log checkers for the operators as being correct, and it was found that the scoring system they used was their own, giving 6 points for JA6, 29 points for P29, 4 points for WA4, and 1 point for PA0 (why not 107). Very few logs had duplicates removed—In future deduct 10 points for each one not removed. Please don't accept logs that look like a Chinese laundry ticket. One log, even my chemist could not work out the call signs for me, it was so poorly written.

In one high scoring log I checked 50 contacts and found 20 were invalid. What will we do about it?

Some comments from the logs:—

VK2XT—It appears that according to the 1978 results, most have gone away from the multi-band operation because of the rules (ZL organised in 1978), and I guess it will be reflected again because of the altered points scoring this time. To me it is disappointing to find that a contest does not encourage multi-band operation.

ZL1BQD—Perhaps the organisers may give consideration to a different method of scoring to give more incentive to work all bands. At the moment, an operator is penalized by lack of OSOs in trying to pull out, say 10-20 OSOs on 160m.

L30092—As one who until 1977 had entered almost every one of these contests since 1934, I can only say that to eliminate the Listeners' Section was LOUSY—all the more so because of the fact that no reason has been published for doing so.

# YOU and DX

Mike Bazley VK6HD

8 James Road, Kalamunda W.A. 6076

A7XE is very active on all bands CW 80 through to 10, on the low end, QSL via DF4NW.

DJ1US/ST3 is also another CW station that is active on all bands 80 through 10 and often found on 40 metres from 1600Z to 2300Z. QSL via DF2RG.

3B6CD is often ORV from 1400Z on 7015 kHz.

3C1AB, 3C1JP, 3C1NE and 3C1NM are constructing a TV station in Bata and will be there for about nother year. QSL via EA1QF. Active on all bands using SSB.

N4HX/TT8 skeds ON5NT every Sunday on 21240 kHz at 0930Z. A call to ON5NT 5 minutes before sked time can result in a QSO with the TT8.

If you worked PPOMAG recently he was operating from Trinidad. QSL via PY1MAG.

Finally, rumour has it that XZ0ONU will be active from mid-April.

Thanks to those who have supported this column in the past. 73 es DX to all, Mike VK6HD.

Will you miss this column? This has been the last column by Mike Bazley VK6HD and readers will join with the production staff of Amateur Radio in thanking Mike for his efforts over the past year. We now would like another writer—any suggestions?

# IONOSPHERIC PREDICTIONS

Len Poynter VK3ZGP/NAC

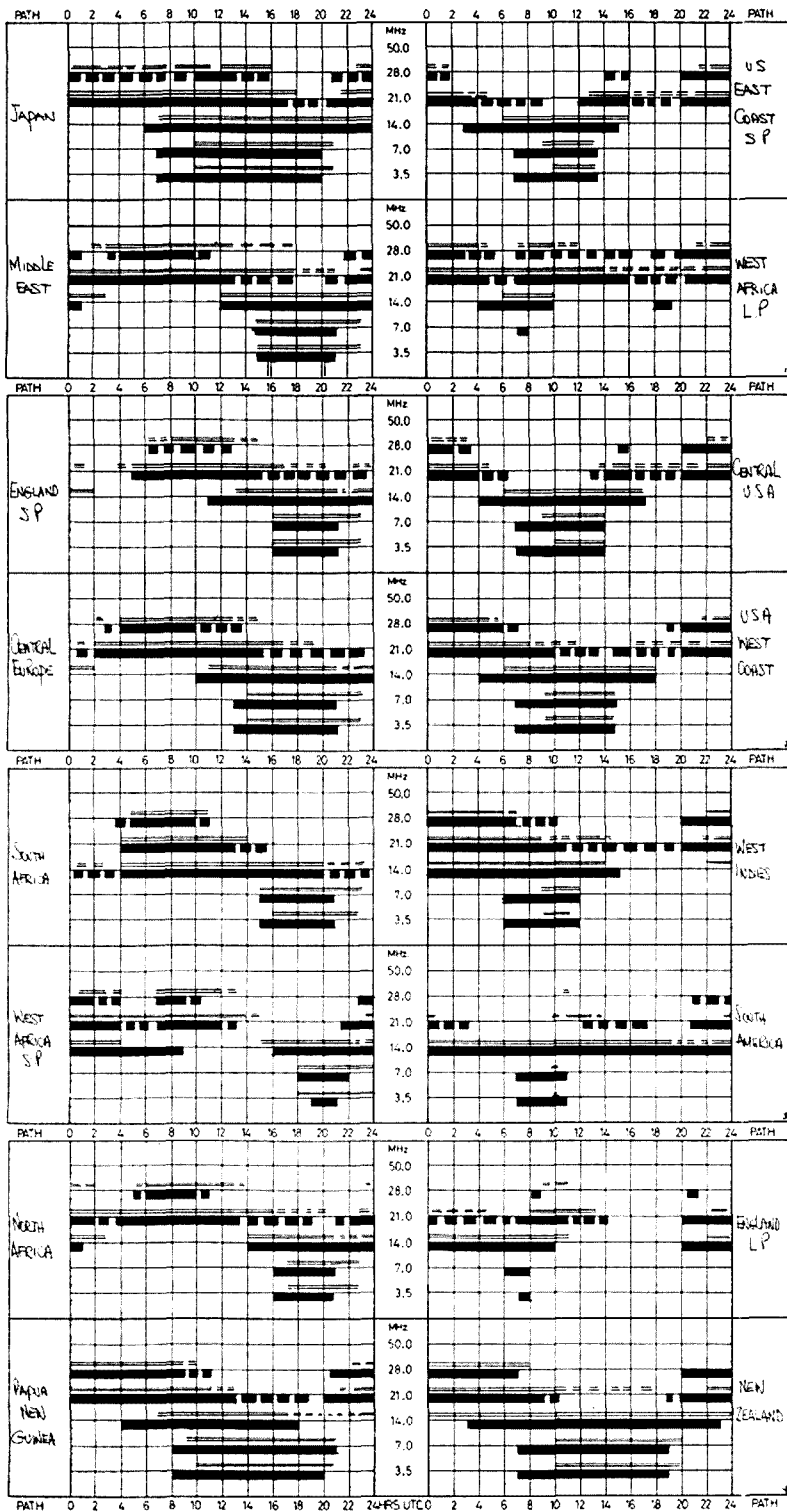

**LEGEND**

FROM WESTERN AUSTRALIA  
FROM EASTERN AUSTRALIA

BETTER THAN 50% OF THE MONTH, BUT NOT EVERYDAY

LESS THAN 50% OF THE MONTH

PREDICTIONS COURTESY I.P.S. SYDNEY

ALL TIMES UNIVERSAL UTC (GMT).

**JOIN A NEW MEMBER — NOW!**

# HAMADS

- Eight lines free to all WIA members. \$9 per 3 cm for non-members.
- Copy in typescript please or in block letters to P.O. Box 150, Toorak, Vic. 3142.
- Repeats may be charged at full rates.
- Closing date: 1st day of the month preceding publication. Cancellations received after about 12th of the month cannot be processed.
- QTHR means address is correct as set out in the WIA 1979 Call Book.

## FOR SALE

Yaesu FT2F 2m Txcvr, xtlals rep. 2, 4, 8, simplex 40, 50, in very good working order, \$100. VK3SS. Ph. (051) 47 2265.

Free Standing Radio Tower, triangular 4 ft. base, 2 sections to 47 ft., 60 ft. with 2 in. tubing, top section hinges down, rust-proofed and galvanised, small working platform at top, complete with top bearing thrust race, ART 3000 heavy duty rotator and 150 feet rotator cable, plans and computations supplied, dismantled ready for transport, price \$500. David VK3ADM, QTHR. Ph. (03) 592 2168 after 5 p.m.

FT75B, AC, DC, VFO, GC. VK3NXL. Ph. (059) 62 5236.

Drake Txcvr TR4C with noise blanker fitted, as well as 12V DC and 240V AC p/s, \$650, ONO. Alf Chandler VK3LC, QTHR. Ph. (03) 99 5344.

Yaesu FLDX 400 Tx, with FR DX 400 Rx, \$450. W. H. Cure. Ph. (002) 44 1268, or Box 42, Bellerine, Tasmania 7018.

T159 Programmable Calculator with PC100A printer, standard plus advance manuals, as new, \$385. VK2BHE. Ph. (066) 21 2211 Bus., (066) 24 1447 AH, or PO Box 570, Lismore 2480.

Galaxy 3 HF Tcvt, 80, 40, 20m, 300W PEP 1/p SSB/CW, automatically selects USB/LSB for band in use, Galaxy PSU to match, \$215. Dave Morrell VK5NDM/ZOW. Ph. (08) 44 4226 AH, (08) 225 6647 BUS.

Drake SSR-1 Rx, 0-30 MHz, SSB and AM, \$200. VK2AAB. Ph. (02) 487 1428.

Amateur Shack, including 5-roomed house, complete with functional aerial systems and extensive earthing complex, \$29,950. VK5HR, QTHR. Ph. (08) 31 2181.

TS520S Txcvr, with DG-5 dig. readout, sell for \$700, ONO; also TH3JR triband yagi for \$120, ONO. Please contact Jack VK2NTK, QTHR. Ph. (02) 344 7436 AH, (02) 31 3273 Bus.

IC-22S, in excellent cond., with mobile mounting bracket, \$200. VK4ZRL. Ph. (071) 28 2785.

FT101Z Txcvr, dig. readout and fan, as new, modified for Novice, \$800; FT7 Txcvr, in mint cond., NB mod. with yaesu whips and base, \$400; SP820 Kenwood speaker with filters, \$50; Dick Smith keyer, \$40. VK5NAR. Ph. (087) 62 2034.

Yaesu FT620 Txcvr, mint cond., \$350. VK4AMQ, QTHR. Ph. (075) 31 7923.

Yaesu FT200 with FP200 power supply, instruction manual and spare final tubes, \$325. VK3MX, QTHR. Ph. (03) 557 2260.

Hygain TH3, Mk. 3 Triband Beam, partly disassembled, in sound cond. and with balun and original instructions, \$95. Buyer must collect. VK3AEP QTHR. Ph. (03) 90 2568.

Kenwood TS120-V, new cond., complete with mic., instruction manual and accessories, \$500. Sydney metropolitan area sale preferred. Ross Treloar VK2BPZ. Ph. (02) 239 5267 Bus.

Hidarka Vertical Trap Antenna, 10-80 m, \$70; lightweight rotator by Crown, 1 month's use, \$60. Rob Williams VK3VOS. Ph. (03) 439 9632.

Kenwood TS600 6m All-mode Txcvr, incl. VOX attachment, new cond., original packing, \$550. VK3KK, QTHR. Ph. (03) 469 4200 after 6 p.m.

Standard C-6500 HF Wadley Loop Comm. Rx, 0.5-30 MHz, three different power sources, 12 months old, very good cond., \$290. Les L31187, QTHR. Ph. (03) 277 1874.

# SILENT KEYS

It is with deep regret that we record the passing of —

Mr. D. R. GARRATT	VK3BDQ
Mr. E. C. HOWARD	VK2XX
Mr. J. T. WILSON	VK3ACV
Mr. D. McKENZIE	VK3ALQ
Mr. R. S. J. SMITH	VK1JS
Mr. G. R. S. SMITH	VK1ED
Mr. P. GARRISON	VK4NHT
Mr. K. F. PETERS	VK3AKP
Mr. D. McKENZIE	VK3ALQ
Mr. J. T. WILSON	VK3ACV
Mr. W. K. WITT	ex XKW
Mr. A. H. REID	VK3AHR

# OBITUARY

Mr. P. GARRISON VK4NHT  
It is with deep regret that I announce the passing of Peter Garrison VK4NHT/ZCN, aged 32, victim of an unfortunate accident on Sunday, 20th January, 1980.

Although an amateur radio operator for only a short period of time, Peter made many friends, due to his friendly attitude and from his willingness to help people in things, such as erecting antennas, etc., and I feel that they will join me in offering our condolences to his wife, Brenda, and families, for their great loss. Peter was a big man with an even bigger heart, and I consider it an honour to have been able to call him "friend".

Ernie Hall VK4ACX/ex-NKO. ■

Audio Frequency Generator, Trio AG-202A CR oscillator, range X 1 20 Hz to 200 Hz through X 1000 20 kHz to 200 kHz, sine and square wave, attenuator provides for output 10V RMS to 0, perfect cond., \$100, ONO; Ultrasonic burglar alarm, Philips, AC with battery reserve, alarm delay 1 to 15 secs., output 1 watt at 2000 Hz, facilities for transducer strips, ideal for ham shack, \$100, ONO. Trevor VK3NNR, QTHR. Ph. (03) 459 3845.

FR101, all bands, filter, etc., 160-2m, matching FL101 with sp. proc., \$1000 pair, might consider split; YQ101 late model monitroscope, \$200; FTV250 2m 1/v with preamp, \$150; FTV650B 6m 1/v with preamp and 6883B, \$150; FT-201 80-10m trcvr, 2 units fitted with 3 filters, \$400 each; BS-6D AC version of MR6A with Ch. 40, 4, 5, 6, 7 and 8, \$75; Alda 103 mobile, 100 watts, 80, 40 and 20, compl., \$300; Lunar 2m 10/150P PA with preamp, \$300; IC211, 12 mo., \$550; IC551D, 100W 6m, 3 mo., \$750; PS20, 20A supply, 3 mo., \$125; 2m s/s HB amp with MRF345, 90W o/p, \$100; 2m PA board 2N6084, 60W, \$20; 3 6A AC/DC p/s, \$20 each; p/s hardware with 40V AC 20A 1/f, \$75; Osker blocks, 2 only, used, \$35 each; Ring for other bits and pieces. Steve Gregory VK3OT, QTHR. Ph. (055) 72 3333.

14 AVQ Wide Band Trap Vertical, 10 to 40m, suitable for home station, field days or camping, no guys required, \$95. VK3ASL, QTHR. Ph. (03) 598 9467.

2m 40W Amplifier (6 up model), \$25; nine element qualitronics 2m yagi, \$20; MR3 tscrv, needs rejuvenating, \$20. VK3IG, QTHR. Ph. (058) 52 1636.

IC215 2m Txcvr, Ch. 42, 44, 48, 50, as new, little used, in original packing, \$150. J. N. Thornton VK4AJT (ex VK4ZJT), 38 John St., Scarness, Old. 4656. Ph. (071) 28 1685.

Multi 7 Mobile 10W/1W accessories, socket repeaters 2, 4, 6, 8, simplex 40, 50, exc. cond., with mic., \$180. VK3BBM, QTHR. Ph. (03) 232 7084.

Two Only New Shugart SA-400 minifloppy disk drives with cables, connectors and manual, \$390 each, ONO. VK3ZMV, QTHR. Ph. (03) 435 0130.

Yaesu Linear FL2000, v.g.c., \$325. VK3BCY. Ph. (03) 438 3369.

Kenwood TV 506 6m Transverter, suit 520 and TS520S series, mint cond., \$175, includes three element beam free. VK2CI, QTHR. Ph. (049) 66 2231.

Dalwa RF550 Deluxe, filter type speech processor, AC/DC operation, meter, superb performance, 10 dB lift in signal, as new in carton, \$135, ONO; Kenwood KP202 hand-held 2m FM txcvr, xtlals for repeaters 2, 4, 6 and 8 and simplex 40 and 50, complete with nicad batteries, charger, leather case, "rubber duck" antenna, manual and orig. carton, excellent cond., \$160, ONO. VK3ARZ, QTHR, or Ph. VK3OM (03) 560 9215.

Collins 75S-3, 32S-1 and speaker/power supply, \$950; Collins 75A4 receiver with 3 mechanical filters, \$385. VK1VP, QTHR. Ph. (062) 48 5882 AH.

FT200, plus matching PSU and external speaker, also fan for finals, v.g.c., \$350, ONO. VK3BHL, QTHR. Ph. (03) 557 4465.

FR101D, complete with all options and all frequencies possible, mint cond., \$800, will take smaller Rx as part payment; FT-221 all mode 2m unit, mint cond., \$500; FT-75B, plus YC-7B remote digital display, \$550. VK4UX, QTHR. Ph. (074) 62 2596.

Drake Txcvr TR4C with noise blanker fitted and 12V DC/240V AC PS, \$650, ONO. VK3LC, QTHR. Ph. (03) 99 5344.

Realistic DX-160 Com. Rx, SO-239 coax. socket fitted, \$125; sideband SE-502 23 channel 10m Txcvr, 12W, \$100; both with manuals and in orig. packing; will sell separately. Ross VK4NXB, 51 Spicer Street, Laidley. Ph. (075) 65 1445 after 6 p.m.

A-TRONIX Code Reader, alpha-numerical display, 7 to 40 w.p.m., 12V or 240V AC, just the unit to upgrade your CW, no further use. full instructions and circuit diagram, \$125 posted. VK4NMJ, QTHR.

## WANTED

Kenwood T599D Transmitter. Price and particulars to VK4NMJ, QTHR.

Someone to come and rid a Model 15 Teleprinter of various problems, will pay for travelling and time spent. T. Robinson L31105, Lot 92, Russell Avenue, Woodend, Vic. 3442.

Donation of a quantity of high band VHF radios, mobile or base. If you can help please send any sets or even parts to Broadford Railway Station, Victoria 3658 or Ph. (057) 84 1558, VK3NTU (for most worthy cause), QTHR.

Swan 240 Tri Band Transceiver with or without PS. VK2QC, QTHR. Ph. (044) 76 7927.

Kenwood KP202 2m FM, hand-held, c/w nicad batteries and charging base. Please contact VK2NTY/YOC, QTHR. Ph. (080) 5285.

General Coverage Rx, working, for young lad showing interest in ham radio, looking for something at the low end of the price range. Laurie VK2AQW. Ph. (02) 436 2766 Bus., (02) 358 3995 AH.

## TRADE HAMADS

High-Gain Beams for 40, 20, 15, 10, 6, 2 and 70 cm, also UHF CB and ATV repeaters, DSI frequency counters and kits, Mirage PWR/SWR meters, also 2m amps with preamp., 10W in 80W out, amp. with Rx preamp., suit 50-54 MHz. Write ATN Antennas, Box 80, Birchip 3483, for catalogue.

# ADVERTISERS' INDEX

AMATEUR RADIO ACTION	43
BAIL ELECTRONICS	2
CHIRNSIDE ELECTRONICS	0BC
CW ELECTRONICS	24, 25
DICK SMITH ELECTRONICS	27
SIDEBAND ELECTRONIC ENGINEERING	37
SCALAR INDUSTRIES	7
VICOM	9, 14, 15, 23, 47
WILLIAM WILLIS & CO. PTY. LTD.	27

# WHY ICOM HAS THE 2 METRE MARKET SEWN - UP . . . . .

## 6 Great Rigs of the highest quality!



### "THE FAMOUS IC22S"

Over 3000 of these popular am fm mobile rigs in use in Australia. Uses a programmable divide matrix giving 22 channels. Comes complete with mic, mobile mounting bracket, dc leads and VICOM 90 day warranty. LIST PRICE \$299.



### "IC260A SSB/FM/CW MOBILE"

This new mobile all-mode rig covers 144-148 MHz. Features uP control, multi-purpose scanning twin VFO's, efficient noise blanker, CW break-in and many other circuits for your convenience. The IC260A runs 10 watts and offers outstanding performance. Your new IC260A comes complete with mic, manual, mobile mounting brackets and 90 day warranty. LIST PRICE \$599.



### "IC251A all-mode base station/mobile"

The popular ac/dc Microprocessor-controlled rig incorporating multi-purpose scanning, dual VFO's light weight and featuring the ICOM outstanding performance. The optical chopper tuning system means no backlash and problem free use as there is no dial gear or variable capacitors. Drop in and see a new IC251A at your VICOM dealer today! LIST PRICE \$847.



### "IC2A mini hand-held"

ICOM'S newest am rig, about the size of a \$2 note! 1.5 watts output using unique slip on/off and selectable size nicad packs. Offers 800 channels 144-148 MHz. The cheapest am hand-held around. ONLY \$279



### "IC255A 25w FM MOBILE"

The uP controlled fm mobile runs 25 watts output which means greater QSO range. The receiver uses the newly developed low-noise and large dynamic range junction FET's (for the RF amplifier and first mixer) and helical cavity filters providing excellent sensitivity and intermod distortion characteristics. Your new IC255A comes complete with VICOM'S 90 day warranty. OUR PRICE \$425.



### "IC280 Remotable mobile"

The IC280 squeezes optimum performance into the tightest spaces. Using a detachable front section, the diminutive IC280 is designed to fit the most cramped modern vehicle. Small size means big performance with ICOM - your new IC280 remotable comes complete with mic, mobile bracket and comprehensive instruction manual. STILL ONLY \$450!

## ICOM PERFORMANCE: NOBODY DOES IT BETTER!

# ICOM

Distributed in Australia by VICOM

set your sights on this ...

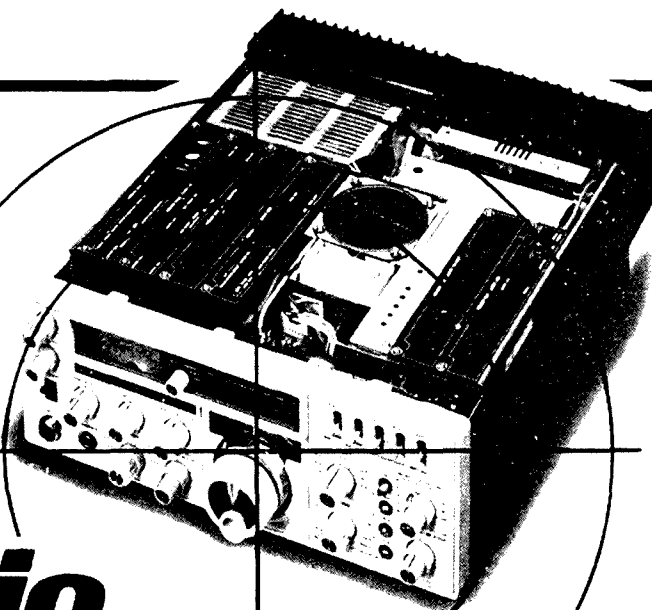

# YAESU *The radio.*

now presents you the all new

## FT-107 SERIES SOLID STATE HF TRANSCEIVER

The FT-107M is the rig you've been waiting for. The versatility of all solid state construction is teamed with the time-proven design techniques from the FT-901 and FT-101Z transceivers to give you—today's active amateur—the competitive edge under the demanding conditions of the next decade.

MELBOURNE'S LEADING AUTHORIZED YAESU DISTRIBUTOR.

# BIG DISCOUNTS ON YAESU NOW!

FT-101Z. 160-10M Transceiver. analog dial.  
FT-101ZD. 160-10M Transceiver. Digital.  
optional digital display for FT-101Z.  
optional Fan.  
optional DC-DC converter.

YE-7A Hand mike.  
YD-148 Desk mike.  
FT-901DM. 160-10M Transceiver.  
FV-901. ext. VFO for FT-901 & FT-101Z.  
YO-901. Panoramic adapter monitorscope.  
FC-901. Antenna coupler.  
FTV-901. Converter. 6M, 2M, 70 cm. all inc.  
FTV-901. Converter. 6M, 2M.  
SP-901. ext. speaker.  
FRG-7. Communication receiver.  
FRG-7000. Digital communications receiver.  
LF-2A Narrow band filter for FRG-7.  
FT-7B. 80-10M Transceiver.  
FP-12. 12 Amp. power supply for FT-7B.  
YC-7B. Digital display for FT-7B.  
FT-227RB. 2M Digital programmable transceiver.  
YP-150. Dummy load/Watt meter.  
FF-50DX. Low pass filter. 2kw.  
QTR-24D Deluxe 24 hr. World clock.  
FT-207R Handheld.  
Base charger.  
FT-107 NEW HF RANGE.  
FT-707 NEW HF TRANSCEIVER RANGE.



WRITE OR GIVE US A CALL TODAY!



FRG7 Synthesized Receiver.  
For amateurs, novices and shortwave listeners. Electronic band changing with 0.5 - 29.9 MHz continuous coverage. Uses Wadley Loop to derive synthesized heterodyne oscillator signal. LSB, USB, AM and CW. Frequency readout better than 10KHz. stability within 500Hz. Write for full details

\$309.--

We also stock:

ICOM IC22S .....	\$289.
LEADER Ham scope .....	\$309.
LEADER Dip meter .....	\$89.
TONO 7000E Computer .....	\$895.
DIAWA CN620 SWR meter .....	\$95.
DIAWA Ant. Coupler CN217 .....	\$155.
AUTO Ant. coupler CN1001 .....	\$259.
KENWOOD R-1000 Communications Receiver .....	\$489.
TS-120S HF Transceiver .....	\$689.
TL-120 Solid State Linear .....	\$229.
HC-500A Tokyo Hy-Power Labs transmatch .....	\$229.
500 W PEP .....	\$109.
HI-Q Baluns for dipoles, beams etc .....	\$16.
5 Position coax switches .....	\$38.
2 Position coax switches .....	\$16.
plus Morse keys, dummy loads etc.	

### EMOTATOR ROTATORS

103LBX. Medium Duty .....	\$169.
502Cxx. Heavy Duty .....	\$249.
1102MXX. Extra Heavy Duty .....	\$349.
1103MXX. Extra Extra Heavy Duty .....	\$395.
502 Mast Clamp .....	\$32.
103 Mast Clamp .....	\$20.
VCTF-7. 7 Core Cable per metre .....	\$1.20.
VCTF-6. 6 Core Cable per metre .....	\$1.00.



welcome here

CHIRNSIDE ELECTRONICS, 26 Edwards Road, Chirnside Park, Lilydale, 3116. Phone (03) 726 7353



# amateur radio

JOURNAL OF THE WIRELESS INSTITUTE OF AUSTRALIA



VOL. 48, No. 5

MAY 1980

## ***FEATURED IN THIS ISSUE:***

- ★ **POINTING ANTENNAS WITH MICROCOMPUTERS**
- ★ **ON-AIR MONITOR FOR SSB**
- ★ **VK-ZL OCEANIA DX CONTEST 1980 RULES**
- ★ **REVIEWS — THE MIRAGE B108 AMPLIFIER and  
DSI5500 FREQUENCY COUNTER**
- ★ **QRP CW — LET'S GIVE IT A SHOT IN THE ARM**

Registered for posting as a Publication —  
Category "B".

# commodore

## NOVICE OR FULL LICENSE

The worlds of the Personal Computer Enthusiast and the Amateur Radio Operator are overlapping. More and more Amateurs are communicating in Morse or RTTY (and ASCII)\* via their mini-computers. Computers such as the Commodore CBM and Pet have added an exciting new dimension to enthusiast radio communications.

Next to your Commodore mini-computer all that is needed to join this aspect of our hobby is a Macrotronics Morse/RTTY interface, which comes complete with its own software. This interface is the link pin between computer and station. Macrotronics interfaces are also available for Apple TRS-80, Sorcerer and soon the new System 80. The desk top minicomputer is not only used as a

communication terminal but can be utilized for keeping log books, QSL mailing lists, competition logs. As the band of enthusiast grow so new software and uses come available. While the Commodore, the interface and your station are all that is needed to join this exciting area of Amateur Radio, optional extras are available to increase the functions and abilities of the computer. Floppy Disk Drives - like four draw filing cabinets from which, and at very high speed, one can store and draw messages and information. Printers - some of which enable you to take printed records of communications and print out log books etc. The worlds of the Amateur Radio Operator and the Computer Enthusiast are open to you through CW Electronics.

### MINICOMPUTER INCENTIVE OFFER UNIQUE TO CW ELECTRONICS

With each Commodore 16K or 32K mini-computer purchased from CW Electronics by a licensed Amateur Radio Operator will come, at no extra cost, a MACRO-TRONICS M65 Ham Interface for Morse Code and RTTY (and ASCII) Transceiving.\*  
**SAVE \$149**

### SERVICE DIVISION

We have a fully equipped electronic service division. We can service enthusiast and commercial electronic gear efficiently and at a reasonable charge. Wholesalers, agents, manufacturers and retailers please consider us for your next Queensland service contract. CW can arrange service and service contracts of Commodore computers within Australia and PNG.  
Telephone: (07) 341 5377 A.H.: (07) 341 4767

**\*\*WHILE CURRENT STOCKS OF M65 LAST \*Refer to license limitations on Morse and RTTY communications.**

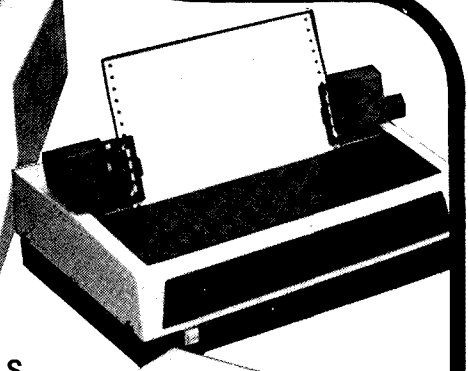

### PERIPHERALS SOFTWARE INTERFACES

### BUSINESS MEN

We have available software packages available for the COMMODORE Minicomputers

- Creditor package
- Debitor Package
- Complete Word Processing
- Stock Control and others

We have a customising service for modification and specials.

**PROGRAMMERS**-we are interested in merchandising your original quality software packages for popular mini and personal computers.

AUTHORIZED  
DEALER

VICOM



**MACROTRONICS, inc.**

Delux RTTY and Morse System for Commodore computers including complete software on cassette, assembled and tested hardware, and extensive instructional manual.

**M650 DELUX**

Interfaces also available for TRS-80, Apple, Sorcerer and soon the System 80

# ELECTRONICS

CNR. MARSHALL RD AND CHAMBERLAND ST.,  
TARRAGINDI - BRISBANE PH. (07) 48 6601  
P.O. BOX 274, SUNNYBANK, QLD. 4109  
AH: BRIAN (07) 341 4767 TELEX AA 40811



**MAY 1980**  
**VOL. 48, No. 5**  
**PRICE: \$1.20**

Registered Office:  
3/105 Hawthorn Road,  
Caulfield North 3161.

**MANAGING EDITOR:**  
BRUCE BATHOLS\* VK3UV

**PRODUCTION MANAGER:**  
MARK STEPHENSON\* VK3NOY

**TECHNICAL EDITORS:**  
BILL RICE\* VK3ABP  
EVAN JARMAN\* VK3ANI  
RON COOK\* VK3AFW  
GIL SONES\* VK3AUI

**CONTRIBUTING EDITORS:**  
BOB ARNOLD VK3ZBB  
MIKE BAZLEY VK6HD  
ROD CHAMPNESS VK3UG  
ROY HARTKOPF\* VK3AOH  
RON FISHER\* VK3OM  
ERIC JAMIESON VK5LP  
PETER MILL VK3ZPP  
LEN POYNTER\* VK3BYE  
BILL VERRALL VK5WV  
WALLY WATKINS VK2DEW

**DRAFTING:**  
NEIL OSBORNE\* VK3YE1

**BUSINESS MANAGER:**  
PETER DODD VK3CIF

\*Member of Publications Committee

Enquiries and material to:  
The Editor,  
PO Box 150, Toorak, Vic. 3142

Copy is required by the first of each month. Acknowledgement may not be made unless specially requested. All important items should be sent by certified mail. The editor reserves the right to edit all material, including Letters to the Editor and Hamads, and reserves the right to refuse acceptance of any material, without specifying a reason.

Advertising: Material should be sent direct to P.O. Box 150, Toorak, Vic., 3142, by the 25th of the second month preceding publication. Phone: (03) 528 5962. Hamads should be sent direct to P.O. Box 150, Toorak, Vic., 3142, by the 1st of the month preceding publication.

Trade Practices Act: It is impossible for us to ensure that advertisements submitted for publication comply with the Trade Practices Act 1974. Therefore advertisers and advertising agents will appreciate the absolute need for themselves to ensure that the provisions of the Act are complied with strictly. Readers are reminded that, when buying, obtaining or receiving goods from overseas including goods listed in advertisements by overseas organisations in this Journal, Customs import duties and Sales Tax may be levied on the goods at the time of importation. These amounts, if any, are payable by the purchaser unless the terms of sale state otherwise and the seller has made specific provision to this effect in his quotation to the buyer or unless other prior arrangements are in force between the buyer and the seller.

Typesetting: MUELLER INDUSTRIES  
1a Levenswell Road, Moorabbin, 3189  
Tel.: 553 0292

Printers: EQUITY PRESS PTY. LTD.  
50-52 Islington Street, Collingwood, 3066  
Tel.: 41 5054, 41 5055

## CONTENTS

### TECHNICAL

An On-Air Monitor for SSB 10  
Pointing Antennas with  
Microprocessors 6

### GENERAL

Amateur Radio and the Public 22  
NOVICE NOTES —  
Bit of Psychology 24  
GRP CW — Let's give it a Shot  
in the Arm 20  
Reviews — The Mirage B108 2m  
Amplifier and DS5500 Frequency  
Counter 18  
VK/ZL Oceania DX Contest 1980 15  
WICEN in Victoria 19

### DEPARTMENTS

Afterthoughts 9  
ALARA 37  
Amateur Satellites 30  
Around the Trade 37  
Awards Column 35  
Contests 36  
Divisional Notes 39  
Hamads 41  
International News 38  
Intruder Watch World-Wide 36  
Ionospheric Predictions 40  
Letters to the Editor 36  
Listening Around 25  
Magazine Review 38  
Magpubs 23  
Main QSP 4  
Novice Notes 24  
QSP 5, 16  
Stolen Equipment 39  
VHF-UHF — an Expanding World 33  
WIANEWS 5  
You and DX 39

ADVERTISERS' INDEX 42

## Cover Photo

### AMATEUR RADIO PHILATELISTS

The Radio Amateurs' column in the December 1979 issue of the Telecommunication Journal reviews the postage stamps issued to honour amateur radio. The first was the USA 5 cent postage stamp issued in 1965 on the occasion of the 50th anniversary of the ARRL. The second was an 0.85d. stamp in 1966 by Yugoslavia to mark the 20th anniversary of SRJ. Colombia issued a 60 peso stamp in 1973 to mark the 40th anniversary of the LCD. Also in 1973 the USSR issued a 4k stamp paying homage to Ernst Krenkel, a prominent amateur. Poland issued a 1.50z stamp in 1975 for the IARU Conference in Warsaw that year. In the same year Costa Rica issued three separate airmail stamps of 1.00, 1.10 and 2.00c values to recognise the 16th annual meeting of FRACAP. In 1977 the Dominican Republic issued two stamps of 6c and 12c for the 50th anniversary of RCD. Brazil issued a 1.30Cr dollar stamp carrying the words "Day of the Radio Amateur" and Japan issued a 50y stamp commemorating the 50th anniversary of JARL. In 1979 the Dominican Republic issued a 10c stamp relating to the Beata Is. amateur competition. Bolivia issued a 3p stamp carrying the insignia of RCB. West Germany a 60p stamp honouring WARC 79 and finally Switzerland issued a 70c stamp for the 50th anniversary of USKA. V. Clark W4KFC.

# WIRELESS INSTITUTE OF AUSTRALIA

Federal President: Dr. D. A. Wardlaw VK3ADW

## Federal Council:

VK1 Mr. R. G. Henderson VK1RH

VK2 Mr. T. I. Mills VK2ZTM

VK3 Mr. G. A. G. Williams VK3XZW

VK4 Mr. A. R. F. McDonald VK4TE

VK5 Mr. C. J. Hurst VK5HI

VK6 Mr. N. R. Penfold VK6NE

VK7 Mr. R. K. Emmett VK7KK

Stall: Mr. P. B. Dodd VK3CIF, Secretary.

Parl-time: Col. C. W. Perry, Mrs. J. M. Seddon and Mr. Mark Stephenson (AR Production).

Executive Office: 3/105 Hawthorn Rd., Caulfield North, Vic. 3161. Ph. (03) 528 5962.

Divisional Information (all broadcasts are on Sundays unless otherwise stated).

## ACT:

President — Mr. A. Davis VK1DA

Secretary — Mr. F. Robertson-Mudle VK1NAV

Broadcasts— 3570 kHz and 2m Ch. 6 (or 7): 10.00Z.

## NSW:

President — Mr. F. S. Parker VK2NFF

Secretary — Mr. T. I. Mills VK2ZTM

Broadcasts— 1825, 3595, 7146 kHz, 28.32, 52.1, 52.525, 144.1, 145.6, 146.4, Rptr. Ch. 3— Gosford, Ch. 4—Lismore, Ch. 5 Wollongong, Ch. 8—Dural 11.00h local (Evening 0930Z). Relays on 160, 80 and 10m, VHF and Repr. Ch. 3, Ch. 5, Ch. 8, and Hunter Branch, Mondays 0930Z on 3595 kHz, 10m, and Ch. 3 and 6. RTTY Sunday 0030Z 7045, 14090 kHz, Ch. 52, 0930Z 3545 kHz, Ch. 52.

## VIC.:

President — Mr. E. J. Buggee VK3ZZN

Secretary — Mr. G. F. Atkinson VK3YFA

Broadcasts— 1840, 3600, 7135 kHz— 53.032 AM, 144.2 USB and 2m Ch. 2 (5) repeater: 10.30 local time.

Gen. Mtg. — 2nd Wed., 20.00.

## QLD.:

President — Mr. A. J. Aarsee VK4QA

Secretary — Mr. W. L. Gielis VK4ABG

Broadcasts— 1825, 3580, 7146, 14342, 21175, 28400, kHz; 2m (Ch. 42, 48): 09.00 EST.

Gen. Mtg. — 3rd Friday.

## SA:

President — Mr. I. J. Hunt VK5QX

Secretary — Mr. W. M. Wardrop VK5AWM

Broadcasts— 1820, 3550, 7095, 14175 kHz; 28.5 and 53.1 MHz, 2m (Ch. 8): 09.00 S.A.T.

Gen. Mtg. — 4th Tuesday, 19.30.

## WA:

President — Mr. Ross Greenaway VK6DA.

Secretary — Mr. Peter Savage VK6NCP.

Broadcasts— 3560, 7075, 14100, 14175 kHz. 28.47, 53.1 MHz, 2 metres Ch. 2 Perth, Ch. 6 Wagin. Time 0130Z.

Gen. Mtg. — 3rd Tuesday.

## TAS.:

President — Mr. I. Nicholls VK7ZZ

Secretary — Mr. P. T. Blake, VK7ZPB

Broadcasts— 7130 (AM) kHz with relays on 2m Ch. 2 (S), Ch. 8 (N), Ch. 3 (NW), 09.30 EST.

## NT:

President — Mr. T. A. Hine VK8NTA

Vice-Pres. — Barry Burns VK8DI

Secretary — Robert Milliken VK8NRM

Broadcasts— Relay of VK5WI on 3.555 MHz and on 146.5 MHz at 2330Z. Slow morse transmission by VK8HA on 3.555 MHz at 1000Z almost every day.

## Postal Information:

VK1 — P.O. Box 46, Canberra, 2600.

VK2 — 14 Aitchison St., Crows Nest, 2065 (Ph. (02)

43 5795 Tues & Thurs (10.00-14.00h).

P.O. Box 123, St. Leonards, NSW 2065.

VK3 — 412 Brunswick St., Fitzroy, 3065 (Ph. (03) 41 3535 Weekdays 10.00-15.00h).

VK4 — G.P.O. Box 638, Brisbane, 4001.

VK5 — G.P.O. Box 1234, Adelaide, 5001 — HQ at West Thebarton Rd., Thebarton.

VK6 — G.P.O. Box N1002, Perth, 6001.

VK7 — P.O. Box 1010, Launceston, 7250.

VK8 — (Incl. with VK5), Darwin AR Club, P.O. Box 37317, Winnellie, N.T., 5789.

Slow morse transmissions — most week-day evenings about 09.30Z onwards around 3550 kHz.

## VK QSL BUREAUX

The following is the official list of VK QSL Bureaux, all are inwards and outwards unless otherwise stated.

VK1 — QSL Officer, G.P.O. Box 46, Canberra, A.C.T. 2600.

VK2 — QSL Bureau, C/- Hunter Branch, P.O. Teralba, N.S.W. 2284.

VK3 — Inwards QSL Bureau, Mr. E. Trebilcock, 340 Gillies Street, Thornbury, Vic. 3071.

VK3 — Outwards QSL Bureau, Mr. R. R. Prowse, 83 Brewer Road, Bentleigh, Vic. 3204.

VK4 — QSL Officer, G.P.O. Box 638, Brisbane, Qld., 4001.

VK5 — QSL Bureau, Mr. Ray Dobson VK5DI, 16 Howden Road, Fulham, S.A. 5024.

VK6 — QSL Bureau, Mr. J. Rumble VK6RU, G.P.O. Box F319, Perth, W.A. 6001.

VK7 — QSL Bureau, G.P.O. Box 371D, Hobart, Tas. 7001.

VK8 — QSL Bureau, C/- VK8HA, P.O. Box 1418, Darwin, N.T. 5794.

VK9, 0 — Federal QSL Bureau, Mr. N. R. Penfold VK6NE, 388 Huntriss Rd., Woodlands, W.A. 6018.

## QSP —

# U N I T Y

The value of a strong national society, as well as unified action, well reflected in the results of WARC 79.

It is now just as important, in the post-WARC period, to maintain the unified strength of the WIA. There are still many vital issues to be decided such as TV channels 0 and 5A, the incorporation of the new HF bands at 10, 18 and 24 MHz into the Australian frequency table and various other matters.

Also on the international scene the unified action of the national societies making up the IARU will be needed to continue the good work commenced by IARU Headquarters.

There are countries that need to know more about amateur radio, including some in our Region. The IARU could also help in easing the difficulties in obtaining permission by visiting amateurs to operate away from their home countries.

Apart from giving WIA a stronger voice, an increasing membership helps to keep the cost per individual member down.

As you know the benefits obtained by the representations of the WIA are not restricted to members only. It therefore behoves all amateurs to belong. Remember: "Strength and Unity" for the good of amateur radio.

To ensure continuity, support the WIA.

D. A. WARDLAW VK3ADW,  
Federal President.

# WIA NEWS

## 1980 FEDERAL CONVENTION

Because the Convention will be over by the time you read this, only a brief resume will be given of the Agenda Items received after WIA NEWS for April AR was written. This is to allow you to follow any items through if you wish to.

One Agenda Item of interest relates to the well-known "International Diamond" style of membership badge, well-known because anyone who has travelled overseas can vouch for the effectiveness of an instantly-recognisable badge used by many of the larger societies such as ARRL, RSGB and DARC. This Agenda Item looks at this style of badge, not to replace the existing well-favoured badge, but to offer members an alternative, particularly for overseas travel.

VK2 requested a review of the entire examination and licensing privileges conditions, whilst three from VK3 cover specific topics — permanent morse exemptions for Novices who pass the 10 w.p.m. test, that only one theory syllabus should be used with, say, 70 per cent pass marks for AOCP and 50 per cent for Novices and discussions on third party traffic. Also VK3 wants discussions about a common band for all licensees, perhaps a segment on 6m or even 70 cm. Some of these items had been debated at previous Conventions and, in the case of third party traffic, the P. and T. Department was asked in 1977 to grant this but nothing further has transpired despite reminders.

Another item from VK2 wanted primary and secondary WICEN frequencies for amateur bands not already provided for (see WIA 1979 Call Book, pages 24 and 25). VK5 wanted a discussion about WIA broadcasts and VK3 submitted an item proposing that anyone knowingly making fraudulent applications for VHF awards or records should be debarred from receiving any of these. An Executive item sought discussions on AR and Magpubs activities.

Hopefully it will be possible to include a brief report in June/July ARs on some of the major issues discussed.

Every year there is always much discussion on one or more of the Annual Reports submitted by the specialised Federal Sub-Committees. At this Convention there will be debate on the Contests and Award Reports. Both areas are showing considerable increases in activity and more publicity is sought. The Federal Awards Manager suggests, however, that the WAVKCA (VHF) should be deleted because of poor results (only 13 issued in seven or eight years) or some overlapping with the WAS (VHF) Award. Possibly also the VHFCC needs reviewing for similar reasons, he wrote.

There will obviously be considerable discussion about the IARU and WARC 79 reports, particularly as both have future repercussions, for which Federal Council guidance will be required.

## CHANNEL 0

The following paragraphs are quoted directly from a letter dated 7th March received by VK3NM from the Minister for Post and Telecommunications —

"You should perhaps be aware that insofar as multilingual television is concerned, transmission on UHF is to proceed with the target date of October 1980 for commencement. An interim VHF service on channel 0 is to commence as close as possible to October 1980 simulcasting the same programmes as transmitted on UHF. After some time transmission on channel 0 will cease and continue solely on UHF.

I am aware of difficulties experienced by Amateur Radio enthusiasts like yourself as a result of the use of channel 0 but regrettably, the use of this channel in the Melbourne Metropolitan area is unavoidable in the present circumstances.

It is recognised that the low frequency of channel 0 (45-52 MHz) has limitations as far as television transmission is concerned. However, it is still a very useful television channel, and there is no possibility in the foreseeable future that this channel will be phased out completely. However, you may be assured that in assigning channel 0 the problems of the amateur service are kept in mind and are minimised wherever possible.

The merits of the UHF band are also well recognised and this band is being opened up for television use as is evidenced by the fact that the permanent allocation for the multicultural television service is in this band.

## MEETINGS

At the meeting of the Executive on 20th March much discussion took place about AR arising out of a Publications Committee meeting held on 4th March. The draft Profit and Loss Account and Balance Sheet for 1979 were examined as well as a draft superannuation scheme for permanent staff. Applications to join IARU made by the amateur societies of Monserrat, Cuba, Cambia and the Solomon Islands were voted on in favour. Among many other subjects discussed were the International Diamond Style of alternative membership badge, many of the 1980 Convention Items, and agreement to close Box 67, East Melbourne, for WIA use.

## QSP

### LDEs

In his TT column in Radio Communications February 1980 Pat Hawker refers again to long delay echoes and draws attention to a carefully researched paper from D. B. Muldrey of the Canadian Department of Communications Research on the subject. Very briefly LDEs are explained as ionospheric phenomena relating to ducting or non-linear interactions which could account for delays up to tens of seconds. Could it be, he asks, that the difference between pre-war and post-war reports of LDEs may be explained by the vast increase in high-power broadcast, television and radar transmitters during the period 1939-1950, all raising the electron temperature of the ionosphere which, in some way, invalidated the "natural conditions" that gave rise to echoes? ■

### INFRARED LIGHT CONTROLS FOR CORDLESS TELEPHONES

"Infrared light, today the preferred medium for remote control of television sets, garage doors and interior lighting, is now conquering the telephone. In this case the invisible light is used to do away with the cumbersome cord; the receiver is on its own; it is connected with the telephone and the telephone network simply by a wireless infrared link." One system was displayed at Telecom 79 in Geneva. The user of the receiver section can move around the room freely while telephoning. Control pulses and speech are transmitted via an infrared link between the receiver and a stationary section mounted on a wall. Both receiver and stationary section are equipped with infrared transmitters and receive diodes. Direct line of sight between

the two is unnecessary because the infrared rays are distributed by reflection within the room. Sensitivity is sufficient for closed rooms up to 100 sq. m. and propagation is restricted within the room. No radio frequencies are required.—From Telecommunication Journal, December 1979, new products section. ■

### SOMETHING KNOWN, MAYBE SOON FORGOTTEN?

"Amateur radio is a great delinquency preventer" says W6ONC and he certainly ought to know. He is a distinguished judge in the Superior Court of Los Angeles County, currently in the Juvenile Department. "Amateur radio can be a tremendous character builder for young people, keeping young minds busy, and out of difficulty."—Worldradio, February 1980. ■

# Pointing Antennas with Microcomputers

Bill Johnston N5KR  
1808 Pomona Drive, Las Cruces,  
New Mexico 88001 USA

The impact of microcomputers on amateur radio has been significant in recent years and is expected to increase at a dramatic rate. Radio amateurs are considered to be the founders of the "hobby computer" movement, and in the United States no area of ham radio remains unaffected. On the basis of reports appearing in the various computer and amateur radio magazines, it appears that the Australian experience closely parallels ours.

A frequently asked question is, "What can I do with a microcomputer in my ham shack?". To be perfectly honest, what you can do depends only upon your imagination. There are, of course, many trivial problems and games that come to mind, but sooner or later one desires to put his equipment to work on useful and substantial problems.

One of the most remunerative applications is in the pointing of antenna systems for HF and VHF DX work. The value lies in the fact that, for most of us, it is difficult to visualize the shortest path between two points on the surface of the earth. That path is called the great circle path, and it leads us to some surprising discoveries.

As a case in point, consider the relationship between Australia and South America. Most of the South American land mass lies east and north of Australia, but the great circle paths between most points in Australia and South America take a southerly course. Some of these paths pass over Antarctica, and even the South Pole!

The angle that the great circle path forms with a line running due north through your QTH is called the *great circle bearing*. (The term *azimuth* is sometimes used interchangeably, especially in satellite tracking applications.) If the great circle bearing between your QTH and the station you are in contact with is known, you can line your antenna up on that bearing and be assured that the antenna is aimed along the shortest possible path. If you are interested in learning more about great circle bearings and the relationship between distant stations, you may wish to refer to "DX Antenna Pointing", which appeared in the August 1978 issue of *Ham Radio Horizons*.

Calculating the bearing is a relatively simple matter involving nothing more complicated than trigonometry. The appropriate formulas have appeared many times in the amateur literature, and one straightforward approach which yields non-ambiguous

answers are given in *QST*.<sup>2</sup> The process is tedious and time consuming, however, so the microcomputer has become our salvation.

There are various degrees to which the problem can be reduced by the computer. In the simplest form, co-ordinates of the two stations would be provided as input, and the computer would function as a glorified calculator to provide the bearing. A particularly industrious amateur with a good knowledge of digital electronics might want to interface his rotator directly to the computer. In that way the computer would not only calculate the correct bearing, but it would also command the antenna to turn to that direction.

An intermediate approach is more suitable for most of us. A computer programme can be written to calculate the great circle bearing and distance from one's own QTH to a number of distant locations. The results can then be listed out on paper or on a video screen for ready reference. Using large scale digital computers, the author began preparing printouts of this type in 1966. These charts were described in *Radio Communication*<sup>3</sup> in 1972. The need for large computers has long since passed. The average ham can now produce equivalent charts on a home computer in a matter of seconds.

Fig. 1 illustrates such a chart, centred on Birdsville, Queensland. The bearing, distance in miles and kilometres, and return bearing are given for each of 220 distant locations. Note that the return bearing (RBNG) is the bearing at which the distant operator should set his antenna to point at Birdsville. This bearing is not merely 180 degrees opposite from the outward bearing (BNG); it must be computed from the same equations that are used to arrive at the outward bearing. The easiest way to do this is to simply interchange the co-ordinates of the two stations and run through the calculations a second time. The actual numerical difference between BNG and RBNG can be anywhere from 0

to 180 degrees, depending upon the relative locations of the stations.

Long path bearings are a different matter. Though it is not shown on the printout, the long path bearing from your own QTH is indeed 180 degrees opposite that of the regular bearing (BNG). The long path bearing from the distant station back to you is 180 degrees opposite RBNG.

Rather than take the fun out of the project, the actual development of the computer programme is left to the reader. A few useful hints will be offered, however. First of all, there have been a number of antenna pointing computer programmes (all in BASIC) published in the American ham literature in the past three or four years. Virtually all of these contain errors and yield incorrect results. Unless you enjoy debugging someone else's programme, it is best to steer clear of them.

Be sure to remember the distinction between the outward bearing, the return bearing, and the long path bearings. Also be sure to properly take into consideration the algebraic sign of the latitudes and longitudes of the stations.

If you would like something to check your answers against, the author will be happy to send you a printout like that shown in Fig. 1, centred on your own QTH. There is a nominal charge of US \$2 (\$3 by airmail) to offset the cost of materials and postage. The chart illustrated lists only Australian cities (220 locations total), but there is another version available which lists 330 DX plus 330 USA cities (660 locations only). The same minimum charge applies to this printout also. Either or both charts will be prepared, as desired. Send your request directly to the author, Bill Johnston, 1808 Pomona Drive, Las Cruces, New Mexico 88001, USA. Be sure to indicate the town that you want the chart centred on. If it is not one of the 220 cities listed on the chart in Fig. 1, please give the latitude and longitude or describe its location.

UK4 OLD. BIRDSVILLE  
25-345 139-22E

UK1	A.C.T.	CANBERRA	141	869	1399	316	*	UK2	N.S.W.	UAGGA WAGGA	145	794	1278	321
UK1	A.C.T.	DUANBEYAN	141	881	1417	315	*	UK2	N.S.W.	WAVERLY	131	900	1449	305
UK2	N.S.W.	ALBURY	149	833	1430	326	*	UK2	N.S.W.	WEST WYALONG	142	726	1168	318
UK2	N.S.W.	ARMIDALE	116	812	1307	290	*	UK2	N.S.W.	WILCANHTA	149	461	741	327
UK2	N.S.W.	BANKSTOWN	131	890	1432	305	*	UK2	N.S.W.	WILLOUGHBY	130	893	1438	305
UK2	N.S.W.	BATHURST	139	932	1500	314	*	UK2	N.S.W.	WOLLONGONG	133	904	1456	307
UK2	N.S.W.	BATHURST	133	803	1292	308	*	UK2	N.S.W.	WOY WOI	129	888	1429	303
UK2	N.S.W.	BFGA	145	965	1533	317	*	UK3	VIC.	ALTONA	160	886	1426	337
UK2	N.S.W.	BLACKETOWN	131	879	1414	305	*	UK3	VIC.	APOLLO BAY	165	922	1484	343
UK2	N.S.W.	BOURKE	127	494	794	304	*	UK3	VIC.	ARARAT	166	813	1309	344
UK2	N.S.W.	BROKEN HILL	164	436	702	343	*	UK3	VIC.	BAIRNSDALE	152	955	1537	327
UK2	N.S.W.	CANTERBURY	131	894	1439	305	*	UK3	VIC.	BALLARAT	163	849	1364	341
UK2	N.S.W.	COBAR	136	549	884	313	*	UK3	VIC.	BENDIGO	160	804	1294	338
UK2	N.S.W.	COFFS HARBOUR	113	891	1434	287	*	UK3	VIC.	RENTLITOH	160	893	1430	337
UK2	N.S.W.	CROWS NEST	131	895	1440	305	*	UK3	VIC.	RIRCHIFF	164	728	1172	342
UK2	N.S.W.	DEWILIDUIN	155	743	1196	332	*	UK3	VIC.	BOX HILL	159	889	1431	336
UK2	N.S.W.	DURRO	130	709	1140	304	*	UK3	VIC.	BRIGHTON	160	893	1437	337
UK2	N.S.W.	EDEN	144	988	1590	318	*	UK3	VIC.	BROADMEADOWS	160	875	1408	337
UK2	N.S.W.	FATFIELD	131	884	1423	305	*	UK3	VIC.	BRUNSWICK	160	882	1420	337
UK2	N.S.W.	FORBES	137	732	1178	313	*	UK3	VIC.	CAMBERWELL	159	889	1430	336
UK2	N.S.W.	GILGANDRA	128	689	1110	303	*	UK3	VIC.	CANN RIVER	147	989	1591	322
UK2	N.S.W.	GLENFIELD	132	886	1426	306	*	UK3	VIC.	CAULFIELD	160	892	1435	337
UK2	N.S.W.	GULRHURN	137	867	1396	312	*	UK3	VIC.	COBURG	160	881	1418	337
UK2	N.S.W.	GRAFTON	111	868	1397	284	*	UK3	VIC.	DROUIN	157	926	1489	334
UK2	N.S.W.	GHWADAGAI	143	819	1318	318	*	UK3	VIC.	EAST BRIGHTON	160	893	1438	337
UK2	N.S.W.	HAY	152	678	1091	339	*	UK3	VIC.	ESSEBORN	160	881	1440	337
UK2	N.S.W.	HOLROYD	131	884	1422	305	*	UK3	VIC.	FITZROY	160	885	1424	337
UK2	N.S.W.	HURSTVILLE	131	895	1441	305	*	UK3	VIC.	FOOTSCRAY	160	883	1421	337
UK2	N.S.W.	KATOOMBA	132	847	1363	307	*	UK3	VIC.	GEELONG	162	893	1430	340
UK2	N.S.W.	KU-RING-GAI	130	889	1431	304	*	UK3	VIC.	GLEN IRIS	159	891	1434	336
UK2	N.S.W.	LEICHHARDT	131	893	1437	305	*	UK3	VIC.	HAMILTON	170	833	1341	348
UK2	N.S.W.	LISMORE	106	876	1410	280	*	UK3	VIC.	HASTINGS	160	921	1482	337
UK2	N.S.W.	LITHGOW	132	831	1338	306	*	UK3	VIC.	HEIDELBERG	159	884	1422	336
UK2	N.S.W.	LIVERPOOL	131	885	1424	304	*	UK3	VIC.	HORNSHAW	168	766	1232	347
UK2	N.S.W.	LORD HIDE TS.	113	1254	2018	283	*	UK3	VIC.	LAKES ENTRANCE	151	968	1559	326
UK2	N.S.W.	MARRICKVILLE	131	894	1441	305	*	UK3	VIC.	LEONATHA	150	885	1528	334
UK2	N.S.W.	MOREE	113	686	1105	289	*	UK3	VIC.	MAFFRA	151	968	1559	326
UK2	N.S.W.	NARRANDRA	147	746	1200	323	*	UK3	VIC.	MALVERN	160	890	1433	337
UK2	N.S.W.	NEUCASTLE	126	889	1431	300	*	UK3	VIC.	MELBOURNE	160	886	1425	337
UK2	N.S.W.	NORTH SYDNEY	131	895	1441	305	*	UK3	VIC.	MILDURA	164	597	960	343
UK2	N.S.W.	NOURA	136	911	1467	310	*	UK3	VIC.	MOE	156	937	1508	333
UK2	N.S.W.	ORANGE	133	775	1247	309	*	UK3	VIC.	MOORABBIN	160	894	1439	337
UK2	N.S.W.	PARFES	135	728	1171	311	*	UK3	VIC.	MORNINGTON	160	913	1469	337
UK2	N.S.W.	PARRAMATTA	131	885	1423	305	*	UK3	VIC.	MORWELL	156	945	1521	332
UK2	N.S.W.	FORT MACQUARIE	118	905	1456	292	*	UK3	VIC.	MOUNT MAVERLY	159	893	1438	336
UK2	N.S.W.	RANDWICK	131	900	1449	305	*	UK3	VIC.	NORTHCOLE	159	883	1421	336
UK2	N.S.W.	ROCKDALE	131	896	1442	305	*	UK3	VIC.	NUNAWADING	159	890	1432	336
UK2	N.S.W.	RYDE	131	889	1431	305	*	UK3	VIC.	OAKLEIGH	159	894	1438	336
UK2	N.S.W.	SPLIT JUNCTION	130	896	1442	305	*	UK3	VIC.	ORROST	149	973	1565	324
UK2	N.S.W.	SYDNEY	131	897	1443	305	*	UK3	VIC.	PORTLAND	172	870	1399	351
UK2	N.S.W.	TANWORTH	120	786	1266	294	*	UK3	VIC.	PRAHRAN	160	888	1429	337
UK2	N.S.W.	TARFF	121	893	1437	294	*	UK3	VIC.	PRESTON	159	882	1420	336
UK2	N.S.W.	TERRALBA	126	883	1421	300	*	UK3	VIC.	QUEENSCLIFF	161	908	1461	339
UK2	N.S.W.	TORONTO	137	884	1422	301	*	UK3	VIC.	ST. KILDA	160	889	1431	337
UK2	N.S.W.	TWEED HEADS	103	884	1422	277	*	UK3	VIC.	SALE	154	955	1536	338
1			DMS	MT	KH	RBNG	*	2			RBNG	MI	KB	RBNG
UK3	VIC.	SUNSHINE	160	881	1417	337	*	UK5	S.A.	CEBUNA	217	550	885	40
UK3	VIC.	THURNBURY	159	882	1420	336	*	UK5	S.A.	COOPER PEDY	232	357	575	54
UK3	VIC.	TOURAK	160	889	1430	337	*	UK5	S.A.	COOK	237	634	1020	61
UK3	VIC.	TRARALGON	156	947	1523	332	*	UK5	S.A.	ELIZABETH	184	610	982	4
UK3	VIC.	VERMONT	159	892	1435	336	*	UK5	S.A.	ENFIELD	184	622	1001	5
UK3	VIC.	WARRABOOL	149	881	1418	347	*	UK5	S.A.	EYRE	238	901	1451	44
UK3	VIC.	WERRIBEE	161	885	1421	338	*	UK5	S.A.	GAILER	183	603	971	4
UK3	VIC.	WONTNAGGI	159	949	1527	336	*	UK5	S.A.	MARION	184	631	1045	5
UK4	QLD.	AIRLIE BEACH	59	709	1140	235	*	UK5	S.A.	MITCHAM	184	629	1012	4
UK4	QLD.	ATHERTON	35	714	1148	212	*	UK5	S.A.	MT. GAMRIER	175	828	1333	354
UK4	QLD.	BALMORAL HGTS.	100	852	1371	274	*	UK5	S.A.	ODDNADATTA	244	264	428	66
UK4	QLD.	BIRDSVILLE	0	0	0	0	*	UK5	S.A.	PORT ADELAIDE	185	620	998	5
UK4	QLD.	BLACKALL	76	395	635	254	*	UK5	S.A.	PORT AUGUSTA	192	464	750	12
UK4	QLD.	BRISBANE	100	850	1368	274	*	UK5	S.A.	PORT LINCOLN	198	645	1037	20
UK4	QLD.	BUNDABERG	88	813	1308	262	*	UK5	S.A.	VICTOR HARBOUR	184	669	1077	4
UK4	QLD.	BURKETOWN	54	0	0	0	*	UK5	S.A.	YAYALLA	192	504	811	13
UK4	QLD.	CAIRNS	35	744	1197	212	*	UK5	S.A.	WOODVILLE	194	422	1002	5
UK4	QLD.	CALOUNDRA	97	855	1376	271	*	UK5	S.A.	WOODNERA	198	410	660	19
UK4	QLD.	CHARLEVILLE	96	428	689	273	*	UK6	W.A.	ALBANY	239	1422	2288	70
UK4	QLD.	CHARTERS TOWERS	49	595	957	226	*	UK6	W.A.	BROOME	293	1225	1971	120
UK4	QLD.	CUNNAMULLA	112	416	670	290	*	UK6	W.A.	RUNBURY	245	1510	2430	76
UK4	QLD.	DALBY	100	740	1191	274	*	UK6	W.A.	CARNARVON	267	1602	2579	98
UK4	QLD.	EMERALD	75	576	926	252	*	UK6	W.A.	DAMPIER	279	1478	2370	109
UK4	QLD.	GLADSTONE	82	759	1221	257	*	UK6	W.A.	ESPERANCE	238	1180	1899	67
UK4	QLD.	GOLD COAST	103	876	1410	276	*	UK6	W.A.	GERALDTON	237	1529	2461	88
UK4	QLD.	GONDWINDIE	108	496	1121	283	*	UK6	W.A.	GILES MET STATION	273	692	1114	97
UK4	QLD.	GYMPF	94	825	1328	268	*	UK6	W.A.	KALGOORLIE	249	1137	1830	77
UK4	QLD.	HUGHENBEN	42	464	747	220	*	UK6	W.A.	MADURA	238	854	1375	64
UK4	QLD.	INNISFAIL	38	719	1156	215	*	UK6	W.A.	MARBLE BAR	281	1283	2066	108
UK4	QLD.	IPSWICH	101	834	1343	275	*	UK6	W.A.	MOUNT MAGNET	259	1333	2145	89
UK4	QLD.	LONGREACH	62	351	564	240	*	UK6	W.A.	NORSEMAN	244	1146	1845	72
UK4	QLD.	MACKAY	44	702	1130	240	*	UK6	W.A.	PERTH	248	1479	2380	80
UK4	QLD.	MARYBOROUGH	91	830	1335	265	*	UK6	W.A.	PORT HEDLAND	282	1374	2212	110
UK4	QLD.	MONTEAGUE	103	879	1415	277	*	UK6	W.A.	SURFACO	248	1482	2385	80
UK4	QLD.	MITCHELL	96	534	840	222	*	UK6	W.A.	WYNHAM	313	1023	1646	137
UK4	QLD.	MOGGILL												

N5KR AZIMUTHAL EQUIDISTANT MAP CENTERED ON  
VK4XYZ

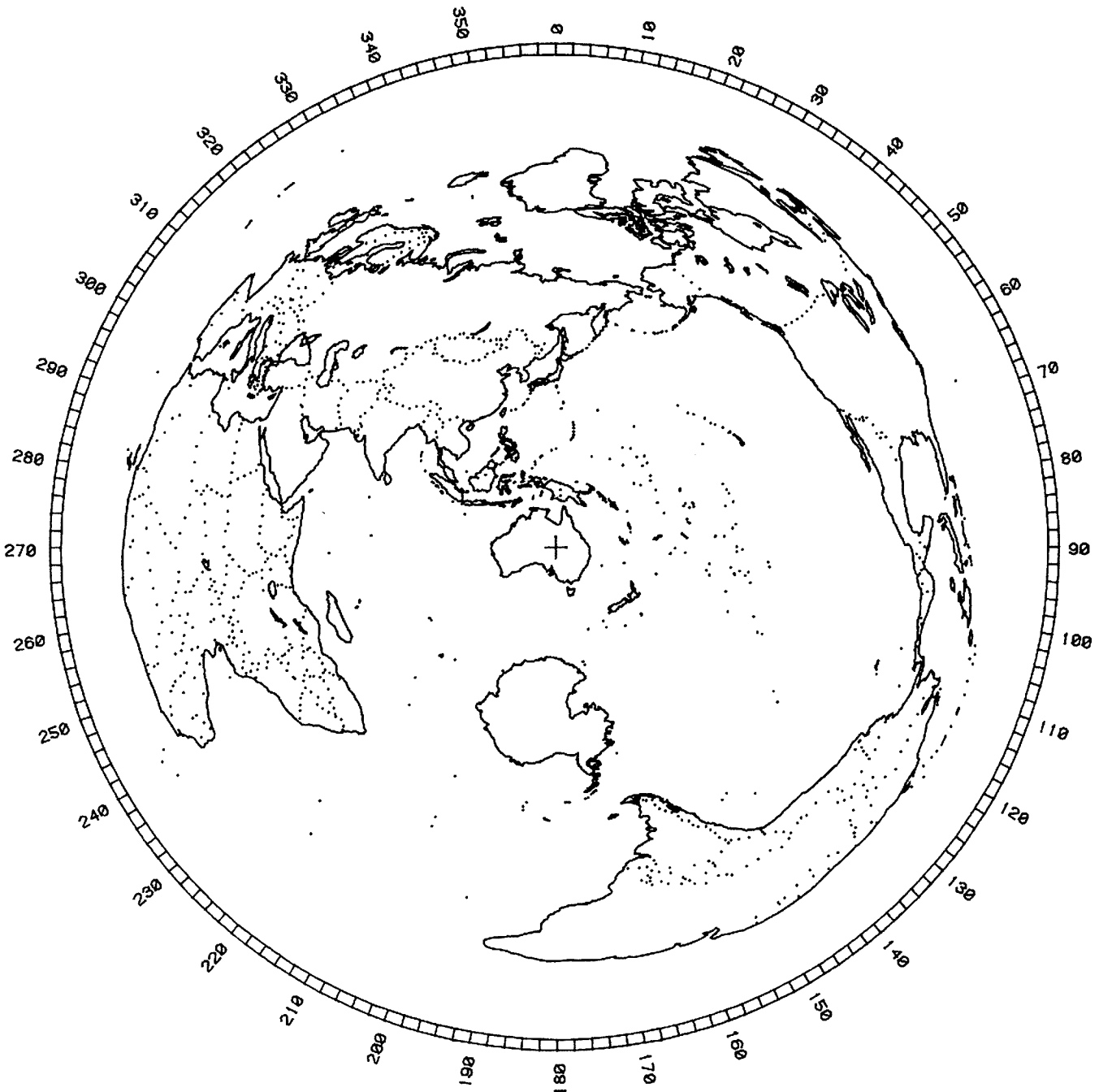
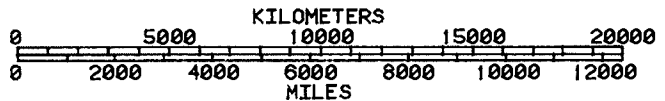

FIG. 2: A computer generated great circle map, based on an azimuthal equidistant projection, centred on Birdsville, Qld. The map is unique, and a different map must be generated for every different location. The same computer programme that makes the print-out illustrated in Fig. 1 can also be used to make the necessary map projection computations.

SCALE OF DISTANCE FROM CENTER





## GREAT CIRCLE MAPS

Once you have your great circle bearing programme running, there is another fascinating project you can complete with little additional work. Your computer can draw great circle maps, using the same programme to do the mathematical calculations. All you need is a plotter or CRT graphics device.

Fig. 2 illustrates a computer drawn azimuthal equidistant map (the technical name for a great circle map). This particular map is drawn centred on Birdsville so the reader can make comparisons with the printout in Fig. 1. Just as every great circle bearing printout must be computed based on the user's exact QTH, the azimuthal equidistant projection must also be computed and drawn based on the user's exact QTH. In other words, every map for every different location is unique.

As a matter of review, great circle maps are used in the following manner. Suppose that a ham in Birdsville wants to point his antenna toward Auckland, New Zealand. Using the map in Fig. 2, he would draw a line from the centre (Birdsville), through Auckland, and out to the edge of the map. There the great circle bearing would be read from the legend on the perimeter. The distance can be measured using the scale provided at the bottom of the map.

The reason that the same computer programme can be used to draw the map is this: The computed great circle bearing to a distant point is the same angle as

measured on the map. The radial distance from the map centre to the distant point is in direct proportion to the great circle distance on the surface of the earth. In other words, the computed bearing and distance are also the map co-ordinates in polar form. All you have to do beyond that is to multiply the distance by the appropriate scale factor to make the map the desired size.

For a great many years great circle maps existed for only a few cities in the world. Less than five years ago the author was quoted a price in excess of \$1,200 to have a great circle map drawn for his own QTH by a commercial map company. Now it is possible to make one with your own computer. The only obstacle remaining is the high cost of peripheral graphics equipment, especially for high quality, high resolution applications.

For those who do not have the graphics hardware to produce their own maps, the author has made arrangements to have this done for interested persons. The maps will be of the style shown in Fig. 2 and will be drawn by the computer on a high quality pen-and-ink plotter. The finished size is 11 by 14 inches (28 by 35 cm). The total cost for materials, postage, computer and plotter time is \$10 (\$12 via air-mail). Be sure to indicate the call sign that is to be printed at the top.

There are many other types of maps which have applications in amateur radio. All of these can be made on a home com-

puter with the proper software and peripheral hardware. An in-depth discussion of the subject, including programme listings in BASIC, was carried in *BYTE*.<sup>4</sup>

## SUMMARY

Recent advances in computer technology have put enormous computing power in the hands of the radio amateur. The solution of the great circle bearing and distance problem on a home computer is an instructive project whose results can be used every time one's station is put on the air.

The author would like to acknowledge Cyril Bird VK4CB, who prompted the development of a data base of 220 Australian cities and their co-ordinates. It was this data base that was used when generating the chart illustrated in Fig. 1.

## REFERENCES

1. "DX Antenna Pointing", William D. Johnston N5KR, *Ham Radio Horizons*, August 1978, p. 26.
2. "Bearing and Distances Calculations by Sleight of Hand", Jerry Hall K1PLP, *QST*, August 1973, p. 24.
3. "A Handy Chart for Great Circle Bearings", William D. Johnston N5KR, *Radio Communication*, November 1972, p. 740.
4. "Computer Generated Maps—Parts 1 and 2", William D. Johnston N5KR, *BYTE*, May 1979, p. 10, and June 1979, p. 100. ■

# WIA (FEDERAL) DIRECTORY

## MEMBERS OF EXECUTIVE

Dr. D. A. Wardlaw VK3ADW, Federal President.  
Mr. P. A. Wolfenden VK3ZPA, Exec. Vice-Chairman.  
Mr. K. C. Seddon VK3ACS, Member.  
Mr. H. L. Hepburn VK3AFQ, Member.  
Lt.-Col. J. McL. Bennett VK3ZA, Member.  
Mr. C. D. H. Scott VK3BNG, Hon. Treas.  
Secretary: Peter B. Dodd VK3CIF.  
Amateur Radio: Mark Stephenson VK3NOY

## IARU LIAISON OFFICER AND IMMEDIATE PAST FEDERAL PRESIDENT

Mr. M. J. Owen VK3KI.

## INTRUDER WATCH CO-ORDINATOR

Mr. G. J. Fuller VK3NXI

## FEDERAL REPEATER SUB-COMMITTEE

Mr. K. C. Seddon VK3ACS, Chairman.  
Mr. J. J. L. Martin VK3ZJC.  
Mr. P. B. Mill VK3ZPP.

## MANAGING EDITOR AND CHAIRMAN OF PUBLICATIONS COMMITTEE

Mr. B. Bathols VK3UV.

## FEDERAL BROADCAST TAPE CO-ORDINATORS:

Mr. R. Fisher VK3OM.  
Mr. W. Roper VK3ARZ.

## FEDERAL EDUCATION CO-ORDINATOR

Mr. G. F. Scott VK3ZR.

## FEDERAL HISTORIAN

Mr. G. M. Hull VK3ZS.

## FEDERAL CONTESTS MANAGER

Mr. W. A. Walkins VK2DEW

## FEDERAL AWARDS MANAGER

Mr. W. D. Verrall VK5WV.

## FEDERAL VHF/UHF ADVISORY COMMITTEE

Mr. K. G. Malcolm VK3ZYK, Chairman.  
Mr. P. A. Wolfenden VK3ZPA.

Mr. I. W. Cowan VK3BGH.

Mr. L. Janes, VK3BKF.

Mr. J. J. L. Martin VK3ZJC.

Mr. K. L. Phillips VK3AUC.

Mr. W. M. Rice VK3ABP.

## FEDERAL RTTY COMMITTEE

Mr. H. P. Mulligan VK2ABH, Chairman.

Mr. J. J. Lupton VK2BVJ.

Mr. R. E. Taylor VK2AOE.

## PROJECT ASERT COMMITTEE

Mr. R. C. Arnold VK3ZBB, Chairman.

Mr. P. A. Wolfenden, VK3ZPA/NIB.

Mr. K. G. McCracken VK2CAC.

Mr. L. Janes VK3BKF.

Mr. G. C. Brown VK3YGB.

## AMATEUR SATELLITES

Mr. R. C. Arnold VK3ZBB.

## FEDERAL WICEN CO-ORDINATOR

Mr. R. G. Henderson VK1RH.

## VK/ZL/O CONTEST MANAGER (VK)

Mr. N. R. Penfold VK6NE.

## FEDERAL VIDEOTAPE CO-ORDINATOR

Mr. J. F. Ingham VK5KG.

## FEDERAL COUNCILLORS

Please see main Directory.

## ALTERNATE FEDERAL COUNCILLORS

VK1 — Mr. A. Davis VK1DA.

VK2 — Mr. P. B. Card VK2BX.

VK3 — Mr. A. R. Noble VK3BBM.

VK4 — Mr. D. T. Laurie VK4DT.

VK5 — Mr. G. Preston VK5PI.

Mr. W. M. H. Wardrop VK5AWM.

VK6 — Mr. P. J. Savage VK6NCP.

Mr. B. Hedland-Thomas VK6OO.

VK7 — Mr. P. D. Frith VK7PF. ■

## AFTERTHOUGHTS

I struck again with the FT-75 VXO article in AR, March 1980.

The following omissions and errors may be noted:

1. Page 23, under Fig. 9, should read: "One filter required between each carrier generator and corresponding converter". Note that carrier excitation to each converter is not switched — it goes direct via coaxial cable and the carrier filter.
2. P.22, Fig.4, under "SK4 to SK6" read: "SK4 to SK6 via carrier filter".
3. P.22, Fig. 6, 50Ω output connector should be labelled "SK6".
4. P.21, Fig. 1, second row — dual band converter block should be linked to dual heterodyne carrier generator block. Amateurs desirous of producing a compact version using PC boards should proceed as follows:  
3 separate enclosures are required.
  1. Contains PC board for VXO and 53 MHz multiplier.
  2. Contains PC board for the 3 converters.
  3. Contains PC board for the 3 carrier generators.The filters should be in separate enclosures external to the main enclosure.  
Signed, Murphy. ■

# An On-Air Monitor for SSB

K. Nagatomo JA6BC  
603 Harisuri Chikushino Fukuoka 818, Japan

**Before the age of SSB, we used to have some methods to monitor RF output either by using a separate receiver with cut-off bias on an RF amplifier or by using a simple detector with an AF amplifier. Frequently we used to listen to our own modulated signals to check the audio quality or tone of the CW signal. Of course AM contains a carrier which makes it easy to demodulate signals using simple circuits. In those days rigs were mostly home brew which generally meant less reliable equipment than the commercially manufactured equipment which you have now. Monitoring was essential in the days of home brew gear.**

After SSB took over from AM and particularly when commercial transceivers came to be very common the practice of monitoring RF output was greatly reduced except for the few amateurs who have monitorscopes. However, we are still encountering stations whose signals are over-modulated, over-compressed or distorted. The need for a monitor, or ON AIR MONITOR to be more exact, cannot be ignored and it is getting more important now since there are so many more stations with very effective but quite critical devices like speech processors and kW linears. As a matter of fact, there are more technical problems in demodulating SSB signals than there are for the AM mode if we provide a monitor system for use with the transceiver. The manufacturers seem to be backward in developing conventional built-in monitoring systems in their products. Recently some high grade models such as the TS820 and the FT901 have provided a built-in monitor function. However, we cannot regard them as ON AIR MONITORS because the monitoring signals are just taken from the microphone amplifier and have nothing to do with RF output on the air. In this article some methods of monitoring the transmission of SSB or CW signals are discussed and some examples of a practical monitor are shown either by the modification of a speech processor or by home brewing a separate unit.

## THE PRINCIPLE OF THE SSB MONITOR

To demodulate SSB signals a carrier or BFO, together with the signal, should be injected into a product detector. If you have VFO which covers your frequency you can demodulate SSB. However, such a straight type monitor requires you to zero-in and you must follow your signal whenever you QSY. In order to eliminate the need for tuning which is troublesome in practice the monitor tuning should be linked with the transceiver or its VFO. The VFO signal will produce a constant

intermediate frequency after the heterodyne mixer. This IF can be demodulated by injecting a constant frequency BFO. In fact if the transceiver is of single conversion, the IF and the BFO are exactly the same as the transceiver itself but if your gear uses double conversion the IF frequency is different for each band and different BFO frequencies are required for each band — as many as the number of the bands.

Here what I define as single conversion includes the pre-mix type of single conversion so long as the output signal after the pre-mixer is available. If it is not available and only the VFO output is available you should regard it as double conversion. The fundamental scheme is shown in Fig. 1 and the relationship between the VFO and the intermediate frequency output after the heterodyne mixer of the various types of commercial equipment available are shown in Table 1. There is a temptation to take advantage of the local oscillator and the BFO in the transceiver itself as the heterodyne signals and feed them into the monitor because the mixing process is very similar. However this idea is usually quite risky and it may produce spurious output due to the leakage of these signals through the external circuit used for the monitor. The next problem is the IF coupling circuit between the mixer and the detector. As already mentioned, if the transceiver is of double conversion the IF varies according to the band you need. The IF coupling circuit should have a broad bandwidth by means of either RF coupling or a broadband transformer using toroidal cores.

The other way is by reversing the injection frequencies to the mixer and the detector. That is, the BFO to the mixer and the VFO to the detector. This inverse injection makes the IF equal to the VFO frequency varying over the same frequency range as the VFO. A resonant bandpass coupling circuit becomes of use for the IFT.

## AN EARLY FAILURE

Three years ago I tried to build a monitor into a Kenwood TS520. This monitor was of the type that we called a *hermit crab*. All heterodyne signals were drawn from the TS520 itself and the output from the detector was fed into the AF amplifier in the TS520. This device was built on the small printed board as shown in Photo 1, and its circuit is shown in Fig. 2. The unit used double conversion, the same as in the TS520, and buffers were placed on external connections. The demodulated audio quality was normal and no worsening of carrier leakage was detected and so I put it into operation. However it was not long before I was called by a JA1 station saying that the signal on 14.150 MHz was 59 + 20 dB but in the CW band there was an LSB spurious of 55 to 56. I tried to eliminate this problem by altering the injection level and varying the value of the coupling capacitors to as small a value as possible but could not resolve the problem. Finally I removed the monitor board from the TS520.

It may be hasty to draw a conclusion from this simple experiment but I am sure that a system like this is always very critical from the point of view of troublesome spurious signals. Judging from the fact that some commercially built gear such as the SIGNAL ONE or the recent Kenwood TS120 have an internal mixer in their circuitry mixing the VFO with the BFO signal for the purpose of providing the variable pass band function it should be possible to make a viable unit if the system is suitably designed and set up. Anyway the following items would be of importance when you try to implement such a *hermit crab* system.

1. Mixers and the product detector must be of balanced or double balanced type to cancel straight through leakage.
2. All parts should be mounted in a suitable shielded enclosure so as to pre-



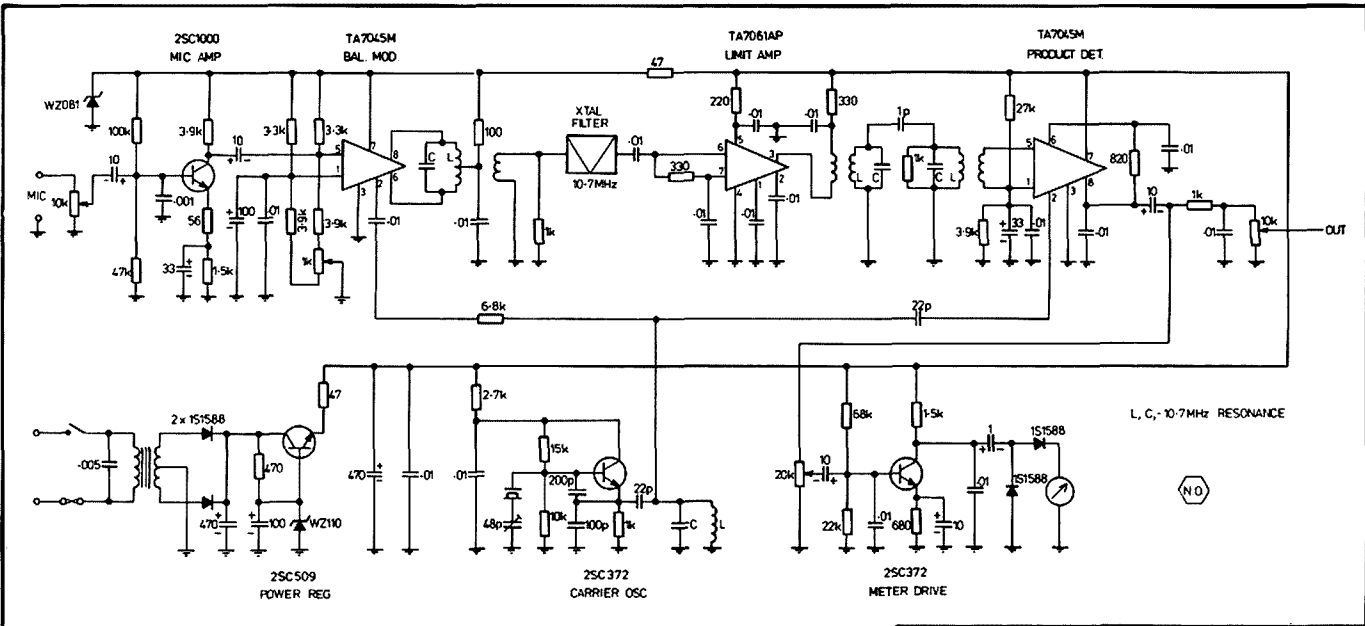

FIGURE 3

fication of a speech processor. For this reason the modification of the KP12 has some shortcomings for the double conversion application such as the IFT, which has a resonant frequency around 10 MHz and has no provision for multiple BFO oscillators. I will show you another way to minimise these problems.

**ANOTHER EXAMPLE FOR HOME BUILDERS**

The following is just my design and has not been verified yet by building a prototype. However, all the necessary details for such a system have been included. The mixer is a double balanced IC to cancel straight through leakage. The local oscillator and not the BFO in this case is injected into the mixer instead of the VFO signal as in the previous example. This inverse order makes the IF equal to the frequency of the VFO and an IFT which has a resonant frequency in the VFO range must be used.

The product detector uses the same IC as the KP12 and the equivalent circuit of this IC is shown in Fig. 5. There are some ICs which may be substituted for the TA7045M, such as CA3053, CA3028 or LM301. The same IC as used for the mixer can be quite a good product detector although it requires more external components. The circuit is shown in Fig. 6 and three local oscillators are provided for multi-band use. Of course more oscillators can be provided if necessary.

**ADJUSTMENTS ARE AS FOLLOWS CARRIER SUPPRESSION**

Using a general coverage receiver such as a domestic portable radio, tune the frequency of the local oscillator at the output port of the mixer by coupling with a small piece of twisted wire. Adjust VR3, 50k, so as to find minimum carrier leakage. Reduce Rx to reduce injection level if the carrier suppression is poor.

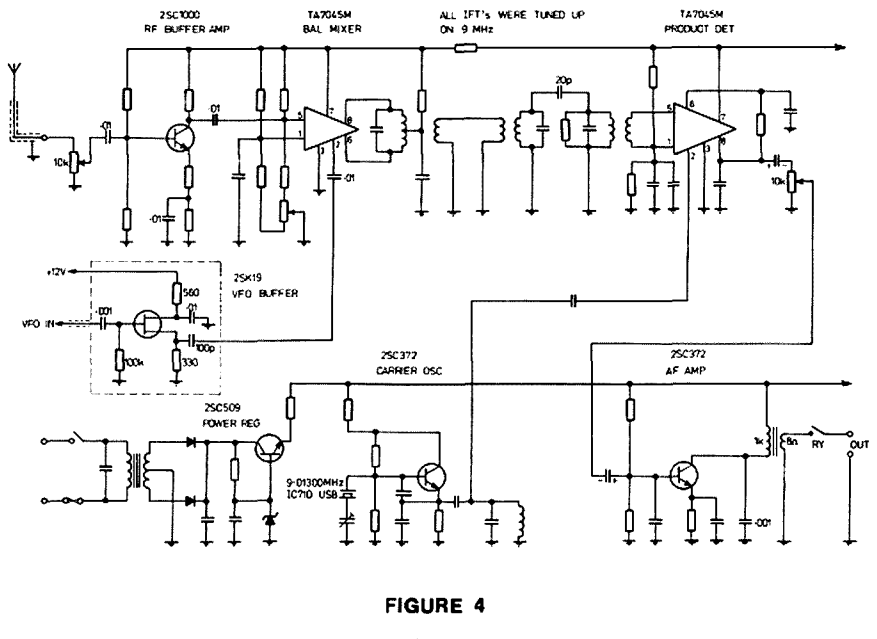

FIGURE 4

the transceiver and monitor output during transmission.

Here I have described the modification of a speech processor type KP12, but any type of speech processor is suitable so long as it is of the RF type. If you plan to build this kind of monitor the example shown here is perhaps not the best way because the IC in the balanced modulator is a so-called differential pair IC which requires a balanced output. The IFT in the KP12 has balanced input and unbalanced output which may be troublesome for a home builder. I recommend that you use a double balanced device like the MC1496G if your project is not the modi-

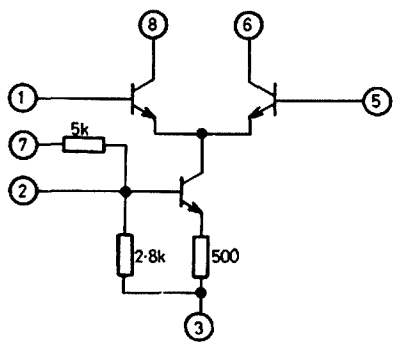

FIGURE 5

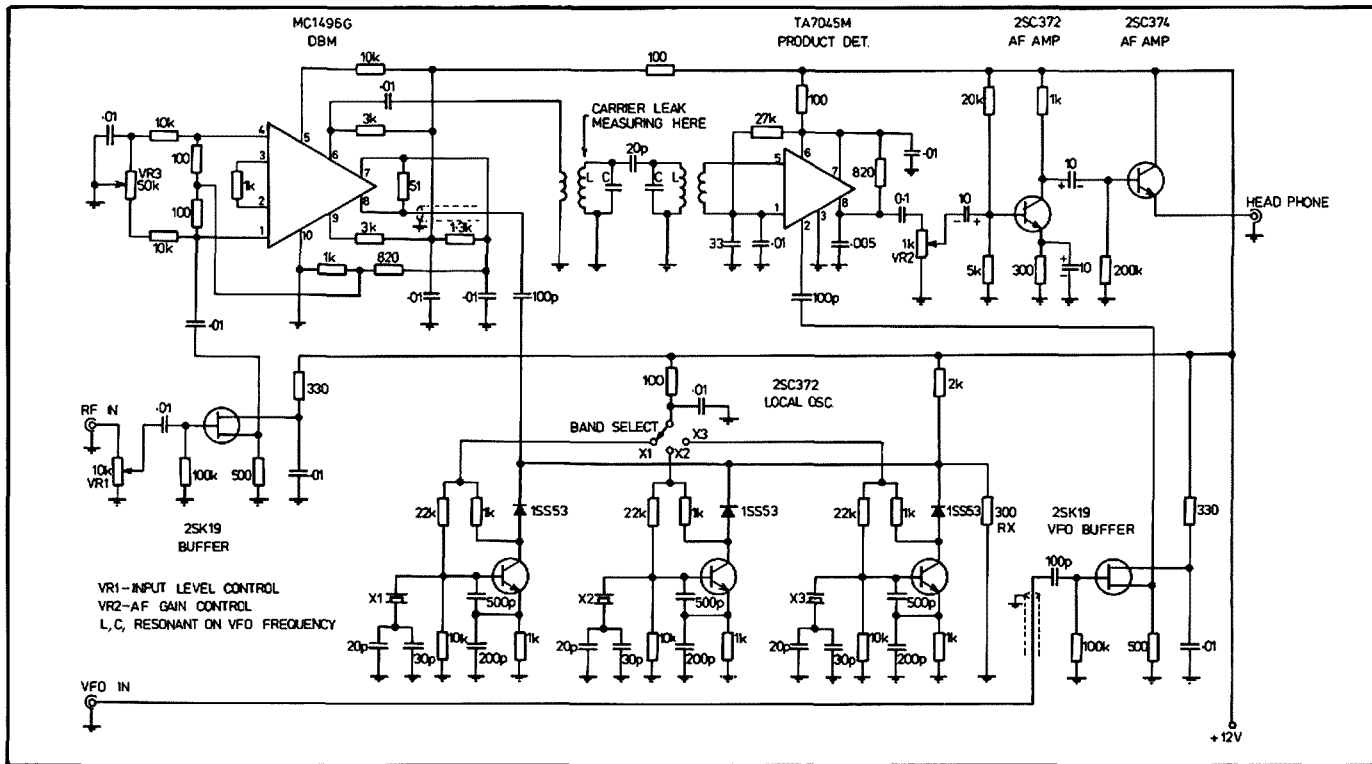

FIGURE 6

**FREQUENCY**

The adjustment of the frequencies of the local oscillators may be either by using a frequency counter or just listening to the audio quality of a voice coming from the monitor. Just like tuning a normal SSB signal.

**RESULTS**

With a small wire taped on the surface of the antenna coax cable enough RF Input can be obtained to allow you to demodulate the transmitted signal. The volume controls are necessary because the input level changes according to the direction of antenna, bands, SWR on the feed line and the output power level. In other words if a problem develops in the antenna system resulting in a very high SWR the problem will be noticed immediately due to the unusually high input level to the monitor.

On CW the beat is 1500 Hz for both LSB and USB and the monitor becomes a CW monitor. It is almost a year since I put this device into operation. I have come to believe that the monitor described here is of great practical use. In practice it is more useful than a monitroscope since a monitroscope is only effective when you look at the screen. It is an indispensable device for any amateur station to ensure proper operation of the equipment.

I hope that the ideas described here will be useful and will be tried by as many amateurs as possible in Australia. I also hope that it will contribute to building up the habit of listening to one's own signal before transmitting it on the air.

Finally I would like to express my gratitude to Don VK6DY for his assistance with English, and Glen VK6IQ, who gave me the opportunity of reading AR since 1975.

**APPENDIX**

A lot of Japanese manufactured equipment is in use in Australia as well as in many other countries. However, components like transistors, FETs or ICs with Japanese Type Numbers are not popular in these countries when compared with American components.

The circuits described use Japanese components, but I am afraid that most of them are unfamiliar in Australia. So I think it is worth writing briefly about Japanese semi-conductors.

Japanese diodes, transistors, or FETs are registered with the Electronics Industries Association of Japan and their products are type numbered according to the registration with EIAJ. The codings are as follows:—

The 2SC type holds 60 per cent of the 4000 registered type numbers.

I don't know how many transistors are actually available now but there are probably around 1000 type numbers still in production. The latest type number is the order of 2SC2800. If you would like to know more about Japanese transistors or FETs the Japanese Transistor Manual and the FET Manual from CQ Publishing Co., 1-14-2 Sugamo Toyoshima-Ku, Tokyo, Japan, are good guide books. The price is 500 Yen each. As far as ICs are concerned production is by 21 companies, but type numbers are not registered with EIAJ. I cannot tell you how many types of ICs there are but I feel that most of them are supplied to equipment manufacturers of products such as TV, radio, computers or industrial equipment. Around several hundred types are available on the local Japanese market. Generally ICs manu-

Semiconductor	Serial number of registration	Design code
2 S C	1997 G	
1 — Diode		A — PNP RF use
2 — Transistor or FET		B — PNP AF use
3 — Dual gate FET		C — NPN RF use
Generally it means the number of elements		D — NPN AF use
		F — Thyristor or SCR
		H — Unijunction transistor
		J — P channel FET
		K — N channel FET

There are 35 manufacturers of semiconductor products and more than 4000 types have already been registered.

manufactured in the USA are very popular amongst home builders rather than domestic Japanese ICs.

# Vicom's got it!

## Australia's largest range of Ham Gear

Base or Mobile - we've got the gear to get you on air and keep you there! And all our sales are supported by technical back-up that's unequalled in the industry.

Count on VICOM for personalised service every step of the way. Give us a call today.

### ICOM GEAR

- IC225A 2m FM 25watt synthesised - \$425.00
- IC502A 6m SSB portable \$289.00
- IC251A 2m all mode ac/dc - \$847.00
- IC551 6m, all mode all options - \$59.00
- IC551D 6m all mode, 10w, PBT & VOX - \$849.00
- ICPS20 240V pwr supply - \$230.00
- ICSP2 matching speaker - \$56.00
- IC2A 2m FM synthesised handheld - \$279.00
- IC260A 2m FM/SSB 10w mobile - \$599.00
- IC701 HF solid state 160m-10m transceiver \$1199
- IC225 2m FM synthesised transceiver - \$299.00
- Quantity 5 - 10 - \$299.00
- IC280 2m FM remotable cpu controlled - \$450.00
- IC402 70cm ssb portable, 3 watts - \$439.00
- IC202S 2m ssb portable, 3 watts - \$318.00

### MICROPHONES

- VM-1 Noise cancelling hand ppt, dynamic low Z Qty 10-15 - \$10.00

### MORSE KEYS

- HK702 Deluxe Key with marble base - \$41.00
- HK708 Economy key - \$23.00
- HK706 Operator's key - \$22.00
- MK701 Manipulator (side-swiper) - \$45.00

### TONO 2m BI-LINEARS

- MR900E 80-90W, incl RX preamp - \$289.00
- MR1300E 120-130W, incl RX preamp - \$350.00

### RADIO TELETYPE TERMINAL

- O-7000E Tono TRRY CW/Baudot/ASC11 - \$899.00
- O-350 Theta 350 Tono receiver terminal - \$599.00
- HC-800 Tono Dot matrix printer - \$999.00

### TUBES

- 6DK6 Finals for Yaesu linears - \$10.00
- 6JS6C Finals for Yaesu transceiver - \$10.00
- 12BY7A Driver - \$4.75
- 6146B Finals - \$13.00

### VICOM ANTENNAS

- VAR/2 Ringo 2m 6dB gain 135-170MHz - \$55.00
- VAH/80 80m helical whip - \$28.00
- VAH/40 40m helical whip - \$28.00
- VAH/20 20m helical whip - \$28.00
- VAH/15 15m helical whip - \$28.00
- VAH/10 10m helical whip - \$28.00
- VAB/2/5 5el yagi 8dBd gain 500W pep 2m - \$35.00
- VAB/2/10 10el yagi 12dBd gain 500W pep 2m - \$74.00
- VAB/7/16 16el yagi 15dBd 1KW pep 70cm - \$53.00
- VAB/6/5 5el yagi 9dBd gain 1KW pep 6m - \$89.00

### RAK ANTENNAS

- LISTENER 3 Short wave Rx antenna - \$49.00
- LISTENER 1 Short wave Rx antenna - \$22.00

### HY-GAIN ANTENNAS

- 204BA 4el monobander for 20m - \$259.00
- 203BA 3el beam 20m - \$199.00

### JAYBEAM ANTENNAS

- 5V/2m 5el 2m 7.8 dBd gain, length 1.6m - \$43.00
- 8V/2m 8el 3m 9.5 dBd gain, length 3.8m - \$51.00
- D8/70cm Twin 8el, 70cm, 12.3 dBd, 1.1m - \$64.00

## ICOM 6 Metres DX

### Two great models available

Includes scanning facilities, 2 VFO's microprocessor.

- IC551 (10 W) \$859
- IC551D\* (80w) \$849

\*requires ac PWR supply

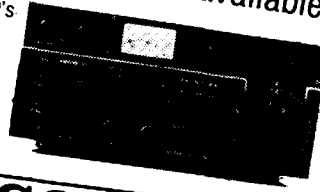

- PBM 18/70 18el, 70cm, 14.9 dBd, 2.8m - \$96.00
- MBM 48/70 48 el, 70cm, 15.7 dBd, 1.83m - \$83.00
- MBM 88/70 88el, 70cm, 18.5 dBd, 3.98m - \$105.00
- PMH/2C Phasing harness - \$20.00
- 8XY/2m 2m cross yagi, 8el, 9.5 dBd, 2.8m - \$99.00
- 12XY/70cm 70cm cross yagi, 12el, 13.0 dBd, 2.6m - \$139

### NAGARA

- V4JR 40-10m trap vertical, 5.2m high - \$99.00

### SCALAR

- M22T 1/4 wave 2m mobile whip, top only 1-4 - \$7.5-9
- M25T 5/8 wave 2m mobile whip, top only 1-4 - \$14.5-9
- BASE B/L for above - \$4.00

### COAXIAL SWITCHES

- CS201 2 position, high pwr, to 500MHz - \$23.00
- CS401 4 position, high pwr, to 500MHz - \$59.00

### BALUNS

- A3-BL Aashi 50 ohms for beams - \$34.00
- BL50A 50 ohm 4Kw 1:1 for dipoles - \$32.00
- BL70A 70 ohm 4Kw 1:1 for dipoles - \$32.00

### COAXIAL CHANGE-OVER RELAYS (DAIWA)

- CX-2L 1.8 thru. 170MHz, 100W pep max - \$69.00

### AIRCRAFT RECEIVERS

- 747 16ch, ac/dc scanning, inc 4 xtals - \$199.00
- Qty 10-20
- XTALS Additional crystals - \$7.50

### BEARCAT SCANNERS (PROGRAMMABLE)

- BEARCAT 210F VHF/UHF, 10chs, ac/dc - \$412.00
- BEARCAT 220BF 20chs incl. aircraft AM - \$556.00
- BEARCAT 250FB VHF/UHF, 50chs, ac/dc with 68-88 MHz - \$556.00

### KENWOOD

- TS120S..... poa
- TS180S..... poa
- R1000..... poa

CALL US FOR A GOOD DEAL ON KENWOOD PRICES!

### AMATEUR RADIO EQUIPMENT

- LDM-815 Dip meter, 1.5MHz-250MHz - \$89.00
- LPM-885 SWR/Wattmeter, 1W-100W - \$97.00
- LAC-895 Antenna coupler, 3.5MHz-28MHz - \$182

- LBO-310HAM 3" oscilloscope for HAM use, 20mV/4MHz - \$330.00
- LA-31 HAM scope adaptor - \$26.00

### SWR/PWR METERS AND DUMMY LOADS

- VC-2 Twim meters 3-15MHz with cal. chart - \$35
- SW110A Daiwa 1.8 thru 150MHz - \$79.00
- SW210A Daiwa 1.8 thru 150MHz 20/120W direct - \$99
- CN620 Daiwa Cross-needle, 1.8 - 150MHz direct - \$99.00
- CN630 Daiwa \$140-450MHz, 20/200W direct read - \$135.00
- CN650 Daiwa 1.2-2.5GHz, 2/20W direct read - \$169
- LPM-885 Leader SWR/PWR meter - \$89.00
- LPM-880 RF Power meter - \$135.00
- RW-155D Kuranishi RF Power meter - \$185.00
- RW-151D Kuranishi RF Power meter - \$165.00
- RW-1002L Kuranishi RF wall meter - \$139.00

### MAST HEAD DIVIDER

- AD103X Mast-head splitter 70cm/2m/HI - \$59.00

### RF MATCHING TRANSFORMERS

- PALOMAR 500W, switchable 6 impedances - \$96.00

### LOW PASS FILTERS (DAIWA)

- FD30LS 32MHz, Fc, 200W, 3 stages Qty 1-10 - \$20

### ANTENNA COUPLERS

- CL67A Daiwa 1.9 - 28MHz 500w pep - \$135.00
- CNW217 Daiwa incl. SWR/PWR meter, 200W - \$165
- MFJ901 MFJ, Matches everything 1.8-30MHz - \$119
- MFJ16010 MFJ, Random wire tuner 160-10M - \$71
- LAC-895 Leader 3.5 thru 28MHz - \$169.00
- CNA-1001 Daiwa, automatic, 200W - \$269.00
- CNA-2002 Daiwa, automatic, 2.5KW - \$569.00

SYDNEY: 339 Pacific Hwy, Crows Nest.

Ph 436 2766

MELBOURNE: 68 Eastern Rd. Sth Melb.

Ph 699 6700

Sydney: 635 6399, 436 2766

Adelaide: 272 8417, 43 7981

Brisbane: 48 6601, 38 4480

Perth: 321 3407, 446 3232

Hobart: 43 6337

VICOM gear available from most reputable dealers!

# VK/ZL/ Oceania DX Contest 1980

NZART and WIA, the national amateur radio associations in New Zealand and Australia, invite world-wide participation in this year's VK/ZL/OCEANIA DX contest.

## WHEN?

Phone — 24 hours from 1000 GMT, Saturday, 4th October, to 1000 GMT, Sunday, 5th October.

CW — 24 hours from 1000 GMT, Saturday, 11th October, to 1000 GMT, Sunday, 12th October.

## RULES

- There shall be five main sections in the contest:—
  - transmitting phone, open.
  - transmitting CW, open.
  - receiving, "phone and CW" combined.  
For VK and ZL only — QRP sections, 5 watts argonaut rating.
  - transmitting phone, QRP.
  - transmitting CW, QRP.
- The contest is open to all licensed transmitting stations in any part of the world. No prior entry need be made. Mobile marine and other non-land based stations are permitted to enter. Their "country status" will be determined by the country which issued the call sign used in the contest.
- All amateur bands may be used but no cross band operation is permitted. *Note:* VK and ZL stations, irrespective of their location, *do not* contact each other for contest purposes *except* on 80 and 160 metres on which bands contacts between VK and ZL stations are encouraged.
- Phone will be used during the first weekend and CW during the second weekend. Stations entering both sections must submit separate logs.
- Only one contact on CW and one contact on phone per band is permitted with any other station for scoring purposes.
- Only one licensed amateur is permitted to operate any one station under the owner's call sign. Should two or more operate any particular station, each will be considered a competitor and must submit a separate log under his own call sign. This is not applicable to overseas competitors operating club stations.
- Entrants must operate within the terms of their licences.

# RECEIVE THE BEST!!

WITH HIGH PERFORMANCE  
ANTENNAS FROM

# SCALAR

Be a DEVIL!  
Buy a PITCHFORK!

*HF Mobile Operation was never like this!*

Up to three bands on one antenna...

No more messing about changing whips!

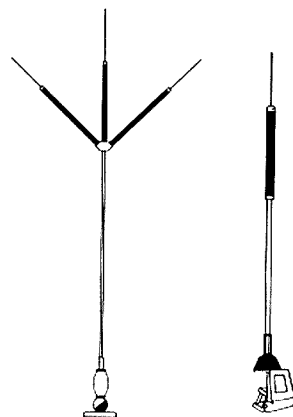

SC2M	2 METRE MAST	.....	\$15.85
SC6M	6 METRE MAST	.....	\$18.70
SC1015	TRIBAND ATTACHMENT	.....	\$18.70
SC80R	80 METRE RESONATOR	.....	\$25.90
SC40R	40 METRE RESONATOR	.....	\$20.15
SC20R	20 METRE RESONATOR	.....	\$18.70
SC15R	15 METRE RESONATOR	.....	\$18.70
SC10R	10 METRE RESONATOR	.....	\$17.25

## INTRODUCTORY OFFER

**SC33DX**  
3 ELEMENT  
TRIBAND BEAM  
10-15-20 METRES  
**\$270.00**

## ALSO AVAILABLE

- SC22DX 5-BAND TRAPPED VERTICAL **\$129.00**
- 2m and 70cm WHIPS
- DIPOLE TRAPS
- INSULATORS
- BALUNS 3-30 MHz
- QUAD HUBS

PLEASE ASK FOR OUR CURRENT PRICE LIST



## THE SCALAR GROUP

VIC: 20 SHELLEY AVENUE, KILSYTH. (03) 725 9677  
NSW: 20 THE STRAND, PENSHURST. (02) 570 1788  
QLD: 8 FERRY ROAD, WEST END. (07) 44 8024

## 8. CYPHERS

Before points can be claimed for a contact, serial numbers must be exchanged and *acknowledged*. The serial number of five or six figures will be made up of the RS (phone) or RST (CW) report plus three figures which may begin with any number between 001 and 100 for the first contact and which will increase in value by one for each successive contact, e.g. if the number chosen for the first contact is 021, then the second must be 022, followed by 023, 024, etc. After reaching 999, restart from 001.

## 9. SCORING

### (a) For Oceania Stations other than VK/ZL

2 points for each contact on a specific band with VK/ZL stations and 1 point for each contact on a specific band with the rest of the world.

### (b) For the rest of the world other than VK/ZL

2 points for each contact on a specific band with VK/ZL stations and 1 point for each contact on a specific band with Oceania stations other than VK/ZL.

### (c) For VK/ZL stations

Points for each QSO on different bands as follows: 20m, 1 point; 15m, 2 points; 10m, 3 points; 40m, 5 points; 80m, 10 points; 160m, 20 points. Score for *each band* will be the total points score for that band multiplied by the total prefixes worked on that band. Final "all band" score is the *sum* of the different band scores.

*Note:* W1, K1, WA1, WN1, A1, N1 (although all in the same call area) are different prefixes and count as multipliers. W6AA/1 is same as above and counts as a "W1" and not "W6".

### (d) 80 metre section

For 80 metre contacts between VK and ZL stations, each VK and ZL call area will be considered a "scoring area" with each contact counting 10 points. Each different call area will count as a multiplier.

### (e) 160 metre section

Contacts permissible between VK/ZL, VK/VK, ZL/ZL, as well as VK/ZL to the rest of the world. Each VK and ZL call area will count as a "scoring area" with each contact counting 20 points. Each different call area will count as a multiplier.

*Note:* A contestant may claim points for contacts with other stations in the same call area for this 160 metre section.

## 10. LOGS

### (a) Overseas stations

(1) Logs to show in this order — date, time in GMT, call sign of station contacted, band, serial number sent, serial number received. *Underline* each new VK/ZL call area contacted. Separate log must be submitted for each band used.

(2) Summary sheet to show call sign, name and address in *block letters*; details of equipment used; and, for *each band*, QSO points for that band—VK/ZL call areas worked on that band.

"Single band" score will be QSO points for that band multiplied by total VK/ZL call areas worked on that band.

"All band" score will be total QSO points for all bands multiplied by total VK/ZL call areas worked on all bands.

### (b) VK/ZL stations

(1) Logs must show in this order — date, time in GMT, call sign of station worked, band, serial number sent, serial number received. *Use separate log for each band.*

(2) Summary sheet to show name and address in block letters, call sign, for *each band* — QSO points for that band. "All band" score will be total of single band scores. Give details of equipment used and declaration that all rules and regulations have been observed.

11. The right is reserved to disqualify any entrant who, during the contest, has not strictly observed regulations or who has consistently departed from the accepted code of operating ethics.

12. The ruling of the Executive Council NZART will be final.

### 13. AWARDS

Separate awards for phone and for CW.

#### World-wide except VK/ZL

(a) Attractive multi-colour certificates to the top scorers in each country (call areas in "W", "J", "U").

(b) Depending on reasonable degree of activity, separate awards may be made for top scores on different bands.

(c) Where many logs are received, consideration will be given to awarding second and third place certificates.

#### To VK and ZL stations — Certificates

##### Open section

##### Certificates —

(a) To top three scorers in each call area VK/ZL.

(b) To top three scorers on individual bands (160, 80, 40, 20, 15, 10) in VK and in ZL.

##### GRP section

(a) Top three scorers in VK and in ZL.

(b) Others depending on activity.

## 14. ENTRIES

From VK/ZL stations should be posted direct to:

NZART Contest Manager, ZL2GX,  
152 Lytton Road,  
Gisborne, New Zealand,

to arrive before 31st December, 1981. From overseas stations to be posted to the above address or to Headquarters, Box 1459, Christchurch, to arrive not later than 31 January 1981.

## SWL SECTION

1. The rules are similar to the transmitting section but is open to all members of any SWL Society in the world. No transmitting station is permitted to enter this section.

2. The contest times and logging of stations on each band per weekend are as for the transmitting section except that the same station may be logged twice on any band — *once on phone and once on CW*.

3. To count for points, the station heard must be in QSO exchanging cyphers in the VK/ZL/Oceania DX contest and the following details noted — date, time in GMT, call of the station heard, call of the station he is working, RS(T) of the station heard, serial number sent by the station heard, band, points claimed.

4. Scoring is on the same basis as for the transmitting section and a summary sheet should be similarly set out.

5. Overseas stations may log *only* VK/ZL stations, but VK receiving stations may log overseas stations and ZL stations, while ZL receiving stations may log overseas stations and VK stations.

6. Certificates will be awarded as listed in the section under awards. ■

## QSP

### DXCC

According to January 1980 QST there are now 319 countries on the DXCC list. Because of deletions, etc., over the years there are more than this in total. In the listings two US amateurs (W8AM and W9BG) top the mixed CW/phone section with 365, and one (W6AM) tops the phone section with 363. In the mixed section VK4QM has 362 countries and VK3YL has 331 — no others from the 300 level. In the phone section VK5MS has 353, VK4QM has 338 and VK8LK with 302 are the only three to top the 300 mark. How about our own DXCC someone asks. Over to you Bill — VK5WV. ■

### 10 to 30 MHz ANTENNA

A few years hence amateurs will begin thinking how they could use one aerial to cover all the six amateur bands from 10 to 30 MHz. You could certainly play with ideas for a practical multi-band rotatable yagi or think about a nine element log periodic on an 18m long boom.—Ham Radio, January 1980. ■





# TH5DX

## 10-15-20 METERS

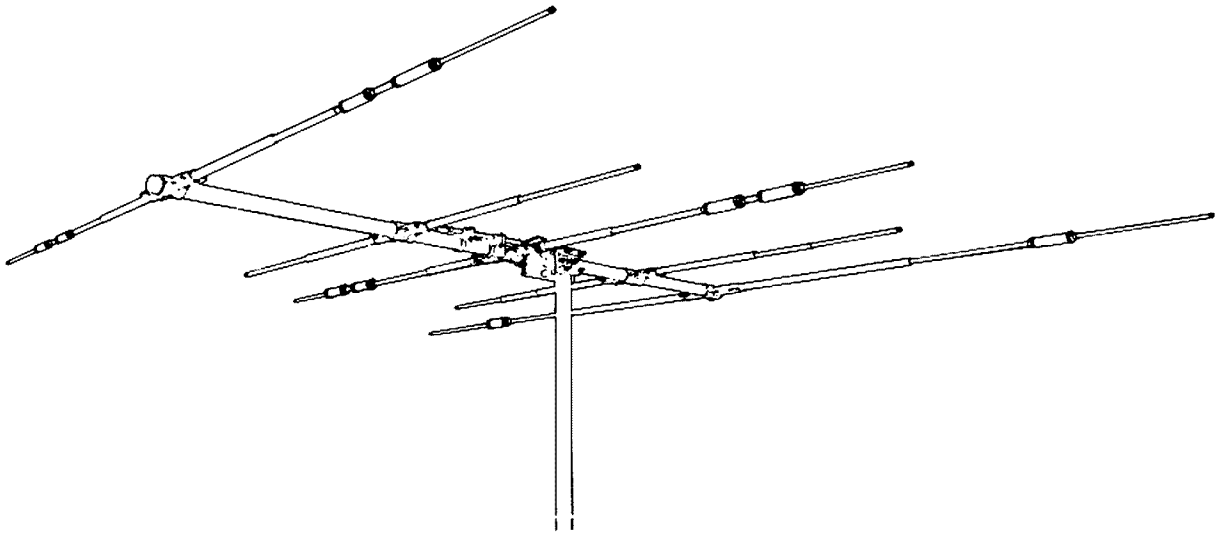

We are proud to introduce the newest member of our famous Thunderbird line of Tri-Band antennas. The TH5DX offers outstanding performance on 20, 15 and 10 meters. It features 5 elements on an 18 foot boom, with 3 active elements on 15 and 20 meters and 4 active elements on 10 meters. The TH5DX also features separate air-dielectric Hy-Q traps for each band. This allows the TH5DX to be set for the maximum F/B ratio and the minimum beam width possible for a Tri-Band antenna of this size. Also standard on this antenna are Hy-Gain's unique Beta-match, rugged Boom-to-mast bracket, taper-swaged elements and improved element compression clamps.

Boom length..... 18 feet  
 Longest Element..... 31 feet  
 Turning Radius..... 18 feet  
 Surface Area..... 6.4 sq. feet  
 Wind load..... 164 lbs  
 Weight..... 50 lbs

VSWR at resonance..... less than 1.5:1  
 Power Input..... Maximum Legal  
 Input Impedance..... 50 ohms  
 -3dB Beamwidth..... 66° average  
 Lightning Protection..... DC ground  
 Forward Gain..... 8.5dB  
 Front-to-Back Ratio..... 25 dB

**WRITE OR CALL FOR A FREE BROCHURE AND THE NAME OF YOUR NEAREST HYGAIN DEALER  
 SOLE AUSTRALIAN DISTRIBUTOR**

AUDIO TELEX COMMUNICATIONS  
 PTY. LTD.



**MELBOURNE:**  
 7 Essex Road,  
 MOUNT WAVERLY 3149  
 Tel: 277 5311

**BRISBANE:**  
 394 Montague Road  
 WEST END 4101  
 Tel: 44 6328

**SYDNEY:**  
 1 Little Street,  
 PARRAMATTA 2150.  
 Telephone 633 4344

## REVIEWS

# The Mirage B108 2m Amplifier and DSI5500 Frequency Counter

## Mirage B108 2m Amplifier

It has a built-in receive pre-amplifier (10 dB), variable SSB delay and remote keying capability.

Complete remote control is available as an accessory when using the optional remote head (RE-1).

It will amplify FM, SSB and CW signals to nominally 80 watts with approximately 10 watts drive.

The heart of the amplifier is the Motorola MRF 247, which is mounted on a large heat sink and covers the entire case. Size is 5½ in. x 3 in. x 8 in., weight 1.5 kg.

The unit itself is rugged, neat and compact. Microstripline circuitry is extensively used and the amplifier operates from the usual rectified RF sampling and relay switching method. The circuitry is basic and contains diode DC protection for accidental reverse polarity connection—a most important requirement for all solid state equipment.

Power requirements are 13.6V DC at 10-12 amps. The amplifier and receiver pre-amplifier are operated independently of each other, with switching on the front panel.

The amplifier is designed to work into a load of 50 ohms, but will still operate at reduced power with a high SWR.

### ON-AIR TESTING

The unit was tested at a base station installation using a Kenwood TS700A all mode transceiver as the driver. The TS700A output is 12 watts FM and 14 watts PEP SSB. The antenna used was a AR2X ringo mounted at 50 feet and a Heathkit "Cantenna" dummy load together with a Yaesu in-line power meter.

The reviewer was looking basically for reliability from an operator's point of view, as exclusive test equipment such as a spectrum analyser was not available at the time the tests were made.

With 12 watts FM drive from the TS700A, the amplifier registered approximately 80 watts output to the antenna.

Several weak stations were worked simplex and the general consensus of those worked gave the amplifier a good report.

On FM, the receive pre-amplifier proved effective on weak and noisy signals. Some signals just opening the mute were brought up to a good readability, although full quieting was not attained as the limiters in the receiver were not saturated.

Noisy but readable signals brought the receiver to full quieting.

Similar receive tests on SSB also proved very effective, particularly on Oscar 7,

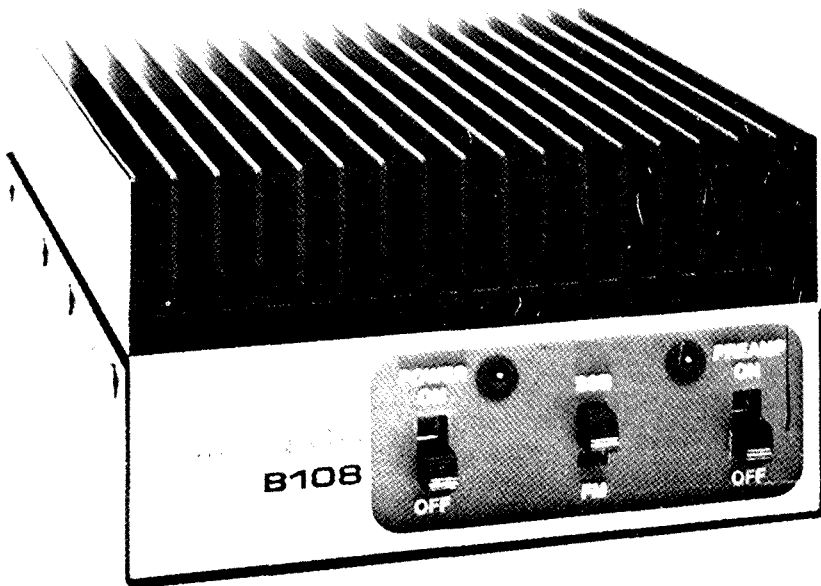

The Mirage B108 2 metre amplifier is the latest power amplifier to come out of the United States for sale on the Australian market.

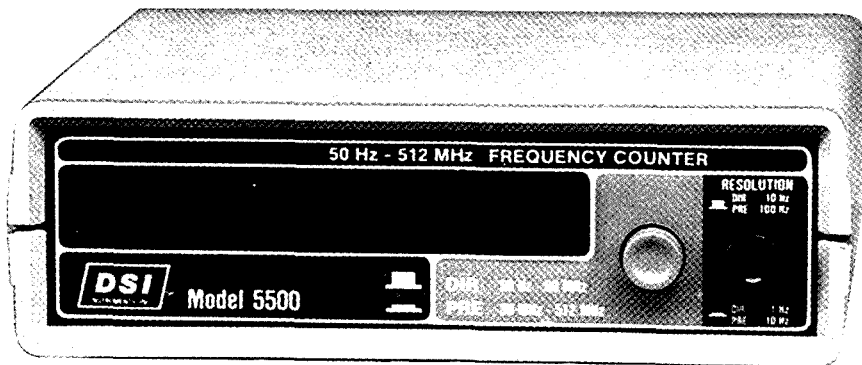

Mode B, where reception was brought to readability 5 from a just detectable signal.

The unit tested met the published specifications, and it was with reluctance that the amplifier was returned to the distributor.

Due to its ruggedness, the distributors are confident that little can be done to damage the unit. To back up this claim, a 5-year parts and labour warranty is made for the unit, excluding the final transistor, which carries a 1-year warranty.

At the review date the price is \$229 with an extra \$30 for the RC-1 remote control head.

Enquiries for supply should be made to the distributors, ATN Antennas, Box 80, Birchip, Victoria 3483.

Many thanks to Eric Buggee VK3ZZN for assistance with the tests and use of his test equipment.—(VK3UV.) ■

## DSI5500 512MHz Frequency Counter

This counter from DSI (United States) is one of several available from the same manufacturer, but we chose it specially for review mainly because of its size and cost, and to see if it would come up to the quoted specifications.

The counter will fit into the palm of your hand, has eight easy to read LED digits, covers from 50 Hz to 512 MHz at very good

sensitivity varying from 10-50 mV. The temperature controlled crystal oscillator holds an accuracy of 1 PPM from 17°C to 40°C.

The 5500 is able to resolve 1 Hz from 50 Hz to 50 MHz, and 10 Hz from 50 MHz to 500 MHz.

The sensitivity and compactness of the 5500 enables this unit to operate from all situations.

Power requirements are 8.2-14.5V DC, and it will operate from an optional rechargeable Nicad battery pack or 240V AC using a 9V adapter.

A BNC socket is provided for Input signals, and a 12 in. telescopic antenna with BNC connector attached is available for readings on air.

#### ON TEST

To gauge sensitivity over distance, a 10 watt 2m FM mobile gave a stable reading at a little under 100 feet, and a one watt 2m FM hand-held transceiver gave full lock at 30 feet.

With the assistance of Eric Buggee VK3ZZN and the use of his extensive test equipment, the following results were obtained for comparison to the specifications.

100 Hz-25 MHz specifications are 10-15 mV sensitivity.

Our tests showed that from 20 Hz-100 kHz, levels of drive in this audio range required the locking varied from 1.5V to 50 mV up to 50 kHz.

Specifications were reached at 100 kHz where a level of only 4 mV was required to lock. From 100 kHz to 25 MHz, an average of 8 mV gave full lock.

Apart from the low audio range, the unit under test was well within the specifications published.

The limit of the signal generator was 503 MHz, and at this frequency the counter was still locking in at around 85 mV. We have no doubts whatever that the frequency of 512 MHz as specified would have been reached and possibly even higher had we possessed a generator at this range.

#### SUMMING UP

From the tests made, the DSI 5500 is most suitable for amateur use, and its portability enables it to be used either in the shack or field.

We compliment the manufacturers on engineering such a compact and neat frequency counter.

It comes with a limited 1-year warranty and the greatest surprise is the price. At the time of writing the cost is \$150 for the fully wired and tested unit itself, and the optional extras of Nicad battery pack, AC adapter and BNC antenna total \$45.

This represents excellent value for its performance against counters costing nearly three times the price.

Enquiries regarding supply and delivery should be made to ATN Antennas, Box 80, Birchip, Vic. 3483, from whom the test unit was made available.

Many thanks to Eric VK3ZZN for the use of his equipment in making the tests possible.—(VK3UV.)



**PHOTO 1:**  
John Payne (l),  
Victorian WICEN  
Co-Ordinator,  
accepting the G24  
from the  
director of  
Scalar Industries,  
Frank Welsh  
VK3BPV (r.).

## WICEN in Victoria



During November last year WICEN again provided communications for the International Alpine Car Rally. The WICEN portable two metre repeater was installed on Mt. Stanley (near Beechworth). The repeater provided the communication over the rally route from Bright-Porepunkah to Wodonga-Shelley.

WICEN Victoria would like to thank Scalar Industries for the donation of a G24 omni-directional 3 dB gain aerial for the repeater and the loan of an AR 240 2 FM walkie talkie from Vicom.

The G24 was also put to good use for the regular WICEN exercise over Christmas and New Year at the Red Cross Canoe Marathon.

**PHOTO 2:**  
Peter VK3ZPP using the AR240 on top  
of Mt. Stanley during the exercise.

# QRP CW – Let's give it a Shot in the Arm!

J. Swiney VK6JS  
59 Collova Way, Wattleup, WA 6166.

There has been an increasing trend in countries overseas in the last few years towards low-power CW operation by amateurs who are seriously interested in the study of radio propagation and antennae experimentation and it suddenly struck me that there was a possibility of similar interests here in Australia.

Listening around the bands and operating occasionally in the CW mode at less than 5 watts output I re-discovered the joys and frustrations that our early amateur pioneers must have experienced in their normal endeavours.

Of course things have come a long way since the "good ol' days" and the advancement of amateur radio communication techniques since then would stagger their imaginations.

Now most of us, whether OTs or newcomers, will have read or heard that last statement at some time or other and might ask what this is all leading up to. Sure, those early experimenters battled with low-power and CW, you say, but all that is in the past and amateur radio today is doing very nicely, thank you.

And that's precisely the point! Have we forgotten, or do we tend to ignore, the very foundations upon which this great hobby of ours was built?

After some serious thought and a few cross-sectional enquiries it was revealed that there was a strong possibility of a good reaction amongst amateurs generally in experimenting with periodical low-power CW operation providing there was some tangible evidence for their efforts. Consequently I have formulated a proposal for the creation of a "VK CW QRP CLUB" and some brief details follow.

The basic aims of the Club, as mentioned earlier, are to encourage the challenge of working with very low-power and thereby promote the study of radio propagation and antennae experimentation. Throw in a goodly handful of sheer fun and you have the recipe for some real moments of truth and severe tests of one's patience!

When the idea of this project finally germinated, the problem of evaluating formulae for some method of Club point scoring raised its ugly head. Much published literature on radio propagation and its effect on low-power operation was studied and digested. The object in mind



**PHOTO 1:**  
The QRP'ers main weapons, efficient and well-constructed antenna systems — well, maybe one system, in some cases perhaps a wire?

was to keep any final decision to basic simplicity and we finally devised a formula which would be an equaliser for low-power/short distance and high-power/long distance. "High power" in this instance being a whopping big 5 watts!

The square root of the distance between

stations (in kilometres) divided by the square of peak output power (in watts) into the antenna was chosen to be the solution. Sounds complicated, I'll admit, but when the equation is written mathematically, as shown below, it looks a lot better!

$$\text{No. of points} = \frac{D \text{ (km)}}{P^2 \text{ (watts)}}$$

D = Distance between stations as measured in accordance with the Club rules.

P = Indicated watts of peak output power into the antenna as required by the Club rules.

Having decided that we now had the essentials for a good prospective reaction among amateurs in VK, we proceeded to draft a letter for mailing to numerous CW operators who we considered might be interested in the idea. The results were favourable and encouraging and, at last, the "VK CW QRPp CLUB" was off the ground!

I must point out, at this stage, that the scope of the Club will encompass CW QRPp operation within the confines of the Australian Commonwealth only and QSOs with overseas stations whilst transmitting very low power will not be valid for Club point scoring but will, nevertheless, be of great interest to all and would oblige a mention in our monthly newsletter.

Increased membership for any venture of this kind is always being sought and, naturally, we are no different. If the idea intrigues you or you are a serious QRPer please drop us a line at the above address and we will mail you complete details.

One other interesting aspect of CW QRPing not mentioned earlier is home-brew construction of transmitters. I believe there's just as much excitement when making your first QRP contact via your own matchbox transmitter which was put together, and perhaps even self-designed, with tender loving care as there is in catching that first rare country on high power!

So there we have it . . . CW QRP and all the joys and frustrations attached to it. Have a go and you'll be surprised! But let me warn you . . . it's not easy; be prepared to call CQ till your patience is stretched to the limit. However, I reckon if you use the suffix /QRP after your call sign you will identify your intentions on air and get a good response.

It's not a new idea but a revival! I'll be watching out for you on CW QRP!

#### OPERATING RULES FOR THE VK CW QRPp CLUB

1. All amateur stations holding a current VK call sign are eligible to gain membership.

The aims of the Club are to encourage the challenge of working with very low power and thereby promote the study of radio propagation and antennae experimentation.

A nominal fee of \$1 will apply for initial membership on application to the QRPp Club but admittance to full associateship will only be granted on the accrual of 20 (twenty) points or more.

2. A1 mode (CW) *only* will be used and peak output into the antenna will NOT exceed 5 (five) watts.

Power levels will be determined by methods or calculations by each individual station that give an accurate assessment of output. The historical "honour system" will be sufficient.

3. Point scoring will be based on the formula:

$$\text{No. points} = \frac{\text{Distance between stations (km)}}{\text{Power}^2 \text{ (watts)}}$$

and rounded off to one figure after the decimal point.

4. All authorised amateur bands are permitted to be used and each member will be credited on the Club listings with a total points accumulation plus a breakdown of points gained on each band.

Only contacts made on or after zero hours GMT 1st January, 1980, will be valid.

Contacts with any one station may be made *twice daily* per calendar month on each band for the purpose of point scoring.

Note: Stations worked do *not* need to be QRP.

5. Minimum exchange of reports will not be less than RST 328. Readability 3 (three), Strength 2 (two) and Tone 8 (eight). (Example: A 519 report will NOT be sufficient.)

6. The Australian Map No. 150 printed and published by Gregory's Guides

and Maps Pty. Ltd., 142 Clarence Street, Sydney 2000, will be considered the standard reference for the measurement of distance in the formula. Distance to contacted stations in proximity (100 km or less) may be assessed from any local accurate road map.

7. Minimum acceptable distance for point scoring will not be LESS than 25 (twenty-five) kilometres.

8. Cross-mode or cross-band contacts are not admissible. QSOs established during contests will only be accepted PROVIDING all the rules of the Club have been adhered to and the claimed contact has submitted an admissible contest log as shown in the published results.

Mobile or portable operation (transmitting or receiving) will be considered as VALID contacts.

9. QSL cards are not required to be produced as proof of valid contacts; log extracts will be accepted with a simple signed declaration that the station has been operated within the limitations of the licensing regulations as applicable to its operation.

10. Essential information required will include call sign of station worked, his location, band (MHz), date and time (GMT), RST received, RST given, power output (watts), estimated distance and points scored.

Note: If last two requirements are not readily calculable, QRPp headquarters will enter this information on to the application. ■



PHOTO 2:  
One of the popular QRP rigs — the HW7 now superseded by the HW8.

# Amateur Radio and the Public

Sam Voron VK2BVS  
 2 Griffith Ave., East Roseville, NSW 2069.  
 Phone (02) 407 1066 (between 6-8 p.m.)

The Amateur and Citizens Radio (VKCB) Club of NSW has designated 1980 as the fun year.

In the last three years amateur radio has relied on the tremendous interest caused by CB to generate the rapid growth in Australian amateur radio. The current drop in newcomers into CB is reflected in the diminished numbers sitting for the amateur licence.

The loss of momentum which CB had in bringing amateur radio to the attention of many new people means that amateurs now need to directly create the interest which will attract newcomers to our hobby. Throughout the year the Amateur and Citizens Radio Club will be planning many displays and radio patrols which will bring amateur radio to the people.

Already the Club has been active. 1980 started with hand-held 27 MHz AM and 147 MHz FM walkie talkies being used

as members circulated among the crowd of sixty thousand at the Sydney Opera House New Year's eve pop concert.

With bright green "glowing" cyalume chemical lights affixed to the top of whip antennae, Club members made an impressive sight as night fell.

The second 1980 project was the display at Fitzroy Gardens, Kings Cross. The Sydney City Council granted the Club approval to conduct the display over two weekends.



**PHOTO 1**  
 Five element 10 metre beam being constructed in the middle of the park. From right to left we have John VK2ZBA, Chris VK2NYA and Peter VK2NVA.

**PHOTO 2**  
 The WIA being promoted by Club members.



**PHOTO 3**  
 The amateur radio reports broadcast at midnight, 1 and 2 a.m., publicised the display over commercial radio for two weeks leading up to the event.



1980 project No. 3 was the display at the Manly shopping centre. Manly Council approved to Club application within two weeks, giving us access to this popular northern suburb beach-side shopping area.



**PHOTO 4**  
Up goes Peter's VK2NVA 5 element 10 metre beam.



**PHOTO 5**  
The beam mast in a bucket of beach sand, then comes the water to harden the base, which is a plastic garbage bin.



**PHOTO 6**  
The public show a big interest in a well set up, diverse, active and accessible open air display.

Project number 4 was a radio patrol in Sydney's "Moomba" festival. The Club joined a hundred thousand who jammed the main streets of the city to take part in this fun procession.



**PHOTO 7**  
Martin operating 160 metres hand-held pedestrian under supervision meets two Roman officers in Sydney's procession of the year.

# MAGPUBS

## ● A Service to Members



- Books and other items are *normally* available direct from your Division or write to Magpubs, Box 150, Toorak, Victoria 3142. Always add extra for postage.

- Here is a small selection:—

	\$	Wt(g)
1980 ARRL Handbook	12.00	1000
RSGB H'book, Vol. 1	16.95	1200
RSBG H'book, Vol 2	14.50	920
Understanding AR	5.70	420
NZ Basic Training Manual	3.30	250
Course in Radio Fundamentals	4.70	260
Int. DX Call Book 1980	15.20	1100
Int. US Call Book 1980	16.10	1300
RSGB VHF/UHF Man.	11.95	1020
Prefix World Map	1.50	100
Solid State Basics	5.70	350
Hints and Kinks	4.40	200
AR Techniques	6.75	520
Beam Antenna H'book	4.55	270
SSB for RA	4.95	380
RFI	3.70	150
FM and Repeaters	4.95	330
Test Equip. for RA	7.55	520
RA Data Book	5.20	400
TVI Manual	3.50	300
WIA Stickers	0.20	—
WIA Badges	2.00	—
WIA Call Book	2.45	250
WIA Log Book	2.50	220

and many more normally in stock — ask for list.

- Ask your Division or write to —

**MAGPUBS —**  
**P.O. BOX 150, TOORAK, VIC. 3142**

# NOVICE NOTES

## BIT OF PSYCHOLOGY

Believe it or not, but hams are only human! So next time you're launching your very best CQ calls and a purposeful knock comes at the front door, don't be too ashamed of that hunted look that springs to your eyes and those little warning lights that flash "TVI" and "BCI" through your brain. Oh yes — your rig just bristles with suppressors; you boast the biggest Faraday screen east of the Rockies; and you've tucked a trim little wavetrapp into every aerial for miles around. But don't dare rest content till you've learnt how to act when that inspired "CQ" has burst bodily through all your protective barriers and the XYL is calling "Darling . . . there's a man at the door and he's asking about your broadcasting!" Then it is, OM, that a little applied psychology can come to your aid. Remember, your only hope is to convince the complainant that the reins of science are held firmly in your grasp and that every microwatt that has ever jumped off your aerial has winged its way unswervingly along the path of progress. Here's what to do . . .

Greet your neighbour at the door with an expression of delight, unsmiling wisdom. Wring his hand to the point where he is about to sue for peace and lead him straightway to the shack, uttering not a word. Once inside your den, of course, he's at your mercy. Soften him up! Fire up the rig without delay, switch on the carrier, and nonchalantly dangle your trusty bulb and loop as near to the PA tank as personal safety and your nerves permit. Idly strike neons in the most unexpected places, and slyly observe his reactions. Now all this may seem very naive to you but few of the uninitiated can withstand the lure of lamps illuminated by unseen hands, and your victim will be no exception. His eyes will widen with childlike wonderment, his lips will tremble at HF, and the softening-up process will be well under way. Just for good measure, draw a sizable spark from the aerial, hand him the screwdriver and invite him to do the same. Quick now! — you must thwart his endeavours to bolt for the door . . . and promptly turn his attention to the receiver. With AF and RF gains wide open, swing to and fro over 7 MC. (See now why this band is called the Roaring Forties?) QRM? QRN? Don't let them worry you. It's noise that counts, and the more of it the better. Human powers of resistance are normally such that three minutes of this treatment will implant a frightening fixed grin upon the visitor's features and bring you a fervent apology for having been troubled.

If it fails — One final measure remains, only to be resorted to in the most troublesome cases. So you break in on his

Brahms? So the TV picture of bird-life in Outer Mongolia are accompanied by a voice that no bird ever owned? Very well! Announce firmly your intentions of popping round to look over his set and then, with awful deliberation, proceed to pack your tool kit. Hack-saw? Yes, you'll need that. Four pound hammer? Of course! Cold chisel! In it goes! Add a meter or two if you must but these are uncalled for embellishments. Then stride with shining eyes towards the door. See? Your problem is solved. Your visitor has fled to protect his domain. That diplomatic cup of tea the XYL thought of just won't be needed now. Relax, OM, and drink it yourself — and get after Zone 23 again!

By F. Hennig G8SW, from "The Lyrebird".

## MORSE EXAMS

Candidates for morse exams are specially reminded that the morse sending or receiving of letters is not adequate in itself. There is a space of 7 dots between words and this has to be observed so that whatever is sent or written down should be in understandable composition English. Thus, to omit a space between two words is one error. Many errors could be recorded against you if, for example, in receiving morse, you write down a string of letters not separated into discrete words. This reminder is given to dispel any rumours to the contrary and to alert candidates to the official requirements.

Start 'em young is the motto in VK2, where one such young participant in amateur radio is four-year-old Cherrie, granddaughter of Nev VKZBQ and Daphne VK2NXD. Cherrie is a keen future CW operator and is pictured brushing up on her CW (at right).

Triple trouble for those who confuse call signs, from left to right: Wally VK6NCL from Geraldton in WA, Carol VK2NCL from Tamworth, NSW, and last but not least Ian VK1NCL from Canberra (below).

## GRADUATES

Below in a sea of faces are Graham Scott VK3ZR and some of those who have been successful in classes held at the Box Hill Technical College in Melbourne. The photograph was taken on an outing to Radio Australia VNG Lyndhurst, and all attending enjoyed the outing. Rumour has it that VNG were missing an antenna or two but this was not confirmed, and VNG are still on the air anyway!!!!



From l. to r.: Allan VK3VAT, Les L31187, Chris VK3NFC, Peter VK3VBA (now also VK3YPV), Geoff VK3NWW, Rod VK3NXS, Graham VK3ZR, Stevo (ex VK3VKG) VK3BXX, and David VK3VBE.





# LISTENING AROUND

With Joe VK2NIM

(From "Flux", September and October '79)

There's no doubt about the fact that, as Jack VK3NTR says, "8" is the "friendly band".

I first listened to "80" almost 30 years ago when everyone was using Ancient Modulation and anyone with a shortwave set could hear "80" without the dooverometer called a BFO, which now must be used to make "duck talk" intelligible to today's SWL listener, and when almost every amateur sported his own home brew rack and panel transmitter with its many dials, knobs and switches. I hear talk these days of so-called "appliance operators" who have everything ready made, but even for these I think there are many areas for experimentation with various types of antennas, ATUs, pre-amps, to name but a few areas where even "appliance operators" could still find things to build.

I marvel at the variety of occupations of the rag chewers I meet on 80. A few weeks ago I spoke with a member of the Law Reform Council at Boroko, a suburb of Port Moresby (P29KC). A day or two ago I spoke with a worker at a piggery farm at Kadina, South Australia, who said he was covered in dust and very smelly and had 17,000 gallons of pig manure not far from his transmitter. (I wonder if he's thinking of manufacturing methane — perhaps to power his rig in these days of the looming energy crisis!) And last night I was speaking with a very happy-go-lucky boiler attendant at the Morwell power house who didn't seem to have even heard of the energy crisis. Shane, aged 21, is also required to sweep the floors in the boiler house. He's proud of Traralgon where he lives and where electricity is produced in bulk.

There are several railway workers whom I often talk to. Jack VK3NTR, "No Trains Running", is a diesel-electric locomotive driver from Ararat, as is also Greg VK3BRU from Donald. Ewart Jowett VK2BEJ from Doon-Doon in the Tweed Valley is an ex-Melbourne-ite who quit Melbourne 26 years ago "to go banana bending" and says that he won't ever go back to Melbourne. He's worked in this Sunrayasla area also and knows the Bailey family (friends of mine at Gol Gol). Jeff VK5OX is an ex airline pilot who has had much experience of flying in Europe, and VK5FF (Robert from Hungary) works with forensic science in Adelaide. Neville VK5NNT from Port Lincoln works for Telecom on telephone installation and repair, and also seems to be involved with the installation of radio navigation equipment on fishing boats. There's a doctor — a Surgeon Commander

in Canberra—who can be heard on a weekly marine operator's net (people associated with coastal radio), and I have regular contact with a young scientist who photographs the Milky Way through the optical telescopes at Siding Springs, near Coonabarabran.

It's certainly a mixed bag on 80! ■

Had a QSO with Joan VK3NLO at Bendigo the other night and her OM, Graeme, who has a call sign of his own. Graeme says that he has happy memories of his 1960-66 stint in Mildura at the High Ball launching site at the aerodrome. He remembers amateurs like Vern Macey, then manager of the Irymple Community Hotel, Brian Withers and Noel Ferguson, who I hear is back in Mildura. He also mentioned Clem Gier (who worked at Motor Spares) and mentioned boss of the High Ball team, Eric Kerwin. Graeme says that according to his better half, Joan, VK3NLO stands for "Nice Lady Operator". Graeme told me that in 1962 he was sent to Texas (USA) to receive some training in connection with the High Ball job. He spoke also of Alan Matthews, who piloted the tracker plane when the High Ball balloon occasionally wandered off into the sticks.

One of my regular contacts on 80 is Brian VK1NAI, who commutes regularly by charter plane between his QTH at Canberra and his work at the Siding Springs optical telescopes near Coonabarabran, NSW, in the New England Ranges. Brian's job at the work QTH involves the taking of photographs of parts of the Milky Way through the telescope that he is assigned to. He has his FT7 with him at the telescope site, and when the early morning sky is overcast, he can be heard on 80 chattering to someone like me or Gordon VK5HM (Holy Moses if it's a Sunday). Apparently the picture taking telescope has to be readjusted for a new "scan" every fifteen minutes, and in between "scans" Brian also comes up on air. But time and fate wait for no man and neither does the celestial sphere with respect to the movement of mother earth, so Brian has to do a bit of re-focussing or something to do yet another "scan" of the Great White Way.

There's some real veterans among those heard on 80 these days. The Novice call has enabled many oldtimers to take to the air, and I hear that a World War 1 fighter pilot has just got "his wings" on 80 as a Novice. Unfortunately, I know neither the name nor the call sign, but I'll be pleased to say hello to him if ever I hear him.

If you were swimming in waters located 40 degrees south, 100 degrees east, a very long way from the most southerly part of Western Australia, in the Southern Ocean, you might see a tuna boat, and on that boat is a Japanese named Toshi who's been very active on 80 from down that way. Earlier, Toshi's tuna boat had called at Fremantle, where he was welcomed by two friendly VK6s who showed him around.

Toshi will be in the Southern Ocean latitudes for the next two months, after which his tuna boat will call at Hobart before heading for Japan. Have heard Toshi, and look forward to making direct contact with him before he leaves the spot where they are fishing.

## EDITOR'S NOTE

Joe VK2NIM writes a regular column in "Flux", the journal of the Mildura Amateur Radio Club. We will publish portions of his notes from time to time. Some feedback from readers would be appreciated.

If you have an item to contribute in the sense described above, why not drop Joe a line — QTHR. ■

## Reference Data for the FT101B

Roy Hartkopf VK3AOH

After spending quite a lot of time and trouble digging out information about modifications for the FT101B I feel that the information might also be useful to others who want to repair or modify this popular transceiver. As far as possible I have listed the original source and author. Many of these hints have been reprinted several times, sometimes with mistakes and omissions.

### 1. REFERENCES FROM AMATEUR RADIO

Review. Ron VK3OM, February 1974 — Useful Mods. Geoff VK3AMK, March 1975 — Alignment Problems. Tom VK2BHT, May 1975 — Bias Setting, Noise Blanker. Bruce VK3BM, September 1975 — RF Speech Clipper. Harry G3LLL — VOX Instability, "Hot Mike", Fan Mod., AM Filter. Roy VK3AOH, December 1975 — Further Mods. Geoff VK3AMK — Overload Elimination. Arn VK5XV, January 1976 — Crystal Selection. Ray VK2AVR, August 1976 — RTTY Reception. Peter VK3ZU, November 1977 — Digital Readout. Keith VK2BGZ, October 1978 — Digital Readout Mods. Noel VK3ABH, October 1978 — Preamp. VK5KL, September 1979 — Preamp (SL 1611C). VK3SM, December 1979.

### 2. REFERENCE FROM BREAK-IN

Mods. to Cure Strong Signal Overload, C. Donoghue ZL2BAF, March 1978. (Reprinted several times in other places.)

### 3. REFERENCES FROM FOX TANGO CLUB MAGAZINE

(There is much more information available from the Fox Tango Club on maintenance, repairs and mods. Also service and alignment charts, extender boards, accessories and parts. Contact Milt Lowens WA2AOQ, 248 Lake Dora Drive, West Palm Beach, Florida 33411, USA.)

IC Diagram Information, Vernier for Dial, Protective Pass Filter for PO Adjust, Walter WB4ITH, October 1973 — Band Pass Filter Alignment, Harry G3LLL, September 1975 — Fan Control, Don VK5PX, February 1976 — Fast and Disabled AGC, Tom K0RPH, April 1976 — Electronic TR Switch, Alfie G3KEY, August 1976 — Elimination of Speaker Clicks, Jim W6EHG, Side Effect of Fan Mod., Roy VK3AOH, September-December 1976 — Noise Blanker Layout, February 1977 — The Blank Band Switch Position, March 1977 — VFO Unit Details, Hum Problems on Receiver, Doug WB1ADB, August 1977 — Pilot Lamp Removal, December 1977 — Audio Derived AGC, Bob N4BP, December 1978.

For anyone interested in working on the FT series the Fox Tango Club can provide a vast source of practical information. Good luck. ■

BUYING OR SELLING GEAR?

# HAMADS

MAKE IT HAPPEN FAST

The Question we seem to get most often from our customers:

# “WHEN IS ICOM COMING OUT WITH A HANDIE-TALKIE!”

## ICOM IC-2A SYNTHESISED 2 METRE HANDIE TALKIE

### FEATURES YOU'VE WANTED

- 800 T/R Channels. synthesised.
- 1.5 Watt Output High/Low Power Battery Saving Switch to .15 Watt.
- Separate built in Speaker & Mic. Excellent audio quality.
- Compact. About the size of a \$2 note.
- Variable size Nicad Power Pack, 3 sizes available to suit your needs. (250 MA standard). Makes the IC-2A the most compact synthesised HT on the market.
- ICOM level Receiver Performance-ICOM Quality Receiver in a compact package (.2uv/20db typical)
- 600 KHz offset for Repeaters provided.
- With slip on/slip off Bottom Nicad Pack, you can vary the size of the HT from about 116 mm high to 175 mm high. Easy to carry extra Snap-on packs with you for extended trips.
- Backed by **VICOM** 90 day warranty.

### TYPICAL TECHNICAL CHARACTERISTICS (Australian model)

**GENERAL:** Frequency Coverage 144.000 - 147.995 HMz, Power Supply Requirements DC 8.4V with attendant batteries, Current Drain Transmitting: High (1.5w) approx. 600mA, Low: (0.15W) approx. 200mA, Receiving: At max audio approx. 140mA Squelched approx. 20mA, Dimensions 116.5mm(H) x 65mm (W) x 35mm(D) without battery case, Battery case: 49mm(H) x 65mm(W) x 35mm(D), Net Weight 450g including batteries and flexible antenna

**TRANSMISSION** Transmission Power High: 1.5w (at 8.4v) Low: 0.15w, Max. Frequency Deviation 5 KHz, Modulation System Variable reactance frequency modulation, Spurious Emission More than 60dB below carrier, Microphone Built-in electric condenser microphone optional 600 ohm dynamic microphone can be used.

**RECEPTION** Sensitivity Less than 0.4uV for 20dB Noise quieting, Selectivity #7.5KHz At the -6dB point, #15KHz At the -60dB point, Audio Output, More than 300mW.

actual size: Cut out along the dotted line and put the ICOM IC-2A in the palm of your hand.



TOP VIEW

BNC antenna connector  
"Rubber Duckie" standard  
transmit indicator  
squelch  
volume control

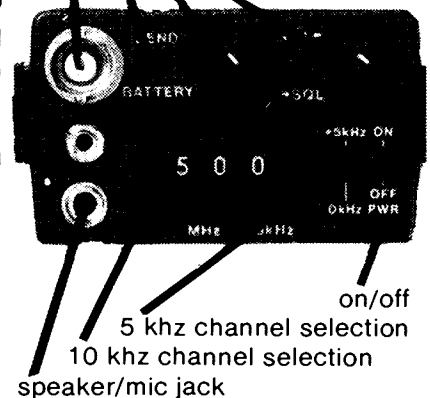

only \$279

# THE ANSWER IS: NOW!

ALL 800 channels of it!

Distributed in Australia by VICOM

VICOM

YAESU  
**The radio.**

**NOW  
PRESENTS**



ALL SOLID STATE

# FT-707 "WAYFARER"

NEW BANDS FACTORY INSTALLED

## SPECIFICATIONS

### GENERAL

#### Frequency coverage:

80m 3.5-4.0 MHz, 40m 7.0-7.5 MHz,  
30m 10.0-10.5 MHz, 20m 14.0-14.5 MHz,  
17m 18.0-18.5 MHz, 15m 21.0-21.5 MHz,  
12m 24.5-25.0 MHz, 10m 28.0-29.9 MHz.

#### Modes of operation:

LSB, USB, CW, and AM.

#### Power requirements:

13.5 volts DC, negative ground.

#### Current consumption:

DC 1.5 amps receive, DC 20 amps  
transmit.

#### Case size:

93(H) x 240(W) x 295(D) mm incl. heat  
sink.

Weight: Approx. 6.5 kg.

### TRANSMITTER

#### Power Input:

SSB/CW 240 watts DC, AM 80W DC.

#### Carrier suppression:

Better than 40 dB.

#### Unwanted sideband suppression:

Better than 50 dB at 14 MHz, 1 kHz  
mod.

#### Spurious emissions:

At least 50 dB down.

#### Frequency response:

350-2700 Hz (—6 dB).

#### Third order distortion products:

At least 31 dB down.

### RECEIVER

#### Sensitivity:

SSB/CW 0.25  $\mu$ V for 10 dB S/N, AM  
1.0  $\mu$ V for 10 dB S/N.

#### Selectivity:

SSB 2.4 kHz (—6 dB), 4.0 kHz (—60  
dB); CW\* 0.6 kHz (—6 dB), 1.2 kHz  
(—60 dB); CW\*\* 350 Hz (—6 dB), 1.2  
kHz (—60 dB); AM 3.6 kHz (—6 dB),  
6.8 kHz (—60 dB).

#### Image rejection:

60 dB (80-12m), 50 dB (10m).

#### Audio output impedance:

4-16 ohms.

#### Audio output:

3 watts at 4 ohms at 10% THD.

#### Variable bandwidth control:

Continuous from 300 Hz to 2.4 kHz  
(SSB/CW modes only).

\*with optional 600 Hz CW filter.

\*\*with optional 350 Hz CW filter.

## FEATURES

- Advanced receiver front end design provides the wide dynamic range required in demanding base station installations.
- LED level meter provides indication of the received signal strength, relative power output, and ALC voltage level.
- Continuously variable width of the IF passband.
- Digital plus analog frequency read-out.

The optional FV-707DM Digital VFO provides up/down scanning in 10 Hz steps (so close together that you'll think you're using a regular analog VFO). Scanning control — up/down, fast/slow — may be exercised from the optional scanning microphone.

### ELECTRONIC SERVICES

Stan Roberts VK3BSR

38 FAITHFUL STREET, WANGARATTA 3677

Telephone: (057) 21 6260. Telex: Teletra AA 56880

#### AUTHORISED DISTRIBUTORS:

**VIC:** Chirnside Electronics (03) 726 7353, G.F.S. Electronics (03) 873 3939, Imark (03) 329 5433. **NSW:** Emtronics (02) 398 6378. **QLD:** C. W. Electronics (07) 341 5377. **SA:** Graham Stallard (08) 43 7981, Farmers Radio (08) 293 2155. **WA:** Willis Electronics (09) 321 7609. **TAS:** J. D. Electronics (003) 44 5000.

Agents are located in many regional centres throughout Australia.

# CUSTOM COMMUNICATIONS

## HAM RADIO & AMATEUR GEAR

Shop 11,  
PARRAMATTA ARCADE  
Cnr. Church & Darcy Sts.,  
PARRAMATTA N.S.W. 2150



**NEW**

### TONO-DOT MATRIX PRINTER

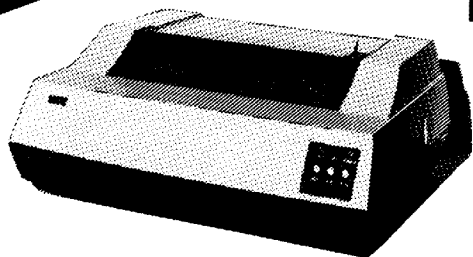

**\$990**  
MODEL  
HC-800



**NEW**

**ICOM IC-2A**  
SYNTHESIZED 2 MTR  
HANDHELD 800 CHANNELS  
**\$279**

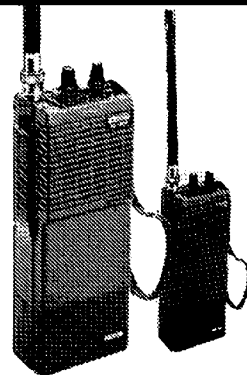

**NEW**

### AUTO-ANTENNA TUNER

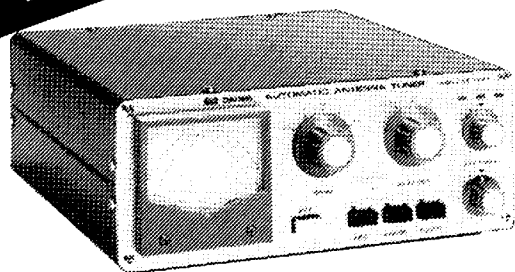

CNA 1001  
200 WATT  
**\$269**  
CNA 2002  
2.5 Kw  
**\$569**

**TONO - 7000E**  
COMMUNICATIONS COMPUTER **\$899**

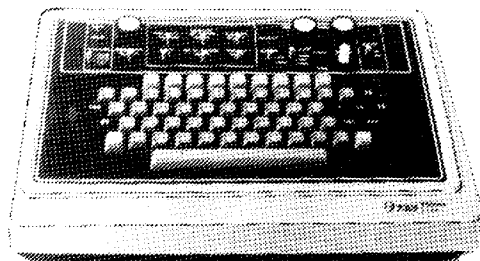

**NEW**

### SWR - BRIDGE

3.5 - 150 MHz

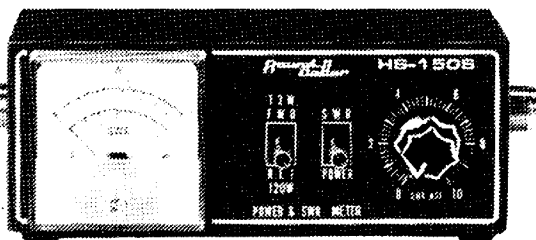

**\$29**



**STILL  
POPULAR**

**IC - 22S**  
LOW COST 10 w MOBILE

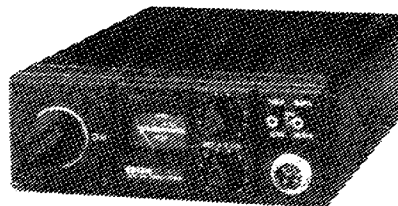

**\$299**



#### OTHER LEADING ICOM EQUIPMENT

IC-260 2 MTR ALL MODE MOBILE . . . . . \$599.00  
IC-701 HF-TRANSCEIVER 160-10 MTR \$1199.00  
IC-551 6 MTR ALL MODE 100 w . . . . . \$859.00  
IC-251A 2 MTR ALL MODE AC/DC . . . . . \$847.00

... AND MANY OTHERS! CALL IN AND INSPECT

#### VICOM HELICAL WHIPS AND YAGIS

10 TO 80 MTR . . . . . \$28.00  
5 ELEMENT YAGI 2 MTR . . . . . \$35.00  
10 ELEMENT YAGI 2 MTR . . . . . \$74.00  
16 ELEMENT YAGI 70 CM . . . . . \$53.00  
5 ELEMENT YAGI 6 MTR . . . . . \$89.00

**VICOM**

Phone: 635 6399, 635 6546, A.H.: 674 1719

# CUSTOM COMMUNICATIONS HAM RADIO & AMATEUR GEAR



Shop 11,  
PARRAMATTA ARCADE,  
Cnr. Church & Darcy Sts.,  
PARRAMATTA N.S.W. 2150

**NEW**

**10 TO 80 MTR  
VERTICAL  
ANTENNA**  
500 WATTS  
MAX 6.9 m HIGH  
ONLY \$79.00

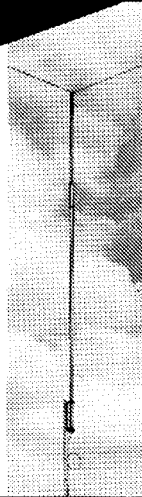

**NEW**

**SSTV EQUIPMENT**  
CAMERA — MONITOR  
— SCAN CONVERTOR  
ALSO CHARACTER  
GENERATOR

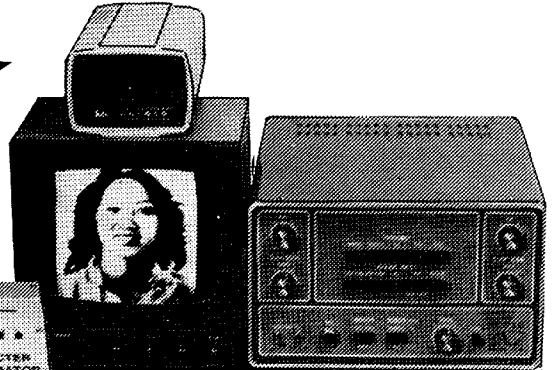
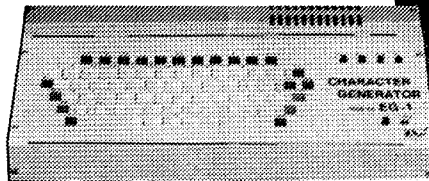

PRICE T.B.A.

**NEW**

**2 MTR  
GROUNDPLANE**  
7/8 WAVE COLINEAN  
7 db GAIN  
ONLY \$49.00

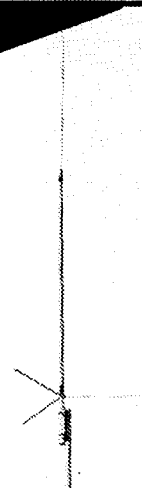

**NEW**

**2 MTR LINEAR  
AMPLIFIERS**  
**6 MTR LINEAR AMPLIFIERS**

FROM 10 WATTS TO 150 WATTS ON 2 MTRS  
FROM 10 WATTS TO 75 WATTS ON 6 MTRS

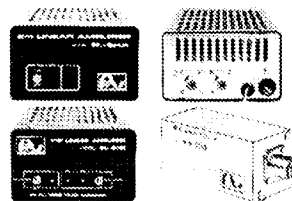

PRICE T.B.A.

PLEASE RING OR SEND FOR MORE DETAILS.

**NEW**

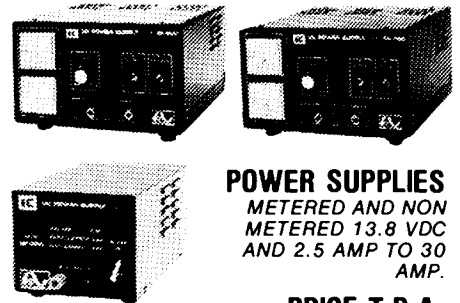

**POWER SUPPLIES**  
METERED AND NON  
METERED 13.8 VDC  
AND 2.5 AMP TO 30  
AMP.

PRICE T.B.A.

**NEW**

**5/8 WAVE AND  
7/8 WAVE 2 MTR  
MOBILE**  
COMPLETE WITH  
COAX AND MOUNT.  
TILT OVER  
5/8 WAVE  
\$32.00  
7/8 WAVE  
\$37.00



**NEW**

**ASTRO-A HF/SSB  
TRANSCEIVER**

HIGH PERFORMANCE, SUITABLE  
FOR MARINE USE

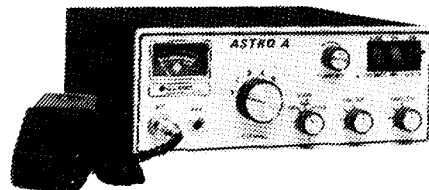

PRICE T.B.A.

**NEW**

**ASTRO-C (AN/URC-XX)**  
THE MOST ADVANCED AND  
MODERN RADIO AVAILABLE

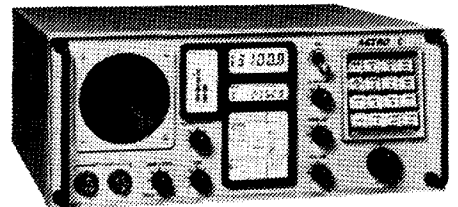

PRICE T.B.A.

**VICOM**

Phone: 635 6399, 635 6546, A.H.: 674 1719

# AMATEUR SATELLITES

R. C. Arnold VK3ZBB

## PHASE III OSCAR

Launch date is now set for 20th May, 1980. The satellite has been delivered by AMSAT to the French authorities at Toulouse for final integration.

Peter VK7PF has been working on orbit predictions for the Phase III Oscar which will be known as AMSAT OSCAR 9 after launch. Peter has very generously given me permission to publish two of his sets of calculations which, all being well, should provide a basis for tracking A09 on its varying orbits.

The first set of figures refers to the transfer orbit which will be applicable to the early orbits — listen only, NO OPERATION. The second set of figures applies to the final orbit situation which we hope will be a continuing situation — NO OPERATION UNTIL ADVISED.

Some explanation of the figures is necessary:

1. The time is that applicable at the first equator crossing, i.e. similar to AO7, etc.
2. The longitude at 0 is a reference only and the actual longitude at the start must be added on.
3. HT is height in km from earth.
4. DIST. is maximum distance from satellite.
5. RADIUS in degrees is the coverage of the satellite. To convert to kilometres multiply by 111.98.

Peter now has his computer set up to accept any alteration to the basic provisional data which may be affected at the time of launch.

## SATELLITE OPERATORS

- Welcome to Paul VK3BWC, who is active on all Modes of AO7 and 8.
- Jim ex P29ZFB is now VK4ZJK in Cairns. At present on Modes A and B, Jim is working on his rigs and will soon be on Mode J.
- Eddie VK4ZEZ is now located in Brisbane and will shortly resume operation.
- Rod VK4ZRQ is working JA on Mode B.
- Proportionately to licensed amateurs, VK8 is probably the most active call area with Maurie VK8OB and Albert VK8HW regular operators.
- After a long break, Barry ZL3AR is back on AO7B. Ray ZL1BDU is a stalwart on all Modes with ZL1TXX, ZL3BWC and ZL1BNC as regular operators.
- Stewart ZK1AA will shortly resume operations on Mode A.
- Peter H44PT is regularly heard on both AO7 and AO8 and is welcome DX for operators in VK7 and VK3.

- Peter VK4PJ is active each morning and is looking for contacts on Modes B and J in particular. Sorry we are unable to help Peter unless we can set up a rig at the work QTH!
- Peter also sends a reminder to users of the QM70 transverter that it is not fitted with polarity protection — sounds as though some wires were crossed in Peter's rig!

## BIBLIOGRAPHY

The January 1980 edition of "Radio Communication" (RSGB) contains two interesting articles —

- (a) Oscar 7 between sunlight and the earth's shadow.
- (b) A review of a new piece of equipment "The Oscarbox".

Both good reading for Oscar enthusiasts.

## PREDICTIONS

As I have mentioned in previous editions of these notes it is a pretty hairy business to give accurate predictions some ten weeks ahead and consequently some criticism has been forthcoming on the inaccuracies which have crept in. Also, the publication dates of AR have been late in recent months, making some of the figures "old hat". However, the regular operators have obviously overcome these de-

ficiencies by devious means as they appear on time as the birds pass over. Consequently, I am leaving predictions out for the time being but I will give a couple of reference orbits (with tongue in cheek) to assist calculations for the rest of the month.

## AMSAT OSCAR 7

April 6th, 1980, Orbit 24659 EQX 0135Z at 93°W.

## AMSAT OSCAR 8

April 6th, 1980, Orbit 10635 EQX 0139Z at 75°W.

All interested in amateur satellites can keep updated in several ways:—

1. Join AMSAT and receive "ORBIT" magazine.
2. Qualify for the Mode J Award and receive the Mode J magazine.
3. Listen to the regular Sunday news broadcasts from VK2WI, VK4WIA and VK5WI.
4. Participate in, or listen to, the AMSAT nets on Sunday evenings —  
VK net 7065 kHz, 1000 hr. Z (VK3ACR), Pacific Net 14275 kHz, 1100 hr. Z (JA1ANG).
5. Monitor W1AW daily 2300 hr. Z (RTTY).

## ACKNOWLEDGEMENTS

To VK3ACR, VK4PJ, VK7PF, ZL3AR. ■

## SATELLITE SUB. POSITION

Derived from AMSAT Bulletin, Dec. 1976 by VK7PF  
Time and position from equator for AO9 Transfer Orbit

Period: 603.78 minutes.  
Inclination: 17.5 degrees  
Argument of Perigee: 190.587 degrees  
Perigee: 200 km.  
Apogee: 34411.28021 km.  
True anomaly steps: 10 degrees.

Time	Long	Lat	Ht (km)	Dist (km)	Rad
M	W				Deg
0.0	0.0	0.0 N	32,680.7	38,528.5	80.6
69.8	7.9	3.0 N	34,405.7	40,275.9	81.0
140.2	15.9	5.9 N	33,030.2	38,882.7	80.7
201.5	21.5	8.6 N	29,153.7	34,948.7	79.7
248.9	23.6	11.1 N	24,165.0	29,864.0	78.0
283.0	22.1	13.3 N	19,246.1	24,812.2	75.6
306.8	17.9	15.1 N	14,986.0	20,384.6	72.8
323.4	11.7	16.4 N	11,527.2	16,725.9	69.1
335.2	4.3	17.2 N	8,801.9	13,770.5	65.2
343.8	358.9	17.5 N	6,679.7	11,389.9	60.8
350.2	347.1	17.2 N	5,031.7	9,456.9	56.0
355.2	337.9	16.4 N	3,751.3	7,865.8	51.0
359.2	328.6	15.1 N	2,755.7	6,535.1	45.7
362.5	319.3	13.3 N	1,983.2	5,404.0	40.3
365.3	310.0	11.1 N	1,388.2	4,428.9	34.8
367.8	300.8	8.6 N	937.5	3,581.1	29.3
370.0	291.6	5.9 N	607.3	2,847.2	24.1
372.0	282.5	3.0 N	380.9	2,235.6	19.3
373.9	273.5	.0 S	247.3	1,792.1	15.7
375.8	264.4	3.0 S	200.1	1,609.4	14.2
377.7	255.3	5.9 S	237.3	1,755.1	15.4
379.6	246.1	8.6 S	360.5	2,173.4	18.8
381.6	236.7	11.1 S	575.6	2,768.6	23.5
383.8	227.3	13.3 S	892.9	3,489.1	28.7
386.2	217.7	15.1 S	1,328.3	4,323.2	34.2
389.0	208.1	16.4 S	1,904.9	5,282.1	39.7
392.2	198.5	17.2 S	2,654.5	6,393.0	45.1
396.1	189.0	17.5 S	3,621.0	7,697.5	50.4
401.0	179.8	17.2 S	4,864.2	9,254.2	55.5
407.2	170.9	16.4 S	6,463.9	11,142.1	60.2
415.5	162.7	15.1 S	8,524.1	13,463.8	64.7
426.8	155.4	13.3 S	11,171.5	16,344.7	68.7
442.7	149.4	11.1 S	14,538.6	19,915.3	72.3
465.5	145.2	8.6 S	18,708.0	24,254.2	75.3
498.3	143.7	5.9 S	23,567.2	29,252.4	77.7
544.0	145.5	3.0 S	28,598.0	34,383.7	79.5
603.8	150.9	.0 S	32,680.7	38,528.5	80.6

## SATELLITE SUB. POSITION

Derived from AMSAT Bulletin, Dec. 1976 by VK7PF  
Time and position from equator for AO9.

Period: 656.2 minutes.  
Inclination: 57 degrees.  
Argument of Perigee: 210 degrees.  
Perigee: 1500 km.  
Apogee: 35813.87632 km.  
True anomaly steps: 10 degrees.

Time	Long	Lat	Ht (km)	Dist (km)	Rad
M	W				Deg
0.0	0.0	0.0 N	26,279.0	32,022.4	78.7
49.1	6.8	8.4 N	30,912.7	36,735.3	80.2
110.5	16.4	16.7 N	34,461.7	40,332.6	81.0
179.9	27.5	24.8 N	35,813.9	41,701.0	81.3
249.7	37.9	32.6 N	34,461.7	40,332.6	81.0
311.2	44.8	40.0 N	30,912.7	36,735.3	80.2
360.2	46.7	46.6 N	26,279.0	32,022.4	78.7
395.9	43.0	52.0 N	21,566.6	27,201.5	76.8
423.5	33.8	55.7 N	17,346.5	22,845.8	74.4
442.7	20.7	57.0 N	13,814.3	19,153.5	71.6
456.7	6.2	55.7 N	10,958.8	16,116.2	68.4
467.2	353.0	52.0 N	8,688.2	13,645.2	65.0
475.2	342.1	46.6 N	6,895.7	11,638.8	61.3
481.5	333.4	40.0 N	5,484.4	9,998.1	57.5
486.5	326.2	32.6 N	4,375.9	8,654.9	53.6
490.8	320.2	24.8 N	3,509.2	7,551.7	49.8
494.4	314.8	16.7 N	2,837.9	6,649.3	46.2
497.6	309.9	8.4 N	2,327.7	5,922.6	42.9
500.5	305.1	.0 S	1,953.6	5,358.1	40.1
503.2	300.3	8.4 S	1,697.9	4,951.5	37.9
505.7	295.2	16.7 S	1,548.9	4,704.9	36.4
508.2	289.6	24.8 S	1,500.0	4,622.0	36.0
510.7	283.1	32.6 S	1,548.9	4,704.9	36.4
513.2	275.3	40.0 S	1,697.9	4,951.5	37.9
515.9	265.7	46.6 S	1,953.6	5,358.1	40.1
518.8	253.5	52.0 S	2,327.7	5,922.6	42.9
522.0	238.4	55.7 S	2,837.9	6,649.3	46.2
525.6	221.4	57.0 S	3,509.2	7,551.7	49.8
529.9	204.5	55.7 S	4,375.9	8,654.9	53.6
535.0	190.0	52.0 S	5,484.4	9,998.1	57.5
541.3	178.6	46.6 S	6,895.7	11,638.8	61.3
549.2	170.3	40.0 S	8,688.3	13,645.2	65.0
559.7	164.5	32.6 S	10,958.8	16,116.2	68.4
573.7	160.9	24.8 S	13,814.3	19,153.5	71.6
592.9	159.4	16.7 S	17,346.5	22,845.8	74.4
619.5	160.4	8.4 S	21,566.6	27,201.5	76.8
656.2	164.0	.0 S	26,279.0	32,022.4	78.7

# NEW HF TRANSCEIVERS FROM YAESU.

The exciting new FT-107 range and FT-707 compact HF range.



FT-107 series.



High quality transceiver.  
All solid state operation with inbuilt DC power supply makes it well ahead of its time.  
Available in two colours : grey or ivory.  
Complete range of accessories available.  
Write for brochure now!

Our list prices are very low

FT-707. All solid state HF transceiver. Incl. 10, 16, 24 MHz.  
FV-707. Digital VFO for FT-707 incl. scanning.  
FC-707. Antenna coupler for FT-707.  
FP-707. DC power supply for FT-707 with in-built speaker.  
Rack mount for all the above items also available.  
FT-107M. HF transceiver excluding power supply.  
FT-107DMS. HF transceiver incl. DMS and power supply.  
FC-107. Antenna coupler for FT-107.  
FV-107. External VFO for FT-107 series.  
SP-107. External speaker.  
FT-107 Range is available in the colours grey or ivory.



FT-207R Handheld.

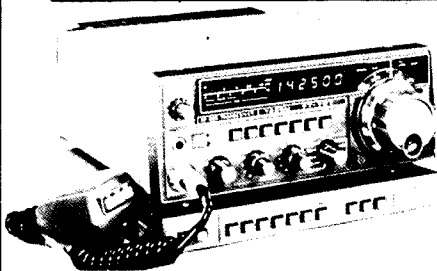

FT-707

FT-707 features all solid state operation including the new 10, 16, and 24 MHz bands factory installed.  
240 watts DC input on Tx.  
Dual 6 pole filters and variable band width control from 300 Hz to 2.4 KHz.  
Digital and analog displays.  
Digital VFO with scanning is available as an optional extra, and makes it ideal for mobile use.

"NEW" digital displays for FRG-7.

Exclusive to Chirnside Electronics.  
Why not install one of these in your FRG-7 Now!  
Fits directly in place of 100KHz dial.  
Save yourself all that eye strain for just \$69 plus pack and post.



NEW FRG-7D .....\$399.

Special POA

MELBOURNE'S LEADING AUTHORIZED YAESU DISTRIBUTOR.

DIAWA  
AUTO Ant. coupler  
CN1001



We also stock:



## HELICALS.

CH-80 .....	\$25.
CH-40 .....	\$25.
CH-20 .....	\$25.
CH-15 .....	\$23.
CH-10 .....	\$23.

Helicals from 80 M. to 20 M. feature stainless steel tip rod for easy adjustment.  
Excellent quality.

ICOM IC225 .....	\$229.
LEADER Ham scope .....	\$309.
LEADER Dip meter .....	\$89.
TONO 7000E Computer .....	\$895.
DIAWA CN620 SWR meter .....	\$95.
DIAWA Ant. Coupler CN217 .....	\$155.
AUTO Ant. coupler CN1001 .....	\$259.
KENWOOD R-1000 Communications Receiver .....	\$489.
TS-120S HF Transceiver .....	\$689.
TL-120 Solid State Linear .....	\$329.
HC-300A Tokyo Hy-Power Labs transmatch .....	\$109.
500 W PEP .....	\$16.
HI-Q Baluns for dipoles, beams etc .....	\$38.
3 Position coax switches .....	\$16.
2 Position coax switches .....	\$16.
plus Morse keys, dummy loads etc.	
Low pass filters, baluns, co-ax and connectors.	MANY MORE!!!!!!

## "DIAWA ROTATOR"

DR7500R Medium duty "R" .....	\$182.
DR7500X Medium duty "X" .....	\$189.
DR7600R Heavy duty "R" .....	\$284.
DR7600X Heavy duty "X" .....	\$220.

## EMOTATOR

103LBX. Medium Duty .....	\$169.
502Cxx. Heavy Duty .....	\$249.
1102MXX. Extra Heavy Duty .....	\$359.
1103MXX. Extra Extra Heavy Duty .....	\$395.
502 Mast Clamp .....	\$32.
103 Mast Clamp .....	\$20.
VCTF-7. 7 Core Cable per metre .....	\$1.20
VCTF-8. 8 Core Cable per metre .....	\$1.00

Most mail orders despatched within 24 hours of receipt of payment with order.

Please allow sufficient for freight, insurance etc.

CHIRNSIDE ELECTRONICS, 26 Edwards Road, Chirnside Park, Lilydale, 3116. Phone (03) 726 7353

# SIDEBAND ELECTRONICS ENGINEERING

P.O. BOX 23, SPRINGWOOD, N.S.W. 2777  
 WAREHOUSE 213 HAWKESBURY RD. SPRINGWOOD  
 TELEPHONE (047) 54 1392

We now have stocks of Audio-Telex imported HY-GAIN TH3-Jr antennas at \$250. We expect to once again carry a greater range of HY-GAIN antennas in the near future; 2M 8 and 14-el yagis, 10M yagis etc. Also in the pipeline are more of the popular FT-101ZD YAESU-MUSEN Transceivers at the right price, a CDE Ham 1V rotator to replace the heavy duty Ham 3 rotator, and a large shipment of KEN KR-400 and KR-500 medium duty rotators and KS-065 stay/thrust bearings. Prices of imports from the USA, due to inflation there, are still rising and shipping costs increase plus in the case of antennas 30% import duty however we will still do our best to maintain sensibly low prices on our imports.

**ROY LOPEZ.**

## HENRY RADIO A Famous Brand

### NEW LINEAR AMPLIFIERS

2-KD5-2KW PEP 80-10M SSB/CW/RTTY/AM.....	<b>\$1050</b>
1-KD5 1200W PEP 80-10M SSB/CW/RTTY/AM.....	<b>\$850</b>

## ANTENNAS

TET HB 35C 5-el 10-15-20M periodic/yagi.....	<b>\$375</b>
HY-GAIN TH3-JR 10-15-20M yagi.....	<b>\$250</b>
HY-GAIN 18-AVT/WB 10-80M vert.....	<b>\$110</b>
HELICAL MOBILE WHIPS —	
80M — 40M each.....	<b>\$28</b>
20M — 15M each.....	<b>\$26</b>
10M.....	<b>\$25</b>
GPV-5 2M vert collinear 2x5/8W.....	<b>\$48</b>
OSCAR 2-D 2M mobile 1/4 or 5/8 W c/with gutter mount, cable/plug.....	<b>\$27</b>
BN-86 Balun for TH-3JRs.....	<b>\$20</b>
Hi-Q Baluns 50-ohm 1-KW 1:1.....	<b>\$15</b>

## ROTATORS AND CABLES

All rotators now come with bottom brackets and control indicator boxes wired for 28V AC —

CDE BT1A BIG TALK light duty programmable 4-pos. push button plus normal operation.....	<b>\$85</b>
KEN KR-400 medium duty.....	<b>\$120</b>
KEN KR-500 vertical rotator.....	<b>\$150</b>
CDE Ham 1V heavy duty (June/July).....	<b>POA</b>
CDE T2X Tail twister extra HD.....	<b>\$250</b>
RG-8U foam co-ax. per meter now.....	<b>\$1.20</b>
8-cond. rotator cable. per meter.....	<b>80c</b>

## ACCESSORIES

ASAHI chrome bumper mount.....	<b>\$8</b>
Standard bumper mount.....	<b>\$5</b>
Chrome base and spring to suit ASAHI mount.....	<b>\$20</b>
FERGUSON 240V AC transformer 2 x 9V secondaries at 3A.....	<b>\$10</b>

## TRIO KENWOOD PRODUCTS

TS-180S 10-160M 12V solid state.....	<b>POA</b>
TS-120S 10-80M 12V solid state.....	<b>POA</b>
TS-820 10-160M 240V transceiver.....	<b>POA</b>
TS-520S 10-160M 240V transceiver.....	<b>POA</b>
TS-700SP 2M all mode trans.....	<b>SPOA</b>
R-1000 digital clock receiver.....	<b>POA</b>
VFO-520 for TS-520S.....	<b>\$130</b>
SP-520 for TS 520S.....	<b>\$30</b>
SP-120 for TS 120S.....	<b>\$32</b>
SP-100 for R-1000.....	<b>\$32</b>
DK-520 Adaptor TS-520 to DG-5.....	<b>\$10</b>

All further Trio-Kenwood accessories transceivers and test equipment at competitive prices.

## KYOKUTO FM 2025A

The very latest 2M FM from KYOKUTO 2M FM mobile 25W 10 memory channels plus full scanning etc.....	<b>\$350</b>
--	--------------

## CO-AX CONNECTORS

PL-259, SO-239, cable joiners ea.....	<b>.60c</b>
Right angles and T connectors ea.....	<b>\$1.50</b>
GLP right angle, RG-58U to SO-239 w/lock nut & weatherproof cap.....	<b>\$1.50</b>
Double female connectors.....	<b>75c</b>
MLS right angle RG-58U to PL-259.....	<b>75c</b>
In-line mic. sockets 3 & 4 pin ea.....	<b>60c</b>
Mic. sockets 3 & 4 pin each.....	<b>60c</b>
M-ring body mount w/lock nut.....	<b>\$1.50</b>

## NOVICE SPECIALS — CONVERSION CRYSTALS

Here are two sets of crystals which will convert 23-channel CB crystal synthesised transceivers for novice amateur use. Suits units with 4 x 14.9 MHz and 6 x 23 MHz crystal in synthesiser and with 11.275 MHz IF. Set of 8-crystals. Converts 28.480 to 28.595 MHz in 5-kHz steps. Clarifier tuning on Tx and Rx plus info to re-activate 24th channel per set.....

Set of 4 x crystals converts 28.310 — 28.600 MHz as above.....	<b>\$15</b>
---	-------------

All prices are NET, ex Springwood NSW, on pre-payment with order basis. All risk insurance is free of charge, allow for freight charges by air, road, rail or postal, excess will be refunded. Prices are subject to change without prior notice. All orders cleared on a 24-hour basis after receipt of order with payment.

**ROY LOPEZ (VK2-BRL) Manager**



# VHF-UHF

An expanding world

Eric Jamieson,  
VK5LP



Forrester, S.A. 5233

## VHF/UHF BEACONS

Freq.	Call Sign	Location
50.005	H44HIR	Honiara
50.023	HH2PR	Haiti
50.025	6Y5RC	Jamaica
50.035	ZB2VHF	Gibraltar
50.036	HC1JX	Quito
50.038	FY7THF	French Guiana
50.040	WA6MHZ	San Diego
50.040	ZS6VHF	Edenvalle
50.048	VE6ARC	Alberta
50.050	ZS3E	South West Africa
50.055	ZL1UHF	Auckland *
50.060	PY2XB	Sao Paulo
50.070	YV5ZZ	Caracas *
50.070	VP9WB	Bermuda *
50.080	W1AW	Connecticut
50.080	TI2NA	Costa Rica
50.085	WA6JRA	Los Angeles
50.088	VE1SIX	New Brunswick
50.089	WD4CEI	North Carolina *
50.100	KH6EQI	Pearl Harbour
50.104	K4EJQ	Tennessee *
50.105	KC4AAD	McMurdo, Antarctica *
50.110	KH0AB	Saipan *
	JD1YAA	Minami, Torishima Is. †
50.110	AL7C	Anchorage *
50.120	4S7EA	Sri Lanka *
50.144	KC6IN	Ponape, Caroline Is. *
50.498	5B4CY	Cyprus
51.999	YJ8PV	New Hebrides
52.200	VK8VF	Darwin
52.250	ZL2VHM	Palmerston North
52.300	VK6RTV	Perth
52.350	VK6RTU	Kalgoorlie
52.400	VK7RNT	Launceston
52.440	VK4RTL	Townsville
52.450	VK2WI	Sydney
52.500	JA2IGY	Mie †
52.500	ZL2VHM	Palmerston North
52.510	ZL2MHF	Mt. Clifmie
52.800	VK6RTW	Albany
52.900	VK6RTT	Carnarvon
53.000	VK5VF	Mt. Lofly
144.010	VK2WI	Sydney
144.162	VK3RGI	Gippsland
144.400	VK4RTT	Mt. Mowbullan
144.475	VK1RTA	Canberra
144.500	VK6RTW	Albany
144.600	VK6HTT	Carnarvon
144.700	VK3RTG	Vermont
144.800	VK5VF	Mt. Lofly
144.900	VK2RTX	Ulverstone
145.000	VK6RTV	Perth
147.400	VK2RCW	Sydney
432.400	VK4RBB	Brisbane

\* Denotes a new listing and comes from a recent list sent of me by SMIRK, and as the USA has been in the thick of 6 metre activity it seems these new listings are more permanent than some.

† Denotes a change of location or call sign.

Although not in the general list, remember by the time you read this the beacon from Geelong on 52.330 may be operating; the March advice I received was that there were still some problems being ironed out in regard to the licensing.

## SIX METRES OVERSEAS

Bill W3XO and "World above 50 MHz" report a collapse of 6 metre DX in the Northern Hemisphere, occurring about mid-January and continuing through until March, despite solar flux readings around 220 and single figure A index. The poor conditions were very disappointing for E16AS, who received permission to operate on 6

metres on 5-1-80 and at time of writing had worked no DX! The north-south path to South America has not totally collapsed, on 15-1 WB3HZC who operated as 8P6II for about 10 days in mid-January worked LU6DCA, LU3EX, LU6DII, PY1RO, PY1DMQ, PY2XB, CP8AZ, HC1BI and HC1FM, all using FT620B and 3 element beam, which at the end was left with 8P6BN so that he and 8P6FV can supply Barbados OSOs.

On 5-2 at 0620Z JA3EGE worked 4S7EA in Sri Lanka, while PY2XB reports three contacts with JR6RRD, Okinawa, around 0200Z on 31-1, 4-2 and 11-2. Sao Paulo and Okinawa are about on opposite sides of the earth from each other, so that's about as far as you can go PY2XB also reports PPOMAG, Trinidad Island, has been working into South America and Caribbean about 2300Z running 1 watt! HP1XRK is the new Panamanian call of KZ5JM, and HP1XDS is also active on 6 metres. CP8AZ is operating from Bolivia, South America.

EI2W in Ireland began operating on 20-10-79 using an FT620B and 3 element yagi, and up to the end of December had made 1552 OSOs with 600 stations across the Atlantic. All USA call areas plus VE1 to 4 and 0 have been worked as well as XE1FE, KP4 and KP2. Best day 18-11 with 106 stations contacted, 20-11 70 stations, and 11-12 saw 83 stations added to the log. On 15-12 the MUF rose to 62.250 MHz and 72 six metre stations were worked, including K08FH using 3 watts and 5 x 7.

## THE LOCAL SIX METRE SCENE

John VK5ZBU writes that since his last correspondence terminated on 14-12-79 conditions have been a mixture of good and poor, depending where you live! To report without qualification is unwise, hence John says "at this OTH".

18-12 VK1, VK2, VK3, VK4 and VK7; 22-12 VK4; 23-12 VK2, VK4 and VK8; 24-12 VK4; 26-12 VK4; 28-12 VK2; 30-12 VK2, VK3, VK4, VK5. Thus ended 1979 and 20 days when the band was open. HL9TG appeared on 31-12.

1980 opened quietly. 2-1 VK2 and VK7 5 x 9. 11-1 a big opening to VK7 for over four hours with nine different VK7s being on. Anthony VK7ZTA reported he was hearing signals from VK5 at levels never heard before. Between 12-1 and 16-1 VK2, VK3, VK4 and VK7 all 5 x 9; 17-1 VK3, VK7; 18-1 VK4; 19-1 VK4. Between 20-1 and 31-1 worked VK4ZVZ, VK4ZJB, VK4ZGI, VK4QO, VK4ZYA, VK6XY, VK2ZZV, VK2ZZY, VK2YOT, VK2ZRU, VK2ASZ, VK2ZBQ, VK2ZYI, VK7DA, VK1RK, VK8ZRT, VK3YII, VK3DKC plus ZL2AOR at 5 x 9 plus 20 dB! Very few signals were below S9 during January, and the band was open for 22 days.

January was thus a month of outstanding contacts for Es at a time when unexpected, with the special conditions to VK7 on 11-1 and VK3 on 17-1, plus ZL2AOR, being the highlights. During the VK7 opening ZL4LV and ZL4OY were heard but not worked.

February did not prove very fruitful, only 12 days when signals were recorded in Adelaide, but these included contacts with JA2HMO, JA4KJO and a few VK2 stations. During this time many weak signals from Japan were noted late in the evenings on 50 MHz, at one stage 5 out of 6 days JAs were audible weakly.

March has proved to be the doldrum period; on 15-3 VK1VP and VK2YOT providing good contacts, with a brief appearance of VK4ALM. On 21-3 at 0130Z JAs appeared on 50 MHz, in fact most of the lower part was active with hertodynes. Quickly some JAs were heard with JA8RC at S9+ and JA8RVR and JA8HWL were heard working various VKs. At one point stations were to be found every 5 to 10 kHz on the band. The band, however, was not stable and signals to VK5 dropped right out as if switched off (only to re-appear later but weaker. KG6DX was quite strong on 50 MHz with Col VK5RO working from 28 MHz as 52 MHz was not productive of signals from Guam. Joe seems to be really keen since working the PY1 over a distance of about 12,000 miles.

With most interesting reports coming in from the north, east and west, John remarks that VK5 looks like being the last to receive the benign smile from whatever gods rule the radio spectrum, but April is close at hand and we may soon discover what is in store DXwise. It would be a very brave

man who tries to put a tag or label on what form of conditions have existed during the present cycle, no doubt in due course text books will be rewritten and much of the now ancient theory discarded.

Little has been heard of VK9XT in southern Australia, so Christmas Island may still be a "wanted" country down south, on 6 metres. The weekend of 22-3 and 23-3 showed some promise at times but did not develop as hoped, an opening to JA was not generally in good shape here. Commencing about 0240Z signals were variable but enough to encourage interest amongst the VK5s at any rate. Col VK3YII seems to be really enjoying his travels State-wide, frequently appearing on stations visited.

## NEWS FROM ALICE SPRINGS

It is not often a letter appears on my desk from Alice Springs, but Rodger VK8ZRT has written to indicate what went on up there during the last "season". JAs were worked on 27-9, 29-9, 30-9, 2-10, 3-10, 4-10, 5-10, 8-10, 10-10, 11-10, 16-10, 18-10, 24-10, then on 26-10 five VK5s and three VK3s; 27-10 JA1, 2, 3, 4, 5, 6, 7, 0 at 5 x 9; 16-11 VK2BMX; 26-11 VK6ZEL, VK6ZKO, JK1BER, all 9 plus 27-11 VK4QO; 28-11 VK2VC.

4-12 VK2ZRU 2300Z and again 0202Z 5 x 9, VK2AVW and VK2HZ. 30-12 VK1RK, lots of VK2s, VK3ATN 5 x 9 plus 30 dB, plus VK3BHS, VK3OT and VK3NM, then VK5ZZZ, 26-1 VK5, VK3. 3-2 VK3II and VK3CI. 12-2 to 28-2 JAs 1 through 9 with JK1BER best signal at 5 x 9 plus 20 on 17-2 at 1215Z. Later JJ1TLK dropped out on 20-2 when his rig died at 0440Z, so he borrowed another rig to finish QSO!

Thanks Rodger, and I note you are using an IC502 and home brew 25 watt amplifier and 4 element yagi up 7 metres, and in the process of building a transverter for use with your TS520S.

## TWO METRE METEOR SCATTER

Mike VK7MC has written outlining some proposals for 2 metre operation. He currently has 400 watts PEP from a QB3-300, one 16 element yagi finished and another under construction.

The VK3RGI beacon on 144.165 presumably in the Gippsland area was copied in Hobart on 19-2, with not other VK3 signals or repeaters to be heard! The VK7RTX beacon is evident most of the time, peaking S9 on 19-2 and the path is difficult. VK7DA has also been worked, all of which indicates a good capability for 2 metre DX. 2 metres from Hobart is mostly difficult.

Mike would like to hear from interested operators on 2 metres, giving details of their equipment plus phone number and when they can be contacted. He would like to arrange regular skeds leading towards 2 metre meteor scatter work, and suggests 80 and 40 metres as suitable. Operators in VK2, VK3 and VK5 are therefore invited to try their luck and contact Mike. His address is QTHR or Mike Hennessy, PO Box 52, Sorell, Tasmania 7172.

Quite a bit has been written on the art of meteor contacts during the past 10 years in AR, so it may pay to look up the articles to assist in any such work which may be undertaken. Go to it.

## SIX METRES FROM TASMANIA

Greg VK7ZYT writes with latest DX worked on 6 metres from Collinsvale near Hobart, when the band opened on 2-3-80 with Ch. 0, Wagga, at 0955Z at S2. At 1006Z VK5AS 5 x 1 heard working VK1VP, who was not audible. At 1018Z Greg worked JJ1NLR, followed by JR1MFD, JE1CZV, JA4MBM and JI4WEU, and hearing JA4HTW, JA2HMO, JE6DQ and JK1VBX. Signal strengths varied from S1 to S5. Ian VK7ZIF worked JA4HTW only, paying the penalty of coming late on the band after listening to JAs on 10 and 15 metres! Bard closed 1132Z.

At the same time above Joe VK7JG worked KH6NS 5 x 6 both ways. The JAs were not heard in the north of VK7, but were worked by a few in VK3 and VK4. Looks like Class II TEP was involved in view of flutter on signals.

Greg uses a home brew solid state transverter running 15 watts PEP to a 3 element beam at 22 feet, his QTH is about 1,000 feet a.s.l. Thanks for writing, Greg.

## NOTES FROM ROCKHAMPTON

It's good to at last have some news from VK4, and Hal VK4DO writes to say the first JAs this year came into Rockhampton on 31-1, then nil until 9-2, and from then on about every day. At his time of writing (20-3) he had worked 503 JAs on 52 MHz and could have worked many more.

On 5-3 Hal got his first two KH6 at S6 and S3, and then KG6DX on 17-3, first time for 1980, but their tenth contact. No USA contacts so far in 1980, but hoping for a break-through. (Aren't we all!)

Hal reports the 1980 six metre pattern is following closely that of 1948 and 1949 as far as JA is concerned, the number of contacts in each year from February to March 20th being 509, 345 and 503 respectively, with the total contacts being 1,357 in 1948, 1,661 in 1979. All 47 Japanese Prefectures worked on 52 MHz SSB and CW by 14-10-79, and only want Yamanashi QSL for the award. Total is now 12 countries on six metres. Thanks Hal.

## NEWS FROM YORK PENINSULA

For those of you who don't know York Peninsula, it is west of Adelaide by about 60 miles and at a place between the towns of Mailand and Artherton on the Peninsula you will find that doyen of VHF, David VK5KK, having moved from his former abode at Wasleys into an apparently even better VHF site! He can now run 400 watts PEP on 6 metres to an 8 element yagi, some power on 2 metres to a 10 element at 20 feet (shortly to be replaced by a 15 element long-boomer) and a 16 element vertically polarised for FM.

David reports the area is even better than the Adelaide plains for operation into or hearing Ch. 7, Mt. William. Good series of tropo openings on 21, 22, 23 March to VK1, VK2 and VK3, best day being 22-3, with following worked: Ch. 2 VK5RMW, Pt. Pirie; Ch. 3 VK2RWG3 Wagga; Ch. 3, Ballarat; Ch. 4, Berdigo; Ch. 5, VK3RMM, Mt. Macedon; Ch. 5, VK5RHO; Ch. 5, Griffith; Ch. 7 VK3RWZ, Mt. William; Ch. 7 in VK1, Mt. Ginini; Ch. 8 VK5RAD; Ch. 8 VK3RWE, Wodonga; and another unidentified Ch. 8. All from 2200 to 0100Z. Not a bad effort, David.

On 16-3 David worked Ch. 7, Mt. Ginini, at S2 compared with Ch. 7 VK3RWZ almost inaudible. The three most consistent repeaters interstate are Cr. 5 VK3RMM, Mt. Macedon; Ch. 7 VK3RWZ, Mt. William; and Ch. 8 VK3RNE, Wodonga! On 22-3 worked VK3HS/P at Eildon through three repeaters mentioned above in 30 minutes. (Big deal, how about trying it on SSB!! . . . 5LP.) After that snide remark it is good to see David doing the best he can as he assembles the various bits of gear, and it looks as though he will continue to keep VK5 before the notice of others with his activities; the ball and chain around his foot will not help at times though!

## HF LIAISON FREQUENCY

George VK4ZG/NOT writes asking for consideration to be given to an HF liaison frequency for use in Australia similar to the 6 metre liaison frequency of 28.885 MHz which is being used internationally, resulting in some very good DX contacts taking place.

George points out that quite a portion of VHF operators in Australia are Z calls and possibly novice licence holders, and a frequency outside the bands on which they can operate isn't much help. He suggests its main value would probably be for 2 metre and higher bands contacts, 99.9 per cent of which would be confined to Australia anyway.

The question of such a liaison frequency has been discussed in VK5 on several occasions but the suitability of such a frequency is not easy to fulfil when one considers our time differences, particularly in the summertime. 80 metres would be a good choice in some ways as it is always available on a night time basis throughout the year, but noisy in summer and rather cluttered with signals — if you go to the end nearer to 3.7 MHz where signals are not so plentiful you leave out the novices. For day time usage a frequency on 40 metres would be preferable and this would not be hard to find. At the moment 28 MHz is reasonable and provides a band relatively free of QRM

and QRN, and the ability to cater for novices/Z calls, but skip conditions may not always allow contacts, particularly over shorter distances.

So what do we do. The idea is OK. Have you any thoughts and, if so, are you prepared to write to me outlining them? For starters, may I hear what you think about 3600 kHz for night time, 7100 kHz day time, and 28.385 MHz while conditions last. This latter frequency you will note is 500 kHz below the 28.885 kHz now being used, hence it would only need the flick of a switch on the average transceiver to go from one to the other for listening purposes anyway, and places the lower frequency one in the novice band. The 7100 kHz won't suit novices but there is little else to offer at present if you want a local day time band.

If you study all the pros and cons of the matter you will soon realise just how difficult it is to satisfy everyone — the 28.885 MHz international net is working well because conditions are such at the moment that contacts are possible at almost any time to most places, but this will not always be so, but when conditions do fade there then the 6 metre DX will too! It is unfortunate that QRM on any frequency in the 80 metre band will probably preclude anyone monitoring a particular frequency as you can with 28885, so perhaps we should look at 28385 as a possibility. What are your thoughts?

## HONG KONG AGAIN

A letter from Anthony VS6EZ advises that between 1301 and 1352Z on 5-3 on 52.100 SSB and running 3 watts output to a 5 element beam (which is tuned to 50 MHz) he had contacts with VK8GB 5 x 9 and received 5 x 6; VK8VV 5 x 9 plus 20, and 5 x 9; VK8ZBW 5 x 8 and 5 x 9. Others who worked from Hong Kong were VS6FX Icom 551 and 100 watt linear to a groundplane, VS6AB IC551 to 2 element beam, and VS6EG using Trio equipment and a HF multi-band vertical antenna! After all this activity slowed down, Anthony worked VK4ZBJ at 5 x 2.

On 7-3 VS6EZ and VS6FX both worked VK8VV for a second time at 1301Z, 5 x 9 and 5 x 4. Anthony uses the RM3 unit in conjunction with the IC211 and the 2 and 6 metre transverter to scan between 52.040 and 52.180, but emphasises his only out-of-band allocation is 52.100 ± 10 kHz, so that's where you will have to be to work any VS6 station on SSB, and for CW use 52.025 only. Apparently all this operating has stirred up the Hong Kong gang to some extent, but the stirring would be much more useful if better antennae were in use at their end — perhaps something will be done now to produce some reasonable beams.

## TWO METRES AND UP

16-3 provided some good tropo conditions on 2 metres, with VK5CK VK5RO, VK5ZPS and VK5LP and possibly others working VK2DGW, VK2DAB and VK2ADZ on SSB from about 2150Z onwards, signals depending on where you lived varied from 5 x 2 to 5 x 5; these stations are located in Griffiths, NSW, and provide good long haul contacts. VK3ATN and other VK3 stations were there, too. At 2246Z VK5LP worked VK3ATN on 432.1 MHz at 5 x 5 both ways, while VK3AXV and VK3AOS were both worked on 6 and 2 metres as well. Garry VK5AS at Cowell on the West Coast also was in the act, and had 5 x 9 signals on both bands at this QTH. Rob VK3BHS also came on and it seemed like old times to have so many stations from interstate on 2 metres again. Of course David VK5CK from his box seat on the top of the mountains had to virtually knock back contacts to give his jaw a rest!

During the opening Ray VK3ATN mentioned he worked during the Ross Hull Contest to get 168 contacts on 6 metres, 303 on 2 metres and 89 on 432 MHz. At least half the 432 contacts were with interstate stations, best scoring for 48 hours was 1,402 points. A perusal of the copy of his log which he sent me shows what can be done if you want to try and have a location somewhere in the middle of the activity.

Other things learnt the other night when the bard was open included information that VK5IK at Eudunda, about 70 miles north of Adelaide, has been doing well on 2 metres, but not much information coming through at this stage. Also Roy VK3AOS is operational on 432 MHz and there will

be others in western Victoria coming on 432 in the near future in an effort to get around the likely interference problems of Ch. 5A in that area.

In an effort to try and stimulate further interest in 432 MHz I propose departing from usual practice in this column and have the circuit of a very low noise pre-amplifier published, with advice on a kit of parts costing about \$22. I have been too busy on other matters this month to have the time to prepare what is necessary.

On 25-3 comes news the VK5VF beacon was heard in Perth again by VK6HK, so perhaps conditions will be suitable again soon for some extra stations to work into Perth from Adelaide, not an easy thing to do.

On 26-3 a set of reasonable tropo conditions produced good signals across VK5 on 2 metres, with Ch. 7, Mt. William, being very good, also Ch. 2, Port Pirie. On 144.1 SSB three stations from Pt. Pirie area were worked here, VK5ZMJ, VK5ZNP and VK5NW, while VK5ZMJ and VK5LP had a 432 MHz contact.

## SOLOMON ISLANDS INTO VK5

In response to a hurried phone call from David VK5KK I was quickly on the air on 52.050 at 2222Z on 26-3 (GMT day) and worked H44PT 5 x 9 both ways and H44DX 5 x 8 and 5 x 9. David had earlier worked H44PT with a report received of 5 x 9 plus 30 dB! I am not sure who else worked the H44 stations, but they were the first for me. Apparently it all started from 28885 when Keith VK5SV was talking with Peter H44PT, so the liaison frequency paid off once more.

Soon after the H44 contacts Eddie VK1VP was heard but no contact made. A Y8J maritime mobile station in the Pacific was also heard on 50.109 at 2240Z at S2. Later talking to Andy VK6OX on 28885 he mentioned working VK8XT on backscatter on 15-3 at 1338Z; pleasing to know Steve was able to work into VK6 from Christmas Island. Andy same day worked VS6FX at 1423Z and VS6CT 1424Z both 5 x 1 SSB, and plenty of JAs to be heard at the same time. On 17-3 Andy worked Ross VK4RO at 1200Z on backscatter — so far Andy has never been able to work Ross on ES. Also on 17-3 VK6OX worked KG6DX and KG6JDX at 1147Z 5 x 3/4, being the first time Guam has been heard in the evening. On 18-3 he heard H44PT on 50 MHz and tried to work him split frequency but Peter was too weak.

## CLOSURE

Just before closing, if you have an IC502 and want it to tune 50 MHz at the flick of a switch I suggest you write to David VK5AMK (VK5ZMO in the Call Book), who could help you with information. Requires about an hour to modify and needs a couple of diodes, a few capacitors and resistors. This will allow for split frequency working, so perhaps a stamped, addressed envelope to David might be worth your while if you have the need to monitor 50 MHz.

Thought for the month: "A man who says he understands his wife, probably doesn't speak the truth about other things either."

73. The Voice in the Hills. ■

## QSP

### WARC 79

"While the IARU fielded an experienced, hard-working team, the real heroes are those members of national delegations, amateurs and non-amateurs alike, who spoke up time and again in defence of amateur interests. Of course, they would not have been able to do so had it not been their national policy to support Amateur Radio, and in most cases this reflected a lot of effort over the past several years by the amateur societies of those countries. In general, the atmosphere of the Conference was favourable to the Amateur and Amateur Satellite Services. To most administrations there was no need to justify our existence; opposition generally was based not on an anti-amateur attitude, but on the feeling that other services had a greater need or deserved a higher priority, in parts of the spectrum where we made gains, few other services made greater gains; where we suffered setbacks, many other services also suffered." —QST January 1980. ■

# AWARDS COLUMN

Bill Verrall VK5WV  
7 Lilac Ave., Flinders Park, S.A. 5025

## ALARA AWARD

This award is sponsored by the Australian Ladies' Amateur Radio Association, which now has 85 members.

## BASIC AWARD

Class A: Work 10 members in VK, ZL or P29, including at least 3 VK call areas. No more than 3 VK3 stations to be included in the 10 members.

## ADVANCED AWARD

Class B: Work 15 members, including 4 VK call areas. No more than 4 VK3 members to be included in the 15 members worked for the award.

## SPECIAL ENDORSEMENTS

All Phone, all CW, all Novices, mixed, band endorsements, e.g. all 10 metres.

A sticker is available for each additional 10 members worked.

The award is open to both OMs and YLs.

Contacts may date from 30th June, 1975, which is the date marking the birth of ALARA.

Applications for the award may consist of a log extract signed by two amateurs.

ALARA net contacts cannot be counted toward the award; however, contacts made in other nets may be claimed.

**COST**  
\$A1.00 or 4 IRCs.

## APPLICATIONS

Should be forwarded to the Award Officer, Heather Mitchell VK3AZU, c/- ALARA, Box 110, Blackburn, Victoria 3130.

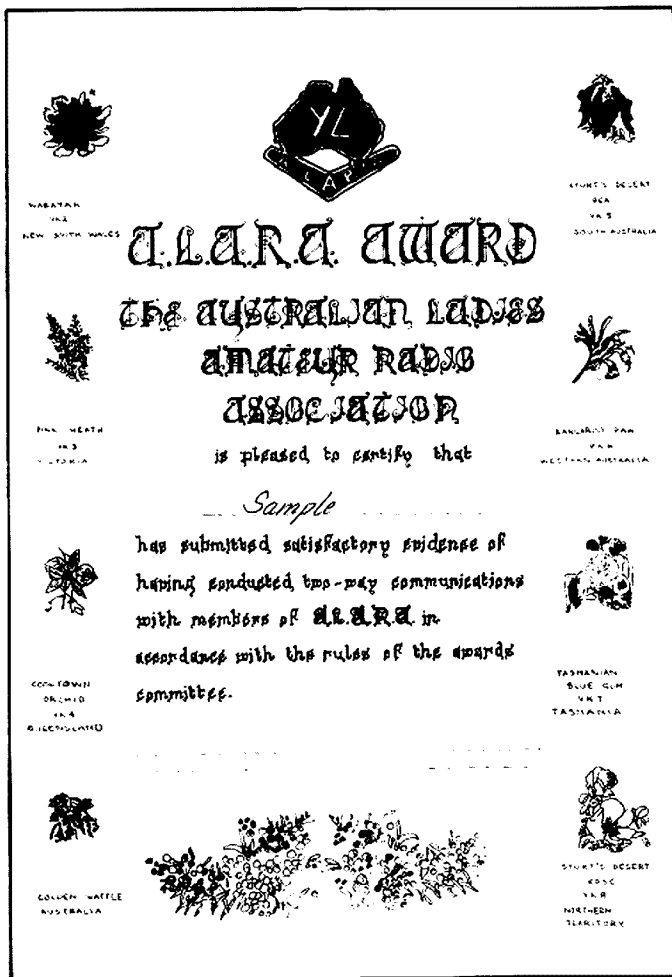

## MARIS

(\*NSW branch)

This is to certify that Amateur Radio Station \_\_\_\_\_ has contacted six (6) Maltese Amateur Radio Stations during the period \_\_\_\_\_ and \_\_\_\_\_

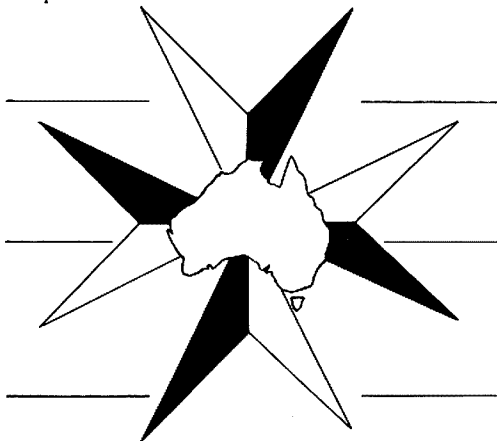

As an achievement of the above we award this certificate.

Date \_\_\_\_\_

*Heather Mitchell*  
president MARIS

*Bill Verrall* MARIS No. 10  
award custodian

## DESCRIPTION

This award measures 2100 mm x 295 mm printed on high quality matt paper. The nine Australian flower emblems are in multi-colours with the logo in yellow and black and printing in black — quite an unusually attractive award.

## MARIS AWARD

This award is sponsored by the Maltese Amateur Radio International Society (NSW Branch).

## REQUIREMENT

Australian stations are required to work 6 (six) Maltese amateur radio stations.

Contacts may be on any band and any mode.

The six Maltese amateur radio stations contacted must be as follows:

- 2 VKs — one must be a committee member of MARIS (NSW Branch); one must be a member of MARIS.
- 1 9H1-4 — must be from Malta/Gozo.
- 3 9H1-4 — must be any Maltese amateur radio station in any part of the world.

Log details only are required including the name of the station operator worked.

## COST

\$2.00 or equivalent in Australian stamps or IRCs to cover postage by return airmail.

## APPLICATIONS

Should be sent to the MARIS Award Custodian, 57 Fairview Road, Cabramatta, NSW 2166, Australia.

## DESCRIPTION

This award measures 210 mm x 300 mm printed on high quality matt card. The logo and border are in red and printing in black.

Good hunting.

# LETTERS TO THE EDITOR

Any opinion expressed under this heading is the individual opinion of the writer and does not necessarily coincide with that of the publisher.

"Sonoma".

Wellington Road, Narre Warren East 3804.

The Editor,

Dear Sir,

A steady trickle of enquiries prompts me to set on record in this, the Journal of the Wireless Institute, the history as far as I know it of what is probably the first minute book of the Institute. Some excerpts from this document were discussed in Amateur Radio magazine by the then editor, Ken Pincott, in August 1970; he also drew attention to the conflict with the history being prepared by Max Hull, a history necessarily based largely on recollection of early amateurs, the relevant part of which appears in AR for March 1970.

My uncle, Herbert Howberry Blackman, was born in 1884. He evidently had all the warped curiosity well known in the amateur, though the recollections of his interests, activities and equipment which I received from my father I think may date from after World War I rather than before. That he was an amateur prior to 1914 is clear, because he is listed in a publication called "Wireless in Australia", compiled by the Wireless Institute of Victoria in 1915, when the call XOE (all "experimental" stations then were prefixed "X"); the late Arnold Hoist (VK3OH) appears as XPH, and the WIV itself as XPJ. He fought in the War, and on return was active as an amateur until about 1930; I am not sure what his call sign was, but I suspect it was VK3PE. His house and shack were in Closter Avenue, Ashburton, which was pretty rural until after World War II; he died there in 1967. He is recorded in the minutes as giving a lecture on telephony 1915 Mar. 9, which also happens to be the last entry in the minute book; he appears not to have been an office-bearer in the period covered by the book, and he left for the War in, I believe, 1916. I think we can ascribe to his wireless activity after the War, the time at which he acquired the minute book, but why he had it and why he was not called upon to return it are matters of conjecture.

Upon his death I asked the executors of his estate if I might look through his shack for items of historical interest, they agreed, and I took with me the late Ken Gillespie VK3GK. It was an awful mess; I think he had just thrown stuff in from the doorway for 20 years. There were a few complete pieces of apparatus, but many, many remnants. Monash University got a moderately complete home-made receiver, of about 1920, and Ken took a bus load of other material, including anything that looked remotely useful to be dispersed among the amateurs he knew involved in restoring old equipment. The floor was about a foot deep in paper; delving had all the elements of an archaeological "dig", and as we worked down we dated the level we had reached. A number of old textbooks on electrical topics came out of this, which are now held by the Hargrave Library at Monash. On the penultimate level we found the call book mentioned above, and at the lowest level of all, right on the floor, the minute book.

The book itself is a quarto-size exercise book, bound in black cloth, of about 100 pages. Apart from a few paste-ins, it is handwritten. When found it was damp, and in a parlous condition; the handling it received while its more obvious treasures were being mined did not help. Its preservation posed two problems. Firstly it required the attention of an archive specialist to arrest further deterioration in its condition. Secondly, if it were not to suffer a second and perhaps permanent occlusion, some way of preserving it for future reference was needed. As I saw it, the Institute could not offer either of these facilities. After a long period of reflection and enquiry, I offered the manuscript to the Adolph Basser Library, in Canberra. This library, part of the Australian Academy of Science, is devoted to the preservation of original documents relating to

science in Australia. There, it seemed to me, was an appropriate place to house this historic document; there the minute book would receive the repair it needed; there it would be tolerably certain of preservation; there under the control of a disinterested administration it was accessible to anyone who wished to refer to it. However, a pilgrimage to Canberra to consult original manuscripts is not a common amateur accomplishment. I therefore made it a condition of the gift that a copy be made of both the minute book and the call book for the Institute. This was accepted, and the copy was sent late in 1975 to the Federal office; I also have a copy.

I have set out this matter in some detail for several reasons. I think it should go on record where the material is available for reference; few members of the Institute are aware that the Institute has this copy. I also wished to explain, to present and future historians of the Institute, how this arrangement came about. Thirdly, there will soon be no person with experience, and hence some sort of recollection, of those years and this book may be the only surviving record of the beginnings of amateur wireless in Victoria; I have included the information about the provenance of the book to assist researchers in setting a value for the creditability of what it offers.

Yours faithfully,

Deane Blackman VK3TX.

3 Gardenia Street, Pakenham 3810.  
3rd March, 1980.

The Editor,

Dear Sir,

I have recently been given an old radio receiver which, if possible, I would like to restore. So far I have been unable to find any material on the unit, which is a 5-valve made by Splittdorf, and is a model R500, serial No. 19891.

It has three single-gang variable capacitors, two wire wound variable resistors and two transformers, one of which appears to be a power supply. Unfortunately, a substantial amount of the wiring is missing, and I cannot trace the circuit.

Perhaps one of your readers may be able to help with information on this receiver to help me in this project, and I would be most grateful for any circuit diagrams, etc., which I undertake to copy and return with the utmost care.

Yours faithfully,

D. E. Jackson VK3VAA.

## CONTESTS

Wally Watkins VK2DEW  
Box 1065, Orange 2800

### CONTEST CALENDAR

May	
10/11	SANGSTER SHIELD CW (NZART)
11	RSGB WAB HF-CW CONTEST
17/18	COMMON MARKET CONTEST
17/18	FLORIDA OSO PARTY
24/25	CQ WORLD-WIDE WPX CW CONTEST
June	
14/15	VK/ZL/OCEANIA RTTY CONTEST*
21/22	21st ALL-ASIAN PHONE CONTEST
28/29	ARRL FIELD DAY
August	
	REMEMBRANCE DAY CONTEST

\* This is not a WIA contest. Logs to ANARTS, c/- 55 Prince Charles Road, Frenchs Forest 2086.

### SANGSTER SHIELD (NZART)

CW contest, 80 metres only, 0800-1200Z each day. Exchange is RST from VK stations but they must receive RST plus branch number plus power input — 579/18/04.

All overseas contacts are worth 10 points.

Scoring is total points multiplied by the number of different branches. Certificates to overseas stations with the highest score.

Logs to Jock White ZL2GX, 152 Lytton Road, Gisborne, before 30th May.

### CONTEST RESULTS —

20th ALL-ASIAN PHONE CONTEST 1979  
Oceania — Multi-band single op., VK6NBU; multi-band multi-op., VK2DCB.

JARL Certificates also to: Single band op., 21 MHz, VK2XT; single band op., 28 MHz, VK6NEX.

### BRIEF RULES FOR 21st ALL-ASIAN DX CONTEST 1980

**PHONE**  
48 hours from 0000Z to 21st June to 2400Z 22nd June, 1980.

**CW**  
48 hours from 0000Z 23rd August to 2400Z 24th August, 1980.

Operation on all or one band.

### DIVISIONS

Single op., on band; single op., multi-band; multi-op., multi-band.

### EXCHANGE

RS(T) plus 2 figures denoting age (YL's RS(T) plus 00).

Full details including scoring and recommended sample log sheet and front sheet — SASE to FCM only.

## Amateur Radio in Emergencies

The following comes from IARU R2 News of December 1979 and is by VP2VI —

"Hurricane David, one of the worst of this century, passed over Dominica leaving devastation in its wake. Telephone and power lines were destroyed. After the hurricane, Fred White J7DAY in Dominica was the only means of communication with the outside world. He had been operating continuously for 48 hours when he received a message from Dr. Robin Tattersall, via VP2VI, asking if he could be of assistance. A message came back from the Prime Minister asking him to come immediately. J7DAY also asked Bob Denniston VP2VI to come to Dominica and help with the operation of his station as he was getting very tired by this time. He also asked him to bring another amateur station. So, while Dr. Tattersall was arranging for an Air BVI charter flight to Dominica, Matt and Bob Denniston packed their amateur station and food and headed for the airport.

Pilots Gordon Nissen and Jeremy Hunter flew the group to Antigua and then to the Melville Airport in Dominica. The group consisted of Dr. Tattersall, Dr. McKenzie, Bill Schenefeldt of the Red Cross, and Matt and Bob Denniston with the amateur radio. As they flew over the island approaching the airport they could see that all the banana trees were flat on the ground and most of the coconut palms were broken off. These crops were Dominica's two main sources of income. The road from the airport to Roseau, 35 miles away, was blocked by landslides and fallen trees. There was one helicopter ferrying doctors to Roseau; Tattersall and McKenzie managed to get to Roseau the next day after arrival. Matt and Bob Denniston and Bill Schenefeldt rode in a pickup truck to where the road was blocked. As they passed giant trees with no leaves or bark left on them the driver pointed out Carib Indians along the road by their reserve in the mountains. The trio then hiked several miles carrying their radio equipment and supplies over the trees and the landslides blocking the road till they came to the chew working up the road from the other direction. There they met the Captain of the HMS FIFE which had been anchored off Cane Garden Bay a few weeks ago and was now giving relief aid to Dominica. He detailed a car and driver to take them down to the police station in Roseau where Fred White and his station was set up. The road was washed half away in places along the coast and warehouses in the seaport were knocked

down by the 30 foot waves whipped up by the 150 miles per hour sustained winds and higher gusts in David. Many houses were badly damaged or demolished.

The police station, a three-storey reinforced concrete building, was still in good condition (about the only building that was) so the government officials had moved into it. The Commissioner of Police met the three men from Tortola as they arrived and took them through the crowd and into the police station in his car. Fred White was still operating J7DAY when they arrived. He was very tired and very glad to see them. That night he had his first night's sleep while Bob and Matt alternated at the operating position.

The next day WODX/J7 was set up in the same room with Fred so that messages could be sent and received simultaneously on two amateur frequency bands, thereby doubling the traffic handling capacity. Frequencies used were 3808 kHz and 7213 kHz, the frequencies of the Antilles Emergency and Weather Net, a network of stations in the Caribbean which meets twice daily and has been tracking hurricanes for more than 20 years. Also used were 3505 kHz and 7185 kHz, frequencies borrowed from the Barbados amateur net.

The operation continued for seven days more and over 3,000 messages were handled most of which were to and from government officials of various countries. The largest volume of traffic was to and from the US Embassy in Barbados which organized a large relief effort. Two other radio amateurs, 8P6GB/J7 from Barbados, and KP2A/J7, John Ackley from St. Thomas, US Virgin Islands, brought their stations to Dominica, set them up at the Red Cross headquarters and handled 3,000 messages concerning the health and welfare of Dominicans. ■

## The Intruder Watch — World-Wide

As you all know, for amateur radio (as for ITU) the world is divided into three regions, region 1 being Europe and Africa, region 2 the Americas, and region 3 the rest of the world.

I, as IARU Region 3 co-ordinator, am responsible for the rest of the world, specifically the Pacific and Asia.

In Australia, the Intruder Watch is divided into the Federal, with Graeme VK3NXI as co-ordinator, and the States with their respective co-ordinators.

It has been my experience over a ten year period that the apathy shown by members to participate in reporting intruders is the one stumbling block facing the organization, and it is this fact that gives our administration the excuse for not acting on reports as they should.

Unfortunately, this apathy is not confined to Australia alone, but is world-wide. Apparently the average radio amateur has the same make up all over the world, and his attitude of "I'm OK, let George do it" predominates. It is this trait which hampers the IW, and is an unfortunate phenomena because administrations take the line that unless many, many reports are submitted on any one intruder and their monitoring stations can find and also report him they cannot initiate a complaint to the offending country's administration.

When we talk about intruders we do not mean CBers or fellow amateurs who sometimes disrupt communications, but commercial and Government stations who are permitted by their authorities to proliferate in our bands. We mean teletype (F1), CW (A1), over the horizon radar, broadcast (A3), and harmonics and spurious emissions from such stations. Fundamental emissions by Iron Curtain countries are the hardest of all to eliminate, but by direct approach most times engineers, if alerted, will fall over backward to eliminate any spurious transmissions generated by their equipment, and welcome such approaches.

For many years now I have kept a regular weekly schedule with my contemporaries in the

USA and in the United Kingdom with rewarding results. Monthly summaries of intruders submitted by Australia, New Zealand and Malaysia are sent to Bill K6KA, who evidently has a hot line to the FCC monitoring system in Washington, DC, and he often alerts them of reports submitted which he also has heard, and they file a complaint of harmful interference to the country concerned. "Harmful" is the key word here. No administration will take notice of reports unless it shows that "harmful" interference is present.

Some intruders are alerted to G5XB on our skeds, too, and then submitted to the British Post Office with rewarding results. They have been known to act upon reports submitted by Australia.

So far the only Asian country participating is Malaysia and monthly reports are regular. The Japanese prefer "to do their own thing", and only supply me with a summary of their findings at three monthly intervals. Although very sketchy, they are, however, very welcome. New Zealand is by far the most active in reporting, and Bob ZL1BAD forwards his reports monthly for my inclusion with the Australian and Malaysian reports to headquarters in England. He also forwards a summary for my records, and one to the US. The discussions over the air on 28500 kHz on a Tuesday at 2300Z (Wednesday morning our time) by Bill are very interesting, and anybody with the time and interest should listen to them. They are very illuminating!

The reports submitted by the few Australian members who take the trouble to do so are well set out, and identifications are often made, but our administration gives the IW a very low priority because they say "We don't get enough reports, so how can we take it too seriously". It behoves members to take more interest and get behind their IW to reverse that attitude. If our administration were swamped with reports they'd have to take notice and do something. Think about it! ■

## ALARA

AUSTRALIAN LADIES' AMATEUR RADIO  
ASSOCIATION

In New South Wales there are several licensed YL operators located in all parts of the State. You may already have met these four Novices on the air.

Carol VK2NCL is from Tamworth and has been licensed for nearly a year now. She enjoys her share of DX on 10m when conditions are good. She describes herself as "guilty of being a real ragchewer". Carol can be heard having OSOs with VK stations and she often gets to meet the people she has contacted on air. Club activities such as Field Days and fox hunts give her those opportunities. Her OM, Bob VK2NLR, prefers homebrew activities, and Carol works by his side on most of his projects. They have two sons, ages 7 and 3.

Roma VK2NZW was studying for her Novice licence at the same time as her nursing exams. The nursing studies are now complete, the Novice ticket is in hand, and now Roma intends to upgrade. She shares the rig with her husband and can be heard most often on 10m. Roma's main interest in amateur radio is CW, and her QTH is Boorai.

Geraldine VK2NQI is from Greystanes. Like many YL operators, her interest in amateur radio was sparked off by her OM, who in this case is an active SWLer. Geraldine is the ALARA net controller and feels that the net has helped quite a few YLs who are mic. shy get some operating experience and build their confidence. Her primary interest is DX, particularly YL DX.

Daphne VK2NXD became interested in radio back in 1935 when she took a correspondence course in radio reception. She became employed with Breville Radio and learned about quality control and how to test components. When the war broke out, she gained employment with another radio company and became the first woman there to take

on tasks which previously only men had done. The war ended, Geraldine married, and for the next ten years she spent all her time working on home improvements and making her own clothing. Nev got his licence in 1956 and became VK2ZBQ. He encouraged her to study but it wasn't until the Novice licence was introduced that Geraldine decided to get her ticket also.

Her personal decision was reinforced by the members of the newly formed Liverpool and District Radio Club. Geraldine has had to re-organise her thoughts to stop thinking in cooking and dress-making terms in order to comprehend volts, amps, and ohms. To absorb radio theory, she wrote circuit diagrams and formulas on every scrap of paper that was blank. "It's a good thing the waste bin can't tell lies," she says. Now that she has the Novice licence, Geraldine has set her mind to study for the AOCF.

YL Activity Day is the 6th of every month. Look for YLs on the hour, every hour, at the following frequencies: 3.688, 7.088, 14.288, 21.188, 21.388, 26.688. If no YLs are heard, please call "CA YL".

If you are a YL and would like to join ALARA, please contact the Secretary, Box 110, Blackburn, Victoria 3130.

Maggie VK3NQQ. ■

## AROUND THE TRADE

ICOM RELEASES NEW 2m TRANSCIVERS  
Icom have recently added two new transceivers to their list of numerous communications equipment.

The first is the IC2A, a 1.5 watt 800 channel transceiver powered from a snap on-off nicad pack of three optional sizes. The IC2A is an extremely small unit as the photograph shows. Unlike similar units incorporating digital frequency reading techniques, the IC2A remains a simple unit to operate with channel selection via thumb wheel frequency change selectors. Optional accessories include speaker/microphone and nicad charger.

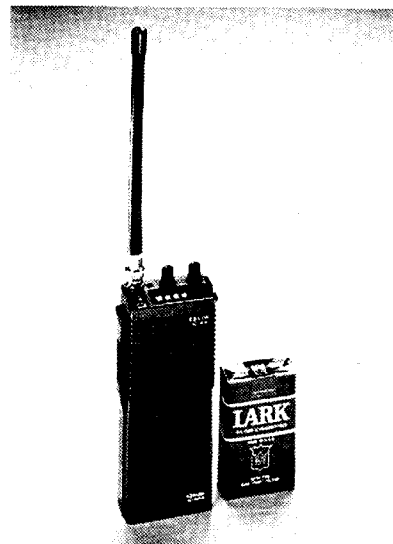

Second of the new line is the IC260A — a mobile SSB/FM/CW transceiver incorporating scanner, twin VFOs, NB, CW break-in and CW monitor. The 10 watt unit is sold complete with mobile mount, DC leads and microphone. Current list price is \$599.

For further information on both units contact Vicom International Pty. Ltd., Melbourne. Phone (03) 699 6700, or Sydney (02) 436 2766. ■

# INTERNATIONAL NEWS

## RECIPROCAL LICENSING

Hearing about tighter controls over the issue of reciprocal licences, it is refreshing to read in February 1980 QST that Canadian licensed radio amateurs may operate their stations in the USA without having to obtain a written permit from the FCC. The reverse is also permitted on the same basis.

In a letter dated 3rd March to an enquiry from an interested expatriate in Tokyo, the Secretary of the Postal and Telecommunications Department stated that an approach had been made by the Department to the Japanese Authorities in an effort to obtain for Australian amateur licensees visiting Japan privileges equal to those extended by Australia to overseas amateurs visiting this country. Members will be aware that any amateur of any nationality can obtain a visitor's licence in Australia. See AR for January 1978, p. 25.

In a circular from JARL they state that nationals of the USA, Federal Republic of Germany and Finland are at present capable of operating club stations in Japan under a system rather different from that of the normal run of reciprocal licensing agreements.

The address of the Japanese licensing administrations is The Radio Regulatory Bureau, Posts and Telecommunications Ministry, 2-3, 1-chome, Kasumigaseki, Chiyoda-Ku, Japan.

JARL also announces details of the 1980 Amateur Radio Festival to be held in the new hall at the International Trade Centre in Tokyo from 22nd to 24th August, 1980. There were some 30,000 visitors to the third such Hamfest held in 1979 and more are expected this year. Further details are obtainable from JARL, Box 377, Tokyo Central, 100-99, Japan.

Finally, from 1-2-1980 the VK5 QSL Bureau has been taken over by Ray Dobson VK5DI, 16 Howden Road, Fulham, SA 5024. Other amateur societies please copy.

# MAGAZINE REVIEW

Roy Hartkopf VK3AOH

## BREAK IN December 1979

Galbraith Power Supplies. 18 Amp (C).  
**RADIO COMMUNICATION** January 1980  
 Annual Index (G). Repeater Logis Control System (TC).

## QST May 1979

VMOS Transmitters and Amplifiers (GC).  
 QST December 1979  
 Low Pass Filters (TG). AMSAT-OSCAR Phase III (G).

## QST January 1980

3 Band VFO (NC). Universal Digital Frequency Readout (C). Antenna Matching Network (GC). Microprocessor and SSTV (GT).

## HAM RADIO December 1979

VHF Pre-amplifiers (GT). 2 Metre Synthesiser (C). Log Periodic and Antenna Design (GT). 1969-1979 Cumulative Index (G). L Band Local Oscillators (GC).

## HAM RADIO January 1980

Video Console for ATV (C). Yagi Antenna Design (T). HF Log Periodic Antennas (TG). Audio Processor for Reception (GC).

## CO February 1980

Q Signals for Amateur Radio (NG).

**HELP WITH INTRUDER WATCHING**

## NEW FREQUENCY RANGE SKY ACE AIRBAND RECEIVER

GFS Electronic Imports of Mitcham, Victoria, recently announced that their hand-held Airband Receiver, the Sky Ace R517, is now available with new frequency coverage.

The previous version covered the range of 118 to 144 MHz. The latest version now available covers 108 to 140 MHz, allowing its users to take advantage of the many Aerodrome Terminal Information Services (ATIS) transmitted within the navigation band (108-118 MHz) by major aerodromes throughout Australia.

All other features on the new Sky Ace are the same. These include the ability to install up to three crystal locked channels or, if desired, use the across-the-band tuning supplied. A fine tuning control is also included. Sensitivity and performance are excellent with price still the same at \$104 plus \$2.50 post. Crystals (if required) are \$7 each for standard frequencies or \$17 each for special frequencies.

For more information on the Sky Ace R-517 contact GFS Electronic Imports, 15 McKeon Road, Mitcham, Victoria 3132. Phone (03) 873 3939.



## DICK SMITH IN ADELAIDE

Dick Smith's Adelaide store has moved — to much larger premises a few hundred metres away in the same street, Wright Street.

The new premises are significantly larger, and also provide adequate off-street parking.

The new building has an area nearly half as big again as the existing store (550 sq. m vs. 370 sq. m), and also has parking space for approximately twenty vehicles.

It was officially opened by Dick in March, and is located at 60 Wright Street, Adelaide. Phone (08) 212 1962.

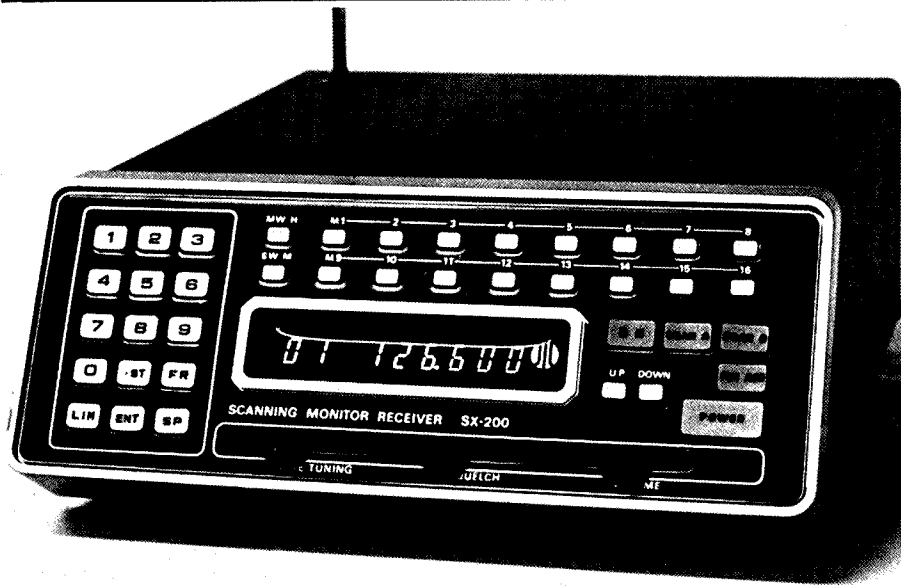
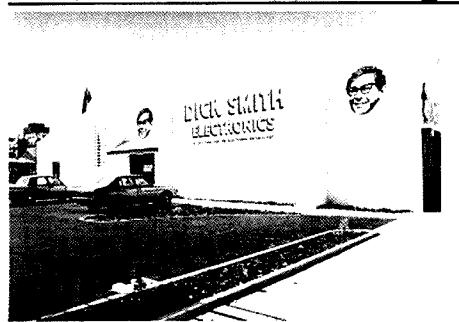

## NEW SX-200 SCANNING RECEIVER

GFS Electronic Imports of Victoria, Australian agents and distributors for JIL, recently announced the release of a new model scanning receiver, the SX-200.

The new SX-200 covers quite a large frequency range, including 26-88 MHz (encompassing 27 MHz CB band, 10 metre and 6 metre Amateur Band, and the Australian VHF LOW BAND), 108-180 MHz (Aircraft Band, Satellite Band, 2 metre amateur and HIGH BAND VHF), and 380-514 MHz (UHF Commercial Band, 70 centimetre Amateur Band and UHF CB Band).

This nearly continuous coverage from 26 MHz combined with the SX-200's ability to detect both

AM and FM signals makes the unit a very versatile device.

Other features on the SX-200 include the ability to accept upper and lower search limits (allowing signal searching over a given band), line tuning control for monitoring away from standard channels, 0 or 4 second scan delay, special squelch circuitry which causes the squelch to bypass spurious or unwanted carriers when scanning, digital readout dimmer, non-volatile memory, variable scan and seek speeds, 12 volt DC or 240 volt AC operation, and 16 memory channels that can partially or all be scanned.

For more information about the new SX-200 contact the Australian distributors, GFS Electronic Imports, 15 McKeon Road, Mitcham, Victoria 3132. Phone (03) 873 3939.

# DIVISIONAL NOTES

The Trade Display held at the Club rooms of the Moorabbin and District Radio Club in Turner Road, Moorabbin, on Friday, March 7th, was a great success.



Organised by the "Old Timers" Tuesday morning coffee group, the display of more than \$20,000 of gear was provided by ATN Antennas, BWD Pty. Ltd., Bail Electronic Services, Elmeasco, Instant Component Services, Philips, Scalar Antennas, Tardy Cheltenham, and Vicom Pty. Ltd.

All exhibitors expressed pleasure at the attendance and interest from more than 600 visitors during the 10 a.m. to 9 p.m. exhibition.

Allan Doble VK3AMD,  
Publicity Officer.



## 6 METRE BEACON

Considerable progress has been made on the Geelong Amateur Radio TV Club beacon on 52.330 MHz. The beacon is presently running on an attended basis at Lara using 3 watts to a set of crossed dipoles. The 25 watt power amplifier will be completed by the time readers read this column and the beacon installed on a permanent basis at Mt. Anakie. (From GARC Newsletter, March.)

# STOLEN RADIO EQUIPMENT

**Stolen Radio Equipment:** During a burglary on the 21st February, 1980, all radio equipment, property of VK2VLC, was stolen. Description as follows:— Kenwood TS520S transceiver, serial No. 840457; Kenwood AT200 aerial tuner, serial No. 28379; Kenwood MC50 desk mic.; Kenwood world ham clock; Kenwood digital frequency readout to fit Kenwood 520S. Should any amateur, either in NSW or interstate, know of the whereabouts of any of the abovementioned items please contact your local police or Brian Belcher VK2VLC direct on Sydney phone (02) 438 2647 or (02) 438 2370 (Bus.) and reverse charges.

# YOU and DX

Mike Bazley VK6HD

8 James Road, Kalamunda W.A. 6076

## HEARD ISLAND

Listening to comments over the air, it would appear that certain amateurs are upset because of the letter I published "in March AR" concerning the Radio Officer aboard the "Cape Pillar". I believe this criticism was unjustified and that several points need to be considered before a judgement is made. Firstly with so few amateurs contributing to this column, though it appears to be widely read, any information on DX activity is welcome. Secondly, under the heading "DX Rumours, Fact and Fiction", readers are left to make their own value judgements on the information presented. Finally, I did suggest "the best bet would be to check the usual DX frequencies". Whether the recent VKORM operation will count or not time will tell; as I have said so many times before in this column, work them first and worry about the status later.

## DX RUMOURS, FACT AND FICTION

The gremlins crept into the story in March AR concerning VP1KS, several VKs claiming to be the only VK QSO. This should have read "including some to VK". I do not know that he worked into VK on 80 through to 10, though I believe he did not have many QSOs with Australia.

It finally looks as if Burma will be on the air once again. Time: 15th April to the 15th June. Frequencies: SSB, 3900, 7075, 14160, 21300 and 28440; CW, 6 kHz inside each band. It will be an official UNICEF operation. All QSLs and QSOs will be numbered and if you do not get your number then you do not get your QSL! The operators are suggesting that those fortunate to QSO XZ00NU might like to make a donation to the UNICEF Fund "Medical Needs of Children". (This information supplied by HS4AMI via VK3YL.) Since receiving the information from Austine VK3YL, this writer has heard that there will be six operators and that the SSB frequencies could be 3805, 7075, 14195, 21300 and 28440. For those interested, I would suggest listening to "Sea Net" 14320 kHz daily at 1200Z for further information.

Further to my note on Jan Gould WA6YQW in March AR, the following extract from the ALARA Newsletter is, I think, of interest.

## "DXPITIONER INJURED

We were quite distressed to learn that Jan Gould WA6YQW had been severely injured in an airline landing accident as a member of a DXpedition.

The other members on board were not hurt but Joan was pinned by heavy equipment that had broken loose from the cargo hold when the airplane impacted into bush adjacent to the runway. Jan has crushed bones and a broken back.

Many VKs met Jan on air when she operated on a DXpedition to Chatham Island last year. Articles

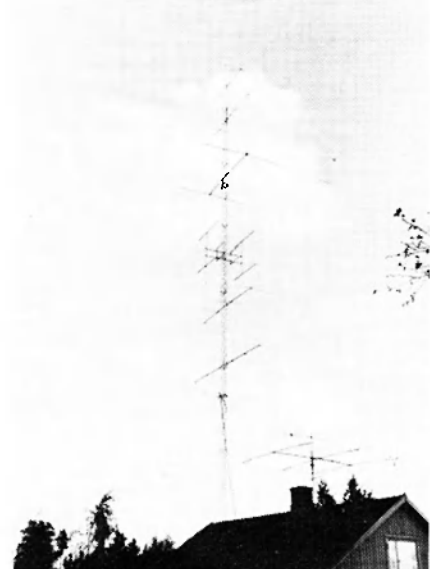

PHOTO 1:

The OH7BR antenna system. Feast your eyes upon the 40m 2 el. at 38m, 20m 4/4 el. at 45m and 10m 6 element beam at 18m! Who said DX was hard to get? Obviously the man with a long wire!



PHOTO 2:

Co-authors of the book "The Radio Amateurs Conversation Guide", at left OH2BAD and at right OH2BR.

about 'That Chatham Gang' appeared in several radio magazines. She is an alive and vital lady who loves hamming with her good friends around the world.

Jan is being moved to a hospital closer to her home QTH, and she has told us that the cards and good wishes have helped to keep her going since the accident. Please address correspondence to Jan Gould WA6YQW, 1542 Beach Ave., Anaheim, CA 92802, USA."

An interesting book, which is published by OH1BR and OH2BAD, has been received by VK6HD. "The Radio Amateurs' Conversation Guide", to give it its full title, gives in general form a QSO in eight languages (English, German, French, Italian, Spanish, Portuguese, Russian and Japanese). The book is planned in OSO format, moving from the CQ call through the various phases of report, QTH, WX, etc., and finishing with signing off procedures. There is also a dictionary at the end itemizing the most common words used. With this book it should be possible to have a QSO with some of those rarer South American countries. Cost is US 7 dollars or, if sending a bank order, 8 dollars (the additional dollar is to cover bank charges). Write to Transselectro OY, Box 8, SF-00610, Helsinki 61, Finland. For the DX chaser I believe it is good value.

It is rumoured that 9L1CA has been transferred to 9U5, Burundi. Let's hope that a licence is forthcoming so that this one can be taken off the wanted lists.

Does anyone know the QSL information for CM2ER, C5A?? via OZ5QU, W5JMM/SU and K7SE/VP2A?

It would appear that there is a pirate BV2A active on 15 metres, asking for QSLs via JA1KSO. As far as this writer is aware Tim BV2A is active on 10 and 20 metres CW and SSB and has always handled his own QSLs.

Are SWLs a dying race? It has been suggested that as soon as people get into contact with amateur radio they immediately try for their Novice ticket. Looking through the call book there appears to be quite a few "L" series issued. How about letting us know what you've heard?

LU3ZY, the new operator "Manuel", has been active on 14290 kHz, often working to a list by I1AGC. Time: 2100Z.

Well, I'm afraid that's the short offering for the month. Once again DX information would be appreciated, bearing in mind that copy has to be finished at my QTH 6 weeks before AR publication. Thanks to VK3YL, VK6LK, VK6NE, VK7RO, L70107 and "Geoff Watts News Sheet", 73 es DX Mike VK6HD.

**QTHs YOU MAY HAVE MISSED**

- A350M — via N6OM
- CLONA — Box 1, Havana
- W7LPP/DU2 — via N2CW
- HZ1SH — Box 3366, Jeddah
- J28CC — Box 215, Djibouti
- J28CB — via I8JN
- WD8QGQ/KH7 — via KH6JEB
- W7KHN/KH9 — via W7KHN
- OA4JR — via WB9FMX
- PR8ZPJ/9 — via W7BUN
- TF5TP — via DL7MQ
- N4HX/TT8 — via ON5NT
- VP2KAJ — via WB8LDH
- VP2VEJ — via WB3KGY
- 3B9CF — via 3B8CF
- 4S7DX — via WB2VFT
- 6H1MEX — via XE1MEX
- 8P6KY — via WB4RRK

# IONOSPHERIC PREDICTIONS

Len Poynter VK3ZGP/NAC

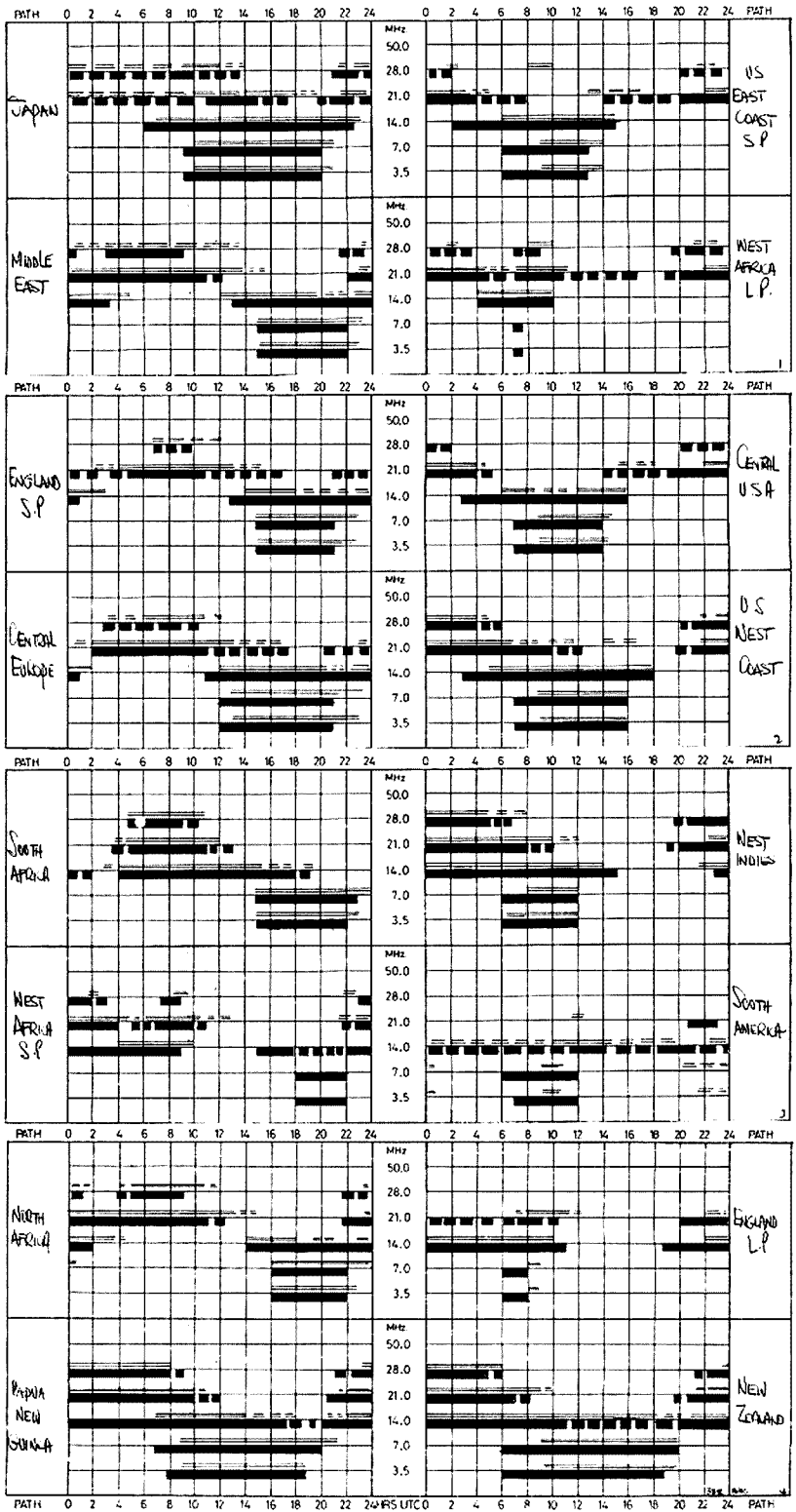

**LEGEND**  
 FROM WESTERN AUSTRALIA  
 FROM EASTERN AUSTRALIA  
 BETTER THAN 50% OF THE MONTH, BUT NOT EVERYDAY  
 LESS THAN 50% OF THE MONTH  
 PREDICTIONS COURTESY I.P.S. SYDNEY  
 ALL TIMES UNIVERSAL UTC (GMT)

**AMATEUR RADIO IS A RESPONSIBLE SERVICE**  
 LET'S KEEP IT THAT WAY



**IF  
YOU'RE  
NOT  
BUYING  
AMATEUR  
RADIO  
ACTION**

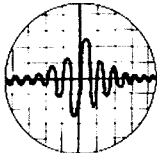

(IT'S AUSTRALIA'S BEST  
SELLING AMATEUR MAGAZINE)

**THEN  
YOU'RE NOT  
KEEPING  
UP WITH  
THE LATEST  
NEWS, VIEWS  
AND REVIEWS**

Please put me down for 12 editions of  
Amateur Radio Action, starting NOW!

Rates in Australia - \$14.40 Surface  
mail overseas - \$18.40 Air mail: To  
New Zealand - \$A28.70; Malaysia -  
\$A32.60; Japan - \$A38.45; USA -  
\$A42.35; UK - \$A46.25

Herewith enclosed cheque/postal  
note/money order to the value of:

\$A.....

Name.....

Address.....

.....

.....

Postcode.....

Post to: Amateur Radio Action Sub-  
scriptions, Box 628E, Melbourne  
3001.

**AT LAST!**

**THE TYPE 610 BRITISH  
POST OFFICE designed  
MORSE CODE KEY**

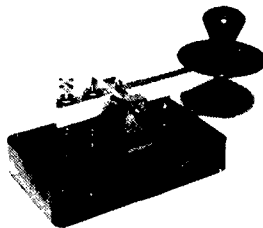

There has never been a better designed  
Morse Code Key — SOLID, ROBUST  
and BEAUTIFULLY BALANCED.

**\$27.50** (Post Paid)

"LEARNING THE MORSE CODE" —  
Cassette Album Training Course. You  
will progress rapidly using this modern  
training system.

**PRICE \$20** (Per Album of  
3 Cassettes)

**WILLIAM WILLIS & Co. Pty. Ltd.**

77 CANTERBURY ROAD, CANTERBURY, VIC. 3218  
PHONE 836 0707

**MAGPUBS**

A WIA MEMBERSHIP SERVICE

**OVERSEAS MAGAZINE  
SUBSCRIPTIONS**

(One year only)

QST .....	\$19.00
Radio Communications .....	\$19.00
Break-In .....	\$12.00
Ham Radio .....	\$15.50
((\$28.50 for 2 years)	
CQ .....	\$13.50
(\$21.50 for 2 years)	
CQ-TV .....	\$5.50
VHF Communications —	
Surface mail .....	\$8.20
Airmail .....	\$12.40
(Binders \$2.75, plus 50c P & P)	
AR — Overseas surface mail subscription .....	\$14.40

Write to

**MAGPUBS**

P.O. BOX 150  
TOORAK, VIC. 3142

**HAMADS**

- Eight lines free to all WIA members.  
\$9 per 3 cm for non-members.
- Copy in typescript please or in block letters to  
P.O. Box 150, Toorak, Vic. 3142.
- Repeats may be charged at full rates.
- Closing date: 1st day of the month preceding  
publication. Cancellations received after about  
12th of the month cannot be processed.
- QTHR means address is correct as set out in  
the WIA 1979 Call Book.

**TRADE HAMADS**

For a very long time commercial advertising has  
not been accepted in AR Hamads, but as the result  
of discussions at the 1978 Federal Convention a  
decision was made to open up a "Hamada-Trade"  
section. The rate will be \$10 for 4 lines plus \$2 per  
line (or part thereof), minimum charge \$10, pre-  
payable. Copy is required by the first day of the  
month preceding publication. This will mean that in  
future ordinary Hamads submitted from members  
who are deemed to be in the general electronics  
retail and wholesale distributive trades should be  
certified as referring only to private articles not  
being re-sold for merchandising purposes. ■

**FOR SALE**

Surplus Equipment — Collins KWM2A round emblem  
with 240V supply, unmarked cond., \$1,250; Kenwood  
TS120S, new, unopened, \$630; power supply, new,  
unopened, \$190; Drake T4XC with Drake AC supply,  
new, plus Drake SPR4 Rx, six months old, the lot  
\$350. Cliff Coverdale VK2VK. Ph. (065) 52 4477 Bus.,  
(065) 59 1508 A.H.

Kenwood KP202, 2m, hand-held, with Ch. 34, 40,  
50 and rpters 1 to 6, nicads, charger, extl. mic.  
connector, BNC connector, leather case, \$160; plug-  
on synthesiser, 144 to 148 MHz in 25 kHz steps  
(95 per cent finished), \$50. Mike Richter VK2BMM.  
Ph. (02) 476 3861, (02) 233 5330 Bus.

Home Brew Builder's Note: HY-Q single sideband  
filter QF09002, complete with 8998.5 kHz and  
9001.5 kHz crystals, unused, current price \$69, sell  
for \$50 post paid; suits the Hepburn building  
blocks txcvr of 1975 and others. VK2AZT. Ph.  
(069) 42 1392.

Yaesu 2m FM Txcvr FT223, rpters 1-8 inclusive,  
simplex 40, 50, 51, plus private call channel, mic.,  
mounting bracket, handbook, etc., included, \$180.  
Ted Egan VK3XT, QTHR. Ph. (03) 751 1721.

TR7200G 2m FM Tcvr, complete, \$170 (VFO 30G);  
external VFO for above rig, \$70; 5/8 GP antenna,  
\$30. VK4CJ, QTHR. Ph. (07) 343 2235.

FL200QB Linear Amplifier, 2 x 572B triodes in  
grounded grid, best offer. VK2BOA, QTHR. Ph.  
(049) 61 1580.

Yaesu Linear FL2100B, as new, 2 hr. use, in orig.  
box, \$450 firm; 2 new 572B tubes, in cartons, \$40  
ea.; 2 bandit quad hubs, new, \$6 ea.; solid brass  
key, silver contacts, \$15; 2m 5/8 Asahi whip, new  
\$8; Hustler RM80 resonator, new, \$15. VK2FY,  
QTHR. Ph. (02) 602 9043.

Linear Parts — One used but good 4/100 tube plus  
brand new SK500 socket, SK506 chimney and  
special heat sink top cap, the lot \$100; tower,  
70 ft. steel lattice, four legs 6 ft. at base, never  
used, fully hot dip galvanised, local government  
rules forbid me to assemble, \$400. VK2RG. Ph.  
(02) 644 9193.

FTDX560 Tcvr, 160-11/10m, \$400; FTV650 6m Txcvr,  
\$125; MB40A 40m S/S mobile Txcvr, \$125; multl 7  
2m FM Txcvr, rep/anll 1-9, 40, 50, \$150; TCA1677  
2m FM Txcvr, 25W, 4 Ch., \$50. Don VK2ADY,  
QTHR. Ph. (067) 65 8564.

AX-190 Rx, plus matching speaker, perf. order,  
\$130, ONO; also 10m txcvr, 28.310, \$600; 7KC slide,  
15W PEP, perf. order, \$150, ONO. Wayne Bell  
VK3NNG. Ph. (053) 67 2816.

Txcvr, 2m "Icom" IC211, little used, frequency  
unstable; a letter from maker advises servicing  
procedure and says trouble probably IC6 in PLL  
unit; with fault \$450 firm. VK2CE, QTHR. Ph. (02)  
871 7758.

Collins 51J4 Rx, b/c to 30 MHz with cabinet and manual, \$350; Drake MN200 antenna matcher, as new, \$250; Daiwa RF550 speech processor, \$145; Heath SB620 scanalyser, \$75; Heath IB28 impedance bridge, \$95; Heath IT121 transistor/FET tester, \$75; Comdel RF speech processor, \$95; manuals for each item; will consider offers. VK3BM, QTHR. Ph. (050) 32 4102.

Yaesu FT101E Tcxvr, used less than ten hours, surplus to present requirements, complete with all accessories, including 700 Hz CW filter, mint cond., also unused Astatic D104 microphone, complete with stand (cost \$100 to land from USA), will not separate, \$650 the lot. Roth Jones VK3BG. Ph. (03) 848 7945 evenings.

HRO ("National") SS Comm. Rcvr, c/w coil boxes from 100 kHz to 30 MHz, Incl. BC band, optional bandsread on 80, 40, 20, 15 and 10m bands, recently modified and overhauled, new front end using GBA6 1st and 2nd RF stages, GBE6 mixer and GC4 osc. with added GAL5 noises limiter and GBE6 product detector for SSB, extra vernier on main dial, panel mounted osc. trimmer, adjustment on SSB, also regulated power supply, storage boxes for spare coils, 1F xtal, numerous manuals, circuits and many spares, still outperforms many modern se's, excellent cond., finished in light grey, \$400. VK3KP, QTHR. Ph. 20 5929 Bus., 509 7617 AH.

TV506 6m Transverter, 3 mths. use, still in orig. carton and with manual, \$195. George, QTHR. Ph. (071) 41 1544 Bus., (071) 48 7293 AH.

Atlas 2x10 Tcxvr, complete with AR-230 power supply, mobile mounting kit, DC cable, mic. and handbook, \$750; Kenwood AT-200 SWR meter-antenna tuner, \$120; TH3JR antenna, \$2; VK3DH. Ph. (03) 387 2531.

Microwave Module Transverter MMT432/144, all mode, 2m, 10W input, 10W 432 MHz output, \$200; Icom 502 SSB 6m portable, \$160; Kyokuto 2m FM tcxvr., ex. cond., 800 channels, digital readout, fully synthesised, \$250. VK2ZDJ, QTHR. Ph. (069) 62 4937 AH.

Kenwood TS-520S, exc. cond., with manual, novice conversion provided, \$550, ONO; 11-80m Dick Smith transverter, \$80, ONO; US army type BC-348 Rx, good cond., \$150, ONO. Keith VK4AKA. Ph. (074) 62 3147 AH.

Sell variety pre-WWII component parts, assortment coils, var. condensers, vernier dials, var. grid leaks, meters, etc., etc., plus many types octal and earlier valves. Send SAE for list to VK4SS, 35 Whynot St., West End, Brisbane 4101.

Drake 260W Input TR4CW Tcxvr., AC-DC P/S, NB and 500 Hz filter, hi imp. mic. and 18 AVT multi-band ant., \$725; Kenwood TS-700A 2m tcxvr, AC-DC P/S and mic., incl. Cushcraft "Ringo" vert. antenna, \$475; Cushcraft 10-11m vert. ant., \$40; RTTY gear model 15 50 BD sync. motor, \$40; Siemens 68F tape teleprinter and punch, 45-50 BD, /45; triple head TD-14, 45-50 BD, \$35; ST-5 demod., incl. P/S, in cabinet, excellent performer, \$55; AK-1 Hal. modulator, variable shift, \$40. VK2ZN. Ph. (02) 76 9647.

Drake SSR1 Comm. Rx, 0.5 to 30 MHz, solid state, 220V AC/12V DC, as new, still in the orig. carton, book and accessories, \$200. VK2ZFN, QTHR. Ph. (02) 560 9415 Bus.

New Unused Items: Kenwood TS202(S) CW filter, 35S noise cancelling mic. high imp. and GE low imp. mic., both include 4-pin plug, etc., what offers? VK6NRO, 111 Ravenswood Dr., Nollamara 6061, WA. Ph. (09) 349 4471.

Kenwood TS520S Tcxvr., g.c., 12 mths. old, origl. packing, and manual, DC-DC converter, VFO dial mod. for finger tip tuning, MC-50 mic., \$650; 3 el. 10m Yagl, rigid construction, \$50; SWR, PWR, mod. FS meter, 0-1 kW, useful freq. range, 3.5-150 MHz, \$40. Peter VK3VAH, QTHR. Ph. (03) 288 8741 AH.

IC22 2m FM Tcxvr, repeaters 2 (and reverse), 3, 4, 5, 6, 8, simplex 40, 50 Victor, recently checked by dealer, v.g.c., \$120; IC202 2m SSB portable, used twice, \$150; BC211 frequency meter with AC P/S, \$50; all copies of Amateur Radio Action; best offer; will consider exchange solid state 6m or 70 cm gear. Leo VK3ZGF, QTHR. Ph. (03) 25 3968.

Swan 350 Tcxvr, 350W PEP, SSB, good cond., proven performer with long term stability, complete with manual, mic., heavy duty power supply and spare finals, \$350. Nick VK3TY. Ph. (03) 725 5116.

## SILENT KEYS

It is with deep regret that we record the passing of—

Mr. D. W. ALBRECHT VK4ADA  
Mr. R. J. OVERELL VK3AOR  
Mr. H. M. ROBERTS VK5MY  
Lt.-Col. C. F. NEWTON-WADE VK4QW  
Mr. V. KERR VK4LK  
Mr. AMOS VK2ANK

## OBITUARY

Mr. JOHN AMOS VK2ANK

John Amos, of Badgery Creek, NSW, passed away on Friday, April 14th, 1980.

John's radio background included service with the RAAF, AWA and commercial flying. In these services he operated for many years until ill-health forced his retirement, severing his connection with the airline industry.

To my knowledge John was the first operator to install and operate the radio gear for the first Sydney-Hobart yacht races. He did this for some years.

He was a dedicated and thorough technician and operator, and only ill-health prevented him continuing with amateur radio these last few years. His radio and RAAF signal friends will dearly miss him.

G. W. LANYON VK2AGL. ■

## OBITUARY

Mr. C. F. NEWTON-WADE (NEWT) VK4QW Was born 22-8-1895 in Somerset, England, and operated first from 1912 to 1914 in London with a spark transmitter and receiving by Coherer before valves and voice. A copy of this Coherer is lodged in the care of the Brisbane Museum.

Later he was in charge of all communications in Jesselton where at that time the country was known as Sarawak. His call was NWX with plenty of room for rhombics, using a rotary spark gap transmitter.

Returning to England he operated from Portsmouth using valves in 1923 with the call 5PC.

In 1924 to 1932 from Jesselton, Colonel Newton-Wade operated as VS4A.

Subsequently after WW2 he operated from Sandakan, then British North Borneo, with the call ZC5NW.

In 1955 his Australian call was VK2AXW, issued on arrival in Sydney.

When Newton came to England for the opening of TVQ9 he became well known to all in joining the various net QSOs, always the centre of any discourse no matter how profound.

Newton operated until two days before death.

In respect the Coral Coast Group observed one minute's silence in the 7 a.m. hook-up.

de John Atkinson VK4RZ. ■

Kenwood TS520D Tcxvr, with dynamic PTT mic., dynamic desk type mic. for VOX, \$500; Kyokuto 2m tcxvr, with reg. pwr. supply, PTT mic., quarter and five-eighth mobile whips, Cushcraft 11 el. 2m beam, with 50 ft. RG18U 52 ohm coax, \$350; all in first class cond., little use. VK2BDB. Ph. (02) 546 2163.

Deceased Estate, all equipment in excellent cond.: Hipower Apadar regulated P/S 12V DC; Weller 100W 8100D soldering gun; Yaesu hand mic., suit 101, 101Z, 301, etc.; Yaesu FT301 solid state tcxvr; Yaesu FP301 matching 20A P/S; home brew digital clock; Leader TR LDM 815 dip meter, still in box; Leeson base station power mic., good cond.; home brew antenna tuner for balanced lines; Dick Smith Q1140 multimeter with case, as new; Lanson TE1205 stereo/mono headphones; low pass filter, 1kW rated; Portatlab 500D pwr/swr/field strength unit; brass hand key; paddle keyer kit, nearly complete; TE101 signal injector Archer-electronic thermometer kits, as new, never constructed; Commander FU400 rotator control box and cable; TVI 30 low pass filter; CB receiving booster; tool box, 3 split trays, complete with components, suit hobbyist; Hygain 18 AVT 10-80m vertical trapped, as new; PA speakers, suit siren, burglar alarm, etc. (2 off); hobby boxes, two sizes; Yaesu RSM-2 gutter grip and complete set of Novice resonators 10-15-80; Unimatrix Stingray CB tcxvr., exc. cond.; quarter wave whip, suit 10m stainless steel; best offer. Mrs. J. H. Hayhoe. Ph. (03) 842 5955.

Fernseh 14 in. TV Monitor, \$25; 14 in. Marconi TV monitor with built-in wave-form monitor, \$45. VK4CB, QTHR. Ph. (07) 202 6566.

### WANTED

Handbook or Copy for Freq. Meter, AN/URM, 32A, price, etc., to VK4CB, QTHR. Ph. (07) 202 6566.

19 in. Rack, light construction; also low power 2m AM rig, home brew suitable. VK3AXE, QTHR. Ph. (03) 857 5882.

Beg, Borrow or Buy—service manual or circuit diagram panoramic adaptor, RAN type PRA-1. Ken Plincott VK3AFJ, QTHR.

Circuit Diagram and/or Handbook for AWA oscilloscope, type 1A56069, can return after photocopying. VK2NTF, QTHR. Ph. (060) 26 3282.

Hy-Gain 2 Element Quad, model 244. Bailly VK7NZZ. Ph. (002) 64 1320.

Battery Box to suit Eddystone EC10 HF communications receiver. Hans Smit VK5YX, QTHR. Ph. (08) 74 2350.

Yaesu FC301 Antenna Tuner and Yaesu FV301 external VFO, preferably in cartons with all manuals, leads, jacks, etc. Details to VK6NDW, QTHR.

### TRADE HAMADS

Kenwood Buyers, your money is needed urgently in the mission fields all over the world. I can't ask you to give them your money, but I can sell you Kenwood gear at a very low price and use any profit to help them in their work. TS120S \$629; TS180S \$1,100; R1000 \$429. Ph. Cliff Coverdale VK2VK, (065) 52 4477 Bus., (065) 59 1508 AH.

High-Gain Beams for 40, 20, 15, 10, 6, 2 and 70 cm, also UHF CB and ATV repeaters, DSI frequency counters and kits, Mirage PWR/SWR meters, also 2m amps with preamp., 10W in 80W out, amp. with Rx preamp., suit 50-54 MHz. Write ATN Antennas, Box 80, Birchip 3483, for catalogue.

Amidon Cores—refer ARRL Handbook, iron powder and ferrite toroids, ferrite beads and sleeves for wideband RF amps. Large SASE for data/price list. R.J. & U.S. Imports, Box 157, Mortdale, NSW 2223.

## ADVERTISERS' INDEX

AUDIO TELEX	17
AMATEUR RADIO ACTION	41
BAIL ELECTRONICS	27
CHIRNSIDE ELECTRONICS	31
CUSTOM COMMUNICATIONS	28, 29
CW ELECTRONICS	2
SCALAR INDUSTRIES	15
SIDEBAND ELECTRONIC IMPORTS	32
VICOM INTERNATIONAL	14, 26, 43, 44
WILLIAM WILLIS & CO.	41

# NEW QUALITY ROTATORS WITH WORLD MAP CENTRED ON AUSTRALIA!



- \* Safe to operate with low voltage 24VAC
- \* High brake torque with the newly designed brake mechanism.
- \* Specially designed reduction gear train for minimal power loss and dependable long-life operation.
- \* The mast clamp guide (patent pending) eliminates any alignment problems.
- \* Rotator is weather sealed and factory lubricated. Housing is die-cast aluminium with melamine - resin coating to prevent oxidisation.

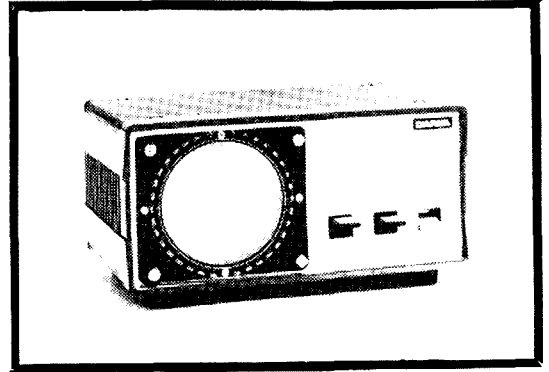

THE "R" TYPE CONTROLLER

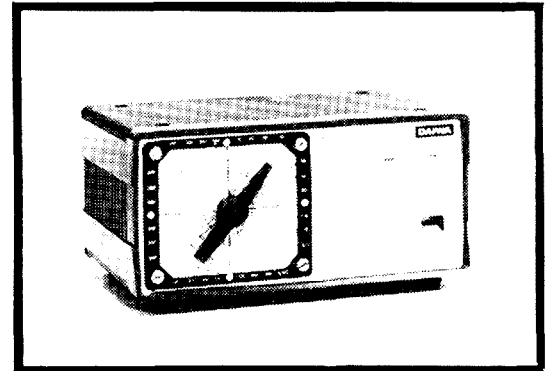

THE "X" TYPE CONTROLLER

## Typical operating characteristics:

	DR7500 (medium duty)	DR7600 (heavy duty)
Power consumption	40VA	40VA
Motor	24V split phase	24V split phase
Rotation time (approx)	50 sec	64 sec
Rotating torque	500kg/cm	600kg/cm
Braking Torque	2000kg/cm	4000kg/cm
Vertical load	200 kg	200 kg
Weight	4.5 kg	4.6 kg
Cable	6 core	6 core

## Prices:



**DAIWA**

	Controller	Price
DR7500R Medium duty	"R"	189.00
DR7500X Medium duty	"X"	172.00
DR7600R Heavy duty	"R"	269.00
DR7600X Heavy duty	"X"	239.00

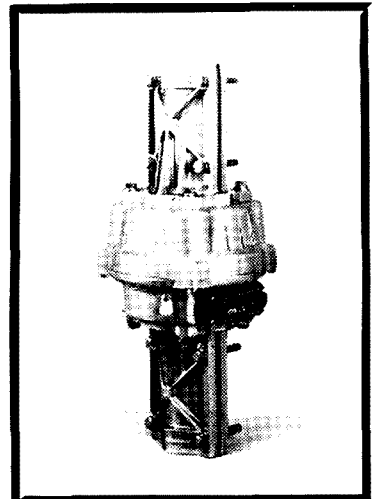

MEDIUM DUTY ROTATOR

Available at your VICOM DEALER

**VICOM**

# WHY ICOM HAS THE 2 METRE MARKET SEWN - UP . . . . .

## 6 Great Rigs of the highest quality!



**"THE FAMOUS IC22S"**

Over 3000 of these popular am fm mobile rigs in use in Australia. Uses a programmable divide matrix giving 22 channels. Comes complete with mic, mobile mounting bracket, dc leads and VICOM 90 day warranty. LIST PRICE \$299.



**"IC260A SSB/FM/CW MOBILE"**

This new mobile all-mode rig covers 144-148 MHz. Features uP control, multi-purpose scanning twin VFO's, efficient noise blanker, CW break-in and many other circuits for your convenience. The IC260A runs 10 watts and offers outstanding performance. Your new IC260A comes complete with mic, manual, mobile mounting brackets and 90 day warranty. LIST PRICE \$599.



**"IC251A all-mode base station/mobile"**

The popular ac/dc Microprocessor-controlled rig incorporating multi-purpose scanning, dual VFO's light weight and featuring the ICOM outstanding performance. The optical chopper tuning system means no backlash and problem free use as there is no dial gear or variable capacitors. Drop in and see a new IC251A at your VICOM dealer today! LIST PRICE \$847.



**"IC2A mini hand-held"**

ICOM'S newest fm rig, about the size of a \$2 note! 1.5 watts output using unique slip on/off and selectable size nicad packs. Offers 800 channels 144-148 MHz. The cheapest fm hand-held around. ONLY \$279.



**"IC280 Remotable mobile"**

The IC280 squeezes optimum performance into the tightest spaces. Using a detachable front section, the diminutive IC280 is designed to fit the most cramped modern vehicle. Small size means big performance with ICOM - your new IC280 remotable comes complete with mic, mobile bracket and comprehensive instruction manual. STILL ONLY \$450!



**"IC255A 25w FM MOBILE"**

The uP controlled fm mobile runs 25 watts output which means greater QSO range. The receiver uses the newly developed low-noise and large dynamic range junction FET's (for the RF amplifier and first mixer) and helical cavity filters providing excellent sensitivity and intermod distortion characteristics. Your new IC255A comes complete with VICOM'S 90 day warranty. OUR PRICE \$425.

**ICOM PERFORMANCE:  
NOBODY DOES IT BETTER!**

**ICOM**

Distributed in Australia by VICOM

# amateur radio

JOURNAL OF THE WIRELESS INSTITUTE OF AUSTRALIA



VOL. 48, No. 4

JUNE 1980

## ***FEATURED IN THIS ISSUE:***

- ★ A SPECTRUM SCANNER
- ★ A DECADE ON VHF
- ★ AMATEUR SATELLITES — PHASE III
- ★ THE STATIC ELECTRICITY SYNDROME
- ★ VK/ZL/OCEANIA DX CONTEST 1979, FOREIGN RESULTS

# VICOM ..... the one-stop communications shop! Offering ICOM, KENWOOD & YAESU.

Base or Mobile - we've got the largest range of ham gear to get you on the air and keep you there! All our sales are supported by technical back-up that's unequalled in the industry. Count on VICOM for personalised service every step of the way. Give us a call today!

**CALL US FOR A GOOD DEAL ON KENWOOD PRICES!**

## BALUNS

AS-BL Asahi 50 ohms for beams - \$34.00  
BL50A 50 ohm 4Kw 1:1 for dipoles - \$32.00  
BL70A 70 ohm 4Kw 1:1 for dipoles - \$32.00

## HY-GAIN ANTENNAS

204BA 4el monobander for 20m - \$259.00  
203BA 3el beam 20m - \$199.00

## JAYBEAM ANTENNAS

5Y/2m 5el, 2m 7.8 dBd gain, length 1.6m - \$43.00  
8Y/2m 8el, 3m 9.5 dBd gain, length 3.8m - \$51.00  
D8/70cm Twin 8el, 70 cm, 12.3 dBd, 1.1m - \$64.00  
PBM 18/70 18el, 70cm, 14.9 dBd, 2.8 - \$96.00  
MBM 48/70 48 el, 70cm, 15.7 dBd, 1.83m - \$83.00  
MBM 88/70 88el, 70cm, 18.5 dBd, 3.98m - \$105.00  
PMH/2C Phasing harness - \$20.00  
8XY/2m 2m cross yagi, 8el, 9.5 dBd, 2.8m - \$99.00  
12XY/70cm 70cm cross yagi, 12el, 13.0 dBd, 2.6m - \$139

## NAGARA

V4JR 40-10m trap vertical, 5.2m high - \$99.00

## SWR/PWR METERS AND DUMMY LOADS

VC-2 Twin meters 3-15MHz with cal. chart - \$35  
SW1 10A Daiwa 1.8 thru 150MHz - \$79.00  
SW2 10A Daiwa 1.8 thru 150MHz 20/120W direct \$99  
CN620 Daiwa Cross-needle, 1.8-150MHz direct \$99  
CN630 Daiwa \$140-450MHz, 20/200W direct read \$135.00  
CN650 Daiwa, 1.2-2.5GHz, 2/20W, direct read \$169  
LPM-885 Leader SWR/PWR meter - \$89.00  
LPM-880 RF Power meter - \$135.00

## BEARCAT SCANNERS (PROGRAMMABLE)

BEARCAT 210F VHF/UHF, 10chs, ac/dc - \$412.00  
BEARCAT 220FB 20chs incl. aircraft AM - \$556.00  
BEARCAT 250FB VHF/UHF, 50chs, ac/dc with 68-88 MHz - \$556.00

**LOOK AT THESE BARGAINS!**

VMI noise cancelling mics \$10  
2M 1/4 wave whips only \$7  
2M 5/8 whips, only \$14  
HF385 Preamp VHF/UHF \$30  
HF395 Preamp to 225MHz \$6  
HF65 FM Tx Kit \$9  
2M Ringos \$55 BACK AGAIN!

## LOW PASS FILTERS (DAIWA)

FD30LS 32MHz, Fc, 200W, 3 stages Qty. 1-10-\$20

## HELICAL WHIPS

VAH/80 80m helical \$28  
VAH/40 40m helical \$28  
VAH/20 20m helical \$28  
VAH/15 15m helical \$28  
VAH/10 10m helical \$28

## MAST HEAD DIVIDER

AD103X Mast-head splitter  
70cm/2m/HI - \$59.00

## RF MATCHING TRANSFORMERS

PALOMAR 500W, switchable 6 impedances - \$96.00

## ANTENNA COUPLERS

CL67A Daiwa 1.9 - 28MHz 500w pep - \$135.00  
CNW217 Daiwa incl. SWR/PWR meter, 200W - \$165  
MFJ901 MFJ. Matches everything 1.8-30MHz - \$119  
MFJ16010 MFJ. Random wire tuner \$160-10M - \$71  
LAC-895 Leader 3.5 thru 28MHz - \$169.00  
CNA-1001 Daiwa, automatic 200W - \$269.00  
CNA-2002 Daiwa, automatic, 2.5KW - \$569.00

## AIRCRAFT RECEIVERS

747 16ch, ac/dc scanning, inc. 4xtals - \$199.00  
Qty. 10-20  
XTALS Additional crystals - \$7.50

## ICOM GEAR

IC551 6m transceiver, all mode \$859  
IC551D 6m transceiver, all mode, 100W \$849  
ICPS20 Power supply \$230  
ICSP2 Matching spaker \$56  
IC402 70cm SSB portable, 3W \$439  
IC202S 2M SSB portable 3W \$318

## MORSE KEYS

HK702 Deluxe Key with marble base \$41  
HK708 Economy Key \$23  
HK706 Operator's Key \$22  
MK701 Manipulator (side-swiper) \$45

## TUBES

6KD6 Finals for Yaesu linears \$10  
6JS6C Yaesu finals \$10  
6146B Kenwood, Uniden, Yaesu finals \$13

## LEADER TEST EQUIPMENT

LDM-815 Dip meter 1.5-250MHz \$89  
LPM-885 SWR/Watt meter 1W - 100W \$97  
LAC-895 Antenna Coupler \$182  
LBO-310H Ham Oscilloscope \$330  
LA-31 Ham scope adapter \$26  
LHM-80A High voltage probe \$32  
LSG-16 RF Signal Generator \$129  
LAG-26 AF Signal Generator \$159

**SYDNEY: 339 Pacific Hwy, Crows Nest  
Ph. 436 2766**

**MELBOURNE: 68 Eastern Rd., Sth. Melb.  
Ph. 699 6700 Tlx. 36935**

**DEALER ENQUIRIES INVITED**

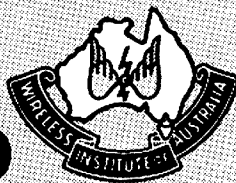

# amateur radio

**JUNE 1980**  
**VOL. 48, No. 6**  
**PRICE: \$1.20**

Registered Office:  
 3/105 Hawthorn Road,  
 Caulfield North 3161.

**EDITOR:**  
 BRUCE BATHOLS\* VK3UV

**PRODUCTION MANAGER:**  
 MARK STEPHENSON\* VK3NOY

**TECHNICAL EDITORS:**  
 BILL RICE\* VK3ABP  
 EVAN JARMAN\* VK3ANI  
 RON COOK\* VK3AFW  
 GIL SONES\* VK3AU1

**CONTRIBUTING EDITORS:**  
 BOB ARNOLD VK3ZBB  
 MIKE BAZLEY VK8HD  
 ROY HARTKOPF\* VK3AOH  
 RON FISHER\* VK3OM  
 ERIC JAMIESON VK5LP  
 LEN POYNTER\* VK3BYE  
 BILL VERRALL VK5WV  
 WALLY WATKINS VK2DEW

**DRAFTING:**  
 NEIL OSBORNE\* VK3YE1

**BUSINESS MANAGER:**  
 PETER DODD VK3CIF

\*Member of Publications Committee

Enquiries and material to:  
 The Editor,  
 PO Box 150, Toorak, Vic. 3142

Copy is required by the first of each month. Acknowledgement may not be made unless specially requested. All important items should be sent by certified mail. The editor reserves the right to edit all material, including Letters to the Editor and Hamads, and reserves the right to refuse acceptance of any material, without specifying a reason. Material should be sent direct to P.O. Box 150, Toorak, Vic., 3142, by the 25th of the second month preceding publication. Phone: (03) 528 5982. Hamads should be sent direct to the same address by the 1st of the month preceding publication.

Trade Practices Act: It is impossible for us to ensure that advertisements submitted for publication comply with the Trade Practices Act 1974. Therefore advertisers and advertising agents will appreciate the absolute need for themselves to ensure that the provisions of the Act are complied with strictly. Readers are reminded that, when buying, obtaining or receiving goods from overseas, including goods listed in advertisements by overseas organisations in this Journal, Customs import duties and Sales Tax may be levied on the goods at the time of importation. These amounts, if any, are payable by the purchaser unless the terms of sale state otherwise and the seller has made specific provision to this effect in his quotation to the buyer or unless other prior arrangements are in force between the buyer and the seller.

Typesetting: MUELLER INDUSTRIES  
 1a Levenswell Road, Moorabbin, 3189  
 Tel.: 553 0292

Printers: EQUITY PRESS PTY. LTD.  
 50-52 Islington Street, Collingwood, 3068  
 Tel.: 41 5054, 41 5055

## CONTENTS

### TECHNICAL

A Spectrum Scanner	11
More on the DJ4LB ATV Transmitter as a Basis for a 70 cm SSB Transverter	26
Try This with the Technical Editors — Simple Elliptically Polarised Antenna	31

### GENERAL

A Decade on VHF	12
Putting up a TH3JR	22
Quo Vadis?	35
Technical Correspondence	35
The Static Electricity Syndrome	21
The WIA in VK2	20
VK CW QRP	29
VK/ZL/Oceania DX Contest 1979 Foreign Results	34

### DEPARTMENTS

Amateur Satellites	23, 31
Around the Trade	40
Awards Column	29
Contests	36
Divisional Notes	33
Hamads	42
Intruder Watch	36
Ionospheric Predictions	37
Letters to the Editor	39
Magpubs	40
Main QSP	5
Obituary	41
QSP	31, 36, 39
Silent Keys	41
VHF-UHF — an Expanding World	32
WIANEWS	5
WICEN	38
You and DX	37

ADVERTISERS' INDEX 41

## Cover Photo

Our cover this month shows Eric Jamieson VK5LP, The Voice in the Hills. Eric was licensed in 1961 as VK5ZEJ, then in 1968 became VK5LP. He is operational on all bands 160 metres to 70 cm, but his greatest interest centres on VHF/UHF. Eric works as a TV service technician and has been interested in electronics from the age of 10. His other hobbies include photography, audio visuals, coin and stamp collecting, vintage wireless collecting, radio valves and collecting items of historical interest. Perhaps the greatest interest is keeping ahead of Dave VK5CK for the number of VK3s worked on 2 metres!

(See Page 12 for "A Decade on VHF")

# GOOD GEAR FROM TONO!

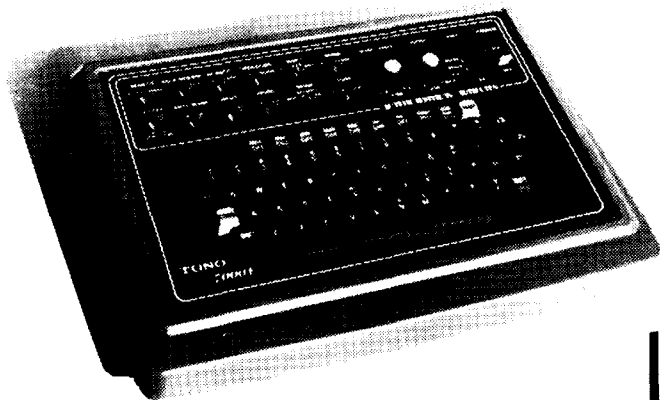

## THETA 7000E COMMUNICATIONS COMPUTER

- Just connect to any TV set
- Provides send/receive for CW, RTTY and ACSII.
- Stacks of features
- Receive commercial CW and RTTY news bulletins

STILL ONLY \$899 cat 7000E

**NEW!**

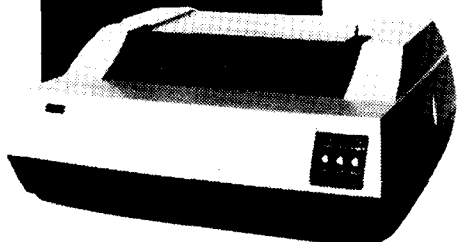

### HC800 DOT MATRIX PRINTER

- 125 cps, 9 x 7 dots
- Bidirectional
- Interfaces with 7000E or Theta 350

PRICE \$999 cat. HC800

**TONO**

**NEW!**

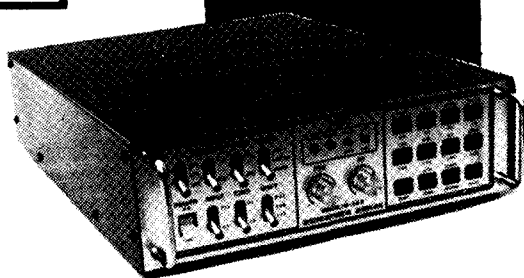

### THETA 350 RECEIVE ONLY TERMINAL

- RTTY, CW and ASCII
- Video output for connection to TV set

\$599 introductory price

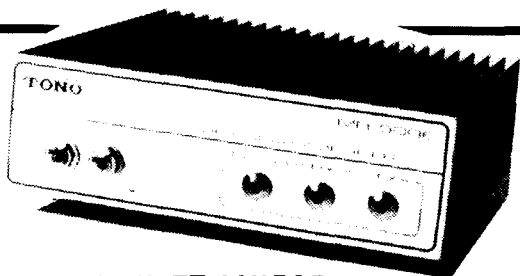

### 2M 90 WATT LINEAR MODEL MR900E

- FM/SSB/CW/RTTY
- Inbuilt 13dB receiver preamp
- Output 80-90W, input 10-15W
- Current 7-8A

PRICE \$289



### 2M 130 WATT LINEAR MODEL MR1300E

- FM/SSB/CW/RTTY
- Inbuilt 13dB receiver preamp
- Output 120-130W, input 10-15W
- Current 10-11A

PRICE \$350

**VICOM**

SYDNEY: 339 Pacific Hwy, Crows Nest Ph. 436 2766  
MELBOURNE: 68 Eastern Rd., Sth. Melbourne Ph. 699 6700

AVAILABLE AT MOST  
GOOD HAM STORES



# QSP —

# INTO THE EIGHTIES

## (AND BEYOND)

### GREETINGS

It was once said that a camel was really a horse designed by a committee.

The "highest" committee of the Wireless Institute, the Federal Council, recently held its annual meeting (the Federal Convention) in Melbourne.

At these meetings, reports by the various officers are tabled, procedural items are dealt with and policies are determined. Members of the 44th Council this year also gave consideration to the future of our leisure activity: Not so much the immediate future — but beyond.

- What form will our hobby take at the end of this decade?
- Will developments in technology affect the average amateur? If so, in what way?
- What about our nearby neighbours in this Region, in particular those who at this stage see little or no value in Amateur Radio for personal communications?
- How is this attitude likely to affect us? Our new bands — how best to use them?
- "Future shock" — is this already affecting some areas of our hobby? If so, can we overcome it with special upgrading of technical services and facilities?
- How can we best prepare for the possibility of future major radio conferences before the year 2000?
- Should we be gearing up further to help the large influx of novices to gain this limited or full licence?

Crystal Ball gazing is a difficult and often dangerous occupation, but without some form of long-term plan, we may well find ourselves in difficulties: And when I say "we" I mean all Australian amateurs.

Twenty or so people gathered around a table once a year cannot answer these types of questions without help — if they do attempt it, the result is likely to be a slightly distorted "horse"!

What is required is YOUR personal contact with people who can in turn pass on YOUR views to the Federal Council via Club or Divisional meetings. Please request that they be passed on to your State's Federal Councillor. His name is printed elsewhere in this journal.

The future of our hobby requires a solid foundation. How about you helping to lay a stone or two?

P. A. WOLFENOEN VK3ZPA  
Federal President

## WIANEWS

This is in the nature of a "STOP PRESS" report on the 1980 Federal Convention held in Melbourne over the Anzac holiday weekend, 25th-27th April. After seven years in office as Federal President, David Wardlaw VK3ADW, announced his retirement from the Executive and Peter Wolfenden VK3ZPA was elected in his stead. David will not be severing his connections with Executive, however, because of now being Immediate Past President. Both he and Michael Owen VK3KI will both continue their IARU and ITU/WARC involvements for the amateur service and the WIA as joint IARU Region 3 liaison officers.

A very pleasant ceremony during the Convention was the presentation of suitable gifts to both David and Michael and their families, in appreciation of their work for the amateur service and the WIA. The recognition of the roles of both Mrs. Wardlaw and Mrs. Owen in support of their respective husbands during several years of amateur radio involvement was much appreciated by them. The surprise element of the presentation took the amateur recipients aback when the Convention business was "rudely" interrupted by Alex McDonald VK4TE, suddenly, on a signal, taking charge of proceedings and making the presentation. A secret well kept by both the wives and the Divisional Councillors.

Visitors at the Convention included Gerry Kilpatrick ZL1BBS, a Councillor of NZART, Bob Arnold VK3ZBB, Alf Chandler VK3LC

and Graeme Fuller VK3NXI, his successor, Wally Watkins VK2DEW and Neville Wilde VK2DR, Roy Hartkopf VK3AOH, who has taken over from Graeme Scott VK3ZR as Federal Education Co-ordinator on the latter standing down for business reasons, and, naturally, Bruce Bathols VK3UV, Managing Editor of AR, supported by Ron Cook VK3AFW from the Publications Committee.

A more detailed report of the Convention is scheduled to appear in July AR but a few items may be of general interest at this stage. Both Michael Owen and David Wardlaw gave further reports on the background at WARC 79 and the 17 State delegates heard a brief description of New Zealand amateur activities well presented by ZL1BBS. Each of the other visitors listed above presented and answered questions on their annual reports.

It was noted that ITU/WARC must be an ongoing task because several specialised ITU conferences (e.g. Space) scheduled for this decade quite apart from work connected with the Australian frequency table as a corollary of WARC 79.

The Convention noted with pleasure recognition of the tremendous amount of WIA work done by the late Keith Roget VK3YQ, by the Victorian Council re-activating the Victorian Award started by him, and close to his heart, under the new name of the Keith Roget National Parks Award.

# WHY ICOM HAS THE 2 METRE MARKET SEWN - UP . . . . .

## 6 Great Rigs of the highest quality!



### "THE FAMOUS IC22S"

Over 3000 of these popular fm mobile rigs in use in Australia. Uses a programmable divide matrix giving 22 channels. Comes complete with mic, mobile mounting bracket, dc leads and VICOM 90 day warranty. LIST PRICE \$299.

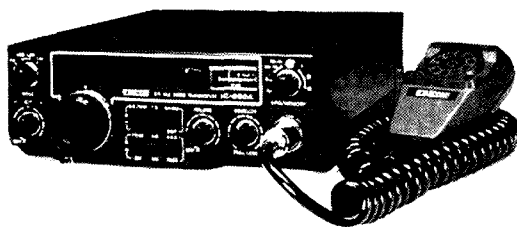

### "IC260A SSB/FM/CW MOBILE"

This new mobile all-mode rig covers 144-148 MHz. Features uP control, multi-purpose scanning twin VFO's, efficient noise blanker, CW break-in and many other circuits for your convenience. The IC260A runs 10 watts and offers outstanding performance. Your new IC260A comes complete with mic, manual, mobile mounting brackets and 90 day warranty. LIST PRICE \$599.

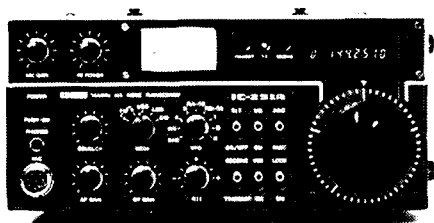

### "IC251A all-mode base station/mobile"

The popular ac/dc Microprocessor-controlled rig incorporating multi-purpose scanning, dual VFO's light weight and featuring the ICOM outstanding performance. The optical chopper tuning system means no backlash and problem free use as there is no dial gear or variable capacitors. Drop in and see a new IC251A at your VICOM dealer today! LIST PRICE \$847.



### "IC2A mini hand-held"

ICOM'S newest fm rig, about the size of a \$2 note! 1.5 watts output using unique slip on/off and selectable size nicad packs. Offers 800 channels 144-148 MHz. The cheapest fm hand-held around. ONLY \$279.



### "IC280 Remotable mobile"

The IC280 squeezes optimum performance into the tightest spaces. Using a detachable front section, the diminutive IC280 is designed to fit the most cramped modern vehicle. Small size means big performance with ICOM - your new IC280 remotable comes complete with mic, mobile bracket and comprehensive instruction manual. STILL ONLY \$450!



### "IC255A 25w FM MOBILE"

The uP controlled fm mobile runs 25 watts output which means greater QSO range. The receiver uses the newly developed low-noise and large dynamic range junction FET's (for the RF amplifier and first mixer) and helical cavity filters providing excellent sensitivity and intermod distortion characteristics. Your new IC255A comes complete with VICOM'S 90 day warranty. OUR PRICE \$425.

**ICOM PERFORMANCE:  
NOBODY DOES IT BETTER!**

**ICOM**

Distributed in Australia by VICOM

In-depth discussions took place on the future of your magazine AR, on the Amateur Advisory Committee system, on press publicity, recruitment of new members and the role of the WIA, as well as several technical and administrative subjects. The inclusion of Divisional bulletin material in the printed page of AR was thoroughly aired and generally favoured on the grounds of interest by readers in other States and problems connected with inserts into the magazine. Improving and updating the presentation of AR were considered essential. In 1981 the WIA Call Book could be mailed to members subject to a closer examination during the next month or two of all that this involves.

The areas of education, examinations and licensing received detailed attention, especially the most effective way of utilising the \$3,500 which accrued in 1978 from the Dick Smith sale of equipment. As it was now evident that the production of professional-style educational videocassettes was outside the amount of money available and in the light of delays which had already occurred, it was agreed that this money be apportioned equally among the Divisions for local education/promotion type projects which must be properly itemised and reported by the end of October.

Amateurs who go overseas will be aware of the popularity of the "international diamond" style of membership badge which readily identifies the amateur radio enthusiast. It was decided to adopt the style of badge as an alternative, but it was strongly emphasised that the existing badge must continue.

Much thought was given to the problems arising from the use of TV Channels 0 and 5A and the compensation deemed thus far inadequate for the loss of the 11 metre band. These were seen as political issues of considerable sensitivity requiring caution in the methods believed desirable if any lobby is to be mounted. This is particularly the case to avoid undesirable, and undesired, repercussions.

A motion to request the P. and T. Department to grant a small downward extension of the 80 metre band Novice segment generated considerable debate and finally ended up with an equality of voting for and against, with one Division unable to make an immediate decision. The question of gentleman's agreements on the use of modes within the HF bands came into these debates, particularly on the basis that if amateurs ignore them (remembering that CW as a mode may be used throughout all the HF bands) it would be unthinkable to ask for them to be apportioned by regulation as occurs in the USA, which is a very special case. Adherence to WIA band plans was also strongly supported.

A small working group was set up for the future planning of amateur radio in Australia; Ron Henderson VK1RH and Dave Laurie VK4DT are the Co-ordinators of the shorter term planning for the three new, small, HF bands. In the latter case it was clear that world-wide co-ordination through the IARU was essential. A vote was carried unanimously re-affirming the Institute's commitment to the IARU and the IARU R3 Association. This naturally includes sister Societies, particularly NZART.

As in all Conventions over the past few years a budget for next year was adopted subject to review at the end of August. An increase of the Federal dues by \$1.00 was decided.

The Executive wishes to acknowledge with grateful thanks the receipt of further donations received from members towards WARC 79 expenses (but it is believed the final listing is still incomplete) —

Blue Mts. ARC per VK2YGE ..... \$1.00  
VK4NLX ..... 1.50

## WIRELESS INSTITUTE OF AUSTRALIA

Federal President: Mr. P. A. Wolfenden VK3ZPA

Federal Council:

VK1 Mr. R. G. Henderson VK1RH  
VK2 Mr. T. I. Mills VK2ZTM  
VK3 Mr. G. A. G. Williams VK3ZXW  
VK4 Mr. A. R. F. McDonald VK4TE  
VK5 Mr. C. J. Hurst VK5HI  
VK6 Mr. N. R. Penfold VK6NE  
VK7 Mr. B. J. Morgan VK7RR

Staff: Mr. P. B. Dodd VK3C1F, Secretary.

Part-time: Col. C. W. Perry, Mrs. J. M. Seddon and Mr. Mark Stephenson (AR Production).

Executive Office: 3/105 Hawthorn Rd., Caulfield North, Vic. 3161. Ph. (03) 528 5962.

Divisional Information (all broadcasts are on Sundays unless otherwise stated).

ACT:

President — Mr. A. Davis VK1DA  
Secretary — Mr. F. Robertson-Mudle VK1NAV/ZZZ  
Broadcasts— 3570 kHz and 2m Ch. 6 (or 7): 10.00Z.

NSW:

President — Mr. F. S. Parker VK2NFF  
Secretary — Mr. T. I. Mills VK2ZTM  
Broadcasts— 1825, 3595, 7146 kHz, 28.32, 52.1, 52.525, 144.1, 145.6, 146.4, Rptr. Ch. 3 — Gosford, Ch. 4 — Lismore, Ch. 5 Wollongong, Ch. 8 — Dural 11.00h local (Evening 0930Z). Relays on 160, 80 and 10m, VHF and Repr. Ch. 3, Ch. 5, Ch. 8, and Hunter Branch, Mondays 0930Z on 3595 kHz, 10m, and Ch. 3 and 6. RTTY Sunday 0030Z 7045, 14090 kHz, Ch. 52, 0930Z 3545 kHz, Ch. 52.

VIC.:

President — Mr. E. J. Bugbee VK3ZZN  
Secretary — Mr. G. F. Atkinson VK3YFA  
Broadcasts— 1840, 3600, 7135 kHz — 53.032 AM, 144.2 USB and 2m Ch. 2 (5) repeater: 10.30 local time.  
Gen. Mtg. — 2nd Wed., 20.00.

QLD.:

President — Mr. A. J. Aarsse VK4QA  
Secretary — Mr. W. L. Giells VK4ABG  
Broadcasts— 1825, 3580, 7146, 14342, 21175, 28400, kHz; 2m (Ch. 42, 48): 09.00 EST.  
Gen. Mtg. — 3rd Friday.

SA:

President — Mr. I. J. Hunt VK5QX  
Secretary — Mr. W. M. Wardrop VK5AWM  
Broadcasts— 1820, 3550, 7095, 14175 kHz; 28.5 and 53.1 MHz, 2m (Ch. 8): 09.00 S.A.T.  
Gen. Mtg. — 4th Tuesday, 19.30.

WA:

President — Mr. Ross Greenaway VK6DA.  
Secretary — Mr. Peter Savage VK6NCP.  
Broadcasts— 3560, 7075, 14100, 14175 kHz. 28.47, 53.1 MHz. 2 metres Ch. 2 Perth, Ch. 6 Wagin. Time 0130Z.  
Gen. Mtg. — 3rd Tuesday.

TAS.:

President — Mr. R. Emmett VK7KK  
Secretary — Mr. B. J. Morgan VK7RR  
Broadcasts— 7130 (SSB) kHz with relays on 6 and 2m Ch. 2 (S), Ch. 8 (N), Ch. 3 (NW), 09.30 EST.

NT:

President — Mr. T. A. Hine VK8NTA  
Vice-Pres. — Barry Burns VK8DI  
Secretary — Robert Milliken VK8NRM  
Broadcasts— Relay of VK5WI on 3.555 MHz and on 146.5 MHz at 2330Z. Slow morse transmission by VK8HA on 3.555 MHz at 1000Z almost every day.

Postal Information:

VK1 — P.O. Box 46, Canberra, 2600.  
VK2 — 14 Atchison St., Crows Nest, 2065 (Ph. (02) 43 5795 Tues & Thurs (10.00-14.00h). P.O. Box 123, St. Leonards, NSW 2065.

VK3 — 412 Brunswick St., Fitzroy, 3065 (Ph. (03) 41 3535 Weekdays 10.00-15.00h).  
VK4 — G.P.O. Box 638, Brisbane, 4001.  
VK5 — G.P.O. Box 1234, Adelaide, 5001 — HQ at West Thebarton Rd., Thebarton.  
VK6 — G.P.O. Box N1002, Perth, 6001.  
VK7 — P.O. Box 1010, Launceston, 7250.  
VK8 — (Incl. with VK5), Darwin AR Club, P.O. Box 37317, Winnellie, N.T., 5789.

Slow morse transmissions — most week-day evenings about 09.30Z onwards around 3550 kHz.

VK QSL BUREAUX

The following is the official list of VK QSL Bureaux, all are Inwards and outwards unless otherwise stated.

VK1 — QSL Officer, G.P.O. Box 46, Canberra, A.C.T. 2600.  
VK2 — QSL Bureau, C/- Hunter Branch, P.O. Teralba, N.S.W. 2284.  
VK3 — Inwards QSL Bureau, Mr. E. Trebilcock, 340 Gillies Street, Thornbury, Vic. 3071.  
VK3 — Outwards QSL Bureau, Mr. R. R. Prowse, 83 Brewer Road, Bentleigh, Vic. 3204.  
VK4 — QSL Officer, G.P.O. Box 638, Brisbane, Qld., 4001.  
VK5 — QSL Bureau, Mr. Ray Dobson VK5DI, 16 Howden Road, Fulham, S.A. 5024.  
VK6 — QSL Bureau, Mr. J. Rumble VK6RU, G.P.O. Box F319, Perth, W.A. 6001.  
VK7 — QSL Bureau, G.P.O. Box 371D, Hobart, Tas. 7001.  
VK8 — QSL Bureau, C/- VK8HA, P.O. Box 1418, Darwin, N.T. 5794.  
VK9, 0 — Federal QSL Bureau, Mr. N. R. Penfold VK6NE, 388 Huntriss Rd., Woodlands, W.A. 6018.

# "MORE GREAT DAIWA GEAR TO TURN YOU ON!"

## ROTATORS NEW TYPE WITH MAP CENTRED ON AUSTRALIA!

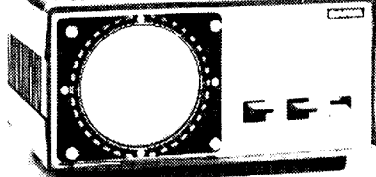

**DAIWA**

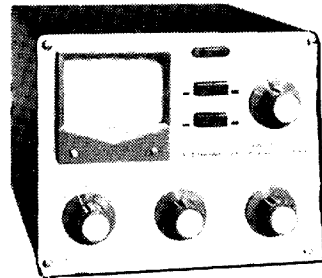

DR7500R	Medium Duty	189.00
DR7500X	Medium Duty with pre-set controller	172.00
DR7600R	Heavy Duty	269.00
DR7600X	Heavy Duty with pre-set controller	239.00

## ANTENNA COUPLERS

CL67A	1.9-28 MHz, 500 wpep	135.00
CNW217	incl SWR/PWR Meter, 200W	165.00
CNW418	as above, with new WARC freqs	179.00

High quality models with SWR/PWR Meter include unique cross-needle meter.

## COAXIAL SWITCHES

2 Position model CS201	23.00
4 Position model CS401	59.00

Professionally engineered cavity construction, high isolation.

Power rating: 2.5 KW pep, 1 KW CW  
Impedance: 50 ohm  
Insertion loss: less than 2dB  
Maximum frequency: 500 MHz  
Isolation: Better than 60dB at 300MHz.

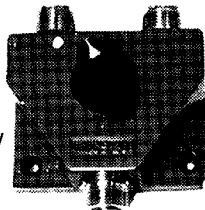

## SWR & POWER METERS

Model	Freq.	PWR	Cross-Needle	Price
CN620	1.8-150 MHz	20/200/1 KW	yes	99.00
CN630	140-450 MHz	20/200	yes	135.00
CN650	1.2-2.5 GHz	2/20	yes	169.00
SW210A	1.8-150 MHz	20/120	no	99.00

Cross-needle type offer DIRECT readings.

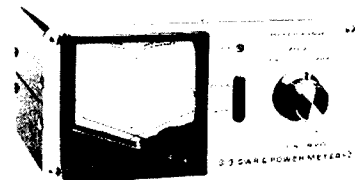

## SPEECH PROCESSORS

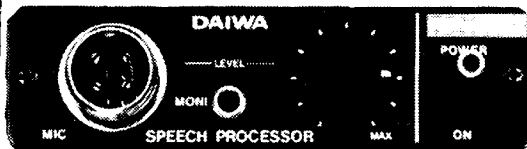

RF660	Phasing type dc	109.00
RF440	Phasing type ac/dc	126.00
RF550	Fitter type, ac/dc	169.00
MC330	Speech compressor	99.00

Increase talk power with splatter free operation. RF clipping (not in MC330) assures low distortion. Simply install between microphone and transmitter.

Typical specs RF660:

Talk power: Better than 6dB  
Freq. Response: 200Hz-3000Hz at 12dB down  
Distortion: less than 3% at 1 KHz, 20dB clipping.  
Power Req.: 13.8 Vdc at 50mA.

## AUTOMATIC ANTENNA TUNER

New model with the extra WARC frequencies included. The VSWR is automatically adjusted below 1.5 PWR  
Rating 500W pep.

CNA1001 269.00

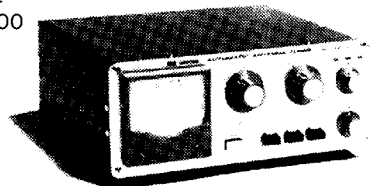

SYDNEY: 339 Pacific Hwy, Crows Nest  
Ph. 436 2766

MELBOURNE: 68 Eastern Rd, Sth Melb.  
Ph. 699 6700

# VICOM

AVAILABLE AT REPUTABLE HAM  
DEALERS

# OUR CARDS ARE ON THE TABLE!

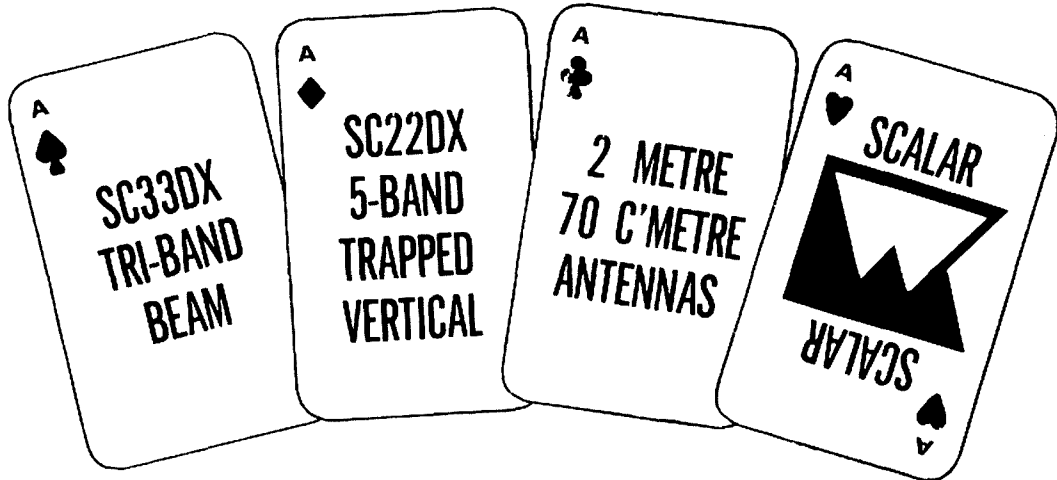

Comments at field days indicate that you don't really know what we've got!  
So now we'll **SHOW YOU OUR HAND** - and where to **GET THE BEST DEAL!!**

## PRODUCT LIST AND RECOMMENDED RETAIL PRICES

### 70 cm BAND

SCA40T dB Fibreglass Whip.....	\$13.10
OB UHF Mobile Antenna Base.....	\$5.20
C54/OB Guttergrip with OB Base.....	\$19.00
C60/OB Trunkmount with OB Base.....	\$8.65
GSA46 6 dB Colinear Base Antenna	\$100.65

### 2 m BAND

SCA21T S/S 1/4 Wave Whip.....	\$4.15
SCA22T Fibreglass 1/4 Wave Whip.....	\$6.15
SCA25T Fibreglass 5/8 Wave Whip...	\$12.90
MB VHF Mobile Antenna Base.....	\$3.65
C54 Guttergrip with MB Base.....	\$17.25
C60 Trunkmount with MB Base.....	\$6.90
GSA203 3dB Colinear Base Antenna	\$131.10

### H.F. BANDS

SC22DX 5 Band Trapped Vertical...	\$129.00
SC33DX 3 Element Triband Beam...	\$P.O.A.
HA6T 6' Helical Whips for 10,15,20,40 & 80 metres.....	\$39.70
M27B Heavy Duty Base for HA6T.....	\$6.70

### MOBILE TRIBAND H.F.

Run one, two or three H.F. Bands Mobile . . .  
without changing antennas!!

SC2M Mast - 5/16 Ferrule.....	\$15.85
SC6M Mast - 3/8 Ferrule.....	\$18.70
SC1015 Duo/Triband Attachment.....	\$18.70
SC8OR 80 Metre Resonator.....	\$25.90
SC4OR 40 Metre Resonator.....	\$20.15
SC2OR 20 Metre Resonator.....	\$18.70
SC15R 15 Metre Resonator.....	\$18.70
SC1OR 10 Metre Resonator.....	\$17.25

**Be a DEVIL — Buy a PITCHFORK!**

## BREAKTHROUGH

3 dB Gain on a 2 Metre Mobile Whip  
and its ONLY 32" LONG!!



SCA26T

**ONLY \$12.90**

**Also available: Baluns-Insulators-Quad Hubs-  
Antenna Traps-Reflector Coils-Magnabase.**

### PRODUCTS AVAILABLE FROM:

**VIC.:** SCALAR INDUSTRIES PTY. LTD.  
20 Shelley Ave., Kilsyth (03) 725 9677

**N.S.W.:** SCALAR (N.S.W.) PTY. LTD.  
20 The Strand, Penhurst (02) 570 1788

EMTRONICS (02) 211 0531

ELEKTRON 2000 (049) 26 2644

**QLD.:** SCALAR (QLD.) PTY. LTD.  
8 Ferry Rd., West End (07) 44 8024

ELITE ELECTRONICS (07) 38 4480

CW ELECTRONICS (07) 48 6601

**W.A.:** EVERETT INTERNATIONAL PTY. LTD.  
Northwood St., W. Leederville (09) 381 5500

# “Quality is always the right answer.”

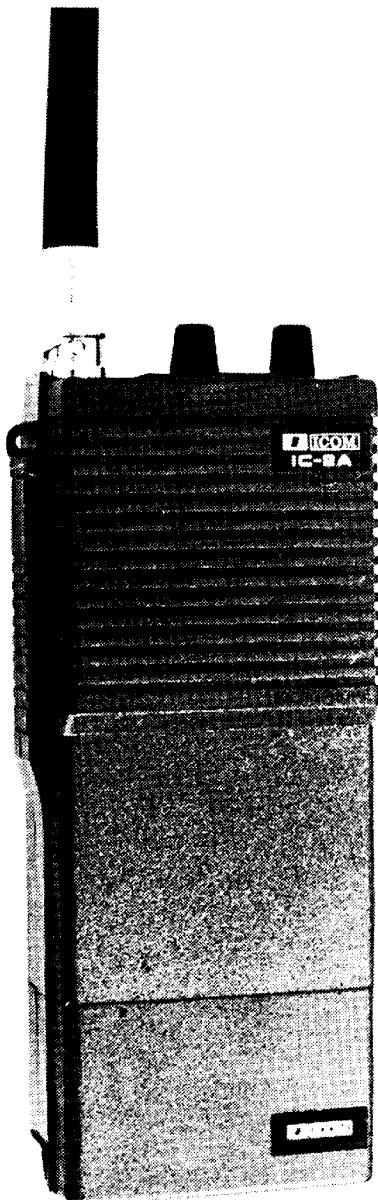

## Quality.

That's ICOM's new IC2A fm hand-held transceiver:

- Smaller and about half the weight of the others.
- Optional power packs for operation up to 5 watts output.
- Best sensitivity of the “big three.”\*
- Two hinged circuit boards for easy maintenance.\*
- 800 channels, 144-148 MHz, 600 KHz repeater offset.
- ICOM's quality backed by 90 day warranty
- At \$279 the ICOM IC2A offers the best price of the “big three”.

Accessories coming soon:

- BP-5 Nicad pack, 2-3W output
- BP-6 Nicad pack, 5W output
- CP-1 cigarette lighter charger
- HM-9 Speaker/microphone
- LC-1 Leather case

**GIVE YOUR VICOM DEALER  
A CALL TODAY!**

\*See review "Amateur Radio Action" Vol 2/13

Distributed by VICOM

SYDNEY: 339 Pacific Hwy,  
Crows Nest. Ph. 436 2766  
MELBOURNE: 68 Eastern Rd.,  
Sth. Melb. Ph. 699 6700

**VICOM**

VICOM gear is available from  
most reputable dealers!

# A Spectrum Scanner

W. Nickols VK7EM  
4 Quinn St., Penguin 7316

This device, built from readily available parts, enables the VHF bands from 40-220 MHz to be viewed on an oscilloscope. Instantly it is possible to see what band conditions are like by observing distant TV channel frequencies. Also, at a glance, 2 metre activity can be seen and appropriate equipment can then be activated.

## THEORY OF OPERATION

Briefly, a Varicap Tuner (as used in press-button tuned television receivers) can be tuned by applying a voltage, determined by a small potentiometer, one for each channel. The full channel allocation is usually covered in two ranges, while the UHF band can be covered in a third. If, then, by applying a repetitive sweep voltage covering the complete tuning range which is usually 0-30 volts, and with this also driving the X or horizontal amplifier of an oscilloscope, the bands can be swept. Any signals found will be detected and a voltage proportional to the signal strength will, if coupled to the Y or verti-

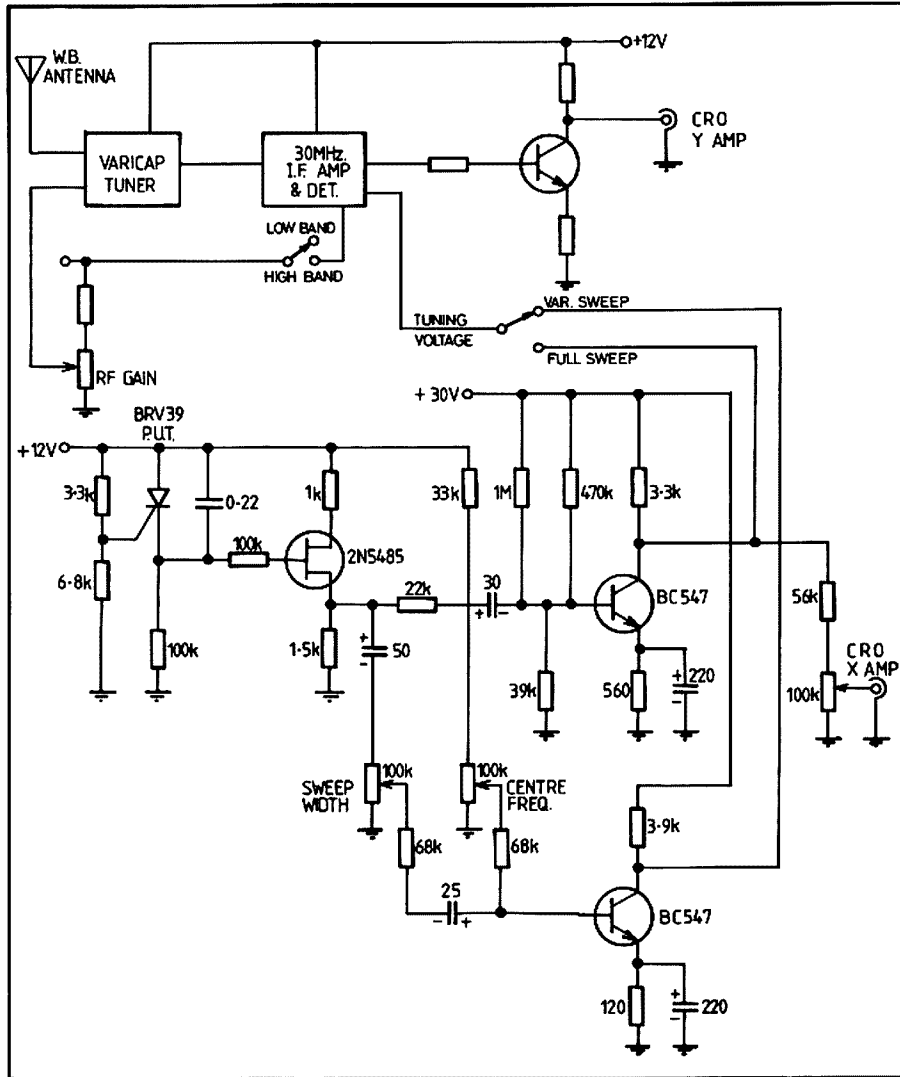

ABOVE: The spectrum scanner circuit and LEFT: The CRO display for VHF high band.

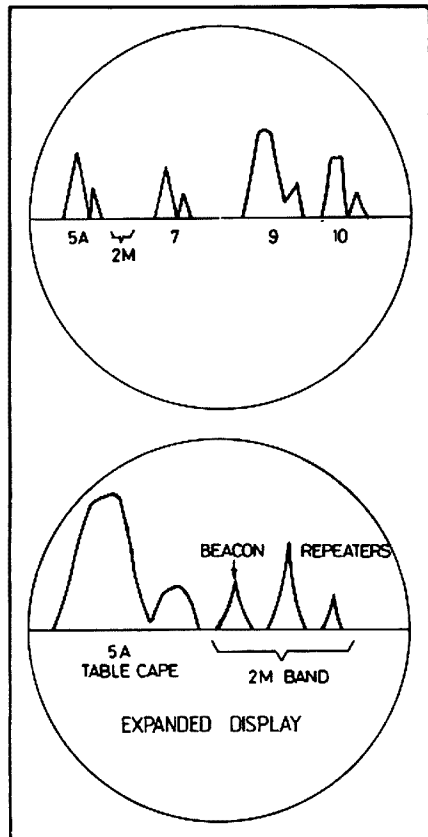

cal amplifier will cause "pips" on the horizontal trace. Therefore on FULL SWEEP, either 45-140 MHz or 140-220 MHz can be displayed on the CRO at the one time. A section only of the band can be displayed by switching to ADJUSTABLE SWEEP and setting the CENTRE FREQUENCY and SWEEP WIDTH controls until the desired section is located and expanded.

## CONSTRUCTION

A Varicap Tuner can be obtained from several suppliers at a reasonable cost. The amplifier used in the prototype was from a wrecked Philips monochrome TV receiver. It was re-aligned simply by peak-

ing the relevant tuned circuits and adjusting the traps until a narrow bandwidth, high gain amplifier was obtained. The video amplifier following the detector was retained and the output taken from where the sync separator was fed. Layout of the sweep board is not critical. Almost any CRO can be used providing it can accept external horizontal drive.

It is fascinating to watch the activity as mainland TV signals fade up out of the noise (or grass), the various two-way services busily occupy their segments and the strength at which home-station receiving equipment local oscillators radiate.

Reproduced from QRM June 1979. ■

# A Decade in Review

## The Expanding World on VHF in the 70s (Part 1)

Ten years have elapsed since that "momentous" occasion in 1969 when I was asked to fill the position of VHF Sub-Editor for "Amateur Radio". I was never sure whether to thank or kick Geoff Taylor VK5TY, the then VK5 Federal Councillor, for his recommendation that I might be suitable for the job! However, as history has shown, I did accept the position at the vast salary of nothing except the honour and privilege of the position, presenting me with a unique opportunity of moulding the VHF scene into a situation where it might be recognised for what it is, both in Australia and overseas.

That the VHF scene is recognised is supported by the scores of letters and bulletins I receive annually from all over Australia, New Zealand, USA and Japan, offering information of all kinds relative to VHF. It has always been my policy to acknowledge through the columns of "AR" all those letters sent to me — they all contain some item of news worthy of inclusion. In so acknowledging those letters it tends to keep the writers interested enough to send further news, and every now and again something outstanding arrives on my desk, making the effort worthwhile. I am rarely in a position to personally write in return, the column plus my many other public and community activities preclude this, but those who write are aware of this, and have accepted the situation.

The last ten years have seen considerable changes with the solid penetration of SSB in place of AM, together with a continuing interest on a smaller scale with CW. Repeaters and FM operation has spread nation-wide, ATV and RTTY are well known on the VHF/UHF bands. Single frequency operation as on HF has become the norm, whether SSB, CW, FM or even AM, with the advent of VHF transceivers and transverters. Operating aids which formally were the province of HF have found their way on to the VHF scene, items such as power and SWR meters, frequency counters, CW filters, power amplifiers, etc., so that today it would be no problem to spend more than \$5,000 on a VHF/UHF station, and still not be wasting money.

Whilst the state of the art must have surely shown some improvements, particularly at the moment with the introduction of very low noise figure transistors, FETs and GAAs FETs for use into the microwave regions. In many cases bigger and better antennae, more output power, etc., to offset this one has to remember a considerable increase in power line noise with the widespread coverage now given by high tension lines, the proliferation of interfering television stations, and the increases in population density in many areas leading to TVI problems, so that not all has been plain sailing. Despite these limitations the distances over which two-way communication has taken place are being constantly lengthened, and new world

records set, particularly in the UHF regions; the term "expanding world", therefore, is very relevant, and will continue to be while there are still amateurs prepared to experiment, and after all, the VHF and UHF bands are the homes of the experimenters, who in turn are being constantly assisted by improvements made in commercial industry and the natural flow-on of better components and techniques which can then be explored further by the amateur.

Interest in propagation has been renewed with the solar activity of Cycle 21 reaching its peak about this time, mostly manifesting itself on the 50 to 54 MHz band and leading to two-way contacts half-way across the world. The northern hemisphere by reason of its amateur population and the geographical placement of participating countries has had the greatest share of exotic contacts, and will continue to do so. The majority of Australian amateurs therefore will only pick up the crumbs, so to speak, except perhaps for some operators living in far northern areas, but there will be enough crumbs for Cycle 21 to have been of great interest to those prepared to keep watching the 6 metre band.

And now we go have a look at what the past ten years has meant to us; no doubt what is written will refresh memories for the old hands, and be something new for the newcomers. It is written largely in chronological form and I hope will serve as a reference of sorts for the future. Thanks go to David VK5KK for assistance in the preparation of the material and to the Editor of AR for accepting it.

### DECEMBER 1969

"The purpose of this page in the future will be to try and foster more interest in VHF/UHF, particularly with a view to promoting contacts with neighbouring and other States." That was the initial lead-in. First beacon list published p. 31 with initial prod at VK2 for lack of beacons.

Cook Bi-Centenary Award to include VHF section. VK5LP got Certificate 31.

VK7VF beacon warns of inversion, Allan VK2ZEO therefore worked Wilf VK7WF on 144 and Collins VK5ZKR worked VK7WF on 432.

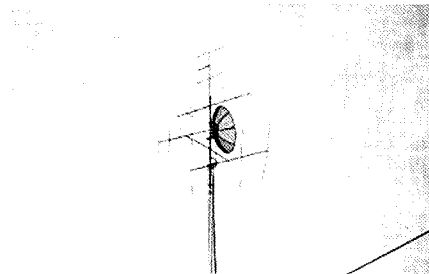

Bob VK5ZDX built special 100 watt 6 and 2 metre portable field day station and joined Wally VK5ZWW to score 11,000 points to win VK5 Field Day.

Doug VK8KK Darwin worked HL9 on 51 as part of Cycle 20.

The VK5QZ standard of comparison 432 MHz converter developed. Over 50 sold!

The VK5 1296 MHz record set on 28-9-69 between Rod VK5ZSD, Eden Hills, to Alan VK3ZHU/5, South Hummocks, 75 miles, 5 x 9 both ways. Rod moves to VK2!

"Meet the other man" segment started with Mick VK5ZDR.

ZL1BFA and ZL1AJP had their second two-way contact on 5800 MHz over 86.25 miles.

John ZL1AZR continues EME skeds with SM7BAE and KOMQS.

First thought of the month: "In a democracy the votes of the vicious and stupid count. But under any other system they might be running the show."

First use of the signature "The voice in the hills".

### JANUARY 1970

AM still in main use on 6 and 2 metres, but SSB increasing.

Move to launch a message across Australia and back again on 144. It was queried whether it might fail as VK6 was so far away!

JA11GY beacon still on 51.995 MHz.

Beacon list growing, but asking for 2 metre beacons in VK2 and VK4.

Meet the other man VK5ZDX, with photo, said he was to erect four 7 element beams for 2 metres and get on 432 as well.

Wally VK5ZWW heard JA5DEI at 0845Z on 19-12-69 on 52.010.

576 MHz record set between VK5QZ/5 and VK5ZJL/5 5 x 9 both ways over 200 miles using 5 watts of AM and 32 element phased arrays.

Eight active stations in Melbourne on 1296 MHz, with skeds up to 50 miles.

Controversy over AM stations not being able to resolve the new SSB stations.

Meet the other man, Ron VK3AKC, who operates 52, 144, 432 and 1296 MHz.

New Australian record on 1296 MHz at 149 miles between VK2ZAC and VK2BDN set on 7-12-69. Setting their sights on 220 miles next time.



## MARCH 1970

VK4VV beacon on 144.390 using MCW comes on air.

Tremendous 144 MHz opening across southern areas commencing 30-1-70 and continuing for four days and nights. About every station in VK5 with 2 metre equipment worked Albany stations, longest distance being to Bob VK3AOT, 1,550 miles.

Commencement of VK6TS beacon at Carnarvon on 52.900 while VK2ZRH reports spasmodic contacts with JA stations during November, December and January.

On 25-1 Brian VK5ZBR worked JA1, 3 and 7 to S9.

Suggested GMT be used for VHF contacts and QSLs, but opposition to move!

Meet the other man, Lance VK4ZAZ, who made the observations that some TEP conditions seem to be useless with SSB and CW—extra high level AM appears to be superior under these conditions.

## APRIL 1970

Herb VK3NN works VK6KJ on 2 metres.

Possible 432 MHz record between VK5ZDY and VK3ZY0 over 410 miles.

VK3AKC and VK7WF maintain 1,296 skeds over 4 to 5 months, finally rewarded on 4-2-70 with two-way contact at 1000Z, 223 miles, same again on 5-2, then VK3ZXB worked VK7WF for 250 miles. Also on 5-2 VK3ATN worked VK7WF on 432 for 370 miles.

VK3AOT had caravan trip to Mt. Bunlonyong for 420 contacts on 52, 144 and 432. Enough blow-outs and vehicle troubles getting there and back to satisfy most people! Best contacts AX1ACA/2 and VK2ZKP/2.

Comment in VK6 Bulletin that John Moyle FD Contest creates little interest in that State due to poor scoring arrangements for VHF.

VK5LP and VK5QZ take gear for 160 metres to 432 MHz for John Moyle Field Day. Struck hottest day of year, 112°F in caravan, heat sinks boiling, and very few contacts!

144 MHz beacon on Oscar 5 goes silent. Mt. Gambier operators work VK2, 3, 5, 6 and 7 on 144 MHz. VK3ATN worked VK1.

Meet the other man, Eddie VK1VP.

## MAY 1970

Letter from VK2ZTM reporting plans for 6 and 2 metre beacons in Sydney, also 432 and 1296 beacons will double as WIA broadcast transmitters!

AX7ZRO with 1 watt works two stations in Mt. Gambier and four in Melbourne on 144 MHz from top of Mt. Wellington.

Lance VK4ZAZ reports JAs each day since 5-2-70, and has now worked nine countries on 6 metres.

Mention made of QST article of 1940 on then VHF records: 56 MHz W1EYM—W6DNZ 22-7-38, 2,500 miles; 112 MHz W9WYX/9—W9VTK/9, 7-10-39, 160 miles; 224 MHz W1AIY—W1KLJ, 27-4-40, 6 miles.

A further claim of 200 miles on 112 MHz was being considered.

Meet the other man VK5QZ, who operates on 52, 144, 432, 576 and 1296 MHz, and holds the 576 MHz record at 200 miles with VK5ZJL.

## JUNE 1970

Record issue of notes so far, two full pages! JA1IGY 51.995 and WB6KAP 50.091 new beacons added, latter heard by VK4RO and VK4ZPL as well as VK8KK on 28-4-70.

VK3 and VK5 work JA for five hours on 25-4 from 0530Z, signals to S9.

Suggested rules for working DX when close neighbours both on band!

Ron VK3AKC wins 1969-70 Ross Hull Contest with 3,388 points.

VK5LP asking for better deal for VHF operators in Remembrance Day Contest, also worried by lack of interest in Ross Hull Contest.

VK2ZEO working regularly into Melbourne on 432 at 160 miles.

Beacons for 6 and 2 metres being considered in Darwin. VK3 beacon soon to be on air.

Editor of AR disagrees with VK5LP on suggestions for operation of worked-all-bands award!

South East Radio Group in Mt. Gambier now have club station VK5SR.

Project Moonray—world-wide DX on 432 MHz. Sam Harris W1FZJ/KP4 has a 100 foot square parabolic type reflector built on the ground to achieve this. Gain 31 dB on 144, 40.2 dB on 432.

1296 MHz activity in Queensland, AX4NO works AX4ZT 217 miles on CW, AM and FM, on 11-4-70. Extended to 248 miles on 12-4.

Growing interest in FM repeaters in VK5, prototypes being tested.

VK8KK and VK8AU keeping skeds with W6ABN, WB6NMC and W6JRA on 6 metres, but nothing heard so far, although the Ws running up to 600 watts with stacked 9 element beams! JAs working KX6HK on 52.2 AM.

Meet the other man, VK7WF, who operates on 52, 114, 432 and 1296 MHz.

## JULY 1970

Brian VK6VV/4 worked DU1MM on 52.120. Doug VK8KK missed this one as he was inside watching the wrestling on TV! On 22-3 JA2AYM worked VS6BF 50.100. W6ABN reported in April first TEP 50 MHz DX for season to South America. ZK1AA regularly working to KH6, plus K5AGI.

VK9JL on 53.032 from Madang.

VK2ASZ reports Russian TV on 49.750 and ZL TV during April, and then proceeded to work 58 JAs for good measure; JAs worked by VK1, 2, 3, 4, 5 and 7.

Meet the other man, VK2ASZ, who operates on 52, 114, 432, and who holds WAS 50, VHFCC 50, VHFCC 144, AJD and several Ross Hull certificates!

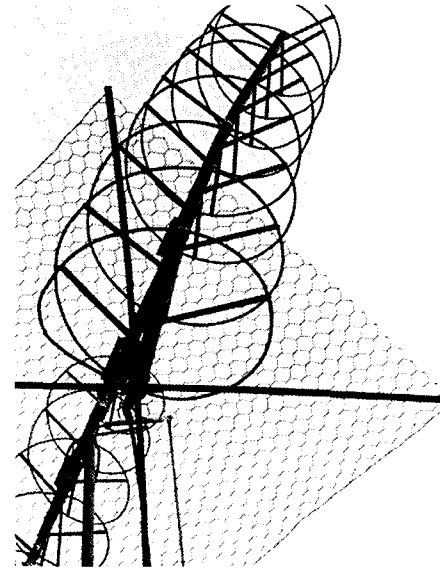

PHOTO 1: An antenna widely used for specialised purposes — the Helix.

VK8KK worked VS6DA Hong Kong for probably first VS-VK on VHF, on 2-6-70 via TE scatter, signals 5 x 9, operated split 50.110 to 52.110. Later proved that VK5RO heard VS6CJ on 30-3-58 and VK6HK worked him early April. Doug VK8KK has now worked 14 countries on 6 metres.

## AUGUST 1970

VK8KK, Darwin, and VK8AU, Tennant Creek, working via CW scatter occasionally.

Report on VK2 mid-winter field day mentions a two-way contact by VK2ZNC/P on 10 GHz using 25 mW to an 8 in. parabola 40 feet high!

VK2ZRH reported TV sound on 49.750 from north on 14 occasions during April and May, and worked a number of JAs.

Keith VK5ZKG going to Antarctic for 12 months.

## SEPTEMBER 1970

VK4ZAZ reports receiving QSL from KX6HK for hearing him in April!

Peter VK5ZPG goes to Pt. Lincoln and opens up that area on 2 metres.

A 1947 QST mentions first 50 MHz contact between VK5KL at Darwin and Hawaii to W7ACS/KH6 taking place on 27-8-47, distance 5,350 miles, a new record.

A new home station record on 144 MHz between VE1QZ and W1OSQ of 520 miles.

OX5AP testing on 50.150 from Greenland.

## OCTOBER 1970

Letter from VK3BEC advising construction of 580 MHz beacon. What became of it? Work still progressing on VK3 beacon. VK6VE Albany beacon heard in Geelong on 7-8 at S3.

VK7EM now on ATV on 426 MHz.

Main FM channels currently in use are Ch. A and Ch. B, the latter being the more popular.

VK8AU reports JAs again on 6 metres, while VK8KK predicts 1971 will be a bumper year for TEP working.

Six metres coming alive with scatter contacts between VK8AU, Tennant Creek, and VK8KK, Darwin, and to Wally VK5ZWW/5, at Andamook Opal Fields, and Bov VK6ZDX, Adelaide. Good outline of meteor scatter procedure p. 24.

#### NOVEMBER 1970

VK9XI a new beacon on Christmas Island on 144.600.

Kerry VK5SU at Ceduna commences operation.

Write-up of EME activity of ZL1AZR.

VK8KK reports excellent conditions on 6 metres with up to five countries being available most nights. HL9WI runs beacon on 50.100.

Meet the other man, Ross VK4RO, on 52 and 144, and Doug VK8KK on 52, 144 and 432 MHz.

#### DECEMBER 1970

Latest method of finding north—see column 1, third paragraph—well worth reading!

VK8AU worked JA1MAS on 6 metres, 4 x 3, using 10 mW!

John VK4ZJB going to be on 53.200 with 150 watts and 10 element beam!

Starting and finishing dates of Ross Hull Contest lengthened.

Bob VK3AOT going portable on 52, 144, 432, 576, 1296 and FM!

Extensive 144 MHz openings across USA with distances up to 1,300 miles.

Colin VK5DK reporting their Club station VK5SR would be operating all bands from 80 metres to 1296 MHz during New Year weekend.

#### JANUARY 1971

WB6KAP beacon on 50.091 listed—also heard by VK2ZBU 599 on 8-11-70 0300 to 0430Z. JAs in Sydney at same time.

Balloon sent up from Mildura carrying translator equipment, input 146.000, output 432.170, power output 2 watts.

Preliminary advice from VK3ATN his dish available to interested groups for EME experiments.

Sam Harris KP4BPZ bought 28 acres near the 1,000 foot dish at Arcibo, and hoping to improve his own 100 foot dish by extending it to 300 feet!

Meet the other man, VK3ATN, operating on 52, 144 and 432.

#### FEBRUARY 1971

Beacon list grows to 15 stations, VK3VE finally made it, but still no sign of any VK2 beacons.

Christmas Island contacted Port Hedland on 156.8 MHz using commercial equipment, distance 960 miles.

ZL stations on 6 metres to VK5 for first time in over a year.

C21AA in Nauru worked VK2ZRH and VK4ZRW on 6 metres on 20-12-70. Es at a very high level compared with some previous years.

Garry VK5ZK worked Bernie VK6KJ, Albany, 5 x 8 0100Z on 15-12.

Tony VK5ZDY at prime spot in Stirling having good contacts on 144 and 432 to VK3, plus 576 MHz contacts to VK5QZ and VK5ZWW.

Noel VK9GA running a beacon on 52.150.

MUF rises to well over 100 MHz as observed on TV sets, predictions for possible good Es on 144 MHz for end of 1971.

#### MARCH 1971

VK0GA beacon on 53.544 at 2 w.p.m. for 55 seconds. Others operating from down south include VKOPF, VKOMX and VKOZPO.

VK5 repeater goes into operation, running 15 watts, solid state equipment.

Ken VK3ZNJ gets WA ZL areas by working ZL4PG on 4-1. VK3AOT worked VK4ZAZ on 12-1 on 144 MHz.

VK3ATN to try to work Q3LTF on 1296 MHz EME with 100 watts.

KP4DJN has 100 foot dish for EME steered by movement of the feedline.

Meet the other man, George VK3ASV, on 52 and 144.

#### APRIL 1971

VK8AU works JA1MRS, HL9WI and KR6CR. 1296 MHz record broken again, Ron VK3AKC works Kevin VK7ZAH, 274 miles. HL9WI worked five VK6s, VK8KK and VK8AU.

Meet the other man, Wally VK5ZWW, on 52, 144 and 432.

#### MAY 1971

ZL going ahead with beacons for 2 metres, and Albany amateurs building beacon for six metres. VK2 talking about building 6 and 2 metre beacons.

Bill VK3AMH workers Bernie VK6KJ on 2 metres after hearing the Albany beacon.

Ron VK3AKC works VK7ZAH and VK7EM almost daily on 432, and to VK7ZAH on 1296 with skeds. VK5ZER, Mt. Gambier, testing on 1296.

RTTY starting to move in VK5 with VK5JE, VK5ZLA and VK5ZND operating.

JAs into Perth. VK5ZWW worked JA1ODA 52.010 SSB. VK3ZWF worked a JA3.

Hi-Ball experiment successful—first flight to 70,000 feet, second 100,000.

Harry VK5MY of HF CW fame finally comes on to VHF using phone and a beaut letter outlining his first experience using phone on HF!

#### JUNE 1971

ZK1AA added to beacon list, now totalling 19 stations.

KH6EQI beacon being heard by VK8KK, VK8AU and VK4RO.

HL9WI and C21AA regulars into Darwin on 6 metres, also many JAs.

VK1VP and VK2AAK running skeds on 144.1 with success.

JA2IY worked an LU3 on 16-4, while VK4ZRW heard W2 on CW.

Bob VK3AOT stirring up activity on 576 MHz, worked VK3BDA over 143 miles, and VK2ZEO at Deniliquin trying 432 to VK3ZDW.

David VK8AU sponsoring a VHF/UHF Contest for July.

#### JULY 1971

VK0PH, Casey Base, works a station on Macquarie Island for possible first 6 metre Antarctic area contact.

David VK8AU to return to VK3, hopes to try 1296. Is also "Meet the other man" for this month, currently on 52 MHz.}

#### AUGUST 1971

Bob VK3AOT to try and work Tony VK5ZDY on 576 MHz to take the record off VK5QZ!

Further information on requirements for successful 6 metre meteor scatter contacts makes good reading, second column.

#### SEPTEMBER 1971

New publication, "The Victorian VHFer" comes on the scene. Has 18 pages of VHF Information, and very good. VK3AOT is editor.

Thoughts on having special segments for 2 metre beacons voiced, i.e. 144.5 to 144.7.

Perpetual trophy launched by SERG at Mt. Gambier for most successful amateur at their Convention—it's a 4CX10,000A tube suitably mounted, and won for the first time by Kevin VK3ZYP.

#### OCTOBER 1971

Two new solid state beacons being built in Albany, beacon list now 21 stations.

John VK4ZJB running 400 watts SSB on 144 MHz. He intends being heard!

JA1RNJ says VK stations being heard regularly in Japan but VK stations don't bother to listen for them!

Further useful information on meteor scatter contacts for the newcomer.

#### NOVEMBER 1971

Temporary 6 metre beacon appears in Sydney signing VK2II.

Advice of withdrawal of 21,000 to 22,000 MHz band from Amateur Service and 24,000 to 24,250 MHz substituted. Considered a better band anyway, as a peak in atmospheric attenuation occurs at 22 GHz due to absorption of signals by water molecules.

"QRM", the bulletin of Northern Zone in Tasmania, arrives for first time at my desk.

Transition from AM to SSB on VHF becoming much more apparent—pleas are being made for stations to say if they are operating transceive or not!

#### DECEMBER 1971

Advice of an increase in activity on 6 metres from ZL4.

Albany beacon now operating on 52.950 MHz.

Len VK7BQ retires from amateur radio, aged 81. Commenced in 1925 on 200 metres, progressing through all HF bands then on to 50, 144 and 432.

Discussions on Project Australis and satellite frequencies.

Matter of the establishment of DX calling frequencies raised; it was suggested 52.010 could be suitable.

# MARCH MADNESS IN JUNE?

**YES! Your response to our Mad March Mailer was so encouraging we've decided to keep our March Madness prices going right through June! And we've even thrown in an extra special just to make life interesting!**

**Hop in for your new Yaesu soon: you'd be a bunny to miss out!**



**WHY TAKE CHANCES?  
BUY YOUR YAESU GEAR  
FROM THE AUTHORISED  
AUSTRALIAN YAESU  
AGENTS!**

TERMS WELCOME - OR USE YOUR BANKCARD.  
We'll send any of these transceivers anywhere in Australia for just \$6.00 extra by road freight: that's below cost. Take advantage of this offer soon!

Description	Cat No	Originally:	Now:	SAVING:
FT901D Digital HF Transceiver	D-2854	\$1375.00	\$1199.00	\$176.00!
FT-101Z HF transceiver	D-2862	\$849.00	\$775.00	\$74.00!!!
FT-301 solid state HF transceiver	D-2870	\$895.00	\$795.00	\$100.00!
FT-227RB 2 metre with memorizer	D-2891	\$445.00	\$319.00	\$126.00!!!
CPU-2500RK CPU cont. 2m rig	D-2889	\$575.00	\$549.00	\$26.00!!!
FT-7B HF mobile transceiver	D-2868	\$649.00	\$599.00	\$50.00!!!
FL-2100B 1.2kW HF linear amp	D-2546	\$599.00	\$529.00	\$70.00!!!
FC-901 antenna coupler	D-2855	\$289.00	\$265.00	\$24.00!!!
DC/DC converter for 101Z/901	D-2856	\$75.00	\$69.00	\$6.00!!!
Fan for 101Z	D-2865	\$39.00	\$29.50	\$9.50!!!
YC-500S 500MHz freq. counter	D-2892	\$499.00	\$475.00	\$24.00!!!
FTV-250 transverter	D-2894	\$339.00	\$299.00	\$40.00!!!
FRG-7 communications recvr	D-2850	\$395.00	\$319.00	\$76.00!!!
FRG-7000 digital comm. recvr.	D-2848	\$695.00	\$599.00	\$96.00!!!

Remember: Even these low, low prices are subject to our exclusive 'won't be undersold on Yaesu guarantee (see details below). You can't lose . . .

## INCREDIBLE SAVINGS ON YAESU 6m RIG: ANOTHER \$100.00 OFF!!!

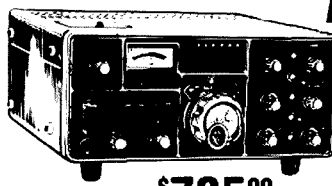

Cat D-2886 **\$795<sup>00</sup>**

Yes, this superb 6 metre transceiver is being sacrificed. All modes (yes, FM too) on 6 metre band. Was incredible value at \$795.00 . . . look at what we've done to the price now! Hurry, stocks won't last at this price!

**\$695<sup>00</sup>**

Dick Smith personally guarantees to beat any genuine Australian advertised price on Yaesu amateur radio equipment. If you find a current Australian advert with lower Yaesu prices than ours, take the advert to a Dick Smith store in the city the goods are being offered in. After confirming the advertiser has stock available to sell at that price, we will offer a lower price. If the re-seller is in another city, we will better the price plus freight charges to get the goods to your location.

# DICK SMITH ELECTRONICS

**NSW** 125 York Street, SYDNEY Ph 290 3377  
147 Hume Highway, CHULLORA Ph 642 8922  
162 Pacific Highway, GORE HILL Ph 439 5311  
30 Grose Street, PARRAMATTA Ph 683 1133  
263 Keira Street, WOLLONGONG Ph 28 3800  
613 Princes Highway, BLAKEHURST (Opening Soon)

**VIC** 399 Lonsdale Street, MELBOURNE Ph 67 9834  
656 Bridge Road, RICHMOND Ph 428 1614  
166 Logan Road, BURANDA Ph 391 6233  
**QLD** 842 Gympie Road, CHERMSIDE Ph 59 6970  
96 Gladstone Street, FYSHWICK Ph 80 4944  
**SA** 60 Wright Street, ADELAIDE Ph 212 1962  
**WA** 414 William Street, PERTH Ph 328 6944

  
welcome here

SHOPS OPEN 9AM to 5.30PM  
(Saturday: 9am till 12 noon)  
BRISBANE: Half hour earlier.  
ANY TERMS OFFERED ARE TO  
APPROVED APPLICANTS ONLY  
RE-SELLERS OF DICK SMITH  
PRODUCTS IN MOST AREAS OF AUSTRALIA.



MAIL ORDER CENTRE: PO Box 321, NORTH RYDE NSW 2113. Ph 888 3200. PACK & POST EXTRA.

Ron VK3AKC presented with VK3 VHF Group trophy for his earlier 1296 MHz contacts to VK7ZAH.

#### JANUARY 1972

Beacon list shows 26 stations of which about half are overseas. Only the VK5, ZL and 145 MHz and KH6EQI beacons remained unchanged from original listings.

Repeaters becoming more common with introduction of VK3WI/R3, Latrobe Valley, VK7WI/R2, Mt. Barrow, and an unusual experiment near Moe, Victoria, a repeater with 147.760 in and 432.2 out!

SSB gaining a good grip on VHF but still plenty of AM stations around.

VK0MX heard in Sydney on 25-11 and 26-11-71.

VK4ZTK worked at least 200 JAs in last equinox.

#### FEBRUARY 1972

This issue carried DX and records of some fame. The first VK-VE 144 MHz EME contact between VK3ATN and VE7BQH on 1-1-72, also present was K6MYC, all during an "unusual half-hour window" to the moon from 1140Z.

A new Australian 10 GHz record between VK5CU/P and VK5ZMW/P on 30-12-71. Weather indicated no tropo assistance, gear all solid state except for Klystrons. Power out about 100 mW.

VK4RO heard VK0ZVS on 52.1 at 0945Z on 2-1, running 20 watts to 4 element from Macquarie Island.

Approval given for beacons VK0GR on 53.1 and 53.2 at Casey and Mawson respectively, to run 200 watts input, mode A2.

FM'ey AM stations get the cane but poor SSB signals also need a bit of cleaning up too; seems like things are still caught up in progress!

During VK2 Field Day VK2ZZI/P worked ZL2TGT, ZL2TLY and ZL3AR/2 on 2 metres. VK2TK/P also worked two ZLs. Bob VK5ZDX worked Aub VK6XY on 2 metres 3-1.

Nothing new on 144 tropo (and Es) . . . VK5LT and VK5LP heard (saw?) Ch. 5A, Wollongong, on 29-12-71, a good indication that Es is on its way back after the Cycle 20 dump.

#### MARCH 1972

Reports of 2 metre tropo to Albany from Adelaide and Mt. Gambier.

Claim for first contact within Antarctica between WB5DYJ/KC4 McMurdo Sound to VK0PF, Casey Base, on 6 metres, distance 1,200 miles, 559 both ways. Also VK0PF heard by UA1KAE/1 at Russian base in Antarctica.

Who can remember the Ionospheric Prediction Service and the early warning system for TEP on 6815 kHz?

Some interesting results on something which still hasn't been exploited greatly, namely 144 MHz meteor scatter . . . Rod VK2ZQJ and John VK5QZ are conducting experiments using this form of propagation.

VK3YEO to VK7JV with one-way SSTV on 144 MHz!

#### APRIL 1972

More on 2 metre tropo from Albany. The old 10 kW WRE tropo beacon on 135 MHz pops up a lot from Albany.

JAs to VK5ZWW (who else?) on 26-2-72. Also much VK3, 5, 7 tropo DX with another first. VK3ZPA to VK7EM on 70 cm ATV on 26-2, with noise free pictures. Also first reception across Bass Strait by VK3ZBZ on 24-2 from VK7EM. And on 1296 Ron VK3AKC continues to work Kevin VK7ZAH.

#### MAY 1972

C21AA heard VK8VF on 52.2 MHz.

On 18-3 band open to JA from VK2, 4 and 6 and also KX6 and KR6 to VK4ZJB.

VK5ZDY worked JA1, 7, 8, 9, 0 on 22-3, while VK4ZJB worked C21AA on 1-4-72, and VK4ZEL also.

8P6EN (ex VK5ZEI) had worked 34 countries on 6 metres from Barbados!

#### JUNE 1972

TEP summary. Good conditions to VK4 from 20-2 to late April. Lesser to VK2, 5 and 6 with most countries around late March to JA. KH6HK worked VK4RO and other VK4s. C21AA worked KH6HK on 22-3.

Further complaints about rules for the Ross Hull Memorial Contest.

#### JULY 1972

Christmas Island beacon off air, DCA resumed equipment!

on 13-3-72 on 432 MHz, own echoes heard. On 18-4 worked WA6HXW.

Roger Harrison VK2ZTB clears up some misconceptions on subject of TEP.

2300 MHz experiments between VK2BDN and VK2ZAC continue.

Results of antenna gain contest published in Victorian VHFer show wide variation; winner a 13 el. yagi on 24 foot boom with 14 dB down to a 5 element yagi with — 12 dB!

Ian VK3ALZ develops quad-yagi on 33 foot boom with reputed gain of 19 dB.

#### AUGUST 1972

1296 MHz preparations for EME in shacks of VK3AKC and VK3ATN, while VK2AMW prepares to work OZ7UNI in Denmark on 432 MHz.

Some interesting notes on making observations on tropo from the weather map, work which was pioneered by Mick VK5ZDR.

Bill VK4XZ suggests 6 metre beacons operate from 52.4 to 52.5.

#### SEPTEMBER 1972

VK2 beacon finally comes on the air, 52.450 MHz.

Some good points raised on having exclusive 6 metre beacon segment.

Meteor scatter between VK2ZQJ and VK7ZJG and VK5ZWW on 6 metres.

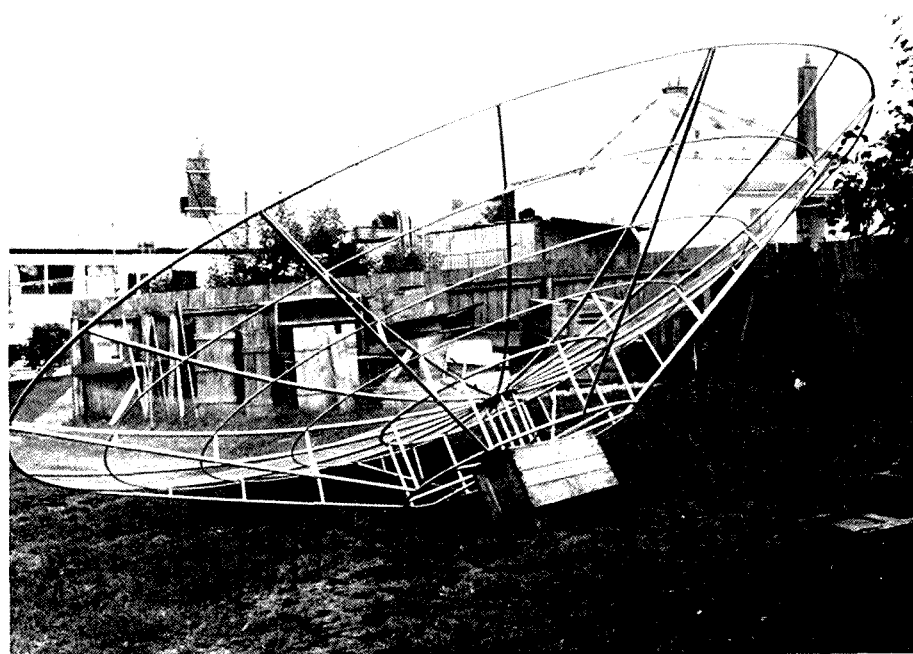

PHOTO 2: The 1296 MHz dish of the late Ron Wilkinson VK3AKC. Ron's efforts on VHF/UHF were outstanding.

Suggestions again for 2 metre beacons to be located between 144.5 and 145.0.

XE1PY reports almost daily openings to South America on six from 1-3, and hearing VK and ZL video signals.

On 21-5 Tony VK5ZDY worked nine VK3 and three VK7 stations on 144 MHz.

VK2AMW EME station at Dapto first tests

#### OCTOBER 1972

Roger VK2ZTB going to Cocos Is. until end of 1972.

VK5SU at Ceduna on 27-8 worked many parts of VK5 on 2 metres, very rare.

Groundwave contacts on 2 metres between VK2ZQJ, Sydney, and VK2ZAY,

Boggabri, very consistent over this 250 mile path.

Interesting report on Apollo S-band signal reception.

#### NOVEMBER 1972

2300 MHz record claim. VK2BDN/P to VK2ZAC on 3-9-72 on 2304 MHz AM, distance 28.5 miles.

WA5HMK looking for 50 MHz EME contacts. Low noise location essential.

VK3 antenna test day must have embarrassed some people—even those Orr and Johnson designs as well as other types work poorly if the measurements are not followed!

#### DECEMBER 1972

More 2 metre tropo between VK3, 5, 6 and 7. Also VK2ZAY, VK2ZRH, VK2ZQJ and VK2BKL, all into 2 metre groundwave contacts.

First substantial JA opening for September equinox to VK4 on 28-9-72. 1 watt of SSB from VK4ZEL was sufficient to work the lower JA areas.

Everyone getting ready for a repeat of the 1962-64 style Es openings on 2 metres. Oscar 6 is up and tumbling.

#### JANUARY 1973

Report on EME efforts of Chris VK5MC on 144 MHz. First echoes heard on 24-10-72. On 28-10 Chris recorded 11 minutes of echoes from 0054 EST. Power 100 watts from one 4X150A into 4 stacked rhombics with 50 wavelengths per leg. Receiver . . . MPF131 front end converter to FR100. Active AF filter giving 200 Hz bandwidth.

Also details of a revised 2 metre FM channel system.

#### FEBRUARY 1973

First working of VK0 to mainland to VK2 on 10-12-72, but on 11-12 VK0ZVS and VK0WW both worked by VK5ZWW and VK5ZMW at 1830 local peaking to S7. Later VK2 and VK3 heard working those stations. At 2137 local VK5ZDX heard VK0GR at Casey at 5 x 4 using FSK ident but no contact. Local conditions excellent with both backscatter and short hop Es to VK3.

On 11-12-72 VK5ZDY worked VK6WG on 432 MHz for a new Australian record of 1,185 miles and not far short of the world record of 1,215 miles.

VK8KK reports seeing VK7JV on SSTV via Oscar 6, while VK7EM looking for ATV skeds and reports from VK3 at least.

Roger VK9RI (2ZTB) reports hearing VK8VF and VK5 and VK6 beacons on 6 metres from Cocos Is.

#### MARCH 1973

VS6DA and VS6BE active on 6 from Hong Kong.

VK9BP, Port Moresby, on 6 with 400 watts and hoping to run a 4-250 on 2m SSB.

On 22-12-72 Lance VK4ZAZ, Rockhampton, worked VK3AOT, VK3AOS and VK3CI via 2 metres Es.

On 28-12 VK5ZMJ heard in Sydney with strong signals on 2 metres.

VK7EM had two-way with VK3ZPA on ATV on 13-12. Also viewed by VK3ZBZ, VK3YEC, VK3YGB, VK3ZBB and VK3ZSB.

VK3ASQ's famous 6 and 2 metre transverters reviewed from January 1973 Geelong Newsletter. Wonder how many people used the ideas or parts eventually?

#### APRIL 1973

VK0WW worked about 30 VK stations from VK2, 3, 4, 5 and 7 in 72-73 season. First contact to VK2NN on 10-12 with 5 x 9 SSB.

On 1296 EME VK3AKC worked W2NFA at 2228 EST on 19-2-77, first such QSO to Southern Hemisphere. VK3AKC was 339 and W2NFA 559. Equipment used by VK3AKC a 20 foot dish, horn fed with a pair of 3CX100A's. Two stage mast head pre-amp on receive.

Thought for the month: "Blessed are they who go round and round in little circles—for they shall be called 'Big wheels'."

#### MAY 1973

Geelong Amateur Radio Club mounts a campaign "RETURN TO TWO" to try and overcome the decline in 2 metre activity of recent years.



**PHOTO 3: Peter VK3ZPA adjusting his 432 MHz AN transmitter. In August 1973 Peter co-held the official record for VK ATV when he worked VK7EM — a distance of 257 miles.**

"6 UP" reappears under the leadership of Roger Harrison VK2TB, and challenges the Darwin boys to get on 144 MHz and work TEP!

Bendigo repeater now operating on Ch. 4.

#### JUNE 1973

Four VK1s working via Oscar 6.

VK1ZT copied W2NFA during contact via EME to VK3AKC, and attempted to work VK3AKC on 1296 but could only hear radar pulses whilst portable on Mt. Ginini.

VK1MP heard VK2ZAY on 2 metres, distance 340 miles.

VK5PB worked JAs at 2030 EST on 24-4 after accidentally turning on his 6 metre rig!

Continuing reports of meteor scatter activity.

Plenty of JAs to northern parts of VK still in autumn 73 equinox.

#### JULY 1973

Good tropo between VK2 and Melbourne with VK2NN working VK3ZNJ two-way SSB 5 x 9.

Geelong Amateur Radio Club celebrates its 25th anniversary.

VK5AO, VK5ZOF and VK5ZEF all using colour on 70 cm ATV.

"RETURN TO TWO" campaign in full swing with some thoughts on converters, old and new. RTV and H 6ES8 converters still OK.

#### AUGUST 1973

New 2304 MHz record for Australia. VK2ZAC/P worked VK2BDN/P from Mt. Gibraltar (Bowral) to Mt. Kulmura, 5 x 8 over the 100.5 miles path.

Official record for VK ATV goes to VK7EM and VK3ZPA for 257 miles contact.

Thoughts on curing RF feedback with 2 metres and the FT200.

Good tropo conditions, VK5ZDY worked VK2BDT 90 miles west of Sydney on 20-5, on 2 metres. VK2NN worked VK3AJN, Wangaratta, on 11-5, and still on 2 metres.

VK1MP working into Sydney with 3 watts on 27-5, and on 28-5 those to work Sydney included VK1VP, VK2ZAA, VK2ZEO, VK3AJN, VK3ANP and VK3APF, so please don't say it can't be done!

#### SEPTEMBER 1973

New by-law for amateur equipment importation, originally excluding HF equipment.

FM nets get the cane with ever increasing use of "appliance".

Bendigo repeater operating on low power from Flora Hill.

#### OCTOBER 1973

VK2HZ reports excellent Es conditions between 8-7 and 14-7, MUF high across the Tasman with lower TV channels being received in early evening during this period.

VK0WI heard in Sydney on 12-7 from 1715 to 1810 EST.

Following stations had worked meteor scatter from VK2, namely ZQJ, AM, AQQ, ZVD, ZXL, ZYP, ZAY, BHO and TB. VK2BHO and VK2ZAP often heard in Sydney on backscatter MS.

#### NOVEMBER 1973

EME report from VK2ALU; K2UYH received on 43 2MHz with 7 dB or more clear of noise. Stronger than echoes originating from VK2ALU had been up to this time.

ATV colour first? VK5AO and VK5ZEF claim first duplex (579 and 441 MHz) colour QSO on 17-9-73. VK5AO was on 579 MHz and simultaneously VK5ZEF transmitted on 441 MHz.

VK8AZ worked JAs plus KG6RA on 27-9 on 6 metres. VK8DI also present.

JAs hearing VK8VF beacon consistently throughout the openings.

#### DECEMBER 1973

More changes to beacon call signs. New VK6 beacons.

State of the Art contest winner VK5ZWW, who entered only his 6 metre scatter contacts.

Also some interesting distances on 144 MHz and a 30 mile contact on 1926 with 0.2 watts between VK3AUI and VK3ZBJ.

VK3AKC allowed 500 watts input on 1296 MHz for EME with the usual 10° elevation bottom limit.

Oscar 6 all the rage . . . VK5ZWW using 3 watts into a ¼ wave on a shed roof!

## JANUARY 1974

Large scale openings in November herald Es season. VK3ZAZ reports hearing VK0WI at 1430 EST on 21-11 at over S9 but no contact made.

VK3AKC's EME contact on 1296 MHz confirmed as world record. An interesting and exact tabulation of everything used both ends (right down to the 75AW connectors) was given. Contact VK3AKC to W2NFA on 6-10-73 on 1296 with Ron's signal 10 dB above noise for three minutes.

15-10-73 VK3ATN worked VE2DFO and W6PO on 144 EME. VK5MC also heard KH6NS on 17-10. On 27-10 and 28-10 getting SSB echoes (his own) back from the moon.

## FEBRUARY 1974

Some good scores noted in Ross Hull Contest. A comment noted "Some were very cagey about their high scores, whispering them just loudly enough into their SSB rig for the other end of the contact to hear and with hopes of no one else!".

VK5ZWW challenged VK5SU to top honours in contest, but failed!

SSB stations outnumbered AM, increased FM and CW activity noted also.

In VK5 the 6 metre band opened to DX on 23 days in December with best days on 15, 22, 23, 30 and 31-12, which would be normal for the centre of cycle. 30-12 and 31-12 were so good that all States plus ZL districts were worked.

As predicted at end of last year's ES season, 144 MHz did really peak with Es activity, e.g. 22-12-73 VK3AMK and VK3ZAZ worked VK4. VK1VP worked VK4EN and VK4ZAZ on Ch. B. VK1MP worked VK4ZAZ on Ch. B. VK2ZRH copied VK5SU and worked crossband to 6 metres but no direct contact. VK5ZDY worked VK2ZRH. VK2GX to VK4EN. Both VK2ZRH and VK2GX copying VK5VF beacon.

On 23-12 VK5SU worked VK2ZRH, and heard by VK2CG and VK1MP. VK5DK heard VK4ZAA and VK2ASI on Ch. B, moved down to low end and worked VK4FE. VK5NC worked VK4FE. 28-12 VK3ADT/P worked by VK5s.

30-12 VK4ZBB worked VK2ZBP, VK4ZDI and VK4EL worked VK3AMK, VK5MC worked VK4ZEL. 1-1-74 VK2ZRH heard VK5VF and VK5SU. VK5RO and VK5ZWW worked VK2ZRH. VK2ZQJ heard VK5ZWW, and VK5RO heard VK2ZQJ but said he was too strong to resolve successfully! VK5SU worked VK1VP, VK1MP and VK2AM, while VK1VP heard VK5VF. (And you can reasonably expect that sort of thing to happen again about 1984 . . . 5LP.)

Now while all that exotic 144 DX was going on, Ron VK3AKC wasn't mowing the lawns. He and Kevin VK7ZAH worked each other on 1296 on 27, 28 and 29-12, each contact worth 250 points in the Ross Hull Contest, and for good measure they did have contacts on 144 and 432!

Steve VK3ZAZ advised he was using an 88 metres per leg rhombic on 6 metres fixed on NE Australia. It has a gain of 12 dB, and is used for scatter work.

## MARCH 1974

Summing up, an excellent Es season. The last of the wobbly AM stations get another lecture! VK3AMK outlines pertinent points. VK5LP said calling frequencies of 52.050 and 144.100 were OK by him although he did mention 52.100 was on a calibrator point on most transceivers and may therefore be slightly more accurate for meteor scatter, etc. But it seems 52.050 fairly firmly entrenched as the 6 metre calling frequency.

Geoff VK3AMK confirms working many VK4s on 2 metres during December.

Some serious shack losses due to flooding in Queensland.

## APRIL 1974

VK7ZAH and VK3AKC reported as having contacts twice a day for many days during Ross Hull on 52, 144, 432 and 1296 MHz!

Some words in favour of 2 metre FM operation on nets by VK2YC.

## MAY 1974

VK2WI beacon back on air. VK1RTA receives its licence, which means all States are now represented by beacons.

VK5ZWW reports VK0WI heard at 2005 EST S3 on 9-3-74, and worked JA3, 6, 7 and 9 on 23-3 from 1530 to 1730 EST. Again on 24-3, and 30-3. VK4ZIM worked JA8.

No reports of VK3 or VK7 to JA this equinox.

Oscar 7 reported and its clash with the old VK2 Ch. 4 output on 145.9, right in the middle of the passband!

VK5ZWW moving to Orange, NSW. Coincidentally, no more JA or KH6, etc., for two years down south!

EME report from VK2AMW/ALU with details of K2UYH tests.

## JUNE 1974

YJ8KM, visiting Australia, shows great interest in 6 metres.

EME report: New 432 MHz EME world record VK2AMW to G3LTF on 30-3-74.

5.6 GHz record between VK2AHC/P, Kurrajong Heights, and VK2SB/ZND/P, Belrose, distance 59 km. Horn antennae used with RK549 klystrons and 1N23E receive mixers in a duplexer system. Signals 5 x 9.

Interference to radio control model aircraft from CB, etc., reported. Luckily the aircraft were shifted to 29.7 to 30 MHz when CB became legal!

## JULY 1974

New Zealand calling frequencies 52.2, 144.2, 432.2, 1296.2.

Mention of net operation being touchy subject with some people, but nets being formed nevertheless.

Large list of contacts on 6 metres made by VK2ZRH from 1-4 to 14-4-74, a period away from the usual Es time, and covers contacts to VK4, 5, 6 and 7, JA2, 3, 4, 5, 6 and 9, video on 49.75, etc.

Roger VK2ZTB said the JAs worked in Sydney on 13-4 were the first recorded instance of Class 2 (night time) TEP in the Sydney area, and as VK4EN was heard at the same time it seems Es extended the opening further south.

Mention of a good crystal calibrator for 144 MHz in RSGB manual.

The Dapto EME Group are currently testing RTTY equipment for possible EME contacts.

VK2ZQJ running high power on 52, 144 and 432 all on SSB, 80 watts on FM. Proposes running 250 watts into a pair of 3CX100A5s on 1296. Also noted that Rod uses a crystal set for b/c listening!

## AUGUST 1974

Another excellent guide to tropospheric DX reprinted from Victorian VHFer.

Also the summer VHF Field Day is on the way with VK5LP on 52, 144, 432 and 576 MHz on AM, SSB and FM. Lowest output 20 watts — bet that 240 volt generator got a thrashing!

## SEPTEMBER 1974

Mid-winter ES between VK2, 3, 4, 5 and 7 on 14-7. On 2-7 open between VK2, 5 and 7.

VK2AMW group have approval for A0, A1, F1 and F2 modes on the high power permit until April 1975.

## OCTOBER 1974

3D2CM custodian of 3D2AA beacon on 52.5 MHz. Also 3D2AZ active on 6 metres.

VK4RO indicates some increase in 2 metre activity in north Queensland.

VK5MM worked VK2 and VK7 on 6 metres during RD contest, via meteor scatter!

## NOVEMBER 1974

Golden age of button pushers! Low end of 2 metres reaches low ebb as a result.

Ch. 0 gets the axe from VK3AQR in the Geelong Newsletter. Darryl cites the upper VHF only TV system plus UHF as being more satisfactory than the present 13 channel VHF system. We all wish those in power had shown wisdom.

The migration of Z calls to HF on obtaining full calls gets a mention.

35 stations operating on Ch. 50 in Townsville area.

The demise of Victorian VHFer and Sydney's "6 UP" looks troubled.

## DECEMBER 1974

JA1IGY goes QRT for the last time. Albany beacon on 2m gets moved to Mt. Adelaide (hame QTH as WRE beacons on 135.5 and 1.6 GHz).

HL9WI works into northern VK on 19-10. VK3ZAZ hopes to operate from Norfolk Island, but believed did not eventuate.

Some more on DX operating and those AM stations again! With the emergence of the FT620 plus FTV650s and other transverters around the 74-75 season, probably represented the last major stand of AM. Next season you could count the AM stations easily on one hand!

#### JANUARY 1975

P29GA beacon off air.

Es season providing all VK States, ZL and P29 to all areas.

Co-channel interference between Ch. 1, Mt. William and Mt. Dandenong.

Details of VK5SUs contacts on 2 metres tropo to three States from Ceduna — all in one day to VK3, 5 and 6.

Around 20-10-74 HL9WI worked VK4RO, VK4GS, VK4AAL and VK4ZRG on 6. VK4ZIM now VK4AAL, and Rod VK2ZQJ becomes VK2BQJ.

A large spree on the effect Ch. 5A will have on 2 metre activity.

#### FEBRUARY 1975

No VHF notes, can't remember why, perhaps the Editor and I were not speaking to one another at the time!

#### MARCH 1975

Where do you start? 3D2AA heard by VK7JV, VK7ZAH on 24-11-74. On 16-12 JAs to VK4ZJB. 27-12 VK7ZAH heard 3D2AA and worked VK2BKE on Lord Howe Is., and VK5ZMJ also worked VK2BKE.

2 metres and Ceduna when VK5SU worked VK2ZAY on 21-12 by Es, also worked VK2ZCV, VK2ATI and VK2YBZ, heard VK4ZJB. During same opening VK5ZMJ at Pt. Pirie worked 22 stations on 2 metres from VK2 and VK4 using SSB.

23-12 VK5SU to VK2ZRH on 2. On 16-12-74 VK5LP and VK5ZDY worked VK7ZDA on 2.

29-12 VK6ZCN and VK6ZFY heard VK5VF 2 metre beacon from Perth!

21-12 many many stations working VK3, 5 to VK2, 4 on 2m FM. Es the best seen on 2 metres since early sixties.

VHF Field Day plagued with 50 knot winds in VK3 and 5 . . . VK5LP virtually blown off Myponga Hill, covered with salt spray from sea seven miles away!

VK5MC and EME on 144 MHz, possibly first SSB EME out of Australia worked W8KPY on 30-11-74. Dapto EME group in trouble with lightning strike and solid state control gear.

432 MHz Australian record broken between VK6WG and VK3ZBJ, 2,440 km. Little did anyone know that the contact on 2-2-75 was unofficially the world record and stood for several years! All this happened during massive tropo conditions between VK3, 5 and 6 from 31-1 to 5-2-75.

Report that Andrew VK6ZCN going on 144 MHz EME, also Barry VK2ZAY looking for suitable receiver to start an EME station.

#### APRIL 1975

Much more on tropo opening January-February 1975.

EME: VK3AKC worked PA0SSB on 432 MHz, while Christ VK5MC worked K1WHS and K2RTH on 23-2 on 144.

Many operators heard WA6LET during special EME tests using 150 foot dish!

New Australian 2304 MHz record between VK3ZHU, Mt. Cowley, and VK3ATY, Lake Mount, distance 130 miles, on 7-12-74.

VK5LP gets the Higginbotham award for 1974.

Bob VK6BE had 98 two metre contacts to VK3 and 5 during big tropo opening!

#### MAY 1975

Special beacons on 28 MHz, one being ZL2MHF.

VK2HZ reports hearing 3D2AA on 6-1-75. Also survey of 52 MHz FM activity in VK2 by VK2HZ, over eight years 239 VK2s worked, all different, over 95 per cent on net channels, both AM and FM.

VK3ASV reviews AM and FM net frequencies.

FMT4575 transistor with 1.5 dB noise figure on 432 MHz now \$44 each after a price reduction. (Today an MRF901 which does about the same job costs \$2.)

#### JUNE 1975

VK0MA and VK0GR beacons confirmed as being on 24 hours a day.

VK5ZAD reports on 2m FM activity in USA.

Complaints of QRM on EME contacts due to very high gain antennae picking up ordinary transmissions via the moon!

VK2AM reports on G-land 2m activity. Only 2 repeaters going to London area (backward or smart?). High activity there on UHF bands.

Four P29 stations in Port Moresby on 6 metres.

Letter of note from K5ZMS of SMIRK giving membership 744 in 46 US States and 13 countries. VK6ZDY first VK SMIRK station with No. 722.

VK5ZPW and VK5ZMK active on 2 metres from Barossa Valley during VK3 openings.

Plans to put Mt. William repeater on Ch. 7.

VK3ZAZ claims contact with 3D2AZ via Oscar.

#### JULY 1975

VK3ZAZ receives QSL for contact with VK2BKE, Lord Howe Island.

VK5LP taken to task by VK3AKN for asking why Mt. William had to change to Ch. 7.

George VK3ASV sends a list of repeaters showing 39 now in operation in VK.

Quote from QST, "A ham in Akrom (rather carelessly) announced his location at one of the large mall parking lots and that he would be back on the repeater after some shopping. Some thieves did some shopping in his absence, taking all ham equipment and the stereo tape deck.

A word to the wise, repeaters can be useful, in more ways than you might think."

#### AUGUST 1975

VK2AMW 1 kW linear for 432 EME now going.

VK4RAT going on Ch. 1 from Townsville. Letter from JA1PLI says about 21 countries worked from Japan during Cycle 20!

Rod VK2BQJ makes rude comments on the 2½ element yagi on 6 at VK5LP QTH!

3.3 GHz record in New Zealand set at 238 miles, power 60 milliwatts!

#### SEPTEMBER 1975

Interest on 6 and 2 sprouting from YJ8.

VK1VP has comments to make on the VK3AKN letter on repeaters last month.

VK2ZNW (5ZWW) again going with meteor scatter to VK7ZGI and VK5KK, VK5ZPW several times on 6 meters.

#### OCTOBER 1975

Details of the former Darwin beacon (destroyed during cyclone Tracy) and its transponder. VK8CM and VK8DI only active 6 metre stations at time.

Some "fine" detail on the occurrence of meteor scatter and the velocities of meteors being greatest around 0600 local because of earth's orbital velocity being directed towards the zenith. (Meteor velocity mean value equals 70 km/s.)

#### NOVEMBER 1975

All ZL beacons relisted on some new frequencies including ZL2VHP 52.500 MHz for the first time.

Indications of a good number of stations in Brisbane active on 6 and 2 SSB.

EME: VK2AMW to W3CCX and F9FT on 432 on 9-8-75. VK2AMW contacts now total 6 to 4 countries.

VK5SV works VK3 on a number of occasions in September.

Report from SMIRK indicating what goes on on 50 MHz in the north even in the bottom of the cycle. Include VK4IK to KG6. No TEP in VK6 for 1975 on 6.

#### DECEMBER 1975

EME and VK5MC on 144 MHz — worked JA6DR on 1-9, W7CNK on 25-9, and W6PO, while on 29-9 K2RTH. VK2AMW on 432 to PA0SSB and F9FT on 7-9.

VK7EM to be active on ATV again this summer.

Tropo openings up and down the VK4 coast on 12-10, mostly FM contacts.

#### EDITOR'S NOTE:

A Decade in Review will be continued next month when Eric outlines highlights on VHF/UHF from 1976 until December 1979. The regular VHF/UHF column will include the latest happenings on VHF/UHF. ■

WHEN PURCHASING GOODS,  
SAY YOU SAW IT ADVERTISED  
IN AR

# The WIA in VK2

It was seventy years in March since a group of "Wireless telegraph experimenters and enthusiasts" met to co-operate and improve their lot with the government of the day. From records to hand, the meeting was held on the 11th March, 1910, in the Hotel Australia, Sydney, and as a result of that meeting the Wireless Institute of Australia was born. Soon after groups were forming in other States.

The WIA was formed two years ahead of what is now the RSGB and four years before the ARRL.

In the early 20s the amateurs in the group drew up the Memorandum of Association of the Wireless Institute of Australia, New South Wales Division. In doing so it took over the effects and liabilities of the then unincorporated Club of the same name. Seven amateurs moved to form a Company on the 26th of May, 1922, and on the same day registered an Association of the above name as a limited company.

In the early 1930s differences arose between the professional and hobbyist within the Division and for some 18 months the hobbyists became the "New South Wales Amateur Transmitters". The professionals became the IRE (now the IREE), and the Division absorbed the hobbyists to again become the WIA NSW Division.

In 1939 permission was granted by the Radio Branch for Divisions to conduct broadcasts to inform their country members of happenings. Outbreak of war, however, stopped amateur activities and during this period the WIA was kept operational by the Federal Executive, who were located in Sydney.

At war's end amateur radio boomed with trained personnel from the Services coming into the ranks. The early 1950s saw many activities in the Division. Meetings at this stage were held at Science House in the city. A move was begun to establish a "Home for VK2WI" and a five acre property on what was then very much the edge of Sydney was purchased at Dural. Work commenced around 1953 and the building formally opened in 1957, after untold hours of work by members and friends. The property is the site of the Division's repeater and beacon HF broadcast facilities.

In 1954 the Amateur Service saw the introduction of a new class of licence, the Limited. This licence enabled those not proficient in morse telegraphy to participate in the wonderful hobby of Amateur Radio, thus swelling the ranks with many more operators aspiring for the "Full" ticket.

During the same period interest was shown in obtaining a city property for the Division and a Co-op. was formed. However, nothing came of this venture. The end of WW2 had left this country with enormous stocks of radio equipment, and the Division set up a disposal buying and selling section for its members. The operation of this section produced the money used to purchase the Atchison Street property in 1960. With surplus funds the hail and basement area were soon added. Since then considerable development has occurred in the area with several high-rise buildings nearby.

Many new clubs have been formed in Sydney to cater for the needs of amateurs, as the central location of the WIA is prohibitive to some.

The Division has for many years been heavily involved in education with personal classes. For almost twenty years the Correspondence Course has helped perhaps thousands both in Australia and overseas to join the amateur ranks. The Division pioneered the CW practice format and still conducts nightly on-air morse training. To supplement this HF session one of the Sydney clubs developed a continuous transmission VHF morse training facility which utilizes a microprocessor for programme control. To cater for training the younger members of our community the Youth Radio Scheme came into being during the 60s. With the explosion for knowledge during the mid-1970s the YRS expanded to become the Division's Education Service, who have since published several books to help intending amateurs with studies.

The Division has an active WICEN facility at the moment. Over the years it has had its ups and downs. The Amateur Radio Service has always been available in times of communication needs. This Division's WICEN has become recognised by our State's authorities as a trained, reliable reserve communication facility.

Amateur Radio is always changing, new modes, new equipment, but perhaps the area which technically altered Amateur Radio the most in recent times was the granting of permission in 1968 for VHF repeaters. VK2, considered at times by other States to be out of step, has always been in the middle of band planning (??) and utilization of more channels than most of the other areas put together. We cannot help it if they did not smooth off the hills when "they" made the place. (It's always "they" who did it.) Also in 1968 the Division hosted, during the Federal Convention held at Atchison Street, the formation of the Region 3 section of the IARU.

## A WIRELESS ENTHUSIASTS' INSTITUTE.

THE GOVERNMENT AND LICENSES.  
"THREE GUINEAS FOR THE USE OF THE AIR."

Wireless telegraphy experimenters and enthusiasts are beginning to co-operate, and a number met last afternoon in the Hotel Australia in order to take the preliminary steps towards forming an institution. Vigorous comment was made upon the Government's action in regard to experimental licences, and it was plain that besides a feeling for mutual help and interest, the restrictions alluded to had had a large share in hurrying on the movement. Two ladies were among those present.

Mr. G. A. Taylor, who was elected chairman, explained the object of the meeting, and touched on the wonderful future ahead of the movement. "It is wise," he said, "to put our heads together and profit by each other's discoveries. Experimenters did not think the authorities were giving them fair encouragement. Every experimenter was at the beck and call of the military, naval, and postal authorities, and was allowed no legal redress if departmental officers thought he was breaking the rules. Mr. Taylor proposed the formation of an institution amongst experimenters and enthusiasts in wireless, for their mutual benefit. The object of founding the institution was to obtain justice, he explained; it would not be founded in opposition to any Government institution or department.

Mr. W. H. Hannam, according to the motion, repeated the account of his attempts to obtain a Government licence, which were described in "The Daily Telegraph" last week. "I have had a great deal of trouble with three Postmaster-Generals," said he, "and haven't got my licence yet. They're still quibbling. We have all been treated in the same way, but no one has said or done anything until lately. Seventeen months of my time have been wasted

## DAILY TELEGRAPH

12-3-1910

since I was ready to erect my plant. Why should we have to pay three guineas for the use of the air, so far as experiments are concerned? The aerial navigation experimenters are charged nothing." One regulation, he complained, penalised an experimenter if the chief electrical engineer of the Postmaster-General's Department should certify telegraphic communication had been interfered with by his wireless appliance used "or intended to be used".

Mr. J. H. A. Pike also supported the motion, which was carried, and a provisional committee was appointed to arrange for the next meeting.

Later, a general meeting of those interested will be called, and officers elected. It is proposed to assist in the formation of, and perhaps affiliate with, similar organisations in other States. The provisional committee is as follows:—Messrs. J. H. A. Pike, W. H. Hannam, F. Bartholomew, W. H. Gosche, P. and H. Leverrier, F. A. Chary, and A. Garrwey. Major Rosenthal, Captain Cox-Taylor, Dr. Hriscondon, and the chairman, Mr. Hannam will act as hon. secretary pro tem. Besides these gentlemen, the Messrs. Ferratt Hill, and Messrs. R. B. Armstrong and J. A. Henderson attended, and gave in their names as prospective members.

PRESENTED BY:

JOE REED, VK2JR.

A copy of 12th March 1910 Daily Telegraph report outlining the feeling against licence fees for radio experimenters.



## A WIRELESS ENTHUSIASTS' INSTITUTE.

THE GOVERNMENT AND LICENSES.

### "THREE GUINEAS FOR THE USE OF THE AIR."

Wireless telegraphy experimenters and enthusiasts are beginning to co-operate, and a number met last afternoon in the Hotel Australia in order to take the preliminary steps towards forming an institution. Vigorous comment was made upon the Government's action in regard to experimental licenses, and it was plain that besides a feeling for mutual help and interest, the restrictions alleged had had a large share in hurrying on the movement. Two ladies were among those present.

Mr. G. A. Taylor, who was elected chairman, explained the object of the meeting, and touched on the wonderful future ahead of the movement. "It is wise," he said, "to put our beads together and profit by each other's discoveries. Experimenters did not think the authorities were giving them fair encouragement. Every experimenter was at the beck and call of the military, naval, and postal authorities, and was allowed no legal redress if departmental officers thought he was breaking the rules. Mr. Taylor proposed the formation of an institution amongst experimenters and enthusiasts in wireless, for their mutual benefit. The object of founding the institution was to obtain justice, he explained; it would not be founded in opposition to any Government institution or department.

Mr. W. H. Hannam, seconding the motion, repeated the account of his attempts to obtain a Government license, which were described in "The Daily Telegraph" last week. "I have had a great deal of trouble with three Postmaster-Generals," said he, "and haven't got my license yet. They're still quibbling. We have all been treated in the same way, but no one has said or done anything until lately. Seventeen months of my time have been wasted

## DAILY TELEGRAPH

12-3-1910

since I was ready to erect my plant. Why should we have to pay three guineas for the use of the air, so far as experiments are concerned? The aerial navigation experimenters are charged nothing." One regulation, he complained, penalised an experimenter if the chief electrical engineer of the Postmaster-General's Department should certify telegraphic communication had been interfered with by his wireless appliance used "or intended to be used"!

Mr. J. H. A. Pike also supported the motion, which was carried, and a provisional committee was appointed to arrange for the next meeting.

Later, a general meeting of those interested will be called, and officers elected. It is proposed to assist in the formation of, and perhaps affiliate with, similar organisations in other States. The provisional committee is as follows:—Messrs. J. H. A. Pike, W. H. Hannam, F. Bartholomew, W. H. Gosche, F. and H. Leverrier, F. A. Cleary, and A. Garusey, Major Rosenthal, Captain Cox-Taylor, Dr. Brissenden, and the chairman. Mr. Hannam will act as hon. secretary pro tem. Besides these gentlemen, the Misses Perratt Hill, and Messrs. R. B. Armstrong and J. A. Henderson attended, and gave in their names as prospective members.

PRESENTED BY:

JOE REED. VK2JR.

**A copy of 12th March 1910 Daily Telegraph report outlining the feeling against licence fees for radio experimenters.**

The 70s saw the introduction of the third class of amateur licence — the Novice — and VK2 quickly took the lead in numbers. Only now in ratio are other areas catching up. VK2 now has a little over one-third of the nation's amateur population. This number has expanded the QSL bureau from a few cards a week to a thousand plus a day. Expansion of the scale of the last few years means that we no longer know everybody and the Institute may appear to some to have become a little distant or impersonal. The last decade also saw the great expansion of interest in radio spectrum utilization by others, and the Division did what it could to knock on the doors of

government to put the amateur case. And what of the 80s?

In my brief time within Amateur Radio and the WIA I am concerned by what little history we preserve. Next time you have a clean up, check all gear out. Is there some information which might be worth preserving? Is it of interest to the Federal Historian, your Division, the Museum of Arts and Sciences in Ultimo, your own museums or other government facilities for the preservation of our history?

I would welcome information or communication from amateurs and SWLs in

VK2 who might help to fill some of the historical gaps. Any communications may be directed to me via the Divisional office at Crows Nest or their address, PO Box 123, St. Leonards 2065. (Interstate amateurs should contact their own Divisions or the Federal office if they have local information they would like to pass on.)

Tim Mills VK2ZTM.

(Editor's note: Tim was licensed in 1959 and joined the WIA a little before that time. He has since then almost continuously held one or more offices at Divisional and/or Federal level.) ■

# The "Static Electricity" Syndrome

**Whenever people come up against something which they do not thoroughly understand there tends to crop up a host of old wives' tales, superstitions, rituals and a mass of just plain garbage! Often among this welter of superstition and theorising we find a few rule of thumb practices where people do the right things for the wrong reasons and then when they get results they hail the theory instead of looking carefully at the rule of thumb actions.**

Roy Hartkopf VK3AOH

34 Toolangi Road, Alphington 3078

The mass of folklore which has arisen over the subject of protecting semi-conductors — specially MOS (Metal Oxide Semi-conductor) devices is a case in point. According to some people one should hardly take them out of their original package! Among some of the more usual recommendations are grounded benches covered with foil, masses of conductive plastic foam all over the place, grounded people with metal straps, turn off all power before inserting or removing them, and shorting straps across all the runs of the circuit board. If one followed all the suggestions one wouldn't use semi-conductors at all!

Let us start with the big bogey, static electricity. Just how much trouble can it cause in practice? Most people have experienced the crackling sound, and possibly have even seen or felt the electrical discharges when they have been putting on or taking off a nylon shirt. Obviously in this case there is a lot of static electricity around — particularly in dry weather — and if one rubbed a MOS IC over the shirt under these conditions one would be asking for trouble. So clearly the wearing of nylon clothing is not calculated to make a MOS IC any happier, though the danger is far less than is often supposed. Wearing earth straps is all very well if one is working on a space project where a failure can be disastrous, but for all practical purposes it is hardly necessary.

It is rather amusing that the MOS static electricity superstition assumes that the person working on the equipment is completely isolated from ground and everything else — one couldn't get static charges otherwise — while the people who write the booklets dealing with the dangers of electrical shock always assume that the person has an almost short circuit path to earth and that even touching a live mains terminal can be fatal. Really one can't have it both ways all the time. If you were so well isolated that you would be capable of zapping a MOS device with static electricity you would be able to touch the EHT terminal of a television set and never notice it. How often are you well isolated enough to be able to do that?

Apart from anything else most modern devices have inbuilt protection and in practice there is very little difference between MOS and normal semi-conductors. But even the older type MOS devices were handled by the writer for years, including early Insulated Gate FETs such as the 3N140, and often they were resoldered from one experimental board to another several times and were still as good as new.

But transistors and ICs do blow up and some people have so many failures with them that they have given up and gone back to "safe" and "reliable" valves which "will stand any kind of treatment". This

is just as much a fallacy and old wives' tale as any of the others. So valves are capable of standing any abuse? Have you ever tried dropping them on the floor? But, the old-timer would protest, that is ridiculous. Nobody would do a silly thing like that. But the point is that valves, IN THEIR OWN WAY, are just as fragile as semi-conductors — perhaps even more so — but because we have got used to their limitations we accept these for granted.

In some ways transistors and ICs are much MORE robust than valves. You can drop them and throw them around and they won't notice it. They will often accept voltage variations better. Many linear ICs will work from five to twenty volts. Try putting twenty volts on the heater of a five volt valve! If you happen to splash water on an IC it won't worry. Try spilling your beer on a hot valve — specially a power output one!

Many high power valves and mercury rectifiers will be ruined unless the heater is brought to working voltage before HT is applied. And what happens to voltage stabiliser valves if one forgets to put in a limiting resistor? The fact is that valves are every bit as dicey and fragile as semi-conductors but their weaknesses are different. It is only when one persists in treating semi-conductors as though they were valves that the trouble begins. One has to learn the new rules of a new ball game.

The first rule in dealing with valves is that one never lets them drop on to the floor. In the same way the first rule with semi-conductors is that one never, BUT NEVER, puts an excessive reverse voltage on a base-emitter or diode junction. One can get transistors which will stand hundreds of volts on the collector and take amps of current. But in most cases a reverse base emitter voltage of less than five volts will blow it out like a light. To expect a high power transistor to stand this treatment is as silly as expecting a high power valve to survive a drop on the floor.

The second rule with semi-conductors is to ground soldering irons and other equipment, NOT AGAINST STATIC ELECTRICITY, BUT AGAINST MAINS VOLTAGE LEAKS WITH APPRECIABLE CURRENT BEHIND THEM. If you want to see a practical example of this kind of thing put the probe of an oscilloscope or VTVM on to the body of a "low voltage" soldering iron — or even to a wire wrapped round the outside of a power cord. The secondary

voltage of the iron may only be three or four volts (the peak of this, by the way, could blow up a reverse base emitter junction!), but the voltage from the secondary could be up to 90 per cent of the mains voltage. The only time I blew up a board of ICs (they were TTL, not even MOS) was when I had to try to do an emergency repairs at a work bench where the Scope iron was not properly grounded.

The third rule, and perhaps the most important for those who are changing over to semi-conductors, is that the most dangerous things one can do is to mix valve and semi-conductor equipment. It is more dangerous to the semi-conductors than the proverbial mixing of drinks is to the automobile driver! In the first place the mains equipment may be earthed (sometimes) or it may not. If it isn't you can be sure that hundreds of volts of capacitively leaked AC will be floating round. If it is earthed and runs from a different supply there may be high and dangerous ground loop currents. The heater voltage is 6.3 volts RMS with lots

of amps. Five volts reverse will blow a transistor sky high. Finally when the valve equipment is switched on—and also when it is switched OFF—any semi-conductor equipment nearby can receive a belt of several hundred volts, positive or negative, with amps of current (instantaneously) behind it. Considering it only takes a microsecond to blow a semi-conductor, this could wreck the most rugged and well protected device. You might as well connect it directly across the mains!

All of these things, when one really understands the habits of semi-conductors, will be avoided, just as the valve buff wouldn't think of letting his expensive power valves roll off the bench. If either happens you should expect what you get! But if you remember that with semi-conductors you are playing a new ball game, that in some ways they are more rugged than valves, BUT THAT THE RULES ARE COMPLETELY DIFFERENT, then you will find they are just as reliable and predictable, perhaps even more so, than any other electronic equipment. ■

## Putting up a TH3JR

W. J. Brown VK3BYD

45 Lahona Ave., East Bentleigh 3204

I had recently acquired a TH3JR second-hand and I decided to put it on a home brew 20 ft. 4 in. x 2 in. tilt-over tower. By placing a length of ¾ in. water pipe (having had since I put up my first antenna six years earlier) against the pole, I could rotate it with an Armstrong rotator.

The first thing I did was to put some guy wires on my mast to help take the weight. Then I took the water pipe off the roof of the garage but on the way down it slipped, dropped and of course, Mr. Murphy was there to help catch it—leaving me with a neat break next to the joiner which had made the two pieces one.

Next it was down to the local hardware to get another piece of pipe; a setback of around \$9.

It arrived the next day and I set about getting the hardware together to hold the pipe and mast together. Again I went back to my local hardware for three "U" bolts. The piece of angle iron I was going to use to stop the pipe from sliding down was easily acquired from around the house (XYL hasn't noticed it missing from the bed yet) and last of all the rubber hose to put around the pipe to reduce friction removed from the washing machine (she did notice that was missing).

I started to put the mast and pipe together first. I put holes for the "U" bolts in the angle iron and earth lead, then the

holes had to be put in the mast which was very much easier said than done. The holes had to be counter bore which was the main problem because the drill I had was an old 1 in. wood drill which was as sharp as a rubber tennis ball, but we battled on and finally got there.

With that all done I put the pipe and mast together, placed the pipe against the mast and tightened the "U" bolts. The mast was then pushed up and guys tightened to keep it out of the way when putting the antenna together.

All the elements and the boom of the TH3 were spread out on the ground and with some help from my 3-year-old niece, put together.

I then tilted over the mast and leant it on a ladder so it was about 6 ft. above ground, the same height as the antenna "U" bolts. I then shifted the antenna across (with it beaming straight down) to the mast. Mr. Murphy visited again and the boom was on the wrong side of the mast. To save taking it apart I decided to walk it around to the other side and, of course, I had to come the long way because the top of the pole was very close to a tree. In the process two trees were mutilated and some washing wrenched from the line (I had by then fixed the washing machine). When I finally got it into place I noticed that one side of the Director was just touching the garage making it impossible

to get it in place so it was removed. I then manoeuvred it into place and connected the coax only to find half of the reflector and driven element in the tree. Upon my knees I asked for permission to remove a branch of the tree and after a barrage of saucepans and plates (she had not forgotten about the washing machine or the washing) I was told to take off only the smallest amount. I did this.

With all hands on the antenna, i.e. my sister holding a piece of rope to stop the antenna from swinging because it was lopsided with an element missing, my 3-year-old niece holding a piece of wire which was in no way connected to the antenna (clever girl that kid), XYL on a piece of rope which was being used to help support the mast and my brother-in-law helping me push the mast up from centre, the TH3 was ready to go up. When it was 8 feet up I replaced the missing element. At this stage my next door neighbour arrived home and made some comment about more space junk going up. With the element in place the antenna was pushed up to its final resting place. Guys were tightened and SWR checked. It tuned up very well with good SWR in each band.

One last comment about the TH3JR: It works very well as an antenna but it does not give much protection from the rain when you sleep under it. ■

# Amateur Satellites

Bob Arnold VK3ZBB

## COUNTDOWN No. 5

A further report from Pat Gowen G3IOR is reproduced below:—

By early February the Phase III project began to look like a satellite and, thanks to much hard work by the many dedicated volunteers, final integration was completed.

Earlier, a major snag had occurred with the flight-computer memory which, despite many weeks of intense investigation, refused to function reliably. A standby spare was used in the environmental testing, and the final unit will be integrated at a later date. The THIOKOL single kick motor will be installed at the last moment at the Kourou launch site in French Guiana.

The satellite successfully completed its Thermal-Vacuum testing on 11th February, when all the sub-systems were potted, and went to the NASA Wallops Island Flight Centre, where dynamic testing and weight-addition in order to achieve the correct spin-balance were completed. Following packing, the spacecraft then left by road for New York City, leaving by air the following day, to arrive at Frankfurt on 19th February. On 25th February it arrives at

Toulouse for mating and test integration on 27th February, to be ready for the flight-readiness review on 19th March. The final terrestrial journey takes place on 9th April, when it goes to the ESA Kourou launch site, with the OSCAR team arriving later.

Originally expected to weigh some 75 kg AMSAT-OSCAR 3 will now approach 85 kg. ESA are aware of this heavier payload.

Launch is now set for the window between 1500-1800 UTC on 23rd May, and full coverage of the event will take place in real-time by a direct line commentary from the launch site to WA2LQQ, who will transmit from 1400 on until well into the post-launch period using 28.880 MHz. If propagation is poor, 21.280 MHz will be employed, and even 14.280 MHz, to ensure good coverage to Europe and Africa. WA6GFY will cover the Pacific areas and Japan, and W1AW will cover the USA and South America on one or more of their voice bulletin frequencies of 28.590, 21.390, 14.290, 7.290, or 3.990 MHz.

Due to the precedence of engineering tests and evaluation, the transponder will not be available until it is declared operational, and this will not occur until AO9

has completed a number of orbits following the kick-motor firing. Thus, it is regretted that none of the broadcasts planned for the H-3 General Bulletin channel during the transfer orbit will now be possible, as any transmissions in the pass-band could seriously jeopardize the whole mission. It is imperative that no potential users attempt to access the satellite transponder until actual operational service is declared. The general beacon will be giving out its regularly hourly updated information at 60 w.p.m. 170 Hz shift FSK Radio Teletype, and in A1 Morse Code, and in addition an HF bulletin service will be maintained to run from one week pre-launch up to three weeks into the post-launch period, giving short one-way transmissions every week-day from W2JT of the NJDJA as follows:

From 1800 to 1805 UTC beaming to Europe on 28.555 MHz; from 1805 to 1810 UTC beaming to Africa on 28.555 MHz; from 1815 to 1820 UTC beaming to Africa on 21.260 MHz; from 1820 to 1825 UTC beaming to Europe on 21.260 MHz; from 1830 to 1835 UTC beaming to Europe on 14.260 MHz; from 1835 to 1840 UTC beaming to Africa on 14.260 MHz.

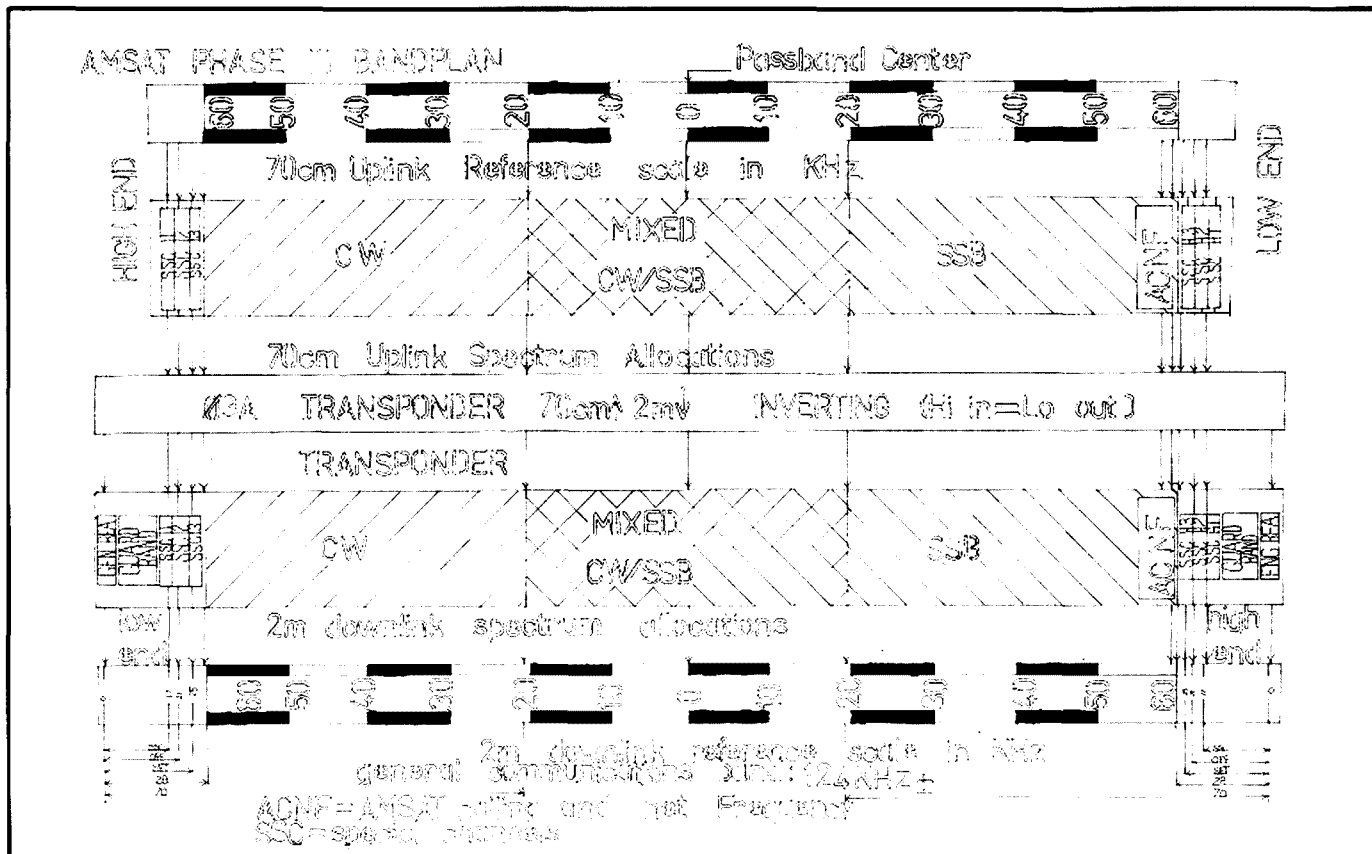

FIGURE 1: The AMSAT Phase III Bandplan.

WA6GFY will provide a similar service to cover Australasia, the South Pacific, Japan, etc.

Each bulletin will consist of a one minute call-up and announcement, followed by three minutes of bulletin, finishing with a one minute summary and sign-out. The broadcasts are subject to confirmation or modification at a later date.

A preliminary test of the beacons at room temperature showed the general beacon nominally on 145.8046 MHz and the engineering beacon on 145.9834. A further small change might occur following potting, and when in orbit.

The AMSAT Net and Calling Frequency (ACNF) on the H-4 channel is recommended as an emergency calling frequency also, as it would be continuously under monitoring by active personnel.

The 435 MHz uplink receiver now has an excellent noise factor, but once in operation in the transponder, it is apt to be degraded by computer and ion noise, probably to a working figure of some 4 dB, thus an input of up to between 500 and 1000W ERP RHCP may prove to be necessary for access.

The perigee of AO9 may now be between 1500 and 3000 km, and the kick-motor may well be fired within a period of only two and a half weeks of appearance in transfer orbit after launch.

Further information and more detail of the technicalities of the first Phase III satellite will appear in the pages of "Orbit" magazine, the first issue of which will appear this month. "Orbit" is posted free to all AMSAT members bi-monthly, and will carry news and articles on all forms of space communication with moon-bounce, meteor scatter, as well as topical matters on the current AMSAT-OSCAR satellites.

To date, 4,414 solar cells have been contributed to the AMSAT Phase III venture but the project so far has already cost in excess of \$100,000, and this amount is expected to be at least \$US150,000 by the time the travelling and shipping costs and the ground command controls are set up, etc., have been met when the satellite is in operational status by the end of June. AMSAT's budget is severely depleted, and financial assistance is desperately needed.

AMSAT are looking for volunteers living between 15°N and 15°S to take doppler measurements on the AMSAT-OSCAR 9 satellite whilst it is in the transfer orbit and to report these. Any potential helpers are asked to write to AMSAT at PO Box 27, Washington, DC, 20044 USA, or to call in on any of the AMSAT nets where full details will be provided on the means of measurement needed.

Errata . . . my apologies for an error in the AMSAT Phase III Countdown No. 4, which stated that "a 1.5 kHz 'ripple' from the spinning satellite to linearly polarized ground stations" would be effected. This

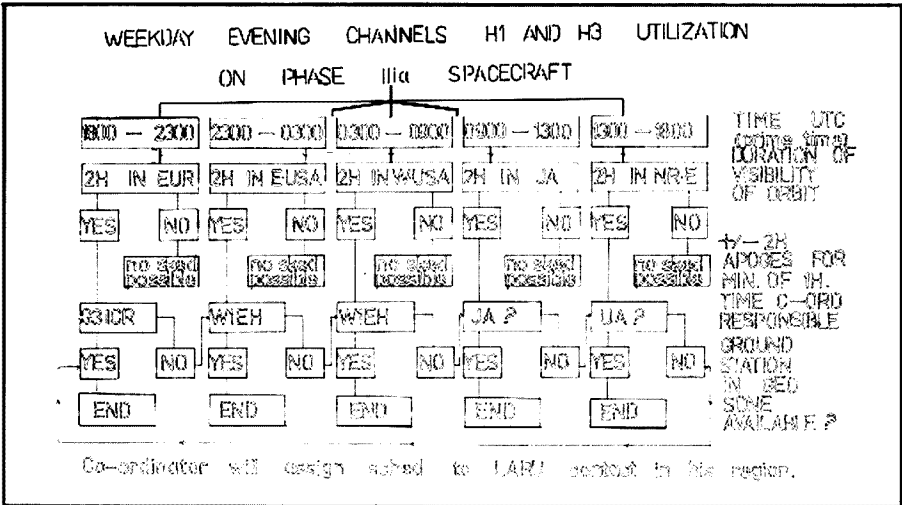
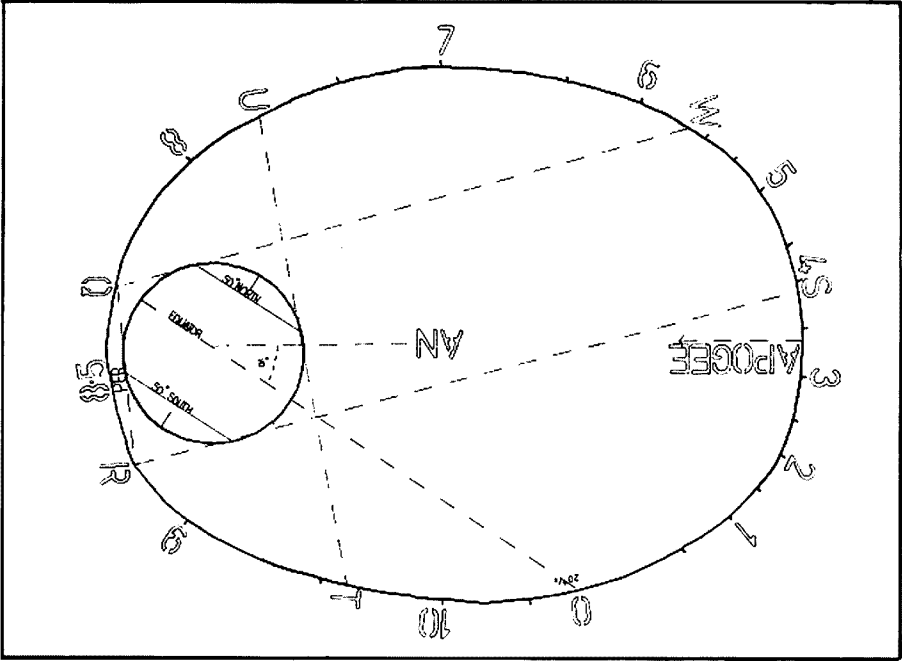

FIGURE 2 (above): Weekday evening channels H1 and H3 utilisation on Phase IIIa spacecraft.

FIGURE 3 (below): AMSAT OSCAR 9 access and coverage as seen from 50°N and 50°S at optimum and minimum apogee position relationships. Showing differences according to apogee emanation point. Based on initial 26°N apogee expected for first month of use in tinal orbit.



should have read "a 1.5 Hz 'ripple' from the spinning satellite . . ."

**OSCAR DX?**

Pat G3IOR tells me that in the last week of February he heard a VK4 (HS? MS?) working through OSCAR 8 during a pass at AN160. I have sent a SOS to Peter VK4PJ with hope that he can trace the station in question and validate the hearing.

Pat has also given some details of countries which may be worked through Phase IIIA (AO9), assuming it is in its predicted orbit parameters. He suggests it is possible to obtain WAC in one orbit and DXCC in ten orbits. Here is a selection of countries to whet your appetite.

Eqx	Time after Apogee	Areas in Sight
360	+ 10 hr	Antarctic, South & Central America, West Coast North America, Japan.
300	+ 11 hr	North and South America, All Pacific countries.
265	+ 1 hr	Most of Africa, all Asia except UA0.
225	+ 3 hr	Most of Asia and Europe.
230	+ 3 hr + 4 hr	Europe with short opening to U.K.

## RUSSIAN SATELLITES

Information emanating from JA1ANG indicates that two new satellites are under test and could be launched later this year.

These are to be designated RS0 and RS3. Beacon frequency for RS0 is believed to be 29.410 and for RS3 29.333, but these could change slightly after launch.

## BAND PLANS

From time to time we experience severe interference via our satellites from ground stations, not only in VK and ZL, but also from USA on 29 MHz. These notes are probably only read by the converted but for those who are not familiar with satellite frequencies used at present, it would be appreciated if the following segments could be kept clear:—

29.30-29.5 MHz, 145.80-145.99 MHz, 432.125-432.175 MHz, 435.0-438.0 MHz, 1260-1270 MHz, 2400-2450 MHz, 5650-5670 MHz, 5830-5850 MHz, 10.45-10.50 GHz.

The WIAW teleprinter channels are also read by many operators and these should also be kept clear to assist reception. These are 14090, 21090, 28090.

## PREDICTIONS

	Oscar 7	Oscar 8
<b>Date 1 May 80</b>		
Orbit No.	24972	10983
Eqx GMT	0020	0019
Eqx deg W	75	56
<b>Date: 15 May 80</b>		
Orbit No.	25148	11197
Eqx GMT	0130	0128
Eqx deg W	93	73

## ACKNOWLEDGEMENTS

Thanks to VK3ACR and VK4PJ for assistance in compiling these notes. ■

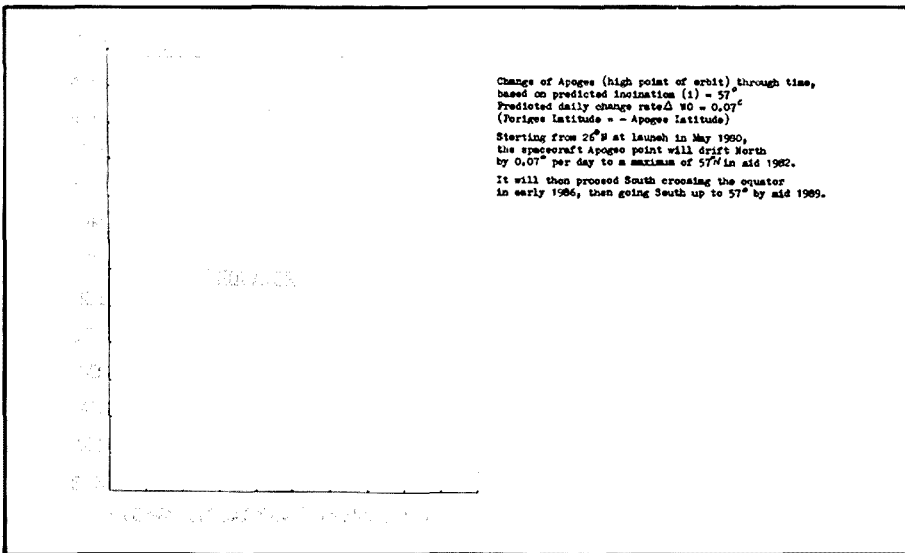

FIGURE 4: Change of apogee point of AMSAT OSCAR 9 with time.

NOTE: Phase III Countdown is edited by G3IOR, printed and dispatched by G2BVM and G3AAJ for AMSAT and is free to all publications and media, nets, bulletins for the radio amateur.

# CALLING ALL COUNTRY AMATEUR RADIO CLUB PROGRAM ORGANISERS!

Having trouble finding suitable speakers for your Club's Technical Meetings?

## THE WIA LIBRARY OF TECHNICAL LECTURES MAY SOLVE YOUR PROBLEMS!

Most were recorded at the VK5 WIA Monthly Meetings SPECIFICALLY FOR COUNTRY AR CLUBS!

### Subjects presently on Hand (Group C):

Wire Antennas	B & W	40 mins.
Radio Teletype	B & W	40 mins.
Tracking Oscar	B & W	30 mins.
The Apollo 13 Disaster	Colour	1 hr. 20 mins.
The Signal to Noise Story	Colour	45 mins.
Microcomputers	Colour	50 mins.
Microcomputers	Colour	10 mins.
Winning Foxhunts	Colour	45 mins.
Auxilliary Battery Charging	Colour	30 mins.
VK5RTV ATV Repeater	Colour	1 hr.

The average 60 min. Umatic Cassette and case weighs 850 gm. At this time the only formats for which this service is available is: ¾" Umatic — first choice, ½" Philips N1500 — second choice. Sorry, NO Betamax, VHS or N1700 etc.

For a full catalogue listing of WIA videotaped programs and a complete description of the services provided, refer to Jan. 1980 issue of Amateur Radio.

### HOW TO ORDER

Send your request with blank ¾" Umatic cassette(s) and sufficient stamps to cover postage from Adelaide to your town to:

**JOHN INGHAM**  
 Federal Videotape Co-Ordinator  
 37 Second Avenue,  
 Sefton Park, S.A. 5083

# More on the DJ4LB ATV Transmitter as a Basis for a 70 cm SSB Transverter

Murphy struck again in the April issue of Amateur Radio.

Budding ATVers, please take note of the following corrections.

FIGURE 2 (Page 16) —  
Oscillator injection should be 404 MHz for 28 MHz IF.

FIGURE 3 (Page 16) —  
The 2N5946 is shown in the wrong position. Where it is indicated to wrongly be, there should appear a coupling capacitor and the transistor located between two RF chokes — Capacitors C2, 3 and 6 are not shown in the diagram. Additional by-passes may be required around the mixer stage.

FIGURE 11 (Page 19) —  
This is the layout for Figure 12.

FIGURE 10 (Page 19) —  
This is a converter similar to the Micro-link ATV Converter.

**CHECK ALL OUTPUTS WITH WAVE-METER OR SIMILAR DEVICE BEFORE GOING TO AIR.**

Ian Glanville VK3AQU and the staff of Amateur Radio would sincerely like to thank Nev Darragh VK3YDR for the many hours of work devoted in aiding the presentation of this excellent article, not only in constructing various test units, but also in producing the photographs on this page. ■

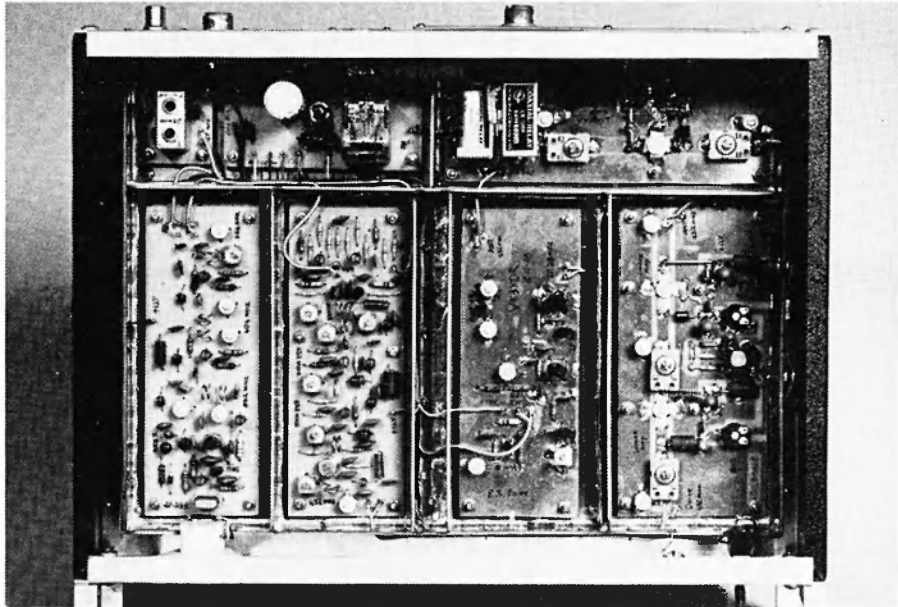

**PHOTO 1:**  
Internal view of the 70 cm SSB transverter. showing streamlined layout and easy access to all components.



**PHOTO 2:**  
Front view of the transverter.

YAESU  
**The radio.**

**NOW  
PRESENTS**



**ALL SOLID STATE**

# **FT-707 "WAYFARER"**

**NEW BANDS FACTORY INSTALLED**

## **SPECIFICATIONS**

### **GENERAL**

#### **Frequency coverage:**

80m 3.5-4.0 MHz, 40m 7.0-7.5 MHz,  
30m 10.0-10.5 MHz, 20m 14.0-14.5 MHz,  
17m 18.0-18.5 MHz, 15m 21.0-21.5 MHz,  
12m 24.5-25.0 MHz, 10m 28.0-29.9 MHz.

#### **Modes of operation:**

LSB, USB, CW, and AM.

#### **Power requirements:**

13.5 volts DC, negative ground.

#### **Current consumption:**

DC 1.5 amps receive, DC 20 amps  
transmit.

#### **Case size:**

93(H) x 240(W) x 295(D) mm incl. heat  
sink.

**Weight:** Approx. 6.5 kg.

### **TRANSMITTER**

#### **Power input:**

SSB/CW 240 watts DC, AM 80W DC.

#### **Carrier suppression:**

Better than 40 dB.

#### **Unwanted sideband suppression:**

Better than 50 dB at 14 MHz, 1 kHz  
mod.

#### **Spurious emissions:**

At least 50 dB down.

#### **Frequency response:**

350-2700 Hz (—6 dB).

#### **Third order distortion products:**

At least 31 dB down.

### **RECEIVER**

#### **Sensitivity:**

SSB/CW 0.25  $\mu$ V for 10 dB S/N, AM  
1.0  $\mu$ V for 10 dB S/N.

#### **Selectivity:**

SSB 2.4 kHz (—6 dB), 4.0 kHz (—60  
dB); CW\* 0.6 kHz (—6 dB), 1.2 kHz  
(—60 dB); CW\*\* 350 Hz (—6 dB), 1.2  
kHz (—60 dB); AM 3.6 kHz (—6 dB),  
6.8 kHz (—60 dB).

#### **Image rejection:**

60 dB (80-12m), 50 dB (10m).

#### **Audio output impedance:**

4-16 ohms.

#### **Audio output:**

3 watts at 4 ohms at 10% THD.

#### **Variable bandwidth control:**

Continuous from 300 Hz to 2.4 kHz  
(SSB/CW modes only).

\*with optional 600 Hz CW filter.

\*\*with optional 350 Hz CW filter.

## **FEATURES**

- Advanced receiver front end design provides the wide dynamic range required in demanding base station installations.
- LED level meter provides indication of the received signal strength, relative power output, and ALC voltage level.
- Continuously variable width of the IF passband.
- Digital plus analog frequency read-out.

The optional FV-707DM Digital VFO provides up/down scanning in 10 Hz steps (so close together that you'll think you're using a regular analog VFO). Scanning control — up/down, fast/slow — may be exercised from the optional scanning microphone.

### **ELECTRONIC SERVICES**

**Stan Roberts VK3BSR**

**38 FAITHFUL STREET, WANGARATTA 3677**

Telephone: (057) 21 6260. Telex: Teletra AA 56880

#### **AUTHORISED DISTRIBUTORS:**

**VIC:** Chirnside Electronics (03) 726 7353, G.F.S. Electronics (03) 873 3939, Imark (03) 329 5433. **NSW:** Emtronics (02) 398 6378. **QLD:** C. W. Electronics (07) 341 5377. **SA:** Graham Stallard (08) 43 7981, Farmers Radio (08) 293 2155. **WA:** Willis Electronics (09) 321 7609. **TAS:** J. D. Electronics (003) 44 5000.

Agents are located in many regional centres throughout Australia.



# 1<sup>ST.</sup> ANNUAL STOCK TAKING SALE

**PRICES  
SLASHED**

## STOCK TAKING CLEARANCE (SPECIALS ONLY)

Kenwood	TS120V	normally	\$550	special	\$ 529
Kenwood	TS120S	normally	\$735	special	\$ 689
Kenwood	DG-50 Readout	normally	\$282	special	\$ 255
Kenwood	AT-200	normally	\$160	special	\$ 150
Kenwood	SM220	normally	\$360	special	\$ 339
Kenwood	VFO520	normally	\$164	special	\$ 153
Kenwood	SP520	normally	\$ 34	special	\$ 30
Kenwood	TS520SE	normally	\$720	special	\$ 669
Kenwood	TRS2400 Hand held	normally	\$345	special	\$ 325
Kenwood	R1000 Receivers	normally	\$498	special	\$ 468
NDI HC100	2 metre 25 watt Transceiver "		\$399	special	\$ 349
YAESU	FT101ZD	normally	\$929	special	\$ 889
YAESU	FT101Z	normally	\$779	special	\$ 739
YAESU	FT227RB	normally	\$399	special	\$ 369
ICOM	IC701	normally	\$1199	special	\$1099
ICOM	IC225S	normally	\$299	special	\$ 289
Commodore	8K Pet Computer	normally	\$1499	special	\$ 999
Macrotronics	M65 Rtty Interface	normally	\$149	special	\$ 135
Century 21	Receivers	normally	\$329	special	\$ 299

All Electronic toys and games less 30% to 40% make us an offer. All the above available and in stock at time of going to publication - check (call in) for further items. All specials have 30 day warranty. Price only available whilst existing stock lasts and prior to end of June stock taking. All Prices Ex Brisbane. Mail orders welcome.

### MINICOMPUTER INCENTIVE OFFER

UNIQUE TO CW ELECTRONICS  
With each Commodore 16K or 32K mini-computer purchased from CW Electronics by a licensed Amateur Radio Operator will come, at no extra cost, a MACRO-TRONICS M65 Ham Interface for Morse Code and RTTY (and ASCII) Transceiving.\*  
**SAVE \$149**

#### SERVICE DIVISION

We have a fully equipped electronic service division. We can service enthusiast and commercial electronic gear efficiently and at a reasonable charge.

Wholesalers, agents, manufacturers and retailers please consider us for your next Queensland service contract.

CW can arrange service and service contracts of Commodore computers within Australia and PNG.

Telephone: (07) 341 5377

A.H.: (07) 341 4767

\*Refer to license limitations on Morse and RTTY communications.

**CW**  
**ELECTRONICS**

CNR. MARSHALL RD AND CHAMBERLAND ST.,  
TARRAGINDI - BRISBANE PH. (07) 48 6601  
P.O. BOX 274, SUNNYBANK, QLD. 4109  
AH: BRIAN (07) 341 4767 TELEX AA 40811

# VK CW QRP

Jack Swiney VK6JS  
59 Collova Way, Watheup, WA 6166

Undoubtedly, the top news item this month would have to be the high score that Phil VK6NDF has knocked up! Details are shown below on the scoreboard and this makes him the leader by several lengths. One of his QSOs with Mark VK3NOY in Preston was very interesting because Phil was running half a watt to give him 104.3 points for an individual contact. FB, Phil, keep it up. We will HAVE to pull up our socks, you guys, and give this fella a run for his money!

Okay . . . let's have a look at the scoreboard to date:

Phil VK6NDF: 521.6 (15m: 131.8, 10m: 389.8).

Gordon VK4AGW: 13.6 (80m: 5.5, 20m: 32.4, 15m: 96.7).

Jack VK6JS: 87.2 (80m: 4.0, 15m: 83.2).

Brian VK6NCU: 58.9 (15m: 25.4, 10m: 33.5).

## HIGHEST SCORING INDIVIDUAL CONTACT TO DATE

Phil VK6NDF (QSO with VK3NOY): Rockingham Park, WA/Preston, Vic., with 0.5 watts, 104.3 points.

## LONGEST DISTANCE COVERED, INDIVIDUAL CONTACT, TO DATE

As mentioned earlier, co-holders of this record are Gordon VK4AGW and Phil VK6NDF, established during a QSO with each other.

Thinking caps on? Question: Which two QTHs would make for the longest distance covered in VK? Let's know what you come up with.

Another two members have joined our ranks! An enquiry early last month from Jim VK2AKE has resulted in another QRP "battler". He tells us that his Ten-Tec Argonaut 509 does an excellent job and we wish him all the best on QRP CW. Watch out for Jims high scoring rate once he gets his two new 40 ft. dipole supports up and away. At that height his 80m calls are going to make quite a stir.

Eric VK3BXA is the other new recruit to the QRP gang.

As usually happens in the progress of all club-type activities, so it has now reached a point where we have formed a Club Committee.

President: Jack VK6JS.

Secretary: Phil VK6NDF.

Bulletin Editor: Jack VK6JS (once again!).

Any graphical illustration of an equation showing its variable parameters is always revealing and the formula we use to compute point scores is no exception. For a start we've shown below Points vs. Watts for five different distances in km to give us an insight into how operation within the rules would push up the scores!

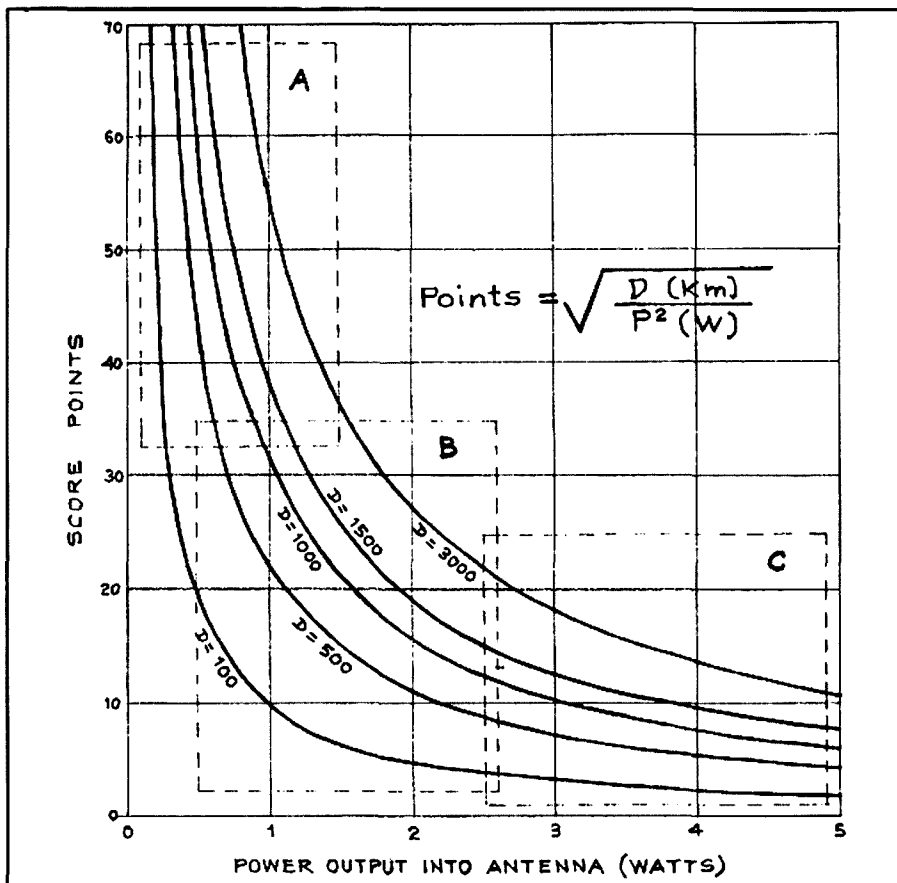

TABLE 1: A graph of power output vs. score points. Undoubtedly the highest score is proportional to the distance the linear is thrown away from the shack.

Areas A, B and C outline the obvious advantage of the reduction of power whenever possible consistent with band conditions. As an adjunct to the graph shown we hope to have a table of computer calculations next month by Phil VK6NDF giving precise distances between various points in VK.

A REMINDER! Please don't wait till you have made numerous QRP contacts . . . send in your log entries as frequently as possible. That way we can enter your score regularly for each month. Try and mail them to reach us before the start of the last week of each month.

And now that we have an official Club Secretary we request all Club members to mail their scoring logs direct to Phil VK6NDF.

Address them to: The Secretary, VK CW QRP Club, 20 Hercules Street, Rockingham Park, WA 6166.

That's all for this issue — readers' contributions on QRP activities are invited and can be sent to the VK CW QRP Club.

## EDITOR'S NOTE:

For details on the VK CW QRP Club see page 20 May Amateur Radio. ■

# AWARDS COLUMN

Bill Verrall VK5WV  
7 Lilac Avenue, Flinders Park, SA 5025

## THE BLUE LAKE AWARD

This award is offered by the South East Radio Group located in Mount Gambier, South Australia. The object is to create an interest between radio operators throughout the world and the south-east of South Australia.

The award is available to any amateur who:—

1. Establishes two-way communication with five (5) South East Radio Group members.

- All amateur bands and modes are permitted. Crossband operation is not permitted.
- No QSLs are required, only full log entry.

**COST**  
\$1.00 or 5 IRCs.

**APPLICATIONS**

Applications should be forwarded to:—

Awards Manager,  
SERG,  
PO Box 1103,  
Mount Gambier, SA 5290.

Contacts made on or after 1st January, 1980, will be eligible for this award.

**DESCRIPTION**

The award measures 185 mm x 200 mm, printed on high quality white matt card with the illustration of the Blue Lake in light blue and all printing in red.

The introduction of this award is most timely to coincide with the SERG Convention which is held at Mount Gambier this month. I hope to see all the regulars there!

**REDCLIFFE CITY AWARD**

This award is issued to amateurs who contact members of the Redcliffe City Radio Club located in Queensland.

**REQUIREMENTS**

- Australian and New Zealand amateurs require 6 points.
- Overseas applicants require 4 points to qualify.
- Any band, any mode. Crossband contacts are not permitted.
- Contacts with the Club station VK4RC counts as 2 points.
- Contacts with Club members count as 1 point.
- Send log details only. QSLs are not required.

**COST**

I do not have these details but I suggest you include \$1 or the equivalent in IRCs to cover postage.

**APPLICATIONS**

Applications should be forwarded to:—

Custodian,  
Redcliffe City Radio Club,  
PO Box 20, Woody Point, Qld. 4019,  
Australia.

The Club station VK4RC goes "on air" each Sunday evening from 8.00 p.m. on various frequencies — presently on 21.175 MHz. From May to July the frequency is 3.610. When propagation is favourable the station may be found on 14.300.

**DESCRIPTION**

This award measures 210 mm x 170 mm, printed on high quality paper. The illustration and background are in blue and the award motif and printing in gold.

Good hunting. ■



# BLUE LAKE AWARD

SOUTH EAST RADIO GROUP

(S) (E)

*The South East Radio Group has pleasure in granting this certificate*

to           SPECIMEN ONLY          

*who has complied with the conditions under which this award is granted by contacting the required number of members.*

Mode .....

Award No. .... Date .....

.....

Awards Manager ..... President .....

**SERG: MOUNT GAMBIER, SOUTH AUSTRALIA**  
P.O. Box 1103, Mount Gambier. 5290

ABOVE: The Blue Lake Award issued by the SERG in Mt. Gambier; and BELOW: The Redcliffe City Award, another attractive piece of wallpaper.

# REDCLIFFE CITY AWARD

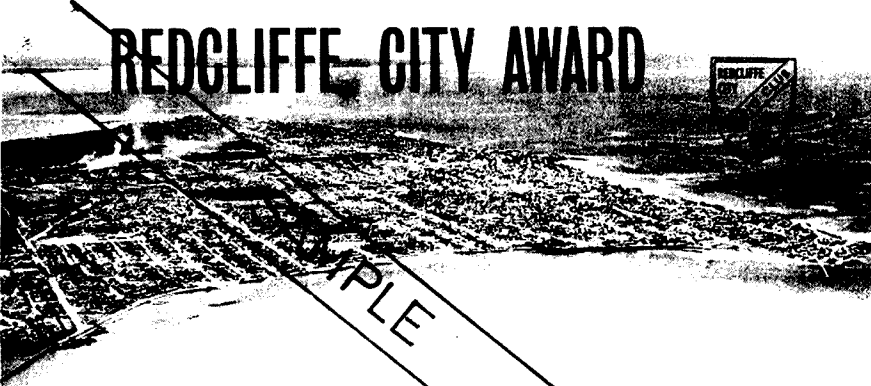

Awarded to .....

*for radio contact with*

REDCLIFFE CITY RADIO CLUB MEMBERS

Award Number .....

Mode ..... Date .....

Awards Manager .....

SPECIMEN ONLY

# TRY THIS

WITH THE TECHNICAL EDITORS

## SIMPLE ELLIPTICALLY POLARISED ANTENNA

Elliptical polarisation is similar to circular polarisation but the horizontal and vertical components are not equal. In other words there is some difference in both the horizontal and the vertical planes.

Very often the crossed dipoles which we use with a phasing line will actually produce an elliptically polarised signal as we will not have exactly equal currents in each dipole.

A Russian design which makes no pretence of producing anything but elliptical polarisation does away with the quarter wave line. This produces a much simpler antenna which produces fairly close to circular polarisation. The elliptical polarisation achieved would appear to be practically the same as circular when used to make contacts.

The design appeared in the Russian magazine *Radio* for July 1979. The design uses two dipoles cut so that the terminal impedance of one is inductive and the other capacitive. In this manner the currents in each dipole can be made to differ by 90 degrees. The lengths used are 0.46 wavelength and 0.54 wavelength. These lengths are with respect to an 0.5 wavelength dipole and so would require further correction for end effect.

The dipoles are connected as in Fig. 1 and the equivalent circuit of the dipole feedpoints is shown in Fig. 2. The resultant impedance plot is shown in Fig. 3, which

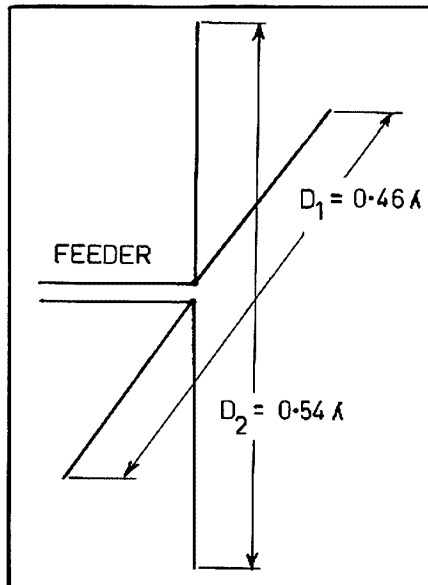

FIG. 1: Crossed dipoles connected for elliptical polarisation.

illustrates how the 90 degree phase difference is obtained.

From Fig. 3 it is also apparent how the currents in the dipoles will be of different magnitudes due to the different impedances. It is possible to calculate by how much they will differ and what degree of elliptical polarisation will result. Calculations in the article suggest that one component will be 0.85 of the other. This would not be very noticeable in practice.

The original article may be found in the magazine *Radio* for July 1979. However swot up on your technical Russian before rushing to obtain a copy. The author was K. Kharchenko.

VK3AUI. ■

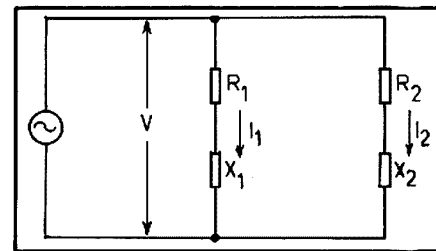

FIG. 2: Equivalent circuit of dipole feedpoints.

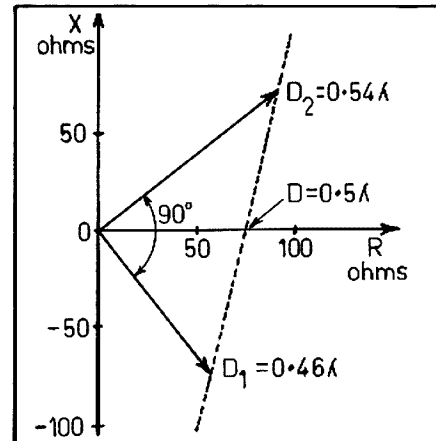

FIG. 3: Crossed dipole impedance plot.

## QSP

"HMAS CASTLEMAINE", a former naval coastal minesweeper, has been given the distinct privilege of having the only R series call sign issued to a station and not a repeater. Mike Thorne VK3BKK and a host of dedicated workers are currently restoring the "Castlemaine", complete with radio room.

The new call sign VK3RAN can be heard in the future most Sunday mornings on 21.175 and when the radio room is completely restored amateurs will be welcome to view the result and/or operate equipment.

The whole venture has been sponsored by the Royal Naval Amateur Radio Society, whose numbers now exceed 120 members. The RNARS hold one net Monday evenings on 80 metres (3613 kHz), commencing at 1030 GMT (SSB), and on Tuesday evenings at 1030Z on 3527 kHz using CW. All are welcome to join in to the net.

As a matter of interest to readers, two other special call signs to look for are GB2RN, that of "HMS Belfast", and W4USN, special call sign for a former US aircraft carrier. ■

## USA EXAMS

According to Ham Radio February 1980 Presstop the FCC in the USA has ruled that volunteer amateur examinations are illegal and must be terminated. Responsibility for novice exams had rested with the Amateur Service since June 1954. Another comment, from February 1980 QST, is that the status quo will continue for now but there could be a significant impact on the novice licensing programme in the not too distant future. ■

# AMATEUR SATELLITES APPENDIX

Bob Arnold VK3ZBB

There has been a sparsity of information on the future of OSCAR Phase IIIA, which will be known as AMSAT-OSCAR 9 after its launch on the 23rd May.

Several enthusiasts will be monitoring information obtained from AMSAT, ARRL and the satellite itself and this will be disseminated via the Australian and Japanese nets as outlined in the May edition of "AR".

Bill Magnusson VK3JT is co-ordinating the educational aspects of our satellites and has asked me to include the following notes:—

## "OSCAR IN THE CLASSROOM"

Response has been encouraging so far to the recent article on the potential for educational uses of amateur satellites. I have received enquiries from VKs 1, 2, 3 and 5.

The project is being advertised through various education department standing committees. Curriculum material is under preparation and I am in contact with the teachers' colleges to alert their students of the possibilities. I have had a number of enquiries for orbital data, frequencies, etc., for satellites other than the OSCARS, e.g. weather, landsat, etc. I have no knowledge of these but I believe that some amateurs are experimentally receiving and tracking such satellites. Can someone help with data? This would seem to be compatible with the OSCARS for senior study. All information or enquiries QTHR or Footscray Technical School." ■

GIVE AN ADVERTISER YOUR SUPPORT

# VHF-UHF

## An expanding world

Eric Jamieson, VK6LP



Forrester, S.A. 5233

### VHF/UHF BEACONS

Freq.	Call Sign	Location
50.005	H44HIR	Honiara
50.023	HH2PR	Haiti
50.025	6Y5RC	Jamaica
50.035	ZB2VHF	Gibraltar
50.036	HC1JX	Quito
50.038	FY7THF	French Guiana
50.040	WAGMHZ	San Diego
50.048	VE6ARC	Alberta
50.050	ZS3E	South West Africa
50.055	ZL1UHF	Auckland
50.060	PY2XB	Sao Paulo
50.070	YV5ZZ	Caracas
50.070	VP9WB	Bermuda
50.080	W1AW	Connecticut
50.080	T12NA	Costa Rica
50.085	WA6JRA	Los Angeles
50.088	VE1SIX	New Brunswick
50.089	WD4CEI	North Carolina
50.100	KH6EQI	Pearl Harbour
50.104	K4EJO	Tennessee
50.105	KC4AAD	McMurdo, Antarctica
50.110	KH0AB	Salpan
50.110	AL7C	Anchorage
50.120	457EA	Sri Lanka
50.144	KC6IN	Ponape, Caroline Is.
50.498	5B4CY	Cyprus
51.999	YJ8PV	New Hebrides
52.200	VK8VF	Darwin
52.250	ZL2VHM	Palmerston North
52.300	VK6RTV	Perth
52.350	VK6RTU	Kalgoorlie
52.400	VK7RNT	Lanceston
52.440	VK4RTL	Townsville
52.450	VK2WI	Sydney
52.500	JA2IGY	Mie
52.500	ZL2VHM	Palmerston North
52.510	ZL2MHF	Mt. Cimlie
52.800	VK6RTW	Albany
52.900	VK6RTT	Carnarvon
53.000	VK5VF	Mt. Lofly
144.010	VK2WI	Sydney
144.162	VK3RGI	Glippsland
144.400	VK4RTT	Mt. Mowbullan
144.475	VK1RTA	Canberra
144.500	VK6RTW	Albany
144.600	VK6RTT	Carnarvon
144.700	VK3RTG	Vermont
144.800	VK5VF	Mt. Lofly
144.900	VK2RTX	Ulverstone
145.000	VK6RTV	Perth
147.400	VK2RCW	Sydney
432.400	VK4RBB	Brisbane

### CHRISTMAS ISLAND DX

Steve VK3OT, who operated on Christmas Island for a fortnight in March as VK9XT, certainly didn't sit around doing nothing! His note to me indicates working 11 countries and approximately 1700 JAs on 6 metres integrated with some 12,500 QSOs on 10 through 80 metres!

Best DX was JA8 at 4500 miles and H44 3800 miles. Backscatter via evening TEP path to VK4RO, VK4ZBJ, VK4JH, VK8GE and VK6OX. Direct down east range QSOs with P29ZFS, H44PT, H44DX, VK8GB, VK8VV and VK8ZBW. Other DX included 4 or 5 openings to KG6, YB1 on 2 or 3 occasions, their 52 MHz allocation is 52.120; then DU1GF, KPNT/DU2, HS1BG, JDTAKE, HL9TX. All five VS6 stations appear to be operating. Every JA call area and prefecture including Okinawa.

Other signals heard included FM repeaters using 1 MHz offset, one occupies 52.000, another 53.500. TV on 52.400 very strong.

Craig VK9XW has ordered an IC551D for use on 6 metres and Steve left behind the 4 element beam for that purpose. Steps are being pursued to activate the VK9XI beacon, probably on 52.390 in accordance with VHFAC bandplan. Thanks for writing, Steve, and placing those very fine stamps on the envelope!

### NEWS FROM NORTHAM

Tony VK6BV writes to say he had to wait until 28-1 to work VK5, being the first DX for him. Openings to Japan started on 17-2 and continued on 19-2, 20-2, 21-2, 22-2, 25-2, 26-2, 8-3, 13-3, 15-3, 17-3, 18-3, 19-3, 20-3, 23-3, 27-3, 28-3 and 29-3.

"With most of the JA openings they would start off with JA8 and sometimes JA7. After an hour or so band would close for various lengths of time. On re-opening it would be to the more southern call areas of Japan. As a rule signals peaked to S9 on most openings. Night time openings around 1000Z have been relatively weak and very fluttery, more so than last year. Another point which may be worth noting is the way the MUF has risen and fallen. While listening on the PRC10 the MUF may have reached 43 MHz. On listening again some five minutes later the MUF will have risen to 52 MHz and above. Another fascinating point is the sharp frequency cut-off. Don VK6HK also made note of this fact when he was listening to the 49.750 video carrier sidebands, the upper sidebands would cut off before the lower sidebands. To make the point clearer, after contacting a Japanese station on 52.050 I asked him to QSY to 52.075. Both moved up, called, no reply. Went down to 050 again and repeated request, again called on 075 and still no reply. Went down to 050 again and completed contact. The JA told me he was unable to copy on 075 although I was 5 x 9 on 050. You work it out!

"Listening short path to Europe the band MUF rose to 41.500 on many occasions between 1000 and 1300Z. On 16-2 audio was S9 and video at 45.000 very strong between 1210 and 1235. Next was on 7-3 when TV audio and video was again strong between 0945 and 1100Z up to 45 MHz. On 8-3 band really opened when MUF rose to 51.750 between 0945 and 1010Z but quickly dropped to below 45 MHz, and by time contact was established between G3JPC and VK6WD and VK6HK the band was on its way down and no crossband contact resulted." Thanks, Tony.

### FURTHER WEST

Garry VK5AS at Cowell, about 130 miles north-west of Adelaide and on Eyre Peninsula has been having a "ball" updating equipment. His latest band is 432 MHz from a microwave modules transverter to an 88 element antenna, so all you 432 buffs in western Victoria had better make a note of this!

On 2-3-80 52 MHz VK1, VK2; 4-3 144 MHz VK3ANQ, VK3AOS; 9-3 52 MHz JA1, 2, 3, 4, 5, 6, 7, 9 and 10; 14-3 144 MHz VK3AOS; 15-3 52 MHz VK4ZJB, 144 VK3ZHP and VK2BY; 16-3 144 MHz VK2ADZ, VK2DGV, VK2DAB, VK3BFY, VK3CI, VK3BKF, VK3ZHP, VK3AXV, VK3YLV, VK3ATN, VK3YQX, K3BHS, VK3AOS, VK3AQR, VK3ANQ, VK3YNV.

After that effort on 15-3 we can now surely feel there has been a renewal of 2 metre activity from over the border, and with the operation of several strategically placed stations in VK5, namely VK5CK at Piccadilly, VK5SV at Wasleys, VK5KK Arthurton and VK5AS at Cowell, plus VK5RO in Adelaide, we can now offer a range of contacts over considerable distances to operators from other States. Of course those of us in the poorer areas, like VK5LP, and generally speaking many of the other boys in the Adelaide area, have to sit on the sidelines and hear one side of the activity!

### VK4 DISTANCE RECORD

Word has come to hand from the VHFAC advising confirmation of the claim for a new VK4 distance record between VK4ZEZ/VK4NFR and N6CT on 2-3-79 on 52 MHz for a distance of 11,857.3 km or 7,367.8 miles. Congratulations to Ed for this contact, and with luck you may be able to increase that distance in the near future.

### ROUND UP OF SIX METRE NEWS

John VK5ZBU reports hearing W7KMA beacon 51.973 at 0000Z and 0226Z on 1-4, very weak and watery! Same day appears Bill ZL2CD worked 17 stations in W5, W6 and W7, open from 2100Z but not to VK areas. Dick VK5AHZ reports reception of 5B4CY beacon S1-2 0915Z; VK6OX heard same beacon from 0900Z.

Keith VK5SV reports the W7KMA beacon uses old OMEGA gear and runs about 30 watts to a half-wave dipole, but hopes to attach it to a 3 element yagi in due course! On 13-3 VK6WD worked KG6DX on an otherwise dead band (?) and KH6IAA heard the VK4RTL beacon. On 2-4 G5KW said to be copying ZS6 at 0945Z on 50 MHz . . . 3-4 W7 copying ZL4OY 2329Z 50.109.

3-4: VE1ASJ worked ZL2CD, distance 15,213 km, which is probably a new Canadian-New Zealand 6 metre record. If you hear VE1ASJ phone (506) 847 5656. 4-4: H44PT worked FY7AS. Peter H44PT will be off air from 1-6 to some time in August. KP4CL and KP4CK work JAs 1430Z. ZS6 working G 50 to 28 MHz.

On 3-4 again ZSSLN to G5KW about 1130Z, also to D1DH, DK1PZ 50.050 CW and SSB to 28 MHz. ZSEPW also working Europe. ZS6LN running 10 watts worked ZS5TR 8 watts, both using 8 element KLM antennae and FT620 barefoot. VK TV being heard by ZS6LN. Also a report of ZS6LN being copied by a station in Athens on 2 metres, but no confirmation of this.

5-4: ZS6LN worked E16AS on 50.100 CW and SSB at 1104Z, this being a two-way contact on 6 metres! E12W and E19D are also on 6 metres. KH6EQI beacon reported operating again by VK6WD. H44PT working ZB2BL on 10 metres at 1209Z, trying for 6 metres. Report again of contacts between SV1AB and SV1DH in Athens and ZS6 on 2 metres, while on 4-4 ZS6LN worked ZE5JJ in Rhodesia on 432 MHz.

6-4: ZL to W on 6 metres; 7-4 KG6DX to VK2 and VK4 on 6m with contacts which actually started on 28885. Also to VK5ZK, 2345Z S2-4, and to VK5RO and VK5KK all on CW. JA on 52.050 1248Z S1-3 talking to VK4GI. Lonely contact between JA1PLI and Jim VK5ZMJ 310Z on 7-4.

10-4: Joe VK4JH reported hearing KH6 regularly, also JAs. He had worked three Okinawa stations, plus KG6KG/KH3 and KG6JQ/KH0. Same day ZL to XE1GE 2100Z. VK2BYX had half a contact with XE1GE! VK5KK and VK5AS copied the XE station on 50.005, but not audible on 52.005. KH6IAA worked YJ8PD.

11-4: Solar count 247, A index 22, K index 3. C5ACY Bahamas transmitting 50.101 to ZL, then at 2114Z XE1GE appeared on the band and worked ZL4LT, then ZL2CD at 2115, VK5RO at 2130, then contacts with VK5AS, VK5KK, VK5ZDR, VK5ARZ, VK5ZK, VK5LP (2241Z), VK5ZBU, VK5SV, ZL3NE, VK3AWY and heard VK7RO on CW. All this took place on a very awkward split frequency set-up. XE1GE transmitted on 50.094 and received on 52.004, so those stations without separate receivers or VFOs had to do much switching and dial tuning to make the contacts, but it was done. It seems likely the contact between VK5AS and XE1GE could be a new Australian record for 6 metres. The signals from Mexico were peaking to S9 with an average of S5-6 and he was there for about 1½ hours.

Subsequently learnt from Geoff XE1GE that the band had been open to VK on 8-4, 9-4 and 10-4. ZLs were heard calling W5, and reports of several ZLs working C6ACY in the Bahamas. ZS6LN copying KH6EQI at 0430Z, ZLs working W4, W5 and W6 and JA. ZL TV extremely strong in Adelaide 2200Z.

On 12-4 VK2ZZV reported hearing KP4 about 2230Z but one way only. KH6EQI at 0000Z for short period. At 0400Z VK5RO got stuck into the JAs on CW on 52.010, followed by VK5KL and VK5ZK. JAs to S9 on 50 MHz only.

13-4: Large and long opening to Japan from about 0400Z, mainly JA7 and JA8 with signals well over S9 into VK5, VK3 and VK2 at least. XE1GE heard again working ZL. On 14-4 XE1GE again into VK5 and to VK3AMK at 2340Z, others to work him were VK5RO, VK5ZK, VK5LP and we tried valiantly to get VK5AMK to work him. XE1GE hearing VK1VP and worked VK7JG at 2353Z, also

said to have worked VK3AUI and VK3AWY. Still there at 0020Z. On 15-4 XE1GE appeared again around 2300Z but much weaker. Interesting to note the absence of any signals from W during these periods of extensive openings to Mexico.

At this point I am now handing over to John VK5ZBU to finish the column this month, as I will be flying out to New Zealand on 19-4 for a break of a month, and where I hope to catch up with some of the VHF gang as time permits. Over to you, John, and many thanks.

With Eric making contacts the easy way, "eyeball wise" in ZL, we will continue the story of a somewhat dismal April.

Despite the prophetic comments following the events of last April, we in VK5 and seemingly other southern areas of Australia have not enjoyed the same exciting contacts, but other areas have had vastly different and more satisfying results.

April 16: 1140 GMT KH6EQI was heard in VK5 for half an hour. Some JAs on 50 MHz, also on 52 MHz, with KG6DX very strong on 50 MHz.

April 17, 18 very quiet, with Suzy JA8HWL being the strongest signal on 50 MHz. No signals on 52.

April 19: 0130 GMT stations heard or worked were 2Z2V, 2ZQX, 4AMF, 4ZAZ and 4LR.

April 20: The most interesting happening was some two hours of very excellent signals between ZS and KH6 (more of this later).

April 21: 3D2DB and N6CT heard in VK5, no contacts.

April 22: A la'e opening at 1330 GMT with JA1MRS, JE2LRW, JA2DDN and JF2TLR on 52 MHz for half an hour.

April 23: Although the KH6 beacon was heard in VK3, nothing of note was recorded in Adelaide. While VK6 and VK4 were working JA nothing was

heard in VK5 until 1420 GMT when Nort JA1VC and Mic JA1MRS were worked, Mic for the third time in a week.

April 24, 25, 26, 27 and 28 were times to ponder on what did not happen, no activity and in general a case of "Never have so many expected so much and received so little".

A ZBU definition of a sunspot cycle: "A period when man's imagination is directly proportional to sunspot activity and fiction becomes stronger than truth."

#### OBSERVATIONS

Following countless hours of observing and trying to come to a reasonable conclusion regarding some of the more unusual and interesting contacts noted during this period of solar activity and having noted the spate of pseudo-scientific explanations that have been circulating, one is left with a feeling of doubt about what has been happening, certainly a vivid imagination is a requisite. Imagine, if you can, a little 6 watt signal all dressed up in top hat, white tie and tails doing a Fred Astaire routine across some thousands of miles from ZS6 to finally take a bow in KH6!!! As Pygmalion once said, "Not b . . . . likely!" Now! Let's take the same signal and direct it (minus the tails, etc.) into a wave-guide-like ionised gaseous vasiform or tubular duct and, hey presto, the story becomes believable, the same may be applied to most of the long distance contacts between VK and XE, JA to LU, ZS to Europe and KG6 to LU, to mention but some. The stability and strength of the signals are different to other modes of propagation as study will show, but much of the necessary black magic is removed.

The orientation of these ducts determines what the path will be usually, it appears that they are trans-equatorial (magnetic) in character and vary in dimensions.

These ducts occur during periods of mounting ionospheric upheaval and also during the decline of ionospheric disturbances until a point where a state of normalcy is reached. The origin may relate to equatorial plasma bubbles, such has been considered, whatever the relationship if any, the involvement of ionised gases with the earth's magnetic field during geomagnetic storms at times of high solar activity would appear to create the ducts which may persist for minutes or even hours before collapsing.

Space does not permit elaboration of all supportive evidence, but suffice to say a study of propagation reports and comparison with events will show a distinct relationship. Ducts have been quite accepted on 2 metre paths, but ionospheric ducts have been rather neglected, hence the study of long distance paths. The unusual and confusing beam headings, the slewing of signals and the strange angles involved, such as the KG6 signals beaming to KH6 and at the same time reaching LU, all of these become more readily understood and much more plausible when ducting in association with other forms of propagation are considered.

And now to conclude with yet another 5LP thought for the month: "It's not what you stand for that makes life difficult, but what you fall for!!"

Late news-flash: Anthony Green VS6EZ has written asking that all amateurs note the change in frequency allocation for Hong Kong. VS amateurs may now operate between the following frequencies: from 52.022.5 continuous to 52.110 MHz. The VS6EZ main frequency will still be 52.100.

"It's great stuff, that Sporadic E! If I knew who the agents were I'd buy a bottle!"

Good ducting and 73.

John.

## DIVISIONAL NOTES

### VK2

Pictured are members of the Goulburn Amateur Radio Society partaking in sunshine at the annual convention last October held at Young. The next South West Convention will be held at Griffith in November — more details will appear in a later edition of Amateur Radio. Nonetheless participants at the next convention will no doubt see some or all of those pictured, from left to right, Barry VK2DBA, Pat (XYL VK2BDT), David VK2VWH, Scott VK2VUT, Penny (Harmonic VK2PP), Peter VK2APP, David VK2BDT, David VK2NAW and Phillip (Harmonic VK2NAW).

### VK3

An informal get-together lunch is held each Thursday commencing midday at the WIA Victorian Division Centre, 412 Brunswick Street, Fitzroy (one of the inner northern suburbs of Melbourne). ALL amateurs, both local and visiting, are invited.

The Centre can be reached by taking Nos. 9, 10 or 11 trams, to Stop 22, from Collins Street in the City of Melbourne. For those contemplating a visit the Divisional Centre can be contacted on telephone 41 3535. Amateurs announcing their intentions on the Channel 5 or 8 repeaters and who are lost will no doubt find their way through their ever-listening counterparts on the repeater network.

### VK5

#### WOOMERA AMATEUR RADIO CLUB

The Club was first established in 1955 and is 25 years old this year.

Postal address: PO Box 538, Woomera, South Australia 5720.

Meetings: Club house, Killara Avenue, Woomera, every Wednesday night, 1900h CST.

On air some Club nights, most contests and field days and at other random times.

Award: VK5WC Award, three colours based on QSL card, good quality material. Cost \$2.50 Australian.

Work Club station plus two local members or work four local members, since 3rd May, 1978.

Any band, any mode or cross band or cross mode. Earth and satellite repeaters permitted.

Certified log entry signed by two other amateurs.

Member activity: Some 2m FM (Port Pirie and Adelaide repeaters when path is open. Some CW, SSB and RTTY on 80-10m.

AGM: June each year.

Present officers: President, Dick Menz VK5OL; Past President, Alex Smith VK5MQ; Secretary, Mick Lindsay VK5ZMN. Ex officio: Awards Manager, Dick Ashton VK5DQ.

Membership: Varies from time to time. On air at present: VK5OL, VK5MO, VK5LA, VK5DQ on HF; VK5OL, VK5ZMN on 2m.

Club station: Yaesu FDX400, HF dipole and rhombic, Icom 202, steerable 2m yagi for Oscar.

Membership of the Club is a prerequisite under Department of Defence regulations for permission to transmit within the community including from the Club station; amateurs visiting either for business or social reasons are able to apply for permission to join.

Until 3rd May, 1978, VK5WC was the only call sign permitted to be used within the Woomera Prohibited Area.

## AR ADVERTISERS SUPPORT WIA MEMBERS



# VK/ZL/Oceania DX Contest 1979 - Foreign Results

CW SECTION		LISTENERS' SECTION		LISTENERS' SECTION		JH4FOG		U0Y		OK2BBJ	
<b>USSR:</b>		<b>USSR:</b>		<b>Phone:</b>		670		2222		112	
UK2PCR	11100	<b>Phone:</b>		DM10280/E	11220	JA1ALX	645	LZ2KIM	2220	YU3NP	108
UK1AAA	8466	UA6-150-952	1692	BRS32525	9372	JA9KGU	540	DK1KB	2139	OK2SPS	108
UK9HAC	8184	UO5-039-27	2208	JA5-3033	6916	JA5XRF	504	HA9KOL	2058	HA7TM	90
UA1DZ	6984	UC2-009-453	2583	JA1-22717	6000	JF2FHQ	496	HA4XT	2057	OK1AIA	84
UA3EAL	5379	UA4-095-381	4337	DM8252/H	5940	JH4MVB	462	HA4XX	2024	SP5EPF	84
UK2BBK	4901			DM5173/G	4275	JH7AJY	450	LZ2KKZ	1958	LZ1IA	84
UW0IX	4814	<b>CW:</b>		SP06SK	4160	JA9AQE	448	DM3SBM	1794	OH2BAH	72
UA9NN	4536	UA0-107-324	79	DM5173/G	4275	JE3OUU	408	SP3KEY	1562	LA9HW	64
UK4FAV	4455	UA9-145-197	4816	SP06SK	4160	JA1AAT	308	ON4FD	1560	OK2BMA	60
UW9PT	3450	UA4-095-381	4375	SP06SK	4160	JA9NTR	272	I5YDI	1512	OZ1BII	50
UA1ZW	3312	UA2-125-267	285	1070612	4104	JL1ONG	222	HA8VB	1411	OK1PBG	50
UA0MI	3025			ONL383	3950	JA3AA	140	LZ1QV	1406	DM2BGG	48
UK6AAJ	2640			DL-8148	3432	JH4DRB	130	G3ESF	1311	EA2JA	48
UA0ACM	2600	<b>PHONE SECTION</b>		JA9-2243	3751	JA3BVJ	80	HA5KKN	1292	HA3GJ	40
UT5EM	2520	<b>USSR:</b>		OK3-915	3784	JE3CRA	80	LA3UG	1216	SP9AKD	40
UA9OBL	2400	UK2GKW	22770	DM8580/A	2950	JA0GTM	56	ON4XG	1139	HA4XS	32
UK3ACR	2300	UK5MCS	19470	WDX9JFL	2520	JR1INZ/JDI	2	HA5KFL	1110	DM3ZDA	32
UP2BAO	2200	UK2PCR	14112	HA5-273	2592			HA8BY	1072	DM2FZH	24
UW0LN	2160	UK0FAI	13878	FE8957	2392	<b>CW SECTION</b>		DM3PAA	1072	DM3VLG	24
UK0FAD	2134	UK9UAO	7364	DM5724/C	2394	<b>Japan:</b>		HA5KHB	1024	EA4BV	20
UK6LBM	2002	UK9HAC	6525	DM9572/E	2320	JA7DAH	9350	HA5KNA	1020	OK2SGW	18
UK3XAB	1692	UA0TC	5486	DM9876/A	2016	JG11GX	8679	G5MY	1054	OK1KZ	18
UR2OD	1659	UA1DZ	4480	BRS15822	1846	JJ1KUV	7424	DJ5JH	880	DM2CLM	8
UL7PBY	1440	UV3CE	3650	DM7215/1	1680	JA7AMK	7260	G3KSH	816	SP6DMJ	8
UK2WAS	1034	UA3EAL	3312	DM9337/A	1320	JA2WB	7099	OZ1DTF	781	OH2KI	8
UK0ZAF	1023	UL7PBY	2967	DM9561/G	1120	JA9CWJ	6528	DM2BUB	759	SM6BBX	8
UH8DC	1020	UA6LBQ	2576	I067612	1008	JA6GU	6235	F6DY	756	SP5LM	2
UA9SBP	1010	UA3QAQ	2030	JA8-3769	840	JA3BK	6003	HA8KAZ	742	OH5Y	2
UW1LW	960	UW0IX	2028	I550661	812	JH0BBA	5973	SM5ACQ	705	OK1KCF	2
UA6ARX	954	UK9WBR	1800	DM9878/A	648	JR3WXA	5856	OK2ABU	700		
UO5OWC	936	UK4ABW	1615	HA7-517	528	JA1NI	5508	DM4YZA	675	<b>PHONE SECTION</b>	
UA6LHK	884	UR2FQ	1550	DL13266	540	JA2DCN	4867	OK1ATZ	650	<b>European Area</b>	
UL7PAZ	878	UK4FAV	1548	OZ1239	528	JA2BI	4030	LZ2KSB	598	DL8PC	22225
UA3QEL	800	UV3DN	1472	SP48/JG	230	JH3WKE	3666	YU4VOY	585	OE3NPW	8932
UK3AAR	795	UK5IBM	1408	DM9540/A	160	JA1AEW	2919	YO8ZF	506	G3TTJ	8816
UA6AYR	795	RA9CGC	1392	DM4406/G	120	JH2JEV	2772	G3PVA	468	PA0FSK	8758
UA0QDH	728	UK9CIU	1375	NL5288	120	JH1UUT	2672	OK3KJF	460	OZ5EV	8585
UK6VAF	702	UA0LEO	1364	JA9-2352	78	JA4CTL	2332	OK1FCA	448	DM2CMF	7500
UD6CN	689	UK6AAJ	1229	<b>CW:</b>		JA2P5V	2178	DJ6TK	432	DM2DTP/A	5539
UK5WAA	672	UD6HG	1134	HE9EVI	4260	JA1ODE	2093	OH2SX	432	I2VYR	5450
UP2BFE	611	UG6JJ	1134	HA5-745	2184	JH1MTR	1932	OZ1FRR	430	DL1KB	4752
UA6LLT	592	UL7MAR	1125	LZ2-P73	706	JA8SW	1566	Y08KGA	420	SP3KEY	4209
UB5MDI	565	UA9SBP	940	<b>PHONE SECTION</b>		JH1BCY	1275	4X4KX	408	HA4XN	4004
UO5AP	549	UA1AHZ	632	<b>Japan:</b>		JA2QZU	1088	HA5DE	352	4Z4KX	3738
UW3HY	492	UA9CBO	868	JR1WHW	28944	JA7EC	952	OH7NW	350	HA7/KLG	3600
UQ2GDM	450	UQ2GBW	656	JA7GLB	28280	JH4DRB	860	HA5JK	344	G3UVZ	3400
UB5UWG	429	UP2BAR	624	JA7YKA	17520	JA7JT/JDI	816	OK3CFP	342	DM3XI	3140
UA3TBQ	400	UK6VAF	621	JA2YKA	17520	JG1JMH	675	OK2OX	342	OK2BBI	3297
UL7PA	396	UO5AP	600	JA6LCJ	13431	JA1OUM	590	HA3HZ	320	XE1LLS	3087
UP2BEI	384	UF6QAC	598	JA7AMK	9870	JE3YJ	540	OK3CFP	342	DM2CDL	3068
UA6LCN	352	UA9YE	550	JR1GSE	9720	JJ1OSP	539	OK2OX	342	PA0EHF	3024
UA6APP	333	UA6LCN	540	JG1GX	9145	JJ1KZS	360	SP7HOV	260	I4CSP	3001
UB5WCB	333	RB5IWF	536	JA2YH	8845	JA2KPV	270	DM4ZA	260	DL1JF	2992
UA6LAH	308	UR2RAM	504	JA2YH	8845	JA8PON	260	OK1KLX	256	OK1QX	2904
US2OCS	304	UR2RAM	504	JA7YQ	7414	JH8KAN	240	DM2BJA	240	OK1AGN	2793
UA3ESN	296	UB5WCB	480	JH1VRO	6812	JR2AGL	196	PA5OTA	240	YO8ZF	2751
RB5IWF	288	UA1MU	468	JA2PSV	6524	JR2BDG	182	HA3GA	234	EA2IA	2751
UB5ZAT	210	UP2BBF	462	JH0BBA	6524	JE3OUU	140	OK1MKU	210	I1YBM	2480
UA0LDN	203	UK5WAA	420	JE2IEQ	5454	JA9SQJ	126	OK1CIJ	224	HB9IK	2457
UB5OE	200	UA0MI	396	JA8DHI	5035	JA6GGD	90	HB9DX	224	DM3WMJ	2392
UM8MBN	182	UR2QD	374	JA0JES	4225	JH0DNX	50	OH7UV	216	OH2PM	2261
UA9QBT	161	RB5IWF	371	JA6ABG	3427	JA1AAT	42	HA5NK	210	DM3OAA	2200
UA3IDT	150	UW1LW	304	JA9SQQ	3348	JK1LUY	30	HA5LX	210	LZ2RF	1920
UF6OAC	140	UA1AWA	288	JA5AHH	2717	JA9KGU	8	HA3HE	196	EA1TA	1890
UQ2PP	126	UP2BFR	287	JR3WXA	2480	JA6FYM	2	HA5HM	192	DM3SIC	1677
UL7EAT	120	UK5WBV	280	JF3TVD	2430			OK2BCI	192	GM4FDM	1666
UB5HCU	114	UB5HCU	280	JR3CVO	2266	<b>CW SECTION</b>		OH2PM	180	OK1AMI	1630
UR2OI	110	UA6AJG	144	JA7AQR	2244	<b>European Area:</b>		OH1LU	175	HA5KFL	1638
UK0LAD	107	UA2FBZ	132	JA6GGD	2196	SM5EVR	5445	YU75F	168	OK1STU	1479
UP2BEL	72	UC2BF	132	JA5CPO	1600	OE3NPW	4495	DM3ZUE	162	DM5ZFL	1376
UK2AAZ	48	UK5OBE	120	JR3CVJ	1375	DM3PO	4350	SM5CSS	160	EA3NA	1066
UH8EAD	45	UA1CAI	112	JR1PUO	1233	OH5UX	3870	OK1ZY	156	ON6JG	1034
UO5GX	36	UA6AKB	108	JA0FMB	1166	DL1YF	2825	DM4WFF	140	OZ8T	990
UQ2GFM	32	UP2BCD	100	JA2MYA	1065	DL0KF	2782	HA3QV	132	OK1JW	970
UW3UO	24	UJ6XCW	80	JH0IJC	1050	LZ2RF	2678	SM7CZC	126	HAKVB	966
UA6CP	18	UA3TAG	36	JH7UJU	900	SMSBAX	2475	YO2BEO	126	HB9AMA	780
UB5IFN	18	UO5GX	20	JA2OZU	780	DJ9CB	2438	OH5SS	126	I1SAT	774
		UV3CS	20	JA9AAZ	710	OZ1LO	2400	DM5BA	120	LA5NM	714
								Y05AVP	120	HA4YO	689

SM5CSS	684	DM30ML	104
OK2BJR	594	HA3KNA	90
DM4YZA	588	SP7HOV	76
LZ1QV	506	OK3ZFB	72
HB9DX	480	OH7UV	60
OH6IU	432	OH3JR	50
HB9BAM	378	YO6AWR/P	54
OZ2DM	369	DM4XCE	50
DM4WFF	322	F6DRP	50
DM4PSN	320	OK2SWD	48
SM0MC	300	SP9HWN	48
LA2AD	216	YO7NM	40
DM4SF	216	CT1AHG	40
YU7NZR	224	DM2FLN	36
LX1MH	224	SP9EPF	30
LZ2KKZ	270	OK1HCH	30
HA0IG	288	HA5HM	30
SM7ABL	288	OZ4PM	24
OK2SPS	216	OZ3KE	18
OH5UX	189	OK3CFP	14
DM2BGG	182	OH7NW	8
OH2KI	180	OK1KIR	8
PA0COR	176		
HA4XX	144		
OK1TW	144		
G5MY	144		
EA6DE	144		
DM2GFF	142		
OK1KYS	130		
OK3CFA	120		
LA4HA	120		
OK1CIJ	110		

PHONE SECTION	
North America:	
K0CL	20300
K3TW	18722
WA0TKJ	10881
K6BPY	10620
VC3GCO	9290
KB8JF	6630
K4KUZ	5238

K0SVL	4764
W5OB	3480
N7XX	3420
VE7VT	3322
W7LGG	3014
WD5DUD	2090
K9GM	1926
W9QWM	1444
AE5Y	1425
WA4QMQ	1027
W3CM	1001
N2LT	948
W1YOU	870
N3RL	740
K1MEM	680
VE2WA	590
K4BAI	590
N6NNV	304
WB4WHE	72
W2UL	56
WA3DMH	48

CW SECTION	
North America:	
W7IR	12558
K0FX	8576
W1EVT	6765
W5OB	4644
W8UVZ	4125
K3TW	3822
N2LT	2706
WA4OML	1547

K1MEM	1022
W7LGG	1008
AE5Y	624
KL7HBK	532
VE2AEJ/3	408
WA4QMQ	320
WA3DMH	224
N4QN	182
W8EAO	154
VO1AW	128
W1PWK	96
W0BMM	55
VE3JKC	30
W2UL	24

PHONE SECTION	
World:	
VP2ML	888
5WIBZ	18360
P29CH	4544
HS1ABD	35156

CW SECTION	
World:	
HS1ABD	10255
5WIBZ	23222

CW SECTION	
South America:	
PY1DHG	2040
PY1BOA	260
PY3CFD	80

Conditions this year were reasonably kind for the contest period. Some high scores were obtained by operators on 10 metres, but unfortunately there appears to have been no real contest DX stations around in VK/ZL or Oceania.

Checking logs, however, we found VK9NW, YJ8PD, 5W1AZ, VK9XW, P29NDX, ZD1KR, 3D2, KH2 were operating and in doing so gave many operators their first DX into that part of the world. Some log comments asked where were ZL5, VK0, Chatham, Willis—Lord Howe? All VK/ZL mainland stations were found in abundance, with the "N" calls in good proportions. Compliments to the many operators for their well laid out logs, specially those who used the organisation's summary sheets.

**COMMENTS FROM LOGS**  
**JR3CVJ**, I want that VK/ZL/O stations more QRV on 15m band. **JA1NI**, on same day we had big contest in Japan, so had some confusion. **JR2BDG**, I enjoyed this contest, would like to contact VK9 and VK0. **W3CM**, 10m did open, but not good enough for my dipole. I screamed my lungs out for **ZK1DR**, but never worked him, but had a lot of fun. **WDSUD**, I enjoyed working 49 great guys. **VE3JKC**, my first VK QSO, not bad for 3 watts hi. **SM3EVR**, activity seemed low but worked **VK4X?** and **ZL3GO** on 4 bands.

And that completes another contest, with the 1980 Contest being conducted by the NZART.

73s. Neil Penfold VK6NE.

# TECHNICAL CORRESPONDENCE

16 Carl Street,  
 Charlestown, NSW 2290  
 PO Box 74  
 21st November, 1979.

The Editor,  
 Dear Sir,  
 "SPREADING"

One hears this sort of thing on the HF bands from time to time: "He was spreading over 10 kHz . . . I tracked him out for 3 (or 4) kHz on either side of his signal and took readings on the S-meter at 1 kHz intervals and so was S9 all the way . . . overdrive, of course . . . some blokes can't be told."

This is utter nonsense.

Am I asked to believe in all conscience that the transmitter was actually radiating energy over the whole of the 10 kHz band of frequencies referred to above? Am I further asked to believe that the energy is of sufficient magnitude to sustain an S9 meter reading throughout the whole range? If queried on these points the observer would no doubt cite the evidence of his own eyes, accompanying it with a show of indignation. I suggest, however, that he would be overlooking two important points:—

1. The S-meter reading is not an indication of the magnitude of the energy received on the frequency to which the receiver is tuned. The S-meter reading is determined by the entire energy received by the receiver in accordance with its selectivity curve centred on the frequency to which the receiver is tuned. The compass of the selectivity curve may extend quite some distance frequency-wise from the frequency to which the receiver is tuned.

2. AGC will cause the sensitivity of the receiver to vary from point to point over the 10 kHz (or whatsoever) band of frequencies being considered. In the case of a very strong signal one would expect the receiver to be heavily desensitized over the centre 4 kHz or so and hardly de-sensitized at all at the extremities of the 10 kHz section being considered. Unless this change of sensitivity, arising from the action of AGC, is properly taken into account then S-meter readings don't mean much anyway!

We recently had the distasteful spectacle of a well known VK5 being harassed by a groups of VK2s who accused the VK5 of "spreading" on 20

## Quo Vadis?

From the numbers of CB manufacturers going to the wall, and the report that exports of Japanese CB equipment to the USA dropping by 78 per cent in 1979, and from the drop in numbers moving to amateur radio from CB, it seems that CB growth has reached its peak. The CB truckie movies, the TV shows and pop songs are history now, and even though there must still be interference problems, and big stories about rescues with CB, the stories just don't make the news much any more.

Perhaps this is the time for the amateur radio clubs to take stock of the situation. The present situation in the CB movement means that fewer prospective amateurs will be coming to fill the local club amateur classes. Those who wanted to upgrade have already done so.

Let's face it. At the peak of the CB rush, amateur radio never had it so good. We had a growth rate hitherto unprecedented, and all for so little effort. From hereon it's not going to be quite so easy.

How can we avoid the stagnation in radio activity and growth?

● Firstly, we're no better advertisers than we were then. How many clubs

have a regular splurge in the local radio shop? How many clubs have put on a display of gear (under glass) at the local store or bank?

- How many clubs canvass their local schools to see whether they have any electronics courses, or try to encourage interest from the school staff in starting a school radio club as a "feeder" for the area club? Has the school had an offer of help from the club?
- How about co-operating with your local show society to run a competition for constructors of radio gear, simple and complex.
- Is your club the kind of place that members look forward each week to the next club night?
- How welcome is a newcomer or visitor in your club? Do you have a roster of members to welcome strangers and show them over the place, or is such a person the object of furtive stares?

What's your idea—where will your new members come from?

By Ken Hargreaves VK2AKH, Editorial from Zero Beat, March 1980.

metres. I checked out the VK5 by scientifically-correct methods on a number of occasions, and on every occasion that I checked him the bandwidth of the channel that he was occupying was no more than 3.5 to 4 kHz. You would not call this "spreading"! Certainly the signal was very strong at times.

I have here before me, as I write, a letter from a well known VK2 who says inter alia: ". . . asked him to reduce his audio gain as he was spreading well above his operating frequency . . ." I suppose it is more socially acceptable within the amateur movement as at present constituted to say: "The VK5 spread" rather than to say: "My receiver lacked the necessary selectivity to discriminate against a very strong VK station only a few kilohertz away; I was not helped in this difficult situation by my AGC, which persisted in attempts to operate the receiver at its maximum

sensitivity". This fairly puts the blame where it properly belongs—on the inadequacies of the receiver—and not (quite unfairly) on the transmitter.

To conclude, I commend this simple experiment to the experimentally minded: Find yourself a station that you believe to be "spreading", preferably someone who is making a long speech. Incapacitate the AGC. Tune the station under manual RF gain control so that he is coming in nicely at comfortable strength. Disregard the S-meter. Now without touching the gain control (this is most important) tune off on either side in turn. You may be astonished to find how rapidly, frequency-wise, the signal disappears from view, or should I say audibility. No sign of spreading! I leave you to ponder your observations.

Yours faithfully,  
 Colln Yates VK2AGZ.



# CONTESTS

Wally Watkins VK2DEW  
Box 1065, Orange 2800

## June:

- 14/15 VK/ZL/OCEANIA RTTY CONTEST\*
  - 21/22 21st ALL ASIAN PHONE CONTEST
  - 21/22 WEST VIRGINIA OSO PARTY
  - 28/29 ARRL FIELD DAY
- \* This is not a WIA contest.

## July:

- 1 CANADA DAY CONTEST
- 20 RSGB WAB LF CW CONTEST
- 26/28 COUNTY HUNTERS CW CONTEST

## August:

- 9/10...REMEMBRANCE DAY CONTEST
- 9/10 EUROPEAN CW CONTEST
- 23/24 21st ALL ASIAN CW CONTEST

## October:

- 4/5 VK/ZL/OCEANIA PHONE CONTEST
- 11/12 VK/ZL/OCEANIA CW CONTEST

## 21st ALL ASIAN CW CONTEST

### ASIAN COUNTRY LIST

A4, A51, A6, A7, A9, AP, BV, BY, CR9, EP, HL/HM, HS, HZ/7Z, JA/JE/JG/JH/JI/JJ/JR, JD1/JT, JY, OD5, S21, TA, UA/UK/UV/UW9-0, UD6/UK6C/D/K, UF6UK6F/O/Q/V, UG6/UK6G, UH8/UK8H, UI8/UK8A/G/I/L/O/T/Z, UJ8/UK8J/R, UL7/UK7, UM8/UK8M/N, VS6, VS9M/8Q6, VU, VU/A, VU/L, XU, XV, XW8, XZ, YA, YI, YK, ZC4/5B4, IS (Sprally), 4S7, 4W, 4X/4Z, 70 (Yemen), 70 (Kamarnan), 8Z4, 9K2, 9M2, 9M8, 9N1, 9V1.

## JOHN MOYLE MEMORIAL FIELD DAY 1980

Once again this contest proved to be very popular and there were a few newcomers on the list. The standard of log was excellent and made checking a pleasure. The rivalry between clubs makes this annual event the success it is. Thank you for participating.

## "THE OOPS WE GOOFED IT AGAIN DEPT." — 1979 RD ERRATA, ETC.

Add to VK6 CW — VK6WT 1620 now first place; add to VK2 Phone — VK2AGF 669; change VK6 CW and Phone — VK6FI to VK6IF; change in VK5 Phone VK5NCL to VK5NLC.

## SUNSHINE STATE JACK FILES MEMORIAL CONTEST 1980

### AIM

1. To prepare Queensland Radio Amateurs for the 1980 Remembrance Day Contest.
2. To enable Queensland Radio Amateurs to complete the "Worked all Queensland" Award.

### OPERATING TIMES

Saturday and Sunday, July 19 and 20, 1980. A total of 8 (eight) hours of operation, divided as follows:  
Saturday, July 19: 0830-1230 GMT (1830-2230K).  
Sunday, July 20: 0000-0400 GMT (1000-1400K).

### SECTIONS

- (a) \*Transmitting ALL authorised radio amateur frequencies.
- (b) \*Transmitting HF only.
- (c) \*Transmitting 50 MHz and up.
- (d) Receiving ALL bands.

\* The 1979 Queensland Radio Club Workshop resolved that, for local contests, only specific frequency sections be used, so as not to cause interference with normal amateur traffic. It is hoped that by giving this example National Contests may follow suit.

The following frequencies on the HF bands only will be used for the Jack Files Contest:

†1.810-1.820 MHz, 3.525-5.575 MHz, 7.000-7.060 MHz, †14.125-14.175 MHz, 21.125-21.175 MHz, †28.200-28.450 MHz.

† These frequencies are applicable for section (b) for Novice and Full Call use.

VHF and UHF contestants will follow accepted band plans.

## SCORING

1. (a) One (1) point per contact on each band.  
(b) A BONUS score of ten (10) points for the FIRST contact made into a City, Town or Shire, each band. These bonus points will only apply for the first contact on BOTH days, NOT FOR EACH DAY.  
(c) CW to CW contacts will attract DOUBLE points, including bonus points.
2. 50 MHz and up:  
The same scoring as under 1(a), 1(b) and 1(c), PLUS ADDED points for distances worked:  
0-50 km, no bonus points; 50-100 km, 2 (two) points; 100 km and over, 5 (five) points.

## CONTACTS

- (a) One contact per band per mode per hour.
- (b) Cross band and mode contacts are not permitted.
- (c) Terrestrial VHF and UHF repeaters are not permitted.

## LOGS

These are to show:

- (a) The section(s) entered.
- (b) Points claimed for each contact (if not filled in correctly, only 1 (one) point will be allowed).
- (c) VHF and UHF logs must show the distance in kilometres between the stations.
- (d) Logs to show: Date and time in GMT; band and call sign of station worked; report and serial number sent and received; bonus points claimed, where applicable; for 50 MHz and up, distances over 50 km.

Closing date for logs is August 29th, 1980, and addressed to WIA Queensland Contest Manager, PO Box 964, Townsville, Qld. 4810.

## AWARDS

A trophy will be awarded to the highest scorer in each section.

Good luck and let those logs roll in!  
Dave Noble VK4NOB, VK4 Contest Manager, 1980.

## MOORABBIN AND DISTRICT RADIO CLUB ANNUAL MID-WINTER FIELD DAY, 1980

### DATE

Sunday, July 13th.

### TIME

11 a.m. to 4 p.m. E.A.S.T.

### SECTION A

VHF. Any band 52 MHz and above.

### SECTION B

28 MHz only.

### MODES

Any authorised mode may be used.

1. All stations must operate within the terms of their licence.
2. Portable stations must be located not less than 2 km from their home QTH.
3. Portable stations must not use private or public mains supply.
4. Any station may be worked twice provided that at least two hours elapse between the two contacts.
5. Net frequencies or repeaters must not be used for scoring contacts.
6. No cross band operation permitted for scoring purposes.

### 7. SCORING

Section A: VHF/UHF. Portable to portable.

- 4 points per km up to 500 km on 52 MHz;
- 1 point per km over 500 km on 52 MHz;
- 4 points per km for all contacts on 144 MHz;
- 12 points per km for all contacts on 432 MHz;
- 16 points per km for all contacts on 576 MHz;
- 24 points per km for all contacts on 1296 MHz.

N.B.: Scoring for portable to fixed stations are half above.

Section B: 28 MHz. Portable to portable.

- 4 points per contact within your own call area;
- 2 points per contact outside your own call area.

N.B.: Scoring for portable to fixed stations are half above.

Bonus Points both sections:

All contacts with MDR Club station VK3APC count double.

8. All competitors are limited to only one operator at any one time.
9. ENTRIES: Entries will be accepted from any portable station subject to Rule 8 above. NO ENTRY FEE REQUIRED.
10. FORM OF ENTRY: Log extract with all points calculated and totalled.

Post to: Contest Officer, Moorabbin and District Radio Club, PO Box 88, East Bentleigh 3165, Vic., to arrive not later than August 11th, 1980.

11. Winners of each section will receive Honorary Membership Certificate, 12 months Club membership, 12 months subscription to the MDRC magazine.

All enquiries to Graham Mason VK3YGM. Phone (03) 95 8108.

# INTRUDER WATCH

Graeme Fuller VK3NXI

As you all know, I took over the position of Federal Co-ordinator from Alf VK3LC in January. I am not sorry on taking the position but very disappointed with the lack of response in reporting intrusions into our bands.

At a recent meeting with the Frequency Management Division of the Postal and Telecommunications Department it was impressed upon me that, owing to the lack of reports coming in, it wasn't worthwhile following up complaints. Furthermore, if more complaints were received (with bearings) more action would be taken.

When one considers there are only approximately 20 individual reports coming in each month from an estimated 12,000 amateurs, one can't really blame the authorities for not taking action under these circumstances. The only answer is to send in reports and not sit back cursing under our breaths, hoping someone somewhere will do something about these intrusions. You as amateurs are the only ones that can do anything about it, or else just sit back and put up with whatever comes along.

I sometimes wonder if there would be an outcry if a few stations intruding in our bands were to use phrases like 10-4, Good Buddy, what's your 108, etc., etc., it's just the same as having pulse, FI and AO, etc., on our bands all the time. With the ever increasing intrusions into our bands, how long before they are totally unusable?

Recently it was brought to my attention that the Intruder Watch monitors job was to report on misconduct by fellow amateurs. This of course is totally untrue. The behaviour of amateurs is monitored by an advisory committee not Intruder Watch monitors.

Intruder Watch monitors have a regular sked Thursday evening, 1030 GMT, frequency 3.540±. Originally it was 3.620, but owing to ORM we have moved down the band. Anyone at all is invited to join in, perhaps to make a complaint or enquire about our activities.

Graeme Fuller VK3NXI, Federal Co-ordinator.

## QSP

### PREFIXES

During 1980 amateurs in Belgium may use the prefix OR in place of ON. This is part of the 150th anniversary celebrations of the independence of the Kingdom of Belgium. Employees of the RTT (Regie des Telegraphes et Telephones) may use the prefix OT in place of ON to mark the 50th anniversary of the founding of the RTT — this is also throughout 1980.

# IONOSPHERIC PREDICTIONS

Len Poynter VK3BYE

# YOU and DX

Mike Bazley VK6HD

8 James Road, Kalamunda W.A. 6076

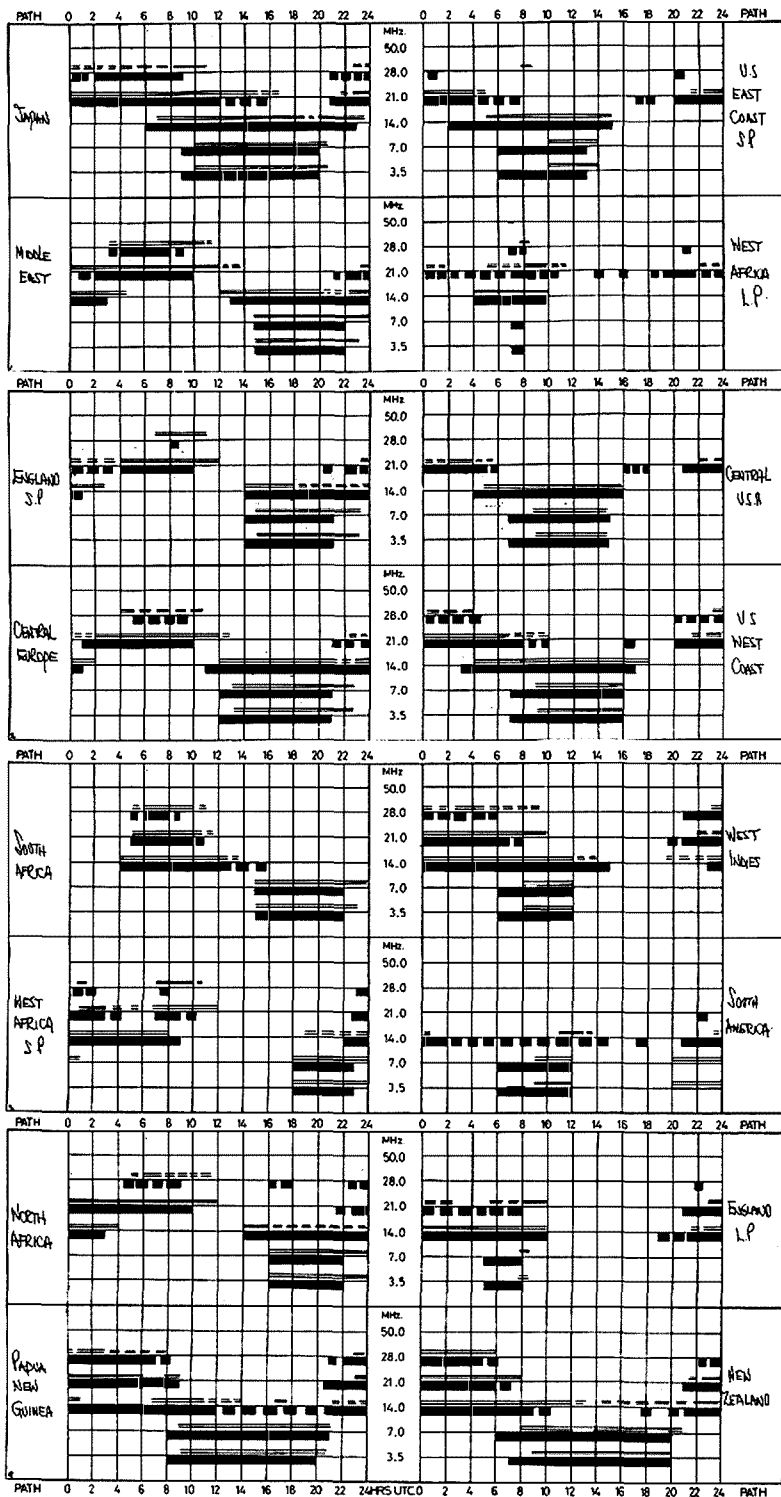

**LEGEND**

- ▬ FROM WESTERN AUSTRALIA
- ▬ FROM EASTERN AUSTRALIA
- ▬ BETTER THAN 50% OF THE MONTH, BUT NOT EVERYDAY.
- ▬ LESS THAN 50% OF THE MONTH.

PREDICTIONS COURTESY I.P.S. SYDNEY.

ALL TIMES UNIVERSAL UTC (GMT).

Amateur Radio is a great hobby! I do not expect to get any disagreement to that statement, but is Amateur Radio as good as it used to be? Speaking for myself, I have always been interested in DX, firstly as a listener then as a licensed amateur. Thinking back 30 years ago, my first transmitter and most of my first receiver was built from other amateurs' junk boxes. All QSLs seemed to go via the bureaux, there were no DX news sheets or DX nets, and a DXpedition was really an unknown quantity. To be able to work a hundred countries required patience and listening ability. Nowadays we have Instant QSOs, DXCC in a weekend, DXpeditions, IRCs, news sheets telling us where such and such a station is going to be at such and such a time. No one seems to have a junk box any more, and to suggest building a 10 watt Tx with a 6L6 final, well!!! (What is a 6L6?)

Yes, I still get a kick out of chasing the DX, but if I'm to be honest with myself, perhaps I object to the new breed of younger amateurs showing me how it should be done. Good old nostalgia!

From VK3OT comes news of his recent trip to VK9 (Christmas Island) signing VK9XT. To quote from Steve's letter —

"At the time of writing the following results are evident from my one man assault on the DX world, VK9XT.

- 1,700 JAs on 6 metres.
- 11 countries on 6 metres.
- 12,500 HF QSOs on all bands.
- Majority on 10, 15 and a lesser part 20.
- 750 on 40 CW.
- 10 on 80 CW/SSB with VK6, one VK7, one W6, one JA3.
- Nil on 160 metres.

As far as a band plan, the Indonesian amateurs use AM right down to 3500, so it is virtually impossible to copy VK amateurs on 80 especially since the band only comes good at 13.00 UT. Some of the calls worked here included: C5, JY, JT, YU, TY9, TZ, EP3, JW, JX, VK0, CP6, VR6, 9A1, 7X2, J28, UM8 U18, UJ8, UG6, UD6, UF6, UK1PAL, GD4, GJ4, HR1, PZ1, HK0, S2, VU2, AP2, A7, A6, A4, HS, 9N, 9G1, TJ1, ZS3, SV5, SV0, 9H, OJ1, OH0, OY5, EI, etc. etc.

Operating was for 17 hours per day with an average of three contacts each minute for the total operating time. Single op., single transmitter and single quad ant.

Thanks go to Craig and Lois Woodford for their hospitality, bed and meals which ensured the continuity of the operation over the 18 days. QSLs direct only to VK3OT with 22 cent stamped addressed envelope for VK and sufficient postage for return for the rest."

Jill VK6YL forwards extracts from a letter she recently received from Moody VS5MS, which is as follows:—

"The other day my QSL manager sent me my first batch of cards, to tell you the truth I was overwhelmed by all the kind words and good wishes. I only wish I had the time to reply to each card myself. In such troubled times it's nice to know that there are still some good people walking this earth.

Maybe you will do a little something for me! If you have the time in your local ham paper, magazine, etc., could you on my behalf send a letter thanking all the hams in Australia for all their cards, their goods wishes, and the very best of 1980 to all the Roos, Hi! —not forgetting the Tas.-devils. In 1979 I really had a wonderful time DXing to Australia, twisted quite a few tails — and in general had a wonderful time with your ham friends and the girls and guys on the Natter Net. Also for information N200 is my manager. I am sure there are a few people that are still fuming because VS5MS has not replied to their cards! So N200 is the man to track down."

Whilst writing about VS5MS, I was sorry to learn that his father, 9M2AT, is now a silent key. Our condolences to Moody, and we are sorry to know that the amateur radio ranks will now be a little poorer.

A reminder not to neglect those LF bands during winter. Even though 10 may be wide open, 80 and 40 still carry some worthwhile DX. Stations worked from the West recently include A7XE, FH0FLP, GQ4BEG, JW7FD, S8AAP, ZD8TC, 4S7OL, 4S7DA, 6W8DY, 8Q7AR, and 8Q7AW.

The Heard Island DX Association has been formed to plan a major DXpedition by a group of experienced operators. Dates are given as between December 1980 and February 1981. As the cost of mounting such a DXpedition is considerable, offers of help, monetary or equipment, are sought. It is suggested that if you wish to help you can contact P29JS for further details. (G. Watts News Sheet.)

It has been reported that N4HX/TT8 had to leave Tchad in a hurry due to the recent change in the political situation. The ARRL are accepting his cards for DXCC though at the present time QSLs from TN8AJ are not being accredited.

This really is the last DX notes that 6HD will be writing for some time. Many thanks to those who have given news and to those who wrote asking me to continue. When I accepted the position, I did so on the understanding that it would be for one year only. I hoped (I do not know how this fits in with AR editorial policy) that different people would write for successive one year periods. Thanks to VK3DU, VK3OT, VK6AJ, VK6RZ, VK6LK, VK6YL and L70107.

Vy 73s ex DX Mike VK6HD.

**QTHs YOU MAY HAVE MISSED**

- A4XHI — Box 8530, Salalah
- C07UP — PO Box 41, Camaguey, Cuba
- H5SAID — Box 169, Chiang Mai, Thailand, or via AG8D
- FK8AI — via I0PQ
- FR7BE — via W4LZZ
- H44AJ — PO Box 151, Honiara, Solomon Is.
- HZ1AB — via K8PYD
- JY3ZH — via DJ9ZB
- JY5ZM — via WB4RRJ
- KC6BS — via JH7LMZ
- KH3AA — Box 89, APO, San Francisco
- SV9JL — Box 502, Heraklion, Crete
- TG8DX — via W3HNK

During 1979 WICEN became very strong in the southern area. At the present time we have twenty-one registered members and about fifteen of these have taken part in exercises during the year. Two exercises were conducted: the first to provide back-up communications for the Boy Scout Regatta at St. Helen's in May; the other was in the Lakes Pedder and Gordon area in October with the Police Search and Rescue Unit. An experiment was also conducted to determine the propagation of 160 metre signals in caves, in conjunction with the Police SAR Unit and the Southern Caving Society, in December. Finally a field day was held at South Arm to give the portable equipment (including RTTY) a good workout.

As a general comment, two things can be said about these exercises: firstly, that all who took part in them enjoyed themselves (it is only a hobby!) and, secondly, that a lot was learned about equipment and techniques, and how these could be applied to best effect in an emergency. Five individual amateurs have assembled complete stations into a rugged "box" capable of being taken into the field as a self-contained unit. The boxes contain an HF SSB transceiver, HF antenna tuning unit, 146 MHz FM transceiver, 240V AC-12V DC power supply, and even a 12V light. Combined with the 9 metre portable aluminium masts, which support an inverted-V HF dipole and a 146 MHz ground-plane or coaxial dipole, a complete HF/VHF station can be operational within 10 minutes.

Portable 2m repeaters, assembled from mobile transceivers, have been developed and tested, and five sets of patch cords and modified transceivers are now available. The complete details will be revealed in a forthcoming article in "Amateur Radio". Battery lead and aerial connector conventions have been agreed upon, and work is continuing on construction of a patch system from HF to VHF and vice versa. There is also some experimentation being carried out with 160 metre transceivers, following the encouraging results of the joint exercise. At this stage it appears that we may be able to provide radio communications underground in some situations.

The Police SAR Section has contacted the employers of southern members and obtained agreement for release of personnel if required in an emergency.

In the other areas of the State, the northern branch conducted three WICEN exercises, two associated with car rallies run by the Light Car Club, and one with the mini Olympics run by the St. George's School Parents' and Friends' Association. Six amateurs from Launceston registered with WICEN (by returning the questionnaire) and hopefully 1979 will be seen as the beginning of a strengthening of WICEN in that area.

Apart from some monitoring of the Lake Pedder exercise by individual amateurs, there has been no WICEN activity in the north-western area.

Looking to 1980, there are three things which I would like to see occur. The first is the commencement of WICEN activities, field exercises and related technical activity in the north-western area. While the response to the questionnaires was not very good, I know that there are many north-western members interested in WICEN, and I hope that the activities of the southern group in 1979 will give them some idea to start off with. Secondly, the interested members in the north must become a more active and identifiable group. And finally, on a State-wide scale, I hope that some formal training in WICEN procedures, based on the syllabus prepared by the Federal Co-ordinator, will commence.

In conclusion I would like to thank the WICEN Co-ordinators who have assisted me during the year, and all those members who have participated in WICEN activities. I can only hope that they enjoyed the year as much as I did, and that we can arrange things in 1980 so that WICEN becomes even more effective, and the interest of members is maintained at the present high level.

Andrew Boon VK7AW, State WICEN Co-ordinator.

PS WICEN: Wireless Institute Civil Emergency Network . . . providing a pool of trained, licensed operators, with equipment, available for deployment to aid communications in an emergency.)

# AMATEUR RADIO ACTION

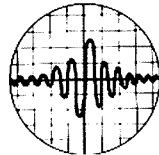

is the NEW GENERATION amateur magazine.

- ★ Comprehensive DX notes
- ★ Propagation forecasts
- ★ Very technical - and not so
- Technical articles
- ★ Useful projects

Hera are just a few of the articles which have appeared in recent months

- ★ Fixed wire beams
- ★ Case for UHF beacons
- ★ 80W linear for 6m
- ★ Wilson System Three review
- ★ Spratly DX exclusive
- ★ Backyarders - good or bad?
- ★ A.T.V. Special
- ★ SWL notes

Average page content is 80 pages - at \$1.20 an issue that's good value.

Please put me down for 12 editions of Amateur Radio Action, starting NOW-

Rates in Australia - \$14.40. Surface mail overseas - \$18.40 Air mail: To New Zealand - \$A28.70; Malaysia - \$A32.60; Japan - \$A38.45; USA - \$A42.35; UK - \$A46.25

Herewith enclosed cheque/postal note/money order to the value of:

\$A .....

Name .....

Address .....

Postcode .....

Post to: Amateur Radio Action Subscriptions, Box 628E, Melbourne, 3001.

## WICEN

Ron Henderson VK1RH

Federal WICEN Co-Ordinator,

53 Hannaford St., Page ACT 2614

Ph. (062) 54 2059, A.H.

**WICEN VK7 ANNUAL REPORT 1979-80**

Since this is the first formal WICEN Annual Report for a number of years, I will briefly outline events and activities since the WICEN organisation was rejuvenated, starting with June 1978.

At that time the WIA was asked to attend a seminar on Search and Rescue Communications, and the inaugural meeting of the State Disaster Communications Planning Committee, set up by the State Emergency Services. The previous State WICEN Co-ordinator, VK7RR, delivered a paper at the SAR Seminar (organised by the P. and T. Department), and I attended the SDCPC meeting, initially as Assistant Co-ordinator. The SAR Seminar was mainly concerned with the problems of communications between air and sea, also air and land, but the capabilities of amateur radio operators was explained to the relevant authorities.

The SDCPC has been meeting at regular intervals since June 1978, and has recently completed the communications sub-plan of the State Disaster Plan. The bulk of this plan is taken up with a complete list of the communications resources of the various bodies represented. It is interesting to note that WICEN is the only non-Government organisation represented on the Committee, and the WICEN section of the plan describes the organisation, functions, contact points, equipment, frequencies and modes available.

# LETTERS TO THE EDITOR

Any opinion expressed under this heading is the individual opinion of the writer and does not necessarily coincide with that of the publisher.

PO Box 11, Woomera,  
South Australia 5720.  
5th March, 1980.

The Editor,  
Dear Sir,

## MARITIME DISTRESS WORKING ON AMATEUR FREQUENCIES

With reference to the QSP on page 19 of Amateur Radio, February 1980, about the "White Wave" (VK4NXV/MM) incident in the Indian Ocean, I would like to add some pertinent information which shows how useful our service can be, with members all over the world, when someone gets into trouble. On occasions, as at this time, the official authorities appear to be unable or unwilling to do anything to assist.

There were of course many stations involved; perhaps I might mention the principal ones, Doug VK3YK, Tom VK6TB, the yacht "Rainbow" (Frank) VK8AB/MM also in the Indian Ocean, Barrie 9M2RR, Nara 9M2LN, Mike and June ZS2MJ/ZS2JJ, 3B8DA, and ZS6AQY to whom credit must go for causing search and rescue operations to be initiated. Also to the SEANET (not restricted to South-East Asia) controllers' QSP'd updates to stations all over the world. I discovered after suggesting a 21 MHz similar net that Don VK7DK, 9M2LN and 9M2RR had already discussed this a few months previously; I understand that although nothing formal has yet materialised, many ideas have been kicked around including running both simultaneously—something like this could be of value in future. Fortunately for all involved the assistance of the South African emergency services was obtained as a direct result of a change QSO 3YK had with Dennis ZS6AQY at 1050Z on 4th December. Dennis is an airline captain from Johannesburg, who immediately telephoned the authorities in Cape Town, and I suspect pulled strings as results occurred at daybreak.

May I emphasise that VK4NXV/MM was eventually located as a result of a CW SOS transmission, that outdated inefficient mode that some people would have thrown out of the window. They had flat batteries, a jury-rigged antenna and a busted microphone. If CW was deleted from the requirements for operation, eventually OTs (who can read it) would be silent keys and nobody would be around to recognise a distress call.

Thanks should also go to Col VK1AU who personally contacted Marine Ops in Canberra with as little effect as VK4SE had a day or so earlier; I understand that Marine Ops had a regular telephone sked with Steve so that they could be updated!

The usual congestion around 21.150 MHz eased after a few days. Literally hundreds of people all over the world were listening in relays around the clock for the eventual QRPppppp SOS several days after the last R/T transmission that told us all that there was still life there, and which a ship standing by with fuel for them was able to D/F on to.

To change to a different but related subject, may I comment on VK2DQS's letter to the editor in the same issue of "AR" concerning operators not knowing what to do when confronted by a "Mayday". I am not by profession a marine operator, though I do hold the 3rd Class Commercial Operator's Certificate of Proficiency in telephony and telegraphy, was for a brief period a pilot with the Royal Air Force and was for several years a member of the British Life-Boat Service, so feel reasonably competent to comment on emergency procedures.

A distress message may be originated by a station not in distress itself if (1) the station in distress is unable to transmit, (2) the person responsible for the station considers further help is necessary, or (3) it has heard an unacknowledged distress message. Under international maritime law the control of ALL traffic is the responsibility of the station which SENDS the original distress message, unless that station delegates the respon-

sibility to another station. The control station has absolute authority to impose silence on ALL OTHER TRAFFIC, not only on that but on adjacent frequencies. These points are stated categorically in the handbook quoted above.

To conclude, silence periods are enforced on marine calling frequencies for three minutes past each hour and half hour on phone bands, and past the quarter past and quarter to on CW bands, regardless of whether or not any distress traffic is being handled; this to enable weak signals to be heard without QRM. It might be an idea when conducting maritime and other emergency traffic handling in the future to adopt this international practice; we may be amateur operators but let us not operate amateurishly! Let's learn what to do and what not to do (perhaps more important) if we are to preserve our public service image. In addition perhaps the IARU might be asked to recommend a 5 or 10 kHz "slot" on the 20 and 15 metre bands to be used for the ever increasing maritime mobile amateur traffic, both for emergency and routine check-in purposes, as is done on 2162 and 8204 kHz by the professionals. Maybe the parallel SEANET discussions will produce some thoughts along these lines.

I would be extremely happy to talk about and expand these ideas with anyone, either on air or through the mail (SASE please).

Vy 73 de VK5DQ.

C. R. W. Ashton.

(Apologies that space precludes publication of the Distress and Urgency Signals section from the P. & T. R/T Ship Station Operators' Handbook but the new Amateur Handbook expands slightly on this subject.—Ed.)

The Editor,  
Dear Sir,

Anybody who has followed the recent activation of Heard Island will be disappointed in the misfortune suffered by the people involved. Even if all had gone well, the size and duration of the operation (indispersed as it was with the requirements of a scientific expedition) meant that the total of anticipated contacts would not exceed around 1000 QSOs.

Prior to VK0RM, Heard Island had not been activated for 8-10 years and has never been the subject of a full blown DXpedition. It is intended to try and change this situation within the next 10 months.

The Heard Island DX Association has been formed for the purpose of activating Heard Island.

A considerable amount of research has already been done in conjunction with the scientific expedition which took place in March this year. During the coming months further work involving the necessary logistics to support a serious amateur DXpedition to Heard Island will continue.

The Australian authorities concerned have indicated that there would be no serious objection to a well planned, well founded and good intentioned amateur DXpedition. It is intended that the Association will offer a place in the team to a professional scientist to carry out research on Heard Island over the duration of the DXpedition.

It is anticipated that the team will consist of a number of experienced "contest type" operators who, while capable of dealing with the tremendous demand that exists for Heard Island, will have the capability of offering other skills which will contribute to a successful operation.

The financing of any major operation invariably creates problems; the costs of mounting this DXpedition will be considerable. Many people and DX groups have indicated a tremendous interest in the activation of Heard Island and offers of assistance have been numerous.

Funding of the 1980-81 DXpedition will be based on the following criteria:—

- Each member of the amateur team will be required to contribute to the expedition fund.
- Individual donations will be accepted.
- Offers of financial assistance from the various amateur radio societies, radio clubs and DX groups will be accepted.

(d) Residue of funds accrued after completion of QSL commitments.

A trust account has been established by the founder members of the Heard Island DX Association to account for the funds received, and receipts will be issued for all contributions.

In the unlikely event of the DXpedition not taking place as scheduled, all donations will be either refunded or allocated to another DXpedition or worthy charity. In either event, all donors will be notified personally.

Firm offers of radio equipment have already been received. But no offers of ancillary equipment, antennas or power supplies, etc., have as yet been solicited.

Owing to weather conditions the time slot available is mid-December to mid-February. As you can see the time factor to allow an operation to take place in 1980 is very limited.

We would seek your help in, firstly, publishing the intended venture as widely as possible and, secondly, in requesting fellow amateurs to support the DXpedition in any way they can.

We thank you for your co-operation and assistance in helping us to activate one of the most difficult and rare DX countries in the world today.

Yours faithfully,

Jim Smith P29JS,  
President Heard Island DX Association.

13-15 Bewley Street, St. Arnaud, Vic. 3478.  
11-3-80.

The Editor,  
Dear Sir,

At around 10.30 a.m. EAST on 9-3-80, I had just concluded an SSB QSO on 7042 kHz when a "voice" broke in with "This is the official International RTTY frequency. Move off this frequency—AND STAY OFF!!" Such an unmannerly outburst rather flabbergasted me, and I neglected to ask for a station identification.

Apparently "the voice" was not aware that "the amateur is always courteous", or perhaps felt himself the Almighty's gift to amateur radio?

His fundamental frequency was around 7041.5 kHz. I can find no official reference to an allocation of an International frequency (exclusive or shared) for RTTY. The only reference I can see is to a WIA-VK2 broadcast on 7045.

My first inclination was to refer the matter to the Licensing Branch but on consideration feel the interests of amateurs generally would be best served if you would publish what information you have. It is unfortunate that I did not identify the station, but hope you may enlighten me and, I feel, lots of others.

Many thanks and 73.

Harry M. Finnigan VK3PX.

## EDITOR'S NOTE:

Although the "gentleman's agreement" still applies on the various modes for each band, there is no excuse for blatant rudeness by fellow amateurs. No frequency belongs to any one person or group (the WIA included).

The details of the agreed Band Plans, both International and local, are published on page 24 of the current Call Book.—VK3UV.

## QSP

### YRCS

It seems much too long since this abbreviation hit AR but rest assured it is alive. "Zero Beat" is the national quarterly of the Youth Radio Scheme and is edited by Ken Hargreaves VK2AKH. Where to obtain details of YRCS clubs, how to start one and other details? The March 1980 Issue of Zero Beat lists addresses of three States, nothing is known about the others. For VK2 write to VK2AKH (QTHR), for Victoria Roy Hartkopf VK3AOH, and for VK5 and VK8 the Secretary is Maxine McEvoy, 5 Tyne Avenue, Kilburn 5042. Study material for novices, AOCPC candidates and morse code C60 cassettes are obtainable from the WIA NSW Education Service, Box 109, Toongabbie 2046.

## AROUND THE TRADE

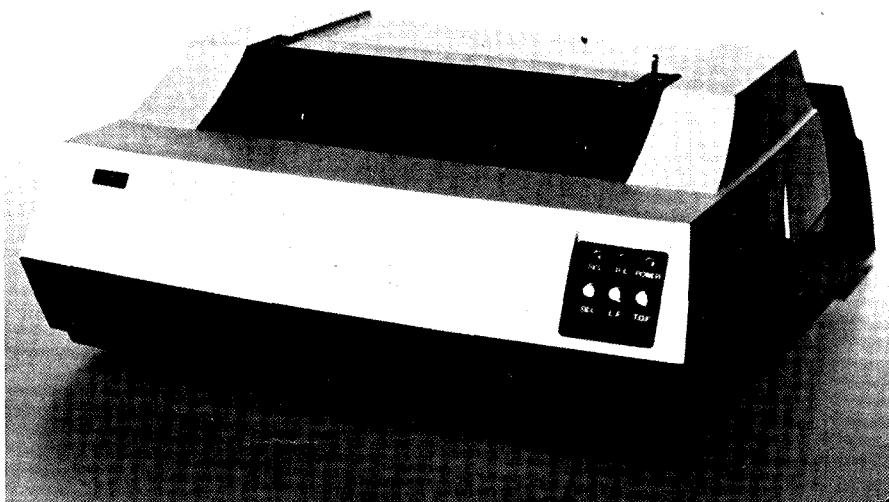

### TONO DOT MATRIX PRINTER

The Tono Corporation has released the HC800 matrix printer, incorporating the latest microprocessor technology. The unit has been specifically designed for connection to the Tono series of communications computers but can also be connected to any microprocessor having standard interface.

The HC800 features ● Adjustable forms width — from 155 to 240 mm ● Programmable character width — normal, double or narrow width (60, 40 or 132 columns/line) ● Internal buffer holds full line of characters ● Software programmable vertical format unit (VFU) providing full control of vertical formatting by the computer via control codes (when using with microprocessor) ● Manual control panel allowing convenient override of main control functions. Also status indicators ● Paper feed from either underneath or at rear ● Takes readily available paper and ribbons.

Specifications include: ● Bidirectional matrix-type impact printer taking standard fan-fold sprocketed paper between 115 and 240 mm wide ● Print speed 125 characters per second ● Throughput speed 64 lines per minute (form feed speed 10 lines per second) ● Full upper and lower case ASC11 character set (96 characters) ● Character format 9 x 7 dot matrix ● Character spacing 10, 5 or 16.5 characters per inch (80, 40 or 132 columns) — software selectable ● has inbuilt 80 byte character buffer, self-test string generation facility, software programmable vertical format unit ● Interface: 7-bit parallel, Centronics type. Signal levels TTL compatible ● Power consumption 7W on standby, 80W when printing (at 240V AC) ● Data input ASC11 (9½ characters).

Retail price is around \$970 and the unit should be available from May from Vicom Pty. Limited.

For further information contact the distributors, Vicom International Pty. Ltd. on Sydney (02) 435 2766 or Melbourne (03) 699 6700.

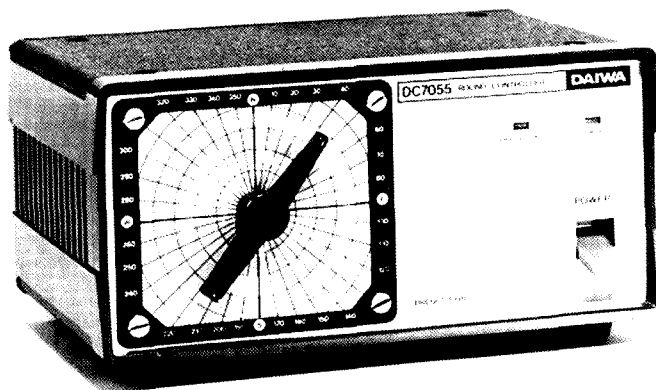

### NEW DAIWA ANTENNA COUPLER

Daiwa Company of Japan has released a new range of antenna rotators which incorporate a map of the world — centred on Australia.

Two new control boxes are available for both the heavy and medium duty rotators. With the "pre-set" type of controller the antenna direction is set by turning the knob to the correct bearing for the country concerned. The rotator then turns to the desired heading.

The other type of controller uses the traditional method of pressing a button until the direction pointer stops at the correct bearing.

The Daiwa range of rotators is distributed in Australia and the Pacific by Vicom and are available at most amateur radio dealers.

### ICOM SOON TO RELEASE NEW WARC HF RIG

Following the success of the IC701, ICOM will soon release an additional HF transceiver to be known as the IC720.

The IC720 will incorporate all the new WARC frequencies together with a general coverage receiver up to 30 MHz.

A microprocessor is used in the IC702 which enables simple interface to another microprocessor or a range of new options to be introduced by ICOM.

For further information on the new IC720 contact Vicom International on (03) 699 6700 or (02) 435 2766.

## MAGPUBS — Overseas Magazine Subscriptions

Will those concerned please note that Magpubs will no longer process subscriptions to overseas magazines (EXCEPT VHF COMMUNICATIONS and BREAK-IN).

- Members wishing to subscribe to QST, Radio Communications, CQ, Ham Radio, etc., or wishing to renew existing subscriptions to these magazines, or wishing to follow up missing issues (etc.), should direct their enquiries to the publishers concerned.

- Magpubs subscriptions to VHF Communications —

#### Rates:

Sea mail ..... \$8.20 p.a.  
Airmail ..... \$12.40 p.a.

(Back issues from 1970 are still available.)

Break-In ..... \$12.00 p.a.

Magpubs, PO Box 150, Toorak, Vic. 3142.

- Books (ARRL, RSGB, etc.) and other items are available from your Division or from Magpubs, PO Box 150, Toorak, Vic. 3142.

**The Advertisers in "Amateur Radio" support the WIA member — give them first preference — and tell them so, too!**

# SILENT KEYS

It is with deep regret that we record the passing of —

Mr. F. E. GRIFFITH VK2A00  
Mr. H. A. PERKINS VK4AXH  
REV. D. E. LAVER VK4ZDL  
KEITH PETERS VK3AKP

## OBITUARY

H. J. (JOHN) AMOS VK2ANK

John had spent much of his life as a radio operator with different airlines, including Trans Oceanic Airways and later OANTAS. John was the radio operator on the first Sydney to Hobart yacht race. In recent years John retired from the aircraft industry to run a dog kennel located west of Liverpool.

To his wife and sons, the Amateur Radio service would like to extend its sympathy.

HARRY PERKINS VK4AXH

Harry passed away late December 1979 and will be sadly missed by his fellow amateurs.

Harry was first licensed in the early fifties as VK4XH in Townsville. He then moved to NSW and operated under a VK2 call. Recently Harry became very interested in amateur radio through his son Alan VK4NJA, a very active Novice operator. Harry will be remembered for his cheery operating techniques and also helpful attitude. He was a pioneer in general aviation avionics and spent 25 years in the industry. Our deepest sympathies to his wife and children.

Barrie Smeaton VK4ALK.

KEITH PETERS VK3AKP

We were all saddened to hear of the death of Keith Peters VK3AKP, which occurred in Stawell recently. Keith gave five years service in the RAAF as a wireless operator, air crew, then wireless operator mechanic. He rendered service in Australia and the Islands.

After the war he joined the amateur ranks and also conducted a Radio and TV Service of his own, which he carried on until his untimely death.

He took an active part in all WIA activities and instructor in amateur radio classes, so his help was greatly appreciated by all members of the Western Zone.

Keith was active on all bands but was extra keen on DX, having nightly skeys with friends in the UK.

His gear was something to be admired by all those privileged to see it; a lot was home-brew with a very professional touch. His antenna system was the last word in perfection, the main antenna 110 ft. with rotating beams, the smaller one for higher frequencies, also with fingertip control. To his wife Dorothy and family we all convey our kindest thoughts.

BIII VK3AKW.

EDWARD CHARLES HOWARD VK2XX

My grandfather was born in 1906 at Paddington and at about five years old moved to the Sutherland Shire, where he spent the rest of his life. He left school in 1919 and his first job was with the Sutherland-Cronulla Steam Tramway. He worked as an assistant fitter, then conductor until 1929 when he obtained his driver's certificate.

This was the last certificate to be issued to a driver of the steam trams due to the electrification of lines. He worked the Cronulla-Sutherland passenger service till 1931. He then transferred to the Kokarah-Sans Souci steam trams until the closure of that line in 1937. He then drove trolley buses and diesel buses till his retirement owing to ill-health in 1967.

My grandfather took an interest in radio from its infancy and obtained his amateur radio licence in May 1948. Since then he has been an active member on most bands, and over the years, through his illness, he would always have a cheerful QSO for everyone. I have applied to have my grandfather's call sign allocated to me, and will endeavour to maintain his high standard.

Ian Howard VK2DCX.

TED KENNY VK2EK

After a long illness, Ted Kenny VK2EK passed away on the 9th April at his home, 13 Stapleton Street, Wentworthville. Ted was 77 years old and had been involved with amateur radio since 1923, when he held the unofficial call of 2EK, later to be changed to AOEK, and finally when the licences were issued in 1927 to VK2EK, the call held ever since. His licence number was 373. He had been active ever since, except during the war years when he served in the army. Returning to civil life he again carried on with his amateur radio until a few days before his passing. He was a very active CW man, and could be heard almost every evening talking to his G friends on CW.

Ted was involved in building some of the early radios in Sydney and until a few years ago was employed in the radio industry. Some of his old sets are now in museums as an indication of the radio industry in Australia in the early days.

Ted will be missed on the bands, and locally he will never be replaced as a friendly person to visit when passing through Wentworthville. Ted leaves a wife, Joyce, to whom our heartfelt sympathy is directed. We know that you will miss your lifelong companion.

Syd Molen VK2SG.

ALAN H. REID VK3AHR

Alan's first appearance on the air was as 3HR in the 1920s while he was still a school boy. After leaving school, as a budding electrical engineer of a decidedly practical turn of mind, he revelled in the setting up of stop-jar and other power supplies which brought quite often a blush to the plates of various self-excited oscillator tubes, as "wavelengths" fell

progressively below 200 metres. He did his share of brass-pounding to open up the wonderful DX of the "30 metre" band before closing down and setting off to obtain experience in his chosen profession in UK.

Alan returned to Australia in 1938, joining a group involved in research and development in the communications field at AWA, where he found numerous friends from his time on the air. With true "ham" instinct for exciting new technical fields, war-time found him involved in the important work of producing radar stations for the fighting forces.

At the end of the war, Alan came back on the air as VK3AHR, his well known fist being heard via a variety of ex-war-time rigs. Very soon, however, he began to sense the exciting possibilities of that strange new technique derisively known as "duck talk". He successfully built a number of phasing and other rigs and became well known in many parts of the world as one of the successful VK SSB stations of the 1950s. Gulie soon he acquired the well deserved luxury of a KWM2, but continued his active "build your own" interest in linears and beams.

Alan preferred to devote his time on the air to in-depth discussions with the many kindred spirits with whom he made close friends over the years. In this he was fortunate to have the support and understanding of his wife Gladys and their children David and Leslie. As did we all, they appreciated how Alan had made far more of amateur radio than just a technical hobby and used it to spread the warmth of his friendship and encouragement and help over the wide circle of friends on whose behalf it is my sad task to set down these words of tribute.

Dave VK2IJ.

## "WILLIS" AIR-WOUND INDUCTANCES

Take the hard work out of Coil Winding, use — "WILLIS" AIR-WOUND INDUCTANCES

No.	Turns			B & W Equiv	Price
	Dia. Inch	per Inch	L'gth Inch		
1.08	1/2	8	3	No. 3002	\$1.20
1.16	1/2	16	3	No. 3003	\$1.20
2.08	3/4	8	3	No. 3006	\$1.45
2.16	3/4	16	3	No. 3007	\$1.45
3.08	3/4	8	3	No. 3010	\$1.70
3.16	3/4	16	3	No. 3011	\$1.70
4.08	1	8	3	No. 3014	\$1.90
4.16	1	16	3	No. 3015	\$1.90
5.08	1 1/4	8	4	No. 3018	\$2.10
5.16	1 1/4	16	4	No. 3019	\$2.10
8.10	2	10	4	No. 3907	\$3.10

Special Antenna All-Band Tuner Inductance (equivalent to B. & W. No. 3907, 7 inch)

7" length, 2" dia., 10 TPI Price \$5.25  
Reference: A.R.R.L. Handbook, 1961

Willis Pi-Coupler Unit — \$28.50

Stockists of Transmission Cables, Insulators and Hard Drawn Copper Antenna Wire  
Write for range of Transmission Cables

**WILLIAM WILLIS & CO.**  
PTY LTD

Manufacturers and Importers  
77 CANTERBURY RD., CANTERBURY  
VIC. 3126 Phone 836-0707

## ADVERTISERS' INDEX

AUDIO TELEX	43
AMATEUR RADIO ACTION	37
BAIL ELECTRONICS	28
CW ELECTRONICS	28
DICK SMITH ELECTRONICS	15
SCALAR INDUSTRIES	9
SIDEBAND ELECTRONIC ENGINEERING	48
VICOM INTERNATIONAL	2, 4, 6, 8, 10
WILLIAM WILLIS & CO.	41

**HELP WITH INTRUDER WATCHING**

# HAMADS

- Eight lines free to all WIA members. \$9 per 3 cm for non-members.
- Copy in typescript please or in block letters to P.O. Box 150, Toorak, Vic. 3142.
- Repeats may be charged at full rates.
- Closing date: 1st day of the month preceding publication. Cancellations received after about 12th of the month cannot be processed.
- QTHR means address is correct as set out in the WIA 1979 Call Book.

## FOR SALE

ICOM IC-211, mint cond., with outboard scanner. John VK2BTQ. Enquiries VK2ABA. Ph. (02) 50 4681. Info-Tech M300 Trimode Keyboard, RTTY features, 4 speeds, 2 shifts, AFSK or FSK, CWID, RY, BROWN FOX; also model 200E Trimode converter, both as new, half price. VK7HV, QTHR. Ph. (002) 28 4622.

Yaesu FT101D Rx, 160-2m, complete with filters, manual, etc. in exc. cond., \$700; also Kenwood antenna tuner, AT200, \$150. L30853, QTHR. Ph. (053) 31 1138.

Kenwood TS820 Txcvr, CW filter, mint cond., little use, with original packing, owner and service manuals, \$730. VK4UR, QTHR. Ph. (07) 266 7873.

Transformer, 240V to 1800-0-1800V at one amp., \$25, ONO; auto transformer, 240V to 110V, 1.3 kVA, \$20, ONO; 2 filter chokes, approx. 0.5 amp rating, \$5 ea., ONO. VK2BDL, QTHR. Ph. (069) 62 1206.

HRO 500 RX, continuous coverage from 5 kHz to 30 MHz, good cond.; also Yaesu FTV 650, 6m, transverter, unused, \$150; Kenwood DG-1 digital display for TS-820, unused, \$120. Ph. (02) 98 6249.

KW Power and SWR Meter, 0-100W and 0-1000W, covers 160m to 10m, exc. cond., \$35; electronic keyer, Katsumi EK-105A (does not include a monitor but has provision to key an external monitor if required), 5-50 w.p.m., 240V AC, exc. cond., \$40. B. Bathols VK3UV, QTHR. Ph. (03) 90 6424 AH.

Eddystone EC10 Receiver, 550 KC to 30 MC, \$80. VK2AAB. Ph. (02) 487 1426.

TR7200G 2m Tcvr, ch. 40, 42, 44, 46, 48, 50, ext. VFO, VR30G, 5/8 GP, the lot \$270. VK4CJ, QTHR. Ph. (07) 343 2235.

Two Metre 9 Element Commercial Yagi, \$15; 2m 40W (6 up) amplifier, \$15; MR3 carbphone, Rx section needs livening up, \$15. VK3TG, QTHR. Ph. (058) 52 1636.

100 ft. Free Standing KVC Southern Cross Tower, easily dismantled into 10 ft. sections for transportation, exc. cond., no rust. For further information write to I. Buchanan VK2VPK, 11 Shore Street, Moruya, 2537 NSW.

Shack Clearance: Kenwood TS120S, PS 30 power supply, 20 amp, MB100 mobile locking bracket, MC30 mike, \$775, ONO; Barlow-Wadley XCR30 receiver, AC-DC portable, full coverage, \$195; Trio TR7200G, 2m, FM, \$135; linear amp, QM70, \$50; HC500A antenna coupler, \$80. Ph. (03) 435 4336.

Power Supply, 240V Input, 300 and 400V DC at 300 mA, 12V DC at 2A and 6V AC at 4A, \$35; 80-11m transverter, complete with 11m exciter, 4 crystals supplied, 10 watts output, \$70; Ferris car radio with push-button selector, works well, needs speaker \$10. Steve VK4NBY, QTHR. Ph. (07) 52 0171, ext. 282, Bus.

Galaxy 5 Txcvr, complete, \$280; 2m FM repeater with 90W linear, \$138; Dentron match, \$60; 2m transverter with 11m CB modified with wide range clarifier, \$128. VK2ZUZ, QTHR. Ph. (067) 65 5539 AH.

Kenwood TS120S, PS 30 supply, MB 100 mobile bracket, plus microphone, genuine reason for sale, \$800; consider trade-in 520 or FT200. Ph. (03) 341 5913 Bus.

Unden 2020 HF Tcvr with manual, \$535; Yaesu FTV-650B 6m transverter, \$180; Multi-quartz-16 2m FM txcvr with rpters 1 to 8 and simplex 40 and 50, complete, \$185. Peter VK2BJF, QTHR. Ph. (042) 96 2891.

AR7 Receiver, complete with all coil boxes (not working), 035. VK2LK, QTHR. Ph. (02) 635 6874.

Yaesu FT901DM SSB Txcvr with CW and AM filters factory installed, FV901DM external scanning memory VFO, SP901DM speaker/phone patch, Yaesu microphone, all equipment brand new in unopened boxes, never unpacked, surplus to my requirements, \$1750 the lot. James VK2JO. Ph. (02) 799 5566 or (02) 36 7756. GPO Box 5076, Sydney 2001, NSW.

Kenwood TS700A 2m All-mode Txcvr., new cond., orig. packing, \$500; Kenwood VOX-3 unit, suit TS700A, TS600, etc., new in orig. packing, \$15. VK5YX, QTHR. Ph. (08) 74 2350.

Yaesu FT101, AC-DC, mic., etc., excellent cond., \$450; Heathkit SB101 80-10 transceiver, as new, \$350; Icom DV-21 digital VFO, suit IC22/22A, \$150; Icom IC-RM2 remote control for IC701/211, \$125. VK3QM, QTHR. Ph. (03) 560 9215.

1675 Tx with xtals for Ch. 2 and 40; Swan 240 (copy), built by late 2JZ, complete with manual, will accept best offer, reason for selling only lack of time to use. VK5XR, QTHR.

Geloso Rx and Tnx in mint cond., can be heard on the air by arrangement with VK4LN any time, Rx G209 covers SSB, USB and LSB, Tnx AM, all bands except 160, beautiful museum pieces, matched cabinets, \$100 each; Galaxy Mk. III transceiver, with CW filter, ext. VFO, spare valves, P/S, can be heard any time on sked at 8 a.m. on 7.12 mcs, 400W PEP, \$350, ONO. VK4LN, QTHR. Ph. (071) 82 2675.

National Solid State RJX 601 6m Portable, VFO, AM/FM, \$160; Icom IC22A 2m FM txcvr., with crystals, \$150; Realistic AX190 coms Rx in orig. carton, \$190. VK3ZPV. Ph. (03) 561 5119.

Complete Station: Yaesu FT101E in good cond., with carton, manual and CW filter, \$600; Kenwood TR7600 2m txcvr, complete, \$350; RM76 micro-processor for TR7600/7625 transceiver, \$90; SX100 scanning receiver, \$300; Fichard Cowles. Ph. (02) 699 9403.

Model 15 Teleprinter with "Electronics Australia" demodulator and good power supply, also many rolls of paper, the lot in e.c., for only \$100; reason for sale is that I can't get this lot to copy off-air at my QTH. Terry Robinson L31105, QTHR.

Yaesu FT200 Txcvr with power supply, as new cond., in orig. packing, \$350. Ph. (03) 528 6598 AH.

Icom IC701 160-10m Txcvr, good cond., slight scra:ch on case, no PSU, urgent sale, \$850; Icom 22S 2m FM txcvr, as new, 6 mths. old, \$250; Tokyo Hy-Power Labs 2m Antenna Tuner, PWR and SWR meter, 0-5W, 0-20W, 0-150W, SWR to 450 MHz, good cond., \$60. Trevor Pitman VK3NMJ/YTP. Ph. (03) 789 3129 after 6 pm., (03) 797 4230 Bus.

Atlas 210X, limited edition, D6C digital display, 10XB xtal oscillator, Shure mobile and desk mics, MFJ antenna tuner, complete mobile or home station, mint cond., \$875; Icom IC-245 SSB/FM synthesised port./mobile, all accessories, \$485; Icom IC215 2m portable, 10 channels supplied, mobile bracket, nicads, \$175; Commercial 2m FM/SSB amplifier, 130W from 2/10/25W Input, \$200. Alan Nutley VK2BNA. Ph. (02) 230 5122 Bus., (02) 80 2516 AH.

IC701 HF Transceiver, \$1050; Hygaln 204BA 20m beam, \$140; Anshel 80-10m mobile whips, complete with base and coax, \$100; SX100 VHF/UHF scanning Rx, \$350; Realistic patrolman 50 Rx, \$40; B47 army rig, 38-56 MHz, \$10; B47 army rig, not working, \$5; Vln1en 6m FM, 52-525, \$5; old tape recorder, \$25. Lionel VK3NM, QTHR. Ph. (03) 88 3710 AH, (03) 568 2733 Bus.

Steel Radio Tower, 45 ft. free standing, fully dismantled and ready to take away, \$65; heavy duty rotator, suit large beam, \$75. Peter Nesbit VK3APN. Ph. (03) 523 6932.

FT75B, good cond., AC, DC, DC converter and VFO, \$375. VK3NXI. Ph. (059) 62 5236.

R-390A/URR, 0.5-32 MHz Rx, with all filters, \$480; Yaesu FT221 2m SSB/FM txcvr., \$475; both with service manuals. VK1VP, QTHR. Ph. (062) 48 5882.

Yaesu FT-101 Tcvr, exc. cond., no mods., with mic., key, cables, manual, SWR bridge, original carton, \$450; University R/C bridge with spare 6U5 indicator, \$12; Siemens Lab. type Wheatstone bridge with centre-zero meter, \$15; Philips micro cassette recorder and extra tapes, \$20. Mervyn VK4SO, QTHR.

Trio Rx, type 9R-59DS, with manual, \$79. VK2ABI, QTHR.

Hinged Metal Base Plate with tabernacle for use anchoring a tilt-over mast, \$25. Buyer to collect from St. Ives, Sydney. VK2AXR, QTHR. Ph. (02) 44 1389.

Yaesu FTDX401 with spare valves, incl. new finals, also mic., manuals, etc., \$450, ONO. Graham Basden VK6GG, QTHR. Ph. (09) 405 2897.

New Baternut Vert. Ant. HF5V-S, 80to 10m, suit low-profile restricted height/space areas, e.g. roof of high-rise building or caravan park, traps used for 15 and 15m operation, entire radiator 16 ft. length active on all other bands, \$140, ONO. VK2NI, QTHR. Ph. (02) 872 1470.

Yaesu FT200 with FP200 PSU, black front panel, mint cond., some mods., handbook, mic., cooling fan and spare finals (6JS6C), \$400, ONO. Cmd. R. M. Liddon VK1ZRQ/NCS, RAN, College Mess, HMAS Creswell, Jervis Bay 2540. Ph. (044) 42 1001, ext. 270 after 2000h.

ICOM IC211 2m Base Mobile Transceiver, mont cond., \$650; ICOM ICSM2 base mike, new \$45; Kenwood AT200 antenna tuning unit, as new, \$145. No offers. VK2BYS, QTHR. Ph. (069) 47 1998.

Yaesu FT101E, latest model, unmodified, mint cond., almost nil use, \$590, ONO. Rod Taylor. Ph. (07) 277 3633 Bus.

Yaesu FT620B with 50-54 MHz xtals, plus xtal for 49.5-50 MHz, AM filter and calib., \$450; Yaesu FT221 all mode 2m with 2 x U310 preamp, \$550; Palomar HF (10-30 MHz), \$180; FL110 HF linear, \$190 (both 100W plus o/p). VK3AQR, QTHR. Ph. (052) 78 1043 Bus., (052) 78 7558 Bus.

Yaesu FT101E, late model with front panel control of speech processing level AC/DC with cooling fan and accessory 600 Hz filter for CW/RTTY 160-10m Tx, plus 10 MHz and 27 MHz Rx only. Has had little use, exc. cond., overseas travel and study costs compel sale, \$675 or reasonable offer. Alan Beagley VK4AFE, QTHR. Ph. (07) 371 4399 AH.

## WANTED

Wanted to Buy: Handbooks, circuits or copies of World War II Navy, Army or Air Force transceivers. VK5NTY, 57 10th Avenue, Joslin, SA 5070.

Valves, 9001, 9002, 6C4WA and 5670; AN/ARC-51BX (ORX) UHF transceivers and handbook or parts thereof. VK3BFB, QTHR. Ph. (03) 93 1638.

Colour TV Pattern Generator, CRT tester, TV service manuals and circuit boards, etc. Details to VK3YEJ, QTHR. Ph. (053) 23 2467 AH.

RM-3 Remote Control for IC-701. Contact Rob VK3VFP. Ph. (03) 311 9185 AH.

Control Unit Type MCU-178 or similar, to suit CDR ham rotator type TR44. Price, etc., to VK2AS. Ph. (02) 467 1784.

FT200 with AC-DC facilities, or Kenwood 520 with DC converter, reasonable. Ph. (03) 341 5913 Bus.

Collins 30LI Linear Amp., any cond., even if damaged or faulty, also frequency counter to 150 mcs. VK4LN, QTHR. Ph. (071) 82 2675.

Can somebody tell me the name of a good book on "Cobol" programming as I am having trouble with same. Details to J. Kitchen VK6TU, QTHR.

Aircraft Receiver, Bendix model. RA10DB, and/or manual or circuit. Colin Gradie L30060, PO Cavendish 3408.

## TRADE HAMAD

Amidon Cores — refer ARRL Handbook, iron powder and ferrite toroids, ferrite beads and sleeves for wideband RF amps. Large SASE for data/price list. R.J. & U.S. Imports, Box 157, Mordialue, NSW 2223.

# AMATEUR RADIO IS A RESPONSIBLE SERVICE

LET'S KEEP IT THAT WAY



# TH5DX

## 10-15-20 METERS

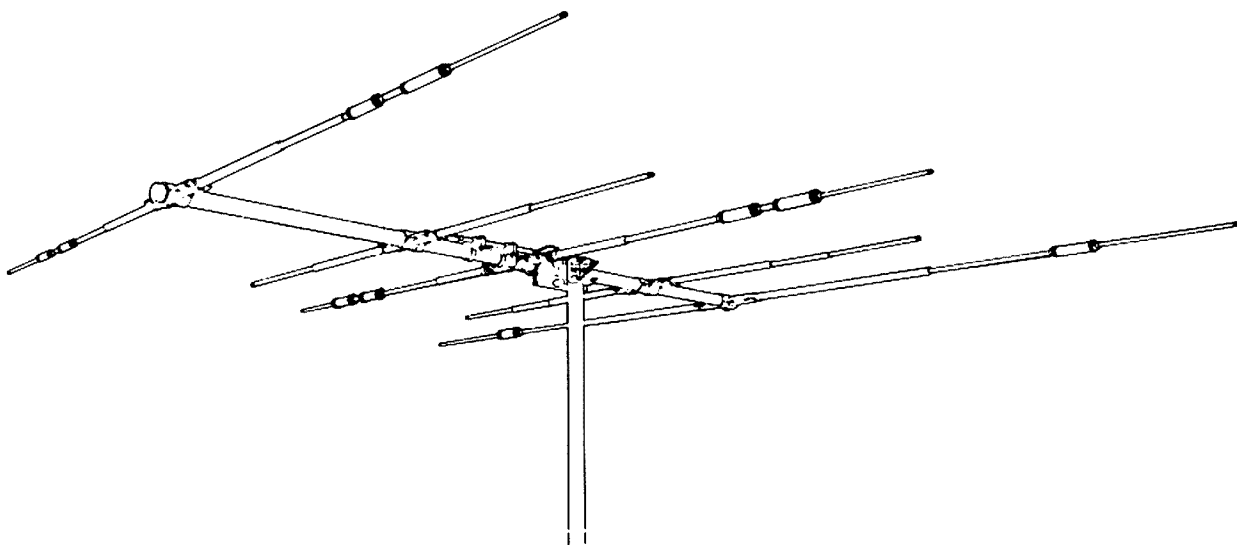

We are proud to introduce the newest member of our famous Thunderbird line of Tri-Band antennas. The TH5DX offers outstanding performance on 20, 15 and 10 meters. It features 5 elements on an 18 foot boom, with 3 active elements on 15 and 20 meters and 4 active elements on 10 meters. The TH5DX also features separate air-dielectric Hy-Q traps for each band. This allows the TH5DX to be set for the maximum F/B ratio and the minimum beam width possible for a Tri-Band antenna of this size. Also standard on this antenna are Hy-Gain's unique Beta-match, rugged Boom-to-mast bracket, taper-swaged elements and improved element compression clamps.

Boom length..... 18 feet  
 Longest Element..... 31 feet  
 Turning Radius..... 18 feet  
 Surface Area..... 6.4 sq. feet  
 Wind load..... 164 lbs  
 Weight..... 50 lbs

VSWR at resonance..... less than 1.5:1  
 Power Input..... Maximum Legal  
 Input Impedance..... 50 ohms  
 -3dB Beamwidth..... 66° average  
 Lightning Protection..... DC ground  
 Forward Gain..... 8.5dB  
 Front-to-Back Ratio..... 25 dB

**WRITE OR CALL FOR A FREE BROCHURE AND THE NAME OF YOUR NEAREST HYGAIN DEALER  
 SOLE AUSTRALIAN DISTRIBUTOR**

AUDIO TELEX COMMUNICATIONS  
 PTY. LTD.



**MELBOURNE:**  
 7 Essex Road,  
 MOUNT WAVERLY 3149  
 Tel: 277 5311

**BRISBANE:**  
 394 Montague Road  
 WEST END 4101  
 Tel: 44 6328

**SYDNEY:**  
 1 Little Street,  
 PARRAMATTA 2150.  
 Telephone 633 4344



# SIDEBAND ELECTRONICS ENGINEERING

P.O. BOX 23, SPRINGWOOD. N.S.W. 2777  
 WAREHOUSE 213 HAWKESBURY RD. SPRINGWOOD  
 TELEPHONE (047) 54 1392

## AN APOLOGY

We apologise for our inability over the past month or so to satisfy the demand for our ever-popular KEN KR-400 medium duty and HAM-3 heavy duty rotators. All being well, at the time of publication we should have ample stocks of the KR-400 (at \$120 complete with upper and lower mast brackets, control unit etc. it just has to be the best rotator deal available) and KR-500 vertical rotator. Fresh stocks of CDR HAM-IV and T2X Tail twisters should be here by July. HB-35C Antennas at \$375 and YAESU MUSEN FT-101ZD Transceivers with cooling fan etc. at \$895 should also be available at the time of publication.

— Roy Lopez

## HENRY RADIO A Famous Brand

### NEW LINEAR AMPLIFIERS

2-KD5-2KW PEP 80-10M SSB/CW/RTTY/AM.....	<b>\$1050</b>
1-KD5 1200W PEP 80-10M SSB/CW/RTTY/AM.....	<b>\$850</b>

## ANTENNAS

TET HB-35C 10-15-20M log/yagi HY-GAIN.....	<b>\$375</b>
TH6-DXX 10-15-20M 6 el yagi.....	<b>\$385</b>
TH3-JR 10-15-20M 3 el yagi.....	<b>\$235</b>
DB10-15A 10-15M 3 el yagi.....	<b>\$190</b>
153-BA 15M 3 el yagi.....	<b>\$120</b>
18AVT/WBa 10-80M vertical.....	<b>\$110</b>
GPG-2 2M 5/8W collinear 3-4db gain.....	<b>\$25</b>
HELICAL mobile whips w/adj. tip	
80M 40M.....	each <b>\$28</b>
20M 15M.....	each <b>\$26</b>
10M.....	<b>\$25</b>
GPV-5 2M collinear 2 x 5/8W.....	<b>\$48</b>
OSCAR 2D 2M mobile 1/4 or 5/8W.....	<b>\$27</b>
BN-86 balun for beam buyers.....	<b>\$20</b>
HI-Q baluns 50 ohm 1 KW 1:1.....	<b>\$15</b>

## ROTATORS AND CABLES

All rotators now come with bottom brackets and control indicator boxes wired for 28V AC —

CDE BT1A BIG TALK light duty programmable 4-pos. push button plus normal operation.....	<b>\$85</b>
KEN KR-400 medium duty.....	<b>\$120</b>
KEN KR-500 vertical rotator.....	<b>\$150</b>
CDE Ham 1V heavy duty (June/July).....	<b>POA</b>
CDE T2X Tail twister extra HD.....	<b>\$250</b>
RG-8U foam co-ax. per meter now.....	<b>\$1.20</b>
8-cond. rotator cable. per meter.....	<b>80c</b>

## ACCESSORIES

ASAHI chrome bumper mount.....	<b>\$8</b>
Standard bumper mount.....	<b>\$5</b>
Chrome base and spring to suit ASAHI mount.....	<b>\$20</b>
FERGUSON 240V AC transformer 2 x 9V secondaries at 3A.....	<b>\$10</b>

## TRIO KENWOOD PRODUCTS

TS-520 SE.....	<b>POA</b>
TS-180S 10-160M 12V solid state.....	<b>POA</b>
TS-120S 10-80M 12V solid state.....	<b>POA</b>
TS-700SP 2M all mode trans.....	<b>SPOA</b>
R-1000 digital clock receiver.....	<b>POA</b>
VFO-520 for TS-520S.....	<b>\$130</b>
SP-520 for TS 520S.....	<b>\$30</b>
SP-120 for TS 120S.....	<b>\$32</b>
SP-100 for R-1000.....	<b>\$32</b>
DK-520 Adaptor TS-520 to DG-5.....	<b>\$10</b>

All further Trio-Kenwood accessories transceivers and test equipment at competitive prices.

## ICOM & YAESU-MUSEN PRODUCTS

In the future we will be carrying a greater range of Yaesu-Musen products and a range of Icom products.

YAESU-MUSEN	
FT-101ZD 160-10M trans.c/w cooling fan & AM	<b>\$895</b>
FRG-7.5 -30Mhz receiver.....	<b>\$310</b>

## KYOKUTO FM 2025A

The very latest 2M FM from KYOKUTO 2M FM mobile 25W 10 memory channels plus full scanning etc.....	<b>\$350</b>
--	--------------

## CO-AX CONNECTORS

PL-259, SO-239, cable joiners ea.....	<b>.60c</b>
T connectors.....	<b>\$1.50</b>
GLP right angle, RG-58U to SO-239 w/lock nut & weatherproof cap.....	<b>\$1.50</b>
Double female connectors.....	<b>75c</b>
MLS right angle RG-58U to PL-259.....	<b>75c</b>
In-line mic. sockets 3 & 4 pin ea.....	<b>60c</b>
Mic. sockets 3 & 4 pin each.....	<b>60c</b>
M-ring body mount w/lock nut.....	<b>\$1.50</b>

## NOVICE SPECIALS — CONVERSION CRYSTALS

Set of 8-crystals. Converts 28.480 to 28.595 MHz in 5-kHz steps. Clarifier tuning on Tx and Rx plus info to re-activate 24th channel.....	per set <b>\$32</b>
Set of 4 x crystals converts 28.310 — 28.600 10 x 20 kHz steps MHz as above.....	<b>\$15</b>

All prices are NET, ex Springwood NSW, on pre-payment with order basis. All risk insurance is free of charge, allow for freight charges by air, road, rail or postal, excess will be refunded. Prices are subject to change without prior notice. All orders cleared on a 24-hour basis after receipt of order with payment.

ROY LOPEZ (VK2-BRL) Manager

# amateur radio

JOURNAL OF THE WIRELESS INSTITUTE OF AUSTRALIA



VOL. 48, No. 7

JULY 1980

## ***FEATURED IN THIS ISSUE:***

- ★ **AMATEUR RADIO FOR THE CRUISING YACHTSMAN — Part 1**
- ★ **A DECADE ON VHF — Part 2**
- ★ **THE 1980 FEDERAL CONVENTION, ANNUAL REPORT**
- ★ **REMEMBRANCE DAY CONTEST RULES 1980**
- ★ **COLLECTORS CORNER — NUMBER 1**

# The Hands-off Meter!

- No need for frequency adjustment or looking up tables.
- No forward/reverse switching required.
- Features DAIWA's unique direct reading "cross-needles".

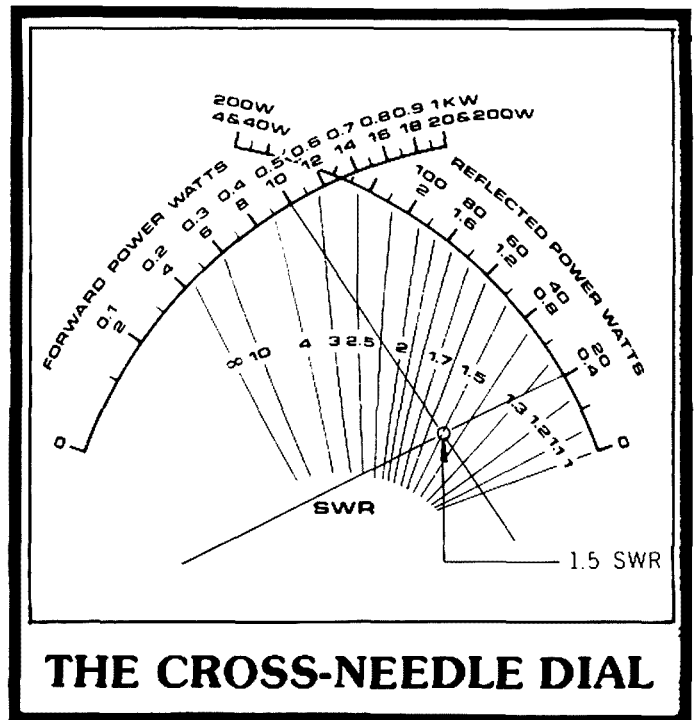

**THE CROSS-NEEDLE DIAL**

## CN620 SWR/PWR METER

- \* 1.8 - 150 MHz
- \* 20W/200W/1 KW pwr ranges
- \* List Price \$99

## CN630 SWR/PWR METER

- \* 140 - 450 MHz
- \* 20W/200W pwr
- \* List Price \$135

## CN630 SWR/PWR METER

- \* 1.2 - 2.5 GHz
- \* 2W/20W ranges
- \* List Price \$169

Also a range of quality antenna couplers incorporating cross-needle SWR/PWR Meters.

Distributed by VICOM

SYDNEY: 339 Pacific Hwy,  
Crows Nest. Ph. 436 2766  
MELBOURNE: 68 Eastern Rd.,  
Sth. Melb. Ph. 699 6700

VICOM gear is available from most reputable dealers!



# amateur radio

Published monthly as its official journal by the Wireless Institute of Australia, founded 1910.

**JULY 1980**

**VOL. 48, No. 7**

**PRICE: \$1.20**

Registered Office:  
3/105 Hawthorn Road,  
Caulfield North 3161.

**EDITOR:**  
BRUCE BATHOLS\* VK3UV

**PRODUCTION MANAGER:**  
MARK STEPHENSON\* VK3NOY

**TECHNICAL EDITORS:**  
BILL RICE\* VK3ABP  
EVAN JARMAN\* VK3ANI  
RON COOK\* VK3AFW  
GIL SONES\* VK3AUI

**CONTRIBUTING EDITORS:**  
BOB ARNOLD VK3ZBB  
MIKE BAZLEY VK6HD  
ROY HARTKOPF\* VK3AOH  
RON FISHER\* VK3OM  
ERIC JAMIESON VK5LP  
LEN POYNTER\* VK3BYE  
BILL VERRALL VK5WV  
WALLY WATKINS VK2DEW

**DRAFTING:**  
NEIL OSBORNE\* VK3YEI

**BUSINESS MANAGER:**  
PETER DODD VK3CIF

\*Member of Publications Committee

Enquiries and material to:  
The Editor,  
PO Box 150, Toorak, Vic. 3142

Copy is required by the first of each month. Acknowledgement may not be made unless specially requested. All important items should be sent by certified mail. The editor reserves the right to edit all material, including Letters to the Editor and Hamads, and reserves the right to refuse acceptance of any material, without specifying a reason. Material should be sent direct to P.O. Box 150, Toorak, Vic., 3142, by the 25th of the second month preceding publication. Phone: (03) 528 5962. Hamads should be sent direct to the same address by the 1st of the month preceding publication.

**Trade Practices Act:** It is impossible for us to ensure that advertisements submitted for publication comply with the Trade Practices Act 1974. Therefore advertisers and advertising agents will appreciate the absolute need for themselves to ensure that the provisions of the Act are complied with strictly. Readers are reminded that, when buying, obtaining or receiving goods from overseas including goods listed in advertisements by overseas organisations in this Journal, Customs import duties and Sales Tax may be levied on the goods at the time of importation. These amounts, if any, are payable by the purchaser unless the terms of sale state otherwise and the seller has made specific provision to this effect in his quotation to the buyer or unless other prior arrangements are in force between the buyer and the seller.

Typesetting: **MUELLER INDUSTRIES**  
1a Levenswell Road, Moorabbin, 3189  
Tel.: 553 0292

Printers: **WAVERLEY OFFSET PUBLISHING GROUP**  
Geddes Street, Mulgrave 3170

## CONTENTS

### TECHNICAL

Collectors' Corner, Number 1 25

### GENERAL

A Decade in Review, Part 2 17

Amateur Radio for the Cruising Yachtsman, Part 1 10

OSCAR for Beginners 24

Remembrance Day Contest Rules 1980 42

The 1980 Federal Convention Annual Report 35

### DEPARTMENTS

Amateur Satellites 30

Around The Trade 48

Awards Column 48

Contests 41

Divisional Notes 43

Editor's Desk 5

Forward Bias 33

Hamads 49

Ionospheric Predictions 43

Letters to the Editor 45

Magazine Review 47

Main QSP 7

Obituaries 49

QSP 31, 43

Silent Keys 49

Spotlight on SWLing 31

VHF-UHF — An Expanding World 32

WIANEWS 9

WICEN 45

ADVERTISERS' INDEX

50

## Cover Photo



Navigation and Radio Area on a Cruising Yacht — See Article: "Amateur Radio for the Cruising Yachtsman", commencing on page 10.

Photo by Eddie Rooms VK4AER/MM

# GOOD GEAR FROM TONO!

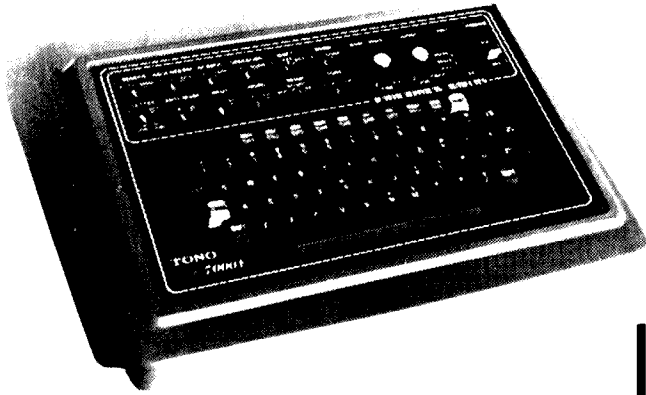

## THETA 7000E COMMUNICATIONS COMPUTER

- Just connect to any TV set
- Provides send/receive for CW, RTTY and ACSII.
- Stacks of features
- Receive commercial CW and RTTY news bulletins

STILL ONLY \$899 cat 7000E

**NEW!**

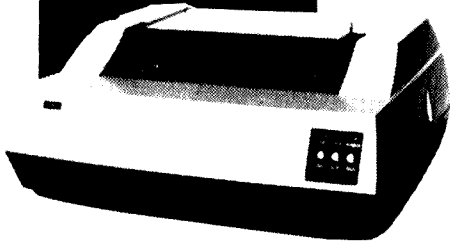

### HC800 DOT MATRIX PRINTER

- 125 cps, 9 x 7 dots
- Bidirectional
- Interfaces with 7000E or Theta 350

PRICE \$999 cat. HC800

**TONO**

**NEW!**

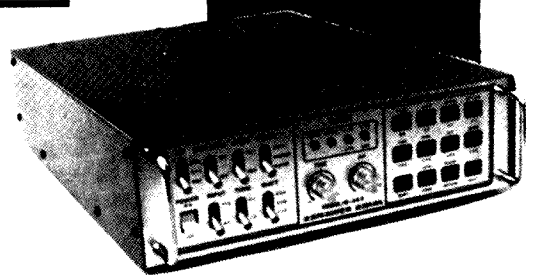

### THETA 350 RECEIVE ONLY TERMINAL

- RTTY, CW and ASCII
- Video output for connection to TV set

\$599 introductory price



### 2M 90 WATT LINEAR MODEL MR900E

- FM/SSB/CW/RTTY
- Inbuilt 13dB receiver preamp
- Output 80-90W, input 10-15W
- Current 7-8A

PRICE \$289

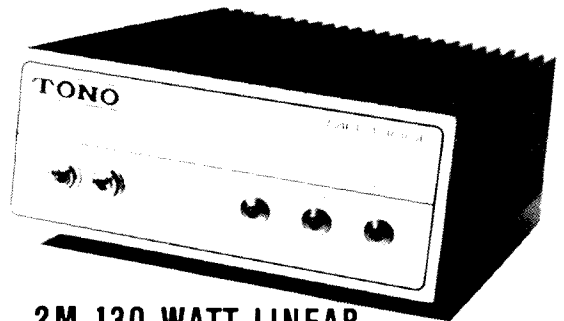

### 2M 130 WATT LINEAR MODEL MR1300E

- FM/SSB/CW/RTTY
- Inbuilt 13dB receiver preamp
- Output 120-130W, input 10-15W
- Current 10-11A

PRICE \$350

**VICOM**

SYDNEY: 339 Pacific Hwy, Crows Nest Ph. 436 2766  
MELBOURNE: 68 Eastern Rd., Sth. Melbourne Ph. 699 6700

AVAILABLE AT MOST  
GOOD HAM STORES

# WIRELESS INSTITUTE OF AUSTRALIA

**Federal President:** Mr. P. A. Wollenden VK3ZPA

**Federal Council:**

VK1 Mr. R. G. Henderson VK1RH

VK2 Mr. T. I. Mills VK2ZTM

VK3 Mr. G. A. G. Williams VK3ZXW

VK4 Mr. A. R. F. McDonald VK4TE

VK5 Mr. C. J. Hurst VK5HI

VK6 Mr. N. R. Penfold VK6NE

VK7 Mr. B. J. Morgan VK7RR

**Staff:** Mr. P. B. Dodd VK3CIF, Secretary.

**Part-time:** Col. C. W. Perry, Mrs. J. M. Seddon and

Mr. Mark Stephenson (AR Production).

**Executive Office:** 3/105 Hawthorn Rd., Caulfield North, Vic. 3161. Ph. (03) 528 5962.

**Divisional Information** (all broadcasts are on Sundays unless otherwise stated).

**ACT:**

**President** — Mr. A. Davis VK1DA

**Secretary** — Mr. F. Robertson-Mudie VK1NAV/VZZ

**Broadcasts**— 3570 kHz and 2m Ch. 6 (or 7): 10.00Z.

**NSW:**

**President** — Mr. A. D. Tilley VK2BAD

**Secretary** — Ms. S. J. Brown VK2BSB

**Broadcasts**— 1825, 3595, 7146 kHz, 28.32, 52.1, 52.525, 144.1, 145.6, 146.4, Rptr. Ch. 3 — Gosford, Ch. 4 — Lismore, Ch. 5 Wollongong, Ch. 8 — Dural 11.00h local (Evening 0930Z). Relays on 160, 80 and 10m, VHF and Repr. Ch. 3, Ch. 5, Ch. 8, and Hunter Branch, Mondays 0930Z on 3595 kHz, 10m, and Ch. 3 and 6. RTTY Sunday 0030Z 7045, 14090 kHz, Ch. 52, 0930Z 3545 kHz, Ch. 52.

**VIC.:**

**President** — Mr. E. J. Buggee VK3ZZN

**Secretary** — Mr. G. F. Atkinson VK3YFA

**Broadcasts**— 1840, 3600, 7135 kHz — 53.032 AM, 144.2 USB and 2m Ch. 2 (5) repeater: 10.30 local time.

**Gen. Mtg.** — 2nd Wed., 20.00.

**QLD.:**

**President** — Mr. A. J. Aarasa VK4QA

**Secretary** — Mr. W. L. Giells VK4ABG

**Broadcasts**— 1825, 3580, 7146, 14342, 21175, 28400, kHz; 2m (Ch. 42, 48): 09.00 EST.

**Gen. Mtg.** — 3rd Friday.

**SA:**

**President** — Mr. I. J. Hunt VK5QX

**Secretary** — Mr. W. M. Wardrop VK5AWM

**Broadcasts**— 1820, 3550, 7095, 14175 kHz; 28.5 and 53.1 MHz, 2m (Ch. 8): 09.00 S.A.T.

**Gen. Mtg.** — 4th Tuesday, 19.30.

**WA:**

**President** — Mr. Ross Greenaway VK6DA.

**Secretary** — Mr. Peter Savage VK6NCP.

**Broadcasts**— 3560, 7075, 14100, 14175 kHz. 28.47, 53.1 MHz. 2 metres Ch. 2 Perth, Ch. 6 Wagln. Time 0130Z.

**Gen. Mtg.** — 3rd Tuesday.

**TAS.:**

**President** — Mr. R. Emmett VK7KK

**Secretary** — Mr. B. J. Morgan VK7RR

**Broadcasts**— 7130 (SSB) kHz with relays on 6 and 2m Ch. 2 (S), Ch. 8 (N), Ch. 3 (NW), 09.30 EST.

**NT:**

**President** — Mr. T. A. Hine VK8NTA

**Vice-Pres.** — Barry Burns VK8DI

**Secretary** — Robert Milliken VK8NRM

**Broadcasts**— Relay of VK5WI on 3.555 MHz and on 146.5 MHz at 2330Z. Slow morse transmission by VK8HA on 3.555 MHz at 1000Z almost every day.

**Postal Information:**

VK1 — P.O. Box 46, Canberra, 2600.

VK2 — 14 Atchison St., Crows Nest, 2065 (Ph. (02) 43 5795 Tues & Thurs (10.00-14.00h).

P.O. Box 123, St. Leonards, NSW 2065.

VK3 — 412 Brunswick St., Fitzroy, 3065 (Ph. (03) 41 3535 Weekdays 10.00-15.00h).

VK4 — G.P.O. Box 638, Brisbane, 4001.

VK5 — G.P.O. Box 1234, Adelaide, 5001 — HQ at West Thebarton Rd., Thebarton.

VK6 — G.P.O. Box N1002, Perth, 6001.

VK7 — P.O. Box 1010, Launceston, 7250.

VK8 — (Incl. with VK5), Darwin AR Club, P.O. Box 37317, Winnellie, N.T., 5789.

**Slow morse transmissions** — most week-day evenings about 09.30Z onwards around 3550 kHz.

**VK OSL BUREAUX**

The following is the official list of VK QSL Bureaux, all are inwards and outwards unless otherwise stated.

VK1 — QSL Officer, G.P.O. Box 46, Canberra, A.C.T. 2600.

VK2 — QSL Bureau, C/- Hunter Branch, P.O. Teralba, N.S.W. 2284.

VK3 — Inwards QSL Bureau, Mr. E. Treblcock, 340 Gillies Street, Thornbury, Vic. 3071.

VK3 — Outwards QSL Bureau, Mr. R. R. Prowse, 83 Brewer Road, Bentleigh, Vic. 3204.

VK4 — QSL Officer, G.P.O. Box 638, Brisbane, Qld., 4001.

VK5 — QSL Bureau, Mr. Ray Dobson VK5DI, 16 Howden Road, Fulham, S.A. 5024.

VK6 — QSL Bureau, Mr. J. Rumble VK6RU, G.P.O. Box F319, Perth, W.A. 6001.

VK7 — QSL Bureau, G.P.O. Box 371D, Hobart, Tas. 7001.

VK8 — QSL Bureau, C/- VK8HA, P.O. Box 1418, Darwin, N.T. 5794.

VK9, 0 — Federal QSL Bureau, Mr. N. R. Penfold VK6NE, 388 Huntriss Rd., Woodlands, W.A. 6018.

## EDITOR'S DESK

Bruce Bathols VK3UV

At the last Federal Convention, AR came under much scrutiny. One of the present problems is the increasing costs of publication. A substantial portion of your annual subscription is set aside for AR production, and as the next year's fees are fixed during the current year, any excess costs outside normal inflationary trends strain the Institute's resources.

To maintain the quality our members have come to expect, the entire production itself is kept constantly under review. Last year, observant readers will have noticed a slight change to the paper quality. This saved the Institute many hundreds of dollars over the year alone.

We are again now hit with the inflationary spiral through wage awards, paper and printing costs, postage increases, etc. You name it, if it can be increased this year, it will be, and of course we the WIA members must pay for these rises if we desire to maintain and improve our existing standard.

Many of you will also have noticed the lesser number of traders advertising in AR. The reasons for this are varied, but can be summarised mainly under the heading of increased costs due to inflation. Advertising is not cheap, but the revenue it brings helps to defray our publication costs. In order to keep our advertisers happy and to gain their continued support, positive feedback is required. How often do you tell the advertiser that you are buying his goods because you read his advert in AR? Let him know, often and loud, that AR was the vehicle which made you purchase his goods offered for sale. If the advertiser does not get this type of feedback, he goes elsewhere, and of course the quality of AR will suffer as a result.

This month sees the start of our efforts to adjust to this increasing spiral. From this issue forward, AR is being printed fully by the Web Offset method, and as we become accustomed to this change-over, some teething problems are to be expected. Please bear with us while we smooth out the rough edges. As a result of the Web Offset printing, subtle changes and improvements will be gradually introduced over the next few months.

Lead times for current materials will be able to be slightly lengthened (but not yet, we shall advise you shortly of the new cut-off dates), a greater use of spot colour will be made, and an increase to the number of printed pages will be possible eventually.

With these changes we also expect to be able to maintain our present standard and to stay within the executive budget for the rest of the year.

Also at the Convention we agreed to include once again "Divisional Notes". There is much other general information contained in each Division's notes which are sent as an insert to a particular Division's members only, but is lost to WIA members as a whole.

Therefore, in the next few months, Divisional inserts as such will be phased out, and instead will form part of a special new section within AR. This will also alleviate some distribution problems previously experienced with inserts. We hope that everybody will be better informed as a result, and we look towards greater unification of our membership without the fragmentation that exists today.

"Amateur Radio" is the only vehicle to achieve this.

Many of you will have noticed the International flavour creeping into some of our articles. Several original articles have been received direct from our subscribers overseas, and it goes to prove that AR has become widely accepted overseas as well as within Australia.

This does put us into a slightly embarrassing situation. At the present time we are slightly overloaded with original articles, and these will be published as soon as we can make the space available. Unfortunately, some extra delays will have to be expected before publication can be made. However, do not let this deter you from submitting your articles as in the past. I think you will agree that a slightly longer delay is worth the wait, when you consider the vast coverage AR gets, and the possibility of being reprinted in the larger International amateur magazine.

A list of original articles accepted for publication will be published shortly to let everyone know what is around the corner.

Authors can help us to clear the backlog and speed up publication in the following ways:—

1. Type on one side of the paper only, double spaced preferred — this includes Hamads and letters to the editor.

If no typewriter is available, please print clearly, leaving sufficient space between the lines for editorial corrections, etc.

2. For technical articles requiring drafting, ensure the diagram is laid out clearly, and labelled legibly. Alternatively, if you are capable of drafting yourself to the standard previously published, please do so, allowing for sufficient definition for items which will be reduced photographically.

I know that we have our members' support and we are all going to benefit because of it.

73 for now, and don't forget — SUPPORT OUR ADVERTISERS, AND TELL THEM YOU SAW THEIR ADVERTISEMENT IN AR.

(VK3UV)

## HELP WITH INTRUDER WATCHING

# "MORE GREAT DAIWA GEAR TO TURN YOU ON!"

## ROTATORS NEW TYPE WITH MAP CENTRED ON AUSTRALIA!

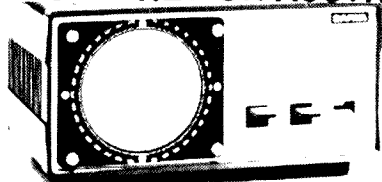

**DAIWA**

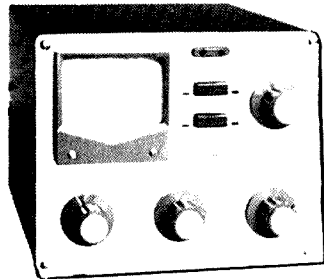

DR7500R	Medium Duty	189.00
DR7500X	Medium Duty with pre-set controller	172.00
DR7600R	Heavy Duty	269.00
DR7600X	Heavy Duty with pre-set controller	239.00

## ANTENNA COUPLERS

CL67A	1.9-28 MHz, 500 wpep	135.00
CNW217	incl SWR/PWR Meter, 200W	165.00
CNW418	as above, with new WARC freqs	179.00

High quality models with SWR/PWR Meter include unique cross-needle meter.

## COAXIAL SWITCHES

2 Position model CS201	23.00
4 Position model CS401	59.00

Professionally engineered cavity construction, high isolation.

Power rating: 2.5 KW pep, 1 KW CW  
Impedance: 50 ohm  
Insertion loss: less than 2dB  
Maximum frequency: 500 MHz  
Isolation: Better than 60dB at 300MHz.

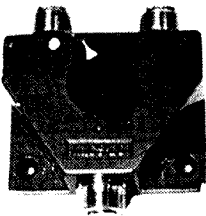

## SWR & POWER METERS

Model	Freq.	PWR	Cross-Needle	Price
CN620	1.8-150 MHz	20/200/1KW	yes	99.00
CN630	140-450 MHz	20/200	yes	135.00
CN650	1.2-2.5 GHz	2/20	yes	169.00
SW210A	1.8-150 MHz	20/120	no	99.00

Cross-needle type offer DIRECT readings.

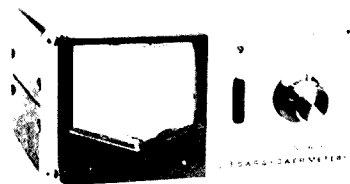

## SPEECH PROCESSORS

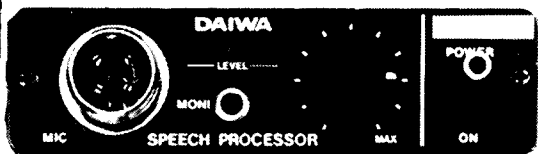

RF660	Phasing type dc	109.00
RF440	Phasing type ac/dc	126.00
RF550	Fitter type, ac/dc	169.00
MC330	Speech compressor	99.00

Increase talk power with splatter free operation. RF clipping (not in MC330) assures low distortion. Simply install between microphone and transmitter.

Typical specs RF660:  
Talk power: Better than 6dB  
Freq. Response: 200Hz-3000Hz at 12dB down  
Distortion: less than 3% at 1 KHz, 20dB clipping.  
Power Req.: 13.8 Vdc at 50mA.

## AUTOMATIC ANTENNA TUNER

New model with the extra WARC frequencies included. The VSWR is automatically adjusted below 1.5 PWR  
Rating 500W pep.  
CNA1001 269.00

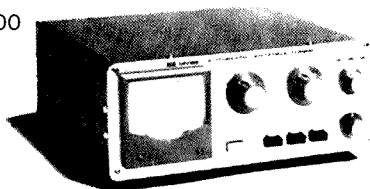

**SYDNEY:** 339 Pacific Hwy, Crows Nest  
Ph. 436 2766

**MELBOURNE:** 68 Eastern Rd, Sth Melb.  
Ph. 699 6700

# VICOM

**AVAILABLE AT REPUTABLE HAM  
DEALERS**

# QSP —

## The Art of Communication

Paradoxical as it may seem, radio amateurs are in the main very poor communicators. Oxford defines communicate as "the exchange of information", that is to say communication must be a TWO-WAY exchange. Our ability to communicate "on air" therefore is unquestioned.

However, whilst attending Federal Conventions, I have often conceived the impression that the trend of discussion has been influenced through a lack of communication, both Councillors to the membership and the membership to Councillors. In this instance we must all accept various degrees of guilt.

Nonetheless, the situation can be readily rectified, by ensuring that all agenda items for the Convention are received in sufficient time for inclusion in the January or February issues of Amateur Radio. This would then allow all members to analyse the agenda items and where they felt that they can constructively comment, either for or against any item, communicate those views to the Divisional Council or Federal Councillor.

It is imperative that the views of the membership be solicited and injected to Federal Conventions to ensure a more democratic deliberation, on the matters before the Convention. The time to instigate the submission of an agenda item to your Divisional Council is now.

Let us all unite and COMMUNICATE proficiently on the implementation and amendment of policies governing the direction and administration of amateur radio both nationally and internationally.

COLIN HURST VK5HI,  
VK5 Federal Councillor. ■

### CALLING ALL COUNTRY AMATEUR RADIO CLUB PROGRAM ORGANISERS!

#### HOW TO ORDER

Send your request with blank ¾" Umatic cassette(s) and sufficient stamps to cover postage from Adelaide to your town to:

JOHN INGHAM  
Federal Videotape Co-Ordinator  
37 Second Avenue,  
Sefton Park, S.A. 5083

Having trouble finding suitable speakers for your Club's Technical Meetings?

#### THE WIA LIBRARY OF TECHNICAL LECTURES MAY SOLVE YOUR PROBLEMS!

Most were recorded at the VK5 WIA Monthly Meetings SPECIFICALLY FOR COUNTRY AR CLUBS!

#### Subjects presently on Hand (Group C):

Wire Antennas	B & W	40 mins.
Radio Teletype	B & W	40 mins.
Tracking Oscar	B & W	30 mins.
The Apollo 13 Disaster	Colour	1 hr. 20 mins.
The Signal to Noise Story	Colour	45 mins.
Microcomputers	Colour	50 mins.
Microcomputers	Colour	10 mins.
Winning Foxhunts	Colour	45 mins.
Auxilliary Battery Charging	Colour	30 mins.
VK5RTV ATV Repeater	Colour	1 hr.

The average 60 min. Umatic Cassette and case weighs 850 gm. At this time the only formats for which this service is available is: ¾" Umatic — first choice, ½" Philips N1500 — second choice. Sorry, NO Betamax, VHS or N1700 etc.

For a full catalogue listing of WIA videotaped programs and a complete description of the services provided, refer to Jan. 1980 issue of Amateur Radio.



# FM...SSB...CW...

# ICOM Does it All!



 **ICOM**

## ICOM IC-260A

Enjoy VHF mobile at its best, Sideband, FM or CW, the ICOM IC-260A does it all. The ICOM IC-260A contains all the features a mobile operator would want in a compact 2 metre mobile package with FM, SSB, CW operation. Features customers ask for most including:

- ❑ 3 memories built in (quick access to your favorite frequencies).
- ❑ Memory scan - automatically stops on an active frequency programmed in the memories.
- ❑ Programmable band scan - scan the whole band or any portion of it you desire (adjustable scanning speed).

- ❑ Squelch on SSB. the 260A will automatically and silently scan the SSB portion of the band seeking out the SSB activity on 2.
- ❑ 600KHz repeater offset built in. Easy repeater operation on the FM portion of the band.
- ❑ Your new IC260A includes NB, CW break-in, CW monitor, APC and many other circuits for your convenience.
- ❑ Multimode operation - USB, LSB, CW, and FM. Great for getting into OSCAR, plus enjoying SSB rag chewing as well as repeater operation.
- ❑ Backed by 90 day VICOM

technical/spares support.

The RF amplifier and first mixer circuits using FETs, and other circuits provide excellent Cross Modulation and Intermodulation characteristics. The IC-260A has excellent sensitivity demanded especially for mobile operation, high stability, and with Crystal Filters having high shape factors, exceptional selectivity.

The transmitter uses a balanced mixer in a single conversion system, a band-pass filter and high performance low-pass filter. This system provides distortion-free signals with a minimum spurious radiation level.

**GIVE YOUR VICOM  
DEALER A CALL TODAY**

Distributed by VICOM

SYDNEY: 339 Pacific Hwy,  
Crow's Nest. Ph. 436 2766  
MELBOURNE: 68 Eastern Rd.,  
Sth. Melb. Ph. 699 6700

# VICOM

VICOM gear is available from  
most reputable dealers!

# WIA NEWS

A meeting of the Joint P. and T./WIA Committee was held on 21st May. A great many subjects were discussed but few could reach finality.

The new Handbook is now available. Another sample paper of 50 AOC questions will be issued by the Department soon. The WIA asked what in the Handbook should not be subjects for examinations — one example constantly quoted is Repeater conditions (paragraph 5.11). A list was promised for early June.

Copies of the Handbook can also be obtained from your Division or from Magpubs — see advert.

As stated before, the Handbook interprets the Regulations and does not modify or over-rule them. If the Regulations change so also the Handbook must be changed. The new WT Act still appears as far away as it ever was.

Stating your equipment, or intended equipment, is no longer a requirement on the licence application.

The Department is still examining the request by the WIA to reserve WIA to WIZ call sign suffix blocks. The Department is issuing special out of series suffixes as RAN and SAA. Special prefix requested for 1988.

The Department felt a need to re-examine the theory syllabuses not only to spell out some subjects in greater depth but also to include some items not previously dealt with (e.g. simple treatment of ICs). A joint review is scheduled to re-early June.

Procedure when amateurs possess equipment capable of power output greater than permitted was also raised by the Department but WIA drew an analogy to motor vehicles and speed limits. It must be obvious that if amateurs possess such equipment it must be operated in accordance with the Handbook or they must expect special attention from Departmental officers and others, together with running the risk of causing interference, etc.

At a meeting of the Executive on the following day much time was occupied with various organisational affairs, including the appointment of the various Federal Chairmen of Committees or other officers (virtually unchanged) and secretarial or office arrangements and procedures. A copy of the new ARRL amateur radio film, "World of Amateur Radio", has been obtained and Divisions can now obtain videocassettes of this from the Federal Videotape Co-Ordinator.

A submission is to be prepared for the P. and T. Department's "Review of Citizens' Band Radio Service Policy" on matters likely to affect the amateur service. This submission is expected to include a re-statement of WIA policies adopted over several years. See Amateur Radio, October 1974, page 8; January 1977, page 4; February 1977, page 4; June 1977, page 5. These policies are as fresh today as when they were adopted.

## 1980 CALL BOOK

This edition is now being finalised. There are a great number of changes and additions since the 1979 edition. Supplies should become available next month or early in September. If you want any changes to your call sign, address, etc., it might be possible to include them in the new Call Book even at this late date.

## QSP

### MONEY ORDERS — SUBS (ETC.) PAYMENTS

Did you know it costs you 60 cents to buy a money order for \$2 amount and over? It costs you another 50 cents if we have to cash it through a bank account. Postal notes have of course been discontinued.

Bankers will issue bank cheques for less than it costs you to buy a money order. If you send money this way have the cheque made out to "WIA" or "WIA ..... Division", whichever is appropriate. Although it is cheaper to pay in hard cash it is better not to send cash through the post.

### TV Rx INTERFERENCE

"For many amateurs the interference radiated from nearby colour television receivers continues to represent a considerable handicap to weak-signal operation. The prospect of a further, significantly more powerful, source of interference from millions of consumer equipments is thus something of which we should take careful note (microwave ovens is one current item of concern) and, if possible, join with other sufferers in trying to persuade manufacturers and authorities to mitigate the worst effects."—TT in Radio Communications February 1980.

### DIXIE NET

VK amateurs are invited to join the "Heart of Dixie Net" on 28277 kHz at 0110Z on Fridays and at 1900Z on Wednesdays. The latter net of 1900Z is controlled by WD4ENZ, XYL of WD4ENY, who controls the net at 0100Z.

### 1980 SEANET CONVENTION

This year is the 10th Seanet Convention to be held in Manila 28th to 30th November, 1980. How about fitting this into your holiday cruise programme? For details write to DU1JJT, C/- PARA, Box 4083, Manila 2801, Rep. of Philippines.

NEW	NEW	NEW	NEW
-----	-----	-----	-----

## AZDEN (PIEZO) 2 METER MOBILE FM TRANSCEIVER

KEYBOARD CONTROL UNIT SEPARABLE  
FROM TRANSCEIVER UNIT.

**CMOS MICROCOMPUTER CONTROL**

DIGITAL  
READOUT

ARA'S RIG  
OF THE YEAR

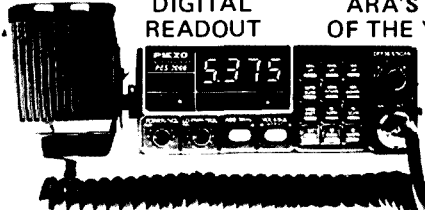

25 WATT

**6 CHANNEL MEMORY**

**MICROPHONE WITH  
REMOTE CONTROL**

**STANDARD ACCESSORY**

\$425<sup>00</sup>

TAX IN.

CALL IN FOR A DEMONSTRATION AT  
**STANDARD COMPONENTS PTY. LTD.**  
9 HILL ST., LEICHHARDT. NSW  
(02) 660 6066

STOCK	STOCK	STOCK	STOCK
IN	NOW	IN	NOW

AR

A change of printer has been finalised and thanks must go to our previous printers for their work on the magazine since July 1975. As the change made in April 1973 from letterpress to sheet offset was dictated to some degree by increasing costs so the change now from sheet to web offset is primarily for financial reasons.

The Executive wishes to acknowledge with grateful thanks the following donations to the WARC 79 fund received via the VK5 Division:—

VK5ZIB .....	\$20.00
VK8NHT .....	\$8.00
VK5NMY .....	\$5.00
VK5IT .....	\$25.00
L50456 .....	\$20.00
VK1MP .....	\$5.00
YMCA Electronics Club .....	\$17.90
Anonymous .....	\$10.00

# Amateur Radio for the Cruising Yachtsman

By Eddie Rooms VK4AER-MM  
C/- Yacht "Assegai"

---

## INTRODUCTION

*This article is in two sections —*

*The first section deals with the author's description and his findings whilst cruising aboard his yacht "Assegai", together with some installation procedures of amateur equipment in sailing vessels.*

*It makes very interesting reading and is geared more towards the boating enthusiast.*

*Amateurs will no doubt skip over the basic amateur radio terms quoted, but nevertheless makes us realise how little the general public knows about our hobby.*

*The first section only will be published in "Modern Boating" magazine in the near future, and the copyright is held by Modern Magazines, 15 Boundary Road, Rushcutters Bay, NSW 2011. Our thanks to Modern Magazines for allowing us to publish the article exclusively in "Amateur Radio".*

*The second section will be published next month, and gives the author's personal comments on how the WIA may improve its service to amateurs, and increase general interest in amateur radio.*

*We suggest readers give serious thought to these comments, and let your Division know what you think. (Letters to the Editor are always welcome, too.)*

*The possibilities here are boundless, but it requires the personal backing of the Australian radio amateur.*

*Here now is part one. I hope you obtain some benefit from the article.*

*(— VK3UV, Managing Editor.)*

---

## PART 1

The tremendous advantages of amateur radio as a communication media for cruising yachtsmen are not well known to Australian sailors. The following information will be of great interest to anyone contemplating foreign cruising, especially if they are thinking of fitting radio equipment, but are deterred by the high cost of marine single sideband equipment and the limitations of marine VHF.

"Assegai" has now done over 25,000 miles cruising throughout the South Pacific and the Australian coast. We have visited New Zealand, Austral Islands, Tahiti, Tuomotus, Marqueses, Suvarov, American Samoa, Tonga, Fiji and the New Hebrides over a four year period.

We left Australia with normal, type-approved marine radio as used in racing yachts in Australia. Now, like scores of other cruising yachtsmen, we realise the tremendous advantage of having amateur radio equipment aboard. Most foreign yachts that have radio, have SSB high frequency amateur transceivers of the type used by radio amateurs all over the world. They use it to keep in touch with friends ashore and afloat, contact a doctor, get parts to remote areas in an emergency, report their positions while on telephone calls\* to home, obtain weather reports and any information required other than business or commercial traffic.

\* Uses of course depend on nationality of licence and extent of third party privilege, if any.

Amateur radio can handle emergency traffic for yachts and radio amateurs are organised to do just that.

There are countless examples of it saving lives at sea but they all have one thing in common. With this type of equipment, the yachtsman can communicate not only with radio amateurs but also with emergency services such as the US Coastguard, military vessels and aircraft and commercial ships. The Australian yachtsman may ask what point there is in being able to contact the US Coastguard if, for example, he is near Fiji. To state the obvious, the US Coastguard have telex and will raise Nadi search and rescue for him.

It is difficult for those without amateur radio on their yachts or experience of it to realise that it gives the yachtsman world-wide communication, and contacts all over the Pacific from Australia to the US or anywhere in between can be expected night or day.

In 1976 the C&C 61, "Sorcery" was rolled and dismasted in the North Pacific. It was a Mayday situation involving injured crew. A 200 watt Atlas amateur transceiver had been installed and with a 20 foot wire strung along the deck, the operator was able to contact a ham operator in Alaska, several hundreds of miles away. The 14 MHz band was used. Amateurs in Hawaii and Seattle joined in the frequency along with the US Coastguard. A nearby Danish freighter overheard and altered course to join the "Sorcery" until a Coastguard cutter arrived to take her in tow. Incidentally, the amateur aboard "Sorcery" was a woman and the Alaskan ham contacted her hus-

band in California by direct phone patch. By this means, she was able to speak direct to home from the stricken yacht.

At Eiao, an uninhabited island in the Muarqeses, French Polynesia, a seriously injured man was rescued from a ravine in rugged country thanks to amateur radio.

One of the three yachts there at the time had amateur radio and the skipper, Steve WB6MMW, contacted Alaska and the Pacific Maritime Mobile Yacht Net. The net relayed the emergency situation and information to Nuku Hiva, the nearest main centre to the accident. We took the medical team the 80 miles on "Assegai".

A 36 foot yacht "Aburab" from the US had a medical emergency while it was in the eastern Pacific near the Central Americas. One of the crew was suffering from appendicitis, so the owner, an amateur, contacted an amateur club station in Panama. A C130 aircraft with a surgeon and two paramedics located the yacht using the amateur frequencies. The co-pilot was an amateur operator. The critically ill crewman was successfully treated aboard the yacht.

On the international amateur bands there is always someone listening somewhere. Because of the wide range of frequencies and the fact that these frequencies are shared by amateurs world-wide, a cruising yacht can go anywhere, even to the South Pole, and still keep in contact with other yachts and shore stations.

In fact, "Solo" recently did so on her trip to Antarctica. For most of the trip she was out of range of the marine fre-

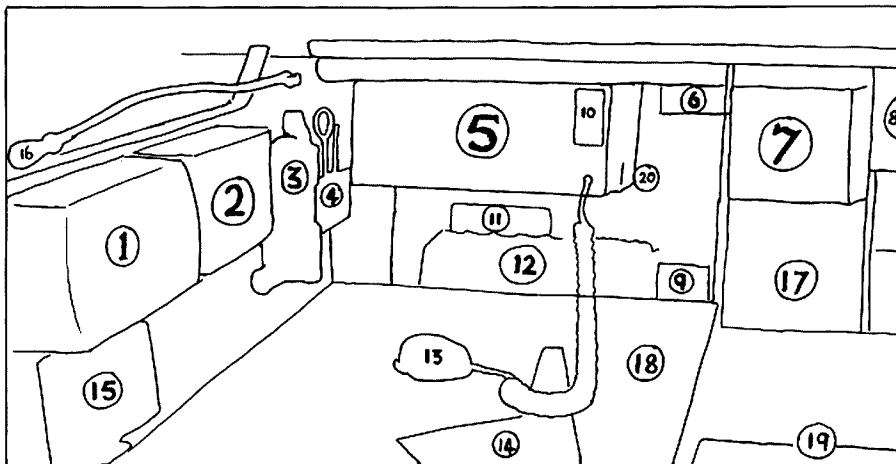

Key to Photo No. 1 (Cover Photo) and No. 2: Navigation and Radio Area on a Cruising Yacht.

1. Brookes and Gatehouse "Harrier-Hermes" electronic ship's log and speedometer shows speed and distance in knots and nautical miles.
2. Brookes and Gatehouse "Homer Heron" Model C radio direction finder receiver. A superheterodyne receiver designed principally for long wave RDF aeronautical and marine non-directional beacons. Also receives broadcast band and 2-4 MHz marine band. Operates from ship's aerial or from (3).
3. Hand bearing compass integral with tuned ferrite rod antenna for ascertaining position lines by finding the "null" point of a non-directional beacon. With an experienced operator position lines accurate to 2° can be achieved.
4. Pencil rack, dividers, etc.
5. Atlas model 350XL DR Mk. II HF SSB transceiver. Covers all bands 160-10 metres inclusive and operates on 12-14V DC ship's batteries. 350 watt PEP input transmitter section with four CD-2545 output transistors and all solid state circuitry. Single conversion

6. Asahi twin meter, SWR and PWR.
7. (See photo No. 2.) Unique Transmatch antenna tuner. Provides continuously variable LC combination as well as a T network for coax fed antennas. Will match long wires or coax antennas to any frequency 1.7 MHz-30.00 MHz. Can handle 1500 watts output power. It makes use of a 600 pF air variable capacitor, three 68 pF ceramic capacitors (selectable by jumper bars at the rear) and a continuously variable 0-28 micro-Henries roller inductor. Four networks are available and SWR when feeding the backstay aerial is always 1:1.
8. (See photo No. 2.) Barker and Williamson model 590G coaxial change-over switch selects either of two feed points on base loading coil of backstay or Scalar SC HF whip system. Dipole can be plugged in to spare outlet for in-port operation. Backstay

aerial is a 5/8 wave vertical on 20 metres and gives very low angle of radiation and about 3.5 dB gain over a half wave dipole. Radiating section is 41 feet long approximately and its top is about 43 feet above the water. A base loading coil of 16 turns of 3/8 in. copper tube is fed for resonance on 80 metres, but its greatest efficiency is on 20. Coil is 4 in. in diameter and grounded for the ship's ground plane and the sea. Although technically it should not the vertical works well on 15m when feeding the 80m tap thanks to the tuner.

9. Stowage for British Post Office style brass CW key. In times of bad QRN CW could save the ship and her crew so some practice is always worth it for a maritime mobile amateur.
10. Auxiliary VFO on Atlas 350XL allows duplex operation.
11. Field strength meter for antenna tuning tests.
12. Pilot books and other navigation publications.
13. Shure 404C hand-held microphone.
14. Brooker and Gatehouse "Hurst" plotter for laying off courses and bearings on chart.
15. Brooker and Gatehouse short wave converter for Homer/Heron receiver allows 2.5, 5, 10 and 15 MHz crystal locked reception of WWV and WWVH. The Atlas 350XL also covers 5, 10 and 15 MHz WWV, making two fine signal receivers for celestial navigation purposes.
16. Flexible chart light.
17. Navigation books.
18. Chart table lid hinges up. Chart stowage bin underneath.
19. Navigation seat is actually head of his quarter berth.
20. Mounting cradle for Atlas 350XL allows quick removal of transceiver from boat and has power supply, antenna, mike and external speaker connections.

quencies and used amateur radio for communication with Melbourne, Mawson and even the pilot of a Qantas 747 with friends and relations aboard.

#### TYPES OF AMATEUR RADIO EQUIPMENT

There are two main kinds of commercially made amateur radio equipment. These are high frequency single sideband transceivers for the amateur bands from 1.8 MHz to 30 MHz and VHF equipment covering amateur frequencies above 30 MHz. Like marine VHF, the latter provides line of sight propagation over 50 to 75 miles. However, automatic repeater stations located at high points along the coast receive a signal on the VHF 2 metre band, amplify it and re-transmit it. Thus with low powered amateur VHF equipment and a short 19 inch masthead antenna, contacts can be maintained while coastal cruising.

However, the high frequency amateur transceiver is the best choice for an offshore yacht. These sets are capable of communication from 0-25,000 miles, or from Australia to England. A workable antenna can be the boat's backstay or a suitable whip aerial. The higher the frequency the easier it is to install a resonant antenna. This is one of the big difficulties in using 2182 kHz 2524 and 2284 aboard small vessels.

#### FREQUENCY COVERAGE OF HF AMATEUR TRANSCEIVERS

These sets have variable frequency oscillators (VFO) and are not crystal locked like marine SSB. The VFO allows the operator to move up and down any 500 kHz segment of the various amateur bands.

The most useful bands for the long distance and coastal cruising yacht are 80,

40, 20 and 15 metres. The operator simply selects the frequency suited to the distance required.

A big advantage of amateur radio for the foreign going yacht is that these bands are shared internationally and the problem of fitting and tuning appropriate frequencies on a world or Pacific cruise never arises.

#### PROPAGATION, RANGE AND COMMUNICATION CAPABILITY

With marine SSB the yachtsman is restricted to fixed 2 MHz, 4 MHz, 6 and 8 MHz crystal locked channels. On these, casual conversation is prohibited. This is all right for purely coastal cruising work and for working OTC coast stations and weather services. There are limitations to this, as for example, if you are between Suvarov and Bora Bora, you will be very

lucky to be heard on 2182 or 6215.5 kHz. There are no radio relay vessels around those parts. Foreign countries don't share most of the Australian small ships frequencies and very few cruising yachts have them.

In a yacht race around Tetiroa atoll in French Polynesia, we were asked by the organisers to report any sightings which were unusual as a local yacht was reported missing. On seeing a red flare, "Assegai" and "Tentation", the only yachts with marine radio, reported to Mahina Radio, Tahiti, on 2182 and their 8 MHz working frequency. There was no answer and we were assured on good authority that the listening watch is only sometimes kept. This situation is not uncommon in other parts of the Pacific. If you are going cruising don't expect the kind of outstanding service that the OTC or Auckland Radio provides for small ships.

With Amateur HF SSB, as already stated, you can have world-wide communication capability from aboard a cruising yacht. Sophisticated antenna systems such as yagi beams are not necessary and an efficient aerial can be worked into the boat's rigging.

Due to their ability to make best use of ionospheric skip, amateur radios make CB radios seem like mere toys. High power allows great flexibility in antenna systems and HF amateur sets have many times the range of marine SSB. One simply selects the band suited to the distance required. In practice, most yachts use 20 metres for long range and either 40 or 80 for closer range. A 20 metre signal from Melbourne would bounce right over Sydney, but be clearly heard in Tahiti or Los Angeles. Communication between Tahiti and Vancouver, mid-Tasman and Fiji or Auckland, Japan and Sydney, England and New Zealand, Cairns and Melbourne, Hawaii and Bass Strait, Bass Strait and Melbourne, Melbourne and Geelong, etc., etc., can be expected with reasonable reliability with only an elementary knowledge of propagation. The amateur bands are international which means one can communicate with other yachts or amateurs from other countries. Distance is irrelevant.

About 70 per cent of US yachts and 30 per cent of Canadian yachts have amateur radio equipment aboard. There are very few New Zealand and Australian yachts with it but the number is certainly increasing. When properly set up it is definitely the most reliable form of communication for the foreign going yacht. An ocean racer with it aboard has a better communication capability than the radio relay vessel. "Solo" took a 200 watt Atlas to the Antarctic, "Kiadoa" has an Atlas 350 XL. A Costa Rica yachtsman who sailed a "470" from the Galapagos to the Marqueses also had an Atlas.

Most of our friends on cruising yachts have either Yaesu or Atlas equipment. "Assegai" has an Atlas.

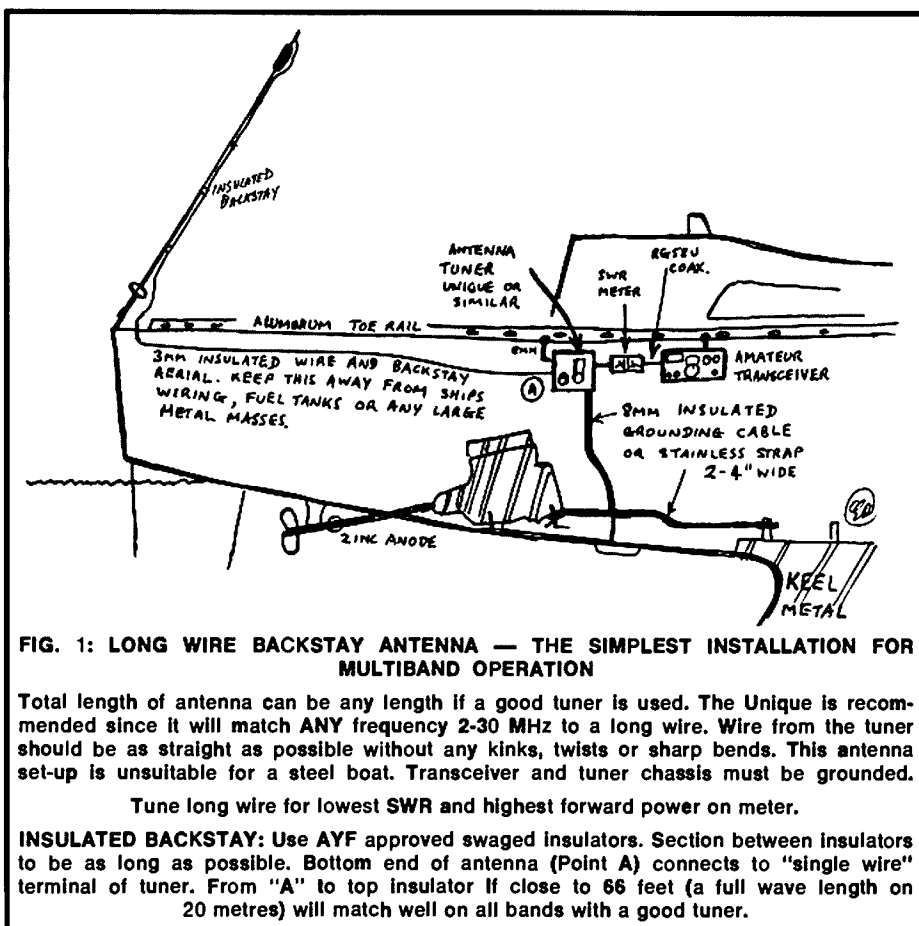

**FIG. 1: LONG WIRE BACKSTAY ANTENNA — THE SIMPLEST INSTALLATION FOR MULTIBAND OPERATION**

Total length of antenna can be any length if a good tuner is used. The Unique is recommended since it will match ANY frequency 2-30 MHz to a long wire. Wire from the tuner should be as straight as possible without any kinks, twists or sharp bends. This antenna set-up is unsuitable for a steel boat. Transceiver and tuner chassis must be grounded.

Tune long wire for lowest SWR and highest forward power on meter.

**INSULATED BACKSTAY:** Use AYF approved swaged insulators. Section between insulators to be as long as possible. Bottom end of antenna (Point A) connects to "single wire" terminal of tuner. From "A" to top insulator if close to 66 feet (a full wave length on 20 metres) will match well on all bands with a good tuner.

### BRANDS AND PRICES — HF, SSB AMATEUR RADIOS

It is best to use a brand which provides output in the better than 100 watt PEP range. The most popular brands on cruising yachts are Atlas 210 X, 215 X and Atlas 350 XL, Yaesu FT 101E and FT 101B, the Kenwood TS 520. All of these can be operated from a 12 volt battery. There are dozens of other brands such as Swan, Drake and Heathkit. Prices vary, but a general rule is that amateur gear is about half the price of marine SSB for the same output. For around \$900 one can have a 100 watt PEP output set covering the amateur bands. An antenna tuner is most desirable in order to match the backstay or other aerial to the wide range of frequencies as is an SWR bridge in order to monitor antenna match. Tuners vary in price from about \$100 to \$400 and an SWR bridge costs about \$30.

Contrary to what many yachters think one need not be an electronics wizard to operate a set and many brands are designed to be "idiot proof", particularly the Atlas and Drake. The market for amateur equipment is very large and world wide. It is very competitive and a good brand is very reliable. It is quite common for a manufacturer to sell many thousands of one model.

The all solid state types are best for maritime mobile amateur use as they are

physically smaller and do not have valves, thus being less susceptible to vibration damage. The use of transistors instead of valves in the final output stages of a set does away with the need for heating elements which demand more battery power before the set can go into transmit mode.

### NET OPERATION

A valuable service to the yachtsman cum amateur radio operator is the use of "nets" by increasingly large numbers of both land based and maritime mobile ham operators.

What then is a net? A net is comprised of a group of amateurs who meet at a specific time (either daily, weekly or whatever) and a specific frequency in order to share a common interest, pass on traffic or contact other amateurs. Nets are run by a net controller who is always strictly voluntary and who is usually assisted by various relay stations. The members check in with the controller to let him know they are listening either to help out with information or look for a friend should he come up on frequency. Should any two stations or group wish to have a more private QSO they simply move off the net frequency, for example up or down 10 or 15 kHz and carry on their QSO without holding up the net traffic on its pre-arranged frequency. In a well run net very large volumes of traffic can be

**IF  
YOU'RE  
NOT  
BUYING  
AMATEUR  
RADIO  
ACTION**

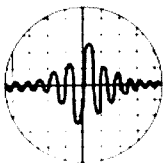

(IT'S AUSTRALIA'S BEST  
SELLING AMATEUR MAGAZINE)

**THEN  
YOU'RE NOT  
KEEPING  
UP WITH  
THE LATEST  
NEWS, VIEWS  
AND REVIEWS**

Please put me down for 12 editions of  
Amateur Radio Action, starting NOW!

Rates In Australia - \$14.40 Surface  
mail overseas - \$18.40 Air mail: To  
New Zealand - \$A28.70; Malaysia -  
\$A32.60; Japan - \$A38.45; USA -  
\$A42.35; UK - \$A46.25

Herewith enclosed cheque/postal  
note/money order to the value of:

\$A.....

Name.....

Address.....

.....

.....

Postcode.....

Post to: Amateur Radio Action Sub-  
scriptions, Box 628E, Melbourne  
3001.

**RECEIVE THE  
BEST!!**

WITH HIGH PERFORMANCE  
ANTENNAS FROM

**SCALAR**

**Be a DEVIL!  
Buy a PITCHFORK!**

*HF Mobile Operation was  
never like this!*

Up to three bands on one  
antenna...

No more messing about  
changing whips!

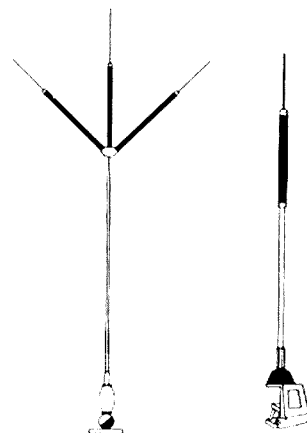

SC2M	2 METRE MAST	.....	\$15.85
SC6M	6 METRE MAST	.....	\$18.70
SC1015	TRIBAND ATTACHMENT	.....	\$18.70
SC80R	80 METRE RESONATOR	.....	\$25.90
SC40R	40 METRE RESONATOR	.....	\$20.15
SC20R	20 METRE RESONATOR	.....	\$18.70
SC15R	15 METRE RESONATOR	.....	\$18.70
SC10R	10 METRE RESONATOR	.....	\$17.25

**INTRODUCTORY  
OFFER**

**SC33DX**  
3 ELEMENT  
TRIBAND BEAM  
10-15-20 METRES  
**\$270.00**

**ALSO AVAILABLE**

- **SC22DX 5-BAND TRAPPED VERTICAL \$129.00**
- 2m and 70cm WHIPS
- DIPOLE TRAPS
- INSULATORS
- BALUNS 3-30 MHz
- QUAD HUBS

PLEASE ASK FOR OUR CURRENT PRICE LIST



**THE SCALAR GROUP**

VIC: 20 SHELLEY AVENUE, KILSYTH (03) 725 9677  
NSW: 328 KINGSGROVE ROAD, KINGSGROVE (02) 502 2888  
QLD: 8 FERRY ROAD, WEST END (07) 44 8024

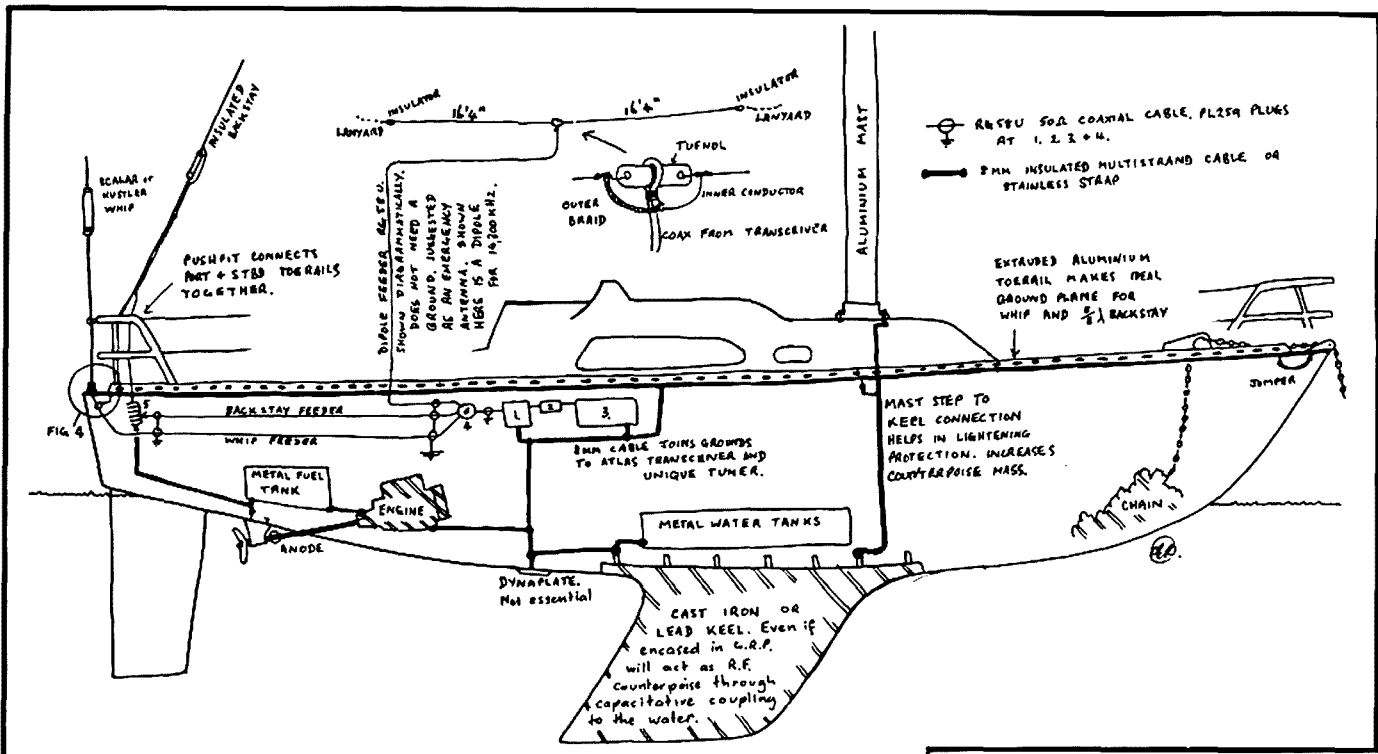

FIG. 2: ANTENNA AND GROUND SYSTEM ON "ASSEGAAI"

**LEGEND:**

1. Antenna tuner. Unique recommended as it has continuously variable inductance/capacitance capability.
  2. SWR and power meter in RG58U coax line, e.g. Asahi MF-11X or Toyometer YM-1E.
  3. Amateur Transceiver. At least 100W PEP output recommended. All solid state preferable. 12-14V DC.
  4. Coaxial changeover switch selects antenna.
  5. Copper loading coil for base loaded backstay. Coil is fed for resonance at desired frequency. Backstay length from 5. to top is critical (see Ham Books).
- (DC Cables omitted for clarity)

The net is now run by a New Zealander named Noel ZL1CU in Auckland. He carries on the work of recording yachts' passages and arrivals, emergencies are relayed directly to the relevant authorities and are also broadcast to all persons who could help. Medical traffic is given priority as is Mayday traffic. The American Amateur Radio Medical Service can be brought on frequency at any time by phone in Hawaii. This means the doctor himself speaks to the patient at sea. The US Coastguard has a frequency in the same amateur band and its helicopters worked in conjunction with "hams" in the "Sorcery" incident in the North Pacific. The net has communications capability extending well beyond the range of coast radio small ships service, which was never designed for international cover. If Australian Coastal Surveillance, Canberra, wants to find a yacht in the Pacific or Indian Ocean, it asks Noel in Auckland to put over a bulletin on its behalf.

There are other nets. Some are big and more formal like the Pacific Maritime Mobile Net, while others are small, informal and more localised, comprising of only a few friends in the Fiji area for example.

Examples are: Atlantic Maritime Mobile Service Net, Jerry's Net for Canadian yachts and friends in the Pacific area. "The 40 Metre Net" covers mainly French Polynesia. "Earl's Net" mainly for US yachts out of Southern California. The 15 metre net is another. These are all maritime mobile nets. There are many, many others designed for land stations, such as the Pacific Inter-Island Net, which is large and handles traffic for Americans and others in Pacific Island territories.

handled. The most useful net for the cruising yachtsman in the Pacific Ocean, China Sea and Indian Ocean is the Pacific Maritime Mobile Yacht Net. It was founded by an amateur named Robbie YJ8AN. Robbie would be there every day, 365 days a year, at 0530 GMT, 14315 kHz ± QRM. This was in 1973, and because of the tremendous range of his signal from the New Hebrides, distance was irrelevant, thus enabling Robbie to receive and reply to yachts checking in from thousands of miles away. These included yachts from Tahiti, Hawaii, Vancouver, California, the Caribbean, Guam, Pago Pago, Cairns, Bay of Islands, New Zealand, Fatu Hiva, Pitcairn, Manihl Atoll, Yasawas, Isle of Pines, Antarctica, Timor, Okinawa, Kodiak and on passage all over the map. Robbie was nicknamed "Mickey Mouse" after MM for Maritime Mobile, the official term for an amateur station operating outside territorial waters.

Scores of people tuned in to listen and work this most interesting guy, who could pass an extraordinary amount of traffic in the hour or two after 0530 GMT. The Mickey Mouse Net was later run by Ted

VK4AEM, from Caloundra, Queensland. Ted ran the net efficiently and like all radio amateurs kept a log. Furthermore, he plotted the positions of boats making passages on a large blackboard after they had checked in. About the only time he became annoyed was when yachts which had checked in while on passage failed to notify him on arrival at their destinations. Yachts which checked in on a regular basis and failed to do so over several days were "called" by Ted to ensure all was well on board. He also arranged schedules between yachts, noted when particular yachts would be up on frequency again and many other details, such as an alert for a stolen yacht. US Coastguard and Marine Operations Centre, Canberra, have contact with this net.

The Maritime Mobile Net over the years has involved more and more yachts, and amateur radio operators who are primarily concerned with the welfare of "yachties", who have been and are able to check in on the 20 metre band. Emergency, priority and medical traffic are all handled at the beginning of the "net" when the frequency is left open for a reasonable amount of time.

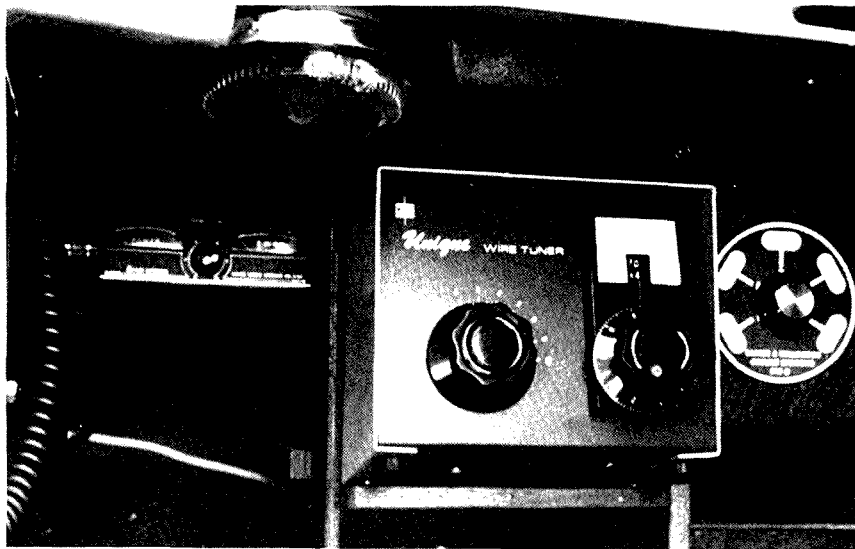

PHOTO 2 (left): SWR Bridge, unique transmatch antenna tuner and antennae selection switch. Atlas 350XL is to the left — see key diagram.

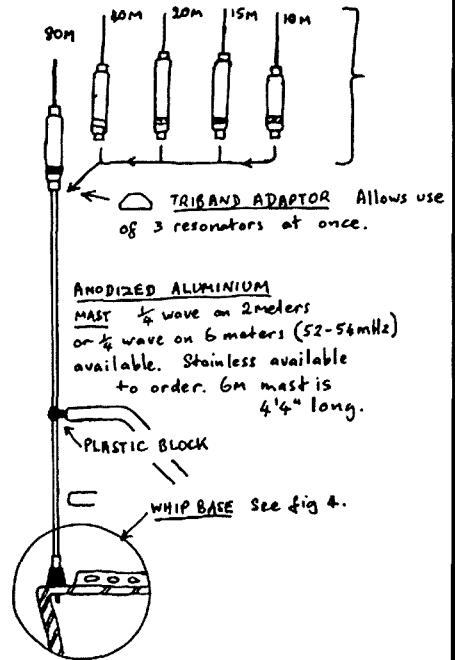

FIG. 3: MULTIBAND WHIP SYSTEM

**RESONATORS** with adjustable tips. One for each band screws to top of mast. Marine band resonators are available to order. An SWR bridge has to be used to adjust the tip to resonance in order to gain maximum effective radiated energy. High SWR will result in very low power transfer to the whip (see table four). Resonators are colour-coded and cover the whole band to which they apply. They are small and easily removed for stowage.

**NB.:** It is essential that the base of the whip be close to a good ground plane such as toerails, life lines and pushpit. They should be grounded to the sea. Keep the whip low as at HF a large proportion of the signal is bounced into the ionosphere from the ocean's surface.

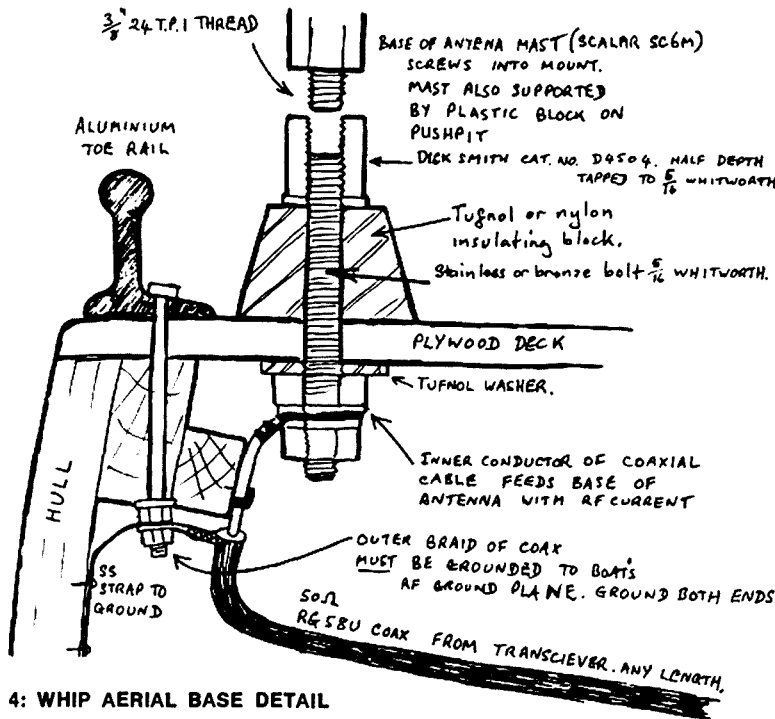

FIG. 4: WHIP AERIAL BASE DETAIL

**NOTE:** It is very important that a whip has a good ground plane from which the RF signal will be reflected into the ionosphere (see Fig. 3). The aluminium toe rail, life lines, pushpit and pulpit, when connected to the water, are perfect. Keep the whip low and close to the water.

### MAYDAY TRAFFIC

I should point out here that it is not necessary to wait until a net time if you have an emergency situation. With amateur radio equipment aboard which is properly set up, the yachtsman can expect to contact someone, somewhere. There are always thousands of amateurs listening all over the world. Remember that if someone is talking, there will be someone listening. Call as soon as he stops talking or before he does and either he or his contact will hear you. Amateurs are obliged by law to

handle Mayday and Pan traffic. Loss of the licence would be the result of ignoring this law. Amateurs can be found in your own home town. They are on islands, on yachts, in private and commercial aircraft (The DC10 has a 14 MHz amateur frequency), commercial ships, military bases, Scout camps, technical schools, US Coast-guard stations and vessels. There are 20,000 amateurs in California alone and nearly 13,000 in Australia.

### WHAT IS A PHONE PATCH?

Amateurs in certain countries, notably

USA and Canada, but not Australia, UK and New Zealand, have a device called phone patch. This enables them to relay telephone traffic through their amateur radio equipment. An example will show how it works. A yacht's skipper with a VE7 call spoke from his yacht which at the time was near the island of Raiivavae in French Polynesia, to his wife in Toronto on the telephone via a VE7 ham in West Vancouver. They arranged to meet in several days at Tubuai airport, also in French Polynesia, but 100 miles from the yacht. The skipper had regular skeds with the Vancouver amateur, who simply made a collect call to Toronto while he was on frequency. Note that French Polynesia no longer allows phone patch traffic from



yachts within 70 miles of any of its islands but patches from a high seas location are legal. The Canadian and Americans make many similar situations possible and international third party traffic is legal for them. Australian amateurs would lose their licences if they did the same thing, and an American would be in trouble if he passed third party traffic for an Australian amateur. It is in order, however, for an amateur aboard a yacht to speak with mutual friends in another amateur's radio room. It is also quite legal for a yachtie to keep skeds with a land based amateur. There are many amateurs in NSW, Victoria and Queensland who keep private skeds with Australian yachts while the vessels are on passage or just relaxing at anchor.

#### INSTALLATION

All too often, radios are not well set up on boats, despite the fact that owner installation is an easy matter when a few basic principals are followed. Three things need to be considered:

1. Location of the transceiver and its power supply.
2. The antenna system.
3. The ground system.

If a vessel is properly designed, there will be a dry place away from salt spray and possible surging bilge waters in which to install the radio. This is usually at the chart table which is a handy position for the operator. It may also be beside a settee berth in the main cabin. "Assegai's" radio is located at the chart table and we have plastic screens which roll down over the radio and antenna tuner in case of water finding its way over the spray dodger which covers the main hatch.

It is very important that the heat sink fins on the solid state equipment are in a well ventilated position to enable proper cooling of the output transistors. The power cable running to the batteries should be as short as circumstances will allow in order to minimize voltage drop. The cables should be double insulated 2.5 mm to 3.5 mm multi-strand and they should go direct to the battery with a fuse or circuit breaker in the battery end of the run.

#### THE AMATEUR LICENCE AND HOW TO GET ONE

As is the case with all radio equipment, one requires a licence to operate an amateur transceiver. Full details of requirements are available from the Radio Frequency Management branch of the Posts and Telecommunications Department in capital cities or also from any radio inspector's office in provincial centres. A great deal of material such as past exam papers is free for the asking. The Department conducts exams every six months in major centres. Most radio inspectors are very helpful and will advise you as to the best study courses in your area, run either by the local technical school or radio club. Correspondence courses are available from the Education Service of the NSW Branch of the Wireless Institute of Australia at PO Box 123, St. Leonards 2065, NSW.

The WIA also sells excellent morse code instruction cassette tapes for only \$3 each. It has offices in all States and welcomes enquiries from people interested in amateur radio. It is the official arm of Australian radio amateurs and represents them not only at a Federal but also on a world level. Morse code practice is broadcasted by its stations VK2BWI and VK5WI

in the 80 metre band on 3550 kHz between 7.30 p.m. and 9.30 p.m. every night of the week.

There are three levels of licence.

AOCOP — Amateur Operators' Certificate of Proficiency.

AOLCP — Limited Amateur Operator's Certificate of Proficiency.

NAOCP — Novice Amateur Operator's Certificate of Proficiency.

AOCOP or NAOCP are the best certificates for the cruising yachtsman. The AOCOP or "full call" allows use of all amateur bands, whereas the novice is allowed on 80, 15 and 10 metres, which gives him access to international as well as Australia-wide communication. Morse for novice is only 5 w.p.m. send and receive, which is easy. The full call requires 10 w.p.m. morse and needs much more practice. Both novice and full call require passes at the same regulations exam, but the theory for the full is more involved. Many fully licensed amateurs have had no previous electronics background.

Novice frequencies are 3525-3575 kHz (80 metres), 21125-21200 kHz (15 metres), 28100-28600 kHz (10 metres).

The limited exam is the same as AOCOP full call but without any morse code requirement. The holder is restricted to frequencies above 52 MHz and therefore denied use of HF SSB transceivers which are so valuable to the cruising yacht. Section 92 and 93 of the Handbook for Operators of Radio Stations in the Amateur Services make it clear that an amateur station is legal aboard Australian vessels. It is the operator not the vessel which is licensed and he may bring his equipment aboard. The owner of the yacht need not be the operator and the station is legal in foreign territorial waters or on the high seas. A station in this situation is maritime mobile and would have a call sign as follows — VK4AER/MM. The VK refers to Australia, the 4 is the State of Queensland, the operator's normal home State, AER is the amateur's call letters, while the MM refers to maritime mobile.

Many Pacific Island countries will issue call signs for a small fee to foreign yachts, but these calls are to be used only while the operator is in the territorial waters of the countries concerned. They are not valid for other areas. It is advisable to have a call sign and licence before going cruising.

I hope that this gives you some idea of what amateur radio means to the cruising yachtsman. I'll say 73 at this point and catch the Pacific Net as it is nearly 0530 Zulu and an old friend Ian WA6DNU, who is maritime mobile and approaching Chile, will be checking in with Noel ZL1CU in Auckland. It will be interesting to see how Ian's current cruise is going.

Good luck and good sailing.

END PART ONE.

Part 2 continues next month. ■

TABLE 1  
Some Amateur Maritime Mobile Nets

Net	Time GMT	Net Control	Frequency kHz	Coverage
Pacific Maritime Mobile Net	0530 daily	ZL1CU Auckland	14,313	Total Pacific area via relays
DDD Net (Doers, Duffers & Dreamers)	0400 daily	VE7CEM Vancouver	14,116	Eastern and Central Pacific
The "15 Metre Net"	2300 wk. days only	Various	21,404	Pacific area
*Pacific Inter-island Net	0800 daily	Usually a Guam station	14,313	Pacific area, especially U.S. possessions
UK Maritime Service Net	A new net. Time as yet unknown to writer but control is UK station		14,313	Atlantic area for cruising out of UK and Europe

\*The net for handling traffic and contacts between many Pacific Islands and mainland USA, but US yachts often use it for phone patch traffic and contacts with home. Other Maritime Mobile are welcome.

There are many other nets which will also handle maritime mobile check-ins. Examples are the South East Asia net, the Seafarers Net, Tony's Net, the Coral Coast Net, the 40 Metre Net.

# A Decade in Review

## The Expanding World on VHF in the 70s (Part 2)

---

This month we present Part 2 of an article by our VHF/UHF Sub-Editor, Eric Jamieson VK5LP. The last few years have brought excellent conditions to the VHF/UHF orientated amateur and readers will recall some of the highlights presented with a wish that such good conditions prevail in the future.

---

### JANUARY 1976

The Mt. Gambier 144.65 beacon under construction. (What happened to it?)

EME: VK2AMW to K8UQA on 432 on 27-10. During WA6LET tests on 432 VK5NC, VK5MC, VK5QR and VK3ZUR copying signals.

VK3ZAZ trying skeds to C21 around 1900Z — MS to equatorial regions?

A ZL trying to get vertical polarization on 2 metres standard for all modes!

AMSAT report that rare stations like 4W1ED, ZB2BL, TU2EF and FY7AS being worked via Oscar 6 and 7 in Europe.

### FEBRUARY 1976

Report on northern VK4 2m activity.

VK4UX reports JAs for the first time this cycle on 12-10-75.

VK4UI worked C21KM/MM via Gold Coast repeater (C21KM 250 km out to sea!).

VK3ZAZ says to turn your power down with strong signals around. Quote, "It is proven that long haul DX only appears October-November and March-April, with slight exceptions".

2 metre SSB really active with those IC202s getting into the act.

### MARCH 1976

VK8GF has 2 metre SSB.

Large tropo openings between VK3, 5 and 6 during December and January.

VK5PB and VK6XY set world RTTY record on 144.08 on 1-1-76, distance 1,170 miles.

VK5ZK worked VK6XY on a Ken handheld on Ch. 40 same date.

VK4ZRF 5 x 9 on 6 metres with his 20 mW. Very little AM on 6 in 75-76 season.

### APRIL 1976

Mt. William goes to Ch. 7.

EME: VK2AMW contacts W1SL, K0TLM, W0Y2S and JA1VDV on 432 during January 1976.

During December 1975 contacts to W9GAB and K2UYH. On 144 EME VK5MC worked WA7BJU and W4WNH/8 February.

Suggested 70 cm band plan to remove EME QRM troubles.

Also a 144 MHz band plan — seems the explosion of IC202s has really given SSB a lift.

Proposed beacon plan from VK3AQR.

### MAY 1976

More overseas beacons appearing in the listing. Brisbane VHF Group have a beacon

on 432.4 running 10 watts to three half-wave dipoles.

VK4UX reports more JA contacts during March 1976.

Increased numbers of IC202s, some backed up with 6/40 linears.

### JUNE 1976

Details of Malaysian VHF allocations.

JA activity to VK4 good during April with all afternoon openings.

Five Rockhampton stations with 2 metre capability.

EME: VK2AMW to JA1VDV, F9FT and hearing VE7BBG, I5MSH, VE4JX, SM5LE and ZE5JJ in March! VK5MC worked W6PO and WA2BIT on 144 EME. A list of 13 stations worked on 144 MHz EME by VK5MC with following statistics: 7 using 8877s, 5 using two 4CX250Bs and 1 using 3CX1000A! Almost all using U310s as preamps as well.

### JULY 1976

VK7 432 beacon receives approval to operate 432.475 MHz.

VK5SU leaving Ceduna for Moree, NSW.

WA6LET signals heard by many during May EME tests.

No JAs into Brisbane during last equinox.

### AUGUST 1976

More on VK7 432 beacon: using bi-directional antenna and 20 watts output.

VK4RO, VK4JH and VK4MS have 432 gear.

VS6BE and KG6JDX being worked from Japan.

JA1VOK looking for 144 MHz TEP contacts to VK.

WA6LET worked W3CCX, WB7BST, VK3ATN, JA9BOH and W9WCD on 24-6 via EME.

### SEPTEMBER 1976

Mid-winter Es between VK4, 5 and 7 on 12-6 on 6 metres.

Gold Coast have operational UHF repeater on 433.225/438.225.

Possibility of Chatham Is. being active on 6 metres, population 600 people, 50 chickens, 4 dogs and 2 amateurs!

VK2AMW to W1JAA (ex W6FZJ) on 5-6 via EME. W3CCX going portable EME to Columbia, South America, on 432 MHz.

### OCTOBER 1976

VK6ZDY and SMIRK reported Northern Hemisphere DX looks interesting.

VK2ZAY lists some 14 stations worked during winter Es.

VK5SU/2 (now VK2BXT) had his first 6 metre contact from Moree to VK7ZGI on 6-7-76 using 40 metre dipole! VK2YDY active from Moree on 2 metre SSB.

ZL4MB reports 6 metres poor out of Dunedin last season with only one contact to Hobart.

Advice offered to keep ears on 50 MHz more often.

### NOVEMBER 1976

The beginning of a lot of historical contacts, VK6WG to VK6KZ/P crossband 1296.8 to 146.0 over 10 km on 6-9-76. VK6WG used 3CX100A tripler to 36 inch dish, mode AM. VK6KZ/P using 12 inch electric radiator reflector and diode mixer converter to Barlow Wadley!

Report on VK7ZYT 144 MHz linear using popular combination of 2N5590 driving two 2N5591 to give 50-60 watts.

### DECEMBER 1976

JA arrives to VK3 and VK7 on 23-10 with VK3BIZ working 14, VK3AKK 11, VK7JV 9, VK3AMK, VK3ZRY, VK3ZSJ, VK7JG, VK7ZAH each 5, etc. VK3BIZ reports working RA0CCB crossband to 6 metres.

Report that ZL1VHF beacon on 145.1 copied by K6QJS/KH6.

KG6JDX running beacon on 52.050 from 0800 to 1000Z beamed on Australia.

VK2AMW via EME worked LX1DB on 26-9, K8III on 21-7-76.

### JANUARY 1977

Six metres off and running again. YJ8KM most popular, first contact to VK4ZSH on 1-11-76 and to VK1, 2, 3, 4, 5 and 7 during November. All ZL areas being worked in VK1, 2, 3, 4, 5 and 7 and occasional VK6.

Both VK4ZCL and VK4ZKL report hearing French language telephone conversations on 144.360 MHz, possibly from New Caledonia.

P29MJ now VK7MC. VK3AKC complains of lack of VK5, Adelaide station, on 2m. Sixteen VK1 stations now on 2m SSB.

VK8ZCU hearing VS6, KH6, UA, ZL, JA, JR6, HL9, P29 and VK from Darwin!

EME report and some interesting observations at time of total eclipse 23-10-76.

### FEBRUARY 1977

2 metre Es to four States, 16-12-76 VK4 to VK5, with VK4ZRQ and VK4ZNC to VK5KK, VK5GL, VK5ZBU and VK5ZRK.

6 metres and YJ8KM to Perth on 1-12-76 with good signals.

2 metre Es on 11-12 from VK4 to VK5 again.

VK4ZAZ heard VK1RTA beacon on 144.475 on 4-12. Tropo between VK3, 5 and 6, all December, on 2 metres.

JAs to VK5 on 52 MHz on 11-12.

Albany beacons shifted to Mt. Adelaide, near Albany. VK6WG ready for 1296 MHz.

### MARCH 1977

More 2 metres Es, VK4ADC heard VK7ZAE on 30-12, VK5KK heard by VK7PS same time.

2 metre Es solid copy for 45 minutes from VK1 and VK2 to VK5KK and VK5LP on 31-12. Four VK1 stations worked along with VK5NY and VK5ZPS working VK2 only, and several country VK5s working VK1MP.

VK5KK works VK1, 2, 3, 4, 5, 6 and 7 in less than 14 days on 144 MHz!

Tropo on 432 MHz to VK6WG, VK6KZ, VK6ZED, VK6ZBW from VK5KK, VK5NY, etc., on 27-12.

VK7RTW damaged by fire.

### APRIL 1977

More on 2 metres, both Es and tropo. VK7PD mobile in Ulverstone heard Brisbane repeater! VK7ZAH was heard in Brisbane exchanging reports with VK3YJI. VK7NR/M worked VK6ZDT, Wagin, via Geelong repeater on 9-2-77. Also on 9-2 UHF mobiles reported to be working from NW Tasmania to VK2/4 area between Armidale and Brisbane!

VK4ZRF, VK4ZSH and VK4ZRQ out for VK2 mid-summer field day report, no Sydney stations, but beacons audible, only Newcastle and Brisbane stations worked with temperature at 42°C plus.

VK5 ATV repeater granted a licence.

VK5QR to VK6WG contacts on 1296 MHz numbered over 8 in just one day alone in February! VK3AKC and VK3ZBJ attempt QSOs but no go. VK6WG being copied in VK5 on 1296 by VK5KK and VK5NY.

EME contacts to VK2AMW include JA1ATL, JA1VDV, K3PGP, F2TU, WB5LUA and FY2AS on 432 during December and January.

### MAY 1977

KH6EQI heard in VK5 by VK5ZPW on 27-3-77.

VK5RO heard working a JH6 crossband 52 to 28 MHz on 20-3.

A VK3 heard WB9AK? on 26-3, no other details.

VK8ZCJ (now VK8GB) reports 6 and 2 metre activity in Darwin with VK8VV and VK8ZCU active also. First JA opening for equinox on 13-3-77.

VK2ZTB reports 144 MHz TEP with LU7DJZ being heard by YV5ZZ on Oscar up-link.

Prediction of JA contacts to VK8 from Kyushu on 144 MHz via same mode as surety in light of WRE research.

General conditions of JA licencing from VK3HV.

VK9NI to become active on 6 metres.



**PHOTO 4: Reaching for the top on VHF! VK1 amateurs installing the ill-fated Mt. Ginini repeater installation on 12th February 1977. The original repeater antenna system featured 3 bays of 4 gamma matched dipoles fed quadrature (90° out of phase).**

### JUNE 1977

More JAs and TEP in April. VK3OT works KG6APP and hearing KH6EQI on 50.110 MHz on 9-4-77.

Band open to JA for several hours from VK2, 5, etc., on 9-4 and 11-4-77.

VK5LP says Korean FM on 49.305 and TV on 49.750 very consistent.

KL7HAM active on 6 metres from Shemya Is.

VK6BV reports JA openings to Kalgoolie on 16-4 and 19-4.

### JULY 1977

3D2AZ's only 6 metre contact for years was ZL1QI. Although hearing VK2WI beacon in summer had no other contacts.

VK3AMK reports great success with vertical polarization in Channel 0 areas.

VK4RO hearing KH6EQI on same day as VK5ZPW plus a few times in April. On 17-4 had QSO with KH6GRU 5 x 9, first really long haul DX for the cycle; many JAs through to VK4 and VK8.

### AUGUST 1977

Details of JA to W6 contacts in Northern Hemisphere summer.

VK8ZCJ and VK8VV work VS6BE on 6-6 and 7-6-77. Also VK8ZCJ hearing 11th harmonic on RRI in Sumatra on 51.909 MHz on 8-6-77!

VK4ZNC appeals for 6 metre gear for FK8AB.

VK8ZER/6 at Giles Weather Station active on 6 and 2 metres.

### SEPTEMBER 1977

Announcement of the Ron Wilkinson VK3AKC trophy.

First of many pleas for use of 50 MHz in VK for coming seasons.

P29HV reports on 6 and 2 metres activity in P29.

VL5SA beacon on 48.450 MHz running 100 watts into 4 element beam pointing to JA from HMAS Coonawarra, near Darwin. VK2AMW EME site at Dapto vandalised on 25-6-77.

#### OCTOBER 1977

Reported mid-winter Es during June-July between VK1, 2, 3, 4, 5 and 7.

KC4AAA active on Oscar 6 and 7.

Cycle 21 predicted to be a cross between Cycles 19 and 20.

VS6GG informs that all Hong Kong TV operates on UHF.

VK8NER/ZER/P6 heard VK5VF from Giles on 20-8 but no contacts.

Upsurge in local 1296 MHz activity.

#### NOVEMBER 1977

KC6PO works JA from Caroline Is. on 6 metres on 11-9-77.

JA2BZY copying WB5LBJ/DU6 on 11-9 also.

VK3ZY0 worked VK2, 3, 4, 5, 6, 8 and P29 last season using 250 mW.

VK4KK mentions hearing ZS1ET on MCW on 50.020 at 0700Z to 0726Z on 18-1-1948! The time looks interesting and should be kept in mind for now. Very similar to KH6-ZS6 time.

#### DECEMBER 1977

Darwin well alive on 6 metres.

JA2IGY back on 52.500 MHz.

KG6 worked in Darwin on 9-10 and 11-10 by VK8VV and VK8ZCJ, the latter working WB5LBJ/DU6 on 11-10 also.

List of active KG6 stations include KG6APP, KG6DX, KG6JDX.

VK3OT worked nine JAs on 11-10. Band open to JA from VK2 and VK5 through October, but no openings in Melbourne.

Complaints voiced about credibility of information from certain sources.

#### JANUARY 1978

The occurrence of 2 metre TEP is noted for the first time in Darwin. On 27-10-77 VK8ZCJ (now VK8GB) heard JA signals on 144 MHz SSB/CW and 144.34 MHz FM. Unfortunate to miss contact with a JE2. Several letters from JA stations interested in working VK.

VK6BV and VK6ZGQ active from Kalgoorlie with 52, 144 and 432 MHz.

KG6APP writes telling of HL9WI, KC6PO, JA and VK8ZCJ contacts.

JAs reported having been available to all States during last equinox.

#### FEBRUARY 1978

VS6 Hong Kong allowed spot allocations on 52.025 CW and 52.100 SSB.

VK8ZCJ reports the scheduling of KH6EQI beacon beam headings throughout day.

3D2CM is definitely active with 30 watts PEP into 3 element yagi. According to Dick he has a clear take-off in the VK-ZL direction.

P29HV active towards VK, ZL and JA on 6 metres.

J11HHX lists at least a dozen rare DX stations in almost as many countries during last equinox on 6 metres.

P29HV looking for North Queensland stations on 2 metres.

52.050 MHz being clogged by stations working JA DX, while VK7KJ worked KH6NS.

2 metre tropo on 13-11 between VK5 and VK7.

VK5SV hearing VK6WG on 1296 MHz for 90 minutes with a HAND-HELD 3 foot dish. (Would this be hand-held portable 1296 DX?)

VK5ZPW, VK5KK, VK5MT to VK3ZQV in East Gippsland on 432 MHz 5 x 9 and 500 miles over land.

On 2-1-78 VK2BXT at Moree worked VK7ZAH, VK7DA and VK7JG on 144 MHz.

#### MARCH 1978

First widely worked 144 MHz DX out of VK8, giant Es opening to VK2 and VK4, and one-way to VK5. VK8ZGF and VK5ZSH/8 worked VK4ZRQ, VK2YDY, VK2BXT, VK4AZE, VK2ZAY; and VK5ZSH/8 heard by VK5ZWR and VK5KK all on 16-1-78.

Report of enormous workings between VK3, 5, 6 and 7 in last tropo season.

VK2ZTB reports on RS satellites.

VK0GM setting up for Oscar operation from Casey Base.

#### APRIL 1978

Two new world records in VK. VK6WG and VK5QR on 2304 MHz for contact on 17-1-78 with 5 x 9 signals, VK5QR using SSB; VK6XY and VK3ZQV work on 432 MHz to establish a new world record of 1600+ miles.

New 144 MHz record to LU5DJZ and KP4EOR on 12-2-78, distance 3,977 miles.

VK8GB contacts JH6TEW for his first JA 2 metre contact via TEP on 24-2-78.

VK8VV also working to JA.

New SMIRKS include VK3OT, YJ8KM and VK5KK.

JAs excellent to southern States during February.

VK5KK hearing VK7RTW on 432.475 to S7 on 28-2-78, distance 700 miles.

#### MAY 1978

Large scale openings on 6 and 2 metres in Darwin. Stations worked/heard in VK4 and VK8 included KG6JIH, KG6JDX, KG6DX, HL9WI, KH6HI, KH6EQI, KH6IAA, KH6JSI and VK4IK/KG6.

144 MHz contacts from Darwin to JA4 and JA6 areas only.

On 1-3-78 XE1GE heard ZL TV audio on 50.750; same day JA5CMO worked CE3OK on 6.

On 19-3 KH6JSI worked LU7FA and LU3HFU.

26-3 KH6 to PY2CSS and PY5WBR. VK4ZNC to KG6JDX and KG6JIH on 15-3.

VK4ZSH "partially" worked P29ZWW on Ch. 40 FM on 22-1-78.

VK2AMW Dapto EME project terminated after extensive vandalism to site.

#### JUNE 1978

More 6 metres DX. FK8AB active to JA on 28-3, same day VK2BXT and VK2BOV worked KG6DX.

1-4-78 VK5KK to KG6DX and JA to YJ8KM. 12-4 VK3OT to KG6DX.

Large night time openings on 13-4 and 16-4 from VK5 to JA1, 2, 3, 4, 5 and 6.

HL9WI working into Perth on 9-4, and HL9WI heard WA6JRA beacon on 9-4 also.

VR4DX looking for 6 metre gear, while VK2ZTB reports on TEP type 2.

#### JULY 1978

6 metres continues. YJ8ZV worked in Japan on 13-4.

Letter from late K6RNQ indicates stations heard or worked during 1958 including VK5RO and VK5BC! (Plus VK2s and VK4s of course.)

3-5-78 HL9WI worked VS6HK, indicating some activity in Hong Kong.

JAs still being worked in Darwin on 2 metres in May. VK8GB total of 2 metre JA contacts for equinox now 359!

VK3OT sent 157 QSLs to JARL for \$6.11 for season's workings!

Mt. Dundas Channel 5A proposal causing trouble already.

New Australian 10 GHz record between VK4ZSH and VK4ZNC on 14-5-78 with 5 x 7 signals over distance of 106.1 miles.

#### AUGUST 1978

P29 activity on 6 metres. Contacts made to many countries in South Pacific on P29 50 MHz band.

WA4TNV/KL7 operates out of KL7FBI club station on 6 metres.

HL9WI running 6 metre skeds with LU3EX.

The mysteries of "Sporadic E (Es)" revealed with reference to Skylark rocket launchings from Woomera in late fifties. 1971 launching managed to measure exact proportions of an Es layer.

#### SEPTEMBER 1978

An interesting look into the past on 6 metres . . . did you know K6GDI was the first to obtain WAC on 6 metres?

ARRL WAS listings shows EI2W with 35 USA States! SM7ZH had 29, PZ1AE 26.

LU3EX to JA6FR record of 1,200 miles still standing in 1978.

Details of meteor showers for following months.

And the problems of Channel 5A; proposed Ethnic TV using Channel 5A.

#### OCTOBER 1978

The band has yet to shut in Darwin on 144 MHz!

A list of ten active UA stations worked on 2 metres from Japan.

VK2ZBD working VK7 in mid-winter Es. Some more past news. Details of all the firsts in 1947 cycle. This includes the one time world record between VK5KL and W7ACS/KH6 on 6 metres.

Details of early VXX4, VK5, VK8 to JA openings in September.

Auroral openings on 6 metres and 2 metres between VK3, 5 and 7 on 28-8-78.

#### NOVEMBER 1978

VK5LP on holiday and a "fill-in" editor employed!

Details of early VXX4, VK5, VK8 to JA openings in September.

Auroral openings on 6 metres and 2 metres between VK3, 5 and 7 on 28-8-78.

VK5ZAU provides some "overseas" DX from Kangaroo Island on 144, 432 and 1296 MHz around 25-8-78 to Adelaide and points north over a 150 mile path well shielded from line of sight.

IC401 hits the market place; modifications to commercial 2 metre rigs.

#### DECEMBER 1978

KH6 to VK2 and VK5, first time in 20 years, KH6EQI to VK2BXT, VK2YDY, VK5KK, all on 16-10-78.

JA and other news from Darwin looks like a list from the JA Call Book.

FO8DR active on 6 metres.

Auroral propagation on 29-9-78 with VK5KK to VK7ZAH on 144 MHz, plus 6 metres between VK1, 2, 3, 5 and 7.

VK9ZM leaving Willis Island on 6-12-78.

#### JANUARY 1979

Beacon format changed to list stations in order of frequency, 45 amateur band beacons and 7 TV sound channels listed.

First mention of the Army type PRC10 transceiver for listening 38 to 56 MHz.

VK8GB works CR9AJ for country 13 on 6 metres, continues to work many JAs on 2.

Observations show 144 MHz contacts to Japan start mostly about 1100Z except on very active days when contacts may start 1030Z. Band remains open for 1 to 1½ hours.

Peter Wolfenden VK3ZPA, Chairman VHF/UHF Advisory Committee, reports there is unlikely to be any further proliferation of Channel 5A.

#### FEBRUARY 1979

KH6EQI and KH6HI again on 6. Many JAs, band open for some contacts almost every day during October and November.

ZLs on 6 on 5-12. P29ZNL works KH6EQI (KH6HI).

VK works 3D2CM 15-12, KH6IAA 19-12, P29ZWW and ZL3QK 20-12.

ZLs again 23-12, some using handbags and whips! 31-12 more ZLs.

VK5KK total of 621 contacts with JA stations during 1978.

VK5ZBU and VK5RO hear WA6JRA and TI2NA beacons.

22-11-78 VK5KK hears VK6WG on 1296.1 MHz 5 x 2.

24-12-78 VK3 to VK5 on 144 MHz. 28-12 VK6 on 144, 432, 1296 and 2304 MHz.

New world record set on 1296 at 1,310 miles between Wal VK6KZ/P and Chris VK5MC on 29-12-78. David VK5KK also worked VK6KZ/P about same time, on 1296.

Hal VK4DO worked 1357 JAs on 6 to 13-11-78.

VK4ZJB confirms there is a Channel O translator between Townsville and Cairns.

Carnarvon working through Busselton Ch. 8 repeater 150 miles south of Perth.

16-12 FK8AA worked by VK3OT, VK3AMK and VK3AKK.

27-12 FK8AB and FK8AX to VK2ZBD and others.

Passing of Sam Harris W8UKS/W1FZJ/WIBU on 6-11-78 recorded.

7-1-79 VK2 and VK4 work New Zealand on 2 metres. Same time VK2BQJ works

ZL1TAB on 432 MHz — first VK contact to another country on 432 MHz.

Alice Springs repeater VK8RCA Ch. 8 now on, 19 watts output.

#### MARCH 1979

ZL2MHF beacon operating on 52.510. 4 hours of ZL to VK5 on 14-1, plus many JAs.

VK2YJC worked more than 200 ZLs on FM during the big January 2 metre opening.

Lyle VK2ALU confirms 432 EME project at Dapto will be shifted to safer place.

YJ8PV now being heard in Brisbane more often than southern beacons.

Good 2 metre tropo conditions between VK4 and VK2.

Col VK5RO having constant contacts with Frank VK2ZI in Broken Hill on 2 metres.

#### APRIL 1979

Bob Grimm K6RNQ joined silent keys on 13-1-79, well known for his extensive VHF activities, especially 50 MHz during cycle 19.

Wal VK6KZ says he wants to try the path from Augusta in the south-west of WA for his portable jaunts — this is about as far west as one can go!

Hal VK4DO has been on air for 56 years, made life member of Central Queensland Branch of WIA.

JA2BZY worked 27 countries on 6 metres as at 3-2-79.

SMIRK lists 42 countries as allowing 6 metre operation at present.

6 metre liaison net now established on 28.885 MHz, much info being swapped.

#### MAY 1979

Newspaper report that General Manager of Channel O said the change to Channel 10 in about 9 months would cause little inconvenience.

VK3AMK said many old guidelines of years ago for 6 metre propagation are no longer valid.

Colin VK6CM and Roger VK6NR created a State first bi-directional contacts on 10.280 GHz on 14-2-79, distance 25 km for 10 mW.

Peter VK5ZCT in Port Lincoln used Bunbury repeater Ch. 6 to contact Perth. VK2ZQT has a manned repeater on 432 MHz.

First known opening Cycle 21 between W6 and Geelong on 11-3-79.

KG6DX extremely strong to VK2, 3 and 5 on 18-3, and H44DX bursts forth on 6.

TEP type propagation noted on 432 MHz between Rhodesia and Greece on 20-3, distance 6,623 km!

HS1SD active from Thailand on 6 metres, and VQ9KK (?) active on Diego Garcia.

VK8GB heard KC6IN, Caroline Is., also KZ5NW 50.110 on 11-3.

ZS6LN beams to VK 0600 to 1000Z on 50.050.

HL9WI reports hearing VK8s on 144.110 on 8-3.

4/3 K7KV to VK4RO; 10-3 Okinawa to VK5; 11-3 VK3 to W6; WB6NMT heard in Adelaide.

ZL1AQR used crystal locked DSB and ZL3QK used 80 metre dipole to work W stations during big opening on 10-3.

WA4TNN/KL7 worked VK1, nine VK2, VK4, four VK5 to 5 x 9 on 13-3, and on 17-3 W6XJ works into VK2.

HL9TG works LU3EX and LU8AHW for possible new 6 metre world record.

Chris VK5MC works ZE5JJ on 432 MHz EME 31-3-79.

#### JUNE 1979

28-3-79 HL9TG worked over wide area of VK2, 3, 4, 5, 6, 7 and 8!



PHOTO 5: Another well-known operator on VHF/UHF — Reg VK5OR in his well-equipped shack.

3-4-79 XE1GE heard by VK2BYX, VK3OT, VK5KK and several other VK5s on 50.009.

VK4RO works KZ5NW, Canal Zone, W4YYS, WB4GHA and heard T12NA.

VK1FT worked W6XJ using 10 watts, signals 5 x 9!

10-4-79 VK5KK worked split frequency to XE1GE, heard by many others.

12-4 W to VK5. 13-4 VP1MT to VK2, 3 and 5. 14-4 XE1GE again.

16-4 ZS6LN worked KH6HI, KH6NS, KH6JSI and KH6IAA, the latter about 11,900 miles.

18-4 3D2CM works W4, W5 and W6. ZK1AA active on 50, 51 and 52 MHz. 9N1BMK to operate from Nepal. YBOX special DXpedition to Indonesia 28-4 to 8-5.

20-4 VK5ZBU and VK5AVQ hear VE1SIX beacon.

22-4 VK5LP and VK5KK hear W6XJ being worked by VK7JG.

26-4 an outstanding day for DX — FO8DR heard, others heard, some worked include KG6DX, KH6IAA, many JAs, HL9TG, KA6EDI, KG6JEI, KG6JFK, ZK1AA, DU1DM, VQ9KK, H44DX, JD1YAA, YJ8PV, KH6EQI, also VK2BQJ reported working over 200 JAs!

VK3ATN and VK5MC active on 432 EME working VE7BBG, ZE5JJ, I5MSH, etc.

Moves to supply VK0BC with 6 metre equipment.

5B4AZ Cyprus and ZB2BC, Gibraltar, have permits to operate on 6 metres, and ZS6LN, South Africa, worked 5B4AZ with 70 mW output!

## JULY 1979

Beacon list now shows 58 stations.

Large trans-continental backscatter — VK2BQJ to VK6WD with VK5KK in middle.

28-4 W6XJ to VK5KK crossband 28 to 52 MHz.

30-4 YBOX works VK5KK, VK4RO, VK8GB, VK8VV and VK8ZBB.

2-5 VK8s work 9N1BMK Nepal, also hearing W5, W6 and W0 on 50 MHz.

VK8VV worked KA5CEB, and W6XJ works VK8GB, VK8VV and VK8DI on 52 MHz.

9N1BMK worked by H44PT, KA6HF, K9PNT/DU2. CR9AJ on but hard to catch. VU2RM on.

SMIRK warns all operators that no awards will be made which include out-of-band contacts. ARRL very upset about these contacts, too.

Phil VK2BYX has now worked 13 countries on 6 metres.

News from Europe showed first W to Europe opening on 10-2-79 between WB2RLY/VE1 and G3COJ, crossband 50 to 28 MHz. DK2ZF hearing ZS6PW beacon on 50.030. EI2W in Dublin still licensed to operate 50 MHz.

New trans-equatorial 144 MHz record established between SV1DH in Greece and ZS6LN, South Africa, on 13-2-79 at 7,117 km, distance later extended to 7,127 km by SV1AB!

G3 working ZS6 crossband 28 to 50 MHz.

David VK5KK receives his SMIRK 100 Award.

VK8HW and VK8EW work to Japan on 2 metres FM.

## AUGUST 1979

6 metre DX gone quiet but 2 metre tropo good.

1-6-79 VK5SV worked VK2DAB, VK2BEV, VK2ADZ, all in Griffith, on 144 SSB; VK5ZDR worked VK2DAB, David VK5KK worked him as well as VK7ZAH, VK5CK is content to work 7 stations in Melbourne! Good tropo on 6 metres to over 300 miles.

2-6: 2 metres still open to Griffiths and Melbourne, plus VK7ZAH 5 x 9.

VK7ZTA works repeaters in Canberra, Newcastle and Melbourne.

One-way reception of signals on 432 MHz between SV1AB, Athens, and ZE5JJ, Rhodesia, distance 6,300 km, longest 432 terrestrial reception.

## SEPTEMBER 1979

14-7-79 best Es for winter — open from VK5 to VK2 and VK4, VK2 and VK3 to VK7, and on 15-7 to ZL1AVZ.

24-6 good tropo on 2 metres, VK2ZRU works VK3AUR, while VK2YHS and VK2BQJ work VK5MC.

Beacon on 144, 432 and 1296 being built for installation at Cape Leeuwin on southwest tip of WA.

Ed Roche Trophy made available for North Queensland operators for VHF achievements.

## OCTOBER 1979

Auckland VHF Group placing beacon on 52.100 MHz, while the Wellington Group are operating a 10 GHz beacon!

YJ8PD to increase power to 500+ watts on 6 metres with driver stage supplied by VK5KK and VK5LP.

T2AAA (ex VR8) hoping to get on 6m. KZ5NW leaving Canal Zone, leaving only KZ5JM there on 6 metres.

C21AA DXpedition successful, 10 countries worked on 6. HS1WR active in Thailand.

28-7 opening to H44 from VK4 and VK8.

VK9NI most emphatic he will not be operating on 6 metres.

Andy VK6OX and Tony VK6BV have successful 6 metre skeds via meteor scatter.

New distance records announced: VK3OT to XE1GE on 6 metres at 13,768 km; VK2BYX to W6XJ on 6 metres at 12,092 km; VK4VC to ZL2BFC on 2 metres at 2,571 km.

VK5KK receives QSL from 3D2CM, VK8GB receives QSL from KX6BU.

ZLs working to W again on 6 metres.

W0YZS completes first WAS on 70 cm for USA award.

70 cm spans the Pacific — WB6NMT to KH6HME on 18-7-79 for new terrestrial record on 70 cm, while VK8GB looking to work JA on 70 cm.

Dick K2RIW working on an array of sixteen 19 element yagis for 70 cm.

Reports on new pre-amplifiers for 70 cm with NF of less than 1 dB. 5B4AZ allocated 50.499 MHz for CW working.

## NOVEMBER 1979

VK2ALU says his main interest centres on 10 GHz, at the moment pending re-installation of 432 MHz EME equipment.

CW signal copied on 44.250 MHz on 23-9 signing "VPS".

23-9 JA5CMO worked several LU stations on 50 MHz from 0100Z.

6 metres not dull overseas: JA stations recently have worked VK4, VK6, VK8, P29, KC6, KG6, KH6, H44, YJ8, FO8, KX6, HS1, JD1, 5W1, A35, 3D2, etc.

N6DX DXpedition successful, but mainly JAs worked, plus KG6 and YJ8.

K9PNT/DU2 can now operate on 52 MHz with FT620 and quad antenna.

Rumours say VU2RM doesn't have a 6 metre allocation.

VK3OT and VK2BYX/ATZ to have DX-pedition to Lord Howe Is. 27-10 to 31-10.

VK5KK fires up temporary manned beacon seeking permit to operate full time.

VK5LP offers info on 13 element beams in effort to promote interest in 2 metres SSB/CW.

Carlos T12CF hoping to be on 6 metres by Christmas.

Gary W6XJ wins SMIRK Party Contest with 22,720 points, followed by Steve VK3OT, operating as YJ8OT, with 588 points. David VK5KK wins Australian section with 13 points!

## CONCLUSION

And on that note we can close the November 1979 AR and say that 10 years of very interesting events have been covered. Scattered throughout the many words taken from the past 10 years one can confirm the immense value which has been gained from having a nationwide coverage by CW beacons, on many occasions they have served as a warning of impending openings, sometimes they have let us down due to being on elevated sites and coastal ducting and inversions have been below them, but overall they have been very worthwhile. They have certainly also helped much 6 metre DX in other places of the world where beacons are operating, and few countries are without them.

If the research needed for and the writing of this long article, which cannot be successfully shortened, serves to instil enthusiasms in more amateurs to enjoy the fruits of the VHF/UHF bands, then the work has been worth while. If anything more remains to be done in the way of achievements in amateur radio, then it will be done on VHF and UHF, where, despite the inroads made by availability of commercial equipment, much experimenting is still being done, perhaps on a lesser scale than previously, but the dedicated are still to be found there, the result of their work will be the continual lengthening of record distances on all bands available to them.

Thought for the decade: "We judge ourselves by what we feel capable of doing, while others judge us by what we have already done."

The Voice in the Hills. ■



# TH5DX

## 10-15-20 METERS

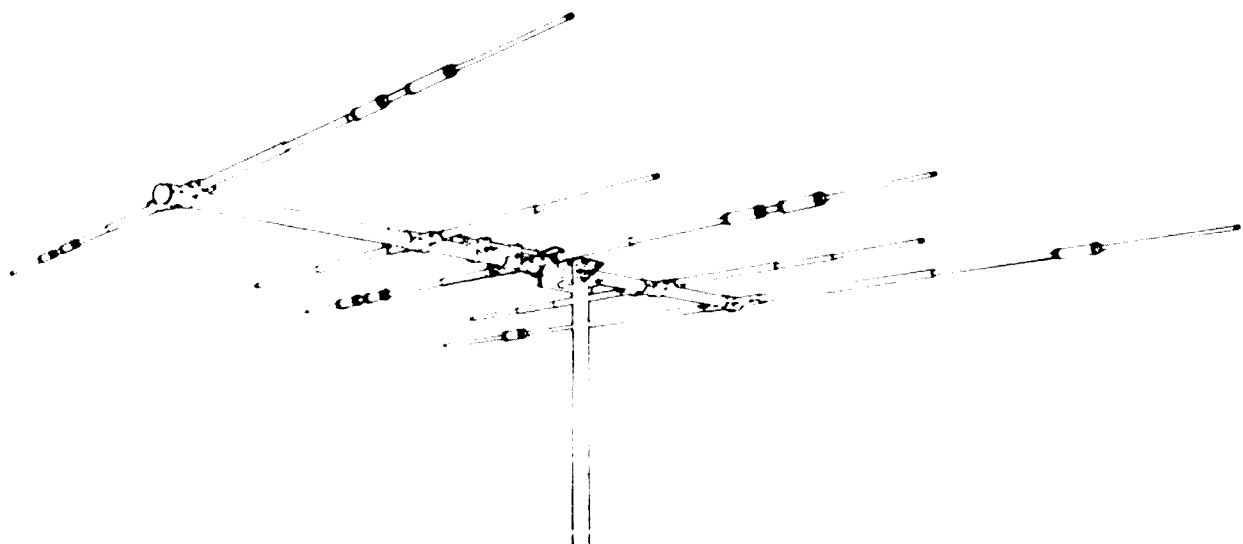

We are proud to introduce the newest member of our famous Thunderbird line of Tri-Band antennas. The TH5DX offers outstanding performance on 20, 15 and 10 meters. It features 5 elements on an 18 foot boom, with 3 active elements on 15 and 20 meters and 4 active elements on 10 meters. The TH5DX also features separate air-dielectric Hy-Q traps for each band. This allows the TH5DX to be set for the maximum F/B ratio and the minimum beam width possible for a Tri-Band antenna of this size. Also standard on this antenna are Hy-Gain's unique Beta-match, rugged Boom-to-mast bracket, taper-swaged elements and improved element compression clamps.

Boom length..... 18 feet  
 Longest Element..... 31 feet  
 Turning Radius..... 18 feet  
 Surface Area..... 6.4 sq. feet  
 Wind load..... 164 lbs  
 Weight..... 50 lbs

VSWR at resonance..... less than 1.5:1  
 Power Input..... Maximum Legal  
 Input Impedance..... 50 ohms  
 -3dB Beamwidth..... 66° average  
 Lightning Protection..... DC ground  
 Forward Gain..... 8.5dB  
 Front-to-Back Ratio..... 25 dB

**WRITE OR CALL FOR A FREE BROCHURE AND THE NAME OF YOUR NEAREST HYGAIN DEALER  
 SOLE AUSTRALIAN DISTRIBUTOR**

AUDIO TELEX COMMUNICATIONS  
 PTY. LTD.



**MELBOURNE:**  
 7 Essex Road,  
 MOUNT WAVERLY 3149  
 Tel: 277 5311

**BRISBANE:**  
 394 Montague Road  
 WEST END 4101  
 Tel: 44 6328

**SYDNEY:**  
 1 Little Street,  
 PARRAMATTA 2150.  
 Telephone 833 4344

# WOULD YOU BUY A TRANSCEIVER THAT IS ALREADY OBSOLETE?

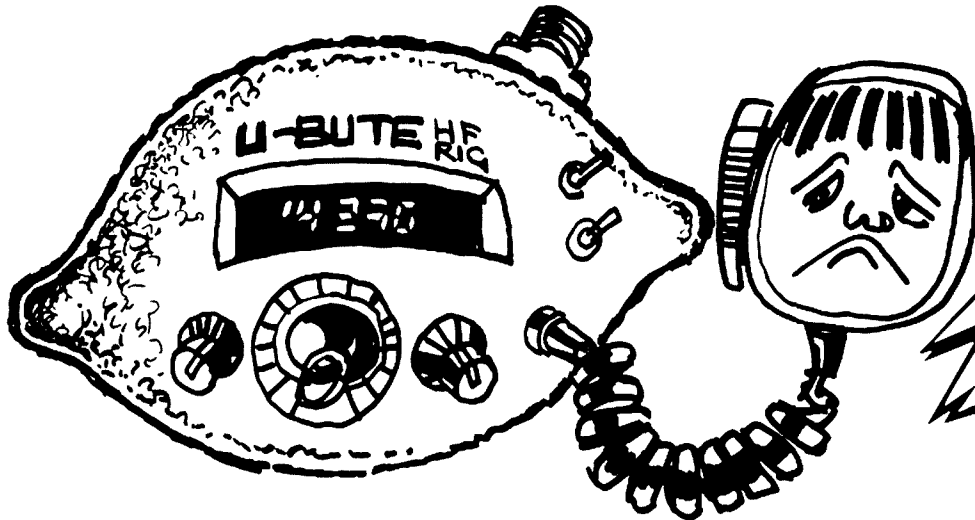

**STOP PRESS!!!**  
 A BRAND NEW CONTEST FOR AMATEURS - WITH A TRIP TO HONG KONG - DETAILS NEXT MONTH!  
 OR FROM YOUR DICK SMITH STORE!  
 DON'T BUY A TRANSCEIVER ELSEWHERE UNTIL YOU FIND OUT ABOUT THIS CONTEST!

Let's face it: a modern transceiver is quite an investment. Are you prepared to buy a transceiver which would let you down in years to come?

The new Yaesu FT-707 HF transceiver is, as far as we know, the only transceiver on the market with the new HF amateur bands already included. Its modern circuitry represents the 'state-of-the-art' in communications technology. And the really good news: the FT-707 actually costs LESS than many of the superseded transceivers it is replacing. Shouldn't your next transceiver be a Yaesu FT-707?

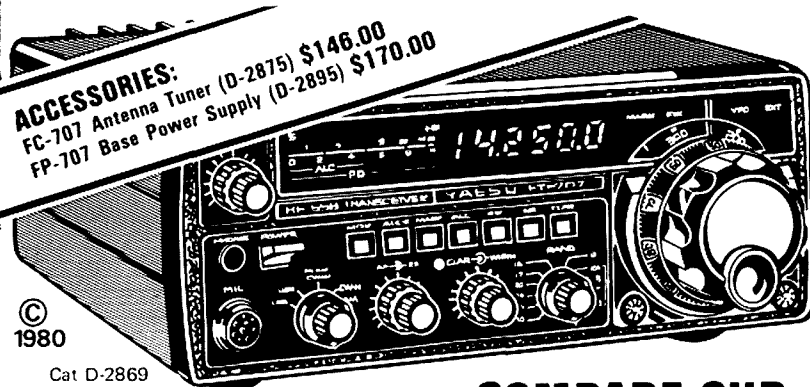

**ACCESSORIES:**  
 FC-707 Antenna Tuner (D-2875) \$146.00  
 FP-707 Base Power Supply (D-2895) \$170.00

© 1980

Cat D-2869

FREIGHT: \$6.00 ANYWHERE  
 in Australia (that's below cost!)

## NOVICES:

You can legally use this transceiver on the Novice bands - then when you get your full ticket, it's ready for you! Why buy a 'Novice Only' rig now and be disappointed later???

**COMPARE OUR PRICE:**

**\$735<sup>00</sup>**  
INC TAX

**EASY TERMS AVAILABLE TO APPROVED APPLICANTS!**

## 'PLANNING AHEAD' was Amateur Radio Action's introduction (review in June issue).

Here's some more of what they said:

... physically very attractive ... one of the finest velvet smooth tuning arrangements on any transceiver in the world ... VFO stability is superb ... receiver performance is excellent ... sensitivity is very good ... audio output is clean ... performance (of the noise blanker rated 'great' on the FT101Z) if anything is better ... the transceiver is well laid out and simple to operate ... makes an ideal mobile rig ... expected to retail for around \$850 and therefore on present standards represents good value ...

One minor discrepancy: our price for the FT-707 is over \$100 less than the price quoted above. This must mean it is far and away the best value transceiver on the market in Australia!!!

# DICK SMITH ELECTRONICS

**NSW** 125 York Street, SYDNEY, Ph 290 3377  
 147 Hume Highway, CHULLOBA, Ph 842 8922  
 162 Pacific Highway, GORE HILL, Ph 439 5311  
 30 Grose Street, PARRAMATTA, Ph 683 1133  
 613 Princes Highway, BLAKEHURST, Ph 546 7744  
 263 Keira Street, WOLLONGONG, Ph 28 3800

**VIC** 399 Lonsdale Street, MELBOURNE, Ph 67 9834  
 656 Bridge Road, RICHMOND, Ph 428 1614  
**QLD** 166 Logan Road, BURANOA, Ph 391 6233  
 842 Gympie Road, CHERMSIDE, Ph 59 6255  
**ACT** 96 Gladstone Street, Fyshwick, Ph 80 4944  
**SA** 60 Wright Street, ADELAIDE, Ph 212 1962  
**WA** 414 William Street, PERTH, Ph 328 6944

**bankcard**  
 welcome here

SHOPS OPEN 9AM to 5:30PM  
 (Saturday: 9am till 12 noon)  
 BRISBANE: Half hour earlier.  
 ANY TERMS OFFERED ARE TO APPROVED APPLICANTS ONLY  
 RE-SELLERS OF DICK SMITH PRODUCTS IN MOST AREAS OF AUSTRALIA.



MAIL ORDER CENTRE: PO Box 321, NORTH RYDE NSW 2113. Ph 888 3200. PACK & POST EXTRA.



# OSCAR for Beginners

Prepared by the staff of the American Radio  
Relay League  
Newington, Connecticut 06111  
Submitted by Bob Arnold VK3ZBB

## WHAT IS OSCAR?

**OSCAR** is the name given a series of satellites designed and built by amateur radio operators from several nations of the world. There have been eight OSCARs (Orbiting Satellites Carrying Amateur Radio) in the series. The first OSCAR was put into orbit in 1961, just four years after Sputnik 1 brought the world into the space age. OSCAR 1 was the world's first non-governmental satellite, having been designed and built by a group of volunteer amateur radio operators from California. The two most recent OSCARs, numbers 7 and 8 are still circling the earth, providing two-way communication between amateur radio stations up to 5,000 miles (8,000 km) apart.

## HOW DO THEY GET UP THERE?

When an OSCAR is planned, arrangements are made well in advance with NASA, the National Aeronautics and Space Administration, to schedule a launch alongside another satellite. OSCAR 8, for example, was launched "piggyback" with a Landsat C Earth Resources Satellite. The most recent OSCARs were designed and constructed under the supervision of AMSAT (the Radio Amateur Satellite Corporation), a non-profit scientific organisation in Washington, D.C. Amateur radio operators from Australia, West Germany, Canada, the U.S. and Japan have contributed time and materials, making the satellites a truly international effort.

## WHAT DO THEY DO?

As active communications satellites, OSCARs relay radio signals sent up to them from ground stations, allowing amateur radio operators all over the world to talk to one another. Communication across oceans is common, bringing people from different nationalities and cultures into direct contact. OSCARs 7 and 8 can receive and transmit several different types of communication—voice, Morse code and slow-scan television, among others. The "transponders" aboard the satellites make communication possible. AMSAT-OSCAR 7 contains two transponders which alternate regularly (see "NOTES" on reverse). One of them, "Mode A", converts signals sent to it on the amateur 2-metre band to the 10-metre band; the other, "Mode B", converts 70 cm signals to signals in the 2-metre band. AMSAT-OSCAR

8 also contains two transponders. Its "Mode A" is nearly identical to the one aboard OSCAR 7 (2-10m), but the other, called "Mode J" after its Japanese builders, converts signals from 2 metres to 70 cm. The precise frequencies are listed in the table on the reverse of this sheet.

Live demonstrations of the OSCAR satellites are held in schools to help teach general science, foreign languages, physics, astronomy and electronics. In addition, they can be used for emergency communications when a natural disaster, such as an earthquake, knocks out other ties to the outside world. Successful experiments have shown that the OSCARs can relay medical information such as electrocardiograms from a disaster area to a hospital and help locate a downed aircraft.

## HOW CAN I HEAR OSCAR?

You can hear OSCAR's signals when the satellite rises above your horizon. Since it is travelling at nearly 16,000 m.p.h. (25,000 km/hr.), it soon speeds far over the horizon and out of range. But you will have up to 25 minutes to hear the satellite as it passes overhead. The radio or receiver you'll need to pick up OSCAR's signals is one that covers the amateur 10-metre band. In most cases you must have an amateur radio licence to talk through OSCAR with a 2-metre amateur transmitter (although anyone can listen!). The OSCARs are the only satellites that can be used with such relatively simple equipment. For further information on becoming an amateur radio operator, contact your WIA Divisional Officer.

## WHEN CAN I LISTEN FOR OSCAR?

To determine when to listen for the satellite, you have to know something about its orbit. Both satellites are in almost circular polar orbits, which means they pass nearly over the North and South poles, OSCAR 7 at a 910-mile (1,450 km) and OSCAR 8 at a 540-mile (900 km) altitude. They come within range of every place on earth twice a day, at about the same times each day (morning and evening). Since each orbit takes an exact amount of time (called the "period"), a little under two hours, and the earth rotates a certain number of degrees longitude during the orbit (called the "increment"), it is easy to determine when the

satellites will be within range of your particular location. The ARRL OSCAR-LOCATOR is a simple device that lets you visualize how the satellites circle the earth and predict when you will hear them.

## WILL THERE BE MORE OSCARS?

Yes, dedicated volunteers in Japan, West Germany, the U.S. and the United Kingdom are working on various components of future OSCARs. One of these, the AMSAT Phase III anticipated for launch mid-1980, will have an elliptical orbit that will keep it within range of the entire Northern Hemisphere for several hours at a time. This will expand the amateur satellites' practical uses significantly.

The group of radio operators in California who put together OSCAR 1 expended just over \$63.00 to design and build it. Although the more recent satellites are more complex and expensive, they are still designed and constructed by people from various professions who share a common interest—furthering the amateur satellite programme that has contributed so much to bringing people closer together.

For further information, see *Getting to Know OSCAR from the Ground Up*, a practical manual on radio amateur satellite use published by the American Radio Relay League, 225 Main Street, Newington, Ct. 06111, at \$US5.50 p.p., also available from technical book shops, Dick Smith Electronics stores and Magpups. ■

## AR ADDRESS LABELS



Please check your call sign, name, initials, address, grade and other details on your address labels.

Advise any corrections **NOW** to your **Division** or direct to **WIA**, Box 150, Toorak, Vic. 3142.

- The coding on the label reads: Letter Numeral Two digits One digit Two digits Grade Division Unused Distribution Zone.
- The Call Book data derives from the same EDP file.

## COLLECTORS' CORNER

# No. 1 — The ICOM IC 280

Have you ever wanted to know more about a piece of equipment except its price and have never got around to gaining the information you desire? Perhaps you are sick of wading through countless magazines to find some small portion of a circuit diagram needed to complete your own personal file on a piece of equipment?

In this and future issues of Amateur Radio we will feature a particular rig showing details of circuitry, specifications and design to enable readers to readily familiarise themselves with amateur equipment on the market today. For the newcomers we will also detail older equipment from transceivers for VHF to receivers for HF. This will enable readers to build a reference library on equipment, a handy addition to the shack.

This month we feature the Icom IC280 2m FM transceiver. The IC280 uses a P-Channel MOS 4-bit microcomputer to control frequency, band edge detection and the display. The 3 channel memory is controlled electrically by the use of a 256-bit RAM area. The circuits for these IC280 functions are equivalent in capability to conventional circuits having a large number of C-MOS MSIs.

### SPECIFICATIONS — ICOM IC280

#### GENERAL

Numbers of semi-conductors	:	Transistors	37	
		FET	4	
		IC	26	
		Diode	49	
Frequency coverage	:	143.90-148.11 MHz		
		143.900 ~ 146.000 MHz:	5 kHz steps	
		146.010 ~ 148.110 MHz:	15 kHz steps	
Memory channels	:	3 channels, any inband frequency	programmable	
Usable conditions	:	Temperature: —10°C-60°C (14°F-140°F)		
		Operational time: continuous		
Frequency stability	:	Within ± 1.5 kHz		
Antenna impedance	:	50 ohms unbalanced		
Power supply requirement	:	13.8V DC ± 15% (negative ground)	3.0A Max.	
Current drain	:	Transmitting	HIGH (10W)	Approx. 2.5A
			LOW (1W)	Approx. 1.2A
		Receiving	At max. audio output	Approx. 0.7A
			Squelched	Approx. 0.5A
Dimensions	:	156 mm (W) x 58 mm (H) x 228 mm (D)		
Weight	:	Approx. 2.2 kg		

#### TRANSMITTER

Output power	:	10W (HIGH), 1W (LOW)	
Emission mode	:	16 F <sub>s</sub>	
Modulation system	:	Variable reactance frequency modulation	
Max. frequency deviation	:	± 5 kHz	
Spurious emission	:	More than 60 dB below carrier	
Microphone	:	600 ohms dynamic microphone with push-to-talk switch (IC-SM2 electret condenser microphone may also be used.)	
Operating mode	:	Simplex, Duplex (± 600 kHz from receive frequency)	

#### RECEIVER

Receiving system	:	Double conversion superheterodyne	
Modulation acceptance	:	16 F <sub>s</sub>	
Intermediate frequency	:	1st: 10.695 MHz	
		2nd: 455 kHz	
Sensitivity	:	More than 30 dB S + N + D/N + D at 1 µV	
		Less than 0.6 µV for 20 dB Noise quieting	
Squelch sensitivity	:	Less than 0.4 µV	
Spurious response rejection ratio	:	More than 60 dB	
Selectivity	:	More than ± 7.5 kHz at —6 dB point	
		Less than ± 15 kHz at —60 dB point	
Audio output power	:	More than 2.0W	
Audio output impedance	:	8 ohms	

# IC-280 SCHEMATIC DIAGRAM

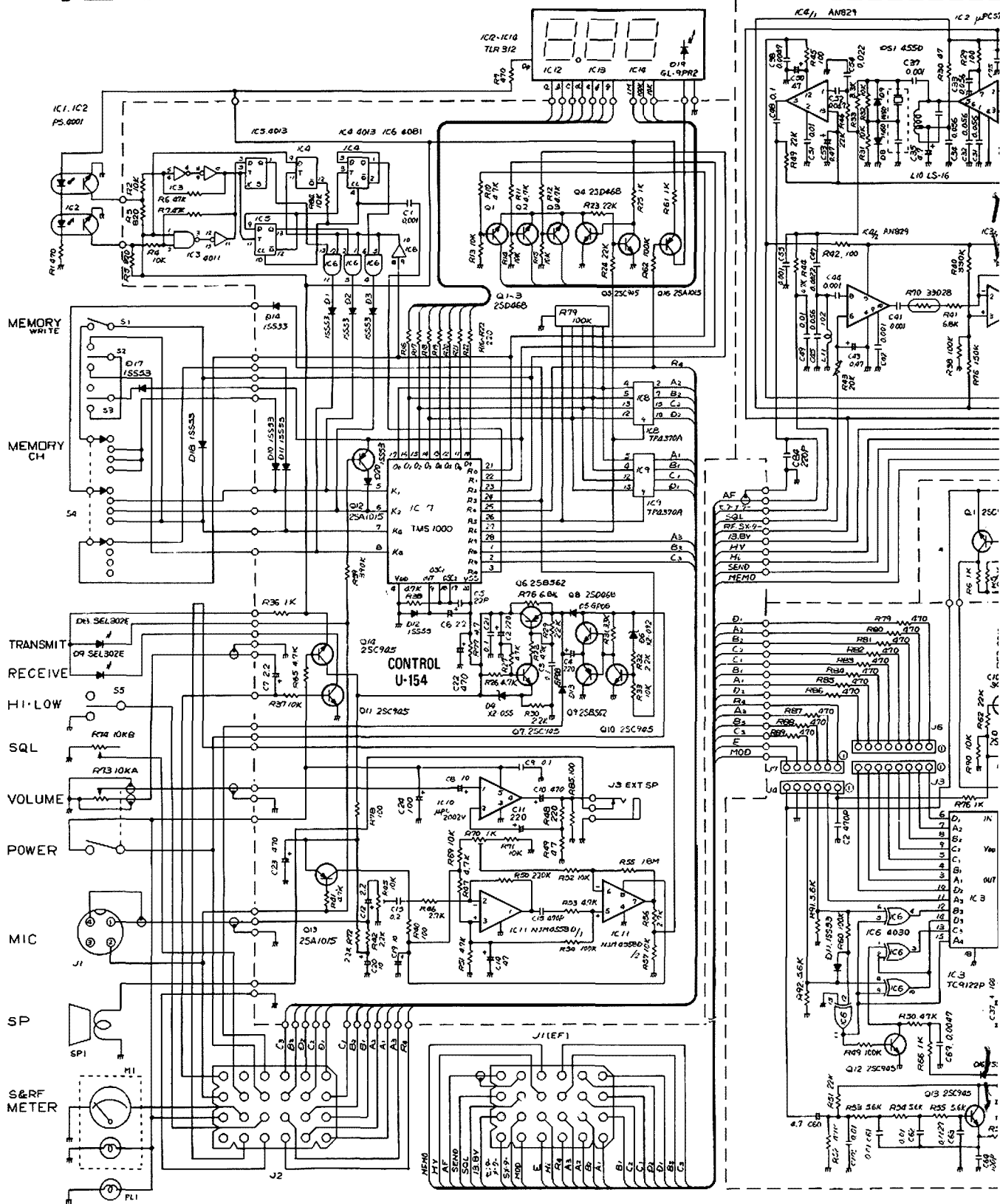

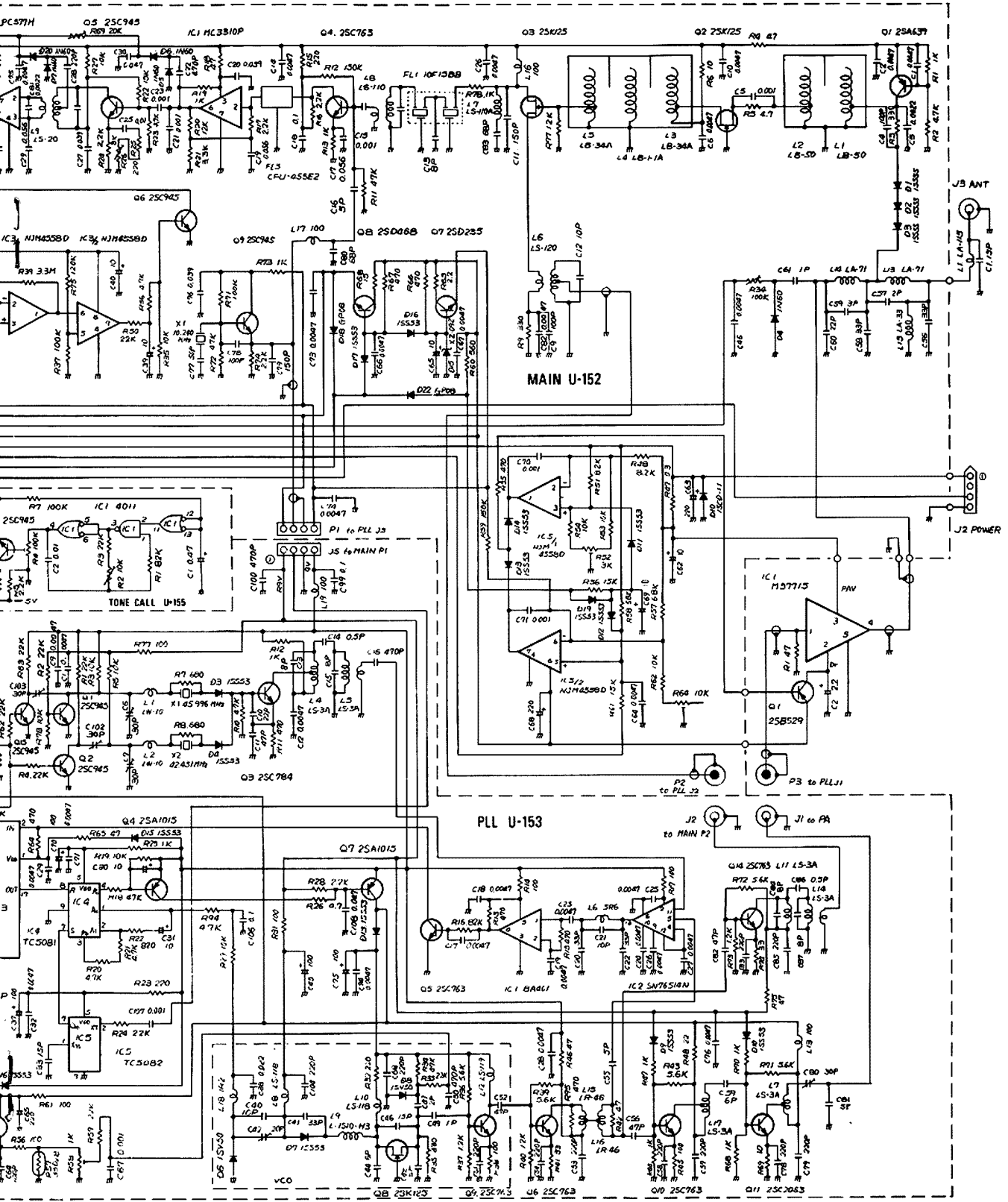

The control portion (front panel) of the IC280 can be separated from the rest of the unit and the two parts can be connected with a cable. The control unit is approximately one-third of the whole unit.



PHOTO 1 (above): The IC280 and at right (PHOTO 2), showing front control functions.

FRONT VIEW

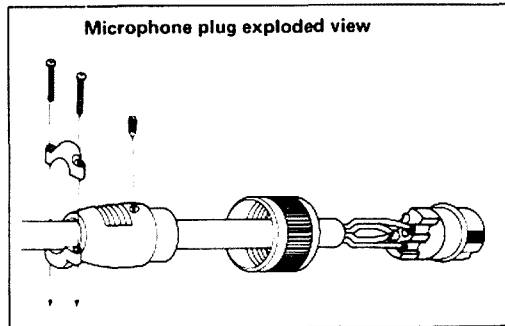
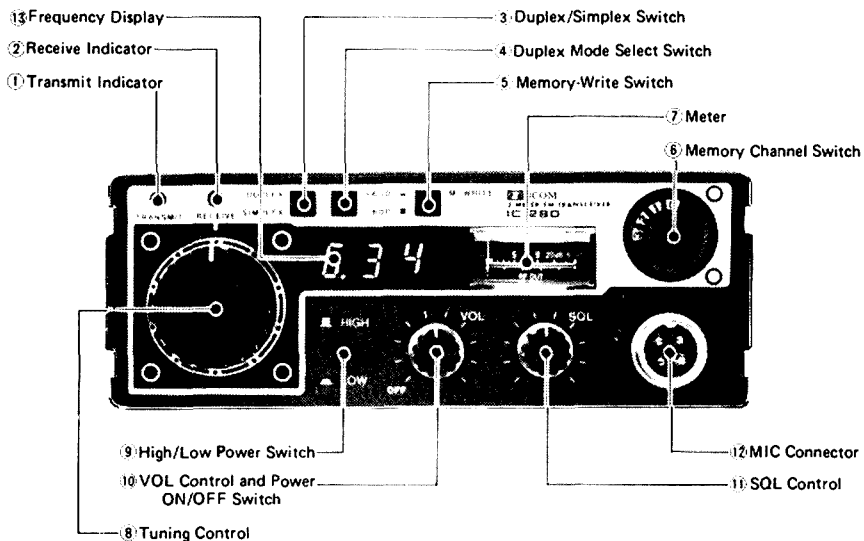

FIGURE 1

For newcomers to VHF: be sure to use a suitable VSWR meter designed for VHF when tuning an antenna for 2 metres. A diode meter not engineered for VHF can produce an error up to 40 per cent. It is advisable when adjusting a mobile antenna to do so with the motor running preferably above idling speed ensuring proper voltage level to the transceiver.

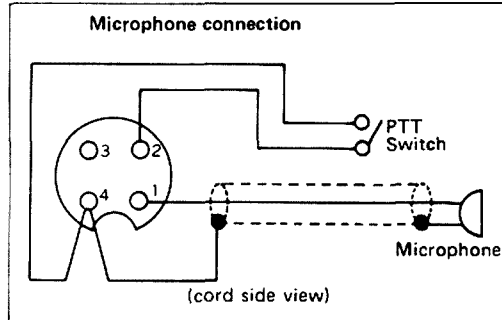

FIGURE 2

(Thanks to Vicom International for the supply of photographs)

(TOP)

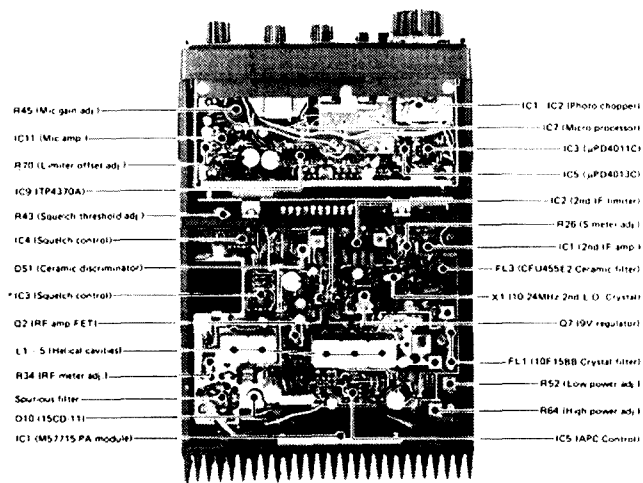

PHOTO 3: Top view of circuit layout.

(BOTTOM)

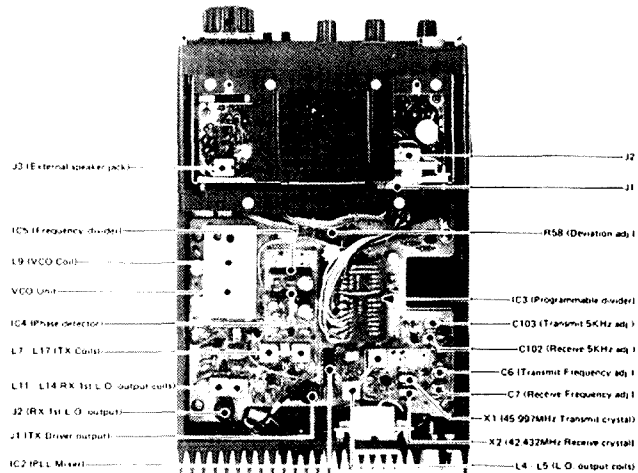
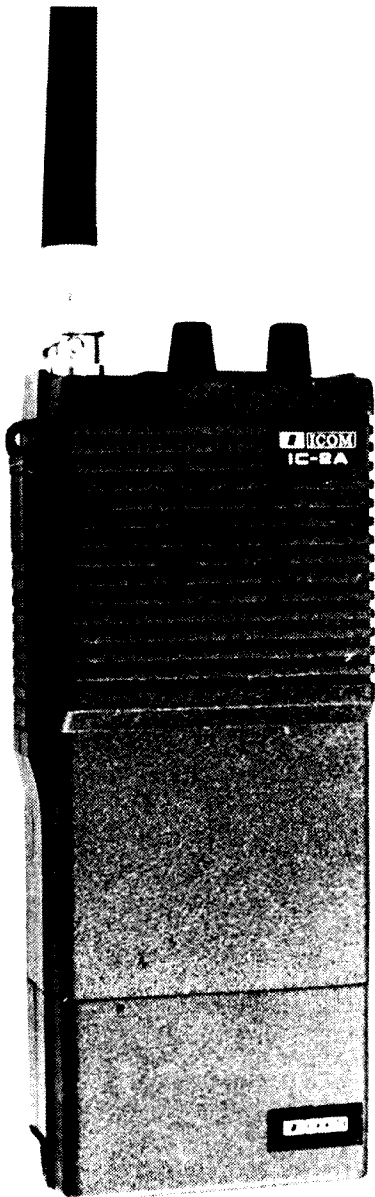

PHOTO 4: Bottom view of circuit layout.

# “Quality is always the right answer.”



## Quality. That's ICOM's new IC2A fm hand-held transceiver:

- Smaller and about half the weight of the others.
- Optional power packs for operation up to 5 watts output.
- Best sensitivity of the “big three.”\*
- Two hinged circuit boards for easy maintenance.\*
- 800 channels, 144-148 MHz, 600 KHz repeater offset.
- ICOM's quality backed by 90 day warranty
- At \$279 the ICOM IC2A offers the best price of the “big three”.

Accessories coming soon:

- BP-5 Nicad pack, 2-3W output
- BP-6 Nicad pack, 5W output
- CP-1 cigarette lighter charger
- HM-9 Speaker/microphone
- LC-1 Leather case

## GIVE YOUR VICOM DEALER A CALL TODAY!

\*See review "Amateur Radio Action" Vol 2/13

Distributed by VICOM

SYDNEY: 339 Pacific Hwy,  
Crows Nest. Ph. 436 2766  
MELBOURNE: 68 Eastern Rd.,  
Sth. Melb. Ph. 699 6700

# VICOM

VICOM gear is available from  
most reputable dealers!

# AMATEUR SATELLITES

R. C. Arnold VK3ZBB

## AMSAT PHASE III — COUNTDOWN No. 6

Unfortunately this could not be included in AR prior to launch date but the information may be of interest:—

By the time that you receive this last Phase III Countdown, the Phase III Satellite and FIREWHEEL will be at Kourou, in French Guiana, ready for the launch with the ESA LO2 Mission, nominally on 23 May 1980.

The LO-2 launch has a far wider latitude than most previous launches of OSCAR satellites, which previously accompanied meteorological and weather satellites demanding a precision window, and A-O-9 may be launched between 1100 and 1430 UTC on any day from 20 May until 8 June 1980.

Due to the memory problem vulnerability under hard cosmic radiation bombardment a new dynamic memory has been built by DJ4ZC, but with only half the memory of the original. Some limitation in the versatility of both the CW and RTTY store in the general beacon may be expected.

The antenna system also has been re-designed and modified in order to ensure encompassment and good housing in the payload enclosure.

The final mass of the Phase III satellite is 85 kg, this being inclusive of the kick-motor-unit, the propulsion mass of which alone is 30.16 kg. It has a specific impulse of 264 seconds,  $AV = 1168\text{m/second}$ .

The factors for the initial (transfer) orbit are as follows:—

Height Apogee: 35,800 km. Height Perigee: 200 km. Inclination: 17.50°. Eccentricity: 0.7302. Initial argument of Perigree: 189.7°. Shift: 0.7427°/day. Period: ca. 10.5 hours.

For the final orbit, following kick-motor firing:—

Height Apogee: 35,800 km. Height Perigee: 1500 km. Inclination: 57-55°. Eccentricity: 0.6852. Shift: 0.0714°N per day, e.g. 26.0897° per year.

Potential users are advised that whilst the orientation of circular polarization of the spacecraft's 435 MHz receiving uplink

## UOSAT LAUNCH CONFIRMED

NASA has formally agreed to launch Britain's first spacecraft, UOSAT. It will be a secondary payload on the launch of the Solar Meosphere Explorer mission from the Western Test Range in California. Launch is present scheduled for 30 September 1981 and the Thor-Delta rocket will place UOSAT in a circular polar orbit at a height of 530 km.

The purpose of the spacecraft is primarily educational and it is being constructed at the University of Surrey. See AR August 1979 for details of the anticipated onboard equipment.

## "ORBIT" MAGAZINE

AMSAT members should have now received their copies of the first edition of the new magazine "ORBIT", which replaces the AMSAT newsletter. The volunteer editorial staff must be congratulated on an excellent production.

"ORBIT" is sent free to all members of AMSAT (extra for airmail) and all satellite enthusiasts should subscribe in order to be up to date with AMSAT happenings. The March edition contains articles on:—

- (a) Radio Transmissions from Outer Space by ZS1BI, which discusses the availability of signals from some seventy satellites transmitting on the 136/7 MHz and the 149 MHz bands. These range from Alpha I, launched in 1962 — yes 1962 — to Cosmos 1092, launched in 1979.
- (b) 70 cm Satellite Antenna Techniques by WDFAB — some interesting ideas for satellite antennae.
- (c) Lots of interesting information on the Phase III satellite by G3ZCZ and WA2LQQ.

The AMSAT address is PO Box 27, Washington, DC 2044, USA, and as from 1st July the subscription will be \$US20 per annum.

## SPACECRAFT DATA

### Orbital Data (March 1980):

AO7 progresses an average of 28.836363° W per orbit in a period of 114.943333 minutes. AO8 progresses an average of 25.801665° W per orbit in a period of 103.206666 minutes. AO7 operates on Mode A and Mode B on alternate days (but see jottings).

### Operating Modes:

AO8 modes of operation are Mode A, Monday and Thursday; Modes A and J,

having worked VK3, ACR, BWC, ZBB, YQX. He is looking for a VK7 to achieve a new and greater distance.

Cedric VK6CD has probably the clearest and strongest signal on AO7, B — he runs only 9 watts — who says high power is necessary?

We are still looking for a VK3 enthusiast to provide satellite notes for the weekly Divisional broadcast and liaise with me in my capacity of Federal Co-Ordinator.

During May AO7 has been acting peculiarly as it did this time last year. The beacon transmits garbage and acquisition is rarely made earlier than seven minutes after the calculated time. The problems are probably due to the satellite flying in partial darkness — see my earlier reference to an article in "Radio Communication".

ZL1AOX is operating a control station for Phase III.

Pat G3IOR is looking for records of operating experience by VK amateurs. I shall be grateful if operators, particularly "old timers", will take a little time to outline their experiences during the past 20 years, and let me have them as soon as possible. Participation will ensure a permanent record will be maintained, and one day I hope our experiences will be printed in "Amateur Radio".

## POSTSCRIPT

As we go to press we have some sad news of OSCAR Phase III. The satellite was launched on Friday, 23rd May, at 1429Z but unfortunately the main rocket failed after approximately three minutes, resulting in an uncontrollable spin which caused the rocket and both the professional and the amateur satellites on board to land in the Atlantic Ocean. At this stage it is not known whether the back-up satellite is available for early launch but it is presumed that development of the Phase III satellites will proceed. It is hoped that much of the data which has been previously disseminated through Amateur Radio will be applicable some time in the future.

This incident is a great disappointment to participating amateurs in Australia and is a sad blow for AMSAT and the satellite group in Germany, who devoted so much time and money to the project. The failure was completely beyond the control of the amateur fraternity. ■

## Spacecraft Frequencies

Craft	Uplink	Downlink	Beacon
AO7 Mode A	145.850-145.950	29.400-29.500	29.502
Mode B*	432.125-432.175	145.975-145.925	145.972
AO8 Mode A	145.850-145.950	29.400-29.500	29.402
Mode J*	145.900-146.000	435.100-435.200	435.095

antenna remains right-hand circular that of the 145 MHz transmitting downlink antenna shows LEFT-hand circular.

The balance of this report was circulated to Divisional Satellite Co-Ordinators for dissemination via the Divisional broadcasts.

Tuesday and Friday; Mode J, Saturday and Sunday. Wednesday is an experimental day and may be on Mode A, Mode J or Mode D, the recharge state.

## JOTTINGS

9M2CR in Port Dickson, Malaysia, has achieved his furthest AO7, B, contacts,

## NOTE MAGPUBS REMINDER

Not handling subscriptions to Overseas magazines, except Break-In and VHF Communications.

As already advertised.

## MAGPUBS

P.O. Box 150, Toorak, Vic. 3142

# SPOTLIGHT ON SWLing

Robin Harwood VK7RH  
5 Helen St., Launceston, Tasmania 7250

**What is Short-wave listening? Is it different from operating a ham station or a CB? Is it expensive? Do I need a licence?**

These are the most often asked questions by those uninitiated in the art of short-wave listening, even from those with technical or operating experience over a number of years. This column aims to present each month information not only for the beginner, but for those advanced in electronics to AOCB and beyond. Short-wave listening or monitoring is an integral part of radio telecommunications.

In the radio spectrum, frequencies of between 3,000 and 30,000 kilohertz are known as the High Frequency Bands. These frequencies carry signals over many thousands of kilometres, whilst medium frequency signals are for local to medium areas of up to 200 kilometres. The distances covered on HF are dependent on several factors—the time of day, the season, the frequency chosen, and the power of the transmitter. However, we will not get into propagation at this stage. Those interested in SWLing, concentrate on listening to signals outside the local area, to long distance or DX signals as they are known.

What do the SWLs listen for? Many things—for example, it may be a broadcast of a concert live from the Albert Hall in London; Mass from the Sistine Chapel in the Vatican; perhaps a debate in the United Nations Security Council in New York, or a Japanese fisherman thousands of kilometres away from his home communicating with other trawlers scattered throughout the oceans of the world. They also could be listening to communications between the pilot of a Jumbo Jet and an airport in Europe; maybe an orbital satellite carrying signals from deep space.

As can be seen, there are many facets of short-wave listening. Some concentrate exclusively on specific areas such as foreign broadcasts, propagation, utilities, amateur radio and current affairs, etc.

Short-wave broadcasts have been going on for about 50 years or more. When radio first commenced broadcasting in the early twenties, it was confined to the low and medium frequency ranges. However, as the number of stations increased, so did the pressures for more frequencies, and many of the non-broadcasting sectors of communications moved to the shorter wavelengths. The public broadcasters were given the medium frequencies to use.

It was not too long before the broadcasters found that the higher frequencies did provide a wider coverage of distances.

Broadcasts initially were usually confined to news and information in the local languages for tourists and expatriates abroad. However, as the International situation worsened, they then commenced programming in other languages, and presenting their points of view for the people of other nationalities.

It was Dr. Joseph Goebbels who developed radio broadcasting into a new and powerful weapon of war. It was the birth of *propaganda in radio*. The outbreak of hostilities led to the increase of short-wave broadcasting. A radio war broke out between the combatants, with claims and counter claims bouncing off the ionosphere, and it was hard to discern the truth for those, particularly in neutral countries.

With industry geared up for the war effort, radio and electronic technology made significant advances, especially in the field of higher powered transmitters and directional antenna systems to service a wider and diverse area and audience.

With the cessation of hostilities in 1945, short-wave broadcasting had not abated, as the International situation had altered the maps of Europe and Asia. New powers had emerged with their ideologies, as radio was extensively utilized in the period known as the Cold War. Nations commenced to jam programmes emanating from other lands as tensions increased. In many countries, broadcasting became a State Monopoly, an arm of government, conforming to its needs and directions. Hence there arose a need for independent sources of information and entertainment.

*A Call to all  
holders of a*

## 'NOVICE LICENCE

Now you have joined the ranks of Amateur Radio, why not extend your activities?

**THE WIRELESS INSTITUTE  
OF AUSTRALIA  
(N.S.W. DIVISION)**

conducts a Bridging Correspondence Course for the AOCB and LAOCB Examinations.

**Throughout the Course, your papers are checked and commented upon to lead you to a SUCCESSFUL CONCLUSION.**

For further details write to:

**THE COURSE SUPERVISOR,  
W.I.A.**

**P.O. BOX 123,  
ST. LEONARDS, N.S.W. 2065**

As many colonial powers divested themselves of their possessions and territories in the fifties and sixties, a new voice—the voice of the Third World was heard.

Today, broadcasting via short-wave is still very active. Whereas 40 years ago there were perhaps a dozen or so organizations, there are hundreds of stations active today with a multiplicity of programmes.

In next month's column we will discuss what is required for those wishing to take this activity, or to further their knowledge.

## AMATEUR OPERATOR'S HANDBOOK — 1978

**MAGPUBS**

**P.O. Box 150, Toorak, Vic. 3142**

**NO AMATEUR STATION SHOULD  
BE WITHOUT ONE.**

## QSP

### GEMFIELDS RADIO GROUP

The Centenary Certificate draw for the cut Sapphire organised by the Gemfields Radio Group was won by John Martin VK4NOP.

### SAFETY FIRST

To drive a nail without smashing your finger, hold the hammer with both hands or have your XYL hold the nail.

If people talked about only what they understood, the silence would be bearable.

Lose an hour in the morning and you will be looking for it the rest of the day.

—ARNS Bulletin, January 1980.

### PROPHECY?

A voice said unto me "Smile and be happy, things could be worse".

So I smiled and was happy, and behold, things did get worse.

### CAN YOU HELP?

At a recent "Workshops" conference held by the VK4 Division, a motion was passed that the WIA promote a series of articles on the subject of digital techniques, particularly in relation to transceivers.

The publications committee would be most pleased to publish such a series, and we now appeal to our literary members to contact the editor if you can be of assistance in this regard.

### RFI

According to N4XX's column in CQ March 1980, the FCC (in the USA) received 15,825 RFI complaints in the quarter July to September 1979; lower than the 17,942 in the previous quarter. 12,065 cited a TV receiver as the victim and of these 9,891 emanated from CBers and 525 from amateurs. A disturbing statistic was 377 complaints by amateurs citing other amateurs compared with 295 in the previous quarter. "Many of these complaints relate to co-channel interference, something which a so-called "self-policing" service should be able to resolve with Commission intervention."

### SAFETY STANDARDS

A Commissioner of the (USA) Consumer Product Safety Commission recently stated that a mandatory safety standard is needed for CB antennas. His concern results from the fact that about 200 people in the US are electrocuted every year while installing (or removing) CB antennas—accidentally touching HV power lines.—N4XX column in CQ March 1980.



# VHF-UHF

## An expanding world

Eric Jamieson, VK5LP



Forrester, S.A. 5233

### VHF/UHF BEACONS

Freq.	Call Sign	Location
50.005	H44HIR	— Honiara
50.023	HH2PR	— Haiti
50.025	6Y5RC	— Jamaica
50.035	ZB2VHF	— Gibraltar
50.036	HC1JX	— Quito
50.038	FY7THF	— French Guiana
50.040	WA6MHZ	— San Diego
50.048	VE6ARC	— Alberta
50.050	ZS3E	— South West Africa
50.055	ZL1UHF	— Auckland
50.060	PY2XB	— Sao Paulo
50.070	YV5ZZ	— Caracas
50.070	YP9WB	— Bermuda
50.080	W1AW	— Connecticut
50.080	TI2NA	— Costa Rica
50.085	WA6JRA	— Los Angeles
50.088	VE1SIX	— New Brunswick
50.089	WD4CEI	— North Carolina
50.100	KH6EQI	— Pearl Harbour
50.104	K4EJQ	— Tennessee
50.105	KC4AAD	— McMurdo, Antarctica
50.110	KH0AB	— Salpan
50.110	AL7C	— Anchorage
50.120	4S7EA	— Sri Lanka
50.144	KC6IN	— Ponape, Caroline Is.
50.498	5B4CY	— Cyprus
51.999	YJ8PV	— New Hebrides
52.200	VK8VF	— Darwin
52.250	ZL2VHM	— Palmerston North
52.300	VK6RTV	— Perth
52.350	VK6RTU	— Kaigoorlie
52.400	VK7RNT	— Launceston
52.440	VK4RTL	— Townsville
52.450	VK2WI	— Sydney
52.500	JA2IGY	— Mie
52.500	ZL2VHM	— Palmerston North
52.510	ZL2MHF	— Mt. Climie
52.800	VK6RTW	— Albany
52.900	VK6RTT	— Carnarvon
53.000	VK5VF	— Mt. Lofly
144.010	VK2WI	— Sydney
144.162	VK3RG1	— Gippsland
144.400	VK4RTT	— Mt. Mowbray
144.475	VK1RTA	— Canberra
144.500	VK6RTW	— Albany
144.600	VK8RTT	— Carnarvon
144.700	VK3RTQ	— Vermont
144.800	VK5VF	— Mt. Lofly
144.900	VK2RTX	— Ulverstone
145.000	VK6RTV	— Perth
147.400	VK2RCW	— Sydney
432.400	VK4RBB	— Brisbane

No changes to the beacon list this month. The Geelong beacon VK3RGG on 52.330 MHz still awaits P. and T. approval — it seems months since I first reported the beacon awaited such approval

### SIX METRES

The 1980 autumn equinox didn't live up to various predictions of being the possible peak for cycle 21 in the southern hemisphere anyway. There have been the usual scattered contacts to various places overseas but nothing substantial.

Tony VK6BV rather sums up the situation by saying "April did not bring much in the way of DX for me. Instead of going through the month day by day, will start with the three days on which DX was worked! 5-4: JA1 and JA2 0500 to 0520Z. 12-4: JA1, JA2 0615Z on. 13-4: JA7, JA8,

JA0 0540 to 0625Z. Days on which JA activity was observed on 50 MHz were April 1, 2, 3, 5, 7, 12, 13, 14, 20, 27, 28, 29. The TV video on 49.750 was heard every day of the month except 8, 9, 10, 15 and 26.

"ZL TV video on 45.250 was observed on 4, 14, 19, 20, 21, 22, 23, 24, 25, 27, 28, 29 and 30. Audio on 50.750 on 14-4 for 5 minutes on 14-4 at 0220Z. VK video on 46.250 heard on 14, 20 and 29, no audio at all. No European TV signals heard, or any other of note. ZL TV comes in between 0000 and 0200Z and departs between 0500 and 0700Z. VK TV never very strong, mostly about 0200Z. Northern TV on 49.750 at times so strong harmonics and rubbish can be heard right up to 52.500."

It would seem that about sums up the situation. Did hear on the grapevine that VK8GB had been having a few reasonable contacts, and still getting a few contacts on 144 MHz to JA.

John VK4ZJB has written to say liaison on 28.885 indicates XE1GE has not so far worked into VK4, so it looks as though Geoff will have to work hard now to make it there or anywhere else in VK for that matter, and his contact to Garry VK5AS is probably as far west he was able to work.

A feature of the autumn just past seems to be the lack of any substantiated reports of working between VK5 and W. There are reports from time to time of beacons, etc., being heard but nothing else. It seems the same peculiar conditions have existed this cycle as cycle 19 in 1958, when W and ZL contacted on many more occasions than W to VK. But what peculiar conditions exist which allow contacts to VK2, VK3 and VK5 from XE1GE over a period of 5 days in April, without so much as a whisper from W land. Strange indeed.

There is little doubt our inability to work on 50 MHz cost us many contacts. Look at the times Tony VK6BV, mentioned above, heard JAs on 50 MHz but not 52 MHz. The same has applied in the southern States, and what has been worked has been by sheer hard work when split frequencies are involved, especially when some odd part of a megahertz are used as with XE1GE!

From the "Geelong Newsletter" it is noted XE1GE was first heard by Peter VK3AWY on 10-4 at about 2300Z, then worked on 11-4 at 2310Z, with the best performance from the Mexican station on 14-4 when he worked VK3ASQ, VK3AQR, VK3ZZX, VK3BGI and VK3AKK. So coupled with the working of sundry VK2 and VK5 stations Geoff XE1GE should have something to remember.

### FROM SMIRK

Latest SMIRK Newsletter is again stacked with information on six metre happenings in the northern hemisphere in particular. Some excerpts which might interest you include a report on the operating of Harry EI2W in Ireland, who commenced operations on 50 MHz at 1423Z on 20-10-79,

first QSO to VE1AVX, who was heard every day for two months! In about 6 months Harry had 1552 QSOs with over 600 different stations in USA, working all call areas, plus VE1, 2, 3, 4, KP4, VI and XE. Activity noted was much greater than during IGY. Highest MUF recorded was 62.750 MHz on 15-12-79. On 11-12 worked KOSFH, and KOKS, who was using 3 watts. At last count Harry had worked 43 US States, probably more now! FY7AS is to QRT in June with no one to take over the station. Pity. In addition to Harry, two other Irish stations licensed to operate 50 MHz are EI6AS and EI9D. No G stations permitted to operate 6 metres, but crossband working between 6 and 10 metres has netted the G stations all W call areas, VE, Sable Is., VP9, KP4, YV4, ZB2, HC1JX.

Bill W3XO of "World Above 50 MHz" is trying to establish who holds the world distance record on 6 metres. Some job. Until something else comes along it still is held by LU3EX and JA6FR, standing since 24-3-56! Just to make the job interesting for Bill he has to contend with such things as ZB2BL working four JAs over the pole 0000 to 0030Z on 9-4-80.

### WORLD-WIDE LOCATOR

A meeting of European VHF Managers was held in London on 26th and 27th April, 1980, to discuss the question of the introduction of a world-wide locator system which would allow the accurate locating of stations anywhere when distances have to be considered for record and other purposes. A form of locator has been in use in Europe for 20 years, and modified types have been suggested for and discussed at the London meeting, but the one most favoured is called the G4ANB system. Details of this system have been sent to me for the Australian area, and I propose making it available very soon for publication and look forward to your comments, so they may be relayed back to SM5AGM in Sweden, who has been making the overtures up till now. The system looks good, and could well be of great value in Region 3. More about it soon.

### REGION 1 DX RECORDS

The following information will give you some idea how the operators in Region 1 (basically Europe) have fared in the distance records for VHF and UHF. It is interesting to note their lowest band being 70 MHz that Es does not feature as a mode of operation for contacts, though it does on 144 MHz. The 70 MHz distances are very short when compared with our 52 MHz but then the British Isles are not very big and it appears no other European country uses 70 MHz.

**70 MHz:** Tropo GM3WOJ to GU3HFN 602 km. Aurora G3OSS to GM3JFG 28-8-78 709 km. Meteor G3SPJ to GM3JFG 13/-12-78 728 km.

**144 MHz:** Tropo IT9KSO to 4Z4AQ 26-8-77 2168 km. Aurora G3CHN to UP2BBC 26-3-76 1915 km. Meteor GW4CQT to UW6MA 12-8-77 3099 km. Es CT1WW to OD5MR 28-6-79 3864 km. F2 (TE) 14EAT

to ZS3B 30-3-79 7788 km. EME SM7BAE to ZL1AZR 4-3-69 17525 km.

**432 MHz:** Tropo DK2NH to EA1CR 29-11-79 1608 km. Aurora SM5CUI to UA3ACY 9-11-75 1260 km. Meteor SK6AB to SM2AID 12-8-77 1033 km. EME I5MSH to ZL2BCG 6-10-79 18437 km.

**1.3 GHz:** Tropo GD2HDZ to HD9AMH 26-10-75 1131 km. EME PA0SSB to VK3AKC 22-2-75 16640 km.

**2.3 GHz:** Tropo G3LQR to OZ9OR 30-6-76 764 km.

**3.4 GHz:** Tropo DC0DA to G3LQR 29-11-79 430 km.

**5.7 GHz:** G3BNL to G3EZZ 23-4-73 152 km Tropo.

**10 GHz:** Tropo I2FZD to I4CHY 27-7-79 633 km.

**24 GHz:** Tropo HB7AKR to HB9MDN 6-10-79 177 km.

It is interesting to note from the above table that no less than seven records were established in 1979 and most have been set in the past five years. It surprises me the 432 MHz tropo record is not further. It also makes me wonder whether during the past 12 months or so when so much has been done working crossband from Europe to USA 10 to 6 metres, what lost opportunities there may have been on 144 MHz for a crossing of the Atlantic because there have been some very good Es conditions in the northern hemisphere as well as conditions produced by the high solar activity. It seems to me to be an area which should be looked at from both sides of the Atlantic during the trough of solar activity when Es should be at its best. I would not have been surprised to read of someone bridging the ocean there on 144 MHz, probably no one has been even trying when it has been so easy on 6 metres!

#### SIX METRES OVERSEAS

A rather interesting contact took place on 16-3-80 when Peter H44PT worked FY7AS along a path which closely followed the equator all the way for a distance of almost halfway around the world (Solomon Islands to French Guiana). The same day between 0030 and 0420Z AI KH6IAA worked into South America with contacts to PY, LU, CX, HC, TI and HK! KG6DX and KG6JKS worked PY1RO around 0450Z. KH6NS has now worked all 50 US States on 6 metres, an effort of considerable achievement and is believed to be the first station outside USA to do so.

The South African stations are still active; on 9-3 ZS6LN worked K5KW cross-band, and the two beacons of ZS6LN and ZS6PW are being widely heard (but not in VKI). The ZS6LN beacon has apparently been heard in Japan, while on 13-3 ZS6LN worked 5B4AZ on 50.112 at 1900Z.

#### 10 GHz RECORD

Advice has been received from the VHF Advisory Committee confirming a 10 GHz contact between Rob VK3YFU and Geoff VK3AUX on 15-3-80 over a distance of 59.71 km or 37.10 miles, establishing a

VK3 record. Congratulations to the two participants, and hopefully this will only be the start of moves for ever increasing distances.

#### NEW ZEALAND

Having just returned from a month's visit to New Zealand I am full of praise for such a lovely country. Whilst the visit was not designed to be an amateur radio visit, I nevertheless took the opportunity to meet a few people. First pleasure was to renew acquaintances with Mac ZL3RK and XYL Nell, whom I had met when they visited South Australia in the sixties, and later his daughter Ailsa and son-in-law Newton Dodge, who stayed with us on their honeymoon. It was a great re-union.

This was followed by a pleasant evening spent at the QTH of Graham ZL3AAD of EME fame, and it gave me a deal of pleasure to be permitted to key his transmitter and hear my own call sign come back as echoes from the moon.

I tried to meet Bill ZL2CD in Wellington, but due to distances involved and lack of vehicles, had to be content with a couple of long phone conversations with Bill.

Moving on to Auckland I just missed the VHF Group meeting by one night, but at the home of Vaughan ZL1TGC, my counterpart in New Zealand who writes the VHF Notes for "Break-In", had the pleasure of meeting some of the ZL1 gang, including Ray ZL1TAB, Quenton ZL1BPW, Ian ZL2AOV/1 and Tim ZL1AQF. Made use of the Auckland repeater to speak to a few other operators, and managed to get QRM'd off the band by one of those people whom we have all heard about who has nothing to do than to run a powerful carrier on selected people! However, the conversation was completed via a simplex channel. It takes all kinds to make a world I guess.

Perhaps the best bit of news I can bring back from there is that the Christchurch Branch are raising the question of 600 kHz offset for their repeaters instead of the current 700 kHz at their National Conference soon. There seems to be more interest in being compatible with VK at the moment, probably helped to a degree by the big opening across the Tasman last year, which indicated the problems of non-compatibility.

Since returning on the 19th May I found I didn't miss all the good 6 metre DX, there hadn't been any in VK5 other than an occasional JA, and this despite the very high solar flux which rose from 205 to 270 in six days to 23-5, with A5 and K3, but producing no DX.

Finally, I am sorry to pass on the news that Allan Parker VK4JS of Longreach joined the ranks of Silent Keys on 27th February, 1980. I knew Allan back in the early sixties when we often had long QSOs on 6 metres when we were able to share a common interest at that time in orchards. I am indebted to Allan VK4ABP for the information, and have sent a card of condolence to Allan Parker's wife, Francis.

Since there is not much else to report, having been away from the VHF scene as well, now seems to be the time to close. I thank John VK5ZBU for finishing the June notes for me. Thought for the month: "Money doesn't talk these days — it just goes without saying."

73. The Voice in the Hills. ■

## FORWARD BIAS

### VK1 DIVISION

(Postal Address: WIA (ACT Division) Inc., PO Box 46, Canberra, 2600 ACT)

The VK1 Division holds a General Meeting for all members on the fourth Monday of each month at 8 p.m. at the Griffin Centre (Room 1, Ground Floor), Bunda Street, Canberra City. Hams visiting Canberra who would like to meet Territorians (or renew old friendships) are most welcome to come along.

QSL Bureau operations, book sales, and equipment (and junk) sales are regular features at each meeting and, with general business out of the way, we always co-opt the (willing?) services of an "expert panel of speakers" who seize on a topic and initiate discussion.

Meeting topics planned for 1980 and beyond are: 28th July: Test Gear: GDO, CRO, Noise Bridge, etc. 25th Aug.: CW: From Pump-handle to Electronic Keyer. 25th August: CW — From Pump-handle to Electronic Keyer.

22nd Sept.: Microprocessor Applications in AR. 27th October: (To be advised.) Possibly a (tame) Politician.

24th Nov.: Synthetic Music: Wine and Cheese Night. December: No meeting.

19th January: (To be advised.)

23rd February: Annual General Meeting (Elections!).

HAMAD — For Sale: Universe 224-M 24-channel 10m Novice Tx/Rx, 28,480-28,595 MHz, plus helical whip antenna, \$80. Les Thurbon VK1NBK, QTHR. Ph. (062) 88 9226.

## "WILLIS" AIR-WOUND INDUCTANCES

Take the hard work out of Coil Winding, use — "WILLIS" AIR-WOUND INDUCTANCES

No.	Turns		B & W Equiv.	Price
	Dia. Inch	L'gth Inch		
1.08	½	8 3	No. 3002	\$1.20
1.16	½	16 3	No. 3003	\$1.20
2.08	¾	8 3	No. 3006	\$1.45
2.16	¾	16 3	No. 3007	\$1.45
3.08	¾	8 3	No. 3010	\$1.70
3.16	¾	16 3	No. 3011	\$1.70
4.08	1	8 3	No. 3014	\$1.90
4.16	1	16 3	No. 3015	\$1.90
5.08	1¼	8 4	No. 3018	\$2.10
5.16	1¼	16 4	No. 3019	\$2.10
8.10	2	10 4	No. 3907	\$3.10

Special Antenna All-Band Tuner Inductance (equivalent to B & W. No. 3907, 7 inch)

7" length, 2" dia., 10 TPI Price \$5.25 Reference: A.R.R.L. Handbook, 1961

Willis Pi-Coupler Unit — \$28.50

Stockists of Transmission Cables, Insulators and Hard Drawn Copper Antenna Wire Write for range of Transmission Cable

## WILLIAM WILLIS & CO.

PTY LTD

Manufacturers and Importers

77 CANTERBURY RD. CANTERBURY VIC. 3126 Phone 836-0707

# SIDEBAND ELECTRONICS ENGINEERING

P.O. BOX 23, SPRINGWOOD, N.S.W. 2777  
 WAREHOUSE 213 HAWKESBURY RD. SPRINGWOOD  
 TELEPHONE (047) 54 1392

## "SETTING UP A NEW STATION OR UPDATING EQUIPMENT?"

Why not contact us now for a special price on a package deal — transceivers and accessories, antennas, rotators, cables and coax connectors available. THINKING OF GOING MOBILE?

How about our de-luxe helical whips for 10, 15, 20, 40, and 80M. Whips \$25 each or 2 whips plus heavy duty chrome plated bumper mount and heavy duty chrome plated adjustable spring mount for \$60 or a set of 5 whips plus bumper mount and spring mount for \$115."

### HENRY RADIO A Famous Brand

#### NEW LINEAR AMPLIFIERS

2-KD5-2KW PEP 80-10M SSB/CW/RTTY/AM.....	<b>\$1050</b>
1-KD5 1200W PEP 80-10M SSB/CW/RTTY/AM.....	<b>\$850</b>

### ANTENNAS

TET HB-35C 10-15-20M log/yagi HY-GAIN.....	<b>\$375</b>
TH6-DXX 10-15-20M 6 el yagi.....	<b>\$385</b>
TH3-JR 10-15-20M 3 el yagi.....	<b>\$235</b>
DB10-15A 10-15M 3 el yagi.....	<b>\$190</b>
153-BA 15M 3 el yagi.....	<b>\$120</b>
18AVT/WBa 10-80M vertical.....	<b>\$110</b>
GPG-2 2M 5/8W collinear 3-4db gain.....	<b>\$25</b>
HELICAL Mobile whips 10-15-20-40-80M heavy duty de-luxe model w/adj. tip.....	<b>each \$25</b>
GPV-5 2M Base. Collinear 2 x 5/8W.....	<b>\$55</b>
OSCAR 2D 2M mobile. Collinear 2 x 5/8W.....	<b>\$35</b>
BN-86 balun for beam buyers.....	<b>\$20</b>
HI-Q baluns 50 ohm 1 KW 1:1.....	<b>\$15</b>

### ROTATORS AND CABLES

All rotators now come with bottom brackets and control indicator boxes wired for 28V AC —

CDE BT1A BIG TALK light duty programmable 4-pos. push button plus normal operation.....	<b>\$85</b>
KEN KR-400 medium duty.....	<b>\$120</b>
KEN KR-500 vertical rotator.....	<b>\$150</b>
CDE Ham 1V heavy duty (June/July).....	<b>POA</b>
CDE T2X Tail twister extra HD.....	<b>\$250</b>
RG-8U foam co-ax. per meter now.....	<b>\$1.20</b>
8-cond. rotator cable. per meter.....	<b>80c</b>

### ACCESSORIES

SWR meter Hansen twin meter 150MHz.....	<b>\$35</b>
SWR meter Single meter 150MHz.....	<b>\$25</b>
ASAHI chrome bumper mount.....	<b>\$5</b>
Standard bumper mount.....	<b>\$2</b>
Chrome base and spring to suit ASAHI mount.....	<b>\$15</b>
FERGUSON 240V AC transformer 2 x 9V secondaries at 3A.....	<b>\$8</b>

### TRIO KENWOOD PRODUCTS

TS-520SE 10-160M 240V AC transceiver.....	<b>POA</b>
TS-180S 10-160M 12V solid state.....	<b>POA</b>
TS-120S 10-80M 12V solid state.....	<b>POA</b>
TS-700SP 2M all mode trans.....	<b>SPOA</b>
R-1000 digital clock receiver.....	<b>POA</b>
TV-502 2M transverter for TS-520/TS-820.....	<b>\$250</b>
VFO-520 for TS-520 series.....	<b>\$140</b>
SP-520 for TS-520 series.....	<b>\$30</b>
SP-120 for TS-120 series.....	<b>\$32</b>
SP-100 for R-1000.....	<b>\$32</b>
DK-520 Adaptor TS-520 to DG-5.....	<b>\$10</b>

All further Trio-Kenwood accessories transceivers and test equipment at competitive prices.

### ICOM & YAESU-MUSEN PRODUCTS

In the future we will be carrying a greater range of Yaesu-Musen products and a range of Icom products.

YAESU-MUSEN	
FT-101ZD 160-10M trans.c/w cooling fan & AM	<b>\$895</b>
FRG-7.5 -30Mhz receiver.....	<b>\$310</b>

### KYOKUTO FM 2025A

The very latest 2M FM from KYOKUTO 2M FM mobile 25W 10 memory channels plus full scanning etc.....	<b>\$350</b>
--	--------------

### CO-AX CONNECTORS

PS-259 - RG-8U and RG-58U types.....	<b>each 60c</b>
Cable joiners RG-8U and RG-58U types.....	<b>each 60c</b>
GLP right angle, RG-58U to SO-239 w/lock nut & weatherproof cap.....	<b>\$1.50</b>
SO-239 - 4 hole and single hole types.....	<b>each 60c</b>
MLS right angle RG-58U to PL-259.....	<b>75c</b>
In-line mic. sockets 3 & 4 pin ea.....	<b>60c</b>
Mic. sockets 3 & 4 pin each.....	<b>60c</b>
M-ring body mount w/lock nut.....	<b>\$1.50</b>

### NOVICE SPECIALS — CONVERSION CRYSTALS

Set of 8-crystals. Converts 28.480 to 28.595 MHz in 5-kHz steps. Clarifier tuning on Tx and Rx plus info to re-activate 24th channel.....	<b>per set \$32</b>
Set of 4 crystals converts 28.310-28.600 MHz. 10 and 20 KHz steps. Clarifier tuning Tx and Rx .....	<b>per set \$15</b>

All prices are NET, ex Springwood NSW, on pre-payment with order basis. All risk insurance is free of charge, allow for freight charges by air, road, rail or postal, excess will be refunded. Prices are subject to change without prior notice. All orders cleared on a 24-hour basis after receipt of order with payment.

ROY LOPEZ (VK2-BRL) Manager

# The 1980 Federal Convention and Annual Report

The 1980 Federal Convention has come and gone. No world shattering news but steady progress towards the improvement of amateur radio in Australia to the benefit of all operators.

What the WIA does for amateur radio is for all amateurs not for WIA members alone.

The Federal Convention, held in the Brighton Savoy Motel in Melbourne from 25th to 27th April, came out strongly in favour of the IARU and re-affirmed support both for the IARU and the IARU Region 3 Association. Thought is being devoted to the future of this important international organisation. Equally important is the thought going into amateur radio in Australia arising from the decisions of WARC 79.

The Convention hours are long and arduous, the work is intricate and complex and not enough hours are available for rest. Is it any wonder that Federal Councillors return home dry and ready for a holiday.

All Federal Councillors and Alternates attended. Their names appear in May AR except for VK7, which was represented by Brian Morgan VK7RR and Reg Emmett VK7KK, Fred Parker VK2NFF in place of Phil Card VK2ZBX and Geoff Atkinson VK3YFA attending as an additional Alternate Councillor. The Federal President, David Wardlaw VK3ADW chaired this meeting — his eighth since the 1974 Convention. Executive members attending full time were Peter Wolfenden VK3ZPA, Executive Vice-President and elected Federal President during the Convention, Ken Seddon VK3ACS and Courtney Scott VK3BNG were both re-elected. Harold Hepburn VK3AFQ was absent overseas but also was re-elected, as well as Bruce Bathols VK3UV, Editor of AR.

Visitors who attended the Convention relating to their own portfolios also included Keith Malcolm VK3ZYK, Chairman of the VHFAC (see last month's WIANEWS).

## AMATEUR RADIO

Your own magazine, AR, came in for a good share of the discussions, mainly because of rising costs. Motions were passed that publication must continue, that an AR Publicity Officer be appointed in each Division to obtain advertising and articles for publication and that Divisions be strongly encouraged to incorporate Divisional Bulletins into the printed pages of AR. A suggestion was made that only 11 issues be published each year with the Call Book making the 12th issue. This was overtaken by a motion calling on the Executive to examine the feasibility of posting the Call Book to each member each year. As this could not occur until 1981, the motion added that any increase in fees to cover this must be considered and finalised by 15th August next before the 1981 Budget comes up for review.

Adding Divisional news into AR increases costs which would be reimbursed by Divisions partly or wholly by offsetting present insertion costs and having regard to the amount of space used. It was generally felt that good Divisional news items would be of interest to readers in other States.

AR will be produced web offset from this issue to hold costs. This is obviously the first of many proposed changes in the pipe-line which will be noticed when the new system gets into its stride.

## EDUCATION AIDS

Last year it was thought that the production of original material for educational purposes from the money received from the Dick Smith donation was finalised. However, upon reflection during the year, the question was asked if the end result would be acceptable. As the result of a much closer examination of precisely what would be involved the Convention came to the conclusion that costs would be well in excess of the amount available if a worthwhile quality production were to be achieved. It was finally decided that the money should be split equally amongst the Divisions to be spent on educational promotional material and that each is to report not later than 31st October on how they have applied their shares or how they intend to use them.

On the question of examinations it was decided to ask the Department to grant permanent morse exemptions to Novices who obtain a pass at 10 words per minute in an exam. Concern was expressed over delays in issuing exam results as well as the issue of licences in some States. The recognition of examinations conducted by other competent bodies, e.g. Technical Colleges, was also to be pursued as in the past.

## TV CHANNELS 0 AND 5A

This remains of major concern. A motion was passed expressing a clear policy. The concept of Independent Multi-Cultural Broadcasting is not a matter which concerns the Institute, but the continuing use of Channel 0 and 5A is a matter of concern and must continue to be opposed by all means at our disposal. This extends to encouraging all amateurs to petition their local Federal Parliamentary members to express concern at the continuing use of TV Channels 0 and 5A. The message is plain. The Institute opposes the use of Channels 0 and 5A for television broadcasting by anybody.

## AMATEUR ADVISORY COMMITTEES

The status quo is maintained. The Institute continues to support Amateur Advisory Committees. Work requires to be done on the terms of reference. The establishment of local P. and T./WIA Joint Committees at State level is to be encouraged.

## BAND PLANS

The Convention re-affirmed the existing policy that established VHF and UHF band plans be adhered to by all. The "gentleman's agreement" relating to the HF bands (i.e. CW only in one specified segment and all permitted modes elsewhere in each band) are seen as essential and all amateurs are to be asked to respect these segments so as to avoid chaos.

This also came up in discussions on extending the 80 metre Novice segment down to 3500 kHz. This was rejected. An amending motion to seek an extension down to 3515 kHz instead also resulted in no decision at the Convention — three Divisions for, three against and one abstaining. The abstention could result in a yes or no vote within 30 days. As it later turned out that vote is in the negative and no downward extension is to be sought.

A 70 cm band plan was adopted as a guideline in the FM section of that band. RTTY spot frequencies are to be re-checked.

Publicity on all these band plans will be following in future issues of AR.

The IARU is to be approached in relation to gentlemen's agreements for all the new proposed HF amateur bands incorporating all applicable modes in a manner similar to those of existing HF amateur bands. Also that agreements should be negotiated regarding power limitations in the new proposed 10 MHz band.

## GENERAL

The Institute is to approach the P. and T. Department for the early use of the new proposed HF bands at 10, 18 and 24 MHz as well as seeking alternative channels in the 500 to 900 MHz region, approximately, for ATV if the present 50 cm temporary allocation is withdrawn.

An alternative membership badge based on the International diamond style of badge is to be designed. This badge does not in any way supplant the existing WIA badge.

A motion was carried that adequate justification for a common band being made available to all amateur licensees had not been established at the Convention.

It was agreed that there should be primary and secondary WICEN frequencies on bands above 14 MHz. The exact frequencies are to be determined later. The requirement that amateurs must state on licence application forms the equipment to be used was seen as undesirable and a motion to this effect was passed. Also the Department is to be asked to grant permanent exemptions in the CW exam to those Novices who pass the 10 w.p.m.

tests. In reviewing the examinations field, concern was expressed over delays in issuing results and delays in issuing licences in some States, where "over the counter" licensing does not yet operate. It was also agreed not to ask for copies of the exam papers and to continue work on other responsible organisations (such as Technical Colleges) conducting end of the year amateur exams on behalf of the Department. The principles affecting Divisional broadcasts were discussed, as well as the implications which could arise if the CW portion of the 80m band were to be extended to 3540 kHz in place of the present 3535 kHz. An investigation is to be carried out to prepare a case to be put to the Department for an allocation in the 80 or 40m American phone band segment.

## ORGANISATIONAL

The possibility of appointing a voluntary Press Agent was discussed with the view to taking advantage of potential space in local newspapers (etc.) to promote amateur radio. Further enquiries are being made and comments are welcome.

Ongoing publicity and recruitment measures were reviewed. It was noted that the A to Z leaflet is available, selective advertising is carried out and some Divisions (VK4 and VK5) had prepared hand-outs. Long term plans for amateur radio in Australia were discussed with the result that the VK1 and VK4 Federal Councillors would be glad to receive comments so as to prepare a paper on the subject. A motion was passed that pensioners' Federal dues should be the same as for Full and Associate members. A new form of membership application was agreed upon for universal use in all Divisions.

The Federal Constitution was examined and it was agreed to seek amendments on the lines that the Editor of AR need not be a member of the Executive but should be appointed by the Executive as well as the Publications Committee. It was also agreed to delete the requirement that AR be issued monthly. A very long standing policy that the Executive must be located in the same city as the Central Office of the P. and T. Department was set aside on the grounds that if Central Office shifts to Canberra it would become extremely difficult for the necessary number of volunteers to be found for both Federal and VK1 Divisional functions.

After discussions it was agreed that Magpubs shall not handle subscriptions to overseas magazines on behalf of members, except for Break-In and VHF Communications. Magpubs would continue to handle books and WIA items. The Executive were asked to investigate and identify the need for additional office facilities and personnel.

The next Convention was set down for 2nd to 4th May, 1981, at the same place. A number of agenda items were withdrawn on the grounds mainly that the matters were already WIA policies and were ongoing or had already been done.

## ANNUAL REPORTS

Each Annual Report was presented and discussed in great detail. There is much material in these reports of general interest and as they will form part of the official Convention Minutes (as well as having been previously circulated to Divisions) can be read on application to your Federal Councillor. One of the problems with Contests was the apparent indifference of amateurs to make useful comments on aspects they did not like when rules were published. Some feedback came after the contest which was valuable. In fact the complaint about the indifference of amateurs to make comments in advance of any proposed changes could be carried through to many other subjects.

During the Convention a most pleasing presentation ceremony was undertaken by Alex McDonald on behalf of all delegates. Dr. and Mrs. David Wardlaw and Mr. and Mrs. Michael Owen were presented with mementos (chosen secretly beforehand by the wives whose contributions in aid of their husbands was clearly to be recognised) for work on behalf of amateur radio before and at WARC 79. Another presentation was the handing over by VK1 to VK5 of the coveted RD Trophy.

**EXECUTIVE REPORT 1979-80  
THE EXECUTIVE**

1. As in the past, the Executive through the Executive Office has continued to produce WIANEWS and the Federal tapes in order to give up to date news of Federal happenings within the WIA and also international items of interest. By this means there has been a continuous report from the Executive throughout the year.

2. The Executive for the year 1979/80 was elected as follows:

David Wardlaw VK3ADW	President, Chairman
Peter Wolfenden VK3ZPA	Executive Vice Chairman Vice President
Courtney Scott VK3BNG	Hon. Treasurer Chairman Finance Sub-Committee
Ken Seddon VK3ACS	Chairman Federal Repeater Sub-Committee
Harold Hepburn VK3AFQ John Bennett VK3ZA	Nominal Editor

3. We welcomed a new Executive member this year — Courtney Scott VK3BNG. Courtney in taking over the Treasurer's job has been a very valuable member of Executive, bringing to us his expertise in the financial field.

4. We also have Harold Hepburn back again on Executive. When he was last on Executive, Harold was concerned with the previous revision of the "Handbook" and has become deeply involved in the negotiations with the Department on this again during the current revision.

5. With my own involvement as a member of the Australian Preparatory Group for WARC 79 and as a member of the Australian Delegation to WARC 79, Peter Wolfenden as Executive Vice Chairman has had to carry much of the day to day load and has done so in an admirable manner.

6. Ken Seddon has continued to hold office as Chairman of the Federal Repeater Sub-Committee.

7. John Bennett, the last member of Executive, provides us with expertise in the publicity and PR area.

8. I must mention the two members of the previous Executive who retired:

Graeme Scott VK3ZR who has contributed so much in the education field.

Keith Roget VK3YQ. We were all deeply shocked to learn of Keith's sudden death at Port Vila in the New Hebrides in February of this year. Keith was one of the hardest working and loyal members that the Institute has ever had and his influence will be felt for many years.

9. Attendances for the first 11 meetings since the last Convention were —

Dr. D. Wardlaw	9
Mr. H. L. Hepburn	8
Mr. C. D. H. Scott	10
Mr. K. C. Seddon	11
Mr. P. A. Wolfenden	11
Lt. Col. J. McL. Bennett	4

The following also attended —

Mr. G. F. Scott	1
Mr. B. Bathols	9
Mr. K. Malcolm	4
Mr. T. Pitman	3
VK3JY	1
VK3ZXW	1
VK3YFA	1
VK3BBM	1
Mr. M. Stephenson	7
Mr. P. B. Dodd	11

**OFFICE**

10. Our Landlord at 517 Toorak Road, The Commonwealth Bank, gave indications early in the year that it was hoping to rebuild and as a consequence would only accept a monthly tenancy. Although we had not been given any order to vacate we initiated a search for alternative accommodation.

11. Suitable premises were found in Hawthorn Road, Caulfield North. We moved the office to these new premises on the 29th November.

12. The office space at Hawthorn Road is only slightly larger than the space at Toorak Road but

the configuration is markedly superior which is a great advantage particularly as there is now greater involvement of the office in the preparation of 'Amateur Radio' Magazine.

**STAFF**

13. A decision of the 1979 Convention was to add a full-time member to the Federal office staff of the WIA to handle 'Amateur Radio' magazine matters. His job would be to take over the work of the part-time employee doing AR advertising, who would be no longer needed, and to relieve the Editor of the job of pasting up AR.

14. Mark Stephenson VK3NOY was employed on a provisional basis and having satisfactorily completed his probationary period he has been employed on a permanent basis.

15. Peter Dodd in his role of Secretary Manager has been of constant assistance to the members of the Executive and various appointed officers.

**MEMBERSHIP**

16. Again this year it is very pleasing to report a significant increase in membership.

17. It is to be hoped that this growth of the WIA will be maintained in the post WARC period as strong representation of the Amateur Service by a strong WIA will continue to be needed, particularly to obtain speedy implementation of the decisions of WARC 79 in Australia amongst other things.

**WARC '79**

18. The preparation for WARC 79 continued throughout the year with myself, David Wardlaw VK3ADW, and Michael Owen VK3KI attending all the Preparatory Group meetings, culminating in our appointment as Australian Delegates to WARC 79.

19. Appended as Report 80.04.01A is a comprehensive report of the Conference and results. Sufficient to say in this part of the report that the Amateur Service obtained many of its goals at the Conference but not without difficulties and due in no uncertain measure to the extensive preparation put in beforehand.

20. The most important single factor was the Amateur participation in the Special Preparatory meeting of the CCIR held one year before the Conference. I was extensively involved in the preparation for WARC in Australia which took up a major part of my time.

21. As there is a question in CCIR Study Group 8 concerning the Amateur Service, the WIA will participate in National Study Group 8L.

22. During the year, donations to WARC finances continued to be received and it looks as if we will be very close to our goal.

**IARU**

23. The WIA must continue to support the IARU both world-wide and through the Region 3 Association. Careful thought will have to be given to the implications of any suggestions made by overseas societies with regard to the future of the IARU alongside our own thoughts on the matter. This is important as an effective IARU is needed to ensure that Amateur Radio becomes as widespread and unfettered as possible in the newly developing countries.

**VHF TV FREQUENCIES**

24. The move of ATV from Channel 0 to Channel 10 was good news for Melbourne 6 metre operators.

25. However, this was negated by the announcement that "Ethnic" TV would use the vacated channel 0 when it commences in October 1980; this service to run in parallel with the one on UHF as was originally announced.

26. Our immediate protests were forwarded to the Minister for Post & Telecommunications by the Federal President asking why there had been a change in the plans for Ethnic TV from his earlier announcement. So far no reply has been forthcoming and, consequently, a reminder has been forwarded to the Minister. It is understood that this assignment will also apply in Sydney.

27. Members and Divisions, particularly Victoria and NSW, were asked to make their views known. Some have received replies, unlike the Federal body, indicating that this is only a temporary assignment and will be terminated eventually leaving only UHF. However, it was pointed out that despite its known shortcomings the Minister and his advisers consider 0 as a useful TV channel.

28. As has been the case ever since the introduction of TV in Australia, the number and allocation of TV channels has been a political issue. Anyone who has studied the facts going back prior to 1956, when TV was introduced in Australia, will have no difficulty in seeing the piecemeal way the matter was dealt with; showing little concern for other users — particularly the Amateurs. This has disadvantaged the Australian Amateur VHF operator when compared with his counterpart in other developed countries. It has also involved the WIA in endless discussions and negotiations.

29. In his reply to our report on the increasing use of Channel 5A, the Minister for P. & T. alluded to the complexity of the matter but said that no further allocations of Channel 5A would be made until a detailed report is prepared following WARC 79, although where projects were well advanced it would be difficult to change the channel and we could expect a number of 5A stations to come into operation over the next 12-18 months. At WARC 79 the Australian footnote 279A was modified to read "in Australia the band 137-144 MHz is also allocated to the Broadcasting Service for television until the service can be accommodated within the regional broadcasting allocation".

30. Also, the world-wide Aeronautical Mobile (R) band has been extended up to 137 MHz the lower limit of Channel 5A.

31. For many years the WIA has advocated that in areas where there is no Channel 0 transmitter permission be granted for the use of the frequency band 50-52 MHz by Amateurs as this is allocated in other countries in R2 and R3 in the International table and sometimes the MUF reaches 50 MHz but not 52 MHz.

32. There now seems to be the possibility of the segment 50.00 to 50.15 MHz being made available for use by the Amateur Service outside TV hours.

**AMATEUR HANDBOOK**

33. Following last year's Convention, as a result of intervention by the Minister, the WIA was given further opportunity to comment on the draft "Handbook". Many of the WIA suggestions have been accepted but others were of course unable to succeed because of the nature of the regulations governing the Amateur Service.

34. The Department has stated that this re-write of the Handbook is only an interim measure until the new legislation is enacted by Parliament. This legislation still appears to be some way off.

35. The WIA has repeatedly made the point that if very specialised information is in the Handbook, such as repeater conditions, then this material should not be the subject of examinations. The Department has agreed to this and I hope some indication will be given in the finally printed Handbook as to which material will not be examined on.

**JOINT COMMITTEE**

36. The Federal Joint Committee of WIA and P. & T. Department met on three occasions during the year. Although many matters were discussed the main themes during the year were the Handbook and matters concerned with examinations. It had been hoped that firm decisions and agreements would come out of these meetings. We are disappointed to a large extent that this has not happened. This is not to say these meetings are not useful but not as decisive as we had hoped.

37. Negotiations with the Department over repeater conditions have at last been concluded with the mutual agreement of both parties to them all. These negotiations were protracted but show the value of insistence on close examination of unrealistic clauses in order to obtain a satisfactory alternative.

38. In response to our request for F5 on bands above 1 GHz, we should be granted permission to operate on this mode between 1240-1300 MHz on a trial basis.

39. Reciprocal licensing has been discussed with the Department in an attempt to increase the number of countries with which we have reciprocal agreements. This is necessary as few countries have the twelve month visitor's permit such as Australia and a reciprocal agreement is necessary for an Australian to obtain permission to operate overseas. Japan is one country of particular interest and it looks as if there may be a breakthrough.

## EDUCATION AND EXAMS

40. In the education field the AOCIP syllabus has now been agreed on, with a change to multi choice questions. Because of this change the Department feels that it is impossible to issue copies of past examinations using this format. However, a sample paper of 50 questions has been promulgated and will appear in the new Handbook.

41. The WIA has made a number of suggestions in the examination area which have been acted upon; for example, the carrying of a pass in Morse sending which will save a considerable amount of examination time. There also has been an increased facility for examination in remote areas.

42. It is disappointing that not much progress has been made in the production of educational material as decided on at the last Convention.

## Project Aserit

43. This worthwhile project continues to flourish and during the year the purchase of further recorders was authorised. It is projects such as this that do much to enhance the image of Amateur Radio.

## VIDEOTAPES

44. The WIA Videotape service under the care of Coordinator John Ingham VK5KSG has continued to expand.

## "AMATEUR RADIO"

45. Thanks must go to Bruce Bathols VK3UV and the Magazine Committee, for maintaining the quality of "Amateur Radio".

46. With Mark Stephenson taking over the routine production work, which is now carried out in the Federal office, much of the load has been taken from the shoulders of the Editor.

47. Early in the year rapidly escalating costs hit AR necessitating prompt action and close monitoring. With a slight reduction in paper quality the printer agreed to hold his charges constant until December. The change in paper was well received by the members. During the year there has been a marked drop in advertising which is causing us concern. Consideration is being given to going to Web Offset printing which could continue to hold our printing costs at a reasonable level. Unfortunately, we have still had some problems with the mailing service on the insertion of Divisional Bulletins.

48. Callbook. The call sign listings in the 1979 callbook were typeset, using our computer file, by an organisation that specialises in this type of operation. This was a vast improvement compared with the listings taken directly from the Monash printout. 10,000 copies were printed and not a great number are left. It is intended to publish a further edition this year in a more basic form and of a limited printing.

Magpups continues to augment our funds.

49. WICEN. At the Federal level WICEN has made steady progress throughout the year having reached a state of acceptance with the Amateur community and many disaster control agencies. This has been achieved as a result of call outs for bush fires, standbys for cyclones, standbys because of breakdown of Telecom communications during industrial unrest, simulated exercises, and also by regular columns in AR and liaison at State and Regional levels.

50. Intruder Watch. At the end of 1979 Alf Chandler retired as Federal Intruder Watch Co-ordinator. Alf has been the backbone of Intruder Watch in Australia for many years. Our thanks must go to him for his service to the Institute in this field. Alf continues to serve Intruder watching as R3 Intruder Watch Co-ordinator. Alf's successor is Graeme Fuller VK3NXL.

Sometimes because of the lack of results the effectiveness of Intruder Watch is questioned. However, if we do not complain at all we are leaving ourselves open to hordes of intruders who would claim they are causing no harmful interference.

51. OSL Bureau. Ray Jones VK3RJ has retired from the position of Federal QSL Manager after 50 years of service. I would like to pay tribute to Ray's service to the WIA and to thank him on behalf of the members.

This year there has been a marked increase in the number of cards handled with a 10% increase in handling the cost of 100 cards.

52. Non-ionising radiation hazards. The Standards Association of Australia has set up Committee TE/1/2 to study non-ionising radiation hazards. The WIA is being represented by Jim Lloyd VK1CDB who also represents the Australian Radiation Society and the Department of Defence. Jim is well qualified to look after the interest of amateurs. Ken Seddon continues to represent us on SAA Committee 14\$4 — Siting of Radio Communications Equipment. He has been assured that none of the restrictions will apply to Radio amateurs.

53. VHFAC. The VHFAC under its new Chairman Keith Malcolm VK3ZYK has provided strong support for the Executive throughout the year. This was especially welcome on the matter of Channels 0 and 5A.

## Membership Statistics

54. These were compiled on the same basis as for previous years. Please note that P. & T. Dept. statistics refer to licences issued whereas the WIA statistics refer to the number of individual members. A short tabulation shows the number of second licences held by members. All statistics at 31.12.1979 (previous years in brackets).

55. In conclusion I would like to thank all those officers of the Institute who gave so readily of their time. Their help was especially appreciated this year with my heavy involvement with WARC 79. On this account please exercise tolerance if I have accidentally omitted mention of any subject which others believe ought to have been mentioned.

(Sgd.) D. A. WARDLAW VK3ADW  
Federal President

## WORLD ADMINISTRATIVE RADIO CONFERENCE GENEVA 1979

### REPORT BY AMATEUR DELEGATES

1. Dr. D. A. Wardlaw and Mr. M. J. Owen were members of the Australian delegation to the World Administrative Radio Conference Geneva 1979 representing the Amateur Service and nominated and funded by the Wireless Institute of Australia.

2. This report annexes an article by Mr. Owen published in Amateur Radio (March 1980) and extracts from the ARRL publication "QST" as well as extracts from the current radio Regulations of the ITU and extracts from the Final Acts of the World Administrative Radio Conference which together enable the new provisions affecting the Amateur Service to be fully understood. By this means considerable unnecessary work is avoided and hopefully a more useful report may be presented.

3. This part of the total report therefore deals with matters that are not otherwise covered.

4. Mr. Owen arrived in Geneva on September 20th and Dr. Wardlaw arrived in Geneva on September 23rd. The Conference was scheduled to finish on Friday, November 30th, but in fact the Final Acts were not signed until the evening of Thursday, December 6th. In these circumstances Dr. Wardlaw adhered to his previous schedule and left Geneva on Saturday, December 1st, whilst Mr. Owen remained to attend the Final Plenary meetings.

5. As Mr. Owen was accompanied by his family and had a larger apartment, he was able to undertake more entertaining than Dr. Wardlaw and thus expended more of the entertainment allowance granted by the Institute than Dr. Wardlaw. Dr. Wardlaw accordingly transferred 1,000 Swiss francs from his allowance to Mr. Owen and thus funds sufficient to cover his extended stay were made available. Neither Dr. Wardlaw nor Mr. Owen claimed any additional reimbursements over the amounts already advanced by the Institute.

6. The general report published in Amateur Radio outlines the options facing the Australian Administration in relation to the new HF bands to be allocated to the Amateur Service. We believe strongly that we should press for their availability at as early a date as possible. Whilst, because of its secondary status, the band at 10 MHz is not subject to a transitional procedure, the other two bands are. Logically we can expect the 10 MHz band to become available first. Given the inevitable congestion that will arise in that very small segment we believe that it is open to the Institute to press for the other two bands to be made available on an experimental basis outside the

transition period on the basis of existing Regulation 115. We do not believe we should be fearful of overcrowding in these new bands. We argued at the SPM and at the WARC that there was now and in the future there would be congestion in Amateur bands but that an enlarged family of frequencies would reduce congestion in the most spectrum economic way as it would enable Amateurs to select frequencies most appropriate for particular paths at particular times and different seasons and different parts of the sun spot cycle. Not only would any artificial rationing be inconsistent with that argument, it would also, in respect of the 10 MHz segment, remove pressure to not allocate fixed services in that band. Further, we argued that 50 kHz was not enough. There will be a next time around. By then let us be able to point to the great use being made of all Amateur bands.

7. We particularly wish to acknowledge the very close relationship that existed between Mr. Fred Johnson, the New Zealand delegation's Amateur representative nominated by NZART and the other members of the New Zealand delegation.

8. In submitting this report we would like to record our appreciation to the WIA and its Federal Council for the trust that has been reposed in us. We can assure you that we have always been very conscious of our heavy responsibility. We would also like to record our thanks to the leader of the Australian delegation, Mr. E. J. Wilkinson, and all of the members of the delegation. We may have been "Amateurs" but we were never made to anything other than full members of the delegation and were able to participate in many matters that were not of an immediate interest to the Amateur Service though many will have an indirect influence on the specific interest we were representing. Finally, we would like to thank those individuals, clubs and groups, who very often quietly and personally have wished us well and assured us of their personal support. We may not have thanked everyone who did this but we can assure you that we have appreciated this thoughtfulness.

(Sgd.) D. A. Wardlaw  
(Sgd.) Michael J. Owen

25th March, 1980.

## THE WIRELESS INSTITUTE OF AUSTRALIA A COMPANY LIMITED BY GUARANTEE INCORPORATED IN VICTORIA UNDER THE COMPANIES ACT 1961.

In accordance with the Companies Act, 1961, the Executive state the following:—

- (a) The names of the Executives in office at the date of this report are:—
- |                          |        |
|--------------------------|--------|
| Dr. D. A. Wardlaw        | VK3ADW |
| Mr. P. A. Wolfenden      | VK3ZPA |
| Mr. K. C. Seddon         | VK3ACS |
| Mr. C. D. H. Scott       | VK3BNG |
| Lt. Col. J. McL. Bennett | VK3ZA  |
| Mr. H. L. Hepburn        | VK3AFQ |
- (b) The principal activity of the Wireless Institute of Australia is to:—
1. Represent generally the views of persons connected with Amateur Radio in the Commonwealth of Australia, its territories and dependencies.
  2. Promote the co-operation between the Divisions in the encouragement and development of amateur radio.
  3. Safeguard the interest of the Divisions and the members in relation to frequency allocations, rights and privileges.
  4. Promote the development, progress and advancement of amateur radio in all matters in relation to amateur radio in general.
- (c) The surplus of income over expenditure for the the year ended 31st December, 1979, was \$4,734 compared with \$6,821 for 1978. There is no provision for income tax required as the Company is exempt under Section 103A(2) of the Income Tax Assessment Act.
- (d) During the year provisions were increased:—
1. Provisions for holiday and long service leave was increased by \$1,692 to \$5,192.
  2. Provision for Superannuation — increased by \$1,000 and Interest received \$227 to \$5,879.
- (e) The Executive has taken reasonable steps, before the Statement of Income and Expenditure and Balance Sheet were made out, to ascertain

that action had been taken in relation to the writing off of bad debts and making of provision for doubtful debts and to cause all known bad debts to be written off and adequate provision to be made for doubtful debts.

- (f) At the date of this report the Executive is not aware of any circumstances which would render the amount written off for bad debts, or the amount of the provision for doubtful debts, inadequate to any substantial extent.
- (g) At the date of this report the Executive is not aware of any circumstances which would render the values attributed to current assets in the accounts misleading.
- (h) At the date of this report no charges exist on the assets of the Institute which have arisen since the end of the financial year and do not secure the liabilities of any other person.
- (i) There does not exist any contingent liability which has arisen since the end of the financial year.
- (j) No contingent liability or any other liability has become enforceable within the period of twelve months after the end of the financial year which in the opinion of the Executive will or may affect the ability of the Institute to meet its obligations when they fall due.
- (k) Since the end of the previous financial year the Executive has not received or become entitled to receive a benefit by reason of a contract made by the Institute or a related corporation with the Executive or with firms of which they are members or with companies in which they have substantial financial interests.
- (l) The results of the Institute's operations during the financial year were in the opinion of the Executive not substantially affected by any item, transaction or event of a material and unusual nature. There has not arisen in the interval between the end of the financial year and the date of the report any item, transaction or event of a material and unusual nature likely, in the opinion of the Executive, to affect substantially the results of the Institute's operations for the next succeeding financial year.

Dated at Melbourne this 24th day of March, 1980.

#### MEMBERS OF THE EXECUTIVE

(Sgd.) C. D. H. SCOTT  
(Sgd.) K. C. SEDDON

#### STATEMENT OF INCOME & EXPENDITURE

	1979	1978
<b>Income:</b>		
Members' Subscriptions	\$97,098	\$81,936
Interest Received	5,138	5,074
Surplus — Magpubs	7,055	8,426
— Call books	13,688	—
Donations — ASJA Award	75	—
— Other	6	—
<b>Expenditure:</b>		
Amateur Radio (Note 1)	56,517	33,445
Audit Fees — 1978	578	489
— 1979	700	—
Bank Charges	381	685
Catering and Entertainment	—	122
Committee Expenses	1,011	524
Convention Expenses	4,330	2,492
Depreciation	534	340
EDP Expenses	3,300	4,734
Electricity and Power	524	370
General Expenses	749	542
Holiday Pay and LSL Provision	1,692	—
Insurances	757	540
Membership Recruiting	3,023	2,568
Provision for Amateur Satellites	—	3,000
Postage & Freight	4,205	3,362
Rent and Rates	3,317	2,230
Repairs and Maintenance	228	167
Superannuation	1,000	1,000
Stationery and Printing	2,789	4,545
Salaries and Secretarial	29,658	26,448
Telephone	851	884
Travelling Expenses	182	128
	<b>118,326</b>	<b>88,615</b>
<b>Net Surplus</b>	<b>4,734</b>	<b>6,821</b>
Accumulated Funds Brought Forward	33,100	26,279
Accumulated Funds Carried Forward	\$37,834	\$33,100

TABLE 1

	Total Licences	WIA Licensees	% members to total licensees	Other WIA members	Total WIA members
VK1	280 (229)	157 (123)	56 (53)	60 (53)	217 (176)
VK2	4091 (3633)	1841 (1530)	45 (42)	246 (243)	2087 (1773)
VK3	3639 (2941)	1747 (1417)	48 (48)	367 (442)	2114 (1859)
VK4	1726 (1334)	944 (757)	55 (56)	157 (209)	1103 (966)
VK5/8	1528 (1296)	854 (690)	56 (53)	226 (265)	1080 (955)
VK6	914 (807)	488 (409)	53 (50)	107 (111)	595 (520)
VK7	384 (328)	256 (212)	67 (64)	62 (75)	318 (287)
Other	34 (19)	— (—)	— (—)	— (—)	— (—)
<b>Totals</b>	<b>12596 (10587)</b>	<b>6287 (5138)*</b>	<b>50 (48)</b>	<b>1227 (1398)</b>	<b>7514 (6536)</b>

Net gain = 978.

% increase in total licences 19% (2009).

% increase in licensed WIA members 22% (1149).

\*TABLE 2. Total number of double calls in WIA member lists:

VK1	2	
VK2	88	
VK3	81	
VK4	39	Add 260 to 6287 = 6547
VK5	26	6547 = 52% of total licences
VK6	16	
VK7	8	
	260	

TABLE 3. Total licences by grades:

	Full	Limited	Novice	Total
VK1	171 (157)	45 (43)	64 (29)	280
VK2	2129 (2006)	943 (897)	1019 (730)	4091
VK3	1630 (1506)	1132 (980)	877 (455)	3639
VK4	741 (639)	459 (391)	526 (304)	1726
VK5/8	729 (667)	369 (321)	430 (305)	1528
VK6	496 (452)	224 (207)	194 (148)	914
VK7	198 (184)	100 (94)	86 (50)	384
Others	32	1	1	34
<b>Totals</b>	<b>6126 (5611)</b>	<b>3273 (2933)</b>	<b>3197 (2024)</b>	<b>12596 (104587)</b>

TABLE 4. WIA members by grade:

	F/C	A/T	S (Student)	G (Pens.)	L (Life)	X (Fam.)	Other	Total
VK1	155	60	—	—	1	—	—	216
VK2	1628	219	72	151	12	5	—	2087
VK3	1545	320	88	136	7	6	1	2103
VK4	887	148	4	45	4	5	10	1103
VK5/8	770	197	31	70	5	7	—	1080
VK6	440	96	17	37	4	1	—	595
VK7	238	58	5	9	4	4	—	318
Fed.	—	—	—	—	12	—	—	12
	<b>5663</b>	<b>1098</b>	<b>217</b>	<b>448</b>	<b>49</b>	<b>28</b>	<b>11</b>	<b>7514</b>

TABLE 5. Discontinuance of membership:

An examination of the EDP records for 1979 showed that 592 members listings were removed and these have been analysed as follows:		Resignations — Recorded on receipt of letter or returned subs. notice. Many reasons given — lack of funds, going overseas, no longer requires AR, etc.
Deceased	39	Deletions — Almost wholly because of being unfinancial. These listings also include deletion of the double record when full call obtained, i.e., obtaining full call after holding both Limited and novice calls (in this case the "X" record only is deleted — the other is amended). The same applies if a member holding two call signs resigns or dies.
Resignations	40	
Deletions	— in year after joining	44
	— in 2nd year after joining	149
	— in 3rd year after joining	140
	— 4/5 years after joining	73
	— 6/8 years after joining	48
	— over 9 years after joining	59

**BALANCE SHEET AS AT 31ST DECEMBER, 1979.**

	1979	1978
<b>Members' Funds:</b>		
Accumulated Funds	\$37,634	\$33,100
<b>Special Funds — ITU/WARC</b>		
(Note 2)	533	14,737
IARU (Note 3)	842	390
RWAA (Note 4)	1,213	1,153
	<u>\$40,422</u>	<u>\$49,360</u>
<b>Represented by:</b>		
<b>Current Assets:</b>		
Commonwealth Bank — General Account	\$14,521	\$41,260
Commonwealth Savings Investments	2,104	25,223
Australian Savings Bonds	42,100	23,100
Australian Resources Development Bank	2,200	2,200
Sundry Debtors — Less Provision for Doubtful Debts (\$2,000)	16,264	12,572
Stock on Hand — at Cost	4,714	4,276
<b>Non-Current Assets:</b>		
Furniture and Fittings — at Cost Less Provision for Depreciation (\$874)	1,798	1,955
<b>Deduct Current Liabilities</b>		
Sundry Creditors	1,603	2,468
Subscriptions in Advance	25,833	42,437
Provision for Superannuation	5,879	4,652
Provision for Amateur Satellites	2,972	4,349
Provision for Holidays and Long Service Leave	5,192	3,500
Deposit VK4	300	300
Dick Smith Education Fund	3,500	3,500
	<u>45,279</u>	<u>61,206</u>
	<u>\$40,422</u>	<u>\$49,380</u>

**NOTES TO AND FORMING PART OF THE ACCOUNTS**

**AMATEUR RADIO (Note 1)**

	1979	1978
<b>Income:</b>		
Advertising	\$32,196	\$37,756
Subscriptions and Sales	1,719	2,742
Inserts and Sundries	2,946	4,346
	<u>36,863</u>	<u>44,844</u>
<b>Expenditure:</b>		
Awards	90	90
Honoraria	4,400	4,540
Postage	13,555	10,099
<b>Publishing, Printing and Distribution Costs</b>	66,095	54,919
Salaries	7,941	7,778
Travelling Expenses	1,299	863
	<u>95,380</u>	<u>78,289</u>
<b>Excess Expenditure Transferred to General Account Representing Cost of AR to Members</b>	\$58,517	\$33,445
<b>Special Funds — ITU/WARC (Note 2)</b>		
Balance 1.1.79 — ITU Fund	\$3,062	\$9,521
— WARC Fund	10,894	9,604
— WARC — Public Donations	781	—
	<u>14,737</u>	<u>19,125</u>
<b>Add Interest</b>	749	1,699
<b>Members Contributions</b>	5,049	—
<b>Public Donations</b>	4,330	781
<b>Members Donations</b>	—	573
	<u>24,865</u>	<u>22,176</u>
<b>Less Expended</b>	24,332	7,441
	<u>\$ 533</u>	<u>\$14,737</u>
<b>IARU Fund (Note 3)</b>		
Balance 1.1.79	\$ 390	\$ 4,663
Add Members Contributions	1,145	1,338
	<u>1,535</u>	<u>6,001</u>
<b>Less Expenditure</b>	693	5,611
	<u>\$ 842</u>	<u>\$ 390</u>

**TABLE 6 (Supplementary). WIA members:**

	Members with Limited Licence (No. of Licences)	Members with Novice Licence (No. of Licences)	Members with Full Calls (No. of Licences)	No. Lic. Lim. Grade	No. Lic. Nov. Grade	No. Lic. Full Calls	Percentage of total Licensed WIA Members	Percentage of Total Limited Licences	Percentage of Total Novice Licences	Percentage of Total Full Call Licences
VK1	30	27	100	19.2%	17.2%	66.7%		66.7%	42.2%	58.5%
VK2	354	481	1006	19.2%	26.1%	54.6%		37.5%	47.2%	47.3%
VK3	373	421	953	21.4%	24.1%	54.6%		33%	48.0%	58.5%
VK4	151	338	455	16%	35.8%	48.2%		32.9%	64.3%	61.4%
VK5	147	256	451	17.2%	30.0%	52.8%		39.8%	59.5%	61.9%
VK6	66	110	312	13.5%	22.5%	63.9%		29.5%	56.7%	62.9%
VK7	52	69	135	20.3%	26.7%	52.7%		52%	80.2%	68.2%
<b>Total</b>	<b>1173</b>	<b>1702</b>	<b>3412</b>	<b>18.7%</b>	<b>27.1%</b>	<b>54.3%</b>		<b>35.8%</b>	<b>53.2%</b>	<b>55.7%</b>
	(= 6287)									

**RON WILKINSON ACHIEVEMENT AWARD**

(Note 5)		
Balance 1.1.79	\$1,153	\$1,100
Add Interest	110	103
	<u>1,263</u>	<u>1,203</u>
Less Award Payment	50	50
	<u>\$ 1,213</u>	<u>\$ 1,153</u>

**AUDITORS' REPORT TO THE MEMBERS OF THE WIRELESS INSTITUTE OF AUSTRALIA**

1. In our opinion the attached accounts give a true and fair view of the state of the Institute's affairs at 31st December, 1979, and of its surplus for the year ended on that date.

2. As required by the Companies Act 1961, we report as follows:



**PHOTO 1:** The coveted "RO" Trophy is now back in VK5 and at the 1980 Federal Convention Andrew Davis VK1DA (extreme right) hands over the trophy to Col Hurst VK5HI. Dr. David Wardlaw VK3ADW (left) looks on.

**In our opinion**

- (a) The attached accounts are properly drawn up (1) so as to give a true and fair view of the matters required by Section 162 to be dealt with in the accounts; and (2) in accordance with provisions of that Act.
- (b) The accounting records and other records, and the registers, required by the Act to be kept by the Company have been properly kept in accordance with the provisions of that Act.

**HEBARD & GUNNING**, Chartered Accountants  
Melbourne (Sgd.) P. W. HEBARD  
24th March, 1980 Partner

**THE WIRELESS INSTITUTE OF AUSTRALIA EXECUTIVE STATEMENT**

**In our opinion**

- (a) The statement of Income and Expenditure is drawn up so as to give a true and fair view of the surplus of the Institute for the financial year ended 31st December, 1979.
- (b) The Balance Sheet is drawn up so as to give a true and fair view of the state of affairs of the Institute as at the end of the financial year.

**MEMBERS OF THE EXECUTIVE**  
(Sgd.) C. D. H. SCOTT  
(Sgd.) K. C. SEDDON

**STATEMENT OF PRINCIPAL ACCOUNTING OFFICER**

To the best of my knowledge and belief the accounts for the year ended 31st December, 1979 give a true and fair view of the matters contained in Section 162 of the Companies Act, 1961, and required to be dealt with in the accounts as presented.

**PRINCIPAL ACCOUNTING OFFICER**  
(Sgd.) P. B. DODD



# HF TRANSCEIVERS FROM YAESU

NEW YAESU FT-707 "WAYFARER"

The exciting new FT-107 range



High quality transceiver.  
All solid state operation with inbuilt AC power supply makes it well ahead of its time.  
Available in two colours : grey or ivory.  
Complete range of accessories available.  
Write for brochure now !.



FT-207R Handheld.  
2M Digital programmable transceiver.

We also stock:



ICOM IC22S .....	\$289.
LEADER Ham scope .....	\$309.
LEADER Dip meter .....	\$89.
TONO 7000E Computer .....	\$885.
DIAWA CN620 SWR meter .....	\$95.
DIAWA Ant. Coupler CN217 .....	\$155.

"DIAWA ROTATOR"



DR7500R Medium duty "R" .....	\$182.
DR7500X Medium duty "X" .....	\$169.
DR7600R Heavy duty "R" .....	\$264.
DR7600X Heavy duty "X" .....	\$229.

Please Note !!!  
These are recommended retail prices only.  
We do better.

Chirnside Vertical Antenna Type CE-5B Features.  
Long length and high Q traps makes the CE-5B more efficient than similar types of antennas especially on 80 Metres.  
It is also very easy to tune and its construction is very rugged.

Specifications of the CE5B.  
Bands: 80-40-20-15-10 M. Operation.  
Power handling: 2 kW PEP.  
SWR: 1.5 to 1 or better.  
Length: 30' (approx)  
Weight: 9KG. Packed.

**\$99.--**

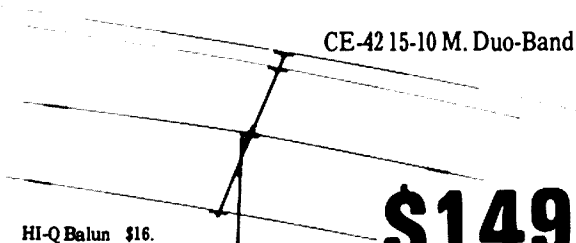

**\$149**

CHIRNSIDE CE-42 rugged duo band beam features 4 elements and uses independent reflectors for optimum results.  
3 elements on 15 M.  
3 elements on 10 M.  
Director and driven elements have hi-q traps.  
Forward gain is 8 dB and front to back ratio is in excess 25 dB.

- FT-707. All solid state HF transceiver. incl. 10, 18, 24 MHz. ....
- FV-707. Digital VFO for FT-707 incl. scanning. ....
- FC-707. Antenna coupler for FT-707. ....
- FP-707. DC power supply for FT-707 with inbuilt speaker. ....
- Rack mount for all the above items also available.
- FT-107M. HF transceiver excluding power supply.
- FT-107DMS. HF transceiver incl. DMS and power supply. ....
- FC-107. Antenna coupler for FT-107. ....
- FV-107. External VFO for FT-107 series. ....
- SP-107. External speaker. ....
- FT-107 Range is available in the colours grey or ivory.
- FT-720 New FM Transceiver.
- YM-35 Scanning hand mic. ....
- NC-2 Base Charger for 207A .....
- FV-101Z Ext. VFO for FT-101Z series .....
- FT-720 2M FM Transceiver Inc. Scanner .....
- FL-2100Z Linear for FT 101Z range.
- FT-101Z. 160-10M Transceiver. analog dial .....
- FT-101ZD. 160-10M Transceiver. Digital. ....
- optional digital display for FT-101Z. ....
- optional Fan. ....
- optional DC-DC converter. ....
- YE-7A Hand mike. ....
- YD-148 Desk mike. ....
- FT-901DM. 160-10M Transceiver. ....
- FV-901. ext. VFO for FT-901 & FT-101Z. ....
- YO-901. Panoramic adapter monitorscope. ....
- FC-901. Antenna coupler. ....
- FTV-901. Converter. 6M,2M,70 cm. all inc. ....
- FTV-901. Converter. 6M,2M. only .....
- SP-901. ext. speaker. ....
- FRG-7. Communication receiver. ....
- FRG-7000. Digital communications receiver .....
- LF-2A Narrow band filter for FRG-7. ....
- FT-7B. 80-10M Transceiver. ....
- FP-12. 12 Amp. power supply for FT-7B. ....
- YC-7B. Digital display for FT-7B. ....
- FT-227RB. 2M Digital programmable transceiver. ....
- YP-150. Dummy load/Watt meter. ....
- FF-50DX. Low pass filter. 2kw. ....
- QTR-24D Deluxe 24 hr. World clock .....
- FT-207R Handheld. ....
- NC-2 Base Charger for 207A .....
- CHIRNSIDE CE-33 Triband Beam .....

All FT-901 Accessories are compatible with FT-101Z series.

SPECIAL PRICE ON APPLICATION

MELBOURNE'S LEADING AUTHORIZED YAESU DISTRIBUTOR.  
CHIRNSIDE ELECTRONICS, 26 Edwards Road, Chirnside Park, Lilydale, 3116. Phone (03) 726 7353

# CONTESTS

Wally Watkins VK2DEW  
Box 1065, Orange 2800

POSTAL & TELECOMMUNICATIONS DEPT.



## CB RADIO WHAT CHANNELS? PUBLIC COMMENT WANTED

Radio frequency arrangements and regulations for CB radio are to be reviewed.

The Postal and Telecommunications Department is conducting a public inquiry with the following terms of reference.

To report to the Minister for Post and Telecommunications as soon as possible on whether the present 18 channel 27 MHz Citizens Band Radio Service, which was established on 2 June 1977, should be retained after June 1982.

In considering this issue regard should be had to:

- (1) all matters associated with the technical operating conditions, regulations, frequencies, channel allocations and procedures governing the Citizens Band Radio Service in both the HF (27 MHz) and UHF (477 MHz) bands;
- (2) the need to utilise and manage the radio frequency spectrum for the maximum overall benefit to the Australian community;
- (3) Australia's international obligations in radio frequency management; and
- (4) the need to minimise interference to other services.

The Department is seeking written submissions on these issues from interested individuals and organisations. Submissions should be sent to:

**First Assistant Secretary  
Radio Frequency Management Division  
Postal and Telecommunications Department  
PO Box 5412CC  
MELBOURNE VIC. 3001**

**CLOSING DATE FOR SUBMISSIONS:  
15 AUGUST 1980**

**TELEPHONE INQUIRIES:  
MR. J. KENNEDY (03) 609 1512**

### July:

- 19/20 JACK FILES MEMORIAL CONTEST
- 19/20 10-10 INT. NET QSO PARTY
- 20 RSGB WAB LF CW CONTEST
- 26/27 VENEZUELAN CW CONTEST
- 26/28 COUNTY HUNTERS CW CONTEST

### August:

- 9/10 REMEMBRANCE DAY CONTEST
- 9/10 EUROPEAN CW CONTEST
- 16/17 SEANET PHONE CONTEST
- 116 QLF ZL CONTEST (LOTS OF FUN)
- 23/24 ALL ASIAN CW CONTEST

### September:

- 13/14 EUROPEAN PHONE CONTEST

### October:

- 4/5 VK/ZL/OCEANIA PHONE CONTEST
- 11/12 VK/ZL/OCEANIA CW CONTEST
- 18/19 JAMBOREE ON THE AIR
- 25/26 CO WW DX PHONE CONTEST

### REMEMBRANCE DAY CONTEST — 9-10 AUGUST 1980

This year there are no rule changes and the formula is also the same, so there should be no need for any confusion. In order to help your Division each full call should put in two logs, one for CW and the other for Phone, even though they may only be for the minimum number of contacts. Good luck in the contest — the friendly contest — and hope to work you.

For those looking for rules CO magazine has the most comprehensive list available. However a SASE to the FCM will get any of the above contest rules.

### 10-10 INTERNATIONAL NET SUMMER QSO PARTY Starts: 0000Z July 19, 1980. Ends: 2400 July 20, 1980.

QSO parties are open to all amateurs, but only 10-10 members are eligible for awards. All contacts must be made on 10m. Modes acceptable are AM, SSB, FM. QSO parties are not intended to demonstrate technical or contest endurance abilities, but to encourage interest in 10 metre operation. Members may submit numbers collected for bar awards, non-members may use them to qualify for 10-10 membership.

### RULES

1. Exchange call, city, State, name and 10-10 number.
2. All station logs must be in UTC (GMT).
3. A station may be counted only once.
4. An operator may credit his/her score only to a local chapter of which he/she is a member. A local chapter is one that can be worked on ground wave when the band is closed.
5. One may work any 24 hours of the 48 hours available. They need not be consecutive, but must be in a minimum of one hour increments starting with the first contact. Any portion of a clock hour must be counted as a full hour. Example: You operate from 0130Z to 0229Z. This counts as two hours operating.

### CLASSES OF OPERATION

1. Single operator.
2. QRP (20 watts PEP output SSB, 10 watts output AM).

### SCORING

1. Each contact is worth one point.
2. Add an additional point if the station has a 10-10 number.

### AWARDS

In each class a first place certificate to each Australian call area.

Logs are accepted from members only and are due by August 20th, 1980. Mail to Robert Watson, 2 Suffolk Ct., Oceanside, NY 11572. Cover sheet must show name, call, QTH, 10-10 number, chapter affiliation, total hours of operation, total contacts and total number of points claimed.

# Remembrance Day Contest 1980 — Rules

## 9-10 AUGUST 1980

A perpetual trophy is awarded annually for competition between Divisions of the Wireless Institute of Australia. It is inscribed with the names of those who made the supreme sacrifice and so perpetuate their memory throughout Amateur Radio In Australia.

The name of the winning Division each year is also inscribed on the trophy and, in addition, the winning Division will receive a suitably inscribed certificate.

## OBJECTS

Amateurs in each VK call area will endeavour to contact other amateurs:—

- In other VK call areas, P29, and ZL on all bands 1.8 through 30 MHz.
- In any VK call area (including their own), P29, and ZL on authorised bands above 52 MHz and as is indicated in rule 5.

## CONTEST DATE

0800Z 9th August, 1980, to 0759Z 10th August, 1980.

All amateur stations are requested to observe 15 minutes silence before the commencement of the contest on Saturday afternoon. An appropriate broadcast will be relayed from all Divisional stations during this period.

## RULES

- There shall be 3 sections —
  - Transmitting Phone.
  - Transmitting CW.
  - Receiving.
 However separate logs may be submitted for sections (a) and (b).
- All Australian Amateurs (VK call sign) may enter the Contest whether their stations are fixed, portable or mobile. Members and non-members of the Wireless Institute of Australia are eligible for awards.
- Amateurs may use the following modes:—
 

Section (a) — AM, FM, SSB, TV.

Section (b) — CW, RTTY.

 However separate logs may be submitted for sections (a) and (b).
- Cross mode operation is permitted but both stations may only claim points as for a phone/phone contact. Cross band operation is not permitted excepting via a satellite repeater.
- SCORING Contacts:
  - On the 3.5, 7 and 14 MHz bands a station in another call area may be contacted once on each band using each mode. That is, you may work the same station on each of these bands on Phone, CW, SSTV and RTTY.
  - On the 1.8, 21 and 28 MHz bands, a station in another call area may be contacted twice on each band, using each mode provided that not less than 12 hours has elapsed since the previous contact on that band using that mode.
  - Between 1600 hours GMT and 2100 hours GMT on Saturday, intra-call area contacts may be made on the 1.8, 7, 21 and 28 MHz band once for each mode on each band.
  - Between 0300 hours GMT and 0759 hours GMT on Saturday, intra-call area contacts may be made on 1.8, 21 and 28 MHz bands, once for each mode on each band.
  - On the bands 52 MHz and above, the same station in any call area may be worked using any of the modes listed in rule 3 at intervals of not less than two hours since the previous same band/mode contact. However, the same station may be contacted repeatedly via satellite not more than once by each mode on each orbit.
  - All CW/CW, SSTV/SSTV and RTTY/RTTY contacts count double. Note rule 4 re cross mode contacts.

- Multi-operator stations are not permitted (except as in rule 7), although log keepers area allowed. Only the licensed operator is allowed to make a contact under his/her own call sign. Should two or more licensed operators wish to operate any particular station, each will be considered as a contestant and must submit a log under his own call sign.
- Club stations may be operated by more than one operator, but only one operator may operate at any one time, i.e. no multi-transmissions. All operators must sign the declaration.
- Entrants must operate within the terms of their licences.
- CYPHERS:
 

The serial number will consist of three figures that will be incremented by one for each successive contact. A contestant may start with any number between 001 and 999 but when 999 is reached he will start again at 001.
- ENTRIES must be set out as shown in the example using one side of the paper only. Envelopes must be marked "Remembrance Day Contest", postmarked no later than 8th September, 1980, and posted to FCM, Box 1085, Orange 2800.
- TERRESTRIAL REPEATERS: Contacts via terrestrial repeaters are not permitted for scoring purposes. However, contacts may be arranged through the repeater and if successful on another frequency, that contact counts for scoring purposes.
- PORTABLE OPERATION: Log scores of operators located outside their own call area will be credited to that call area in which operation takes place, e.g. VK5XY/2. His score is added to the VK2 scores.
- All logs shall be set out as in the example shown and in addition MUST carry a front sheet showing the following information in this order:

## EXAMPLE OF TRANSMITTING LOG

Date/time GMT	Band	Mode	Callsign worked	NR sent	NR rec'd	Points
---------------	------	------	-----------------	---------	----------	--------

## EXAMPLE OF RECEIVING LOG, VICTORIAN SWL

Date/time GMT	Band MHz	Mode	Callsign heard	NR sent	Station called	Points
10/8/80						
0612	7	P	VK5PS	002	VK6RU	2
0615	7	CW	ZL2AZ	004	VK4KI	6
0618	14	P	VK0ZZ	006	VK6FI	6
1620	28	P	VK3NAA	077	VK6NZZ	1

## SCORING TABLE FOR PHONE CONTACTS — ALL CW/CW, SSTV and RTTY CONTACTS COUNT DOUBLE (VK)

From	0	1	2	3	4	5	6	7	8	9	P29	ZL
VK0	—	8	6	8	6	6	6	6	6	6	6	8
VK1	6	—	2	3	3	3	4	3	4	5	5	3
VK2	6	2	—	2	2	3	4	3	4	5	5	3
VK3	6	3	2	—	3	2	4	2	5	5	5	3
VK4	6	3	2	3	—	3	5	5	2	4	2	4
VK5	6	3	3	2	3	—	2	3	3	5	5	4
VK6	6	4	4	4	5	2	—	3	2	5	5	5
VK7	6	3	3	2	5	3	3	—	5	5	5	3
VK8	6	4	4	5	2	3	2	5	—	2	2	4
VK9	6	5	5	5	4	5	5	5	2	—	5	4
P29	6	5	5	5	2	5	5	5	2	5	—	4
ZL	6	3	3	3	4	4	5	3	4	4	4	—

All Intra-call area contacts on 52 MHz and above, or as indicated in Rules 5 (c), (d) and (e), are worth one point.

Section, Score, Call Sign, Modes, Name, Address.

Declaration: "I hereby certify that I have operated in accordance with the rules and spirit of the contest."

Signed \_\_\_\_\_ Dated \_\_\_\_\_

- The Federal Contest Manager has the right to disqualify any entrant who, during the contest, has not observed the regulations, or has consistently departed from the accepted code of operating ethics. The Federal Contest Manager also has the right to disallow any illegible, incomplete or incorrectly set out logs.
- The ruling of the Federal Contest Manager of the WIA is final and no disputes will be entered into.

## AWARDS (Sections (a) and (b))

Certificate will be awarded to the top scorer in each section for each call area and will include the top Limited and Novice station. There will be no outright individual winner. Further certificates may be issued by the FCM at his discretion.

The Division to which the Remembrance Day Trophy will be awarded shall be determined by the following formula:—

Total call area score from sections (a)-(c) of rule 1 multiplied by the number of full call logs received from that area and divided by the number of full licences in that call area.

VK0 scores are added to VK7 and VK8 to VK5. Scores by VK9 stations are added to the mainland call area geographically nearest. Scores claimed by ZL and P29 stations are not included in the scores of any VK call area.

Acceptable logs for all sections shall show at least 10 valid contacts. The Trophy shall be forwarded to the winning Division in its container and will be held by that Division for the specified period.

## RECEIVING SECTION

- This section is open to all Short Wave Listeners in Australia, Papua, New Guinea and New Zealand, but no active transmitting station may enter.

- Contest times and logging of stations on each band are as for transmitting.
- All logs shall be set out as in the example. It is not permissible to log a station calling "CQ". The detail shown in the example must be recorded.
- Note the times and conditions set out in rule 5 (transmitting).
- Club stations may enter this section. All operators must sign the declaration.

#### AWARDS

Certificates will be awarded to the highest scorers in each call area. Further certificates may be awarded at the discretion of the Federal Contest Manager.

## DIVISIONAL NOTES

### VK2

The Tamworth Amateur Radio Club wishes to advise that the "NOEL TAYLOR MEMORIAL FIELD DAY" will be held in the Tamworth area on the long weekend of October 4-5.

All amateurs from Novice to Full Call will be entering together with children of those attending.

For further details please contact the Field Day Committee via Peter Squires VK2DAU, PO Box W107, West Tamworth 2340. Also listen for VK2NJW, VK2NXZ, VK2NMB, VK2DAU and VK2DHT for information.

### VK3

From Jack Thomas VK3NTR, Publicity Officer of the Western Zone, comes the following news.

The annual meeting of the Western Zone of the WIA (Vic. Division) was held at Ararat on May 3rd, 1980.

Unfortunately attendance was poor.

Office-bearers for 1980-81, with Woody VK3AGD in the chair, were:—

President: B. Stares VK3ZBS/NVI.  
 Senior Vice-President: J. Hinton VK3ZML/NDT.  
 Junior Vice-President: K. Reid VK3BPH.  
 Secretary/Treasurer: J. Thomas VK3NTR.  
 Zone Technical Officer: J. Dennis VK3BPM.  
 Wiclen Co-Ordinator: O. Gellert VK3AEU.  
 Intruder Watch Co-Ord.: D. Baulch VK3AKN.  
 Publicity Officer: J. Thomas VK3NTR.  
 Zone Committee: John VK3BPM, Peter VK3AQO, George VK3GN, Brian VK3BWA, Oliver VK3AEU, Charlie VK3VEJ.

Repeater Committee: John VK3BPM, Ray VK3AOS, George VK3GN, Jim VK3ZML, Brian VK3BWA, Laurie VK3NDL.

The Zone has its hook-up every Monday at 8 p.m., 1000 hrs. UST on Channel 7 2m and 3.585 plus or minus QRM.

### QSP

#### APRIL WAS HERE

Most intriguing to read about a device which looked like a large toroidal core and had the effect of completely reversing the direction of any field trying to pass through it. The mathematics are stated to be very involved but an important consequence was that gravitational attraction was completely reversed within the area of the device. After some experimentation by the amateurs who invented and developed it, the logical outcome was an "aerial station" 70 cm repeater tethered some 300 metres above ground, the height being governed only by feeder losses. This gem came from the April issue of Radio Communication. CQ for the same month carried an article explaining that sporadic E does not exist. Amateurs and scientists world-wide appear to have been the victims of a gigantic hoax. In fact, says the article, the phenomena ascribed to sporadic E is really caused by a closely-guarded secret, a lightweight aluminium wire grid with a weight of about 0.035 grams, 4 metres in diameter, suspended at a height of 50 to 60 miles by 150 kW of electromagnetic radiation.

# IONOSPHERIC PREDICTIONS

Len Poynter VK3BYE

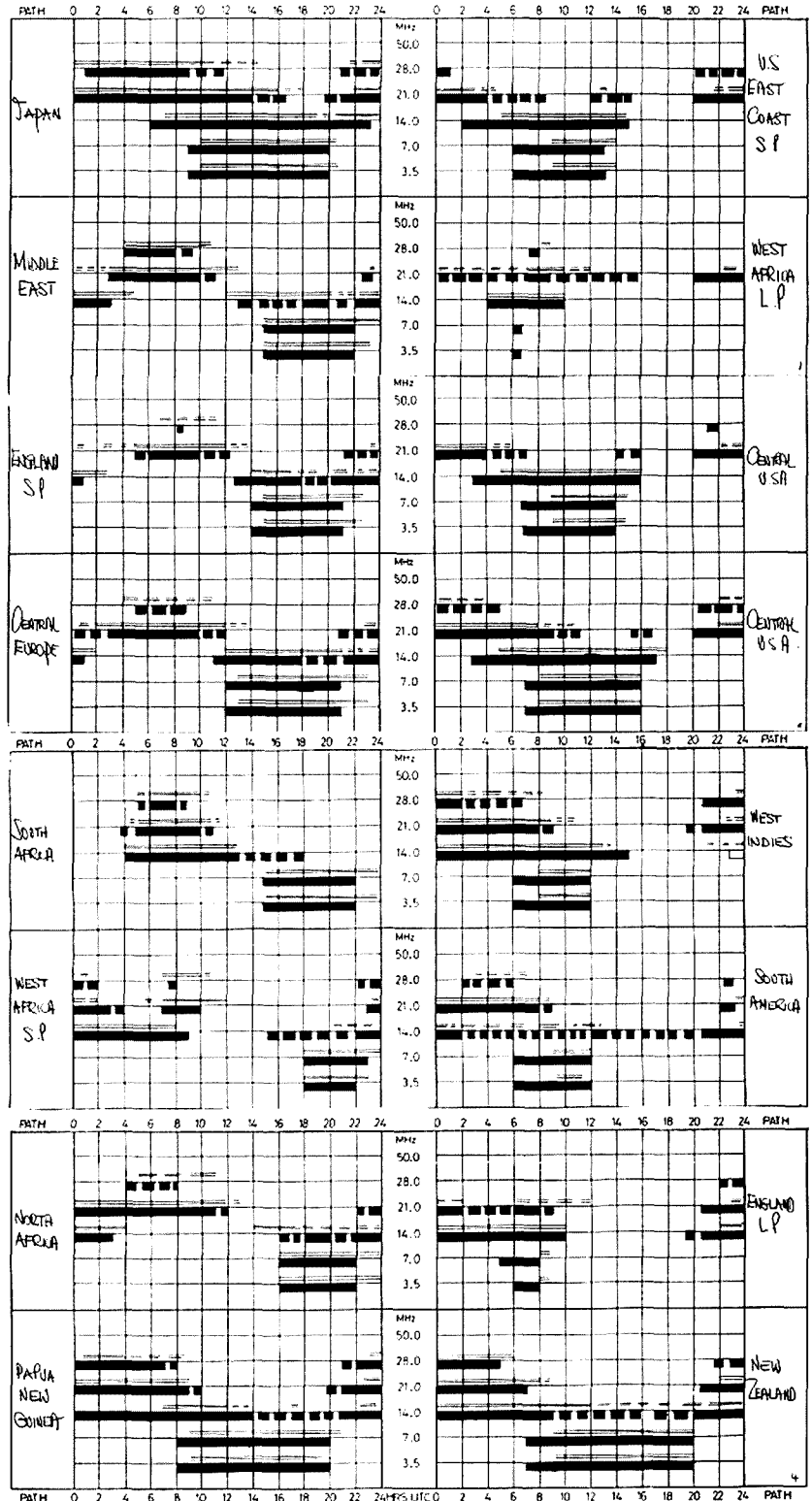



# NOVICE

FT-7  
HF MOBILE  
TRANSCIVER



FT-101Z  
BUDGET-MINDED  
TRANSCIVER

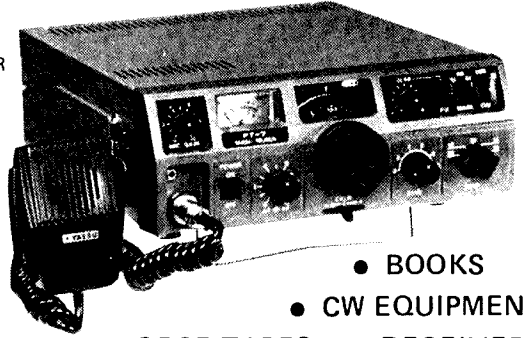

- BOOKS
- CW EQUIPMENT
- MORSE TAPES
- RECEIVERS
- SERVICE
- TRANSCIVERS
- ANTENNAS
- TEST GEAR
- SECOND HAND GEAR
- ENCOURAGEMENT AND ASSISTANCE
- MINI COMPUTERS, PERIPHERALS, SOFTWARE AND INTERFACES for APPLE, TRS-80, SCORCERER, PET AND CBM and soon SYSTEM 80

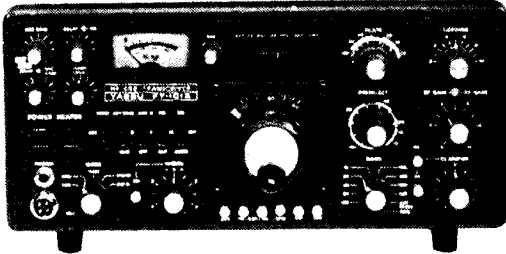

This HF rig is high performance at budget price with today's technology. An SSB/CW Transceiver providing resolution to greater than 1 kHz, RF speech processor, analog frequency display. FT-901 series accessories can be added later.

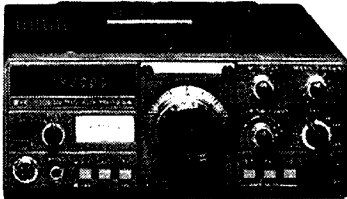

TS-120V  
ALL SOLID STATE  
HF SSB TRANSCIVER

A transceiver specifically built for the novice and the limited budget. Modular in design optional extras can be added as required. The ideal layout of the front panel means simple operation as fixed station or mobile. A marvellous combination of high performance at modest cost. Kenwood is one of the most widely used brands of amateur gear in Australia.

### SERVICE DIVISION

We have a fully equipped electronic service division. We can service enthusiast and commercial electronic gear efficiently and at a reasonable charge.

Wholesalers, agents, manufacturers and retailers please consider us for your next Queensland service contract.

CW can arrange service and service contracts of Commodore computers within Australia and PNG.

Telephone: (07) 341 5377

A.H.: (07) 341 4767

**\*\*WHILE CURRENT STOCKS OF M65 LAST** \*Refer to license limitations on Morse and RTTY communications.

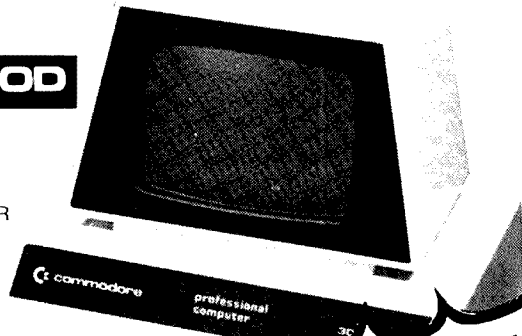

### MINICOMPUTER INCENTIVE OFFER

UNIQUE TO CW ELECTRONICS  
With each Commodore 16K or 32K mini-computer purchased from CW Electronics by a licensed Amateur Radio Operator will come, at no extra cost, a MACRO-TRONICS M65 Ham Interface for Morse Code and RTTY (and ASCII) Transceiving.\*

SAVE \$149

DEALER

VICOM



ELECTRONICS

CNR. MARSHALL RD AND CHAMBERLAND ST.,  
TARRAGINDI - BRISBANE PH. (07) 48 6601  
P.O. BOX 274, SUNNYBANK, QLD. 4109  
AH: BRIAN (07) 341 4767 TELEX AA 40811

# LETTERS TO THE EDITOR

Any opinion expressed under this heading is the individual opinion of the writer and does not necessarily coincide with that of the publisher.

Box 68, Yarram 3971.  
April 20.

The Editor,  
Dear Sir,

Like many other amateurs I understood that Novice licensing was to be of a limited tenure of two years.

It is fortunate that most Novice calls are keen to progress to the full ticket, and of course being on air is an ideal way of improving one's capabilities, both theoretically and CW.

Seems to me, however, that a fair number, having reached the dizzy heights of 5 w.p.m. and that "hard" multiple choice paper, are prepared to remain Novices for evermore. (Be interesting to know how many are still "N" calls from early days.) Furthermore some of these fellows put out remarkably strong signals from their modified (?) appliances. Could of course be super efficient aerial systems.

Before we degenerate completely to CB level (and I reckon we are well on the way) is it possible to get the department to bring in limited tenure. Whilst we are at it, introduce some system to give the "home-brew" type Novice some incentive. Bad enough most full call blokes (self included) are appliance operators these days. Let us at least start the new intake off on the right tram.

It's my opinion that if you cannot make AOCOP after two years on air then you are definitely in the wrong hobby.

Yours faithfully,

Jack Mellor VK3AMG.

15 Broughton St., Tumut, NSW 2720.  
17/4/80.

The Editor,  
Dear Sir,

I feel prompted to write this letter after a lot of thought and reading several issues of AR. I would have thought by now that someone would have given a reason for several of my fellow amateurs (if they will allow someone so humble to call himself that) to feel they are so special that they deserve their own frequencies; I am of course writing about the new allocations that came out of WARC 79.

Do these people think they are so alone in wishing for a clear piece of the spectrum to work on? The rest of us would like to have a contact without the problem of other stations spluttering all over us, but I think we are getting a bit selfish in suggesting that a special person with better qualifications be allowed the 24 MHz section or any other section for that matter.

I think the whole Amateur Radio Fraternity AOCOP are entitled to use the new allocated bands, not just a few people who think they are special because they know a bit more. (I agree — Ed.)

I am sorry this letter sounds a bit sour, but that's how I feel. I will admit I am a bit spoiled, the amateurs who taught me were completely unselfish, and some of that must have rubbed off.

Yours sincerely,

Butch Chapman VK2BYS.

202 Frankston-Flinders Road,  
Balnarring 3926,  
17th March, 1980.

Mr. P. B. Dodd,  
Wireless Institute of Australia,  
PO Box 150,  
Toorak 3142

Dear Peter,

Your letter of 8th February and the attached cheque came as a great and pleasant surprise to me.

The thought that I may be awarded the 1979 Higginbotham Award as a "thank you" for the work I put in on the Magazine/Publications Committee

over the past twenty-odd years. Only the other day I went through my "personal papers" file and discovered a letter from George W. Baly VK3AOM when he acted as secretary to the Committee, dated 15-3-66, indicating that I had joined the Committee on 18th February, 1958.

I would like to thank Bruce and the other members of the Committee very much for this award, which I shall always treasure, and I shall always remember the pleasure I received from my association with the Committee.

If members happen to be passing here at any time I am sure that my wife and I will always be glad to make them welcome in the best spirit of "Amateur Radio".

Yours sincerely,

Syd Clark VK3ASC.

## WICEN

Ron Henderson VK1RH

Federal WICEN Co-ordinator,

53 Hannaford St., Page ACT 2614

Ph. (062) 54 2059, A.H.

WICEN is the Amateur Radio Service Emergency Communications Organisation established to assist the Statutory Authorities during periods of Civil Emergencies.

The Amateur Radio Service is defined in International Telecommunications Regulations as a service of self-training, intercommunication and technical investigation conducted by duly authorised persons with a personal non-pecuniary interest in the development of radio techniques.

In Australia, the Wireless Institute of Australia (WIA) is the national organisation representing Amateur Radio licensees. Established in 1910, the WIA is the oldest radio society in the world and is a member of the International Amateur Radio Union, whose membership representation includes almost every country in the world — East and West — developed and developing.

Each State in the Commonwealth except the newly created Northern Territory State, is a Division of the WIA, with its own autonomous Divisional Council, its own WICEN organisation and with representation on the Federal Council of the WIA.

A Federal WICEN Co-ordinator, residing in Canberra, is the WICEN advisor to the Federal Executive body and the liaison officer to the Natural Disasters Organisation.

In New South Wales, the WICEN organisation is controlled by a State WICEN Co-ordinator, who is also Chairman of the State WICEN Committee, which is a sub-committee of the NSW Divisional Council.

The State is subdivided into ten Regional WICEN areas, plus five smaller Regions covering the densely populated districts of Sydney and adjoining areas.

Each WICEN Region is controlled by a Regional WICEN Co-ordinator assisted by a number of local WICEN Co-ordinators who, in the main, reside in the major centres of population in the Region.

WICEN is also a fully affiliated member of the NSW Volunteer Rescue Association, which is closely aligned to, and operates in conjunction with, the NSW Police Rescue and Disaster Branch.

From the foregoing it will be apparent that the WIA, and WICEN, is well structured and efficiently administered.

In NSW the administrative organisation of WICEN has been specifically tailored to meet the requirements of any NSW Government Act that could be involved during the course of a Civil Emergency.

The self-imposed discipline and dedication that a prospective amateur licensee must acquire to obtain a licence is a most valuable asset when that person is involved in an emergency situation and is bound by the particular Parliamentary Act governing the emergency.

Without exception all members of the NSW WICEN organisation are volunteers and are licensed Radio Amateurs — many of whom occupy senior

positions in the electronics and communications industry. To obtain a licence, a prospective amateur must successfully complete examinations conducted by the Postal and Telecommunications Department of the Australian Government. The examinations embrace radio and electronic theory (transmitters, receivers, aeriels, power supplies, etc.), national and international regulations and, for certain grades of licence, Morse code proficiency.

Prior to acquiring a licence the prospective amateur must complete and sign a Secrecy of Wireless Transmissions Statutory document which prohibits the licensee divulging any text, or portion thereof, of any transmission made or received.

Radio Amateurs are licensed to operate in designated frequency bands ranging from medium frequency (1800-1860 kilohertz) to super high frequency (2100-2200 megahertz), and, resulting from the recommendations of the 1979 World Administrative Radio Conference (WARC) in Geneva, a number of additional bands are to be made available shortly; which is indicative of the international recognition of the role and importance of the Amateur Radio Service. The amateur licence has a wide choice of modes of communication, with Morse code, amplitude and frequency modulation, single side band, radio teletype and slow scan television being most popular, and has other modes available for specialised and experimental purposes.

To date, the Amateur Radio Service has placed eight amateur HF/VHF/UHF satellites in orbit around the earth, with more planned and under construction. The satellites were designed, built and financed by amateurs on a world-wide co-operative basis.

The majority of NSW WICEN members operate both fixed and mobile stations, together with portable and hand-held transceivers for use in areas inaccessible to vehicles.

The increasing number of amateur VHF repeater stations, over twenty in New South Wales alone, provides amateurs with reliable noise free communications throughout the majority of the State and offers up to 100 km range from low-power hand-held portable transceivers.

In NSW, WICEN is an organised disciplined body which can provide a unique, specialised community service that no other organisation, be it voluntary or Statutory, can provide.

WICEN offers the Statutory Authorities a variety of communication modes, a wide range of sophisticated equipment and the trained, disciplined manpower to operate the facilities and, if required, competent relief personnel for the Authorities' own communications terminals — all at no cost to the Authorities, the Government or the general community.

The foregoing is but a brief resume of the Amateur Radio Service and the NSW WICEN organisation.

H. Freeman VK2NL

### WICEN IN THE HOUSE

Extract from the NSW Legislative Assembly Parliamentary Debates (Hansard), 6th March, 1980. The Member for Gordon, T.J. Moore, LL.B., M.P., speaking during the debate on Bush Fire matters:—

"I draw attention also to one group of volunteers not often mentioned — the Wireless Institute of Australia emergency surveillance network — who come in to help provide communications between volunteer brigades working outside their area with a radio network that is not on their own domestic frequency. They do a magnificent job and are far too often overlooked in the bouquets handed out by people, such as the Minister, the honourable member for Pittwater and the honourable member for Nepean when dealing with disasters in their areas."

BUYING OR SELLING GEAR?

# HAMADS

MAKE IT HAPPEN FAST

# AWARDS COLUMN

Bill Verrall VK5WV  
7 Lilac Avenue, Flinders Park, SA 5025

## WORKED ROCKHAMPTON AWARD

This Award, known as the WRA, is awarded by the Central Queensland Branch of the Wireless Institute of Australia to any licensed amateur in any part of the world operating from a fixed, portable or mobile amateur station, on the following conditions:—

1. STATIONS OUTSIDE AUSTRALIA: By making ten (10) two-way contacts with licensed amateur stations in Rockhampton, Queensland, on either CW, AM, SSB or RTTY on any HF and/or VHF band.

2. STATIONS WITHIN AUSTRALIA: As in Rule 1, but fifteen (15) two-way contacts. (Stations resident in Rockhampton are not eligible for the award.)
3. No cross mode contacts are permitted.
4. Contacts via Rockhampton's 2 metre repeater are allowed.
5. Contacts with the official Central Queensland Branch station VK4WIR will count as two points.
6. Specially endorsed certificates will be issued for contacts made on one band and/or one mode only, i.e. CW, AM, SSB, etc.
7. Claims are to be submitted on a LIST showing stations worked, date, GMT, band and mode. QSL cards are NOT to be sent.
8. The cost is 5 IRCs or equivalent.
9. Applications together with the list should be forwarded to:—  
Central Queensland Branch WIA,  
GPO Box 496, Rockhampton, Queensland 4700, Australia.

## DESCRIPTION

The Award measures 215 mm x 285 mm, printed on white card with the map of Queensland in blue, surround in blue and motif and all printing in black.

## DEVIL AWARD

The TASMANIAN DEVIL AWARD is created to interest Australian and overseas amateurs in contacting reasonably rare VK7s. Tasmania, the island state of Australia, has many features, the "Devil" Award is named after one of these.

## TO QUALIFY

You may qualify for the Award in any one of the sections or sub-sections.

## SECTIONS

1. MF-HF:
  - (a) Open — by the use of any combination of bands up to 30 MHz, and modes available to applicant.
  - (b) One band — of those available.
  - (c) One mode — of those available.
  - (d) All Novice — contacts with Novice calls.
2. VHF:
  - (a) Open — by the use of any combination of bands above 30 MHz, and modes available to the applicant.
  - (b) One band — of those available.
  - (c) Satellite — contacts via amateur satellites. Cross band to HF allowed if permitted under licence terms.
  - (d) Repeater — via in-band repeaters.

## Claims:

### HF:

Applicants must establish two-way contact with a number of VK7 amateurs depending on the applicant's location.

Australia, including Tasmania	50 contacts.
Oceania, Antarctica	30 contacts.
Asia, North America	20 contacts
Europe, South America	10 contacts.
Africa	7 contacts.

### VHF:

Applicants to contact 20 VK7 amateurs with at least one station in each of the three WIA Branch areas.

### Verification:

Claim logs, with applicant's name, call, section, to show station contacted, date, time, band and mode. The claim to be signed by applicant and countersigned by two other amateurs. Spot checks will be made with contacted stations in VK7 for confirmation. OSLS will not be required.

### Commencement:

Contacts made since first day in January 1978 can be used in claims.

### Applications:

A fee of 10 IRCs overseas or 5 IRCs within Australia or equivalent should accompany claim to cover cost of award and postage and be sent to:—

VK7 QSL Bureau,  
PO Box 371D,  
Hobart, Tasmania 7001.

### Description:

The Award measures 205 mm x 230 mm, printed on light blue card with the map of Tasmania in green, "DEVIL AWARD" and the nose and mouth in red, the head in black and all printing in black.

Good hunting. ■

# DEVIL AWARD TASMANIA



147 E

42° S

The Tasmanian Division of the  
Wireless Institute of Australia  
grants the

TASMANIAN "DEVIL" AWARD

No. to  
operator of Amateur Radio

Station

Awards Manager

Date

Section

Section

Award No.

## THE RADIO AMATEUR'S CONVERSATION GUIDE

A most useful adjunct for working  
the DX station not proficient in  
English. Good also for contests.

**\$9.00** brings you a copy, post paid.

**MAGPUBS**

**P.O. Box 150, Toorak, Vic. 3142**



## MAGAZINE REVIEW

Roy Hartkopf VK3AOH

### ZERO BEAT March 1980

(Youth Radio Scheme magazine.) State News (G), VHF Sniffer (C), Etched Circuit Boards (G), "Battleship" game using TIL 305 LEDs (C), YRCS Directory (G).

### BREAK IN January-February 1980

WARC Results (G), Pin Diodes for TR Switching (TC).

### HAM RADIO February 1980

Coaxial Line Transformers (GC), Yagi Antenna Design (T), Plasma Diode Experiments (Micro-wave Detectors) (TP).

### NOTE

Radio Electronics is running a series of articles (Part 6 in the March 1980 issue) on a backyard satellite TV receiver. Frequency around 4 GHz and some interesting stripline design is included. If copies are difficult to find, try the public reference library.

(G) General. (C) Constructional. (P) Practical without detailed constructional information. (T) Theoretical. (N) Of particular interest to the Novice.

## AMATEUR RADIO IS A RESPONSIBLE SERVICE

LET'S KEEP IT THAT WAY

# WANTED

## RIPPED OFF TAPE BUYERS

Are you tired of paying too much for your cassettes and accessories? Your problems are over... for one dollar!

# \$1.

You receive:

- One sample Dindy Super C46 cassette with a 5 year guarantee.
- One copy of Dindy News, the cassette user's journal, packed with info, accessories and bargain-priced cassettes (all brands, of course) at prices up to 50% off retail.
- A special introductory offer too good to refuse.



To: DINDY MARKETING  
15 BOUNDARY STREET  
P.O. BOX 55, RUSHCUTTERS BAY, SYDNEY 2011

20,000 people have bought over 1,000,000 cassettes from us. They all can't be wrong. \$1 spent could save you hundreds.

Mr/Mrs/Miss .....

Address .....



P/code

PP6004/AR01



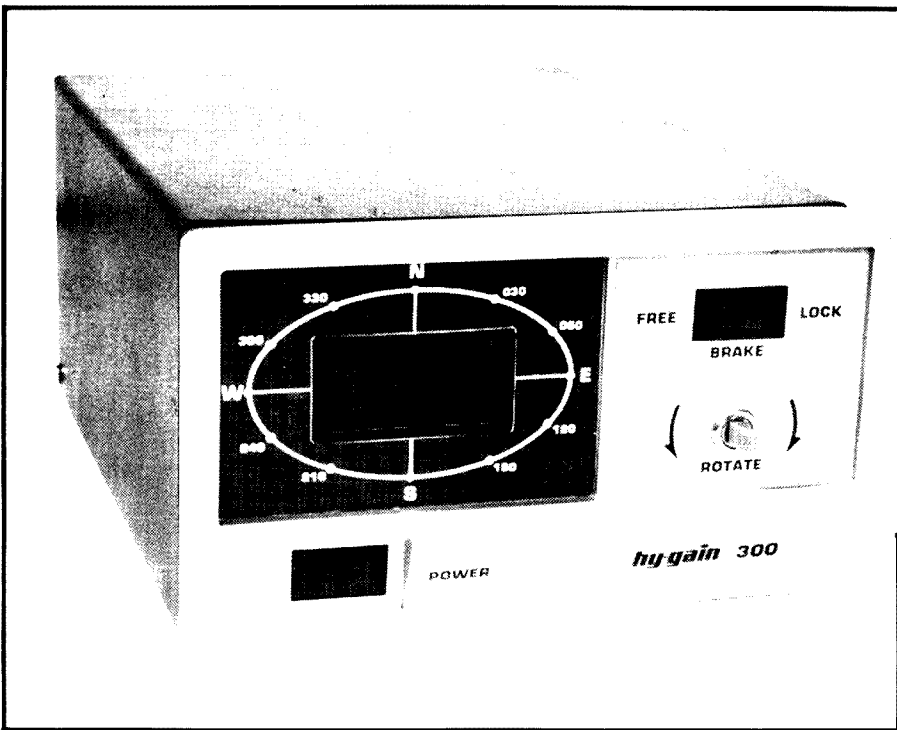

**HYGAIN HEAVY DUTY ANTENNA ROTATOR**  
Hygain have recently announced the release of their new heavy duty antenna rotator, the HDR-300.

The HDR-300 when tower mounted will easily turn and hold up 25 square feet of antenna area and with a stall torque of 5000 lbs., is rated higher than any other amateur rotator on the market. The HDR-300 weighs 12.7 kg (28 lbs.) and the control console 7.26 kg (16 lbs.). Rotation time for 360 degrees is sixty seconds and power requirements are 110/220V AC at 50/60 cycles and for the motor 24V AC 12A maximum, 1/10 HP PSC, single phase.

Maximum vertical load for the unit is 226.8 kg (500 lbs.), braking torque (min.) 5000 in. lbs. (565 N-m) and coasting torque 600 in. lbs. (67.8 N-m).

For further information and current price contact the distributors, Audio Telex Communications Pty. Ltd., 1 Little Street, Parramatta, NSW 2150. Phone (02) 633 4344 or telephone their regional offices, Melbourne (03) 277 5311, Queensland (07) 44 6388.

**At left: the control box for the new Hygain HDR300.**

**VICOM NEW ZEALAND EXPANDS**

Due to the huge success of VICOM's New Zealand operation an address change which will provide both larger and better positioned premises has been made.

The new address is 84 Whites Line East, Lower Hutt. Phone 69 7625.

**DAIWA RELEASES NEW WARC ANTENNA TUNER**

Daiwa look like being first on the market with an amateur radio antenna tuner which has been designed to incorporate the WARC bands of 10, 18 and 24 MHz. The coupler handles 500W PEP and includes the popular direct reading "cross needle" type SWR/PWR meter.

Output impedances of 10-300 ohms can be handled with an input impedance of 50 ohms. The new model will be called the CNW418, is distributed by Vicom and should be available soon at most amateur stores.

For further information contact Vicom International or your favourite amateur dealer.

**ICOM RELEASES NEW WARC TRANSCEIVER**

ICOM of Japan have released their latest HF amateur transceiver, the Model IC720. The new-comer to the ICOM stable incorporates a general coverage receiver (0.1-30.0 MHz) and all the new bands approved by WARC 79.

In common with most other ICOM transceivers, the nucleus of the unit is a microprocessor. Tuning is accomplished by the successful "optical chopper" VFO, which means better linearity, no backlash and no variable capacitors — eliminating problems known to occur in other transceivers.

The IC720 also features a speech processor, bandpass tuning and an effective noise blanker as standard.

To enhance the IC720 a new range of options will be released including an automatically tuned HF mobile antenna system, covering all HF bands.

Principal specifications are as follows:—

**FREQUENCY COVERAGE**

Receive 0.1 to 30.0 MHz.  
Tx/Rx 160m, 80m, 40m, 20m, 15m, 10m, plus 10/18/24 MHz.

**MODES**

SSB/RTTY/CW/AM.

**OUTPUT POWER**

SSB 10-100W variable.

**SPURIOUS**

Better than 60 dB below.

**SENSITIVITY**

Better than 0.25 uV for 10 dB S + N/N.

For further information and latest price on the new IC720 contact the Australian distributors, VICOM International, on Melbourne (03) 699 6700, Sydney (02) 436 2766 or any of their authorised dealers.

**AROUND  
THE TRADE**



**The new ICOM IC720 is pictured above and should be available shortly.**

# SILENT KEYS

It is with deep regret that we record the passing of —

Mr. H. A. J. NOTTINGHAM	VK2HN
Mr. T. TATHAM	VK2TQ
Mr. W. F. M. HOWDEN	VK3BP
Mr. E. PERKIN	•x-VK3EQ
Mr. F. H. PRICE	L60030
Mr. R. F. HENWOOD	VK6RL
Mr. A. H. DOWNWARD	VK3AHD
REV. D. E. LAVER	VK4ZDL
Mr. J. H. STEPHEN	VK5JS

# OBITUARY

**TERRY TATHAM** VK2TQ  
It is with regret that we have to advise of the passing on the 14th May 1980 of Terry Tatham VK2TQ from Turramurra.

Terry was well known to Sydney two-metre and HF operators for many years. During the 1950s when Terry was in his teens, he contracted polio and spent a great many years in hospital. In recent times Terry was able to live at his home at Turramurra where with the aid of his electric wheelchair he was fully mobile about the property. His interests were diverse — besides Amateur Radio he was in the process of construction of a large boat. He was widely read as well as undertaking courses in various subjects including real estate and auctioneering. Regrettably, this year Terry had been back in hospital for long periods. ■

**EDWARD (TED) PERKIN** Until 1953 VK3EP  
Passed away 22nd March, 1980, at Bendigo, Victoria. Commenced operating in Rochester, Victoria, on 19th March, 1933, and moved to Bendigo in December, 1938.

While off the air during the war years, he was a Morse code Instructor for the RAAF Air Training Corps in Bendigo.

VK3EP was licensed again on 8th January, 1946, and transmitted continuously until 1953. From that date on he only maintained his receiving rig.

1937 was his record year for OSOs, recording a total of 883 for the year in his log book.

B. P. Ellis VK3BFI. ■

**ARTHUR HARVEY DOWNWARD** VK3AHD  
On April 26th, 1980, amateur radio in Australia lost one of its more colourful characters when Arthur Downward lost his life as the result of a road accident.

Born in Port Melbourne on the 17th January, 1924, and first licensed on the 6th September, 1950, Arthur's first love was amateur radio. He was a strong opponent of any measure which might have an adverse effect on our hobby.

He was interested in most branches of amateur radio, and at the time of his death was preparing to take up ATV.

Arthur served an apprenticeship with Johns & Waygood as a filter and turner in what is now Kingsway in South Melbourne, and when bronchial troubles made it inadvisable to follow this trade, he became a telephone technician, an occupation he retained up to the time of his death.

To his two sisters and family we extend our condolences.

Arthur Harvey Downward will be sadly missed by his many friends in all sections of the community, and especially in amateur radio.

John Ireland VK3AJI. ■

# OBITUARY

**HERBERT NOTTINGHAM** VK2HN  
It is our sad duty to report the passing on 13th May 1980 of Herbert Nottingham VK2HN of North Ryde. Herb was located near Lane Cove Road and his tower and quad were a landmark in the area. ■

# HAMADS

- Eight lines free to all WIA members. \$9 per 3 cm for non-members.
- Copy in typescript please or in block letters to P.O. Box 150, Toorak, Vic. 3142.
- Repeats may be charged at full rates.
- Closing date: 1st day of the month preceding publication. Cancellations received after about 12th of the month cannot be processed.
- QTHR means address is correct as set out in the WIA 1979 Call Book.

## FOR SALE

External VFO, suits FT101Z or FT901, connecting cable supplied, has 40 memories and manual or auto scan, perfect cond., new price \$430, sell for \$380; will consider offers. VK2AZT. Ph. (069) 42 1392.

Tri Band Antenna, 20, 15, 10m, 3 elements, Western DX33, HD traps, 1 kW rating, with balun, same specs as Hygain TH3 Mk 3, 6 months old, exc. cond., \$195; 5 el. 2m quad, built as per RSGB VHF/UHF manual, good cond., \$35. B. Bathols VK3UV, QTHR. Ph. (03) 90 6424 evenings.

New Butternut Vert. Antenna, HF5V-S, for use on 80-10m, especially in low profile, restricted, height/span areas like roof of high rise bldg. or caravan park, traps are used for 10-15m operation but entire radiator 16 ft. length is active on all other bands, \$120, ONO. VK2NI, QTHR. Ph. (02) 872 1470.

FT101S Tx Rx, imported direct from Japan, full legal power, 400W PEP, DC to DC converter, fan cooled, original packing, immaculate cond., \$525. VK3BSU/NKV, QTHR. Ph. (03) 550 1839 after 6 p.m.

Kenwood TS520, 5 el. 10/11 yagi and rotator, 100 coax RG58U, desk mic., 2-way coax switch, HF 250W linear, 3 el. 10/11 yagi, small 38 ft. tower, CW key, all near new cond., the lot \$1,000. Bruce Emerson VK2NSE, QTHR.

IC280, removable head, synthesised 2m FM Tcxr (S/N 03505), incl. inbuilt scanner, less than 1 year old and in mint cond., sacrificed to sell quickly at \$325, ONO. Mike VK1VW. Ph. (062) 88 8994 AH, 83 2684 Bus.

Yaesu FT101E Tcxr, from deceased estate, in excellent cond., complete with mic., \$550. VK5AGO, QTHR. Ph. (087) 25 4241.

Complete Station: Yaesu FT101Z, with CW filter, fan, desk mic., 18-AVT vertically (Hygain), 8 spare 6146, and Kenwood TR2200A with 5 el. beam plus much more, \$1,100, ONO. SASE to F. Redburn, 25 Netherwood Rd., Maida Vale, WA 6057. Ph. (09) 454 6811.

Argonaut 509 QRP Transceiver, as new cond., home brew keyer, mos, really good rig, \$400; transformer, 1500 volts a side at ½ amp., \$20. VK2LH, QTHR. Ph. (02) 456 2027.

TS120S, as new cond., in carton, and MC10 mic., \$640, no offers. VK2BYS, QTHR. Ph. (069) 47 1998.

Yaesu Linear FL2100B, excellent cond., \$375. VK3AL, QTHR. Ph. (03) 690 1691.

Uniden 2020, 80-10m Transceiver, CW filter, as new, \$550, ONO. VK3BTO. Ph. (03) 489 7468.

Tommy VK4FW received his licence on the 3rd January, 1980. His grandma bought him a full brand new outfit for his ham shack. Unfortunately he was so ill that he only made 20 OSOs. He passed on at the end of March at sixteen years old. Now comes the sad part . . . the equipment listed is for sale at a most reasonable price. Kenwood TS820, external VFO for the 820, 820 speaker, SWR meter, key and headphones, vertical antenna 80-10, collection of odds and ends; all the above equipment in unmarked brand new cond., the lot for around \$1,250, ONO. Please contact Ray VK4ACU. Ph. (075) 45 1629 or QTHR.

DX-160 Rx, with speaker, excellent cond., \$125. QTHR via L10016 or phone Ken Ray (062) 65 2083 Bus., (062) 88 6459 AH.

Admiralty Wavemeter, G78 model, 200-250 MHz, made in 1942, not complete. Ph. (02) 73 2662 AH.

ICOM IC22 2m Mobile Tcxr, repeaters 1 to 9 inc., simplex ch. 40, 50, complete with mic. and mobile mtg. bkt., excellent cond., \$145. Laurie Wade VK2AOW. Ph. (02) 436 2766 Bus., (02) 969 2160 AH.

ICOM IC280 2m FM Tcxr, full 4 MHz coverage, mint cond., \$385; 2 TCA 1677s, fair, \$30 each; MR6 on 52.525 MHz, good, \$40; sundries. VK3YMW, QTHR. Ph. (058) 21 9458.

FT7, immaculate, little used, incl. CW/SSB audio filter, relay switching for linear, split frequency facility, 10 dB step attenuator, \$440; Palomar broad band 80-10m solid state amplifier, 200W PEP output, new in carton, \$195; Daiwa RF 550 speech processor, as new in carton, \$120; new FT7 9 MHz xtal filter, \$40. VK3ARZ, QTHR, or phone VK3OM (03) 560 9215.

Orake R4A T4X5 MS4 Speaker, mic and PS, instruction book, \$475; IC22A 7 ch. 2 repeaters, \$170; instruction book and mic. VK3CB, QTHR. Ph. (03) 24 4154.

Shack Clean Out: Hewlett Packard 608D VHF signal generator, 10-420 MHz, \$500; Hewlett Packard 540B transfer oscillator, measures F to 18 GHz, in-built CRO, etc., \$75; Panoramic LP1A RF spectrum analyser, 10 MHz-44 GHz, \$270; Panoramic audio spectrum analyser with response and IMD accs., \$250; digital equipment Cpn. analogue to digital converter, \$200; Bercher transistor test unit, very comp. lab. Inst., 5 major modules, superb, \$270; Tektronix pre-amp. PSU type 127, \$70; Telequip 3 in. 6 MHz CRO, \$75; EAL, DMM, \$20; Wilton fidelity test set 701, \$80; Phillips transistor test set, \$35; constant current PSB, 0-25V, \$30; environment oven, approx. 8 c. ft., \$50; Beckman RA 8 channel pen record, 16 in. width, 4 pre-amps, \$110; K. & H. coax. X-acceptance tester, 30 MHz CRO, \$40; Houston X-Y timebase, \$27; TV gear: Marconi sync. gen., \$37; AWA harmonic gen., \$13; Astor pulse and bar gen., \$15; Astor pulse reflection set, \$15; Astor VHF sweep gen., SG1, \$35; Astor waveform gen. 1A, \$50; Astor waveform gen. 2, \$72; AWA sync. gen. panel TSG1, \$55; plus lots more. Leon VK3ZN. Ph. 557 6031.

8m and 2m Transverter with accessory/control unit; Yaesu FTV650 6m unit, v.g.c.; home brew FTV250 2m unit, professionally designed and constructed, 200W PEP capability; accessory/control unit, professionally designed and constructed, providing power supplies, full metering, switching and cross band operation for up to 4 transverters and HF, two tone generation and speech compression for the tcxvr, provision for auto CW, tape rec., swept VFO, all in matching Yaesu 400 series cabinets, comprehensive collection of spares, all manuals, circuit diagrams, design notes and drawing supplied, complete set for VHF at \$500; Marconi FT92A VHF test set/signal generator, accurate and operational, with manual, \$75; JVC Nivico TD684 4 track stereo tape deck, with new reel of tape, 7 in., \$60. Graham VK3NVP, East Gippsland Zone Disposal Officer, QTHR or phone (051) 56 2397.

Kenwood KP202 2m Tcxr, ch. 40, 50, rept. 2, 4, 6, 8, perfect cond., flexible and standard aerial, with special universal charger, \$150, ONO. Roy VK3AOH, QTHR.

Vibroplex Bug, bought new in the USA earlier this year, but surplus to requirements, hardly used, \$35; also two Rotron whispers exhaust fans, 12 cm sq., 115V, ideal for linears, \$15 the pair. Roth Jones VK3BG. Ph. (03) 870 3333 Bus., 848 7945 AH.

ICOM 701 with power supply, mic., 4 memory remote control unit and junction box, \$1,350, ONO. VK5XT, QTHR. Ph. (08) 339 2392.

Kenwood TS520S, with DO converter and SWR meter, \$550; Yaesu FR101 Rx, 160-2m, bands as new \$530; Yaesu FLDX 2000 linear amp with new spare set of valves, \$280; DR tail-twister rotator, unused, still in carton, \$180; VC2 SWR bridge, \$25; SP520, \$20. Ian Rau VK3AQJ, QTHR. Ph. (052) 78 7751.

SSTV Camera and Monitor, robot model, 80A and 70A, \$500. VK3NEV, QTHR. Ph. (060) 7112, ask for 295.

Deceased Estate, all equipment in excellent cond.: Hipower Apadar regulated P/S 12V DC; Waller 100W 8100D soldering gun; Yaesu hand mic., suit 101, 101Z, 301, etc.; Yaesu FT301 solid state txcvr.; Leeson base station power mic., good cond.; home brew antenna tuner for balanced lines; Dick Smith Q1140 multimeter with case, as new; Lanson TE1205 stereo/mono headphones; Portatlab 500D pwr/swr/field strength unit; brass band key; paddle keyer kit, nearly complete; TE101 signal injector; CB receiving booster; tool box, 3 split trays, complete with components, suit hobbyist; PA speakers, suit siren, burglar alarm, etc. (2 off); hobby boxes, two sizes; Yaesu RSM-2 gutter grip and complete set of Novice resonators 10-15-80; Unimetric Slingshot CB txcvr., exc. cond.; quarter wave whip, suit 10m stainless steel; best offer. Mrs. J. H. Hayhoe, 11 Skellington St., Heidelberg West 3081.

IC201, 144-148 MHz, tunable CW, SSB, FM, inbuilt pre-amp., with power supply and mic., \$395. VK3B0B, QTHR. Ph. (03) 578 7441.

TS820, digital readout, DC-DC supply, CW filter (not fitted), MC 10 mic., good cond., \$790, ONO, for quick sale. VK2DAB, QTHR. Ph. (089) 62 5001 Bus., (069) 62 5163 AH.

Drake TR4CW txcvr., with remote VFO, noise blanker and power supply, \$900. QSY to SM-land. Ralph VK4QK, QTHR. Ph. (07) 261 1626.

Shack Clear-out, Deceased Estate Late VK3AHR: Collins KWM2 transceiver with power supply, mic., Morse key, instruction book and spare valves, \$950; 70 ft. winch operated tilt-over lower with Hy-gain 204BA antenna, CDE rotator with controller/indicator, control and coax cables, \$500 (will assist to dismantle); IC22A 2m transceiver with mic., nicads and charger, 11 crystals, instructions and orig. packing, \$150; Trio CO1303G monitor scope, \$150; aerial equipment as follows: 3 element 20m beam with concentric pipe supports dismantled, rotator (prop pitch), pair selsyns, trap dipole 20, 40, 80m with balun and coax, dummy aerial with 0-4 RF amp meter, MFJ antenna tuner, B & W 5-way antenna switch, Keathkit SWR bridge, 50m UR67 coax cable, multimeters, transformers, museum pieces and all usual ham shack sundries mysterious indeed to this executor. Ph. (03) 844 3879 or (03) 49 2910 Bus.

Atlas 215 HF 5-band Txcvr, 200W PEP input, small size (3 1/2 x 9 1/2 x 9 1/2 in.), in good cond. and works well, with handbook and DC cable, \$475. VK4XT, QTHR. Ph. (074) 62 2389.

ICOM IC701/IC701PS/ICSM2 Mic., as new, orig. carton, \$1,100. VK3BAX, QTHR. Ph. (052) 9 5949 Bus., (052) 9 7401 AH.

Yaesu FT7, complete, as new, little use, incl. fixed xtal 28.320 Sydney net freq., plus Leson TW232 mic., \$450 (will not separate); converted CB super Panther, thumbwheel freq. selection, complete coverage Novice Phone section 10m band, mic., etc., with JD5050 Ireq. counter, \$199; Lunar Electronics HF3-100 linear amp., \$150; ideal Novice rig. Neil VK2NBA, QTHR. Ph. (02) 634 1882 AH Castle Hill.

QGE03/20 Valve, with base, \$12; QGE02/5 valve, \$5; Phillips microphone, \$3; David Perry. Ph. (08) 255 1421 Bus., (085) 22 1919 AH.

Hy-Gain TH6DX Triband Beam, \$235; 80-10m trap vertical, \$60; Comdel speech processor, \$65, ONO. VK3KW, QTHR. Ph. (03) 379 1152.

Yaesu FRDX400 Rx (most options) and FL200B transmitter, both mechanical filter systems, can be used as transceiver, spare tubes, good order, \$400; KW107 super match antenna tuner, \$150; Barlow-Wadley XCR-30 mk. 2 receiver and AC power supply, good order, \$160. VK3JI, QTHR. Ph. (03) 93 6505.

Kenwood TS180 with DFC, complete, Inc. w/shop manual, as new, in carton, \$1,000; Kenwood TV502 2m Transv., mod. to suit TS180, complete, cables to suit TS180, as new, in carton, manuals, \$120; Kenwood TS120V, as new, in carton, Inc. w/shop manual, \$400; Kenwood TL120 linear, suit TS120, in carton, \$195; Daiwa RF680 speech processor, suit TS120, \$85; Dentron super tuner, plus 1 kW ATU, as new, \$185. VK2BXU. Ph. (02) 57 4648.

Tx TU units, Tx cond., Tx colls, Hi-voltage transformers, chokes, valve tester, valves, speakers, Hi-selectivity IFs, sundry parts. Offers to Frank VK3AFC, QTHR. Ph. (03) 89 5031 A.H., 661 2294 busa.

ASCII Teletype Model 38ASR tractor feed terminal fitted with full duplex WRU, break and RS232 interface, recently reconditioned by STC, operates at 100 bauds and is complete with integral tape units and console stand, very good order, ideal for use as a computer terminal for hard copy and access or use in shack, \$850; scanning model SX100, covers all amateur VHF frequencies, as advertised in AR, as new, no further use due to a change in QTH; RTTY Fleisher regenerative speed converter model TR128, will cover 60, 67, 75 and 100 w.p.m. in baudot and 100 baud in ASCII, full transceive with fully variable character output rate, memory and preload functions, only 3 months old, as new, perfect cond., see page 15 Feb. AR, \$250. Ian Foster VK3ST. Ph. (051) 52 4027.

Philips SC108 100W SSB TF Txcvr, 4 channel, \$180. Hvy. duty power supplies, ex computer, with 5" Ferranti meters 6V25A (easily converted to 12V), \$90. 28V 20A, \$140. 3.6 kW 240/240 computer mains isolation TFR with screen, \$65, ICL401 visual display unit, \$80. CDC 9450 disc drive with packs, \$250. Friden 4321 mag data recorder with tapes, \$200. VK4EF, QTHR. Ph. (07) 38 1803.

Yaesu FT101E, late model with front panel control of speech processing level. AC/DC, with cooling fan and accessory 600 Hz filter for CW/RTTY, 160-10m Tx, plus 10 MHz and 27 MHz Rx only, has had little use, exc. condition. Overseas travel and study costs compel sale. \$675 or reasonable offer. Alan Beagley VK4AFE, 322 Birdwood Tce., Toowoong 4066. Ph. (07) 371 4399 A.H.

Yaesu FT101B Txcvr with G3LLL speech processor, external VXO, SWR meter, mic., manuals and spare valves, perfect working order, \$600. Ray VK3RF. Ph. (03) 678 5305.

Kenwood TS520 Txcvr., exc. cond., in orig. carton, 12/240V power supply, mic., spare xtals, accessories and manual, \$475. Multi-2000A all mode synthesised 2m Txcvr., 12/240V pwr. supply, ideal for Oscar, \$345. Communicator VHF Rx, 12/240V, \$40. Hygain 27 MHz mobiles (2) 5W/23 chan. PLL synth., brand new in cartons (suit 6m conv.), \$30 each. Wal VK2ZAV, QTHR. Ph. (02) 211 4444 bus.

Dummy Load YP150, 6W-30-150W-50 ohm, \$75. True RMS meter AWA E260, AC volts .001V-10V, DC volts .1V-100V, \$125. Ant. coupler HC500, 3.5-30 MHz, \$80. Transverter TV502, 144-146 MHz, TS520 companion unit, \$150.18AVT vertical ant., \$60. All with handbooks. VK4MQ (QTHR as for VK4AMQ). Ph. (075) 31 7923.

Trio TR2200G Portable 2m FM Txcvr, xtals for rpts. 1-8 and simplex 40, 50, 51, \$185; Eddystone Rx 888A with speaker, instruction manual, g.c., \$100; HW17A 2m Tx/Rx, AM/FM, Rx tunable 144-148 MHz, Tx xtal working, needs attention, comprehensive manual, \$50. VK3VB. Ph. (03) 781 2614.

ICOM IC211 2m all mode Txcvr, in as new cond., \$600. Kenwood TS520 HF Txcvr with CW filter, DC-DC converter and new finals, \$535. Both rigs with cartons, manuals, etc. Also Kenwood SP820 speaker, \$45. All perfect. Andrew Gray, QTHR. Ph. (03) 25 1885.

Deceased Estate: Hygain, 18HT, Hytower, complete with manual, 160m coil and coax., \$150. 4 Johnson neut. cond., 2-11 pF, 11 kV, \$2 ea. 2 ceramic 829B type sockets, \$2 ea. Johnson spinner knobs — 4-1 1/2" diam., 2-1 1/2" diam., 3-2 1/4" diam., \$1.50 ea. Woden potted univ. mod. 60W trans., \$10. Collins 310-C2-PTO, 80m excit. VFO on 160m, calib. dial, \$40. Heath DX100B, mod. for xtal, comp. with manual and orig. parts, offer. 240V AC Hi v PS in cabinet, 700, 500, 450V DC, 1000V meter switched, 200m, \$40. Postage extra. VK3CP, QTHR. Ph. (03) 859 2614.

Plessey SL600 Series SSB Txcvr Board, complete with all components from crystal filter, all ICs, crystals, MD108 mixer, G3ZVC libreglass PC board etc., all assembled. This is a full 9 MHz Txcvr., measuring 5 x 3 1/2 inches, requiring only a VFO and linear amp. to make a complete transceiver for almost any frequency, circuits etc. included, \$100. VK4XT, QTHR. Ph. (074) 62 2389.

Multi-Palm II, 2m hand held Txcvr., rpts. 2, 3, 5, 8, 40 & 50, as new cond., complete with car DC lead and charger, also leather case, \$200. Osker Bloc SWR and power meter to 200 MHz, as new, \$60. Tokyo Hi-Labs HC250 antenna tuner, 80-10m, as new, \$80. Stan VK3BNJ, Ph. (03) 743 6708.

Hygain Hy-Quad Type 244 Antenna, partly assembled but never installed, as new cond., \$200 ONO, buyer to collect. VK3XY, QTHR. Ph. (03) 557 1265.

Wilson System 1, 4 el. trapped yagi on 20, 15, 10m, separate reflector on 10m, exc. performance, as new cond., \$200. Enquiries to B. Bathols VK3UV, QTHR. Ph. (03) 90 6424 evenings.

#### WANTED

Receiver 51J4, R392/URR, R392/URR, SP600JX, also transmitter KWS-1, 32V-1, 32V-2, 32V-3, or similar. VK5QO, QTHR.

MN26C Compass Receiver, circuit diagram and other relevant information, appreciate any help and gladly pay costs photostat, postage, etc. VK3AHU, QTHR. Ph. (03) 328 2282 Bus., (03) 534 4616 evenings.

Neon Type Globe NL6S, suit FLDX400 Tx. VK2NSE, QTHR.

Does anyone have conversion information, circuit diagram or service manual on a Pye Victor type MFV 529 or similar high band carphone to be used on 2m, if so I will be glad to pay any reasonable costs. Ph. (02) 73 2682 AH.

External VFO for FT75B. Price, etc., to D. Robins VK5NFB, 24 William St., Clare 5453. Ph. (08) 42 2517.

2m Meteor Scatter Skeds, suitable station would require a minimum of 100W out, to 10 dB min. aerial system (incl. coax), low noise pre-amp. in front of any commercial 2m transceiver, would need to be 1,000 to 1,800 km from Brisbane. If interested please contact Allan VK4ZRF, QTHR.

Assistance Wanted: I urgently need a good 3BPI or 3API CRO tube, happy to pay and will accept any reverse charge calls. VK3NXX, QTHR. Ph. (03) 527 4029.

Borrow copy of AR July 1971 and October 1971, or photostat of articles therein on noise bridge, will pay all copying and postage charges. VK2AJV, QTHR. Ph. (02) 46 2134.

Picture Tube, CRT 140CB4, for Sony model TV5-303E. VK3HL, QTHR. Ph. (052) 73 0488, 75 3398 AH.

Beg, Borrow or Buy: operator's or service manual for AWA oscilloscope, type IA56031. N. May L31096, Flat 7/24 Blyth St., Brunswick 3056. Ph. (03) 380 5810.

Old-Time Radio Fans: Are you a collector of old-time radio or TV programmes (either domestic or overseas)? Do you have air checks or interesting commercials from Australian or foreign sources? VK2ATJ, Box 140, Kensington, NSW 2033.

4CX250B Tubes and Sockets, HT transformer, approx. 1500V-0-1500V at 500 mA, FHJ4 helix connectors. QTHR or phone (03) 338 9284.

Rx Section of Kenwood KP202 hand-held 2m FM transceiver, parts required in particular are RF and mixer transformers in front end. VK2BDD, QTHR. Ph. (02) 529 4356.

Circuit or copy for Comm. Rx. Type, Model HCR-62, letters E.I.L. on main dial, also 3.5 MHz band-edge crystal. VK2QQ, QTHR. Ph. (02) 644 7512.

Handbooks (or copies) for freq. meters TS323/UR and BC-221-AL. Front panel "hold in" screws for BC221. VK3BFB, QTHR. Ph. (03) 93 1638.

#### TRADE HAMAD

Amidon Cores — refer ARRL Handbook. Iron powder and ferrite toroids, ferrite heads and sleeves for wideband RF amps. Large SASE for data/price list. RJ and US Imports, Box 157, Mortdale, NSW 2223.

## ADVERTISERS' INDEX

AUDIO TELEX	22
AMATEUR RADIO ACTION	13
BAIL ELECTRONICS	51
CHIRNSIDE ELECTRONICS	40
CUSTOM COMMUNICATIONS	52
CW ELECTRONICS	44
DICK SMITH ELECTRONICS	23
DINDY MARKETING	47
NSW DIVISION WIA	31
POSTAL AND TELECOMMUNICATIONS DEPT.	41
RJ AND US IMPORTS	50
SCALAR INDUSTRIES	13
SIDEBAND ELECTRONIC ENGINEERING	34
STANDARD COMPONENTS	9
VICOM PTY. LTD	2, 4, 6, 8, 29
WILLIAM WILLIS	33

# What about a change of subject?

You will have seen our adverts for Yaesu's **FT107M** and **FT707** – but we should remind you that there are many other products available from “Yaesu **The Radio**” and Bail. Take a look at this brief list.

## “Yaesu The Radio” present:

**FRG7** Receiver  **FRG7000** Receiver  **FL2100Z** Linear Amp  **FT101Z** and **FT 7B** Transceivers  **FT901D** Transceiver  **Monitor Scopes**  **External VFO's**  **Transverters**  **Ant. Couplers** to match your rig  **FT 207 R VHF** Handheld  **FT 227 RB** 2m Mobile  **FT 225 RD** 2m All Mode  **FT 625 R** 6m All Mode  **FT 220** VHF/UHF Mobile

Write or call for our brochures.

## And We stock:

Electronic Morse Keys  Morse Keyers  HF & VHF Antennas  Rotators  Cables  Mobile Antennas  Yaesu World Clock  CW/RTTY reader and **ASC11** Key Board.

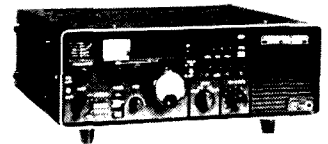

## And

### We stock Spares:

We hold an extensive inventory of spare parts for Yaesu equipment and we will service your Yaesu set.

**Service to Australian Hams  
is our Slogan.**

# bail

ELECTRONIC SERVICES

STAN ROBERTS VK3BSR

38 Faithful St., WANGARATTA 3677

Telephone: (057) 21 6260 Telex: Teletra AA 56880

**AUTHORISED DISTRIBUTORS.**

VIC.  
CHIRNSIDE ELECTRONICS (03) 7267353  
G.F.S. ELECTRONICS (03) 8733939  
IMARK (03) 3295433  
HORSHAM (053) 822271  
N.S.W.  
EMTRONICS (02) 3986378  
WAGGA (069) 212125  
QLD.  
C.W. ELECTRONICS (07) 3415377

S.A.  
GRAHAM STALLARD (08) 437981  
FARMERS RADIO (08) 2932155  
W.A.  
WILLIS ELECTRONICS (09) 3217609  
KALGOORLIE (090) 211906  
TAS.  
HOBBY ELECTRONICS (002) 436337  
J.D. ELECTRONICS (003) 445000  
BURNIE (004) 311708

*And other regional centres.*

JAS 7980-34

# CUSTOM COMMUNICATIONS

## HAM RADIO & AMATEUR GEAR

Shop 11,  
PARRAMATTA ARCADE  
Cnr. Church & Darcy Sts.,  
PARRAMATTA N.S.W. 2150

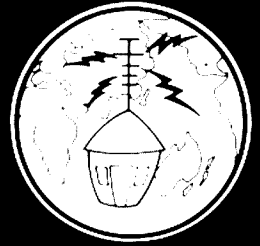

**NEW**

### TONO-DOT MATRIX PRINTER

**\$990**  
MODEL  
HC-800

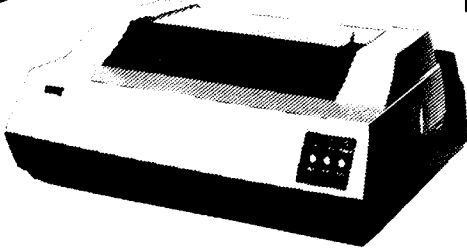

**NEW**



**ICOM IC-2A**  
SYNTHESIZED 2 MTR  
HANDHELD 800 CHANNELS  
**\$279**

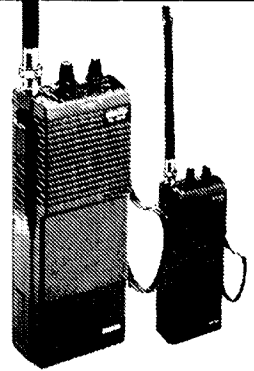

**NEW**

### AUTO-ANTENNA TUNER

CNA 1001  
200 WATT  
**\$269**  
CNA 2002  
2.5 Kw  
**\$569**

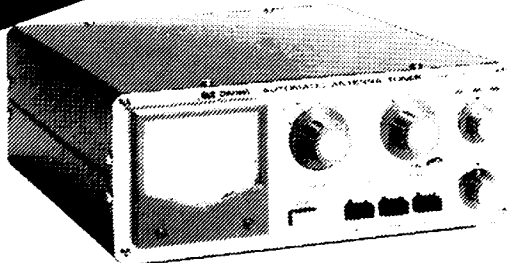

**TONO - 7000E** **\$899**  
COMMUNICATIONS COMPUTER

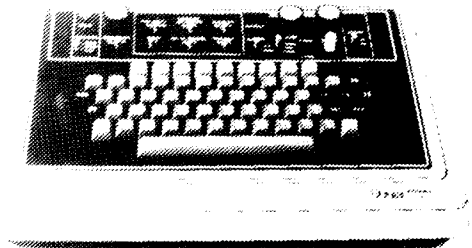

**NEW**

### SWR - BRIDGE

3.5 - 150 MHz  
**\$29**

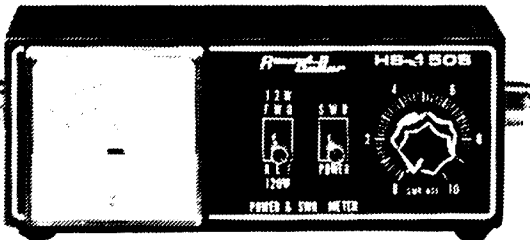

**STILL  
POPULAR**

**IC - 22S**  
LOW COST 10 w MOBILE

**\$299**

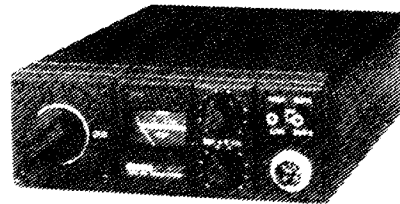

### OTHER LEADING ICOM EQUIPMENT

IC-260 2 MTR ALL MODE MOBILE ..... \$599.00  
IC-701 HF-TRANSCEIVER 160-10 MTR \$1199.00  
IC-551 6 MTR ALL MODE 100 w ..... \$859.00  
IC-251A 2 MTR ALL MODE AC/DC ..... \$847.00

... AND MANY OTHERS! CALL IN AND INSPECT

### VICOM HELICAL WHIPS AND YAGIS

10 TO 80 MTR ..... \$28.00  
5 ELEMENT YAGI 2 MTR ..... \$35.00  
10 ELEMENT YAGI 2 MTR ..... \$74.00  
16 ELEMENT YAGI 70 CM ..... \$53.00  
5 ELEMENT YAGI 6 MTR ..... \$89.00

**VICOM**

Phone: 635 6399, 635 6546, A.H.: 674 1719

# amateur radio

JOURNAL OF THE WIRELESS INSTITUTE OF AUSTRALIA



VOL. 48, No. 8

AUGUST 1980

## ***FEATURED IN THIS ISSUE:***

- ★ *How Your Favourite  $\frac{5}{8}$  W-L Antenna Doesn't Work*
- ★ *Two Metre Linear with a Difference*
- ★ *Amateur Radio for the Cruising Yachtsman — Part 2*
- ★ *John Moyle Memorial Field Day Contest, Results 1980*
- ★ *Equipment Review: The TenTec Omni D Series B Transceiver*



# ANNOUNCING A GREAT NEW CONTEST



## WIN A TRIP TO HONG KONG!

Yes! A trip to magnificent Hong Kong, with your flight and accommodation paid for!!! That's the prize in our exciting new Yaesu/Dick Smith Competition: and you could be the winner!

### OPEN TO ALL PURCHASERS OF YAESU AMATEUR GEAR FROM DICK SMITH

#### Here's how it works:

We at Dick Smith Electronics want to know what you, the amateurs of Australia want from your hobby: the amateur radio service. And we want to know how we, as a company, can serve you and Australia best for the benefit of Australia. So we're asking you to tell us, in fifty words or less. The best way that Dick Smith Electronics can promote the fantastic hobby of Amateur Radio to the benefit of Australia'

Entry to this competition is only open to purchasers of any Yaesu equipment from Dick Smith stores or authorised Dick Smith Yaesu re-sellers, between August 1, 1980, and November 1, 1980.

If you think about it, your chances of winning this trip are very, very good: the number of entries cannot be all that high - all it takes is a little originality and constructiveness of comment from you, and you could be going to Hong Kong: free!

Entries will be judged initially by a panel from Dick Smith Electronics to produce five finalists: these will be judged by Neville Williams, MIREE, Editor-in-chief of Electronics Australia magazine.

The winner will be notified by Dick Smith, and will be announced in Electronics Australia and Electronics Today International.

So if you're thinking about buying Yaesu, why not buy it in the next three months: of course, only from Dick Smith Electronics or authorised Dick Smith Yaesu re-seller!

**Remember: we're the number one supplier of Yaesu amateur gear in the Southern Hemisphere!**

#### HERE'S HOW TO ENTER: RULES AND CONDITIONS

Entries will only be accepted on the official entry form, which is available only with the purchase of any item from the Yaesu range from a Dick Smith store or a Dick Smith authorised re-seller.

All entries must show the model number and serial number of the item purchased, (if applicable), and be signed by the store manager or authorised person.

In the space provided on the entry form, write in one paragraph of not more than 50 words.

The best way that Dick Smith Electronics can promote the fantastic hobby of Amateur Radio to the benefit of Australia'

Post your entry to:

Amateur Radio Contest,  
Dick Smith Electronics  
PO Box 321,  
North Ryde, NSW, 2113.

Entries close at 5PM on Monday, 3rd November, 1980. Entries received after this date will not be considered.

Final judging will take place on 10th November, 1980. The judge's decision will be final and no correspondence will be entered into.

As this flight departs from, and returns to Sydney, the winner must travel to Sydney at his/her own expense.

All entries become the absolute property of Dick Smith Electronics Pty Ltd, who may use such entries as they see fit.

## DICK SMITH ELECTRONICS

**NSW** 125 York Street, SYDNEY Ph 290 3377  
147 Hume Highway, CHULLORA Ph 642 8922  
162 Pacific Highway, GORE HILL Ph 439 5311  
30 Gross Street, PARRAMATTA Ph 663 1133  
613 Princes Highway, BLAKEHURST Ph 546 7744  
263 Kaira Street, WOLLONGONG Ph 28 3800  
531 Pittwater Road, BROOKVALE (OPENING SOON!!)

**VIC** 399 Lonsdale Street, MELBOURNE Ph 67 9834  
656 Bridge Road, RICHMOND Ph 428 1614  
**QLD** 166 Logan Road, BURANDA Ph 391 6233  
842 Gympie Road, CHERMSIDE Ph 59 6255  
**ACT** 96 Gladstone Street, Fyshwick Ph 80 4944  
**SA** 60 Wright Street, ADELAIDE Ph 212 1962  
**WA** 414 William Street, PERTH Ph 328 6944



SHOPS OPEN 9AM to 5.30PM  
(Saturday: 9am till 12 noon)  
BRISBANE Half hour earlier.  
ANY TERMS OFFERED ARE TO APPROVED APPLICANTS ONLY  
RE-SELLERS OF DICK SMITH PRODUCTS IN MOST AREAS OF AUSTRALIA.

MAIL ORDER CENTRE: PO Box 321, NORTH RYDE NSW 2113 Ph 888 3200. PACK & POST EXTRA



# amateur radio

**AUGUST 1980**

**VOL. 48, No. 8**

**PRICE: \$1.20**

Registered Office:  
3/105 Hawthorn Road,  
Caulfield North 3161.

**EDITOR:**  
BRUCE BATHOLS\* VK3UV

**PRODUCTION MANAGER:**  
MARK STEPHENSON\* VK3NOY

**TECHNICAL EDITORS:**  
BILL RICE\* VK3ABP  
EVAN JARMAN\* VK3ANI  
RON COOK\* VK3AFW  
GIL SONES\* VK3AUI

**CONTRIBUTING EDITORS:**  
BOB ARNOLD VK3ZBB  
G. NICK NICHOLS VK6XI  
ROY HARTKOPF\* VK3A0H  
RON FISHER\* VK3OM  
ERIC JAMIESON VK5LP  
LEN POYNTER\* VK3BYE  
BILL VERRALL VK5WV  
WALLY WATKINS VK2DEW

**DRAFTING:**  
NEIL OSBORNE\* VK3YEI

**BUSINESS MANAGER:**  
PETER DODD VK3CIF

\*Member of Publications Committee

Enquiries and material to:  
The Editor,  
PO Box 150, Toorak, Vic. 3142

Copy is required by the first of each month. Acknowledgement may not be made unless specially requested. All important items should be sent by certified mail. The editor reserves the right to edit all material, including Letters to the Editor and Hamads, and reserves the right to refuse acceptance of any material, without specifying a reason. Material should be sent direct to P.O. Box 150, Toorak, Vic., 3142, by the 25th of the second month preceding publication. Phone: (03) 528 5962. Hamads should be sent direct to the same address by the 1st of the month preceding publication.

**Trade Practices Act:** It is impossible for us to ensure that advertisements submitted for publication comply with the Trade Practices Act 1974. Therefore advertisers and advertising agents will appreciate the absolute need for themselves to ensure that the provisions of the Act are complied with strictly. Readers are reminded that, when buying, obtaining or receiving goods from overseas including goods listed in advertisements by overseas organisations in this Journal, Customs import duties and Sales Tax may be levied on the goods at the time of importation. These amounts, if any, are payable by the purchaser unless the terms of sale state otherwise and the seller has made specific provision to this effect in his quotation to the buyer or unless other prior arrangements are in force between the buyer and the seller.

Typesetting: MUELLER INDUSTRIES  
1a Levanswell Road, Moorabbin, 3189  
Tel.: 553 0292

Printers: WAVERLEY OFFSET PUBLISHING GROUP  
Geddes Street, Mulgrave 3170

## CONTENTS

### TECHNICAL

Audio Activated Saturating Switch	15
A Multiband Mobile Antenna System Evolved from the Junk Box	9
How your favourite 2m $\frac{5}{8}$ Wavelength Antenna doesn't work	8
Modification of SSB 27 MHz PLL Tcvr for 10m operation	11
Two Metre Linear Amplifier with a Difference — using a QQE 03/20	16

### GENERAL

A Look at the John Moyle Memorial Field Day Contest, 1980	30
Amateur Radio for the Cruising Yachtsman — Part 2	20
Collectors' Corner No. 2 — The FRG7 Receiver	25
Do it Electrically	24
Equipment Review: The TenTec Omni D Series B Transceiver	17
John Moyle Memorial Field Day, Results, 1980	7
QSL?	45
Satellite Solar Illumination	14
She's a Beaut, Mate	23
The Emergency Net	22
Try This — Antenna Carriage for Free Standing Towers	13

### DEPARTMENTS

Afterthoughts	5
Amateur Satellites	37
Around the Trade	47
Awards Column	46
Book Review	47
Contests	45
Divisional Notes	42
Forward Bias	40
Hamads	50
Intruder Watch	46
Ionospheric Predictions	44
International News	42
Letters to the Editor	48
Magazine Review	43
Main QSP	5
Novice Notes	32
Obituary	48
QRK5	40
QSP	5, 43, 47
RTTY News	48
Silent Keys	49
Spotlight on SWLing	38
VHF-UHF — an expanding world	34
WIANEWS	7
YOU and DX	44

ADVERTISERS' INDEX 50

## Cover Photo



Pictured this month is Peter VK3BEJ, President of the Mildura Amateur Radio Club. The Club is active in the Sunraysia District and also enthusiastically participates in WICEN exercises as far afield as the Wimmera. Amateurs contemplating a trip to the Mildura district will be heartily welcomed by the friendly amateurs like Peter.



# GOOD GEAR FROM TONO!

## THETA 7000E COMMUNICATIONS COMPUTER

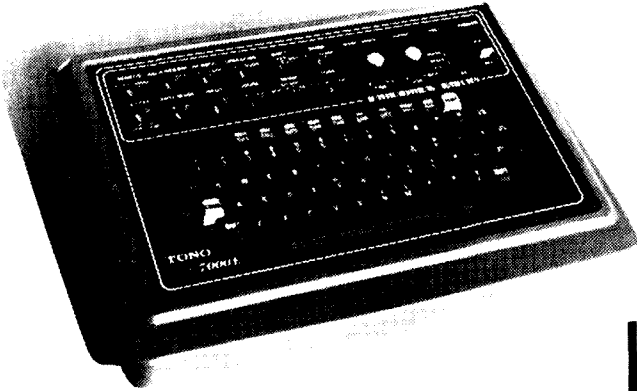

- Just connect to any TV set
- Provides send/receive for CW, RTTY and ACSII.
- Stacks of features
- Receive commercial CW and RTTY news bulletins

STILL ONLY \$899 cat 7000E

**NEW!**

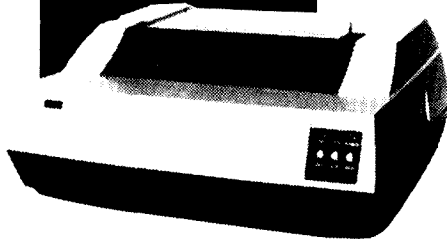

### HC800 DOT MATRIX PRINTER

- 125 cps, 9 x 7 dots
- Bidirectional
- Interfaces with 7000E or Theta 350

PRICE \$999 cat. HC800

**TONO**

**NEW!**

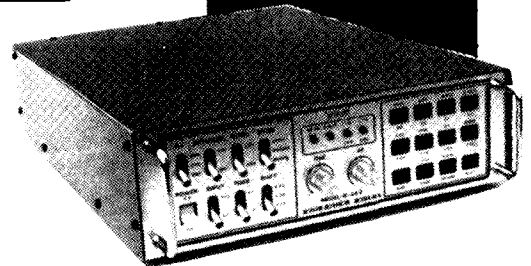

### THETA 350 RECEIVE ONLY TERMINAL

- RTTY, CW and ASCII
- Video output for connection to TV set

\$599 introductory price

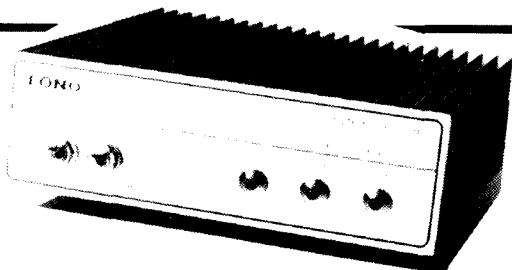

### 2M 90 WATT LINEAR MODEL MR900E

- FM/SSB/CW/RTTY
- Inbuilt 13dB receiver preamp
- Output 80-90W, input 10-15W
- Current 7-8A

PRICE \$289



### 2M 130 WATT LINEAR MODEL MR1300E

- FM/SSB/CW/RTTY
- Inbuilt 13dB receiver preamp
- Output 120-130W, input 10-15W
- Current 10-11A

PRICE \$350

**VICOM**

SYDNEY: 339 Pacific Hwy, Crows Nest Ph. 436 2766  
MELBOURNE: 68 Eastern Rd., Sth. Melbourne Ph. 699 6700

AVAILABLE AT MOST  
GOOD HAM STORES

How often do you hear amateurs complaining about some aspect of our hobby or knocking the work being done by others?

Amateurs, it has been said, are amongst the world's greatest moaners; I prefer to think not!

The very nature of our hobby is such that our views can be easily communicated to others albeit as a "knee jerk" reaction perhaps to an ill-informed comment by another.

It is disturbing enough to overhear two amateurs debating an issue based on a false premise. It is even more disturbing to hear an amateur, who is a member of the WIA and therefore should be better informed, leading a number of fellow amateurs up the proverbial "garden path".

Keeping up to date with Institute activities and policy can be a time-consuming task. Our hobby is a most complex one requiring on the individual's part a knowledge of technical, operating and regulatory matters together with an overview of international aspects.

The Institute, since its inception, has been involved (if not the initiator) in most facets of our hobby, both national and international. By way of example, I have picked at random some of the matters dealt with by your Federal Council over the past three years:

- Novice extension to 80 metres
- Beacon licensing conditions
- P. and T. liaison
- FM repeater licence conditions
- 70 cm band plan
- Channels 0 and 5A
- WARC 79
- CB effect on the amateur radio service
- Handbook revision
- Examinations
- Intruders in our bands
- Amateur Advisory Committees
- Amateur Radio magazine
- Electromagnetic compatibility
- WIA broadcasts
- Microwaves
- Customs duties
- Video tapes for use by clubs and others
- Long term plans for amateur radio in Australia

This is by no means a comprehensive list — the point is that the Institute is involved in a diverse range of matters. A glance at the list of names in the Federal directory will verify this and this list does not include the many amateurs involved at the Divisional level.

How, you might ask, can you keep up to date? Ideally by becoming involved. This of course is not always possible, in which case I would recommend that you remember the following:—

1. A precis report of the Federal Convention proceedings is published each year in AR — usually the July issue.
2. Read WIANEWS and QSP in AR each month.
3. Buy yourself a copy of the new P. and T. Regulations Handbook and bring yourself up to date.
4. Remember the Call Book contains a lot of additional information, including band plans, beacon and repeater licence listing, awards, etc.
5. Listen to your Divisional weekly broadcasts for the latest news and happenings.

You can see that, as a member of the Institute, you should be fully informed and, further, you should be in a position to help others — especially newcomers. Please do not be associated with the following quotation made by an American novelist, Jack Kerouac — "I have nothing to offer anybody except my own confusion".

73

P. A. WOLFENDEN VK3ZPA/NIB,  
Federal President. ■

# QSP —

## ARE YOU A MINE OF

# M I S I N F O R M A T I O N

# ?

## AFTERTHOUGHTS

For those contemplating building the "Spectrum Scanner" — by Winston Nickols (page 11, June AR), Murphy advises the following:

1. A 12 volt rail supplies the "low-band — high-band" switch and the output from the switch is applied to the tuner — not as shown.
2. The P.U.T. is a BRY39 — not as shown. ■

## QSP

### 10 MHz BAND

"Amateur Radio's new 10 MHz band should be limited to CW only the IARU R1 Executive Committee agreed at its London meeting, to provide minimum utilization of the shared 50 kHz allocation when it becomes available January 1, 1982. Strong support for an all CW '30 metre' band has also been registered by US amateurs who have written ARRL headquarters on the subject, with only a small minority advocating setting aside sub-bands for other modes."—Ham Radio, April 1980. ■

### REPEATERS

There are now over 110 licensed repeater stations in the U.K., Rad. Comm., April '80. The RSGB is the licensee of all the U.K. repeater stations and is responsible to the licensing authority for all aspects of repeater licensing and operation. ■

### EXAM STATISTICS ELSEWHERE

Radio ZS of Jan. '80 reports receiving advice from their licensing administration about the November 1979 examination. There were 649 applications and 514 sat the exam of whom 45.14% passed, the highest aggregate being 87.5% pass rate and the lowest 5%. The Institute is still trying to obtain something similar for Australia. ■

FM...SSB...CW...

# ICOM Does it All!



 **ICOM**

## ICOM IC-260A

Enjoy VHF mobile at its best, Sideband, FM or CW, the ICOM IC-260A does it all. The ICOM IC-260A contains all the features a mobile operator would want in a compact 2 metre mobile package with FM, SSB, CW operation. Features customers ask for most including:

- 3 memories built in (quick access to your favorite frequencies).
- Memory scan - automatically stops on an active frequency programmed in the memories.
- Programmable band scan - scan the whole band or any portion of it you desire (adjustable scanning speed).

- Squelch on SSB. the 260A will automatically and silently scan the SSB portion of the band seeking out the SSB activity on 2.
- 600KHz repeat... offset built in. Easy repeater operation on the FM portion of the band.
- Your new IC260A includes NB, CW break-in, CW monitor, APC and many other circuits for your convenience.
- Multimode operation - USB, LSB, CW, and FM. Great for getting into OSCAR, plus enjoying SSB rag chewing as well as repeater operation.
- Backed by 90 day VICOM

technical/spares support.

The RF amplifier and first mixer circuits using FETs, and other circuits provide excellent Cross Modulation and Intermodulation characteristics. The IC-260A has excellent sensitivity demanded especially for mobile operation, high stability, and with Crystal Filters having high shape factors, exceptional selectivity.

The transmitter uses a balanced mixer in a single conversion system, a band-pass filter and high performance low-pass filter. This system provides distortion-free signals with a minimum spurious radiation level.

**GIVE YOUR VICOM  
DEALER A CALL TODAY**

Distributed by VICOM

SYDNEY: 339 Pacific Hwy,  
Crows Nest. Ph. 436 2766  
MELBOURNE: 68 Eastern Rd.,  
Sth. Melb. Ph. 699 6700

**VICOM**

VICOM gear is available from  
most reputable dealers!

# WIANEWS

Licence fees are up from 1st July — full and limited from \$12 to \$15, novices from \$6 to \$10. In case you missed this news item on broadcasts, etc.

The Executive carried out a feasibility study of issuing the 1981 Call Book to all members and decided this was not feasible. The possibility of the Federal dues for 1981 being increased for this reason therefore falls away. The Publications Committee strongly favoured 12 issues of AR each year and this was accepted by Executive.

At an Executive meeting on 19th June Mr. Bill Roper VK3ARZ accepted nomination to fill the vacant position on the Executive in abeyance from the 1980 Federal Convention. It was reported that the VHFAC were preparing a draft band plan for 23 cm so that it can be published for comments.

The Executive supported the efforts being made by the Federal Awards Manager to untangle the situation relating to the VK0RM contacts made from Heard Island.

An incident was reported in Victoria late in June when a licensed amateur was said to have replayed a video recording of a commercial TV programme over an ATV repeater.

In Victoria it is observed that novice licences in the suffix series PAA-PZZ are being issued. ■

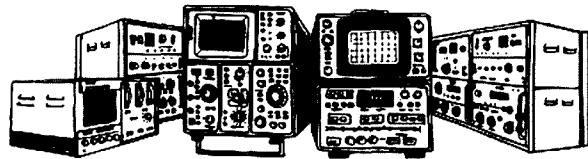

## SERVICE PROBLEMS?

Suffer no more — contact the experts:

### GFS ELECTRONIC IMPORTS

15 McKeon Road,  
Mitcham, Vic. 3132  
Phone (03) 873 3939

Because we have many years experience in the Communications Service Industry, encompassing the CB, AMATEUR and COMMERCIAL sectors we are able to offer you the best service that your set deserves at a realistic price.

Call and discuss your problems with our experts.

## John Moyle Memorial Field Day Contest, Results 1980

### 24 HOUR DIVISION

#### Section (A): Portable Field Station Transmitting Phone.

VK5CCT	5481	VK3APZ	431
VK4NFU	2638	VK4VX	420
VK3NZM	2422	VK4AAQ	420
VK2VNP	1910	VK4ADB	420
VK4XZ	1390	VK4ARH	420
VK5NNC	1309	VK4NDX	360
VK6TJ	1109	VK4NHS	360
VK2BDT	594	VK5ABS	202
VK5NTV	456	VK4NLV	80
VK4AHO	440	VK4NDW	60

#### Section (B): Portable Field Station Transmitting CW.

VK5ZE 544

#### Section (C): Portable Field Station Transmitting Open.

VK5OR 2272

#### Section (D): Portable Field Station Tx Phone Multi-operator.

VK4WIZ	12321	VK1ACA	3190
VK2MB	7690	VK5ACE	2861
VK3BGG	5008	VK5LZ	2758
VK4ARZ	4025	VK5PP	1931
VK4WIP	3893	VK4WIM	1919
VK3BML	3501	VK2BNR	997
VK3XK	3230		

#### Section (E): Portable Field Station Tx Open Multi-operator.

VK3ATL	17046	VK4WIT	5701
VK3APC	11936	VK5SR	5368
VK2DBK	10070	VK7NB	3055
VK2WG	9650	VK3AWS	3028
VK3ATM	9580	VK5VE	2945
VK3ANR	9437	VK5WC	2899
VK6DA	6068	VK5ARC	2512

#### Section (F): VHF Portable Field or Mobile Station Tx.

VK3XQ	2214	VK4ZRQ	300
VK3ZJS	1504	VK2DBA	74
VK2BNR	398	VK1LF	66

#### Section (G): Home Transmitting Stations.

VK3XB	1850	VK3AEW	1260
VK3KS	1405	VK7NFR	255

#### Section (H): Receiving Portable or Mobile Stations.

L40804	Nancy Heaton	1475
L40018	Charles Thorpe	495

### 8 HOUR DIVISION

#### Section (A): Portable Field Station Transmitting Phone.

VK3VKZ	1335	VK4NBW	506
VK2BTZ	1152	VK3AKJ	435
VK3SP	1022	VK2DCW	379
VK5MX	1009	VK3YRP	320
VK1RP	929	VK2BUT	307
VK5AIM	859	VK5NEB	215
VK2VWH	690	VK2NMK	200
VK3HE	678		

#### Section (B): Portable Field Station Transmitting CW.

VK3TX 558 VK2JM 504

#### Section (C): Portable Field Station Transmitting Open.

VK2EL	1249	VK2VUT	569
VK4UX	916	VK3VF	509
VK1DL	820	VK2GT	250

#### Section (D): Portable Field Station Tx Phone Multi-operator.

VK4WIN	3152	VK4NLX	1161
VK3ATO	2392	VK3BRL	1157
VK3BTH	1980	VK3CAU	936
VK5KR	1675	VK2BSU	518

#### Section (E): Portable Field Station Tx Open Multi-operator.

VK3ABP 1608

#### Section (F): VHF Portable Field or Mobile Station Tx.

VK3AVJ	648	VK2EL	94
VK3YIW	576	VK2ZQC	40

#### Section (G): Home Transmitting Stations.

VK3ZI	645	VK4VOJ	160
VK5OU	600	VK2YGL	120
VK2BQS	560	VK4VCE	45
VK4LT	455		

#### Section (H): Receiving Portable or Mobile Stations.

L60036	P. K. Dean	1077
L50505	Robert Dayman	460
L30042	Eric Trebilcock	260

Check log from VK1CC.

### RESULTS OF THE 1979-80 ROSS HULL MEMORIAL CONTEST

Outright winner of the trophy is Ray Naughton VK3ATN.

#### Section (A): Transmitting Phone.

Call Sign	7 Day	48 Hour
VK2BYX	1244*	604
VK2BYX	720	316*
VK2BQN	578	284
VK2HZ	602	246
VK2YEP	238	80
VK3ATN	3320	1402
VK3YLD	1214	392*
VK3AUI	900	383
VK4DO	2242*	768
VK4ZNG	1719	724*
VK4ZTV	596	262
VK4ZCO	264	84
VK5LP	944*	442
VK6OX	422*	152

\* After a score denotes a certificate winner. ■

# How Your Favourite 2m $\frac{5}{8}$ W-L Aerial doesn't work

Rodney Champness VK3UG  
31 Helms Court, Benalla, 3672

Having firmly kicked that sacred cow, the  $\frac{5}{8}$  wave aerial, saying that it doesn't work, I had better come up with some good hard facts, or expect to be excommunicated by all its believers. Until about 12 to 18 months ago, I too had been a firm believer in the statement that a  $\frac{5}{8}$  aerial had a gain of 3 dB over a  $\frac{1}{4}$  wave. Well, it does have a gain of 3 dB over a  $\frac{1}{4}$  wave, but not often in the direction that you want it to have this gain — and this is the crux of the story.

I have become most interested in aerials and getting the best performance out of them. I decided to do some experiments with vertically polarised 2 metre ground-plane aerials. I made up a quarter wave groundplane radial system and placed a mobile aerial base in the centre of it so that I could quickly connect and disconnect the aerials that I was about to try. The radials were at 90 degrees to one another and horizontal. The aerial base was connected by a short length of coaxial cable to a detector circuit as shown in Fig. 1. The output from this goes to a sensitive multimeter with several dB ranges marked on the meter face. The aerial base was mounted at a height of about 2 metres on a pole.

A signal source of about 10 watts was set up on a frequency of about 146.3 MHz (one not in use) at a distance of a few wavelengths from this test aerial. The signal source fed a  $\frac{1}{4}$  wave aerial although possibly a more directional aerial at the signal source may have made the job easier. The transmitter was placed on air and suitable identification used as per P. and T. requirements.

With the  $\frac{1}{4}$  wave aerial attached to the groundplane, it was tuned for maximum reading on the dB meter. This was then considered 0 dB or reference. The radials were then bent down to obtain a better match and at 45 degrees droop the gain had risen to +1 dB, and the  $\frac{1}{4}$  wave was also probably better matched into the 50 ohm cable. The next experiments was to tune up the  $\frac{5}{8}$  aerial on the same ground-plane with drooping radials. The maximum gain was -1 dB (????). I then tried my Hustler CG-144 aerial which is a rather large monster being over 2 metres long. I was able to obtain a gain of +4 dB, not the 5.2 dB that the literature would have you believe.

I now tried tilting the various aerials towards and away from the signal source and obtained some interesting results. The  $\frac{1}{4}$  wave stayed much the same in performance with moderate tilt and then dropped off with increasing tilt. The Hustler immediately dropped off when tilted towards the signal source but did show a

1 dB rise in performance when tilted about 10 degrees away from the signal source. The  $\frac{5}{8}$  showed a further drop when tilted away from the signal source but came up to between +2 and +3 dB when tilted about 30 degrees towards the signal source.

So now it is obvious what is happening, the  $\frac{5}{8}$  aerial used on a  $\frac{1}{4}$  wave ground-plane does not have its radiation along the horizon but at an angle of 30 degrees ABOVE the horizon. This finding has not been mine alone. In fact at about the time I was doing these experiments I read an article in Practical Wireless for April 1978 by F. C. Judd G2BCX on the "Slim Jim" 2 metre aerial. I would commend this article to you. The "Slim Jim" appears to have a quite reasonable following who are very happy with its performance. I didn't have a "Slim Jim" made at the time of these experiments so no comparison has been made. Naturally the  $\frac{5}{8}$  aerial would be quite a good performer if you live in a valley with hills all around and the stations you wish to work are high up or over the hills. It is also suitable if you tilt it to work as a one element beam with a few dB of directivity.

The tests above were repeated using a weak signal source a couple of kilometres away. This time the detector was my receiver with a Hewlett-Packard 1 dB per step attenuator in the aerial line. The system was set up with the S meter reading a convenient level with the attenuator set to about half attenuation. The test aerial base this time was above the house. The  $\frac{1}{4}$  wave,  $\frac{5}{8}$  and Hustler CG-144 were tried alternatively using only the drooping radial system. Using the  $\frac{1}{4}$  wave with droopy radials as the 0 dB standard, the Hustler gave +3 dB and the  $\frac{5}{8}$  -3 dB. Comparing the  $\frac{1}{4}$  wave with horizontal radials these would have been Hustler +4 dB and  $\frac{5}{8}$  -2 dB. Once again the  $\frac{5}{8}$  did not show up at all well; the Hustler was consistent with previously measured figures.

The next series of tests were conducted in a similar manner with the aerials mounted on top of a car with the base mounted through the centre of the roof. These were line of sight tests (nominally),

in other words the whole of each aerial was above any surrounding obstructions. The  $\frac{1}{4}$  wave was again used as 0 dB reference, the Hustler gave +4 dB (consistent with previous measurements) and the  $\frac{5}{8}$  aerial gave +1 dB, which is an improvement over previous measurements. You might ask why the  $\frac{5}{8}$  showed this improvement in this case. The reason is that the aerial has a much larger ground-plane. The groundplane size for a  $\frac{5}{8}$  to work with a low angle of radiation is at least a  $\frac{1}{2}$  wavelength radius; I suspect it is larger. Information on this is contained in the excellent book "The Amateur Radio Vertical Antenna Handbook" by Captain Paul Lee K6TS (published by COWAN, a "CQ" Technical Series). I would also commend for your reading September 1979 AR, the equipment review on a UHF aerial and the comments on mounting aerials, page 16.

Many will say that their  $\frac{5}{8}$  aerials work better than a  $\frac{1}{4}$  wave and no doubt some do. I suspect the reason for this is that the aerial is physically higher than the  $\frac{1}{4}$  wave when mounted on a vehicle, and this applies to the Hustler even more so as the tip of this aerial is about 3.6 metres above ground level on my vehicle. As the height of the aerial is increased it will naturally clear more of the surrounding fences, people, and other low obstructions which attenuate the signal, so this in many cases is how the  $\frac{5}{8}$  and the Hustler get their apparent gain figures which exceed pure line of sight figures. With the  $\frac{1}{4}$  wave (its tip height on my vehicle being 1.8 metres) the radio horizon is 5.5 km away and for the 3.6 metre aerial tip height the radio horizon is 7.7 km away, under smooth earth conditions.

A few other problems also rear their ugly heads for the mobile operator to contend with; the main one is bending of the aerial with speed. The aerial when bent back will have its radiation pattern altered; in the case of the  $\frac{5}{8}$  behind-the-car performance will be enhanced, and in front seriously degraded. With the Hustler the reverse happens, and with the  $\frac{1}{4}$  wave being so small and rigid with a fairly broad doughnut shaped radiation pattern no

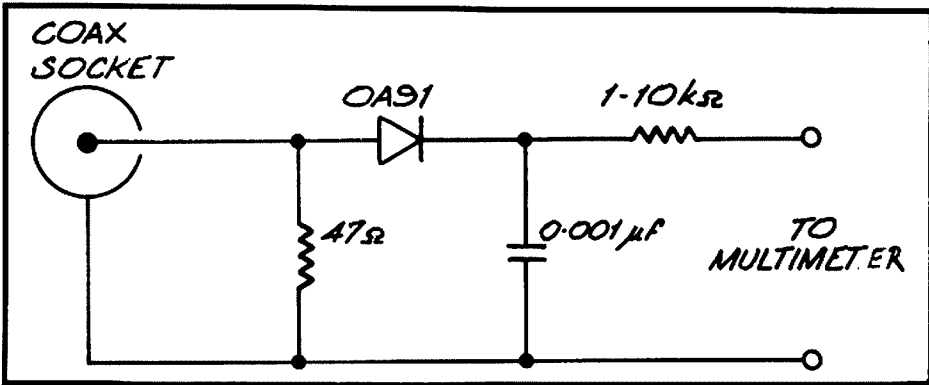

FIG. 1: Mount resistor, diode capacitor on the coax socket with minimal lead length.

variation is usually noted. How do we overcome these problems? We make the aerial as rigid as possible so that it stands up straight. This can be achieved at least in part by tying nylon fishing line to the aerial a fair way up and anchoring it to the vehicle guttering near the windscreen. You will have to make your own decisions on how to stop the line slipping on the aerial but perhaps insulation tape would do it. This will tend to stop some of the flutter that mobile signals often have, although just movement of the aerial isn't the only story. During my experiments I flicked the whips around and found that moving the 1/4 wave about had very little effect on the gain figures obtained, the Hustler varied a bit and the reading for the

1/4 fluctuated violently even when the aerial was only flexing a few centimetres at the tip. I might add I use either a 1/4 wave or the Hustler CG-144 when mobile. If I want extra range I use the Hustler. The mounting of your aerial on the vehicle is important; it is to me as I work repeaters usually at the limit of their range. Aerials mounted on gutter mounts or on ski-bars or mudguards rarely work efficiently, for a simple reason—they don't have effective groundplanes. The ski-bar mount can, however, be made to work quite efficiently comparatively speaking. The ski-bar mounting is improved markedly by putting two 51 cm radials pointing fore and aft from the aerial base on the ski-bar. Slope them downwards but clearing

the roof and the aerial should work considerably better. Unfortunately it doesn't look very attractive and your wife may dislike this. Another thing that often causes mobile reception to be poorer than it might be is the ignition and other noise generated by the vehicle. Suppression methods described in articles in AR for January and March 1975, July 1976, February 1977 and April 1978 will help with this problem. Don't get the idea that FM transmissions are not affected by ignition interference—they are and your effective communications range can be reduced by up to 50 per cent. Good luck and effective mobileing.

**COMMENT**  
For central roof mountings on medium-sized station wagons careful tests made by Lew VK1ZLW and myself showed that the 1/4 had a gain of about 4 dB with respect to a 1/2 wave. We also confirmed that a 1/2 wave vertical was 3 dB better than the 1/4 wave, and that its performance was essentially independent of the groundplane. A gutter mounting was as effective as central mounting. Radials are very efficient in preventing RF current flow along the outside of the coaxial line, an event that can make the antenna almost useless. Bending the radials of a groundplane to provide a match for the 1/4 wave would put them in a less than optimum position for the 1/4. As the bottom of the Hustler CG-144 is an end fed 1/2 wave it should be less dependent on the groundplane than either the 1/4 wave or the 1/2.—VK3AFW. ■

# A Multi-Band Mobile Antenna System evolved from the Junk Box

I received delivery of a bargain-priced Yaesu FT-7 transceiver just prior to going north in my Ford Transit Campervan on holiday in June 1979. I looked around for some quick way to install the unit and FL-110 companion amplifier in the vehicle and provide it with some form of mobile aerial system capable of working most HF bands.

N. Chivers VK2YO  
51 Meeks Grove, Faulconbridge, 2776

Being in possession of one of those six feet long fibreglass car radio whips and mudguard mount I decided to try it out on HF with a home made antenna matching device that I use with a long wire at the QTH. This combination worked well enough to provide contact on most days at lunch-time on 40 metres from wherever we were in Queensland back home to the Blue Mountains of NSW with my first harmonic VK2AVW operating from that end, and at other times on 20, 15 and 10 to various parts of the world.

However it soon became apparent that, although the antenna matching device was effective, its physical size mounted against the firewall near the passenger's feet (XYL) became a source of annoyance because of the foot-capacity effect detuning (same as hand-capacity but the other end), which on transmit invited a zap to the XYL's big toe with consequent rise in SWR and operation of the FL-110 amplifier's automatic final protection circuit! This situation could only be suffered until I arrived back home. What to do then? Why, formulate specifications of course.

1. Total enclosure of transmatch device in a metal box (saves zap to XYL's toes or anything else for that matter). □
2. Ease of adjustment with one control on all bands (the home-brew transmatch has three controls so four hands are needed on tune up). □
3. Able to handle full power SSB from FL-110 without flashing over. □
4. Small as possible physically.

There are many possible combinations of inductance and capacitance which when connected together will match a short vertical radiator to the transmitter with minimum SWR on most HF bands. I set out with a roller inductor and various combinations of variable capacitors to assess what circuit would suit the present requirements. I ended up with Fig. 1.

This circuit must have appeared in just about every radio magazine since Marconi! So much for my original scientific experiments.

Okay, so evolution has narrowed the controls down to two. I found that with the capacitor set at one particular position, adjustment of the roller inductor alone could be made to resonate the circuit on 40m, 20m, 15m and 10m. So I lifted out the variable capacitor and measured it on my home-brew bridge. It turned out to be near enough to 100 pF. In went one fixed 100 pF, 1000V ceramic and the controls were down to one. Now to miniaturise the roller inductor and we might get something practical after all. A smaller tapped and switched coil was tried but without success. It became apparent that something infinitely variable was needed in the inductance department, but what?

While rummaging through assorted junk accumulated under the bench over the years, I came across a box containing some power rheostats of various size and resistance. Now these things I remembered show considerable inductance and 3 or 4 were tried in place of the roller inductor. I finally settled on one branded IRC wire-wound 25 watt, 50 ohms. There must be hundreds of these sitting around in junk boxes just waiting to be used in a project such as this. The wire-wound element is wound over a composition strip in a semi-circle inside the body of the rheostat, so if the one you come across has too high a resistance (too fine a wire) it should be a simple matter to replace the fine wire with something a bit thicker (and preferably of copper!—Tech. Ed.).

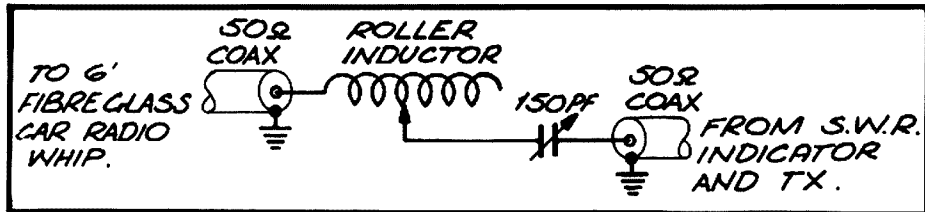

**FIGURE 1:**  
Combining inductance and capacitance to enable matching of a short vertical radiator.

Well that turned out very nicely, now what to put in it? As usual, the junk box came to the rescue again, by way of one oil-filled capacitor of WW2 vintage, which when relieved of its innards left a metal box about 4 in. x 2 in. x 2 in.; just the thing to mount the components in. So there it is mounted under the dash of the Transit Van. Beside the FT-7, with just one adjustment knob out front to match the 6 ft. fibreglass whip to the FT-7 with minimum indicated SWR on 40m through 10m.

Now your next question naturally is "how does it go on 80m?", and my answer is "hopeless!". 6 ft. of whip appears to be physically too short to work efficiently on 80m; but don't worry, if you pull up in a caravan park or rest area, clip a length of wire (every amateur carries some on holiday) to the base of the antenna and run it out horizontal to the nearest tree branch, fence post or what have you, and tune it up with the little "VK2YO" under-dash tuner. I was surprised how well it worked at night, even with the FT-7 barefoot from such localities as Coonabarabran and Noosa Beach. If you can run out about 66 ft. (20m) in length (even if it is not in a straight line) that will work on 80m quite well.

How does the 6 ft. fibreglass BC antenna and tuner compare with a helical, centre-loaded or base-resonated mobile whip? On a cost basis very well, as only one broadcast fibreglass whip is required for 4 band operation (the tuner cost nothing), and being a common sight on vehicles these days would not attract the attention of thieves. On an efficiency basis, I haven't got a clue, as I don't possess any other types of mobile or portable aerials to compare it with; and if I had I probably would not have gone to all this trouble in the first place! This project is a good example of the old axiom, necessity is the mother of invention; or if you keep something in that junk box long enough you will find a use for it!

And this is how it all ended up (Fig. 2).

I next plan to affix a wire to the perimeter of the pop-up fibreglass roof section of the Camper Van and tune that. If it goes okay can you imagine the cost saving in mobile whips that would represent? All anyone would have to do is buy a mobile antenna mount trade-named Kombi Campa or such like for X thousand dollars, and you would save at least \$100 in mobile HF helicals. But don't go out and buy one of these Kombi mobile antenna mounts yet; wait and see if my idea works first.

(Note: Our first inclination was to publish this article in the April issue without comment, but the scheme does have some merit. The SWR would be low using an unmodified 50 ohm potentiometer, but so would the efficiency! With the potentiometer rewound with copper wire, and minimal coax length to the antenna, the system may well be usable.—Tech. Ed.)

**FIGURE 2 (below):** The end results.

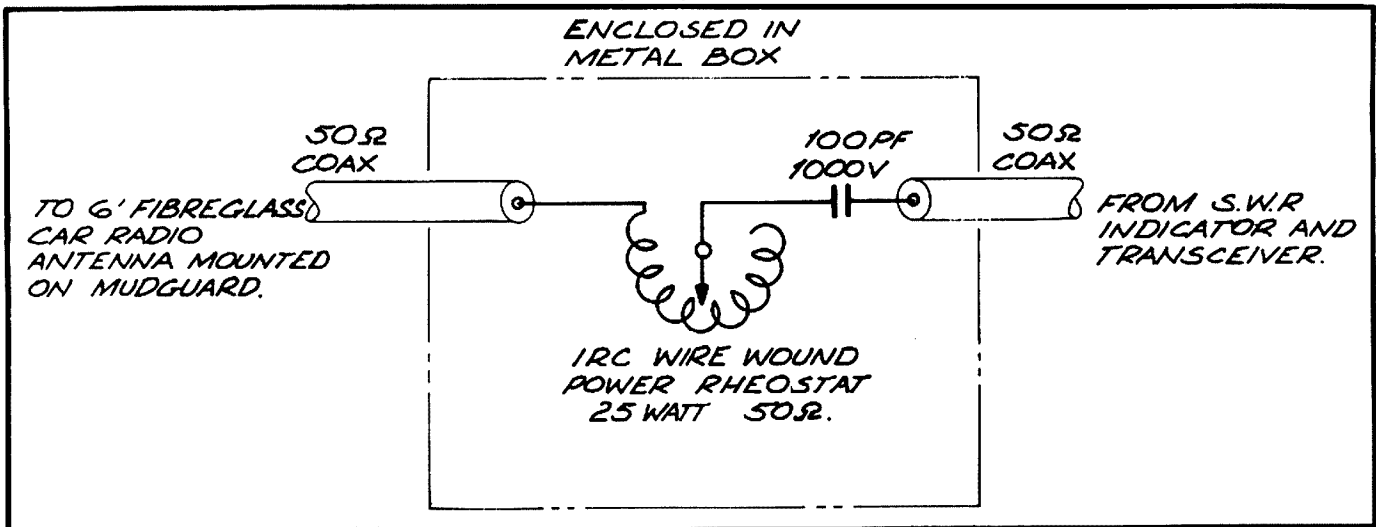

# Modification of SSB 27 MHz PLL Tcvr for 10 m Operation

G. T. Ryan VK4AR

This article discusses the modification of the CYBERNET range of transceivers utilising the PLL02A phase-locked loop integrated circuit. Such sets include Super-Panther, Super Bengal, Appollo and Karinna.

The resulting changes allow operation with a 5 kHz channel spacing, almost to its limit frequency of 29515 kHz (see Tech. Ed. note). when using the existing channel selector and additional switches. While this may appear cumbersome, it does allow the modification to be simple and effected in a couple of hours.

In order to gain some knowledge from this modification additional information is included for your reference. The heart of the PLL circuit (PLL02A) is identical to a Motorola integrated circuit type MC145109. The pinout and internal block diagram is shown in Fig. 1.

## PIN DESCRIPTION

### Pin 15-7 P0-P8

Programmable divider inputs (Binary) which can set the division ratio ( $\div N$ ) between 2 and 511. This allows 510 channels with the highest frequency being 29.515 MHz (see Tech. Ed note). Internal pull-down resistors place logic zero on unused programme pins.

### Pin 2 VCOin

Frequency input, to the programmable divider, which is derived from the VCO after being mixed with the heterodyne crystal.

### Pin 3 REF-OSCin

Frequency input fed from the 10.240 MHz reference oscillator.

### Pin 4 5 kHz/10 kHz

Placing an earth on pin 4 sets the reference divider to  $\div 2$  and correspondingly divides the 10.24 MHz input to the required 5 kHz reference frequency.

## Pin 5 DET OUT

This output voltage (DC) is for control of the external VCO frequency. Output voltage

goes high when  $\frac{F/vco}{N}$  is less than Fref.

The output goes low when  $\frac{F/vco}{N}$  is

greater than Fref which will be set to 5 kHz during the modification.

## Pin 6 LOCK DET

This voltage goes low when PLL is in the unlocked state (e.g. during channel change) and mutes the transmitter to prevent radiation of an undesired frequency.

As seen in Fig. 2 the configuration is different from that found in the popular 2 metre synthesised rigs. In this instance the VCO frequency is mixed with twice the heterodyne crystal frequency and the sum is fed to the transmitter and receiver mixers, while the difference is the VCO derived frequency fed to the programmable divider input. This derived frequency is highest at the lowest frequency while decreasing to 10 kHz (5 kHz reference) at the highest operating frequency (29515 kHz — see Tech. Ed. note).

## MODIFICATIONS

The modifications have been performed on a 23 channel Super-Bengal (Base Station), which vary from the mobile units in that a power supply is included and the channel selector is removed from the master circuit board and connected to it via a wiring form. When using either an

18, 23 or 40 channel switch certain frequencies will be missed because the switches were originally designed for the Citizen Band in which some frequencies are allocated for other services. Additional switches can be added to fill in the gaps left by the channel selector. Two stages of modification are described: (a) 10 kHz channelling, and (b) 5 kHz channelling.

## Careful

The PLL02A is a CMOS device and may be destroyed due to carelessness. During modification ensure that the soldering iron is earthed and that the transceiver is not terminated to any power supply or other equipment.

## Step 1

Pin 8 to be left open circuit by cutting the printed circuit tracks. The internal Pull-Down resistors place Pin 8 at earth potential.

## Step 2

Pin 9 and 10 are to be connected to additional switches after cutting the printed circuit.

The NB lead is left open circuit to allow continuous NB operation which does not affect normal receiver performance. The PA/CB switch wiring is reconnected to allow CB operation only. The four combinations of these two switches and the channel selector in 4 x 320 kHz segments enables operation from approximately 28.245 MHz to 29.5 MHz (see Tech. Ed. note).

## Step 3

Replace L2 (6.8 uH) with a 2.2k 1/4W resistor if the VCO will not lock when frequencies above about 28.8 MHz are selected. Operation around 28.6 MHz will be normal without the above change (see Tech. Ed. note).

## Step 4

After the above changes connect to a power source and place a high impedance DC voltmeter (20k ohm/volt or more) between TP1 and the negative supply terminal to measure the VCO control voltage. Careful adjustment of the VCO slug should alter the reading and it is suggested that at the lowest frequency setting the slug be adjusted for a reading of +4.8 volts. When the highest frequency is selected the control voltage should not fall

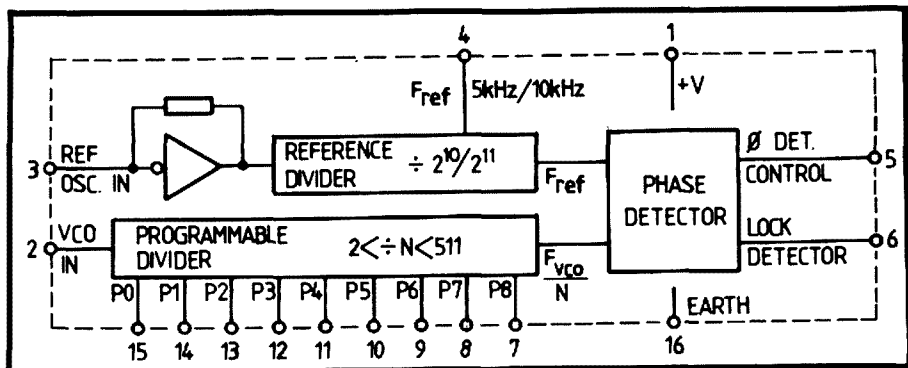

FIGURE 1: Phase locked loop MC145109 (PLL02A).



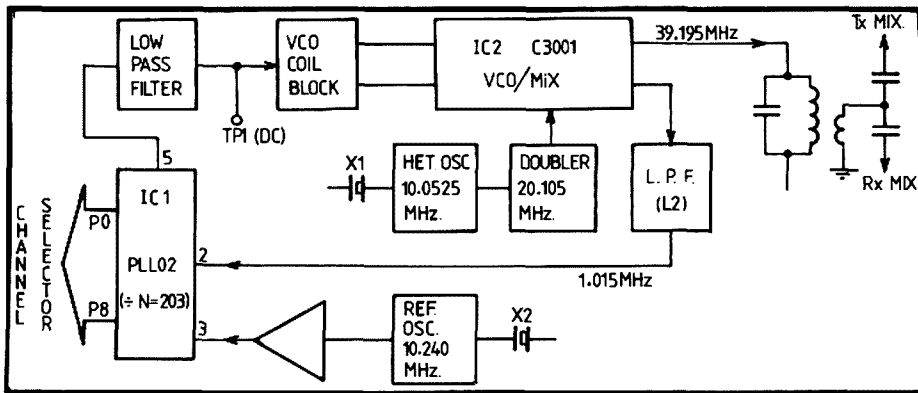

FIGURE 2: PLL block diagram — 28.5 MHz selected.

to zero! In between frequencies will correspond to a control voltage between the above readings.

**Step 5**  
Align the receiver and transmitter tuned circuits (see Fig. 6).

**Step 6**  
Some in-between frequencies missed by the channel selector may be gained with the use of a three position switch connected between Pin 15 and the channel selector as shown in Fig. 4.

This switch can allow either an increase or a decrease in frequency by 10 kHz, depending on the channel selector position and its corresponding logic (Binary) code.

#### 5 kHz CHANNELLING

This is a more complex operation, but the added advantage of a switch to select a frequency 5 kHz down from that on the channel selector will prove to be a great asset.

**Step 1**  
Earth Pin 4.

**Step 2**  
Cut the printed circuit going to Pin 9 and Pin 8 and take to the switches as in the 10 kHz version (Step 2).

**Step 3**  
Now the complex and almost confusing part. The involved process is dependant on whether your set is a mobile or base station as the terminations of the channel selector pins have to be advanced up one position each on the programmable divider input connections, i.e. —

Switch	PLL02A
P0	P1 (Pin 14)
P1	P2 (Pin 13)
P2	P3 (Pin 12)
P3	P4 (Pin 11)
P4	P5 (Pin 10)

Pin 15 (PLL02) now becomes the 5 kHz Down select terminal and is taken to a switch mounted on the front panel.

With mobile units It will be necessary to cut the printed circuit connections between the switch and IC1.

Base station sets are easier as the wires on the switch need only be unsoldered and moved to the new termination points. Beware the pin out of the switch is not in

Binary order and will need to be traced from the original pins of IC1 right through to the switch connections. A map may help your selection of the correct terminal (see Fig. 5).

Note the Brown wire is pulled out of the wiring form and taken to the 5 kHz Down switch mounted on the back of a replacement squelch pot. This conserved front panel space and drilling.

**Step 4**  
In-between channels may be obtained by terminating Pin 14 (PLL02A) via the 3 position switch (as in Fig. 4) to the channel selector. This may be substituted in place of the dimmer or calibrate controls found on some sets.

**Step 5**  
Replace L2 (6.8 uH) with 2.2k ohm resistor.

**Step 6**  
Align the VCO and RX/TX tuned circuits (see Fig. 6).

#### ALTERNATIVES

Some may desire to modify their transceiver but consider the above method in-

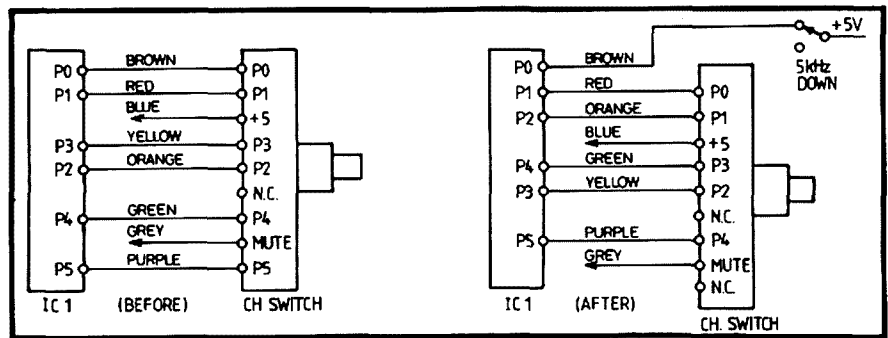

FIGURE 5: The author's 23 channel base station version.

adequate for their needs. Another approach is to disconnect the channel selector and use an external switch box incorporating the nine switches required. Both this method and the above work best if a frequency versus switch position chart is tabulated.

If the heterodyne crystal is changed, then the switch box concept would be more versatile as the switches can then

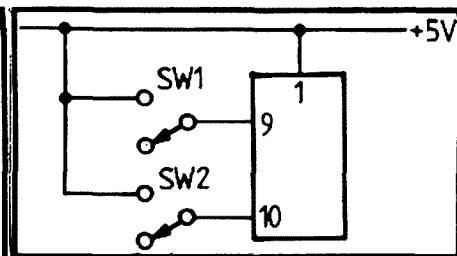

FIG. 3: Switches for extra channels. The NB and PA/CB switches were used for SW1 and SW2 respectively.

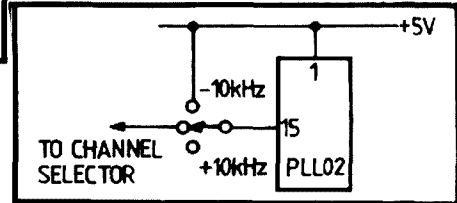

FIG. 4: In between channel switch.

be labelled according to frequency increase above the lowest or reference frequency which would probably be 28.000 MHz (as set by the crystal). E.g.:

SW1 = + 10 kHz	SW6 = +320 kHz
SW2 = + 20 kHz	SW7 = +640 kHz
SW3 = + 40 kHz	SW8 = +1.28 MHz
SW4 = + 80 kHz	SW9 = +2.55 MHz
SW5 = +160 kHz	

10 kHz Version.

An improvement on the above methods would be to build a scanner incorporating two 74C193 up/down counters and a programmable frequency counter. This however is more than just an afternoon's modification.

#### CIRCUIT

The modification could be carried out with only these instructions, but a schematic

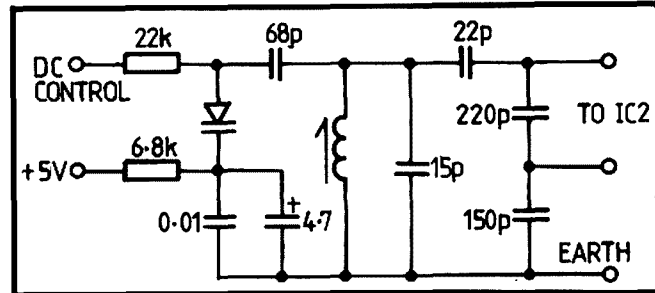
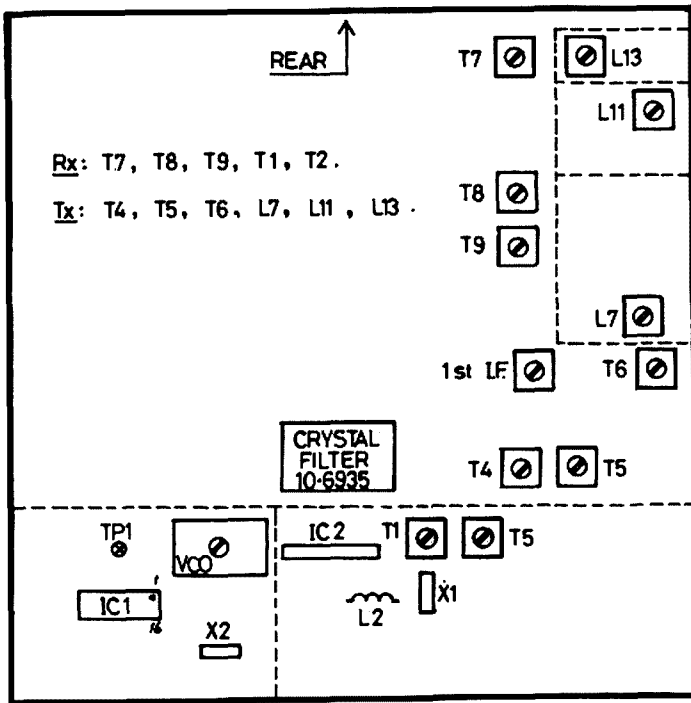

FIG. 7 (above) depicts the VCO block.

approaches the second harmonic of both the VCO frequency and the 20.105 MHz injection frequency.

For 29.500 MHz the input to the Phase Lock Loop programmable divider is 15 kHz and the injection frequency to the Transmit and Receive mixers is 40.195 MHz. However the second harmonic of the mixer injection is on 40.210 MHz and the second harmonic of the VCO is on 40.180 MHz.

Unfortunately a 40 MHz tuned circuit cannot be expected to reject signals only 15 kHz away and Spurious Response will result 15 kHz on either side of the signal.

Even a 1 MHz frequency difference as exists at around a 28.5 MHz output frequency will be approaching the limit of acceptable suppression of spurious responses.

As a result of the possible spurious responses this modification should NOT be used to produce output frequencies greater than 28.5 to 28.6 MHz. This should be regarded as the practical upper limit. ■

FIG. 6 (left): Layout of relevant components.

I hope this article will assist more amateurs to investigate PLL transceivers and enjoy the DX openings on 10 metres.

#### TECHNICAL EDITORS' NOTE

Whilst this modification has an apparent upper frequency limit of 29.515 MHz the possibility of spurious output is very great

as this limit is approached.

As the upper frequency limit is approached the difference between the 20.105 MHz injection frequency and the VCO frequency become only a matter of a few kHz. As a result of this the injection frequency, which is the sum frequency,

## TRY THIS – WITH THE TECHNICAL EDITORS

### ANTENNA CARRIAGE FOR FREE STANDING TOWERS

Listening around, I hear so many amateur operators who have handicaps of some kind and are unable to work on their beam antenna. Here is an idea for such people,

and those of us who do not like climbing towers. The system is to have a track on which a carriage travels carrying rotator and antenna; this allows the antenna to be lowered down the side of the tower to which the track has been attached. The

antenna shaft is set vertical and therefore at an angle to the side of the tower. As the beam is lowered it is moved to such a position that the elements clear the tower, and may be worked on at the 6 foot level rather than the 60 foot level.

John Tower VK6IM, 12 Ramsay Road Bunbury, WA. ■

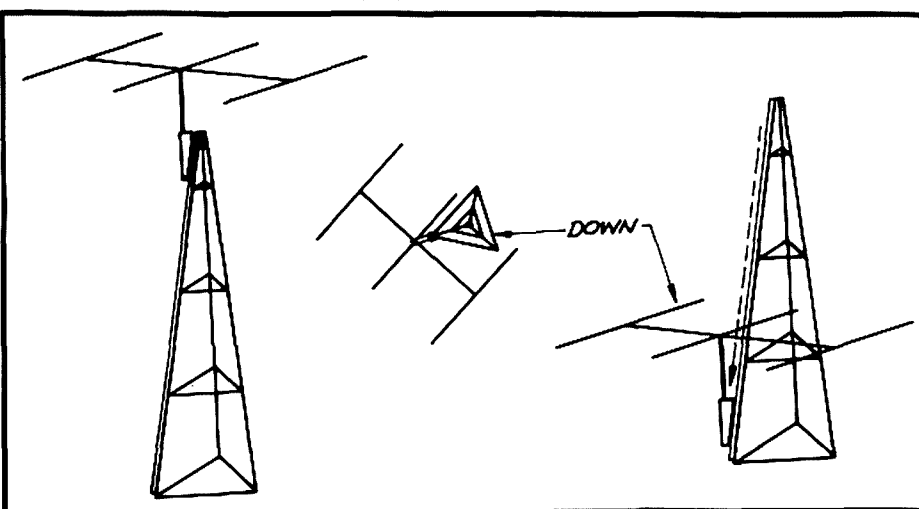

FIGURE 1.

### MORSE EXAMS

Candidates for morse exams are specially reminded that the morse sending or receiving of letters is not adequate in itself. There is a space of 7 dots between words and this has to be observed so that whatever is sent or written down should be in understandable composition English. Thus, to omit a space between two words is one error. Many errors could be recorded against you if, for example, in receiving morse, you write down a string of letters not separated into discrete words. This reminder is given to dispel any rumours to the contrary and to alert candidates to the official requirements. ■

# Satellite Solar Illumination

By Greg Roberts VS1BI  
(Reprinted by courtesy of AMSAT-UK)

The computation of solar illumination conditions for artificial earth satellites has become of considerable interest to some amateurs in view of the behaviour of OSCAR 7 as outlined in OSCAR NEWS No. 26. Several articles have appeared in the amateur press on the subject, some of them good and some not so good, but perhaps I am biased because I think that the method I use is easier, whilst at the same time it is accurate, as shown by numerous optical observations of satellite shadow entry and exit predictions.

I must confess that the method was not developed by me, but is a bit cribbed here, there and everywhere, so there is no single source. Perhaps my approach was most strongly influenced by an article on "Solar Illumination" by G. E. Taylor that appeared in the "Artificial Earth Satellites" memoir of the BAA of August 1961. Another useful source was "Astronomical Papers Translated from the Russian", No. 12 of the Smithsonian Institute, May 1968.

The method to be outlined is incorporated in all my computer satellite tracking programmes and is employed as a small sub-routine and so far has proved entirely satisfactory.

**APPROACH**

1. Determine the declination (DEC) of the sun on the particular year day, D, required for. This can be obtained either from the current "Astronomical Ephemeris" (AE) or by calculation. Since most amateurs do not have access to the AE, the second alternative will be used. The expression is not 100 per cent accurate but is more than good enough for our purpose.

$$DEC = 23.4417 \sin [(D - 82.3) 0.98562] \dots\dots\dots (1)$$

example:  
For Jan. 31, D = 31 and  
DEC = -18.10°  
For May 26, D = 147 and  
DEC = +21.03°

2. Determine the value of T where T = 12 hours plus the equation of time. This item is also given in the AE but it can be calculated as follows:

$$N1 = 8 \sin [D - 1.2) 0.98563]$$

$$N2 = 10 \sin[(2D + 17.) 0.98563]$$

hence  
A = N1 N2 and T = 12 hrs + A  
..... (2)

example:  
For Jan. 31, D= 31, A = 13.7,  
T = 12 hr 13.7 min  
For May 26, D = 147, A = -3.38,  
T = 11 hr 56.7 min

N.B.: Throughout all these calculations Greenwich Mean Time will be used.

3. Evaluate the quantity  
B = (time required for — T) ..... (3)  
and convert to degrees, recalling that four minutes of time is equal to one degree of arc.

4. Determine the quantity of DY where  
DY = SATLONG — B ..... (4)  
where SATLONG is the sub-satellite longitude at the time required for and DY is the difference in longitude between the sub-satellite position and the sub-solar point B. If DY is GREATER than 180°, subtract it from 360°. Ignore the sign of DY.

5. Compute the angular distance between the sun and the satellite:  
cos X = sin (DEC)s in (SATLAT + cos (SATLAT) cos (DY) ..... (5)  
where DEC is from equation 1, SATLAT is the sub-satellite latitude and DY is from equation 4.

6. Evaluate:  
$$S = \arccos \left( \frac{6370}{6370 + H} \right) \dots\dots\dots (6)$$

where H is the height of the satellite, in kilometres, above the earth's surface. For OSCAR 7 S = 35.5°.

7. Determine:  
EP = 90.7 + S ..... (7)  
where EP is the point by which time the satellite has faded several magnitudes in brightness and is in effect completely in shadow. Observation has shown that the value of 90.7° is more close to the true situation than 90°.

8. Compare EP and X.  
If X is GREATER than EP, satellite is in SHADOW.  
If X is LESS than EP, the satellite is in SUNLIGHT.

That concludes the method and I do not think the maths will scare anyone, but to try and make it clearer, let us do an example:

**PROBLEM**

In mid-February 1980 it was reported that OSCAR 7 was experiencing mode slipping near the southernmost portion of its orbit in the vicinity of South America as a result of poor solar illumination. Is this correct?

**SOLUTION**

From a ground track computation the following is obtained:

DATE: 15 February 1980. TIME: 21 h. 13 m. 00 sec. Z. LONG.: 345.25°W. LAT.: -72.96°. HEIGHT: 1461 kilometres.

We now obtain D = 46 days.

$$DEC = 23.4417 \sin [(46 - 82.3) 0.98563] = -13.705°.$$

$$N1 = 8 \sin [(46 - 1.2) 0.98563].$$

$$N2 = 10 \sin [(92 + 17.2) 0.98563].$$

$$A = B1 + N2 = 15.10 \text{ minutes.}$$

$$T = 720 \text{ minutes} + 15.10 = 735.10 \text{ minutes.}$$

$$B = (21 \text{ hr. } 13.0 \text{ m.} - 735.10) = 537.90 \text{ minutes} = 134.475°.$$

$$DY = 345.25 - 134.475 = 210.775° = 149.225°.$$

$$\cos X = (\sin -13.705 \sin -72.96) + (\cos -13.705 \cos -72.96 \cos 149.225)$$

$$X = 91.036°.$$

$$S = \arccos \{6370 / (6370 + 1461)\} = 35.567°.$$

$$EP = 90.7 + 35.567 = 126.267°.$$

Since X is 91.036° the satellite is out of shadow by 126.267 — 91.036 = 35.2°, so it CANNOT possibly be experiencing mode slipping DUE to poor illumination, as in fact it is very far from the earth's shadow. Additional checks for all southern latitudes on this date will reveal that there is no illumination problem, so any mode slipping must result from some other cause.

As a matter of interest, the entire orbit of OSCAR 7 was examined at one minute intervals (by computer) for every 15th day of the month for solar illumination and is summarized in the table below:

Date	Max.	Lat.	Min.	Lat.
15 Jan.	57.5	-30	14.9	+31
15 Feb.	53.5	-6	18.9	+7
15 Mar.	56.3	+24	16.0	-25
15 Apr.	65.2	+44	7.1	-46
15 May	72.6	+58	-0.4	-57
15 June	75.6	+60	-3.3	-62
15 July	73.1	+60	-0.7	-60
15 Aug.	66.3	+55	6.1	-56
15 Sept.	59.3	+33	13.0	-34
15 Oct.	56.6	+2	15.8	+2
15 Nov.	56.8	-24	15.6	+25
15 Dec.	55.6	-37	16.8	+37

where Lat. is latitude in degrees; south is -, north is + and Max. and Min. are the maximum and minimum distances the satellite is clear of the earth's shadow.

From this some interesting information can be obtained:

- (1) The satellite will experience maximum solar illumination in mid-June over 60° north latitude during the northern hemisphere summer.
- (2) The only time the satellite will be in eclipse is from about mid-May to the end of July and occurs with the satellite in the southern hemisphere — local winter — with the satellite being deepest in shadow about 60° south.
- (3) As would be expected, the maximum illumination for any particular month is 180° away from the position of minimum illumination.

(4) It will be noticed that the sum of Max. + Min. is always about 72.4°. The significance of this escapes me at the moment!

It should be pointed out that the illumination conditions for a sun-synchronous satellite depend primarily on the satellite latitude. If the satellite is in shadow over South Africa on say 30°

latitude, then the satellite will be in shadow every time it crosses 30° south latitude on that particular date. (There will be a slight drift of the satellite either deeper or shallower into eclipse, but this can be ignored, except in cases where precise values are necessary.) Solar illumination is not a longitude dependent function for satellites such as OSCAR 7 and OSCAR 8 as the

orbital plane always passes over a particular location at the same local time each day—note that orbital PLANE is specified and the satellite could be anywhere around its orbit.

I hope this simple explanation of solar illumination will shed some light on the subject for those who are in darkness—puns intended! ■

# Audio Activated Saturating Switch

Ralph Holland VK2ZZB

388 Rouse Street, Tenterfield, NSW 2372.

I lived in a country area at the time and we had a pirate frequenting the 2 metre band. As in most country areas the normal ham activity was sparse, particularly on the 2 metre band. Thus the AASS was designed to interface with the audio output of my rig and the remote/auxiliary sockets of my cassette tape recorder for unattended recording.

The following points were kept in mind:

1. The amplification must be such that audio turns on the switch but noise does not operate it.
2. There must be provision to adjust the level of audio to the auxiliary (or perhaps the microphone) socket, in case the tape recorder does not have automatic level control or becomes overloaded.
3. The unit should not draw too much power and if possible be portable. (A saturating transistor switch was employed to that effect.)
4. There must be a hold facility so that the switch remains saturated long enough for the recorder not to break during short intervals or even between words.
5. The switch must work as quickly as possible.

These requirements have been fulfilled with the simple circuit that follows. The fifth requirement, as expected, could be improved upon. The best way would be to supply audio via a delay to the tape recorder so that the motor has sufficient time to start—but this complicates an otherwise simple design.

## DESIGN AND OPERATION

The audio transformer, as well as supplying audio of sufficient level to be rectified, provides good isolation between the audio lines and the remote switching lines. It allows the possibility of using either positive or negative earth supplies. (The remote lead polarity need only be changed at the saturating switch.)

To ensure saturation of the transistor, sufficient current must be applied through the base—emitter junction.

To obtain a "hold", but not a delay, a 2.2 uF tag tantalum capacitor is con-

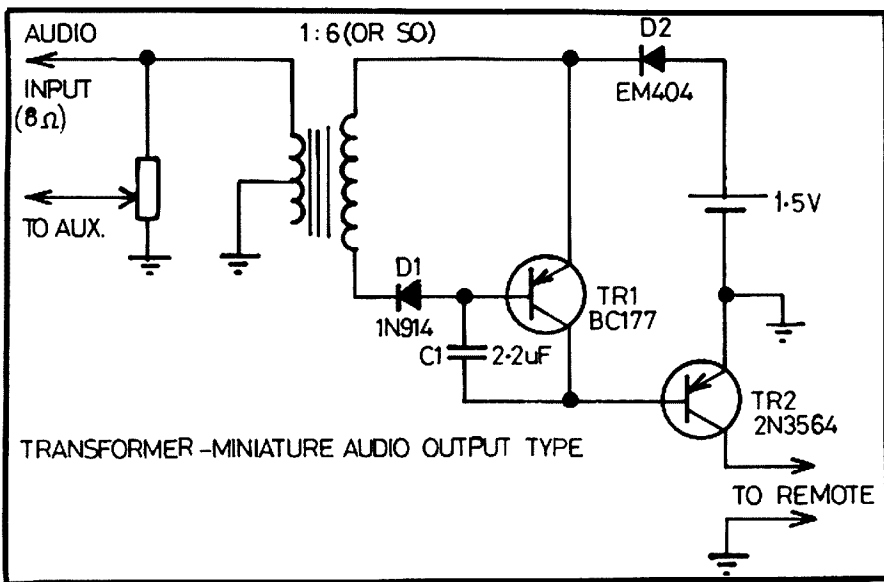

FIG. 1: Audio Active Saturating Switch.

nected from the base to the collector of TR1.

Low level audio is applied to the input lead and is returned to the tape recorder via the level control; the remaining audio path is via the input transformer. The transformer transforms the low level voltage in the primary to a high enough level in the secondary to overcome the junction potential of diode D1. The diode rectifier provides sufficient current to turn on TR1, and C1 supplies the holding current so that TR1 always remains on for at least some predetermined interval. The current flowing through TR1, provided by the 1.5 volt battery, causes TR2 to saturate.

The collector-emitter voltage drop approaches 0.1 volts or so. D2 provides a forward biased voltage drop sufficient to limit the current from the dry cell. Note the two different earth returns. ■

## JOIN WICEN WIRELESS INSTITUTE CIVIL EMERGENCY NETWORK

providing a pool of trained, licensed operators, with equipment, available for deployment to aid communications in an emergency.

# Two Metre Linear Amplifier with a difference – using a QQE 03/20

Gordon Loveday VK4ZBI/NMJ  
 "Aviemoire", Rubyvale 4702

Many circuits have been through the pages of AR over the years, most using transistors. However, the writer was brought up with valves and gets most satisfaction working with these "outdated" marvels.

Most valves are much easier on the pocket and can survive a mistake of the builder. Having tried quite a few circuits, with varying degrees of success, I tried to put some ideas of my own to work. I might mention that I don't expect everyone will get the same results as I have. Firstly, my HT is 330V under load, from a DC/DC power supply, with 12V DC input. I use battery bias on the final. The idling anode current is 2.5 mA peaking to 100 mA on carrier, with an average of around 75 mA on voice peaks. The power supply is capable of about 250 mA. Relays are

operated either by COR circuitry or PTT, whichever suits the builder. The screens are opened on receive position. It appears that there are quite a few types of the popular QQE03/20 to be had; some are more suitable on 2m than others. Mine are Philips (with gold-plated pins). Other brands, i.e. Brimar, Marconi, Mullard, may show signs of not wanting to co-operate, in being difficult to tame. No neutralising was needed in my unit, however I did take the precaution of lining up the chassis level with the circular shield within the tube. I do not provide coil data as this

never seems right in any other layout! However, most VHF addicts will find this no problem. I found a shield helped in my layout around the base end of the final. The input from the IC202 was much easier to feed in directly than with the usual inductor coupling, but please yourself here. All the parts came from my "junk box". The unit lifts my signals 2 S points from my QTH to Rockhampton (380 km). Let's hear some more 2m activity from all you barefooted IC202 owners!

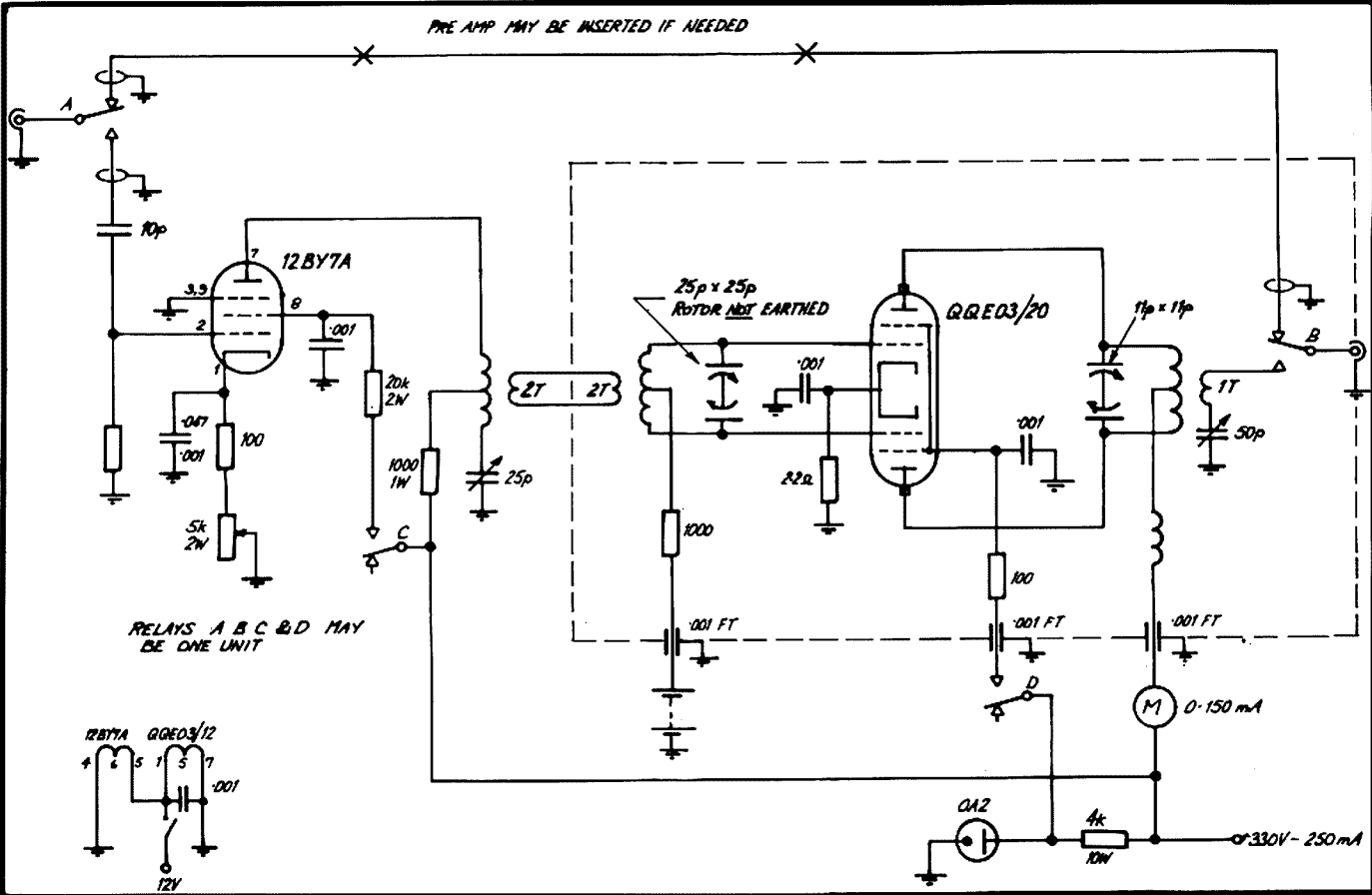

FIGURE 1: Circuit for the 2m linear using QQE03/20.

# The Ten-Tec Omni-D Series B Transceiver

Review Article and Photos by  
Ron Fisher VK3OM

3 Fairview Avenue, Glen Waverley, Vic. 3150

The American TEN-TEC Company has for some years produced an interesting range of amateur gear with an emphasis until recently on simple low power CW and SSB transmitters, receivers and transceivers. While, in this country at least, they are best known for their little low power Argonaut transceiver, their full feature 100 watt output transceivers have had a small but enthusiastic following for the last two or three years. Our review is of the latest of these transceivers.

TEN-TEC are represented in Australia by Graham Stallard of Lockleys, South Australia.

As we have stated in equipment reviews before, it seems that most of the real advances in amateur design come initially from the United States. Perhaps in view of this, it is a strange thing that we seem to buy Japanese equipment in large quantities, but only relatively small quantities of American gear. Let us take a good look at the TEN-TEC OMNI and see what it has to offer. There is no doubt it has a lot to offer and in fact has possibly more operating aids than any other transceiver on the market.

But first let us get an overall picture of the OMNI. It has full amateur band coverage from 160 to 10 metres, with 10 MHz coverage for reception of WWV and future modification for transmission on our new band in this region. There is also an auxiliary band switch position for another of our future new bands. The OMNI is fully solid state and in common with most other transceivers of this type, does not require any transmitter output tuning. Power supply requirements are 13.8 volts which makes the OMNI ideal for mobile or portable use, for home station use a power supply delivering a peak output of 18.5 amps is required.

First encounter with the OMNI produced a slight surprise. It was larger than I had imagined. It is in fact 360 mm wide, 355 mm deep and 140 mm high. This makes it of similar size to the larger Japanese transceivers with valve finals and in-built power supplies. I would make this point a very definite plus. When the cabinet is opened up, all of the 23 circuit boards are instantly accessible. Trouble shooting or adjustment would be easier with the OMNI than on any other rig I can call to mind.

The cabinet is in two pieces, making accessibility very easy. The material used is vinyl covered aluminium, and it is perhaps here that the OMNI loses points. It is definitely a plain Jane. While the overall appearance is attractive and certainly functional, it in no way compares with the

equipment styling that we are used to in Japanese gear. And therein lies the possible reason that we favour Japanese amateur products. What do you think? Does styling sway your thinking? If so, then read on and we might change your ideas.

We started off by saying that the OMNI offered more in operating aids than any other transceiver on the market. Let us look at them.

First off, most current transceivers do not provide CW operators with anything approaching state-of-the-art facilities. The OMNI provides full break in CW up to about 50 words a minute. Add to this three active CW audio filters with bandwidths of 150, 300 and 450 Hz, plus the optional 500 Hz crystal filter and a most effective notch filter, you might start to get the picture. For further comments on the OMNI CW performance, I suggest readers refer to Geoff Thompson's article "New Developments for the Morse Enthusiast" in January 1980 Amateur Radio.

It should be noted that the new series B we are reviewing has some additional features over the earlier OMNI which Geoff refers to in his article, namely the notch filter plus greater flexibility with the filter switching.

Receiver offset tuning is switched to allow for two degrees of bandspread,  $\pm .5$  kHz or  $\pm 5$  kHz. In use I found the .5 kHz offset to be the most useful, and I have felt for a long time that most transceiver RITs go too far. With this system you can have it any way you like.

The digital readout has a novel feature. The six LEDs are each about 1.2 cm high with the last or 100 Hz indicator in green instead of red for all the others.



## THE OMNI CIRCUIT DETAILS

The OMNI is based on a single conversion 9 MHz system. The standard filter supplied is a 2.4 kHz 8 pole device with a shape factor of 1.7 at 60 dB down. Available as optional extras are a 1.8 kHz 8 pole filter and a 500 Hz CW filter. Front panel switching is arranged to allow the 2.4 and 1.8 kHz filters to be in series for exceptional SSB selectivity. The MOSFET RF stage for the receiver operates without AGC and the RF gain operates on the IF stages only. This, along with the double balanced diode first mixer, provides a high degree of front end performance. Cross modulation and strong signal handling are excellent. The receiver has a Resonate control to tune the preselector for peak performance. This control operates on receive only. Receiver sensitivity is automatically set to provide a 10 dB S = N/N on input signals of 2 uV on 160 metres through to .3 uV on ten metres. In addition to all of this an 18 dB attenuator using PIN diodes can be selected with a pull-on switch on the RF gain control. No calibrator is provided with the digital readout, but the OMNI can be obtained with a normal analog dial and a calibrator with push button On and an adjustable time off of five to ten seconds. The digital readout is set up to give an accurate reading while in the normal sideband position. When switched to reverse sideband or CW the readout will be in error by up to 2.5 kHz. The transmitter output stage is rated at 100 per cent duty cycle, an important consideration for RTTY and slow scan operators.

Power output on both CW and SSB can be varied from full output down to a few watts for QRP operation by means of the drive control. Metering is a little on the bare side for a transceiver of this class.

Apart from the S meter only an SWR reading is provided in the transmit mode. A red LED just below the S meter shows when the transmitter ALC is in operation.

### THE OMNI ON AIR

Our review model was supplied with the matching TEN-TEC power supply which has a built-in ammeter. Power output was checked by feeding a Heath Antenna via a Drake W-4 ammeter. We obtained the following figures on steady CW carrier; 160, 80, 40, 20, 15 and 10 metres gave the following power—110, 105, 100, 90, 80 and 80 watts. PEP output on SSB was slightly higher as indicated on the Heath SB610 monitorscope. Transmit waveform was excellent and speech quality was clean with the quality dependent on the microphone used.

VFO stability was adequate with just on 500 Hz drift measured over a one hour period. After the first hour the drift rate slowed down to a marked extent. This amount of drift is adequate, but not exceptionally good compared with many current transceivers.

The tuning was exceptionally smooth and covered the band at 18 kHz per turn of the knob. All wanted controls are on the front panel including VOX gain, delay and anti-trip. One interesting function brought out to the rear panel is a spare set of band switch contacts to operate an external antenna switching relay or other device requiring selective band switching.

In all the OMNI proved a delight to use and the superb selectivity with the notch filter pulled many signals through that were not copiable on other transceivers set up for comparison.

One feature not appreciated was the carry handle come tilt device. It did its job in lifting the front panel to a convenient height but was rather hard on the polished surface of my desk.

PHOTO 3: Top view Omni-D.

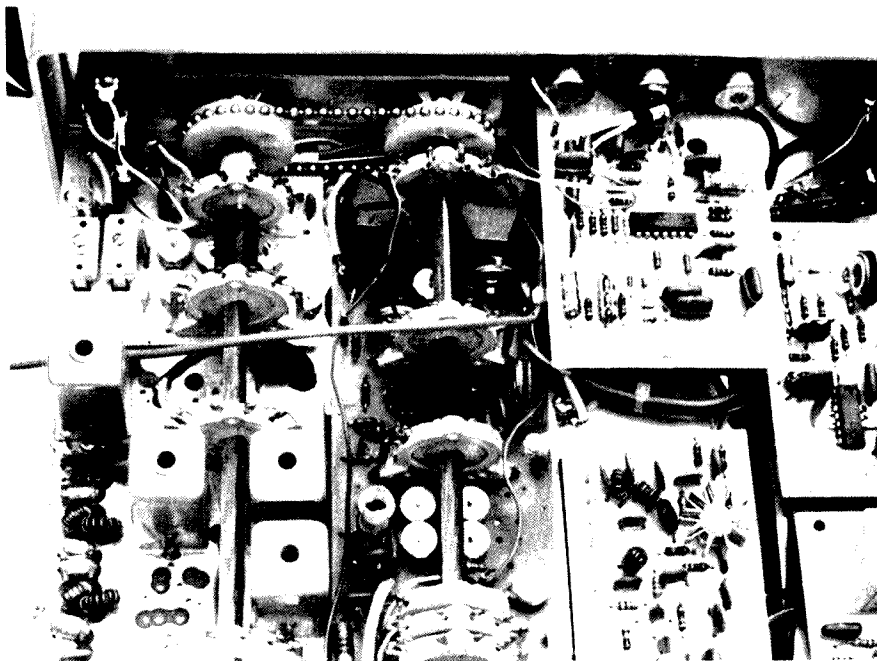
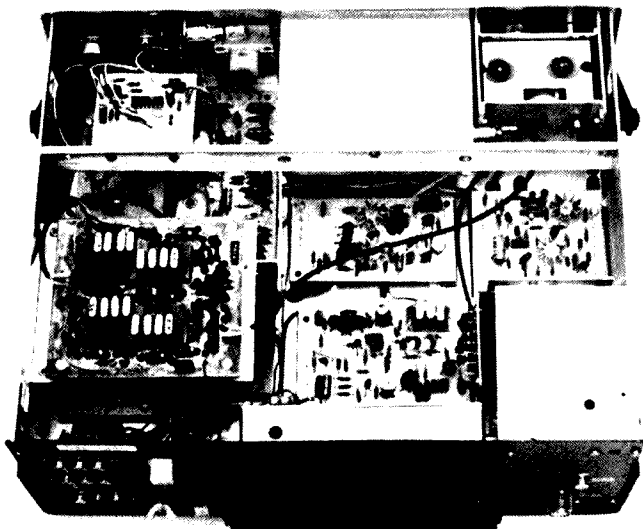

PHOTO 2: Close up of the inside layout of the Ten-Tec Omni-D Series B Transceiver.

Two speakers are built into the bottom rear of the OMNI cabinet and are described in the TEN-TEC literature as Dual Compression-loaded speakers. They are claimed to eliminate the need for an external speaker. I must say that I did not like the quality from them. I am one of the old school who prefers a large external speaker which I consider gives a better transient response. However, in fairness, some other operators who heard the OMNI rated the quality as good. There is no rear panel connection for an external speaker, but one can be fed from the front panel

headphone jack. The microphone is connected by a standard tip ring and sleeve plug and a high impedance unit is required. No speech processing is included in the OMNI but with the 100 per cent duty cycle there would be no problems in using one.

A few internal receive spurious signals were noted when tuning around. Most are well down and would not be heard during normal operation, however one on 28.980 was over S9 on the meter.

### INSTRUCTION BOOK

The instruction book would have to be the one by which all others should be judged. I had previously seen the instruction manual of the TEN-TEC Argonaut and was most impressed with it. They are keeping up the standard. Each circuit board is described in some detail with a large photo showing the location of components. An individual circuit of the board is published along with the above details.

### CONCLUSIONS

As stated at the beginning of the review, the OMNI offers many features just not obtainable on other equipment. It is however a relatively expensive transceiver by present standards (current price should be checked with the agents), but if you are looking for a transceiver that will perform where others will give up or if you are a really keen CW man, the OMNI may be just what you are looking for.

Before writing this review I contacted a few TEN-TEC owners (all Argonauts) to check on Graham Stallard's service. Take a bow, Graham, they were all unanimous that your attention was the best they had ever had.

For details of price and delivery of the TEN-TEC OMNI contact Graham Stallard, 27 White Avenue, Lockleys, SA 5032. ■

# the world of difference in hf transceivers —

from **SCALAR**

**SOLE VK  
DISTRIBUTOR**  
for the products of

**TEN-TEC**

TEN-TEC  
are world famous for  
the QRM BEATING  
QUALITY of their  
transceivers.

- ➔ *Model 580 DELTA*
- ➔ ARGONAUT 515
- ➔ THE OMNI SYSTEM

★ **New Bands  
Included**



**SCALAR GROUP**

**VIC: 20 Shelloy Ave, Kilsyth. Phone 725 9677**  
**NSW: 328 Kingsgrove Rd., Kingsgrove. Phone 602 2888**  
**QLD: 8 Ferry Rd, West End. Phone 44 8024.**



# Amateur Radio for the Cruising Yachtsman

## PART TWO

Last month we featured Part 1 of this article which told us how amateur radio communications enabled yachtsmen to maintain reliable radio contact with land-based stations, etc.

Here now are the author's views on how we may integrate amateur radio with the yachting community, and perhaps improve our public image with great benefits to ourselves and yachtsmen in general —

Feedback from readers is most important to enable the Wireless Institute of Australia to formulate a policy in this area.

Amateur radio is the fastest growing communication media for the foreign going yacht, and the Wireless Institute of Australia is missing out on an excellent chance to gain new members, but more importantly, gain the support of an influential section of the community by outwardly promoting amateur radio to racing and cruising yachtsmen in Australia. The marine frequencies are of very limited use and Australian made type approved marine SSB is very expensive. Except for racing yachts, who have to fit it in order to be allowed to race, many people are looking for another media of communication.

As is often the case, poor old Aussie lags behind the times and is very reluctant to change. The P. and T. Radio Branch is pushing for marine VHF and rightly so, but it is not taking one as it has in Europe and the USA. The reasons are threefold:—

1. Australian made type approved sets are up to twice the price of US made counterparts.
2. Australian technical specifications prevent admission of foreign made gear on to this market, not to mention high import duties—with the exception of some high priced European sets.
3. OTC is very very slow to install VHF repeaters for international marine VHF channels, consequently operations are restricted to near principal ports and cities. It is therefore not possible to make a coastal cruise and be always in VHF radio contact as it is with amateur 2m equipment.

Getting back to marine HF SSB. Cruising yachtsmen in USA, Canada and lately UK, hardly even consider fitting it any more. Prior to 1976 before the "Sorcery" capsizement incident was publicised in "Sail" magazine, American yachts heading into the Pacific often had marine SSB. So many found it so useless once away from USA that they tried to sell it during their cruise, usually to uninformed Australians and New Zealanders. However, in the last two or three years the situation has changed. The Americans and Canadians don't even have marine SSB aboard. Those

who intend foreign cruising into the Pacific and Atlantic get their amateur licence and fit HF SSB amateur transceivers. There are hundreds such yachts every year leaving North America and very few of them are "pirates". The ARRL and FCC have seen to that of late. In any case most former pirate calls got themselves qualified during their cruising when they had the time to study.

The choice is obvious. Fit a marine SSB 100 watt set with 12 or so crystal locked channels costing around \$1,600-\$2,000 and be able to communicate on a very limited basis, or fit the same power amateur transceiver at half the price and have world-wide communication capability no matter where you sail. In this sense the amateur licence is worth \$1,000 to the holder, and dozens of lives have been saved at sea by amateur radio when all else failed.

Recently the English have got the message and amateurs keen on sailing have set up a UK maritime mobile net for boats heading across the Atlantic and down to the Mediterranean. They did more than that. They set up an amateur station aboard a yacht at the "In the water boat show at Southampton". It aroused tremendous interest.

Of course any US yachting will tell you that it was Atlas Radio that deliberately promoted "Ham Radio Afloat" in the USA, but all Herb Johnson was really doing was telling people in sailing of what was already known to be an excellent idea by a handful of hams on yachts in the Pacific as early as the late 1960s and early 1970s.

In Australia the only group that can effectively promote ham radio for yachtsmen is the WIA. Myself and many other yachtsmen who are amateurs and are experienced foreign cruising folk or land based amateurs involved in maritime mobile nets consider that the WIA should do exactly that.

The reason are:—

1. More people in amateur radio means a stronger and larger pressure group to prevent loss of amateurs' share of the frequency spectrum.

2. Amateur radio has proven itself to be the most effective SOLAS communication media for the small craft. There are countless examples all documented in USCG logs, Australian Coastal Surveillance logs, logs of maritime mobile net control stations and maritime mobile stations.

3. As previously stated, the WIA would gain support of organisations involved in sailing, particularly yacht clubs, who organise long races such as Sydney-Suva Race and Parmelia Race. The Cruising Yacht Club of Australia recently showed great interest in amateur radio. But it is the rapidly increasing numbers of cruising yachtsmen who are now just beginning to realise the advantages of amateur radio and therefore represent a new group in the community from whose support the WIA could benefit and to whom the WIA can offer guidance.

4. Learning by overseas experience the increase in amateur radio afloat will go ahead in this country with or without the support of the WIA. It is only proper that the WIA should be involved in any extension of amateur radio in this country and in the interests of good public relations is well advised to show positive interest in what is a new area of amateur radio, at least to the majority of the yachting community.

It has become obvious to me that the ARRL is well known to American and Canadian yachtsmen, but most Australian yachtsmen have never heard of the WIA. In the same vein why is it that 99 per cent of Australians don't know that for the first 48 hours of Cyclone Tracy all communications with Darwin were through radio amateurs?

Like so many friends, I worked to get my amateur licence and it's more than a little disconcerting to hear that the grapevine around Melbourne yacht clubs simply assumed that the amateur station aboard "Assegai" was illegal. The average yachting thinks that an amateur radio aboard a yacht is some special kind of CB.



**PHOTO 3:** Using the Brookes and Gatehouse RDF hand held antenna to find the bearing of radio-navigational beacons. The operator uses headphones and rotates the antenna until a null is found.

How then can the WJA promote amateur radio to the yachting community should it see fit to do so? Atlas Radio Inc. always has a stand at the Los Angeles Boat Show in the interest of advertising. UK amateurs recently set up a demonstration station on a boat in the "Southampton in the water show". The response was dramatic.

WJA affiliated clubs run amateur stations and Scout jamborees. Why not set up an amateur station on a cruising yacht at the annual in the water yacht/boat show in Sydney? A small WJA stand at the Melbourne, Sydney and Brisbane boat shows would do marvels for PR, and some of the amateur radio dealers would only be too happy to subsidise such a stand as long as their equipment was on display. Every second cruising yacht in the Pacific has an Atlas or Yaesu and quite a few other brands enjoy sales in that area.

No doubt the secrecy provisions of the Australian regulations are helping prevent the amateur radio fraternity from gaining the respect it deserves from the community at large.

I have been personally involved in rescue operations in which amateur radio was the only communications media even before we had amateur gear aboard "Assegai". There are several details of emergencies at sea down in "Assegai's" radio log which would make excellent news type articles for the yachting magazines

and do wonders for improving public respect for amateur radio. However the secrecy provisions prevent me from giving them to editors who have shown great interest in getting them into print. It's ironical that half the Pacific know of many such incidents whilst the Australians are kept ignorant

"Solo's" trip to Antarctica clearly demonstrated the advantage of amateur radio and was well covered in AR from the communications angle (see AR August 1978). It was also well publicised in Modern Boating/Seacraft Magazine in an interesting colourful article. However the absence of any mention of the second-hand Atlas 210X transceiver aboard was significant, especially when one considers that as cruising yachtsmen David Lewis and his crew found the amateur gear so useful, as do many of their counterparts all over the world. The net effect, however, is that once again the Australian yachting community, unlike its overseas counterparts, remains in the dark.

Lastly, the WJA could promote greater awareness of maritime mobile amateur radio among its own members by running an MM news column in AR. This would work well as long as amateurs involved made the effort to provide the written information. Perhaps my article will spark off some interest with AR readers. It certainly will in the yachting community. ■

# CALLING ALL COUNTRY AMATEUR RADIO CLUB PROGRAM ORGANISERS!

## HOW TO ORDER

Send your request with blank ¾" Umatic cassette(s) and sufficient stamps to cover postage from Adelaide to your town to:

**JOHN INGHAM**  
Federal Videotape Co-Ordinator  
37 Second Avenue,  
Sefton Park, S.A. 5083

Having trouble finding suitable speakers for your Club's Technical Meetings?

## THE WIA LIBRARY OF TECHNICAL LECTURES MAY SOLVE YOUR PROBLEMS!

Most were recorded at the VK5 WIA Monthly Meetings SPECIFICALLY FOR COUNTRY AR CLUBS!

### Subjects presently on Hand (Group C):

Wire Antennas .....	B & W	40 mins.
Radio Teletype .....	B & W	40 mins.
Tracking Oscar .....	B & W	30 mins.
The Apollo 13 Disaster .....	Colour	1 hr. 20 mins.
The Signal to Noise Story .....	Colour	45 mins.
Microcomputers .....	Colour	50 mins.
Microcomputers .....	Colour	10 mins.
Winning Foxhunts .....	Colour	45 mins.
Auxilliary Battery Charging .....	Colour	30 mins.
VK5RTV ATV Repeater .....	Colour	1 hr.

The average 60 min. Umatic Cassette and case weighs 850 gm. At this time the only formats for which this service is available is: ¾" Umatic — first choice, ½" Philips N1500 — second choice. Sorry, NO Betamax, VHS or N1700 etc.

For a full catalogue listing of WIA videotaped programs and a complete description of the services provided, refer to Jan. 1980 issue of Amateur Radio.

# The Emergency Net

Ken Ayers VK4KD

Here on Queensland's sunny Gold Coast we are prepared for just about any contingency, whether it be a lost bush-walker in the hinterland or a full force cyclone.

About two years ago the writer realised that the local amateurs could play an important part in assisting the authorities with back-up communications in various situations and, after studying reports about Darwin, Brisbane floods and overseas disasters, prepared the basis of what is now called the GOLD COAST AMATEUR RADIO EMERGENCY NETWORK.

It was decided that every amateur living between Kingscliffe, in the Northern Rivers area of NSW, and Beenleigh to our north, a coastal strip of some 50 miles, would be able to participate in an emergency.

The hard core of the network, some 15 amateurs, who were dedicated enough to give priority to other people's needs, were approached and "detailed" for specific important jobs should the occasion arise. (We used to call this "volunteering" in the RAF.)

After much sweat, blood and tears, the original plan was evolved and monthly exercises commenced. We soon found that there was more than the one plan needed, in fact separate situations could arise needing a different plan to reach.

We now have three plans—A, B and C—as follows:

- A: Search and Rescue (with the State Emergency Service).
- B: Limited Emergency (severe storm, wind or minor flooding).
- C: Full Emergency (cyclone, tidal surge or earthquake).

Each of the above plans has a different deployment of personnel and frequencies. All 15 hard core amateurs carry a red folder in which are the three plans, call-out procedure and deployment.

The network is controlled by NET CONTROL (VK4KD), who is situated on a hill, well above flood level and pretty well cyclone proof. This station is equipped with emergency power, emergency food and water supplies and first aid kits. It is therefore capable of continual operation for a considerable period under severe conditions.

To cater for the many individual stations of this 50 mile strip, two AREA CONTROL stations were included. One, VK4TN, maintains contact with the many

## PLAN A (Search and rescue)

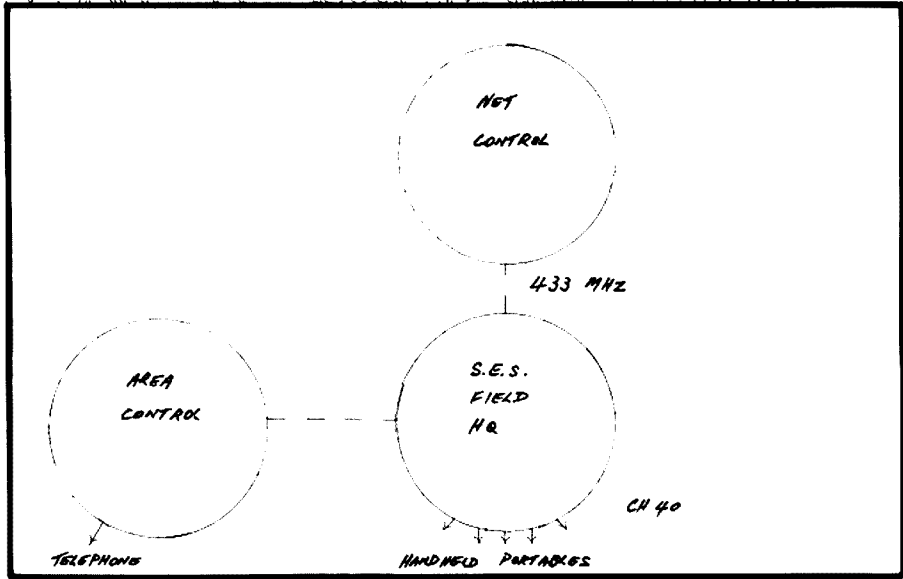

PLAN A

## PLAN B (limited emergency)

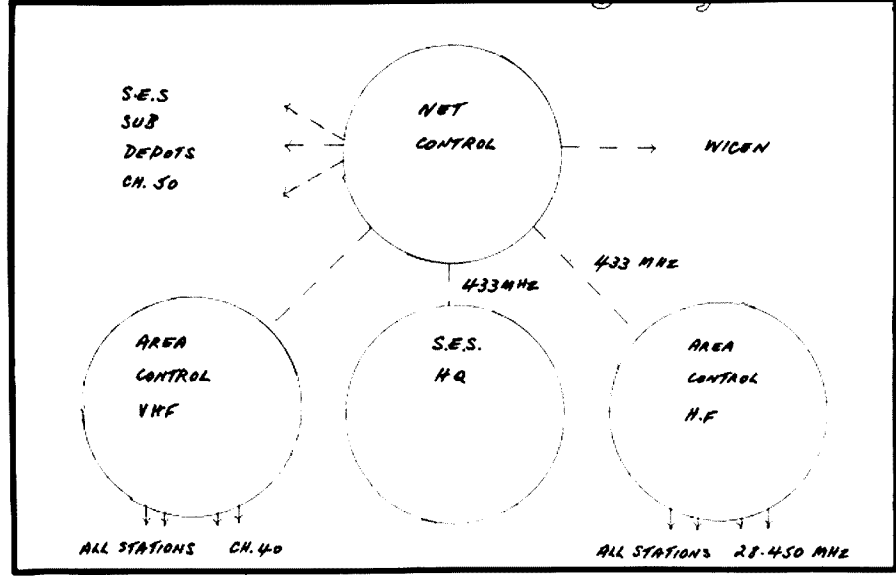

PLAN B

2m mobiles and base stations, the second, VK4NJK, is responsible for the many Novice stations on 28,450 kHz. Both these stations are linked to NET CONTROL. This

takes care of "situation reports" coming in from the whole area, the information or messages are passed to the "OFFICIAL" stations by NET CONTROL.

## PLAN C (full emergency)

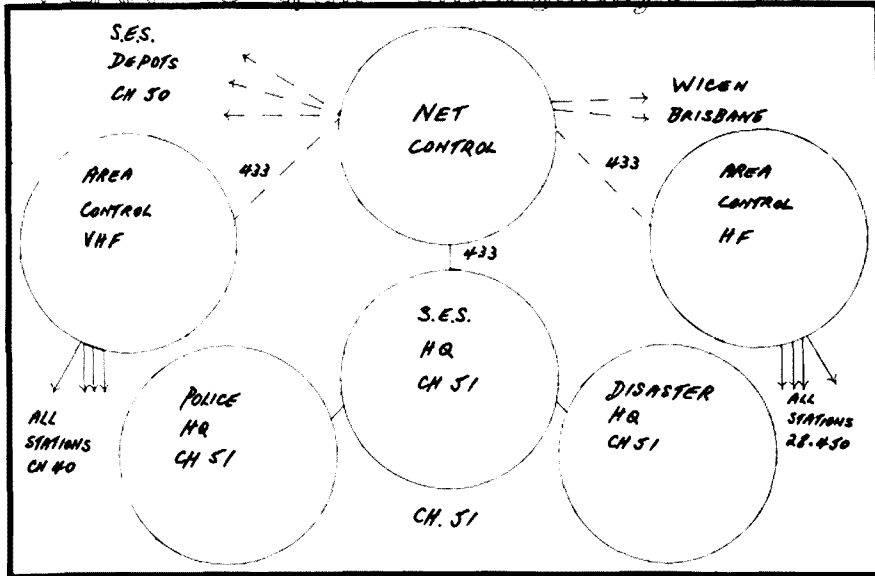

PLAN C

### OFFICIAL STATIONS

By this is meant any station of the network who is responsible for communications to either the State Emergency Headquarters, Police Headquarters, Disaster Headquarters, Meals on Wheels, etc. Study of the plans will show that, say in a full cyclone, the SES can be linked direct with the Police or Disaster HQ on their own frequency (Ch. 51) or can route a message through NET CONTROL to any area on the coast or into the national WICEN network.

Here on the Coast we have the State Emergency Headquarters located in Southport, and three other sub-depots, Coolangatta, Burleigh and Mudgeeraba. All these are linked together through our network.

Exercises are carried out on the first Monday of each month and field exercises, in conjunction with the SES, from time to time.

This description of our own local arrangements may be an incentive for other areas to form local groups with a link into WICEN if necessary. ■

# She's a Beaut, Mate!

Ron Petrich VK4ACZ

22 Amethyst Street, Bayview Heights, Cairns 4870

If you have to ask "what is?" you obviously haven't been to the far north of Queensland this year, for 1980 is the year of VK4RCA, the Cairns 2 metre repeater. Declared operational on 24th January, 1980 at its permanent location atop Mt. Bellenden Ker, VK4RCA has dramatically extended two metre activity in the far north of Queensland. Contacts have been made with mobile stations as far south as Mackay and as far north as Cooktown — the distance between these two places being of the order of 400 nautical miles (740 km).

So she's a beaut all right — in fact, she's too much of a beaut! Because of the range of VK4RCA, interference to two metre repeaters at Port Moresby and Mackay, both of which are also on Ch. 8 (7000), will undoubtedly cause problems. Consequently, consideration is being given to a frequency change for the Cairns repeater. (Probably Ch. 6950.)

Mt. Bellenden Ker is 5200 ft. high — only marginally less than Queensland's highest mountain (Bartle Frere) and barely a whisker less than Mt. Ginini, which carries Australia's highest amateur repeater. Before anyone protests that we are 80 ft. short of joining the mile high (repeater) club, we should mention that our antenna is 150 ft. up the Telecom mast, consequently our antenna height is 5350 ft. above sea level.

During the time which elapsed between March 1977, when the project was first proposed, and January 1980, a number of possible sites were considered, but the Club's repeater sub-committee, headed by

Nick VK4YT (who first suggested that the Club build a repeater), had always been keen on Bellenden Ker, or BK as it is known locally.

BK has many advantages, height being only one of these. Among the others are power availability and security. The Telecom installation on BK houses the transmitters for the two Cairns TV stations, consequently mains power as well as emergency power is available.

Access to the site is by cable car, operated by Telecom, and the terrain over which the cable car passes on its ascent is not only rugged but is jungle/rain forest covered. It is possible to walk or climb up the mountain by foot but one would need to be highly motivated to do so. Consequently, the mountain top does not attract casual sightseers, etc.

It was recognised that the chances of obtaining Telecom approval to use their site for our repeater were slim indeed and it could be said that our initial approaches received anything but encouragement. But

the enthusiasm of the RSC was contagious and the Club continued to pursue their goal. Many letters were exchanged between the Club and Telecom and ultimately approval was given — but it carried an annual price tag which exceeded the Club funds — which had taken years to accumulate. It was obviously unacceptable to members that the Club should commit itself to an annual debt which far exceeded the Club's income, present or future. So the paper war continued. We were fortunate that around this time we were able to put our case, in person, to the Telecom Commissioner from North Queensland who had been newly appointed and who was to represent the interests of residents of the far northern areas of Australia. Our case received a sympathetic hearing and, although some time was still to pass before finalisation, Telecom reviewed the situation and offered the Club an attractive agreement. Although initial costs were relatively high for a small Club, the yearly charges were well within our modest means. Needless to say, the Telecom offer

was gratefully accepted. It then became a matter of speeding up activities to complete our end of the project so that Telecom would be able to finalise their part of the activity, such as attaching our antennas to the tower before all work was brought to a stop by the wet season. Tied to this also was the impending departure of Ian VK4AWB, who had carried the responsibility for the technical aspects of the repeater.

Last minute delays caused by antenna problems, people being unavailable due to Christmas/New Year holidays, etc., caused many a hiccup but, although it rained heavily for a few days early in the New Year, the wet hasn't eventuated. All the loose ends came together and on 24th January VK4RCA was on air live from BK. It seemed that every amateur in Cairns who had 2m gear either had it at work with him or had taken a "sickie". Two metres was never so active! Results on that and subsequent days exceeded expectations and it was very pleasing that when Ian VK4AWB left Cairns for Brisbane a day or so later, he was able to maintain two-way communication from his car with amateurs in Cairns virtually throughout the drive to Townsville.

The Cairns area and surrounding

The technical details:

<b>LOCATION</b>	:	Mt. Bellenden Ker 17° 15' S 145° 40' E
<b>TRANSMITTER</b>	:	Modified STC 151 Hi-Band, 25 watts output
<b>RECEIVER</b>	:	Modified Pye MVF-516, 0.4 uV for 20 dB quieting
<b>ANTENNA</b>	:	Cushcraft G6-144 6 dBd gain, Vertical
<b>(Channel) FREQUENCY</b>	:	7000 (146.40 in, 147.00 out)
<b>ELEVATION</b>	:	5350 feet (1630 metres)
<b>EFFECTIVE RADIATED POWER</b>	:	35 Watts
<b>TIME OUT</b>	:	4 Minutes
<b>PRACTICAL MOBILE COVERAGE</b>	:	150 km
<b>CONTROL CIRCUITRY</b>	:	Solid state TTL, with design by Ian VK4AWB and ideas borrowed from Mt. Ginini and Adelaide repeaters.

countryside is notorious for difficulties with VHF communication — including TV. The number of translators serving the surrounding area is high and the problems rate a mention in the book "The Australian System of Antenna Craft" by Bob Thompson. It was therefore very gratifying to Club members to be able to demonstrate to State Emergency Service officials how mobile stations operating with low power could communicate with each other and with the Club station, which in fact is housed in the Cairns SES HQ building. Using a hand-held two metre transceiver,

Club members worked mobiles in areas previously in shadow — locations such as the Barron River Gorge, where the only way out is straight up!! and stations on the Tablelands, which could only communicate through isolated "windows" to the coast without the repeater.

Provision has been made to link VK4RCA with the Townsville repeater VK4RAT and a Yagi has already been attached to the Telecom tower for this purpose. When this phase is completed, solid coverage in those areas which are noisy at present is expected.

So let her eyes bolt glances hot,  
 Right in poor Volt's direction.  
 The current of Watt's wrath flowed strong!  
 He vowed Volt should not meter.  
 For daughter Poly Phase had long  
 Hoped that Volt would be sweeter  
 And so to Milli Ampere, he  
 A stern note did transmitter,  
 Requesting she transform, and be,  
 If possible, less bitter.



PHOTO 1 (below): A view of the VK4RCA Cairns repeater attractively housed in its cabinet. The repeater location is however unattractive to sightseers. PHOTO 2 (above) shows the cable car supports barely visible from the low cloud near the mountain top.

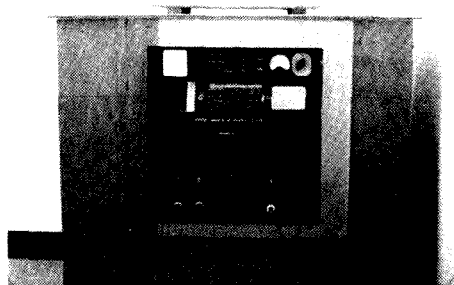

If there is any moral to be drawn from all this, it must surely be that perseverance pays off and that while setbacks are certainly discouraging, they need not be allowed to colour the argument or divert the effort of achieving the goal. To other Clubs in the same position as our own with limited finances, may we urge patience and perseverance. We would have achieved only limited improvement to 2 metre coverage in our particular area, with its terrain problems, had we not been able to site our repeater on the top of Bellenden Ker.

## DO IT ELECTRICALLY

When Milli Ampere first saw Volt  
 Her charms past all resistance.  
 A spark coiled in his heart poor coil —  
 He needed prompt assistance.  
 And she, tho plighted to old Watt,  
 Could alternate affection,

So Milli Ampere flirted not,  
 But knew that it was wise  
 To regulate the rage of Watt  
 And with him synchronize.  
 Then Volt with Poly Phase did fuse —  
 From her he did not roam.  
 They recited divergent views  
 And started a small Ohm.  
 W. F. Legget in Western Electric News,  
 1919.

## COLLECTORS' CORNER

# No. 2 – The Yaesu FRG 7

This month in Collectors' Corner, we feature the Yaesu Musen FRG7, an analog frequency reading receiver which has enjoyed considerable popularity since its introduction in 1976.

The FRG7 is an all solid state synthesised triple conversion superheterodyne communication receiver designed to cover the entire high frequency spectrum from 500 kHz to 29.9 MHz. This receiver was one of the first to incorporate the "Wadley Loop" principle utilizing a synthesised heterodyne oscillator for excellent stability.

Good selectivity is provided for SSB, AM and CW using a ceramic filter in the 455 kHz IF circuits, while a tone switch on the front panel of the FRG7 provides varying audio response in any one of three ways.

In the normal position, the audio amplifier passes frequencies of 250 Hz through 3000 Hz, at narrow 400 Hz through 2500 Hz and at low 250 Hz through 1500 Hz.



PHOTO 1: Front view of the Yaesu FRG7 receiver.

Early models of the FRG7 did not incorporate any means of varying the received frequency other than by adjusting the main tuning dial, a rather hazardous

manoeuvre when trying to remain on a particular frequency accurately.

(continued on page 28)

## SPECIFICATIONS

### Frequency Range:

0.5 MHz ~ 29.9 MHz

### Type of Emission:

AM, SSB (USB or LSB), CW

### Sensitivity:

SSB/CW: Better than 0.7  $\mu$ V at S/N 10 dB

AM : Better than 2  $\mu$ V at S/N 10 dB

### Selectivity:

$\pm$ 3 kHz at  $-6$  dB,  $\pm$ 7 kHz at  $-50$  dB

### Stability:

Less than  $\pm$ 500 Hz at any 30 minutes after warm up

### Antenna Impedance:

High impedance for 0.5 MHz ~ 1.6 MHz

50 ohm unbalanced for 1.6 MHz ~ 29.9 MHz

### Speaker Impedance:

4 ohms

### Audio Output:

2 watts

### Power Requirement:

100/110/117/200/220/234 volts AC 50/60 Hz, 12 volts DC external or internal dry cell UM-1 x 8

### Power Consumption:

AC 14VA

### Size:

340 (W), 153 (H), 285 (D) mm

### Weight:

Approx. 7 kg without batteries

# FRG 7 Circuit Diagram

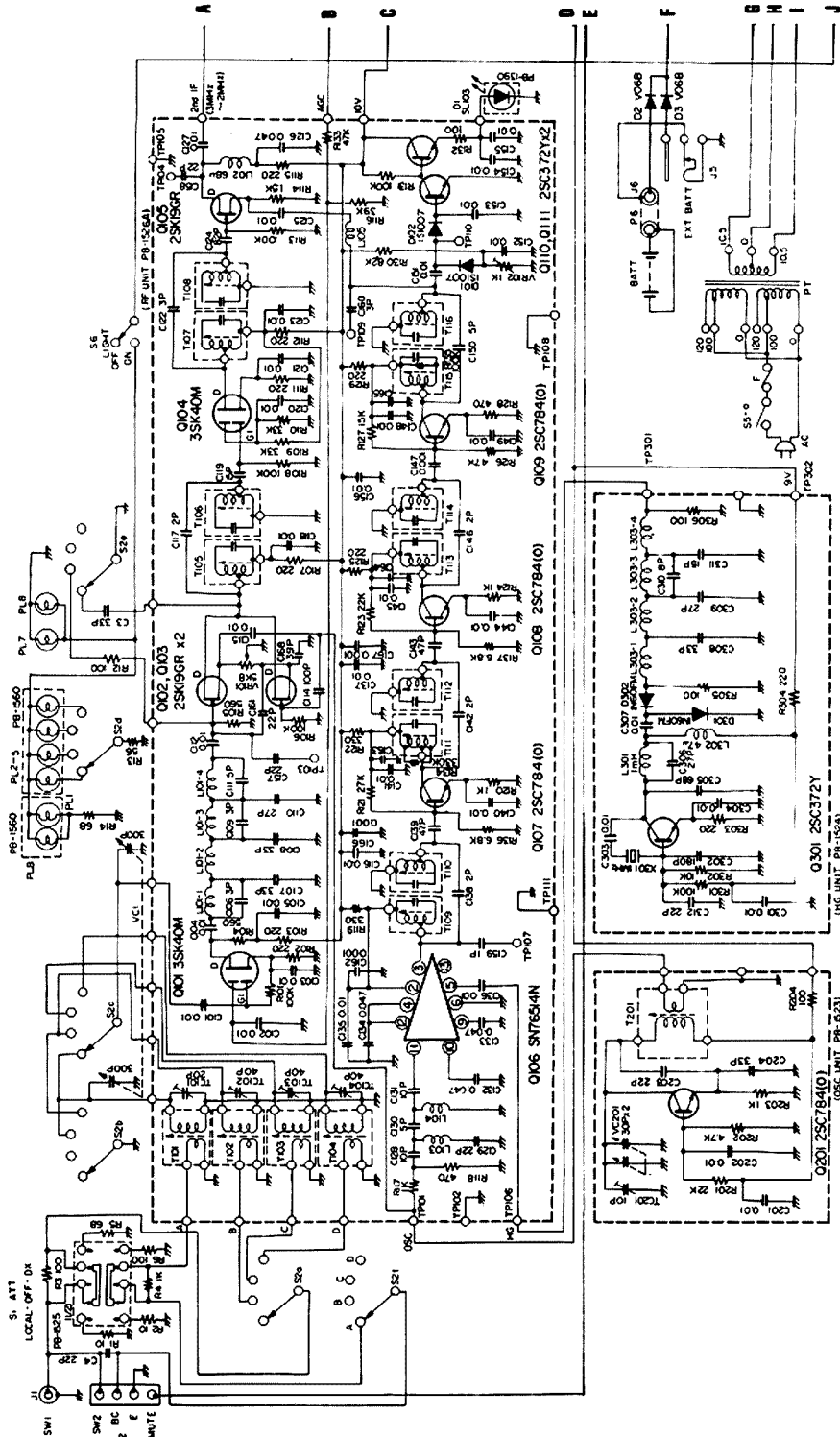

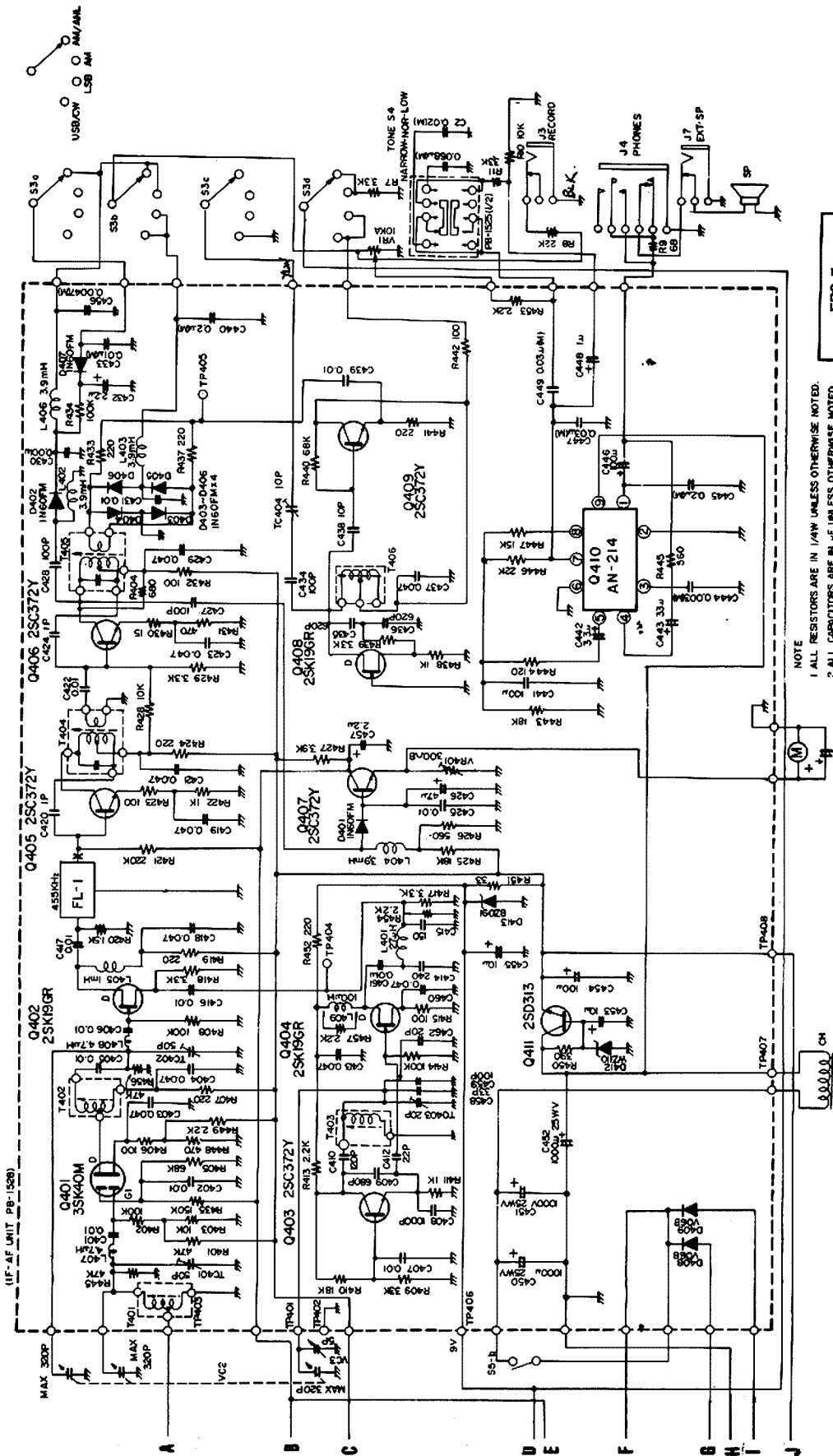

**FRG-7**  
**CIRCUIT DIAGRAM**

NOTE  
 1 ALL RESISTORS ARE IN  $\Omega$  UNLESS OTHERWISE NOTED.  
 2 ALL CAPACITORS ARE IN  $\mu$ F UNLESS OTHERWISE NOTED.  
 3 ALL ELECTROLYTIC CAPACITORS ARE MWV UNLESS OTHERWISE NOTED.

(IF AF UNIT PB-152B)



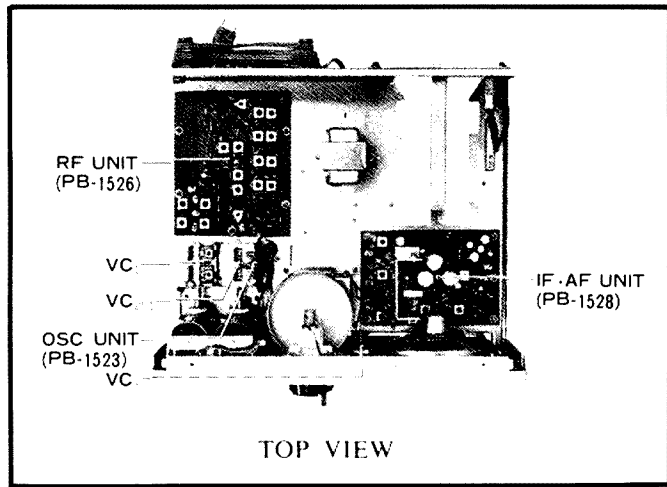
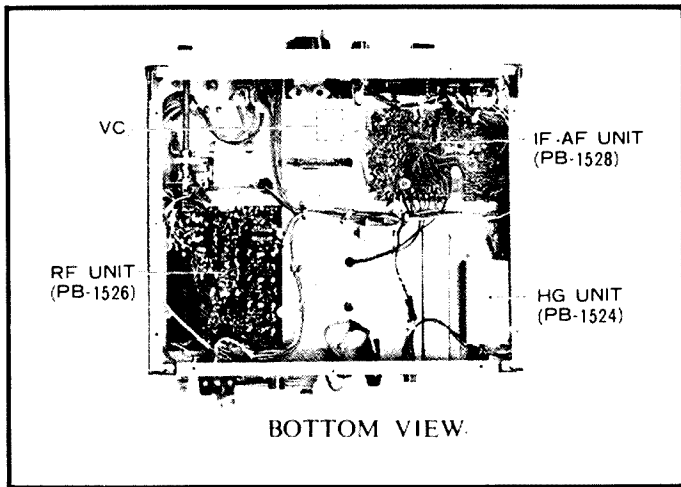

(continued from page 25)

PHOTOS 2 and 3 (above and left): Views of the FRG7 internally. HG unit — harmonic generator.

Later models of the FRG7 incorporated receiver incremental tuning (RIT). This feature consisted of a 5 pF variable capacitor wired in parallel with the main VFO tuning capacitor, thus providing a means of netting on stray stations in a net or for listening either up or down without shifting the main dial from a frequency required.

Like most receivers the FRG7 provides the listener with a headphone jack for private listening, together with a record

output jack for those wishing to preserve transmissions heard for posterity or perhaps to provide an amateur with an accurate appraisal of his transmissions. The output level is kept constant at 50 mV regardless of the setting of the FRG7 volume control.

In any receiving station the antenna is perhaps the most important tool to the SWL. The FRG7 will readily accept a balanced 50 ohm line for listening with an

antenna resonant at a particular frequency, or random wires may be connected via two terminals at the rear of the unit for use on Short Wave frequencies or for monitoring broadcast stations on Medium Wave. A MUTE facility is also provided to disable the receiver while transmitting.

The FRG7 includes a self-contained three-way power supply for 100/110/117/200/220/234 volts AC 50/60 Hz, an internal battery or external 12 Volt DC. If the AC power source fails, the unit switches automatically to an internal battery which uses eight UM-I cells. The receiver is ideally suited for home or portable use. To save battery consumption, the dial lamps can be switched off. Cells for the internal battery arrangement are not included when purchasing an FRG7.

For modifications to the FRG7 prospective or current owners are advised to read *Amateur Radio*, March, 1977, page 21, and *Amateur Radio*, March 1980, page 18.

For further information on the FRG7 contact Bail Electronics, 38 Faithful Street, Wangaratta 3677. Ph. (057) 21 6260 or any of their authorised distributors.

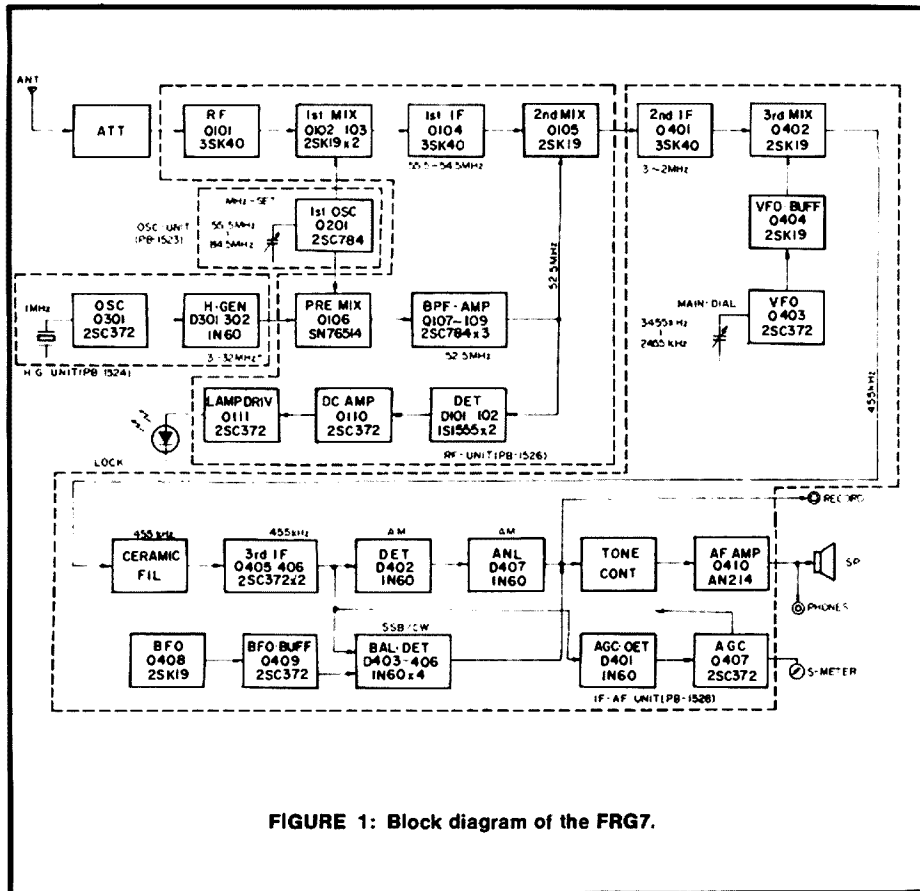

FIGURE 1: Block diagram of the FRG7.

## MORSE EXAMS

Candidates for morse exams are specially reminded that the morse sending or receiving of letters is not adequate in itself. There is a space of 7 dots between words and this has to be observed so that whatever is sent or written down should be in understandable composition English. Thus, to omit a space between two words is one error. Many errors could be recorded against you if, for example, in receiving morse, you write down a string of letters not separated into discrete words. This reminder is given to dispel any rumours to the contrary and to alert candidates to the official requirements.

# YAESU FRG-7 COMMUNICATIONS RECEIVER

The FRG is a precision-built high-performance communications receiver, providing coverage of the MF and HF bands from 0.5 MHz — 29.9 MHz. Its modern technology and convenience features bring you versatility and performance you'd expect only on much-higher-priced equipment. For many hours of satisfying shortwave listening, build your station around the FRG-7.



## RELIABLE PERFORMANCE

The Wadley Loop System (drift cancellation circuit), coupled with a triple-conversion superheterodyne system, guarantees high sensitivity with rock-solid stability.

## 10 KHZ DIRECT DIAL READOUT

The extremely stable VFO, equipped with a precision dial mechanism, permits 10kHz direct dial readout. Thus, you can preset the dial to the desired station with the assurance of being "on target". In addition, a line tuning control allows precise zeroing on stations under crowded conditions.

## RF ATTENUATOR

The selectable three-position RF attenuator is effective for minimizing interference caused by strong adjacent-channel stations. Choice of DX, LOCAL, or OFF is provided.

## EXCELLENT SELECTIVITY

The ceramic filters used in the FRG-7 guarantee sufficient bandwidth, while providing high selectivity for rejection of unwanted interference.

## ALL MODE RECEPTION

The FRG-7 allows reception of all commonly-used modes on the MF and HF bands: SSB voice, AM broadcast, and CW Morse Code transmissions.

## AUTOMATIC NOISE SUPPRESSION CIRCUIT

When impulse-type noise is experienced, the AM/ANL mode may be selected, activating the automatic noise suppression circuit, thus minimizing the offending noise during AM reception.

## THREE POSITION TONE SELECTOR

The audio spectrum in voice communications is limited to the range of 300 Hz — 2700 Hz. Broadening the audio bandwidth will introduce noise or other interference. The tone selector in the FRG-7 will limit the audio spectrum, thus increasing the readability of voice signals being received. The operator may select LOW (high cut), NORMAL, or NARROW (high and low cut).

## AC/DC OPERATION

The FRG-7 can be operated from AC, DC, or internal batteries (using optional battery holder). When more than one power source is connected, the FRG-7 will automatically select the most economical source. In addition, a front panel switch will turn off the front panel lamps to conserve energy. For portable operation, a line cord retainer helps maintain an orderly station.



# YAESU

# FT-720R VHF/UHF FM TRANSCEIVER

ADVANCED PLL TECHNOLOGY

## FEATURES:

### CHOOSE YOUR FAVOURITE BAND

The FT-720R Control Head may be used with either the FT-720V 2 Meter RF Deck or the FT-720U 70 cm RF Deck.

### OPTIONAL CONTROL BOX

The S-72 control box option will allow you to connect the control head the 2 meter RF Deck and the 70 cm RF Deck together, thus enabling you to choose the desired band is simply by throwing one switch!

### SCANNING

Fingertip controls on the microphone provide instant up/down scanner control. The scanner may be programmed to stop on a busy or clear channel, if you wish.

### FIVE MEMORY CHANNELS WITH PRIORITY FEATURE

As many as five memory channels may be programmed, for instant return to a favourite repeater or simplex channel. One of the memory channels may be used as a priority channel, as well and the microprocessor will then search between the priority channel and your main dial frequency!

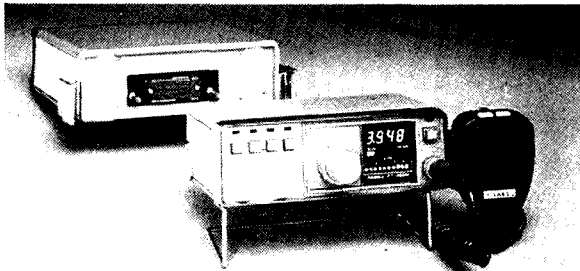

## SPECIFICATIONS:

	FT-720RV	FT-720RU
<b>Frequency coverage:</b>	144.00—147.99 MHz 144.00—145.99 MHz	430—439.975 MHz 440—449.975 MHz
<b>Synthesizer steps:</b>	10 or 12.5 kHz	25 kHz
<b>Power output:</b>	10 watts (RV model) 25 watts (RVH model)	10 watts
<b>Receiver type:</b>	Double conversion superheterodyne	Double conversion superheterodyne
<b>First IF:</b>	10.7 MHz	16.9 MHz
<b>Second IF:</b>	455 kHz	455 kHz
<b>Sensitivity:</b>	0.32 $\mu$ V for 20 dB quieting	0.5 $\mu$ V for 20 dB quieting
<b>Selectivity:</b>	$\pm$ 6 kHz (—6 dB) $\pm$ 12 kHz (—60 dB)	$\pm$ 12 kHz (—6 dB) $\pm$ 24 kHz (—60 dB)
<b>Power requirements:</b>	13.8 VDC, negative ground 13.6 VDC (RVH model)	13.8 VDC, negative ground
<b>Current consumption:</b>	Approx. TX 3.5A (RV model) TX 6.5A (RVH model) RX 0.5A	Approx. TX 4.5A RX 0.5A
<b>Case size:</b>	150(W) x 50(H) x 247(D) mm	150(W) x 50(H) x 247(D) mm
<b>Weight:</b>	Approx. 2.5kg	Approx. 2.5kg

Specifications subject to change without notice.

**BAIL ELECTRONIC SERVICES**  
**38 FAITHFUL STREET, WANGARATTA**  
 Telephone: (057) 21 6260 — Telex: AA 56880  
**DISTRIBUTORS AND AGENTS IN ALL STATES**

# A Look at the John Moyle Memorial Field Day Contest 1980

Peter Wilkinson VK6YW  
For the 2nd Busselton Scout Amateur  
Radio Club VK6TJ.

The 9th of February had arrived and we, the Second Busselton Scout Amateur Radio Club, should have been prepared for the John Moyle Contest. We had talked about the oncoming event but could not somehow manage to get things together; most members seemed to have problems of their own and the contest seemed so far away.

Alas, the day had arrived and nothing had been planned. The junior members would have to return to school on the coming Monday and it was uncertain if they would be able to camp out for the weekend. The weather in the south-west corner of WA had been very hot and a change was imminent.

On the Saturday morning some of the senior members met to see what could be done: with only a couple of hours to go we decided to try and get the Club operating portable. The lighthouse at Cape Naturalist would have been the ideal spot, but as the weather was changeable we decided that Signal Park, near the jetty, would be the better choice, with most amenities not far away. Signal Park was named from the old days when signals were sent to and from sailing ships tied up at the Busselton jetty.

We arrived at Signal Park, a mixture of cars, trailers, bicycles and tents, not to mention all the other bric-a-brac. It certainly seemed for a while that we would never get on the air. Ted Davies VK6ED and a junior member, Wayne, made up a G5RV and, after picking out two suitable trees, soon had the antenna up. Another member, Gordon Strong, positioned the 4 kW portable generator some distance away, whilst Terry Mitchel VK6ZAU and myself VK6YW were struggling with a tent. After erecting an old 23 ft. sailing mast, my newly constructed spider quad, then untried, looked very impressive lashed on the top.

The big moment had arrived and we were ready to go. The genny was switched on and the FT101E (which the Club was able to purchase after an extensive fund-raising campaign last year) burst into life. We were late starters and it was some time around 1700 hrs. when we received our first contact. Excitement was high and so was the wind, and a few drops of rain fell, but not enough to dampen our enthusiasm. In between gulps of tea and mouthfulls of biscuit we started logging the numbers. As this was an outdoor exercise we decided to let the public know of our efforts, and a sign was erected on the nearby road.

We were very surprised at the interest in our activity and spent quite a deal of time explaining to people about amateur radio and the event. I feel certain we have aroused some interest in would-be amateurs, apart from a considerable number of shortwave listeners who made themselves known to us. We had a surprise late in the evening when our local MLA, Barrie Blakie, stepped into the tent and passed some time with us. He was very impressed with all the action at hand.

Late in the evening the remaining junior members, Glen and Wayne, retired to their sleeping bags, while Ted and Terry carried on through the night, doing most of the operating. By 2.30 a.m. local time the bands were very quiet and very few contacts were made from then until morning.

The morning came with a very cold change and very little wind. I took over the operating and picked up quite a few contacts on fifteen and ten metres. It was very frustrating at times when some VK amateurs would come up and ask what the contest was about, and we lost extensive time explaining. We also felt disappointed in the number of WA participants. More people could have made the effort and participated. However the day progressed well, with junior members setting up our 2m channel 6 rig (converted car phone

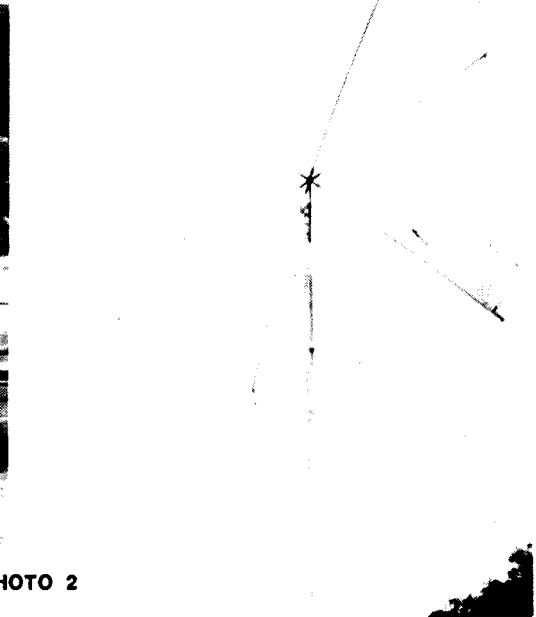

PHOTO 1 (above) shows a general view of the camp at Signal Park, while PHOTO 2 (right) gives a view of the Homebrew Spider Quad for use on 10 metres.

Terry had put together), which did manage to get into the repeater at Bunbury with a home brew beam lashed to my car. Although this was not used in the contest it was useful for having a chat with local amateurs and good practice for the junior members, who hope to sit for the exam this year.

We finished the last contacts with Terry using the spider quad and a converted CB rig on 10m which proved itself to be a very useful antenna in spite of the SWR which was about 3 to 1.

When the last contact had been logged and the guy wires loosened, all the members and some enthusiastic relatives gave a hand to pack all the gear away and clean up the area.



**PHOTO 3 (left):** Terry VK6ZAU operating on 10 metres with the Spider Quad about an hour before closing down. Roger Mularky is sitting in the foreground straining his ears.

Although our Club is small, with only seven or eight active members and although we knew we wouldn't win the contest, we all felt the exercise was worth while and as the rain began to trickle down our plans for next year were beginning to form. ■



Meanwhile, in the quiet surroundings at Whipetick Forest, about 15 km north of Bendigo (Vic.), Bob VK3BRL and XYL Barbara scored well over 1000 points in the six hour phone section.

At left, the site of operation showing the generator well away from the camp site and at night Bob notched up more points!



Further south, the Geelong Radio and Electronics Society made the 1980 John Moyle Field Day a family affair and managed to improve their score as compared to previous years.

The happy group (at left) after their most enjoyable family day.

## PENSIONERS

ONLY YOUR DIVISION CAN APPROVE RE-GRADING TO PENSIONER STATUS — PLEASE APPLY TO YOUR DIVISION IF YOU BELIEVE YOU CAN NOW QUALIFY.

# NOVICE NOTES



Edited by Ron Cook VK3AFW

The sharp-eyed reader will have noticed a change; this section of the magazine now has an editor. The aim is to include additional material specifically for the novice and other newcomers to amateur radio. It has been suggested that up to one-third of the readers of AR have a novice licence or have been involved in amateur radio for less than two years. Although much good material for these readers arrives in the AR mail there is an unsatisfied demand for simple articles on specific topics. Often we have heard "Why don't you guys (on the Publications Committee) write an article on topic X or topic Y?". Until the recent re-organisation of the AR production team there simply was not enough time.

Of course no one person, especially this editor, can write on all topics. Readers' contributions are therefore still required for this column. Indeed they are vigorously encouraged.

Topics to be covered in the coming months will include: building and using simple test equipment; small base and mobile antennae; the truth about VSWR. These articles will include readers' contributions, some theory not given in common texts and some constructional details.

Now that the introductory comments have been completed let us commence. To prepare the ground for following articles we start with a discussion on construction of simple equipment.

## BUILDING YOUR FIRST PROJECT

### What to build

For your first project it is obvious that you must choose something simple. A small Dick Smith kit would be a wise choice. Next a more complex kit such as one of the Josty Kits from Vicom. You can then proceed on to making up items described in this magazine and perhaps eventually build your own transceiver. Remember the acorn and start small.



PHOTO 1: The handyman's shadowboard. A place for everything and everything in its place.

## THE WORK AREA

Before commencing you must organise a clear working space. Initially you will only need an area about 1m by 0.5 m. This may be a workbench or the kitchen table. I have used a folding card table on occasions. It is wise to cover the work area with a sheet of rubber or linoleum or even several sheets of newspaper. This prevents damage to the equipment and the table. A comfortable stool is also required. An ordinary chair is too low and will cause back ache. The stool should for preference have a back for support and be of such a height that your lower arm is horizontal when working at the bench.

An untidy work area is a source of frustration and can cause accidents. The only way to keep the area tidy is to have a storage place for all tools and parts and to return everything to its right place at the end of each session. Hand tools, particularly those with cutting edges, are better hung on a "shadow-board" rather than being tossed on the bench or even in a drawer. Cutting edges are easily blunted by contact with other tools. Photo 1 shows a handyman's shadow-board. The tools are hung from nails driven into a vertical sheet of chipboard or heavy plywood. The outline of the tool is drawn on the board after giving the board a coat of white paint.

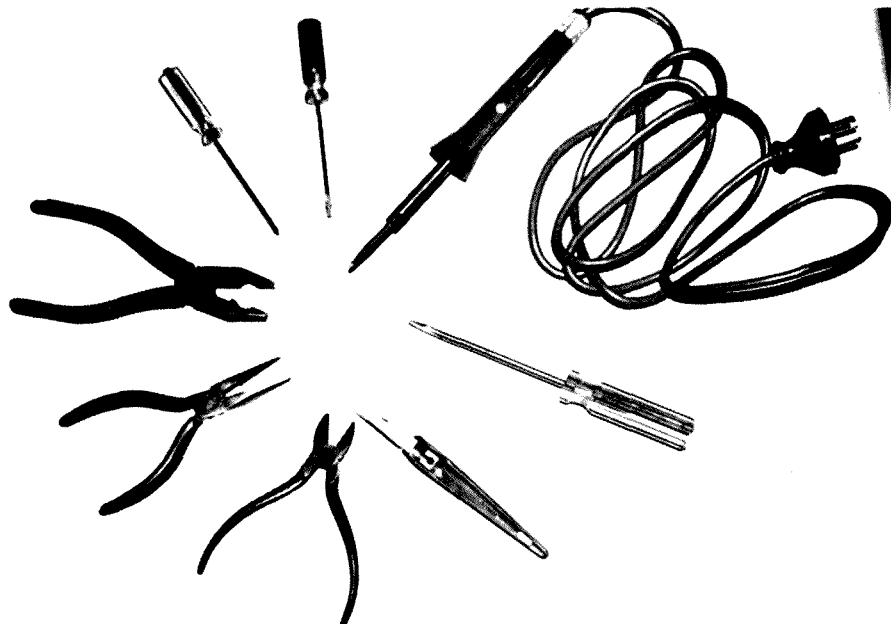

PHOTO 2: Hand tools for the beginner.

This is invaluable for locating missing tools and for helping in replacing tools in the right place. Although the lines are not visible in the photograph they are there. If you wish, the area enclosed by the line can be painted in a dark colour to produce a "shadow" of the tool.

### TOOLS YOU WILL NEED

Now what tools will you need? Photo 2 shows the minimum requirement for most kits. Starting at 2 o'clock and proceeding clockwise we have a soldering iron (see later), a medium sized screwdriver (5 mm

soldering is most important. Perhaps the most common faults in otherwise properly assembled circuits are "dry" or electrically open joints and unwanted solder connections called "bridges" or "tracks" between adjacent conductors. If you have not had any experience in soldering get some practice before going any further. Twist two bare copper wires together for about 20 mm and practise the technique described here. Cut the joint out, retwist the wires together again and resolder. Repeat until you can make a satisfactory job.

In the right-hand corner the old champion of thermionic valve days, the Scope quick heat iron. It has a rating of about 120 watts and is useful for heavy duty electrical work such as soldering to a steel chassis. It can also be used to peel off the copper track from printed circuit boards if you want to remove a link.

The soldering iron tip must be kept clean at all times. This can be done by firmly wiping the tip on a moist sponge before and after making each joint. The practice of dobbing a little solder on to the tip and then flicking off the excess is wasteful and messy.

There are two types of tip, one is solid copper and the other is plated steel or plated steel and copper. Plated tips must not be filed. If an oxide layer builds up on a plated tip this may be removed by wiping on a fine plastic scourer made for cleaning saucepans.

Solder will gradually dissolve a copper tip but not a plated tip. Savbit is a resin cored solder with copper added to reduce this action. When the copper tip becomes concave or pitted it should be "dressed" or filed to restore the flat chisel faces. A single-cut 6 in. file is suitable and available at most hardware stores. Don't forget to buy a handle. After dressing the tip it should be "tinned" by allowing it to heat up and then melting a little solder on to both tip faces.

### SOLDER

Never use liquid soldering flux or soldering paste on electrical work. They are corrosive and they will produce as much corrosion as if you washed the circuit in battery acid. The stick of solder in the centre of Photo 4 is suitable for the plumber but not for you. The two spools contain 60/40 multicore solder. This is a solder with 60 per cent tin and 40 per cent lead around a core of resin flux. It is the most versatile solder for electronic work. Although it is more expensive I prefer the thinner solder for printed circuit work because it produces a neater joint and less tracks.

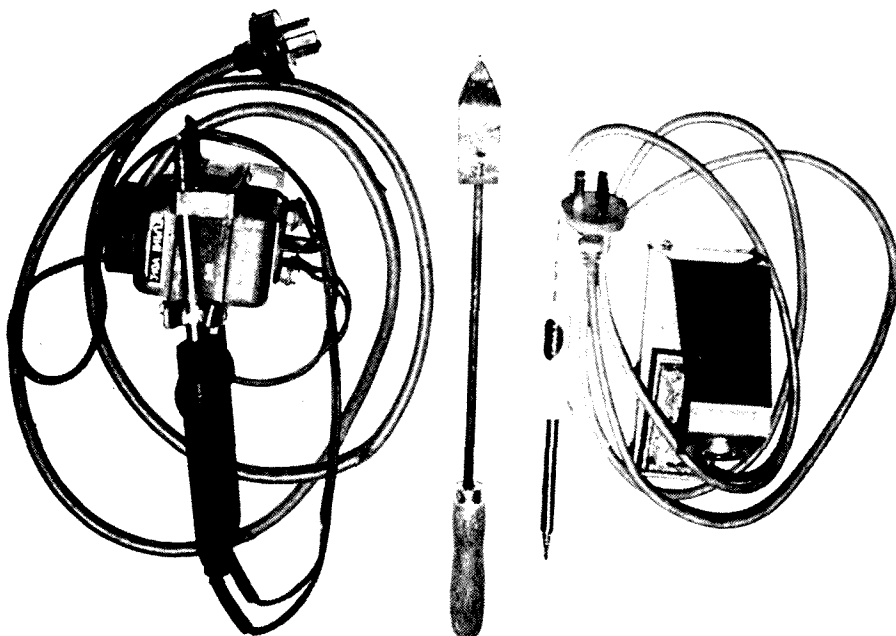

PHOTO 3: Soldering irons for transistors, leaky gutting and valve wiring.

blade), a sharp knife, small side cutters (15 mm cutting edge), small long nose pliers (25 mm jaws), Philips head screwdriver (3 mm blade), small screwdriver (2.5 mm blade).

### GETTING READY

Before starting, read the instructions carefully at least once. Omitting this simple and obvious step may cause much grief later. Check that you have all the parts required. For some kits a little drilling and other mechanical work is required — this should be completed before any wiring commences.

Sort out the components so that they are easily located when required. An egg carton is a very useful temporary storage bin for capacitors, resistors, transistors, etc. If you are unsure of the coding used for resistors and capacitors check your copy of the ARRL Handbook or a Dick Smith catalogue.

### SOLDERING

Most electronic circuits use components soldered on to a printed circuit board. As the solder provides both electrical and mechanical connections the quality of the

### THE SOLDERING IRON

The choice of a soldering iron is an important matter. A small 25 watt electric soldering iron with a 1.5 to 3 mm wide chisel tip will be the most useful. Photo 3 shows three different types of soldering iron. The iron on the left is a temperature controlled type complete with stand and wiping pad. The advantage of this type is that it provides just enough heat, and no more, to melt the solder even if the type of joint varies from hair thin wires to tinfoil. It is really equivalent to having a 10 watt and a 20 watt and a 40 watt and a 60 watt iron, all in one. In fact the performance is better than having all four separately. If your budget is fairly elastic this type of iron should be seriously considered.

The iron in the centre of Photo 3 is a plumber's delight. It is heated on a blow-lamp and used to solder water tanks and car radiators. If that is what you want then that's fine, but don't use it, or anything that looks like it, on printed circuit boards. Even the fibreglass laminate boards are not plumbers special proof.

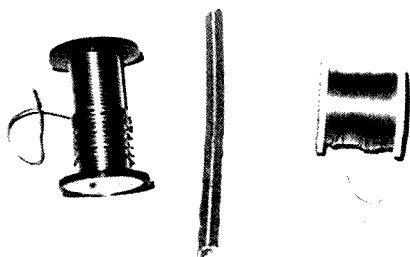

PHOTO 4: Three types of solder commonly used in radio applications.

## SOLDERING TECHNIQUES

1. Check that the surfaces to be joined are cleaned and bright. If the surface is dull and oxidised rub gently with a hard ink eraser until it is shiny.
2. Carefully bend the lead of the components to be mounted with a pair of long nosed pliers so that the leads fit properly through the holes in the board. It is good practice to align the colour bands of resistors in a top-to-bottom and left-to-right orientation and to arrange other parts so that their value may be readily seen when fitted to the board.
3. After poking the leads through the holes, bend them to an angle of about 45 degrees to hold the part in place.
4. Check that you have the right part in the right place. If not you will very soon have to buy a de-soldering tool.
5. With the iron hot and the tip clean bring the tip of the iron into contact with both the copper track or pad and the component lead.
6. Quickly touch the solder wire to the lead and pad near but not touching the iron tip. If the solder does not melt within two seconds touch both the iron tip and the lead. As soon as the solder melts withdraw the solder and then the iron. Use the solder sparingly.
7. Do not touch the part or joint until the solder has properly solidified. The solder should have a smooth shiny appearance and the surface should make tangential contact with the copper pad and the lead wire. If the surface has a cracked or frosty appearance or is blob-like and has not wet the surfaces of the joint then it must be reheated until the solder melts and a little fresh solder applied. If this does not work the joint was probably not clean or was moved while cooling.
8. Cut off the excess lead wire with the side cutters.

## ASSEMBLY

It is assumed that the first project requires little in the way of mechanical work. (This will be covered at a later date.) Mount any switches, potentiometers, etc., and connect the interconnecting wires as follows. The knife can be used to remove 5 mm of insulation and a 120 degree hook formed with the pliers. The hook can be passed through or around the terminal and squeezed tight with the pliers. This squeezing should be omitted if you intend to remove the wire on occasions, but remember that solder should not be relied upon to provide a strong mechanical joint. As a last point check that all parts are correctly wired. Swab off the resin with methylated spirits.

## TESTING

Refer to the instructions for setting of the controls. In the absence of instructions or any obvious setting indicated by the cir-

cuit set the variable controls to mid-point. Connect the battery or plug the power cable in and switch on. If you have followed the guidelines in the instructions and these notes then there should be no signs of stress such as smoke, flames or frightful noises. In fact the set should show all the symptoms of a well behaved whatever-it-is. In later issues we will discuss fault finding. Hopefully you won't need to know about them for a while.

In the next issue we will continue with advice on building your own equipment. ■

# VHF-UHF

*An expanding world*

Erio Jamieson, VK6LP



Forrester, S.A. 5233

## VHF/UHF BEACONS

Freq.	Call Sign	Location
50.005	H44H1R	— Monlira
50.020	GB3SIX	— Anglesey *
50.023	HH2PR	— Haiti
50.025	6Y5RC	— Jamaica
50.035	ZB2VHF	— Gibraltar
50.036	HC1JX	— Quito
50.038	FY7THF	— French Guiana
50.040	WA6MHZ	— San Diego
50.048	VE6ARC	— Alberta
50.050	ZS3E	— South West Africa
50.055	ZL1UHF	— Auckland
50.060	PY2XB	— Sao Paulo
50.070	YV5ZZ	— Caracas
50.070	VP9WB	— Bermuda
50.080	W1AW	— Connecticut
50.080	T12NA	— Costa Rica
50.085	WA6JRA	— Los Angeles
50.088	VE1SIX	— New Brunswick
50.089	WD4CEI	— North Carolina
50.100	KH6EQI	— Pearl Harbour
50.104	K4EJQ	— Tennessee
50.105	KC4AAD	— McMurdo, Antarctica
50.110	KH0AB	— Saipan
50.110	AL7C	— Anchorage
50.120	4S7EA	— Sri Lanka
50.144	KC6IN	— Ponape, Caroline Is.
50.498	5B4CY	— Cyprus
51.999	YJ8PV	— New Hebrides
52.200	VK8VF	— Darwin
52.250	ZL2VHM	— Palmerston North
52.300	VK6RTV	— Perth
52.330	VK3RGG	— Geelong *
52.350	VK6RTU	— Kalgoorlie
52.400	VK7RNT	— Launceston
52.440	VK4RTL	— Townsville
52.450	VK2WI	— Sydney
52.500	JA2IGY	— Mie
52.500	ZL2VHM	— Palmerston North
52.510	ZL2MHF	— Mt. Climie
52.800	VK6RTW	— Albany
52.900	VK6RTT	— Carnarvon
53.000	VK5VF	— Mt. Lofly
144.010	VK2WI	— Sydney
144.162	VK3RGI	— Gippsland
144.400	VK4RTT	— Mt. Mowbrall
144.475	VK1RTA	— Canberra
144.500	VK6RTW	— Albany
144.600	VK6RTT	— Carnarvon
144.700	VK3RTG	— Vermont
144.800	VK5VF	— Mt. Lofly
144.900	VK2RTX	— Uiverstons
145.000	VK6RTV	— Perth
147.400	VK2RCW	— Sydney
432.400	VK4RBB	— Brisbane

\* Denotes new listing.

At last we can confirm official operation of the Geelong beacon on 52.330 from **Mt. Anakie** with 25 watts to stacked cross dipoles, using the call sign **VK3RGG**. The Geelong boys have waited a long time for official sanction for the use of the beacon and I was pleased to receive a telephone call from Darrell **VK3AQR** recently confirming the news.

## A DECADE ON VHF

The first part of the article appeared in the June issue, and already I have received some favourable letters from readers. I thank you for writing, and hope the second part will also be of interest to you. For those of you who often wondered what I looked like will now have some idea after viewing the front cover photograph of the same issue; I guess most of you will be disappointed!

The article has already brought forth a QSL from **John VK4ZJB** for our first QSO on 6 metres, which took place on 10-11-63 on 50 MHz (we were allowed to operate on that part of the band then), his transmitter was the famous SCR522 and receiver a 6BQ7 converter to a BC312. Thanks, John. I do wonder, though, what other memories the article may have stirred. Should any of you feel disposed to write after reading the second part then I would be pleased to hear from you.

## A LITTLE BIT FROM VK4

Enclosed with the **VK4ZJB** QSL card was a short letter from John, which gives some interesting snippets of information regarding contacts on 6 metres over the past 12 months or so, interesting because they are so different from what we in the south work, and should be of interest to many despite the obvious long date line. I make no apologies for printing it!

20-11-79, made reluctant trip to QTH 30 km north of Brisbane, switched on and worked **H44PT** for first 6 metre **VK4-H44** QSO. Then on 31-3-79 worked 5 overseas countries, three of which were his first to those areas. **P29** and **JA**, then first to **HL9TG**, **KH6IAA** and **KG6DX**. John says the 6 metres was good enough into Guam for it to be relayed via 2 metre link north to Saipan, but no 6 metres there! Joe **KG6DX** apologises, John literally cries!

20-12-79 received a Christmas present from **JARL** for **JCC/100** cities award for 52 MHz (not bad for a Channel 0 area). 6-1-79 **YJ8ZV** and **FK8AB**. 22-12-79, after waiting almost 20 years, landed two **ZL4s** on 52 MHz! They also worked **VK4PU** and **VK4ZGI**. 4-4-79 worked **W6XJ** for first mainland US contact. 9-10-79, whilst mobile worked **KH6NS** 5 x 9 both ways. 13-10-79 magnificent **JA** opening, worked all areas 0 to 9 twice in 6 hours.

25-11-79 listened on 50 MHz 0700 Old. time. Band from 50.1 up was chock full of **Ws**, mostly 5 x 9. Heard both ends of **ZL1AVZ** to **VE1ASJ** contact on 50.110. (No Channel 0 programme at time.) A **W4** was enticed to try 51.100 but nothing heard, **MUF** just not making it to 52 MHz. Heart-

break! VK4PU and VK4ZGI, etc., all going around the bend hearing this on 50 MHz! Whoever says 2 MHz is not important!

Judging by the fact there are no late dates mentioned by John it seems very little of real importance occurred during the autumn equinox even in the Brisbane area, so next spring will probably be our last hope for another 11 years or so!

### SIX METRES — IT'S QUIET!

Because the VHF bands have been generally quiet after so much activity during 1979, especially quiet in the northern hemisphere it seems. It would therefore appear to be an appropriate time to let you read the lead article from Bill W3XO of "QST" and "The World Above 50 MHz". This article is written by Jim Stewart WA4MVI, who is the holder of WAS on 2 metres, and whose thoughts I am sure you will find interesting and thought provoking.

"World-wide DX on 6 metres again became a reality during the fall of 1979 as the long awaited sunspot maximum provided amateurs with rare ionospheric conditions not substantially present for 20 years. The 'old-timers' who were around during the last such glorious time, 1957-58, still remember those years as truly remarkable. Many comments are heard these days that 'Yes, 6 metres is good now, but you should have been on in 1957 . . .'.

"Those were good years for amateur radio and VHF activities. Talk filled the air of tracking the first space satellites, the International Geophysical Year (IGY) project, the first QSO via EME on 144 MHz. 6 metre DX and the relatively new technique of meteor DXing. A good 6 or 2 metre beam could be had for just over 10 bucks. As solar activity exceeded 200-year records, more and more amateurs discovered VHF DX. Contest scores soared, as did the ham population itself. Many achieved WAS and WAC on 6. Europe was worked from the western US for the first time, and the eastern US to Europe QSOs became familiar. The more skilled participants knew that if these DX conditions repeated themselves, it would probably be many years in the future.

"Ionospheric propagation via the F2 layer seldom takes place at 50 MHz except during very high solar maximums which occur about every 11 years. There is evidence now, however, indicating that some events show more correlation with a 22 year cycle and the best DX may very well re-occur with this interval. VHF band conditions were remarkably similar during 1957 and 1979, and less spectacular during 1947 and 1968.

"Modern studies of the sun began around 1610 AD when the invention of the telescope led to the discovery of sunspots. However, talk of these imperfections on the solar disc was quite unpopular in those days because of religious beliefs. Thus, we are uncertain of the accuracy of sunspot records until approximately 200 years ago, when the existence of 11 year cycles was

observed. In recent times, interest in these cycles grew more intense when it was realised that the quality of radio transmission over long distances was related to solar activity. It soon became apparent also that DX conditions seemed to recur with the 27 day cycle, corresponding to the rotation of the sun. At some future time we may be able to say beyond any doubt that the best VHF DX conditions appear on alternate cycle peaks.

"The writer has observed the sun since the beginning of the present cycle by both optical and radio means. Careful analysis of daily records, along with WWV information, enable one to predict the recurrence of monthly events and gain some insight into the mysterious relationship between solar events and DX.

"It appears that our present cycle may have peaked on 10th November 1979. On this date WWV reported a 10.3 cm flux level of 383, and 144 MHz solar noise here at WA4MVI was the highest ever observed. Photographs made on this date show an extremely rare white light prominence associated with intense solar storm activity. Peak monthly 10.3 cm flux values for late 1979 were 232 for August, 233 for September, 242 for October, 383 for November and 247 for December.

"Careful study of band conditions during 1979 shows remarkably similar characteristics to those of 1957, and if the declining portion of the cycle is similar, we may be able to predict with some degree of certainty what may be in store on the bands in the months to come. During both 1957 and 1979, DX got under way by mid-October and peaked in November, with a slight decline in December. Both cycles saw early fall paths very good between the north-eastern US and Europe. As November arrived, the Europeans worked further west and JA contacts spread from the West Coast to the Midwest and parts of the East. The winter of 1958 saw openings shifting to more southerly paths between Africa and south-eastern US and from the western States to Australia and New Zealand. As winter turned to spring, north-south paths became more frequent. Summer days were somewhat quiet with little F2 or Es. During mid-October F2 again re-appeared much as in 1957, although not quite as frequently or widespread. North-south paths remained good for several years and auroral became intense, frequent and widespread.

"The spring of 1980 produced good north-south openings for the southern tier of States, along with some good opportunities toward ZL and VK. Again, the similarity with corresponding months in 1958 is striking. Very good tropospheric conditions could again appear during the summer and fall of 1980 as solar activity may indirectly cause weather patterns to move lazily across the country, allowing stagnant air masses and temperature inverted layers to form.

"The summer and fall of 1979 and 1957 saw remarkable tropo openings on 144

and 432 MHz. The tremendous opening last September will long be remembered. A new 'mode' of propagation on 144 MHz appeared during 1979 between Texas and Florida, with characteristics sounding much like aurora. A similar mode was described back in 1957! Sporadic E short skip was said to be off during 1957 and 1979. While it is still too early to characterise the 1980 Es season, we may be able to show in future years that this mode is poorer during years of high solar activity than in low sunspot years.

"These have indeed been unforgettable times for the VHF world, and they may not be equalled again for many years. If this writer's suspicions are correct, namely that the 22-year cycle is the key to the re-appearance of F2 sufficiently intense to cause widespread 50 MHz openings, then the fall and winter of 2001-2002 may be the time to watch!

"Special thanks to W4AIM and W4YIU for their assistance in obtaining past records of DX and solar activity. I hope that most of us will be around by the year 2000 to partake of whatever Old Sol has in store for us . . . Jim."

### NEWS FROM BRAZIL

Gil VK3AUI passes along a letter from Rolf PY1RO dated 15-4 which, as elsewhere, indicates quite a dramatic falling off in six metre openings from that country. Es still exists from LU and ZD8, and TE only to 5B4 and ZB2. Rolf says the F2 is the big illusion and while the EUs work into ZS every day, there is no propagation from PY to either Eu or North America. But PY2XB had a 2 minute opening to ZL1MQ on 13-4 via Europe at 2155Z.

Dedication does pay off at times, as indicated when Rolf finally worked KG6 at 1 a.m. local time, after monitoring the band for something to happen for more than three hours. Opening lasted only five minutes and he worked KG6JKS and KG6DX within two minutes and heard nothing else. Maybe Rolf will hear more when he completes building that new 34 metre tower!

Gil VK3AUI gave me a list of the JAS he worked through February, March and April, additionally KH6EQI heard on 10-4, and KX6 heard weakly on 13-4 at 2345Z. XE1GE worked split frequency 0004Z on 14-4, at 0019Z Geoff peaked to S9 + 20 dB! On 20-4 3D2DB and KH6EQI both heard briefly, same time observed the KH6 to ZS contacts monitored on 28.885, but nothing heard in VK despite signals being beamed there. Thanks, Gil.

### CAIRNS ON VHF

Ted VK4YG has written to say that on 7-6-80 the Cairns WICEN assisted the local SES with VHF communications using the Cairns Amateur Radio Club's repeater VK4RCA in a search operation for a missing bushwalker on Mt. Bartle Frere (5280 ft.), which is next door to their repeater on Mt. Bellenden Ker (5200 ft.). In spite of dense tropical rainforest, which is very



hard on VHF signals from low power hand-held equipment, communication was achieved between Brian VK4AAU/P with the rescue group and mobiles VK4ACZ (Ron) and VK4YG (Ted) and WICEN control at VK4HM, the Club stations being operated by Mike VK4AMO, and several vital messages were handled. Good work.

Ted also mentions on 17th June from early afternoon until late evening local time **P29CC/P (Danny)** using a 4 element yagi was able to work through the Cairns repeater VK4RCA from Mt. Hagen in PNG — the site understood to be a microwave installation and altitude 11,200 a.s.l. Danny's signals held up to good strength right throughout the opening and he worked many fixed and mobile stations in the repeater service area. Distance about 690 nautical miles, so who has done better than that in VK4? Danny also stated a 2 metre repeater on Ch. 1 was proposed for the site, running about 20 watts.

Whilst talking about the Cairns repeater, Ted advises it will probably change from the present Ch. 7000 to 6950 some time in August, bandplan agreed, to overcome an interference problem with Mackay and Port Moresby on the same channel. The Cairns repeater has such good coverage it is deemed advisable to shift to some other channel.

#### **NORTHAM NEWS**

**Tony VK6BV** has been on annual leave, but sends a few jottings, mainly that ZL video on 45.250 was heard each day up to 8-5 from 0000Z for about five hours, then nothing heard since then. JAs on 3-5 and 4-5.

Included were a few points from Wayne VK6WD. **5Z4YV** ex JA2KTL operating from 1-5 on 6 metres using IC551 to 5 element yagi. **I5TDJ** Pete has permission to operate 50.000 to 50.500 for six months from May. **SV1DH** has permission to operate on 50.150 with the call sign of **SZ2DH**. The **GB3SIX** beacon on the island of Angelsea on 50.020 is now operational with 20 watts to a 3 element yagi beaming west, on air hours are 0000 to 0730Z daily. Thanks for the continuing news, Tony.

#### **GREEK TE PROPAGATION STUDIES**

**Steve VK5AIM** sends a copy of an article in "The Short Wave Magazine" which should be of interest to those who study propagation and I quote:

"Your scribe had a long talk with **Charlie Newton G2FKZ**, recently returned from a trip to Greece, where he met **Costas Fimerellis SV1DH**, one of the keen researchers into 'Transequatorial Propagation at VHF/UHF'. Charlie was manning the RSGB Propagation Studies stand and played a fascinating recording of the pulsed 28 and 144 MHz signals from Africa as received in Athens. **SV1DH** now has Greek Government backing for this investigation into what part of the ionosphere carries VHF signals over such long distances and is making this TEP study the basis of his Doctorate degree.

"Obviously, extreme accuracy is vital if any firm conclusions are to be made. To this end the 2 metre and 10 metre beacons **ZE5JV** at Salisbury are keyed simultaneously in phase with the atomic time standard in Pretoria. The time delays of the arrival of the signals in Athens are 30-plus milliseconds, this interval being measured by reference to the atomic time standard of the Mediterranean LORAN chain.

"The multi-path, Doppler-spread signals sound semi-auroral and a definite time pattern has been observed. It is possible to follow the paths of the heavily ionised blobs as they track across the Indian Ocean, the African continent and finally over the Atlantic Ocean. Indeed, so predictable was this progression when Charlie was with Costas, that **SV1DH** showed Nigerian TV on 62 MHz received on a domestic set with whip aerial at just the right time."

So there you have it. Isn't it nice to see a government backing an amateur with his studies into propagation, if this brings forth information showing predictable trends in VHF propagation it will be a great step forward.

#### **GIBRALTAR TO JAPAN**

Further to my brief mention last month it now seems quite definite that on 10-4-80 between 0010 and 0025 **ZB2BL** completed 6 metre contacts with **JA1BK**, **JA1TGS**, **JA1PVI** and **JA2GHT**. Signals ranged from 579 down to 439 as the end of the opening approached. Antennae at both ends were aimed long path or over the pole. Again, so much for having 50 MHz! Thanks to **Bill W3XO**.

#### **NATIONAL VHF FIELD WEEKEND**

The Geelong Amateur Radio Club has decided to sponsor a field weekend to encourage summer-time portable VHF operation. The weekend has been tentatively arranged to coincide with the start of the Ross Hull, using the scoring and rules of that contest. A log of the best 12 hour segment of the first 48 hours of the Ross Hull Contest will count for individual State winners. Each portable station submitting a log will receive a card. Further details next month.

It is hoped this Contest will receive some good support, the last time such an effort was arranged was in VK5 some years ago, but at the time all anyone could think about at the time was repeaters, so after a few years it fell flat. Today, however, I believe people generally have rationalised their thinking in regard to repeaters and have encompassed it as part of their general operating, where it serves a good purpose. With so much equipment now in shacks operating on 12 volts it is likely more gear would be available for portable operation.

From the shack of **VK5LP** I would like to make a suggestion which might help to get more participation in this or any other Field Day type operation. Normally such

operation assumes equipment will be powered from batteries or an alternator. Unless you own your alternator, they are not very readily available, and as they are generally hired out on a so-much-a-day basis, if you have to pick one up on Friday, use it Saturday and Sunday, return it Monday, you will probably be charged for four days, and this can be expensive, apart from the inconvenience of perhaps having to travel 20 or more miles to get and return the thing! Personally, I cannot see anything wrong with an operator also being allowed to take his own equipment away from his property to either a remote location, or at least some location not being the shack of another operator, and connecting to the 240 volt mains if available. It seems to me there are such sites where two-way radio installations operate from hilltops, beacon sites, country dairies, pumping stations, etc., all provide a means for some operators to go out and work a field day operation. By suggesting away from another shack this ensures that someone just does not pick up his gear, travel to his mate's place, plug it in and use his antennae. The portable operator would at least have to do something about an aerial installation, the fact that he may have the assistance of mains operation is not so important when one considers the very wide distribution of power these days. Give it some thought, boys, it won't suit the purists I know, but it may get more to go out and thus ensure the success of the field day!

#### **OSCAR PHASE 3**

It was certainly an unfortunate demise for the Oscar Phase 3 satellite launched from French Guiana on 23-5-80. The rocket went out of control after the first stage had trouble with one of its four rockets not igniting, and the whole thing had to be destroyed. Over \$100,000 in AMSAT finance was lost, and it may be up to three years before a replacement can be built. I assume therefore that any donations to further the project would be gratefully received.

#### **TWO METRES**

The 2 metre band hasn't been entirely dead, not for **David VK5CK** from his prime location at Piccadilly in the Adelaide hills. He's the voice "on" the hill, I'm "in" the hills! David started out real early on 2-6 at 0608Z and worked **VK3QG** and then continued a long stint on the band, ending at 1539Z with **VK3BNU** at 5 x 9, so the band was still open! In between he worked **VK3ZL**, **VK3ZHP**, **VK3ADR**, **VK3YUZ**, **VK3BEH**, **VK5ZCP** (Penola), **VK3XQ**, **VK3ZBJ**, **VK3BHS**, **VK3YNB**, **VK3ZIW**, **VK3BWC**, **VK3YRY**, **VK3NM**, **VK3DKC**, **VK3BAR**, **VK3ZY**, **VK2DAB** (Griffith), and **VK3UV**. Most of the signals were 5 x 9, but very few were audible at **VK5LP**, those that were were very weak. On 5-6 David worked **VK3YL**, **VK3ZHP**, **VK3ZL** and **VK3BNU** from 1113Z. He had another ball on 22-6, starting even earlier with **VK3UM** at 0400Z 5 x 6, closing at 1237Z with

VK2BXD in Griffith. In between contacts were to VK3ADR, VK3YNB, VK3ZBJ, VK2YEZ (Griffith), VK3BHS, VK3AXV, VK3AFW, VK3BEH, VK3BKF and VK3BNU. The Orange Ch. 8 repeater is heard from time to time just for good measure!

The above effort means David has had contacts with 28 different stations in three stints of operating, but generally the signals from interstate do not reach the Adelaide area at any strength. When they do Col VK5RO works them! David keeps skeds each week with Les VK3ZBJ on Mondays and Thursdays at 1300Z on 144.040, and despite the 400 mile path has been having considerable success in making contacts.

### SERG CONVENTION

The South-East Radio Group Convention held over the Queen's holiday weekend in June at Mt. Gambier attracted a large attendance of amateurs, mainly from VK3 and VK5. The weather turned sour to provide one of the wettest conventions in its 14 year history, but this did not dampen the spirits of the gathering, and all contests and competitions were held with some cars becoming bogged. Winner of the SERG trophy for the contest, gaining the most points throughout the convention, was Bevan VK5TV, who enters everything possible and was a well deserved win.

The SERG are to be complimented on the continuing success of their convention, and the large measure of support from both States should ensure its success in the years to come.

### CLOSURE

I hope that next month I might be able to find enough time to include some information on the proposed "Locator Squares" system of locality identification for this country. The locator is widely used overseas, particularly in Europe, and contests are even conducted trying to work as many squares as possible.

In the meantime, I close with the thought for the month: "Don't be afraid to take a big step if one is indicated. You can't cross a chasm in two small jumps."

73. The Voice in the Hills. ■

## AMATEUR SATELLITES

R. C. Arnold VK3ZBB

### PHASE III

Phase IIIA satellite is now just history and unfortunately lying at the bottom of the ocean. It is obviously a great disappointment to AMSAT and the many satellite operators around the world, particularly as its demise was no fault of the dedicated band of constructors and volunteers who prepared the satellite for launch.

The following joint ESA-CNES press release describes the sequence of events following the launch:—

**Ho + 3.3 sec:**  
Launcher lift-off.

**Ho + 4.4 sec:**  
All four engines function nominally up to this instant.

**Ho + 4.4 sec to Ho + 6 sec:**  
Chamber pressure of engine "D" begins to fluctuate by  $\pm 4$  bar, finally oscillating at an amplitude of  $\pm 11$  bar at a frequency above 1000 Hz; on the films, this anomaly shows up as a yellow colouring. The mean chamber pressure remains nominal.

**Ho + 6 sec to Ho + 28.3 sec:**  
Engine "D" is once again nominal.

**Ho + 28.3 sec to Ho + 28.45 sec:**  
Recurrence of chamber-pressure oscillation of  $\pm 7$  bar on engine "D", showing up in the same way on the films.

**Ho + 28.45 sec to Ho + 63.8 sec:**  
Pressure of engine "D" once more nominal. A temperature sensor on the propulsion bay records a linear rise from  $+24^\circ$  to  $56^\circ\text{C}$ .

**Ho + 63.8 sec:**  
The temperature in question rises sharply to  $100^\circ\text{C}$ , and the chamber pressure of engine "D" falls simultaneously to 10 bar. The vehicle experiences a powerful roll torque.

**Ho + 63.8 sec to Ho + 104 sec:**  
The flight-control system succeeds in maintaining the launcher in the nominal trajectory plane. The roll rate reaches  $60^\circ$  per sec.

**Ho + 104 sec:**  
Fall in chamber pressures of engines "A" and "B", hitherto completely nominal. Engine "C" continues to function nominally.

**Ho + 108 sec:**  
Fall in chamber pressure of engine "C" and destruction of launcher, probably initiated by the breaking of a structural connection, as a result of considerable general stresses. Consequently, the self-destruct system fitted to each tank operates. Tank pressures have been nominal up to this point.

A study in depth of the various recordings and films available will be necessary in order to determine the initial cause of this apparent malfunction of engine "D".

This is only the second major disappointment for the satellite fraternity—actually two failures out of nine—but we should not let it affect our future aspirations. THE PHASE III PROJECT MUST NOT DIE; satellite communication is still a great and interesting challenge for amateur radio to relieve the congestion on the HF bands and to provide educational and emergency facilities.

Phase IIIA was not insured and its loss to AMSAT is probably 20 per cent of the total expenditure of \$150,000, plus the dedicated labour effort of about 30 man months.

IIIB can be a goer as soon as a launch vehicle is found—hopefully within two years—and therefore your continuing

support for AMSAT is essential—let them know you are still interested—recruit new members (particularly life members) and give your financial support, either directly or through your local radio club.

### SATELLITE OPERATIONS

Both AO7 and 8 are performing well. For the past few months AO7 has been permanently in Mode B. Due to its travel in shadow when coming up from the south, we do not obtain acquisition for the first ten minutes after the satellite crosses the horizon (this applies to the south of the continent) and therefore the time of operation is limited. However, contacts have been continued with YB, 9M and JR6, but VK0 seems to have been wiped out due to the shadow problem. AO7, hopefully, should be back to normal in August if our theoretical calculations are correct in practice.

### PREDICTIONS — AUGUST

OSCAR 7				OSCAR 8			
Date	Orb. No.	Eqx Z	Eqx °W	Orb. No.	Eqx Z	Eqx °W	
3	26150	0101	87	12295	0057	67	
10	26238	0136	96	12393	0131	76	
17	26325	0016	76	12490	0021	59	
24	26413	0051	85	12588	0055	67	
31	26501	0126	94	12686	0129	76	

The above figures are computed from the following basic data:—

### AO7

Period (Min/orbit) = 114.9521618 —  
( $3.811 \times 10^{-7} \times \text{orbit number}$ ).  
Angle Increment (deg./orbit) = 28.7374.

### AO8

Period (Min/orbit) = 103.2407098 —  
( $3.1017 \times 10^{-6} \times \text{orbit number}$ ).  
Angle Increment (deg./orbit) = 25.810364 —  
( $6.502 \times 10^{-7} \times \text{orbit number}$ ).

### AMSAT NEWS

Dr. Perry Klein W3PK, the founder of AMSAT, has resigned from his positions as President and General Manager as from 1st July, but will retain his interest as a consultant. Perry has guided the fortunes of AMSAT for the past eleven years and has brought recognition and credit to the Amateur Radio movement. Thanks, Perry, for a job well done.

Dr. Tom Clark W3IWI assumes the office of Acting President and, with "Rip" Riportella WAZLQK as Acting Executive Vice-President, will serve until the Annual Meeting on 13th September.

The AMSAT office has been relocated, with Martha Saragovitz remaining as Office Manager. The mailing address is unchanged at PO Box 27, Washington, DC 20044, USA. Phone No. is 301-459-9230.

A meeting will be held at the University of Surrey, UK (builders of UOSAT), September 19th-22nd, to discuss the formation of AMSAT-International. Federal Executive has approved my attendance as a representative of WIA, and I look forward to this opportunity to participate in discussions which may lead to a closer liaison between the many countries having AMSAT affiliations.

## LOCAL NEWS

Andy Squires VK3YQX has agreed to act as satellite co-ordinator for VK3 and will be supplying a regular feature for the Divisional broadcast.

Other Divisional correspondents are Alan VK2RX, Peter VK4PJ, Colin VK5HI, Peter VK7PF. Do we have an interested amateur in VK6?

The Brisbane VHF Group and Redcliffe Radio Club will become members of AMSAT.

With the demise of Phase IIIA, the local net will be reduced for the time being to the third Sunday in each month at 1000 GMT on 7065 kHz with VK3ACR as control station.

Paul VK3BWC has started a recruiting drive for satellite operators in the Ballarat district — thanks, Paul.

## ACKNOWLEDGEMENTS

AMSAT, Mode J Club, VK4PJ, VK3ACR.

## SPOTLIGHT ON SWLing

Robin Harwood VK7RH

5 Helen St., Launceston, Tasmania 7250



Those pursuing SWL DXing will find no matter what receiving equipment is used, whether it be a two transistor regenerative detector or a sophisticated solid state PLL receiver with digital readout, that the performance depends on the antenna used. It should be clear of any protruding wires such as electrical or telephone cables and the height of the antenna can be 5 metres or more above ground. Another consideration is the polarization of the antenna. Vertical polarized antennas are more prone to electrical noise than a conventional horizontal dipole, and therefore are not recommended for built up areas. However verticals will work fairly well, especially where space limitations rule out the installation of a horizontally polarized dipole. A good ground connection is important in reception, particularly with vertical ground plane antennas. For further help with the construction of the antenna, it is recommended that the SWL consults a good handbook on aerial systems such as the ARRL Handbook. For general coverage listening, I recommend that the antenna length be between 10 and 30 metres, and by experimentation you should obtain optimum results.

With the use of a coupler or transmatch between the receiver and antenna, you can match the set to the correct impedance of the line. This can also improve reception. Most handbooks on antennas do have simple circuits of coupling units or transmatches.

It will soon be realised that there will be a need for accurate calibration of your receiver, so as you can find any given frequency easily. I have included a table of standard frequency stations to assist in this. Also by using a 1 MHz crystal together with some ICs, it is feasible to construct a crystal calibrator with beats of 1, 10, 100 and 1000 kHz.

## STANDARD FREQUENCY TRANSMISSIONS

2500 kHz WWVH Hawaii.  
4500 kHz VNG Lyndhurst, Vic.  
5000 kHz WWV, WWVH.  
8000 kHz JJJ Tokyo.

An aid I find useful, and indeed indispensable, is a publication entitled the World Radio TV Handbook, edited by Jens Frost of Denmark. This annual publication contains a listing of most international, national, regional and local radio and television stations. There are two forms of listing — alphabetically by nations, and numerically by frequency allocations. It also provides the addresses and locations of the broadcasters, as well as reviewing late model receivers. It is obtainable from most technical book stores.

It is also helpful to be with other SWL enthusiasts to exchange ideas and loggings. Contact your local Divisional Secretary and ascertain if there are active SWL groups in your area. Also the Southern Cross DX Club, PO Box 336, Adelaide, SA 5001, publishes an excellent monthly bulletin of loggings and tips for the SWL DXer. This club is affiliated to the WIA through the VK5 Division.

Several international broadcasters have specific programmes designed for the SWL DXer. These programmes bring the listener up to date with developments within electronics as well as current loggings from monitors throughout the world. In Table 2 there is a list of current programmes for DXers heard here in Australia.

## CURRENT DX PROGRAMME

Ecuador HCJB — DX Partyline at 0900Z, Monday, Thursday and Saturday. Frequency 6130, 9745, 11900 kHz.

UK BBC — World Radio Club. Sunday at 0745Z, repeated 1115Z Monday and 2315 Wednesday.

Netherlands — DX Jukebox, Thursdays at 0750Z and also 0850Z in English Programme.

NZ — Radio New Zealand on every second Monday at 0845Z 6105 kHz.

Well that is all for this month. I would welcome your comments and suggested ideas for this column via the above address. Next month we will be looking at reception reports.

# AMATEUR RADIO ACTION

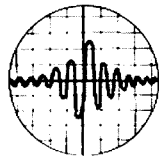

## is the NEW GENERATION amateur magazine.

- ★ Comprehensive DX notes
- ★ Propagation forecasts
- ★ Very technical - and not so
- ★ Technical articles
- ★ Useful projects

Here are just a few of the articles which have appeared in recent months

- ★ Fixed wire beams
- ★ Case for UHF beacons
- ★ 80W linear for 0m
- ★ Wilson System Three review
- ★ Spratly DX exclusive
- ★ Backyarders - good or bad?
- ★ A.T.V. Special
- ★ SWL notes

Average page content is 80 pages - at \$1.20 an issue that's good value.

Please put me down for 12 editions of Amateur Radio Action, starting NOW—  
Rates in Australia — \$15.60.  
Surface mail overseas — \$21.00, not including  
New Zealand — \$23.40.  
Airmail: To New Zealand — \$31.80, Indonesia &  
Malaysia — \$33.00, Japan & India — \$38.40,  
U.S.A. — \$43.80, U.K. & Europe — \$47.40.

Herewith enclosed cheque/postal note/money order to the value of:

\$A .....

Name .....

Address .....

Postcode .....

Post to: Amateur Radio Action Subscriptions, Box 628E, Melbourne, 3001.

# SIDEBAND ELECTRONICS ENGINEERING

P.O. BOX 23, SPRINGWOOD, N.S.W. 2777  
 WAREHOUSE 213 HAWKESBURY RD. SPRINGWOOD  
 TELEPHONE (047) 54 1392

Inflation still spirals prices upwards, as we have advised often. If you are thinking of buying new equipment, now is the time to buy — the next shipment is almost sure to be dearer. Even when purchases overseas are favourable, increased freight and handling costs cause increases. We still continue to sell at as low a price as we are able but as an example the next shipment of goods from the USA will increase by 18%

ROY LOPEZ

## HENRY RADIO A Famous Brand

### NEW LINEAR AMPLIFIERS

2-KD5-2KW PEP 80-10M SSB/CW/RTTY/AM.....	<b>\$1000</b>
1-KD5 1200W PEP 80-10M SSB/CW/RTTY/AM.....	<b>\$800</b>

## ANTENNAS

TET HB-35C 10-15-20M log/yagi HY-GAIN.....	<b>\$415</b>
8 el 2M yagi 14' boom 15db gain.....	<b>\$50</b>
14 el 2M yagi 28' boom 18db gain.....	<b>\$60</b>
TH3-JR 10-15-20M 3 el yagi.....	<b>\$250</b>
DB10-15A 10-15M 3 el yagi.....	<b>\$190</b>
153-BA 15M 3 el yagi.....	<b>\$120</b>
18AVT/WBa 10-80M vertical.....	<b>\$110</b>
GPG-2 2M 5/8W collinear 3-4db gain.....	<b>\$25</b>
HELICAL Mobile whips 10-15-20-40-80M heavy duty de-luxe model w/adj. tip.....	<b>each \$25</b>
GPV-5 2M Base. Collinear 2 x 5/8W.....	<b>\$55</b>
OSCAR 2D 2M mobile. Collinear 2 x 5/8W.....	<b>\$35</b>
BN-86 balun for beam buyers 'only'.....	<b>\$25</b>
HI-Q baluns 50 ohm 1 KW 1:1.....	<b>\$15</b>

## ROTATORS AND CABLES

All rotators now come with bottom brackets and control indicator boxes wired for 28V AC —

CDE BT1A BIG TALK light duty programmable 4-pos. push button plus normal operation.....	<b>\$85</b>
KEN KR-400 medium duty.....	<b>\$140</b>
KEN KR-500 vertical rotator.....	<b>\$170</b>
CDE Ham 1V heavy duty "Aug. delivery".....	<b>\$225</b>
CDE T2X Tail twister extra HD "Aug. delivery".....	<b>\$300</b>
RG-8U foam co-ax. per meter now.....	<b>\$1.20</b>
8-cond. rotator cable. per meter.....	<b>80c</b>

## ACCESSORIES

SWR meter Hansen twin meter 150MHz.....	<b>\$35</b>
SWR meter Single meter 150MHz.....	<b>\$25</b>
ASAHI chrome bumper mount.....	<b>\$8</b>
Standard bumper mount.....	<b>\$5</b>
Chrome base and spring to suit ASAHI mount.....	<b>\$15</b>
FERGUSON 240V AC transformer 2 x 9V secondaries at 3A.....	<b>\$8</b>
DYNASCAN 820 digital capacitance meter.....	<b>\$150</b>
TRIO DM-800 grid dip meter.....	<b>\$120</b>

## TRIO KENWOOD PRODUCTS

TS-520SE 10-160M 240V AC transceiver.....	<b>POA</b>
TS-180S 10-160M 12V solid state.....	<b>POA</b>
TS-120S 10-80M 12V solid state.....	<b>POA</b>
TS-700SP 2M all mode trans.....	<b>SPOA</b>
R-1000 digital clock receiver.....	<b>POA</b>
TV-502 2M transverter for TS-520/TS-820.....	<b>\$250</b>
SP-100 for R-1000.....	<b>\$32</b>
DK-520 Adaptor TS-520 to DG-5.....	<b>\$10</b>

All further Trio-Kenwood accessories transceivers and test equipment at competitive prices.

## ICOM & YAESU-MUSEN PRODUCTS

In the future we will be carrying a greater range of Yaesu-Musen products and a range of Icom products.

### YAESU-MUSEN

FT-101ZD 160-10M trans.c/w cooling fan & AM.....	<b>\$895</b>
FRG-7.5 -30Mhz receiver.....	<b>\$310</b>

## KYOKUTO FM 2025A

The very latest 2M FM from KYOKUTO 2M FM mobile 25W 10 memory channels plus

full scanning etc..... **\$350**

## CO-AX CONNECTORS

PS-259 - RG-8U and RG-58U types.....	<b>75c</b>
Cable joiners RG-8U and RG-58U types.....	<b>each 60c</b>
GLP right angle, RG-58U to SO-239 w/lock nut & weatherproof cap.....	<b>\$1.50</b>
SO-239 - 4 hole and single hole types.....	<b>75c</b>
MLS right angle RG-58U to PL-259.....	<b>75c</b>
In-line mic. sockets 3 & 4 pin ea.....	<b>60c</b>
Mic. sockets 3 & 4 pin each.....	<b>75c</b>
M-ring body mount w/lock nut.....	<b>\$1.50</b>

## NOVICE SPECIALS — CONVERSION CRYSTALS

Set of 8-crystals. Converts 28.480 to 28.595 MHz in 5-kHz steps. Clarifier tuning on Tx and Rx plus info to re-activate 24th channel..... per set **\$32**

Set of 4 crystals converts 28.310-28.600 MHz.

10 and 20 KHz steps. Clarifier tuning Tx and Rx..... per set **\$15**

All prices are NET, ex Springwood NSW, on pre-payment with order basis. All risk insurance is free of charge, allow for freight charges by air, road, rail or postal, excess will be refunded. Prices are subject to change without prior notice. All orders cleared on a 24-hour basis after receipt of order with payment.

ROY LOPEZ (VK2-BRL) Manager

# FORWARD BIAS

## JOTA 1980

It's on again — Jamboree on the Air takes place over the 18th October weekend, when Scouts and Guides will again be at the Scout Hall in Hughes (and we hope at another base station on the north side) to take part in QSOs with other Scouts and Guides, wherever they may be.

The programme has not been finally drawn up; how ambitious it is, will depend on the help of VK1 members. At the moment Gus Napier VK1NBO is busily persuading, inveigling and co-opting willing VK1s! This year we hope to expand the Jamboree activities and give the boys and girls opportunities to see and experience more aspects of AR than in the past.

VK1BP will broadcast the official opening ceremony from Government House on the Saturday afternoon.

VK1HS will be activated and will operate, if there are enough amateurs available on roster, from midnight Friday until midnight Sunday at the Hughes Scout Hall, Kitchener Street (on the border between Hughes and Garran, ACT). It's expected there will be some Scouts camping near the hall.

Late on Saturday afternoon, VK1BP will move to the Hughes site from Government House and will operate for the remainder of the weekend.

If there are enough amateurs available on the Sunday morning, we'd like to conduct a VHF fox-hunt for the boys and girls, starting from the Scout Hall and, if possible, we'd like to set up representative displays of amateur radio equipment (old and new).

As in the past, we'd like some willing amateurs to take small groups of Scouts and Guides to their QTHs and let them see what model ham shacks look like!!

On the Sunday afternoon, if sufficient interest is shown in other Divisions, it is proposed to have a National link-up with as many stations as possible participating in JOTA giving brief reports of their activities over the weekend. Here, and subject to P. and T. approval, the idea is for these reports to follow a standard message format. In the ACT, the WICEN organization has agreed in principle with the proposal — which would be along the lines of a WICEN exercise but not an exercise as such. It would be a JOTA communications net.

So there it is. These are our preliminary ideas. We are looking for help and any assistance and ideas you can offer will be greatly appreciated. Gus Napier 1NBO can be contacted on (062) 65 3555 during the day or at his QTH on (062) 82 1457 at other times. He can be reached of

course on PO Box 46, Canberra. If you are planning to visit Canberra that weekend, we'll be most glad to see you at the Hughes Scout Hall.

## DX CENTURY CLUB

Our Secretary, Fred Robertson Mudie VK1NAV, is now the proud possessor of the WIA DX Century Club Certificate. Fred, we believe, is the first Novice call in VK1 to gain this award. Congratulations and FB, Fred. ■

# QRK5

A monthly transmission from the Victorian Division WIA.

Written and co-ordinated by VK3WW, QTHR.

## WILLY WILLY'S WORDS

What a great idea to print Divisional news and views in AR. I hope these will become a regular line of communication with members and also let other Divisions know what we are doing; of course we will be able to read what other Divisions are doing, so the whole deal will promote an exchange of ideas.

## THE NEW COUNCIL

President: A. Noble VK3BBM  
Secretary: G. Atkinson VK3YFA  
Treasurer: P. Drury VK3JN  
Members: M. N. O'Burtill VK3WW, G. Williams VK3ZXW, A. Heath VK3KZ, J. Adcock VK3ACA, K. Scott VK3SS.

Please note that Councillors all carry one or more special posts and these will be mentioned in profiles to be published in following issues.

## A MAJOR AIM

Have you ever wondered why people whose hobby is built around radio communication do not communicate too well??

If you know the answer please tell me.

Council have decided to make a major effort to improve communication between members and Council — these notes are one way. The weekly broadcast is another way but neither will work if you, the member, wont read or listen.

Will Zone and Club Secretaries please help by ensuring that the broadcast is monitored in your area and that the Federal and Divisional news is passed to all your members as quickly as possible?

Council minutes will be sent to Zone and Club Secretaries as soon as possible after each meeting and members should be made aware of Council resolutions during Zone and Club meetings.

It is of course desirable that members seek information on matters of interest from — the broadcast — Zone and Club Secretaries and WIA Councillors.

Contributions to these notes will be welcomed from any members. Please try and submit items of general interest to all members and if at all possible DOUBLE SPACED TYPED COPY. Remember a lead time of about six weeks is required to make any particular issue of AR.

## QUESTION TIME

If a person who is not a member of an organization is allowed to use one or more of the facilities of that organization, is there any reason why members should continue to pay fees for the same privileges??

## MEET YOUR COUNCILLORS

This month — your scribe VK3WW.

Licensed in 1958 as VK4OM, Mike subsequently made an economic migration to VK3, where he has continued to follow his favourite aspects of AR — DX rag chewing, building test equipment, experimenting with antennas, shooting sacred cows, RD contesting (bring back the open section) and degassing the odd 807. New to Council this year, he has for the past three years been Victorian Division Librarian and has, with much help, established a reference library of texts and magazines, including every issue of AR since its inception.



A firm believer in service for members, he would like to see the WIA adopt a constitution suitable for the 1980s and concentrate on the needs of members. He has held WIA membership for 21 years.

## LUNCHEON MEETINGS

Amateurs and SWLs visiting Melbourne from anywhere are welcome each Thursday at noon lunch with a friendly group of amateurs at the Moonee Valley Hotel, 376 Brunswick Street, Fitzroy (one block south of the WIA Centre). Interstate visitors please note the hotels is in FITZROY, as its name is also a Melbourne suburb.

## QUESTION TIME AGAIN

Are lovers of the lash excited by a helical whip??

## SUPPORT THE RD CONTEST

This month it is on again and I hope we see a lot of new activity. I am completely biased when I say this because I always enjoy the RD. VK3 can win it if everyone puts in a little bit of time and then sends in their log.

That's the lot for this month, if you have any comments or criticism please let me know — if I hear nothing I must assume it is QRK5.

73. Mike. ■

---

## HELP WITH INTRUDER WATCHING

---

# HF TRANSCEIVERS FROM YAESU

NEW YAESU FT-707 "WAYFARER"

The exciting new FT-107 range

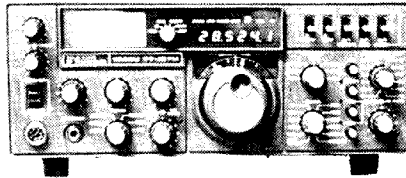

High quality transceiver.  
All solid state operation with inbuilt AC power supply makes it well ahead of its time.  
Available in two colours : grey or ivory.  
Complete range of accessories available.  
Write for brochure now!



FT-207R Handheld  
2M Digital programmable  
transceiver.

We also stock:



SPECIAL  
Chirnside  
Helicals  
Five for  
\$100

ICOM IC22S .....	\$289.
LEADER Ham scope .....	\$309.
LEADER Dip meter .....	\$89.
TONO 7000E Computer .....	\$949.
DAWA CN620 SWR meter .....	\$95.
DAWA Ant. Coupler CN217 .....	\$155.

## "DAWA ROTATOR"



DR7500R Medium duty "R" .....	\$185.
DR7500X Medium duty "X" .....	\$169.
DR7600R Heavy duty "R" .....	\$269.
DR7600X Heavy duty "X" .....	\$249.

Chirnside Vertical Antenna Type CE-5B Features.  
Long length and high Q traps makes the CE-5B more efficient than similar types of antennas especially on 80 Metres.  
It is also very easy to tune and its construction is very rugged.

Specifications of the CE5B.  
Bands: 80-40-20-15-10 M. Operation.  
Power handling: 2 kW PEP.  
SWR: 1.5 to 1 or better.  
Length: 30' (approx)  
Weight: 9KG. Packed.

**\$99.--**

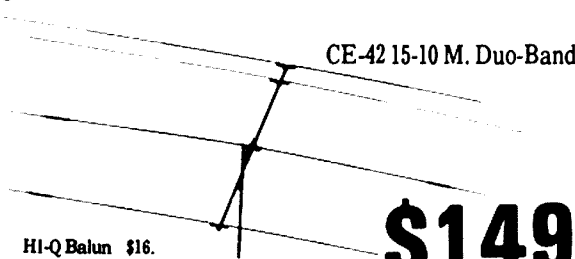

**\$149**

CHIRNSIDE CE-42 rugged duo band beam features 4 elements and uses independent reflectors for optimum results.

3 elements on 15 M.  
3 elements on 10 M.  
Director and driven elements have hi-q traps.  
Forward gain is 8 dB and front to back ratio is in excess 25 dB

CE/33 20/15/10m Triband Yagi 14' Boom	\$249
CE/35 20/15/10m Triband Yagi 19' Boom	\$289

Please Note !!!

These are recommended retail prices only.  
We do better.

- FT-707. All solid state HF transceiver. incl. 10, 18, 24 MHz. ....
- FV-707. Digital VFO for FT-707 incl. scanning. ....
- FC-707. Antenna coupler for FT-707. ....
- FP-707. DC power supply for FT-707 with inbuilt speaker. ....
- Rack mount for all the above items also available.
- FT-107M. HF transceiver excluding power supply.
- FT-107DMS. HF transceiver incl. DMS and power supply. ....
- FC-107. Antenna coupler for FT-107. ....
- FV-107. External VFO for FT-107 series. ....
- SP-107. External speaker. ....
- FT-107 Range is available in the colours grey or ivory.
- FT-720 New FM Transceiver.
- YM-35 Scanning hand mic. ....
- NC-2 Base Charger for 207A
- FV-101Z Ext. VFO for FT-101Z series
- FT-720 2M FM Transceiver Inc. Scanner
- FL-2100Z Linear for FT 101Z range.
- FT-101Z. 160-10M Transceiver. analog dial
- FT-101ZD. 160-10M Transceiver. Digital.  
optional digital display for FT-101Z.  
optional Fan.  
optional DC-DC converter.
- YE-7A Hand mike. ....
- YD-148 Desk mike
- FT-901DM. 160-10M Transceiver.
- FV-901. ext. VFO for FT-901 & FT-101Z.
- YO-901. Panoramic adapter monitorscope.
- FC-901. Antenna coupler.
- FTV-901. Converter. 6M, 2M, 70 cm. all inc.
- FTV-901. Converter. 6M, 2M. only
- SP-901. ext. speaker. ....
- FRG-7. Communication receiver.
- FRG-7000. Digital communications receiver
- LF-2A Narrow band filter for FRG-7.
- FT-7B. 80-10M Transceiver.
- FP-12. 12 Amp. power supply for FT-7B.
- YC-7B. Digital display for FT-7B.
- FT-227RB. 2M Digital programmable transceiver.
- YP-150. Dummy load/Watt meter.
- FF-50DX. Low pass filter. 2kw.
- QTR-24D Deluxe 24 hr. World clock
- FT-207R Handheld.
- NC-2 Base Charger for 207A
- CHIRNSIDE CE-33 Triband Beam

All FT-901 Accessories are compatible with FT-101Z series.

SPECIAL PRICE ON APPLICATION

MELBOURNE'S LEADING AUTHORIZED YAESU DISTRIBUTOR.  
CHIRNSIDE ELECTRONICS, 26 Edwards Road, Chirnside Park, Lilydale, 3116. Phone (03) 726 7353

## BLANK CASSETTES

LOW NOISE (General purpose tape)				
C10	C45	C60	C90	Qty.
0.82	0.90	1.10	1.40	1.9
0.77	0.85	1.00	1.30	10+

WIDE RANGE C60 C90			
(For dynamic range and less tape noise)			
1.45	1.95	1.9	
1.40	1.90	10+	

Assembled by Gluyas Gimmicks using quality German tape and Australian-made cassette cases.

### FULLY GUARANTEED

Available from

## GLUYAS GIMMICKS

14 William St., Donvale, Vic. 3111  
(03) 874 7003

and

## WILLIAM WILLIS & CO.

77 Canterbury Rd., Canterbury Vic. 3126  
(03) 836 0707

All prices ex store. POSTAGE +

	1.9	10+	
VK3	2.00	3.00	C.O.D.
VK1, 2, 7, 5	2.50	4.00	ADD
VK4, 6	2.50	5.00	\$2.70

**GUARANTEED  
BY  
VK3YPL**



## DIVISIONAL NOTES

### VK3

#### ANNUAL WESTERN ZONE CONVENTION

##### LOCATION

"Kangaroo Convention Centre", Princetown (in the foothills of the Otways).

##### SATURDAY

- Registrations.
- Dinner (BYO licence).
- Famous Digger Entertainment.

##### SUNDAY

- Trade Displays.
- Trading Table.
- Competitions for XYLS and Harmonics.
- Competitions for OMs — 40/10m scramble, 2m FM and SSB scramble, 2m sniffer hunts, 80/10m scramble Tx hunts, 2m FM/SSB hidden Tx hunt.

Accommodation, meals available at site. Also motel accommodation available.

Talk in facilities on HF and VHF.

Registration forms, route directory and programme — send stamped, self-addressed envelope to K. J. Reid, 166 Turrong Road, Cooriemugle, via Timboon 3268.

Entries close 11th October, 1980.

### VK4

Readers' attention is drawn to two 80m nets in Queensland, both originated by the VK4 Divisional Council in response to relevant motions, presented and accepted at the Queensland Radio Club Workshop, April 1978.

The first net is held every Tuesday from 0930 UTC on approximately 3.605 MHz with VK4AWI as net control. This net is known as the Queensland Radio Club Net and is intended as a communication channel between Council and representatives

## THE VK3BWW FORMULA FOR DX SUCCESS!!

### HIGH QUALITY AT LOW COST

#### BEAMS

3 EL 10 & 11m	.....	\$66.00
3 EL 15m	.....	\$73.00
3 EL 20m	.....	\$145.00
6 EL 6m	.....	\$102.00

#### DUOBANDER

3 EL 10m, 3 EL 15m \$135.00 ea.  
Prices include Gamma match

Our beams are easy to assemble and adjust. Entirely **NEW CONCEPT** — **NO NUTS OR BOLTS.**

Spare parts, elements, booms and gamma matches available.

For further information

**PLEASE RING (03) 366 7042**

**VK3BWW**

**WERNER & G. WULF**

92 LEONARD AVENUE  
ST. ALBANS, VICTORIA 3021

of affiliated radio clubs in VK4. A number of these Club stations are using the VK4W.. call and are not pirates (!).

The second net is held every Thursday from 0930 UTC on approximately 3.605 MHz with either VK4QA or VK4NLX as net control. This net is known as the Queensland Net with as its main purpose a communication link between WIAQ members and non-members and Council. Certain questions raised are often answered on the spot, while others will be answered by mail.

This particular net is also used as a "meeting ground" by those interested in the VK4 Award, Worked All Cities, Towns and Shires. Lately a renewed interest is also shown for the ACE Award and VK4 net participants are now also announcing, besides their QTH, the Commonwealth electorate. Amateurs from other Divisions are invited to check-in on this particular Queensland net.

The frequency of 3.605 MHz was chosen to ensure that all equipment is known to work well around the 80m WICEN net frequency in case something unforeseen should happen.

Finally, a request to 80m users . . . the net frequencies, when in use on either Tuesday or Thursday, are **NOT** meant as tune-up frequencies. You are better off to go down a few kHz and tune on THAT broadcast station on 3.6 MHz.

For VK4 Award information readers are invited to send an SASE to the WIA Queensland Division, GPO Box 638, Brisbane 4001.

## INTERNATIONAL NEWS

#### RECIPROCAL LICENSING

A few years ago it did appear that reciprocity of amateur licensing showed signs of encouraging improvement. Latest news may prove this view to be over-optimistic.

## AT LAST!

### THE TYPE 610 BRITISH POST OFFICE designed MORSE CODE KEY

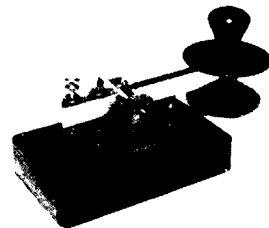

There has never been a better designed Morse Code Key — **SOLID, ROBUST** and **BEAUTIFULLY BALANCED.**

**\$27.50** (Post Paid)

"**LEARNING THE MORSE CODE**" — Cassette Album Training Course. You will progress rapidly using this modern training system.

**PRICE \$20** (Per Album of 3 Cassettes)

**WILLIAM WILLIS & Co. Pty. Ltd.**

77 CANTERBURY ROAD, CANTERBURY, VIC. 3216  
PHONE 836 0707

The Institute won a battle in 1972 by having reciprocal licensing in Australia split into two. One dealt with visitors and the other with intending residents. Prior to that time any amateur coming to Australia could obtain a VK licence only if a formal reciprocal agreement was in existence between his country and Australia or if he passed the VK exam. Reciprocity existed with only eight countries and this still applies to this day, although some negotiations are currently taking place with a ninth country — Japan.

To some extent the existence of a formal reciprocal agreement is not of much importance if each country grants reciprocal licences to visitors — "guest" licences as they are termed. Unfortunately not too many countries grant "guest" licences but the numbers are growing. And this may snowball, particularly when it can be pointed out that Australia has issued "guest" licences since 1972.

Any licensed amateur, irrespective of country, can obtain a VK licence if he comes to Australia on a bona fide visit not exceeding 12 months and produces the proper documentation in support of his application. For further details on reciprocal licensing see AR January 1978, page 25 onwards. QST for May 1980 lists a number of amendments to the Canadian Radio Regulations, some of which refer to reciprocal licensing.

USA amateurs may operate in Canada without prior registration, but they may only use the frequencies, types of emission and modes authorised to their licence in the USA and with the proviso that all these are authorised for use in Canada by the Canadian Regulations. The same principle applies for other foreigners but with the additional proviso that there must exist a reciprocal agreement between Canada and the foreign country concerned and application must be made. There is a formal agreement between Australia and Canada but only in respect of full privilege licences (see AR August 1972, page 17).

The preceding paragraph means that if you, as an Australian full call licensee, obtain a licence for Canada you could in Canada operate on the

# MAGAZINE REVIEW

Roy Hartkopf VK3AOH

160 metre band only between 1800 and 1860 kHz (as authorised in Australia) even though Canadians themselves can operate between 1800 and 2000 kHz subject to location, power and mode restrictions. These Canadian location, power and mode restrictions would also apply to you. Much the same would happen on 6 metres. You could only operate between 52-54 MHz, although the Canadians themselves can use 50-54 MHz.

For any other country, on the other hand, you as an Australian in possession of that country's licence, would be subject to the rules and regulations applicable to amateurs in that country, regardless of what you are permitted at home. For example, if you obtained a "G" licence under the reciprocal agreement, you could, in G-land, make use of their 70 MHz band but you could not operate on 6 metres because G-stations have no band on 6 metres. This is what applies in Australia to any overseas amateur visiting and licensed for Australia. He must comply with our Regulations, which means, for example, that a "W" visiting Australia and licensed in Australia could only operate on 40 metres between 7.0 and 7.15 MHz even though at home he could operate between 7.0 and 7.3 MHz (and he would not be allowed third party privileges, 1 kW power, etc., as he has at home).

Another thing. What call sign would be used? For the visitor to Australia he would have to use the call sign allocated to him on his Australian licence. For the Australian obtaining a licence to operate in another country the rules vary. In some countries you are allocated a call sign in the call sign series of the country (e.g. in G you would be given a G call) but for other countries you could use your home call sign followed by the country suffix (e.g. VK1BZZ/W6). In international waters, if you operate from a vessel, you would use your own call sign (with the suffix such as "Maritime Mobile" or MM).

Now for some pitfalls, especially for anyone too "clever" for his own good. And it is these people who can make licensing administration tighten up on their reciprocity conditions. The USA has reciprocal licensing agreements with some 50 different countries and the UK with 20-odd countries apart from Commonwealth countries. Let us say you, as a licensed Australian full call amateur, would want a visitor's amateur licence in Italy. Your Australian licence would be no good because there is no reciprocal agreement between Australia and Italy. Getting a W licence for yourself specially for this purpose would also be no good because there is no reciprocal agreement between the USA and Italy. However, there is a reciprocal agreement between the UK and Italy, but even if you went to all the trouble of obtaining a G licence on the strength of your Australian licence, it could be debatable whether or not you could then obtain an Italian licence on the strength of your G licence as you would not be a citizen of the UK. (Latest information is that the reciprocity arrangements by Italy with 19 countries, mainly in Europe, have been revised.)

Another aspect. If, say, you lived in Indonesia (there is reciprocity between Indonesia and the USA) but could not pass the necessary exams to qualify for an Indonesian licence but you made a trip to the USA. Being "smart", you might whilst there sit for the USA multi-choice exam and qualify to obtain a USA licence. So you return back home and say, "Please I want my local licence and here is my USA licence". You might or might not succeed, you might or might not be found out later on and then the trouble would start, not only for you but all others after you.

Incidentally, since photo copies of licences can be "doctored", you can understand why some licensing administrations insist on seeing your actual licence or a copy of it properly certified by the licensing administration which issued it.

## OTHER NEWS

Botswana now issues amateur licences using the prefix A22 and Sao Tome uses the prefix S92 (S92AA-S92ZZ).

According to data in an article appearing in Region 1 Newsletter of February 1980 there were 30,034 amateur radio stations in the USSR, of which 3,629 were collectives, 17,234 individual short-wave and 9,111 ultra short-wave. From the

same source it is learnt that in West Germany new technical regulations have been issued designed, inter alia, for some protection for operators of transmitters against unjustified claims from listeners and viewers. Minimum usable field strengths on the antenna of a receiver are set out, for example on VHF and TV ranges the effective antenna input at the receiver must be kept above 42-55 dB/uV. Also set out are the passive interference behaviour of receivers themselves. These new regulations come into force 1-7-1981 and the values given are regarded as somewhat low.

Prefixes in East Germany are now in the series Y21A to Y49Z, Y61A-Y69Z and Y91AA-Y99ZZ. Y21AA to Y29ZZ are for individual licensees.

The Cayman Radio Society (CRS) and the Fiji Association of Radio Amateurs (FARA) have been admitted as the 106th and 107th members of IARU. The number of amateur radio stations in Japan 31-9-1979 was 414,918. New radio regulations, similar to those in New Zealand, have come into force in Western Samoa. Visitors to 5W1 can obtain an amateur licence provided they bring with them their original licence and a photo copy of it, apply formally and pay T12 (about \$13.50). Reg. 3 News February 1980.

The Canadian Radio Regulations were, as stated, changed from 28th February. VEs have lost 420-430 MHz but still have 430-450 MHz, a new VE amateur band for A3 and F3 has been created at 902-928 MHz, a licensed amateur may operate radio-controlled models on certain bands and certain other amendments. Canada's largest amateur Convention (the RSO) will be held in Toronto 3rd to 5th October, 1980.

In a long letter received from Peter Strauss in South Africa he mentioned that "guest" licences are now issued by South Africa for visitors as a special concession. This, as usual, excludes Novice grade licences as there is no such grade in South Africa. The call sign will be the visitor's own home call /ZS (or —/ZR for limited licensees 2m and up). He also mentions that the Australian licensing patterns are being used in various countries in South Africa. See also AR March 1980, page 43. A late report (from R1 News) has it that in Kenya all amateur Tx equipment must now receive type approval as well as any alterations thereto.

Australian amateur licensees proposing overseas visits and requiring overseas licensing details should write to the Executive Office, Box 150, Toorak, Vic. 3142, with a stamped, self-addressed envelope for reply. Details for various countries are gradually accumulating and further information is always most welcome.

## 10 MHz BAND

According to the IARU Liaison Officer, DU1JE, of the Philippine Amateur Radio Association, the Philippine administration has agreed to release the 10.1 to 10.15 MHz band to Filipino amateurs on 1-1-1982. The Society is also negotiating for the release of the 220 to 225 MHz band even though this is not a Region 3 allocation for the amateur service.

The IARU Region 1 Executive Committee recommends that the 10.1-10.15 MHz band be used for CW communications only. Reg. 1 News, June 1980.

## 10m BEACON HONG KONG

According to an announcement by the Hong Kong Amateur Radio Transmitting Society the Society's 10 metre beacon will be in operation from late May 1980. The call sign will be VS6HK, frequency 28.290 MHz, 10W DC input, omni-directional ground plane antenna and located on Cape D'Aquilar, on Hong Kong Island.

Here is a list of beacons operating or shortly to commence operations on 28 MHz:—

28.205 DL0IGI	28.247 EA2HB
28.207 WD4MSN	28.257 DK0TE
28.210 3B8MS	28.274 ZS6PW
28.125 GB3SX	28.277 DFOAAB
28.220 5B4CY	28.280 YV5AYV
28.230 ZL2MHF	28.284 VP8SB
28.235 VP9BA	28.290 VS6HK
28.237 LA5TEN	28.888 W6IRT
28.240 OA4CK	28.894 WD9GOE
28.245 A9XC	28.992 DL0NF

The frequencies 28.260, 28.265 and 28.270 have been reserved for Australian beacons of which one, in VK5, is understood to be operative. ■

(G) General. (C) Constructional. (P) Practical without detailed constructional information. (T) Theoretical. (N) Of particular interest to the novice.

CO April 1980

The AMSAT Oscar 9 Satellite (G).

QST February 1980

VHF-UHF 3 Band Mobile Antenna (C). The Geneva Story (WARC 79) (G).

BREAK IN April 1980

Six Metre Bandpass Filter (C).

CO May 1980

High Gain Antenna for 420 MHz (C).

HAM RADIO March 1980

Auto Product Detector of Double Sideband (GT). LED Tuning Indicator for RTTY (C). Logarithmic Detector (G).

QST May 1980

Circular Polarisation and Oscar (TP). Increasing Receiver Dynamic Range (TG). Nor Gate Break In (N). AMSAT Oscar Phase III (G).

QST April 1980

Ionospheric Radar (and the "Woodpecker") (G) (recommended reading). Adjustable Gain Microphone Amplifier (GN). The Balun (GN). Semi-Automatic Antenna Tuner (G). FDX — A Challenge Accepted (AF). Beginners Look at Op Amps (N).

HAM RADIO April 1980

FCC Study Guide (G). QRP 40 Metre Transceiver (GC).

HAM RADIO May 1980

11th Annual Antenna Design Issue.

BREAK IN May 1980

Scanner for IC22S (P). Solar Disturbances (G). ■

## QSP

### OTHRs

An article by W6QYT in QST April 1980 gives some details of a US "over-the-horizon-radar" known as CONUS OTHB still in the experimental stage. The radar is located in Maine with antenna arrays about 4000 feet long with an average transmitter power of approximately 1 megawatt up to 24 hours a day in the present operating frequency range of 6.7 to 22 MHz. The radar is not authorised to operate in the amateur and some other bands and is permitted elsewhere on a non-interference basis. Separate transmitting and receiving sites are employed so that the transmitter can radiate a continuous signal which is FM-modulated or "chirped" for range resolution. The Russian OTHR (woodpecker) signals consist of millisecond-length pulses at a rate of 10 per second which, the article states, do not stay very long on any given frequency. On the other hand the US OTHR will sound on an AM Rx mode like power-line hum from 20 to 60 Hz. Any reports by amateurs would be welcomed by the US Air Force which has set up a special board of QRM experts as overall interference co-ordinator. A number of other low-powered US experimental radars (WARF, MAORE, White House) have been operated for a number of years with practically no reports of interference. ■

BUYING OR SELLING GEAR?

# HAMADS

MAKE IT HAPPEN FAST



# YOU and DX

G. (Nick) Nichols VK6XI  
6 Briar Place, Ferndale, WA 6155.

# IONOSPHERIC PREDICTIONS

Len Poynter VK3BYE

Having been licensed only 20 months, I feel unqualified to write this column, however AR wasn't exactly swamped with offers; hi! One moment though, how do you qualify? I at least feel any DXer must primarily be a patient listener and for that at least I'm well equipped. My shack consists of an ICOM 701 but far more importantly I have a good home-brewed multi-element quad array with four elements on 15 and 20 interlaced with 6 on 10 on a 31 foot boom at sixty feet.

Before we go any further please don't think arrays of this size are a prerequisite for DXing, they are not, but patience and the ability to listen most definitely are.

This column must, due to printing deadlines, contain for the most part information of DX which may well have been and gone from our bands before it reaches you. Seldom do we get information early enough for you, the reader, to take advantage of it, however we all no doubt get a feeling of satisfaction when one of those "rare" ones rates a mention and you managed to work it.

I wonder how often you also consider that a station you worked should have rated a mention but was overlooked? Well the solution is in your hands. Much of this column is made up of information passed on by correspondence, on-air OSOs and of course a good deal of patient listening. Make a sked, pick up a pen or the phone and make these articles more informative.

From Allan VK2AIR comes the disturbing news that 9L1K is quoting him as Southern Hemisphere QSL Manager. **THIS IS NOT SO.** Allen has gone to great lengths to obtain logs from this station but all correspondence has gone unanswered, while OE3KD has been named as NH QSL Manager (no QTH can be found for him either). Allen would, needless to say, appreciate any additional information on this operation and no more cards please.

For those wondering about the legitimacy of the ZL6IW station on 20 metres, it is in fact an official intruder watch and action call sign. The station operator has fluent Russian as an attribute and is doing a sterling job shifting Russian trawler operators from our 20 metre segment.

Merelyn (SWL20118) contributed this month with a list of log entries for the last couple of months, all stations were heard in the novice band segments and many fall into the category of rare, to summarise 181 countries, 39 zones all heard on a long wire. Here's a prefix extract — A7, A9, A35, C21, FH0, FR0, Gloriosa, FW, HZ, JT, JW, OY, PZ, TF, TU, ZL2 Chatham, 6W8 and 9G1. For the series DXer there is obviously something to be learnt from the list, be a patient listener.

Heard on the bands recently were the following rather dubious and at times downright obnoxious "events". The novice abusing in no uncertain terms a C21 station for forgetting to call him from a list; the practice of "tail-ending" pile-ups has been refined to such an art (?) that the pile-ups can last upward of four minutes with three or four stations all obviously able to hear each other vying for the title "tail end Charlie" — such a pity the DX station got sick of it and closed down and many good mannered stations missed out on a QSO; trying to convince a TL8 that he wanted a net control when he had clearly stated he couldn't clearly read the prospective "organiser" — don't think any further comment is necessary!!

## ON THE BANDS

10 metres has been patchy with some good openings into the African continent, TR8DX, TL8WH, TL8CR, 9G1AP and 7X2AC appearing regularly; propagation in this direction should continue to improve during the winter months. For those still needing zone 23, both JT1KAI and J20DJT have been fairly regular around 28.490. Those needing the Maldives will be pleased to know that Norm 8Q7AV and his son Romesh 8Q7AZ have both been licensed recently and are active, particularly on 10. Norm has indicated that he prefers QSOs rather

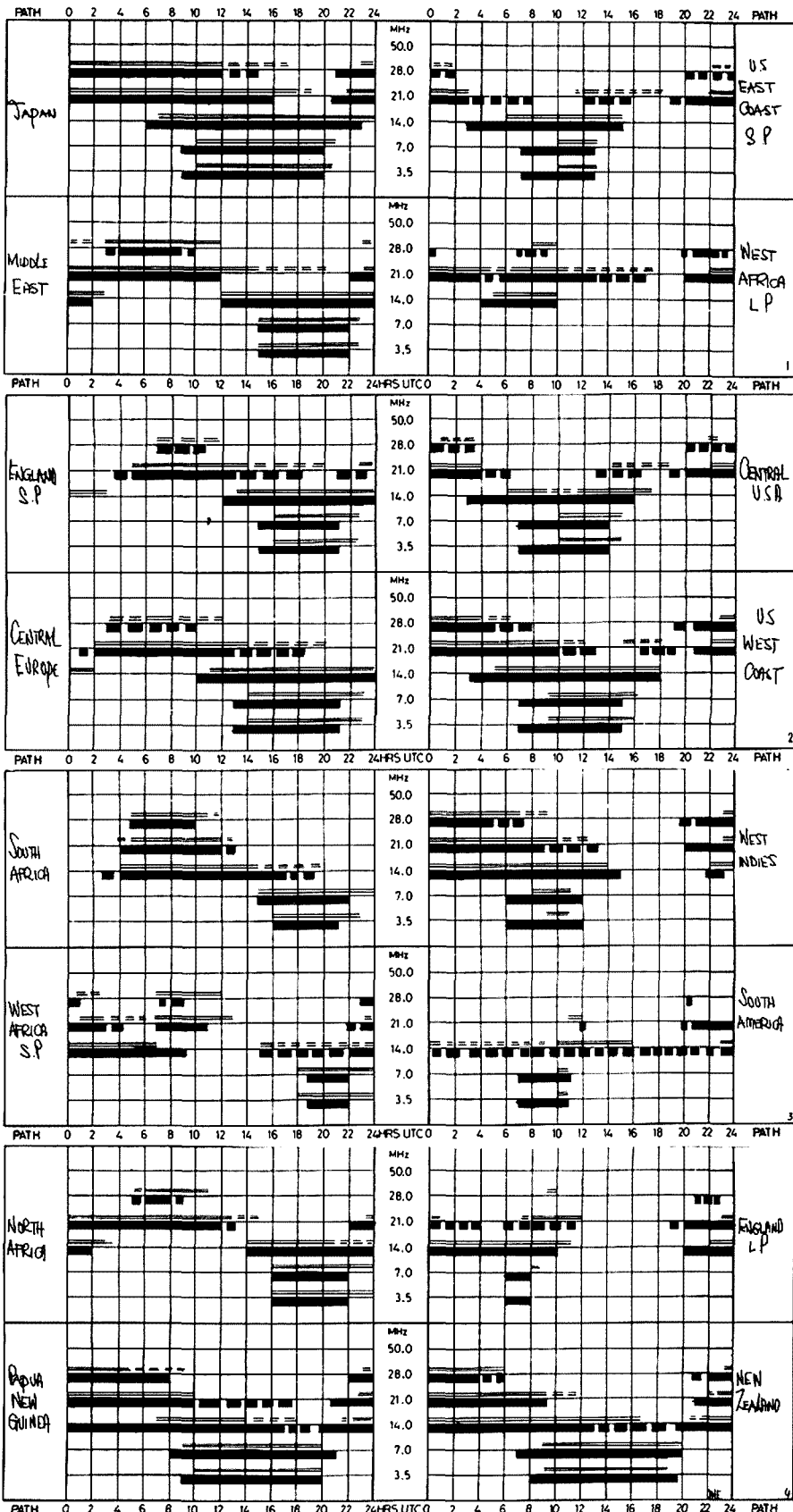

than report exchanges; they'll both be there for a long time, so please accede to their wishes.

15 metres, good long path openings into Europe most afternoons.

20 metres is the usual hive of activity with 5W1CR, 5W1BP, FW0DD (CW), 3B6CF Agalega FB8ZW and many more worthy of mention but too numerous to list here.

40 metres has had its moments, with plenty of Ws whilst on 80. ZS6BNS and ZS5SF were heard and worked early in the morning (2100 GMT) by a VK6 novice; Europe has also been heard at good strength and heralds good conditions for the months.

#### QTHs YOU MAY HAVE MISSED

TR8DX — via F5VU.

5W1CR — via ZL1BCG.

FW0DD — via VE3ODX.

FB8ZW — via F6CUI.

3B6CF — via 3B8CF.

K6LPL/KH5, WA2F1J/KH5 — via home calls.

8Q7AV and AZ — via Four Winds, Mall, Republic of Maldives.

C5ACR — via PO Box 281, Bathurst, The Gambia.

TL8WH — W5RU.

TL8CR — YO9WL.

73s de Nick.

## CONTESTS

Wally Walkins VK2DEW  
Box 1065, Orange 2800

#### August

- 9/10 REMEMBRANCE DAY CONTEST
- 9/10 EUROPEAN CW CONTEST
- 16/17 SEANET PHONE CONTEST
- 16 QLF ZL CONTEST (LOTS OF FUN)
- 16/17 SARTG RTTY CONTEST
- 23/24 ALL ASIAN CW CONTEST

#### September

- 13/14 EUROPEAN PHONE CONTEST
- 13/14 ITALIAN 10 METRE CONTEST
- 20/21 SCANDINAVIAN CW
- 27-28 SCANDINAVIAN PHONE

#### October

- 4/5 VK/ZL/OCEANIA PHONE
- 11-12 VK/ZL/OCEANIA CW
- 18-19 JAMBOREE ON THE AIR
- 25-26 CO WW DX PHONE CONTEST

#### November

- 9 CZECHOSLOVAKIAN CONTEST
- 8-9 EUROPEAN RTTY CONTEST
- 29-30 CO WW DX CW CONTEST

The ZL QLF contest rules may be obtained from "Break-In".

### THE 21st ALL ASIAN DX CONTEST

#### CW SECTION

The purpose of this contest is to enhance the activity of radio amateurs in Asia and to establish as many contacts as possible during the contest periods between Asian and non-Asian stations.

#### 1. CONTEST PERIOD

CW: 48 hours from 0000 GMT August 23, 1980, to 2400 GMT August 24, 1980.

#### 2. BANDS

Amateur bands under 30 MHz.

#### 3. ENTRY CLASSIFICATIONS

- (1) Single operator, 1.9 MHz band (CW only).
- (2) Single operator, 3.5 MHz band.
- (3) Single operator, 7 MHz band.
- (4) Single operator, 14 MHz band.
- (5) Single operator, 21 MHz band.
- (6) Single operator, 28 MHz band.
- (7) Single operator, Multi-band.
- (8) Multi-operator, Multi-band.

#### 4. CONTEST CALL

For non-Asian stations:

- (a) Phone — "CQ Asia".
- (b) CW — "CQ AA".

#### 5. EXCHANGE

- (1) For OM stations: RS(T) report plus two figures denoting operator's age.
- (2) For YL stations: RS(T) report plus two figures "00 (zero zero)".

#### 8. POINT AND MULTIPLIER

(1) For Asian stations:

- (a) Point: Perfect contact with non-Asian stations will be scored as follows:  
1.9 MHz band: 3 points.  
3.5/3.8 MHz: 2 points.  
Other bands: 1 point.

- (b) Multiplier: The number of different countries in the world worked on each band. According to the DXCC countries list.

(2) For non-Asian stations:

- (a) Point: Perfect contact with Asian stations (excluding US auxiliary military radio stations in the Far East, Japan: KA stations) will be counted as follows:  
1.9 MHz band: 3 points.  
3.5/3.8 MHz bands: 2 points.  
Other bands: 1 point.

- (b) Multiplier: The number of different Asian Prefixes worked on each band. According to the WPX rules.

(3) JD1 stations:

- (a) JD1 stations on Ogasawara (Bonin and Volcano) Islands belong to Asia.
- (b) JD1 stations on Minamitori Shima (Marcus) Island belong to Oceania.

(4) Contacts among Asian stations and among non-Asian stations will neither count as a point nor multiplier.

#### 7. SCORING

(The sum of the contact points on each band) x  
(The sum of the multipliers on each band).

#### 8. AWARDS

(1) For both phone and CW, certificates will be awarded to those having the highest score in each entry in proportion to the number of participants from each country and also those from each call area in the United States.

- (a) The number of participants under 10: Award only to the highest scorer.
- (b) From 11 to 20: Award up to the runner-up.
- (c) From 21 to 30: Award up to the top third.
- (d) From 31 or more: Award up to the top fifth.

(2) The highest scorer in each Continent of the single operator multi-band entry will receive a medal and certificate from the Minister of Posts and Telecommunications of Japan.

(3) The highest scorer of the multi-operator multi-band entry in each Continent will receive a medal.

#### 9. REPORTING

Both log and summary sheet must arrive in JARL, PO Box 377, Tokyo Central, Japan, on or before the following dates:—

- (a) Phone: September 30, 1980.
- (b) CW: September 30, 1980.

#### 10. DISQUALIFICATION

- (1) Violation of the contest rules.
- (2) False statement in the report.
- (3) Taking points from duplicate contacts on the same band in excess of 2 per cent by the total.

#### 11. ANNOUNCEMENT OF THE RESULT

- (1) Phone: About February 1981.
- (2) CW: About April 1981.

#### 12. COUNTRIES LIST OF ASIA

A4, A5, A6, A7, A9, AP, BV, BY, CR9, EP, HL/HM, HS, HZ/7Z, JA-JR, JD1 (Ogasawara Is.), JD1 (Okino tori I.), JT, JY, OD, S2, TA, UA/UK/UV/UW9-0, UD6/UK6C .D. K., UF6/UK6F. O. Q. V., UG6/UK6G, UH8/UK8H, UI8/UK8A-G.I.L.O.T-Z., UJ8/UK8J.R., UL7/UK7, UM8/UK8M.N., VS6, VS9M/8Q, VU, VU (Andaman and Nicobar Is.), VU (Laccadive I.), XU, XV, 3W, XW, XZ, YA, YI, YK, ZC4/5B4, IS (Spratly Is.), 4S, 4W, 4X/4Z, 7O (S. Yemen), 7O (Kamran Is.), 8Z4, 9K, 9M2 (West Malaysia), 9N, 9V (Singapore), (Abu Ali).

You may have contest results by enclosing one IRC and SAE with your log.

## QSL?

For those looking for that are QSL, calling in on the following nets may prove useful.

#### Family Hour:

W7PHO: 21.345, 0001Z daily; 14.225, 0130Z daily.

#### Arabian Nights:

JY3ZH: 14.250, 0430Z Friday morning.

#### P29JS:

P29JS: 14.220, 0630Z daily.

#### Pacific DX:

VK3PA: 14.265, 0600Z Friday morning;  
VK2CX: 14.265, 0600Z Tuesday morning.

#### Caribbean Pacific:

VP2/8P6: 14.170, 1030Z daily.

#### Ten Metre:

DK2OC: 28.750, 1200Z daily.

#### Canadians Overseas:

VS6CZ: 14.160, 1400Z daily.

#### Family Hour:

W7PHO: 14.225, 1430Z daily.

#### DX to DX:

WB8ZJW: 21.280, 1700Z Monday, Wednesday, Friday.

#### French DX:

21.170, 1730Z daily; 14.120, 1830Z daily.

#### Africana:

W6BJS: 21.355, 1800Z daily.

#### FOR INFORMATION ONLY

#### Canad-X:

VE3EUP, VE3FRA: 14.173, 1600Z Sunday, except major SSB contests.

*A Call to all  
holders of a*

# 'NOVICE LICENCE

Now you have joined the ranks of Amateur Radio, why not extend your activities?

## THE WIRELESS INSTITUTE OF AUSTRALIA (N.S.W. DIVISION)

conducts a Bridging Correspondence Course for the AOCF and LAOCF Examinations.

**Throughout the Course, your papers are checked and commented upon to lead you to a SUCCESSFUL CONCLUSION.**

For further details write to:

**THE COURSE SUPERVISOR,  
W.I.A.**

**P.O. BOX 123,  
ST. LEONARDS, N.S.W. 2065**

## AMATEUR OPERATOR'S HANDBOOK — 1978

### MAGPUBS

**P.O. Box 150, Toorak, Vic. 3142**

**NO AMATEUR STATION SHOULD  
BE WITHOUT ONE.**

# The Intruder Watch

## 21 MHz AMATEUR BAND?

During the month of May harmful interference has left this band in a useless condition most evenings. Due to pulse jammers, i.e. "wood-peckery" and "motor bike", along with A9, F1 and A0 signals it is becoming impossible to have even a local QSO.

Answer yourselves one small question: Why should I turn my set off in disgust when with very little time and effort I could help to rid the band of intruders. Jot down any details with bearings where possible and forward to your State Intruder Watch Co-Ordinator.

If you happen to be in a Division that does not have an IW Co-Ordinator, call in on 3540 MHz Thursday, 1030Z, and make your report or post to PO Box 158, Healesville 3777.

Graeme VK3NXI, Federal Co-Ordinator. ■

## AWARDS COLUMN

Bill Verrall VK5WV  
7 Lilac Avenue, Flinders Park, SA 5025

### AUSTRALIAN RAILWAYS AWARD

This certificate is being offered by a group of railway workers/employees of railways in Australia for contacts with railway employees or retired railways employees who are amateur radio operators and charter members of the award. The rules of the award are:—

1. CONTACTS MUST BE MADE with 8 award holders, 3 of which must be Charter Members, i.e. all contacts may be with Charter Members.
2. The minimum of 3 Charter Members must be from different States.
3. Contacts may be made on any mode, any band, but cross band contacts are not permitted.
4. Contacts with Charter Members are worth 5 points each and contacts with award holders are worth 2 points each towards the "WHISTLE STOP AWARD", which will be available shortly.
5. To obtain the "WHISTLE STOP AWARD" applicants must possess the basic award plus 50 points.
6. Claims for the award are to be submitted on a list showing the date, time, band, mode, station worked, signal reports, name and location of the station worked. QSL cards are not required.
7. The cost of the basic award is \$3.00 and the cost of further awards is to be determined.
8. Applications, together with the list of stations worked and the fee, should be forwarded to:—

Awards Manager,  
Jack Thomas VK3NTR,  
1 Stevens Crescent, Ararat, Vic. 3377.

### DESCRIPTION

The award measures 290 mm x 225 mm, printed on high quality white paper with an illustration of a steam train (sorry, I am not familiar with the class number as I am not a train buff, but can remember seeing this machine several times in my younger (?) days) in light blue and all printing is in dark blue.

### NETT FREQUENCY

Stations wishing to qualify for the award will find several Charter Members on 3610 kHz, Sundays at 1030 GMT.

### BRISBANE NORTH RADIO CLUB AWARD

The Brisbane North Radio Club, as the name suggests, is primarily for radio enthusiasts living on the north side of the Brisbane River. Meetings are held twice monthly at the Hooper Centre, Kuren Street, Chermside. An award is now available for contacting Club members and the design closely follows that of the Club motif.

1. For stations located in Australia (VKs 1-8), contacts are required with 10 Club members.

## AUSTRALIAN RAILWAYS CHARTER

AWARDED TO ..... WIA ..... ON 1980

FOR WORKING MEMBERS ACCORDING TO CHARTER RULES

AWARD No. ....

CHARTER HEAD

AWARD MANAGER

## THE BRISBANE NORTH RADIO CLUB



### Presents This Award No.....

TO ..... CALL SIGN ..... ON ..... 198 .....

AS PROOF THAT THE REQUIRED NUMBER OF CLUB MEMBERS WERE CONTACTED IN ORDER TO BE ENTITLED TO THIS AWARD

SIGNED THIS DAY ..... 198 .....  
MANAGER.....  
BRISBANE NORTH RADIO CLUB  
BOX 78 CHERMSIDE QUEENSLAND 4032  
AUSTRALIA

2. For all overseas stations (including VK0 and VK9), contacts are required with 5 Club members.
3. Contacts with the Club station VK4WIN count as 2 contacts and this station may be found on 28420 kHz each Monday at 0900Z. BNRC members may also be found on the same frequency on Sundays after the WIA news call-back session.
4. The award is available also to SWLs both in VK and overseas.
5. Contacts may be made on any mode, any band, but cross band contacts are not permitted.

6. Log details only are required. Do not send QSLs.
7. The cost of the award is \$1.00 or 3 IRCs for an airmail reply.
8. Applications, together with the list of stations worked/heard, should be forwarded to:—

Awards Manager,  
P. W. J. Parsons VK4NJO,  
PO Box 242, Alderley, Qld. 4051.

### DESCRIPTION

The award measures 250 mm x 215 mm.

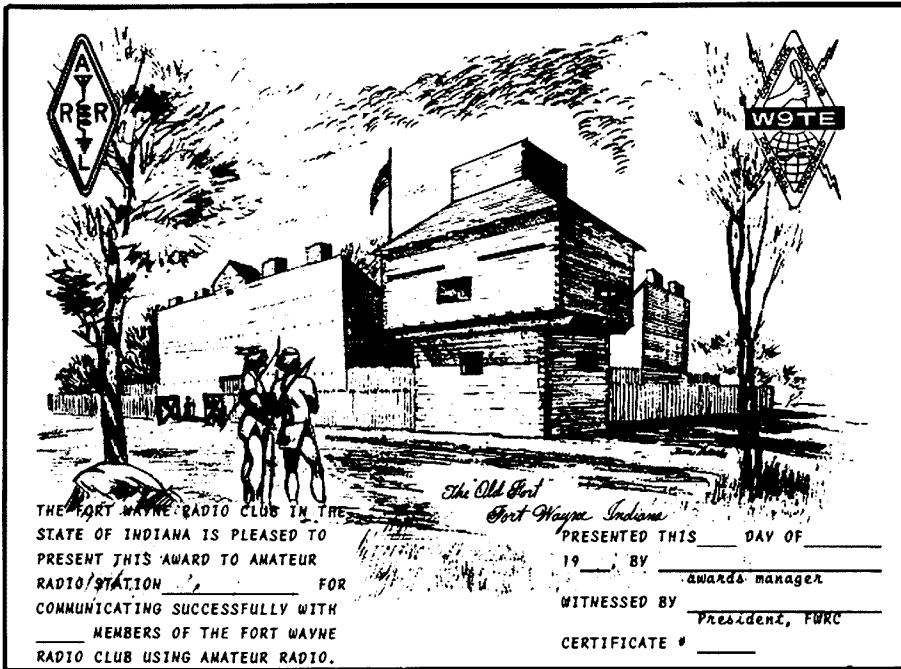

## AROUND THE TRADE

### SERVICE MONITOR EXCELS

Since Vicom International released the IFR communications service monitor five months ago, sales have climbed at a staggering rate.

As a combination instrument, the FM 1000S performs power measurement, spectrum analysis, AM, FM, SSB measurement and generation. Dual synthesized tone generators and phase lock BFO make testing SSB a snap.

Vicom's Technical Director, Peter Williams, pointed out that the internal modular construction and diagnostic plugs allows Vicom's service department to offer a three day service turn around.

Information on this instrument is available from Vicom International. Sydney phone (02) 436 2766, Melbourne phone (03) 699 6700.

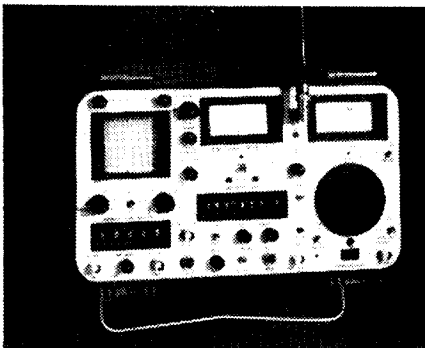

### DUAL SCALAR MOVE

Both Scalar (NSW) Pty. Ltd. and Scalar (Old.) Pty. Ltd. have moved into new premises.

Scalar (NSW) Pty. Ltd. can be found at 328 Kingsgrove Road, Kingsgrove, NSW 2208. The telephone number is (02) 502 2888. Telex AA 27067.

Manager Bert Fraser, together with Mike Kilpatrick and Ron Smith, welcome existing and prospective clients to their new spacious premises. Good parking is available for those wishing to avail themselves of Scalar's technical services, or take advantage of the improved stock holding.

Scalar (Old.) Pty. Ltd.'s manager, Brian Robinson, advises that their brand new factory and warehouse is located at 8 Ferry Road, West End, Old. 4101. The new premises will provide improved technical services and greater manufacturing capability.

Good stocks of Scalar's standard range of UHF/VHF and CB mobiles and base station antennas are available. Brian, Terry O'Meara and Ron Bayton welcome any enquiries. Telephone 44 8024. Telex AA 43007.

Both Scalar (NSW) and Scalar (Old.) represent Scalar Industries Pty. Ltd., Scalar Distributors Pty. Ltd. and Scalar RFI Pty. Ltd. in their respective States and can provide answers and literature for any queries concerning products available from those companies.

### LEADER FUNCTION SWEEP/AM GENERATOR

Leader's LFG-1300 function sweep/AM generator, which has a frequency range from 0.002 Hz to 2 MHz in eight ranges, features an internal and external 1000:1 sweep range (linear or logarithmic), sine, square, pulse, triangle sawtooth and TTL outputs, a built-in 70 dB stepped attenuator (10 dB steps), external AM/FM inputs, a rugged metal housing and a convenient control panel layout.

Accuracy: 3 per cent of reading plus 3 per cent of full scale (0.02-200,000 Hz), 5 per cent of reading plus 3 per cent of full scale (200,000 Hz-2 MHz). TTL output fan out: 20 TTL. Linear or log sweep rate: 20 mS (50 Hz)-5S (0.2 Hz) continuously variable. Ext. sweep output for oscilloscope: 0-10V. Output impedance: 50 ohms  $\pm$  5 per cent. Output level: 0-20V p-p (open circuit). Power source: AC 100/117/200/234V, 50-60 Hz. Dimensions 10 (W) x 5 (H) x 10 (D) in.

## THE RADIO AMATEUR'S CONVERSATION GUIDE

A most useful adjunct for working the DX station not proficient in English. Good also for contests.

\$9.00 brings you a copy, post paid.

**MAGPUBS**  
P.O. Box 150, Toorak, Vic. 3142

## FORT WAYNE RADIO CLUB CERTIFICATE

### REQUIREMENTS

DX stations: 5 contacts with WFRC members.  
US stations: 10 contacts with WFRC members.  
Local Stations (Allen Co., Indiana, or local WFRC members): 25 contacts with WFRC members.

Any frequency. Any mode. All stations must be worked after January 1, 1979.

### COST

DX: Free (surface mail) or 2 IRCs (airmail).  
USA: \$1.00.

### QUALIFICATION

To qualify for the certificate, send a list of WFRC members you worked giving the following information:—

1. Call,
2. Name,
3. Date worked,
4. Time in GMT (or Zulu or UTC),
5. Band,

to the address given below.

The list must be signed by you and certified to be true by two other hams or an officer in your local radio club. OSL cards may be submitted in lieu of the certified list but sufficient postage must be included for return of QSL cards.

To apply for the WFRC certificate, send your certified list and the appropriate fee to:

Fort Wayne Radio Club,  
PO Box 15127,  
Fort Wayne, Indiana 46885.

## BOOK REVIEW

"Weekend Projects for the Radio Amateur. Published by ARRL 1979. \$US3.50 outside the USA. Our copy from the publishers.

This 60 page volume, published in the familiar QST format, is described as "written for the electronics hobbyist interested in constructing low-cost amateur radio equipment while investing a minimum of time. Volume 1 in a series . . . (it) supplies the builder with schematic diagrams and helpful suggestions for the construction of a pre-amplifier (432 MHz), noise blanker, transmatch, 160-metre converter, small transmitters (80 and 40 metres CW), amplifier (100W on 1296 MHz), external VFO (5 to 5.5 MHz), plus various test equipment and amateur radio accessories. All . . . can be completely assembled within hours or a few days."

The test equipment section includes a transistor tester, oscilloscope calibrator, simple bridges, even a sweep generator (to 1 MHz), filters, switches, timers, power supplies, oscillators, and sundry other items. All in all, the book is quite a mine of information, and a powerful incentive for even the faint-hearted home-brewer to make a start, aware that the task will not be so time-demanding it might never be finished!

The front cover has an intriguing colour illustration of a converter under construction. Maybe intended for the VLF band, the item is not described anywhere in the text. Perhaps, to whet one's appetite, it may be in Volume 2, which, if as good as Volume 1, will also be an excellent investment.

VK3ABP.

## QSP

### ANOTHER CHEMICAL HAZARD

"A potentially deadly threat exists in many ham shacks due to the PCB, the potent cancer-causing chemical widely used as a high voltage insulator" until banned recently. "Polychlorinated biphenyls (e.g. Pyranol) have been widely used in the manufacture of capacitors and transformers since the early 1930s. There is no danger so long as seals are intact."—Ham Radio May 1980.

**SUPPORT OUR ADVERTISERS**

# LETTERS TO THE EDITOR

Any opinion expressed under this heading is the individual opinion of the writer and does not necessarily coincide with that of the publisher.

29 Andaman St., Jamboree Heights, Old. 4074.  
28/4/80.

The Editor,  
Dear Sir,

I would like to make a proposal via this column which I hope will solve a problem with the use of FSK ident for beacon transmitters. As it seems one half of the listeners said beacons always tune to the wrong side of the frequency, and decode "inverted" ident, then this should help them. I suggest that each alternate ident be the inverse of the previous one, then after two ident periods everyone will know the legit call. This can be easily done via inverting TTL, etc., and should be incorporated into every further FSK ident scheme and keyer built.

Thanking you,  
Ian Morrison VK2YNM.

8/40 Terrace Rd., Dulwich Hill, NSW 2203.  
10/5/80.

The Editor,  
Dear Sir,

I am writing to you in regard to modifications printed in Amateur Radio Action (issues 7 and 8, vol. 2).

The transceiver in question is the Philips FM-321 70 cm amateur transceiver. The modification was for channel expansion and a scanning facility.

As you are probably aware, the circuitry of the FM-321 is almost identical to that of the Philips UHF CB counterpart, the FM-320. I am concerned that these modifications will find their way into the wrong hands, particularly CBers who may expand the channels from the legal 40 to 80 or, with more difficulty, to 100. More importantly, CBers could modify their FM-320s to cover 70 cm. The same applies to modifications for 11m to 10m conversions and 80m transverters for 11m.

In short, I believe that modifications should be ONLY permitted in a magazine that could not fall into the wrong hands, such as the WIA Journal, which is obtainable only through WIA membership.

I would like to see comments from the intruder watch co-ordinator any and other amateurs who are in agreement with me.

Yours faithfully,  
J. Bush (Assoc. member WIA).

## EDITOR'S NOTE

Most amateur magazines, including AR, are circulated to public libraries, technical schools, clubs, and even some CB groups. Do we therefore delete all such articles in case they might fall into the "wrong hands"? In my opinion, if a CBer can understand what has been written, and even successfully modify his equipment to the specifications printed, he is more than likely two-thirds of the way to becoming an amateur anyway — which is what we want.—VK3UV.

Victorian Disabled Citizens' Association,  
1 Balfour St., Doncaster 3108.  
Phone: 848 3356.  
1-6-80.

The Editor,  
Dear Sir,

## RADIO AMATEURS' GROUP VK3APU

The Radio Amateurs' Group is conducting a Commonwealth-wide appeal on behalf of all physically disabled amateurs and SWLs who until now have been largely forgotten.

Our activities are much the same as the United Kingdom Group — The Radio Amateur Invald and Bedfast Club. We provide social, recreational activities, novice classes for the disabled SWL, contests, field days, liims. Our specialist volunteers for home maintenance and repair jobs are always available.

The VK3APU net on 3575 MHz, Monday/Thursday nights at 0200 hours GMT provides a means where visually disabled and physically disabled amateurs/SWLs can pool their

knowledge, skills and spare components, benefit from each other's experience.

Most of the disabled amateurs and SWLs receive a pension so we have started a store of USEFUL component parts, equipment either donated or purchased, be made available to members at little or no cost, as needed, whenever possible, e.g. ex store, test instruments and Tx-Rx library. Membership fees as low as possible to associates (non-disabled volunteers/supporters) who undertake to help physically disabled members. Fee waived for members in financial straits, e.g. pensioners.

The Radio Amateurs' Group depends entirely on revenue from donations from supporters. Registration with the State Government hospital division of the Department of Health makes us a charitable body, all donations over \$2.00 are tax deductible, legacies and bequests are free from estate and probate duty. Our aims are to provide an activity therapy centre, first aid room, common dining/room, fully equipped amateur shack/classroom workshop, enclosed heated swimming pool, single and double motel type units, tariff to be charged for accommodation. All amenities will be available to country and interstate visitors.

The appeal has the voluntary support of the Victorian Jaycees, all donations received with the exception of printing costs go to the Association.

The appeal will be opened by the Lord Mayor of Melbourne for the 19th and 20th of July, 1980.

We ask all amateurs and SWLs to support this appeal and make life more rewarding for the visually disabled and the wheelchair mobileers.

It is a refreshing feeling knowing what you love to do and that what you are doing is making so many disabled amateurs and SWLs happy.

73.

Ted Wilks VK3UU,  
Lindsay Sykes VK3APU,  
Activities Officers.

9 Albert Street, Oueanbeyan, NSW 2620  
26-5-80.

The Editor,

Dear Sir,  
The following are extracts from a letter rather too long to publish in full:—

I, and I guess many other amateurs, are very incensed at the "snide" remark on page 39, photo 1, of AR May 1980. The last two lines: Many of us have not the facilities to erect beams and so I feel sure you don't know too much about long wire antennas. My experience covers radio (wireless as it was known then) over 50 years as a naval radio operator, where long wire antennas were always a winner, even during the last war, when I erected many long wire antennas, where possibly thousands of men owed their lives to wireless transmissions. Even today I have perfect faith which cannot be shaken from a properly tuned antenna both for reception and transmission. My antenna is a single wire (7/029) inverted "L" tilted (an amateur phrase you may not be aware of) up about 45 ft. over the roof of my house to 20 ft. shack end and facing NW the shack end to SE over the roof. I have also installed a 5 in. copper ball on the far end (very little known to many other amateurs). This ball was used by Marconi in his experiments and proved a winner, as it did to me, raising my signals to the UK from 3-4 to 5-8.9.

Your attention is drawn to page 594 of the Radio Amateur Hand Book 1974, in which it says it is not "UNCOMMON" to find a long wire antenna out-performing a beam antenna in DX contacts, etc. This (it goes on to say) is because it can respond to a variety of incoming wave angles (and can radiate a signal in a like manner), which is not the case with a well designed beam antenna.

I believe an apology should be forthcoming to all long wire users, mobile and portable, too.

Yours sincerely,

K. W. Harris VK2NOJ.

The remark was not intended to be derogatory, merely a jocular cost comparison.—Ed.

C/o Cowell PO, SA.  
18/4/80.

The Editor,

Dear Sir,  
Having been a member of the WIA for a number of years and enjoyed all the privileges this seems to give me, I feel I must let you know how I feel or "bust".

I just opened my April issue and under the heading "QSP — Outlook for the Future" you stated that you were very disappointed about the re-allocation of Channel "0". What I feel is that, as I am a country member, really all I get out of being a member of the WIA is the secure knowledge that they will look after the ham bands or at least lobby for them, but all I can see so far is a lot of talk and no action. What about the six metre operators trying to work overseas? Surely being members as well, shouldn't they be allowed to follow their hobby. It seems that the "CB" boys have really shown the WIA what can be done. Couldn't we follow their lines? Possibly then we might even get back 50 MHz section. How often does one hear really good DX down there on 50 MHz and not able to do anything about it?

Might it not be even possible to have an arrangement which the ZLs have, and that is to work 50 MHz when the local TV is not on. Even that would be something. Having got that off my chest, I can now say I will still remain one of the faithful members, but a sad disillusioned one, who is very disappointed with the WIA.

Yours sincerely,

Gary Hambling VK5AS.

# RTTY NEWS

It is now over three years since the RTTY group was formed in Sydney; since then we have grown and become the Australian National Amateur Radio Teleprinter Society with over 550 members. Our main aim has been to service our members and help them acquire the skills associated with RTTY. Some of the members we have never heard from nor, in the main, do we know they exist, except every year they pay their subs and so are still on the list. This is fine and we are pleased that they are happy with the Society, because if they were not they would either complain or resign. To assist our members, the Society has produced kits for a demodulator, modulator (tone generators) band-pass filters and various other bits and pieces of equipment associated with the RTTY mode.

As has been our custom we are always investigating ways and means of updating the RTTY mode, both on the reception and the transmission side of things. Recently we have been looking at the transmission of ASCII on the various bands. It is legal to use ASCII on the air. The regulations state that ASCII may be used with any internationally recognised speed code and shift. This is a fairly broad statement, and really does not give any indication on what to use. Basically ASCII is not a communication mode, but is an interchange of intelligence between computers. We feel that the regulations need further interpretation, but in the meantime we are attempting to assess the various speeds and shifts to try and give some indication as to the best for each band. Primarily for the HF bands, ASCII is not a viable means of information transfer, as with the number of components in each letter/figure it is possible that a small burst of static or noise will erase a number of letters or even a word or two, even at the slowest speed of 110 bauds. When attempting to transfer at a faster rate you will need perfect conditions at both ends to achieve any kind of accuracy. In the commercial field there have been numerous tests carried out to ascertain the accuracy of information interchange and it has been agreed that the most accurate and fastest speed is 50 bauds BAUDOT. But this is not the answer we are looking for. We would like to know

the error rate which would be acceptable on the amateur bands. This of course leads us to the point as to where to use ASCII — do we use it in among the BAUDOT signals? This would cause some confusion to all, and what speed do we use? And of course what shift? The faster we send the wider the shift we will need, because if we use, for example, 1200 bauds then the 170 Hz shift would be useless or relatively so, mainly because we would not have the rise time available in that shift needed to give accurate digital transfer. Again the regulations state that for RTTY the shift shall not be greater than 850 Hz. Therefore it would appear on the surface this is the widest we can go. But even 850 Hz shift at 1200 bauds still presents some difficulties, and it may be better to go to 1200 Hz shift. Unfortunately if we use this kind of shift on HF bands we will be taking up a lot of space and therefore causing problems to others. Should we have a separate frequency area for ASCII? It's worth thinking about! On VHF it is an entirely different matter, as we do not suffer from the noise problems we have on HF. With a wider band width on our receivers at VHF it is possible to use ASCII at faster speeds and wider shift and still maintain accuracy. Of course we have shorter paths to send ASCII over, therefore it would be possible to use 9200 bauds at 1200 Hz shift and still maintain an accurate transfer. Then we have the chap who works VHF and also HF, would he have to have a multi-speed/shift set of equipment? Or would it be possible to settle for a standard speed and shift? If one were to assume that the 110 baud rate were to be adopted and the 170 Hz shift were also to be adopted as the standard for all bands, then most of the present equipment in use (modulators, demodulators, etc.) will still be able to be used for the ASCII mode, whereas if the standards were to be set up at say 1200 bauds and 1200 Hz shift there would be problems with some of the present equipment, and there would have to be a certain amount of rebuilding of gear. There would then be the problem of the HF bands where the error rate would be astronomical. We are not making the decisions, rather we are trying to ascertain what those interested in ASCII are thinking and what they would prefer.

While this article would appear to be mainly involved with ASCII, we do not all use ASCII. Some use RTTY as a communication mode, and it is good to get on the air and type to other people. Most people use the excuse of not being able to type for not getting on the air. We all could not type in the beginning and we all learnt by practising. More speed is required with typing than by using the keys, and as you cannot get practice by listening, get on the air and make a noise. You will find that most of the chaps are very helpful to the "new" operators.

Early in April the Sydney chaps were very lucky in meeting Colin 9M2CR and his wife Pat, who were in Sydney for a few days from their QTH home in Malaysia. After a drive around the Blue Mountains they then met some of the RTTY fraternity. Colin and Pat were looked after by VK2EW, VK2SG and others. Colin returned to Port Dickson, Malaysia, on the 7th April, and we are sure that we will be hearing his big signal on the air again very soon.

The Australian National Amateur Radio Television Society have a news broadcast every Sunday at 0302Z (1030 EST) on the frequencies of 7045 kHz, 14090 kHz and 146.6 MHz. This broadcast is repeated at 0930Z (1930 EST) on the frequencies of 3545 kHz and 146.6 MHz. The news broadcast is also repeated on VHF in South Australia, Victoria, Northern Territory, and it is believed in Western Australia at times to suit local commitments.

Several points to ponder. RTTY is generally heard around 3545 kHz, 7045 kHz, 14090 kHz, 21090 kHz and 28090 kHz, as well as 146.6 MHz. On all the HF bands these frequencies may be plus or minus 10 kHz, and as we only use about 20 kHz of each band, please try to keep these frequencies clear. We try to keep clear of the CW segments of the bands, so please return the compliment. Not all fast RTTY stations are intruders, some fellows can type at 60 words per minute, so just because you hear a fast RTTY station around the above frequencies, do not assume it must be

an intruder and jam it. Most of the RTTY stations are capable of receiving through single tone QRM, and if you do jam a station you may be spoiling someone else's fun, and I am sure that you would not like someone to jam your CW or SSB QSO. It is also possible that an RTTY station is certainly better equipped to assess a RTTY station and is certainly better equipped to do any jamming which may be necessary in a section of the band. Most can debug the intruder or replay their own transmission, which confuses the station considerably.

Finally, if you have any questions that you would like answered on the RTTY mode, contact Box 860, Crows Nest, Sydney, and we will be happy to answer them for you. We are not the NSW RTTY group but the Australian RTTY Society, and to be the Australian Society we need to know some Australian news, so please send some and we will use it, either in the news broadcasts, the magazine or even in these notes.

Hope to see you again soon.  
de Sugar George.

TERRY TATHAM VK2TQ

It is with very deep regret that I record the passing of another of our good friends and amateurs, Terry Tatham VK2TQ, during one of his all too frequent visits to hospital.

Terry passed away on the 14th May — the end of a battle lasting some twenty-five years, since contracting polio in the early fifties.

He was first licensed around 1956 and was present when VK2-WI Dural was opened.

Terry was a quadriplegic, having very little movement in one hand, and confined to a motorised wheelchair during the day, and sleeping in a large respirator machine at night. Every breath he took he literally had to make. Terry had spent some seventeen years of his comparatively young life in hospital.

Having first met him some ten years ago, along with his most charming wife Hendra, and during those years I, and a number of other amateurs in Sydney, formed a very deep and lasting friendship with Terry, and never once did I hear him complain and enlarge about his handicap. He was an incredible man. His pursuit of knowledge — both electronic and in other fields such as becoming a licensed valuer and auctioneer — and an almost photographic memory, allowed him to join in and discuss most topics in a knowledgeable and lucid style. He did, however, manage a reasonable amount of construction work and had a well equipped workshop.

His greatest achievement and one that will be a monument to him is the beautiful half complete thirty-foot long cruiser being built in his back yard. He organised every detail, every piece of wood, nail, screw and drop of glue that went into this exquisitely built craft. Whilst employing people to do the work — it was certainly Terry's knowledge and total perseverance that created this masterpiece.

Many of us found Terry to be an inspiration. He was active to the last, running a hand-held 2 metre rig in hospital. Amateur radio was a very large and appreciated part of his daily programme, a man who did not suffer fools and could give back biter than he received.

The esteem in which Terry was held was shown when many well known amateurs were present to pay their last respects.

To Hendra, our heartfelt and deepest sympathy.

STEPHEN KUHLMAN VK2ZSK.

VICTOR (VIC) JAMES McMILLAN VK2AWN  
Vic passed away on June 8, 1980, aged 66 years.

He was an electrical engineer, and his training encompassed a wide spectrum, including electronics and structural engineering.

He gained his AOCPE in 1950. The writer wishes to pay tribute to the kindly, unassuming help, both theoretical and practical, given by him to many of his fellow amateurs, who will mourn his passing.

His work had to do with design of large transformers for public instrumentalities. He was employed by Crompton Parkinson for 38 years, and later by Westinghouse for six years prior to his retirement in 1975.

Vic was a bachelor and throughout his life was a quiet and generous contributor to many good causes, one of which was the financial support of an orphaned child living in a Third World country. He also donated in the interest of animal welfare.

His period in retirement was, sadly, a short one, and for the last two years of his life he did not enjoy good health.

W. L. HAYES VK2AJL.

## SILENT KEYS

It is with deep regret that we record the passing of —

Mr. F. H. A. McCLYMONT	VK3AYR
Mr. J. H. STEPHEN	VK5JS
Mr. F. W. HEEPS	VK3ADX
Mr. P. R. NORMAN	VK5NPN
Mr. R. WILKINS	VK2WQ
Mr. V. J. McMILLAN	VK2AWN
Mr. K. SKULIMOWSKI	VK2NUP
Mr. R. A. FOORD	L50503
Mr. A. E. BRIDGE	VK3AEB
Mr. J. H. W. WHITE	VK6UG
Mr. J. R. FISK	W1HR
Mr. F. N. LEVERIETT	VK2ADE
Mr. R. H. R. LINDSAY	VK5NRZ

## OBITUARY

FRANK HEEPS VK3ADX

Mr. Frank Heeps VK3ADX passed away May 19th, 1980, after a short illness. He became interested in amateur radio in 1932 and was licensed in 1935.

Frank served in World War II as a radio operator and was an ardent CW man. He was keen on the building of model warships. In amateur radio the use of low power transmitters was his other interest. He mainly used the 14 meg. spectrum with a dipole.

WM. F. SIEVERS VK3CB.

KEITH PETERS VK3AKP

We were all saddened to hear of the death of Mr. Keith Peters VK3AKP, which occurred in Stawell recently. Keith gave five years service in the RAAF as a wireless operator and later as a radio technician he saw service in Australia and the Islands.

After the war he joined the amateur ranks and also conducted a Radio and TV Service of his own, which he carried on until his untimely death.

He took an active part in all WIA activities and his help was greatly appreciated by all members of the Western Zone. Keith was active on all bands, but was extra keen on the DX bands, having nightly skeys with friends in the UK. His gear was something to be admired by all those privileged to see it, a lot was home-brew with a very professional touch. Antenna system the last word in perfection. Main antenna 110 ft. with rotating beams, smaller one for higher frequencies, also with fingertip control.

W. J. KINSELLA VK3AKW.

# HAMADS

- Eight lines free to all WIA members. \$9 per 3 cm for non-members.
- Copy in typescript please or in block letters to P.O. Box 150, Toorak, Vic. 3142.
- Repeats may be charged at full rates.
- Closing date: 1st day of the month preceding publication. Cancellations received after about 12th of the month cannot be processed.
- OTHR means address is correct as set out in the WIA 1979 Call Book.

## FOR SALE

Txcvr, Drake TR4C, excellent cond., with noise blanker fitted and with 240V AC or 12V DC power supply, \$550; or with both supplies, \$600. Alf Chandler VK3LC, OTHR. Ph. (03) 99 5344.

Kenwood TS520D Txcvr with Dynamic PTT mic. and Dynamic desk mic. for VOX, 10m 3 el. beam, 12 ft. boom with adjustable spacing and element lengths, G5RV ant. complete, all in good cond., station clearance, the lot \$500. VK2BDB, OTHR. Ph. (02) 546 2163 Blakehurst.

IC701 with AC supply, IC22-S, both absolutely as new, beams 204BA 20m, 4 el., 6m 5 el., 2m 8 el., 13.8V 12 amp DC supply. Ph. (03) 240 1231, 509 6637 AH.

MuHi 800D 2m FM Txcvr., 25W, synthesised (see EA Sept. 1978 for review), \$300; 25W 2m linear amp. for use with IC202, \$30; VK2ZYM, QTHR. Ph. (02) 44 6980.

Complete "Novice Station" Halicrafter SX115 and HT 32, exc. cond., \$500. Write to M. Walsh VK4NJC, C/- Railway Station, Eldsvold 4627. Ph. Eldsvold 17 Bus.

FT901DM with SP901 speaker and YO148 desk mic., complete in orig. packing, \$1385, ONO; TS820 in very good cond., \$850; Drake TR4C Txcvr with AC-4C power supply and 34-PNB n.b. with spares, RV-4C remote VFO, complete in orig. packing, \$485, ONO; linear amplifier Alpha 77DX, pair of 8877s ceramic/metal triodes, G/G in output, tunable 1.8-30 MHz continuous POA. Greg VK3BIB, QTHR.

Yaesu FT101B AC/DC, mic., CW filter fitted, complete in carton with handbook, low hours, exc. cond., \$550, ONO; base for mobile mounting still unpacked, \$15; mast ex yacht, 39 ft. tapered and hollowed spruce, light can be erected without a gin pole, \$30; R210 Rx plus cks, specification and alignment, \$85, ONO. Reduction sale, going bush. VK3XZ, QTHR. Ph. (03) 783 1639.

Teletype Mod. 15 Teleprinter, 45-45 bd, syn. motor, \$50; 2 mod. 15s, 50 bd, syn. motors, \$30 ea.; 1 mod. 14 typing reperl., 50 bd, syn. motor, \$20; 1 mod. 14TD governed motor, \$20; 110V step down transformer, \$15. VK3ZYD, QTHR. Ph. (03) 497 3049 AH.

Yaesu FT620, exc. cond., unmarked, unmodified, Yaesu VC75 VOX/compressor unit, CushCraft 5 el. yagi, Elegia mic./phones headset, headphones, \$500 the lot; Belcom liner 2, exc. cond., with extra mixer crystals for Oscar working, home-brew regulated PSU/loudspeaker, dual meter SWR bridge, CushCraft 7 el. yagi, \$300 the lot; Stolle rotator, good cond., with control box and cable, 5 section telescopic mast, \$75 the pair; Ken KP202, good cond., with leather case and strap, nicad batteries and charger, helical and whip antennae, ch. 40, 50, 2, 4, 6, 8, \$135; home-brew 650 MHz counter prescaler, incl. 11C90 prescaler chip, regulated PSU in Horwood case, \$30; part complete home-brew 80m transceiver, includes Horwood case with meter, switches, pots, heatsink, 9 MHz filter and crystals, digital frequency readout module, Dick Smith 30W linear amp., all modules complete, have been working in receive mode, requires mounting and interconnecting of modules, \$150, ONO. VK3BMA, QTHR. Ph. (03) 62 9755 Bus., (03) 404 2241 AH.

RCA Radiola 18 Model AR936 and Burgin phone console 5 radio, very old, with legs, suit collector, both antiques and of historical value, best offers for both. Ph. (03) 88 6696 after 6 p.m. or weekends.

Mic. Cable, two individually shielded circuits, plus one switching pair in braided outer sheath, 100 yard coil, \$25; 50 yds., \$13; 25 yds., \$7. P. Gilck VK3BMG, 15/47 Hanover St., Fitzroy, Vic. 3065. Ph. (03) 419 2516.

Eddystone Transistorised Receiver EC-10, 550 Kc/s to 30 Mc/s, single conversion receiver powered by internal dry cells, includes switchable BFO and AGC, internal speaker, RF and AF gain, in immaculate cond., includes circuit diagram, etc., \$100; Teletype model 15 reperforator, complete with all original wiring, fitted with holding magnets and 110V AC motor, no reasonable offer refused; transformer 240 to 100V, had especially made to supply Teletype, raled at 3.5 amps, brand new, never been used, \$30. Ph. (03) 368 2472 Bus. hrs., ask for G. Brownrigg.

2650 Mini Computer System, complete with VDU, cassette Interface and software, \$300, ONO. Enquiries P. Robbins L40776, 11 Lae Cres. Puckapunyal.

FT200 with mic. and ATU, \$350. Contact John VK3BKT. Ph. (03) 654 4333, ext. 231, BH.

Uniden 2020 240V AC/12V DC, 80-10m, txcvr., mint cond., realistically priced at \$450; Daiwa RF550 speech processor (crystal filter type), \$100; both for \$500, or exchange for Tandy TRS-80 disk drive. VK6JC, QTHR. Ph. (09) 458 3016.

FT301D with 200W PSU, as new cond., had little use, price complete \$900. Ph. (070) 55 6433 or Box 113, Smithfield 4871. VK4NYI.

Collins 32S1 Transmitter with 516F2 AC power supply and speaker unit, 75S1 receiver with 500 CPS, CW filter, all first class units, \$700. Ph. (049) 46 7674.

Shack Clearance: Yaesu FT7, \$350; AWA FPI xtal locked 80m AM, \$50; conv. Johnson Viking 352D, 10m, \$150; power supply, 5 amp. cont., \$100; desk pwr. mike, as new, \$35. Ph. (03) 754 4860.

Yaesu FT401B Txcvr., Yaesu YD-844 mic., Katsumi solid-state speech processor, all mint cond., no mods., spare linals and others, no linear required, 80, 40, 20, 15, 11, 10m, WWV, circuits, manual, \$750; Sony tape recorder, 3 speeds, 4 tracks, mono, 120 or 240V AC, mic., 20 tapes, 7 in. and 5 in., reel to reel, as new, \$140. VK2PT, QTHR. Ph. (049) 43 1308.

Yaesu FT200 Txcvr, in exc. cond., overhauled and modified by VK5MM, improved 10m band reception, new valves, mic., etc., IC 22A, 2m FM txcvr., repeaters 2 (and reverse), 3, 4, 5, 6, 8, simplex 40, 50, recently checked by dealer. VK3BCG QTHR. Ph. (03) 836 6266, ext. 237, between 0900-1700 hrs.

Uniden 2020 with ext. VFO and spkr., \$600; Heathkit SB610 monitorscope, \$80; Diawa MC330 mic. compressor, \$60; Osker Bloc SWR bridge, \$50; 1969 to 1980 AR collection, best offer. VK3AXB. Ph. (054) 39 5458 AH.

Masonry Brick Home, approximately 17 squares, master bedroom, dressing room, ensuite, two other bedrooms with built-in robes, spacious lounge, dining room, family room, kitchen unit with gas cooking, electric hot water service, fully tiled bathroom, masonry block garage, workshop 30 ft. x 16 ft., with rolladour, tower, etc., set on deep block with barbecue area, natural setting, superb views, \$50,000. House of late VK3AKP. All enquiries Gramplains Real Estate, 180 Main St., Stawell, Vic. 3380.



Hi-Gain TH3JR, 10-15-20m beam, good cond. Ph. (02) 602 7653.

Kyokutu synthesised 2m FM Txcvr with mobile mount, regulated power supply and magnetic 5/8 wave antenna, perfect cond., \$275. Erik Bierre VK2BEK. Ph. (02) 476 5096.

Yaesu FT101E, 160-10m, latest model, modified for novice use, exc. cond., complete with AC and DC power cords, mic., manual and spare set of valves, \$750. Contact John Brereton VK5NHB, QTHR.

Icom IC701 with matching PSU and mic., mint cond. orig. cartons, \$990. Ian Ampt VK3CH. Ph. (03) 25 6083.

TONO 7000E, brand new, morse CW RTTY reception and transmission, genuine reason for sale. Andy Squires VK3YQX, QTHR. Ph. (053) 48 2061.

Yaesu FT901DM SSB Tcxr., with AM, CW filters factory installed, FV901DM external scanning, 40 memory VFO, spkr., Yaesu mic., all equipment brand new in unopened boxes, \$1450 the lot. James VK2JO. Ph. (02) 799 5566 or (02) 36 7756, or GPO Box 5076, Sydney, NSW 2001.

Yaesu FRG-7 comm. Rx, .05 MHz-29.9 MHz, AC/DC, exc. cond., \$200. Les L31187, QTHR. Ph. (03) 277 1874.

Kenwood 120S Txcvr., MB-100 mounting bracket, MC-10 mic., \$675 the lot; Kenwood PS-30 power supply, 20 amp. 13.8V DC, \$170. Contact R. Chapman VK2BYV, QTHR. Ph. (02) 47 1998.

Yaesu FT101B HF Txcvr, plus mic. and SWR bridge, good cond., for quick sale, \$475; Yaesu FTV250B, 2m SSB/CW transverter, c/w. low noise pre-amp., matches FT101 series, genuine sale, \$195; Yaesu FTV650B 6m SSB/CW transverter, measured 50 watts output, works very well, rush before DX season, \$200; Yaesu FR100B amateur band, all mode Rx, 20 to 10m, will cover new WARC freqs., good cond., \$145 for quick sale; Eddystone 750 general coverage receiver, good cond., BC band to 32 MHz in 4 bands, \$75 to clear. Ring Ken VK3AKK. Ph. (03) 688 9295 Bus.

IC22A Rptr., ch. 2, 4, 6 and 8, simplex 40, 50 and 51, \$140; Atlas 210 with n.b. and mobile cradle, \$450, ONO; both in perfect cond. VK3ACS, OTHR. Ph. (03) 592 5960.

FTV650 6m Transverter and 5 el. yagi, \$120, ONO. VK3ADD. Ph. (03) 791 7801.

## WANTED

Amplex 8624 Tube. Particulars to Dr. Dan, VK2ABU, QTHR. Ph. (02) 212 3833 Bus., (02) 328 1261 AH.

Be grateful for information to convert Royce I-632 to amateur bands, or circuit of PLL unt. Information will not be misused. R. Davis L70180, C/- WIA North Branch, Box 275, Launceston 7250, or Ph. (003) 32 4111 Bus.

## TRADE HAMAD

Amidon Cores — Iron-powder and ferrite, enlarged range available for tuned/wideband and suppression applications in Rcvrs./Trans., large SASE for data/price list. Closed for business during November. RJ & US Imports, Box 157, Mortdale, NSW 2223.

## ADVERTISERS' INDEX

AUDIO TELEX	52
AMATEUR RADIO ACTION	38
BAIL ELECTRONICS	29
CHIRNSIDE ELECTRONICS	41
CW ELECTRONICS	51
DICK SMITH ELECTRONICS	2
GFS	7
GLUYAS GIMMICKS	42
NSW DIVISION WIA	45
RJ AND US IMPORTS	50
SCALAR INDUSTRIES	19
SIDEBAND ELECTRONIC ENGINEERING	39
VICOM PTY. LTD.	4, 6
WILLIAM WILLIS	42
W. & G. WULFE	42

## A REMINDER

A WIA MEMBERSHIP CERTIFICATE IS OBTAINABLE ONLY FROM YOUR DIVISION.

# commodore

## NOVICE OR FULL LICENSE

The worlds of the Personal Computer Enthusiast and the Amateur Radio Operator are overlapping. More and more Amateurs are communicating in Morse or RTTY (and ASCII)\* via their mini-computers. Computers such as the Commodore CBM and Pet have added an exciting new dimension to enthusiast radio communications.

Next to your Commodore mini-computer all that is needed to join this aspect of our hobby is a Macrotronics Morse/RTTY interface, which comes complete with its own software. This interface is the link pin between computer and station. Macrotronics

interfaces are also available for Apple TRS-80, Sorcerer and soon the new System 80. The desk top minicomputer is not only used as a communication terminal but can be utilized for keeping log books, QSL mailing lists, competition logs. As the band of enthusiast grow so new software and uses come available. While the Commodore, the interface and your station are all that is needed to join this exciting area of Amateur Radio, optional extras are available to increase the functions and abilities of the computer. Floppy Disk Drives - like four draw filing cabinets from which, and at very high speed, one can store and draw messages and information. Printers - some of which enable you to take printed records of communications and print out log books etc. The worlds of the Amateur Radio Operator and the Computer Enthusiast are open to you through CW Electronics.

### MINICOMPUTER INCENTIVE OFFER UNIQUE TO CW ELECTRONICS

With each Commodore 16K or 32K mini-computer purchased from CW Electronics by a licensed Amateur Radio Operator will come, at no extra cost, a MACROTRONICS M65 Ham Interface for Morse Code and RTTY (and ASCII) Transceiving.\*  
**SAVE \$149**

### SERVICE DIVISION

We have a fully equipped electronic service division. We can service enthusiast and commercial electronic gear efficiently and at a reasonable charge.

Wholesalers, agents, manufacturers and retailers please consider us for your next Queensland service contract.

CW can arrange service and service contracts of Commodore computers within Australia and PNG.

Telephone: (07) 341 5377

A.H.: (07) 341 4767

**\*\*WHILE CURRENT STOCKS OF M65 LAST \*Refer to license limitations on Morse and RTTY communications.**

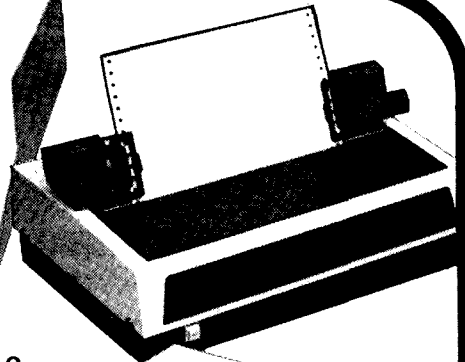
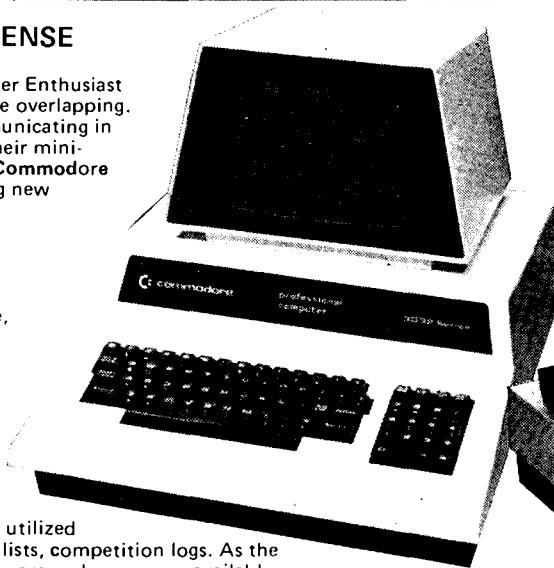

### PERIPHERALS SOFTWARE INTERFACES

#### BUSINESS MEN

We have available software packages available for the COMMODORE Minicomputers

- Creditor package
- Debitor Package
- Complete Word Processing
- Stock Control and others

We have a customising service for modification and specials.

**PROGRAMMERS**-we are interested in merchandising your original quality software packages for popular mini and personal computers.

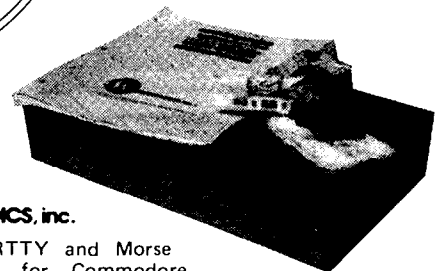

**M650 DELUX**



**MACROTRONICS, inc.**

Delux RTTY and Morse System for Commodore computers including complete software on cassette, assembled and tested hardware, and extensive instructional manual.

Interfaces also available for TRS-80, Apple, Sorcerer and soon the System 80



**ELECTRONICS**

CNR. MARSHALL RD AND CHAMBERLAND ST.,  
TARRAGINDI - BRISBANE PH. (07) 48 6601  
P.O. BOX 274, SUNNYBANK, QLD. 4109  
AH: BRIAN (07) 341 4767 TELEX AA 40811





# DB10-15A

## HF DUO BAND

### FOR 10 AND 15 METRES

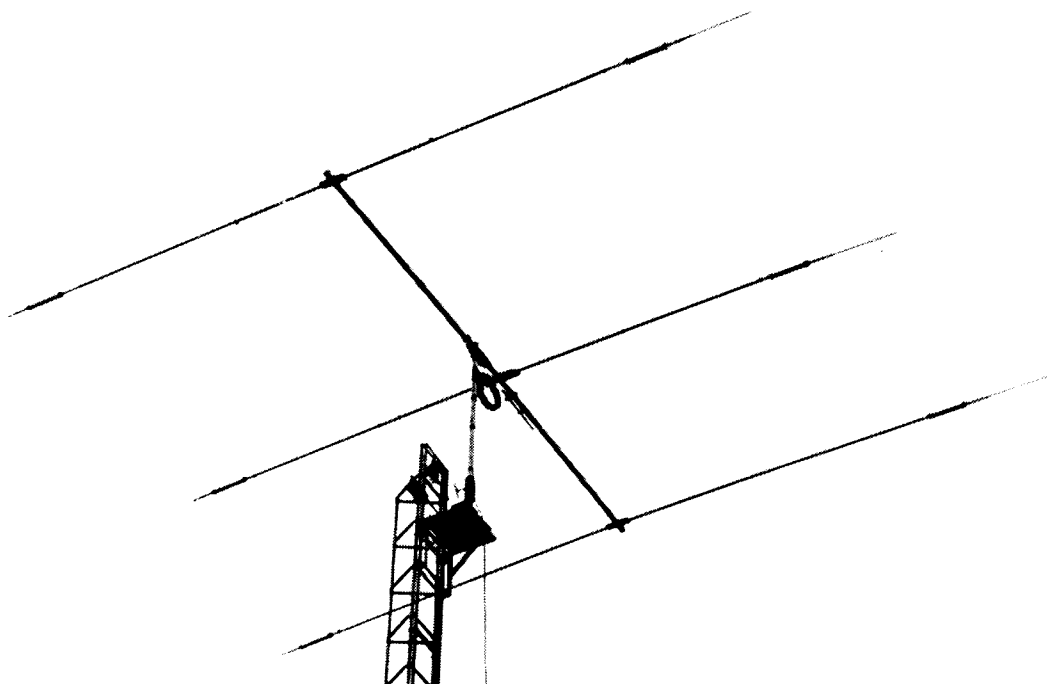

The Hy-Gain Duo Band is not a new addition to our range, but it has established itself as one of the most popular duo band antennas in the world. Equipped with exclusive Hy-Gain Hy-Q traps, both bands feature F/B ratio of 15-25 dB and less than 1.5 : 1 SWR at resonance.

Boom Length .....	18 feet	VSWR at Resonance .....	Less than 1.5 : 1
Longest Element .....	31 feet	Power Input .....	Maximum Legal
Turning Radius .....	18 feet	Input Impedance .....	50 ohms
Surface Area .....	6.4 sq. feet	—3 dB Beamwidth .....	66° average
Wind Load .....	164 lbs.	Lightning Protection .....	DC ground
Weight .....	50 lbs.	Forward Gain .....	8.4 dB
		Front to Back Ratio .....	15-25 dB

**WRITE OR CALL FOR A FREE BROCHURE AND THE NAME OF YOUR NEAREST HYGAIN DEALER  
SOLE AUSTRALIAN DISTRIBUTOR**

AUDIO TELEX COMMUNICATIONS  
PTY. LTD.



**MELBOURNE:**  
7 Essex Road,  
MOUNT WAVERLY 3149  
Tel: 277 8311

**BRISBANE:**  
394 Montague Road  
WEST END 4101  
Tel: 44 6328

**SYDNEY:**  
1 Little Street,  
PARRAMATTA 2160.  
Telephone 833 4344

# amateur radio

JOURNAL OF THE WIRELESS INSTITUTE OF AUSTRALIA

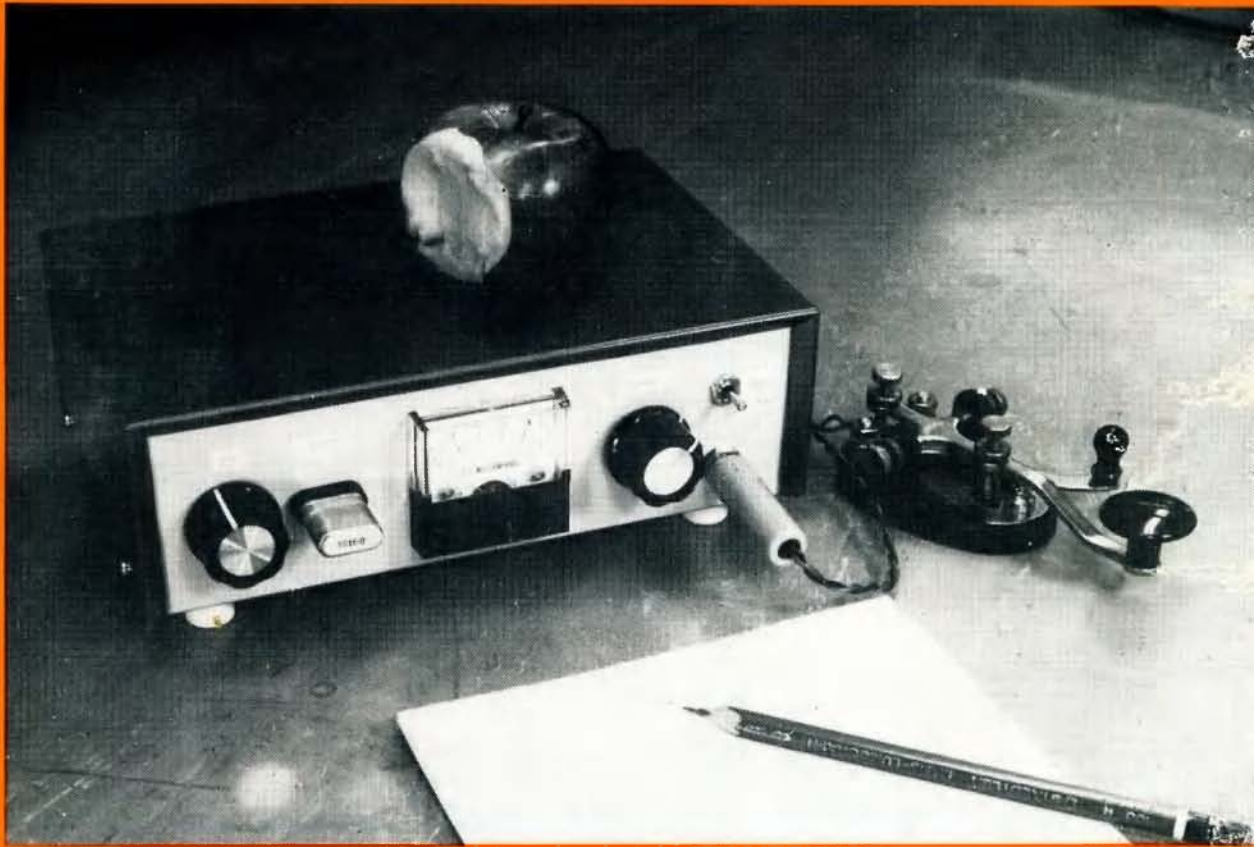

VOL. 48, No. 9

SEPTEMBER 1980

## ***FEATURED IN THIS ISSUE:***

- ★ ***FIVE WATT CW TRANSMITTER***
- ★ ***PORTABLE 2m REPEATER***
- ★ ***TAMING THE MULTIPLE ELEMENT QUAD***
- ★ ***Review — THE ICOM IC2A 2m HAND HELD TXCVR***

# YOU'VE GOT YOUR CALL

And, if you're typical of most amateur radio operators, you're always ready to give assistance to anyone wanting to learn about this fascinating hobby.

But what do you do for a complete beginner? What do you recommend to give them a start in language they can understand?

Amateur handbooks are really above beginners: until now, there hasn't been much around to start them off.



## HERE'S THE ANSWER:

# DICK SMITH'S FUN WAY INTO ELECTRONICS



Cat B-2600

ONLY \$4.95

This book is intended fairly and squarely for the complete beginner. It starts off by identifying components, describing what they do and where they are used. It shows the tools needed for electronics, and hints & tips on project building. Then there are twenty exciting projects to build: each one explaining aspects of electronics and circuit operation. Finally, there's a brief description of radio transmitters and receivers - and how they work.

Dick Smith's Fun Way Into Electronics is the ideal book for the beginner because it shows by doing - you must remember the thrill of building your first projects - and the even bigger thrill when they actually WORKED!

No soldering is required, and all projects are battery operated: so the book is suitable for beginners of all ages!

**KITS FOR FUN WAY PROJECTS:** Two kits are available for 'Fun Way' projects - the first kit (Cat K-2600 @ \$6.90) enables any of the first ten projects to be built. The second kit (Cat K-2610 @ \$7.50) is an extension kit which, together with the first kit, enables any of the projects to be built.

# AND NOW: DICK SMITH'S FUN WAY VOLUME TWO!

After working through Fun Way, the appetite is whetted: the novice (no longer a beginner!) is ready for bigger and better things. Fun Way Volume 2 has twenty more exciting and different projects to build: these are made on printed circuit boards, further advancing the knowledge. We even show how to solder properly, and the trouble signs to look for. All of the projects in Fun Way Volume 2 have been chosen to not only teach electronics in an easy, yet fun way - they are all useful devices in their own right. After working through Fun Way Volume 2, we're sure every reader will want to move on to bigger and better things: who knows - even amateur radio!

ONLY \$6.95

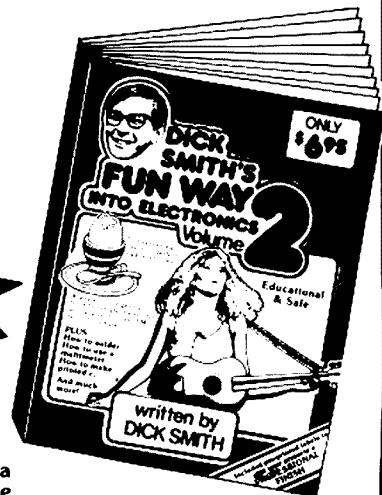

Cat B-2605

**KITS FOR FUN WAY TWO PROJECTS:** Each of the projects in Fun Way Two has a separate kit, which includes the pcb and all components required to build it. To keep the cost to a minimum, no 'hardware' is included. For further details see our current catalog.

**RADIO CLUBS, ETC: ASK ABOUT OUR INCREDIBLE BULK DISCOUNTS ON BOTH THE BOOKS AND THE KITS!**

AVAILABLE FROM YOUR NEAREST BRANCH OF

# DICK SMITH ELECTRONICS

ALSO FROM DICK SMITH RE-SELLERS, AND MOST GOOD BOOKSELLERS & NEWSAGENTS





# amateur radio

SEPTEMBER 1980

VOL. 48, No. 9

PRICE: \$1.20

Registered Office:  
3/105 Hawthorn Road,  
Caulfield North 3161.

EDITOR:  
BRUCE BATHOLS\* VK3UV

PRODUCTION MANAGER:  
MARK STEPHENSON\* VK3NOY

TECHNICAL EDITORS:  
BILL RICE\* VK3ABP  
EVAN JARMAN\* VK3ANI  
RON COOK\* VK3AFW  
GIL SONES\* VK3AUI

CONTRIBUTING EDITORS:  
BOB ARNOLD VK3ZBB  
G. NICK NICHOLS VK6XI  
ROY HARTKOPF\* VK3AOH  
RON FISHER\* VK3OM  
ERIC JAMIESON VK5LP  
LEN POYNTER\* VK3BYE  
BILL VERRALL VK5WV  
WALLY WATKINS VK2DEW

DRAFTING:  
NEIL OSBORNE\* VK3YEI

BUSINESS MANAGER:  
PETER DODD VK3CIF

\*Member of Publications Committee

Enquiries and material to:  
The Editor,  
PO Box 150, Toorak, Vic. 3142

Copy is required by the first of each month. Acknowledgement may not be made unless specially requested. All important items should be sent by certified mail. The editor reserves the right to edit all material, including Letters to the Editor and Hamads, and reserves the right to refuse acceptance of any material, without specifying a reason. Material should be sent direct to P.O. Box 150, Toorak, Vic., 3142, by the 25th of the second month preceding publication. Phone: (03) 528 5962. Hamads should be sent direct to the same address by the 1st of the month preceding publication.

Trade Practices Act: It is impossible for us to ensure that advertisements submitted for publication comply with the Trade Practices Act 1974. Therefore advertisers and advertising agents will appreciate the absolute need for themselves to ensure that the provisions of the Act are complied with strictly. Readers are reminded that, when buying, obtaining or receiving goods from overseas including goods listed in advertisements by overseas organisations in this Journal, Customs import duties and Sales Tax may be levied on the goods at the time of importation. These amounts, if any, are payable by the purchaser unless the terms of sale state otherwise and the seller has made specific provision to this effect in his quotation to the buyer or unless other prior arrangements are in force between the buyer and the seller.

Typesetting: MUELLER INDUSTRIES  
1a Levanswell Road, Moorabbin, 3189  
Tel.: 553 0292

Printers: WAVERLEY OFFSET PUBLISHING GROUP  
Geddes Street, Mulgrave 3170

## CONTENTS

### TECHNICAL

Circuit Mods. to Kyokuto Txcvr for Handicapped operation	12
Five Watt CW Transmitter	8
Portable 2m Repeater	20
Taming the Multiple Element Quad	14

### DEPARTMENTS

Afterthoughts	7
ALARA	38
Amateur Satellites	25
Around the Trade	40
Awards Column	38
Contests	39
Divisional Notes	40
Forward Bias	32
Hamads	41
Intruder Watch	37
Ionospheric Predictions	35
Letters to the Editor	36
Listening Around	32
Main QSP	5
Novice Notes	23
Obituary	41
QRKS	33
QSP	7, 15, 26, 32
Stop Press	7
Silent Keys	41
Spotlight on SWLing	30
VHF-UHF — an expanding world	27
WIANEWS	7
You and DX	34
WICEN	37
VK CW QRP	25

### GENERAL

Cycle 21 Peaks	35
Repeater Quiz	18
Results of 1979-80 Ross Hull Memorial Contest	40
Review — The ICOM IC2A 2m Hand Held Txcvr	18
We are not Pirates	13

ADVERTISERS' INDEX 42

## Cover Photo

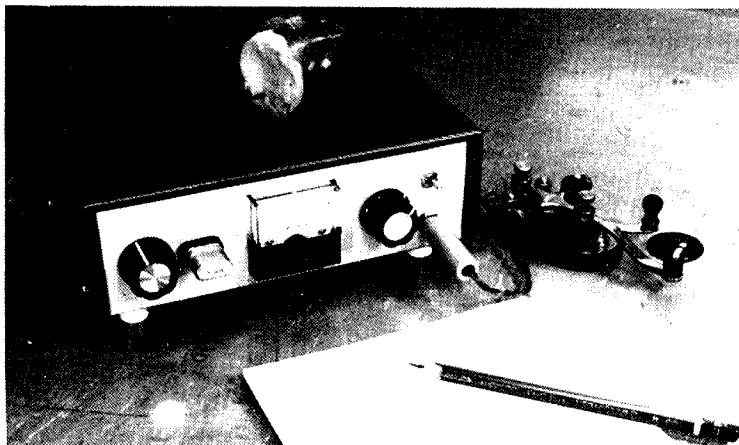

Who said homebrew is dead? If you are a Novice or Old Timer, the 5 watt CW transmitter by Drew Diamond VK3XU, pictured on our cover this month, will drive the "black box syndrome" out of you! Turn to page 8 for details.

# "MORE GREAT DAIWA GEAR TO TURN YOU ON!"

## ROTATORS NEW TYPE WITH MAP CENTRED ON AUSTRALIA!

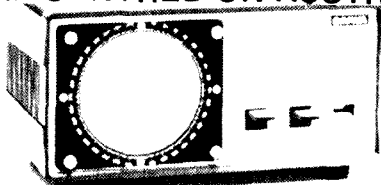

DR7500R	Medium Duty	189.00
DR7500X	Medium Duty with pre-set controller	172.00
DR7600R	Heavy Duty	269.00
DR7600X	Heavy Duty with pre-set controller	239.00



**DAIWA**

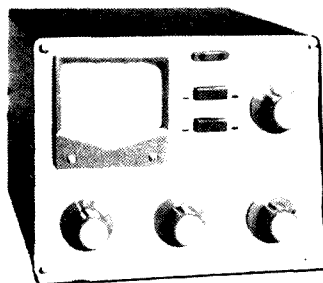

## ANTENNA COUPLERS

CL67A	1.9-28 MHz, 500 wpep	135.00
CNW217	incl SWR/PWR Meter, 200W	165.00
CNW418	as above, with new WARC freqs	179.00

High quality models with SWR/PWR Meter include unique cross-needle meter.

## COAXIAL SWITCHES

2 Position model CS201	23.00
4 Position model CS401	59.00

Professionally engineered cavity construction, high isolation.

Power rating: 2.5 KW pep, 1 KW CW  
Impedance: 50 ohm  
Insertion loss: less than 2dB  
Maximum frequency: 500 MHz  
Isolation: Better than 60dB at 300MHz.

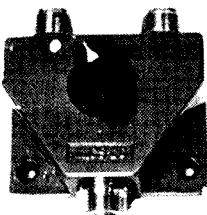

## SWR & POWER METERS

Model	Freq.	PWR	Cross-Needle	Price
CN620	1.8-150 MHz	20/200/1KW	yes	99.00
CN630	140-450 MHz	20/200	yes	135.00
CN650	1.2-2.5 GHz	2/20	yes	169.00
SW210A	1.8-150 MHz	20/120	no	99.00

Cross-needle type offer DIRECT readings.

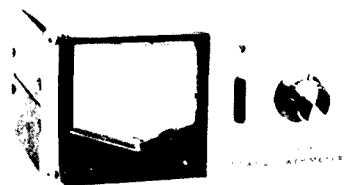

## SPEECH PROCESSORS

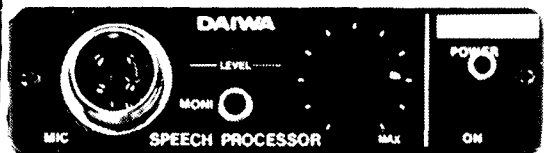

RF660	Phasing type dc	109.00
RF440	Phasing type ac/dc	126.00
RF550	Fitter type, ac/dc	169.00
MC330	Speech compressor	99.00

Increase talk power with splatter free operation. RF clipping (not in MC330) assures low distortion. Simply install between microphone and transmitter.

Typical specs RF660:  
Talk power: Better than 6dB  
Freq. Response: 200Hz-3000Hz at 12dB down  
Distortion: less than 3% at 1 KHz, 20dB clipping.  
Power Req.: 13.8 Vdc at 50mA.

## AUTOMATIC ANTENNA TUNER

New model with the extra WARC frequencies included. The VSWR is automatically adjusted below 1.5 PWR  
Rating 500W pep.  
CNA1001 269.00

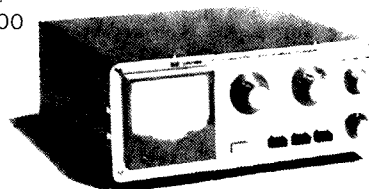

SYDNEY: 339 Pacific Hwy, Crows Nest  
Ph. 436 2766

MELBOURNE: 68 Eastern Rd, Sth Melb.  
Ph. 699 6700

# VICOM

AVAILABLE AT REPUTABLE HAM  
DEALERS

## Why Contests ?

Basically, amateur radio is an individual hobby, pursued in one's own time, at one's own desire and covering a multitude of special interests, one of these being — contests.

An entry in a memorial contest is an expression of an amateur's respect or admiration for the person so honoured. Three of our Australian contests are of this type — the Remembrance Day, John Moyle and the Ross Hull Contests.

Contest working allows an amateur to compete against other amateurs throughout the world on the same basis, thus allowing for individual skill and operating expertise to surpass high power and/or multi-operator stations.

Again, contest operation sharpens the senses and quickens the reflexes, particularly with regard to the phonetic alphabet thus making an excellent training ground for emergency operators.

However, in contests like the Remembrance Day Contest, where the scoring is on a Divisional basis, participation by all amateurs is essential if the purpose of the contest is to be realised, and every Division have an equal chance of winning. Participation means both the giving out of numbers and submitting of a log. So look back through the Remembrance Day results and see if your Federal and Divisional Councillors have shown by example that participation is the name of the game. Remember that leadership comes only from the top.

Contests, although not for everyone, are another facet of our wonderful hobby of amateur radio, perhaps used only by a few, but always available to all.

**WALLY WATKINS VK2DEW,**  
Federal Contest Manager. ■

## WIRELESS INSTITUTE OF AUSTRALIA

Federal President: Mr. P. A. Wolfenden VK3ZPA

### Federal Council:

VK1 Mr. R. G. Henderson VK1RH  
VK2 Mr. T. I. Mills VK2ZTM  
VK3 Mr. G. A. G. Williams VK3ZXW  
VK4 Mr. A. R. F. McDonald VK4TE  
VK5 Mr. G. Preston VK5PI  
VK6 Mr. N. R. Penfold VK6NE  
VK7 Mr. B. J. Morgan VK7RR

Staff: Mr. P. B. Dodd VK3CIF, Secretary.

Part-time: Col. C. W. Perry, Mrs. J. M. Seddon and Mr. Mark Stephenson (AR Production).

Executive Office: 3/105 Hawthorn Rd., Caulfield North, Vic. 3161. Ph. (03) 528 5962.

Divisional Information (all broadcasts are on Sundays unless otherwise stated).

### ACT:

President — Mr. A. Davis VK1DA  
Secretary — Mr. F. Robertson-Mudle VK1NAV/ZZZ  
Broadcasts — 3570 kHz and 2m Ch. 6 (or 7): 10.00Z.

### NSW:

President — Mr. A. D. Tilley VK2BAD  
Secretary — Ms. S. J. Brown VK2BSB  
Broadcasts — 1825, 3595, 7146 kHz, 28.32, 52.1, 52.525, 144.1, 145.6, 146.4, Rptr. Ch. 3 — Gostford, Ch. 4 — Lismore, Ch. 5 Wollongong, Ch. 8 — Dural 11.00h local (Evening 0930Z). Relays on 160, 80 and 10m, VHF and Repr. Ch. 3, Ch. 5, Ch. 8, and Hunter Branch, Mondays 0930Z on 3595 kHz, 10m, and Ch. 3 and 6. RTTY Sunday 0030Z 7045, 14090 kHz, Ch. 52, 0930Z 3545 kHz, Ch. 52.

### VIC.:

President — Mr. A. R. Noble VK3BBM  
Secretary — Mr. G. F. Atkinson VK3YFA  
Broadcasts — 1840, 3600, 7135 kHz — 53.032 AM, 144.2 USB and 2m Ch. 2 (5) repeater: 10.30 local time.  
Gen. Mtg. — 2nd Wed., 20.00.

### QLD.:

President — Mr. A. J. Aarsse VK4QA  
Secretary — Mr. W. L. Gielis VK4ABG  
Broadcasts — 1825, 3580, 7146, 14342, 21175, 28400, kHz; 2m (Ch. 42, 48): 09.00 EST.  
Gen. Mtg. — 3rd Friday.

### SA:

President — Mr. I. J. Hunt VK5QX  
Secretary — Mr. W. M. Wardrop VK5AWM  
Broadcasts — 1820, 3550, 7095, 14175 kHz; 21.160 28.5 and 53.1 MHz, 2m (Ch. 8): 09.00 S.A.T.  
Gen. Mtg. — 4th Tuesday, 19.30.

### WA:

President — Mr. B. Hedland Thomas VK6OO  
Secretary — Mr. Peter Savage VK6NCP.  
Broadcasts — 3560, 7075, 14100, 14175 kHz. 28.47, 53.1 MHz, 2 metres Ch. 2 Perth, Ch. 6 Wagin. Time 0130Z.  
Gen. Mtg. — 3rd Tuesday.

### TAS.:

President — Mr. R. Emmett VK7KK  
Secretary — Mr. B. J. Morgan VK7RR  
Broadcasts — 7130 (SSB) kHz with relays on 6 and 2m Ch. 2 (S), Ch. 8 (N), Ch. 3 (NW), 09.30 EST.

### NT:

President — Mr. T. A. Hine VK8NTA  
Vice-Pres. — Barry Burns VK8DI  
Secretary — Robert Milliken VK8NRM  
Broadcasts — Relay of VK5WI on 3.555 MHz and on 146.5 MHz at 2330Z. Slow morse transmission by VK8HA on 3.555 MHz at 1000Z almost every day.

### Postal Information:

VK1 — P.O. Box 46, Canberra, 2600.  
VK2 — 14 Aitchison St., Crows Nest, 2065 (Ph. (02) 43 5795 Tues & Thurs 9.45-13.45h).  
P.O. Box 123, St. Leonards, NSW 2065.

VK3 — 412 Brunswick St., Fitzroy, 3065 (Ph. (03) 41 3535 Weekdays 10.00-15.00h).

VK4 — G.P.O. Box 638, Brisbane, 4001.

VK5 — G.P.O. Box 1234, Adelaide, 5001 — HQ at West Thebarton Rd., Thebarton.

VK6 — G.P.O. Box N1002, Perth, 6001.

VK7 — P.O. Box 1010, Launceston, 7250.

VK8 — (Incl. with VK5), Darwin AR Club, P.O. Box 37317, Winnellie, N.T., 5789.

Slow morse transmissions — most week-day evenings about 09.30Z onwards around 3550 kHz.

### VK QSL BUREAUX

The following is the official list of VK QSL Bureaux, all are inwards and outwards unless otherwise stated.

VK1 — QSL Officer, G.P.O. Box 46, Canberra, A.C.T. 2600.

VK2 — QSL Bureau, C/- Hunter Branch, P.O. Teralpa, N.S.W. 2284.

VK3 — Inwards QSL Bureau, Mr. E. Trebilcock, 340 Gillies Street, Thornbury, Vic. 3071.

VK3 — Outwards QSL Bureau, Mr. R. R. Prowse, 83 Brewer Road, Bentleigh, Vic. 3204.

VK4 — QSL Officer, G.P.O. Box 638, Brisbane, Qld., 4001.

VK5 — QSL Bureau, Mr. Ray Dobson VK5DI, 16 Howden Road, Fulham, S.A. 5024.

VK6 — QSL Bureau, Mr. J. Rumble VK6RU, G.P.O. Box F319, Perth, W.A. 6001.

VK7 — QSL Bureau, G.P.O. Box 371D, Hobart, Tas. 7001.

VK8 — QSL Bureau, C/- VK8HA, P.O. Box 1418, Darwin, N.T. 5794.

VK9, 0 — Federal QSL Bureau, Mr. N. R. Penfold VK6NE, 388 Huntriss Rd., Woodlands, W.A. 6018.

# SIDEBAND ELECTRONICS ENGINEERING

"THE ANTENNA AND ROTATOR SPECIALISTS"

P.O. BOX 23 SPRINGWOOD NSW 2777  
WAREHOUSE 213 HAWKESBURY RD. SPRINGWOOD  
TELEPHONE (047) 54 1392

For top performance on 10, 15 and 20M you just can't go past the TET HB35C log/yagi antenna. Coupled with a KEN KR-400 rotator, you get results! Since inflation has caused price increases on almost everything these days, a cheaper combination still offering

acceptable results is the HY-GAIN TH3-JR10-15-20M yagi and KR-400 rotator, or how about a CUSHCRAFT A3 full size Tri-bander and CDE HAM-IV rotator?

Roy Lopez

## ANTENNAS

TET HB35C 10-15-20M 5 el log/yagi 13' boom..... \$415  
CUSHCRAFT A3 10-15-20M yagi 14' boom..... \$325

## HY-GAIN

TH3-JR 10-15-20M 3 el yagi 12' boom..... \$250  
DB10-15A 10-15M 3 el yagi 13' boom..... \$190  
153-BA 15M 3 el yagi 12' boom..... \$120  
18-AVT/WBa 10-80M trapped vertical 21'..... \$125  
8 el 2M yagi 14' boom 15db gain..... \$50  
14 el 2M yagi 16' boom 18db gain..... \$60  
GPG-2 2M 5/8W co-linear 3-4db gain..... \$30  
6M and 2M 1/4W whips..... each \$9  
HELICAL MOBILE WHIPS 10-15-20-40-80M  
heavy duty de-luxe models w/adj. tip each..... \$25  
As above ANY TWO WHIPS plus mount & spring..... \$60  
As above FIVE WHIPS plus mount & spring..... \$115  
NOVIE PACK 10-15-80M whips plus mount & spring \$80  
GPV-5 2M base co-linear 2 x 5/8W..... \$55  
OSCAR-2D 2M mobile co-linear 2 x 5/8W..... \$35  
BN-86 balun (for beam buyers only)..... \$25  
HI-Q balun 50 ohm 1KW 1:1..... \$15

## HENRY RADIO FAMOUS LINEARS

2KD-5 2KW PEP 80-10M SSB/CW/RTTY/AM..... \$1000  
1KD-5 1200W PEP 80-10M SSB/CW/RTTY/AM... \$800

## KYOKUTO FM-2025A

The very latest 2M FM from KDK 25W  
10 memory channels plus full scanning etc..... \$340

## ACCESSORIES

SWR meter Hansen twin meter 150MHz..... \$35  
SWR meter single meter 150 MHz..... \$25  
ASAHI Chrome bumper mount..... \$8  
Standard bumper mount..... \$5  
Chrome base & spring to suit ASAHI mount..... \$15  
FERGUSON 240V AC transformer 2 x 9V  
secondaries at 3A..... \$8  
DYNASCAN 820 digital capacitance meter..... \$150  
TRIO DM800 grid dip meter..... \$120

## NOVICE SPECIALS — CONVERSION CRYSTALS

SET OF 8 crystals converts 28.480-28.595 in 5KHz steps. Clarifier tuning on Tx & Rx plus info to re-activate 24th ch. .... \$32  
SET OF 4 crystals converts 28.310-28.600 in 10 & 20kHz steps. Clarifier tuning Tx & Rx..... \$15

## ROTATORS & CABLES

All rotators now come with bottom brackets and control boxes wired for 28V AC.  
CDE BT-1A BIG TALK light duty programmable 4 pos. push button plus normal operation..... \$110  
KEN KR-400 medium duty..... \$140  
KEN KR500 vertical rotator ..... \$170  
CDE HAM-1V heavy duty..... \$225  
CDE T2X TAIL TWISTER extra heavy duty..... \$300  
KEN KS-065 stay/thrust bearings..... \$30  
8 core rotator cable per metre..... .80c  
RG-58U coax cable per metre..... .50c  
RG8U foam coax cable per metre..... \$1.20

## TRIO-KENWOOD PRODUCTS

Ring for a competitive price on Trio-Kenwood transceivers, TS-180S w/WARC frequencies, TS-120S, TS-520SE, TR-9000, TR-2400 etc.

TS-130S HF all band WARC transceiver..... POA  
R-1000 Digital clock receiver..... POA  
SP-100 external speaker R-1000..... \$32  
SP-180 ext. speaker TS-180S w/filters..... \$60  
AT-180 200W ant. tuner/SWR/Power..... \$160  
TV-502 2M transverter..... \$250  
DK-520 adaptor TS-520/DG-5..... \$10

## YAESU MUSEN PRODUCTS

FT-101ZD 160-10M transceiver w/cooling fan & AM\$895  
FRG-7 5-30MHz receiver..... \$300

## COAX CONNECTORS

PL-259 RG-8U & RG-58U types..... .75c  
Cable joiners RG-8U & RG-58U types..... .60c  
GLP right angles RG-58U to SO-239 w/lock nut & weatherproof cap..... \$1.50  
SO-239 4 hole & single hole types..... .75c  
MLS right angle RG-58U to PL-259..... .75c  
In-line mic sockets 3 & 4 pin each..... .60c  
Mic. sockets 3 & 4 pin each..... .75c  
M-ring body mount w/lock nut..... \$1.50

All prices are NET, ex Springwood NSW, on pre-payment with order basis. All risk insurance is free of charge, allow for freight charges by air, road, rail or post, excess will be refunded. Prices are subject to

change without prior notice. All orders cleared on a 24 hours basis after receipt of order with payment.

Roy Lopez (VK2BRL)

# WIANEWS

CB

At the time of writing, this the Institute's submission on the matter of the CBRS Review, has taken shape and will be submitted in time. The Institute's policies are clear and have been much publicised lately.

## MEETINGS

One meeting of the Executive was held in mid-July. It was noted that the attention of the P. and T. Department had been drawn to the withdrawal of the concessions previously granted to holders of "C" calls. Apart from identification, the new Handbook, paragraph 6.38, now requires "C" call station licensees to seek prior approval for a change of address. It is understood these matters will be rectified. Another item discussed was the VK0RM DX-pedition. The Federal Awards Manager was fully supported in accepting contacts made only on 17th March, 1980. A suggestion that contests be banned from all the three new bands at 10, 18 and 24 MHz was received. A suggestion that WAVCKA be made available to VK amateurs was also received.

## 1980 CALL BOOK

If all goes according to plan the new WIA Call Book should have been distributed by the time you read this. There were far too many duplicated call signs in the listings which could not be resolved before the lists went to press. Any assistance from members in sorting these out would be very welcome. It was bad luck that further lists from the Victorian and Queensland licensing officers arrived after going to press. The 1980 Call Book is in the nature of an "intermediate" update because hitherto the Call Book was issued only each second year (1979, 1977, etc.). This issue will contain some new material, such as a DXCC countries list in a format which avid DXers can use and frequency spectrum (existing) charts. In a year or two it is proposed to publish similar charts operative from 1st January, 1982. The 1981 Call Book is intended to include updates of the material (including club listings) in the 1979 Call Book.

## GENERAL

Ken Seddon VK3ACS was elected as Executive Vice-Chairman for the ensuing year. Ken is also Chairman of the Federal Repeater

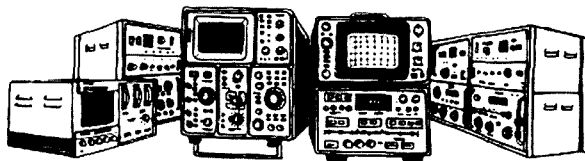

## SERVICE PROBLEMS?

Suffer no more — contact the experts:

## GFS ELECTRONIC IMPORTS

15 McKeon Road,  
Mitcham, Vic. 3132  
Phone (03) 873 3939

Because we have many years experience in the Communications Service Industry, encompassing the CB, AMATEUR and COMMERCIAL sectors we are able to offer you the best service that your set deserves at a realistic price.

Call and discuss your problems with our experts.

Sub-Committee. A design for the international-diamond style of badge was finalised. It was agreed to ask the Department for stations such as VNG to transmit IPS predictions.

## AFTERTHOUGHTS

**MODIFICATION OF SSB 27 MHz PLL Tcrr FOR 10m OPERATION** — by G. T. Ryan VK4AR (Aug. 1980, p.11).

It has been pointed out by Mr. B. Keller VK3AIK that not all PLL ICs referred to are identical. He writes:

In addition to the sets mentioned in the article the PLL02A PLL is also used in the Electraphone and HMV sets.

Unfortunately I have found that not all PLL02As have pin 4 connected as shown, allowing a reference divider ratio of either 1024 (10 kHz) or 2048 (5 kHz).

All PLL marked "PLL02AG" have the dual facility, but those with "PLL02A and either M60, M69 or MGN" do not.

The "G" version has been in two-thirds of the sets that I have seen. ■

## STOP PRESS Third Party Traffic

The Minister for Posts and Telecommunications, Mr. Tony Staley, in opening the 1980 Remembrance Day Contest, announced that forthwith the prohibition on third party traffic by amateurs would be removed for non-commercial messages within Australia. He also indicated that agreement would be sought with other countries, that permit their amateurs to pass third party traffic, to allow international third party privileges for Australian amateurs communicating with amateurs in these countries. Until such agreements are made, Australian amateurs are prohibited from passing any international third party message.

## QSP

### JOTA

A reminder about the 23rd Jamboree on the Air, October 18th-19th, starting at 00.01h local time on the Saturday and finishing at 23.59h local time on the Sunday. Stations are free to begin operations earlier if they wish. World Scout phone frequencies are 3.59, 7.09, 14.29, 21.17 and 28.59 MHz. Listen on the frequency before calling "CQ Jamboree". The opening ceremony will be at 14.00h on Saturday from VK1BP from the grounds of Government House in Canberra. The Chief Scout, Sir Zelman Cohen will give an address, followed by one for the Girl Guides by Lady Cohen, and then one each from the Chief Commissioners for Scouts and Guides. The frequencies used will be 7.09, 14.29 and 21.17 MHz, starting half an hour before the official opening ceremony, so please keep these frequencies clear. Kevin Campbell will operate his station VK0KC for JOTA from Mawson in Antarctica. The World Bureau station will use a GB call sign from Laboratories near Windsor Castle in the UK. VK1BP might continue operating as a participant if another QTH can be arranged for it after the opening ceremony. The station has to close down for security reasons before 16.30h on the Saturday. The 13th Australian Jamboree will take place at Collingwood Park in Ipswich from 29th December, 1982, to 7th January, 1983. ■





When constructing the circuit, mount all the components except Q8. At this stage it will be possible to check the operation of the VXO and amplifiers. Q6/Q7 should provide about 400 mW RF into 50 ohms. Adjust L1 for maximum crystal pull. This will probably occur with the slug fully inserted into the coil. Check for clean keying, absence of spurious, etc. Don't worry if the waveform is not exactly sinusoidal. That's why there is a low pass filter on the output end. The circuit could be used as a 400 mW QRP transmitter at this stage by omitting Q8 and connecting the LPF at the secondary of T2. All being well, Q8 may be mounted into place and soldered. To set bias for Q8, insert a milli-ammeter in

the supply line and set R28 so that Q8 draws 50-100 mA (key must be open during this set-up).

To test the completed transmitter, connect a 50 ohm dummy load to the output, close the key and rotate R10 clockwise from zero (increase level). There should be a smooth power rise indicated by M1. Any sudden changes in reading could be indicative of instability in the PA stage. Instability problems should not arise if the circuit has been closely followed. It should be possible to cure instability by changing the value of R22 (remember to reset Q8 bias) and/or removing C23. Use the station receiver to check for clicks (another indi-

cation of instability) and spurious, etc. There should be no output indication with the key open or crystal removed. Some voltages are provided on the circuit as an aid to trouble shooting should it be necessary.

When an antenna is used, it must present a 50 ohm load to the output, and SWR should generally be less than 2.0 for correct operation of the LPF. No physical damage should occur if the SWR is greater than 2.

The transmitter may be used on 1.8 MHz by using a 1.8 MHz crystal and increasing the value of the LPF constants, i.e. L4, L5 should be 4.4 uH, C34, C36; 1800 pF, and C35; 3600 pF. Other bands,

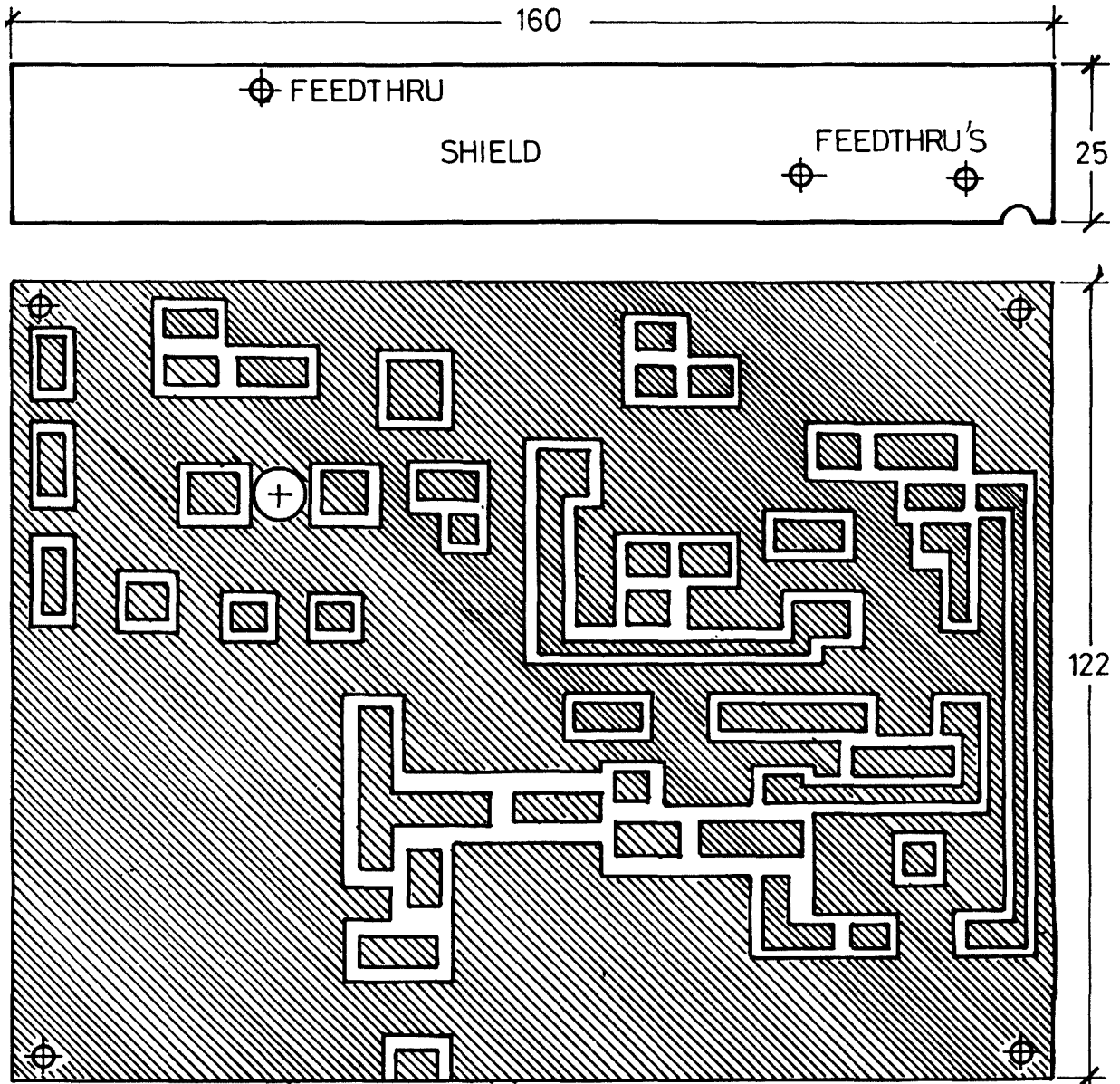
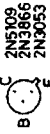
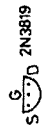
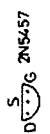
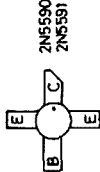
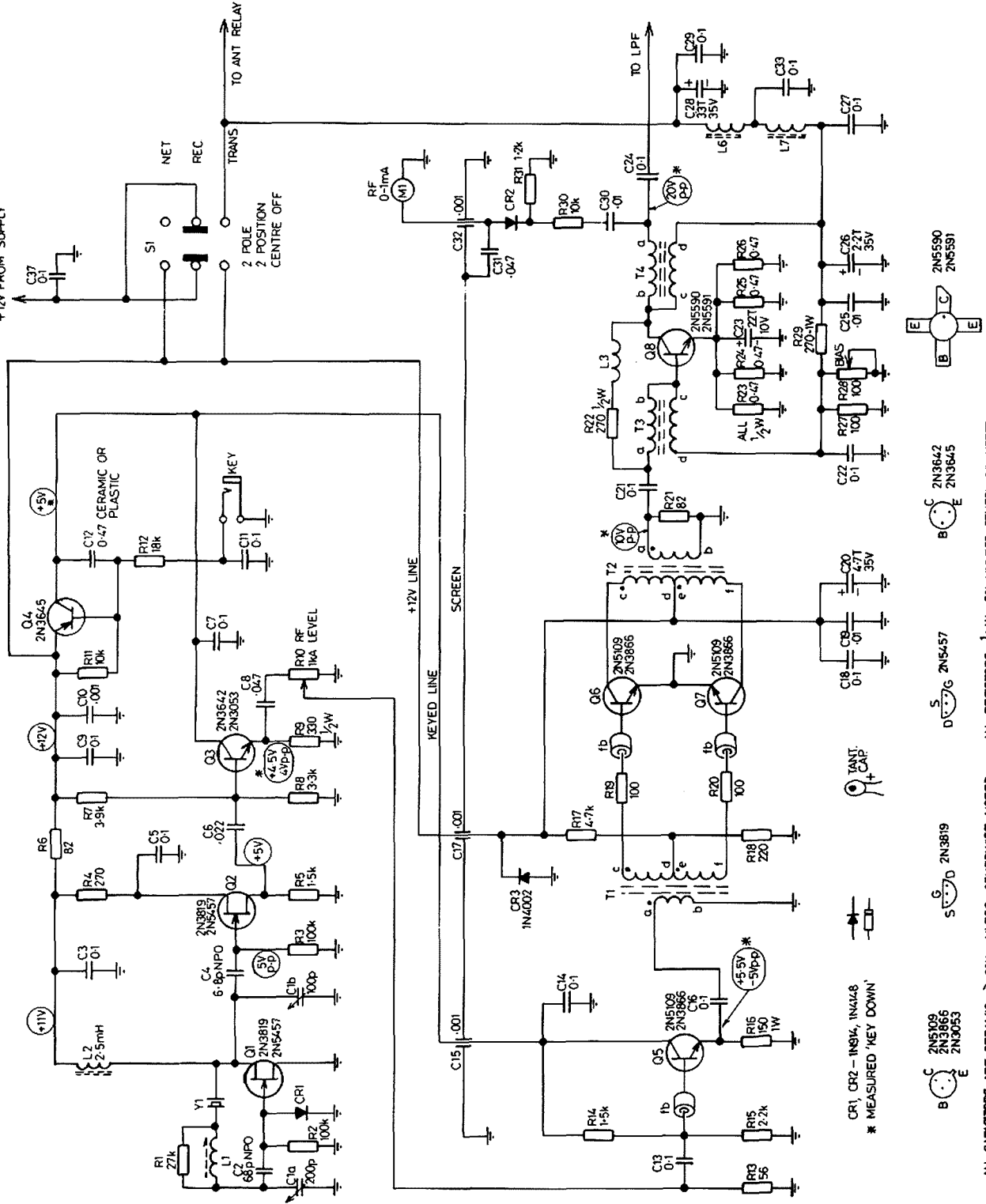

FIGURE 3: Board layout for the 5 watt CW transmitter.

+12V FROM SUPPLY



CR1, CR2 - 1N414, 1N4148  
 \* MEASURED 'KEY DOWN'



ALL CAPACITORS ARE CERAMIC, > 63V UNLESS OTHERWISE NOTED  
 ALL RESISTORS 1/8W, 5% UNLESS OTHERWISE NOTED  
 1b = FERRITE BEAD INSTALLED ON BASE LEAD

FIGURE 4: 5W CW Transmitter circuit diagram.



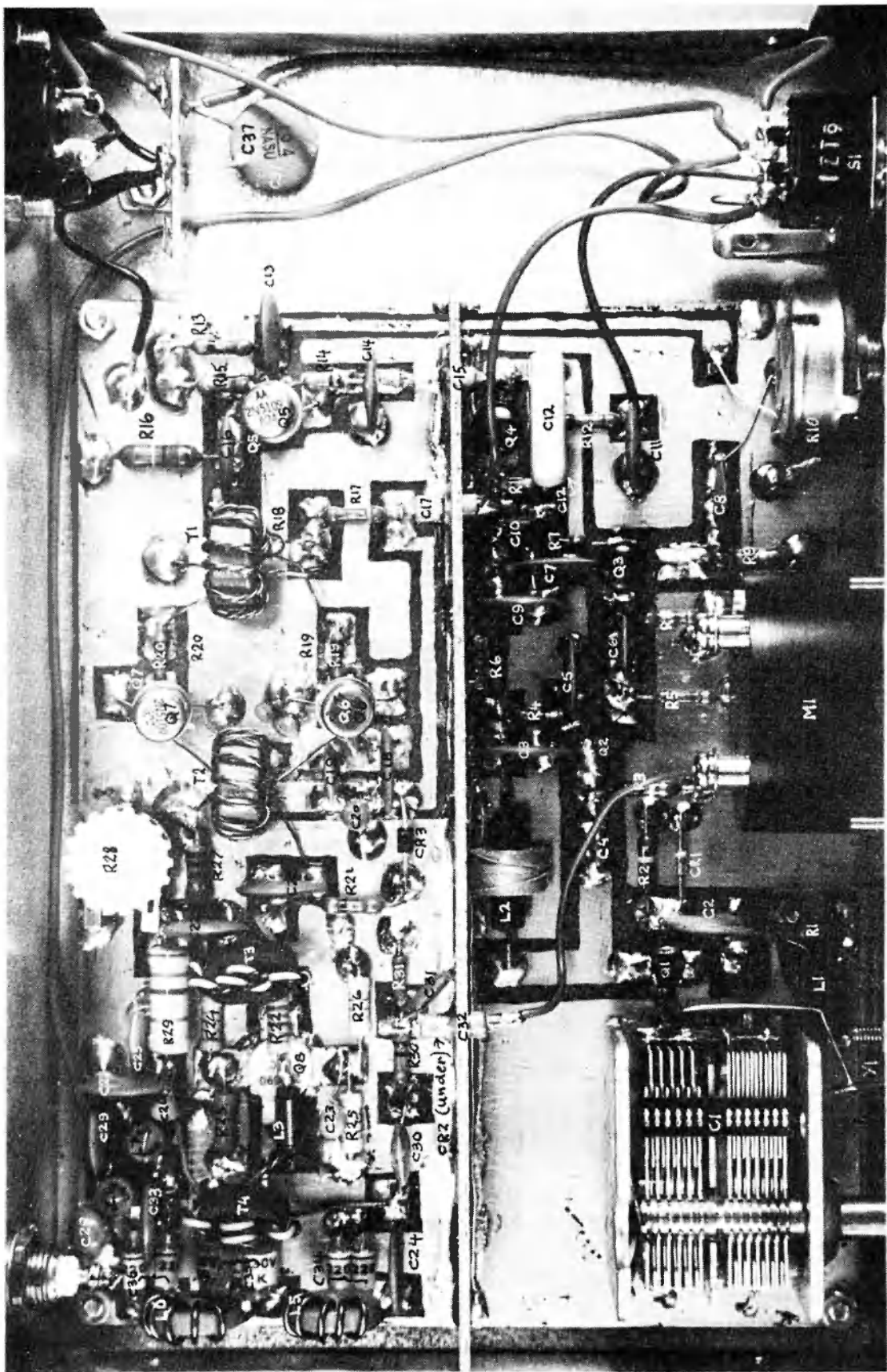

PHOTO 2: Component layout for the transmitter.





# Taming the Multiple Element Quad

A. W. (Tony) DePrato WA4JQS  
205 Cherokee Trail, Somerset,  
Kentucky 42501, USA

It has been a long time since I have written an article for any amateur magazine, but after many "on the air" inquiries as to how my antenna performs and how I overcame various problems which seem to plague so many hams with multi-element quads, I decided to write this construction article.

For years I had used a four element monobander. After the loss of two towers I decided to try the Quad Antenna. My first try was with a two element on an eight foot boom but it did not compare with my four element beam. Next, I used a four element quad on a 20 foot boom. However, my beam worked better. I was plagued with low front-to-back and high SWR and interaction between bands. So out came the books. After many hours of research the results were a quad with high forward gain, high front-to-back ratio, no interaction, and low SWR with a wide band width.

The following specifications as to gain are approximate but can be considered accurate by amateur standards:

Four element tri-band quad.

Boom length — 30 feet.

Boom material 2 in. OD, ¼ in. wall, 6061T6 alloy.

Element spacing — 10 feet equal.

Gain — 13 dB.

Front-to-back ratio — 30 dB.

Wire size — 14g enamelled copper.

Five per cent difference factor between elements.

Design frequencies: 14.250, 21.300, 28.600 MHz.

Directors 1 and 2: Directors 1 and 2 are the same size. I used the formula  $975/f$  MHz. The frequency and wire lengths are listed as follows: 14.250 — 68 ft. 4 in.; 21.300 — 45 ft. 8 in.; 28.600 — 34 ft. 1 in.

Driven Element: For the driven element I used 1005/f MHz. The frequency and wire length are listed as follows: 14.250 — 70 ft. 5 in.; 21.300 — 47 ft. 2 in.; 28.600 — 35 ft. 1 in.

Reflector: Here I used 1030/f MHz to obtain the wire lengths: 14.250 — 72 ft. 3 in.; 21.300 — 48 ft. 4 in.; 28.600 — 36 ft. 0 in.

Spreaders: I used one piece fibreglass spreaders 13 feet long and fitted eyebolts through the arms to run the wire through. This lets the arms move in the wind and not break the wire and also lets the wire draw and sag with temperature changes and not bow the arms. A note of interest: bamboo can be used but should be wrapped with two inch wide duct tape and then sprayed with Krylon or varnish. (Duct tape is heavy duty adhesive tape used for sealing air-conditioner ducts.—Tech. Ed.)

Radius (A) to the screw eyes is found by taking the wire length in feet for each band and multiplying by  $\sqrt{2/8}$  (= 0.1768).

Example: Drill point for driven element 20 metre wire. At 14.25 MHz, wire length = 70 ft. 5 in. = 10.42 ft.

$$70.42 \times 0.1768 = 12.45$$

$$\text{so } A = 12.45 \text{ ft.}$$

or 12 ft. 5 in. from centre.

Below are the drill point radii for each element:

Directors 1 and 2: 14.250 — 12 ft. 1 in.; 21.300 — 8 ft. 1 in.; 28.600 — 6 ft. 0 in.

Driven Element: 14.250 — 12 ft. 5 in.; 21.300 — 8 ft. 3 in.; 28.600 — 6 ft. 2 in.

Reflectors: 14.250 — 12 ft. 8 in.; 21.300 — 8 ft. 6 in.; 28.600 — 6 ft. 5 in.

These figures are used if you measure from the centre of the boom out. To measure from butt of arms, subtract  $1\frac{1}{2}$  in. from each figure. This way the arms may be drilled before attachment to the boom. Each hole should be wrapped with duct tape after drilling, then a small nail can be used to punch a hole in the tape. Each spreader should be sprayed with Krylon or other type of coating to increase life and prevent eyebolts from rusting. I also wrapped the butt ends with duct tape for added strength.

## STRUCTURAL DETAILS

The spreaders are attached to the boom by means of commercially available



The author in his well-equipped shack.

aluminium castings called spider mounts. Mine were made by Kirk Electronics of Chester, Conn., and obtained from Skylane Products of 406 Bon Air Drive, Temple Terrace, Fla. 33617. These mounts are in two halves which are clamped to the boom by bolts on each side.

Note: Kirk Electronics is a division of Viking Instrument Inc., who are represented in Australia by GFS Electronic Imports, a regular AR advertiser. The quad hubs advertised by J. Vaile are the angled type for 2-element "boomless" cubical quads and would probably not be suitable for the 4-element structure. See also an advertisement by Ashpoint Pty. Ltd. in AR September 1978, page 14; much the same comments apply.—Tech. Ed.)

The mast above the Ham-M rotator is 2 inch diameter like the boom. The boom is attached to it by a 6 inch square aluminium plate and four 2½ inch U-bolts. The tower is free-standing and cranks-up to 70 feet. Nested height is 32 feet from ground to quad boom, and in this state the antenna has survived a 90 m.p.h. wind without damage.

One problem is how to string the spreaders. I drove a 2 in. 4 ft. pipe into the ground and attached the arm supports to this pipe. I then drove 2 wooden



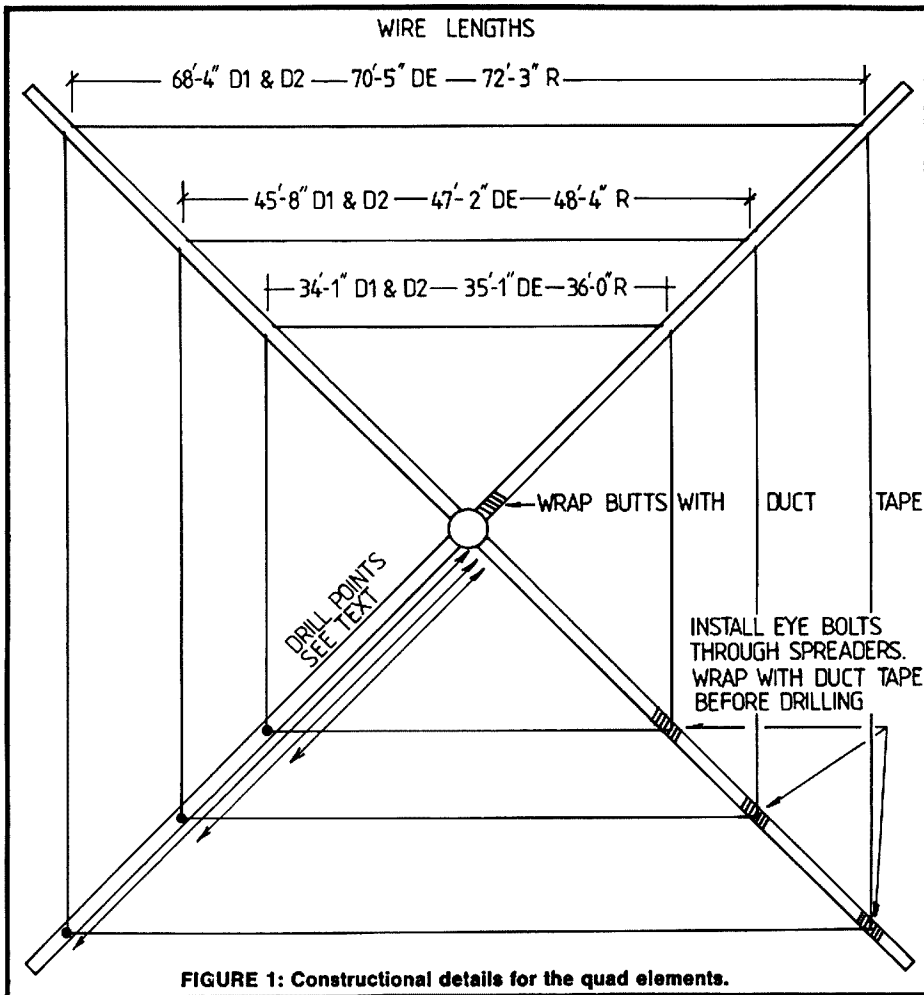

FIGURE 1: Constructional details for the quad elements.

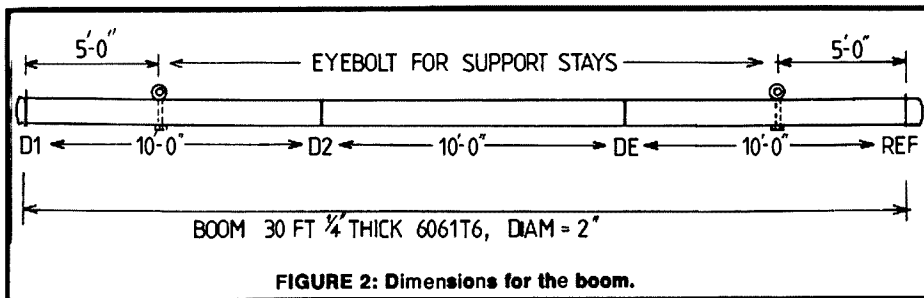

FIGURE 2: Dimensions for the boom.

3 ft. stakes into the ground to support each arm. By using this type of jig each element can be wired, removed, and then placed on the boom. I covered all nuts with General Electric clear silicone rubber then sprayed with Krylon.

Feeding the Quad: I decided to use quarter wave stubs after burning up a 1 kW ring transformer and it's no fun waiting two weeks for a new transformer. This occurred at 700 watts key-down. I used 72 ohm coax but 1 kW twin lead can also be used. Below are the lists of lengths for both coax and twin lead using the formula  $L = 246 \text{ VF}/f \text{ MHz}$  (VF = velocity factor).

Stubs: RG-11A/U coax  $Z = 72 \text{ ohm}$ ,  $\text{VF} = 0.66$ .

Driven Element: 14.250 — 11 ft. 4 in.; 21.300 — 7 ft. 6 in.; 28.600 — 5 ft. 6 in. 1 kW twin leads  $Z = 72 \text{ ohm}$ ,  $\text{VF} = 0.71$ . 14.250 — 12 ft. 3 in.; 21.300 — 8 ft. 2 in.; 28.600 — 6 ft. 1 in.

The stubs were cut as close to lengths as possible with PL 259 and barrel connector on one end and attached to 52 ohm coax to shack. I then checked each 52 ohm feedline using my noise bridge and R4C to confirm the SWR was acceptable.

#### CONCLUSION

After the antenna was installed, measurements were made. The SWR was 1.6:1 at its highest point on any band with very flat response across each band. I can operate either the CW or phone portion with the SWR never going above 1.6:1. I have been using the antenna for five months and have yet not to make it through the pile ups. The work involved is well worth the time with the results obtained. My next antenna is a two element 40 metre Quad. Should anyone want more information they could write or look for me around 14250 or on P29JS net about 0110Z Sundays.

I would like to thank Barry WA4POH. Without his help and encouragement this project would have been scrapped. Barry also put up a quad like mine and is very pleased.

#### REFERENCES

Radio Handbook, 20th Edition — Orr.

## QSP

### RNARS

A note from VK2ALG (QTHR) the VK Branch Manager of the Royal Naval Amateur Radio Society, advises that GB2RN will be on air all bands, CW and SSB, aboard HMS Belfast, museum preserved in London's Upper Pool (opposite the Tower) from 00.01Z on 4th April to 18.00Z on 13th April; QSL only on receipt of card plus IRC (2 IRC for airmail) via RSGB QSL Bureau. From 1st April the price of RNARS Mercury Award is increased to 50 p or 6 IRC. The Australian Branch of RNARS now has over 100 members and has taken over the wireless office of the museum ship HMAS Castlemain, at Gem Pier in Williamstown, for restoration and a permanent exhibition station VK3BZU. This work is headed by VK3BKK, QTHR.

### PENPALS

Are you good at writing as well as talking? Then you not put pen to paper and write to Hidemasa Imakura JG3PLZ. Hide is a fourteen-year-old student who wishes to correspond to VK amateurs. His main hobbies are radio, books, collecting stamps and coins. Are you interested? Write to Hide at 81, Shinbori 2-Chome Sakai-shi Osaka, 591 Japan.

### MOI

To coin an abbreviation — microwave oven interference. Pat Hawker in TT Radio Communications February 1980 draws attention to the concern felt about the rapidly increasing number of crude high-power transmitters that are going into homes in the form of microwave ovens. These devices are already seriously interfering with the observation of weak, extra-terrestrial signals by radio astronomers,

says Sir Bernard Lovell of Jodrell Bank. Detailed investigations showed that concern is felt not only for the spectrum from 1 to 8 GHz but even wider. Ovens operate on the ISM frequency of 2.45 GHz  $\pm 0.05 \text{ GHz}$  generally using magnetrons capable of producing 1 to 2 kW of microwave power, operating from rectified but unsmoothed AC mains. Power is generated for about half of each supply cycle, and the magnetron usually drives a load that is deliberately disturbed by a rotating metal paddle "with the consequence that both the instantaneous frequency and the power are a function of time". Modulation sidebands thus give rise to out-of-band emissions and there is a high harmonic content. G3VA concludes his article "The prospect of millions more high-power, self-excited RAC transmitters radiating over an extremely wide band of frequencies and made unstable by revolving paddles is not one to be dismissed lightly".

## REVIEW

# The ICOM IC2A 2m Hand Held Transceiver

Ron Fisher VK3OM

As the advertisements put it, "When is ICOM coming out with a "Hand-Talkie". Well, they have. And of course, now everyone is going to ask: just how good is the new IC-2A and what does it offer?"



PHOTO 1

There is no doubt that the ICOM name is synonymous with VHF gear of excellent design, reliability and certainly popularity. It might surprise newcomers to the hobby that this reputation has been built up over only about eight years. The first ICOM or, as they were known then, INOUE IC-20 two metre FM transceivers were marketed by the Industrial and Medical Electronic Co. of Melbourne about the middle of 1971. With two channels installed they cost \$295. Those of us who consider amateur gear expensive should make a few comparative calculations. However, the first INOUE gear that came into Australia was in fact an all band HF transceiver imported by Syd Clark VK3ASC, a couple of years before the IC-2D.

ICOM have come a long way in a very short time. So on this basis, just what should we expect in a two metre handie should we expect in a two metre hand talkie from ICOM? I must admit that on my first encounter with the IC-2A I was a little disappointed. After all, it didn't even have one memory, let alone scanning or other features that seem to be essential to the ardent FM operator. However after a short time operating the little rig my opinion changed.

Let's look at the IC-2A in some detail. The size is impressively small. It will fit easily into a shirt pocket and is certainly the smallest two metre hand held on the local market. The overall dimensions are 65 mm wide, 35 mm deep and 16.5 mm high and weight 470 grams. The height and weight can vary depending on the battery pack chosen, and this in turn affects the transmitter output and battery life. Our review is based on the smaller battery pack and so transmit performance figures given later are in accordance with this.

The IC-2A is simplified in both concept and to some extent in operation. Perhaps simplified concept is not quite the right way to describe a full coverage 800 channel two metre transceiver, but ICOM have chosen to offer a transceiver without electronic frequency display, memory or scanning. Perhaps it's a sign of the times that we can describe such a transceiver as basic. Frequency selection is also simplified and uses thumb wheel switches to select the 10, 100 and 1000 kHz segments with a small slide switch for five kHz up. Repeater operation is provided with either a + or -600 kHz transmit facility but no instant selection of reverse repeater mode is available. Transmit-receive change-over

is accomplished by solid state switching so the PTT handle on the side only has to operate a small microswitch. There are two immediate advantages. One, the effort on the part of the operator is small and not tiring over a long period, and two, an external PTT microphone can be plugged in and used in, for example, mobile operation. The antenna supplied with the set is the usual flexible helical connected to the set via convenient BNC socket. Transmitter output is rated at 1.5 watts on high and 0.15 watt on low. Our IC-2A output was a commendable 2 watts and it should be noted that in the near future when the larger optional battery pack is available the output should be around the 5 watt mark.

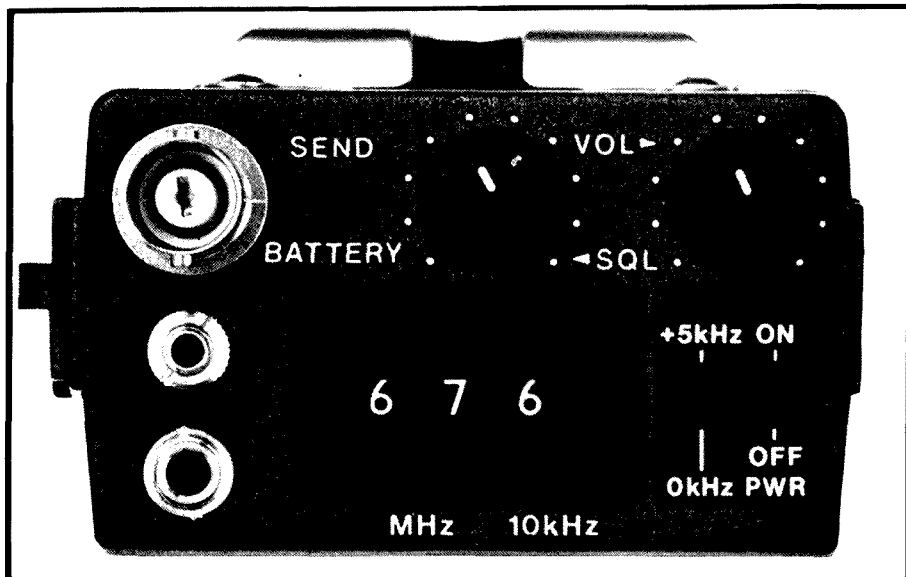

PHOTO 2: The simple control functions on the IC-2A are illustrated in this view of the control panel.

The battery pack itself is worth a note. It can be detached from the bottom of the transceiver simply by sliding it to the side. The charger connection socket is actually part of the pack. ICOM recommend that the battery should be charged when detached from the transceiver. However, we took a chance and found that the IC-2A worked very well while the battery pack was in place and actually under charge.

One common question asked by interested amateurs after looking at the IC-2A advertisement is where is the repeater offset switching? Simple — on the back of the cabinet.

Advertisements claim "ICOM Level Receiver Performance". Presumably this infers that the IC-2A receiver is as good as, say, the IC-22S. In some aspect I don't believe this to be so — but more on this later.

#### THE IC-2A CIRCUIT

With a total of 43 transistors, 3 FET, 5 ICs and 21 diodes, it's amazing just what can be fitted into a small box these days. The heart of the device is the PLL unit that supplies 72 to 73.9975 MHz to the transmitter multiplier stage and 66.6525 to 68.65 MHz to the receiver first mixer. Four crystals are diode switched to produce either simplex, +600 kHz, -600 kHz, or

the plus 5 kHz modes of operation. The thumb wheel switches operate a programmable divider in the PLL chain to actually select the channels. The VCO is modulated to produce an actual FM (not phase) signal).

The receiver circuit is a model of simplicity. Two bipolar transistors in cascade provide RF amplification to FET first mixer. The first IF is at 10.695 MHz and employs a crystal filter and two stages of gain. Now we come to the interesting part. A single IC incorporates the second mixer, its associated crystal oscillator, the 455 kHz IF amplifier, the FM detector and the noise amplifier for the squelch circuit. Some IC. Four more transistors are used in the squelch circuit and a single IC for the receiver audio.

#### THE IC-2A ON THE AIR

First comment is on the thumb wheel frequency selection. I think these should be named fingernail switches. They are definitely easier to operate with the index fingernail, and you then have a chance of seeing the numbers. If you plan to operate after dark, take a torch — there is no provision for illumination of the readout. Selection of a given frequency is quite easy, but it is not so easy to tune across the band to hear what is happening. Receiver sensitivity was rated very good and

quite comparable with other modern FM transceivers. However as noted earlier the receiver performance was not "ICOM Level". Rejection of noise such as auto ignition hash and general household appliance hash was poor. I suspect there is only a very small amount of limiting provided in the multi-function IC described earlier. In general strong signals are not affected, but weak to moderate signal level can be affected to varying degrees depending on the level of the interfering noise.

Transmit audio quality is clean and the response balanced but the distance from the microphone is fairly critical. On the IC-2A we had for review the best quality occurred at about 8 or 9 cm (3 inches) from the microphone with my particular voice. Receive audio quality was clean but output power was limited under mobile conditions. An extension speaker with higher efficiency than the very small in-built unit appeared to help somewhat.

The flexi antenna supplied worked about as well as expected for this type — just so so, but at times one can be surprised just what can be done with hand-helds and simple antennas.

After using the IC-2A over a number of days, only two things came to mind which might be desirable to incorporate in a future model. Illumination of the frequency

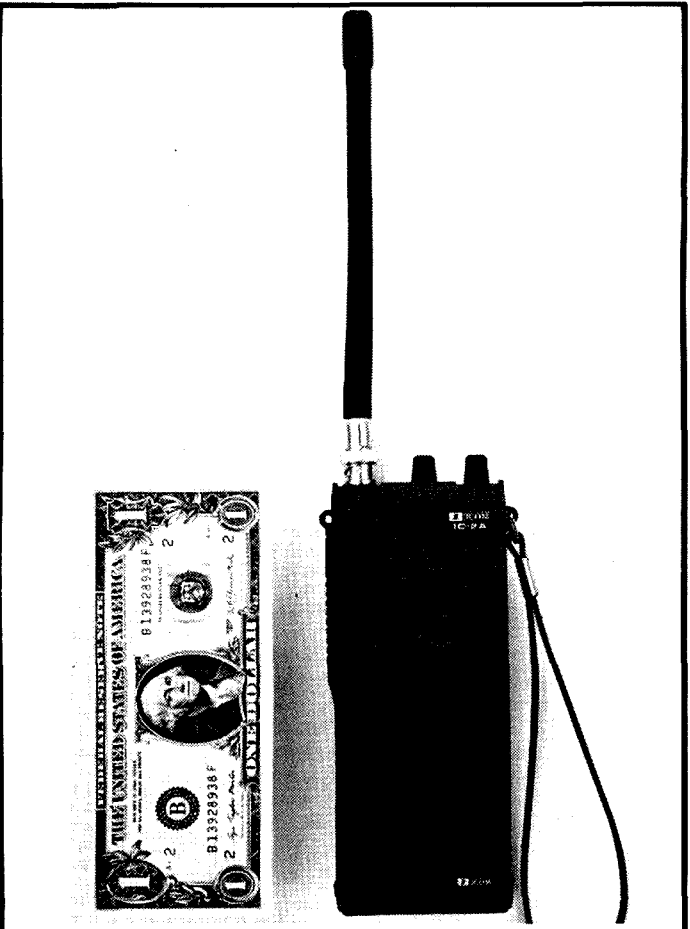
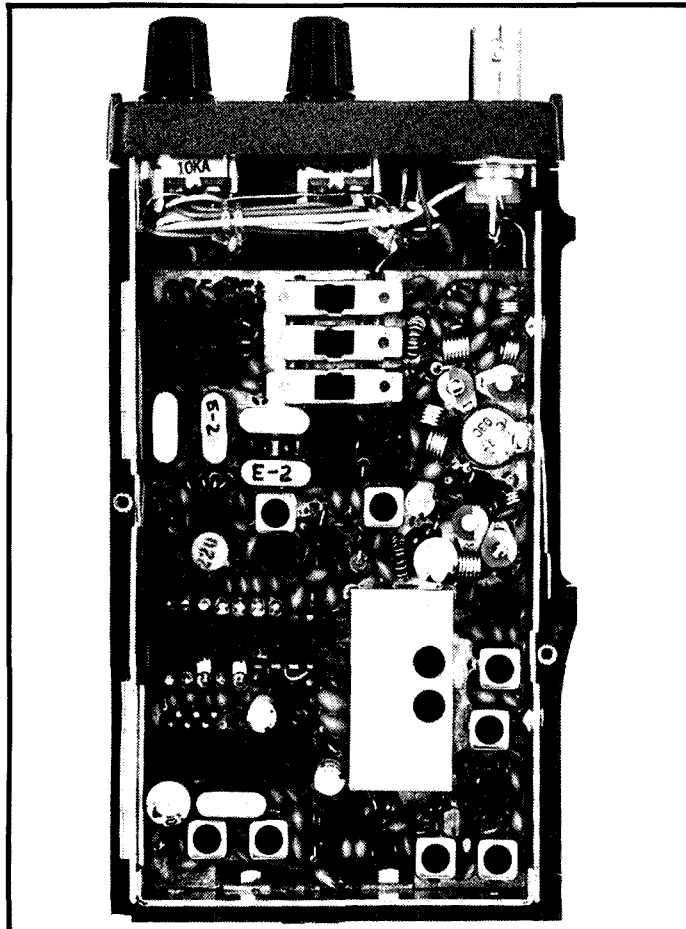

Although the IC-2A is small, the unit is crammed with components as PHOTO 3 (left) shows. The size of the unit is best described in PHOTO 4 (right) where the unit's size is compared to an American dollar bill.

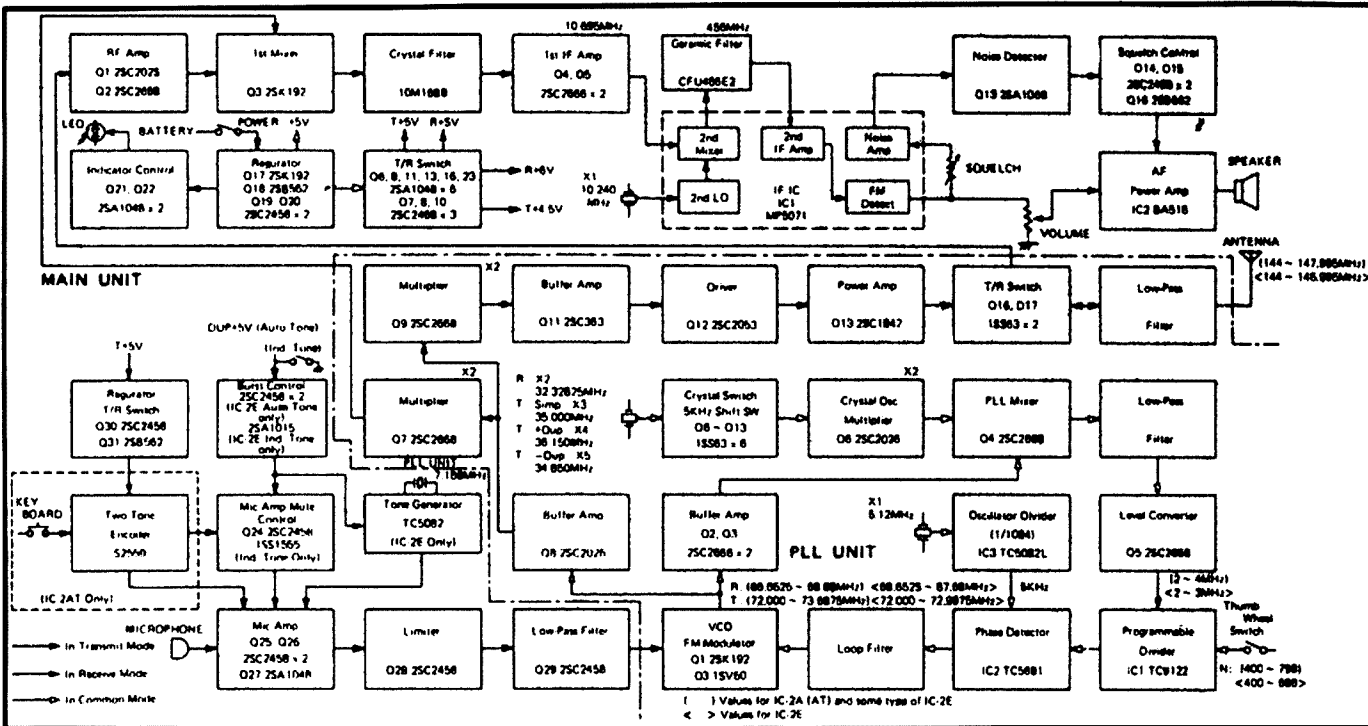

FIG. 1: Block diagram of the IC-2A.

readout, say with a push button switch and the ability to listen on the repeater input frequency. It seems that we are doomed to accept the now universal lack of meters on hand-held transceivers. A pity in many ways. A signal strength indicator was always useful to find the best transmit location into a repeater.

**INSTRUCTION BOOK AND ACCESSORIES**  
Accessories supplied with the IC-2A in-

clude the slide on nicad battery pack, a charger for same, which plugs directly into the AC power point and connects to the battery pack via a flexible lead. There is a flexible antenna, a belt clip and a hand strap, plus a couple of miniature plugs for microphone and earphone connection. We believe that a leather case and an external microphone speaker unit will be available shortly.

The instruction covers all the required information in a clear and concise way. A trouble shooting chart included covers

only operational errors and not technical problems, but a comprehensive voltage chart included would be of help to those game enough to attempt their own service. An internal photo clearly points out the various adjustment locations. The circuit diagram supplied is fairly large and easy to read.

Our test unit was kindly supplied by VICOM of 68 Eastern Road, South Melbourne 3205, and all enquiries regarding price and delivery would be welcomed. ■

**Repeater Quiz**

- The proper way to enter into a QSO on a repeater is to:
  - say "breaker six".
  - just say "break".
  - insert your call during a pause.
  - just talk over the other guy; you're at a base station anyway.
- The main purpose of a repeater is:
  - to keep technical types on their toes.
  - to enhance the range of mobile stations.
  - to provide a soap box for long, one-sided monologues.
  - to allow non-amateur housewives to keep track of their wandering husbands, or anyone else for that matter.
- One of the most important uses of a repeater is to:
  - provide good mobile-to-mobile communications when driving adjacent to each other on the expressway.

- enhance the range of base stations located less than three blocks from each other.
  - extend the range of mobile and low power portable stations.
  - none of the above.
- You should sign your call letters:
    - any time the spirit moves you.
    - after every other word.
    - at the beginning and end of each transmission.
    - once coming on and once leaving the frequency, and once every ten minutes.
  - You are required to mention at least one of the call letters of the stations with whom you have been talking:
    - at the beginning and end of each exchange.
    - at the beginning and end of a series of transmissions, and once each ten minutes during the exchange.
    - only at the end of a series of transmissions, when signing off.
    - none of the above.

- Repeaters:
  - don't cost anything to operate as everything is donated.
  - cost a bundle, but are paid for by a small group of wealthy amateurs and supporters.
  - cost a bundle and are financed by club member dues and contributions.
  - shouldn't expect any donations from users since the airwaves are free.
- When you talk to a regular user of the repeater who is not a member of the club or a financial supporter, you should:
  - tell them they are deadbeats and refuse to talk to them.
  - notify the control operator to turn off the repeater.
  - try to find out if they understand how the club/repeater operates and invite them to participate.
  - try to embarrass them into paying or leaving.

From ARNS Bulletin, January 1980, and probably many other sources. ■

# “Quality is always the right answer.”

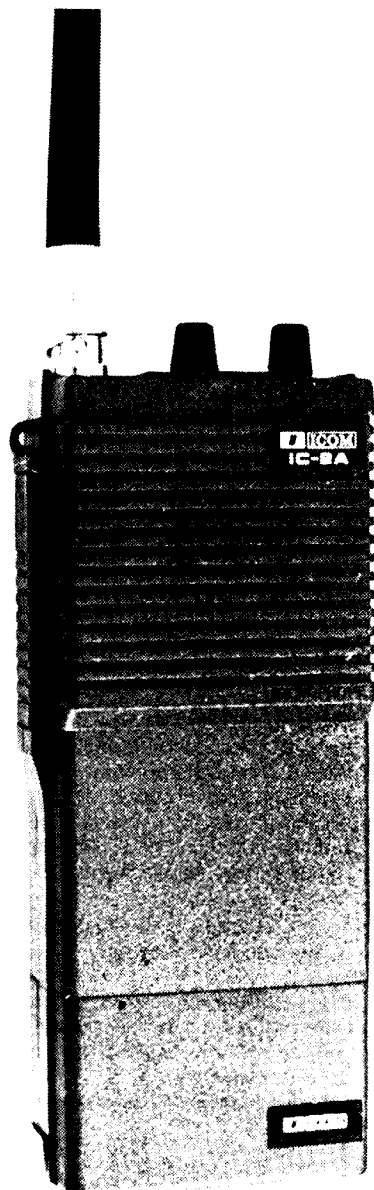

## Quality. That's ICOM's new IC2A fm hand-held transceiver:

- Smaller and about half the weight of the others.
- Optional power packs for operation up to 5 watts output.
- Best sensitivity of the “big three.”\*
- Two hinged circuit boards for easy maintenance.\*
- 800 channels, 144-148 MHz, 600 KHz repeater offset.
- ICOM's quality backed by 90 day warranty
- At \$279 the ICOM IC2A offers the best price of the “big three”.

Accessories coming soon:

- BP-5 Nicad pack, 2-3W output
- BP-6 Nicad pack, 5W output
- CP-1 cigarette lighter charger
- HM-9 Speaker/microphone
- LC-1 Leather case

## GIVE YOUR VICOM DEALER A CALL TODAY!

\*See review “Amateur Radio Action” Vol 2/13

Distributed by VICOM

**SYDNEY:** 339 Pacific Hwy,  
Crows Nest. Ph. 436 2766  
**MELBOURNE:** 68 Eastern Rd.,  
Stn. Melb. Ph. 699 6700

# VICOM

VICOM gear is available from  
most reputable dealers!

# Portable 2 metre Repeater

Andrew Boon VK7AW  
5 Flint Ave., Newtown 7008

This article describes a method of interconnecting two 146 MHz mobile transceivers to form a two-metre talk-through repeater. The circuitry described has been tested on several WICEN exercises in VK7, and performs extremely well.

In order to provide the WICEN group with an effective, portable 146 MHz repeater for use in remote areas of the State, an investigation was made into the possibility of connecting two mobile transceivers together, via an audio patch cord. The Icom IC22S transceiver was selected, as it is the most common type in use in the Hobart area and, as it turned out, the large range of repeater channels available makes it ideal for this application. Using mobile transceivers to form a repeater has several advantages over attempting to construct a separate, dedicated repeater. Firstly, very little extra equipment is required to be transported, since the transceivers are normally on site (with their aerials).

Secondly, the cost of extra radio equipment is avoided. This is a very important consideration for a small group with no corporate funds.

The first task was to determine the desensitisation caused when one vehicle is transmitting and a second is receiving on a frequency 600 kHz removed. A location in Hobart was selected from where VK7RAA on Mt. Barrow (near Launceston, about 170 kilometres away) could be heard as a noisy but readable signal. With one vehicle receiving VK7RAA (Repeater 8), the second vehicle moved slowly away, transmitting on Repeater 8 in put frequency. When the distance between the two vehicles was 40 metres, no difference

could be detected (by ear) with the transmitter off or on. The transmitter output power was 10 watts, the vehicles both had quarter-wavelength whips in the centre of the roof, and were in the same horizontal plane.

This test was actually carried out at midnight, after a WIA meeting and a few beers. The 40 metres were paced out, so the spacing should probably be quoted as "40 ± 10 paces".

Anyway, on the assumption that 40 metres was an adequate separation, 40 metres of shielded twin audio cable was obtained, and a means of keying one transceiver (the transmitting one) automatically,

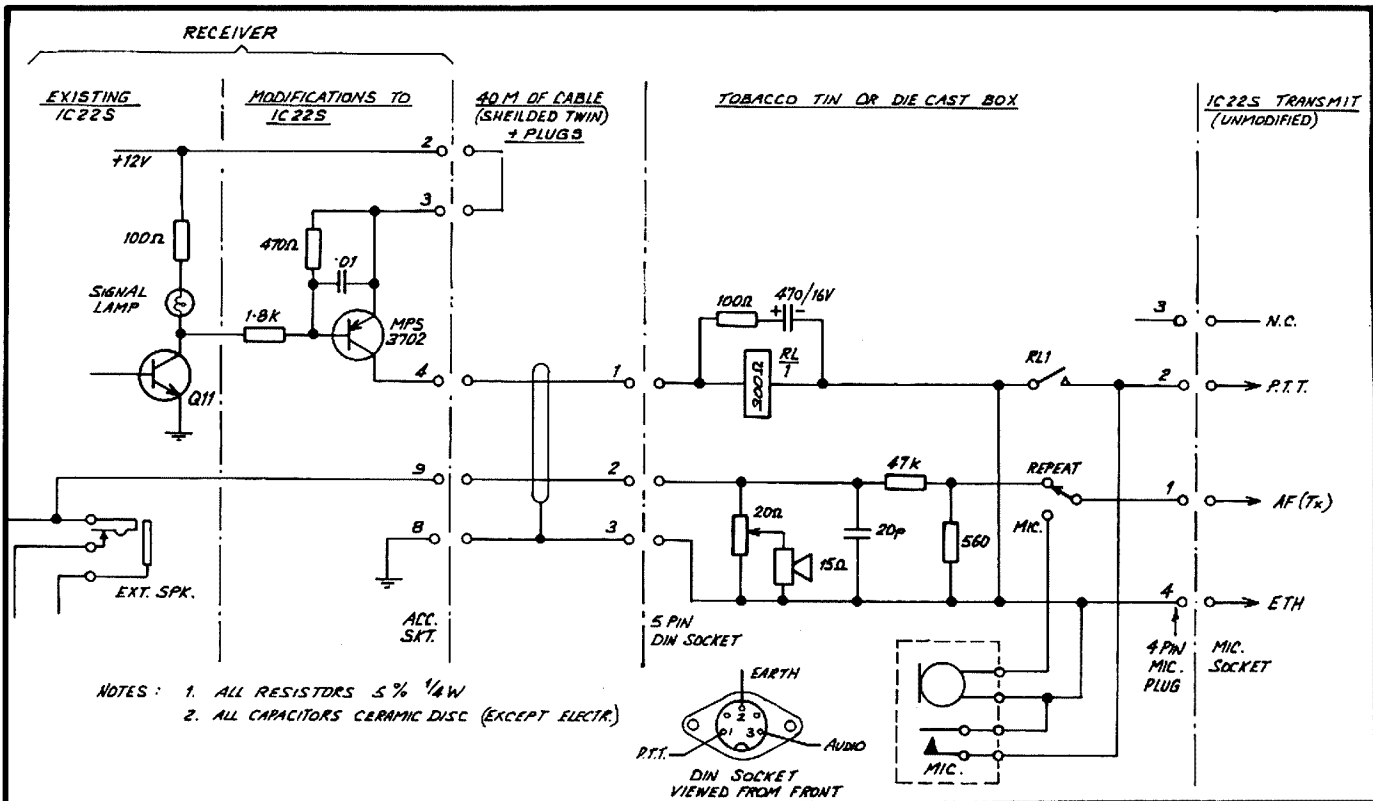

FIGURE 1: Portable receiver circuit.

when a signal was received on the other, was sought. During the course of experimenting, listeners to the particular test channel would have been surprised to hear a local ABC broadcast station, which is normally only heard on 600 kHz. Something about intermodulation . . . ?

Some time later the circuit shown in Fig. 1 was developed, and has since proved to be most successful.

### CIRCUIT DESCRIPTION

When a signal is received on an IC22S, or whenever the mute opens, the SIGNAL LAMP lights and the voltage on the collector of Q11 goes low, to 1.5V or less. This voltage is used to switch on a PNP transistor (shown as an MPS3702, but any general purpose PNP transistor should do), providing 12V along one wire of the shielded twin. This voltage causes relay RL to operate, and RL1 grounds the PTT line of the transmitting IC22S, causing it to transmit. Audio from the receiving IC22S is picked up at the EXT SPKR socket, and extended via pin 9 of the ACC plug along the second wire of the shielded twin. A monitor speaker is located in the "tobacco tin" (or diecast box for the more affluent). The level of the audio signal is then re-

duced by a resistive divider, to about 5 mM RMS, which can be fed directly to the MIC input of that transmitting IC22S.

After the mute of the receiver closes, RL is held operated for about 1/5 sec. by the 100 ohm, 470 uF combination. This provides a "tail" for the repeated transmission.

All components involved in the modification to the receiving IC22S are mounted on a small piece of veroboard, installed immediately behind the ACC socket.

In order that an operator with the repeater can pass traffic or identify the repeater, a switch is included to select either the repeat mode or local audio from a microphone plugged into the "tobacco tin".

### OPERATION

Ideally the two vehicles involved would be parked on top of a hill, both having a good view of the required coverage area. They are separated by the length of the patch cord (40m). The normal configuration is shown in Fig. 2; for the example shown (Repeater channel 4) the receiving IC22S receives on 146.200 MHz (reverse R4) and the transmitting IC22S transmits on 146.800 MHz (reverse R4). Walkie-talkie,

mobiles, etc., can then access the portable repeater by simply selected repeater channel 4. The only adjustment is to the volume control of the receiving IC22S — this is normally set to about 1½ divisions to give adequate frequency deviation of the transmitter.

The operator with the repeater would be located in the vehicle with the transmitting IC22S, with the "tobacco tin" and microphone. From there he can monitor all traffic and manually identify the repeater.

Note that the transmitting IC22S is a standard, unmodified transceiver.

A more interesting mode of operation is shown in Fig. 3. This is a 3 hop repeating system, where a walkie-talkie (for example) operating on a simplex frequency is repeated by the portable repeater to a normal repeater and thence to a second station. The portable repeater in this mode uses two modified transceivers and two patch cords to repeat signals on different input frequencies. The example shown uses channel 50 and repeater 2, VK7RHT on Mt. Wellington (Hobart). This configuration is useful when communication is required between a field party in a remote area and their headquarters in the city. The limits of operation of this mode have not yet been fully explored: some desensitisation will occur as the transmit and receive frequencies are very close, but in many cases the signal from the walkie-talkie and from the normal repeater will be strong enough to overcome this. (A longer cable required perhaps?—Ed.)

### CONCLUSION

Five IC22S transceivers in the Hobart area have been modified in the manner described, and patch cords have been produced for these. Portable repeaters have been set up many times during WICEN exercises and field days, and have all performed faultlessly. Using two modified transceivers and two patch cords, the configuration shown in Fig. 3 was tested in a recent exercise with Tasmania Police in the Lake Pedder area of south-west Tasmania. A link was set up between the field headquarters at Lake Pedder and a station at Police Headquarters, Hobart, via the portable repeater at an elevated site and VK7RHT, Mt. Wellington. The portable repeater in this mode performed extremely well.

The portable repeaters have also been used away from vehicles, using yagis to extend the range to difficult areas, using 1 watt transmitter power where the spacing has had to be reduced, and so on. The possibilities are not endless, but still vast. Considering the small amount of effort and expense involved in establishing the repeater, it is considered to be a very worthwhile addition to the equipment of any WICEN group, especially where there is the likelihood of operating in areas not well served by existing repeaters, or as a back-up or extra channel in an emergency. ■

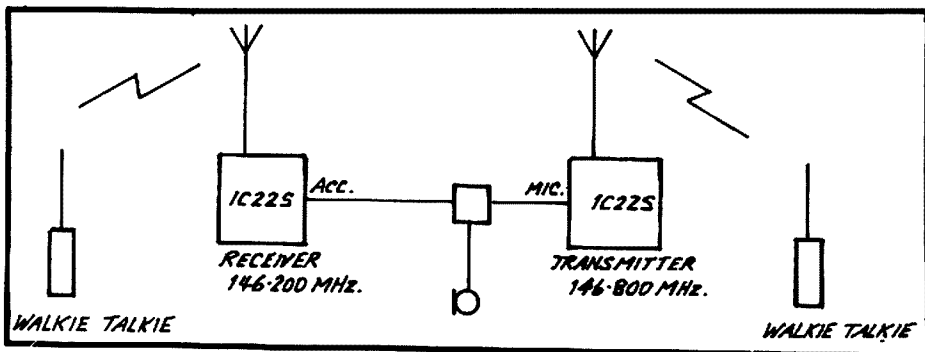

FIGURE 2: Conventional repeater configuration.

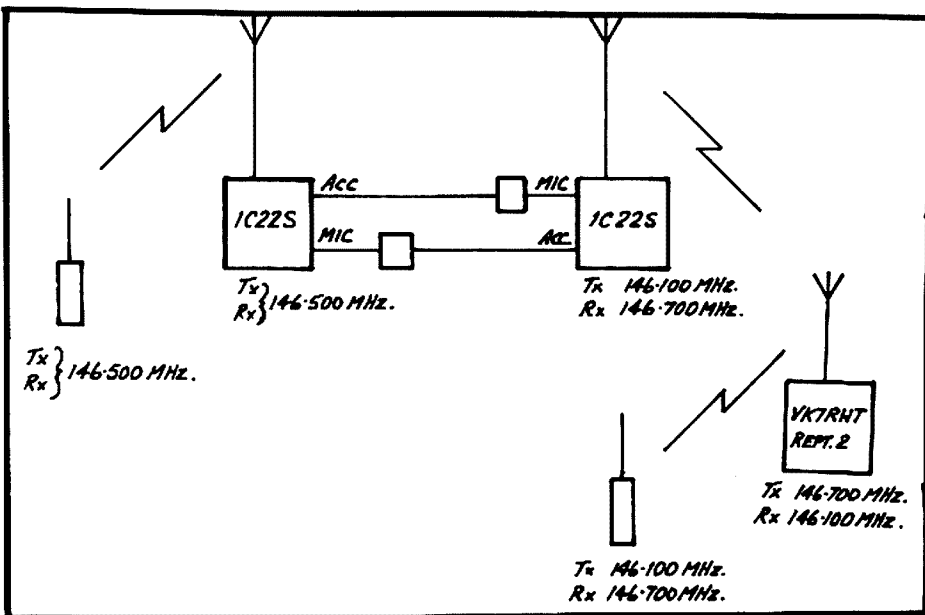

FIGURE 3: The three hop repeater configuration.

TALK TO THE PEOPLE WHO KNOW WHAT TALKINGS ABOUT



# GFS... SUPPLIERS OF MOST OF YOUR COMMUNICATIONS NEEDS INCLUDING YAESU, DENTRON, MFJ, JIL, ETC.

PHONE: (03) 873 3939  
CABLE: "COMIMPORTS" MELBOURNE  
TELEX: AA 38053 GFS

YAESU CPU-2500R  
2m FM transceiver



### PUBLICATIONS

Kit Of Maps Incl. World Map, US Map & Atlas with call prefixes and zones  
Great Circle Map Centred on Melbourne  
US Callbook United States Call listing  
Foreign Callbook Call Listing of the World

6 00  
1 00  
19 50  
18 50

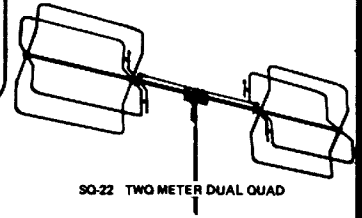

SO-22 TWO METER DUAL QUAD

MODEL	DESCRIPTION	R. RETAIL
<b>YAESU EQUIPMENT</b>		
FT-107M	TCVR, with DMS & AC Power Supply	1425 00
FT-107M	TCVR, with AC Power Supply only	1290 00
FT-107M	HF TCVR, DC Power Supply only	1150 00
FT-707	S HF TCVR 240 watt	795 00
FT-901 DM	HF Transceiver with memory	1380 00
FT-901 D	Same as FT-901 but no memory	1220 00
FT-101 ZD	HF Digital Transceiver	929 00
FT-101 Z	HF Transceiver	779 00
FT-225 R	2Mx Multimode Transceiver	895 00
FT-225 RD	Digital FT-225R	995 00
FT-225 RDM	Digital & Memory FT-225R	1175 00
FT-625 R	6Mx Multimode Transceiver	895 00
FT-625 RD	Digital FT-625R	995 00
FT-625 RDM	Digital & Memory FT-625R	1175 00
FT-7B	Economical HF Transceiver	639 00
FT-227 RB	2Mx 800 Ch FM Transceiver	399 00
CPU-2500 R	2Mx, 25 Watt Synthesized Transceiver	349 00
FT-207 R	Handy 2Mx Transceiver Inc. Nicad battery and NC9C charger	499 00
FT-720 RV	2Mx 800 Ch. FM Transceiver	499 00



MFJ 949 Deluxe Versa Tuner II

MODEL	DESCRIPTION	R. RETAIL
<b>RECEIVERS</b>		
FRG-7000	Digital HF Wadley Loop Receiver	590 00
FRG-7	HF Wadley Loop Receiver	395 00
<b>INTEGRATED ACCESSORIES</b>		
FT-707DM	Digital VFO for FT-707	310 00
FV-107	VFO for FT-107	175 00
FC-107	Antenna Coupler for FT-107	199 00
DMS	Memory Unit for FT-107	135 00
FR-901	External VFO for FT-901 series	475 00
MR-7	Base Mounting Rack for FT-707	40 00
MB-7	Mobile Bracket for FT-707	25 00
FC-901	Antenna Coupler for FT-901 series	245 00
FC-707	Antenna Coupler for FT-707 series	130 00
SP-901	Speaker for FT-901 series	56 00
YR-901	CW/RTTY Reader for FT-901 series	796 00
FL-2100 Z	Linear Amplifier for FT-901/101Z series	599 00
Dig Readout (FT-101Z)	Module	150 00
YC-7B	Dig Readout for FT-7B Transceiver	125 00
<b>MICROPHONES &amp; STATION ACCESSORIES</b>		
YD-844	Desk Mics for Yaesu Transceivers	49 00
YD-148	Desk Mics for Yaesu Transceivers	49 00
YD-846	Hand Mics for Yaesu Transceivers	19 50
YE-7A	Hand Mics for Yaesu Transceivers	19 50
YM-35	Hand Mics for Yaesu Transceivers	30 00
YM-24	Hand Mics for Yaesu Transceivers	36 00
YH-23	Headphones for Yaesu Transceiver/Receivers	19 00
YH-55	Headphones for Yaesu Transceiver/Receivers	34 00
FF-501 DX	Low Pass Filter, 1Kw PEP	59 00
QTR-24D	World Time Clock	45 00
<b>TEST INSTRUMENTS</b>		
YC-500 J	Frequency Counter, 50Hz to 500MHz	349 00
YP-150 J	Dummy Load/Watt meter, 0-150 Watts	112 00
YC-1000L	Logging Data Processor/Counter	POA

MODEL	DESCRIPTION	R. RETAIL
<b>ANTENNAS</b>		
<b>SWISS QUAD SERIES</b>		
BY I.C.T.		
SO-20M	20Mx 10dBd gain. (Elements loaded)	379 00
SO-15	15Mx 12dBd gain	169 00
SO-10	10Mx 12dBd gain	159 00
SO-61	6Mx 12dBd gain	119 00
SO-22	2Mx x 2 15dBd gain	99 00
SO-22D x 4	2Mx x 4 17dBd gain	188 00
SO-24	2Mx x 4 18dBd gain	229 00
<b>CABLES</b>		
RG-58/AU	Standard 5 6dB/100ft @ 100MHz loss	0 60m
5d-FB	Low loss 2dB/100ft @ 100MHz	1 40m
G-R7	High Quality 7 core Rotator Cable	1 20m
8d-FB	Low loss FOAM-DOUBLE SHIELDED, 1 60dB/100ft @ 100MHz	1 90m
<b>A.S.E. HF ANTENNA ADJUSTABLE MOBILE WHIPS</b>		
G-80	80MX Heavy duty helical 7ft long	39 00
G-40 to G-10	40-10MX H.D. Helicals 6ft long	34 00
Super G-80/15/10	80/15/10MX Helical Whip 8ft.	59 50
G-BM	Bumper Mount for A.S.E. Helicals	18 50
<b>BROADBAND VHF/UHF ANTENNAS</b>		
Scan-X	65-520MHz Discone 3dB gain for receivers only	39 00
GDX-1	80-460MHz Discone for Tx & Rx use.	69 00
Gingo	144-170MHz 9dB gain Vertical.	X (61.35) 54 00
<b>ATN ANTENNAS</b>		
28-30-3	10/11MX 3el Yagi 8dB gain	80 00
28-30-5	10/11MHz 5el Yagi 9.5dB gain	135 00
28-30-6	10/11MHz 6el Yagi 10dB gain	175 00
51-53-5	6MX 5el Yagi 9.7dB gain	85 00
51-53-8	6MX 6el Yagi 12dB gain	130 00
51-53-11	6MX 11el Yagi 14dB gain	165 00
144-148-8	2MX 8el Yagi 12.5dB gain	45 00
144-148-11	2MX 11el Yagi 14.5dB gain	55 00
144-148-16	2MX 16el Yagi 14.8dB gain	70 00
420-470-6	0.7MX 6el Yagi 8dB gain	30 00
420-470-14	0.7MX 14el Yagi 13.7dB gain	45 00
432-16	0.7MX 16el Yagi 14.8dB gain	80 00
47-7	CB 7el Yagi 1dB gain	40 00
R-5B-27-29	CB 11el Yagi 17.2dB gain	50 00
560-14	1/2 wave vertical for 28MHz	38 00
C-20-30-1	0.5MX ATU Yagi 15.3dB gain	50 00
	Adjustable Dipole.	30 00
<b>INSULATORS FOR THE HOME CONSTRUCTOR</b>		
Type 1	H.D. 3/4" el to 1/2" boom.	4 00
Type 2	H.D. 3/4" el to 1" boom for D.E.'s	1 00
Type 3	H.D. 3/4" el to 1" boom for Para els.	0 70
<b>ATN POWER DIVIDERS (uses "N" type connectors.</b>		
140-150-2	Couples 2 x 50 OHM Antennas.	40 00
140-150-4	Couples 4 x 50 OHM Antennas.	50 00
400-470-2	Couples 2 x 50 OHM Antennas.	38 00
400-470-4	Couples 4 x 50 OHM Antennas.	48 00
<b>ATN BALUNS</b>		
3-150-1-1-200	200 Watt 3-150MHz 1:1.	10 00
100-800-1-1-200	200 Watt 100-800MHz 1:1.	10 00
3-150-4-1-200	200 Watt 3-150MHz 4:1.	12 00
3-100-1-1-1KW	1KW 3-100MHz 1:1.	20 00
3-100-4-1-1KW	1KW 3-100MHz 4:1.	20 00
<b>ANTENNA ACCESSORIES</b>		
Yagi Insulators see above for types		
SWR-25	Dual meter SWR/Power 3.5-150MHz.	36 00
FS-500H	PEP Reading SWR/Power Meter.	115 00
MFJ-202	Antenna Noise Bridge. See MFJ.	
TV-42	Low pass Filter	29 00

MODEL	DESCRIPTION	R. RETAIL
<b>DENTRON PRODUCTS</b>		
DTR-2000L	2KW Linear Amplifier	1495 00
MLA-2500B	2KW Linear Amplifier	1235 00
Clipperton-L	2KW Linear Amplifier	889 00
GLA-1000	1KW Linear Amplifier	466 00
MT-3000A	3KW Antenna Tuner	460 00
MT-2000A	3KW Antenna Tuner	269 00
JR-Monitor	Baby Antenna Tuner	99 00
Big Dummy	1KW Oil Cooled Dummy Load	43 00
<b>SUGIYAMA TRANSCEIVERS</b>		
F-850S	80 thru 2Mx All mode Transceiver	1350 00
F-850D	80 thru 2Mx All mode Transceiver	1490 00
<b>MFJ ANTENNA TUNERS</b>		
MFJ-984	3KW Ant. coupler/Dual Meter type SWR/Power Meter/Co-Ax switch, for bal and un bal line (inc. Balun)	429 00
MFJ-982	3KW Ant. coupler/SWR/Power meter for bal and un bal line (inc. Balun)	289 00
MFJ-962	1.5KW Ant. coupler/SWR/Power meter 6 pos. Co-Ax SW for bal and un bal line (inc. Balun)	242 00
MFJ-961	1.5KW Ant. coupler/6 pos. Co-Ax SW for bal and un bal line (inc. Balun)	209 00
MFJ-949	300W Ant. coupler/SWR/Power meter Dummy Load/Co-Ax SW for bal and un bal line (inc. Balun)	199 00
MFJ-941B	300W Ant. coupler/SWR/Power meter Co-Ax SW for bal and un bal line (inc. Balun)	155 00
MFJ-943	30W Ant. coupler for bal and un bal line (inc. Balun)	125 00
MFJ-901	200W Ant. coupler for bal and un bal line (inc. Balun)	99 00
MFJ-900	200W Ant. coupler for un bal line (No Balun)	89 00
<b>OTHER MFJ PRODUCTS</b>		
<b>SSB/CW FILTERS</b>		
MFJ-752	Dual Tunable active SSB/CW filter Inc. Peak/Notch, noise limiters and two variable freq. filters	155 00
MFJ-751	Tunable Active SSB/CW Filter	125 00
MFJ-484	Grandmaster Keyer. 400 character memory plus many more features	233 00
MFJ-408	Electronic Keyer with speed meter	155 00
MFJ-481	Memory Keyer. stores 2 x 50 character messages 8-50 WPM	155 00
MFJ-402	Econo Keyer. built in paddle, weight and speed control 8-50 WPM solid state keying	83 00
<b>MISCELLANEOUS</b>		
MFJ-410	Morse Processor, morse code tutor Sends unlimited random code in random groups	122 00
LSP-520x1	Super Logarithmic speech processor 30dB dynamic range & 3 active filters	97 00
MFJ-202	Antenna Noise Bridge, wide range 0-250 OHMS 150pp x c 1-1000MHz	89 00
MFJ/HK-1	Morse Code Manipulator	55 00

MODEL	DESCRIPTION	R. RETAIL
<b>FT901/101Z ACCESSORIES</b>		
CW Filter	For Yaesu Transceivers	65 00
AM Filter	For Yaesu Transceivers	65 00
Keyer	For Yaesu Transceivers	48 00
Memory	For Yaesu Transceivers	172 00
DC Unit	For Yaesu Transceivers	86 00
FM/DC	For Yaesu Transceivers	58 00
Fan	For Yaesu Transceivers	38 00
Battery Holder	For FRG-7	10 00
PB 1292	(N.B. for FT-101)	45 00
FT-101E	DC/DC Converter	60 00
Denso	Electrical Joining Compound	2 90
MR	Rack for Yaesu 707 series	POA
<b>POWER SUPPLIES</b>		
PC-707	AC Power Supply for FT-707	220 00
FP-107E	External AC Power Supply for FT-107	220 00
FP-107I	Internal AC Power Supply for FT-107	190 00
NC-2	FT-207 R Acc. Quick Charger/Adapter	70 00
FNB-1	Nicad battery pack	29 00
FBA-1	Battery pack Charger Adapter	5 75

MODEL	DESCRIPTION	R. RETAIL
<b>ANTENNA ROTATORS</b>		
<b>EMOTATOR</b>		
103SAX	Medium Duty Rotator, 240V	175 00
502SAX	Heavy Duty Rotator, 240V	265 00
1121MXX	Extra Heavy Duty, 240V	379 00
1202	Mast Clamp for 103LBX	20 00
1213	Mast Clamp for 502CXX	33 00
303	Mast Clamp for 1102MXX	30 00
301	Mast Bearing	50 00
301	Mast Bearing	45 00
<b>TOWERS</b>		
G20/1	6m Single Section Self Supporting	85 00
G20/2	6m Double Section Self Supporting	95 00
GM20	6m Tubular 2" Mast.	33 00
G20/B	6m Heavy Duty Box Base for G20/1/2.	179 00
G10/B	6m Heavy Duty Box Base for G20/1/2.	149 00
Gm-15	4.5m Tubular 1 1/2" Mast.	21 00

YAESU MUSEN PRICES ARE RECOMMENDED RETAIL ONLY. DROP IN AND WE WILL GIVE YOU A VERY COMPETITIVE QUOTE.

G.F.S. ELECTRONIC IMPORTS 15 McKEON ROAD, MITCHAM, 3132. (03) 873 3939



# NOVICE NOTES



Edited by Ron Cook VK3AFW

To begin let me clear up a couple of points relating to the August issue. Photograph 3 was reproduced upside down so that a transposition of the Scope iron and the temperature controlled iron occurred. Secondly I have been asked what was meant by solder causing "tracks". "Track" is a term used to describe an unwanted path for electricity to flow along. Tracks are sometimes caused in high voltage equipment by moisture and dust collecting between line pins (pins with voltage applied) on valve sockets. A small current starts to flow through the moist dust generating heat and localised burning or

carbonising of the insulation. This reduces the resistance and the current rises further causing greater carbonising causing the current to rise even further, and so on. Eventually a fuse or some other part will fail. In low voltage equipment tracks are frequently caused by excess solder joining or bridging across adjacent conductors on a printed circuit board. These tracks are often only whiskers of solder so when a board has been completed it should be carefully examined under a strong light. Small tracks or bridges can be removed with a sharp knife and larger ones by careful use of the soldering iron.

## MORE USEFUL TOOLS

Photographs 1 and 2 show a number of tools which most constructors will find as indispensable as those shown in August. In Photo 1 we see at the bottom left a hand drill and on the bottom right is a set of drill bits. A range of drill bits going from 0.6 mm for printed circuit work to 6 mm for component mounting holes will be required. An electric drill (6 mm chuck) with a drill stand would be better but most work can be done with the less expensive hand drill provided that a vice and/or a G-clamp are available to hold the work.

At the centre bottom of Photo 1 is a tapered reamer, which is used for opening out holes bigger than 6 mm diameter. The round file, centre, can be used for larger holes. Below the file to the right is a star reamer, which is used to remove burrs that form on drilled holes.

To mark out the place for a drilled hole requires a square (top right), ruler and prick punch (top left). The square is placed

firmly against an edge and can be used for drawing lines at right-angles to the edge. The ruler is of course used to measure along the line the desired distance. The ruler and square are then used to mark and measure from an adjacent edge to locate the hole centre. A sharp F pencil is recommended for marking out. Although many constructors prefer a scribe (a sharp pointed metal rod about 3 mm in diameter) because it gives an accurate line that will not rub off when touched, it is not easily burnished off front panels. Pencil lines are easily erased with a soft rubber. The punch is used to make a small indentation at the hole's centre to locate and start the drill. The one shown is spring loaded and is pressed against the surface causing it to trip and drive the point into the metal. A less expensive version must be hit with a small hammer.

Beneath the square is a solder sucker. This tool removes solder from joints when a component must be removed. It has a small nozzle in front of a tube containing a spring loaded plunger. The solder is carefully melted with the soldering iron and the nozzle of the sucker held so as to just touch the joint. Pressing the trigger causes the plunger spring up the barrel drawing up the molten solder and leaving the joint clean.

The remaining item is a spot face cutter for quickly and neatly cutting tracks on veroboard. Veroboard is a pre-drilled board with about 30 parallel copper tracks running along the board. It is most useful when printed circuit board facilities are not available.

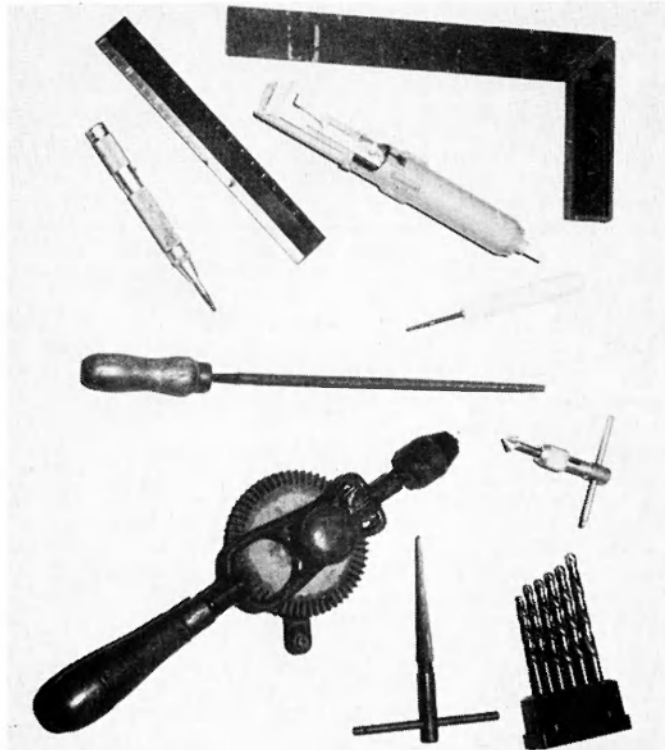

PHOTO 1: More hand tools for the constructor.



PHOTO 2: Hand tools for metal work.

All the tools in Photo 2 are useful for making or working with boxes and chassis. Large round holes can be made with the hole punch set shown bottom right. The nibbling tool, bottom left, will make square and rectangular holes once a 6 mm hole has been drilled.

For cutting up sheet-metal to make small boxes (see p. 16 AR May 1979) the tin-snips, top centre, will be required. The wood chisel can be used on aluminium to deburr rectangular holes.

The sturdy artist's brush is used with methylated spirits to swab off resin flux from printed circuit board, and for brushing away metal filings and cuttings (swarf).

#### FILES AND FILING

To straighten and square up edges cut by tin-snips and to finish off rectangular holes requires a file. Files come in a variety of sizes and cuts. The size is related to the file's length, 150 to 250 mm being the most useful for the novice. For getting a smooth finish a file with small teeth is recommended. These are called single cut files. For taking off more metal bastard cut, double cut or second cut files are best.

There are two basic filing actions to be mastered. The normal stroke is used for removing the maximum amount of metal and for sharpening tools. The handle is grasped in one hand with the forefinger and thumb pointing along the body of the file. The file is laid flat on the work with the tip extending a little past the work. The tip is steadied with the free hand and the file stroked firmly and briskly forward while keeping firm downward pressure. The downward pressure is released for the return stroke: as the file cannot cut when drawn back toward the body, it is better to lift the file clear on the return stroke. The amount of downward pressure during the cutting stroke controls the depth of cut.

The cross-file stroke is used to square off and finish narrow edges. The file is held by its body in both hands. The body is placed flat on the work with the work roughly central and at right-angles to the file. The thumbs are put behind the file on the rear edge on either side of the work and the fingers on the other edge. The file is then pushed firmly away from the body for the cutting stroke. It is lifted for the return stroke.

The work must be firmly held in a vice and a comfortable stance adopted.

After a little use some metal filings will become trapped between the file's teeth. The file card (top left in Photo 2) is a wire brush designed to brush out these filings and so return the bite to the file.

#### OTHER TOOLS

As mentioned before, a vice is necessary when drilling and filing. It should be mounted on a proper work bench; the kitchen table is too light and your XYL may not take too kindly to having holes drilled through the table top for the 10 mm mounting bolts.

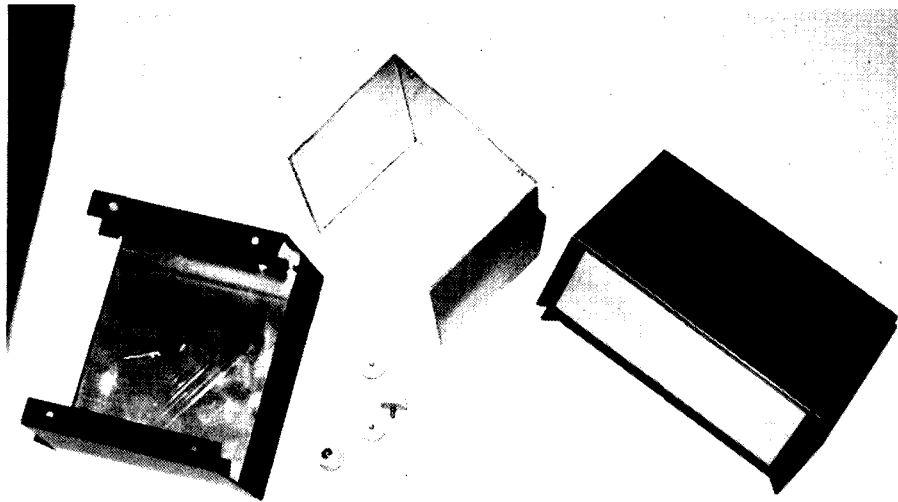

PHOTO 3: Two useful boxes.

After the first few projects are finished you may find that other tools such as a soldering stand, heatsink clips, a brake type metal bender and a hacksaw are required to grace your growing workshop.

Until you decide to make your own cases and boxes, handy little ones such as those in Photo 3 can be bought from Dick Smith and other suppliers. The one on the left is easy to duplicate.

#### SAFETY

Always work safely. Wear safety goggles when using a drill (in case a bit snaps and pieces fly out) and when grinding or cutting. Clean up any rubbish in the work area and don't stack things in piles. Most metal edges are very sharp—running your finger along the edge can give you a nasty gash. Use double insulated electrical tools and beware of faulty extension cords. When clipping off the excess pigtail on components turn the side-cutters so that the cut-off wire will not strike you in the face if (when) it flies out.

#### SCAVENGING

Every amateur needs a "junk box". It is a place to squirrel away all nature of items for a rainy day project. One of the construction articles coming up in this column makes use of a large variable tuning capacitor of about 1200 pF as shown in Photo 4. Similar units can be found hiding in the bottom of the garages of neighbours and relatives. All the old valve radios and radiograms used these capacitors and the owners of such can often be persuaded to part with them at no charge. If you have just erected a new TV aerial or made up an extension cord, etc., don't accept money or a sponge cake—ask for that old radio in the garage. Alternatively, if you have a trip to the tip to make, offer

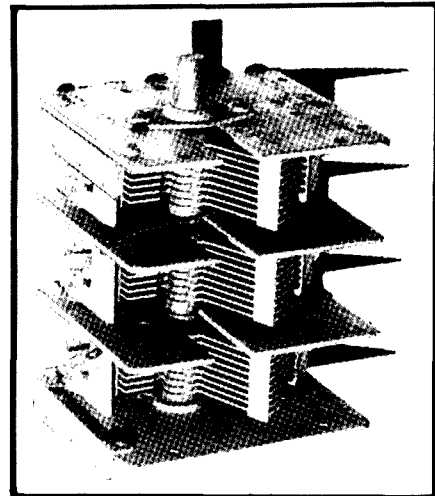

PHOTO 4: A variable capacitor. Scavenge one for a forthcoming project.

to take some of their rubbish. A quick detour via your shack and your junk box is on the way. The power transformer and the knobs will also be useful.

Old TV sets yield power transformers, lengths of wire, diodes and sometimes transistors. Paper capacitors are not worth consideration—they are the wax covered ones. Most electrolytic capacitors are oversize and past their prime. The choice of what else to keep is an individual one. As a rule it is worth while carefully scrutineering any electrical apparatus on its way to the tip as even the brass nuts and bolts are more valuable to the constructor than just their scrap value. If your junk box grows too large there are always the white elephant sales.

Next time I hope to have some readers' contributions on antennae. ■

# VK CW QRP

J. Swiney VK6JS

CW QRPp is alive and well in VK! 30-plus members at the end of six months in existence (June 1980) and still increasing.

As a result of numerous enquiries and suggestions the VK CW QRPp Club is seriously looking at an extension into international spheres but we intend to examine precise parameters for Club scoring before their formulation in the scoring formula. As an initial prod into this possibility we give below the following information.

A very interesting development for all CW QRPers in VK has ensued from our correspondence with Ade Weiss W0RSP, QRPp Editor for CQ Magazine. We are proud to announce that we have received "check-point" status for the CQ Magazine "DXCC QRPp" and "DXCC MILLIWATT" Awards. The latter is deemed to be the most difficult award to attain in existence!

Of course, this has been extended to me in my official capacity as VK6 Awards Manager for the WIA and is my consideration of a real honour! I have the authority, therefore, to verify applications from VK amateurs for these awards. At the last listing in CQ for March 1980 only 12 stations world-wide have made "DXCC QRPp" and 2 for "DXCC MILLIWATT". How about a VK call sign appearing on one of these lists? We've all heard of challenges in gaining some awards but how's this for real effort!

Another interesting item of news for QRPers is the planned very-low-power "activity" initiated by the Michigan QRP Club for January 1981. No information to hand at the present time but we hope to have complete details in a coming bulletin.

Ade Weiss and myself are attempting to line up with the DL-AGW Club, the G-QRP Club and the Benelux QRP Club for a simultaneous DX and local QRPp venture. It will purport to be the first international hook-up of low-power enthusiasts ever and could be a milestone in present-day amateur radio!

Let's keep in mind the insistence that CW QRPp operation has its place as a respectable aspect of this great hobby of and activities, each with its own rewards ours which encompasses so many modes and achievements, and try a periodical bash on very-low-power CW and discover the need for a perpetual memory of our early pioneers in amateur radio who were instrumental in laying the foundations for all of us who today enjoy personal communication and experimentation in the science of "Radio".

It's very important to remember where we came from as well as where we're going!

Publicity in past issues has certainly increased membership and it is good to

## VK CW QRP<sub>p</sub> CLUB

Whereas \_\_\_\_\_

having submitted evidence of achievement  
to communicate with low power using A1 mode  
and having accumulated the required score points  
is hereby entitled to Associate Membership

Membership No. \_\_\_\_\_  
Issued on \_\_\_\_\_



Custodian \_\_\_\_\_

The QRP CW certificate shown (above) is awarded to stations gaining twenty points or more with less than 5 watts output.

see interest in both home-brewing low-power rigs for various bands and improving morse proficiency.

It was hoped that our recruitment of members would be at the rate of five per month, but lately this figure has been well and truly surpassed. We welcome all our new members to the Club and sincerely hope you enjoy the benefits of low-power operation.

Jack VK3NQA is an ex-PMG telegraphist, who will no doubt keep us on our toes with excellent CW. Jack is QRV with home-brew gear on 10, 15 and 80 metres from his QTH in Elsternwick. Reg VK3BPG from Kilsyth has had an interest in QRP for some time and thinks that home-brew is the answer. He is looking for as much information as possible on home-brewing. Rai VK7NRT from West Moonah has the honour of being the first VK7 in the Club and runs a Ten Tec Argonaut 509 and has to date 85 countries using low-power exclusively.

Col VK3BMJ from Ringwood is gearing himself for QRP work and is looking for circuits and constructional articles . . . Bill VK2WN from Wollongong has a souped-up job with output of 0.3 watts on a good day, While Rob VK6NFA in Gosnells will be active shortly with his gear . . . Pete VK2DAB up north in Griffith has nearly completed the power supply for his 200 mW, yes!! 200 mW Tx for 3.540 MHz, so keep an ear to the receiver for his signal . . . Mario VK3NZF in Sunshine is looking for constructional tips for a home-brew rig on 80 metres only and is keen to accumulate scores and have some fun . . . Kevin VK3AUQ from Mount Evelyn is a home-brewer from way back and is active

on all bands with exclusive home-brew gear and can be found on 3507 kHz (although rumour has it he is going to sneak into the novice portion of the band from time to time). Other new members include Ted VK4NZG (Brisbane), Len VK5ZF (Richmond, SA), Rob VK5NBZ (Hyde Park) and Jim VK6ZN (Albany), who incidentally has just returned to the amateur bands after a 14-year lay-off. Just goes to show that once bitten you can't get it out of the system!

Maggi VK3NQQ and Lou VK3VEU are our first XYL and OM team. Maggie and Lou share (?) an Argonaut 509 and would like to build a HW-8 or similar. Tim VK5NEB/ZEV also runs an Argonaut 509 and has already secured a good tally on 80m. Bob VK3VDI has attained DXCC and WAS and now is looking for another challenge in CW at QRPp power. Other new QRPers include Stan VK2NBE, Stewart VK4VAP and Terry VK4TH.

Well, that is all for now, until next time, 73 and good QRPing! ■

## AMATEUR SATELLITES

R. C. Arnold VK3ZBB

Both Oscars 7 and 8 continue to perform satisfactorily. AO7 appears to be running out of the earth's shadow and as predicted will be clear early in August. Although it is not confirmed, AO7 appears to be again under control and it would not be surprising if it reverts to alternate day operation for Modes A and B.

The following release of updated information on the UK UOSAT will be of interest.

#### PROJECT SUMMARY

An AMSAT team at the University of Surrey is constructing Britain's first amateur satellite. The mission objectives of the UOSAT spacecraft represent a departure from the traditional AMSAT-OSCAR satellites — so far oriented predominantly towards providing improved long distance communications for amateur radio operators at VHF and UHF. UOSAT will complement the OSCAR series as an experimental and scientific amateur spacecraft.

#### MISSION OBJECTIVE

The mission objectives are:

- To provide radio amateurs with a readily available tool for the study of the propagation medium through which they communicate from HF to microwave frequencies.
- To stimulate a greater degree of interest in space sciences in schools, colleges and universities by active participation.
- To broaden the scope of the Amateur Space Programme and to cater for the interests of "amateur scientists".
- To establish an active body in the UK with the necessary resources to contribute flight hardware to the AMSAT programme.
- To evaluate the suitability of novel methods and new frequencies for use in later amateur spacecraft.

#### PAYLOAD

The payload is considered in two components — service modules and experimental modules. The service modules comprise all the functions fundamental to the basic operation of the spacecraft, such as the power sources, power conditioning, telemetry and telecommand systems and assume the highest priority during construction and testing.

The experiment modules comprise:  
Propagation — Phase reference HF beacons on 7, 14, 21 and 28 MHz.

Studies — 3-axis, multi-range, flux-gate magnetometer.

Experiment — Particle radiation counters; 2.3 GHz beacon; 10.47 GHz beacon.

Education — Earth-pointing slow-scan TV camera.

Experiments — Synthesised voice telemetry system.

Future Systems — Two-axis, earth-pointing gravity gradient spacecraft stabilisation system.

Experiments — On-board microcomputer (image processing, telemetry and command management, data store and dissemination).

#### RESOURCES

The project is supported primarily by British Industry and Research Organisations, AMSAT, RSGB and the University of Surrey. This support takes the form of cash (£85,000), components and test facilities.

The project team comprises three full-time personnel —

Martin Sweeting G3YJO (Post-Doc. Research Fellow), Project Manager;

Shu Kin Lee (Research Student), SSTV experiment;

Ian Ferebee (Project Technician); and some 30 part-time voluntary personnel of which 12 are within the University.

#### PROGRESS

The UOSAT project has been under way for just over one year and the position is as follows:

- The spacecraft system design has been completed.
- The structural design has been completed.
- Two spacecraft structures are being assembled.
- The interface and launch vehicle attach fittings have been fabricated.
- The honeycomb side panels are being bonded and trimmed to size.
- A breadboard telecommand receiver has been completed and is under test.
- A breadboard telemetry module is under construction.
- A 145 MHz beacon has been constructed and tested.
- A simulation of the UOSAT SSTV image has been completed using TIROS-N Image data. The display will probably be a 256 x 256 digital format with a 3 or 4 bit grey scale.
- The SSTV imaging system is under development using a CCD two-dimensional array.
- A preliminary analysis of the gravity gradient attitude control system has indicated satisfactory operation to be practicable with a 3 metre boom and a 2.5 kg tip mass (which will also house the magnetometer sensor).
- The 10 GHz beacon is under construction at Sheffield University.
- The VHF and UHF aerial design is complete and pattern tests are scheduled for June 1980.
- The honeycomb side panels are being bonded and trimmed to size.

#### LAUNCH

NASA have agreed to provide a launch for UOSAT (at no charge) as a "piggy-back" secondary payload on a Delta 2310 with the Solar Mesosphere Explorer (SME) mission scheduled for launch into a circular, polar orbit in September 1981. The programmed orbital elements are as follows.

Height: 530 km, 3 PM descending node.  
Inclination: 97.5 degrees, sun-synchronous.

## QSP

#### ICOM/KENWOOD GEAR

Did you know there is an association of owners and prospective owners of Icom and Kenwood products which publishes a newsletter ten times a year containing a wealth of information for such users? If interested, send SASE to Users' International Radio Club, 9600 Kickapoo Pass, Streetsboro, OH 44240, USA.

## BLANK CASSETTES

LOW NOISE (General purpose tape)				
C10	C45	C60	C90	Qty.
0.82	0.90	1.10	1.40	1.9
0.77	0.85	1.00	1.30	10+

WIDE RANGE		
C60	C90	Qty.
1.45	1.95	1.9
range and less	1.40	1.90
		10+

Assembled by Gluyas Gimmicks using quality German tape and Australian-made cassette cases.

#### FULLY GUARANTEED

Available from

### GLUYAS GIMMICKS

14 William St., Donvale, Vic. 3111  
(03) 874 7003

and

### WILLIAM WILLIS & CO.

77 Canterbury Rd., Canterbury Vic. 3126  
(03) 836 0707

All prices ex store. POSTAGE +

	1.9	10+	
VK3	2.00	3.00	C.O.D.
VK1, 2, 7, 5	2.50	4.00	ADD
VK4, 6	2.50	5.00	\$2.70



GUARANTEED  
BY  
VK3YPL



#### MODEL 444



SHURE

CONTROLLED MAGNETIC®  
COMMUNICATIONS  
MICROPHONE

GENERAL: The Model 444 is a pressure-operated CONTROLLED MAGNETIC microphone. It is specifically designed for radio communication applications and provides optimum performance from single sideband transmitters as well as AM and FM units. The response cuts off sharply below 300 and above 3,000 Hz, with a rising characteristic to 3,000 Hz. This special response characteristic results in optimum speech intelligibility and audio punch to cut through noise and interference.

MICROPHONE FEATURES: ● A response tailored for single sideband transmissions ● A switch for instantaneous selection of Press-to-Talk or VOX (voice-operated relay control) operation ● Finger-tip control bar (locking or non-locking action) to actuate microphone and an external relay or control circuit ● Long-life switch to satisfy severe requirement of communication systems ● Adjustable microphone height ● A sturdy, high impact ARMO-DUR® base and microphone case ● Dependability — under all operating conditions.

The "SHURE" MODEL 444 has one of the best "sounds" on the amateur bands.

IT'S THE BASE STATION MICROPHONE FOR YOUR STATION PRICE: \$70.00  
Amateur Nett (Incl. Sales Tax and Postage)  
ALSO AVAILABLE — THE WELL KNOWN SHURE 401-A (Hi Z) & 401-B (Low Z) HAND MIKE FOR MOBILE (OR STATION) USE — PRICE: \$32.00.

AVAILABLE DUAL impedance model 444-D  
SHORTLY LOW Z 200 ohms-1000 ohms  
HIGH Z 15K ohms-10M ohms  
ORDER YOURS NOW!

WILLIAM WILLIS & Co. Pty. Ltd.

MANUFACTURERS AND IMPORTERS  
98 CANTERBURY ROAD CANTERBURY VIC  
Phone 836 0707

# VHF-UHF

An expanding world

Eric Jamieson,  
VK5LP



Forrester, S.A. 5233

solar activity at times to make some more overseas contacts possible. The list will probably be repeated in full the next month, after which there will probably be little point in keeping all the stations listed.

There certainly has been a most serious dropping off in 52 MHz contacts, I doubt if anyone quite expected it to be so sudden. One of the best summaries of the late equinox contacts from April onwards in the Pacific area is contained in the SMIRK newsletters, and the following may refresh your memory or be news anyway.

The contacts from VK2, VK3, VK5 and VK7 to XE1GE have already been reported for April, working split frequency 52/50 MHz and odd multiples of a MHz apart at that! FO8DR during March/April worked YJ8PD, H44PT, VK4HD, 3D2CM, H44DX, 5W1BZ, JE3EX, JR6BG, and reports Ken JA2BNT has now contacted 42 countries on 6 metres! W6HTH/KH6 now has his antenna system 31 stories high, and working 5W1BZ, A35DX, P29ZFS, FK8CR, ZK2AE, VK4RO, AH8A, KX6QC, VK4KT.

## 6th ANNUAL SMIRK PARTY

This contest held on 6 metres in June certainly fizzled out as far as VK was concerned. Conditions were just so poor that I couldn't even rustle up one contact with another SMIRK member, and I see by the result sheet it was won, as expected, in USA by Lefty Clement K1TOL, who scored 18,352 points. 105 W stations entered, 3 from Canada, 15 from JA, plus PJ2DW and P29ZFS. As someone commented, June doesn't suit the southern hemisphere; April would probably be better, and possibly more interesting as it would be away from Es seasons around the globe. This will in turn probably mean less entries from USA stations, but you can't have it both ways!

## VK3 TO ZL

Talking to Daryl VK3AQR, he mentioned the consistently good signals from ZL TV during June/July culminating in a contact with ZL4LT on Sunday 20-7 mid-afternoon local time when snow free signals on TV were evident. The generally very widespread coverage of ZL TV throughout Australia leads one to believe the lower frequency (50.750 MHz) still reflects the oft quoted opinion that 50 and 51 MHz often open up but 52 MHz misses out. Look at the number of times ZL TV was heard in Carnarvon, WA, this year, but ZL amateurs heard precious little of Andy VK6OX and others from over there.

## FROM WESTERN AUSTRALIA

Tony VK6BV has written with the sad news that gale force winds on 20-6 badly damaged his 6 and 2 metre antenna system, so is out of action for the time being. That's bad, I know what it's like myself!

However, before the destruction Tony had completed his long awaited 2 metre linear and had had contacts with VK6WD, VK6CU, VK6ZZ, VK6HK all in Perth,

VK6ZFK Katanning, VK6XY Albany and VK6AM Busselton.

On 6 metres worked VK5ZPW and VK5ZRY on 15-6 0400 to 0530Z. Wagga TV occasionally heard, also ZL TV and the odd JA on 50 MHz; so it's been quiet in the west, too. Thanks for writing, Tony, and hope you can get the antennae fixed soon.

## NATIONAL VHF FIELD WEEKEND

The Geelong Amateur Radio Club confirms it will be sponsoring a National VHF Field Day Weekend coinciding with the start of the Ross Hull Memorial Contest on Saturday, 6th September. Rules will agree largely with those of the Ross Hull Contest, but I hope to have more details for the next issue. This date is usually a weekend for VHF Field Day workings in New Zealand as well, so if people will give the idea some support some very interesting contacts might well result.

And while we are on the subject of Field Days, I would like to again draw your attention to my remarks in the last issue when I raised the matter of using mains power for portable/field day operation. I believe they are very relevant, and passed the thoughts along to Daryl VK3AQR for consideration of the Geeiong boys. Anything which will get more people to operate in the field day is worth considering. Some limitations are necessary in the way of linear amplifier usage of course, and I suggest 100 watts RMS would be reasonable, bearing in mind the output of the 551 rigs; the line should surely be drawn at the use of 2 x 4CX250B linears and similar!

I would like to throw in one more reason why use of 240 volt mains has some value. Several years ago when I operated portable from Myponga Hill (before it rained!) several of the local residents came to the hill top to see what was going on. Fortunately I was on Crown land so I couldn't be moved, but they were not too impressed with the alternator running in the summer time. Certainly it was on cleared ground and pretty safe, but one never knows what can happen under windy conditions, so I did feel uneasy, doubly so as I have been a fire control officer myself for 25 years. Summer time operating might be just that much safer connected to the mains! Your thoughts please, and don't be too abusive, you purists!

Anyway, I would like to make an effort and go out portable for the weekend of 6th December, but as I don't have an alternator and live 25 miles from the closest one in Adelaide my support does seem to be dependent on whether the mains can be used. I have an elevated site in mind if this will be permitted. I am sure others will go, too, if they can run their transceivers on the mains instead of flattening their car batteries with extended periods of operation. I have already looked at my portable antennae and they are still in good condition, ready for action!

## VHF/UHF BEACONS

Freq.	Call Sign	Location
50.005	H44HIR	Honlara
50.020	GB3SIX	Anglesey *
50.023	HH2PR	Hall
50.025	6Y5RC	Jamalca
50.035	ZB2VHF	Gibraltar
50.036	HC1JX	Quito
50.038	FY7THF	French Guiana
50.040	WA6MHZ	San Diego
50.048	VE6ARC	Alberta
50.050	ZS3E	South West Africa
50.055	ZL1UHF	Auckland
50.060	PY2XB	Sao Paulo
50.070	YV5ZZ	Caracas
50.070	VP9WB	Bermuda
50.080	W1AW	Connecticut
50.080	TI2NA	Costa Rica
50.085	WA6JRA	Los Angeles
50.088	VE1SIX	New Brunswick
50.089	WD4CEI	North Carolina
50.100	KH6EQI	Pearl Harbour
50.104	K4EJQ	Tennessee
50.105	KC4AAD	McMurdo, Antarctica
50.110	KH0AB	Saipan
50.110	AL7C	Anchorage
50.120	457EA	Sri Lanka
50.144	KC6IN	Ponapa, Carolina Is.
50.498	5B4CY	Cyprus
51.999	YJ8PV	New Hebrides
52.200	VK8VF	Darwin
52.250	ZL2VHM	Palmerston North
52.300	VK6RTV	Perth
52.330	VK3RGG	Geelong *
52.350	VK6RTU	Kalgoorlie
52.400	VK7RNT	Launceston
52.440	VK4RTL	Townsville
52.450	VK2WI	Sydney
52.500	JA2IGY	Mie
52.500	ZL2VHM	Palmerston North
52.510	ZL2MHF	Mt. Cillmie
52.800	VK6RTW	Albany
52.900	VK6RTT	Carnarvon
53.000	VK5VF	Mt. Lofly
144.010	VK2WI	Sydney
144.162	VK3RGI	Glippsland
144.400	VK4RTT	Mt. Mowbullan
144.475	VK1RTA	Canberra
144.500	VK6RTW	Albany
144.600	VK6RTT	Carnarvon
144.700	VK3RTG	Vermont
144.600	VK5VF	Mt. Lofly
144.900	VK2RTX	Uliverstone
145.000	VK6RTV	Perth
147.400	VK2RCW	Sydney
432.400	VK4RBB	Brisbane

\* Denotes new listing.

No changes to the beacon list this month, only to say that Daryl VK3AQR has confirmed the Geeiong beacon on 52.330 is now operating with its 25 watts and initial reports indicate the beacon is being heard well in VK3 and it has been heard in New Zealand. The Geeiong Amateur Radio Club would be pleased to receive any reports of reception, and these may be sent to Box 520, Geeiong 3220.

The above listings will appear during the early part of the spring equinox when there may still be a possibility of sufficient

## QTH LOCATOR SYSTEM

In response to moves being made chiefly in Region 1 of IARU through Folke Rasvall SM5AGM, of Sweden, I would like to present here details of a QTH locator system which is suitable for world-wide applications, and which with other possible systems was discussed at a VHF Managers' Conference in London last April.

A locator is essentially a map reference, allowing the position of a station to be easily and concisely transmitted, giving sufficient information for the position of a station to be calculated with reasonable accuracy. The use of a scientific calculator or computer allows rapid and accurate conversion from locators to bearings and distances, without the uncertainties introduced in trying to make measurements with a ruler on a map. Who has reasonably detailed maps of everywhere they are likely to work anyway? Then there is the matter of awards and the like. The basing of these upon the usually geographically arbitrary placing of international boundaries is absurd on VHF/UHF, where DX usually does mean distance, rather than rarity. A locator system allows a somewhat fairer assessment of achievement to be made by permitting the number of locator areas, rather than countries, worked to be the basis of an award.

### REQUIREMENT

Having decided that a locator system is highly desirable, if not essential, it is worth

looking at what features and characteristics it should have for amateur use. The following list is roughly graded into order of importance.

#### (1) GLOBAL

The locator should cover the whole of the earth's surface. This is becoming increasingly important in these days of satellites, moonbounce, TEP and other trans-continental modes on VHF/UHF.

#### (2) POSITIONALLY UNIQUE

A given locator reference should specify only a single area of the earth's surface, the size of this area depending on the precision of the system in use.

#### (3) NO AMBIGUITY IN LOCATOR

A given position should have only one possible locator.

#### (4) BREVITY

The locator reference should be as short as possible, given other constraints. This is, after all, the reason for using a locator in the first place.

#### (5) CONSISTENCY OF FORMAT

The locator should have a constant basic outline — e.g. two letters, two numbers, two letters. Not only does this make copying the locator easier, but to allow a particular character to be either a letter or number is bound to lead to confusion. (Try writing XYIOZS with XY1420 underneath, in your usual scrawl. Then see if someone else can tell the letters from the numbers!)

#### (6) PRECISION

The locator must be capable of specifying the location of a station with reasonable accuracy. This requirement is clearly in conflict with that for brevity. It is suggested the smallest squares should be about 5 km for general use.

#### (7) COMPATIBILITY

Region 1 already has a fairly good system in operation called the QRA system and many operators have been entering contests and awards on the basis of this system. If a new locator system is to be adopted for world-wide acceptance, then G9BF, having just worked his 250th big QRA square on 2 metres, is going to be justifiably annoyed if he has to start all over again! If the new system is suitably compatible with the present QRA, however, it will be possible to translate from one to the other, with no ambiguity, thus allowing awards and lists to be continued.

#### (8) BIG SQUARES AND LITTLE SQUARES

For lists and awards, fairly large squares are needed, and these should be describable as a part of the whole locator, e.g. ZL34BA is in ZL square. Again, the feeling seems to be that the present QRA system has this about right. Make the "big" squares too big, and those running low power from the valley will seldom get the chance to work anything new. Make them too small, and every other contact will be in a new square.

# John Moyle Memorial Field Day Contest, Results 1980

## 24 HOUR DIVISION

### Section (A): Portable Field Station Transmitting Phone.

VK5CCT	5481	VK3APZ	431
VK4NFU	2638	VK4VX	420
VK3NZM	2422	VK4AAQ	420
VK2VNP	1910	VK4ADB	420
VK4XZ	1390	VK4ARH	420
VK5NNC	1309	VK4NOX	360
VK6TJ	1109	VK4NHS	360
VK2BDT	594	VK5ABS	202
VK5NTV	456	VK4NLV	80
VK4AHO	440	VK4NDW	60

### Section (B): Portable Field Station Transmitting CW.

VK5ZE	544
-------	-----

### Section (C): Portable Field Station Transmitting Open.

VK5OR	2272
-------	------

### Section (D): Portable Field Station Tx Phone Multi-operator.

VK4WIZ	12321	VK1ACA	3190
VK2MB	7690	VK5ACE	2861
VK3BGG	5008	VK5LZ	2758
VK4ARZ	4025	VK5PP	1931
VK4WIP	3893	VK4WIM	1919
VK3BML	3501	VK2BNR	997
VK3XK	3230		

### Section (E): Portable Field Station Tx Open Multi-operator.

VK3ATL	17046	VK4WIT	5701
VK3APC	11936	VK5SR	5368
VK2DBG	10070	VK7NB	3055
VK2WG	9650	VK3AWS	3028
VK3ATM	9580	VK5VE	2945
VK3ANR	9437	VK5WC	2899
VK8DA	6068	VK5ARC	2512

### Section (F): VHF Portable Field or Mobile Station Tx.

VK3XQ	2214	VK4ZRQ	300
VK3ZJS	1504	VK2DBA	74
VK2BNR	398	VK1LF	66

### Section (G): Home Transmitting Stations.

VK3XB	1850	VK3AEW	1260
VK3KS	1405	VK7NFR	255

### Section (H): Receiving Portable or Mobile Stations.

L40804	Nancy Heaton	1475
L40018	Charles Thorpe	495

## 6 HOUR DIVISION

### Section (A): Portable Field Station Transmitting Phone.

VK3VKZ	1335	VK4NBW	506
VK2BTZ	1152	VK3AKJ	435
VK3SP	1022	VK2DCW	379
VK5MX	1009	VK3YRP	320
VK1RP	929	VK2BUT	307
VK5AIM	859	VK5NEB	215
VK2VWH	690	VK2NMK	200
VK3HE	678		

### Section (B): Portable Field Station Transmitting CW.

VK3TX	558	VK2JM	504
-------	-----	-------	-----

### Section (C): Portable Field Station Transmitting Open.

VK2EL	1249	VK2VUT	569
VK4UX	916	VK3VF	509
VK1DL	820	VK2GT	250

### Section (D): Portable Field Station Tx Phone Multi-operator.

VK4WIN	3152	VK4NXL	1161
VK3ATO	2392	VK3BRL	1157
VK3BTH	1980	VK3CAU	936
VK5KR	1675	VK2BSU	518

### Section (E): Portable Field Station Tx Open Multi-operator.

VK3ABP	1608
--------	------

### Section (F): VHF Portable Field or Mobile Station Tx.

VK3AVJ	648	VK2EL	94
VK3YIW	576	VK2ZQC	40

### Section (G): Home Transmitting Stations.

VK3ZI	645	VK4VOJ	160
VK5OU	600	VK2YGL	120
VK2BQS	560	VK4VCE	45
VK4LT	455		

### Section (H): Receiving Portable or Mobile Stations.

L60036	P. K. Dean	1077
L50505	Robert Dayman	460
L30042	Eric Trebilcock	260
Check log from VK1CC.		

## RESULTS OF THE 1979-80 ROSS HULL MEMORIAL CONTEST

Outright winner of the trophy is Ray Naughton VK3ATN.

### Section (A): Transmitting Phone.

Call Sign	7 Day	48 Hour
VK2BYX	1244*	604
VK2BYX	720	316*
VK2BQN	578	284
VK2HZ	602	246
VK2YEP	238	80
VK3ATN	3320	1402
VK3YLD	1214	392*
VK3AUI	900	383
VK4DO	2242*	768
VK4ZNG	1719	724*
VK4ZTV	596	262
VK4ZCO	264	84
VK5LP	944*	442
VK6OX	422*	152

\* After a score denotes a certificate winner.

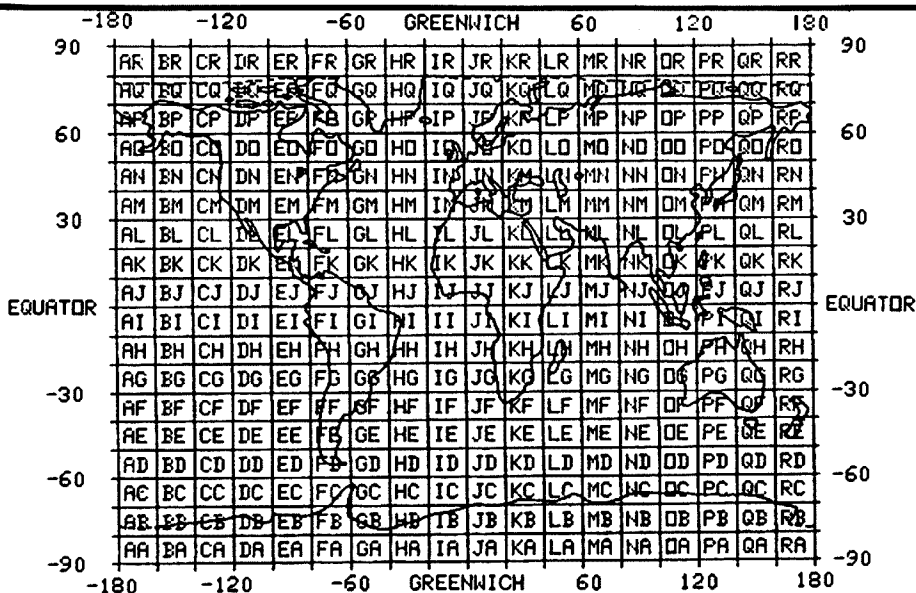
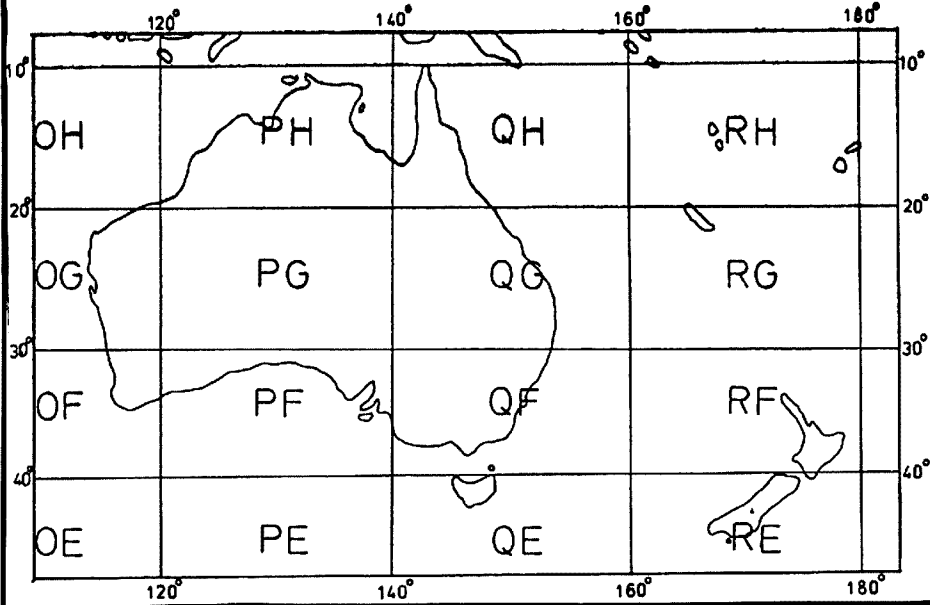

FIGURE 1 (above) shows a proposed locator system for world wide use, while FIGURE 2 (below) gives an enlarged view of those grids affecting VK and ZL amateurs.



**(9) LETTERS AND NUMBERS**

Locators consisting of just letters or just numbers seem for some reason to be more difficult to copy and remember than those with a mixture.

**(10) SIMPLICITY**

Given all of the above constraints, the system should be as simple as possible to translate to and from latitude and longitude.

**MODIFIED G4ANB SYSTEM**

This system was adopted at the London Conference of VHF Managers as an official IARU Region 1 proposal to other regions, and regions such as ours (Region 3) are asked to have a look at this system and hopefully give some answers in time for the next IARU Region 1 Conference on 27th to 30th April, 1981. Consultations are similarly being undertaken in Region 2.

Associated with this information is a map of Europe set out with locator squares under the proposed system, showing in large letters the large square ident, with each of these large squares being further divided and numbered as you see on the map. Information is also provided on a sample selection of longitude and latitude converted to a locator square.

Also provided is a map of the world showing how the globe is divided into large squares, 20° x 10°, and the other map shows how the region around Australia is divided into portions of 10 squares.

A QTH locator system has been in use in Europe for over 20 years, and thousands of hours have been spent in gathering contacts using these squares. Therefore, middle units of size 2° x 1° have been

used to preserve these contacts already made. Additionally, if we tried to get 1° x 1° as middle units, the only solution would have been to use two letters to divide the earth's circumference into 360 parts, since 26 letters and 10 digits give only 260 combinations. Since we do not want to have only letters in the locator there are only 10 digits left, giving the smallest unit 6' x 6'. With the present solution the smallest unit is only 6' x 2.5' giving better accuracy.

All this represents an outline for a proposal which does have a lot of merit, and I would ask each of you to look at it seriously and give me some feedback on your views, at least to indicate in due course how we feel about the locator system in Region 3. It will take you a little while to get the hang of the system, but after a while it does unfold in the brain and you can then appreciate what it could mean to everyone if it could be adopted on a world-wide basis. Over to you for your thoughts.

**EXTRA NEWS FROM VK6**

Graham VK6RO has written to say he has progressed from VK6ZGS to VK6RO and has been having a thrilling time on 6 metres using an IC502 and 25 watt PA and 2 element quad, or mobile with the 502 and whip antenna. On 2 metres he uses an IC202 and 25 watt PA and 5 element yagi and is keenly interested in SSB contacts.

Graham has had a lot of satisfaction in working JAs, starting on 15-3 from home, then 17-3 whilst mobile with 3 watts, same on 18-3, 9-4 and 13-4, so five openings to JA, three worked whilst mobile. Thanks for writing from Bunbury, Graham.

**GENERAL NEWS**

Winter conditions have not produced too much in the way of contacts on 6 or 2 metres of late. Some contacts from time to time on 144 MHz between VK5 and VK3. I took a look around the bands at the time of the VK2 VHF Mid-Winter Contest in July but didn't hear anything. I only came across the details by chance when I saw them published in ETI magazine, which seems to be restricting their coverage to some degree.

Whilst I do not dispute the value of a "State of the Art Contest" for what it means, I think the idea of totally excluding Es and usual tropospheric openings as a means of participation does tend to diminish interest in the contest. By all means foster "State of the Art" techniques, but it is better to increase the level of participation by amateurs by allowing the less exotic forms of propagation to be counted, even if not at the same points level. One never knows just what might be worked if sufficient stations are on the bands, but you have to get them there first for contacts to be made. So go to it, you purists, hammer me if you want to, but if such a contest is to really get off the ground, it needs to be well publicised, in

# SPOTLIGHT ON SWLing

Robin Hawood VK7RH

5 Helen St., Launceston, Tasmania 7250

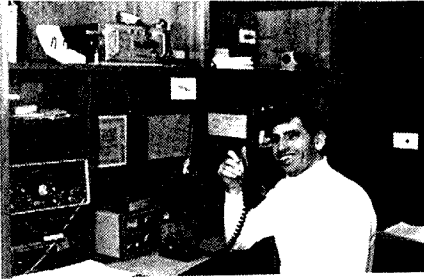

This month, we are considering the reception report. Most international broadcasters do welcome reports from listeners on propagation conditions and signal strength as well as co-channel interference. However, they are more interested in the feedback from their listeners with comments on the content of their programmes. They aim to reach a wider audience than the casual DXer and wish to promote interest on what is happening within their countries, as well as expressing their viewpoint on world events.

Getting QSLs from broadcasting stations is somewhat easier than amateur operators although they require different information to verify their transmissions. As they utilize many frequency bands often using channels simultaneously, they would welcome comparative reports to assist them to find the optimum frequency. They also prefer the use of another reception code than the RST system in amateur contacts. This is the SINPO code, see Fig. 1, sometimes abbreviated to Signal, Interference and Overall Merit. They require also about 15 to 30 minutes details of programme content (especially when verifying foreign

## SINPO CODE

	Strength	Interference	Noise	Propagation	Overall
5	Excellent	Nil	Nil	Nil	Excellent
4	Good	Slight	Slight	Slight	Very Good
3	Fair	Moderate	Moderate	Fair	Good
2	Poor	Strong	Strong	Severe	Fair
1	Barely Audible	Severe	Severe	Extreme	Poor

The SIO Code same as a above but deletes N & P.

language broadcasts where times are critical in checking reports).

A sample reception is shown (Fig. 2) with the required details of date, time (in GMT), frequency, signal levels and programme content. Some broadcasters welcome reception summaries of transmissions over extended periods such as a week, monthly, or quarterly.

With regards to postage, many major international broadcasting organizations are directly funded or controlled by the national governments and sending IRCs is not necessary. Smaller broadcasting stations, however, have limited budgets, particularly in developing nations, and it is recommended to use IRCs with these stations. It is also advisable to check with the World Radio TV Handbook for their QSL policy.

Some broadcasters have altered their policy in that they will issue QSL or verification cards during certain periods only. All still welcome reception reports, especially comments on their programmes.

When submitting reports on foreign language broadcasts, it is recommended that a more detailed report on programme content be given in order that the station can verify that the programme heard could be one of theirs. With reports to Latin America stations, it assists if the report is not in English but in Spanish or Portuguese, if you want speedier QSLs. Also French stations prefer their reports to be

in that language as I have known English language reports to be delayed or ignored.

Make your report neat, tidy and well laid out. This helps in getting that verification, especially from the rarer stations. Also include some details on your equipment, antenna and some information about yourself and your area.

Incidentally, with reports to American stations, write the date in words, for there the month is given before the date, for example 3/4/80 is the fourth of March and not the third of April as it would be here.

I would welcome your comments and suggestions on the content of this column. Until next month when we will discuss "clandestine" broadcasts, amongst other subjects, good DXing and 73s. ■

## RECEPTION REPORT

Station:.....

Frequency:.....

Date:.....

Time:.....

SINPO Report:

Programme Information:

Additional comments:

73s from Rob L. Harwood

SDC ..... AndeX.....

Date:.....

plenty of time, and not be too restrictive in its applications. Now watch the flak!

As I said before, news is scarce, and as I am prevailing on the good auspices of the editor to print some maps for me this month, I had better close and leave enough space. But it will be September when you read this and here's hoping all the TEP hasn't gone yet. Thought for the month: "Putting pen to paper lights more fires than matches ever will."

73. The Voice in the Hills. ■

## SMIRK

SMIRK stands for the Six Metre International Radio Klub. It numbers amongst the membership many of the keenest 6 metre DX operators. Its newsletter contains news of interest to all six metre operators.

To join SMIRK you must send log extracts detailing the required number of contacts with SMIRK members, together with a once only fee of \$4 US to the

Secretary, Ray Clark K5ZMS at 7158 Stone Fence Drive, San Antonio, Texas 78227.

The required number of contacts is six for the USA and for Foreign to Foreign, that's us, it is three. To assist in determining who amongst the JAs you have worked are SMIRK members there have been several lists published in AR from May 1979 to the present update.

To obtain the SMIRK newsletter which is full of news about six metre, openings, contacts, countries on six, DXpeditions, equipment, and lots more, SMIRK members send a supply of SASEs and \$1 US approximately postage per issue to the Secretary. These envelopes should have your SMIRK number on them. This newsletter is published quarterly and is really good for keen six metre operators.

The list below is the latest listing update of recent Japanese and Australian SMIRK members.

JF1IXW 3556, JF1QOI 3555, J1ICWW 3614, J1WEJ 3557, JK1AFU 3617, JK1BCK 3671, JK1DAT 3632, JK1DLR 3663, JK1QXF 3545, JK1PIV 3547, JL1GWL 3529, JE2AOQ 3619, JE2PWN 3546, JF2KOZ 3629, JR2BEF 3647, JA3PTY 3582, JF3LGC 3658, JF3MOK 3598, JF3MXU 3644, JF3RLG 3664, JF3RVF 3639, JF3SVD 3633, JF3TDC 3637, JF3WBD 3635, JG3IND 3638, JG3OEC 3640, JG3RGG 3641, JR3TVH 3533, JA4IQF 3558, JA4RCC 3559, JH4HTC 3560, JH4LSB 3645, JH4NHT 3536, JH4TIG 3561, JH4XIU 3562, JA5GAM 3602, JH5DDI 3616, JH5EJT 3615, JA6MXU 3597, JE6IHW 3618, JH7PAF 3537, JH7SSJ 3661, JH8NIJ 3625, JA9QAD 3665, JH0HQP 3554, VK3YII 3646, VK4YL 3670, VK4ZAY 3656, VK6ZBX 3627. ■

## SUPPORT OUR ADVERTISERS



# AWARDS

## AUSTRALIAN VHF CENTURY CLUB AWARD

### OBJECTS

- 1.1 This Award has been created in order to stimulate interest in the VHF bands in Australia, and to give successful applicants some tangible recognition of their achievements.
- 1.2 This Award, to be known as the "VHF Century Club Award", will be issued to any Australian Amateur who satisfies the following conditions.
- 1.3 Certificate of the Award will be issued to the applicants who show proof of having made one hundred contacts on the VHF bands, and will be endorsed as necessary for contacts made using only one type of emission.

### REQUIREMENTS

- 2.1 Contacts must be made in the VHF Band (Band 8) which extends from 30 to 300 MHz, but such contacts must only be made in the authorised Amateur Bands in Band 8.
- 2.2 In the case of the authorised bands between 30 and 100 MHz, verifications are required from one hundred different stations, at least seventy of which must be Australian. The Amateur Bands 50 to 54 MHz and 56 to 60 MHz will be counted as one band for the purposes of the Award.
- 2.3 In the case of the authorised Amateur Band between 100 and 200 MHz, verification from one hundred different stations are required.
- 2.4 It is possible under these rules for one applicant to receive two certificates, one for each of the authorised Amateur Bands nominated in Rules 2.2 and 2.3.
- 2.5 The commencing date for the Award is 1st June, 1948. All contacts made on or after this date may be included.

### OPERATION

- 3.1 All contacts must be two-way contacts on the same band, and crossband contacts will not be allowed.
- 3.2 Contacts may be made using any authorised type of emission for the band concerned.
- 3.3 Fixed stations may contact portable/mobile stations and vice versa, but portable/mobile station applicants must make their contacts from within the same call area.
- 3.4 Applicants, when operating either portable/mobile or fixed, may contact the same station licensee, but may not include both contacts for the same type of endorsement.
- 3.5 Applicants may only count one contact for a station worked as a limited licensee with a Z or Y call sign who is subsequently contacted as a full AOCIP holder.
- 3.6 All stations must be contacted from the same call area by the applicant (except as below), although if the applicant's call sign is subsequently changed, contacts will be allowed under the same call area.  
If the applicant moves to another call area, contacts must be made from within a radius of 150 miles of the previous location to qualify for award purposes. If the distance of the new location from the old exceeds a radius of 150 miles, a separate application for a new award must be made claiming only contacts made from the new location.
- 3.7 All contacts must be made when operating in accordance with the Regulations laid down in the "Handbook for the Guidance of Operators of Amateur Wireless Stations" or its successor.

### VERIFICATIONS

- 4.1 It will be necessary for the applicant to produce verifications in the form of QSL cards or other written evidence showing that two-way contacts have taken place.
- 4.2 Each verification submitted must be exactly as received from the station contacted, and

altered or forged verifications will be grounds for disqualification of the applicant.

- 4.3 Each verification submitted must show the call sign of the station worked, the date and time of contact, type of emission and frequency band used, the report and the location or address of the station at the time of contact.
- 4.4 A check list must accompany every application setting out the following details:
  - 4.4.1 Applicant's name and call sign, and whether a member of the WIA or not.
  - 4.4.2 Band for which application is made, and whether special endorsement is involved.
  - 4.4.3 Where applicable, the date of change of call sign and previous call sign.
  - 4.4.4 Details of each contact as required by Rule 4.3.
  - 4.4.5 The applicant's location at the time of each contact if portable/mobile operation is involved.
  - 4.4.6 Any relevant details of any contact about which some doubt might exist.
- 4.5 In lieu of forwarding QSL cards or other written evidence as set out in Rules 4.1 to 4.4 above, a list giving the details set out in Rule 4.3, certified by the Awards Manager, Secretary or Council Member of a Division of the Wireless Institute of Australia, or two licensed amateurs known to the applicant, should accompany each application for membership or adjustment of verified country totals.

### APPLICATIONS

- 5.1 Applications for membership shall be addressed to the Federal Awards Manager of the Wireless Institute of Australia, accompanied by the verifications and check list with sufficient postage enclosed for their return to the applicant, registration being included if desired.
- 5.2 A nominal charge of \$1, which shall also be forwarded with the application, will be made for the issue of the certificate to successful applicants who are non-members of the Wireless Institute of Australia.
- 5.3 Successful applicants will be listed periodically in "Amateur Radio". Members of the VHFCC wishing to have their verified totals, over and above the one hundred necessary for membership, listed will notify these totals to the Federal Awards Manager.
- 5.4 In all cases of dispute, the decision of the Federal Awards Manager and two officers of the Federal Executive of the WIA in the interpretation and application of these Rules shall be final and binding.
- 5.5 Notwithstanding anything to the contrary. In these Rules, the Federal Council of the WIA reserves the right to amend them when necessary.

## WORKED ALL STATES (AUSTRALIA) AWARD

### OBJECTS

- 1.1 This Award has been created in order to stimulate interest in the VHF/UHF bands and is of a high standard to fully acclaim the proficiency of the recipients on their achievements.
- 1.2 This Award, to be known as the "Worked All States (Australia) Award", will be issued to any amateur in Australia or overseas who satisfies the conditions following.
- 1.3 A certificate of the Award will be issued to applicants who show proof of having made two-way contact with the specified areas of the Commonwealth of Australia. Additional credit will be given for proof of contact with overseas countries, viz., New Zealand or Papua New Guinea. Countries, for the purposes of this Award, are set out in the Australian DXCC Countries List.

### REQUIREMENTS

- 2.1 Contacts must be made on the VHF/UHF bands 52 MHz and above (Bands 8 and 9). Contacts made on 50-52 MHz prior to 1/4/64 will count towards the 52 MHz Certificate.

- 2.2 One verification from each of the following areas of the Commonwealth of Australia is required —

- (a) Australian Capital Territory.
- (b) New South Wales.
- (c) Victoria.
- (d) Queensland.
- (e) South Australia.
- (f) Western Australia.
- (g) Tasmania.
- (h) Northern Territory.

In all, eight verifications are required.

- 2.3 It is possible under these rules for one applicant to receive one Award for each of the authorised bands between 30 and 3,000 MHz.

### OPERATION

- 3.1 All contacts must be two-way contacts on the same band and crossband contacts will not be allowed.
- 3.2 Contacts may be made using any authorised type of emission for the band concerned.
- 3.3 Portable operation will be permitted provided that the portable location shall be in the State in which the licence was granted and in the call area in which the licence was granted in the case of overseas operation.
- 3.4 All contacts must be made in accordance with the Regulations laid down in the "Handbook for Operators of Radio Stations in the Amateur Service" or its successor for Australian stations, or in accordance with those Regulations applying in the country of the applicant in the case of overseas stations.

### VERIFICATIONS

- 4.1 It will be necessary for the applicant to produce verifications in the form of QSL cards or other written evidence showing that two-way contacts have taken place.
- 4.2 Each verification submitted must be exactly as received from the station contacted, and altered or forged verifications will lead to the disqualification of the applicant.
- 4.3 Each verification submitted must show the call sign of the station, date and time of contact, type of emission and frequency band used, the report and the location or address of the station at the time of contact.
- 4.4 A check list must accompany every application setting out the details for each claimed station in accordance with Rule 4.3. If any contacts were made whilst portable, this must be stated and the portable location given. The applicant must also state whether or not they are a member of the WIA.
- 4.5 In lieu of forwarding QSL cards or other written evidence as set out in Rules 4.1 to 4.4 above, a list giving the details set out in Rule 4.3, certified by the Awards Manager, Secretary or Council Member of an affiliated Society, or two licensed amateurs known to the applicant, should accompany each application.

### APPLICATIONS

- 5.1 Applications for membership shall be addressed to the Federal Awards Manager of the WIA, accompanied by the verifications and check list with sufficient postage enclosed for their return to the applicant, registration being included if desired.
- 5.2 A nominal charge of \$1, which shall also be forwarded with the application, will be made for the issue of the certificate to successful applicants who are non-members.
- 5.3 Successful applicants will be listed periodically in "Amateur Radio". Members wishing to have their verified country totals listed over and above those submitted at the time of application for membership, will notify these details, in writing, to the Federal Awards Manager.
- 5.4 In all cases of dispute, the decision of the Federal Awards Manager and two officers of the Federal Executive WIA in the interpretation and application of these Rules shall be final and binding.
- 5.5 Notwithstanding anything to the contrary. In these Rules, the Federal Council of the WIA reserves the right to amend them when necessary. ■

# LISTENING AROUND

With Joe VK2NIM

Remember some of the blokes you worked in your CB days. Well, I do because if it wasn't for CB, I wouldn't be among the ranks of the amateurs now. Many ex CBers have now joined the amateur ranks and occasionally I meet somebody I have earlier met with on CB. For example, the other morning I spoke with a Novice in WA whom I had last contacted on 27 MHz in those hectic days when CB was at its height.

And I recall that CB has had some good points. I remember once talking with a CB operator in Mildura who was sitting up on top of a pole gathering money for the local hospital by seeing how long he could sit up there with his CB. I don't think he's yet migrated to the amateur ranks, but what a waste of talent if he hasn't. (He was a pretty cluey bloke — electronically speaking anyway).

And having spoken with a CBer atop a pole, the other morning I spoke to an amateur atop of an extension ladder. At least if he wasn't there, his helical antenna was! I'm referring to Ted VK1NAN, whose QTH was given as the Satellite Tracking Station at Orroral Valley, 35 miles south of Canberra. Ted says that VK1ZIF Ian, and VK1WM also Ian, are at the tracking station and there also is Lindsay, Joe and Bob, who one day hope to have their calls.

One of my regular 80 metre contacts is Jack ZL1LK, at Orewa near Auckland, in the North Island of New Zealand. Jack told me recently that a former neighbour of his, aged 80, who was once a wool classer, is now in Mildura and has spotted me eating at a local eaterie where I go for a midnight snack! So, Ted, I don't know you but if you spot me in that eaterie again, why not tap me on the back and say howdy. It would be nice to meet you — specially since you are a friend of ZL1LK.

In the early hours of the morning of the day in which I write this, I was in contact with Keith VK3NBA mobile, who was using a Kraco through a transverter to get him up on to 80, and can switch his Kraco from 27 MHz to 28 MHz when he wants to. It would be handy to still be able to monitor the emergency frequency 27.065 MHz even for little else.

Another very interesting contact in recent days was with Robert VK5NRN, located at Padthaway, 200 miles from Adelaide and 30 miles north of Naracoorte. He received his call on 21/6/80, and I happened to be his first VK2 and his fourth QSO in all! He was using a Johnston Viking converted to 28 MHz plus transverter which is owned by Rod VK5NRR. Robert is working among the grapes in his area in order to save up enough money to buy his own rig. Hope you will have got my card by this time, Robert, and it was nice to speak to you, as it always with any one of the friendly folk on the 80 metre band. Seems the CB and transverter combination is very popular!

Being located as I am, almost on the border of three different States with their multiplicity of different laws and regulations, I'm sometimes tempted to think of all three as three separate countries instead of one Commonwealth of Australia. At least with Federation they abolished the customs duties between Victoria and NSW, and no longer is there a Forestry Inspector on duty near the ageing Mildura bridge (over the Murray) to check vehicles bringing timber from one State into another. And as for that Fruit Fly check-point — well it might as well not be there at all.

But all is not lost, and the marvellous thing about the wireless waves coming from my QTH is that they more than penetrate deep into the territory of all three States and beyond. I'm usually one of the first VK2s that most "Wassies" (VK6s to you) hear first, and I'm well within range of VK5s who sometimes can't hear any other VK2 east of the Blue Mountains.

Another regular contact on 80 is Hugh VK5NIO, who is very active constructing various items for his shack, his friends, or

doing photography work. Then there's Geoff VK5NDZ, who makes violins in between having coffee and sandwiches, or checking the Adelaide radio shops for bargain radio gear. Kim VK5NKY from Reynella works for the Department of Environment, which is involved with trees and highways, mainly in the north Flinders Ranges. Kim says he loves his job and is lucky enough to enjoy the job he does for a living.

Does anyone know the original owner of my call sign VK2NIM? I believe he may be in the Gosford area of NSW. If he reads this, will he please contact me as I have a whole swag of QSL cards for you earned before the call was allotted to me. These cards were sent to me from the VK2 QSL Bureau, but are not for me.

I've had several QSOs with Stewart VK3AIA of Caulfield, who got his first class commercial licence (No. 68) in 1931. Stewart has seen 70 summers and comes up on an Old Timer's Net. With his son, he does PA work in a big way and this includes the Stawell Gift, when he camps out on the job, the Myer Music Bowl, the Melbourne Town Hall and OB work for a Melbourne commercial radio station. His son, Hugh, has a degree in electronics. When Stewart talks about amplifiers and speakers it's really high powered stuff.

Well that's it for now and until next time I hope to work you on 80 or hear from you through the post!

## QSP

### EMDRC STATIONS

Looking through the May issue of the EMDRC Radio Bulletin, the statistics in their supplement call list was interesting as it could reflect the general trend of amateur clubs in Australia. The biggest number of members were listed as retired — 12.2 per cent. As might be expected, students were 11.1 per cent and communications and electronics 10.9 per cent, engineering occupations came 7.5 per cent in the list, with business administration at 7.1 per cent, down to finance and accounting to 1.3 per cent. Of the 451 members, 78.5 per cent held licences plus 3.8 per cent as licensed juniors, 243 of those holding VK licences were also members of the Institute out of a 350 total, plus 16 out of the 101 others (all, except 8 overseas licences, being listeners) were also members. 70 per cent membership of the WIA must be a good record in anybody's book.

## FORWARD BIAS

### VK1 DIVISION

(Postal Address: WIA (ACT Division) Inc.,  
PO Box 46, Canberra, 2600 ACT)

About 60 members, undeterred by winter cold, made it to the July meeting. The evening's topic was "Test Gear" and each speaker described and demonstrated his own particular item of equipment. There was a fair sampling of home-brewed items included in the range of gear set up for

display and operation. It's reassuring somehow to see that the art of home-brew is still with us. VK1 Division's "parts box" was disposed of at long last. Auctioneer extraordinaire Bill VK1MX, after cataloguing something of the order of 100 assorted items in the box, responded to the sole bid offered and sold the lot in one hit — box and all!

Four new members joined us in July — Tony Knight VK1JA, Ian Coleman VK1NDI, A. Hanes VK1ZAZ and Peter Bowles VK2YPL. There were four new calls, too: Jack White VK1ZAD/3D2MW, Dave Gibbons VK1NDG, Barry Bennetts VK1NDO and Ken Pyett VK1NDK. Incidentally, Barry,

an ex-SWL, was recently awarded the HAVKCA certificate. Strange that this award which has been around for some time now, seems to have attracted so few claimants. Barry's certificate is only the 50th issued so far. How about, SWLs? You may well have qualified for the "Heard All VK Call Areas" award. Why not drop a line to the Federal Awards Manager and ask for details — or give him details of your claim.

### FEDERAL EXECUTIVE EDUCATIONAL GRANT

The committee has decided to use some of the (Dick Smith) grant money allocated to VK1 to purchase an overhead pro-

jector—something we've needed for a long time. We may also do something about our aged creaking duplicating machine—either a complete overhaul or a new machine.

### NEW CALL SIGN FOR MELBA HIGH SCHOOL

David Boehm VK1UD has successfully applied for a curriculum development grant of approximately \$780 to establish an amateur radio station at the Melba High School. Equipment on order is a TS-520SE transceiver and an 18-AVT/WB trapped vertical antenna, which should perform well on its 40m x 30m metal ground-plane provided by the school roof.

The call sign VK1MH was applied for in February in anticipation of the grant and sessions, already under way, take place during an activity hour on Wednesdays. Students with a general interest in radio attend these and have already spoken to amateurs in many parts of the world, including five other school stations.

At present, VK1MH is on air using David's FT-200 plus assorted end-fed wires scrounged from the science lab. Transmissions on 40 to 10 metres take place every Wednesday between 11.30 and 12.30 (AEST).

Students seriously interested in passing the Novice examination will be able to attend after-school instructional sessions, which will start in September, probably also on Wednesdays.

David will be happy to provide further information on VK1MH and anyone interested to hear more about this venture can contact David (QTHR) or on (062) 54 8982 AH.

### CHANNEL 6 REPEATER NEWS

Several committee members made the ascent to the Black Hill site on Sunday, 20th July, and inspected the repeater facility there. VK1 has a rack-assembly in a building that houses equipment operated by NASA (associated with the Tidbinbilla tracking station).

On 27th July, Peter VK1DS and Neville VK1NE, heading a task-force comprising Les VK1ZKL/NBK, his son, Bert VK1ZAT, and Ara VK1BM (here in Canberra from JA), also tackled Black Hill. The antenna was inspected and refurbished, new coaxial was put in, and the old Mount Ginini repeater (once stolen, recovered and returned to VK1) was put into operation. Peter has asked for a two-week test period so that performance can be assessed.

Ara, who recorded some of these great moments in history on film, is now writing an article which will be published back home in Japan, where there are no repeaters.

Stopping off at the Cotter River, the stalwarts enjoyed a barbeque, hosted by Peter's XYL and family, including his mother-in-law who is on a visit from the UK. A productive and rewarding day.

### TECHNICAL TOURS

This spring and early summer, the Division hopes to arrange visits or conducted tours for parties of WIA members to the Black Mountain Telecommunications Tower, local TV stations, the Tidbinbilla station, the RAN communications station at Harman (and perhaps the naval transmitters at Belconnen).

In arranging these visits, we want to avoid the well-trodden paths of the usual public tours; the Black Mountain tower for example, is open to the public, but its telecommunications facility is not normally accessible. The list is not exhaustive—other places of interest could include the Solar Physics laboratory at the ANU, certain Divisions of the CSIRO, and so on.

Interested members, planning to visit Canberra, or who may want to come specially to join any of the planned tours, will be most welcome. As the programme develops we'll publish more detailed information in this column. ■

## QRK5

A transmission from the Victorian Division WIA.

Written and co-ordinated by VK3WW, QTHR.

This month's news and views have to be written before I see the first lot in print, so I have no idea of the acceptability or otherwise of the contents or format. Perhaps it serves as a good illustration of "lead time" delays.

### WILLY WILLY'S WORDS

A term of endearment has crept into our vocabulary, which is sometimes misused through lack of understanding of its origin. The following historical facts will explain the origin of the term "half call".

Names and call signs have been changed to protect the guilty.

Many years ago "Bill" VK3A? was busy preparing for the RD contest in which his friend VK3Z?? (Tom) always helped by keeping log.

Bill's XYL is talking to a neighbour.

Neighbour: "Bill looks busy."

XYL: "Yes, he wants everything ready before his ham friend Tom arrives to help him in the contest."

Neighbour: "If Tom's a ham too why doesn't he go in the contest by himself?"

XYL (full of technical knowledge): "Oh! he can't, he's only got half a licence."

Tom arrived as this last sentence was spoken. A generous application of 807 soothing fluid ensured that Tom still keeps log for Bill.

From this one innocent remark the term "half call" was born.

Please note that it applies to **Limited AOCOP** holders only and has no mathematical origins or connotations. It does not

follow that a **Novice AOCOP** holder is a quarter call or a dual holder is a three-quarter call. The Novice licence was planned as a stepping stone to the AOCOP, so if it needs a "jargon title" perhaps Temporary Call would be appropriate.

### QUESTION TIME

Last issue I asked a couple of questions without giving answers. A couple of thugs decided to reply with the following:—

We were wondering whether Wee Willie's wonder would work well without wet winding wire wound within??

Is the answer In AR for February 1980?

### PEOPLE AND TIME

Did you know that the monthly council meetings usually last until midnight—sometimes later—**no not waffle**—just the amount of business and the principle of giving every councillor a fair hearing. When you next feel like criticising the council think about "time".

The WIA Centre at 412 Brunswick Street, Fitzroy, is open five days a week, between 10 a.m. and 3 p.m. We all owe thanks to a willing band of experienced members who provide this service free of cost.

It is **people giving time** that keeps the WIA going—if you don't have the time available to help at least express appreciation to those who have and do.

### MAJOR AIMS

Council would like to improve facilities available to members. The limiting factors are time and finance. Please let council know what you would like in the way of facilities; all ideas will be discussed. If no replies are received it means everyone is satisfied.(???)

### MEET YOUR COUNCILLORS

#### THIS MONTH — NOBODY!!!

All councillors were asked to supply your scribe with brief details for publication—none have after four or more weeks—so they must be shy or perhaps the extra five minutes demand on their time was just too much.

Yes, I will wear a bulletproof vest to the next council meeting!!

Next month more news and an introduction to two well known operators.

Would all zone and club secretaries please submit copy for these notes to the AR Liaison Councillor, VK3WW, QTHR.

73. Mike. ■

## THE RADIO AMATEUR'S CONVERSATION GUIDE

A most useful adjunct for working the DX station not proficient in English. Good also for contests.

**\$9.00** brings you a copy, post paid.

**MAGPUBS**

P.O. Box 150, Toorak, Vic. 3142

# YOU and DX

G. (Nick) Nichols VK6X1  
6 Briar Place, Ferndale, WA 6155.

QSL cards, those colourful pieces of paper that adorn many a DXer's shack, cost at times large sums of money to obtain and often disappoint due to the failure of the donor to complete them correctly, are in the news again this month.

It seems that postal pixies in other countries are not only far less reliable than our own but even stoop to pilfering of mail articles either for the contents or at times just the postage stamps affixed thereto.

**A51PN** reports numerous such occurrences and specifically requests that money **NOT** be included with QSL requests, IRCs are apparently not so prone to this unwelcome attention but **5** are required for return airmail postage (and we complain about our postal rates); should you send IRCs to Bhutan, ensure that their date of issue is clearly shown, pre-1980 frankings are not acceptable.

**9X5PP** in Rwanda has been receiving many second requests for cards and believes his mail is also receiving rather dubious attention. If Peter has not responded to your QSL request I suggest you try again but avoid wherever possible including any mention of amateur radio on the envelope or attractive stamps; keep your direct QSL mail as plain and non-descript as possible and you will reap the returns.

Enough of the bad news. For those stations active DX-wise on RTTY, there will

be some activity commencing 20th September from **3A2IP (10HUB)** — whilst on holiday) on 20, 15 and 10 metres. Clay will also be operating SSB mostly on 10 looking toward VK for contacts. QSL via home call.

## ON THE BANDS

### 160 Metres:

**V55** worked from **VK6**.

### 80 Metres:

Excellent conditions prevailing, good openings into Europe and for the Novices Africa worked again at around 22.30Z, both phone and CW at good strength.

### 40 Metres:

Patchy with some excellent propagation at times, **ZK2YY**, **A22DW** and numerous Ws on CW, together with **EA8AK**, **CE3JK** being the most notable.

### 20 Metres:

Good propagation to all areas, heavy QRM whenever anything a little out of the ordinary appears (and they do with regular monotony), most notable being **VK9CCT** (Cocos), **FB8ZO** (Amsterdam Island) CW, **HK0BKX** (San Andres) CW, **F08GM**, **VK2GX** (Wallis).

### 15 Metres:

If the woodpecker would leave it in peace we could take advantage of the good propagation, excellent openings into Africa and Europe (long path). **7P8BJ**, **CR9A**, **XT2AW** are worth a particular mention.

### 10 Metres:

Despite predictions that the peak had been reached in cycle 21, a renewed upsurge in solar activity could possibly herald a "double peak" cycle as has occurred in the past. Don't write this band off just yet, conditions are certainly better than this

time last year, so for those still chasing single band WAZ or DXCC the outlook remains bright.

On CW **A7XE**, **5B4HF** and **CT2ON** have been making their presence felt whilst on phone. **VE6EP/4U** (YK Syria) has by now returned to Canada and will be sorely missed from the band. Also heard/worked during the month **YS9RYE**, **A7DX**, **HK0GY**, **NP4HW**, **4B4MDX**, **OH2AP/OJ0**, **K5YY/KS6**, **TA1MB**, **ZK2YY**, **6O0DX**, **9Y4JW** and **9X5PP** (for those that need this one, Peter is active most Sundays from around 8.00Z around 28.585).

That's it for this month, now here are some QTHs you may have missed —

- VK9CCT** — via **VK5QX**
- V56IC** — via **K2MTC**
- A22DW** — via **VK7CH**
- 5B4HF** — via **KC51**
- HK0BKX** — via **WB4QFH**
- 3D6BQ** — PO Box 14, Manzini, Swaziland
- 8Q7AV** — Four Winds, Male, Maldives Islands
- 7P8BJ** — Box 30, Maseru, Lesotho
- E6EP/4U** — via Home Call
- K5YY/KS6** — via Home Call
- TA1MB** — via PO Box 1167, Istanbul, Turkey
- F08GM** — via PO Box 3835, Papette, Tahiti
- HS4AMI** — via **VE3DPB**
- FB8ZO** — via **F6EYB**
- CR9A** — via **WBZKXA**
- FR0FO** — Box 200, Tampon, Reunion
- AP5HQ** — via **N0RR**
- 3D2BM** — Box 590, Suva, Fiji
- 5H3FW** — via **DF4TA**
- 4B4MDX** — via **XE10W**
- ZK2YY** — via **K5YY**

# FT 107 M

## THE ULTIMATE IN SOLID STATE DESIGN

Adjustable compression level for RF speech processor.

Adjustable-threshold noise blanker control.

State-of-the-art noise blanker.

Inbuilt AC power supply. (No costly outboard power supply.)

(Microphone optional extra. YM35 has up-down slow-fast scanning.)

Double-balanced diode ring mixer with carefully designed gain distribution for outstanding dynamic range.

Full metering of Vcc, Ic, ALC, compression level, and SWR.

Digital plus analog frequency display. True frequency counter eliminates recalibration when changing modes or bands.

Audio peak and notch filter for enhancement or rejection of signals.

Adjustable AGC: slow-fast-off.

Calibrator for receiver alignment purposes.

Twelve memory channels plus Digital Memory Shift (DMS) for unmatched flexibility. Memory unit optional.

12 memory banks. Each can be shifted 500 kHz from optical shopper or up-down scan buttons from mic. Like having 12 digital VFO inbuilt! Prices start from \$1150, inc. inbuilt AC supply.

Fine tuning control allows offset from memory channels.

TX, RX, or transceive frequency clarifier.

All band coverage: 160-10 metres, J/JY/WWV (RX), and two AUX bands.

Choice of SSB, CW/Wide, CW/Narrow (600 Hz filter optional), FSK, and AM.

Variable IF bandwidth, using 16 poles of crystal filtering. No need to buy expensive filters for 2.1 kHz, 1.8 kHz, 1.5 kHz, etc., to 300 Hz.

All solid state construction for instant band changes. Preset filter networks eliminate "preselector" tuning. That's more contacts in the log for you contest operators!

RF and AF gain controls on concentric shafts.

**MELBOURNE'S LEADING AUTHORIZED YAESU DISTRIBUTOR.**  
**CHIRNSIDE ELECTRONICS, 26 Edwards Road, Chirnaide Park, Lilydale, 3116. Phone (03) 726 7353**

# Cycle 21 Peaks

On November 10th, 1979, the highest daily sunspot cycle 21 was recorded. The count was 302 and it dropped to 98 on the 29th. The monthly mean was 183.3.

Recently the final numbers for 1979 were received and run as follows:

January 1979: 166.6; February: 137.5; March: 138.0; April: 101.5; May: 134.4; June: 149.5; July: 159.4; August: 142.2; September: 188.4; October: 186.2; November: 183.3; December: 176.3.

The yearly mean: 155.4.

The running smoothed mean now looks like this at April 1980:

January 1979: 123.7; February: 130.9; March: 136.5; April: 141.2; May: 147.2; June: 153.0; July: 155.1; August: 155.8; October: 156.2; September: 158.7; October: 163.1.

Up to June 1979 are final, afterwards are provisional.

Provisional monthly means for 1980 are:

January 1980: 162.2; February: 159.3; March: 126.5; April: 166.6; May: 179.7.

The running smoothed number of 163.1 made cycle 21 higher than cycle 18 whose peak of 151.8 in May 1947 ranked it as No. 3 in cycles since 1755. The only other cycle to reach 150 since 1755 was cycle 3 with a maximum of 158.5 in 1778. So it looks like cycle 21 will enter the history books.

Historically, the highest daily sunspot number recorded was 355 on December 24, 25, 1957, and the highest monthly mean was 201.3 in March 1958. The highest recorded 10.7 cm (2800 MHz Radio Noise) solar flux was 457.9 on April 7, 1947, coinciding with the central meridian passage of the largest sunspot group recorded. Measuring some 5520 millionths (millionths of the sun's hemisphere).

The highest daily solar flux reading for cycle 21 was 383, coinciding with the sunspot number of 302 on November 10th, 1979. At this stage there are no details of sunspot sizes for cycle 21.

Whilst the transition across the peak of the cycle has been in progress, the degree of geomagnetic activity has quietened considerably. Just the odd angry burst that pulls out propagation for a few days. Although there are areas of high activity on the sun, the recurring or rotational effects are not clearly showing yet. As the cycle starts to wind down then the greater bursts of geomagnetic activity will start to occur.

The period September 1980 to May 1981 should be worth watching. I have observed that when activity is on the wane, some interesting propagation effects occur, specially so on VHF when the decline is interspersed with some vigorous magnetic activity. Late September from 20-26th and 18th-23rd October, with peaks in solar flux on 11th September and 8th October. Watch the down side of these peaks to 26th September and 23rd October will be the periods to observe.

In July the solar flux peaked to 250, dropping to 128 early in August. May peaked 275, June peaked 251. Each rotation appears to be weakening slightly and by the end of 1980 it should not peak over 200.

This drop will also affect the extremely long skip observed over the past 12 months. Some of the long path activity will diminish in 1981. Ah! well, we haven't done too badly in cycle 21 so far.

73 VK3BYE.

# IONOSPHERIC PREDICTIONS

Len Poynter VK3BYE

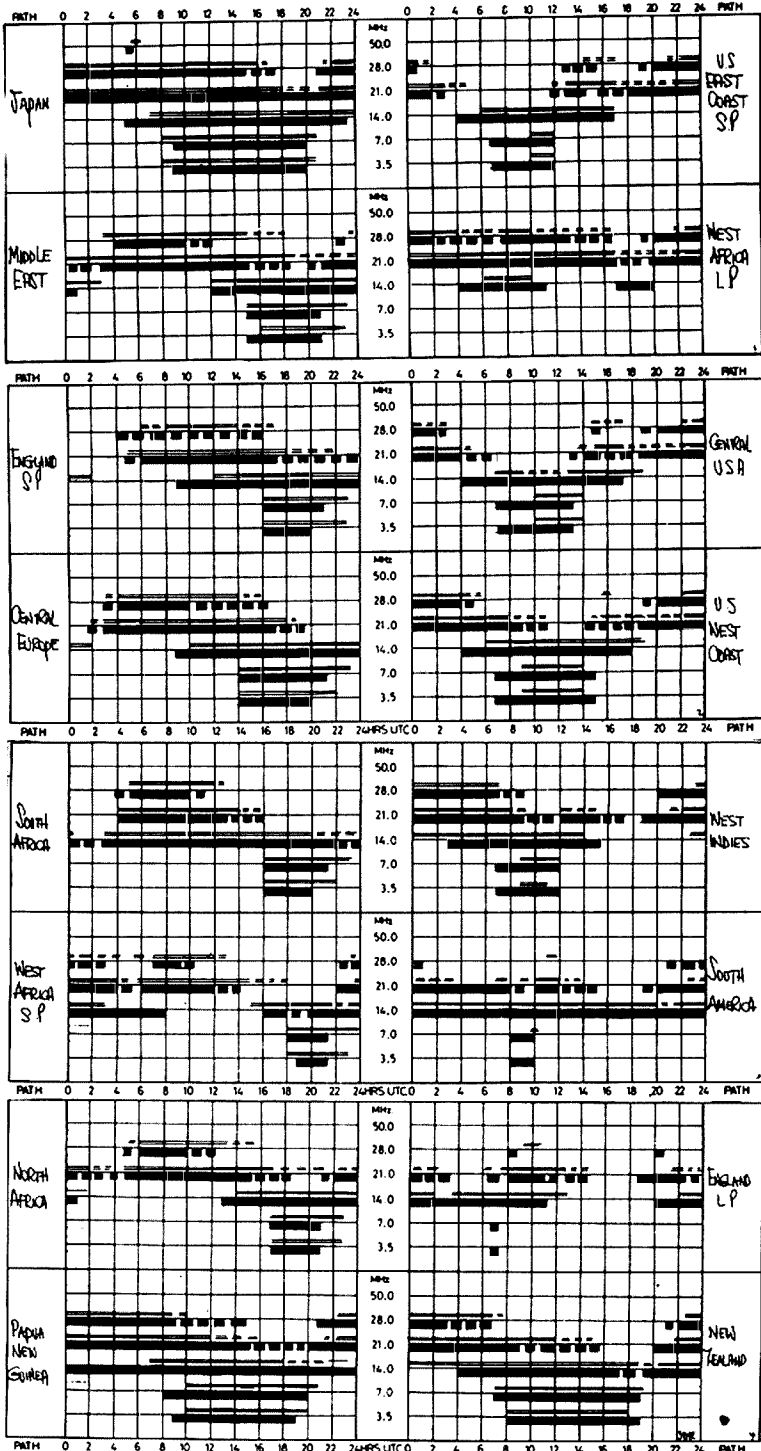

**LEGEND**  
 FROM WESTERN AUSTRALIA. (solid line)  
 FROM EASTERN AUSTRALIA (dashed line)  
 BETTER THAN 50% OF THE MONTH, BUT NOT EVERYDAY. (horizontal bars)  
 LESS THAN 50% OF THE MONTH. (vertical bars)  
 PREDICTIONS COURTESY LP.S. SYDNET.  
 ALL TIMES UNIVERSAL UTC (GMT).

BUYING OR SELLING GEAR?  
**HAMADS**  
 MAKE IT HAPPEN FAST

# LETTERS TO THE EDITOR

Any opinion expressed under this heading is the individual opinion of the writer and does not necessarily coincide with that of the publisher.

## EDITOR'S COMMENT

### A HORNET'S NEST?

Sometimes a letter in this column sparks off a flood of replies from other members.

On this occasion a letter from Jack Mellor VK3AMG, published in the July Issue, obviously has struck a nerve with some of our Novices.

Here are two of the replies received. I regret that the other letters received cannot be published due to space limitations.

At the time of printing, letters were also received from S. Lister VK3VSL, J. Thomas VK3NTR and R. McKibbin VK5NKO. All of these are commenting on the same theme as those published below.—VK3UV.

PO Box 664, Albany, WA 6330.  
14-7-80.

The Editor,  
Dear Sir,

I would like to express my appreciation for an enjoyable magazine and I look forward to each month's issue eagerly. There is, however, in the July issue a letter to the editor that I found to be disturbing and wish to reply to. I refer to Jack Mellor's (VK3AMG) letter regarding "limited tenure of two years" for novice operators.

It appears to me that Mr. Mellor's letter reeks of resentment from start to finish. His sarcastic remarks "having reached the dizzy heights of 5 w.p.m." and "that hard multiple choice paper", also the inference of running more power than legally permitted, I take exception to. The latter could be applied to full call too, however without concrete evidence of this happening, I feel the comment only further shows his resentment of the novice operator.

It would generally be agreed in this country as well as overseas, that the novice operator with his 30 watt PEP has been able to compete quite favourably with full call operators; not by running excessive power, but by plain ingenuity in building a better antennae system than Mr. Mellor has the capability to construct.

The exceptional results attained by the Australian novices and their antennae systems is world known. I personally spent six weeks working nights and weekends to build a tower to my own design that would withstand cyclonic winds if necessary. It holds two five element Yagis, one on 10 metres and one on 15 metres, with the latter having a 40 ft. boom, all of which is "home brew". I can also boast of having "knocked off" plenty of full calls in DX pile up because I did not rely on linear power to an average antennae with little directional ability. And that's how it is, Mr. Mellor, I'm just one of thousands of novices who could teach you how to get a good signal out without excessive power. I run a Kenwood TS180S with the linals removed and run off the 10 watt drive stage. I also run a Kenwood TS 120V with equal result. Frequently I have received up to 5-8 reports to Europe on both bands when the path is open and 5-9 +20 in VK regularly in good conditions. In concluding I'm quite happy as a novice and am in no hurry to move up to full call just yet.

Yours faithfully,

John Dowsett VK6NJD.

47 Russell Street, Avoca, 3467 Vic.  
14th July, 1980.

The Editor,  
Dear Sir,

I am a totally and permanently incapacitated re-patriation pensioner member of the WIA with the novice call sign VK3NWV, which I have held since 10th January, 1979. I am 68 years "young" and now derive much pleasure participating in amateur radio activities in my retirement years, notwithstanding that my physical disabilities will positively

prevent me from ever obtaining a "full call" AOCPL licence. It has become patently obvious to me that amateur radio is more than just a hobby—it is a most friendly world-wide fraternity without equal in our modern day society and I am proud to be a member.

However, I am motivated to write this letter following on a letter in Amateur Radio, July Issue, from one Jack Mellor VK3AMG, in which, apart from contemptuous aspersions he casts about novice licensees which I choose to ignore, he ventilates the question of tenure of novice licences, and I quote from his letter, "... is it possible to get the department to bring in limited tenure ...". To go on to say, and I again quote from his letter, "... most full call blokes (self included) are appliance operators these days ...".

This appears to suggest that not only should the novice licences be of limited tenure but possibly the full call operators should be required to periodically pass a full call examination and failing this, then sit for that "hard" multiple choice paper with "the dizzy heights of 5 w.p.m." to even retain a novice licence.

As this requires a statement of policy by the WIA I brought this matter up during the "call back" session of the WIA weekly broadcast on Sunday, 13th July, and hopefully look forward to a resolution therefrom.

In the meantime, may I suggest to Mr. Jack Mellor VK3AGM at Yarram, that if he does not like the company he meets on the bands and frequencies available to novice licensees—then the obvious thing to do is operate only on the extensive bands and frequencies NOT available to novice licensees—and if he can—then find operators to talk to who think like he does. I suggest he will be very lonely and I can only say how sorry I feel for him; but in my opinion his loss will be the ultimate gain of the amateur radio fraternity.

Yours sincerely,

Alan Stubberty VK3NWV.

Salvado College, New Norcia 6509.  
20th June, 1980.

The Editor,  
Dear Sir,

With reference to the "Letter to the Editor" in Amateur Radio, June 1980, about the Maritime Distress, I feel I need to voice what needs to be brought to the attention of many people.

I am sorry to say, but the White Wave Incident was a terrible example of emergency communication. There was far too much QRM from stations, either unaware of the situation or just too uncertain as what to do in the case of such an emergency.

It is obvious, and Mr. Ashton has made it quite clear in his article, that many maritime stations use amateur frequencies, many of them in the HF spectrum and that the need for a good clear net of emergency frequencies is more than obvious.

I feel, and I'm sure Dick like many other operators must, that something needs to be done about acquiring such a net frequency, if not one net per band, in the HF sector.

The bands most affected are the 15m and the 20m band. We have a responsible hobby so I ask all operators to take note of full emergency procedures and if anyone would like to talk about and expand the ideas of the emergency frequencies, I ask you to contact Richard Ashton, PO Box 11, Woomera, SA 5720 (SASE please), who is more than happy to oblige.

Vy 73 E. Greenfield VK6NIE.

The Editor,  
Dear Sir,

The two-way SSB QSO on 3535 kHz was a deliberate effort to gain attention to the fact that the gentlemen's agreement for the most part is being observed but that many VK novice and full calls are operating on SSB below 3550 kHz.

The novice band plan lists 3535 up for SSB as per VK Call Book, page 24, so I was operating in accordance with the band plan proposed by the WIA, which is absolute rubbish and conflicts with international band plan of SSB above 3550 and CW only below this frequency.

AR might join us in publicising the gentlemen's agreement as used world-wide. (Some Region 1 areas prohibit SSB below 3600.)

With the decline in solar activity 80 metres will become alive with international DX, abuse of the 25 kHz DX window from 3525 to 3550 will prevent two-way contacts being made. The US general class will have similar restrictions to the VK novice, in that he is restricted to CW and to frequencies above 3525.

With the WIA CW broadcast on 3550 and allowing at least a 5 kHz guard band, this leaves a whole 20 kHz for all the VK novices to work USA on CW, not to mention the VK full calls and ZLs who need these contacts.

I hope my S9 plus SSB signal smack in the middle of the band illustrates what would happen if we complied with near-sighted locally produced WIA band plans?

I suggest the WIA rescind the 3535 up SSB allocation as set out in their DX band plan and support a CW only segment of 3525 to 3550 with SSB to start with a guard band above 3550 kHz.

P.S.: I broke in on the contact with VK2BKE and VK4NOI which had been going for over half an hour.

73 Steve Gregory VK3OT.

PO Box 59, Atherton, NQ 4883.  
11th July, 1980.

The Editor,  
Dear Sir,

It was a shock to me to read of Max Howden's passing. I met him for the first time in 1929, when on my way with Al Traeger to Cloncurry to set up the first full time radio base for the AIM's Flying Doctor's radio base.

In those days he was the true pioneer of crystal cutting, which he devoted to a very high degree; also he did a lot of early experimental work in the VHF bands; always helpful to all who asked him; in latter years I lost track of him; there were a few occasions when we still talked over the air.

I have very vivid recollections of that first night we spent having dinner, where he insisted that I carve the joint??

To his family I wish to convey my deepest sympathy to this passing of a "grand old man and pioneer in radio", and trust that you will find space in the next issue of AR.

Very sincerely yours,

Harry C. Kinzbrunner VK4HK (originally VK5HK 1928).

25th June, 1980.

The Editor,  
Dear Sir,

I am sending you herewith a copy of a letter I wrote to Colin Yates, the author of the "SPREADING" letter to the Editor in the June 1980 issue of AR.

The man is completely wrong, waves with big words of technically and scientifically justified checking methods, reducing the sensitivity of his receiver to a point where he can hardly hear anything at all. Please publish my letter to him, you probably will get more similar comments from others.

73 Arie Bles VK2AVA.

"Colin Yates VK2AGZ,  
Charleston.

Arie Bles VK2AVA,  
Springwood.  
22nd June, 1980.

Dear Colin,

Belonging to the much outspoken 3695 kHz fraternity and aware of your communications with Bill Dukes VK2WD, myself having been involved in trying to convince Les VK5LC that he was always overdriving his equipment and spreading over more than his fair share of the frequency spectrum entitled to, I just have to write you about your "SPREADING" letter to the Editor in AR.

You should know me and my not entirely limited experience in amateur matters, having availed of more equipment than many others due to my position, it may be beyond reasonable doubt that if I feel I need to tell someone that he is spreading or having a broad signal, I do have the equipment to determine that and insight how to use it.

Although not yet possessing a spectrum analyser, am still trying to acquire one without having to spend a fortune on it, I can safely determine the width of signals I receive. Testing my monitoring on some of my own transmissions with various types of sets by loading them into dummy loads and with proper shielding able to observe fair and average strengths signals, I have proof that my methods of observation without claiming unspecified scientifically correct methods, you should specify what you mean by that, are showing results.

I can observe test transmissions that way that produce S-9 signals, far from overloading the receiving gear front ends, and ascertain that with good equipment and staying away from non-linear operations, I hear next to nothing on the opposite sideband, showing good desirable sideband rejection and no spurious transmissions. It is my habit to test any new gear that I procure this way and not all do pass these tests. Subsequently, if I receive an amateur's transmission on the air and know that the strength of reception is not such that front end overload on reception can occur, I should be able to expect that if on a clear part of the band, I should not hear much of his transmissions on the opposite sideband, leaving my receiver at full sensitivity, no nonsense with gain and AGC reduction and fiddling, that is a normal test. If I conclude that the transmission is a clean one with my fairly well trained hearing, I can expect that and can prove it time and again on such clean signals, VK6MK Tom Mulder using clean Collins equipment without overdriving or speech processing gives me the proof time and again. No need to tune away from his sideband, up in frequency if he is on USB, or changing sidebands without frequency change, impossible with YAESU MUSEN gear, but if done and assuring that the receiver is not front end overloaded, the transmission will not take up more than just 3 kHz USB and be next to inaudible on LSB.

73 Arle Bles.

22 Rislly Avenue, Royal Park, SA 5014.  
6th June, 1980.

The Editor,  
Dear Sir,

May 1, through the columns of AR, ask the award committees of radio clubs to consider the VHF operator when formulating the rules for their awards?

It is easy to see why there is little interest in awards from those who, from choice or necessity, operate VHF, when some of the rules extend to

outright discrimination! The type to which I refer are those requiring a contact with a club station which has no equipment for operating VHF.

I realise that it is hard to make the rules perfectly equal for everyone, but it is obvious that many award committees do not appreciate the problems of the VHF operator. I have found, on writing to various clubs, that there is little willingness to understand. The standard answer is that those are the rules, if you don't like them it is bad luck, but the rules cannot be modified. I must point out that not all clubs are so bad, but even they won't consider any modifications to the rules. One club in northern Queensland requires six contacts, one being the club station. So far I have eleven contacts, but have not worked the club station, so I have not qualified for the award!

The "Elizabeth Award" (Elizabeth, SA) would be a good example of suitable rules. It requires eight points. The club station is worth two points, members are worth one point on HF, or two points on VHF.

I realise that some awards will not fit in with my suggestions, such as the "Australian Commonwealth Electorates" Award, but those are long term projects anyway. The basic award can be obtained with a little effort, even if the final stage cannot. As evidence, I have my ACE award endorsed for fifty electorates, and need only one more for the seventy-five endorsement. I doubt that I shall ever achieve the full one hundred and twenty-five on six metres, but I shall enjoy trying.

In closing, I would ask that award committees spare a thought for the VHF operator. The best way would probably be to have a keen VHF OXer on the committee. I am not asking that the awards be made too easy, just that it should be possible to get them.

Yours faithfully,

R. W. Pitcher VK5ZGZ.

**JOIN**

**WICEN**

**WIRELESS INSTITUTE CIVIL**

**EMERGENCY NETWORK**

providing a pool of trained, licensed operators, with equipment, available for deployment to aid communications in an emergency.

## WICEN

R. G. HENDERSON,  
Federal WICEN Co-ordinator,  
171 Kingsford Smith Drive,  
Melba, A.C.T. 2615.

### CHANGE OF ADDRESS

Readers are advised of a change of address and telephone number for the Federal WICEN Co-ordinator. The new address is:

171 Kingsford Smith Drive, Melba, ACT 2615.  
Home telephone (062) 58 7904.

### THE FUTURE OF WICEN

In my report to the last Federal Convention and in a Federal tale recently I made mention of the future of WICEN. Nowadays most of our potential clients have communications networks capable of providing a service equal to our repeater VHF systems. However they do have problems in attracting trained operators, and users skilled in getting the most out of such systems, particularly when emergencies strike. Loss of mains power, or Telecom bearers, floods or fires are examples of these circumstances and it is then that the trained WICEN amateur can contribute, with advice, and with his back-up VHF systems. We achieve a great degree of flexibility because we can operate independent of mains power and in field or makeshift situations.

I also said that such requests for assistance will invariably come after the emergency has arisen and often after existing services have collapsed or are nearing that state. Hence we must be ever prepared for the emergency that only rarely happens. The challenge then is to keep up the interest of members in these circumstances, by exercises both in civic aid circumstances and in local SES situations.

### JOTA

The Jamboree of the Air (JOTA) affords WICEN groups an opportunity to practice their field deployments. Why not get your WICEN group to support a local Scout group by setting up a field or portable station? It will allow you to check your equipment load lists, field antennas and power supplies (KVAs). Can you move into a site and be on the air in less than an hour? Treat it as a test and a challenge.

## The Intruder Watch

Some edited thoughts from correspondence with our Intruder Watch personality, K6KA, by Alf VK3LC.

The following treatise is a resume of thoughts as gleaned over the years from our contemporary in the USA, Bill K6KA.

He says — "In summarising Intruder Watch reports we find that Finland is number one in volume of reports, followed by the USA (about five times as many as the next), then Switzerland, Britain, New Zealand, West Germany, Barbados and Australia, followed by five other countries with less than 40 reports monthly. The total result is a very respectable world-wide coverage, capable of solving many intruder problems . . .

"Results in eliminating intruders tend to concentrate on those countries with adequate Government Monitoring Systems, and willingness to follow International procedures for reporting intruders to the source countries, which encourage Intruder Watch International networks weekly to get support from the countries most able or willing to confirm the monitoring, and take diplomatic action or action supported by ITU methods. In addition, some Intruder Watchers have a demonstrated ability to locate unofficial channels to reach someone at the intruding stations to obtain improvement in equipment to eliminate the reported problem . . .

"Often people think that spurious emissions are temporary and not worth the trouble, but experience proves otherwise. Some have as many as 25 in-band spurious signals which is a really important interference problem. Once K6KA counted 80 per cent of USSR source, 10 per cent from the People's Republic of Red China and the other 10 per cent widely and thinly distributed for a very wide range of causes or reasons."

To digress from K6KA's dialogue, the following account may interest readers: In June ZL1BAD, our New Zealand Co-ordinator, reported a very strong spurious signal on 14120 kHz signing "AXM32/34/37", a RTTY and facsimile signal. AXM is located in Canberra, so on being alerted we immediately got in touch with the PTD here in Melbourne and reported the phenomena. A few days later a telephone call was received by our Administrative Secretary from a high official at PTD to the effect that the spurious had been traced and eliminated. Now ZL1BAD reports that the signal on 14120 kHz is no longer there.

To continue with K6KA's remarks — "Radio communications weekly have proved very helpful, often curing problems or locating them, then finding a solution. VK3LC/ZL1BAD/K6KA schedules started some 10 years ago, VK3LC/G5XB possibly three years. One item reported in Australia got attention, and Voice of America located the trouble and corrected it within several weeks, without any official Government involvement, and there are many other similar cases . . .

"In the USSR I found on several trips that documents and correspondence in general never reached the intended engineer, though certain individuals were permitted to go to engineering libraries. I feel that USSR violations are largely due to the fact that nobody knows about treaties, and nobody has any orders to comply with such. For instance, for decades USSR has been using the audio from the Regional MAYAK second programme of Radio Moscow modulated up to about 500 per cent to blot out any Russian language from any Chinese station. One country's monitoring system thought they could embarrass the USSR by suggesting that there was a spurious being received. The USSR reply was 'We did not have any transmitter on that frequency at that time'. Oh yeah? With DF now down to a fraction of a degree error, and multiple stations confirming the fix, it is not very likely that the objecting country had spotted the source of QRM in the wrong country!"

And so goes on K6KA's dialogue, very interesting and thought provoking. The Intruder Watch does very important work, as you can see. Would you like to join the few dedicated amateurs doing that work? Our Federal Co-ordinator and Divisional Co-ordinators would like to hear from you. An IW sked is kept every Thursday evening at 1030Z (8.30 EAST) on 3540 kHz, why not join us? See you there!

ALF CHANDLER VK3LC,  
Region 3 IC Co-ordinator

**IF  
YOU'RE  
NOT  
BUYING  
AMATEUR  
RADIO  
ACTION**



**(IT'S AUSTRALIA'S BEST  
SELLING AMATEUR MAGAZINE)**

**THEN  
YOU'RE NOT  
KEEPING  
UP WITH  
THE LATEST  
NEWS, VIEWS  
AND REVIEWS**

Please put me down for 12 editions of Amateur Radio Action, starting NOW!

**Rates in Australia - \$14.40 Surface mail overseas - \$18.40 Air mail: To New Zealand - \$A28.70; Malaysia - \$A32.60; Japan - \$A38.45; USA - \$A42.35; UK - \$A46.25**

Herewith enclosed cheque/postal note/money order to the value of:

\$A.....

Name.....

Address.....

Postcode.....

Post to: Amateur Radio Action Subscriptions, Box 628E, Melbourne 3001.

**ALARA**

AUSTRALIAN LADIES' AMATEUR RADIO ASSOCIATION

**NEWS FROM VK YL  
CAMEO OF JOAN VK3BJB**

Last month, while on a business trip to Mildura, I had the good fortune to meet Joan VK3BJB. Early one morning Joan whisked me away from the hotel, gave me a tour of the Mildura district, and invited me into her home. I must say that the tales of country hospitality are true.

Joan is a busy woman with two children and husband to care for. Her interest in radio began just prior to 1971 when OM Ray decided he wanted to get his licence. They studied together, although Joan had no intention of sitting for the exam until the last moment. "It was the furthest thing from my mind," she said, while reflecting on those days. At that time, there were only three or four amateurs in the area, so most of their knowledge was gleaned from textbooks. The CW was easier because they received help by practising with an amateur who worked at the airport. In 1971 they received their tickets and Joan became the first YL outside the metropolitan district with a full call.

Many aspects of amateur radio interest Joan. She takes part in contests and has a fair number of awards to her credit, e.g. from the US, New Zealand, Venezuela, and American Samoa. Joan also operates QRPp with 1 to 2 watts output.

Working DX, however, is her favourite. "I would like to retire and work DX all day," mused Joan. She prefers two or three long chats to several short QSOs. Because she operates regularly on particular frequencies, she has gotten to know other amateurs quite well. Look for Joan during the day at 28.47 MHz.

One time she was not able to go on air for a stretch of three weeks. As a result, she received phone calls from amateurs overseas who inquired about her health. She even received birthday greetings from an amateur in Japan whom she had contacted many times. Although the man asked only for Mrs. Joan, the operator was able to place the call due to the household's history of overseas phone calls.

The activity which occupies her time, and Ray's, the most is the building of a new shack/workshop. It has two large rooms with good lighting and power points installed at workbench level. The antenna, a TH6DXX, is nearby on a new tower. The entire complex will be ideal when completed.

ALARA's Victorian Division has applied for and received a club licence with the call VK3BWW (Beautiful Women of Victoria). The call will be used to help novices with their operating procedures and to participate in fox hunts and other contests.

Maggie VK3NQQ is the first YL to become a member of the VK CW QRPp Club.

The first ALARA award has been posted to Diana G4EZI. Diana's enthusiasm in amateur radio is becoming well known. She is the creator of YL Activity Day.

Austine VK3YL is the first VK recipient of the award. She was feted last June by the WIA for her 50 years in amateur radio. Congratulations, Austine!

YLs interested in radio are welcome to join ALARA. For information, please contact Oaurel VK3ANL, Box 110, Blackburn, Victoria 3130. ■

**AMATEUR OPERATOR'S  
HANDBOOK  
LATEST EDITION  
MAGPUBS  
P.O. Box 150, Toorak, Vic. 3142  
NO AMATEUR STATION SHOULD  
BE WITHOUT ONE.**

**AWARDS**

**COLUMN**

Bill Verrall VK5WV  
7 Lilac Avenue, Flinders Park, SA 5025

Here is a list of WIA Awards issued during the period 1st January, 1980, to 30th June, 1980, and the top DXCC tallies, new members and amendments at 30th June, 1980.

**WAVKCA AWARD**

Cert. No.	Call Sign	Cert. No.	Call Sign
790	JA2LFG	828	K6SMF
791	JH3KAI	829	JA4FCC
792	JA7GLB	830	JH1LBR
793	JA2WGD	831	I1HAG
794	JH1IFS	832	JA4GXS
795	CO2OM	833	JL1BDI
796	SM5BBC	834	JE1BDC
797	JH6VLL	835	JA7DOT
798	JH1HKQ	836	JR3RLJ
799	JA6AS	837	JA9FAI
800	JA7BAL	838	JE2KUC
801	LA7AH	839	JE2GTZ
802	PA0JFH	840	JR1FCT
803	DM2CDL	841	PA0PCA
804	JA7RPC	842	JA7AXB
805	JA4AEZ	843	JA6GWU
806	JA7EPO	844	JR6RRD
807	G8PX	845	JE2ARR
808	LA7JO	846	IV3YRN
809	G2AMV	847	UK0LAK
810	JF3LBD	848	JA1UZQ
811	JA9AQE	849	P29GC
812	JH7FNM	850	JA3EUB
813	JH3JEX	851	JH7OSR
814	PA0KB	852	VE6CKW
815	UA9AAX	853	DM3EA
816	UA0OV	854	9M2RR
817	UR2QD	855	HM1QD
818	U0SPK	856	VE6CJO

**THE VK3BWW  
FORMULA FOR  
DX SUCCESS!!**

**HIGH QUALITY  
AT LOW COST**

**BEAMS**

3 EL 10 & 11m	.....	\$66.00
3 EL 15m	.....	\$73.00
3 EL 20m	.....	\$145.00
6 EL 6m	.....	\$102.00

**DUOBANDER**

3 EL 10m, 3 EL 15m \$135.00

Prices include Gamma match

Our beams are easy to assemble and adjust. Entirely **NEW CONCEPT** — **NO NUTS OR BOLTS.**

Spare parts, elements, booms and gamma matches available.

For further information  
**PLEASE RING (03) 366 7042**  
**VK3BWW**  
**WERNER & G. WULF**  
92 LEONARD AVENUE  
ST. ALBANS, VICTORIA 3021



819	UD6HB	857	ZL2BDF
820	UK7LAH	858	K5OGX
821	UA9MS	859	SV1EX
822	UW3IN	860	JA7FLI
823	UP2BCS	861	JA2NKL
824	JA3OCD	862	ZL2AUP
825	JA4BBN	863	WQ8BA
826	JA2AE	864	WD8EMI
827	JA7ZF		

**WAS (VHF) AWARD**

<b>Cert. No.</b>	<b>Call Sign</b>
128 (amendment)	VK3AWY plus 9 additional countries
132	JA2DDN

**NOTE**  
I congratulate "Hiddy" JA2DDN on obtaining this very difficult award for an overseas operator. He submitted QSL cards for 6 metre contacts with the following Australian operators: VK1RK, VK2YDY, VK3OT, VK4ADA, VK5LP, VK6BV, VK7ZAH and VK8AZ.

**VHFCC AWARD**

<b>Cert. No.</b>	<b>Call Sign</b>
103 (144 MHz)	VK4ZEZ
104 (144 MHz)	VK3ZYX

**HAVKCA (SWL) AWARD**

<b>Cert. No.</b>	<b>Call Sign</b>
46	VK3-13062, Maurie Batt
47	ZL2211, B. S. Stupples
46	LS0405, Charles Branch

**OXCC — TOP LISTINGS**

<b>PHONE</b>			
VK6RU	318/362	3JF	297/308
6MS	318/359	7DK	295/309
4KS	317/348	AHO	294/326
6MK	313/349	3AMK	294/302
5AB	308/338	2APK	293/313
4FJ	307/343	4UC	293/306
6LK	303/316	4PX	291/306
7LZ	299/315	5WV	289/300
4VC	299/309	3AKK	287/288
4RF	298/307	4AK	282/290

<b>CW</b>			
VK2EO	309/346	6RU	258/297
2OL	306/344	3RJ	251/277
3YL	303/334	3TL	241/260
4FJ	302/344	3KS	235/254
3AHQ	299/331	3JF	214/228
2APK	283/304	7LZ	207/237
3YD	281/313	4DO	204/228
4RF	274/294	5RX	202/231
3XB	272/300	4SD	186/206
3NC	261/297	4UC	171/178

<b>OPEN</b>			
VK6RU	318/362	4PX	298/317
4KS	317/352	4UC	296/310
4SD	317/348	7DK	296/310
3YL	314/345	3AHO	294/326
4FJ	313/356	3AMK	294/302
6MK	313/349	2SG	293/311
4RF	306/329	4AK	282/291
3JF	306/325	2AHH	279/305
7LZ	301/332	4DP	279/287
2APK	301/329	3XB	278/306

**DXCC — NEW MEMBERS**

<b>PHONE</b>		
<b>Cert. No.</b>	<b>Call Sign</b>	<b>Tally</b>
205	VK6NEP	138/139
206	VK2VAB	154/155
207	VK3NLS	116/117
208	VK3NNR	111/112
209	VK3VDP	107/108
210	VK3NNY	157/158
211	VK2VAO	160/161
212	VK3NOA	106/107
213	VK7AE	275/276
214	VK4BG	232/242
215	VK6PS	115/116
216	VK6PY	103
217	VK3AWY	157/158
218	VK4AOK	115/116
219	VK3BLN	103/104
220	VK2VC	104/105
221	VK6NAT	101
222	VK6NEY	101
223	VK3NOL	128/129
224	VK3VGD	104/105

225	VK1NAV	103
226	VK6RG	101/102
227	VK4NVW	106
228	VK4DP	255/260
229	VK3NSY	100
230	VK1JN	103
231	VK2NRT	99/100

<b>CW</b>		
106	VK3BMJ	105
107	VK7RO	103/104
108	VK7BC	114/115
109	VK3NNY	112/113
110	VK6IE	100
111	VK4DP	167/173

<b>OPEN</b>		
176	VK3VDP	109/110
179	VK3NNY	200/201
180	VK3NOA	109/110
181	VK3YF	96/101
182	VK6PS	116/117
183	VK6PY	143/145
184	VK5NKP	100
185	VK3BLN	105/106
186	VK7DK	296/310
187	VK4DP	279/287

**DXCC COUNTRIES CONFIRMED ON RTTY**  
VK5RY — Tally 75, VK5WV — Tally 35.

**DXCC AMENDMENTS**

<b>PHONE</b>			
VK2FD	151/152	3NDY	205/206
2AHH	271/293	4BG	232/242
2NQL	145/146	4SD	132/143
3DS	152/158	4AWR	152/153
3DU	224/225	5XN	271/284
3GB	201/219	5OU	205/206
3OT	264/265	6FS	259/260
3RF	233/235	6HE	281/284
3ABH	252/253	6YL	206
3AHG	129/132	7BC	257/259
3BRM	201/202		

<b>CW</b>			
VK3ABH	136/142	6PY	112/114
4KS	127/128		

<b>OPEN</b>			
VK2NOG	121/122	4BG	247/260
3ABH	260/266	7BC	275/278
3NDY	208/209		

The item which appeared on page 16 of May 1980 AR under the heading "QSP" is worth a comment. The small number of VKs appearing in the ARRL DXCC listings over 300 confirmed does not surprise me because many operators, including myself, are just not interested for many and varied reasons. Perhaps if the ARRL nominated a check point within VK for processing of QSL cards (as is the case for all "CQ" awards), there would be more interest from VKs.

We now have a situation where, unfortunately, direct QSLing is the accepted practice to obtain QSL cards from rare overseas countries. If you tally up the cost of a card, envelopes, IRCs, postage, etc., you will find that each direct QSL received represents an investment of approximately \$2. I am not prepared to risk this kind of investment in the overseas postal system.

On the other hand, there are some VKs who are not interested in any DXCC listings. I personally know two VK5s who each have over 300 countries confirmed who are not and do not intend to apply for membership of any DXCC award.

Good hunting.

# CONTESTS

Wally Watkins VK2DEW  
Box 1065, Orange 2800

<b>September:</b>	
7	LZ DX CONTEST CW ONLY
13/14	2nd IARU INTERNATIONAL 10 METRES CONTEST
13/14	EUROPEAN PHONE CONTEST
20/21	22nd SCANDINAVIAN CW CONTEST
27/28	22nd SCANDINAVIAN PHONE CONTEST
27/28	AUSTRALIAN NOVICE CONTEST
27/28	ITALIAN YLRC "ELLETTA MARCONI"

<b>October:</b>	
4/5	VK/ZL/OCEANIA PHONE CONTEST
11/12	VK/ZL/OCEANIA CW CONTEST
18/19	CARTG RTTY*
18/19	JAMBOREE ON THE AIR
25/26	CQ WW DX PHONE CONTEST

<b>November:</b>	
1/2	I DIPLOMA "GRAN CANARIA PERLA DEL ATLANTICO"
8/9	EUROPEAN RTTY*
8/9	INTERNATIONAL POLICE CONTEST
9	CZECHOSLOVAKIAN CONTEST
29/30	CQ WW DX CW CONTEST

<b>December/January:</b>	
6 December to 11 January 1981	
ROSS HULL MEMORIAL CONTEST (VHF ONLY)	

\* Rules for these contests from VK2SG or VK2EG QTHR SASE PSE.

BOQUET — 21st SCANDINAVIAN ACTIVITY CONTEST:

Plaque winner — OCEANIA, CW — VK4QK, Phone — VK4QK.

**CONTEST CHAMPION TROPHY 1979 — FIRST AWARD**

Winner with 26 points — VK3XB.  
Second with 24 points — VK3AEW.  
Third with 20 points — VK5QX.

The 1980 contest champion trophy will be decided on these contests:

- 1980 John Moyle Memorial Field Day.
- 1980 VK/ZL Oceania Contest.
- 1980 Australian Novice Contest.
- 1980/81 Ross Hull Memorial Contest.

This is an individual effort and can only be won by a member of the Wireless Institute of Australia.

**SCANDINAVIAN ACTIVITY CONTEST 1980 GENERAL RULES FOR NON-SCANDINAVIANS**

**1. OBJECT**

To encourage activity on the part of Scandinavian and non-Scandinavian amateurs to work each other and to promote communication skills between amateur stations world-wide. For the purpose of the contest, non-Scandinavian stations will try to work as many Scandinavian stations as possible.

Scandinavian stations are defined by prefixes as follows: LA/LB/LG/LJ (Norway), JW (Svalbard and Bear Is.), JX (Jan Mayen), OF/OG/OH/OI (Finland), OHO (Alan Is.), OJO (Markel Reef), OX (Greenland), DY (Faeroe Is.), OZ (Denmark), SJ/SK/SL/SM (Sweden) and TF (Iceland). Not all of these prefixes are geographically located in Scandinavia, but are considered Scandinavian for the purpose of this contest.

**2. DATES AND CONTEST PERIOD**

CW: Third full weekend in September. PHONE: Fourth full weekend in September. Starts 1500 UTC Saturday and ends 1800 UTC Sunday.

**3. CONTEST CALL**

CQ SAC on CW and CQ SCANDINAVIA on PHONE.

**4. BANDS**

3.5, 7, 14, 21, 28 MHz may be used, but only within the following sub-bands:

<b>CW</b>	
3505-3575,	7005-7040, 14010-14075, 21010-21120, 28010-28125.

<b>PHONE</b>	
3500-3650,	3700-3790, 7050-7100, 14150-14300, 21200-21350, 28400-28700.

Region 2 and 3 stations may also transmit on their frequencies above 3795 and 7100.

**5. CATEGORIES**

- (a) Single Op./Single Tx — all band only.  
Single Operator: One person performs all operating, logging and spotting functions. The use of spotting nets or any other form of alerting assistance is not allowed in this category.
- (b) Multi-Op./Single Tx — all band only.  
Only one signal allowed at any one time on any band. The station must remain on the band for at least 10 minutes following initial transmission on that band after band change.
- (c) Multi-Op./Multi-Tx.  
No limit to transmitters, but only one signal per band allowed.  
CLUB STATIONS may work only Multi/Single or Multi/Multi.

## 6. STATION DEFINITION

All transmitters and all receivers, including spotting equipment for a station using one and the same call sign must be located within a 160 metre/500 feet radius.

## 7. CONTEST EXCHANGE

Consists of RS(T) plus a serial number, starting from 001, e.g. (59/9)001. QSOs after 99 are numbered 1000, 1001, etc. Multi-Op/Multi-Tx stations use separate serial numbers, starting from 001 on each band.

The same station may be worked once on each band. Only CW-CW and PHON-PHONE QSOs are valid.

## 8. QSO POINTS

Two-way QSO with sent and received exchange counts for QSO points.

European stations credit their logs with one (1) point for every Scandinavian QSO on any band.

Non-European stations (OX) credit their logs with one (1) point for every complete Scandinavian QSO on 14, 21 and 28 MHz and with three (3) points for such contacts on 3.5 and 7 MHz.

## 9. MULTIPLIERS

Two-way QSO is valid for multiplier credit if complete contest exchange is sent and at least RS(T) is received.

Worked Scandinavian CALL AREAS may be claimed for multiplier credit (LA1 equals LB1 equals LJ1 and SM3 equals SK3 equals SL3, etc.). Portable stations without district number count for the 10th call area, e.g. W4XXX/OZ counts for OZ0 and G3XYZ/LA counts for LA0. OH0 and OJ0 are separate call areas. SJ9 counts for the 9th call area in Sweden.

Each multiplier shall not be credited more than once per band. If serial number is not received, OSO counts for zero (0) points.

## 10. SCORING

Multiply all OSO points by the sum of all multipliers worked on each band.

## 11. LOG INSTRUCTIONS

Signed original logs (or copies of original logs) must be submitted separately for CW and PHONE. Logs to be filled out in the following order: date and time (UTC), station worked, sent and received exchange, band, multipliers (e.g. OZ4, SM3, OH0, etc.) and points.

## SUMMARY SHEET

All entrants must submit a summary sheet showing station call sign, category, name of operator(s) and address. Indicate number of QSOs per band less duplicates, number of multipliers per band, QSO points per band and final score.

## MULTIPLIER SHEET

All entrants must submit a multiplier sheet for each band with more than 200 QSOs.

## DUPLICATE QSO SHEET

Possible duplicate QSOs must be shown in the log and counted for zero (0) points. Each entrant shall submit a duplicate QSO sheet for each band with more than 200 QSOs. Duplicate sheet to contain worked stations listed, e.g. by DXCC countries and call areas.

## 12. DEADLINE

Logs and accompanying sheets, addressed to: SSA Contest Manager, Peter Arninge SMOGMZ, Igeldammgatan 18, S-112 49 Stockholm, Sweden, shall be mailed no later than October 15, 1980.

## 13. CERTIFICATES AND PLAQUES

Top scorer in each country as well as in each US call district, in each category both on CW and PHONE, will receive a Contest Award, provided a reasonable score is made. Depending on the number of entrants from each country, the award of additional certificates will be considered by the Contest Committee.

Top scoring Single Op. stations in each continent will receive a Contest Plaque both on CW and PHONE, providing a reasonable score is made.

## 14. DISQUALIFICATION AND SCORE REDUCTION

Violation of Amateur Radio regulations applicable in the country of the contestant or of the rules of this Contest, unsportsmanlike conduct and the taking of credit for unverifiable OSOs or multi-

pliers may lead to disqualification. A log showing more than one (1) per cent unremoved duplicate QSOs results in unconditional disqualification. Each unremoved duplicate QSO found by the Contest Committee results in a penalty of five (5) OSOs of the same value as the duplicate.

## 15. COMPLIANCE WITH RULES

By submitting a Contest log, the entrant agrees to abide by the rules of the Scandinavian Activity Contest and by the decisions of the Contest Committee.

The Committee's decisions are final and definite.

Next year's Contest will be arranged by NRRL, the Norwegian Radio Relay League. ■

# RESULTS OF THE 1979-80 ROSS HULL MEMORIAL CONTEST

Outright winner of the trophy is Ray Naughton VK3ATN.

## SECTION (A) TRANSMITTING PHONE

Call Sign	7 Day	48 Hour
VK2BYX	1244†	604
VK2YHU	720	316†
VK2BQN	578	284
VK2HZ	602	246
VK2YEP	238	80
VK3ATN	3320	1402
VK3YLD	1214	392†
VK3AUI	900	383
VK4DO	2242†	768
VK4ZNG	1719	724†
VK4ZTV	596	262
VK4ZCO	264	84
VK5LP	944†	442
VK6OX	422†	152

† After a score denotes a certificate winner. ■

*A Call to all holders of a*

# 'NOVICE LICENCE

Now you have joined the ranks of Amateur Radio, why not extend your activities?

## THE WIRELESS INSTITUTE OF AUSTRALIA (N.S.W. DIVISION)

conducts a Bridging Correspondence Course for the AACP and LAOCP Examinations.

**Throughout the Course, your papers are checked and commented upon to lead you to a SUCCESSFUL CONCLUSION.**

For further details write to:

**THE COURSE SUPERVISOR, W.I.A.**

**P.O. BOX 123, ST. LEONARDS, N.S.W. 2065**

# DIVISIONAL NOTES

## VK3

The Eastern Zone held their annual general meeting on 30th June, with a very pleasing attendance of over 40. The office-bearers for 1980-81 are:—

President: M. McDonald VK3ZQV.

Vice-President: E. Allchin VK3BOO.

Secretary/Treasurer: L. Mair VK3BSM.

Repeater Officer: M. McDonald VK3ZOV.

Publicity Officer: K. Feltham VK3ANY.

## VK4

At the Campbell Miles Festival in Mount Isa on the 21st of June, 1980, the Mount Isa and District Amateur Radio Group participated for the first time this year by setting up a display of radio gear and a working station. Many contacts were made in Australia and overseas, and the display seemed to create quite a bit of interest with the general public.

The photograph shows four of our active amateurs, from left to right, Jim VK4NVR, Richard VK4NOD, Denis VK4ACE, and Roger VK4ARZ. George VK4NTL/ZTM was the man behind the camera.

The display was a successful group effort involving amateurs from Mary Kathleen and Mount Isa, and it was a good advertisement for amateur radio, perhaps correcting some of the misconceptions people seem to have about our hobby. We have already booked space for next year's Festival, and look forward to an excellent effort. ■

# AROUND THE TRADE

## NEW TEN-TEC DISTRIBUTOR

The Scalar Group have moved into the amateur equipment field, having been appointed as the sole Australian agents for Ten-Tec Incorporated. Their products are advertised in this magazine.

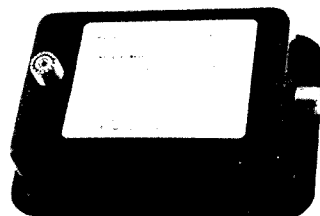

One other interesting line is the WA2ZOT "Interfilter". This low pass filter was designed by WA2ZOT because he was tired of ingress of moisture and dust into the normal filters made in "mini boxes". So he set about making a sealed unit that stays "new" inside indefinitely.

It will take all the power his rig can deliver (3600W) PEP — that's 1800 watts RF key down.

Performance was so good it was decided to produce the unit with the following specifications:—

Pass band 0-30 MHz.

2000 watts PEP.

Insertion loss 0.4 dB.

TVI rejection 70 dB.

There is a guarantee for the lifetime for the original purchaser of the WA2ZOT "Interfilter".

The unit is available through the offices of Scalar Melbourne, Sydney and Brisbane. ■

# SILENT KEYS

It is with deep regret that we record the passing of—

Dr. R. L. SMITH-ROSE, CBE  
Ex Pres. RSGB (also CCIR)

Dr. J. A. SAXTON  
Ex Pres. RSGB (also CCIR)

Mr. G. J. LEE	VK2AFL
Mr. O. E. BLYTH	VK3XW
Mr. G. SUTHERLAND	VK3VW
Mr. H. R. BROWN	VK3NN
Mr. E. J. KERKIN	VK2KL
Mr. R. D. MURRAY	VK2AAI
Mr. H. J. HATHRILL	VK2AQK
Mr. E. C. CHAMPION	VK2AVC
Mr. G. M. BOWEN	VK5CXU
Mr. R. H. LINDSAY	VK5NRZ
Mr. A. A. CHEETHAM	VK2ADB

waited until 1745, so that I would be his first QSO. His grandma had bought him his full outfit, a TS820S, VFO, ATU, P/S and key, as well as a five band vertical antenna.

Dear Tommy made not more than twenty QSOs, as soon after gaining his full licence he was unable to leave his bed. He passed away on the 27th March—just a little over three months after becoming VK4FW.

He said to me once "Ray, you keep telling people that I'm fifteen . . . and I'm sixteen now."

Bless you Tommy.

Ray Robinson VK4ACU  
Magnetic Drive, Eagle Heights, O. 4271

# OBITUARY

Mr. O. E. BLYTH VK3XW  
Oscar Blyth VK3XW. Passed away peacefully 13th July, 1980, at his home in Beaumaris, Victoria.

Oscar was born in Tasmania, came to Melbourne in 1929, joined the Melbourne "Herald" newspaper, and stayed with them until his retirement six years ago.

He received his AOCF in 1936 and was a member of the Victorian Railway Institute, VK3RI.

Oscar joined the RAAF reserve shortly after it started, and was called up for full time duty at the outbreak of World War 2. After a sojourn at Laverton he was posted to New Guinea, where he served as Signals WO at Milne Bay. Here he contracted malaria and a kidney complaint, which was his eventual downfall.

Oscar had been a member of the WIA for 45 years. He obtained a commercial operator's certificate and taught wireless to commercial operators at the Marconi School of Wireless.

Oscar will be sadly missed by his many friends.

All Chandler VK3LC.

# OBITUARY

H. R. BROWN VK3NN

We regret to announce the death of Mr. Herb Brown of Yanac. Herb had been interested in radio since 1923, when he built his first receiver, and became licensed in 1926.

Together with VK3HL (late Allan Hufchings) and VK3RH (Ivan Hodder), he operated an amateur radio station at Nhill during the East-West Air Race held in 1929. This venture was an outstanding success and they were thanked by the organiser of the air race, Captain Guy Moore.

Very interested in higher frequencies, he pioneered many 2m contacts and worked VK5 with regular skeds over a number of years.

When TV came on the scene, together with his son, Gary VK3BBL, he built a TV set with excellent results.

A keen member of WIA, he was President of a number of occasions of our zone.

Not only did he excel in radio but his home farm and grazing properties were a credit to him.

To his sons, Gary and Max, their respective families, and also Mrs. Olney, his sister, who is a keen listener on the ham bands, we offer our condolences.

Bill VK3AKW.

# TRADE HAMADS

For a very long time commercial advertising has not been accepted in AR Hamads, but as the result of discussions at the 1978 Federal Convention a decision was made to open up a "Hamads-Trade" section. The rate will be \$10 for 4 lines plus \$2 per line (or part thereof), minimum charge \$10, pre-payable. Copy is required by the first day of the month preceding publication. This will mean that in future ordinary Hamads submitted from members who are deemed to be in the general electronics retail and wholesale distributive trades should be certified as referring only to private articles not being re-sold for merchandising purposes.

# HAMADS

- Eight lines free to all WIA members. \$9 per 3 cm for non-members.
- Copy in typescript please or in block letters to P.O. Box 150, Toorak, Vic. 3142.
- Repeats may be charged at full rates.
- Closing date: 1st day of the month preceding publication. Cancellations received after about 12th of the month cannot be processed.
- OTHR means address is correct as set out in the WIA 1979 Call Book.

# FOR SALE

Yaesu FT7 HF Txcvr., little use, in original carton, etc., \$400; FL110 HF linear, \$165; FT75B HF txcvr., AC and DC power supplies, SWR bridge and antenna tuner, \$300; Koyokuto 2m FM txcvr., FM144-10SXT, fully synthesised, \$200; Kenwood hand-held KP202, incl. nicads and charger, \$125; miniscope soldering iron, \$5. VK2AOE, OTHR. Ph. (03) 449 6364.

Linear Amplifier, live band, pair 4CX250B tubes in class AB1, fully metered solid const., large free standing unit on castors. VK6EZ, QTHR. Ph. (09) 444 0397.

Yaesu FT101B Txcvr., with G3LL RF clipper, external VXO, SWR meter, mic., manuals and spare valves, perfect working order, \$550. Ray VK3RF. Ph. (03) 678 5305.

Uniden 2020 TXVR Mark II (grey case) with separate VFO and Uniden speaker, CW filter, mic., 12V lead, 12/240V supply, as new, original box, \$600; ICOM 211 2m txcvr. TXVR all mode, 12/240V supply, immaculate, \$575. John VK2BYK. Ph. (047) 21 4205 Bus., (047) 21 2822 AH.

A weekend of Amateur Radio with all the usual convention events, plus a few unique ideas for only \$5 registration. Come along and enjoy the hospitality of the west at the 28th annual SWARS Convention on the 25th and 26th of October, 1980, at Griffith. Details and programmes from the Secretary, Griffith Radio Club, PO Box 4, Griffith 2680. John VK2DFC.

Estate Late VK2AFL: Txcvr., Kenwood TS520S, complete, near new, \$450; txcvr., Swan 7 meg. mobile, MB40A, comp. with whip, \$200; rcvr., Lafayette, ham bands, HA800B, new, unused, \$200; SWR meter, Oskerblok, as new, \$50; SWR meter, Sansui, as new, \$25; antenna, Hustler trap vert., with 30 mtr. RG8, \$75; antenna, dual galy, 10m and 6m, with mast and 30 mtr. RG58, 50; quad centre spider, cast lum., new, \$15; plus copious "throw-ins". VK2CE, QTHR. Ph. (02) 871 7758 or 871 3094.

Kenwood KP202, leather case, nicads and charger, repeaters 2, 4, 6, 8 and simplex 40 and 50, \$150; Eddystone EC10 comm. Rx., 550 kHz to 30 MHz, AC or battery, plus WIA 2m pre-amp. and converter, \$120; set of 20, 40 and 80m helical mobile whips with mount and balun, \$40; ET1 induction balance metal detector, \$40; EA auto-keyer, \$20; No. 10 crystal calibrator, \$15; audio compressor (ham radio), \$15; ultra bal. 2 kW 1:1 balun, \$10. VK3AHG, OTHR. Ph. (03) 288 2024.

Power Supply, 13.8V at 5A continuous; this power supply has excellent regulation and ripple characteristics and is ideal for FT7 or similar txcvr., can be easily converted to 8A continuous by the addition of one transistor, \$39. VK1NAI, QTHR. Ph. (362) 88 2430.

Yaesu FT101E, 160-10m, latest model, modified for novice use, in excellent cond., complete with AC and DC power cords, mic., manual, and a spare set of valves, sell for \$650. Contact John Breton VK5NHB, QTHR.

# OBITUARY

TOMMY LAW VK4FW  
It's just a little over a year ago since I attended a wedding on Tamborine Mountain—about ten miles inland from the Queensland's Gold Coast.

I was taking photographs of the happy newly-wed couple, when a lady came up to me and asked me if I would take a nice picture of her son . . . Tommy. She pointed him out to me . . . a good looking lad of about fifteen, "but," she said, "don't let him know that I asked you." So diplomatically I asked him to sit down and at the same time noticed that he was walking with the aid of a stick. I couldn't quite understand why such a young chap as this had to be using a stick . . . I soon found out, he had cancer of the pelvis.

Tommy, apart from all his other interests, had a great desire to know more about radio, he had been buying books on the subject, and was beginning to talk very knowledgeably on transistors, antennas and the thousand and one items necessary in radio. I liked Tommy from the word go, and although there was a little difference in our ages that didn't really matter—I'm 63 years old—we gradually became very firm friends. Tommy told me that he would really like to obtain a ham licence but he hadn't any knowledge of the Morse code. I knew that wouldn't hold any traumas for him, so we were soon into the mysteries of the Morse code, and before many weeks were passed he was comfortably reading the required five words per minute for the Novice ticket, but Tommy being Tommy said he wasn't interested in just getting a Novice licence—he wanted the Full. So with a few heartaches and lots of enthusiasm, we plodded on until he had reached a comfortable twelve words per minute. His theory and regulations were no problem . . . so he applied to sit for his Full licence. The licensing authorities were really great, although Tommy couldn't by this time make the journey into Brisbane, an examining officer went out to Tommy's home to conduct the examination . . . and on the 3rd January, 1980, Tommy was presented with the call VK4FW . . . and what a proud Tommy that was. I arrived home from the office to a message that Tommy would call me on CW 14050 MHz at 1745. And sure enough dead on the dot . . . VK4ACU de VK4FW hw?—K, in perfect Morse. That must have been one of Tommy's proudest moments, and it certainly was one of mine. He had been given the call sign at 1015 in the morning and

**CPI FC-70** seven-digit digital frequency counter, 30 kHz to 30 MHz, suitable for novice use, \$80. Les Thurbon VK1ZKL/NBK, QTHR. Ph. (062) 88 9226.

**Belcom 70 cm Multi-mode Txcvr.**, LS 707, 430-440 MHz, continuous (VFO) with xtal cal. 10W USB, LSB, FM, CW, AM, includes pre-amp. 1.8 dB NF and 40W linear (prototype), \$600; Kenwood TR 7010 2m SSB Txcvr., \$150. VK2YEV, QTHR. Ph. (349) 49 7546. Can deliver 150 km.

**Antenna Mast**, triangular cross-section of approx. 8 in. centres, uprights of 1 in. heavy pipe and trussed with 5/8 in. solid rod, live lengths of 6 ft. bolt together to give a total height of 30 ft., sections are galvanized, factory produced — not home-made, the lot \$90. ONO. Will deliver Melbourne suburbs if necessary. Graeme Brownrigg VK3CCG. Ph. (03) 368 2369 Bus.

**Yaesu FC301** antenna tuner, mint cond., with hand book, \$185; Telonic SM2000 professional sweep generator, c/w markers, LH 1 plug-in for 0-12 MHz, SH 1 plug-in for 0-460 MHz, accessory detector and hand book, in excellent cond., ideal for aligning RX bandwidths, cavities or as a straight signal generator with accurate step attenuators, etc., \$350; Marconi circuit magnification meter, measures precise values of O, L and C over the frequency range of 15 to 180 MHz, price \$125; Teletype mod. ASR38, full ASCII machine, tractor feed, factory lifted tape punch and reader, WRU, break, duplex and RS232 interface, was recently reconditioned and in very good cond., price \$500; "Roilron" twin squirrel cage blower motor, suit high power linear, very good cond., \$30; high tension transformer, 3 secondary windings, 500-0-500, 750-0-750 and 1100-1100V AC, estimated at 500 mA continuous, 45. Contact Ian Foster VK3ST. Ph. (051) 52 4027.

**2m FM 23 ch.**, fitted with rpt. 1, 2, 3, 4, 5, 6, 7, 8, 10, simplex 40, 50, 51, only 2 yrs. old, Yaesu FT223, \$200 firm; 2m SSB Txcvr., Belcom liner 2, ex. cond., \$200 firm. Steve VK2ZSC. Ph. (02) 674 2104 after 5.30 p.m.

**Yaesu FT200/FP200 Txcvr.** plus P/S, includes FT200 club manual, 2 new 7360 bal. mod. valves, good cond., this unit in use at present time. \$350. Donald Berkeley VK2AXB, QTHR. Ph. (02) 456 1519 AH.

**Multi-Palm II 2m Hand-held Txcvr.**, xtals for rpt. 3, 4, 5, 6 and simplex 40 and 50, nicad charger and DC leaders, good cond., \$175. ONO. VK2YFI. Ph. (02) 636 9753.

**Linear Amplifier Yaesu FL-2100B**, 10-80m, uses two 572Bs, maximum legal power all HF bands, with overlap for new bands, 1.3 kilowatt input, as new, used only few hours, purchased March 1980, with manual, etc., \$395, sacrifice, John L20252, QTHR. 40 Grosvenor Street, Bondi Junction 2022, NSW. Ph. (02) 389 6455 Bus.

**FRG-7000** 0.25 kHz-30 MHz Yaesu Rx digital display, both local and GMT 24 hr clocks, \$500, ONO, or will swap for Yaesu 101E or B TX. Peter Dean L60036, QTHR. Ph. (09) 328 8147 AH.

**Amateur Radio complete** for the years 1957-present, prefer not to separate, offers. VK5BI, QTHR. Ph. (086) 45 6140 Bus., (086) 45 0023 AH, (086) 29 2076 weekends.

**10m Universe**, 15 watt PEP, 12V DC, 24 ch., 28.480-28.595, SSB, mint cond., \$80. VK2CI, QTHR. Ph. (049) 66 2231.

**FT901DM Yaesu HF Txcvr.** with CW, AM filters, mic., brand new (unopened carton), \$975; Alpha 374AE HF 1-30 MHz linear amplifier with automatic or manual tune, two Eimac 8874 tubes, maximum legal power plus, \$2,095. James. Ph. (02) 36 7756 or (02) 799 5566. GPO, Box 5076, Sydney, NSW 2001.

**FT200** and home-brew power supply, \$270 or near offer. VK2ABI, QTHR. Ph. (042) 84 3772.

**SR C6500 Standard Rx**, perfect cond., complete with book and original carton, 6 months old, \$280, ONO. L31280. Ph. (053) 39 5759.

**Icom IC280** remotable FM Tcvt., 2m mobile, will sell for \$375, due to change of QTH and circumstances. Bob VK6ZKL, c/- PO Bakers Hill 6562. Ph. (096) 24 2251 2200-2300Z or (09) 326 1494 0200-0500Z.

**Yaesu Linear FLDX2000**, new tubes, good working order, \$200, ONO. VK2AHM, QTHR. Ph. (050) 27 3331.

**Collins S Line**, 75S-3, 32S-1, 30L1 linear with 572B finals, 516F-2PS plus speaker, spare tubes 572B and 6146, \$1480. VK1BH. Ph. (062) 65 5385 Bus., (062) 88 6062 AH.

**Marconi CR100** 60 kHz to 30 MHz AM/SSB Rx, \$250, ONO; frequency metre, type BC-221-Q, \$70, ONO. Peter Dean L60036, QTHR. Ph. (09) 381 4859.

**Orake MN200 ATU** with built-in SWR/wall meter, to 200W, as new, \$225; regulated PS 13.5V 3 amp., \$25; B & K precision 30 MHz freq. counter, as new, \$100; Realistic DX160 comm. Rx, very good, \$150. VK3PR, QTHR. Ph. (056) 62 2711.

**FT101E**, latest model, never been on air, as new, in manufacturer's carton, \$700, ONO. Jack Mellor VK3AMG, OTHR. Ph. (051) 83 2370 AH.

**IC502** 6m Txcvr., complete with nicad batts and in-built charger, also a 30W linear, as new, complete with original packing and manual, \$225; 1 x QOE 03/10, 1 x 3/12, 6 x 3/20 and 2 x 6/40, offers; STC model 121 car phone, converted to 6m FM, \$20; Hygain 215B 15 element 2m beam, 28 ft. boom, 17.8 dB gain, \$45. Colin VK3ZD, QTHR. Ph. (03) 876 1987.

**IC551**, new and unpacked, VOX, passband tuning, processor, \$700; FT620B, used only three times, mint cond., calibrator board, complete all crystals and boxes, \$450; must sell. VK7NAB. Ph. (003) 31 7914, Launceston.

**Yaesu FL110 Linear**, solid state 100W o/p., \$200; Atlas PS110H 13.8V power supply, \$100; Kenwood KP12 RF speech processor and Yaesu YD844 desk mic., \$130. VK4HE, QTHR. Ph. (079) 27 6922 Bus., (079) 39 1307 AH.

**90 ft. Free Standing KVC Southern Cross Tower**, dismantled into 10 ft. sections for transportation, no rust, would suit commercial applications, \$1700. Write to I. Buchanan, 11 Shore St., Moruya 2537.

**Yaesu FTDX401**, exc. cond., performance and appearance, with speaker and mic., \$450. Bill VK2NJK, QTHR. Ph. (02) 632 3027.

**AR240** 2m synthesised, hand-held, as new, similar to Icom IC2A, 2 watts out, 144-148 MHz, supplied with AC and DC chargers, helical antenna, soft case, leather belt holster, owner's manual and workshop manual, the lot for \$260, ONO. Ray VK1ZJR/4, 1 Heather St., Silkstone, Old. 4304. Ph. (07) 33 7338 Bus.

**Yaesu FT200** with power supply/speaker, DC converter, plus extras, \$435; Kenwood TS120S, as new \$595; PS30 supply, \$125; XCR-30 Bartow Wadley Rx, \$175, or consider offers. Ph. (03) 435 4336 AH only.

On behalf of deceased estate, brand new (never used) Yaesu FT101 Txcvr., complete with mic. and tan and handbook; also three morse code flight training cassettes, plus key, tenders for any item to Ross Delon VK5AG, QTHR.

**Cybernet SSB CB** converted to 10m, 40 channels 28.24-28.68 with 5 kHz shift and slide, \$135; also transverter, 10-80m, compact case, \$90; both units work well. VK5NTF, QTHR. Ph. (088) 63 1268.

## ADVERTISERS' INDEX

AUDIO TELEX	44
AMATEUR RADIO ACTION	38
BAIL ELECTRONICS	31
CHIRNSIDE ELECTRONICS	34
CW ELECTRONICS	28
DICK SMITH ELECTRONICS	2
GFS	7, 22
GLUYAS GIMMICKS	26
NSW DIVISION WIA	40
RJ AND US IMPORTS	42
SCALAR INDUSTRIES	43
SIDEBAND ELECTRONIC ENGINEERING	6
VICOM PTY. LTD.	4, 19
WILLIAM WILLIS	26
W. & G. WULF	38

**The Advertisers in "Amateur Radio" support the WIA member — give them first preference — and tell them so, too!**

**FT200 Txcvr.**, complete with mic., AC power supply/LS, 12V DC power supply (DC 200) and manual, exc. cond., \$420. VK1BE, QTHR. Ph. (062) 81 3301.

**FT7B Yaeu Txcvr.**, rarely been used, mint cond., 10-70m, \$520 firm; also FT101E in above cond., later model, \$680. John VK3VCZ, QTHR. Ph. (054) 84 1777 after 5.30 p.m.

**Drake Trcvr. TR-4C**, 30 watts PEP SSB, 260 watts CW, 260 watts PEP AM 10-80m USB/LSB, with AC-4 power supply, MS-4 speaker, 34-UNB noise blanker and handbook, hardly used, \$650. Ken VK6ZA, QTHR. Supply phone number for quick reply.

**Electronic Keyer**, Katsumi EK105A, 5-50 w.p.m., 240V AC, g.c., \$30; Dick Smith freq. counter, as new, to 200 MHz, \$90; 2m 5 el. quad, built as per RSGB VHF-UHF manual, works well, \$25; Ken KP202 hand-held 2m txcvr., ch. 40, 50, rpt. 2, 4, 5, 8, also xtals for rpt. 6, 7, nicads, charger, leather case, stubby helical and collapsible ¼ wave whip, g.c., \$140. B. Bathols VK3UV, QTHR. Ph. (03) 90 6424 AH.

**Deceased Estate: Eddystone 840C Rx**, general coverage, \$200; quantity of WW II gear, suit spare parts, incl. AT5, AR8, quantity of magazines, QST, 73, CO, what offers? Large quantity of valves. All VK3LC, QTHR. Ph. (03) 99 5344.

**Drake C-line**, complete, T4XC and R4C, power supply, speaker, c/w crystals, noise blanker, 15 receive crystals, power meter, bargain \$1000, no offers; Swan linear 1200-X, \$200, NF; Drake TR3 with power supply, \$200, NF; dummy load Cantenna with transformer, oil, \$50; shack clear out morse keys, inductances, condensers, etc. Alick VK2EF, QTHR. Ph. (02) 918 0526.

## WANTED

**ICOM RH2** or RM3 with or without ICOM 701, any cond.; Kenwood 599TX to suit 599DRX, also 2m and 6m converter units for 599DRX, any cond. John VK2BYK. Ph. (047) 21 4205 Bus., (047) 21 2822 AH.

**Drake R4C Receiver** in good working cond., also must have the noise blanker, instruction manual and accessories. Contact me on reasonable price please. Mr. David Deerman, 222 Parry St., Charleville, O 4470. Ph. 278.

**Borrow** or photostat Galaxy 3 Power Supply Circuit, pay all exs. VK2QC, QTHR.

**IC22A Hand Mic.**, must be in good cond. Ring Errol VK3GG, QTHR. Ph. (03) 370 3258 Bus., (03) 337 8094 AH.

**Information** on converting 40 ch. Pace 100m side-talk (PLL circuit), from 11m to 10m. G. Franklin VK3VLJ, PO Box 24, Thornbury 3071.

**Command Receivers** (BC-453, 190-550 kHz and BC-454, 3.0-6.0 MHz), preferably unmodified. Ken VK6ZA, QTHR. Supply phone number for quick reply.

**FT-7**, will trade FRG-7 and make up difference. Contact Max VK3VSM, 19A Mason St., Regent 3073. Ph. next door (03) 470 1256 between 4-7 p.m.

**Used but Working General Coverage Receiver** for young lad following in father's footsteps. Contact Laurie VK2AQW. Ph. (02) 436 2766 Bus., (02) 952 2160 A.H.

Any information please circuits or manuals for the following items: (1) Phillips sig. gen. type TA101C (or A), RAAF ident. Y10S/60034, S/N 3059; (2) electronic volt/hyst 24/AWA/A56010, S/N 245; (3) radio Rx Tx RT176A/PRC10, S/N 54 (6m FM); (4) Admiral Corporation amplifier PS AM-598/u, S/N 144, Radio Corporation of America (matches item 3). Details to VK6ZKL, C/- PO Bakers Hill, WA 6562. Ph. (096) 24 2251.

**Tri-band Antenna TH3** or similar and rotator. Ph. (053) 42 2245. Maurice Batt, RSD Rokewood Junction, Victoria 3351.

**A pair of v/cond. ABT 250 MMFD**, suitable for an ATU, to handle 150 watts. VK3YW, QTHR. Ph. (055) 62 7496.

## TRADE HAMAD

**Amidon Cores** — Iron-powder and ferrite, enlarged range available for tuned/wideband and suppression applications in Rcvt./Trans., large SASE for data/price list. Closed for business during November. RJ & US Imports, Box 157, Mordale, NSW 2223.

# YAESU THE RADIO

## UPGRADE YOUR STATION WITH FT-101ZD ACCESSORIES

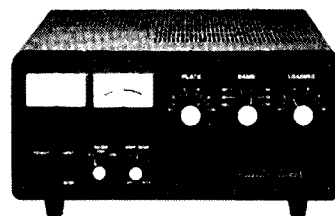

### FL-2100Z LINEAR AMPLIFIER

The FL-2100Z is a compact, high-performance linear amplifier designed expressly for the FT-101ZD transceiver. This amplifier uses two rugged 572B/T160 transmitting triodes in a class AB<sub>2</sub> grounded grid configuration. Operation on the 160 through 10 meter bands is provided.

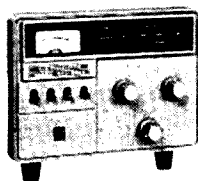

### FTV-901R VHF/UHF/OSCAR TRANSVERTER

In another industry first, YAESU brings you a three-band VHF/UHF transverter for your FT-101ZD station. The basic unit comes equipped with 144 MHz capability, and you may add our plug-in modules for 50 or 430 MHz as options. Repeater offset is provided for 6 and 2 meters, and full duplex operation on OSCAR models A/B/J is possible with an external receiver.

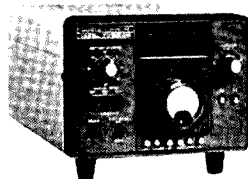

### FV-901DM SYNTHESIZED, SCANNING EXTERNAL VFO

The FV-901DM provides scanning and memory capability for your FT-101ZD transceiver. Using PLL synthesis in 100 Hz steps, the FV-901DM features an auto scan mode, which will search the band until it finds a signal-perfect for watching for openings. The manual scanner will scan at one of three rates, while you just flick a switch. The FV-901DM cannot be used with the analog FT-101Z.

Forty frequencies may be stored into memory, for control of the transmit, receive, or transceive frequency. And a clarifier allows fine tuning between the 100 Hz steps, as well as tracking of a drifting memorized signal. In OX or contest situations, you'll be seconds ahead of the competition with the FV-901DM . . . another YAESU "first."

### FC-901 ANTENNA COUPLER

The FC-901 is a compact, efficient antenna tuner. The FC-901 features an in-line wattmeter, SWR meter, and provision for selection of three coax-fed antennas and one single wire antenna. Present a 50 ohm load for your FT-101ZD all across the band with the FC-901 antenna coupler.

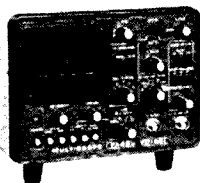
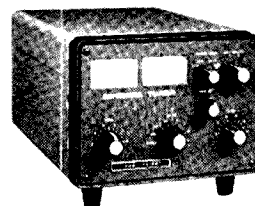

### YO-901 MULTISCOPE

Unsurpassed monitoring capability is yours with the YO-901 Multiscope. Featuring a high-performance oscilloscope, useful for countless station adjustments, the YO-901 also includes a two-tone generator, as well as an optional band scope for instant determination of band conditions and activity. Narrow-band IF signal observation is not possible with the FT-101ZD and YO-901.

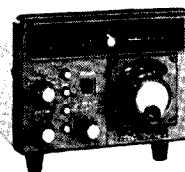

### FV-101Z EXTERNAL VFO

The FV-101Z is a compact remote VFO for your FT-101ZD station. The analog frequency display is geared to a precision tuning mechanism, resulting in silky-smooth operation. Clarifiers for the transmit, receive, or transceive frequency are included, while a unique VFO Shift feature allows  $\pm 8$  kHz shift from the main dial frequency, allowing you to check nearby frequencies for a clear spot. Up to six crystal-controlled channels may be installed.

**For further details and  
coloured brochures, call or  
write to Bail Electronic  
Services, Australian Agents  
for YAESU since 1963.**



**BAIL ELECTRONIC SERVICES**  
38 FAITHFUL STREET, WANGARATTA 3677  
Telephone: (057) 21 6260 — Telex: 56880  
**DISTRIBUTORS AND AGENTS IN ALL STATES**

Stan Roberts  
and Staff —  
VK3BSR



# DB10-15A

## HF DUO BAND

### FOR 10 AND 15 METRES

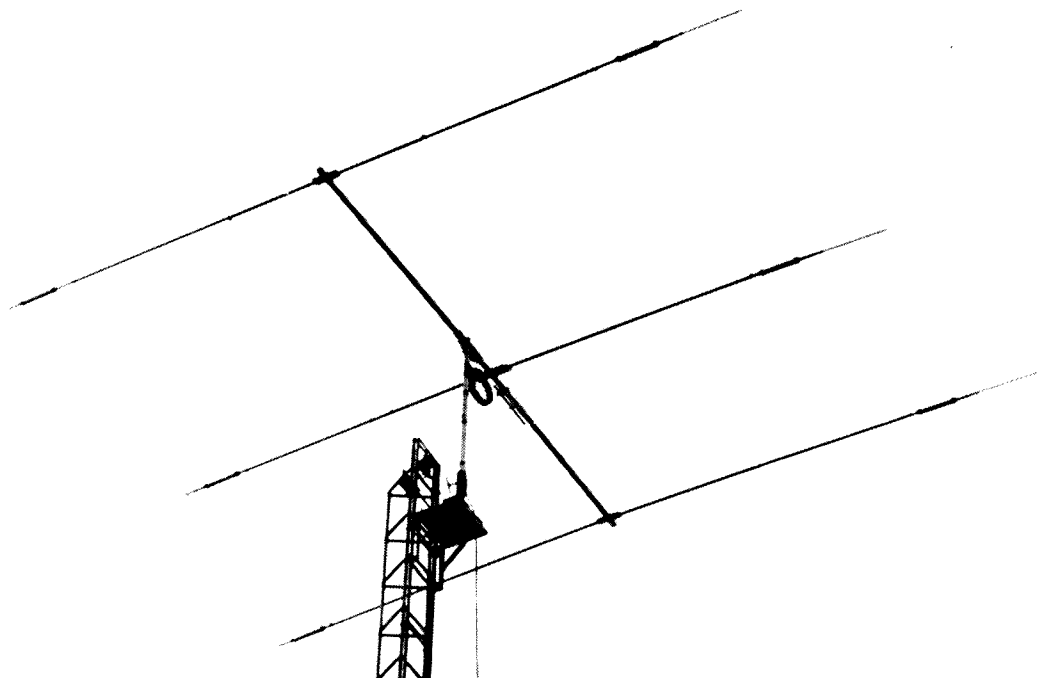

The Hy-Gain Duo Band is not a new addition to our range, but it has established itself as one of the most popular duo band antennas in the world. Equipped with exclusive Hy-Gain Hy-Q traps, both bands feature F/B ratio of 15-25 dB and less than 1.5 : 1 SWR at resonance.

Boom Length .....	18 feet	VSWR at Resonance .....	Less than 1.5 : 1
Longest Element .....	31 feet	Power Input .....	Maximum Legal
Turning Radius .....	18 feet	Input Impedance .....	50 ohms
Surface Area .....	6.4 sq. feet	-3 dB Beamwidth .....	66° average
Wind Load .....	164 lbs.	Lightning Protection .....	DC ground
Weight .....	50 lbs.	Forward Gain .....	8.4 dB
		Front to Back Ratio .....	15-25 dB

**WRITE OR CALL FOR A FREE BROCHURE AND THE NAME OF YOUR NEAREST HYGAIN DEALER  
SOLE AUSTRALIAN DISTRIBUTOR**

**AUDIO TELEX COMMUNICATIONS  
PTY. LTD.**



**MELBOURNE:**  
7 Essex Road,  
MOUNT WAVERLY 3149  
Tel: 277 5311

**BRISBANE:**  
394 Montague Road  
WEST END 4101  
Tel: 44 6328

**SYDNEY:**  
1 Little Street,  
PARRAMATTA 2150.  
Telephone 833 4344

# amateur radio

JOURNAL OF THE WIRELESS INSTITUTE OF AUSTRALIA

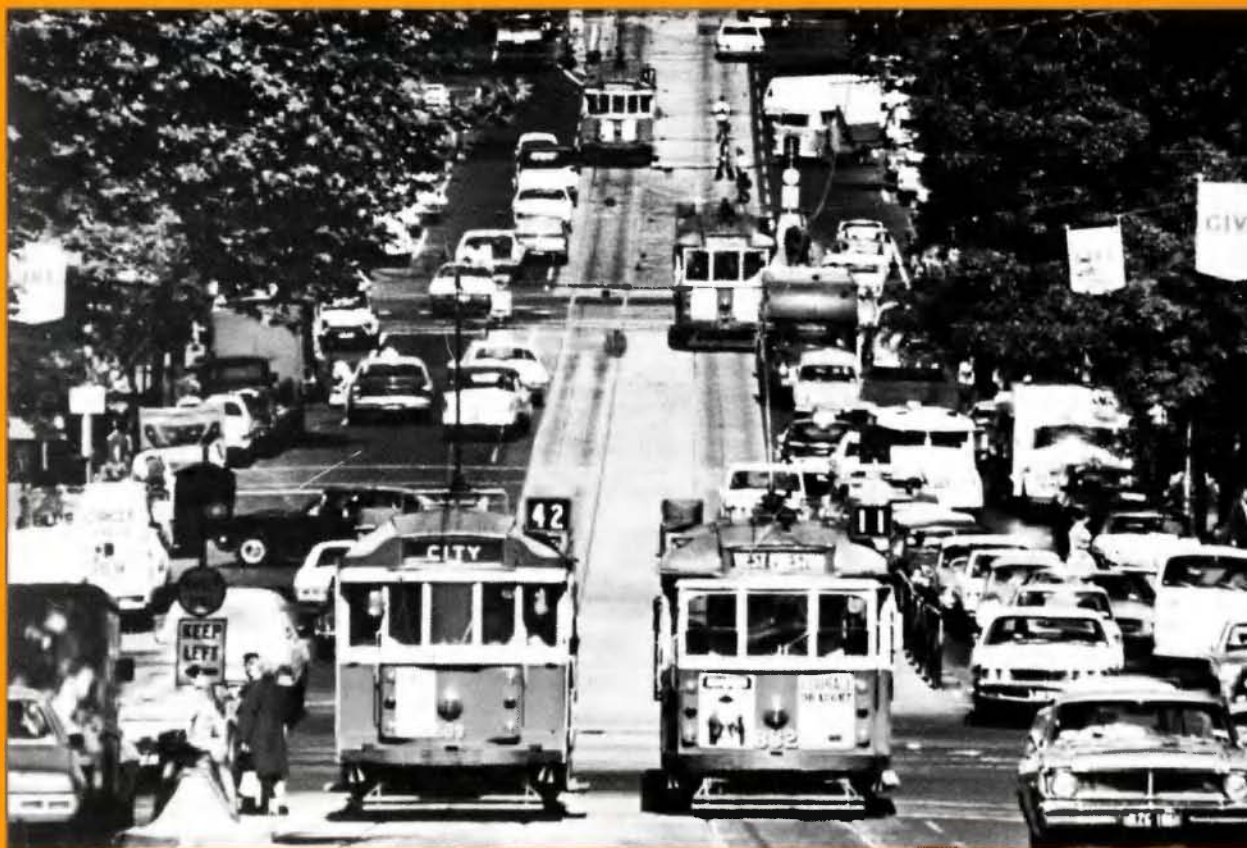

VOL. 48, No. 10

OCTOBER 1980

## ***FEATURED IN THIS ISSUE:***

- ★ **HIGH IMPEDANCE BUFFER AND BROADBAND AMPLIFIER FOR DIGITAL FREQUENCY METERS**
- ★ **WEATHER SATELLITE CONVERTER**
- ★ **MOBILING THE AMERICAN AND CANADIAN ROCKIES**
- ★ **Collectors' Corner No. 3 — THE SX200 VHF-UHF SCANNING MONITOR RECEIVER**

# Your last chance. . .

our **'win a trip to Hong Kong'** contest closes this month. Get your entry in now!

## HERE'S HOW IT WORKS:

We want to know what you the amateurs want from your hobby so that we, as a company, can serve you and Australia better. So we're asking you to tell us, in fifty words or less, 'The best way that Dick Smith Electronics can promote the fantastic hobby of Amateur Radio to the benefit of Australia'.

Entry to the competition is only open to purchasers of any Yaesu equipment from Dick Smith stores or authorised Dick Smith Yaesu resellers, between 1/8/80 and 1/11/80 - enter and you could win and be on your way to Hong Kong.

Entries will be judged initially by a panel from Dick Smith Electronics to produce five finalists: these will be judged by Neville Williams, MIREE, Editor-in-chief of Electronics Australia magazine.

The winner will be notified by Dick Smith, and will be announced in Electronics Australia and Electronics Today International.

So if you're thinking about buying Yaesu, why not buy it in the next few weeks: of course, only from Dick Smith Electronics or authorised Dick Smith Yaesu re-seller!

## RULES AND CONDITIONS

Entries will only be accepted on the official entry form, which is available only with the purchase of any item from the Yaesu range from a Dick Smith store or Dick Smith authorised re-seller.

All entries must show the model number and serial number of the item purchased (if applicable), and be signed by the store manager or authorised person.

In the space on the entry form, write in one paragraph of not more than 50 words.

'The best way that Dick Smith Electronics can promote the fantastic hobby of Amateur Radio to the benefit of Australia'.

Post your entry to:  
Amateur Radio Contest  
Dick Smith Electronics  
PO Box 321  
North Ryde NSW 2113

Entries close at 5pm on Monday, 3rd November, 1980. Entries received after this date will not be considered. Final judging will take place on 10th November, 1980. The judge's decision will be final and no correspondence will be entered into.

The winners flight departs from and returns to Sydney, the winner must travel to Sydney at his/her own expense. All entries become the absolute property of Dick Smith Electronics Pty Ltd who may use such entries as they see fit.

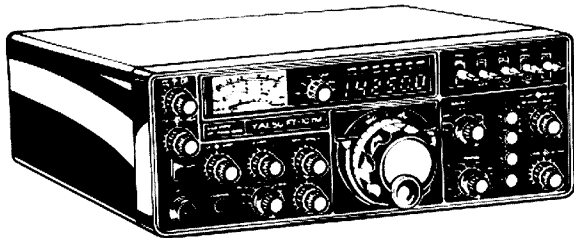

## YES, we have the incomparable Yaesu FT107M/DMS

**ALL THIS FOR ONLY**

**\$1278<sup>00</sup>** Cat. D-2871

The FT107M/DMS is the rig you've been waiting for. Advanced engineering plus rugged design enables this rig to have the 'edge' on the opposition. Features include variable IF bandwidth, audio peak and notch filters, RF speech processor, full coverage from 160 through 10 metres, plus WWV/JJY on receive. It is also fitted with the new WARC frequencies. The AC power supply comes as a plug-in module and is ready fitted in the case. The FT107M/DMS also comes with memory. These plus other outstanding features place the FT107M/DMS in the forefront of what the serious amateur requires from his hobby.

## THE NEW YAESU

Cat. 0-2887

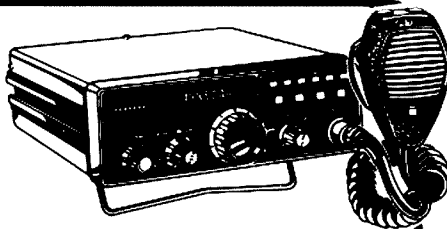

The FT480R is coming — the all new FT480R has sophisticated microprocessor control circuitry to bring new dimensions in flexibility to you — today's 2 metre operator.

At the time of going to press, these units were on the high seas, check with our stores NOW — they could very well be in stock.

Priced at only **\$543<sup>00</sup>**

## TERMS AVAILABLE FROM \$138 DEPOSIT & \$38.32 OVER 48 MONTHS

**SPECIAL NOTE:** Finance company regulations restrict finance to 'approved personal customers' only. However, if you wish to 'pay off' a Yaesu and cannot call into one of our stores, you can always ring us and order your Yaesu' by Bankcard. All you do is quote your Bankcard number, name and address, and we charge your Bankcard account. What is more, we'll send your new Yaesu anywhere in Australia for only \$6.00 road freight: that's below what it costs us!

# NOW, more than ever, it pays to buy Yaesu from Dick Smith







# amateur radio

Published monthly as its official journal by the Wireless Institute of Australia, founded 1910.

**OCTOBER 1980**

**VOL. 46, No. 10**

**PRICE: \$1.20**

Registered Office:  
3/105 Hawthorn Road,  
Caulfield North 3161.

**EDITOR:**  
BRUCE BATHOLS\* VK3UV

**PRODUCTION MANAGER:**  
MARK STEPHENSON\* VK3PI

**TECHNICAL EDITORS:**  
BILL RICE\* VK3ABP  
EVAN JARMAN\* VK3ANI  
RON COOK\* VK3AFW  
GIL SONES\* VK3AUI

**CONTRIBUTING EDITORS:**  
BOB ARNOLD VK3ZBB  
G. NICK NICHOLS VK6XI  
ROY HARTKOPF\* VK3AOH  
RON FISHER\* VK3OM  
ERIC JAMIESON VK5LP  
LEN POYNTER\* VK3BYE  
BILL VERRALL VK5WV  
WALLY WATKINS VK2DEW

**DRAFTING:**  
NEIL OSBORNE\* VK3YEI

**BUSINESS MANAGER:**  
PETER DODD VK3CIF

\*Member of Publications Committee

Enquiries and material to:  
The Editor,  
PO Box 150, Toorak, Vic. 3142

Copy is required by the first of each month. Acknowledgement may not be made unless specially requested. All important items should be sent by certified mail. The editor reserves the right to edit all material, including Letters to the Editor and Hamads, and reserves the right to refuse acceptance of any material, without specifying a reason. Material should be sent direct to P.O. Box 150, Toorak, Vic., 3142, by the 25th of the second month preceding publication. Phone: (03) 528 5962. Hamads should be sent direct to the same address by the 1st of the month preceding publication.

Trade Practices Act: It is impossible for us to ensure that advertisements submitted for publication comply with the Trade Practices Act 1974. Therefore advertisers and advertising agents will appreciate the absolute need for themselves to ensure that the provisions of the Act are complied with strictly. Readers are reminded that, when buying, obtaining or receiving goods from overseas including goods listed in advertisements by overseas organisations in this Journal, Customs import duties and Sales Tax may be levied on the goods at the time of importation. These amounts, if any, are payable by the purchaser unless the terms of sale state otherwise and the seller has made specific provision to this effect in his quotation to the buyer or unless other prior arrangements are in force between the buyer and the seller.

Typesetting: MUELLER INDUSTRIES  
1a Levanswell Road, Moorabbin, 3189  
Tel.: 553 0292

Printers: WAVERLEY OFFSET PUBLISHING GROUP  
Geddes Street, Mulgrave 3170

## CONTENTS

### TECHNICAL

Dirt Cheap Direction Finding	10
High Impedance Buffer and Broadband Amplifier for Digital Frequency Meters	8
Weather Satellite Converter	12

### GENERAL

General	123456	123456	1234	1
Amateur Radio Weekend				30
Artificial Satellites				38
Collectors' Corner No. 3 — The SX 200 Scanning Rx				25
JOTA 1980				30
Mobiling the American and Canadian Rockies				14
Oxley Region Amateur Radio Club 1980 Remembrance Day Contest Opening Address				7
The Value of Wireless Telegraphy				19
Why ASCII??				21
Writing an Article for AR				13
Youth Radio Clubs Scheme of Australia				41

### DEPARTMENTS

Amateur Satellites	38
Around the Trade	49
Awards Column	47
Contests	42
Forward Bias	35
Hamads	50
Ionospheric Predictions	43
Letters to the Editor	45
Main QSP	5
Novice Notes	31
Obituary	48
QRK5	35
QRM	36
QSP	5, 7, 30, 49
Silent Keys	48
Spotlight on SWLing	37
VHF-UHF — an expanding world	39
VK2 Mini Bulletin	35
WIANEWS	7
You and DX	43

**ADVERTISERS' INDEX** 50

## Cover Photo



With the surge in Amateur activity, particularly on 10m in recent years, many Awards have been established to encourage continued activity independent of solar activity. The 10-10 International Club with over 27,000 members continues to promote 10 metres and Awards such as the City of Melbourne Award (pictured) will not only promote activity, but also friendship.

For details of the City of Melbourne Award and other 10-10 awards turn to page 47.

# The Hands-off Meter!

- No need for frequency adjustment or looking up tables.
- No forward/reverse switching required.
- Features DAIWA's unique direct reading "cross-needles".

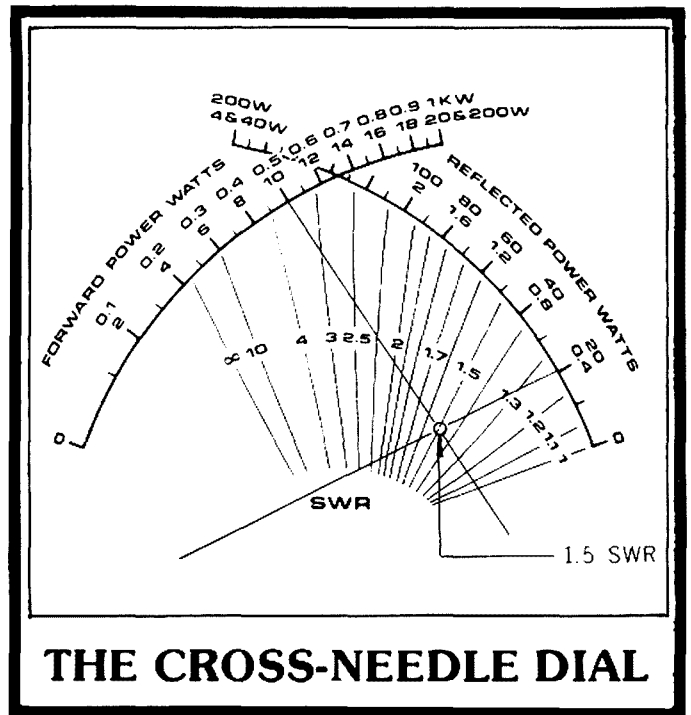

## CN620 SWR/PWR METER

- \* 1.8 - 150 MHz
- \* 20W/200W/1 KW pwr ranges
- \* List Price \$99

## CN630 SWR/PWR METER

- \* 140 - 450 MHz
- \* 20W/200W pwr
- \* List Price \$135

## CN630 SWR/PWR METER

- \* 1.2 - 2.5 GHz
- \* 2W/20W ranges
- \* List Price \$169

Also a range of quality antenna couplers incorporating cross-needle SWR/PWR Meters.

Distributed by VICOM

SYDNEY: 339 Pacific Hwy,  
Crows Nest. Ph. 436 2766  
MELBOURNE: 68 Eastern Rd.,  
Stn. Melb. Ph. 699 6700

VICOM gear is available from  
most reputable dealers!

# QSP —

## Third Party Conditions for Australian Amateurs

In opening the 1980 Remembrance Day Contest, the Minister for Posts & Telecommunications, Mr. Tony Staley, announced that the prohibition on third party traffic for Australian Amateurs would be removed forthwith.

The Postal & Telecommunications Department has now advised The Wireless Institute of Australia of the conditions that will apply to third party traffic within Australia pending changes to the Wireless Telegraphy Regulations. These conditions are the same conditions as apply in the United States of America. The relevant Federal Communications Commission conditions are:

*"The transmission or delivery of the following amateur radiocommunication is prohibited:*

- (a) International third party traffic except with countries that have assented thereto.*
- (b) Third party traffic involving material compensation either tangible or intangible, direct or indirect to a third party, a station licensee, a control operator or any other person.*
- (c) Except for an emergency communication as defined in this part, third party traffic consisting of business communication on behalf of any party. For the purpose of this section, business communication shall mean any transmission or communication, the purpose of which is to facilitate the regular business or commercial affairs of any party."*

In essence, these conditions impose three prohibitions. Firstly, there must be no material compensation of any kind to an Amateur or any other person. Secondly, the message must be non-commercial. Thirdly, until Australia enters into the necessary agreements with other countries permitting third party traffic, third party messages can only be passed within Australia.

The Wireless Institute of Australia first sought third party privileges in June, 1977. The conditions imposed by the Department are precisely the conditions that The Wireless Institute of Australia believes should apply.

The Institute has been concerned for a very long time at the effect of third party restrictions on the ability of Amateurs to be prepared for emergencies. The best practice in passing messages is to pass messages. In different States, the prohibition has been interpreted differently and there is no doubt that Amateurs have been inhibited both in practice and in actual emergency situations. For this reason, the Institute welcomes the Minister's announcement and welcomes the nature of the conditions that have been imposed.

It is worth pointing out that certain restrictions are essential. The ITU Radio Regulations define the Amateur Service. The restrictions imposed ensure that there is no inconsistency between that definition and the nature of the Service in Australia. It should also be pointed out that the prohibition against international third party traffic is also to be found in the ITU Radio Regulations, though these Regulations specifically allow Administrations to agree to the exchange of third party traffic by Amateurs between their respective countries.

The right to carry third party traffic within Australia does not include the right for Australian Amateurs to phone-patch. That is an entirely different issue and is certainly prohibited by the Australian Telecommunications Commission.

The Institute has been invited to advise the Postal & Telecommunications Department of the countries to which third party agreements are desired. The Institute is responding to that invitation.

We believe that the Minister's announcement represents a significant deregulation of the Amateur Service in Australia and one that will, in time, result in the enhancement of the communications skills of the Australian Amateur.

MICHAEL J. OWEN VK3KI

# QSP

## THE ERECTION OF TOWERS

In a recent edition of the WIA's Minibulletin there were quoted instances of amateur operators being refused permission to erect a tower, the localities actually being Fairfield and Campbelltown. In one instance the operator defied the Council's rejection of the application and did erect his tower only to be prosecuted and ordered to remove the tower. Incidentally the operator's tower was not as high as many of the neighbouring towers for TV antennae.

"For the guidance of all amateurs who are contemplating the erection of a tower I would like to offer the following advice; having been an alderman I have seen the regulations being applied many times. First and foremost, always make a formal

application to the shire or council for the erection of any structure be it a minor addition to the house, an outhouse or even a flag pole; if approval is given then this is the answer to any future criticisms from anyone for any reason. Secondly, consider the safety angles of the tower and the necessity of insurance in case the tower should fall on to another property. Thirdly, and this is the one of which few people are aware, there is easy recourse to a person who has been unjustly treated by his local government authority: the Local Government Appeals Tribunal is readily available to everyone, it is inexpensive to have one's matter dealt with by the Tribunal, legal representation is unnecessary and the Tribunal becomes the council (or shire) and their decision is final and cannot be upset except on a point of law. All councils must have a supply of the forms which are used

for application and, by legislation, the council must assist the applicant to complete the form if requested.

Everyone is entitled to the quiet enjoyment of one's own amenity — this is a democratic fundamental. If the enjoyment of this amenity necessitates that a tower should be erected on one's property then, provided it does not constitute a danger to anyone and is not for commercial use, the necessary approval should be forthcoming. If the initial application is rejected by the local authority, the applicant should NOT proceed with the erection of the structure as this will surely invite a losing battle; submit the matter to the Local Government Appeals Tribunal and, provided there are no obvious and serious objections, approval will be given." An article by VK2VRB in Smoke Signals, July 1980.

## INTRODUCING to Australia by "SUPREME" of New Zealand the "MASTER" Range of Antennas

Supreme have been producing the MASTER range of Antennas, and Antenna systems for New Zealand Amateurs for many years, and now we can offer Australian Amateurs the same Antennas, with the high quality and features that have made them the number one Amateur Antenna in New Zealand.

### FEATURING THE WIREMASTER ANTENNA RANGE:

Here is an antenna system that is proving very popular because it offers true dipole operation for more than one band. Parallel resonant traps automatically select the proper dipole length for each operating frequency. Uses High Q weatherproof traps, designed with high tensile strength. Easily wired up into a good performer and also reduces the overall antenna length. A space saver.

**USING THE "WIREMASTER" TRAPS:** There are 3 aerial systems you can choose depending on the bands you prefer operating on.

### USING TWO WM40 TRAPS AS A 5 BAND ANTENNA: (Approx. dimensions)

6.7m WM40 9.75m 9.75m WM40 6.7m

On 80 metres the traps act as a loading inductance and form a shortened 80 metre dipole. On 40 metres the two 9.75 metre sections provide a conventional dipole with the traps acting as insulators and also providing some end loading so as to shorten the dipole length. On the other bands the

system is 3/2 waves on 20m, 5/2 waves on 15m and 7/2 waves on 10m. The system may be assembled only to the traps eliminating the 6.7m sections, thus giving a shortened 40m dipole only.

### USING TWO WM20 TRAPS AS A 4 BAND ANTENNA: (Approx. dimensions)

3.2m WM20 5m 5m WM20 3.2m

On 40 metres the traps act as a loading inductance and form a shortened 40m dipole. On 20m the two 5m sections provide a conventional dipole with the traps acting as insulators and also providing some end loading so as

to shorten the dipole length. On 15 and 10m the system is again multiband. This system may be assembled only to the traps eliminating the 3.2m sections, thus giving a shortened 20m dipole only.

### USING TWO WM40 AND TWO WM20 TRAPS AS A 5 BAND ANTENNA: (Approx. dimensions)

6.7m WM40 3.5m WM20 5m 5m WM20 3.5m WM40 6.7m

Here on 80, 40, and 20m you get proper dipole operation on 3 bands and multiband operation on 15 and 10m. The operation is the same as previously described.

to shorten the dipole length. On 15 and 10m the system is again multiband. This system may be assembled only to the traps eliminating the 3.2m sections, thus giving a shortened 20m dipole only.

Send for Our Brochure on "SUPREME ANTENNA SYSTEMS, including Beams, Trap Vertical Antennas. All prices \$A.

# Tricity House

209 MANCHESTER STREET TEL. (03) 67 443  
P.O. BOX 1410, CHRISTCHURCH, NEW ZEALAND  
SUPREME ANTENNAS—BEST HEARD ON THE AIR

## WIRELESS INSTITUTE OF AUSTRALIA

Federal President: Mr. P. A. Wolfenden VK3ZPA

Federal Council:

VK1 Mr. R. G. Henderson VK1RH

VK2 Mr. T. I. Mills VK2ZTM

VK3 Mr. G. A. G. Williams VK3ZXW

VK4 Mr. A. R. F. McDonald VK4TE

VK5 Mr. G. Preston VK5PI

VK6 Mr. N. R. Penfold VK6NE

VK7 Mr. B. J. Morgan VK7RR

Staff: Mr. P. B. Dodd VK3CIF, Secretary.

Part-time: Col. C. W. Perry, Mrs. J. M. Seddon and Mr. Mark Stephenson (AR Production).

Executive Office: 3/105 Hawthorn Rd., Caulfield North, Vic. 3161. Ph. (03) 528 5962.

Divisional Information (all broadcasts are on Sundays unless otherwise stated).

ACT:

President — Mr. A. Davis VK1DA

Secretary — Mr. F. Robertson-Mudie VK1NAV/ZZZ

Broadcasts— 3570 kHz and 2m Ch. 6 (or 7): 10.00Z.

NSW:

President — Mr. A. D. Tilley VK2BAD

Secretary — Ms. S. J. Brown VK2BSB

Broadcasts— 1825, 3595, 7146 kHz, 28.32, 52.1, 52.525, 144.1, 145.6, 146.4, Rptr. Ch. 3 — Gosford, Ch. 4 — Lismore, Ch. 5 Wollongong, Ch. 8 — Dural 11.00h local (Evening 0930Z). Relays on 160, 80 and 10m, VHF and Repr. Ch. 3, Ch. 5, Ch. 8, and Hunter Branch, Mondays 0930Z on 3595 kHz, 10m, and Ch. 3 and 8. RTTY Sunday 0030Z 7045, 14090 kHz, Ch. 52, 0930Z 3545 kHz, Ch. 52.

VIC.:

President — Mr. A. R. Noble VK3BBM

Secretary — Mr. J. A. Adcock VK3ACA

Broadcasts— 1840, 3600, 7135 kHz — 53.032 AM, 144.2 USB and 2m Ch. 2 (5) repeater: 10.30 local time.

Gen. Mtg. — 2nd Wed., 20.00.

QLD.:

President — Mr. A. J. Aarsse VK4QA

Secretary — Mr. W. L. Glells VK4ABG

Broadcasts— 1825, 3580, 7146, 14342, 21175, 28400, kHz; 2m (Ch. 42, 48): 09.00 EST.

Gen. Mtg. — 3rd Friday.

SA:

President — Mr. I. J. Hunt VK5QX

Secretary — Mr. W. M. Wardrop VK5AWM

Broadcasts— 1820, 3550, 7095, 14175 kHz; 21.160, 28.5 and 53.1 MHz, 2m (Ch. 8): 09.00 S.A.T.

Gen. Mtg. — 4th Tuesday, 19.30.

WA:

President — Mr. B. Hedland Thomas VK6OO

Secretary — Mr. Peter Savage VK6NCP

Broadcasts— 3560, 7075, 14100, 14175 kHz, 28.47, 53.1 MHz, 2 metres Ch. 2 Perth, Ch. 6 Wagin. Time 0130Z.

Gen. Mtg. — 3rd Tuesday.

TAS.:

President — Mr. R. Emmett VK7KK

Secretary — Mr. B. J. Morgan VK7RR

Broadcasts— 7130 (SSB) kHz with relays on 6 and 2m Ch. 2 (S), Ch. 8 (N), Ch. 3 (NW), 09.30 EST.

NT:

President — Mr. T. A. Hine VK8NTA

Vice-Pres. — Barry Burns VK8DI

Secretary — Robert Milliken VK8NRM

Broadcasts— Relay of VK5WI on 3.555 MHz and on 148.5 MHz at 2330Z. Slow morse transmission by VK8HA on 3.555 MHz at 1000Z almost every day.

Postal Information:

VK1 — P.O. Box 46, Canberra, 2600.

VK2 — 14 Atchison St., Crows Nest, 2065 (Ph. (02) 43 5795 Tues & Thurs 9.45-13.45h).

P.O. Box 123, St. Leonards, NSW 2065.

VK3 — 412 Brunswick St., Fitzroy, 3065 (Ph. (03) 41 3535 Weekdays 10.00-15.00h).

VK4 — G.P.O. Box 638, Brisbane, 4001.

VK5 — G.P.O. Box 1234, Adelaide, 5001 — HQ at West Thebarton Rd., Thebarton.

VK6 — G.P.O. Box N1002, Perth, 6001.

VK7 — P.O. Box 1010, Launceston, 7250.

VK8 — (Incl. with VK5), Darwin AR Club, P.O. Box 37317, Winnellie, N.T., 5789.

Slow morse transmissions — most week-day evenings about 09.30Z onwards around 3550 kHz.

VK QSL BUREAUX

The following is the official list of VK QSL Bureaux, all are inwards and outwards unless otherwise stated.

VK1 — QSL Officer, G.P.O. Box 46, Canberra, A.C.T. 2600.

VK2 — QSL Bureau, C/- Hunter Branch, P.O. Teralpa, N.S.W. 2284.

VK3 — Inwards QSL Bureau, Mrs. B. Gray VK3BYK, 1 Amery Street, Ashburton, Vic. 3147.

VK3 — Outwards QSL Bureau, Mr. R. R. Prowae, 83 Brewer Road, Bentleigh, Vic. 3204.

VK4 — QSL Officer, G.P.O. Box 638, Brisbane, Qld., 4001.

VK5 — QSL Bureau, Mr. Ray Dobson VK5DI, 16 Howden Road, Fulham, S.A. 5024.

VK6 — QSL Bureau, Mr. J. Rumble VK6RU, G.P.O. Box F319, Perth, W.A. 6001.

VK7 — QSL Bureau, G.P.O. Box 371D, Hobart, Tas. 7001.

VK8 — QSL Bureau, C/- VK8HA, P.O. Box 1418, Darwin, N.T. 5794.

VK9, 0 — Federal QSL Bureau, Mr. N. R. Penfold VK6NE, 388 Huntriss Rd., Woodlands, W.A. 6018.

# WIA NEWS

The news about Third Party traffic within Australia should go a long way towards alleviating many of the problem areas associated with emergency traffic and emergency training exercises.

One meeting of the Executive on 13th August discussed a range of on-going and routine matters, including an administrative matter relating to the WIA Superannuation Scheme, the submission made to the Department on the CBRS Review and a revision of the budget for 1981.

In relation to the 1981 budget the Federal Treasurer reported on discussions by the Federal Finance Sub-Committee from which derived a recommendation that because of rising costs, especially in connection with AR, an increase in the Federal dues was prudent if a deficit were to be avoided. This would be despite the exercise of all possible economies. After considerable discussion, a small increase of \$1.50 was accepted and passed — this is only a 9 per cent increase in the Federal dues.

Continuing discussions on the future of AR dealt in the main with Divisional Notes and Divisional Inserts. These were matters initiated at the 1980 Federal Convention in an attempt to render the magazine even more interesting for members.

Leaving the JOTA weekend free of contests was agreed as necessary, hence the changed dates for this year's Australian Novice Contest to the 27th-28th September instead.

An interesting item, already referred to Divisions for comments, was a world-wide locator system proposed by the IARU to pinpoint amateurs' QTHs with a reasonable degree of accuracy in as few characters as possible.

And finally, a quote from a note in the mail. "Just as a matter of interest someone has been pirating my husband's call sign for quite a few years now — we received another batch of 'fan mail' the other day. Nice isn't it?"

NEW	NEW	NEW	NEW
-----	-----	-----	-----

## AZDEN (PIEZO) 2 METER MOBILE FM TRANSCEIVER

KEYBOARD CONTROL UNIT SEPARABLE  
FROM TRANSCEIVER UNIT.

**CMOS MICROCOMPUTER CONTROL**

DIGITAL  
READOUT

ARA'S RIG  
OF THE YEAR



25 WATT

**6 CHANNEL MEMORY**

**MICROPHONE WITH  
REMOTE CONTROL  
STANDARD ACCESSORY**

\$425<sup>00</sup>

TAX IN.

CALL IN FOR A DEMONSTRATION AT  
STANDARD COMPONENTS PTY. LTD.  
9 HILL ST., LEICHHARDT. NSW  
(02) 660 6066

STOCK	STOCK	STOCK	STOCK
IN	NOW	IN	NOW

## 1980 Remembrance Day Contest — Opening Address by The Hon. A. Staley, M.P.

It is with a great deal of pleasure that I received your invitation to open the 1980 WIA Remembrance Day Contest.

Since becoming Minister for Post and Telecommunications I have enjoyed close relations with the Institute. Indeed the aims and ideas of the Institute seem to me to be embodied in the contest itself. The contest is dedicated to the memory of those amateurs who laid down their lives in defence of their country during World War 2. Personally I can think of no better way in which they would have wished to be remembered.

This contest is also renowned for its friendliness and fellowship; in fact I understand it is sometimes referred to as "the friendly contest". The form of the contest not only demonstrates the very high degree of skill that amateurs have achieved but also shows the way in which such skills can be used for their fellow man in times of both national or international emergency.

Here we have a contest founded to commemorate sacrifice — duty — renowned for its friendliness and fellowship, and in its formal encouraging the development and refinement of communication skills.

This event not only permits experienced amateurs to demonstrate their expertise but is in reality also an extension for the more inexperienced amateurs of the excellent training offered by the WIA to its members.

Let me take advantage of the opportunity presented in talking at the opening of your 1980 contest to also mention some issues which are

currently under discussion between the Institute and the Government.

First, I am very pleased on this occasion to be able to announce that the long-standing prohibition on the use of third party traffic by amateur radio operators will be removed for non-commercial messages.

As you'll be aware the WIA presented their submission for a restricted form of third party traffic in June 1977. Since that time there has been considerable discussion on this matter between my department and the WIA.

There is no reason why this privilege may not be provided forthwith within Australia but before any international traffic can proceed in this way we must await the agreement of the countries concerned. At this stage it would appear likely that only the United States may agree.

My Department will continue to discuss such aspects with the WIA. Certain legislative changes will of course need to be made to the Wireless Telegraphy Regulations. In the meantime the conditions under which third party traffic will be permitted will exclude certain forms of radio communications, mainly involving communications for the purpose of material gain such as advertising. I will take the necessary steps to ensure that all bodies concerned with this change in policy will be advised in writing and that the required legislative changes will be made as soon as possible.

Second, I have agreed to the proposals made by my Department to provide a draft of the post-WARC Australian Radio Frequency Table in con-

sultation with all interested parties, including of course the WIA itself. It is my hope that you will all see a copy of the draft table within the next few months.

I am sure that you are all anxious to begin the contest and I now have much pleasure in declaring the 1980 Remembrance Day Contest open.

### QSP

#### 1979 VK/ZL CONTEST CORRECTIONS DELETIONS

VK3BQA from 8 hr CW section.  
VK3BOA from 8 hr 20m band winner.  
VK3XB from 24 hr 10m band winner.

**CORRECTIONS**  
VK3AJ in 8 hr CW section should read VK6AJ.  
VK3SF in 8 hr CW section should read VK4SF.  
XL1BCG in 8 hr. CW section should read ZL1BCG.  
VK3XB in 24 hr Phone section score should be 190538.

VK3BRM, reverse 10m and 20m 24 hr Phone score.  
VK6AJ in 8 hr CW section, not VK3BOA.  
VK3BOA in 8 hr Phone section, not VK2BQA.  
ZL1BCG in 8 hr Phone section, not ZL1BGG.  
ZL2BR with 81748 points in 24 hr CW section wins the 10m band award, not ZL1ADI.

**ADDITIONS**  
VK3BRM, 24 hr Phone section, 80m winner.  
VK5MS, 24 hr Phone section, 10m winner.  
VK5WV 26769 points and VK5NCB 43606 points. Murphy didn't strike, he worked overtime; Hi.  
73s Neil VK6NE, VK/ZL Manager WIA.

# High Impedance Buffer and Broadband Amplifier for Digital Freq. Meters

R. Holland VK2ZZB  
388 Rouse St., Tenterfield, NSW 2372

## AN ARTICLE FOR THE WELL EQUIPPED AMATEUR

With the introduction of synthesised transceivers employing the heterodyning of several mixer crystals with the VCO output of a PLL system, there has grown the need to measure frequencies at low levels. In the majority of cases, because we are dealing with solid state devices, we have levels that are around the order of 10 dBm or less (1 dBm = 1 mW).

The impedances around such circuits are not very appropriate for measurement with devices of relatively low impedances, particularly when the circuit impedances can range anywhere between 200 and several thousand ohms. Consequently a high gain and a high impedance device is required if we are to obtain any measurements and accurate measurements respectively. I am sure that we are all familiar with the operating principle of a GDO, in the same way, loading of any oscillator will cause a resultant shift in frequency.

These two devices, the RF buffer and the broadband amplifier, were primarily designed for the input to the front end of a frequency meter and prescaler, in particular the EA Digital Frequency Counter. The application was for the measurement of a Yaesu FT-901D transceiver, as some problems were being experienced on the 10m bands.

Those familiar with this transceiver know that the crystals and the VCOs cover a frequency range from 15 MHz-43 MHz or so. The probe and amplifier were used to obtain measurements over this range with not noticeable shift in the final frequency of the transceiver.

### THE HIGH IMPEDANCE PROBE

Three requirements should be met by the probe:

- High Input Impedance — the probe should be greater than 1M.
- Low Input Capacitance — typically less than 10 pF.
- Wide Band Width — the device should be useful over several octaves.

A JFET was chosen as the active device to be employed in the input of the buffer. The JFET was followed by a PNP Bipolar transistor — which is used for impedance transformation.

The FET is a process 50 type with a typical gain of 12 dB at 400 MHz and a noise figure of 4 dB at the same frequency. The quoted input capacitance is 3.5 pF with zero gate to source voltage, although at a Vds of 6.0 volts and a Vgs

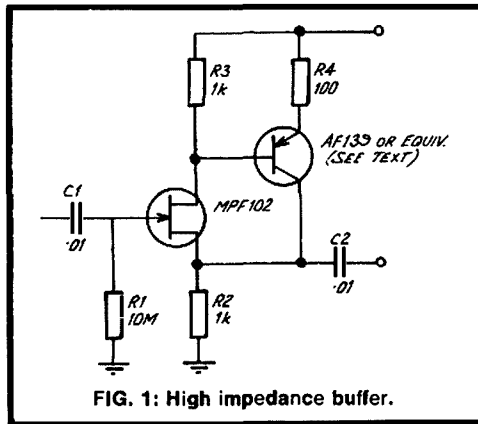

FIG. 1: High impedance buffer.

of -4.0 volts this is significantly improved.

A typical device of this process is the MPF102 (although I used a 2N254).

The impedance transforming transistor employed in inverted mode was an AF139, which is a PNP germanium transistor — this was used only because of its ready availability in the shack and that it has a high Fr. This device is used in TV mast-head amplifiers, so it works within the VHF region.

The design is adapted from National's application notes (AN32).

Layout is not particularly stringent, although good RF practice should be adopted.

The capacitor C1 on the input was included for isolation at high potential and should be a good quality disc ceramic of the appropriate potential desired. C2 may be lowered in value to improve the low frequency response.

### THE BROADBAND AMPLIFIER

From National's specifications it can be seen that process 43 transistors have a minimum Fr of 600 MHz and selected devices have Frs within the GHz region. The process 43 transistors are employed in UHF amplifiers and oscillators with collector currents in the range of 1-20 mA. Their hFE is between 40 and 200, so I chose a 2N3563 as the active device to be employed in this amplifier.

### THE DC BIAS

The DC bias is important, at high currents we achieve greater bandwidth capabilities and better stabilisation of current gain. Looking at the design curve for Constant Gain Bandwidth it was decided to run the transistor with a current of Ic = 10 mA and a voltage of Vce = 7.0 volts as a trade-off in this curve and the supply voltage of 9.0 volts from a No. 216 battery.

Using the following DC network and certain assumptions we will derive the circuit values for the resistors:

- $V_c = V_{cc} - I_c R_c (I_B + I_{Bias} \ll I_c)$   
 $R_1 + R_2$
- $V_b = \frac{V_c}{R_2} (I_B + I_{Bias} \ll I_c)$
- $V_b = V_e + 0.6 (V_{be} = 0.6)$
- $V_e = I_c R_e (I_c = I_e)$

Choosing Ic = 10 mA and Rc = 100 ohms we arrive at R1 = 3.8k, R2 = 1k and Re = 100.

### THE RF CONFIGURATION

To arrive at an RF configuration I will briefly describe two techniques employed by designers. The key to the design problem is the use of RF negative feedback — this is employed to achieve stabilisation, as against oscillation as in the case of positive feedback.

The quoted references in Ham Radio employ some form of series feedback in order to achieve their gain flatness or bandwidth. The results may be a constant voltage gain (which is all to often used for power gain measurements) but has the unfortunate side effect of raising the input impedance of the amplifier by a factor which is proportional to the feedback and the beta of the transistor. Since beta can be approximated by the following expression: fo = Fr/f, where f is the operating frequency, then we have an amplifier that achieves higher gain at lower frequencies.

Another method of feedback that could be employed is the shunt feedback. This form lowers the input impedance and the output impedance as well as stabilising the current gain of the device.

The overall ultimate design employs the application of both forms of feedback and the design parameters are included below.

$$\text{Choose } R_f = \frac{Z_o}{R_e} \quad (Z_o = 50 \text{ ohms})$$

$$\text{Gain (dB)} = 10 \log R_f/R_e$$

The circuit employs a balun to match the transistor's output impedance without loading it too much. It also covers a wide frequency range. The larger the number of turns the lower will the lower 3 dB point occur and conversely the fewer the number of turns the higher the upper 3 dB point will occur. The final circuit is a combination of the DC and AC networks. For a gain of 19 dB chose Rf/Re = 79,

however  $R_e$  was chosen as 4.7 ohms giving  $R_f = 510$  as a good compromise between gain and impedance match.

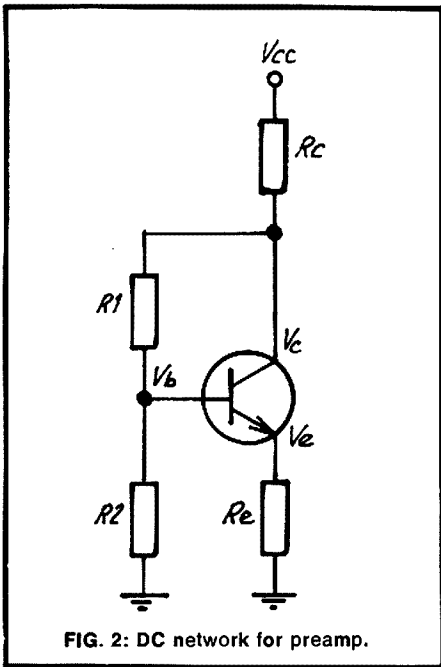

FIG. 2: DC network for preamp.

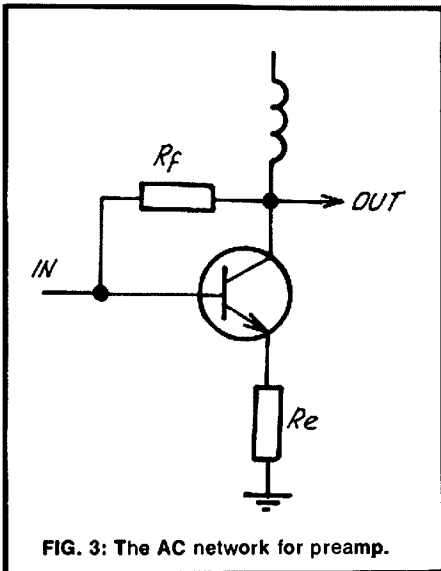

FIG. 3: The AC network for preamp.

Gain  $\sim 19$  dB  
 Input  $\sim 50$  ohms  
 Output  $\sim 75$  ohms  
 BW  $\sim 200$  kHz — 50 MHz

The performance of this amplifier was measured using a single generator and attenuator driving the amplifier into a resistive load — however at VHF the amplifier was tried out as a preamplifier for a TV set.

Since we live in a fringe area for channel 6 and channel 8, Lismore, I was able to use these signals and a colour TV set to perform the gain measurements in the VHF region. The amplifier was preceded

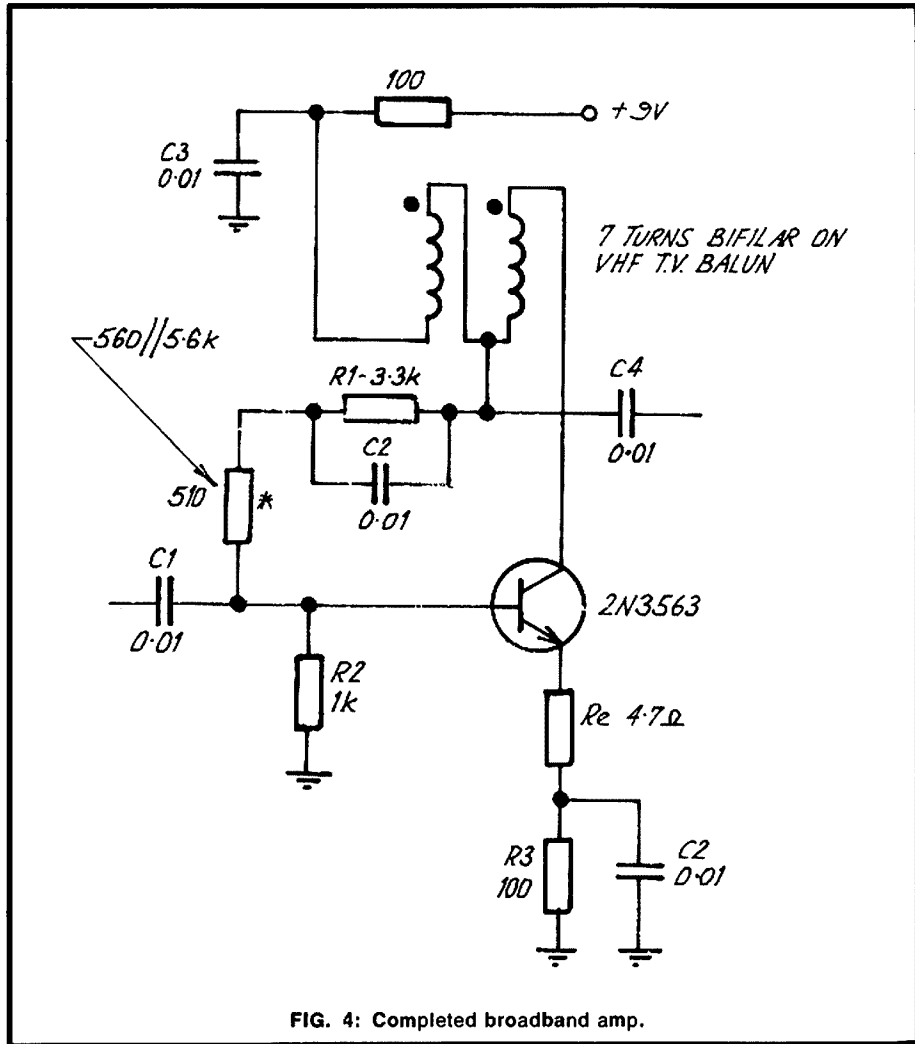

FIG. 4: Completed broadband amp.

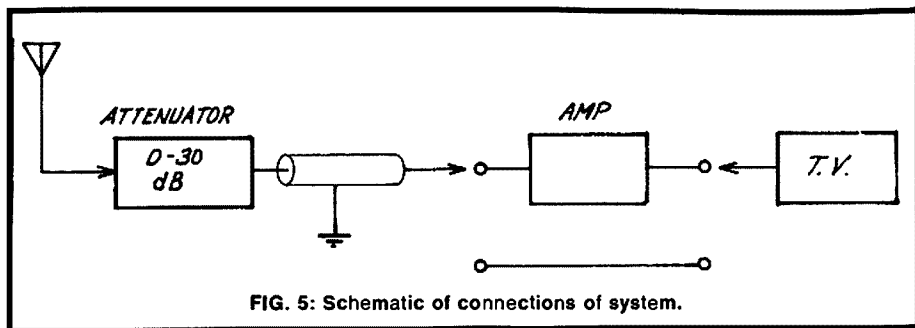

FIG. 5: Schematic of connections of system.

by a step attenuator 0-30 dB and followed by a TV set. The attenuator was adjusted for colour dropout with and without the amplifier present. (All signals were along 75 ohm coax.) This provided a rough estimate of 6 dB gain at 178 MHz and 3 dB gain at 192 MHz.

A special thanks to my father, Rev. Bruce Holland VK2ZAD, for the opportunity to use his reference library and the use of his test equipment.

Thanks also to Nathan VK2DDT for providing me with the original initiative to build the probe and amplifier.

REFERENCES

1. Wideband IF Autotransformer, John J. Nagle K4KJ, Ham Radio, November 1976, page 10.
2. Wideband Preamp, Ed Pacyna W1AAZ, Ham Radio, October 1976, page 61.
3. General Purpose Wideband RF Amp, Randall Rhea WB4KSS, Ham Radio, April 1975, page 58.
4. Linear Application Notes, NS National Volume 1 AN32, page 7.
5. Transistors Small Signal Field Effect Power, National.
6. Solid State Design for the Radio Amateur, ARRL 1977.

# DCDF (Dirt Cheap Direction Finding)

Say "DIRECTION FINDING" to most people and they immediately envision vans full of sophisticated electronic equipment with neat continuously rotating antennas and other "beep-beep" or "ding-ding" systems. Even we highly trained and well-educated amateur radio operators tend to slide off into such day-dreams. But direction finding does not have to be terribly sophisticated to be very effective. Remember, all the DF system is supposed to do is give the operator a fairly accurate indication of which direction a received signal is coming from. How accurate that indication must be is determined more by how versatile the operator is than by the circumstances in most cases. And, of course, cost is inversely proportional to sophistication. So let's get inverse and see how to do the job at lowest possible cost!

First, let's consider the elements of direction finding. The most common approach is to turn a directional antenna until the incoming signal gives the strongest indication of signal strength on some form of signal strength meter. This will give

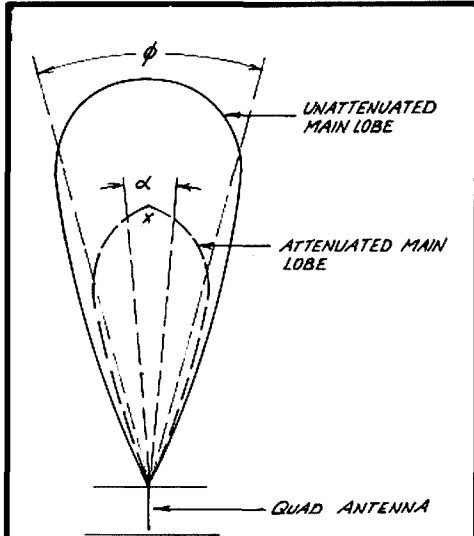

FIG. 1: DF lobe sharpening by attenuation.

another piece of equipment to carry along. However cost should not be a problem!

Another approach to the attenuation requirement is to attenuate the signal within the receiver itself. Before you faint, read on, 'cause it "aint't that bad"! The addition of a small 5000 ohm linear tape potentiometer in the RF section of your receiver will allow you to directly adjust the gain of the RF amplifier, and consequently the apparent signal strength of the incoming signal. This is most simply done by reducing the "B+" voltage applied to the RF stage(s). Specific connection points for several popular transceivers are given in Fig. 3. A quick look at the schematic diagram for your receiver should let you find the equivalent points in your receiver. By using some of those cute tiny new potentiometers, with the sexy little knobs, you can actually make the modification improve the looks of your rig, too! And that would be a real change for me!!!

In anticipation of the comment now made by one of our highly technical members, I will provide appropriate answer. Yes, it will tend to distort the incoming signal to drop the "B+" on the RF stage in an amplitude sense. But isn't FM wonderful!

All this time we have assumed that we had a perfectly good directional antenna giving us all those beautiful directional signals. Now we have to figure out how to build one of those for less than a fortune.

The simplest directional antenna is the legendary DF LOOP. That is a fine directional antenna except that it is bi-directional! So it gives only a line on which the signal source will lie, not the final direction. Why did you think the DF vans continuously rotate their DF loops?

So let's try to find another antenna with good directional characteristics and without the ambiguity of the DF loop. The cubical quad comes to mind almost instantly since it is nothing more than our DF loop with a reflector added to eliminate the other side of the world. And it works very well! Front-to-back ratios of 20 to 25 dB are not at all unusual. It also has a very well defined main lobe so the attenuator technique previously suggested works like a champ! The quad also lends itself very well to minimum cost construction as Fig. 4 demonstrates. Anyone who spends more than \$15 for the materials should find another lumber yard and hardware store!

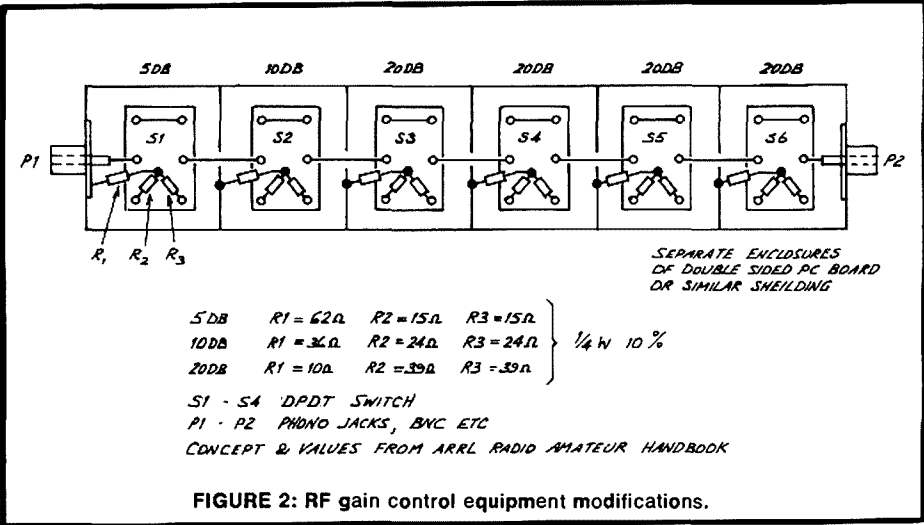

FIGURE 2: RF gain control equipment modifications.

good definition of direction as long as the signal source is far enough away that the signal strength (S) meter is not pegged. For closer signals, the direction definition in terms of beam width gets too wide to be useful. (See Fig. 1.) Rather than move farther from the signal to reduce the signal level (we're trying to find it, remember?), let's fool the receiver S meter by attenuating the signal electronically. This results in the apparent lobe shown by dotted lines in Fig. 1. So we can now move even closer to the signal by just continuing to attenuate the signal until we are right on top of it!

(Note: Some exaggeration exists in the last statement.) But the problem is . . . how to do all this inexpensively!

Let's start by figuring out how to attenuate the signal. Fig. 2 shows an inexpensive home-built attenuator which will provide a rather wide range of reduction capability. It has the advantage of not requiring any modification of the receiver being used for the DF system. It has the disadvantage of precluding use of the transmitter portion of a transceiver without disconnecting the antenna and attenuator each time. It also means



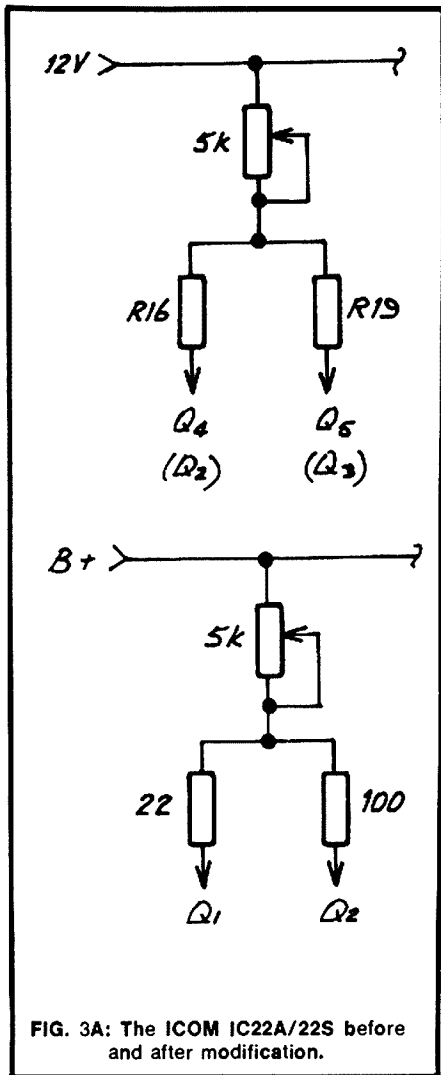

FIG. 3A: The ICOM IC22A/22S before and after modification.

Mounting the antenna on your means of transportation is left to the ingenuity of the builder. One simple method used a single roof-top carrier section. A 2 x 4 length was clamped/tied/nailed to the cross-member and a 5/8 in. hole drilled to accept the 5/8 in. mast of the quad. This turned out to be force-fit and quite adequately damped the rotation of the antenna while moving from position to position. The support was also adequate to keep the antenna from departing the vehicle for all reasonable speeds (legal).

One more technical note—a phenolic block is not required in the reflector loop and tuning of the loops is unnecessary if the dimensions are met reasonably close.

Lest I be given more credit than is my due, I would like to identify the real sources of the information contained in this article. The development of the antenna and the attenuation scheme was done in San Antonio, TX by K5GJN and WB5SXG (now of Oklahoma City). Good luck and good hunting.

Don Graham WA5TAW.

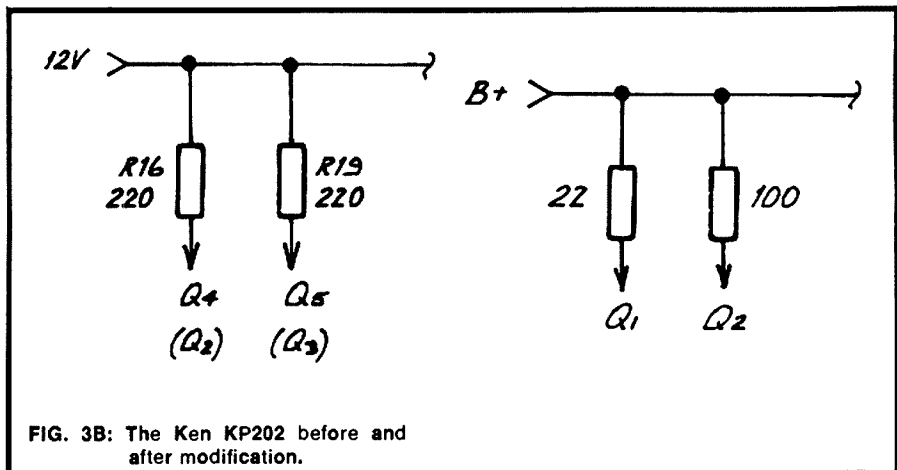

FIG. 3B: The Ken KP202 before and after modification.

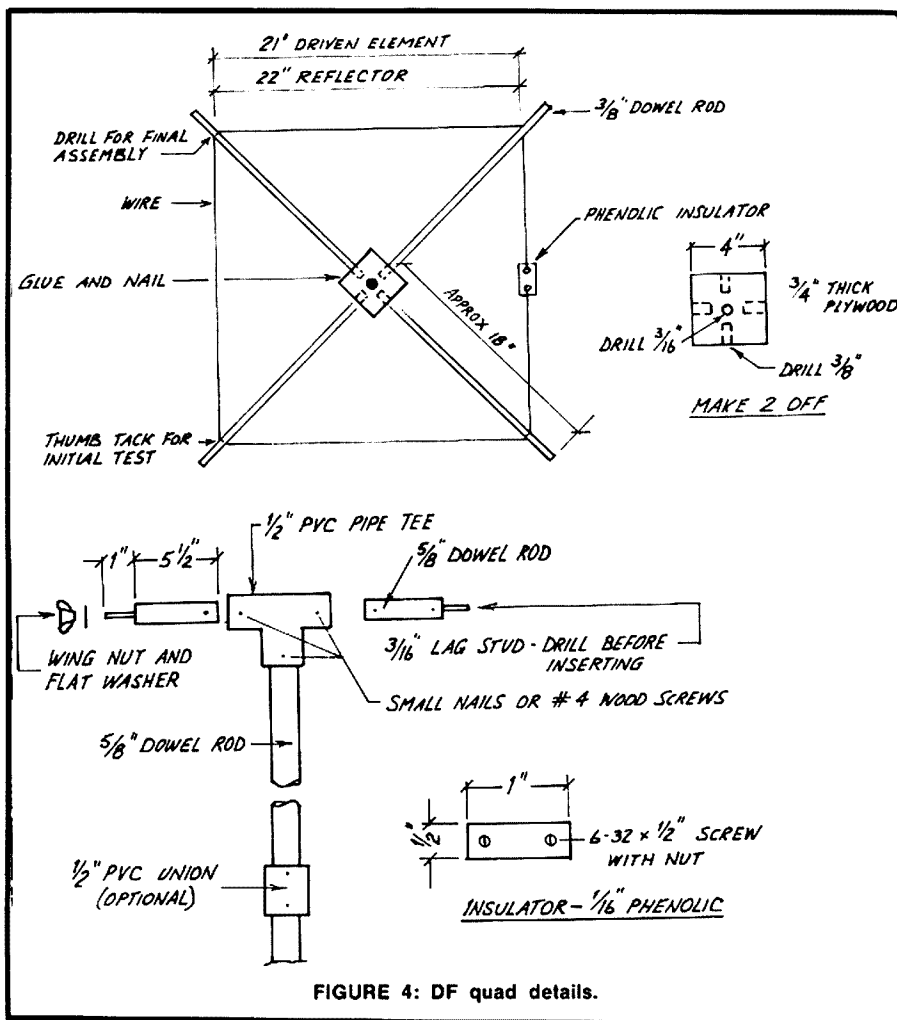

FIGURE 4: DF quad details.

**MATERIALS**

- 4 — 3 ft. x 5/8 in. dowel rods.
- 10 RL — 3 ft. x 5/8 in. dowel rods.
- 2 — 4 in. x 4 in. x 3/4 in. plates.
- 1 — 1/2 in. ID PVC pipe tee.
- 2 — 3/16 in. lag studs.
- 2 — 3/16 in. wing nuts.

- 2 — 3/16 in. flat washers.
- 1 — 1/2 in. ID PVC pipe union (if extra mast if needed).
- 1 — Small phenolic piece.
- 2 — 6-32 x 1/2 in. screws w/nuts.
- 8 ft. of No. 178 AWG (or larger) stranded wire.

# Weather Satellite Converter

John E. Dunkley VK5JE  
9 Elva Ave., Pooraka, SA 5095.

Few communication experiences can equal the excitement of seeing a picture being printed in real time from an orbiting satellite within range of one's home station. A converter for the reception of polar-orbiting weather satellite transmissions in the 135-138 MHz band is described. Dual-gate protected field-effect transistors providing good noise figure and stability, followed by an integrated circuit gain-block form the basis of the unit.

(Although this article is not strictly related to amateur radio as such, building the converter will give the constructor good practice and experience in building VHF FM equipment.)

Weather satellites have been around for some years now, commencing with an experimental version launched in 1963 gaining public awareness, and coming of age with the highly successful ESSA series, through to the current generation known as the TIROS-N series.

Technology has now advanced to the stage where the current series of weather satellites provide very high resolution and low APT (Automatic Picture Transmission) resolution photographs both day and night using visible and infra-red (IR) information covering several spectral bands.

Constructional articles for the reception of pictures from weather satellites have appeared in several overseas magazines dating back to 1965. The introduction of latest generation weather satellites (TIROS-N series) has necessitated some changes from earlier practices. The unit now described is the front-end converter currently being used for regular reception and printout of real-time weather pictures.

Signal from the antenna—via a FET pre-amplifier—is coupled into T1 of the converter via L1, and with L2 provides amplification of the input signal.

A dual-gate protected FET was used for this stage as it requires no neutralisation and is currently a very popular device both in availability and performance. Signal is then coupled into the mixer T2 via L3 which is positioned physically 7/8 in. centre to centre from L2. Oscillator injection is applied to G2 of this device. The 330 ohm resistor in the drain of T2 correctly matches the input of the low-cost 10.7 MHz Murata filter type SF10.7MA. Some sacrifice in gain is made here but it is amply recovered by IC1.

IC1, a uA753 "gain block" as it is called by its manufacturer, has some 30 dB gain at 10.7 MHz and no instabilities of any kind have been encountered during its use. This integrated circuit consists of a three-stage direct-coupled amplifier with 330 ohm input and output terminations and with its 7 pF shunting capacitor appears to have been tailor-made for the ceramic

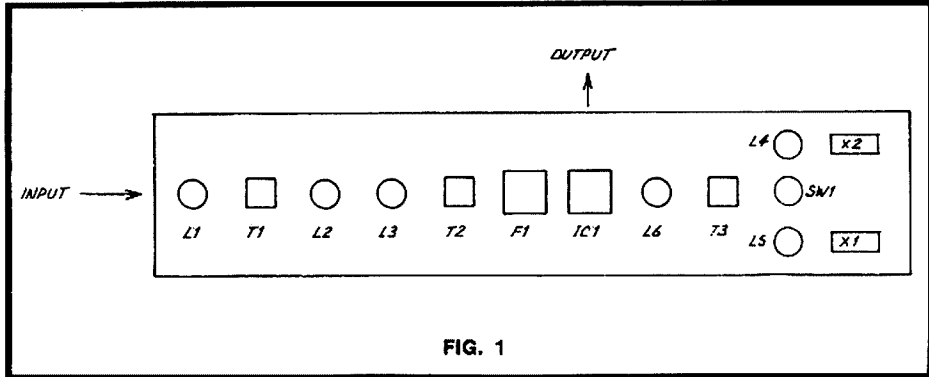

FIG. 1

filter used! Output from pin 5 of this device is AC coupled and goes to the IF strip demodulator.

The local oscillator is a well tried and proven circuit, having appeared several times in this magazine. Some difficulties were initially encountered around the switch area but keeping lead-lengths of L4 and L5 to a minimum cured the problem.

Construction of the unit should follow good VHF wiring practice in that all leads be as short as possible, especially bypass

capacitors. The prototype was constructed using pins through single-sided printed circuit board—remembering to clear the copper from the pin where it is not required! The earth plane provides good connection points for all components connected to ground.

Fig. 1 shows the placement of major components.

The in-line arrangement of all components forms a good basis to ensure stability and the completed unit is totally enclosed in a brass box.

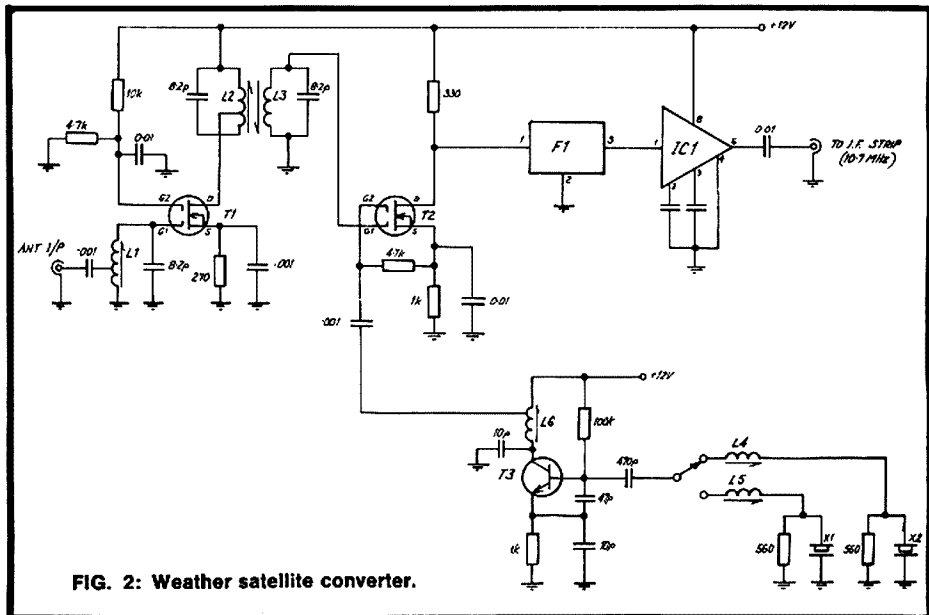

FIG. 2: Weather satellite converter.

Tuning is simple once the crystal oscillator is functioning. L4 and L5 are provided to enable frequency trimming and L6 is tuned to the 3rd harmonic of the crystal. An input signal midway between the two frequencies (137.50 and 137.62 MHz) is applied and L1, L2 and L3 are adjusted for maximum output.

Although the unit as described was constructed specifically for weather satellite reception it requires only minimal modifi-

cation to form the basis of a good 144-148 MHz front end. It should however be kept in mind that the integrated circuit used is a FM limiting device and as such is not suitable for AM or SSB reception.

Further correspondence by interested persons is invited.

Previous article by same author: Amateur Radio, November 1972, "An Integrated Circuit IF Strip".

L1 5T No. 20 tap 1½T from earth.  
L2 5T No. 20 tap 2½T from rail.  
L3 5T No. 20.  
L4, L5 12T No. 28.  
L6 6T No. 18 tap 2T from rail.  
L2 and L3 separated 7/8 in. C-C.

All coils on neosid formers with F29 slug.  
F1 Murata filter SF10.7MA.

# Writing an Article for "Amateur Radio"

One of the purposes of this magazine is to publish technical articles.

From what we hear on air, there are enough people doing interesting things to positively flood us out with articles.

Strangely enough, one of the commonest reasons for not submitting articles seems to be just plain shyness at committing things to print. Next is ignorance of how to go about it. Well, we do want YOUR article and if you read on we will tell you how to go about it.

## WHAT CAN YOU WRITE ABOUT?

Anything which may be of interest to any other amateur. If it interests more than one, so much the better. The easiest thing to write about is something you have built, big or small. (There is a terrific demand for small articles of the Hints and Kinks variety.) Test equipment, VHF, mobile, antennae, gear for the newcomer, receivers, transmitters are all needed. There is also a place for theoretical or instructional articles, but don't try these without a bit of experience. If in doubt, ask the Editor if he thinks the subject would make a suitable article.

## HOW DO YOU WRITE IT?

Technical articles should be written in as simple and direct a manner as possible. The "level" should be chosen to suit the subject and the type of reader for whom the article is intended. Most articles will be intended for that mythical being, the average reader. Simple sentences are usually far more effective than long involved sentences.

Plan your article along logical line so that the reader does not have to jump backwards and forwards between the various sections. For example, a simple constructional article could be organised as follows:—

Introduction: Scope and aim of the article, advantages of the equipment, etc.

Circuit: General description.

Layout and Construction: Special features.

Operational Details: Alignment, testing, etc.

Results achieved.

If possible, type your article and *always use double spacing*; otherwise use lined paper and remember that your article will have to be read by printers and other persons who may not be acquainted with technical terms, so *write legibly*. For preference use a paper size quarto or foolscap and leave 1 in. margins. The printer, quite rightly, charges us for the extra time involved in handling articles written on the backs of tram tickets, brown paper, confetti, etc. Type or print on one side only, number each sheet, and write your name and the title of each sheet.

Articles should be as brief and concise as possible; "padding" should be avoided at all costs. Never hesitate to submit an article simply because it appears to be of less than average length.

Use standard English and avoid jargon such as "short" for "short circuit", "amp." for "current", "volts" for "voltage", etc.

When finished, get someone to read it out aloud. You will soon see if it has continuity and is legible to a person other than yourself.

Sketches and circuit diagrams should be drawn on separate sheets of paper with the figure number, title and your name on the top. Almost invariably these will have to be re-drawn by our draftsmen. This is one of the hardest yet least known jobs of the Magazine Committee. If you have drafting knowledge or can get it done by a friend, then help us to ease the drafting bottleneck by supplying circuit diagrams ready for the plate-maker.

The width is the important measurement. If the drawing will occupy one column in width, make your drawing 4½ in. wide, as it will be reduced in processing to half size. Two and three column drawings should be 9 in. and 13½ in. wide respectively.

All lettering should be 3/16 in. high and make all lines heavy to help reproduction.

All lettering should be kept within the confines of the drawing; we have to pay

on the maximum width and height taken by the plate-maker, in calculating the cost.

We are always happy to print photographs.

As the circuit is usually the heart of the article, you cannot take too much care in seeing that it is correct, that the values of all components are given and that it is arranged so as to be easily read. There are two systems for giving the component values; one is to print the value by the component, the other is to label them R1, R2—C1, C2—L1, L2, etc., and give a table of values underneath. The first system is probably easier to prepare and to read, whilst the second is the only way of stating voltage ratings, wattages, etc., of components. We have no fixed ideas as to which to use. Probably a compromise system is best where usual components are marked with values and unusual components marked R1, etc., and commented on underneath.

## WHAT THEN?

Having written the article and prepared the diagrams, send them to the Editor, C/- PO Box 150, Toorak, Vic. 3142. If you do not receive acknowledgment in say three or four weeks, contact the Editor and ask him what's happening.

The normal delay for drafting, editing and type setting is about three months. Completed articles have to be in the printer's hands not later than the first of the month prior to the month of publication. So the shortest possible time in which an article can be published is approximately five months. Circuits which involve a lot of drafting take longer.

Looking forward to your article,

We remain, your humble servant,

The Magazine Committee.

(Derived from a previous AR article, February 1955.)

## UNITY IS STRENGTH

# Mobiling the American and Canadian Rockies

Arthur Brown VK2IK and XYL Phyl  
26 Winifred Ave., Epping, N.S.W. 2121

During the northern summer of 1940 whilst returning from Britain, a mate and myself motorcycled across USA and Canada on my 1934 600cc Square Four Ariel bike and sidecar. We covered the 6,000 mile journey from New York to Vancouver in six weeks via Niagara, Grand Canyon, the Rockies to Calgary and over what was then the rough Kicking Horse Pass and through to Vancouver. I was so impressed by the scenic grandeur of the National Parks that I had a yearning to see these parts again.

In 1978 plans were laid first of all to visit friends and relations in Britain and then fly to Los Angeles and organise for a nostalgic journey. This would be along the Rockies and as far north as a 12-week period in the American Continent seemed feasible. It was hoped also to take 2 metre gear and to acquire HF gear in the States so that we could meet the "locals" and keep in touch with VK.

## RECIPROCAL LICENSING

Some homework had to be done first with reciprocal licensing for W and VE and also international driving licences. Statements of accident-free driving were also obtained from our insurers which proved quite useful for G-land, but worthless for W-land. Thereby hangs another tale! The Canadian reciprocal licence came almost by return post, but the US application was most protracted even extending to within a few weeks of our arrival from London in Los Angeles (May 1979), taking six months to complete. Intending applicants should note that not only do you supply copies of your Amateur Operator's Certificate and current station licence, together with the appropriate application form, but you must also supply a copy of your Amateur Station Licence which verifies your VK call sign and furthermore, if the expiry date of your current station licence occurs during the period you wish to have the reciprocal licence, then this must be renewed, maybe months in advance, before the application will be processed.

Thus it was in February 1979 that XYL Phyl and myself left Sydney Airport in a heatwave and 29 hours later arrived at Heathrow in a snowstorm! Having had a reciprocal licence previously for G-land it was a fairly simple matter to have the call G3TMO re-validated at the Home Office. This required the re-sighting of the Amateur Operator's Certificate and current station licence, filling in the application and payment of the fee.

The weeks passed rapidly, visiting family and friends. The 2 metre gear fitted into the temporary car we purchased helped to keep in touch with the "locals". Like many others before us we queued around Australia House for two days and finally sold the car.

## W & VE LAND

Next day we flew up into the Arctic Circle and saw glimpses of Iceland and Greenland far below and then the iceberg-strewn sea of the Hudson Bay. Our approach to Los Angeles was over the snow-capped Rocky Mountains, and then over what appeared to be desert areas of California.

At Los Angeles we were met by a nephew who, in conjunction with helpful friends, assisted us with accommodation and local knowledge. A one-owner 1967 Oldsmobile automatic station wagon with power steering and air-conditioning was obtained and fitted up for camping. A support bracket was fitted to the luggage rack, which then mounted the "G whip" multi-band antenna.

## INSURANCE PROBLEMS

As mentioned earlier, problem arose with insurance despite the insurance statements from home. We did not have a Californian driving licence nor were we residents of USA. One insurance broker finally accepted us only to notify us later at Salt Lake City that his company had overruled his decision. And so we went the rounds of SLC until finally a helpful broker solved the situation for us. One broker remarked that there would have been no problem if the vehicle had been owned by a resident of USA with us as nominated users! A useful hint perhaps!

Going south to Oceanside I was able to obtain a 5-band Alda HF 200W PEP solid state transceiver. It was surprising to find the factories of Swan and Atlas all nearby at the same place. The combination of the Alda and G-whip worked well and opened many a door throughout the trip.

It was also very effective in jumping the Pacific Ocean back into VK. Very early in the tour we met up with Harry VK2DA in Balgowlah. We were at our Sunset Crater camp in Arizona when Harry appeared 5 and 9 on 14 MHz. For the next nine weeks he was to be like our "Genie". At a time when mail strikes were "on" in VK Harry brought us news of Sydney and of our family. Sometimes it was by CW but mostly by SSB. Whilst in W6, W7 and KL7, to escape the American kilowatts I was obliged to respond in CW below 14.200, then after exchanging reports, QTH, etc., we would move up to the phone band to try SSB both ways. In VE6, VE7 and VY1 the solution was simple, keep out of the American phone band and use SSB. We were indeed grateful for these early morning contacts which, despite the distance, made VK and home as close as the Alda. At times, with mountains soaring thousands of feet above our camp-site, it was surprising the signal strengths which came over seemingly impossible pathways.

## XYL's DESCRIPTION OF TOUR

A lot of the account which follows was prepared by XYL Phyl from letters to family and friends. From Oceanside we were soon on our way across the Mojave Desert to Las Vegas, Lake Mead and Hoover Dam and seeing the Colorado River which flows through Grand Canyon country. Grand Canyon has to be seen to be believed, as no photo does justice to its mighty splendour and mile-deep gorge. On the South Rim shuttle buses take tourists from one view point to the next, thus eliminating private cars on the rim edge. To see the North Rim it is necessary to drive around 100 miles through the Painted Desert area. We took the opportunity to visit Lee's Crossing where the rubber boats take parties down the rapids. Spectacular orange-red cliffs tower above the river against a vivid blue sky. Our trip

to the North Rim brought us up the mountain range again into snow country and wilderness area.

From Arizona into Utah we traversed Zion Canyon looking up from the Virgin River to great outcrops of massive rock eroded to fantastic shapes by time and weather. Further on Bryce Canyon National Park rose to elevations of 9,000 ft. and we looked down on vast areas eroded by water, ice and snow over the centuries, leaving formations of columns, spires and pinnacles of pink, orange, red, mauve, purple and white. It amazed us to see forests at such high elevations, for our Mount Kosciusko in Australia loses the tree line at 6,000 ft. We were cold at night and snow still lay about. Tiny chipmunks begged at our feet for food and we longed to feed them but complied with the many requests not to do so. It seemed hard to believe that these dainty creatures could be possible carriers of bubonic plague. Following the great mountain range through farmlands and such places as Big Rock Candy Mountain, we came to the modern University Cities of Provo and Salt Lake City, where we stayed for a few days. We visited the Mormon Temple grounds, listened to the famous Tabernacle Choir and Organ, looked over the City and visited the Salt Lake itself.

Further north the Grand Teton National Park with its serrated soaring peaks, blue lakes, streams, glaciers, forests and wilderness is a magnificent area. Crossing the mountains at an elevation of 8,429 ft. we descended into the valley of the Snake River, where fur traders penetrated this entirely Indian country in the early 1800s and hunted beaver. We appreciated the Visitors' Centres in these National Parks, which are a mine of information. This is bear country, with moose, bison, elk and deer, and we could see some of these in the distance far from the road. Entering the famous Yellowstone National Park at an elevation of 6,886 ft., we later crossed the Continental Divide at 8,000 ft. with ice-edged lakes and piles of snow. Then we came to Yellowstone Lake with a crater basin. What an experience to see boiling water holes, mud pots plopping, hissing steam vents and far above it all snow-capped mountains. What a country! Old Faithful Geyser displayed well for us with a spout of boiling water at least 100 ft. high. The Yellowstone Grand Canyon is spectacular with the river descending in two falls a total height of 400 ft. and these viewed from various points along the canyon make an impressive sight. With much thermal activity, high mountains, vast forests, fossil areas, prolific animal and bird life there is so much to intrigue the tourist.

We made further north in the Rocky Mountains to the Glacier National Park, and were pleased to find the "Going to the Sun Road" just opened for traffic. Here we crossed Logan Pass at 6,664 ft. with snow banked 30 ft. high each side of the road and snow ploughs still in operation. Views

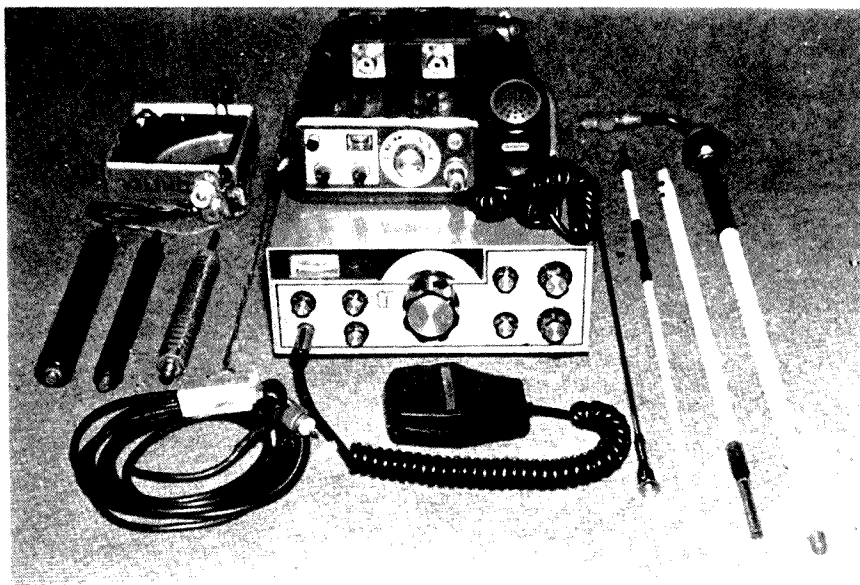

**PHOTO 1:**  
Equipment used for tour. Back, l. to r.: Multimeter and SWR (home brew), Kenwood TR2200G and 10 watt PA (2Mx). Centre, l. to r.: Ant. loading coils (80 Mx, 40 Mx, 20 Mx), 2 Mx quarter wave gutter mounting and cable, Alda 105 HF transceiver, "G" whip adjustable top section, 20/15 Mx helical top section, "G" whip helical section 10 Mx (two halves).

below of lakes and mountains were breathtaking in their beauty. We were soon into the equally beautiful Waterton Park in Canada and later when travelling in the Kootenay National Park we saw our first bears—a mother and two babies. It was rather showery in Banff National Park, but we enjoyed what we could of this lovely setting of mountain, forest, river and lake. From 1940 Arthur had spoken of Lake Moraine as the highlights of his experience. The weather was deteriorating when we visited these, but still it was a glorious sight to view glaciers locked between mountain peaks soaring high above the lake. Lake Moraine was still partly ice with the mountain snows not yet fully melted to fill the lake. Next morning visibility was bad with snow falling and low cloud, so we went down the Kicking Horse Pass viewing waterfalls and the Canadian Pacific Railway which was built here in 1908 using unique spiral tunnels to reduce the grade. The following morning, with the weather slightly improved, we were just able to distinguish outlines of some great mountains along the Icefields Parkway to Jasper. Bow Lake was completely covered with thick ice and it was snowing when we ventured on the 600 ft. thick Athabasca Glacier in a snowmobile. West from Jasper we found Mt. Robson (13,000 ft.), the highest point in the Canadian Rockies, and we appreciated the burst of sunshine and river reflections of this great glacier-capped mountain when we awoke the next morning.

In Prince George on 2 metres we contacted Frank VE7AV (the local RI) and his Australian XYL, Diana VE7DTO, who came

to see us at the camp ground. They gave us useful information on a Field Day scheduled to be held in Whitehorse, Yukon, the following weekend. Making our way towards the famed Alaska Highway, we detoured to look over the W.A.C. Bennett Hydro Dam which supplies Vancouver with electricity, and from Fort St. John we were on THE Highway. Reports stated that the road was unsealed but firm. What we did not expect was the afternoon thunderstorms which came without fail, coinciding with the grading of the road in readiness for the tourist season, and the consequent slush which covered vehicles so that they all appeared one colour—black! Our only puncture on the entire trip happened in rain on the Alaska Highway! Liard Hot Springs proved a pleasant oasis and we thoroughly enjoyed the novelty of bathing in 120°F water in the depths of the forest with snow-covered mountains above. In this pool we met some Australians, including a resident from our suburb! From this area we phoned the radio inspector in Yukon (Ian VY1AR) for permission to use the radio in the Territory. We were promptly invited to share in the Field Day and also offered the use of the Inspector's self-contained flat overnight. This was most acceptable, and next morning we joined the party of amateur radio people at Marsh Lake.

The Field Day proved one of the highlights of our trip, for it was here that we met most of the radio fraternity of Whitehorse. Possibly because of the extremes of winter in this area (—20°C to —60°C) necessitating indoor winter activities some wives had also qualified as radio amateurs,

so that of the 16 operators present, four were ladies. The transmitters were housed in two tents on the lake beach in front of the cabin owned by one family (Bill VY1BJ and XYL Sherron VY1BK). Children of the party amused themselves in the lake itself. We were told that the water had been frozen solid only a few weeks before — brrr! We had many insights into life in the Yukon during those 24 hours of operation of Amateur Station VY1DX portable VY1 and felt privileged to have been there participating in their club activities.

course of being restored and historic tours are conducted telling the short history of the sudden upsurge of population, the consequent influx of con-men, amusement parlours and pubs.

It was sheer luxury to go aboard the MV Malaspina and occupy a cabin overnight and to sit in the lounge by day and watch the scenery go by. Bad weather prevailed, but in the gloom we saw Haines, Juneau, Petersburg, Wrangell and even had a bus tour of Ketchikan. We stayed overnight at Prince Rupert and resumed

stant watch is kept on its seismic movements. Later we travelled to see Mt. Rainier, another 14,000 footer with 27 glaciers atop—scenes like this are unknown in Australia. Leaving Mt. Rainier we met at Mossyrock "Duke" WB7TQD and XYL Moe. It was a surprise meeting through the interest of the proprietor of the motel we stayed at overnight. We enjoyed their hospitality and had a good chat. Further on we saw evidence of great natural upheavals at Crater Lake National Park, Lava Beds National Park and Lassen Volcanic National Park. At Lake Tahoe, altitude 6,000 ft., we admired the scenery of the Sierra Nevada Mountains surrounding the blue forest-edged lake and further on the Calaveras Giant Trees, the largest living things on earth.

To reach the Calaveras we came over the Sierra Nevada Mountains at Ebbetts Pass, a narrow gravel road peaking at 8,700 ft. We later found out that the locals use this rather reluctantly as a better surfaced road taking a longer route is more suitable. After the Calaveras at the mountain village of Arnold, we briefly visited Walt W6ECF and XYL Bernice. From Arnold we found our way up another pass to Yosemite.

Despite the heat, loss of power steering and holiday crowds, Yosemite National Park, with forest, mountain and Sequoias, was something to experience. Likewise, our brief visit to the Sequoia National Forest, King's Canyon. Returning to Los Angeles after nine weeks and 8,820 miles by car and boat, it was great to think over all the varied things we had seen—mountains, canyons, thermal areas, giant forests, wild animals, tiny humming birds, huge glaciers and vast icefields. And with it all we had made a lot of new friends, for in every place we found the American and Canadian people to be most outgoing and friendly.

Several years earlier we had met over the air Em WA6OCT at LA. It was our pleasure to be hosted by him and Bernice his XYL before being farewelled by our earlier mentioned friends at Southgate, Los Angeles.

After an uneventful flight across the Pacific we at last welcomed the sight of our fair City and harbour bathed in early morning sunshine as we prepared to land at Kingsford Smith Airport. It was great to be safely home again with the family. ■

## QSP

### A DIFFERENT BEACON

An article in QST January 1980 describes the WB5ZNL beacon which may be described as an automated, digitally-controlled, high-power standard signal generator. It is on 14100 kHz every 15 minutes at and from the hour and temporarily located on Stanford University, south of San Francisco. The message transmitted via the non-directional antenna is on CW at the 100 watt level followed by a series of five 9 second dahs at power levels decreasing from 100W to 0.01W in laboratory calibrated 10 dB increments. Each dah is preceded by one to five dots to identify the power level. After the 0.01W dah the 100W signal is switched back for the sign off. ■



PHOTO 2:

Group at Field Day, Whitehorse, Yukon VY1DX Club Call. Back row, l. to r.: John VE7CWG, Bill VY1BJ, Brian VY1BE, Ron VY1AD, Ian VY1AR, Al VY1AH, Arthur VK2IK/VY1, Pauline (XYL VY1BE). Front Row, l. to r.: Dennis VY1BZ, Andre VY1CD, Gerry VY1BV, Sheila (XYL VY1BV), Dorothy WB6EPW (XYL VY1AN), Janet VY1BP, Kirk VY1CC, Sherron VY1BK (XYL VY1BJ), Sue (XYL VY1AR), Sharon VY1AL (XYLBR), Finlay VY1BR, Kiratin (friend of VY1BE family).

## MODULATED CORONA

An interesting phenomena observed during the early evening of the Field Day was the corona which appeared atop one of the trap verticals. One of the party had heard strange sounds and seen flashing lights sounding "CQ field day VY1DX portable VY1". Sure enough we had a modulated corona 4 inches long sloped at about 70° because of the breeze across the lake. This appeared from the trap vertical transmitting on 80 metres fed by the 1 kW linear.

Driving on the new highway over the White Pass of perpetual snows proved an intriguing journey en route to Skagway, Alaska. This route of the would-be Klondyke gold seekers is steeped in the 1898 gold rush history and in Skagway we saw evidence of the bitter conditions these people experienced in trying to seek their fortunes. Skagway itself is a funny little "has-been" town at the end of the Inner Passage. Dilapidated buildings are in

our journey on the Canadian vessel "Queen of Prince Rupert" along the narrow Grenville Channel to Vancouver Island. With improved weather we enjoyed driving the full length of the Island midst its extensive forest country. Here again through the radio we met Dick VE7DJH and XYL Cora, were invited to their home and given much appreciated hospitality. Victoria is very British, even to red double-decker buses and a contingent of Palace Guards complete with busbies. Our visit to the Butchart Gardens was rewarding—then over to the mainland and we drove up Howe Sound to Squamish, north of Vancouver. On the way out of Vancouver at Whiterock, we called in to see Al VE7AYN and XYL Evelyn. We had initially contacted Al on 10m earlier in the trip.

Seattle, USA, with its backdrop of Cascade Mountains, is a fine city and, of course, we had to go up the 600 ft. Space Needle to view the surroundings. Nearby Mt. Baker we learn is still active and con-

# The source?...

# SCALAR of course!



**TEN-TEC**, INC.

## **DELTA** All new, all nine hf bands

**DELTA** — the symbol of change — the name of a great new TEN-TEC transceiver. A change in features, in performance, styling, size — and in value. Study it — you will find the DELTA change is what you want in your shack.

**BROADBAND DESIGN** No receiver front end or final amplifier adjustments. From the pioneer in broad-band design, TEN-TEC

**BUILT-IN NOTCH FILTER.** Variable from 200 Hz to 3.5 KHz to notch out interfering carriers or CW signals to a depth of 50dB or more.

**ALL 9 HF BANDS.** First new rig since WARC. 160 meters through 10, including the new 10, 18 and 24.5 MHz bands! With everything incorporated except the plug-in crystals for 18 and 24.5 MHz segments (available when bands open to amateurs).

**ALL SOLID-STATE.** From the leaders in the field. For long life, less heat, and stable, proven performance.

**100% DUTY CYCLE.** For all-mode operation with confidence, without failure. 20 minute maximum key down time.

**“Ask about our range of SWR Meters, Coaxial Switches, Tuners, Linears, Speech Processors, Morse Tutors, Low Pass Filters and Scalar Antennas and accessories.**”



### **“THE SCALAR GROUP”**

**VIC: 20 Shelley Ave, Kilsyth. Phone 725 9677**

**NSW: 328 Kingsgrove Rd., Kingsgrove. Phone 502 2888**

**QLD: 8 Ferry Rd, West End. Phone 44 8024.**



*FOLLOW YAESU'S LEAD  
BE FIRST IN THE FIELD  
WITH EQUIPMENT FROM  
BAIL ELECTRONICS*

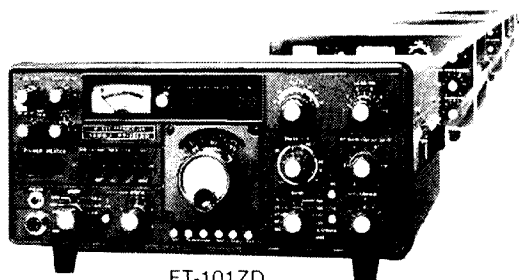

FT-101ZD

BOTH THESE  
UNITS NOW  
HAVE NEW  
WARC BANDS  
160m. to 10m.

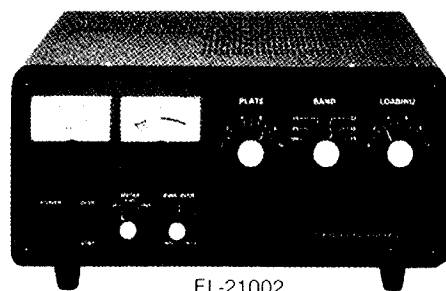

FL-21002

**Add more punch to your FT7 etc. with  
YAESU FL-110 200w linear amplifier**



FL-110

## STOP PRESS

The new 2m SSB, FM  
FT-480R with dual VFO  
here soon.  
Send for a colour  
brochure.

For the ultimate base station choose the FT901DM with tube finals or the FT107DMS all solid state.

All these and more are obtainable from Bail at competitive prices. We don't just sell a set. Our concern extends throughout the life of your equipment.

**bail**

### BAIL ELECTRONIC SERVICES

38 FAITHFUL STREET, WANGARATTA 3677

Telephone: (057) 21 6260 — Telex: 56880

DISTRIBUTORS AND AGENTS IN ALL STATES

Stan Roberts  
and Staff —  
VK3BSR



# The Value of Wireless Telegraphy

Arnold E. Lawrence VK3BHI  
Flat 5, "Brentwood",  
381 Alma Road, North Caulfield 3161

**Death claims fewer victims today from among those who go down to the sea in ships than it did before the advent of wireless telegraphy. How often, in stories of sailing ships, do we read quotations such as these: "She left Monte Video for Australia, but never reached port. Some wreckage, later found near Cape Horn, was identified as part of the ship". Or this: "She left Buenos Aires for Australia, but never arrived. Sighted off Monte Video soon afterwards, she disappeared leaving no trace at all of the 45 cadets and 15 crew who were on board".**

Our story is quite different. It tells of the part wireless telegraphy played in the rescue of the Oil Tanker Havre, adrift in a southerly buster in the Tasman Sea.

With engines stopped through lack of fuel, and lashed by cyclonic storms, the tanker Havre was blown off course in a wide circle in the direction of Lord Howe Island. She was ultimately rescued and towed 365 miles into Newcastle by the tug Champion. Without wireless, there is every likelihood she would have disappeared without trace.

This is not fiction, but a true story of the sea and the actual happenings, as told by the wireless operator, then a youngster, and by now possibly the only surviving member of the crew.

The story begins in New Zealand. At the close of World War 1 I joined the ranks of hundreds of officers and seamen who became redundant as their ships were laid up. Scores of unemployed seamen roamed the waterfront searching for work. One day I was lucky to be on the spot and available when the Tanker Havre arrived in Auckland minus her wireless operator. I was sent up to Auckland to join her.

First Impressions of the Havre were disappointing. She was small and dirty, only a few thousand tons gross burden . . . a real tramp compared to the floating palaces of today, with their glamorized accommodation, but what a mighty ship she proved to be, to come through the pounding she got. To me she was a job, three meals a day, and a bed.

The general bustle of unloading was in progress with the usual rattle and roar of winches. As I stepped aboard I passed the 2nd engineer, a ferocious looking individual, yelling orders to some of the Chinese crew, and calling them a lot of bloody bastards. I wondered what I'd struck, but the 3rd mate said, "Don't worry about him, the bugger's never sober — he doesn't know any better."

I next presented myself to the Captain, and told him I had been sent as the new wireless operator; frankly he seemed quite indifferent.

"I don't know that we really need an operator," he said. "We came all the way from Singapore without one. He wasn't much good anyway, and couldn't get more than 50 miles on the set. He wasn't there on sailing time, so we had to leave without him. Still if you would like a trip to Singapore we'd better get you signed on."

In view of the Captain's remarks, I guessed the transmitter was faulty. We could not go to sea with it like that, so I called in the Auckland Superintendent, and between us we spent a whole day on it, and gave it a complete overhaul, after which it performed perfectly. On the trip out of Auckland stations 500 and 600 miles away were raised easily on transmitter and double that distance receiving — reasonably good even by today's standards.

Our final port of discharge was Dunedin. There was no return cargo — however for the long trip across to Newcastle a large quantity of extra coal was required. The main bunkers were fully loaded, after which extra coal was piled loosely on the well-deck.

The ship's compliment of officers was nine. The bosun, steward, cooks and crew, were all Chinese. Having the wireless in operation was very welcome, bringing, as it did, daily news, racing information, sporting, as well as weather, time checks and contacts with the Agents.

As we passed Banks Peninsula, we were rolling steadily . . . the weather was bitterly cold and threatening. Weather reports were bad. Whisps of icy spray splashed through the decks and rigging. In the distance we could see the snow covered Kaikouras on our port quarter, and shivered in the icy blast from them.

It was on the following morning that I heard intermittent revolver shots coming from the bridge. The Captain and Chief Officer were taking pot shots at sea birds, some of which were Albatrosses, and one or two were shot and killed. This appeared to be flirting with providence somewhat. No one takes the legend of the "Ancient Mariner" seriously these days of

steam and diesel — nevertheless a strange premonition lingered that something grim and mysterious was about to happen to the ship.

Approaching Cook Strait, the glass dropped ominously and we knew we were heading for some kind of dire trouble. We had not long to wait. A gale of hurricane force sprang up with great rapidity, similar to what happened to the Wahine recently. Heavy seas fighting with eight knot currents churned up confused tumbling and bursting seas — the ship became hard to handle — taking sights was difficult and vital to our preservation. The officers were constantly taking bearings on anything visibility would allow. The Captain peered over the charts continuously. If he was worried he was wise and never showed it. He just gave orders in a quiet and even voice.

We got a bearing on Pencarrow light on the cliffs outside Wellington, also another one on the Brother's light on the northern tip of Marlborough Sound. Pencarrow light is very high, and in low visibility many ships have missed it and come to grief on the rocks at the foot of the cliffs, referred to jokingly by sailors as the Pencarrow cemetery. A lower light has since been built, and the light at Pencarrow discontinued. Only fifteen miles separate the two islands at this point, and in this kind of weather, one navigational error is usually the last.

With the gale partly tailing us in a dangerous manner, we slammed and yawed our way through Cook Strait, until Stevens Island light showed up on the port beam. This indicated that we were through the narrows and heading for the open sea. The light now hauled round to the south with fast increasing force, and really hit us. Mountainous seas tossed the ship about in an alarming manner. She heaved and dipped and yawed. The wind shrieked through the rigging and superstructure. Every now and then an exceptionally heavy sea would crash aboard, to hiss and roar through the decks and passageways like a clap of thunder. In the black-

ness of the night the ship would lift up on a huge wave, hover drunkenly on the crest, and slide down headlong into the black depths of the next wave, to bury her nose in it with a sickening thud.

The engineers, too, had a problem calling for endless watchfulness—the drunken movements of the ship brought her stern high out of the water with every second wave, this could set the screw racing and tearing the shaft to bits unless the throttle were clamped down right away.

Weary eyes on the bridge were searching for Cape Farewell light, which was at last picked up through the bad visibility. Numerous bearings were taken giving a good fix. Farewell light is the topmost point of the South Island, and juts well out into the Tasman Sea.

We were now well clear of both islands and heading in the open sea towards Newcastle.

Some confusion existed now about our coal supply. Slamming through Cook Strait, although at a mark-time rate, had consumed as much coal as if a longer distance had been covered. Furthermore, heavy seas breaking aboard had played havoc with the coal on the well deck. Practically all of this had been washed over the side. The Captain and Chief Engineer were gravely concerned with this situation. The Chief seemed unable to calculate the amount of tonnage we had remaining. He finally worked out that with what we had left we might just make Newcastle, provided the weather improved.

During this time, radio contact was maintained with Australian and New Zealand stations, also many ships among which were the R.M.S. Maheno, R.M.S. Ulmaroa, S.S. Maine and the battleship H.M.S. Renown, all of which were ready to stand by.

The weather at this point moderated a little and speed was increased slightly to get well clear of the land. Just as well, because the wind swung round to the south-west bringing a cyclonic gale from that direction. Out in the open sea with a longer fetch the waves reached greater heights, The Second Mate, who got a line from the bridge through a block on the cross-bar, calculated the waves were from 30 to 40 feet high.

Four days of cyclonic storms, and with practically all our coal exhausted, we were still only halfway across to Newcastle. The Chief Engineer admitted that we had only one day's coal supply remaining at this stage, with 430 miles to go. More fuel had to be found, so a start was made in stripping all the woodwork of the ship. This included the linings of the bunkers and the holds. The fires were stoked with this fuel, but it was soon obvious at the speed that it was consumed that this was futile.

As there was no battery emergency set for the radio it was decided to conserve

the rest of the woodwork for raising steam on the donkey engine to run the dynamo for sending wireless messages and making contacts with the outside world.

At this stage the Captain gave orders to heave-to, and a wireless message was despatched to the Agents for a tug to be sent to our assistance. The Mate was ordered to construct a deep sea anchor and a riding sail, and be ready to rig them.

At this stage the Chief Engineer greeted us with the cheerful little announcement that our fuel was exhausted, with the exception of the seven derricks. These we had to hold for sending wireless messages.

We soon lost steerage way and were at the mercy of the screaming gale. We were all over the place, and soon in the trough, wallowing and rolling to an alarming extent, and drifting helplessly northwards.

At breakfast, whilst struggling to eat, an extra heavy wave hit us, and hurled the ship right over on her side. The whole saloon practically stood on end—dishes and gear flew everywhere. We all grabbed the table and hung on to anything at all. The Captain was hurled against the bulkhead on his back.

"My God, she's going over," he exclaimed, in a tense but calm voice—we waited—but she didn't. After what seemed an eternity she gradually righted herself, coming back with a series of shuddering jerks, accompanied by the thunder of blocks and tackle and moving equipment. "We're bloody lucky to be alive after that lot," said the Captain—I have never known a ship roll that far before—"Get that deep sea anchor overboard quick—rig the storm sail too—don't bugger about—get cracking—otherwise we'll all be at the bottom of the sea.

The saloon and officers quarters were reduced to a shambles. Struggling amidst the chaos, I came upon the Second Mate, who had stopped at the Second Engineer's room. With a humorous grin he said, "Get a load of this, Sparks". There was the Second Engineer, amidst the wreckage of his room, on his knees.

"What the hell do you think you're doing?" yelled the Second Mate. "Don't tell me you're praying for that miserable soul of yours—it's not worth bloody-well saving." Rough sailor humour if you like, but a good laugh often helps. After all, weren't we all praying inwardly that the ship would hold together . . . and what about a prayer of thanks to the men on the Clyde who built her.

The Second Mate and I washed up on deck. The deep sea anchor had just gone overboard forrard. Soon it gripped the water. Round came the bow in a series of lurches, dives and shipping of seas. The storm sail on the mizzen blew the stern round fore and after to the wind and sea. The gale was driving us northwards off course, but hove-to as we were, the

immediate danger of capsizing was at least averted.

To maintain wireless contact, fuel had to be found to fire the donkey engine. The remainder of the linings of the bunkers and holds had now been consumed. The stage had now been reached where we were on the last remaining fuel supply—and these only for communication—our seven derricks. These were sawn up into three feet sections, and split in pieces with wedges and used very sparingly. Wireless messages and positions were only sent at special intervals—oil lamps were used for navigation and lighting.

Constant contact was maintained with the Agents, who advised that the tug Champion, fitted with radio, had left Newcastle in search of us, and asked us to wireless constant ship positions, drift, wind force, etc. A series of schedules was worked out. When the power became available, all messages outwards were sent, followed by a request for all inward messages to be sent on speck, and these would be acknowledged later when the power came on again. Regular positions were being sent and received by the Champion, but due to the low power of the transmitter of the tug, Sydney would lose contact during the day as we did. From our positions, wind drift, etc., it appeared we were being blown in a wide circle in the direction of Lord Howe Island. The Champion calculated this also, and headed in that direction.

On the sixth day of the drift, the double humped peaks of Lord Howe Island showed up on the starboard quarter. The thunder of the surf on the rocks could be clearly heard. That same afternoon a loud contact was made with the tug Champion, who reported that she was sixty miles away and making to us at seven knots. Glasses and telescopes were out searching the horizon, but it was not until 10 o'clock that night that an excited yell came from the Third Mate on the bridge—"Ship's light abeam—low down on horizon". First of all the three masthead lights appeared about three miles away, then the red port, and the green starboard lights, and later the porthole lights. A fairly high sea was still running, so the Champion approached us cautiously, working round the stern and standing off our starboard quarter. We could hear the throb of her powerful engines.

Soon she was within hailing distance on megaphones. "HAVRE AHOY" came the hail across the blackness.

"Champion ahoy," yelled our Captain through the megaphone. "Where the hell have you been?"

After a short pause came the reply. "Expected to pick you up nearer Sydney . . . had gales and poor visibility all the way. Left without a chronometer, so had to search on dead reckoning—we're lucky to get here—how are you off for food?—our food supplies are exhausted—have not eaten for 24 hours."

"OK Captain. We're glad to see you anyway. Yes, we have plenty of food. We'll get a line to you as soon as day breaks, which won't be long. Stand by till then."

As dawn was breaking a line was passed to the tug, a bosun's chair rigged, and soon bundles of food were on the way to the hungry crew of the Champion.

About an hour later a tow line was

shackled to the anchor chain of the Havre, and the long tow to Newcastle commenced. Supplies of fuel for the donkey engine were barely sufficient to send our last wireless message out but it got away all right. It was to the effect that the tug Champion had reached us and had us in tow, doing six knots in steadily improving weather. From this stage on the Champion took over communication.

The moral of this story can be summed up in three short findings.

1. Don't kill an Albatross.
2. Don't leave port without efficient wireless equipment and someone to work it.
3. Make sure you have sufficient fuel for any emergency. ■

## Why ASCII?

Stan Horzepa WA1LOU  
72 Stiles St., Wattebury, CT 06706  
Reprinted from QST April 1980

In the February instalment of QST ("ASCII/RPT", page 83), there was a discussion about the merits of a proposed repeater system designed for ASCII communications. As a result of that column, a number of readers asked, "Why ASCII?" Many agreed that ASCII would provide the fastest means of Amateur Radio communications, but that advantage would be lost because the majority of amateurs cannot even type as fast as the slowest Baudot speed of 60 w.p.m.

Can ASCII be used for practical communication? ASCII communications will be different than most of the forms of communications we amateurs are presently accustomed to. ASCII's closest cousin is Baudot-encoded radioteletype (RTTY). If you are familiar with Baudot RTTY, you know about the utilization of pre-punched paper tape and pre-recorded magnetic tape to send "RTTY art" and "brass" messages (messages that contain general information about the operator and his shack). This pre-programmed information is created before it is ever actually transmitted. In ASCII, in order to use high communication speeds to their fullest potential, pre-programmed information will be the name of the game.

The communication of pre-programmed information is not limited to art and brag messages. Some hams, who are also computer hobbyists, are already exchanging computer programmes via Baudot RTTY. Programmes written in machine language, as well as in higher-level languages such as BASIC, are being transmitted on 20 metres daily. Most of these programmes must be converted from seven-level ASCII (assuming that these programmes were written on computers using ASCII) to five-level Baudot. Software, hardware and sometimes both are necessary to perform the conversion. Now that hams are allowed to use ASCII, the conversion to Baudot is no longer necessary, and the conversion software and hardware can be eliminated.

Let's get something straight — a computer is not necessary for ASCII communications. A computer is an accessory. The reason that ASCII and computers are synonymous is that ASCII is used by most computers. ASCII is simply another code, as are the Morse and Baudot codes. The transmission and reception of ASCII will require equipment very similar to that used to transmit and receive Baudot. Some kind of ASCII terminal is necessary. A printer and keyboard will do the job or, if you prefer, the keyboard may be used with a video terminal instead of a printer. As in Baudot, the digital information leaving the terminal equipment must be converted to analog information (to the frequency-shift-keyed pulses used in radioteletype transmission). And all received (analog) signals must be converted back into digital information in order that the terminal equipment may display the received message. The conversion from digital to analog and analog to digital is accomplished with a modulator and demodulator just as it is accomplished in Baudot communications today.

Traffic handlers, who are interested in achieving the most efficient means of relaying traffic, might discover that ASCII can help them reach their goal. High-speed communications will mean high-speed traffic handling, and to take full advantage of ASCII and its relationship with the computer world, an ASCII traffic system may be created.

The key to this system would be regional ASCII-traffic repeaters. Such repeaters would need good coverage and would have to be tied to a microprocessor with a good-size memory. These repeaters would accept ASCII-encoded traffic 24 hours a day. As each message was received, it would be sorted by the microprocessor according to its destination and stored in memory for future relay. Local traffic would eventually be relayed to other stations checking into the repeater that could handle the traffic. Traffic destined for adjacent regions could be relayed to the regional ASCII-traffic repeaters in those adjacent regions. These inter-regional relays would be accomplished by linking the repeaters on a regular schedule. During each link, traffic destined to the other region could be relayed to the other repeater where it would be stored for local distribution. Traffic destined to go beyond adjacent regions could be relayed to a ham who would be a liaison to an HF ASCII transregional traffic net, or perhaps this traffic could be distributed to the distant regions by means of the future Amateur Radio satellites.

The only computer involved in this system would be the one in operation at the repeater. Users of this system would only need a terminal, modulator and demodulator to participate in ASCII traffic handling. Eventually, when the country is completely covered with regional ASCII-traffic repeaters, the HF liaison could be

eliminated and traffic could be relayed from regional repeater to regional repeater right across the continent.

A ham in Newington wishing to send a message to his cousin in San Deigo would sit down at his terminal and compose the message. The message could be punched on paper tape or typed into a message buffer. When the message was complete and ready for transmission, the ham would access the Hartford regional repeater and transmit the message at 1200 baud. This transfer would only take a few seconds, and when it was completed the repeater would acknowledge receipt. The repeater microprocessor would check the message's destination and store it for relay. On schedule, the Hartford repeater would link with the Bridgeport repeater and the message would be relayed to Bridgeport. Later, when Bridgeport and New York City linked, the message would again be relayed. After 20 or so links and relays, the message would reach the San Diego repeater. Upon being received there, the message would be sent into the microprocessor's "local" storage file. When a San Diego ham checked into the system, the message would be relayed to that check-in, who would deliver it to the cousin via the telephone.

Local groups could utilize similar ASCII repeater systems for local activity. Such systems could be the focal point for information exchange between radio club

members. Messages addressed to individual members could be sent to the repeater and stored for relay to the addressed individual whenever he happened to check into the repeater. Club bulletins and Amateur Radio news could also be stored for relay to all stations checking into the system. Computer games could be played through the system. Individuals could compete against each other or against the repeater's computer. Systems similar to this are already in operation. They are using Baudot at the requisite slower speeds, however. Some of these may switch to ASCII in the near future.

High-speed communication is desirable, practical and advantageous in osme situations. Extensive on-the-air experimentation with ASCII will teach us a lot about the mode. The FCC has opened the way — it's up to us to perfect ASCII Amateur Radio communications.

**ASCII PRIVILEGES**

ASCII, conforming to the American Standard Code for Information Exchange as defined in the American Standards Institute Standard X3.4/1968, is permitted between 3.5 and 21.25 MHz as an F1 emission on frequencies where this emission is permitted at a maximum speed of 300 baud; between 28 and 225 MHz as F1, F2 and A2 emissions where these emissions are permitted at a maximum speed of 1200 baud; above 420 MHz as F1, F2 and A2

emissions where these emissions are permitted at a maximum speed of 19.6 kilobaud.

**THE OLD BAUD GAME**

Baud is the number of bits transferred in 1 second. So, 1200 baud means that 1200 bits are transferred in 1 second — 1200 bits per second (b.p.s.).

A bit is a contraction of binary digit. It represents the smallest single unit of information in a binary system. This information is either on or off; on is represented by 1, while off is represented by 0.

ASCII alphanumeric characters each contain 7 bits (for example, the letter "H" is ASCII-encoded as 10001000). Each character may be followed by an optional "parity" bit which is used to detect errors — for a total of 8 bits per character (7 character bits and 1 parity bit). If the transmission timing depends upon the reception of each character (asynchronous transmission), each character is preceded by a "start" bit and followed by one or more "stop" bits, for a total of 10 or more bits per character.

At 1200 baud, 171 7-bit characters will be transferred in 1 second, and 10,285 7-bit characters will be transferred in 1 minute. If parity, start and stop bits are added, only (sic) 120 characters will be transferred in 1 second, and only (sic) 7200 characters will be transferred in 1 minute. ■

# CALLING ALL COUNTRY AMATEUR RADIO CLUB PROGRAM ORGANISERS!

**HOW TO ORDER**

Send your request with blank ¾" Umatic cassette(s) and sufficient stamps to cover postage from Adelaide to your town to:

**JOHN INGHAM**  
Federal Videotape Co-Ordinator  
37 Second Avenue,  
Sefton Park, S.A. 5083

Having trouble finding suitable speakers for your Club's Technical Meetings?

**THE WIA LIBRARY OF TECHNICAL LECTURES MAY SOLVE YOUR PROBLEMS!**

Most were recorded at the VK5 WIA Monthly Meetings SPECIFICALLY FOR COUNTRY AR CLUBS!

**Subjects presently on Hand (Group C):**

Wire Antennas .....	B & W	40 mins.
Radio Teletype .....	B & W	40 mins.
Tracking Oscar .....	B & W	30 mins.
The Apollo 13 Disaster .....	Colour	1 hr. 20 mins.
The Signal to Noise Story .....	Colour	45 mins.
Microcomputers .....	Colour	50 mins.
Microcomputers .....	Colour	10 mins.
Winning Foxhunts .....	Colour	45 mins.
Auxilliary Battery Charging .....	Colour	30 mins.
VK5RTV ATV Repeater .....	Colour	1 hr.

The average 60 min. Umatic Cassette and case weighs 850 gm. At this time the only formats for which this service is available is: ¾" Umatic — first choice, ½" Philips N1500 — second choice. Sorry, NO Betamax, VHS or N1700 etc.

For a full catalogue listing of WIA videotaped programs and a complete description of the services provided, refer to Jan. 1980 issue of Amateur Radio.

# Vicom features all the leaders in electronics for the '80's!

## 'LEADER' Dip-Meter 1.5MHz-250MHz

Probably the most useful test instrument any Ham or CB-er can own! Fully self-contained. Docks with 'Leader' LIM870-A antenna impedance meter to provide the perfect way to achieve optimum matching. Can be used as a highly sensitive frequency absorption meter, too.



(LDM 815) \$99

### Morse Keys

HK-702 Marble Base	
Deluxe Model	41.00
HK-708 Economy Unit	
	23.00
HK-706 Operators Model	
	22.00
MK-701 Paddle, side swiper	49.00

### Speech Processors & Compressors (Daiwa)

MC-330 Audio Compressor	99.00
RF-440 RI Audio processor AC/DC	
6dB gain	126.00
RF-550 RI Audio processor AC/DC	
6dB gain (Filter)	169.00
RF-660 RI Audio processor dc	
phasing unit 6dB	109.00

### Filters Rf Transformers, Dividers

FD-30LS Daiwa Low Pass Filter	20.00
32 MHz 300W	
155 Low Pass Filter	39.00
AF-306 Daiwa Active Filter	76.00
AD-103X Daiwa Mast-Head Splitter	59.00
70cm/2m/HI	

### Baluns

AS-BL Asahi 50 ohms for Beams	30.00
BL-50A 50 ohm 4KW. for Dipoles	30.00
BL-70A 70 ohm 4KW. for Dipoles	25.00

### SWR & Power Meters

CN-620 Daiwa SWR/PWR Needle:	99.00
1.8MHz-150MHz	
CN-630 Daiwa SWR/PWR Needle:	135.00
140MHz-450MHz	
CN-650 Daiwa SWR/PWR Needle:	179.00
1.2GHz-2.5GHz	
CN-720 Daiwa SWR/PWR Needle:	152.00
1.8MHz-150MHz	
LPM-880 Leader Rf Power Meter: HF	137.00
LPM-885 Leader SWR/PWR Meter: HF	97.00
RW-151D Kuranishi Load Watt Meter:	165.00
1.5MHz-500MHz	
VC-2 Vicom SWR/PWR 3-150MHz	36.00
SW110A Daiwa SWR/PWR 1.8MHz	79.00
thru 150MHz	

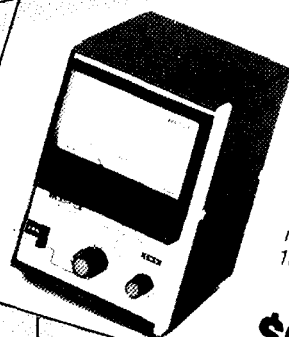

## 'LEADER' SWR/WATTMETER (LPM 885)

Assists you to achieve maximum efficiency from transmitter and antenna. SWR and power output readings ranging from 1.8 to 54 MHz. SWR/power detector circuit is detachable for remote measurements. Monitors from 1W to 1000W output.

\$97

Check right here for the best valves in town—and the cheapest prices!

6KD6	Finals for Yaesu Linears	10.00
6JS6C	Finals for Yaesu Transceivers	10.00
12BY7A	Drivers	4.75
6146B	Finals	13.00

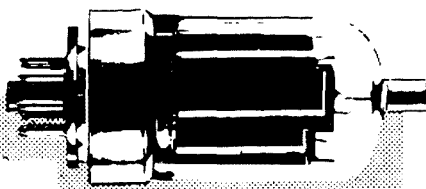

### Antenna Tuners & Couplers

CNA-1001 Daiwa 200W	
Automatic tuner	279.00

### Coaxial Cable (Mil-Spec)

RG-58 A/U-30	
Coaxial Cable 30m Reels	12.00
RG-213/U	
Low Loss Coaxial Cable	
700m Reels	1.50/m

### Plugs and Sockets

NC510	2 Pin Mic Plug	3.00
NC511	2 Pin Mic Socket	1.25
NC512	3 Pin Mic Plug	1.50
NC513	3 Pin Mic Socket	1.50
NC514	4 Pin Mic Plug	1.30
NC515	4 Pin Mic Socket	1.20
NC516	5 Pin Mic Plug	1.50
NC517	5 Pin Mic Socket	1.50
NC518	6 Pin Mic Plug	1.50
NC519	6 Pin Mic Socket	1.50
NC523	8 Pin Mic Plug	1.56

### J B Antennas

<b>6 m &amp; 2 m Beams and Whips</b>		
5Y2M	2 m Jaybeam 5el: 7.8dB gain	43.00
8Y2M	2 m Jaybeam 8el: 9.5dB gain	51.00
10Y2M	2 m Jaybeam 10el: 11.4dB gain	84.00
<b>70 cm Beams</b>		
MBM48/70	70 cm Jaybeam 48el: 14.9dB gain	83.00
PBM18/70	70 cm Jaybeam 18el: 14.9dB gain	96.00
MBM88/70	70 cm Jaybeam 88el: 18.5dB gain	105.00

Melbourne 836 8635  
Perth 321 7609-446 3232  
Hobart 28 1500  
Adelaide 43 7981-272 8417  
Gold Coast 32 2644  
Wellington (NZ) 69 7625

Cairns 54 1035  
Launceston 44 3882  
Brisbane 341 5377-38 4400

Vicom International Pty. Ltd.

68 Eastern Road  
South Melbourne  
Victoria 3205  
Phone (03) 699 6700

339 Pacific Highway,  
Crows Nest, N.S.W. 2065  
Phone (02) 436 2766

# Oxley Region Amateur Radio Club

PO Box 712, Port Macquarie.  
Excerpts from "Oxtales"

## ANNUAL FIELD DAY

The Club held its annual field day over the Queen's Birthday weekend; here are some of the comments associated therewith.

The Wireless Institute of Australia paid our Club a great tribute when four of the top ranking executive of the New South Wales Division journeyed from Sydney to attend at the Field Days. Club President VK2ZCV (Bill) extended a warm welcome to the WIA personnel — VK2BAD (Athol) President — VK2BSB (Sue) Secretary — VK2BOT (David) Treasurer and committee/local club member VK2ZHE (Henry). Smiles all round when they were presented with a genuine Rollands Plains hand made leather key tag complete with call sign etched upon. Tags were beautifully made by VK2PA and family.

Laughs all round when we heard old Mobile Fox come to a halt when claimed by a "hound" flitted out with a great battery of fog lights up front and a smart looking whip antenna! "Took a while to find us eh!" chirped the Fox to his co-pilot — "over here for your card boys — why so long catching us? — Where have you blokes been?"!!!! "Gulp! Good evening Officer — no Officer — we are members of the Oxley Radio Club sir! — Yes — Yes Officer — thank you Officer — Yes — Good night Sir!" . . . wher! . . . "Come to think of it — wordered why he had that blue flashing light up on the turret!"

## RESULTS (Saturday Fox Hunts)

2 metre 2 transmitter: VK2BYY (Jeff, Sydney) first; VK2BLI (Ian, Maitland) second.

40 metre: VK2BSB (Sue, Macquarie Fields) first; VK2BLI (Ian) runner-up again.

10 metre: VK2BAD (Athol, Sydney) first; VK2BSB (Sue) runner-up.

2 metre mobile: VK2AOZ (Aldis, Sydney) first; VK2BYY (Jeff) second this time.

Whilst all this was going on, our ladies served up afternoon tea and the rest of us enjoyed making new friends and meeting up with old ones. Right on the dot of 6 p.m. the hot dishes arrived and a really first class smogabod became the focal point.

## GOLDEN KEY AWARD: CW

The Club decided to answer the critics of CW by putting on the "Golden Key Award" as a contest for CW receiving. Speeds ranged from 5 w.p.m. through to 40 w.p.m. and were mixed random letters and numbers in groups of five. Novices appeared too shy to enter the contest and a really top trophy went begging! You know, only one Novice needed to enter and take the very first letter or so and the prize was theirs! Simple as that. The local club members took out the big event, with VK2PA (Pe'e) running out the winner.

VK2BJH (Jack) and VK2DK (Chic) were runners-up and there was not a lot in it, I can assure you. VK2PA had only 19 errors in over 20 minutes of continuous CW: his top speed peaked at 35 w.p.m. and in legible hand written copy. Pete's normal plain language speed is around 50 w.p.m. The magnificent trophy consisted of a miniature morse key (working model) mounted and framed in a highly polished rosewood frame and base. It was designed and made by local member VK2VWC (Cliff, who received spontaneous congratulations on his excellent craftsmanship. Thanks to all who



PHOTO 1: A great group of smiles. Members of the Oxley Region ARC discussing their 1980 Field Day programme with WIA NSW Division Chief Executive. Left to right: VK2BFP (Lester, Secretary), VK2BSB (Sue, Sec. WIA), VK2BDT (David, Treasurer), VK2ATM (Arthur, Vice-President), VK2BAD (Athol, President WIA), and VK2ZCV (Bill, President).

entered and made the contest really worth while. Thanks VK2ATM (Art) for preparing and decoding the tapes. Also VK2BXO (Rick), VK2ZUM (Graham), who assisted Art with the judging. We've learned a lot from our first try — perhaps you might see the event next year as a perpetual "Challenge" award.

## A TRIP INTO THE PAST

I almost overlooked mentioning an exhibit at the Field Days which drew continuous and obviously genuine interest. Thanks go to VK2AD1 (Jack) for bringing along his "home brewed" 2m (AM) rig of the days gone by. Briefly, the line-up of this "make it yourself days" transmitter is 6A6/CO/Tripler to 24Mc — 807/Doubler/48Mc — 815/Tripler 144Mc — 829 in the PA. The rig first saw the air-waves on 16th September, 1949.

Jack also held a few records with "old faithful" back in those days of very few operators. Most notable was the distance record of 126 miles between Bowral and Aberdare (Jack's then OTH), which was logged with VK2BG on 5th March, 1950. I also took a look over Jack's shoulder at his log book of those times — well over 2,000 contacts in the year — that's really working — remembering it's around 30 years ago!

**A REMINDER**  
A WIA MEMBERSHIP CERTIFICATE  
IS OBTAINABLE ONLY FROM YOUR  
DIVISION.

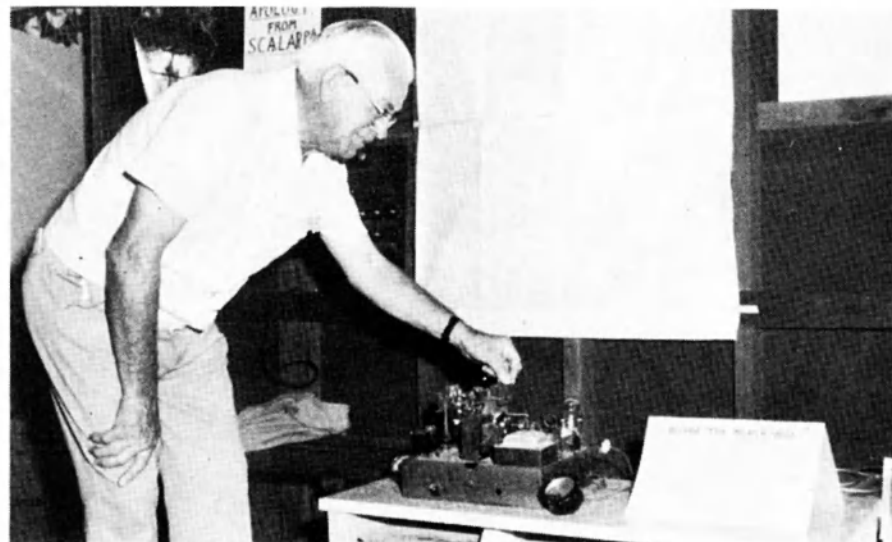

PHOTO 2: Jack VK2ADT displaying his homebrew 2m (AM) rig of days gone by.

# COLLECTORS' CORNER No. 3

## The SX 200 Scanning Monitor Receiver

The days of listeners confining activities to the "DC" bands are long gone as the introduction of microprocessor controlled "ears" for VHF and UHF have opened up a whole new world in listening.

The SX 200 is one of many "new breed" receivers using microprocessors, thus eliminating the old process of crystal acquisition and switching. The SX 200 is the superseded version of the original and very popular SX 100, with increased frequency coverage including switchable FM-AM operation.



PHOTO 1: Front view of the SX 200.

### SPECIFICATIONS

- |                               |  |
|-------------------------------|--|
| 1. Type                       | FM & AM  |
| 2. Frequency Range            | a) 26 ~ 57.995 MHz Freq. Space ... 5 KHz<br>b) 58 ~ 88 MHz " " ... 12.5 KHz<br>c) 108 ~ 180 MHz " " ... 5 KHz<br>d) 380 ~ 514 MHz " " ... 12.5 KHz         |
| 3. Sensitivity                | FM... a) 26 ~ 180 MHz 0.4 uV S/N 12 dB<br>b) 380 ~ 514 MHz 1.0 uV S/N 12 dB<br>AM... a) 26 ~ 180 MHz 1.0 uV S/N 10 dB<br>b) 380 ~ 514 MHz 2.0 uV S/N 10 dB |
| 4. Selectivity                | FM... More than 60 dB at ±25 KHz<br>AM... More than 60 dB at ±10 KHz   |
| 5. Audio Output               | 2 Watts  |
| 6. External Speaker Impedance | 4 ~ 8 ohms   |
| 7. Power Supply               | AC 120V, 50 ~ 60 Hz or DC 12V  |
| 8. Antenna Impedance          | 50 ~ 75 ohms<br>Whip or External Antenna with LO/DX Control (20 dB ATT.)   |
| 9. Frequency Stability        | 26 ~ 180 MHz ... Within 300 Hz<br>380 ~ 514 MHz ... Within 1 KHz<br>(at normal temperature)  |
| 10. Clock Error               | Within 10 sec./month   |
| 11. Memory Channel            | 16 Channels  |
| 12. Scan Rate                 | Fast ... 8 Channels/sec.<br>Slow ... 4 Channels/sec.   |
| 13. Seek Rate                 | Fast ... 10 Channels/sec.<br>Slow ... 5 Channels/sec.  |
| 14. Scan Delay Time           | 0 ~ 4 sec.   |

### KEY TO FRONT PANEL FUNCTIONS — SX 200 (Refer Figure 2, page 28)

- |  |   |
|--|---|
| 1. Keyboard Frequency Selector Buttons (1 — 0)<br>Select any frequency in any of three bands — VHF Low, VHF High, or UHF (including the T-Band). | 3. Limit Write Button LIM<br>Sets upper and lower frequencies of search range.            |
| 2. Stop Button and Dot (•) •ST<br>Stops UP or DOWN Seek or Scan A or B Function. Places decimal point in selected frequency.                     | 4. Frequency Entry Button ENT<br>Is finally pushed to enter frequency.                    |
|  | 5. Speed Change Button SP<br>Controls speed variation for UP or DOWN Seek/Scan Functions. |
|  | 6. Frequency Display Button FR<br>Interrupts constant time display to show fre-           |

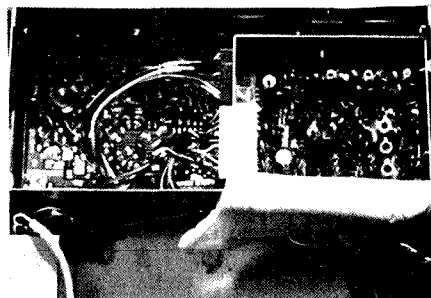

PHOTO 2

Top view of the SX 200 with oscillator/mixer section at right. Note the rectangular metal section at rear of the unit — this is a battery compartment to supply the memory unit for frequency recall when the main unit is switched off.

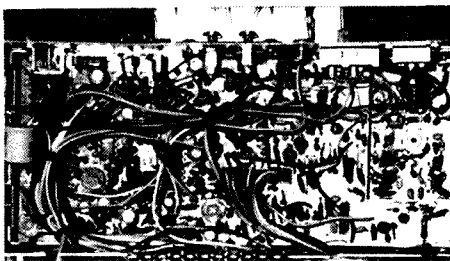
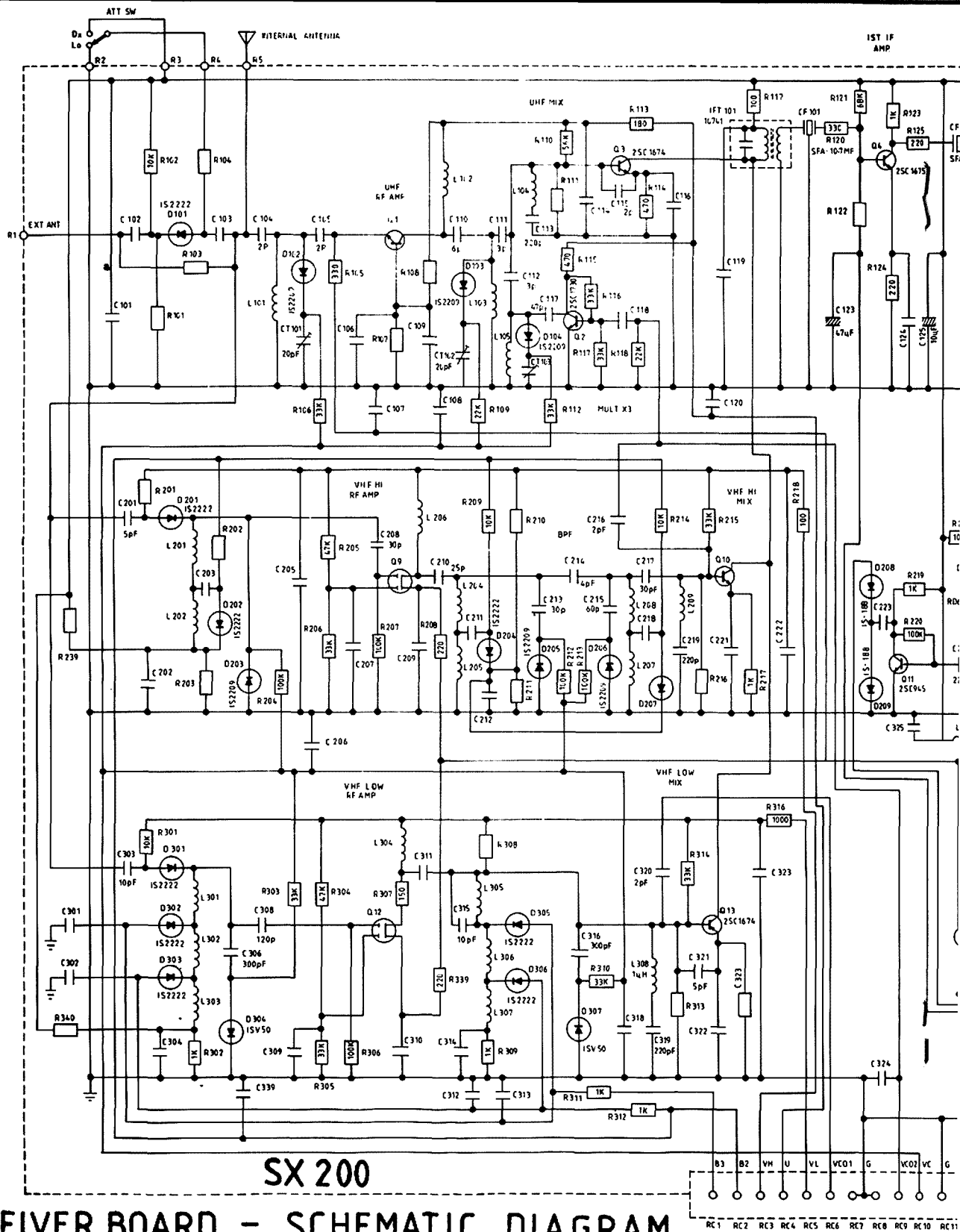

PHOTO 3

Close-up bottom shot of SX 200 showing rear portion neat wiring and lay-out.

The original SX 100 was only able to scan up in frequency. This has been changed on the SX 200 where an upper and lower limit may be programmed into the memory and listeners wishing to find stations may do so between two parameters at ease. As can be seen in the specification table, frequency range is broad and allows a listener to a wide range of services including commercial, aeronautical and amateur.



# RECEIVER BOARD - SCHEMATIC DIAGRAM



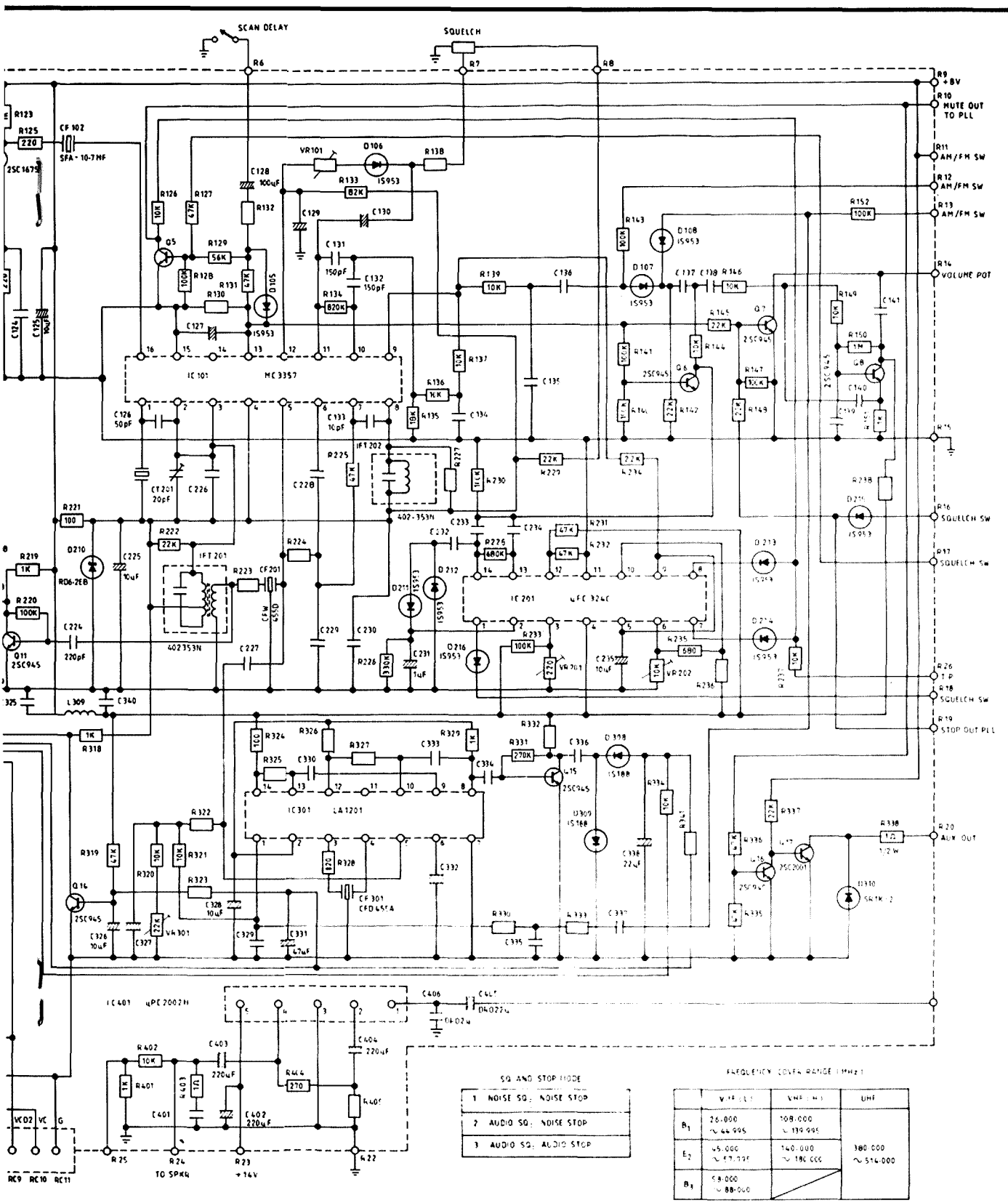

SQ AND STOP MODE

1	NOISE SQ; NOISE STOP
2	AUDIO SQ; NOISE STOP
3	AUDIO SQ; AUDIO STOP

FREQUENCY COVERAGE RANGE (MHz)

	VHF UHF	VHF LWS	UHF
B <sub>1</sub>	26.000 ~ 44.995	108.000 ~ 139.995	
E <sub>2</sub>	45.000 ~ 57.995	140.000 ~ 180.000	300.000 ~ 514.000
B <sub>3</sub>	58.000 ~ 88.000		

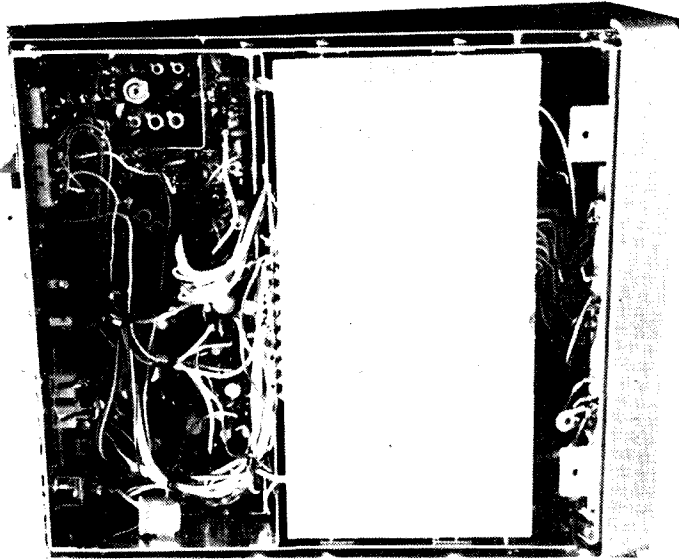

PHOTO 2: Bottom view of the SX 200 interior.

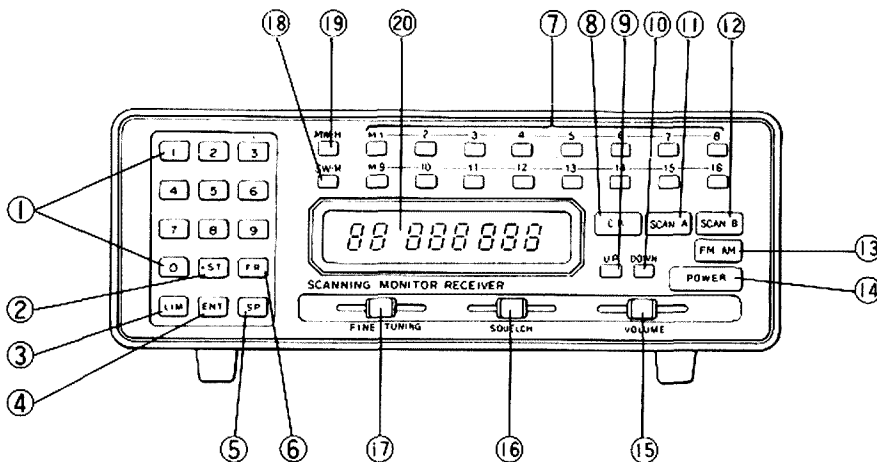

FIG. 2: Control functions — front panel on the SX 200.

7. **Memory Read/Display Keys M1 — M16**  
Programmes your own most-listened to frequencies in any of the three bands. Retrieve any frequency desired when corresponding button is depressed.
8. **Clock Display and Adjustment Button CK**  
Brilliant digital LED clock — accurate to the second. Retrieve and adjust time.
9. **Up Button UP**  
Starts seeking upwards, moving through frequencies in increments of 5 kHz or 12.5 kHz and stopping on a transmitting channel.
10. **Down Button DOWN**  
Starts seeking downwards, moving through frequencies in decrements of 5 kHz or 12.5 kHz and stopping on a transmitting channel.
11. **SCAN-A Button**  
Scans the 16 memory channels (M1 — M16) stopping on a transmitting channel.
12. **SCAN-B Button**  
Scans selected priority channels within the 16 memory channels, stopping on a transmitting channel.
13. **FM-AM Switch**  
Selects modulation of frequency to receive, i.e., Amplitude (AM) or Frequency (FM). If desired AM typed modulation for receiving, push this button. If FM typed required, unlock it.
14. **Power ON/OFF Switch**
15. **Volume Control**  
Adjusts sound level as desired.
16. **Squelch Control**  
Adjusts to block out unwanted noise.
17. **Fine Tuning**  
Small frequency adjustment such kind of figures as 0.0005 MHz is made.
18. **Scan Write and Minute Adjustment Button SW●M**  
Programmes priority memory channels for SCAN-B function and minute.
19. **Memory Write and Hour Adjustment Button MW●H**  
Programmes desired frequencies into memory channels for SCAN-A function and hour.
20. **Digital Display Panel**  
Shows 5-second readout of selected frequencies. Registers passing frequencies during SCAN or UP/DOWN SEEK modes. Shows constant time display (except during SCAN or SEEK modes). Shows time readout when CK button is depressed.

**KEY TO REAR FUNCTIONS OF SX 200 SCANNER**

1. **Local/Distance Switch** allows for optimum reception in both strong and weak signals. Normally set in Distance (DX) pos. for max. sensitivity. In strong signal areas, stations may interfere with each other. To minimize interferences, move switch to LO for Local position.
2. **Connection for External Antenna.**
3. **Scan Delay Control** delays resumption during pause in transmission. Moving the slide switch to ON varies holding time on a freq. 0-4 secs.
4. **Clock Switch.** For only Clock (Time) display, slide switch ON, thus Power switch is off, time always displays.
5. **Dimmer Control Switch** changes light and darkness (ON) of display.
6. **Connection for Power Cord.**
7. **Output for External Speaker (Optional).**
8. **Recording Output REC.** Connect the input of open reel type or cassette tape deck to record.
9. **AUX Control Output AUX.**
10. **Ground Connection GND.**
11. **SQ 1, 2, 3.**

For further information on the SX 200 contact the Australian distributors, GFS Electronics, 15 McKeon Road, Mitcham, Victoria 3132.

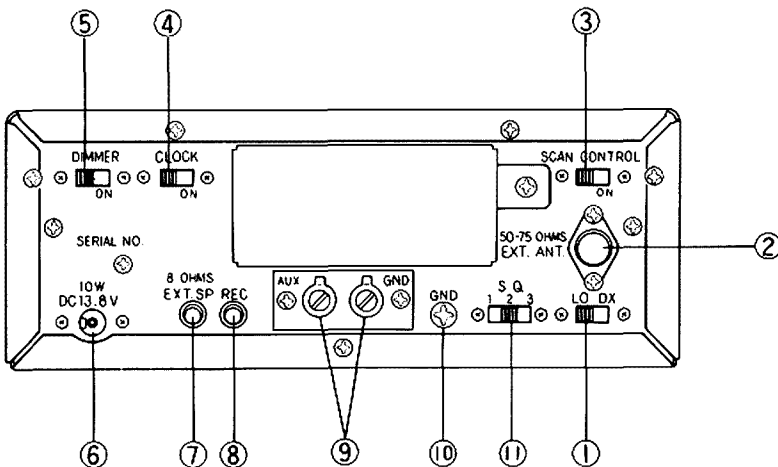
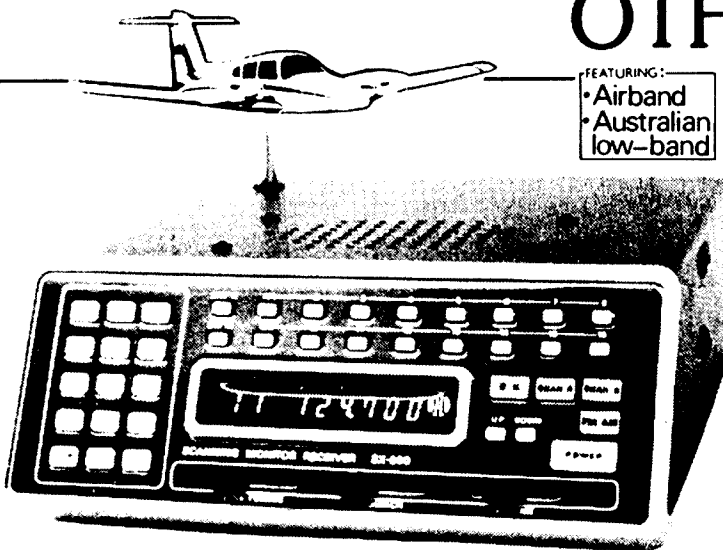

FIG. 3: Rear view of SX 200 scanner. Refer to text for key to accessories.

Collectors' Corner is aimed at giving you, the reader, a better understanding of the types of equipment available for various applications in Amateur Radio. Your suggestions and comments regarding content in this section would be appreciated to ensure widespread reader appeal.

# NEW J.I.L. SX-200

NOW A PROGRAMMABLE  
SCANNER THAT DOES IT ALL.  
26 - 180MHz, 380 - 514MHz.  
AIRBAND, AUSTRALIAN LOW  
BAND PLUS ALL THE  
OTHERS.



FEATURING:  
• Airband  
• Australian low-band

## SPECIFICATIONS

- Type: FM & AM
- Frequency Range: a) 26-57.995 MHz Space... 5 kHz  
b) 58-88 MHz Space... 12.5 kHz  
c) 108-180 MHz Space... 5 kHz  
d) 380-514 MHz Space... 12.5 kHz
- Sensitivity: FM... a) 26-180 MHz 0.4uV S/N 12 dB  
b) 380-514 MHz 1.0uV S/N 12 dB  
AM... a) 26-180 MHz 1.0uV S/N 12 dB  
b) 380-514 MHz 2.0uV S/N 12 dB
- Selectivity: FM.....More than 60 dB at -25 kHz  
AM.....More than 60 dB at -25 kHz
- Audio Output: 2 Watts
- Ant Impedance: 50-75 ohms  
Whip or External Antenna with LO/DX Control (20 dB ATT.)
- Freq. Stability: 26-180 MHz ... Within 300 Hz  
380-514 MHz ... Within 1 KHz
- Dimensions: 210 (W) x 75 (H) x 235 (D) mm  
8-1/4 (W) x 3-1/4 (H) x 9-1/8 (D) in.
- Weight: 2.8 Kgs.
- Clock Error: Within 10 sec./month
- Memory Channel: 16 Channels
- Scan Rate: Fast .....8 Channels/sec.  
Slow .....4 Channels/sec.
- Seek Rate: Fast .....10 Channels/sec.  
Slow ..... 5 Channels/sec.
- Scan Delay Time: 0 or 4 sec.

The new SX-200 represents the latest STATE-OF-THE-ART technology in the development of Scanning Monitor Receivers. It has many features that previous have not been available on receivers of its type.

For example the tremendous frequency coverage, which encompasses all of the following bands:— HF & UHF CB, 27 & 155MHz MARINE, Australian LOW BAND, AIRCRAFT band, VHF SATELLITE band, 10Mx, 6Mx, 2Mx and 70CMx AMATEUR, VHF HIGH BAND and UHF TWO-WAY band. Other features include Automatic detection of AM or FM on all bands, Squelch Circuitry that can be used to LOCK OUT carrier only and spurious signals, Fine Tuning control for off channel stations, 240 VAC plus 12VDC operation, Squelch Operated Output that may be used to trigger a tape recorder or channel occupancy counter and accurate Quartz Clock.

## \$479

NOW MONITOR AIRCRAFT, POLICE,  
AMBULANCE, 10, 6, 2 & 0.7MHz AMATEUR BANDS,  
HF & UHF CB, PLUS HUNDRED MORE.  
INCLUDING SERVICES IN THE  
AUSTRALIAN LOW BAND



J.I.L.

Australian Agent & Distributor.



TRADE INQUIRIES WELCOME

**G.F.S. Electronic Imports, 15 McKeon Road, Mitcham, Vic. 3132 (03) 873 3939**

# JOTA 1980

Gus Napier VK1NBO  
27 Robertson Street, Curtin, ACT 2605

The 23rd Jamboree-on-the-Air will be held over the weekend of 18th and 19th October. On the Saturday afternoon the official opening ceremony will be broadcast from Government House, Canberra.

The suggested starting time for participating stations is 00.01 hours (local) on Saturday, 18th October, and the closing time is 23.59 hours (local) on Sunday, 19th October. These are suggested times only — many stations may well find it more convenient for example to start their operations during Friday evening. Each station will be free to select its own times and periods for operating.

Local regulations must be observed of course. It is suggested that stations look for contacts close to the official World Scout Phone frequencies which are 3.590 MHz, 7.090 MHz, 14.290 MHz, 21.170 MHz and 28.590 MHz. Participating stations in all branches are reminded to listen before calling "CQ Jamboree" to ensure that the frequency is not already in use. As soon as contact has been made on any frequency, stations should then shift to the nearest frequency so that others may be able to use the above nominated calling frequencies.

## NATIONAL AUSTRALIAN OPENING CEREMONY

Again this year His Excellency the Governor-General, Sir Zelman Cowan, Chief Scout of Australia, has kindly permitted the opening ceremony to take place at Government House. This will commence at 2 p.m. on Saturday, 18th October, and the proceedings will be broadcast on 7.090 MHz, 14.290 MHz and 21.170 MHz by the official station VK1BP, which will be set up in the grounds of Government House.

All participating stations are therefore asked to co-operate by leaving these frequencies clear from 1.30 p.m. onwards until the conclusion of the ceremony.

The timetable is:—

1.30 p.m.: VK1BP, calling on each of the above three frequencies, will contact all official Branch Scout and State Guide stations, which will then call in after the official addresses.

2.00 p.m.: The official opening ceremony will commence with an address by His Excellency the Chief Scout, Sir Zelman Cowan. Her Excellency, Lady Cowan, who is President of the Girl Guides' Association in Australia, will then deliver her address, to be followed by supporting addresses by Dr. Norman Johnson, Chief Commissioner for Scouts in Australia and, it is hoped, by Mrs. Charlotte Renshaw-Jones, Chief Commissioner for Guides in Australia.

After the addresses, the officially nominated Branch HQ Scout amateur stations and the State HQ Guide amateur stations will be called in, in turn, starting with VK1 through to VK8, so that the nominated representatives can report briefly on the receipt of the addresses and present their compliments to Their Excellencies. These contacts should be kept brief so that other waiting Scout and Guide stations can be called in and given opportunities of talking to the official guests at the opening ceremony.

At the conclusion of the official opening, VK1BP will close down and will later recommence transmissions from the 1st Hughes Scout Hall, where VK1HS will also be in operation.

## SUNDAY PROGRAMME

On Sunday at 3.00 p.m., VK1BP will be standing by on the official calling frequencies to receive brief reports from JOTA stations throughout Australia. Only one frequency at a time will be used, but advance notices will be given of band changes.

CW/SSB/RTTY may be used for calling in and stations are asked here to observe the following (telegram-type) format for their reports:

1. Call sign (after VK1BP has given the station the go-ahead).
2. The Scout/Guide Groups that are participating at the station.
3. QTH of the station.
4. Number of overseas JOTA contacts.
5. Number of overseas non-JOTA contacts.
6. Number of Australian JOTA contacts.
7. Number of Australian non-JOTA contacts.
8. Brief comments (say 25 words) on anything of particular interest to other JOTA stations.

## JOTA ANTARCTICA

Incidentally, Kevin Campbell, a Rover Scout from Queensland, who is serving at the Mawson Base, has indicated that he will be taking part in JOTA from that QTH. He will be looking for contacts and hopes to use the best of the propagation frequencies as near as possible to the official frequencies. As far as is known, Kevin will be the only Antarctic JOTA representative. His call sign is VK0KC. ■

## Amateur Radio Weekend

Sam Voron VK2BVS  
2 Griffith Avenue, East Roseville 2069  
Phone 407 1066

If you are studying for your November novice exam, in the Scouts or Guides and looking for an amateur station to operate during JOTA or if you are an instructor looking for a holiday in the Blue Mountains, then be advised that an amateur radio weekend has been organised especially for you.

Starting on Friday, 17th October, 1980, at 8 p.m., and ending Sunday, 19th October, 1980, at 2 p.m., the weekend will be held at Camp Carey, Lawson View Road, Wentworth Falls, just a 1½ km walk from the Wentworth Falls railway station.

Fees covering all food and accommodation are as follows: Under 2 years, \$2.00; 2-4 years, \$7.00; full time students and instructors, \$18; others, \$22.

These can be sent to:

Amateur Radio Weekend  
Craig Robinson VK2PDF  
PO Box 35, Croydon 2132.  
Phone: (02) 74 0316. ■

## QSP

### WORLD OF AMATEUR RADIO

For those who might wish to listen to W1AW bulletins from the ARRL telephony segments are given on the half hour daily at 02.30Z and 05.30Z on 14.29 MHz, 21.39 MHz, 28.59 MHz and other bands, including 6 and 2 metres. RTTY bulletins are given daily from 02.00Z, 05.00Z, 23.00Z (also 16.00Z on working days) on 14.095, 21.095, 28.095 MHz and other bands. CW bulletins are daily on 01.00Z, 04.00Z and 22.00Z (also 15.00Z on working days) on 3.58, 7.08, 14.08, 21.08, 28.08 and other bands. Slow as well as fast code practices are transmitted frequently at other times. ■

## PROPOSED NEW BANDS

"The IARU Region 1 Executive Committee recommends that the new amateur allocation 10,100-10,150 kHz be used for CW communication only.

This recommendation was made for the following reasons:

- (i) To accommodate as many stations as possible in a small band which is allocated to the amateur service on a secondary basis worldwide;
- (ii) Because of the fast growing amateur population; and;
- (iii) To avoid harmful interference to the fixed service which uses this allocation on a primary basis.

## 18 AND 24 MHz ALLOCATIONS

The IARU Region 1 Executive Committee agreed that:

- (i) a proposal should be made to the 1981 Conference to set up an HF working group; and
- (ii) this working group should then consider, as a matter of urgency, a band plan for the new allocations at 18 and 24 MHz."—Rad. Comm. July 1980. ■

# NOVICE NOTES



Edited by Ron Cook VK3AFW

This month we start off with some antenna theory and conclude with two constructional articles on HF and VHF whip antennae.

## THE SHORT VERTICAL ANTENNA

### The Ground-plane:

Any wire or metal rod may be used as an antenna. We will only consider those less than 0.25 wavelengths long, that is, short antennae. We will also restrict this article to vertical antennae.

Let us assume that we have transmitting and receiving sites placed 10 km apart on flat highly conducting ground. As shown in Fig. 1 it is possible for the transmitted signal to be received by three paths, a direct ray, a ground reflected ray and an ionosphere reflected ray. In practice the ground reflected ray is usually absorbed by buildings, trees and poorly conducting earth. If our antenna were 20m high the ground reflected ray would be launched at an angle of  $-0.1$  degrees.

The ionosphere reflected ray or sky wave is launched at 85 degrees for this short haul path. (Normally DX stations would require a launching angle of less than 20 degrees.) Note that if the ionosphere and the ground are perfectly smooth and flat then the reflections of the signal occur at 5 km range, exactly halfway between the antennae. This is the action of two perfect mirrors.

Because the earth's surface is curved and because it is covered by trees, houses, mountains, power lines, etc., the direct ray or ground wave travels only some tens of kilometres before being attenuated below the ambient noise.

Now for a question. What is the purpose of  $\frac{1}{4}$  wavelength radials used on the so-called ground-plane antennae? And a second question. What is the purpose of burying up to 20 short radials at the base of a vertical antenna? It is clear that ground reflectives are of minor significance

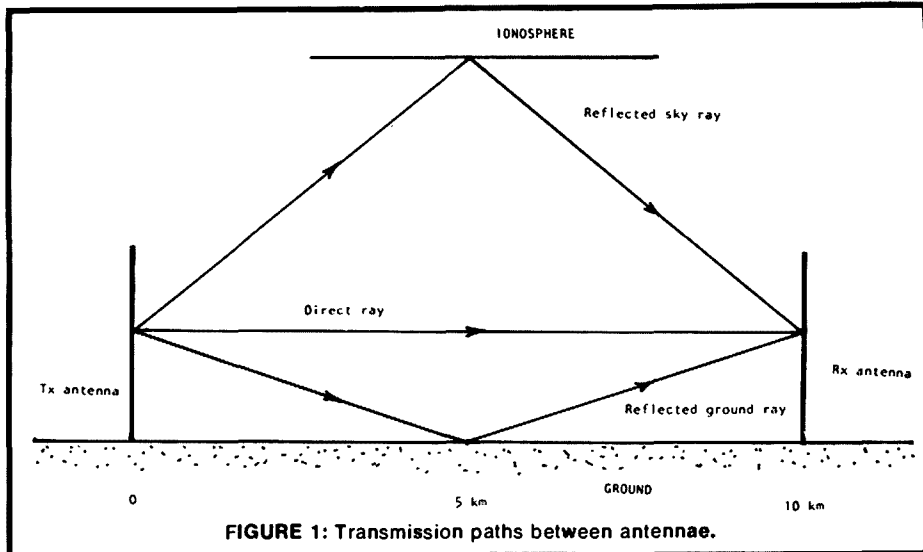

FIGURE 1: Transmission paths between antennae.

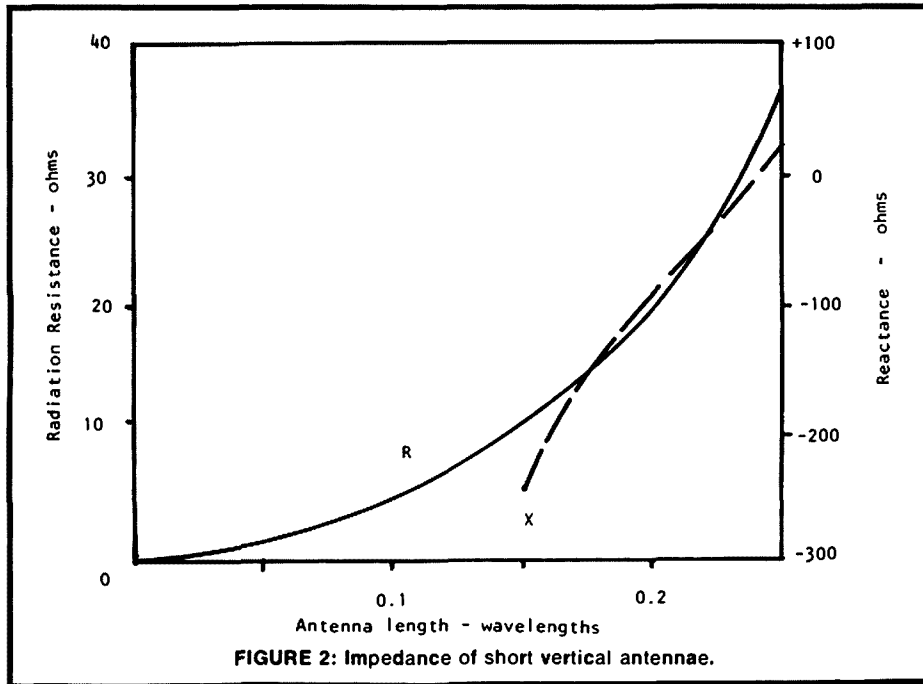

FIGURE 2: Impedance of short vertical antennae.

for all contacts other than the most local. Unless the radials were very long they could not give any mirror effect —  $\frac{1}{4}$  wavelength radials provide reflections to a range of  $\frac{1}{2}$  wavelength!

Yes,  $\frac{1}{4}$  wavelength radials for elevated verticals and buried short radials for ground based verticals are used, but as Professor Julius Sumner-Miller says, I shall leave the answer for another day and let you ponder on the physics.

### ANTENNA IMPEDANCE

I divert and direct your attention to Fig. 2, which is a graph showing the variation with length of resistance and reactance at the base of a short ideal vertical antenna. The base resistance is the radiation resistance in this case. The reactance in particular also varies considerably with variation in conductor thickness. The

curve shows representative values for practical antennae and is based on curves given in the ARRL Antenna Handbook.

We can see that an antenna 0.1 wavelength long (1.04m at 28.0 MHz or 8.35m at 3.50 MHz) has a radiation resistance of about 5 ohms and a reactance of  $-400$  to  $-500$  ohms (equivalent to about 100 pF at 3.50 MHz) in series. This antenna is not resonant but can be made so by adding some 400 to 500 ohms of inductive reactance in series. The inductance may be wound as a solenoid and fitted at the base of the antenna. If its inductance is doubled it may be placed about halfway up the antenna. This is because the capacitance to ground of the antenna above the coil is the primary influence for resonating the coil, especially when the antenna is very short.

Another method of adding inductance is to wind the whole antenna as a long thin coil — the so-called helical whip. The construction of these antennae is simple and, as can be seen by the following articles, eminently suitable for the home constructor.

#### WHY IS THE VSWR SO GOOD?

We have seen that the ideal antenna mentioned above had a feed-point resistance of 5 ohms. This, for a 50 ohm cable, is a VSWR of  $50/5 = 10:1$ . In practice the VSWR will always be lower at resonance. Why? This comes about because after building our vertical we find that the vertical conductor has resistance. This is higher at RF than is measured on a DC meter. At radio frequencies the current crowds into a thin layer at the surface. The higher the frequency the thinner the conducting layer. This skin effect may cause the resistance of the antenna to rise from near zero at DC to say 5 ohms at our operating frequency. This is a loss resistance and does not help radiate a signal. Further, the resonating coil may add another 15 ohms of loss resistance. If this is a mobile installation the finite size of the vehicle, the resistance of the chrome plating, etc., may add 15 ohms of ground loss. The feed impedance at resonance is then 5 plus 5 plus 15 plus 15 = 40 ohms. This gives a VSWR of  $50/40 = 1.25:1$  which seems quite good. Unfortunately only the power delivered to the 5 ohms of radiation resistance produces signal — the other resistances just get hot. The antenna efficiency, or radiated power as a percentage of input power, neglecting mismatch loss, is  $(5/40) \times 100$  per cent = 12.5 per cent. That seems like bad news. The VSWR is better than the lossless antenna but the efficiency isn't flattering. Now the good news is that this means the radiated signal is 9.0 dB down on the signal from a lossless antenna, say  $1\frac{1}{2}$  to 3 S points, depending on your meter. If your signal were about 30 dB over S9 on an ideal antenna then you would drop to 20 dB over on the practical antenna. Until you get down to S3 reports the difference is not very significant. We will return to mismatch losses in the future — it is a fascinating and largely misunderstood area.

#### MODIFYING 5 FT. HELICAL CB WHIPS FOR HF MOBILE OPERATION

Dick VK5DQ has written an interesting article on modifying CB whips for 21 and 28 MHz. This article is reproduced from the SA Division's Journal for October 1979.

I was bitten by the HF mobile bug some months ago, after trying a 27 MHz helical whip on 28 MHz and working a number of Ws straight off from the driveway.

After making the acquaintance of a number of Novices on 15 metres, thanks to the excellent conditions prevailing earlier in the year, I decided to convert a CB antenna into an inexpensive 15 metre

whip. I was given a 27 MHz helical whip with a broken loading coil winding, so I experimented by winding turns on until I got 1:1 VSWR over most of the 15 metre band. In modifying another whip since then, I have found there to be variation between apparently identical units, so any-

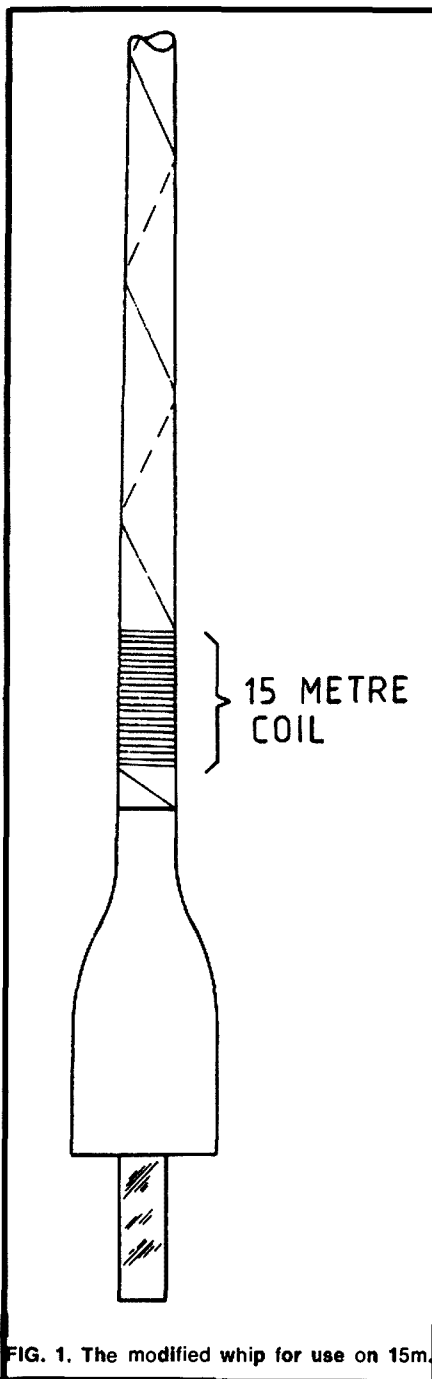

FIG. 1. The modified whip for use on 15m.

one who does this modification will have to use trial and error, preferably helped by a twin-meter SWR bridge.

The number of turns required in the base loading coil also depends upon the way in which the aerial is mounted upon the vehicle and its location. Incidentally, I used Dick Smith "White Flash" antennae and

other brands will probably require a different number of turns in the loading coil.

Using the modified antenna on 15m, I have worked VK, ZS, ZL, JA and W stations, both mobile/ fixed and mobile/ mobile.

Unmodified, these 27 MHz antennae load well on 28 MHz without doing any more than screwing the adjustment sleeve on the top downwards over several turns.

#### MODIFICATION FOR 15m OPERATION

Using a sharp Stanley knife, remove both layers of heat-shrink tubing at the bottom end of the whip for about  $1\frac{1}{4}$  in. Cut the wire about  $\frac{3}{4}$  in. from the base ferrule.

Using 22 B & S or 23 SWG enamelled copper wire, wind on about 33 turns, tightly and closely spaced, starting about  $\frac{3}{32}$  in. from the base, in a clockwise direction viewed from the extreme end of the whip. Scrape the enamel and tin both ends of the coil before soldering to the original antenna wire.

Mount the antenna on the vehicle and measure the VSWR into the feedline. Tune by pruning half a turn at a time from the coil until you reach near to unity VSWR at the centre of the band. You can check whether you need more or less turns simply by measuring the VSWR at different parts of the band. If the VSWR rises more at the top end of the band, then the antenna is resonant at too low a frequency and there is too much inductance in the loading coil, so you need to remove more turns.

On the first whip I used a magnetic base and needed 33 turns on the loading coil. After the antenna (complete with mount) had fallen off the vehicle a number of times while travelling at 20 m.p.h., I mounted the antenna on a single ski bar and found that I needed only 30 turns on the loading coil for resonance. This gave me VSWR readings of 1.0:1 at 21.0 MHz and 1.2:1 at 21.45 MHz, which was amazingly good. The other 15m whip, which I made from an apparently identical unit, needed 32 turns for similar results.

(Journal Editor's note: The mobile whip antenna looks basically like a series resonant tuned circuit, in which the top section is capacitive with a value of perhaps 10-50 pF, depending on length and conductor size. As the capacity to ground of the vehicle body is several hundreds of picofarads, it normally has little effect on the value of inductance needed to resonate the top section of the whip. However, if you use a magnetic base, the system becomes more complex, as the capacitance of the base to the vehicle roof is quite small and the antenna current flows over the outer conductor of the coax feed, back to the set, so introducing further impedance which has to be tuned out.)

#### OTHER BANDS

At present I am experimenting with both base-loaded and centre-loaded whips for other HF bands and will provide construc-

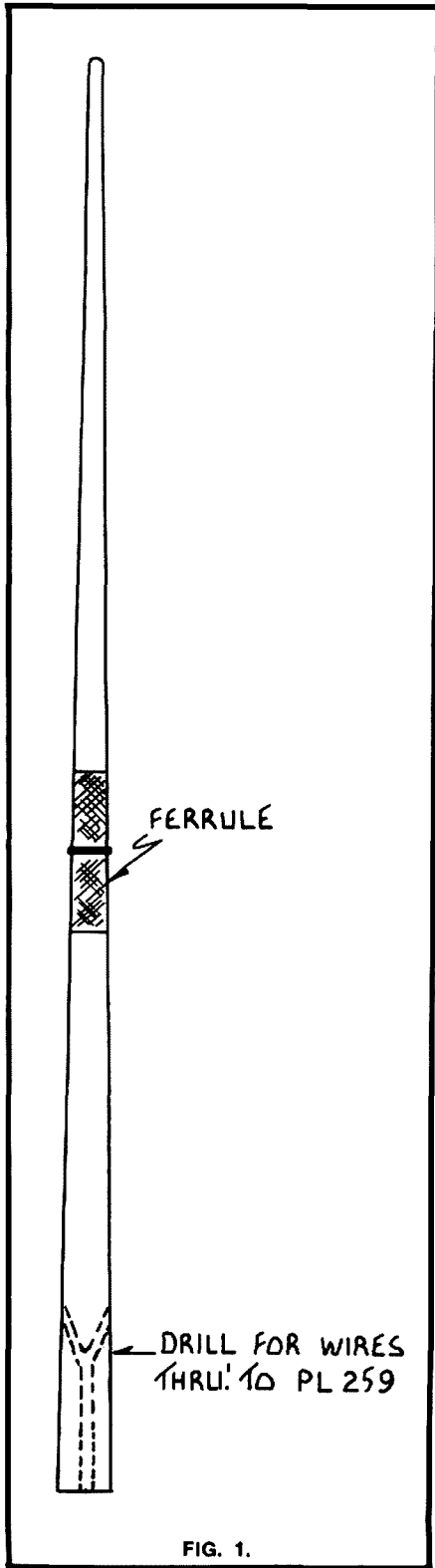

FIG. 1.

tional details when I am sure that I can cover the whole range.

So far my experience with trying tapped centre-loading coils suggests that these are best left well alone.

Thanks, Dick.

**A TWO BAND MOBILE WHIP**

Another interesting article appeared in a recent issue of FLUX. Unfortunately I have no indication of the author but here is the article.

A two piece 4 foot fishing rod blank was the base upon which the aerials described were constructed. These are obtainable from sports stores or the complete fishing rod can be purchased from Coles, etc., and the fittings stripped off. This base to work from should cost about \$6.00. The plug is a standard PL259 UHF connector, and the base is the appropriate matching socket.

As seen in Fig. 1, a Y is drilled in the thick end of the fishing rod to take the wires through to the PL259 connector as in Fig. 2. After the leads are threaded through the end of the blank the plug is araldited to the blank.

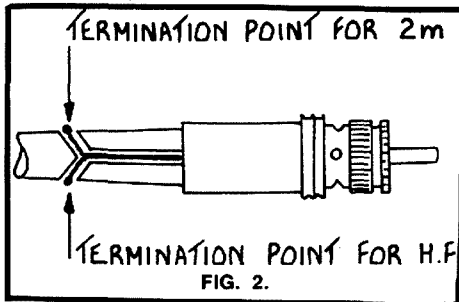

FIG. 2.

You will have noted that we said wires — plural — because we intend to make these dual purpose aerials, i.e. HF and 2m.

**WIRE**

The wire used was what could be called junk box wire. We obtained ours from secondhand power transformers. The wire was approximately 24 gauge. This was used for all aerials except the 80m whip which was slightly finer. This was necessary to fit the longer length of wire to be wound on the blank.

**PREPARATION OF WIRE**

(An important step)

Measure off the wire required. For any helical aerial the amount required is

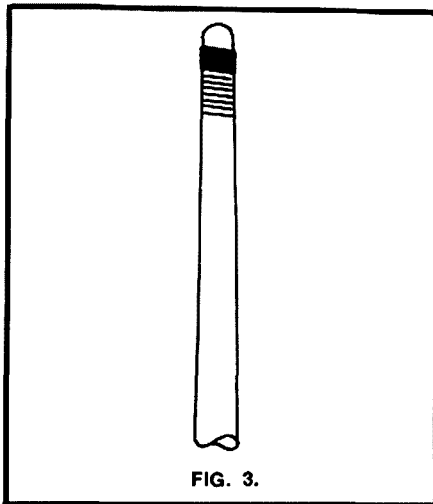

FIG. 3.

approximately  $\frac{3}{4}$  of a wavelength for the frequency of design. For 80m measure off 60 metres of wire — 40 metres you would need 30 metres of wire and so on through the bands.

This will make the aerial longer than is necessary but it is a good starting point. If you are using secondhand wire make sure the insulation is still satisfactory and remove wax residue. This can be done by securing one end of the wire to a fence post in the back yard and with a piece of cloth wipe the whole length of wire and inspect it as you go along. The free end of the wire is cleaned of insulation for approximately 3 turns of wire. This is then tinned and wrapped around the very tip of the blanks thin end and the 3 turns sweated together, as in Fig. 3.

**THE AERIAL**

The wire is now very neatly close wound until the last couple of feet. The last couple of feet is fast spiral wound down and terminated on the PL259 connector or the ferrule, whichever comes first. This will depend on the wire gauge and the band that you have selected. If terminated at the ferrule the lower part of the blank is fast spiral wound (say 4 turns) and terminated on to the PL259 connector.

**THE MOUNTING**

This is clearly shown in Figs. 4a and 4b.

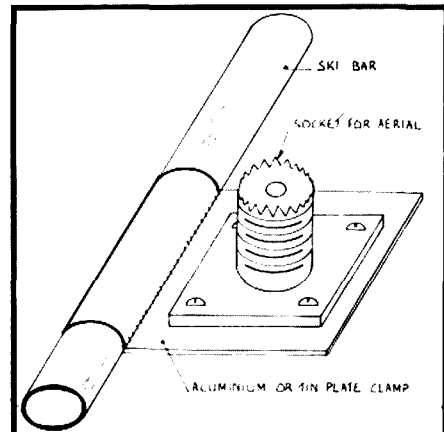

FIG. 4A.

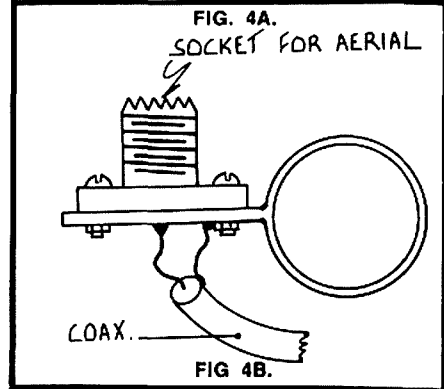

FIG 4B.

**THE TUNE UP**

In our case we used a FT101B and a Vicom VC2 SWR bridge. The first step is

to tune the 101 to the low end of the appropriate band and note the SWR. This could be quite high. The pruning is done from the bottom and in small steps, say 6 inches at a time. On the 80 metre aerial this is especially important as its resonant point will shift very rapidly and you may cut it too short and find yourself on the way to a 40 metre whip. When you see the SWR start to fall re-tune the transceiver to the part of the band you want your aerial to operate in and continue the pruning, with great care. If the SWR falls below 1.5, stop. At this stage you can tune the transceiver and find the actual resonant frequency and then make the final adjustments.

You thought we forget about 2 metres? No we didn't — this is the last step. As can be seen in Fig. 2 a terminating wire for 2 metres comes out on the opposite side to the HF termination. This allows the 2 metre aerial spiral spaced between the lower turns of the HF aerial. The length of this wire is approximately 20 inches to start. Trim this to suitable SWR.

#### FINISHING POINTS

- Make sure SWR bridge is set at maximum sensitivity when tuning aerial.
- Any protective covering put on after the tune up will have some effect on the resonant point. Clear lacquer appears to have very little effect.
- Paint, whether black or a colour to match your car, will have a more pronounced effect. So make sure you paint or lacquer the aerial first and leave to dry.
- Some type of cap is advisable at the top of your aerial to stop corona as in Figs. 3 and 5. Ball-point pen caps, toothpaste tops, etc., are appropriate.

Both interesting and informative articles I think you will agree. Next month we will discuss some of the commercially available kits for simple projects and answer the questions posed this month.

73 de VK3AFW. ■

### MORSE EXAMS

Candidates for morse exams are specially reminded that the morse sending or receiving of letters is not adequate in itself. There is a space of 7 dots between words and this has to be observed so that whatever is sent or written down should be in understandable composition English. Thus, to omit a space between two words is one error. Many errors could be recorded against you if, for example, in receiving morse, you write down a string of letters not separated into discrete words. This reminder is given to dispel any rumours to the contrary and to alert candidates to the official requirements. ■

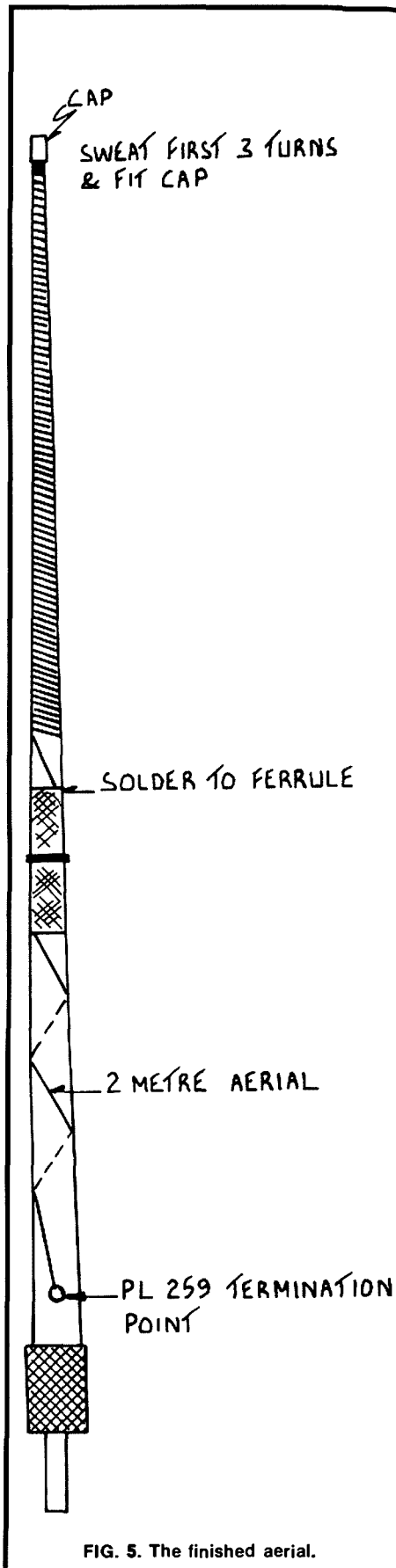

FIG. 5. The finished aerial.

## THE VK3BWW FORMULA FOR DX SUCCESS!!

**HIGH QUALITY AT LOW COST**

#### BEAMS

3 EL 10 & 11m	.....	\$66.00
3 EL 15m	.....	\$73.00
3 EL 20m	.....	\$145.00
6 EL 6m	.....	\$102.00

#### DUOBANDER

3 EL 10m, 3 EL 15m \$135.00

Prices include Gamma match

Our beams are easy to assemble and adjust. Entirely **NEW CONCEPT** — **NO NUTS OR BOLTS.**

Spare parts, elements, booms and gamma matches available.

For further information  
PLEASE RING (03) 366 7042

**VK3BWW**

**WERNER & G. WULF**

92 LEONARD AVENUE  
ST. ALBANS, VICTORIA 3021

*A Call to all holders of a*

## 'NOVICE LICENCE

Now you have joined the ranks of Amateur Radio, why not extend your activities?

**THE WIRELESS INSTITUTE OF AUSTRALIA**  
(N.S.W. DIVISION)

conducts a Bridging Correspondence Course for the AOCF and LAOCF Examinations.

**Throughout the Course, your papers are checked and commented upon to lead you to a SUCCESSFUL CONCLUSION.**

For further details write to:

**THE COURSE SUPERVISOR, W.I.A.**

P.O. BOX 123,  
ST. LEONARDS, N.S.W. 2065



# FORWARD BIAS

## VK1 DIVISION

(Postal Address: WIA (ACT Division) Inc.,  
PO Box 48, Canberra, 2600 ACT)

## VK1 DIVISION

### JOTA 1980

As we announced in the August issue, Jamboree-on-the-Air 1980 will take place over the weekend of 18th and 19th October. Details of the programme for the official opening ceremony, the calling frequencies and suggested times of operating for participating Scout and Guide stations appear separately in this issue.

Gus Napier VK1NBO is still anxious to hear from amateur licensees willing to help in the operation of the three official Canberra stations at Hughes, Duntroon and Page. Gus can be contacted on 82 1457 (AH) or 65 3555 (Bus.). Ken Ray VK1NDR/ZKR is co-ordinating a "talk-in" fox hunt to be held late on Sunday morning on 2 and 10 metres. Ken, too, would be most glad to hear from anyone — particularly Novices and Z calls who would be willing to help out here by taking small parties of Scouts and Guides in their cars. Ken can be reached on 88 6459 (AH) or on 65 2083 (Bus.).

### CW TO THE FORE

The meeting on the 25th August again attracted a good crowd of VK1 members. About 50 turned up to hear all about "CW — From Pump-handle to Electronic Keyer". Our principal speaker for the evening gave a most convincing resume of how he finally decided to "bite the bullet" and take those first hesitant steps into the world of CW operating. The equipment set up for demonstration aroused considerable interest and more than one of the brass-pounding (10-minus w.p.m.) — this writer included — had their first tentative stabs at a high-speed paddle!

The meeting welcomed two new VK1 members — Tony Knight VK1JA, who joined the Division in July, and Al Crocker, already studying for his Novice ticket.

## VK2 MINI BULLETIN

Four Pye Westminster W15Us were donated by Philips to the NSW Division late last year. Two of these are temporarily in use at Dural as a UHF repeater (one transmitting, one receiving). Two units are immediately available for sale to affiliated clubs, one country and one city. A ballot, to be drawn at the Third Conference of Clubs, will be conducted for the units. If your club wishes to be in the draw, write to the Secretary, NSW Division, PO Box 123, St. Leonards 2065.

The Third Conference of Clubs will be held on Sunday, 2nd November, 1980, at

Parramatta Leagues Club, 15 O'Connell Street, Parramatta. The conference will commence at 10 a.m. in the Casino Room and lunch can be bought at the club's bistro. Talk in directions will be given on the day on repeater channel 7000 and 28.32 MHz. Thanks to Barry White VK2AAB of the Hornsby and Districts Amateur Radio Club for organising the venue.

The WICEN Regional Co-ordinator's Conference will be held on the day before the club conference, Saturday, 1st November. Listen to broadcasts for details of the venue. Don't forget the WICEN net on Thursdays at 2130h on 3617 kHz. Schofield's Air Show will not be held in November this year, but possibly February 1981.

Many new publications are available from the Divisional Office at 14 Atchison Street, Crows Nest, for sale either over the counter or by post. Send SASE for an updated list. The new 1980 Australian Call Book is now available for \$2.95 or \$4.00 posted. Clubs may purchase bulk orders at a reduced rate by applying to the Divisional Office.

News for insertion in Divisional Notes must reach Box 123, St. Leonards 2065, by the 1st of the month prior to publication, e.g. by 1st November for December AR.

In each edition of AR, details of several affiliated clubs will be published. If you wish your club news to be included, make sure your club secretary has sent a club information sheet to the Divisional Office.

### AVONDALE AMATEUR RADIO CLUB

Avondale College, Cooranbong 2265 (between Gosford and Newcastle).

Net: Tuesdays 6 p.m. on 21.175 MHz using either VK2BQT or VK2DFX. Classes and meetings held at Avondale College.

President: R. Drewer VK2DFX. Faculty Sponsor: K. Thomson VK2BQT. Other Committee: G. Webber VK5NEZ, K. Myers VK2BNO, R. Lowe.

### OXLEY REGION AMATEUR RADIO CLUB

PO Box 712, Port Macquarie 244.

Net: Wednesdays 8 p.m. on 3.662 MHz using VK2BOR.

Meetings: January, April, July, October, 2 p.m. Saturdays, PM High School.

Classes: 7.30 p.m. Mondays, Port Macquarie High School.

President: W. Sinclair VK2ZCV. Vice-President: A. Monck VK2ATM. Secretary: L. O'Connell VK2BFP. Other Committee: P. Alexander VK2PA, L. Smith VK2LS, F. Gorton VK2YJU/NUG, P. Hill VK2BZA. Newsletter: "Oxtales", published quarterly.

### WAGGA AMATEUR RADIO CLUB

PO Box 71, Koorringal, Wagga 2650.

Net: Saturdays noon on 28.49 MHz.

President: B. Grimmond VK2VKZ. Vice-President: A. Wheaton VK2YSU/VDF. Secretary: R. Read VK2AZR. Other Committee: R. Degabriele VK2DJQ, R. Knight VK2YPO, R. Close VK2NOC, W. Lugton.

## COMING EVENTS

### 18th-22nd October:

Southern Cross Car Rally (Port Macquarie), WICEN. Anyone, including interstate amateurs, will be welcomed as volunteer operators. Contact H. Freeman VK2NL, (02) 665 7434, or write to Box 123, St. Leonards 2065.

### 25th, 26th October:

South-West Amateur Radio Society — 28th Convention. Programmes from Box 4, Griffith 2680.

### 1st November:

WICEN Regional Co-ordinators' Conference, Sydney.

### 2nd November:

Third Conference of Clubs, Parramatta Leagues Club.

### 16th November:

Blue Mountains Field Day.

Submitted by Susan Brown, Secretary NSW Division.

## ALARA NEWS

Any YLS interested in joining ALARA, meeting other YLS sharing the common interest of amateur radio or joining in group meetings, please contact Geraldine Plant VK2NQL, PO Box 56, Kemps Creke 2171, or phone (02) 636 2414.

Submitted by G. Plant, State Co-ordinator, ALARA. ■

# QRK5

A monthly transmission from the Victorian Division WIA.

Written and co-ordinated by VK3WW, QTHR.

The contest held in August was enjoyable. What a pity it could not have been held on the weekend nearest the 15th August — VJ Day.

Council meetings continue to last into the small hours of the morning. Is there anyone out there with modern management skills who can show us the way into the 1980s?? It seems certain that many otherwise able and available members will not stand for Council while the present situation prevails.

## WILLY WILLY'S WORDS

Last month I promised to introduce two well known amateurs. They don't have names but serve a purpose when trying to describe a situation in which you don't want to mention real call signs. To describe a good operator we can use VK3OPR, and for the opposite use VK3LID. LID is a morse code slang term for a poor operator. I believe it originated in the USA way back. If any reader can enlarge on this I will be happy to publish the story in a future column. Of course LIDs are heard on voice also — e.g. when asked "Where are you?" answers are — VK3OPR "Mobile on my way to work". VK3LID "Left the home QTH in the car QTH on the way to the work QTH". The use of Q signals on voice is accepted but not when they are meaningless.

## INCENTIVE LICENSING

This subject is getting yet another airing. What do you think? Should the new bands be available only to those who do higher grade exams? Should existing bands be chopped up so that existing privileges are reduced and then restored after passing more theory, regulations and morse?

Is this form of status seeking compatible with the attitude of the majority of VK amateurs? Finally, would incentive licensing be beneficial to amateur radio in Australia?

Please think about these questions — remember, silence is taken as assent. Voice your opinion through your councillors or in letters to the editor. Your opinion counts. .

## A BUDGET LEAK??

VK3 amateurs must face the possibility of a fee increase. Do you think the Division is comparable to a union or a professional association? Do you think economics could be achieved by more efficient management at Divisional and Federal level?

Do you believe that the facilities provided at present are worth more to members but should remain free to non-members?

Please make yourself heard on these matters — we do not want to lose members through ill-advised action.

## KNOW YOUR COUNCILLORS

### VK3SS KEITH SCOTT.

First licensed in 1937, he did the mandatory six months using morse code (some of the old ideas might be worth re-considering).

A two valve re-gen Rx and a modulated oscillator provided his first voice contact with VK3PR in Leongatha. Keith served with Army Sigs for 4½ years then set up his own business in radio sales and repairs. He has been actively engaged in zone and club activities for over 30 years, particularly WICEN. Keith lives at Maffra and travels 400 km each month to attend Council meetings.

### VK3JN PETER DURY

Now in his second term of office, Peter has the very demanding task of Treasurer. Peter is a radio trades teacher and when not teaching apprentices and amateur classes likes to build and operate equipment. Lately he has been exploring RTTY. He also likes boating and fishing, and enjoys degassing the odd 807 (his friends attend to the even ones).

That's all regarding Councillors. After a three month wait it is obvious that the rest are not prepared to support this column with a short contribution.

## WHITE ELEPHANTS

Saturday, 23rd August, saw a very successful white elephant day. Bargaining in the morning and an auction after lunch. No it's not true that Harold auctioned his own walking stick. A well run popular event — general opinion "More please".

## ON REPEATERS

Users are reminded to leave at least two seconds before transmitting — give everyone a fair go.

## NEWS ITEMS

The following were given to me on 23rd August. Written by one person but unsigned:—

**25-26 October — South-West Amateur Radio Society Convention.** Contact John Chandler, PO Box 4, Griffith 2680. Interest in cloth badge similar to calf badge. If warranted will produce for \$1.50 approximately.

There was also a note regarding an event in July — Contributions are welcome but please sign and address them just in case some clarification is needed.

## QUESTION OR ANSWER?

Regarding question 2 in the August column it has been suggested that they prefer base loading!

All VK3 contesters were pleased to hear VK3WI, VK3AWI, VK3BWI and VK3ZWI active on 2m during the August contest. Sincere thanks to all who gave of their time to make this possible.

## HELP NEEDED

Can anyone help with details of modifications to the Yaesu FT7? I have had requests from all over the country, so all letters will be acknowledged in this column and passed on to the technical editor. Please answer direct — QTHR.

## LIBRARY NEWS

Thanks to the generosity of VK3YTC the library now holds workshop manuals on the commercial equipment listed below.

It is hoped that Council will approve a lending system already submitted so that members can use these books. STC CTR50-128A, 132-MTR25-121, 131, Philips AM1676-TCA 1649A, 1674, Vinten MTR 19 and 20, BTR 19 and 20, AWA MR6A, BS6A, MR15A, BS15A, 60A, Collins 32 RS-IC, Serviscope S32A.

## NEW TO COUNCIL

Welcome to Kevin VK3YPL, who was elected at the August meeting. Appointed to ex-officio positions at the same meeting were John VK3VQV (Minutes Secretary)

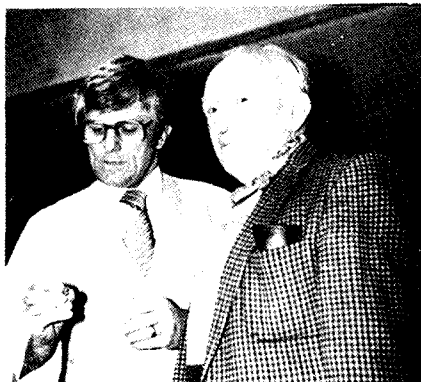

PHOTO 1: Eric Trebilcock (r) receiving his badge of Honorary Life Membership. At left is Eric Buggee.

and Rob VK3YMU (Disposals Officer). Their ability and willingness to help is appreciated.

## 2m FOXHUNT

The winner of the August 2m fox hunt was Ewen VK3BMV. Ewen also won the Vicom Competition for the best performance in the series. The competition had tied the previous month with VK3BMV, VK3BNK and VK3ZXW equal. However, the August hunt broke the tie and Ewen won the competition.

The prize was presented at the September meeting of the Victorian Division.

Finally a farewell and a welcome. Cheers Eric Trebilcock, and thanks for your 20 or more years service in running the inwards QSL Bureau.

Welcome Barbara VK3BYK. We hope you enjoy the job appreciated by many amateurs.

Until next month.

73. Mike VK3WW. ■

## AMATEUR



## RADIO

*Bulletin issued by the North, North West and Southern Branches of the Wireless Institute of Australia, Tasmanian Division.*

# TASMANIAN AR CONVENTION

## VENUE

Penguin High School, Ironcliff Road, Penguin.

## DATE

November 22nd and 23rd, 1980.

## REGISTRATION FEE

A fee of \$1.50 per adult (children free) will be charged at the door and on payment of same you will be supplied with a TARC 1980 name tag which enables you to receive morning and afternoon tea free of charge. If accompanied by your children cordial would be available to them.

Catering is supplied by the Penguin Community Group (Penguin High School P and F Association) at very reasonable charges and will serve Saturday lunch and Sunday lunch at the High School for those who are registered, so make sure you have a name tag.

**SATURDAY LUNCH** of soup, sandwiches and coffee or tea or cordial will be available from 11.30 a.m. to 1.00 p.m. to registered members only.

**SUNDAY LUNCH** will be smorgasbord style and will be served in a closed area of the school from 12 noon to 1.30 p.m. Advice of your attendance to this function is required in advance for catering reasons.

Saturday evening dinner dance will be held at the Penguin Sports Club, which is adjacent to the High School. This Club is licensed, hence drinks are not included.

There is ample room for dancing, a band will be in attendance, but rag chewing is encouraged! lucky door prizes, too.

#### ACCOMMODATION

Limited hotel accommodation is available at Penguin and there are three motels in Ulverstone, hotels and caravan parks. If you require a booking or help with same, please contact Joan Fudge on 25 3770 (area code 004).

Again this year TARC will be open to the public on Saturday afternoon and Sunday morning. Registered members and families enter free. Entrance fee for public is \$1.00 per adult, children free.

Name tags are important so make sure you have one.

CLOSING DATE for bookings to functions is 10th November, 1980.

#### RATES

- (a) Registration: \$1.50 adult, \$1.00 per adult paid in advance, children FREE.
- (b) Saturday lunch: \$1.50 per adult, \$6.00 per family, paid in advance; K2.00 per adult, \$7.00 per family at the door.
- (c) Saturday evening: \$9.00 per single, \$18.00 per double, \$23.00 per family (must be paid in advance).
- (d) Sunday luncheon: \$45.0 per adult, \$11.50 per family (must be paid in advance).

Late registrations, etc., will be received but a penalty of 50c per person will be charged.

For further information contact the N-W Branch of the WIA (Tasmania Division), Box 194, Penguin 7316.

Applications for TARC must be in by NOVEMBER 10. ■

#### JOINT WIA-P & T MEETING

A meeting between Divisional Council and P and T officers was held on August 15th. P and T were represented by the Superintendent, Mr. H. Melling, and Mr. D. Thorne. This is the first occasion that a Superintendent has attended such a meeting and we certainly thank both these people for making time available for this meeting.

Mr. Melling stated that he welcomed meetings with the WIA, and agreed to participate in such meetings at, say, three-monthly intervals. Further he was keen to be invited to Branch meetings or executive meetings when they happened to be in that area.

Changes to the recently produced handbook were a matter of concern. Council asked if a list of these points could be promulgated in writing. For instance the relaxing of third party privileges meant that permission for WICEN type exercises is no longer required. The superintendent noted however that they would prefer to be informed about the use of prime sites on such occasions in case interference to essential services should result.

The need to request permission to use WIA sponsored repeaters for special tasks was questioned and this led to the com-

ment that perhaps some of our requests are a little too restrictive.

The problems of isolated amateur observers were outlined and it was stated that P and T officers handled this work in areas where the WIA did not offer assistance. P and T are not worried about this aspect at the moment.

Examination sessions are under review and although the situation in Hobart is unlikely to change in the near future, "on call" exams in other centres are likely shortly. When a field officer is in the area he may be able to hold such an examination. A centre is to be established at the Launceston Maritime College and this will be available for amateur exams.

The shoddy look of the new licence was mentioned, however it appears this is necessitated by the "over the counter" system.

PLEASE, if members have problems let your Council members know so that your ideas can be discussed at these meetings. We are most fortunate to have this avenue available.

From "QRM", September 1980, Vol. 10, No. 8. ■

---

## SPOTLIGHT ON SWLing

Robin Harwood VK7RH

5 Helen St., Launceston, Tasmania 7250

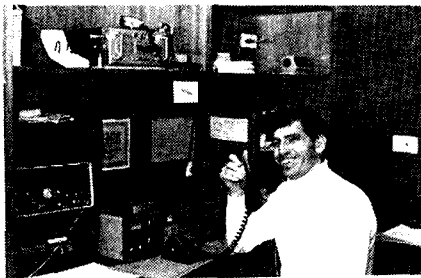

In the course of listening on the short-wave bands amongst the many transmissions heard, I have come across programmes from radio stations doing clandestine broadcasting. These stations present programmes that ordinarily would not be aired by the conventional organizations because their content reflects the views of either minority or dissident groups within a specific region or nation. Their transmissions are usually based from a neighbouring country which is sympathetic to their cause for various reasons. These host countries often grant the use of facilities of their domestic networks to carry the programmes.

Clandestine radio broadcasting began in Europe during the thirties during the ferment leading up to the Second World War. These broadcasts mirrored the political and ideological conflict of the period. The Spanish Civil War saw it being used quite extensively by both sides. For about 30

years after this conflict ended, a programme was presented by the defeated supporters beamed to that region from bases within the Soviet Union.

During World War 2, the utilization of clandestine broadcasts was actively employed by both Axis and Allied Governments. With the cessation of hostilities in 1945, the tensions and turmoil increased and this period became known as the Cold War. This ushered in intense activity by official and clandestine outlets.

In the mid-fifties, a powerful station, Radio Free Europe/Free Liberty commenced broadcasting to the Eastern Bloc from West Germany and Portugal. It carried programmes for emigre and dissident groups within that region, and was backed by the American CIA. Today this station still transmits although its frequencies are registered and it is funded from the United States Treasury through an allocation to the "International Committee for External Broadcasting".

Because the programme content did not please the authorities within the target areas, their transmissions were subjected to heavy jamming, a situation that continues up to the present. Frequently, the forms of jamming consist of over-modulated narrow-band FM signals, usually from one of the domestic network programmes and transmitted from several sites simultaneously. Also "white" noise is emitted at about 200 per cent modulation, which effectively blocks the transmissions. There have been estimates of several thousand transmitters employed exclusively to jam out any unwanted programmes at a cost estimated at four times the expenditure employed to present the programmes.

Identification of clandestine radio stations is made difficult due to the use of unfamiliar languages and dialects. A few have English programming, such as the Voice of the Malayan Revolution on 15780 kHz. QSLing these stations is very hard as no addresses are given, nor do the host nations acknowledge their existence. Radio Free Europe/Radio Liberty will acknowledge reports, that is if you can catch the signals through the heavy QRM.

Most clandestine activity today is centred around the Middle East. There are reports that seven to eight transmit to Iran alone. These transmissions provide a fascinating insight into today's fast changing world.

#### HANDICAP AID PROGRAMME

1981 has been designated by the United Nations as the International Year of the Disabled. Many activities are planned for this to promote the cause of the disabled and handicapped, both here and overseas. In many countries there is an organization that is encouraging short-wave listeners and other related activities such as amateur radio by individuals with handicaps or disabilities. I know of many persons who actively pursue SWL DXing despite severe

disabilities, such as Joachim Wolff of Mitchell Park, South Australia. John is a quadraplegic and is totally bedridden. But despite this, he is active monitoring the short-wave bands and has written an article on modifying the Barlow-Wadley XCR-30 for visually handicapped operators.

I have accepted an invitation of the Southern Cross DX Club of Adelaide, SA, to be National Co-ordinator of the Handicap Aid Programme in Australia. I hope that this will be established on a firm footing in the very near future. I would be pleased to hear from any interested persons or bodies prepared to assist in any way. It would help if an SASE could be included. I hope to have further news on the Handicap Aid Programme in the future.

If you have any news of loggings that you could share, I would like to hear from you. Until next month, 73s, Robin L. Harwood. ■

## AMATEUR SATELLITES

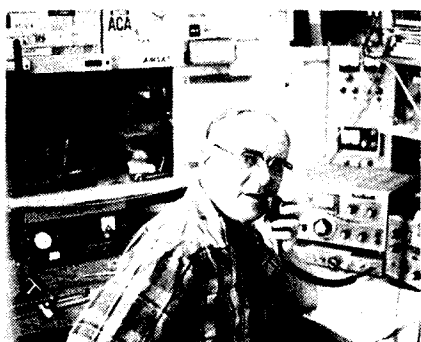

R. C. Arnold VK3ZBB

Several interested amateurs have asked me to repeat the telemetry decoding information for AMSAT OSCAR 8.

Data is sent on 29.402 MHz for Mode A and 435.095 MHz for Mode J in six groups of three figures — this sequence is concluded by HI.

The first digit in each group gives the channel number and the following two digits is the "Number" N, referred to as follows:—

### Channel 1:

Total Solar Array Current —

$$I_t = 7.15 (101 - N) \text{ mA}$$

— if N is 60 (received as 160)  $I_t = 293 \text{ mA}$

### Channel 2:

Battery Current —

$$I_b = 57 (N - 50) \text{ mA}$$

— if N is 50 (received as 250)  $I_b = \pm 0 \text{ mA}$

### Channel 3:

Battery Voltage —

$$V_b = 0.1N + 8.25V$$

— if N is 50 (received as 350)  $V_b = 13.25V$

### Channel 4:

Baseplate Temperature —

$$T_{bp} = 95.8 - 1.48 N^{\circ}\text{C}$$

— if N is 49 (received as 449)

$$T_{bp} = 23.3^{\circ}\text{C}$$

### Channel 5:

Battery Temperature —

$$T_b = 95.8 - 1.48 N^{\circ}\text{C}$$

— if N is 47 (received as 547)

$$T_b = 26.2^{\circ}\text{C}$$

### Channel 6:

RF Power Output (Mode J) —

$$P_{jt} = 23 \text{ mW}$$

— if N is 23 (received as 623)

$$P_{jt} = 529 \text{ mW}$$

NOTE: On Made A Channel 6 is sent as 601 or 602, which means zero output.

A warning from AMSAT. If you want to keep our present satellites operating until the next OSCAR is available — at the earliest 1982 — **DO NOT USE TOO MUCH**

### POWER.

If your downlink signal is stronger than the beacon, you are using excessive power. You can overcome your problem of weak receive signals by improving antennas, using low loss coax and a low noise front end. Keep an eye (or ear) on overloading your receiver front end by your uplink signal — desensing should be avoided.

The French amateurs led by F8ZS are constructing a satellite to be known as ARSENE. It is hoped that this satellite will be launched by an ARIANE vehicle in 1983-84.

The International meeting I was hoping to attend in September has been postponed until May 1981.

Rumour has it that the Russian satellites will not be launched until 1981.

The Mode "J" Club now has 137 members from nineteen countries.

AMSAT OSCAR 7 is now out of shadow as far as Australia is concerned and it is now back to its original routine of Mode A and B on alternate days. Operations are very satisfactory, particularly when the total input power level is not too high — a good sign of overloading is evidenced by higher than average noise levels and spasms of oscillation.

New stations heard include VK2ADJ, VK2ZHR and VK4RR.

The registration of the trade mark AMSAT and its symbol, which was first taken out in 1973, has now been transferred to the Wireless Institute of Australia. This will mean that only persons authorised by the Institute can use this trade mark in Australia. ■

## ARTIFICIAL SATELLITES

During 1979, some 130 satellites were launched according to recent ITU publication. The USSR were responsible for about 70 per cent of the launchings, the remainder being USA, Japan, India and UK.

The frequencies employed were mainly in the GHz bands, however it is interesting to note that VHF (137 MHz) band is still used, and even more surprising HF around 20 MHz.

Purposes varied considerably. Many were for basic scientific research and had a limited life — weeks or days. However, it is interesting to note the large number that fit into the "high resolution reconnaissance" category.

The ITU publication includes spacecraft amongst its satellite listings.

### SOYUZ-32

An example is Soyuz-32, launched by the USSR on 22nd February, 1979. Its description was:—

3-part spacecraft: 2 spherical habitable modules (orbital compartment and command module) connected in tandem to a cylindrical service module; diameter: 2.70m; height: 7.10m; mass: 6680 kg; 2 solar arrays.

Its purpose was given as:—

Two-man spacecraft: V. Lyakhov, flight commander; V. Ruymin, flight engineer. Docked with Salyut-6 (1977 97-A) on 26th February. On 1st March Soyuz-32 was used as a locomotive to transfer Salyut-6 into a higher orbit (308/328 km).

After undocking, Soyuz-32 was returned to earth unmanned on 13th June, 1979.

### SAGE

Four days earlier the USA launched a research satellite, SAGE.

3-axis stabilized spacecraft; 6-sided prism shape; height: 0.64m; mass: 147 kg; 2 solar panels.

For the purpose of stratospheric aerosol and gas experiment. Objectives: To obtain global data on stratospheric aerosols and ozone during at least one year. Carries a 4-spectral radiometer to measure solar intensity attenuation after sunrise and before sunset in wavebands centred at 0.385, 0.45, 0.6 and 1.0 um.

There were also, of course, communication satellites, navigation satellites and meteorological satellites. There were, unfortunately, no Oscars that year. ■

## AMATEUR OPERATOR'S

**HANDBOOK** \$3.60 + POST

**MAGPUBS**

P.O. Box 150, Toorak, Vic. 3142

NO AMATEUR STATION SHOULD BE WITHOUT ONE.

BUYING OR SELLING GEAR?

# HAMADS

MAKE IT HAPPEN FAST

# VHF-UHF

An expanding world

Eric Jamieson,  
VK6LP



Forrester, S.A. 5233

## VHF/UHF BEACONS

Freq.	Call Sign	Location
50.005	H44HIR	Honiara
50.020	GB3SIX	Anglesey
50.023	HH2PR	Haiti
50.025	6Y5RC	Jamaica
50.035	ZB2VHF	Gibraltar
50.036	HC1JX	Quito
50.038	FY7THF	French Guiana
50.040	WA6MHZ	San Diego
50.048	VE6ARC	Alberta
50.050	ZS3E	South West Africa
50.055	ZL1UHF	Auckland
50.066	PY2XB	Sao Paulo
50.070	YV5ZZ	Caracas
50.070	VP9WB	Bermuda
50.080	W1AW	Connecticut
50.080	TI2NA	Costa Rica
50.085	WA6JRA	Los Angeles
50.088	VE1SIX	New Brunswick
50.089	WD4CEI	North Carolina
50.100	KH6EQI	Pearl Harbour
50.104	K4EJQ	Tennessee
50.105	KC4AAD	McMurdo, Antarctica
50.110	KH0AB	Saipan
50.110	AL7C	Anchorage
50.120	4S7EA	Sri Lanka
50.144	KC6NI	Ponape, Caroline Is.
50.498	5B4CY	Cyprus
51.999	YJ8PV	Vanuata
52.200	VK8VF	Darwin
52.250	ZL2VHM	Palmerston North
52.300	VK6RTV	Perth
52.330	VK3RGG	Geelong
52.350	VK6RTU	Kalgoorlie
52.400	VK7RNT	Launceston
52.440	VK4RTL	Townsville
52.450	VK2WI	Sydney
52.500	JA2IGY	Mie
52.500	ZL2VHM	Palmerston North
52.510	ZL2MHF	Mt. Climie
52.800	VK6RTW	Albany
52.900	VK6RTT	Carnarvon
53.000	VK5VF	Mt. Lofty
144.010	VK2WI	Sydney
144.162	VK3RGI	Gippsland
144.400	VK4RTT	Mt. Mowbullan
144.475	VK1RTA	Canberra
144.500	VK6RTW	Albany
144.600	VK6RTT	Carnarvon
144.700	VK3RTG	Vermont
144.800	VK5VF	Mt. Lofty
144.900	VK7RTX	Uliverstone
145.00	VK6RTV	Perth
147.400	VK2RCW	Sydney
432.400	VK4RBB	Brisbane

No beacon changes this month. As this month of October will probably be the only chance we will have to work any stations

outside Australia with the decline in Cycle 21, it is proposed to remove from the beacon list most of the overseas beacons and revert to the usual VK and near countries beacons. It may be useful for you to have a quick check list available so may I suggest you run the beacon list through a copying machine, and hang this last list on your shack wall. If it doesn't do anything else it will be a reminder to you of what areas you didn't work during Cycle 21!

## MELBOURNE NEWS

Gil VK3AUI wrote to say August was a very quiet month, but some improvement in July ZL TV frequently heard. Brief opening to VK on 6/7. Contacts to ZL on 27/7, also to VK4AMF, VK4ANC, VK2YRL, VK4ZFZ from 0535 to 0617Z. KH6EQI beacon heard 0725 to 0745Z. At 0835Z heard JA2BZY in contact with YJ8PD on 50 MHz, but band did not open on 52 MHz. On 20/7 ZL2CD was hearing the VK2 beacon.

Thanks, Gill, if its' been quiet in Melbourne it has been even quieter in Adelaide!

## SOUTH-EAST RADIO GROUP

This active band of people at Mt. Gambier are not letting the grass grow around their feet.; Their new President is Garth VK5AGO, Secretary Len VK5ALC. The SERG Newsletter has been rejuvenated and the first copy has arrived on my desk. The Club has also put machinery in motion to become an incorporated body which will give them the legal protection required.

Of course the outstanding piece of news (!) is their appointment of me, your scribe, VK5LP, as the Club Patron at the same salary as the former Patron! However, to be serious, on behalf of my readers, I wish the Club well, and hope their moves for improvements will be realised. And I did appreciate being asked to be Patron, as I have always had a very soft spot in my heart for the boys in Mt. Gambier.

Possibly by the time you read this the SERG will have commenced its **South-East Area Net on 3586 kHz ± QRM** and through the **Channel 6 repeater**, and if you care to join in the evening's proceedings you will be welcome to participate.

**Peter Becker VK5ZBF** is the **Club Publicity Officer**, and his address is **6 Pigeon Street, Mt. Gambia 5290**. What an appropriate address for a publicity officer!

And while talking about nets, do you know the **Illawarra Amateur Radio Society** conducts a **CW net on 28.460 MHz on Tuesday nights at 1000Z**, and they hope to provide an opportunity for those wanting to gain confidence in CW without noise, QRM and overcrowding of other bands.

## MICROWAVE REPORT

Lyle VK2ALU in "The Propagator" reports a six foot diameter dish has been obtained for use at 10 GHz. The gain is 45 dBi at this frequency and will give an ERP of

approximately 300 watts from the 20 mW source. This dish will also be useful at 23 cm as it has a gain of 27 dBi at this frequency. It is intended to use it as part of the radio telescope system on 23 cm.

It is also noted that the foundations are being dug for the re-installation of the 432 MHz EME dish at its new site, so we all wish the project well.

Also noted in "The Propagator" is that from **Sunday, 17th August**, the **Sunday night net** will be tried on **3565 MHz ± QRM**, starting **1000Z**. It is hoped this change will give a wider coverage and allow others outside of Wollongong to participate.

## THE CENTIMETRE BANDS

The microwave bands are commonly misbelieved to be limited to "line-of-sight" applications. However, the bands over 1 GHz are useful not only for space communications, but also for terrestrial use and well beyond the horizon.

In the 10 GHz band, low power unstable free-running oscillators and "noisy receivers" with 1 MHz passbands have permitted communications up to 500 km on sea and over 350 km on land. These figures do not consider communication between portable stations located high on mountains, but sea-level locations whose horizon is only 20 to 50 km.

There is reasonable hope that these bands, several MHz wide, may become available for regular medium distance communications when amateur techniques shall be improved to a level similar to standards on VHF.

Improvement to receiver sensitivity depends mainly on the transmitter stability; but the "frequency jitter" originated by crystal oscillator multiplication is so far one of the important obstacles.

According to statements by G3RPE, with little improvement of the current techniques, reduction of the receiver passband and the use of an efficient antenna such as a paraboloid 180 cm in diameter, regular communication up to 400-600 km by means of tropo-scatter may become a reality.

The basic conditions for scatter communication at amateur level in the centimetre band are: 2 kHz of passband in the receiver, and 180 cm paraboloid reflectors at both ends. Then the standard conditions become:

- 1.3 GHz band**, 40W output = 16 kW erp — distance 600 km.
- 2.3 GHz band**, 30W output = 30 kW erp — distance 500 km.
- 5.7 GHz band**, 2W output = 10 kW erp — distance 400 km.
- 10 GHz band**, 1W output = 16 kW erp — distance 400 km.

We cannot risk to lose such a powerful medium for communication which may accommodate thousands of new amateurs, only because many of us do not rely enthusiastically enough on it. Re-printed from "The Propagator", July 1980.

## MAGNETIC SUPERSTORMS

A new class of "super magnetic storms" will probably strike earth in the next few years, causing unprecedented disruptions in power transmissions and operations of computers and telecommunications, predicts a National Oceanic and Atmospheric Administration scientist. Howard Sargent of NOAA's Space Environment Services Centre, Boulder, Colorado, says superstorms, which set up currents in power lines causing overloads and cut-offs of power, tend to occur after the peak in the sun's 11 year sunspot cycle. They are especially likely in odd-numbered, active cycles, he says. The sun is now just past the peak of a particularly spotty cycle, Cycle 21. Evidence shows that a series of August 1972 storms, which ranged 220 on an index where a major storm rates 100, could be "weaklings" in comparison!—From WA VHF Group Bulletin.

## SIX METRES v. ETHNIC TELEVISION

I had quite a lot to say a while back on the subject of VK amateurs being allowed to use all or some of the 50 MHz band, particularly during the peak of Cycle 21, but this fell on deaf ears with the result we in Australia missed many contacts which otherwise could have been made. Overseas reports seem to indicate a few VK stations couldn't resist the urge to make some illegal contacts, but I am proud to say the vast majority of those who were sufficiently interested or motivated to keep up band activity at the right times did operate legally, and our standing is all the better for such compliance. From my own observations of six metre band activity I can only say I was very pleased and happy to have worked as many countries as I did, and to share with my fellow amateurs the associated pleasures which stem from making good long distance contacts along with the other stations on the band at the time, the sharing of contact time with overseas stations, with your neighbours, and so I could go on.

I am sure we were all very thrilled for our colleagues in VK3 when Channel 0 closed down and they had an opportunity to work DX without the trauma of TVI, even though most of the best contacts had already passed. But it was a step in the right direction, and we have always hoped our friends in Brisbane and Wagga would also eventually be able to share in the jubilation.

At the same time we rejoiced to hear from official quarters that the use of Channel 5A was to be phased out, and with it a consequent reduction in QRM on 144 MHz, although it appeared as though it was too late to prevent a high powered Channel 5A from being completed in the Hamilton area, right in Steve VK3OT's country! More on this a bit further on.

But back to Channel 0. That new era enjoyed by Melbourne amateurs looks like being rather short if one cares to read

what is currently being said about Ethnic Television in Australia. It was only a brief period after the closure of Channel 0 before Mr. Staley, Minister for Post and Telecommunications, released news of the proposed Ethnic Television Service, and the likelihood Channel 0 would be used to establish it! Whilst it was bad enough to have a few high power Channel 0 stations throughout the country, but if all areas (i.e. principally capital cities for the time being) are to be provided with Ethnic Television, it will not be hard to see what the future of the six metre amateur band is going to be if we finish up with Channel 0 transmitters of 2.5 kW and 5 kW plus antenna gain, as the case may be, in every State of Australia.

I would like to make it clear at the outset I am not against Ethnic Television, but I am against the method of approach to its introduction. Good cases have been made out in the past for moving into UHF television, and this will need to be done ultimately anyway. The vast majority of owners of colour television sets are already provided with the means for reception of UHF television, with the UHF tuner already in the set. It is only some of the older sets which do not have this inbuilt provision, but all have a means by which conversions can be made if necessary. I service television sets, so I do know a little about what I am saying.

If we can believe Mr. Staley the use of Channel 0 is to be on a temporary basis only, with later transfer to UHF. But then again several years ago we were told the 27 MHz band would be evacuated by the Citizens Radio Service in 1982, as it was only a "temporary allocation" until users could be shifted to UHF! P. and T have as much hope of clearing the band of CB users in 1982 as they have of clearing up all their cases of TVI reports by then! From an engineering point of view once a service is operating pure economics dictate the need for at least 10 years operation to make the proposition viable. And so it will go on, Cycle 22 will be here in 1990 and the Channel 0s will be still going fine, thank you!

To have a chain of Channel 0 transmitters across Australia is going to create a pattern of mutual interference during periods of Es activity in the summer time, Adelaide will nicely interfere with Brisbane and Sydney, Melbourne will land in Brisbane nicely as it does now, Hobart also will look into Adelaide, Sydney and Brisbane, whilst Perth will be able to take its pick and land anywhere in the east.

There has been talk of running a parallel service eventually with Channel 0 and UHF simultaneously whilst viewers are given time to get their sets tuned or purchased for UHF. What a costly exercise! Through my considerable contact with the general public, right in their homes, as a TV serviceman it seems to me most homes see the need for a colour TV set as a necessity, and will go without many other

goods and chattels in order to place a colour TV in the lounge, and I will take a lot of convincing that the financial position of most families is the prime consideration when the decision to purchase is made. Most homes will already have the UHF facility available, the only outlay in the main will be an additional antenna, and in some of the better areas even the VHF antenna will provide enough UHF signal. If Bill Smith has Ethnic Television and Tom Jones has not, then the \$100 which might be required to get the Jones's older TV on to UHF will be found somewhere. Most homes have good modern cars in their garages as well as colour TV, so why all the talk about parallel services. Vote catching perhaps? Anyway, once you start any form of parallel service practically all incentive is lost to make changes which ultimately are in the views' best interests, some will plod along using the VHF service year after year, and they will never be using UHF unless forced to do so, so let's start right at the beginning and ensure that the Ethnic Television Service is given a good quality outlet on UHF instead of an obsolete service on the interference prone Channel 0 allocation.

## CORDLESS TELEPHONE EXTENSIONS

And did you stop to read Mr. Staley's warning last July on the subject of those cordless telephone extensions, when he advised the articles presently being sold are illegal, and already causing interference to other services, particularly in Brisbane because of Channel 0 operation there! That means they must be transmitting very close to the 6 metre band, too, so more problems. Referring to the interference in the Brisbane and Gold Coast areas due to the use of these phones, Mr. Staley also said "The Channel will soon be used in Sydney and Melbourne for multi-cultural broadcasting services". That means Channel 0 by any form of reasoning, so the writing is on the wall, fellow amateurs.

I can only hope the VHF Advisory Committee of the WIA will have noted this, and that we can soon have some concrete evidence that the WIA has and is continuing to voice its concern.

And on top of all these things happening to the amateurs, I am now told an FM station operating in Sydney has its sub-harmonic on 52.050, thank you very much, thus effectively blanking out the 6 metre calling frequency for that area!

As amateurs, I don't think we should set out to paint a too selfish image of ourselves, and want everything our own way. But it seems in the total picture of things, we don't ever get asked for an opinion, we have to take what we get, like it or lump it. We have had to endure listening to many 50 MHz DX signals during the past two years in particular without being able to contact the stations concerned because we adhered to our allocation 2 MHz higher; amateurs in Mel-

bourne and Brisbane have virtually had to go off the air or risk the wrath of neighbours and officialdom due to TVI, or if lucky enough not to worry the neighbours, have had to endure countless birdies on the band due to rubbish from the TV stations themselves.

Those who might conceivably answer the question at official level, and one I have often asked, but which so far has been totally ignored, is why the USA, with its vastly greater population than our own, has been able to fit in all its TV stations, FM stations, VHF and associated services, three amateur bands (50 to 50 MHz, 144 to 148 MHz, and 220 to 225 MHz), in the same spectrum area as we have, yet hasn't found the need to use a Channel 0 or 5A allocation.

My spies tell me, too, that NEC transmitters have been purchased for the Ethnic Television Service and are in Australia for use in Sydney and Melbourne, and the newspaper date says 24/25 October. So there!

### THE CHANNEL 5A SITUATION

Is it correct that ABC4 in Gippsland could well finish up as another Channel 5A, despite all the official promises to phase out the frequency? I am also told there are two high power Channel 5A transmitters still to be used somewhere in Australia, two are already destined for Hamilton, one for use and one for spare I suppose.

All this is alarming enough, especially in the light of the Minister's statements that there will not be any more 5A stations. Yet when the present plans are all brought to fruition, it seems like 5A will quite effectively stamp out 2 metre operation in Wollongong, Newcastle, Hamilton, Traralgon, Berrie (SA), Northam (WA), not to mention the low power translators at three locations in Central NSW, plus Cairns, Gympie and Alexander. This makes no account of the off-air translator receivers which will be nicely affected by amateur transmissions in the 2 metre band.

So much for WARC 79. What did it achieve? Very little if officialdom continues to openly and flagrantly escalate the operation of non-standard television channels such as Channel 0 and 5A.

### WHAT CAN WE DO?

Since preparing this article several weeks ago after reading Mr. Staley's comments in the press, I have received my copy of ARA and I would go on record as supporting Steve Gregory VK3OT in his comments there on the Channel 0 and 5A situation. If you have something to say or can help in some way I suggest you write to either of us, outlining your views, as it is a matter of considerable concern to us, and in my own selfish way I am going to miss those 2 metre contacts into Western Victoria which have been a feature of my contacts for many years, because once Channel 5A gets going at Hamilton there will be no more 2 metre contacts to that area.

I feel sorry in one way to have had to take so much of your time in having this matter aired again, but if I don't get up and say something I am accused of being too complacent, and when I do say something I am accused of stirring, so what does one do? But lack of other news this month has given the opportunity for something to be said anyway.

Despite everything which has been said, I am sorry to see Mr. Staley leaving the cause. I feel he has been able to lend a sympathetic ear to these problems, ones which probably he himself hasn't been able to spell out the answers, which at times are probably prepared by others anyway.

### VHF FIELD DAY

To change the subject, might I again remind you of the proposed VHF Field Day for the weekend of 6th and 7th December, and being sponsored by the Geelong Amateur Radio Club. I hope to have full details next month. In the meantime might I respectfully suggest as many of you as possible go out on this Field Day and perhaps the next one, as these may be the last chances you will have to enjoy the activity which can be provided by the VK3 stations on 2 metres, after that they will probably be effectively silenced by Channel 5A at Hamilton. So make the most of it now!

### TECHNICAL TIP

In a brief way I would like to try and include a small segment in this column each month now that DX is declining, detailing a hint or kink which might just make your life that much easier at some time or other. All such suggestions will be VHF or UHF orientated.

I would like to start this month by giving you a hint which I have used for a number of years when constructing my VHF antennae. This hint can apply to 52, 144 and 432 MHz yagi type antennae. If you use those black or grey plastic insulators for attaching the elements to the boom, this generally requires you to drill a hole through the element on each side of the boom, or in some cases, a bolt goes through the centre of the element, down through the centre of the insulator and the boom all in one operation. If something should strike this element, e.g. a flying bird rising upwards particularly, it is quite possible for the element to be snapped in halves right at the centre bolt mounting.

To prevent this, I slightly roughen the outer edges of the insulator and, after mounting the element in the usual way, run the usual slow setting Araldite along each side of the element where it touches the insulator, which when dry effectively gives a supporting area several inches long on each side of the boom, so that a bird collision will at worst bend the element slightly, but will not allow it to break. Should you have to replace the element you will find that a fairly high degree of pressure with your hands will

break the Araldite away from the insulator, as the two do not combine really perfectly, but sufficiently to make a very strong joint. Try it.

Closing with a thought for the month: "We probably wouldn't worry about what people think of us if we could know how seldom they do."

73. The Voice in the Hills. ■

## Youth Radio Clubs Scheme of Australia

### VICTORIAN DIVISION

The Youth Radio Clubs Scheme of Australia was formed almost thirty years ago to develop in young people and others an interest in radio and electronics. It also provides an interchange of information between school clubs. Among its activities are:—

Issue of a quarterly magazine, "Zero Beat", which gives news of club activities, study material, projects, particularly for beginners and those with limited finance, and news of meetings, classes, rallies, and so on.

Provides speakers to visit school clubs, and other organisations to give information and advice. Also advises club and other leaders as to how to organise the club and what projects might be suitable.

Technical assistance with any projects which fail to work and which the club or group cannot get going.

Supplies excellent text books written by members of the YRCS on basic electronics, logic and computer principles at a very low price to club members and individuals registered with the YRCS.

Provides components when these can be obtained at a fraction of the normal price. From time to time lists are sent to clubs and to registered members.

Holds examinations and provides very attractive certificates to all registered individuals and club members who pass. This, while not "official", has in the past proved of considerable help in getting a job in electronics. There is no extra charge for these services.

Registration for clubs and individual members is \$10 joining fee and \$10 per annum. This includes a copy of the magazine "Zero Beat".

The Victorian Division Supervisor is Roy Hartkopf VK3AOH, QTHR, and all enquiries should be directed to him. ■

---

## AMATEUR RADIO IS A RESPONSIBLE SERVICE

LET'S KEEP IT THAT WAY

# BLANK CASSETTES

LOW NOISE (General purpose tape)				
C10	C45	C60	C90	Qty.
0.82	0.90	1.10	1.40	1.9
0.77	0.85	1.00	1.30	10+

WIDE RANGE C60 C90				
(For dynamic range and less tape noise)				
	1.45	1.95		1.9
	1.40	1.90		10+

Assembled by Gluyas Gimmicks using quality German tape and Australian-made cassette cases.

## FULLY GUARANTEED

Available from

## GLUYAS GIMMICKS

14 William St., Donvale, Vic. 3111  
(03) 874 7003

and

## WILLIAM WILLIS & CO.

98 Canterbury Rd., Canterbury Vic. 3126  
(03) 836 0707

All prices ex store. POSTAGE +

	1.9	10+	
VK3	2.00	3.00	C.O.D.
VK1, 2, 7, 5	2.50	4.00	ADD
VK4, 6	2.50	5.00	\$2.70

**GUARANTEED  
BY  
VK3YPL**



# "WILLIS" AIR-WOUND INDUCTANCES

Take the hard work out of Coil Winding, use — "WILLIS" AIR-WOUND INDUCTANCES

No.	Turns			B & W Equiv	Price
	Dia Inch	per Inch	L'gh Inch		
1.08	1/2	8	3	No. 3002	\$1.20
1.16	1/2	16	3	No. 3003	\$1.20
2.08	3/4	8	3	No. 3006	\$1.45
2.16	3/4	16	3	No. 3007	\$1.45
3.08	3/4	8	3	No. 3010	\$1.70
3.16	3/4	16	3	No. 3011	\$1.70
4.08	1	8	3	No. 3014	\$1.90
4.16	1	16	3	No. 3015	\$1.90
5.08	1 1/4	8	4	No. 3018	\$2.10
5.16	1 1/4	16	4	No. 3019	\$2.10
8.10	2	10	4	No. 3907	\$3.10

Special Antenna All-Band Tuner Inductance  
(equivalent to B. & W. No. 3907, 7 inch)

7" length, 2" dia., 10 TPI Price \$5.25  
Reference: A.R.R.L. Handbook, 1961

Willis Pi-Coupler Unit — \$28.50

Stockists of Transmission Cables, Insulators and Hard Drawn Copper Antenna Wire  
Write for range of Transmission Cables

## WILLIAM WILLIS & CO. PTY LTD

Manufacturers and Importers  
98 Canterbury Rd., Canterbury Vic. 3126  
Phone 836-0707

# CONTESTS

Wally Watkins VK2DEW  
Box 1065, Orange 2800

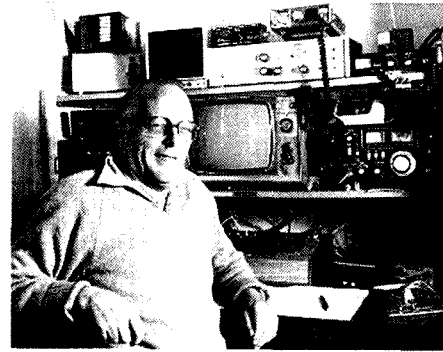

October:

- 4/5 VK/ZL/OCEANIA PHONE CONTEST
- 11/12 VK/ZL/OCEANIA CW CONTEST
- 18/19 CARTG RTTY\*
- 18/19 JAMBOREE ON THE AIR
- 25/26 CQ WW DX PHONE CONTEST

November:

- 1/2 I DIPLOMA "GRAN CANARIA PERLA DEL ATLANTICO"
- 8/9 EUROPEAN RTTY\*
- 8/9 INTERNATIONAL POLICE CONTEST
- 9 CZECHOSLOVAKIAN CONTEST
- 29/30 CQ WW DX CW CONTEST

December/January:

- 6 December to 11 January 1981
- ROSS HULL MEMORIAL CONTEST (VHF ONLY)

\* Rules for these contests from VK2SG or VK2EG QTHR SASE PSE.

# WIA (FEDERAL) DIRECTORY

## MEMBERS OF EXECUTIVE

Mr. P. A. Wolfenden VK3ZPA, Federal President.  
Mr. K. C. Seddon VK3ACS, Member.  
Mr. H. L. Hepburn VK3AFQ, Member.  
Mr. C. D. H. Scott VK3BNG, Hon. Treas.  
Mr. B. R. Hathols, VK3UV.  
Mr. W. E. J. Roper, VK3ARZ.  
Secretary: Peter B. Dodd VK3CIF.  
Amateur Radio: Mark Stephenson VK3NOY

**IMMEDIATE PAST FEDERAL PRESIDENT AND IARU LIAISON OFFICER**  
Dr. D. A. Wardlaw VK3ADW.

**IARU LIAISON OFFICER**  
Mr. M. J. Owen VK3K1.

**INTRUDER WATCH CO-ORDINATOR**  
Mr. G. J. Fuller VK3NXL

**FEDERAL REPEATER SUB-COMMITTEE**  
Mr. K. C. Seddon VK3ACS, Chairman.  
Mr. J. J. L. Martin VK3ZJC.  
Mr. P. B. Mill VK3ZPP.

**EDITOR AND CHAIRMAN OF PUBLICATIONS COMMITTEE**  
Mr. B. Bathols VK3UV.

**FEDERAL BROADCAST TAPE CO-ORDINATORS:**  
Mr. R. Fisher VK3OM.  
Mr. W. Roper VK3ARZ.

**FEDERAL EDUCATION CO-ORDINATOR**  
Mr. R. E. Hartkopf VK3A0H.

**FEDERAL HISTORIAN**  
Mr. G. M. Hull VK3ZS.

**FEDERAL CONTESTS MANAGER**  
Mr. W. A. Watkins VK2DEW

**FEDERAL AWARDS MANAGER**  
Mr. W. D. Verrall VK5WV.

**FEDERAL VHF/UHF ADVISORY COMMITTEE**  
Mr. K. G. Malcolm VK3ZYK, Chairman.  
Mr. P. A. Wolfenden VK3ZPA.

Mr. I. W. Cowan VK3BGH.  
Mr. L. Janes, VK3BKF.  
Mr. J. J. L. Martin VK3ZJC.  
Mr. K. L. Phillips VK3A0U.  
Mr. W. M. Rice VK3ABP.

**FEDERAL RTTY COMMITTEE**  
Mr. H. P. Mulligan VK2ABH, Chairman.  
Mr. J. J. Lupton VK2BVJ.  
Mr. R. E. Taylor VK2A0E.

**PROJECT ASERT COMMITTEE**  
Mr. R. C. Arnold VK3ZBB, Chairman.  
Mr. P. A. Wolfenden, VK3ZPA/NIB.  
Mr. K. G. McCracken VK2CAX.  
Mr. L. Janes VK3BKF.  
Mr. G. C. Brown VK3YGB.

**AMATEUR SATELLITES**  
Mr. R. C. Arnold VK3ZBB.

**FEDERAL WICEN CO-ORDINATOR**  
Mr. R. G. Henderson VK1RH.

**VK/ZL/O CONTEST MANAGER (VK)**  
Mr. N. R. Pentold VK6NE.

**FEDERAL VIDEOTAPE CO-ORDINATOR**  
Mr. J. F. Ingham VK5KG.

**FEDERAL COUNCILLORS**  
Please see main Directory.

## ALTERNATE FEDERAL COUNCILLORS

- VK1 — Mr. A. Davis VK1DA.
- VK2 — Mr. F. S. Parker VK2NFF.
- VK3 — Mr. A. R. Noble VK3BBM.  
Mr. G. F. Atkinson VK3YFA.
- VK4 — Mr. D. T. Laurie VK4DT.
- VK5 — Mr. W. M. H. Wardrop VK5AWM.
- VK6 — Mr. P. J. Savage VK6NCP.  
Mr. B. Hedland-Thomas VK600.
- VK7 — Mr. R. K. Emmett VK7KK.

# YOU and DX

G. (Nick) Nichols VK6X1  
6 Briar Place, Ferndale, WA 6155.

Australians, or more specifically VKs, are an apathetic group of individuals, one might almost say that we are just plain lazy.

Home-brewing is a forgotten art, even antennas, the key element of any station, are being bought in enormous quantities "off the shelf"! Perhaps we are too affluent but does that mean the same lazy, don't give a damn attitude should prevail in our operating techniques and manners whilst on air? Oh dear, perhaps I've offended you, raised a few hackles? Well you can always ignore me, turn the page, take the easy way out.

Still with me? Good! It's nice to see a few operators care. Spending the amount of time I do in listening to the bands reveals that many stations don't even bother to check whether a frequency is in use before commencing transmission. By checking I mean carefully listening, then if nothing is heard, politely asking not once but twice to make sure. Such manners appears to be lacking in many many operators. I could of course cite numerous examples, for instance the VK calling CQ South America right on top of a Brazilian who was already in QSO with Australia, oh and on 20 metres (yes novices aren't the only ones by any means) the VK3 calling right slap bang on the same frequency as a very large net, including many VKs waiting their turn to work LU3ZY on South Sandwich Island; then to cap off that particular operation the considerate VK2 who, after successfully contacting that station, made the supreme physical effect of QSYing down one kC to have a rag chew with another local, linear still on line, with no possible consideration for the other stations awaiting their chance. Many required repeats of signal reports due to the heavy QRM.

I sound disgusted do I? You can be assured that I am, however that's not the end of it.



# IONOSPHERIC PREDICTIONS

Len Poynter VK3BYE

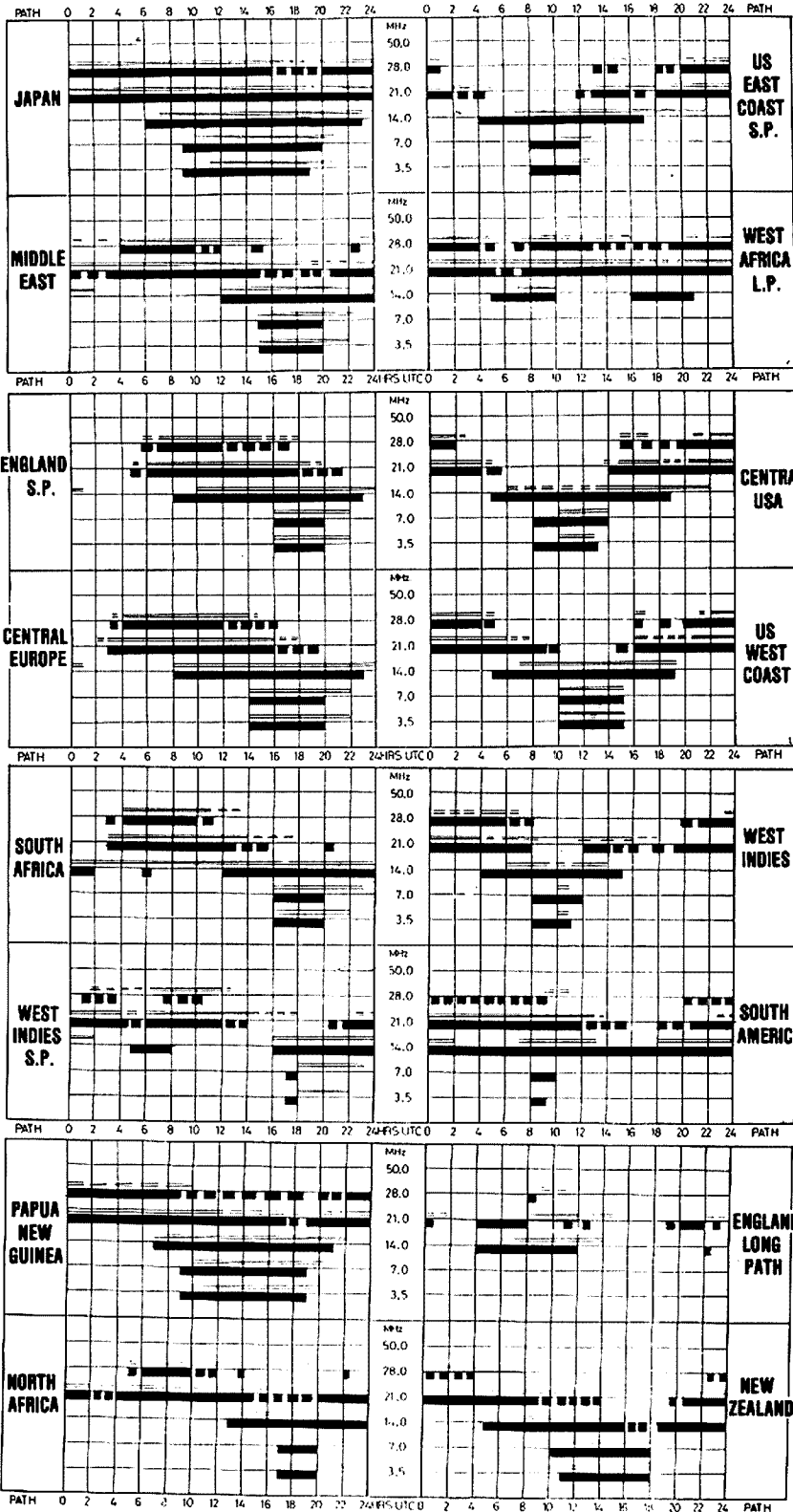

**LEGEND**

- FROM WESTERN AUSTRALIA.
- FROM EASTERN AUSTRALIA.
- BETTER THAN 50% OF THE MONTH, BUT NOT EVERYDAY.
- LESS THAN 50% OF THE MONTH.

Predictions courtesy Department of Science and Environment IPS Sydney.  
All times universal UTC (GMT).

DXers are a competitive bunch (that's right, you say—have to be to be successful). Well that spirit of competition, coupled with brilliant tail-ending mentioned in a previous article, crashing over the top (well you're louder than the bloke the DX station is talking to), is fast earning you an unenviable reputation. We cannot even understand plain English—since when is 3 in call area 5 or 6 in 1 for that matter. I find it no surprise whatsoever that several DX stations have indicated that they won't work VK, they are sick of it—can you really blame them? (If you can't hear a station, you can't work him.—Ed.)

Enough said, I sincerely hope the situation improves but I have my doubts.

**ON THE BANDS  
10 METRES**

Again unstable, the most reliable path being into the African continent, on phone FD8XY, 5Z4YV, TLBWH, 3BZV, AA6AA/3BB, KA6SB/3BB, HZ1HZ, CX7AAR, T3LA, 5H3FW, ZK1CF, and on Cw WA6AHF/KH8 being noteworthy.

**15 METRES**

Excellent conditions prevail both on long and short paths, OH0AM, PJ9EE, OA4AWD, FB8ZO, T2AAA, S8AAW, 600DX, ST2FF/ST0, ZB2GK, SV0AT and WB7RFE/Wake Island all appeared at good strength.

**20 METRES**

Rather unpredictable but as usual a solid DX band. On CW DJ8BO/HB0, AI3E/KX6, HV1D1 and DJ1US/ST3 were of interest, whilst on phone 9Z7CSJ (Trinidad, Scout Jamboree station), 8R1RBF, HK0EIM and LU3ZY were in demand.

**40 METRES**

Excellent activity for the month both on phone and CW. For the patient listener on phone 5Z4YV, HK1AMW, YV1BI, CE1CDO, FR0FLO, XE1UF and HC1NK, we regulars, whilst on CW KV4CI, AH0A, FR7BP, HH2VP, VS6JR, NP4A, ST2FF/ST0 and DL2GG/YV5 all livened up the band.

**80 METRES**

For the novice, solid propagation into New Zealand, together with YJ8NRS, YJ8SE, OA4AWD and ZS6BNS, all on phone, helped brighten up the rag chew band. On CW HH2BP, KL7HBK, ST2FF/ST0, 4S7MX, AA6AA/3BB and UQ2NK were available for the early riser.

**160 METRES**

No report this month.

**QTHs YOU MAY HAVE MISSED**

- BV2B — via Tim Chen, PO Box 30547, Taipei, Taiwan
- 5H3FW — via DF4TA.
- DJ1US/ST3 — via DF2RG.
- HZ1HZ — via PO Box 1999, Jeddah, Saudi Arabia.
- C5ACO — via W2TK.
- KX6MY — via PO Box 1252, APO, San Francisco 96555.
- HK0EIM — via PO Box 842, San Andre Island, Colombia.
- T3LA — via W7OK.
- 600DX — via I2YAE.
- C5ACC — via KB4GQ.
- SV0AT — via AF4B.

David N2KK/6 will be commencing an Indian Ocean jaunt taking in operations from the following countries. It is hoped some of the rarer African prefixes may also figure in this trip but lack of confirmation of reciprocal licensing unfortunately delays the release of this information:

Low bands will be concentrated on, particularly (3695 and below) 80 (Phone and CW) and 160 (CW), but also 10 metres, particularly leaning toward VK novices.

- 15th October to 29th October — 4S7.
- 30th October to 22nd November — 8Q7.
- 23rd November to 2nd December — FR0.
- 3rd December to (period not decided) — J2B.

December to unknown—Southern Sinal area thence to OD5.

Also for those Abu All hunters the news is good, a licence has been granted to K6LPL and J2BAZ (Pierre)—call sign J20/AA to commence 5th December, 1980—all bands. Good luck on this one; I'll be in the pile-up with you.

## YAESU FT-707 "WAYFARER"

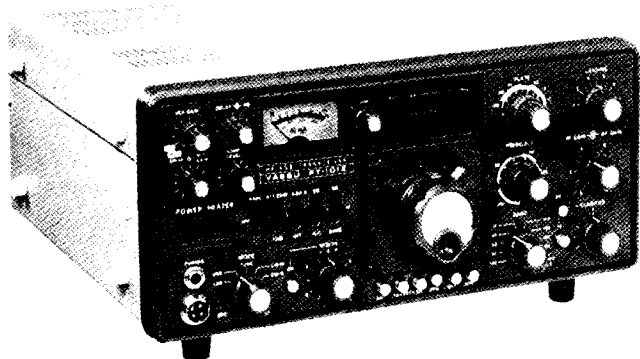

inc. Warc. freq.

We also have special prices on the FT-101Z, around \$720 or the FT-101ZD for around \$850 inc. WARC. FREQ.

Excellent after sales service and normal service facilities always available.

### "DAIWA ROTATOR"

DR7500R Medium duty "R" .....	\$185
DR7500X Medium duty "X" .....	\$169
DR7600R Heavy duty "R" .....	\$269
DR7600X Heavy duty "X" .....	\$249

### CHIRNSIDE ANTENNAS

Chirnside Vertical Antenna Type CE-5B Features Pre-assembly. Long length and high Q traps makes the CE-5B more efficient than similar types of antennas especially on 80 Metres. It is also very easy to tune and its construction is very rugged. Can be assembled in less than 5 minutes.

Specifications of the CE-5B.  
Bands: 80-40-20-15-10 M. Operation.  
Power handling: 2 kW PEP.  
SWR: 1.5 to 1 or better.  
Length: 30' (approx.)  
Weight: 6KG Packed.

only **\$99**

CE-42 15-10 M. Duo-Band

**\$149**

Hi-Q Balun \$16

CHIRNSIDE CE-42 rugged duo band beam features four elements and uses independent reflectors for optimum results.

3 elements on 15 M.

3 elements on 10 M.

Director and driven elements have hi-q traps.

Forward gain is 8 dB and front to back ratio is in excess 25 dB.

Free rail freight for Chirnside Antennas anywhere in Australia.

Compare "the FT-707" with other brands and see if they have an external VFO (optional) available in which you can program 12 of your favourite operating frequencies. Each memory bank has a spread of 500KHZ with the option of scanning slow or fast from the hand mic. or from the digital VFO itself. Yet with all these features it is so compact that it can be carried in the same mobile mount as the FT-707. With this compact system mobile operation is a "breeze". For those not wishing to use the digital VFO the FC-707 antenna coupler with in-built 100W dummy load can also be carried in the mobile mount, saving you the need to interchange mobile antennas.

"Our price for the FT-707 is only around \$700" (so why pay more elsewhere?).

## YAESU.

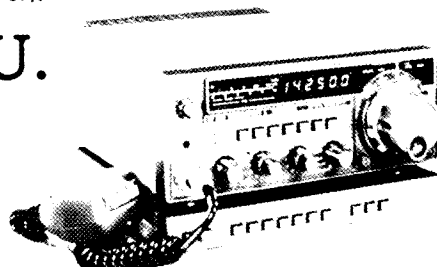

FT-707. All solid state HG transceiver, incl. 10, 18, 24 MHz .....	
FV-707. Digital VFO for FT-707 incl. scanning. ....	
FC-707. Antenna coupler for FT-707 .....	
FP-707. DC power supply for FT-707 with inbuilt speaker .....	
Rack mount for all the above items also available.	
MMB-7 Mobile Mount FT-707.	
FT-107M. HF transceiver excluding power supply.	
FT-107DMS. HF transceiver incl. DMS and power supply .....	
FC-107. Antenna coupler for FT-107 .....	
FV-107. External VFO for FT-107 series .....	
SP-107. External speaker. ....	
FT-107. Range is available in the colours grey or ivory.	
YM-35 Scanning hand mic .....	

FT-101Z. 160-10M Transceiver, analog dial .....	
FT-101ZD. 160-10M Transceiver, Digital .....	
optional digital display for FT-101Z .....	
optional Fan. ....	
optional DC-DC converter .....	
FV-101Z Ext. VFO for FT-101Z series .....	
YO-901. Panoramic adapter monitorscope for FT-101Z.	
FL-2100Z Linear for FT 101Z range .....	
SP-901. ext. speaker .....	
All FT-901 Accessories are compatible with FT-101Z series.	

FRG-7. Communication receiver .....	
FRG-7000. Digital communications receiver .....	
LF-2A. Narrow band filter for FRG-7 .....	
FT-7B. 80-10M Transceiver .....	
FP-12. 12 Amp. power supply for FT-7B. ....	
YC-7B. Digital display for FT-7B .....	
FT-227RB. 2M Digital programmable transceiver. ....	
YP-150. Dummy load/Watt meter .....	
FF-50DX. Low pass filter. 2kw .....	
QTR-24D. Deluxe 24hr. World clock. ....	
FT-207RA Hand held 2M transceiver 10 kc steps. ....	
NFB-1 Nicad for FT-207 RA .....	
YM-24 Ext. Speaker Mic. for FT207RA .....	
NC-3 Base Charger AC Adapt. for 207RA .....	
YE-7A Hand mike .....	
YD-148 Desk mike .....	

Please send stamped, self addressed envelope for brochures.

All equipment carries 90 day warranty, excluding output devices.

PRICE ON APPLICATION

Most mail orders despatched within 24 hours of receipt of payment with order.

Please allow sufficient for freight, insurance etc.

**CHIRNSIDE ELECTRONICS, 26 Edwards Road, Chirnside Park, Lilydale, 3116. Phone (03) 726 7353**

# LETTERS TO THE EDITOR

Any opinion expressed under this heading is the individual opinion of the writer and does not necessarily coincide with that of the publisher.

The Editor,  
Dear Sir,

I wish to bring the following matter to the attention of your executive as I feel a complete violation of the principles of amateur radio has been committed and will continue to be so for the remainder of this week.

Radio station YJ8IND commemorating the nationhood of Vanuatu (New Hebrides) is very active and will be using this call sign till just after independence. The station is being manned by amateurs from YJ8 and I congratulate them on their attempt to promote the ultimate goal of any group of people — nationhood in their own right.

Whilst mobile in Newcastle I was delighted to exchange reports with YJ8IND operator Ken on 21.195 MHz at 0110Z on the 28th July, 1980, then to work the same station on 28.524 MHz at 0205Z the same day. This time the operator signed as Paul.

However the crunch came when after making initial contact on 15 metres I asked if QSLs could be exchanged via the Bureau and was promptly told the following:—

"Sorry but no Bureau on this one. Direct QSL only and you must send 4 IRCs or 1 DB (I presume he meant a dollar bill). No card otherwise."

During the further contact on 10 metres I asked that operator if there was a QSL Bureau on the New Hebrides. This he confirmed but promptly informed me "No money, no card, so forget the Bureau".

This as I see the matter is a complete violation of a basic fundamental of amateur radio DX — the use of the QSL Bureau if one is available. This station is using a specially issued call sign, operated by YJ8 amateurs whose voices would be familiar to many VKs and I presume have the "official blessing" of the authorities.

I regard the demanding of money over amateur radio and the encouraging of international operators to break their countries currency restrictions as deplorable. I can only assume this station will not make any exceptions to their stated demands and send any cards via Box 88, Moscow — HI!

I lodge my strongest possible protest with you concerning the current activities in the New Hebrides (Vanuatu) and you may feel free to publish this letter in "Amateur Radio" if you wish.

Philip Greentree VK2VUQ. ■

(How far do amateurs turn a blind eye to contributing towards the costs of DXpeditions and special stations? And how much is a QSL card worth? Do we all set up shop to see how much we can get for our cards, assuming of course we are not allowed to charge for our own time taken in writing them out? Most operators would probably be satisfied with 2 IRCs to cover postages on QSLs mailed direct, and perhaps 4 IRCs for airmail on direct QSLs. The organiser of station YJ8IND, C/O Box 39, Port Vila, was told this letter would be published and was asked if he would like any of his own comments to be added. No reply came. —Ed.) ■

11 Brett Avenue, Mt. Isa 4825

The Editor,  
Dear Sir,

I wish to publicly thank those who assisted me during the past 1980 Remembrance Day Contest. In particular I would like to say that without the help of VKSNBX, who kept my log for me and also kept me awake with the worst jokes I've ever heard (just ask him about the elephant near my pool).

Also I would like to thank those operators who went out of their way to try and cause interference. They did this by dropping tones on my operating frequency VFOing over the frequency, general QSOing on the frequency and sending recorded

voices on my operating frequency. All this happened in the closing hours of the contest, around 0500Z.

There were a number of operators listening on the frequency who beamed on to the interfering stations, and we do know which State it was coming from, so once again I thank those stations for the interference, it only stirred me on to continue as I was just about to end my transmissions.

See you all again in the 1981 "Friendly" contest.  
73. R. Egan VK4NOD. ■

8 Dexter Drive, Salisbury East, SA 5109  
25th August, 1980

The Editor,  
Dear Sir,

From time to time, due to the nature of the duties performed by Alex VK5CCT, he has the opportunity of an overnight stay on Cocos-Keeling Island. This location is of course as you know still a rather rare and sought after one for DX chasers.

On such occasions Alex has always been prepared by ensuring that he has equipment with him and has also been most obliging by giving up his night's sleep just to provide as many contacts from that location as he can. Operation has been mostly confined to the 20 metre band due to lack of time for erection of antennas, setting up of the station, etc., however we would also like to overcome this problem if we can. We do have ideas of using a multi-band vertical to attempt operation on other bands in the future. Paul, now VK3CGR, also has operated from Cocos in the past as VK9CGR, and Alex has been operating under the call sign of VK9CCT/portable VK9Y. In view of the difficulties of explaining the use of the Australian "C" call series to many of the DX stations, with obvious attendant language problems in some cases, and to simplify things to a large degree the QSL information has been to QSL via VK5QX, which is my call sign.

I do wish though to explain for the benefit of all interested our QSL policy.

Firstly, we are amateur radio operators and are definitely not in the business of trying to make anything out of any of these operations from a financial point of view.

Secondly, we do not in any way ask for payment from anybody for the privilege of receiving a QSL card.

We are extremely critical of this abovementioned practice, and also very much against the practice of "bulk mailing" of return QSLs for those operators who have sent with their card sufficient to cover return postage in the normally accepted manner. We have been upset to hear that such practices exist and indeed feel ashamed that this sort of thing can happen with Australian operators involved. Again I can only say that we strongly condemn any of this type of practice.

Many operators do enclose with their card an American one dollar note, and this is quite acceptable. (Often referred to as a "green stamp".) You would also be quite surprised just where some of these come from too, quite often from European stations, etc. Other operators enclose International Reply Coupons and yet others somehow have affixed to their self-addressed envelope an unused Australian stamp. All these methods suit us quite well.

Some operators send nothing at all, whilst others such as a certain VK station are most generous of their own free will. This particular operator referred to not only sent a stamped self-addressed envelope but included with it two dollars worth of Australian stamps, "Just to help out".

We also fully understand the problems of amateurs from some countries who have access to neither dollar bills, International Reply Coupons, etc. Many of these have enclosed a varied selection of stamps of their own country, which is a nice thought. Alex has a number of times even sent a few IRCs back to these stations so as to help them out in future.

Allow me to just explain another couple of matters.

A one dollar American note here in VK exchanges to about 80 cents. It costs 55 cents Australian to post a card back airmail. This then leaves a balance of 25 cents Australian.

The cost of the printing of the QSL cards also has to be covered and as some stations do not include a self-addressed envelope a stock of these has to be kept on hand.

So you can therefore see that we definitely are not in this for anything other than the fun of amateur radio and the pleasure of so many more people being able to make a rare contact.

We are trying to make arrangements in the case of stations from the USA for a scheme utilising a "Stateside QSL" manager. This would allow operators in that country, and there are many who have made contacts, to obtain their QSL for the cost of just one internal return postage. Here again though we will have to sort out the problem of log information and the printing of cards. This I feel will not be too difficult to achieve.

For stations who send their cards via the QSL Bureau the reply card is returned in the same manner. In each case this costs 4 cents per card from this end and I have sitting on my shelf a batch of 250 cards and a 10 dollar note to cover their cost, which I will be handing to our QSL Bureau Manager tomorrow evening (all VK9CCT).

So that, I think, will pretty well explain the story to you. We do not know of any criticism of our QSL policy to date, however in the light of some of the things which have happened in this sphere of amateur radio in the past and which are apparently still going on, we wished to let everyone know that at least we are, as we say it in Australia, "fair dinkum". Our policy is a one hundred per cent QSL policy in every way possible with no frills or additions.

Before I close I would like to thank all those operators who have assisted in any way during Inese Cocos-Keeling operations which by virtue of circumstances must be mounted at both short notice and certainly under some very difficult conditions for the boys who operate from there at such times as are possible. We hope that we can keep these operations going, as many more stations still remain to be satisfied with a VK9Y contact. We are also hopeful of having more operators in the near future who will be able to come on from there on an opportunity basis.

Last of all I would like to thank all of those USA stations who were most helpful during Alex's recent trip by both standing by, providing advice, refraining from QRM, etc., which allowed him to achieve his Worked All States from Cocos-Keeling. All we have to do now is to get them all confirmed. HI.

73. Ian J. Hunt VK5QX,  
also on behalf of Alex VK5CCT and Paul VK3CGR.

PS: Incidentally, need I also mention the amount of work involved in making out all the QSL cards after up to 630 contacts made in less than 10 hours of operation from the island during the one night? So for those still waiting, please be patient if you can! ■

The Editor,  
Dear Sir,

May I comment further on the VK/ZL Contest scene.

First, let me re-state the nitty-gritty of what any contest should attempt to do. By means of sensible rules and attractive awards, it should provide excitement for maximum participation. Do the present rules and rewards of the VK/ZL meet these criteria? Partly yes — but, in my view, it's time for another look at 'em.

The coming 1980 VK/ZL, sponsored this year by NZART, has five clear sections. This is good, as far as it goes, but there is room for more sections, even if they don't induce a big activity first up. What is needed is an SSB and CW section for the novice licensee. The rules make no special provision for the novice, so if he wishes to compete he must do so in the open section and under the handicap of low power, inexperience and band and frequency limitations. This is not the way to attract maximum participation. The VK novice is a fast growing influence and deserves recognition in our one big national event. It is true that there is a yearly VK novice stir, but it is not a DX contest as such — yet.

The decision of the VK Contest Committee to include an eight (2) hour section is to be applauded and it induced enough participation to justify its continuance. Many cannot devote a whole day and night to AR for various reasons, e.g. many OTs are past a non-stop 24 or 48 hour "go", while others have commitments for part of the weekend—and so on.

Contest Committees, VK or ZL, could also look at the suggestion of creating an added section for YLs. By their nature, the "gals" don't compete as overly aggressively as the males and might be enticed to come on more if they had a separate classification. A little more encouragement in the form of a special section might swell the ranks.

Until a multi-op. classification is added to the already existing sections, it cannot be known if this type of operation would be popular. Some thought should be given to this, especially as the pundits predict increased multi-op. activity in the future.

#### SWLs

It is good to see the section allowing this group to participate has been re-introduced in the 1980 rules. They were debarred from the 1979 list. The main gripe about SWLs is that their QSLs, in the modern scene, have little value; this, of course, is a half-truth. However, in my view, they should be encouraged to become a greater part of the scene, for one very good reason, viz., they are a much bigger group than most realise and, although the percentage may not be great, many eventually become Hams. Still, participation in any activity is usually a two-way stretch. Times have changed and SWLs, in their turn, should be looking to producing a more attractive QSL with something of value written on it. Many I receive would entice no one to respond.

Needless to say, if the VK/ZL Contest is to have more sections it is also going to need to issue more awards, diplomas, etc. "Wall paper" alone, as a display memento, isn't good enough. Something more enticing needs to be offered, in the form of plaques, pennants, medallions, etc. This is not a criticism of what has been awarded in the past: it is now 1980 and time the prizes were updated. Everyone now expects higher rewards. The day of the one-design certificate issued for all categories of prizes should be past. Providing top class trophies for several sections is costly and most contest committees don't have such funds at their disposal. The answer lies in sponsors; there is a long list of them offering attractive rewards in the ARRL and CQ Contests, etc., so why can't the same be done for the VK/ZL? We may not be Big League—but neither are we "small time".

Nell Penfold VK6NE took the courageous and progressive step of accepting summary sheets only, in lieu of logs. The result was, as I thought it would be, when some of these sheets were checked against their corresponding logs, they showed mistakes, irregularities and maybe even cheating. One must take a realistic view of this situation—Hams, by and large, are just as prone to "mistakes" as any other group or society. However, there is no need for the summary sheet idea to be discarded. If it is plainly and clearly written into the rules that the winning logs—and any other that the Contest Committee deems necessary—will be called in for close perusal, and that errors of over 3 per cent can render any log invalid, then any inclination to submit sloppy logs or cheat will be neutralized.

The prefixes VK or ZL are commonplace really and not likely to entice overseas DXers to fire up their rigs, just to knock us off ad infinitum. Larger overseas participation could be expected and more logs submitted if DX to DX working was permitted, with an added bonus for working VK/ZLs; say, 2 points for DX to DX and 5 points for DX to VK/ZL. Many other countries run their contests in this manner and the ARRL, always conservative, has just introduced it with marked success.

The requirement in the rules to exchange a two or three digit number, increasing by one to reach OSO, i.e. 01 or 001, together with the report, is a sore point with some. They feel a fixed two digit is more in keeping with the modern scene. It is not by chance that contests in which a fixed two digit is used are very popular. Those who

would retain the status quo and persist with the sequential numbering defend its use by saying it provides an added test of competency. This is true; but in my view the modern contest is tough enough without it. Now the QSO rate is faster—so much so, logs cannot be hand written and computers are needed to help cope. Mistakes inevitably occur with the old method, whereas the two digit is mistake free. I advocate a trial of the fixed digit swap; but if not let us at least stick with Jock White's ideas of allowing any competitor to commence with any number between 1 and 100. This way no one knows exactly how the other fellow is doing, which is the way it should be if maximum participation is to be maintained.

It seems to me that activity in our VK/ZL, both local and overseas, is not what it should be. By creating more sections, offering more and better prizes and re-writing part of the rules, it may be possible to get to that nitty-gritty and almost double the number of logs submitted. If you have any positive suggestions on the above, write to your Contest Committee.

Alan Shawsmith VK4SS.

PO Box 53, Bairnsdale 3875  
20th July 1980

The Editor,

Dear Sir,

Never having written a letter to the Editor before, I am prompted to do so by a letter in July AR from Jack Mellor VK3AMG, re limited tenure of novices.

It is obvious, without knowing the gentleman personally, that he is either involved in electronics as an occupation, or is retired, with plenty of time on his hands. I think we should all place things in perspective. In other words, first things first. For me, my family comes first, then my job, which by the way is far removed from electronics, and then my hobby. I obtained my novice call after the November 1979 exams, and will in due course try to obtain a full call. But why should I be forced to neglect my first two priorities for that of my hobby? Not everybody is an electronics genius, and I'm not ashamed to admit that it took me two attempts to pass that "hard" novice exam, but I don't think I'm any worse an operator for it. So what if a novice wants to remain one forever. We don't exactly have large portions of the band, and I suggest that if Mr. Mellor feels we are degenerating too far, he has only to tune a little further up the dial.

It may be worth remembering that the recent large influx of novices has without a doubt saved our hobby and the WIA from destruction within a few years due to lack of numbers.

I probably won't make AOCPP within two years, but if my fellow amateurs would like me off the bands, perhaps I have chosen the wrong hobby, from which I obtain much pleasure.

Yours sincerely,

Peter S. Phillips VK3VPC.

Crescent Head, NSW 2440.  
11-6-80.

The Editor,

Dear Sir,

There seem to be two distinct groups of people feverishly insisting on popularising amateur radio. One is well intentioned and the other is ill intentioned.

The well intentioned want as many as possible to share their hobby, which they themselves find so enjoyable. That is very laudable, but they must pause to reflect that they are eagerly inviting others to share something which, only in part, belongs to them. By all means let them share their own possessions, but not those of the many who desire to preserve the individuality of the hobby and who do not want it invaded by a host of newcomers who have been "talked into" it; who were not attracted to it by a consuming inner urge; and who cannot find the way without finger posts and enthusiastic "missionaries" prodding them mercilessly.

The early amateurs were attracted to amateur radio by an urge within themselves and they needed no outside persuasion. They needed assistance then, but never persuasion. As a con-

sequence, they value their hobby and behave with restraint, decorum and circumspection.

There are many old established amateurs who are convinced that the "service" has been degraded by the artificially stimulated influx, because many of the newcomers haven't any concept of the deeper meaning of amateur radio. To them it is only a means to exchange inanities.

There was once a well established and well observed protocol . . . for example: one did not break into a conversation without a very good reason and especially when one of the stations was not readable to the breaker! There was once a willingness to accept a friendly hint to turn down the gain a little, without responding by inviting the adviser to visit a taxidermist!!

With regard to the ill intentioned, they are mostly motivated by the desire to become very wealthy, very quickly. It is perfectly legal to sell transceivers to all and sundry; that it is quite unmoral and unprincipled is of no consequence to these people. For a very few of these latter it may be a desire to undermine and utterly destroy amateur radio as we know it.

To sum up: Let us case this "missionary" work and allow people to gravitate into the hobby of their own volition and let these abundant "missionary" energies be directed towards persuading the Governments, Federal and State, to legislate against the sale of equipment to other than appropriately licensed persons and maybe, with lots of luck, we will preserve a most enjoyable and a most dignified hobby.

R. G. P. Andrews VK2ARN.

51 Meeks Crescent, Falconbridge 2776  
18/4/80.

The Editor,

Dear Sir,

At the head of page 7 of the April issue of AR, under the heading of "New Bands", mention is made of two VK2 agenda items. I would support the first agenda item to have the new bands authorised for use as soon as possible, but the second proposal to limit their use to a select band of elite amateurs who have "higher" qualifications to my mind is a selfish proposal which should be opposed by all full call members before we end up with more grades and band segments than the Americans. To cite the fact that the new bands are so narrow, therefore higher operating requirements are necessary, is an insult to anyone who has passed the AOCPP exam, particularly the essay version. It implies that we already have a problem with out-of-band operators who either do not know how to calibrate their transceivers or willfully break the regulation. If this is the case, and I have no evidence that it is, then those culprits or incompetents should not be allowed to operate on any bands, not further restrictions placed on those who do not offend or in the proposer's estimation might offend.

To also suggest that a higher CW qualification or RTTY exam be discussed in connection with those band segments' usage is ludicrous. It matters not what the mode of transmission is as long as the transceiver is stable, calibrated and tuned correctly; again if the amateur does not know how to do this properly then he should not have an amateur licence. The assumption that if a person can receive CW in excess of 20 w.p.m. or type RTTY, that should qualify him for extra privileges is wrong, as just about any private citizen can be trained to do that in a few weeks.

As there are no popular commercial amateur band transceivers as yet available for these new bands, this would be an incentive to all those true amateurs who are willing to experiment, as opposed to the communicator appliance operator "amateur" who admits over the air his unwillingness to open his black box's case, let alone put a soldering iron near its insides. Those last home truths should make all of us realise that one standard should suffice for all operating privileges of full call operators without placing restrictions on other people's rights by regulation or "higher" standards. If you are good enough to operate on 1.8 MHz (60 kHz band width) then you should be proficient enough to operate on 10 MHz or any other band for that matter, or give the game away.

N. Chivers VK2YO.

# AMATEUR RADIO ACTION

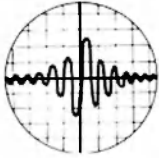

is the **NEW GENERATION**  
amateur magazine.

- ★ Comprehensive DX notes
- ★ Propagation forecasts
- ★ Very technical - and not so
- Technical articles
- ★ Useful projects

Here are just a few of the arti-  
cles which have appeared in  
recent months

- ★ Fixed wire beams
- ★ Case for UHF beacons
- ★ 80W linear for 6m
- ★ Wilson System Three review
- ★ Spratly DX exclusive
- ★ Backyarders - good or bad?
- ★ A.T.V. Special
- ★ SWL notes

Average page content is 80  
pages - at \$1.20 an issue that's  
good value.

Please put me down for 12 editions of  
Amateur Radio Action, starting NOW-  
Rates in Australia — \$15.60.  
Surface mail overseas — \$21.00, not including  
New Zealand — \$23.40.  
Airmail: To New Zealand — \$31.80. Indonesia &  
Malaysia — \$33.00. Japan & India — \$38.40.  
U.S.A. — \$43.80. U.K. & Europe — \$47.40.

Herewith enclosed cheque/postal  
note/money order to the value of:

\$A .....

Name .....

Address .....

.....

.....

Postcode .....

Post to: Amateur Radio Action Sub-  
scriptions, Box 628E, Melbourne,  
3001.

## AWARDS COLUMN

Bill Verrall VK5WV  
7 Lilac Avenue, Flinders Park, SA 5025

Here are details of two Australian awards which  
are available to members of 10/10 International  
contacts on the 10 metre band only. All applicants  
for these awards must possess a current 10/10  
number and this may be obtained by working the  
required number of existing 10/10 members on the

10 metre band. Full calls require contacts with  
10 different stations, novice calls require contacts  
with 5 stations. Send log details only, including  
the name, address and 10/10 number of the stations  
worked to Mr. Art Hart VK2BXN, PO Box M514,  
Central Mail Exchange, NSW 2012, with a fee of  
\$4 for full calls or \$3 for novice calls. Applicants  
will then receive a certificate with their unique  
10/10 number stated thereon. Then you may pro-  
ceed to chase contacts on the 10 metre band for  
the followings awards:—

### WELCOME STRANGER AWARD

This award is available from the "Welcome  
Stranger" ten-ten chapter located in Ballarat, Vic-  
toria. Ballarat was a tiny hamlet, nestling in  
primeval forest, when gold was discovered there  
in 1851. Within a few years Ballarat had become  
the richest of Victoria's goldfields. Thousands of  
miners of all nationalities flocked to the "diggings",  
which soon covered 800 square miles of alluvial  
claims. Gold was mined by the pound.



Second or Endorsement Award of Welcome Stranger, earned when 50 points have been  
attained.

During this period the minors rebelled against a repressive colonial authority, and Ballarat became the scene of the only pitched battle ever fought on Australian soil—the "Eureka Stockade"—when miners fought the police and army in a bloody battle.

It was during this period also that the world's largest nugget was found not far from here. The name given to the nugget was "The Welcome Stranger" that we take the name of the Chapter. We feel that the name expresses all that is best in Amateur Radio—"Welcome Stranger"!

Net time and frequency: 0000 GMT, Sunday (Aust.), 28.530 MHz.

#### BASIC AWARD

The Welcome Stranger certificate requires 10 points, which may be earned by working members on ten metres. The cost is \$2 airmailed. Award credit value is 1 point.

#### GOLD CITY AWARD

50 points required, but any station may be worked twice, and the points totalled, provided that contacts are 24 hours apart. Cost is \$1 plus one IRC airmailed. The award credit value is 1 point.

#### CENTURY STRIKE AWARD

100 points required; conditions are the same as for the Gold City Award. Cost is \$1 plus one IRC airmailed. Award credit value is 2 points.

#### VIP AWARD

250 points required; conditions as above; must include 5 Charter Members. The cost is \$2 plus one IRC. Worth 2 points.

#### VALUES

Charter Members are worth 3 points, Committee Members are worth 4 points. First State, DX and Honorary Members are worth 2 points. Charter Members are worth an additional point. Charter Membership may be granted to any amateur on payment of \$2, and is worth an extra point. Charter Members are limited to ONE per country, and ONE per each Australian State, except in exceptional circumstances.

#### NOTE

A Three Aces award will be automatically granted to any member who achieves three first States on award and endorsements. All members of Welcome Stranger must possess a ten-ten number and be licensed radio amateurs.

#### CHAPTER HEAD

Leo McPherson VK3ADT, PO Box 247, Ballarat East 3350, Victoria, Australia.

#### BASIC AWARDS MANAGER

Geoff Smith VK3NLZ, 829 Laurie Street, Mt. Pleasant 3350, Victoria, Australia.

#### ENDORSEMENTS AWARDS MANAGER

("Gold City", etc.)  
Harry Hekkema VK3NLH, 29 Cromwell Street, Sebastopol 3350, Victoria, Australia.

#### DESCRIPTION

This award measures 300 mm x 245 mm and the two endorsement certificates measure 175 mm x 120 mm. All are printed in two colours on high quality matt finish paper with lettering in black.

#### CITY OF MELBOURNE AWARD

##### CHAPTER REQUIREMENTS

##### BASIC

15 points, including 1C or 2HM or 2HC.

##### FIRST ENDORSEMENT

100 points, including 2C and 2FS.

##### SECOND ENDORSEMENT

250 points, including 3C and 5FS.

##### VIP

500 points, including 5C and 10FS.

Certificates will be awarded to members of 10/10 International who complete the Chapter requirements.

First Country will be awarded to the first correct application received from each Country per WIA Countries List, except Australia.

First State will be awarded to each Australian State and Territory, to each USA State, to each Canadian Province, to each numerical call 0-9 in England and Japan, and 0-4 in New Zealand.

Honorary Members will be appointed to assist in propagating this award.

Honorary Charters will be awarded as decided by the Charter Members from time to time.

Two Honorary Members or two Honorary Charters may be substituted for one Charter on the basic certificate only.

Any HM, HC, FC, FS may act as FS for first, second plus VIP Award. When working for endorsement, FS must be an Basic Certificate. Fs on first, second or VIP do not count towards awards.

Locals are deemed to be those within the greater Melbourne area and are designated "L".

#### POINTS VALUES

Charters, 5 points; Honorary Members, 5 points; Honorary Charters, 4 points; First Country, 4 points; First State, 3 points; Local, 2 points; Others, 1 point; each endorsement, 2 points; FC plus FS on endorsements, 3 points.

All endorsements are Certificates. Cost of each is \$3 airmail return.

Net frequency: 28.580. Time: Friday 2330Z, Saturday 0930 local.

All correspondence to be addressed to: The Manager, Box 242, Sunshine 3020, Victoria, Australia.

#### DESCRIPTION

The award measures 225 mm x 295 mm printed on gloss finish white card. The award features a multi-coloured street scene of Melbourne.

## SILENT KEYS

It is with deep regret that we record the passing of—

Mr. J. G. PRATT	VK2BPC
Mr. R. B. ALFORD	L20743
Mr. H. E. QUILTY	VK2AHO
Mr. L. N. SCHULTZ, M.B.E.	VK2ANM
Mr. R. B. ALFORD	L20743

## OBITUARY

Mr. H. E. (TED) QUILTY VK2AHO

It is with deep regret we record the passing of Ted Quilty, aged 66 years.

Ted will be particularly remembered by the older Hams, having obtained his licence in the mid-1930s. He was a very keen and efficient CW man, being employed as a telegraphist in the Sydney GPO.

Holding a 1st Class Certificate, he transferred to DCA in 1939, taking up duty as Air Radio Operator at the Rose Bay radio station, operating the Sydney end of the Trans-Tasman Flying Boat Service.

After three years he returned to the Sydney GPO and later the Engineering Branch. He was a keen member of the Waverley Bowling Club. Two years ago he replaced his "home brew" rig with modern equipment, plus a substantial tower and beam.

He was hospitalised twice in the last 12 months with cardiac problems and passed away on the 3rd August in the Prince Henry Hospital following a severe heart attack.

Deepest sympathy is extended to his wife Doreen and her family.

Bill Bullivant VK2BC.

## BOOK REVIEW

#### AMATEUR RADIO AWARDS

By The Radio Society of Great Britain.

This book is a dictionary of awards available to Amateurs and Short Wave Listeners from thirty-nine countries or societies throughout the world. The book does not intend to be a comprehensive listing of every award, but nonetheless contains information on most popular of the national society awards available to radio enthusiasts today, including one or two others.

The first edition was released in 1973 and this, the second edition, carries updated information and new material in its 80 pages. Each country's major awards are listed with details on rules and requirements and in some cases reproductions of the award discussed.

For those needing a refresher in geography this book contains excellent small scale maps depicting call areas throughout the world, together with an updated call sign listing and zone locations for the avid DXer.

Overall this book is a must for the serious award hunter and a useful general reference tool for those engaged in other facets of amateur radio but who may "get the bug" at a later stage.

Available from WIA divisions (on order) or your favourite book shop.

VK3NOY.

GIVE AN ADVERTISER  
YOUR SUPPORT

WELCOME STRANGER 10X CHAPTER - VK3

CENTURY STRIKE AWARD

AWARDED TO

DATE

NUMBER

Awards Manager

# TECHNICAL CORRESPONDENCE

56 Sherwin Avenue, Castle Hill  
16-8-80

The Editor,  
Dear Sir,

Re modification of SSB 27 MHz PLL Tcvt for 10m operation.

VK4AR's excellent article tells of one method popular today, however experience has found that 5 kHz channelling is not always possible using the method described. For some reason the majority of PLL02A chips produce an 8.5 kHz reference frequency when pulled to deck. Only PLL02AG chips can be relied upon to give 5 kHz stepping used this method.

An alternative and much more practical conversion involves taking a standard Cybernet CB, replacing the 10.24 MHz xtal (X2) with a 5.12 MHz xtal and this will make Channel 1 28.240 MHz.

After re-aligning and replacing the channel selector with the 9 switch, switch box described in VK4AR's article, the radio will now operate quite happily from 28.240 MHz to about 28.600 MHz, with reasonable output, in 5 kHz steps.

Further, a simple modification can allow operation through all frequencies in this range. Simply remove R23, R24 and D5; bridge D4; pick up voltage from squelch pot VR2 and bridge through a 10k 1W wire-wound resistor to unused terminal of clarifier pot VR3.

The clarifier now alters both Tx and Rx frequency about 7 kHz (about 2.5 kHz down and 4.5 kHz up from centre frequency).

By using combination of switches and clarifier all frequencies in the popular phone section of 10m band can be obtained.

Neil Cornish VK2NBA.

## AROUND THE TRADE

Amateurs Paradise, the well known Queensland retailer specialising in amateur gear, has moved to larger premises in the heart of Southport on the Gold Coast. The new address is Shop 5, 144 Scarborough Street, Southport (opposite the Del Plaza Hotel), and the telephone remains unchanged at (075) 32 2644.

Interstate and foreign visitors have always been most welcome to drop in for a chat and view the comprehensive range of all the major manufacturers equipment and accessories.

**VICOM INSTALLS COMPUTER SYSTEM**  
Melbourne based Vicom International Pty. Limited has recently installed a Honeywell computer system to cope with the rapid increase of business currently being experienced.

The Managing Director, Russell Kelly, believes the inhouse system will greatly improve customer service and enable the company to keep track of thousands of spare parts and products.

"Our sales have increased so much lately that it was impossible to keep up with the paper work."

Vicom have installed a Honeywell Level 6 computer with a number of terminals and screens and operates a real time system to handle inventory and all accounting functions. The company has branch offices in Sydney and also in New Zealand.

As well as being in the amateur radio market, Vicom is also heavily involved in professional, commercial and governmental communications accessories.

### TEN-TEC NEW RELEASE

The Scalar Group are now sole Australian distributors for the products of Ten-Tec Incorporated

Perhaps the best known Ten-Tec transceiver is their QRP rig, the "Argonaut".

**AMATEUR RECEIVING STATION. AW-352-DX**

OFFICIAL  
OBSERVER  
AUSTRALASIAN  
RADIO WORLD





VK2SWL

COFFS HARBOUR  
NSW AUSTRALIA ...

MEMBER  
  
W.I.A.  
**ANTENNAE.**  
DOUBLET  
100 L. 40' H. NE.  
10m. ROTARY.  
*A.R. Payten*  
Operator.

**RECEIVER**

3 TUBE T-R-F.  
6K7-6K7-6F6  
5 TO 600 Mx.

**PSE QSL via W-I-Australia... Vg 73s es DX**

## QSP

### LISTENER'S QSL

Published below is an old listener's QSL card which was handed to me by a local resident. I am not aware whether Mr. Payten is still alive, however you can see the amount of work involved in this particular card. He is obviously a keen or was a supporter of the WIA and I thought that the information might be worth publication and of interest to our members.

The wharf still exists but there are many many other improvements in the area with a growth in

the area which is greater than many other small towns.

J. Brinkman VK2IS, 61 Gundagai Street, Coffs Harbour, NSW.

### 6W8

"6W8AR will be again on 28320 MHz every Sunday 0830-0930 GMT (after the P29 net) from October 1980 to July 1981. QSL manager for 6W8AR is WB4LFM."



The new "Argonaut-515", pictured here, is an improved version and should be very popular with novices and the QRP enthusiast alike.

The updated "Argonaut" includes the following:—

- Full band coverage 3.5, 7, 14, 21 and 28 MHz.
- Improved receiver sensitivity, 0.35 uV for 10 dB S + N/N. max.
- Four pole 9 MHz crystal filter, 2.4 kHz bandwidth, 1.7 shape factor.
- WWV receive at 10 and 15 MHz.
- New LED RF output indicator flashes on 2-watt voice peaks.
- PTT.
- Adjustable side tone level and pitch.
- Built in SWR bridge/S meter.
- Full line of matching.

The "Argonaut" features a no-tune broad-band final amplifier for instant band change, instant operation with 5 watts input and 2 watts output, including LED RF indicator.

The finals are unconditionally guaranteed for 12 months and have a pro rata warranty for five years.

Ten-Tec equipment is available from Scalar offices in Melbourne, Sydney, Brisbane and Perth.

### ADDITIONAL STAFF JOIN VICOM

Vicom, in their programme of expansion, have added several more prominent staff members to their team. Stephen Porch has joined Vicom Sydney office and is well versed in amateur radio and commercial communications products.

Ian McFarlane VK3AQQ has joined the Melbourne head office as Group Accountant. In addition, Mr. Neil Lambert (ZLTJO) has been appointed as Managing Director of Vicom's New Zealand operation.

### SYZYGY

A phenomenon where all the planets of the solar system come into alignment or "conjunction". This occurs about once in every 180 years and the next is due about 1982 to 1984. Not much is known about the last Syzygy in 1797-1806 according to the article in Worldradio News of March '80 but some exceptional tides, volcanic eruptions and tidal waves apparently. Of interest to amateurs is an expected effect on radio propagation, apart from environmental effects (if any) possibly arising from gravitational forces which could affect the sun in respect of solar flares, sunspots and magnetic storms. By the way, pronounce the word like slizz (as in sizzle) l (as in in) and gy (as in geometry or the hard "g" as preferred).

# HAMADS

- Eight lines free to all WIA members. \$9 per 3 cm for non-members.
- Copy in typescript please or in block letters to P.O. Box 150, Toorak, Vic. 3142.
- Repeats may be charged at full rates.
- Closing date: 1st day of the month preceding publication. Cancellations received after about 12th of the month cannot be processed.
- QTHR means address is correct as set out in the WIA 1979 Call Book.

## FOR SALE

4 Element 10m Beam with gamma match, hardly used, excellent condition, \$50. Werner VK3BWW. Ph. (03) 366 7042.

Challenger CIP Computer with 8K ram, extensive programme library, as new, \$400. VK4ST. Ph. (071) 91 1172.

FTDX401, in excel. cond., with Foster mic., Katsumi MC701 speech compressor, spare matched pair of 6KD6s, 2 new 7360 and several other spare tube, hand book, \$450; CDR rotator with control box, 110V transformer and some control cable, ideal for small beam, \$60. VK3GI. Ph. (054) 27 2576, Woodend, to arrange viewing of equipment if necessary.

Galaxy V HF 5-band Txcvr., SSB/CW, 300W PEP input, separate power supply, perfect working order, full service manual and circuit diagrams, spare valves, including finals, compact and powerful shack or mobile rig, size 6 in. x 10 1/4 in. x 11 1/4 in., \$350. VK3BPT, QTHR. Ph. (03) 758 6445.

Icom IC701 with power supply and mic., absolutely as new, in original cartons, \$1000. N. Stillwell VK3ACN. Ph. (054) 42 1268 Bus., (054) 43 7592 AH.

Sell or Swap variety vintage (1920s) component parts, mostly B/C, also WW2 era octal valves. SAE for list to VK4SS, 35 Whynot Street, West End, Brisbane 4101.

FRQ-7, in mint cond., has two 2.4 kC filters for SSB, one 6 kC filter for AM, fine tuning, slow motion tuning, extra dial light, \$250. A. Harrison, Nilma. Ph. (056) 23 2450.

Yaesu FT-901DM AC/DC All-mode Txcvr., with all options fitted, incl. AM and CW filters, plus bug for Curtis keyer and aerial matching unit, orig. carton, only tested due failed full morse, \$1400, ONO; new Kenwood TR2400 plus charger, \$250, ONO. VK2ZQH/VAW, QTHR. Ph. (02) 498 7867.

Diawa CN620 SWR Bridge, IC22S, IC701 w/AC supply, TR2400 hand-held w/stand B1 base, Philips FM320, 432 MHz transceiver, Mirage B108 linear 144 MHz, several yagis for 20, 6 and 2m. VK3ADR, QTHR. Ph. (03) 240 1231 Bus., (03) 509 6637 AH.

Icom IC-22S, exc. cond., 3 mths. old, 147.630 MHz channel installed, \$260. Frank VK3ZO around 6.30 p.m. Ph. (03) 478 5972.

Complete Novice Station: Yaesu FT201S and P/S, \$650; Kenwood MC50, \$40; Dalwa CN620, \$80; 35 ft. lower and emulator 103LBX rotator, \$230; 15m 3 el., \$70; 10m 3 el., \$50; all coax and cable included; will sell complete for \$1000 or separate as above. G. Haywood VK3VFK. Ph. (051) 52 3137 Bus., (051) 52 3753 AH.

Very Large (350 cm x 21 cm), very old glass accumulator jars and lids, Edison brand, collector's item, or use for pickled onions. Further details from VK6NPW, 23 Waddell Road, Palmyra, WA 6157.

Kenwood TS520S Txcvr., with MC10 mic., novice power mod., done professionally, diagram supplied for simple change back to standard specs., this unit is like new in appearance and performance, \$550, ONO. Max Cutbill VK2NVO. Ph. (02) 621 5135 Doonside.

Beam TH3JNR, and KR400 rotator, both new and still in boxes, with balun, \$350, ONO. Peter VK2NVA, QTHR. Ph. (02) 909 1130.

KLM UHF Linear, 10 watts in 70 watts out, solid state, covers entire 70 cm band, ideal all modes, incl. ATV, \$300; microwave modules, 1296 MHz to 144 MHz converter, \$50; microwave modules, 432 MHz to 1296 MHz varactor, \$50; mounting hardware for 2C39, \$12 per sent. VK3ZVJ, QTHR. Ph. (03) 478 8251.

Palomar TX100 Solid State Linear Amplifier, broadband 3-30 MHz, 200W PEP out from 12W PEP in, 100W out from 4W in, includes 10 dB gain RF pre-amplifier and RF relay switching, ideal with FT7, etc., little use, as new in carton, \$195, ONO; SL-56 active audio filter, SSB and W, bypass width variable to 14 Hz, 12 poles, plus 2 pole 60 dB notch filter, imported from USA and not now required, bargain at \$55. VK3ARZ. Ph. (03) 90 7409.

Deceased Estate—Late VK2ADE: Kenwood TS820, VFO 820, \$850; Kenwood TS520, VFO 520, \$650; Swan 500, VFO 500, P/S, \$500; Heathkit SB220, \$500; Atlas 210X tcvr., SS, \$400; Heathkit SB301, SB401, combined units, \$600; Heathkit SB610 monitorscope, \$100; Drake MN2000 ant. matching network, \$150; Hy-Gain 6 el. Thunderbird antenna, 50 ft. crank-up, tilt-over tower, CDE ham M rotator, combined three units, \$560; Ringo 2m antenna, \$30; 4BT vert. ant., \$80; Hustler mobile whips 10, 15, 20, 40 and 80m (5), \$60; D104 Astatic mic. and stand, \$30; Heathkit Cantenna dummy load, \$25; coax switches, \$10 ea.; University multi-meter, MVA100, \$30; FRG7 communication receiver, \$350; plus large amount of spare parts, magazines, etc. Enquiries to John VK2ZPC, QTHR. Ph. (02) 95 5946 AH.

Home Base/Mobile Station: Heathkit SB101 tcvr., with updates to SB102, CW filter, two new 6146Bs in final, like new cond., Heathkit CB640 external VFO, Heathkit HP23A 240V P/S solid state, Heathkit 12V P/S for mobile, connecting cables and manuals, \$550; TH6DXX Hy-Gain tri-band beam, completely refurbished, new boom section, new SS clamps and trap covers, small elements and traps assembled, alminoxed, taped and sealed, tested, beam to mast assembly, etc., \$200. VK2DA, QTHR. Ph. (02) 94 1039.

Yaesu FT200 Txcvr., matching AC power supply, mic., good cond., \$350; DX160 Rx, as new, in carton, \$150. VK4JF, QTHR. Ph. (074) 72 1461, Kilaroy.

Txcvr., Icom IC701/IC701PS/MIC ICSM2, as new. Bill VK3YHT, QTHR. Ph. (052) 21 2162 Bus., (052) 78 8272 AH.

Yaesu FTDX400 Txcvr with Yaesu matching spkr., 80 through 10m, receiver preamp fitted for 10m, plus cooling fan for finals, c/w mic and hand book, plus 240-220V AC transformer, \$250. VK3NHV, QTHR. Ph. (03) 728 4023.

Anybody want to buy a good HF Transceiver? Drake TR4C, 300W, in good cond., noise blanker fitted, with 12V DC as well as 240V AC power supplies, mic and speaker, set of 3 matched finals (6JB6A) and 12BY7A driver, instruction manual, what offers? All Chandler VK3LC, QTHR. Ph. (03) 99 5344.

Hidaka Vertical Trap Antenna, 20 through to 80m, \$60; 2 AR7 receivers, one is modified complete, other is original with power supply, has all coil boxes plus spares and a large range of spare valves to suit. Ph. (03) 439 9632.

Swan 500C Txcvr with P/S, in good cond., \$350; AWA BS50 base station, going on \$2,525 MHz, best offer; AWA BS50 base station, going on 146.0 MHz, best offer. Enquiries to Central Coast Amateur Radio Club, PO Box 238, Gosford 2250, or Ray Wells VK2BVO. Ph. (043) 92 2244.

BWD CRO 509B 7 meg, as new. Wanted Pye Cambridge AM or FM low band transceivers. John Ruston VK5ARK, Renmark, SA. Ph. (085) 86 6127.

Lafayette HA800B, 80m through 6m, amateur Rx, \$40; sideband SC502 10 metre rig, with battery and power leads, \$40; 80m to 11m transverter, \$40; no reasonable offer refused. Steve Porter VK4NBY, QTHR. Ph. (07) 52 0171, ext. 282 Bus.

TS820S, with manual, MC50 desk mic., SP820 spkr., the lot \$800, ONO. Rolf VK3AOF, QTHR. Ph. (03) 366 3478.

Yaesu FT101E, AC-DC, speech processor, cooling fan, spare final and driver tubes, comprehensive maintenance hand book, plastic cover, very little use, absolutely as new, original packing, \$675; KW107 Supermatch, HF combined aerial tuning unit, SWR meter and dummy load, as new, \$125; Yaesu desk mic., YD-844, unused, \$40; Yaesu radio frequency filter, new cond., \$20; Hy-Gain TH3MK3 HF 3 el. beam, unused, \$200; Hy-Gain balun for beam, \$15; Standard C146A 2m transceiver, heavy duty charger, whip aerial, extension mic., 6 channel, very little use, as new, \$150. VK3BFB, QTHR. Ph. (03) 93 1638.

Yaesu 2m xtal-locked FT2FB with power supply, immaculate cond., never been portable and hardly used due to my lengthy overseas secondments over last 3 years, 3 simplex frequencies, 3 repeater frequencies, \$125. Roth Jones VK3BG. Ph. (03) 870 3333, ext. 18 Bus., (03) 848 7945 AH.

Yaesu FL110, HF linear amplifier, \$200, ONO; will trade for 20A 13.8 V power supply; also TS120S Txcvr, \$600. Gus Napier VK1NBO, QTHR. Ph. (062) 82 1457 AH.

Kenwood TS700A 2m Txcvr, all mode, with VOX-3 VOX unit, \$575, ONO; ICOM IC202E with IC20L 10W linear, \$250 ONO. Lionel VK3NM. Ph. (03) 568 2733 Bus., (03) 88 3710 AH.

Frequency Counter, Dick Smith, to 200 MHz, as new, hardly used, \$90. VK3UV, QTHR. Ph. (03) 90 6424 AH.

## WANTED

Require construction details for transverter, 28 MHz to 3.5 MHz, Dick Smith type now out of production, would appreciate this or similar type. John VK4NRQ, 100 Wrigley Street, Maroochydore, Qld. 4558. Ph. (071) 43 3023.

Computer Programme for Apple II 32K, basic ham radio log book listing, editing and search for listing. Please contact Rex Shepherd VK2VVI, PO Box 22, Woonona 2517 or Ph. (042) 83 1040.

Triband Beam, TA32 DX32 TA33, slate cond., age, price, etc., all replies answered. VK6PY, QTHR. Ph. (09) 271 7192.

Information/Advice on conversion of Pye "Overland" (F25) to 2m, all letters answered. VK1NCW, QTHR, or R. Jenkins, 88 Companion Cres., Flynn, ACT.

MEL (Mullard) Equipment Control Unit L348/02, alternatively panel sockets or equipment with panel sockets, types 22-14S, 18-11S, 18-11SX, 18-11SW, 22-23P (one of each). P. Hadgraft VK4APD, 17 Paxton St., Holland Park, Q. 4121. Ph. (07) 397 3751 AH.

Medium Size Tri-band Antenna, swop brand new AT180 for AT200, also 30 yds. of 12 way cable for similar length of 6 way cable. Maurie Batt, Rokewood Junction, Victoria 3351. Ph. (053) 42 2245.

## TRADE HAMAD

Amlidon Cores — Iron-powder and ferrite, enlarged range available for tuned/wideband and suppression applications in Rcvrs./Trans., large SASE for data/price list. Closed for business during November. RJ & US Imports, Box 157, Mortdale, NSW 2223.

**The Advertisers in "Amateur Radio" support the WIA member — give them first preference — and tell them so, too!**

# ADVERTISERS' INDEX

AUDIO TELEX	52
AMATEUR RADIO ACTION	47
BAIL ELECTRONICS	18
CHIRNSIDE ELECTRONICS	44
DICK SMITH ELECTRONICS	2
GFS	29
GLUYAS GIMMICKS	42
NSW DIVISION WIA	34
RJ AND US IMPORTS	50
SCALAR INDUSTRIES	17
SIDE BAND ELECTRONIC ENGINEERING	51
TRICITY HOUSE	6
VICOM PTY. LTD.	4, 23
WILLIAM WILLIS	42
W. & G. WULF	34



# SIDEBAND ELECTRONICS ENGINEERING

**"THE ANTENNA AND ROTATOR SPECIALISTS"**

**P.O. BOX 23 SPRINGWOOD NSW 2777  
WAREHOUSE 213 HAWKESBURY RD. SPRINGWOOD  
TELEPHONE (047) 54 1392**

**"This month we offer reduced prices on Yaesu Musen equipment. FT-101ZD transceiver complete with cooling fan and AM board \$850, FRG-7 receiver \$280 and at very special prices the FT-707 transceiver, FP-707 power supply and FC-707 antenna tuner - ring or write for a price on these."**

## ANTENNAS

TET HB35C 10-15-20M 5 el log/yagi 13' boom..... \$415  
CUSHCRAFT A3 10-15-20M yagi 14' boom..... \$325

## HY-GAIN

TH3-JR 10-15-20M 3 el yagi 12' boom..... \$250  
DB10-15A 10-15M 3 el yagi 13' boom..... \$190  
153-BA 15M 3 el yagi 12' boom..... \$120  
18-AVT/WBa 10-80M trapped vertical 21'..... \$125  
8 el 2M yagi 14' boom 15db gain..... \$50  
14 el 2M yagi 16' boom 18db gain..... \$60  
GPG-2 2M 5/8W co-linear 3-4db gain..... \$30  
6M and 2M 1/4W whips..... each \$9

## HELICAL MOBILE WHIPS 10-15-20-40-80M

heavy duty de-luxe models w/adj. tip each..... \$25  
As above ANY TWO WHIPS plus mount & spring..... \$60  
As above FIVE WHIPS plus mount & spring..... \$115  
NOVICE PACK 10-15-80M whips plus mount & spring \$80  
GPV-5 2M base co-linear 2 x 5/8W..... \$55  
OSCAR-2D 2M mobile co-linear 2 x 5/8W..... \$35  
BN-86 balun (for beam buyers only)..... \$25  
HI-Q balun 50 ohm 1KW 1:1..... \$15

## HENRY RADIO FAMOUS LINEARS

2KD-5 2KW PEP 80-10M SSB/CW/RTTY/AM..... \$1000  
1KD-5 1200W PEP 80-10M SSB/CW/RTTY/AM... \$800

## KYOKUTO FM-2025A

The very latest 2M FM from KDK 25W  
10 memory channels plus full scanning etc..... \$340

## ACCESSORIES

SWR meter Hansen twin meter 150MHz..... \$35  
SWR meter single meter 150 MHz..... \$25  
ASAHI Chrome bumper mount..... \$8  
Standard bumper mount..... \$5  
Chrome base & spring to suit ASAHI mount..... \$15  
FERGUSON 240V AC transformer 2 x 9V  
secondaries at 3A..... \$8  
DYNASCAN 820 digital capacitance meter..... \$150  
TRIO DM800 grid dip meter..... \$120

## NOVICE SPECIALS — CONVERSION CRYSTALS

SET OF 8 crystals converts 28.480-28.595 in 5KHz steps.  
Clarifier tuning on Tx & Rx plus info to re-activate 24th ch.  
..... \$32

## ROTATORS & CABLES

CDE BT-1A BIG TALK light duty programmable 4 pos. push  
button plus normal operation..... \$110  
KEN KR-400 medium duty..... \$140  
CDE HAM-1V heavy duty..... \$225  
CDE T2X TAIL TWISTER extra heavy duty..... \$300  
KEN KS-065 stay/thrust bearings..... \$30  
8 core rotator cable per metre..... .80c  
RG-58U coax cable per metre..... .50c  
RG8U foam coax cable per metre..... \$1.20

## TRIO-KENWOOD PRODUCTS

Ring for a competitive price on Trio-Kenwood transceivers.  
TS-180S w/WARC frequencies, TS-120S, TS-520SE, TR-  
9000, TR-2400 etc.

TS-130S HF all band WARC transceiver..... POA  
R-1000 Digital clock receiver..... POA  
SP-100 external speaker R-1000..... \$32  
SP-180 ext. speaker TS-180S w/filters..... \$60  
AT-180 200W ant. tuner/SWR/Power..... \$160  
TV-502 2M transverter..... \$250  
DK-520 adaptor TS-520/DG-5..... \$10

## YAESU MUSEN PRODUCTS

FT-101ZD 160-10m transceiver w/coding fan & AM board  
..... \$850  
FT-708 80-10m transceiver 12v DC SSB/CW/AM... POA  
FP-707 240V 20A power supply..... POA  
FC-707 ATU/SWR meter/dummy load..... POA  
FV-707 Digital VFO memory unit for FT-707..... POA  
FRG-7 5-30MHz communications receiver..... \$280

## COAX CONNECTORS

PL-259 RG-8U & RG-58U types..... .75c  
Cable joiners RG-8U & RG-58U types..... .60c  
GLP right angles RG-58U to SO-239 w/lock nut & weath-  
erproof cap..... \$1.50  
SO-239 4 hole & single hole types..... .75c  
MLS right angle RG-58U to PL-259..... .75c  
In-line mic sockets 3 & 4 pin each..... .60c  
Mic. sockets 3 & 4 pin each..... .75c  
M-ring body mount w/lock nut..... \$1.50

**All prices are NET, ex Springwood NSW, on pre-pay-  
ment with order basis. All risk insurance is free of  
charge, allow for freight charges by air, road, rail or  
post, excess will be refunded. Prices are subject to**

**change without prior notice. All orders cleared on a  
24 hours basis after receipt of order with payment.**

**Roy Lopez (VK2BRL)**



# TH5DX

## 10-15-20 METERS

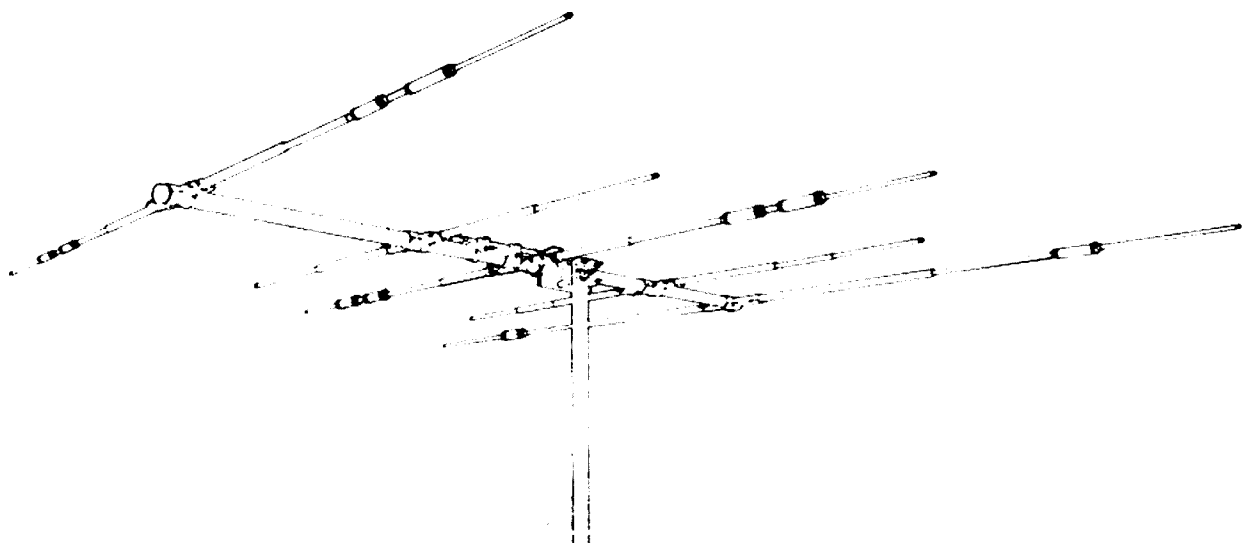

We are proud to introduce the newest member of our famous Thunderbird line of Tri-Band antennas. The TH5DX offers outstanding performance on 20, 15 and 10 meters. It features 5 elements on an 18 foot boom, with 3 active elements on 15 and 20 meters and 4 active elements on 10 meters. The TH5DX also features separate air-dielectric Hy-Q traps for each band. This allows the TH5DX to be set for the maximum F/B ratio and the minimum beam width possible for a Tri-Band antenna of this size. Also standard on this antenna are Hy-Gain's unique Beta-match, rugged Boom-to-mast bracket, taper-swaged elements and improved element compression clamps.

Boom length..... 18 feet  
 Longest Element..... 31 feet  
 Turning Radius..... 18 feet  
 Surface Area..... 6.4 sq. feet  
 Wind load..... 164 lbs  
 Weight..... 50 lbs

VSWR at resonance..... less than 1.5:1  
 Power Input..... Maximum Legal  
 Input Impedance..... 50 ohms  
 -3dB Beamwidth..... 66° average  
 Lightning Protection..... DC ground  
 Forward Gain..... 8.5dB  
 Front-to-Back Ratio..... 25 dB

**WRITE OR CALL FOR A FREE BROCHURE AND THE NAME OF YOUR NEAREST HYGAIN DEALER  
 SOLE AUSTRALIAN DISTRIBUTOR**

AUDIO TELEX COMMUNICATIONS  
 PTY. LTD.



**MELBOURNE:**  
 7 Essex Road,  
 MOUNT WAVERLY 3149  
 Tel: 277 5311

**BRISBANE:**  
 394 Montague Road  
 WEST END 4101  
 Tel: 44 6328

**SYDNEY:**  
 1 Little Street,  
 PARRAMATTA 2150.  
 Telephone 833 4344

# amateur radio

JOURNAL OF THE WIRELESS INSTITUTE OF AUSTRALIA

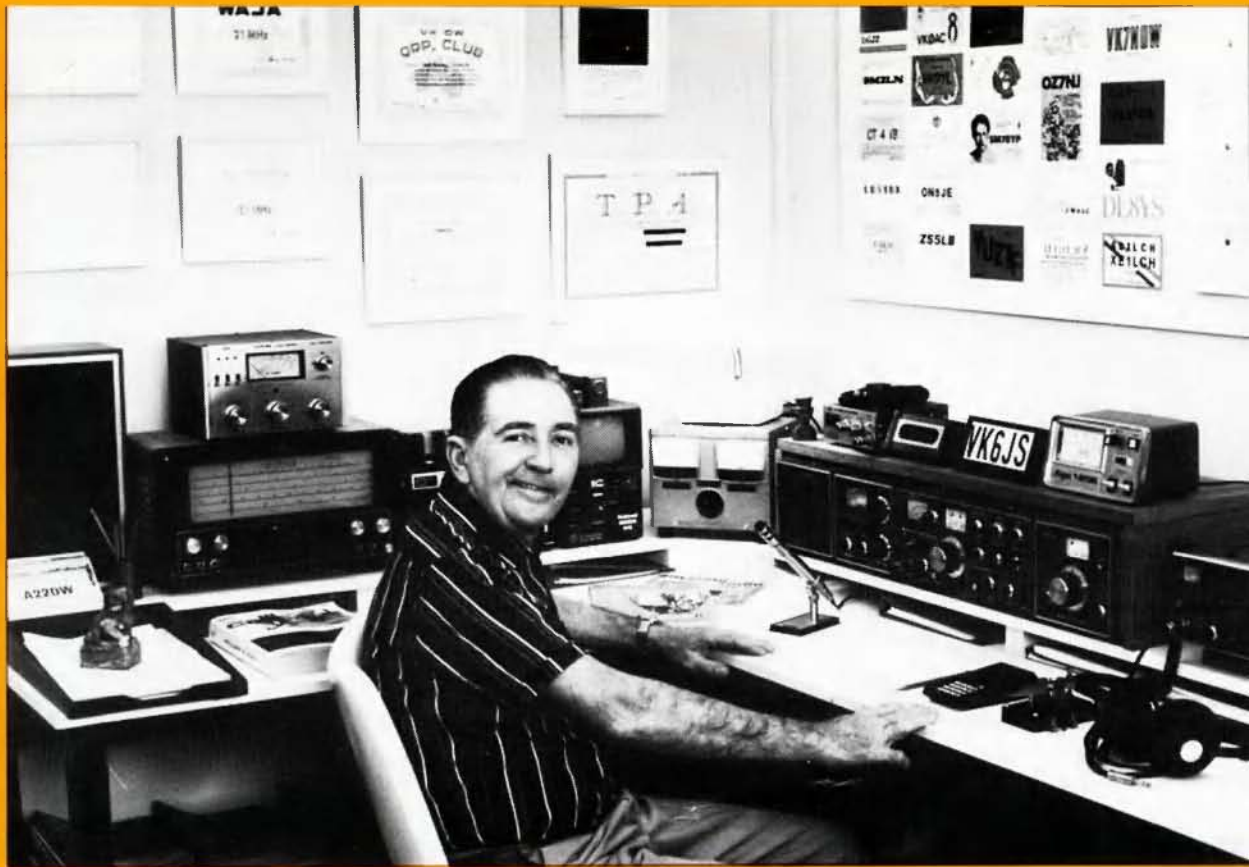

VOL. 48, No. 11

NOVEMBER 1980

## ***FEATURED IN THIS ISSUE:***

- ★ 1980 REMEMBRANCE DAY CONTEST RESULTS
- ★ PRACTICAL MOBILE ANTENNAS
- ★ DELTA-YAGI — THE ANSWER?
- ★ COLLECTORS' CORNER No. 4 — THE IC260A/E

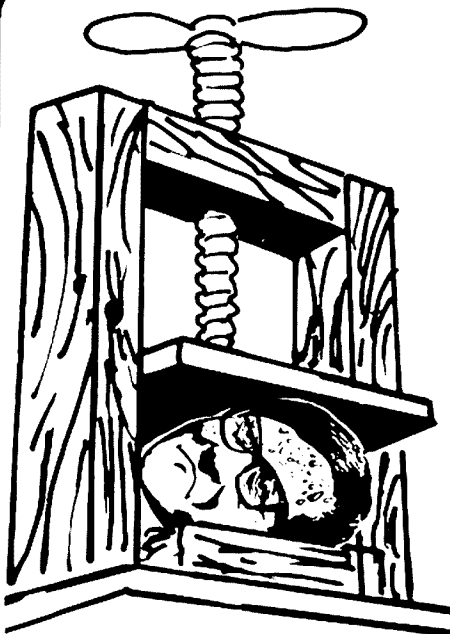

# EXTENDED BY PUBLIC DEMAND!

Whoops! We're sorry! We give up! We will extend the deadline!

When we announced our Dick Smith-Yaesu Win a Fantastic Trip to Hong Kong' competition, we completely forgot about all the new Yaesu models. Little did we realise that the new models would be so popular that they would sell out immediately; and anyone who waited for the next shipment would be too late to enter!

And then there were the customers who wanted the brand new models: the ones that hadn't even arrived yet!

Scores of customers have asked: 'Hey! What about us. Why should we miss out on winning the trip just because you guys ran out of stock!'

You're right, of course! So to give everyone a fair chance, we've decided to extend the deadline until the end of February 1981. So now you can have your new Yaesu - and still be in the running for the fabulous contest prize!

## SO NOW YOU CAN BUY YOUR NEW YAESU: AND STILL BE ELIGIBLE!



### NEW FT480

- All mode 2 metre SSB/CW/FM!
- Microprocessor controlled!
- Digital display!
- 30 watts PEP

**\$543<sup>00</sup>**

OR FROM \$63 DEPOSIT AND \$26.28/MONTH (24 MONTHS)

This is the one they're all talking about the fabulous new 2 metre all-mode transceiver from Yaesu. Offering outstanding performance and ease of controls, it must be the transceiver of the eighties! Cat D-2887

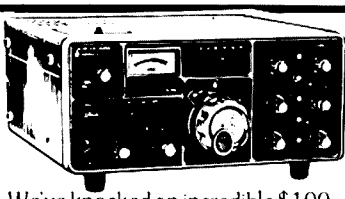

### SAVE ON FT625!

WAS \$795.00 . .  
NOW ONLY

**\$695<sup>00</sup>**

OR FROM \$75 DEPOSIT AND \$20.48/MONTH (48 MONTHS)

We've knocked an incredible \$100 off the price of these popular all-mode 6 metre rigs. There's still plenty of good DX out there on 6 - and the FT-625 is just the transceiver to get it! Cat D-2886

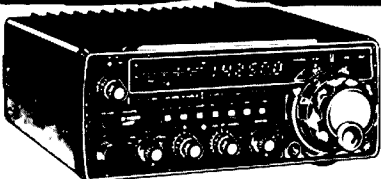

### NEW FT707

- All HF bands!
- AM/SSB/CW!
- Tiny Size!
- True digital display
- New WARC bands!

**\$735<sup>00</sup>**

OR FROM \$75 DEPOSIT AND \$22.48/MONTH (48 MONTHS)

They've been pretty hard to get and small wonder! The superb FT-707 packs a huge punch from its tiny size: 240W DC! It's the ideal rig for mobile, base or portable work. Cat D-2869

### SUPERB FT-207

- Microprocessor controlled hand held giving full 144-148 band!
- Digital display.

**\$358<sup>00</sup>**

OR FROM \$38 DEPOSIT AND \$17.52/MONTH (24 MONTHS)

For today's active ham, this is the set to take with you. Takes up virtually no room, but really gets out! Make contacts wherever you go with the FT-207R

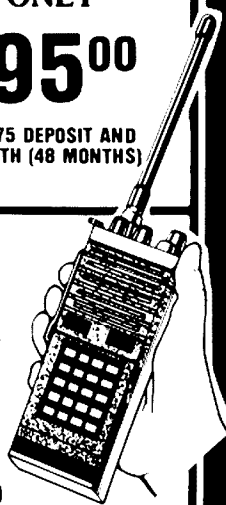

### NEW FT107M

- The ultimate!
- WARC bands
- All solid state
- Variable IF bandwidth!
- Speech proc.

**\$1278<sup>00</sup>**

OR FROM \$138 DEPOSIT AND \$38.32/MONTH (48 MONTHS)

It must be every amateur's dream to own one of these! You can and take full control of the bands. Whatever you want from your transceiver, the FT-107 offers it! Cat D-2871

### BUDGET FT-101Z

We throw in a digital display kit worth over \$100! This turns the FT-101Z into an FT-101ZD!

More hams have 'cut their teeth' on one of the famous '101' series than any other rig! Rugged and reliable, with all the features you really need. Cat D-2862

OR FROM \$85 DEPOSIT AND \$23.19/MONTH (48 MONTHS)



**\$775<sup>00</sup>**

WITH BONUS DIGITAL DISPLAY WORTH \$139!!

ANY TERMS OFFERED ARE TO APPROVED, PERSONAL APPLICANTS ONLY. ORDER BY MAIL: USE YOUR BANKCARD!

# DICK SMITH ELECTRONICS

<b>NSW</b> 125 York Street 818 George Street 162 Pacific Hwy 30 Grosse Street 613 Princes Hwy 147 Hume Hwy 531 Pittwater Road 145 Parramatta Rd.	<b>SYDNEY</b> 290 3377 BROADWAY 211 3777 GORE HILL 439 5311 PARRAMATTA 683 1133 BLAKEHURST 546 1744 CHULLORA 642 8922 BROOKVALE 93 0441 AUBURN (Opening Soon!)	<b>VIC</b> 263 Keira Street 399 Lonsdale Street 656 Bridge Road 166 Logan Road 842 Gympie Road 96 Gladstone Street 60 Wright Street 414 William Street	<b>QLD</b> 842 Gympie Road 96 Gladstone Street 60 Wright Street 414 William Street	<b>WOLLONGONG</b> 28 3800 <b>MELBOURNE</b> 67 9834 BURANONG 428 1614 BURANONG 391 6233 CHERMANSIDE 59 6255 FYSHWICK 80 4944 ADELAIDE 212 1962 PERTH 328 6944
---	---	---	---	---

**bankcard**  
welcome here

SHOPS OPEN 9AM TO 5.30PM  
(Saturday: 9am till 12 noon)  
BRISBANE: Half hour earlier  
ANY TERMS OFFERED ARE TO APPROVED APPLICANTS ONLY  
RE-SELLERS OF DICK SMITH PRODUCTS IN MOST AREAS OF AUSTRALIA.



MAIL ORDER CENTRE: PO Box 321, NORTH RYDE NSW 2113 Ph 888 3200 PACK & POST EXTRA.



# amateur radio

Published monthly as its official journal by the Wireless Institute of Australia, founded 1910.

NOVEMBER 1980  
VOL. 48, No. 11

PRICE: \$1.20

Registered Office:  
3/105 Hawthorn Road,  
Caulfield North 3161.

EDITOR:  
BRUCE BATHOLS\* VK3UV

PRODUCTION MANAGER:  
MARK STEPHENSON\* VK3PI

TECHNICAL EDITORS:  
BILL RICE\* VK3ABP  
EVAN JARMAN\* VK3ANI  
RON COOK\* VK3AFW  
GIL SONES\* VK3AUI

CONTRIBUTING EDITORS:  
BOB ARNOLD VK3ZBB  
G. NICK NICHOLS VK8XI  
ROY HARTKOPF\* VK3AOH  
RON FISHER\* VK3OM  
ERIC JAMIESON VK5LP  
LEN POYNTER\* VK3BYE  
BILL VERRALL VK5WV  
WALLY WATKINS VK2DEW

DRAFTING:  
NEIL OSBORNE\* VK3YEI

BUSINESS MANAGER:  
PETER OODD VK3CIF

\*Member of Publications Committee

Enquiries and material to:  
The Editor,  
PO Box 150, Toorak, Vic. 3142

Copy is required by the first of each month. Acknowledgement may not be made unless specially requested. All important items should be sent by certified mail. The editor reserves the right to edit all material, including Letters to the Editor and Hamads, and reserves the right to refuse acceptance of any material, without specifying a reason. Material should be sent direct to P.O. Box 150, Toorak, Vic., 3142, by the 25th of the second month preceding publication. Phone: (03) 528 5962. Hamads should be sent direct to the same address by the 1st of the month preceding publication.

Trade Practices Act: It is impossible for us to ensure that advertisements submitted for publication comply with the Trade Practices Act 1974. Therefore advertisers and advertising agents will appreciate the absolute need for themselves to ensure that the provisions of the Act are complied with strictly. Readers are reminded that, when buying, obtaining or receiving goods from overseas including goods listed in advertisements by overseas organisations in this Journal, Customs import duties and Sales Tax may be levied on the goods at the time of importation. These amounts, if any, are payable by the purchaser unless the terms of sale state otherwise and the seller has made specific provision to this effect in his quotation to the buyer or unless other prior arrangements are in force between the buyer and the seller.

Typesetting: MUELLER INDUSTRIES  
1a Levanswell Road, Moorabbin, 3189  
Tel.: 553 0292

Printers: WAVERLEY OFFSET PUBLISHING GROUP  
Geddes Street, Mulgrave 3170

## CONTENTS

### TECHNICAL

Collectors' Corner No. 4 — The IC260A/E 2 Mx All-Mode Transceiver	21
Delta Yagi — The Answer?	11
Practical Mobile Antennas	8

### GENERAL

An Open Letter	10
Commonwealth Contest 1980	36
1980 Remembrance Day Contest Results	34
Teletext in the U.K.	12
The Unusual Dangers and Hazards of Radio	26
WICEN Exercise for the North Western Zone	13

### DEPARTMENTS

Afterthoughts	5
ALARA	40
Amateur Satellites	26
Around The Trade	39
Awards Column	38
Contests	36
Divisional Notes	39
Forward Bias	27
Hamads	41
International News	40
Ionospheric Predictions	33
Letters to the Editor	31
Listening Around	14
Magazine Review	33
Main QSP	5
Novice Notes	17
QRK5	29
QSP	5, 6, 10, 26, 38
Silent Keys	41
Spotlight on SWLing	27
VHF-UHF — an expanding world	15
VK2 Mini-Bulletin	27
WIANEWS	6
You and DX	32

ADVERTISERS' INDEX 42

## Cover Photo



Pictured this month is the ever smiling face of Jack Swiney VK6JS. Jack was the initiator of the VKCW QRP Club which is increasing in membership steadily and in doing so bringing back a valued aspect of Amateur Radio. Jack is also known in many circles for his untiring efforts in "paper chasing" for others as well as himself.

# Vicom features all the leaders in electronics for the '80's!

## 'LEADER' Dip-Meter 1.5MHz-250MHz

Probably the most useful test instrument any Ham or CB-er can own! Fully self-contained. Docks with 'Leader' LIM870-A antenna impedance meter to provide the perfect way to achieve optimum matching. Can be used as a highly sensitive frequency absorption meter, too.



(LDM 815) \$99

### Morse Keys

HK-702 Marble Base Deluxe Model	48.00
HK-708 Economy Unit	20.00
HK-706 Operators Model	22.00
MK-701 Paddle, side swiper	50.00

### Speech Processors & Compressors (Daiwa)

MC-330 Audio Compressor	104.98
Rf-440 Rf Audio processor AC/DC 6dB gain	134.00
Rf-550 Rf Audio processor AC/DC 6dB gain (Filter)	183.00
Rf-660 Rf Audio processor dc phasing unit 6dB	114.00

### Filters Rf Transformers, Dividers

FD-30LS Daiwa Low Pass Filter 32 MHz 300W	23.00
155 Low Pass Filter	40.00
AF-306 Daiwa Active Filter	77.00
AD-103X Daiwa Mast-Head Splitter 70cm/2m/H1	67.00

### Baluns

AS-BL Asahi 50 ohms for Beams	31.00
BL-50A 50 ohm 4KW, for Dipoles	25.00
BL-70A 70 ohm 4KW, for Dipoles	25.00

### SWR & Power Meters

CN-620 Daiwa SWR/PWR Needle: 1.8MHz-150MHz	99.00
CN-630 Daiwa SWR/PWR Needle: 140MHz-450MHz	143.00
CN-650 Daiwa SWR/PWR Needle: 1.2GHz-2.5GHz	185.00
CN-720 Daiwa SWR/PWR Needle: 1.8MHz-150MHz	163.00
LPM-880 Leader Rf Power Meter: HF	140.00
LPM-885 Leader SWR/PWR Meter: HF	97.00
RW-151D Kuranishi Load Watt Meter: 1.5MHz-500MHz	169.00
VC-2 Vicom SWR/PWR 3-150MHz	37.00
SW110A Daiwa SWR/PWR 1.8MHz thru 150MHz	79.00

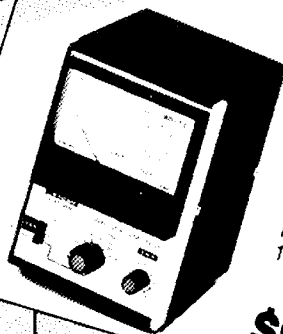

## 'LEADER' SWR/WATTMETER (LPM 885)

Assists you to achieve maximum efficiency from transmitter and antenna. SWR and power output readings ranging from 1.8 to 54 MHz. SWR/power detector circuit is detachable for remote measurements. Monitors from 1W to 1000W output.

\$97

### Check right here for the best valves in town—and the cheapest prices!

6KD6	Finals for Yaesu Linears	11.00
6JS6C	Finals for Yaesu Transceivers	11.00
12B7A	Drivers	5.50
6146B	Finals	14.00

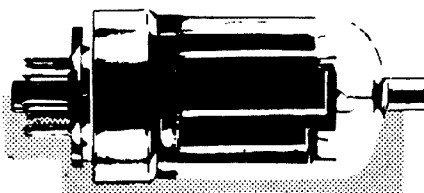

### Antenna Tuners & Couplers

CNA-1001 Daiwa 200W Automatic tuner	295.00
-------------------------------------	--------

### Coaxial Cable (Mil-Spec)

RG-58 A/U-30 Coaxial Cable 30m Reels	12.00
RG-213/U Low Loss Coaxial Cable 200m Reels	1.60/m

### Plugs and Sockets

NC510 2 Pin Mic Plug	3.00
NC511 2 Pin Mic Socket	1.25
NC512 3 Pin Mic Plug	1.50
NC513 3 Pin Mic Socket	1.50
NC514 4 Pin Mic Plug	1.30
NC515 4 Pin Mic Socket	1.20
NC516 5 Pin Mic Plug	1.50
NC517 5 Pin Mic Socket	1.50
NC518 6 Pin Mic Plug	1.50
NC519 6 Pin Mic Socket	1.50
NC523 8 Pin Mic Plug	1.50

### J B Antennas

<b>6 m &amp; 2 m Beams and Whips</b>	
5Y2M 2 m Jaybeam 5el: 7.8dB gain	43.00
8Y2M 2 m Jaybeam 8el: 9.5dB gain	53.00
10Y2M 2 m Jaybeam 10el: 11.4dB gain	89.00
<b>70 cm Beams</b>	
MBM48/70 70 cm Jaybeam 48el: 14.9dB gain	89.00
PBM18/70 70 cm Jaybeam 18el: 14.9dB gain	98.00
MBM88/70 70 cm Jaybeam 88el: 18.5dB gain	116.00

Melbourne 8368635  
Perth 3217609-4463232  
Hobart 281500  
Adelaide 437981-2728417  
Gold Coast 322644  
Wellington (NZ) 697625

Cairns 541035  
Launceston 443882  
Brisbane 3415377-384400

Vicom International Pty. Ltd.

68 Eastern Road  
South Melbourne  
Victoria 3205  
Phone (03)699 6700

339 Pacific Highway,  
Crows Nest, N.S.W. 2065  
Phone (02)4362766

# VICOM

QSP . . . . QSP . . . . QSP . . . .

# HOW TO ALTER POLICIES ETC.

One of the more important of the functions of the Institute is that of representations to the licensing and control authorities on amateur radio matters.

WIA liaison with the Postal and Telecommunications Department occurs on a more or less daily basis in both State and Federal spheres but, in addition, Committee meetings are held on two levels.

These are (a) in the States where local Joint Committees have been or are being established, and

(b) Federally where the Joint Committee has been operational for some years.

The local State Joint Committees, as a general rule, involve the Divisional President with Councillors for the WIA and the State Superintendent with members of his staff for the P. and T. Department. Much valuable negotiation and representations take place on matters relating to amateur activities within the State such as administrative decisions causing local problems, State repeaters, broadcasts and so forth.

At the Federal level, the President with members of the Executive meet on a normally quarterly basis with the senior officers of Central Office. At these meetings policy matters and related issues occupy much of the time in addition to administrative problems seen to affect several States or which are of a Federal nature.

The last such meeting was held on 8th October when some long outstanding issues were finalised and some progress towards finality on others was made.

Among the items discussed were —

- a number of examination subjects and including a promise that broad statistics would be supplied;
- the possibilities of a combined LAOCP/NAOCP licence;
- authorisation for full and limited call operators to use F5(TV) in the 23 cm band for a trial period of six months subject to non-interference to the primary service stations therein;
- agreement approaching, at least, towards some restricted use of the 50 to 50.15 MHz segment;
- conclusion of an agreement about beacon conditions;
- several other licensing, call sign and WICEN matters.

All this work, remember, benefits the amateur service in Australia as a whole and the subjects generally derive from Federal Conventions and cases put forward by both Divisions and individual amateurs as the case may be.

P. A. WOLFENDEN VK3ZPA  
Federal President. ■

---

## AFTERTHOUGHTS

Since submitting the 5W CW transmitter (Sept. '80), a few shortcomings in the design have come to my notice after extended testing:

- If the Tx is to be used on 21 MHz, the amount of inductance at L1 is too great, and could result in uncontrolled operation of the VXO. The remedy is to simply remove the slug from L1. The amount of crystal pull on the lower bands will then be slightly reduced. If the Tx is not to be used on 21 MHz, then the slug can remain.

- The voltage shown at the collector of Q4 is incorrect. It should read 12V with the key down.
- By-pass capacitor C23 is not necessary, and in fact could cause instability in the output stage, and should therefore be left out of the circuit.

If sufficient interest is shown in this Tx, arrangements will be made to have the circuit boards made professionally. If anyone has problems in building this project, please write or call and I shall give any reasonable amount of help necessary.

Drew Diamond VK3XU. ■

## QSP

The South Australian "OLD TIMERS" Dinner will be held at the Marion Hotel, Marion Road, Mitchell Park, South Australia on November 19th, commencing at 12.30 p.m.

Tickets are \$9.00 and all old timers will be most welcome.

For further enquiries regarding this dinner, please contact George Luxon VK5RX (Hon. Secretary) 203 Belair Road, Torrens Park, S.A. 5062. ■

# WIANEWS

## UHF TELEVISION

In a letter from the P. and T. Department in September it was stated that Government is increasingly authorising the use of the UHF band for TV channels throughout Australia, both for main stations and for translators. The extracts to follow are of interest:—

"Many individuals and television industry groups throughout Australia are, however, not fully aware of plans for UHF television channels. I am therefore writing to you and to other representatives of manufacturing, importing, retailing, servicing and related organisations to outline the Government's intentions in this regard.

An information pamphlet on UHF television will soon be available to business organisations and the general public. This will explain what the UHF band is, how it will be used and how to adapt receivers for best reception. By thus making people aware of the television services which will be provided by UHF, I hope that industry will be encouraged to produce and provide more sets with a UHF capacity, and that the public will take UHF services into consideration when buying television sets."

"The Department is investigating the full potential of the UHF band to accommodate future new television services. Meanwhile, however, a number of decisions have already been made to use UHF for television in particular areas. These include the decision to simulcast multicultural television services in Sydney and Melbourne from October 1980 on VHF as well as on UHF operating in television Band IV."

"It is not possible at this stage to provide comprehensive plans for the overall development of UHF television services, but the following general planning criteria can be used as a guide:—

Current intentions are that the lower part of the UHF broadcasting band from approximately 520-620 MHz will be reserved for wide coverage television services, while the upper part of the band from 650-820 MHz will be reserved for television translator services to fill in areas of poor reception. The intervening section, from 620-650 MHz, will be held in reserve to meet other demands as they eventuate."

"In conclusion, I should like to say that by using the UHF band for television, the Government is able to service areas not reached formerly because of the lack of available VHF frequencies. The UHF band will increasingly be used to make good television reception available to as many Australians as possible.

I hope that this letter clarifies any doubts there may be on our intentions to develop UHF television services."

## BEACONS

Correspondence with Central Office is proceeding in relation to conditions of operation for amateur beacons. Basically these are set out in paragraph 5.12 in the Handbook but it was suggested that licences be issued only to those persons with "AOCP status". The Department will be asked to amend this to read "AOCP technical status". Call sign ident is to be made at regular intervals not less than once in every five minutes.

## QSP

### KEYS

I am by occupation an engineer, and have for many years harboured an interest in Amateur Radio. The opportunity to further this interest, however, did not come my way until last year.

Given that commercial morse keys combine almost identical designs with a certain lack of imagination, I have always felt the desire to produce something original. In addition, complaints from other amateurs soon revealed that most commercial morse keys were not nearly heavy enough, and were therefore prone to shifting.

The results of all these thoughts was the morse key shown in the photograph. I have found that

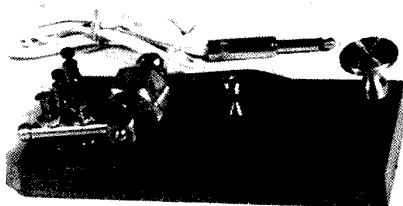

my design is simpler and more practical than those currently on the market, yet works just as well. The base is a solid metal block measuring 16.5 cm by 7.5 cm by 2 cm, and is of course far too heavy to permit any shifting. The remaining parts of the key are made of hardened bronze, cunningly insulated where necessary.

Hopefully my successful experiment will prove to others that the last word on Morse Key design has not yet been said. Why not build your own better Morse Key? If any interested persons require more information, feel free to contact me — Nick Rozakeas (callsign pending), 94 Glenlyon Rd., Brunswick East, 3057.

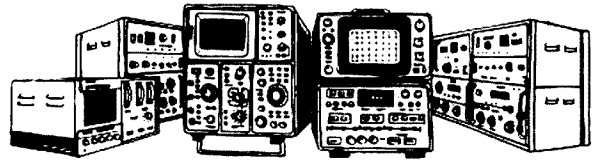

## SERVICE PROBLEMS?

Suffer no more — contact the experts:

## GFS ELECTRONIC IMPORTS

15 McKeon Road,  
Mitcham, Vic. 3132  
Phone (03) 873 3939

Because we have many years experience in the Communications Service Industry, encompassing the CB, AMATEUR and COMMERCIAL sectors we are able to offer you the best service that your set deserves at a realistic price

Call and discuss your problems with our experts.

## RON WILKINSON (VK3AKC) ACHIEVEMENT AWARD

Who should be considered for this Award in 1980? If you have a name to put forward send it now to the President of your Division with your reasons.

## IONOSPHERIC PREDICTIONS

At the suggestion of VK5 an attempt was made to have ionospheric predictions broadcast over VNG. Unfortunately this is not presently possible.

## BEACON CONDITIONS

Correspondence with the P. and T. Department relating to beacon conditions has been revived to the point of near finality.

## LICENCE FEES

The Institute has been following up recent publicity about the possibility of "Clubs" (CB and Amateur) collecting licence fees on behalf of the Department on a commission basis.

## EDP

Assisted by Derek McNeil VK3BYA, the Executive are examining what steps can be taken to improve the efficiency of our data processing systems.



# SCALAR

GET THE EDGE ON THE CROWD, UPGRADE WITH

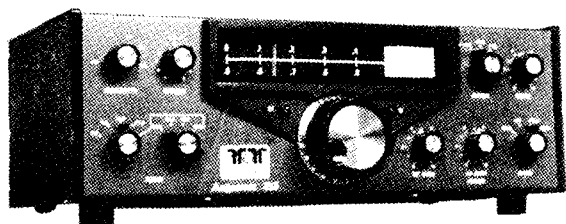

## ARGONAUT 515 *'NOW EVEN BETTER FOR QRP!'*

- TOTAL SOLID STATE
- IMPROVED SENSITIVITY
- NEW HETERODYNE VFO
- NO TUNE FINALS
- FULL CW BREAK IN IQSK
- BUILT IN SWR METER
- OPTIONAL CRYSTAL CALIBRATOR
- OPTIONAL NOTCH FILTER

**ALL FINAL TRANSISTORS FULLY GUARANTEED FOR 12 MONTHS AND THENCE  
A PRO RATA RATE FOR 5 YEARS.**

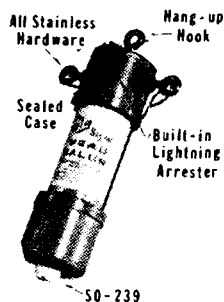

### W2AU 1:1, 4:1

Long wire  
Dipole Baluns  
3-40 MHz  
1 KW DC

### REYCO ANTENNA TRAPS

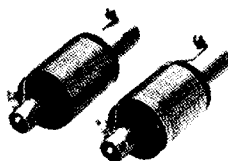

For 10, 15, 20, 40, 80  
Metre Band Dipoles

### "INTERFILTER" LOW PASS FILTER

70 dB TVI  
Rejection      0-30 MHz



### MOBILE TRI-BAND SYSTEM

80 THRU  
10 METRES  
ANY THREE BANDS  
AT ONCE

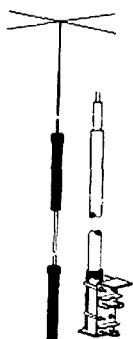

### SC22DX 5-BAND TRAPPED VERTICAL

Self supporting  
light weight  
1 KW PEP



### SC33DX 3-BAND BEAM

10-15-10 Metres  
no bandswitching  
8 dBd Gain  
1 KW PEP

FRANK WELSH..... VK3BPV  
MIKE KILPATRICK..... VK2DJP  
RON SMITH..... VK2DCK  
BRIAN ROBINSON..... VK4NQG

ASK ABOUT ANY OF OUR AUSTRALIAN MADE & IMPORTED PRODUCTS: HF, VHF, UHF, Mobile and base antennas, plugs, & loads more equipment!

★ **BANKCARD AND MAIL ORDERS WELCOME** ★



## SCALAR GROUP

NSW: 328 Kingsgrove Rd, Kingsgrove, 2208.  
VIC: 20 Shelly Avenue, Kilsyth, 3137  
QLD: 8 Ferry Road, West End, 4101  
W.A. Unit 5/319 Pearson St., Osborne Park, 6017

tel: (02) 502 2888  
tel: (03) 725 9677  
tel: (07) 44 8024  
tel: (09) 446 4657

# Practical Mobile Antennas

Arthur Brown VK2IK  
26 Winifred Avenue, Epping, N.S.W. 2121

One of the interesting features of amateur radio nowadays is the relative ease whereby mobile communications can be maintained over wide ranging distances at home and abroad. The most important requirement, of course, is a good transceiver. With the advent of the complete solid state transceiver the bulk and weight of equipment and power demands from the vehicle battery have been dramatically reduced.

The second most important requirement is a range of antennas to suit the intended bands of operation. Many of these are available on the commercial market, however, if one has a small workshop, equally good results can be obtained from home-brew models.

## "G" WHIP

One commercial antenna on the British market is the "G" whip produced by GW3DZJ. This unit is very versatile and, with helical sections, loading coils and an adjustable top whip section, enables coverage from 28 MHz through to 1.8 MHz. I have been using one of these since 1975 when it was originally mounted on the snub nose of a Bedford Campervan which was used in Britain and Scandinavia. The adjustable top on its own is also usable for 146 MHz FM mobile.

The "G" whip is essentially a fibreglass helical base section resonant for 28 MHz. Being 106 cm long (5 ft. 4 in.), this was cut in half and brass threaded couplings fitted so that for overseas mobiling the whole antenna could be carried in a travel bag with clothing, etc. (See previous article on Mobiling the American and Canadian Rockies.)

For operation on 21 MHz and 14 MHz a double section helical is pushed into a socket on the top of the lower helical. A sliding connector allows a 17 cm length of helical to resonate on 21 MHz, and an additional length of 40 cm to operate on 14 MHz. For all other bands 7, 3.5 and 1.8 MHz loading coils and the adjustable whip section replace the top double section helical.

For the purpose of this article, however, it is intended to describe the present antenna systems as used on our Ford Transit van and in particular a multi-band switched centre loading coil. During the late 60s a tall centre loaded whip was developed with individual coils for each band from 28 to 1.8 MHz. These worked very successfully but suffered the disadvantage of having to screw 6 joints for each time

a band change was desired, i.e. 3 to undo and 3 to replace. The present system requires to stop, push a slide switch and resume mobile operation (21-3.5 MHz).

## ANTENNA MOUNTS

The vehicle is fitted with 3 mounting positions for antennas—one on a bracket above the front bumper passenger's side; another on the front mudguard driver's side and another on top of the van canopy which gives a good ground plane effect (see photo 1). All 3 positions will accept all antennas HF and VHF, including the "G" whip. For obvious reasons, however, with the roof being 2m above ground only a hinged 146 MHz quarter wave whip is used in this location whilst mobile.

The first location fitted with a heavy duty spring and wooden support rod from the bodywork is normally used for the HF antennas. The second location takes a fibreglass dual purpose 146 MHz  $\frac{5}{8}$  wavelength/52.525 MHz  $\frac{1}{4}$  wavelength VHF antenna. This duality is obtained by a change-over of trombone stubs to obtain resonance for the desired band. See Fig. 1 for details. The rooftop location is strongly mounted so that the tallest HF antenna may be screwed in for "stationary mobile" operation under wind free conditions.

## MAIN HF ANTENNA

The main HF antenna length is 364 cm (approximately 12 ft.) which includes the mounting spring and lead from coax connector. With the height of the coax connection above ground of 84 cm (2 ft. 9 in.) this makes the tip of the antenna almost 15 feet above the road level. This clears most obstructions but not all garages or low tree branches so care has to be observed especially when changing antennas near low power lines. For 14 MHz operation under stationary mobile conditions, a centre section of tubing (189 cm) can be used instead of the coil which then becomes a quarter wave whip with height above ground of approximately 19 feet. It is definitely not recommended to erect this under power mains, otherwise it could be QRT and ambulance mobile!!

A comparison test made on 14.2 MHz with the "G" whip as a reference shows about a half "S" point increase in gain with the centre loaded whip and another half "S" as a quarter wave whip. Additionally the gain of each antenna is raised another half "S" point when located on the rooftop without a breeze!! (Guying would solve it, I guess.)

## CONSTRUCTION OF A MULTI-BAND LOADING COIL

The starting point is to make a coil former 15.5 cm long, 5 cm in diameter (6 x 2 in.), from PVC tubing (see Fig. 2). Solid ends of



PHOTO 1: Ford Transit van showing dual frequency VHF whip, multiband HF loading G-land whip, and 146 MHz whip on rear top of van.

1.25 cm thick PVC are turned on a lathe (or cut by hand!) to fit neatly in the ends. These are cemented in position with PVC cement and, when solidified, drilled and tapped to take a 1 cm ( $\frac{3}{8}$  in.) thread. The type of thread is not critical, though a medium fine, e.g. BSF 20 threads per inch (8 TP cm) is suitable. A matching button die should be obtained at the same

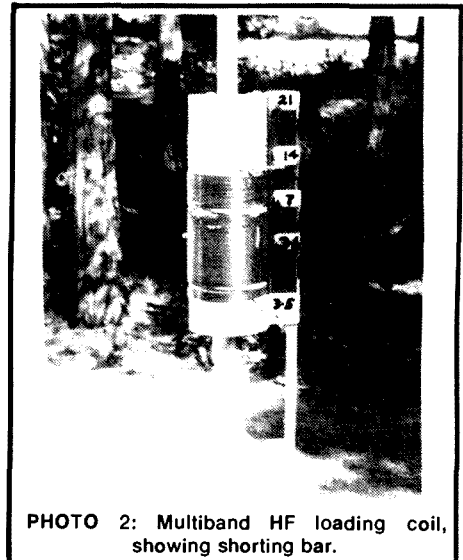

PHOTO 2: Multiband HF loading coil, showing shorting bar.

time as the tap so that mating parts can be made to screw together. Two large washers of aluminium should be cut to fit the ends and secured with self-tapping screws. This will allow electrical connections to be made to the coil ends and the tubing ends when screwed together. Again a lathe (or laborious handwork) will be needed to cut solid aluminium rod to screw into the ends of the coil former and to be able to be rivetted with aluminium rivets on to the tubing. The lower section should be 1.5 cm or 5/8 in. diameter and the upper section 1 cm or 3/8 in. tapered to the top with a 3.2 mm (1/8 in.) diameter aluminium welding rod or short section of 1.6 mm (1/16 in.) galvanised wire about 40 cm long. This top piece will be cut about in the tuning process and will be a different length when used on different vehicles. Changing mine to the car with

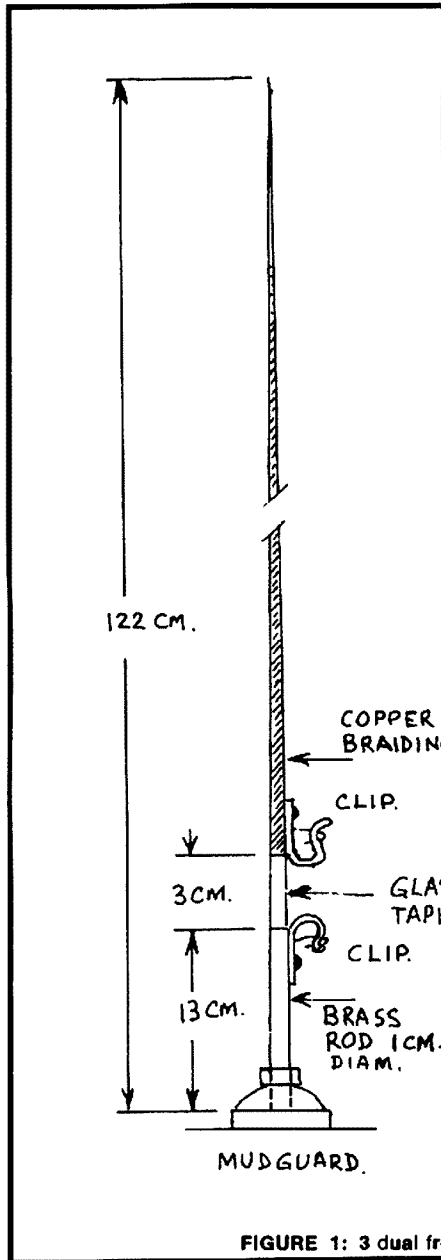

FIGURE 1: 3 dual frequency whip — VHF.

rear bumper mounts requires it to be 8 cm longer. Alternately a normal car radio telescopic whip may be incorporated in the top section.

**INITIAL ADJUSTMENTS**

Basically this antenna will be a quarter wave 21 MHz antenna. This occurs when the coil is shorted through, so the coil should be initially jumpered through, and the top of the whip adjusted for resonance at, say, 21.2 MHz. Several methods can be used to achieve this, but my method is as follows:—First of all use a GDO with a loop turn at the transmitter end of the coax cable and find the resonant frequency. Listening to the GDO on the receiver will give the exact frequency. The top of the whip can be adjusted so that resonance is occurring in the mid-region of the band. In using the GDO do not be beguiled by some of the spurious dips that show up. If changing the top of the whip does not alter the GDO dip then you have a spurious one! Ignore it and look for one near the theoretical frequency.

The transmitter can now be used at low power in conjunction with the SWR Bridge set at full gain, and making small adjustments of the whip top to obtain the best SWR. Fixing points should be located on the former to take the coil ends. These may be small soldering lugs affixed with self-tapping screws. The first coil may now be wound for 14 MHz (see Fig. 2) with turns spaced over a length of approximately 2 cm. The bottom of the coil is jumpered to the base section and the frequency of resonance measured and the coil separation adjusted to bring it to resonate at 14.2 MHz.

This procedure is repeated for the 7 MHz coil which is in series now with the 14 MHz coil. The number of turns or separation is adjusted to resonate at 7.07 MHz. The bottom of the coil is jumpered to the base section also as previously during adjustment.

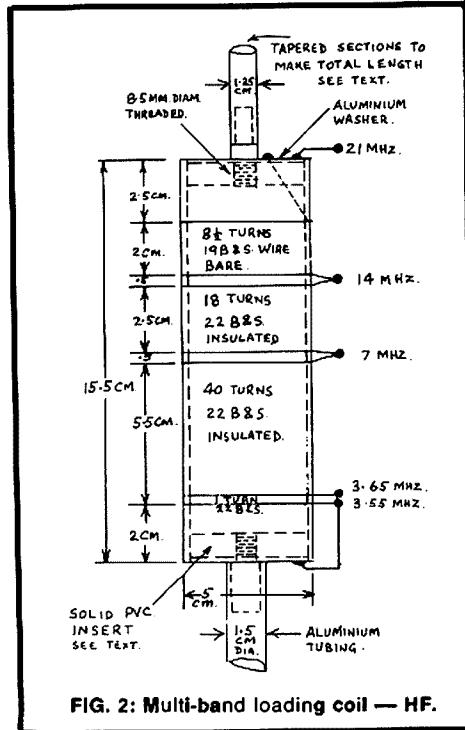

FIG. 2: Multi-band loading coil — HF.

The 3.5 MHz coil is now similarly wound and tested. However, because of the highly resonant characteristic of this section two tapings have been provided, one to resonate at 3.65 MHz and the other for 3.55 MHz.

**THE TRICKY PART**

The next operation is the tricky part and depends upon the reader's mechanical ingenuity. What is now required in some form of shorting bar which will progressively short out sections of the coil. The simplest would be to use a short flexible jumper with an alligator clip. A connection should be made to the base aluminium tubing by a screw and lug to the earlier mentioned large aluminium washers at the ends of the coil.

My first experimental switch was a rotary one at the bottom of the coil. Although it worked well for 21, 14 and 7 MHz, the result on 3.5 MHz was a disaster. It was a lesson in dielectric heating and of the high voltages that develop across a highly resonant coil at this frequency. Arc paths and carbonised tracking took place through half cm thicknesses of the PVC. Additionally coil insulation was damaged. The answer lies in providing a shorting bar that shorts out the required sections without allowing any electrical conductor from the top of the coil to be near the bottom of the coil when on the 3.55/3.65 MHz settings. The final design shown in photo 2 has proven quite satisfactory. To describe it fully would require detailed drawings. However, as may be seen in the photo there are 2 strips of bakelite 2 cm wide the full length of the coil supported at the ends by combination brackets/spring switch wipers. The

# An Open Letter

To all members of our International  
Amateur Radio Community

De: Jan Gould WA6YQW/KH5

*The story, however garbled, of our plane crash landing on Palmyra Island, 5 January 1980, has been told and retold these past months. The miracle that nine of us came through it alive cannot be over-emphasized, although I was critically injured and a brilliant neurosurgeon later sustained serious injuries to his "operating" hand in the course of winding down the DXpedition.*

*What hasn't been made public, until now, are my personal words of thanks and deep gratitude to the 4,000+ Amateur Radio operators throughout the world who came forward with cards, letters, flowers, cablegrams and TX calls. Also sent were financial contributions to the "gift fund" established in trust for me through the kindness and concern of Norm Friedman W6ORD. (The proceeds of that fund are now replacing and repairing much of my damaged or destroyed gear, thanks to some more pretty wonderful and generous hams.)*

*Needless to say, each of the people on that plane was victimized by the cruelest type of shock and terror, if not actual physical injury. Each deserve acknowledgement for his particular personal courage, however it was manifested.*

*My own trip through hell was, first, the horror of being trapped and crushed in the seat of the aircraft, smelling gasoline all around, being fully aware the rest of "my guys" were frantically trying to free me . . . Dr. Dave Gardner doing his best to relieve my pain with medication . . . brown skin natives carrying me several miles, on a makeshift litter, to an old copra shed . . . the hours of waiting for the Coast Guard C130 rescue plane to arrive . . . the 1,100 mile flight back to Hickam Field and the final lap, by military ambulance, to Tripler Army Hospital.*

*...The crash landing occurred about 7.00 a.m. local time and the ordeal in the emergency room of Tripler didn't begin*

*until nearly 9.00 p.m. that night . . . the beginning of weeks of pain, fright, despair and the inevitable, "Why me?"*

*But another "beginning" had begun . . . the realization hundreds of people, all over the world, were praying for me, wishing me well, reaching out with strength and moral support that only a tragedy such as had been experienced could have demonstrated. I'm unable to touch each of you or to embrace you and tell you of the thanks and gratitude I hold dearly for the important role all of you have played in my life.*

*When I hit bottom, the massive community of amateurs reached out, took me by the hand and started pulling me up. You gave me hope and encouragement when I was thousands of miles away from home, family and friends and could see no hope . . . only a long, dark tunnel, wracked with pain and tear. Hams around the world began turning lights on in that abyss with their messages of love, friendship and involvement. The spark caught and there was suddenly an end in sight.*

*To each and every one of you who held your hand and heart out to me, my deepest gratitude and love, and the most sincere thanks from my family . . . none of whom are amateurs and who were totally amazed at the scope of the response from my amateur family throughout the world.*

*It's still quite a long walk to reach the end of that tunnel, but I'm on my way. With the continued good wishes and prayers from the "new world" I've just been introduced to—the braces, good doctors, a full and happy heart and, most of all, your concern and kindness—it won't seem like such a long trip after all.*

*From the bottom of my heart, warmest 73, 88, 33, and God bless you and those you love.*

*There's no other way of spelling THANK YOU!!*

Jan KA6YQW. ■

material is thin gauge springy duralumin (offcuts from Permalum house cladding material). The slider is 3.2 mm aluminium cut into a shape which makes it captive when inserted between the bakelite strips and a 3.2 mm (1/8 in.) spacing strip of bakelite. The intermediate switch wipers are of similar material to the end wipers. All connections are to soldering lugs bolted to the bakelite strips and switch wipers.

When the whole assembly is completed final readjustment will be necessary working downwards from the whip top on 21.2 MHz and then through 14.2, 7.07, 3.65 and 3.55 MHz.

To make provision for 28 MHz a separate whip top is screwed on top of the base section without the use of the coil. This section is partly a car radio antenna with a length of 110 cm being suitable.

Table 1 shows the sort of SWR results which have been achieved with the homebrew antennas in their normal locations. They are not necessarily ideal, however results are very satisfactory.

TABLE 1

Frequency in MHz	SWR (sensitivity set at 3/4 full scale)
3.50 MHz	3.4:1
3.55 MHz	1.4:1
3.60 MHz	2.5:1
3.60 MHz	2.5:1
3.65 MHz	1.2:1
3.70 MHz	2.5:1
7.00 MHz	1.6:1
7.10 MHz	1.7:1
7.15 MHz	2.2:1
14.00 MHz	1.4:1
14.20 MHz	1.2:1
14.35 MHz	1.2:1
<b>With centre section</b>	
14.00 MHz	1.05:1
14.20 MHz	1.03:1
14.35 MHz	1.01:1
21.00 MHz	1.05:1
21.30 MHz	1.05:1
21.45 MHz	1.10:1
<b>Short top, no coil</b>	
28.50 MHz	1.05:1
28.75 MHz	1.10:1
29.00 MHz	1.12:1
<b>Dual VHF Ant.</b>	
Sensitivity to 1/4 f.s.	
52.525 MHz	1.3:1
146.00 MHz	1.8:1
<b>Ground Plane</b>	
146.00 MHz	1.65:1

## TRIPLE RANGE SWR BRIDGE

Of very recent construction is a SWR bridge which enables readings from each of the antenna systems just described to be metered without the need to change over coax leads. This of necessity will have to be written up at a later date. Briefly, it comprises 3 sensing elements into which 3 transmitter outputs are fed which in turn go to the 3 antenna mountings. The 2 meters "forward" and "reverse" are switched to suit the antenna being monitored with one common sensitivity control. So far the unit appears to be very satisfactory. More of this later. ■

## QSP

### ANTENNA GAIN

An article in April 1980 CQ by W8FX on antennas contains a table of selected antenna typical gain figures. The dB gain over a half-wave dipole for a 3 element yagi is given as 8, whilst that for a 3 element quad is given as 10, the same as for a 4 element yagi. The 5/8 wavelength vertical is given as 1.6 and for a 0.64 wavelength vertical it is 2.2. A 2 element yagi rates 5.0 as against 7.0 for a 2 element quad. A VHF colinear mobile antenna is rated at 3.4, whilst a phased VHF 5/8 quarter-wave 5/8 wavelength vertical is 6.0 and a similar vertical with 5/8 spacing rates 7.0. A rhombic with 5 wavelength legs is rated at 12, the same as a

4 element quad, a 10 element VHF yagi and a log periodic (10 to 14). A 44 element VHF quad array is rated at 17.1. At the other end of the scale a 1/4 wave ground-plane vertical is given as -1.8 and the isotropic radiator as -2.1. ■

BUYING OR SELLING GEAR?

# HAMADS

MAKE IT HAPPEN FAST

# Delta-Yagi – The Answer?

D. A. Howison VK2VFN  
P.O. Box 308, Charlestown, 2290

Have you ever wondered what antenna you are going to use as a Novice for 10-15m? Prior to receiving my licence I spent weeks constructing a 10-15m Duo-Band 7-element interlaced Yagi only to be disappointed by its performance on 10m. It appears that the 10m elements suffered severe interaction from the 15m elements, thus killing its performance.

Dejected, I pondered on trapped beams (didn't like the idea of traps), duo-band and cubical quads (didn't really suit my location for mounting reasons) and multi-band dipoles (yuk, who wants to run wires when you can have directional antennas?). There are of course mono-band Yagis but I didn't have enough room or masts to do that either as the yard already contains a 10 m groundplane, 80m dipole and the existing beam.

Then I remembered seeing a friend's aerial, a 2 element 10m delta loop quad and I thought "Well, why wouldn't it work mounted above a mono-band Yagi?" The duo-band Yagi I converted to a mono-band 15m 4 element Yagi and proceeded to work out how to mount a 2 element 10m delta loop on top using the same boom for both antennas. The formulas for the element are (feet and MHz):—

$$\text{Reflector} = \frac{1030}{\text{Freq.}}$$

$$\text{Radiator} = \frac{1005}{\text{Freq.}} \text{ and}$$

$$\text{Director(s) if required} = \frac{975}{\text{Freq.}}$$

I used a spacing of 0.17 wavelength being claimed as optimum forward gain spacing for quads. Each side of the triangle in the loop is 1/3 wavelength. The vertical sides I constructed from telescoping aluminium tubing 3/4 in. diameter to 5/8 in. diameter to 1/2 in. diameter at the top.

Across the top I stretched a length of aluminium welding wire, but any wire could be used. The bottom bracket was manufactured from a 24 in. long piece of aluminium flat bar 1 1/4 in. wide and 1/4 in. thick. It was then bent into a "Vee" form with a 4 in. flat at the bottom and a 75° inclusive angle (this angle allows for the tensioning of the top wire). This bracket was then drilled to suit a muffler type clamp. I used a 2 in. diameter boom and thus at 2 in. muffler clamp, but change this to suit whatever boom you are using.

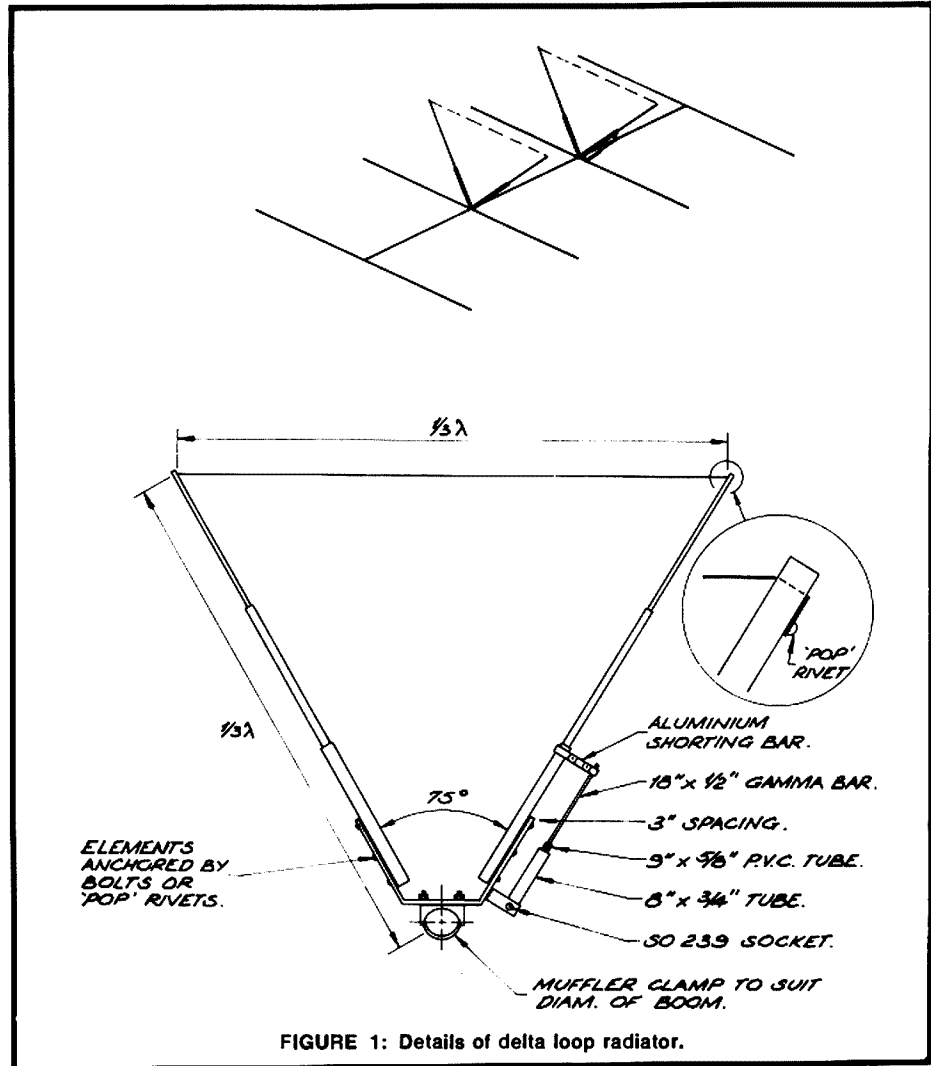

FIGURE 1: Details of delta loop radiator.

The gamma match system was used to match 50 ohm coax to the antenna and this was constructed using 3/4 in. diameter aluminium tube with 5/8 in. diameter PVC plastic tube as the dielectric and a piece of 1/2 in. diameter aluminium tube for the inner rod. This system was then spaced

out 3 in. from the element and mated to a SO-239-PL259 type connector. The gamma match is adjusted to give minimum VSWR at formulated frequency.

Now you should be ready to mount the array on your tower and work all the beaut DX on 10 and 15m.

I have since converted my array to four elements and am very pleased with its performance. There does not appear to be any interaction between the delta quad and the Yagi.

My quad boasts a F/B ratio of 25 dB and F/S ratio of 55 dB.

We have tried using a 10m 4 element Yagi with a 2 element 15m delta quad on top and this also works very well.

I wish you all the success that I've had with the Delta Yagi on DX. ■

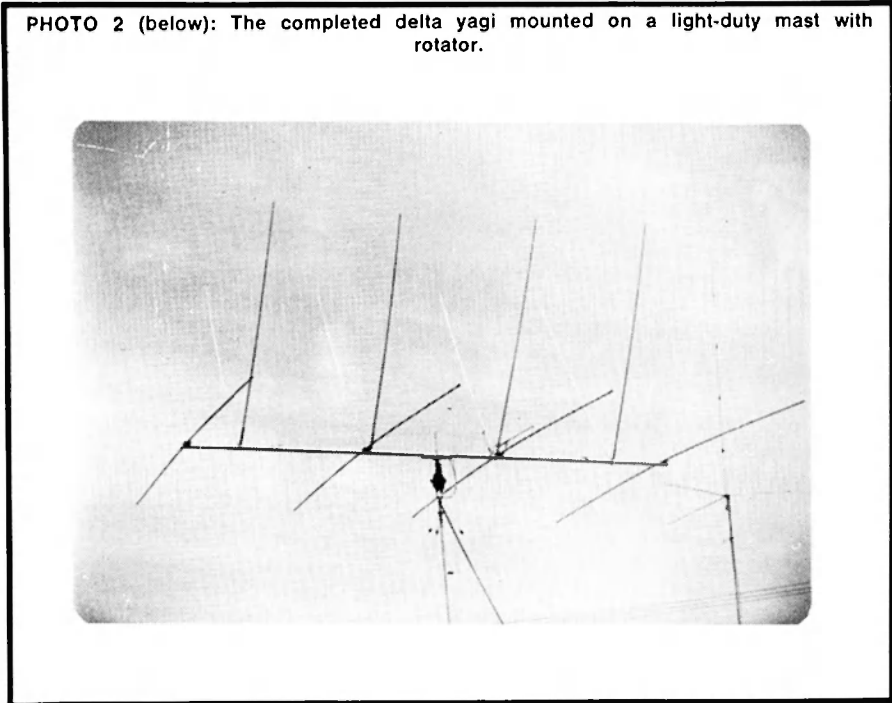

PHOTO 2 (below): The completed delta yagi mounted on a light-duty mast with rotator.

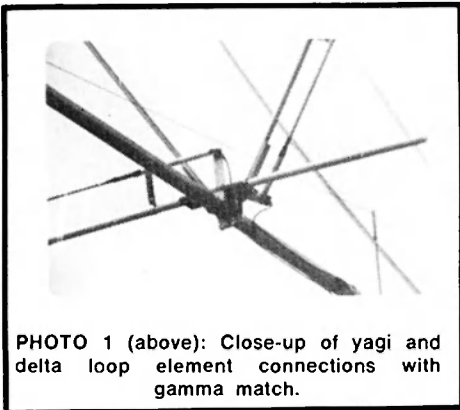

PHOTO 1 (above): Close-up of yagi and delta loop element connections with gamma match.

# Teletext in the U.K.

Ted Trickey G4DCX

The Teletext system makes use of two unused lines in each 625 line frame to transmit data which can be used to construct up to 24 lines of 40 characters.

To view a particular page, the number is called a keypad, the keys are frequently incorporated in the normal ultrasonic remote controller used to control channel, colour and other parameters.

Using this method, up to seven hundred pages are available from each TV channel. Pages may also have many sub pages.

The data received by the teletext receiver includes control characters which are used to control the colour, text or normal picture display (or both), pulsing characteristics of the display and automatic time alarm facility.

Simple graphic symbols can also be displayed. Other characters control hidden data which can be revealed when ordered from the touch pad (children's quiz games and answers). There is also a facility for displaying half screen thereby doubling the size of the characters.

As illustrated, there are three or four pages on amateur radio. These are frequently updated with news and items of interest to radio amateurs and are very much appreciated.

P200 ORACLE 200 Tue22 Jan ITV 1957 11

**ORACLE NEWS**

NEWS	SPORT
HEADLINES 201	HEADLINES 202
Reports 204-219	Reports 240-252
Latest 250	Saturday's fixtures 281-285
Newsfile 290	
<b>FINANCIAL</b>	<b>RACING</b>
HEADLINES 203	Worcester 260
Reports 220-236	Sedgefield 261
Market Report 223	Greyhounds 262
Latest Prices 224	
FT Index 225	
Exchange Rates 226	
Tourist Rates 227	
Pound Report 228	
Company Results 229	
Principal Share Price Changes 230	
Wall Street 231	

**BUDGET DATE CHANGED - 222**

PHOTO 1 (left) shows a sample of amateur radio content, while PHOTO 2 (below) shows an index from the ITV Network 900 page bulletin.

P410 ORACLE 410 Tue22 Jan ITV 1957:14

**Amateur Radio**

Friday Jan 25th is the start of the 42 hour CW DX 160 CU contest and the 1980 French Contest. Rules for both are in January Radio Communication on Page 35.

HF band conditions are expected to decline during the week, as the sun's active region (how) related over the west limb and a steady increase in geomagnetic activity is expected.

Further information on Amateur Radio from The Radio Society of Great Britain 33 Doughty St. London WC1N 3AE. Telephone: 01-257 6166.

**HEARD ANY GOOD "RUMOURS" LATELY? TELL A.R. ABOUT THEM**

# WICEN Exercise for North-Western Zone

M. B. Syme VK3VUA  
Box 91, Irymple 3498

On Saturday, June 14th, a party of seven vehicles left in convoy from Mildura to conduct a WICEN exercise at Lake Tyrell near Sea Lake in north-west Victoria. The object of the exercise was to provide emergency communication facilities for the Mallee Rally conducted annually at that location by the Light Car Club of Australia, Bendigo Branch. This was to be the second year of participation for the North-Western Zone WICEN Group, who have also provided emergency communications each Easter for the Ski Marathon on the Murray River for the past three years.

All were prepared for all eventualities, as the site could provide no creature comforts, not even water! The weather was

cold and bleak, so plenty of rugs were needed. The camping gear varied greatly — two modified Land Rovers, one camper-van, several tents of various kinds, and even two caravans. On arrival at the site where control was to set up, all parties organised camp in a suitable spot with a communal campfire in the centre.

Before nightfall the mast with 2 metre skelton slot and 80 metre dipole were erected, and the control tent set up. Others present at the site included a CMF army transport unit also using the event as a communications exercise, PA van, police communications van and ambulance, as well as many race officials. Much rag-chewing went on round the fire that night



PHOTO 2: Above are pictured some of the happy participants in the exercise. From l. to r.: Graham VK3GZ, Peter VK3BEJ, Bob VK3YVT, Alf VK3VIV, Margaret VK3BVF (seated), Geoff VK3ACZ and Darren VK3VNR. PHOTO 3 (below) shows the antenna installation with 80m dipole and skeleton slot array for 2 Mx.

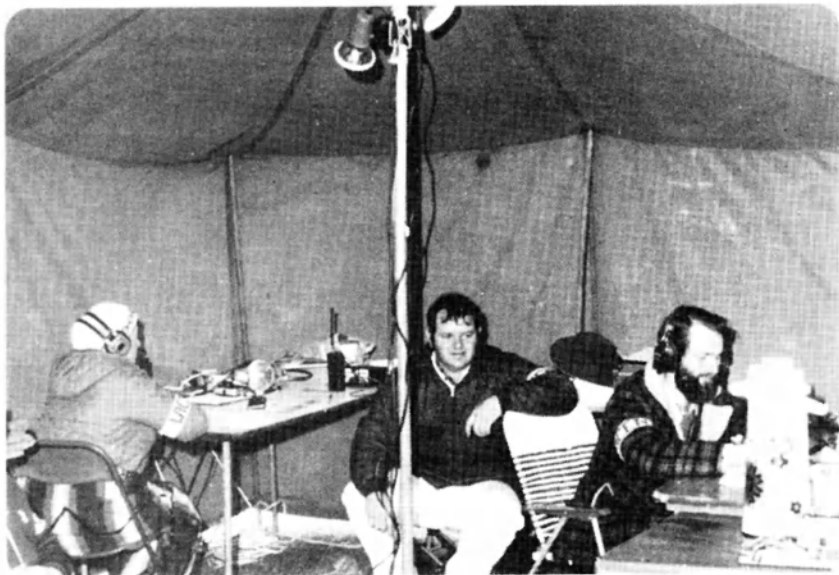
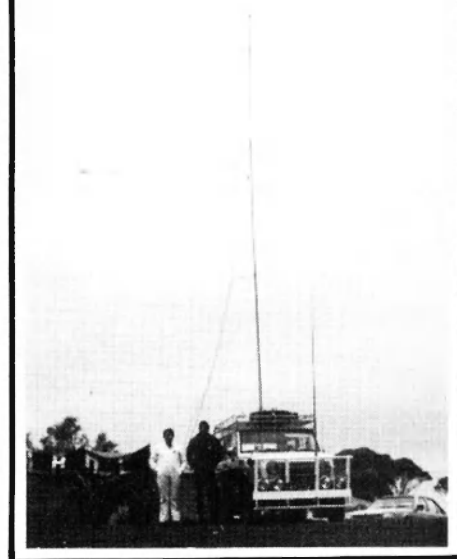

PHOTO 1: "Nerve centre" for the N/W Zone WICEN Exercise. Pictured, bearing the cold, from l. to r.: Marilyn VK3VUA, Peter VK3BEJ and Geoff VK3ACZ.

and some members retired VERY late. One latecomer rolled into camp at 2 a.m., having woken some of the crew by shouting for guidance on 2 metres! (He'll remember to get time off next time!)

All were woken rudely at 5.30 a.m. by a great barrage of dustbin lids, courtesy of the Army! Great way to start a day which remained bleak and cold throughout! By 7 a.m. only the control personnel were left, the others having dispersed to their checkpoints round the lake's perimeter. Control was under the able leadership of Peter VK3BEJ, the local WICEN Co-ordinator.

Sunday was one of constant activity, as all car numbers had to be noted and passed to control (a very good exercise in itself) and of course as the race proceeded the messages started to come in. All traffic regarding car numbers was handled on 2 metres, while all emergency message traffic was passed on 80 metres. The only interruptions on 2 metres came when Peter VK3BEJ went aloft in a plane with his hand-held 2 metre rig. It is probable that the breathlessness of his transmissions was largely proportional to the height above ground at which he was flying — maybe 100 feet! By 5 p.m. all cars



were found and retrieved, and all concerned retired to the campfire for a meal and more rag-chewing. Much time was spent that evening by certain determined people trying to make ashtrays from small melted empty bottles — with no success.

Monday was a repeat performance minus the rude awakening and with improved weather. This time the motorbikes were

racing, and there were three accidents to cope with, one quite serious. As numbers were smaller at control on Monday, the whole afternoon was an excellent test for emergency message handling. Despite various problems, all messages were relayed accurately, and there were no equipment breakdowns (the only casualty was a

certain 2 metre beam whose gamma match got broken en route Monday morning).

Everybody taking part agreed that the standard of operation had improved vastly since the previous year, and there are no lack of volunteers for the next time.

Thanks are due to all who helped make the weekend a success — Alf VK3VIV and

Margaret, Bob VK3YVT, Bev and Bobby, Darren VK3VNR, Dave VK3YTY and Lee, George VK3YML, Graham VK3GZ and Margaret VK3BVF, Geoff VK3ACZ, Marilyn VK3VUA and Cathy, Gordon VK3YOD, Greg VK3BRQ, Kester, Peter VK3BEJ and Barbara, Ron and Marlene — keep up the good work! ■

## LISTENING AROUND

With Joe VK2NIM

There must be a jinx on my typewriter I think because in these last few minutes every time I try to start writing this page, the typewriter goes crazy, so let's hope I can get through this without too many "blues", so . . . testing . . . testing . . . the quick brown fox jumped over the lazy dawg . . . oh, heck there it goes again . . . who ever heard of a "dawg" anyway?

I've heard the old-timers say that "eighty" is the friendliest band, and in two years or so listening I tend to agree.

Every time I tell some distant contact that Buronga is my QTH, they tell me that they've never heard of the place, so I've found myself going through the monotonous routine of saying "Well, look for Mildura in north-west Victoria and draw an imaginary line four kilometres north into NSW and there you'll find me on the NSW end of the bumpy Mildura bridge over the Murray. Well, that technique gives them a clue, but I decided to go one better and obtained my official co-ordinates from the Wentworth Shire Council. And so here for the benefit of posterity and all and sundry that I work on 80 and 10, here they are: Be it known from henceforth that Buronga is located 34 degrees south latitude and 142 degrees east longitude". So there you have it, the mystery of where VK2NIM is located is solved. And I'm not the only one who now includes official longitude and latitude along with my QTH, for Bob VK3NHA has been heard doing the same. And for the benefit of the vast (?) listening audience, why doesn't everybody do it?

Now who are the most interesting people I've heard in recent times? Well, take for example Brian VK2NAI, with whom I used to speak when he was on duty at the Siding Springs optical telescopes near Coonabarabran, NSW. Brian has been overseas visiting Egypt and other places since I last worked him under his VK2NAI call and, since coming back, he's now known as VK1DX. A few nights ago, I spoke to his dad, Lou, the former VK7NLJ, who is now VK7LJ in Hobart.

Was in touch recently with Keith VK5KH at Kapunda. Keith has been on the bands a long while. In 1954, he was secretary of the "Beef Steak and Burgundy Club" in Port Adelaide. I don't know what this has got to do with amateur radio, but I'm

putting it in anyway because it shows where his interests lie. During World War Two he was in the RAAF at Drysdale in the north-west of Western Australia, and later at Gove in the Northern Territory, which Keith says was called after a Wing Commander Gove who was killed there. He was later at Berry Springs hospital after drinking lolly water at the Adelaide River Canteen (which I remember quite well from my own sojourn in the NT on active service). Keith described a raid on the Drysdale Mission station in which a Catholic priest and five aboriginals were killed. While at Drysdale Keith, although not of the same faith, played the organ in the Drysdale Mission church. In this raid "everything was decimated" Keith said. In another period he was at Cape Arnhem and Batchelor, then to New Guinea, and in 1944 he was with the RAAF at Mildura. I forgot to mention also that earlier on Keith was on Middleborough Island and Morotai Islands (where I was also at one time).

Another contact was with Alan VK2AIR of Seven Hills near Sydney. Alan is a very interesting bloke also, and in his trips around the world has marvelled at the stack of antennas atop of the Russian Embassy in Teheran. On the morning I spoke with Alan, a VK4 was heard to mention that he (the VK4) had heard some ZLs discussing "a shake" that had just occurred in New Zealand. It appears that the Shaky Islands quite often get the shakes and when they do its not always news. But VK2AIR says that he was once in Napier when an earthquake occurred.

Was very pleased recently to be able to speak on the 600 ohm line with Barry Theodore VK3VST at Sunbury, who has just got his call and who lives near a friends of my CB days, John Canning. A sked was arranged for 10 p.m. Friday, 20th June, on 3620, and I was on time. It appears that as SWLs, John and Barry have often listened to me in the early morning hours nattering away to perhaps Gordon VK5HM, Leo VK5GJ, Hugh VK5NIO, Steve VK4SE, or any of the many others who inhabit "80" during the wee morning hours. I was pleased to be able to welcome Barry to the bands and was more than pleased to be able to speak with John through Barry's facilities. John is now convinced that amateur radio is for him, and it is his intention to get his Novice ticket. Good work, John, and thanks again, Barry.

Reading the mail recently, I heard a VK5 who, at the age of 16, has got his full call, but having lost my notes I can't recall who it is. And another young fellow, David

from Canberra, who is a friend of Brian VK1DX, got his full call straight off without going for the Novice. David's call is VK1DN, and both sat for the February exam. Gee, the bands will be getting so crowded soon that the sooner they give us that extra spectrum space the better.

I hear that over in VK6-land on 80 in the early morning hours they're getting miscellaneous types of interference from some of our northern neighbours. One VK6 was heard to say that these signals were a homogenous mixture that was both AM and FM and other types which he described as "wobblegogs". How glad I am that I am not in VK6 when all that racket is on.

On Wednesday, 18th June, at about 1 a.m. on 80, I worked a JA with a difference. I say he was a JA with a difference because he was aboard an LP gas tanker carting Bass Strait gas to JA-land. He was "Nob" JA6COM, who was then maritime marine 100 miles south of Sydney. "Nob" comes from Nagoya, and told me that after this voyage he will be vacationing for three months and during this time will be sending cards to all the VKs that he has spoken with en route, and he'll be looking out for some of us on ten metres. "Nob's" ship picked up its cargo at Westernport, and while delayed there for 16 days due to industrial trouble, he stayed at the home of Geoff VK3NLG.

A favourite occupation of John VK5XT of Stirling is feeding honeyeaters and kookas. I enjoyed my recent conversation with John. He says he goes regularly to the local courthouse, so while he didn't specifically tell me his occupation, that could be a clue.

Another newcomer to the bands is Bart VK6NPM, in Perth. Bart was born in VK4, and has worked in several States. His first meeting with me was in our CB days, and it's nice to know that he's among the "converted".

There's another VK6 who likes a drop of the bubbly, and when he's under the affluence of inkahol, has on more than one occasion made things pretty rugged for those trying to have a round-table QSO. In fact, the last occasion was so bad that others were forced to vacate the frequency because he very effectively blocked out the Perth station we were trying to hear, and he is nearer to us than the Perth station. Isn't it a pity there isn't some sort of .05 test for those who drink while operating. You did make it tough for us, mate, so why not wise up to yourself? ("Full" call seems appropriate in this case!) 73 until next time. ■



# VHF-UHF

An expanding world

Eric Jamieson,  
VK6LP



Forrester, S.A. 5233

## VHF/UHF BEACONS

Freq.	Call Sign	Location
50.005	H44HIR	Honiara
50.055	ZL1UHF	Auckland
50.100	KH6EQI	Pearl Harbour
50.105	KC4AAD	McMurdo, Antarctica
50.110	KH0AB	Saipan
50.144	KC6NI	Ponape, Caroline Is.
51.999	YJ3PV	Vanuata
52.200	VK8VF	Darwin
52.250	ZL2VHM	Palmerston North
52.300	VK6RTV	Perth
52.330	VK3RGG	Geelong
52.350	VK6RTU	Kalgoorlie
52.400	VK7RNT	Launceston
52.440	VK4RTL	Townsville
52.450	VK2WI	Sydney
52.500	JA2IGY	Mie
52.500	ZL2VHM	Palmerston North
52.510	ZL2MHF	Mt. Climie
52.800	VK6RTW	Albany
52.900	VK6RTT	Carnarvon
53.000	VK5VF	Mt. Lofty
144.010	VK2WI	Sydney
144.162	VK3RGI	Gippsland
144.400	VK4RTT	Mt. Mowbullian
144.475	VK1RTA	Canberra
144.500	VK6RTW	Albany
144.600	VK6RTT	Carnarvon
144.700	VK3RTG	Vermont
144.800	VK5VF	Mt. Lofty
144.900	VK7RTX	Ulverstone
145.000	VK6RTV	Perth
147.400	VK2RCW	Sydney
432.400	VK4RBB	Brisbane

As advised last month the beacon list this time has been pruned somewhat with the removal of the overseas beacons except for the Pacific area. The chances now for most VK stations to work anything of importance over such long distances are fast fading with the passage of Cycle 21, but I am sure there will be occasions during the next 12 months or so when some contacts will be made from the Pacific area, eventually leading to increased Es activity as the sunspot cycle moves towards its lowest point, with a consequent improvement in long distance 2 metre propagation via Es.

The **VK5KK** beacon on 52.150 can be heard occasionally, whilst I have been receiving reports of a **VK3OT** beacon on 52.435 being heard in VK5 with some consistency although rather weak, at the same time the **Geelong** beacon on 52.330 is being heard at S1.

I note also from the SERG Newsletter that the Mt. Gambier beacon project is

being looked at with a view to trying to get the beacon on the air before the end of the year. If this comes about it will be a great help to both VK5 and VK3 operators being situated about halfway between Adelaide and Melbourne.

## SIX METRES

This band to date has been somewhat quieter than expected, although some watery CW peaking north was heard on 52.050 on 11-9 at 1030Z. On 11-9 **Gerry VK5AGM** worked 5 JAs on CW 5 x 1 around 1005Z, areas worked being JA1 and JR2. On 10-9 JAs were heard working into VK6.

Probably the best contact out of VK5 for the month was that of **Peter VK5ZPW**, who worked **C21NI** on 14-9 at 2319Z at 5 x 9 both ways. Contact lasted for three minutes only. **Arki C21NI** was part of a DXpedition and also worked two VK2s and some ZLs. QSLs are via **JA1UT**. Good work, Peter, shows it still pays to be watching the band.

Incidentally, **Peter VK5ZPW**, from his prime location near Angaston, also worked into Broken Hill recently, working **VK2ZI** first on channel 40, then on 144.100 5 x 9, also worked **VK2BY** and **VK2ADJ**, who incidentally have 432 MHz capability as well. Peter also worked **VK2ZI** on 6 metres at 5 x 4 both ways.

**Gerry VK5AGM** also advises W6 were hearing ZL TV on 27-9, and that Bill **W6HTH/KH6**, formerly **HL9WI**, has been working into a number of the Pacific call areas, and is anxious to work as many areas as possible, including VK.

**Tony VK6BV** has written to advise his antenna system is once again operational, and on 6 metres has a KLM type yagi up 16 metres and a repaired 16 element on 2 metres. Both are working well, with the new 8 element on six going better than his former home-brew 6 element.

**Dick 3D2CM** in Suva generally operates on 50.110 MHz and looks towards ZL and VK for contacts from around 0500Z. So far only ZL TV has been heard. Perhaps as Es improves we might be able to work him, though our 2 MHz split won't help.

## SIX METRES FROM VK6

**Graham VK6RO** wrote to me again as promised following his trip to the northern part of VK6 to work whatever was available on 6 metres. Taking his IC502 plus 25 watt PA and a 1/4 wave gutter mounted whip on the car, plus another IC502 for listening on 50 MHz, he set out and worked 211 JAs, **KG6DX** and three VK6 stations from a total of 15 openings. As an indication that DX doesn't really die in the north, here is what he worked.

Carnarvon 1-9 1250Z 2 JAs 5 x 1. Port Sampson 3-9 0925 to 1025Z 33 JAs, all call areas except JA8. Signals to 40 dB over 9 both ways! 1146 to 1255Z 26 JAs, in areas 1, 2, 3, 4, 6 and 9, 5 x 9 both ways, total 59 JAs for day. Dampier 4-9 1232 to 1310Z 8 JAs 5 x 8. Port Hedland 5-9 1135 to 1300Z 8 JAs 5 x 9. Broome 6-9 1020 to 1328Z 23 JAs 5 x 9. Broome

7-9 funny propagation, no JAs until 1107Z but at 1010Z heard Perth beacon 5 x 9. Called CQ Perth and got **VK6XW Albany**! Then **VK6WD Perth**, followed by **VK6XY Albany** at 5 x 9 plus 20 dB! **VK6WD** went on to work JAs and Graham was able to hear both ends of the contacts. The **VK6RO to VK6XW** contact may constitute a new VK6 internal record. Graham did not know whether **VK6ZFQ** on Koolan Is. worked him. Same day, between 1107 and 1313Z, worked 24 JAs to 5 x 9.

Broome 8-9 no JAs until 1155Z, but at 1122Z whilst listening on 52.050 heard **KG6DX** call CQ, and had a 30 minute OSO with Joe. Worked 18 JAs to 5 x 6 between 1155 and 1309Z. Port Hedland 9-9 5 JAs 1213 to 1335Z. 10-9 nothing except TV carrier on 49.475. Dampier 11-9 1052 to 1332 worked 56 JAs 5 x 9, worked 200th JA. Dampier 12-9 nothing all day! Carnarvon 13-9 only TV. Carnarvon 14-9 0952 to 1013Z 4 JAs 5 x 6. Geraldton 15-9 0851 to 0852Z 2 JAs 5 x 5.

Graham reports the TV carrier on 49.750 was heard every day at up to 5 x 9 even with the IC502 hand-held! Did not hear one JA8. Despite being early September the night time TEP was there.

It may be well worth observing that the first JAs at Carnarvon on 1-9 were weak at 1250Z. A little higher up 2 days later the JAs were very strong and started at 0925Z, much earlier. As Graham progressed further north the main JA signals were being heard from 1100 to 1300Z, and as he came back down the coast again the times gradually became earlier until his last day at Geraldton they started at 0851 and finished 0855Z and 2 only worked. Not only did the numbers generally diminish as he came back, but the times were earlier.

## NEWS FROM NORTH QUEENSLAND

We now swing right across the Continent to hear from Ted **VK4YG** at Freshwater reporting on the Cairns and North Queensland news.

6-8 Colin **P29ZEV/P** worked into the Cairns repeater **VK4RCA** from Mt. Clarence which is 120 miles east of Port Moresby. Time 0700Z. Distance 439 nautical miles. altitude 5300 ft. a.s.l. Many contacts with locals.

15-8: **VK9ZG**, Graham on Willis Island, a weather station 250 N miles from the repeater, had many QSOs with locals. 0755Z and 250 N miles. Altitude: sea level. Contacts continued for several days, and intermittent according to weather conditions. **VK9ZG** also contacted Ken **VK4KT** in Townsville direct on 2 metres SSB over a distance of 290 N miles.

20-8: Ken **VK4KT** at Townsville worked 2 ways with Ian **VK4AFC** in Cairns on 432.100 MHz SSB, at 1220Z. **VK4KT** was running 10 watts with an 8/8 slot fed array, and **VK4AFC** 10 watts and 7 element yagi. Distance 180 N miles, which is a good effort for North Queensland coastline, and a first time contact. (Good work, chaps, may it be the forerunner of many more contacts.—5LP.)

29-8: The Cairns Amateur Radio Club's repeater VK4RCA changed its frequency on this date to channel 6950, i.e. 146.350 in and 146.950 out. Contact with VK9ZG on Willis Island was made at about 0880Z that evening on the new frequency. **Intending visitors please note the change in your books.**

Thanks for writing, Ted, and I note you now have a 6 element on six metres, so we should hear you well this summer.

It is certainly pleasing to note the workings going on in the north of Queensland on 144 and 432 MHz, in an area supposedly unable to support such activity a few years ago.

#### NATIONAL VHF FIELD DAY WEEKEND

As reported previously, I give my full support to the proposed National VHF Field Day Weekend being sponsored by the Geelong Amateur Radio Club to be run in conjunction with the first weekend of the Ross Hull Memorial Contest. This will probably make the starting time the weekend of 6th and 7th December, which also is a VHF Field Day Weekend in New Zealand, so this may help to improve the interest in all areas.

Here are the details of the National VHF Field Day Weekend.

#### AIM

The Field Day Weekend is being conducted by the Geelong Amateur Radio Club in an effort to encourage VHF/UHF usage and participation in the Ross Hull Contest, as well as filling the needs for a nationally co-ordinated VHF Field Day Weekend.

#### CONTEST PERIOD

Any continuous 24 hour period within the first 48 hours of the Ross Hull Contest.

#### RULES

All Ross Hull Contest rules apply, plus/except the following:

Only entries from portable stations will be accepted, however check logs from home stations will be welcome.

A station is deemed portable when it is operated at least 2 km from the home QTH.

No equipment, including antennae, may be set up more than 24 hours prior to the start of the contest.

Power may be derived from any source available.

A scoring contact may be made with the same station on the same band repeatedly provided at least 4 hours elapse between the contacts.

#### SCORING

Scoring as per Ross Hull Contest rules.

#### ENTRIES

Each entry must contain a front sheet giving details of station including location and total score claimed. Plus a photocopy of the log. All entries will be acknowledged and certificates will be awarded to the overall winner, plus the highest score in each call area.

All entries: "Contest Manager", Geelong Amateur Radio Club, PO Box 520, Geelong 3220.

About the only thing the sheet of rules doesn't tell us is the closing date for entries for the Field Day Weekend. Based upon the usual one month after the close of the contest, this could mean the 7th January, 1981. If the closing date for the Ross Hull Contest entries is observed then it will be much later. Might I suggest participants don't tarry too long and get the results in by 7th January, in this way the Geelong Manager will be able to get the results out a lot earlier than if you wait for the later date. Whatever the date is really doesn't matter, but please put in your log, if you put it off too long you probably won't send it in anyway!

#### EME NEWS

I note from "Break In" that **Graham ZL3AAD**, whom I had the pleasure of meeting in New Zealand recently, has been doing very well with his 432 MHz EME activity. To May 18 he had made **39** contacts for 11 countries, and requires only South America for WAC. He believes his contact with **F9FT** on 18-5 is a possible new world record distance of **11,775 miles** or **18,951 km**.

He reported that on 17-5 the QRM from USA and JA stations was so bad he could not get in — signals were S3-4 above the noise with **K3NSS** and **JA6ZCD** creating havoc with their strong signals. **K3NSS** uses an **80 foot dish** and **2 kw** at feed, **JA6ZCD** has a **30 foot dish** and **1 kw** feed.

Graham reports it is hard working out in the East as noise from the city of Christchurch produces almost 9 dB extra until he gets above 15 degrees elevation. Graham notes this is one of the problems with extremely low noise GaAs FET pre-amps in that the noise figure deteriorates when the antenna is horizontal. To use these for terrestrial work produces no improvement in the signal due to ground temperature. They do, however, produce 13 dB of sun noise when elevated.

From "The Propagator" comes an EME report to say the 1296 MHz disc feed was installed in the new six foot diameter dish. The 1296 MHz preamp was mounted directly at the feed with a short length of coax to the converter giving an overall receiver noise figure of approximately 3.5 dB.

4 dB of sun noise was obtained, with quite a clean radiation pattern.

A special EME test for 1296 MHz is being organised by SK2GJ in Sweden for September/October. They will have the use of a 100 foot diameter dish and they are hoping that signals may be received by stations having an antenna with gain equivalent to only a five foot diameter dish.

**VK2BYX** in Moree has started to construct a 432 MHz EME system. He will initially use an antenna array of four long yagis.

#### JOTTINGS FROM HERE AND THERE

The first UK six metre beacon, **GB3SIX**, was due to start up on 18-5-80. It can only

be operated between **0100** and **0830Z** due to TV stations occupying the band at other times.

It is noted with regret the problems the repeaters are having in London with deliberate interference, bad language and pirates. A change of call sign, and the opening up of three additional repeaters really only helped to spread the abuse.

"Short Wave Magazine" reports that during the excellent conditions last May 10-11, **G4ERG** in Hull listened to an hilarious "howl around" between an English and Norwegian repeater. This is possible because the outputs of the RB relays are on the inputs of the IARU Region 1 RU repeaters. Once triggered off, they will continue to access one another until propagation no longer sustains the possibility! So much for non-standard repeater splits!

"Radio Communication" reports that **John Baker GW3MHW**, from Wales, last winter had made over **400** crossband contacts from 28.885 to 50 MHz, working all USA call areas on the way.

It seems the Northern Hemisphere is not content to settle for TEP and F2 contacts on 50 MHz. A report comes to hand of what is believed to be multi-hop Es when at 2230Z on 15-7-80 the Gibraltar 50 MHz beacon **ZB2VHF** in USA at 5 x 9 plus in the W1 call area. A telephone call from **K1DH** to the beacon keeper **ZB2BL** brought him on the air and he worked **K1DH**, **W1QXX**, **WB1FUB**, **WA1UQC**, **K2MUB** and **N3AHI**. Nothing was heard in USA of the **GB3SIX** beacon or from **EI2W**, who also came on the air after receiving a telephone call.

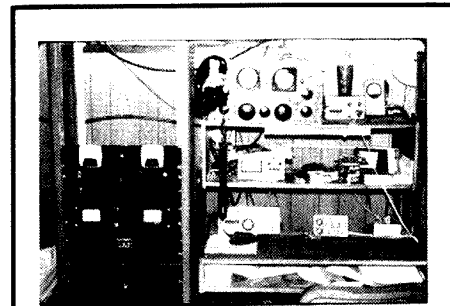

PHOTO 1: This is a view of the 6 Mx operating position of Gary **W6JX**, a renowned 6m DX operator.



PHOTO 2: **W6JX** at his Mt. Palomar QTH. Photos by Lionel **VK3NM**.

**VK2AC** in Sydney has a newly completed crystal controlled transmitter operating on **10 GHz**. Output is at least **25 mW**. The design of the equipment is such that it will allow "narrow band" communication techniques to be used to obtain quite an improvement in capability over the relatively wide-band Gunn diode oscillators at present used on the 3 cm band.

"**The Propagator**" reports the Goroka (P29) amateurs are setting up a **10 metre beacon**, as well as a **2 metre repeater**, on top of a 14,000 foot mountain. QRP tests have been carried out from the site and the Cairns repeater has been accessed. The permanent repeater will have an output power of **50 watts**, so it looks like the repeater should be a great asset to **VK4** operators; they may be able to work Japan through it!

Meteor showers coming up soon which may enhance your 2 metre possibilities: **TAURIDS** — 26-10 to 16-11, peaking 8-11. **LEONIDS** — 15-11 to 19-11, peaking 17-11. **GEMINIDS** — 9-12 to 14-12, peaking 14-12. **URSIDS** — 17-12 to 24-12, peaking 22-12.

Note in October 1947 QST "World Above 50 Mc" reference to the 50 Mc record passing the 5000 mile mark with the contact between Clarry **VK5KL**, then at Darwin, and **W7ACS/KH6** on 25-8-47 for a distance of 5350 miles. That record was to stand for a long time. Clarry used a pair of **834s** in the 100 watt transmitter to a coaxial fed 3 element beam. Interesting.

I haven't received any feedback yet in regard to the suggested Locator Squares method of determining your geographical position. If you have any comments about writing a few lines.

#### HINT FOR THE MONTH

How many times have you looked at that new shiny piece of aluminium tubing bought to be used as the boom of a VHF yagi and wondered how best you could drill the holes in it for the various elements and finish up with everything in line?

If you are fortunate enough to have two pieces of tubing the same size and length your job will be easy. Lay the two pieces side by side on a flat floor, and tie them together every metre or so with masking tape, making sure they can't move and lie flat on the floor when finished.

Select a fine grained file with straight edges, or the back of a hacksaw blade and, holding the implement firmly, place it firmly on top of the two tubes, and draw the implement down the full length of the tubing. This will score a line down each tube, so now you have two tubes marked, one for now and one for when the antenna is blown down at some later date! Centre punch where you want to drill the holes.

You can buy a device for a few dollars which can be attached to an electric drill which will ensure the bit when drilled through the tubing will come out square on the other side (in alignment that is, not a square hole!). Hardware stores have the holes drilled it won't take long to finish

the construction job, with everything in line.

#### ENDING

News for the September period has been rather scarce, hopefully things will improve for October. I hope many of you will make an effort to go out on the National Field Day Weekend in December, start looking over your gear now. With the opportunity of using mains power now this should give more operators a reason for going out.

Closing with the thought for the month: "**How a man plays the game shows something of his character; how he loses shows all of it.**"

73. The Voice in the Hills. ■

## NOVICE NOTES



Edited by Ron Cook **VK3AFW**

Last month I posed two questions; you have discovered the answers I hope, but just in case you have not, here they are.

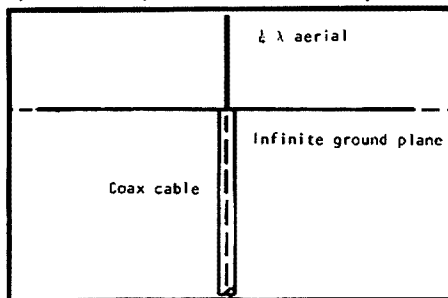

Fig. 1 shows a vertical aerial fed with coax cable and mounted over an infinite ground plane of very good conductivity. For convenience we will assume that the aerial is  $\frac{1}{4}$  wavelength long but this is not critical. The feed resistance is 36 ohms or so, giving a VSWR of 50/36 or 1.4 : 1 in a 50 ohm line.

Current from the transmitter flows up the coax and out along both the antenna and ground plane. No current can flow back down the outside of the coax because the ground plane extends to infinity in all directions. If the ground plane were re-

moved then current would flow down the outside of the coax. As the coax is likely to be several wavelengths long it will act like a long wire and radiate power in the direction its length. This is likely to mean considerable power radiated straight up. Even for moon-bounce work this is not desirable! Also the feed impedance will be different and the VSWR will be different. Murphy says that it will be a lot higher. And another thing that will happen is that RF will appear back in the shack causing RF feedback or RF burns to the lips from a "hot" microphone. Clearly RF flowing down the outside of the coax is to be avoided. Then again an infinite ground plane is expensive and may disturb the neighbours.

Fortunately we can reduce the ground plane in size to a disc  $\frac{1}{2}$  wavelength in diameter. This is a resonant size and acts like a parallel tuned circuit choking off any RF current that tries to flow down the outside of the coax. Because of its symmetry there is no radiation from this disc. Any current flowing out from the centre produces a field but this is cancelled by the effect of an equal current flowing away in an exactly opposite direction. Thus we have only a vertically polarised signal from the aerial itself. The impedance of the aerial is the same as for the infinite ground plane, so we still have an acceptable VSWR.

Quarter wavelength discs have been used at 10 GHz but on 21 MHz they are a bit of a nuisance to build. Fortunately we can cut away most of the disc, leaving only four symmetric  $\frac{1}{4}$  wavelength radial rods as shown in Fig. 2. The system works as well as the disc.

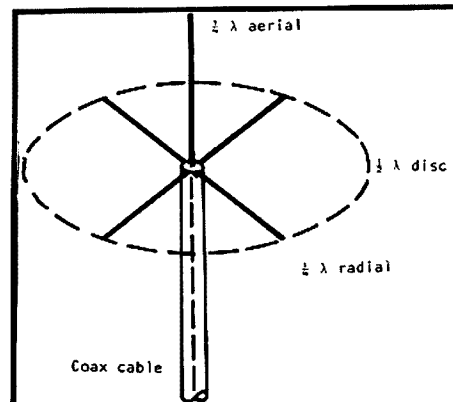

Bending the radials down will raise the feed impedance and reduce the VSWR. Alternatively the aerial can be lengthened by 25 per cent and a shorted coax stub about 0.15 wavelengths long connected to the base of the aerial. The inner is connected to the aerial and the braid to the radials and feed coax braid. The far end is shorted. Some pruning may be necessary. Don't forget to use the velocity factor of the line.

Now if we are erecting a  $\frac{1}{4}$  wave vertical for 160 metres or even for 80 metres it is not practical to use 4  $\frac{1}{4}$  wavelength radials. For best operation (i.e.

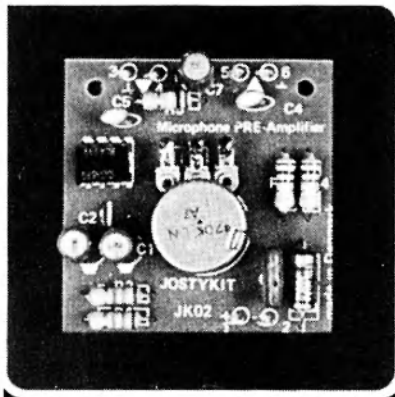

**JK02 Microphone Pre-amplifier**  
The JK02 is specially designed to amplify and control the weak signals from a dynamic microphone so that it can be used with a normal amplifier. For example, if you wish to build a low power public address (PA) system you can use a dynamic mike with the JK02 and a JK01. It has lots of applications with walkie-talkies, tape recorders, dynamic pick-ups etc. Another easy-to-build IC project. Requires 9V DC supply.

**PHOTO 1**

**JK04 FM Tuner**  
Everybody wants to build a radio receiver, the JK04 not only makes this possible, but gives you high quality results as well. Using two integrated circuits and specially wound coils all the problems are solved. The specially designed automatic frequency control (AFC) circuit gives spot-on tuning of stations. The frequency range is 87.5-108 MHz (extendable by  $\pm 10$  MHz). Output to headphones or an amplifier such as the JK01.

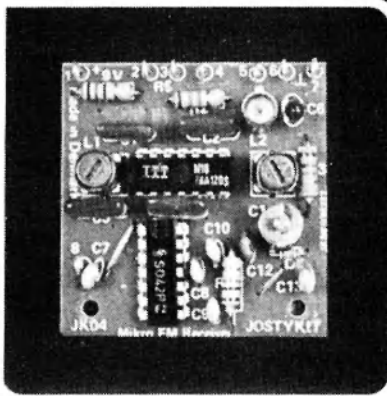

**PHOTO 2**

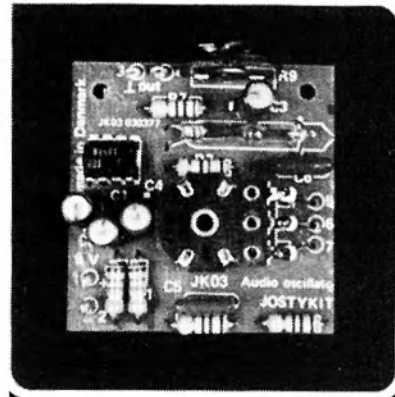

**JK03 AF Signal Generator**  
A project which provides you with an indispensable piece of test gear. This is an integrated circuit oscillator circuit giving a sinusoidal output voltage variable between 20-20,000 Hz. Any frequency in this range can easily be selected by means of the pot. on the front of the module so you have a very useful signal generator. This can be used for testing and fault-finding on all types of audio equipment.

**PHOTO 3**

freedom from interactions with the ground) the radials should be at least one and preferably many wavelengths above ground. The next best thing is to use the ground itself as an approximation to the infinite ground plane. Now unfortunately making a good low loss (low resistance) connection with the ground is not easy. A 2m long pipe may typically look like 20 ohms. Two pipes in parallel a meter or so apart may look like 14 ohms. Two 4m pipes may be better than 10 ohms.

Of course soil conditions are the most significant factor. Wet salty soil is best but causes the ground stakes to corrode. It has been found that extending the ground connections over a longer area is

below the surface (or even a bit shallower) gives a good ground connection of the order of 0.1-5 ohms depending on the soil.

At some future date we will return to the design and construction of vertical aerials and also discuss measuring ground and earthing rod resistances.

Have you taken the plunge and built yourself a kit yet?

Photo 1, 2, 3 shows some simple and useful kits from the JOSTY KIT range sold by Vicom. The microphone pre-amp would be useful for some of the older transceivers. Two of the JR03 kits could be used as the basis of a two-tone generator for testing your rig. The JR04 could be

courtesy of Vicom.) A list of kits available can be obtained from Vicom.

Photos 6 to 10 inclusive are kits marketed by Dick Smith and are some of the vast range available. These are of particular interest to the Novice. They are all Australian designed and come complete with all parts, diagrams and a booklet "Guide to Kit Construction". (Photos courtesy Dick Smith.) I have built several of these kits, including the Morse Keyer and the Transistor Tester. They are easy to build, work well and have a good appearance.

From my experience with the Josty Kits it seems they too meet the same high standards.

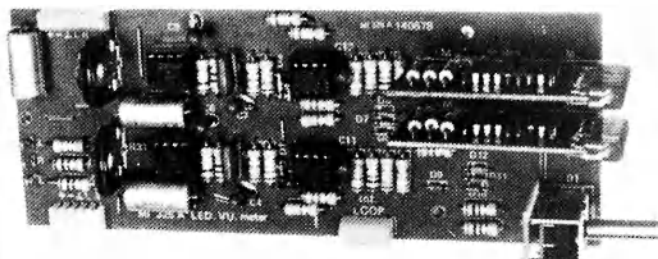

**PHOTO 4**

helpful. Also a long wire buried in even a shallow trench can be as good as a stake driven into the ground. It can be shown mathematically that a large area of contact gives a lower resistance than a small one.

So a radial system of not less than 20 inches 0.1 wavelength long buried 300 mm

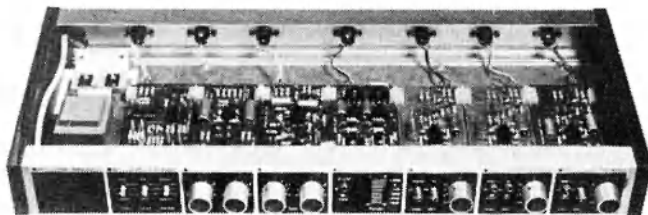
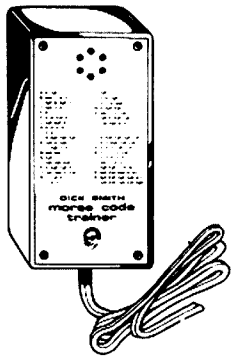

**PHOTO 5**

used to update your stereo system. I am building another of these kits, a photographic timer. Each kit comes complete with all components and a booklet on how to build a kit as well as the circuit and layout diagram for the kit. Quite large systems can be built. Photo 4 shows an LED VU meter and photo 5 shows a conglomerate audio mixing console. (Photographs

The full range of Dick Smith kits is given in the current catalogue.

Generally the overall cost of these kits is less than the cost of buying the components separately and certainly the satisfaction gained from completing a kit is worth more than mere money.



K-3472  
Morse Code Trainer Kit  
Ideal for the budding Novice.

PHOTO 8

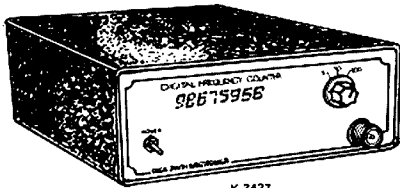

K-3437  
Digital Frequency Counter Kit  
Up to 40MHz or 200MHz

PHOTO 7

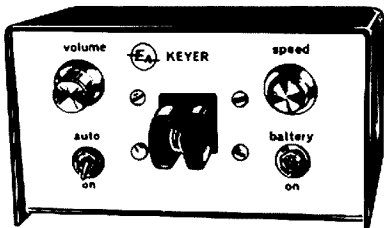

K-3470  
Morse Keyer Kit  
Complete with paddle

PHOTO 8

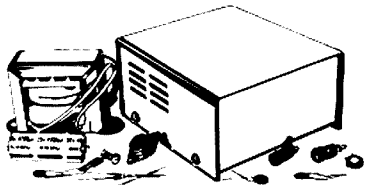

K-3448  
2A 13.8V Power Supply  
Ideal for the converted 10M  
CB radio etc.

PHOTO 9

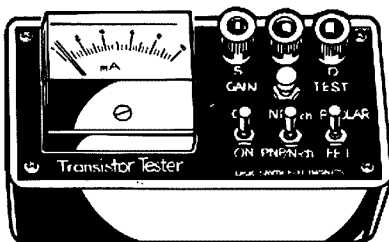

K-3052  
Transistor Tester Kit  
Tests Bipolars, FETS, SCR's,  
5 PUT's.

PHOTO 10

And now over to Peter VK3CIF for some interesting background on call signs.

### AMATEUR CALL SIGNS

The ITU Regulations — Australia is a signatory and therefore adopts them — state that transmissions without identification or with false identification are prohibited (5331), all amateur stations shall have call signs from the international series allocated to each country as given in the Table of Allocation of Call Sign Series (5340), the 26 letters of the alphabet (excluding accented letters) as well as digits may be used to form call signs (5351), but for amateur stations combinations commencing with a digit when the second character is the letter O or I shall not be used (5354) and for amateur and experimental stations the call sign shall consist of one or two letters and a single digit followed by a group of not more than three letters (5375/6).

For other services, as a matter of interest, the call signs shall be (always remembering that the digits 0 and 1 shall not be used when following a letter) —

Land and fixed stations — 3 letters or 3 letters plus up to 3 digits.

Ship stations — 4 letters or 2 or 3 letters plus 4 digits in R/Telephony.

Aircraft stations — 5 letters.

Land Mobile stations — 4 letters plus 1 digit or for R/T stations 2 or 3 letters plus 4 digits.

Space service stations — 2 letters plus 2 or 3 digits.

EPIR stations — Morse letter B plus call sign of parent ship.

Aircraft survival stations — Parent aircraft call plus 1 digit.

### AMATEUR CALL SIGN PREFIXES

The 1979 WIA Amateur Call Book, on page 20, lists the call sign series allocated internationally to each country. Mainly as the result of independence, new call sign series are allocated by the ITU as required. These appear in AR from time to time.

For practical purposes the call sign is split in two — the prefix and the suffix. The prefix refers to the country, the suffix refers to the individual station. Sometimes the prefix also includes an indication of a part of a country, e.g. VK5, VK6, etc.

Many years ago when there were fewer separate countries in the world, alphabetical prefixes were adequate. Some countries were allocated one or more series of one letter calls. Thus the USA took W, K, N, France had F, the United Kingdom G, Russia U, etc. The letter "Q" was, and is not, used to avoid confusion with the "Q" code. Other countries had to be satisfied with two letter call series, such as HS for Thailand. As more and more countries were granted independence, the two letter call series ran out. Digits and a letter were then used — as examples, 9M for Malaysia and then later on C2 for Nauru.

Thus the prefixes heard on the bands range from the simple W6, G3, F8 to HS1, 9M2, C22. Two or three characters. Very occasionally a fourth character (i.e. the first character of the suffix) designates some special location or purpose, such as FB8W for Crozet Is. as distinct from FB8X for Kerguelen Is. and VK3N for Novices and VK3Z for Limited calls; the prefixes remain as FB8 and VK3 however. Local country administrations themselves allocate the prefix to be used, within their ITU allotment/s, for radio services including amateurs in that country. As examples, the British Empire, as it then was, had the V allocation and this was also used for Dominions and Dependencies such as VE for Canada, VK for Australia, and so on. Australia also possesses independently obtained call signs, AXA to AXZ, in addition to VHA to VNZ and VZA to VZZ. In the very beginning of these series (late 1920s), Australian amateur prefixes could have been VH1 to 0 or VM1 to 0, but VK1 to 0 was chosen. Much the same applies to the more recently allocated series — C29 could have been used instead of C21 since Nauru has the C2A to C2Z series. This always follows the principle of one or two letters followed by a digit. Hence 2 character or 3 character prefixes for amateurs.

In day to day usage amateurs refer to a country by its shortest prefix — G for the UK, W for the USA, C2 for Nauru, VK for Australia, etc. For Malaysia 9M may be quite sufficient, because 9M8 refers to Sarawak and 9M2 for West Malaysia. To be consistent though, amateurs use C21 for Nauru, P29 for PNG, etc., because the second digit does not refer to anything beyond the amateur prefix in use.

### AMATEUR CALL SIGN SUFFIXES

The call sign suffix identifies the individual station. The suffix consists of one, two or three letters — never digits. Thus we find ZS2A, VK7AA, VK7AAA. An occasional longer suffix has been known, such as IARU or ARTEK, but is very rare. As a general rule the call sign refers to the station and not to an operator.

### ADDITIONS

For some countries a foreign visitor, when licensed, can retain his home call sign with the addition of the country prefix — thus VE8AA/SU. The QSL card from this station would be accepted as Egypt for awards purposes.

Other additions, which carry no special country status for awards, would include W6ABC/MM (Maritime Mobile anywhere on the high seas except territorial waters), G3AAA/P (portable) and F6AA/M (Mobile in France).

### HISTORICAL

The present series of world prefixes began in the mid-1920s but specifically it arose out of the 1927 International Radio Telegraphic Conference in Washington. About three years prior to that Conference amateurs had begun to conform to a sys-

tem of prefixes which the Transatlantic contacts in 1923-24 made abundantly clear as essential. Thus G was for Great Britain, N for the USA, ON for Belgium and, apparently, A for Australia. The "Listener In" Handbook of Australian Call Signs issued in about 1926 listed amateur stations as "2WI", "4WI", etc. By 1930 these had become "VK2WI", "VK4WI", etc. (Wireless Weekly Call Sign Supplement). However, Australian amateurs were using the prefix "A" for some years prior to 1928.

From about 1910-11 amateur stations in Australia were required to be licensed as wireless experimental stations under the Wireless Telegraphy Act of 1905. A call book published in 1914 by the Wireless Institute of Victoria lists these stations. These call signs were 3 or 4 letters beginning with "X". New South Wales stations went from XAA to XIZ, Victoria XJA to XPZ (XPJ was the WIV station), Queensland XQA-XQZ, SA XVA-XVZ, WA XYA-XYZ and Tasmania XZA-XZZ. 401 stations were in that call book. Re-licensing of amateurs after the First World War was

greatly delayed and the previous "X" calls fell away in favour of 2WI, 4WI, etc.

Prior to about 1910-11 there was possibly little need for identification by call sign as the number of stations were very few and the range of each extremely limited: Probably "handles" sufficed.

#### NOTES

In phone operations it is easy to mistake letters such as B, C, D, P, T for example. Thus phonetics are used such as may be noted in paragraph 8.1 of the Handbook as recommended for general use. Many amateurs still use well known country or city names such as Z for Zanzibar, but this can be confusing to non-English-speaking contacts (e.g. "Spain" for "S" seems odd when the country is "Espania"). It is best to avoid using peculiar phonetics over the air (e.g. VK5 Bright Beautiful Kid).

Some people still want to write their call signs with a hyphen or punctuations — as examples VK1-AA, or VK1.A.A. This is of course not correct because the full call sign is an entity of its own. Capitals for call signs is the correct usage. The

oblique stroke (or slash) is used in denoting some difference — e.g. W6ABC/MM, VK6AAA/3, etc.

For award purposes (other than awards based on prefix calling) a country which becomes independent can only be claimed once. For example, if you already had a QSL card confirmed from ZD6 you cannot claim an additional credit for 7Q7 when the call sign prefix changed from 1-1-1964. Some "countries" became absorbed into larger groups as, for example, a CR8 of Portuguese Timor can be claimed as a country if the contact occurred prior to 15-9-1976; after that date the area became part of Indonesia and can only be claimed as Indonesia thereafter.

Finally, when talking about country prefixes which contain 2 digits it is normal practice to state the number as it is rather than using two separate numerals. For example, P29 would be spoken as "P twenty-nine" and not "P two nine".

Thanks, Peter. Next week we will discuss buying your first rig with particular emphasis on the second-hand market. 73. ■

## TRY THIS WITH THE TECHNICAL EDITORS

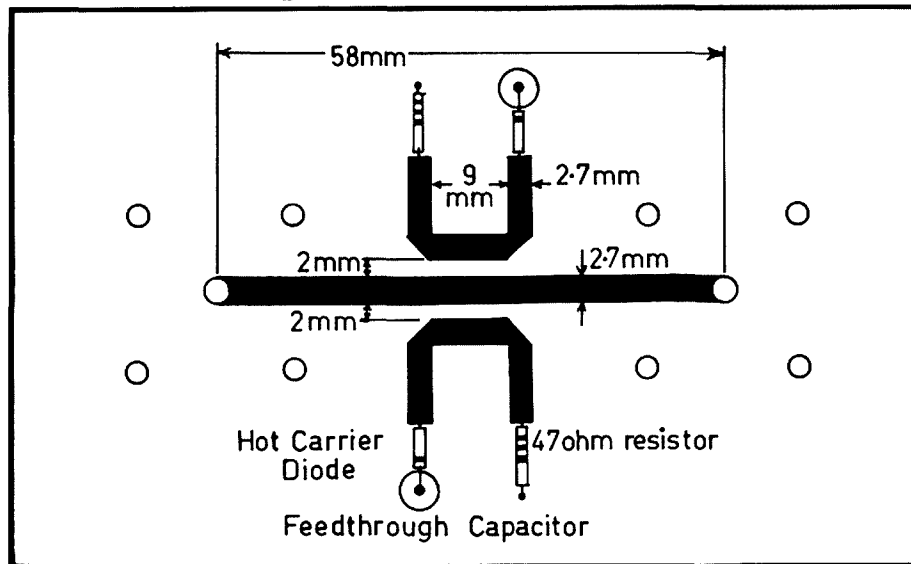

### UHF REFLECTOMETER

Working on the UHF bands the need arises for an "Aerial Has Fallen Off Indicator", otherwise known as an SWR Meter or Reflectometer.

Not being a very competent sheet-metal worker or plumber, the usual masterpieces were viewed with some concern. However, a microstrip design based on a power indicator in the RSGB VHF/UHF manual was a definite possibility.

The design was a piece of double-sided fibreglass circuit board etched to provide a microstrip transmission line and a pair of sampling lines. The layout of this is shown in Fig. 1 with appropriate dimensions. This was laid out using a fine resist pen directly on to the circuit board before etching.

The connectors used are type N and must be shimmed up from the earth plane with some brass or copper. Take care here so as to approximate the impedance by keeping the insulation hard down on to the board. The connector flange must be packed up just the amount needed.

The feed-through capacitors should be UHF types and were scrounged from the junk box. They were originally obtained as "new" disposals. A UHF TV tuner type would be suitable.

The 47 ohm terminating resistors were old style but small solid carbon resistors obtained from a computer board. Modern types have a spiral groove and should be avoided. Select from those available and be prepared to use little taps to tune out

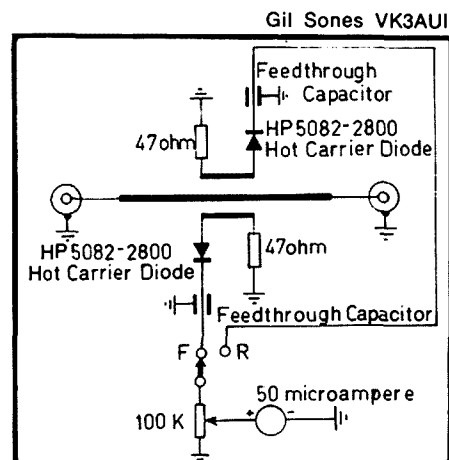

reactance. This approach was needed on a second unit built by Kevin VK3AUQ.

If you are unsure of the characteristics of your circuit board then check the dielectric constant of a piece of it. This is fairly simple to do. Just measure the capacitance of a sample and work out the dielectric constant. The 1/6th inch board used had a dielectric constant of 5 approximately.

If you have different board then the formula in the RSGB VHF/UHF manual should be used to calculate the width of the microstrip. Sounds complicated but is really very simple.

The printed circuit layout is shown in Fig. 1 and the circuit is shown in Fig. 2. Precise hole drilling is not given as this will depend on the components available.

The whole PCB was mounted into the lid of a box so as to eliminate any strange effects due to the surroundings. A diecast box is great but any other metal box will do. ■

## Collectors' Corner No. 4 —

# The IC260A/E 2Mx All-Mode Txcvr

Gone are the days where rock bound rigs govern your operating frequencies as the new breed of CPU controlled devices such as the IC260A/E offer unlimited flexibility for mobile needs, or as a compact base unit.

The IC-260A/E provides FM, USB, LSB and CW coverage in the 143.8-148.2 MHz range (IC260A model), and offers continuous tuning from the low end of the 2m band to the high end and back again. The transmitter uses a balanced mixer in a single conversion system, a band pass filter and a high performance low pass filter. The IC260A/E has a built-in noise blanker, CW break-in, CW monitor and has facility, if required, for the installation of a tone call unit.

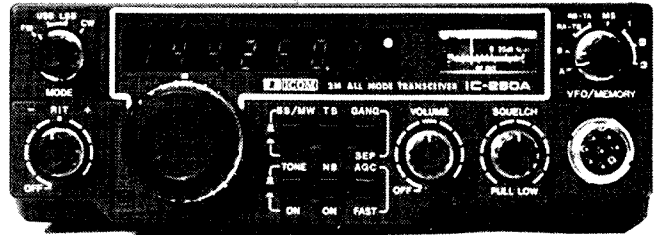

## SPECIFICATIONS

### GENERAL

Numbers of semi-conductors	: Transistor	72		
	: FET	9		
	: IC	45 (IC-260A : 44)		
	: Diode	91 (IC-260A : 90)		
Frequency coverage	: 144.0000 ~ 145.9999 MHz (IC-260A : 143.8000 ~ 148.1999 MHz)			
Frequency resolution	: SSB — 100 Hz steps; FM — 5 kHz steps; 1 kHz steps with TS button depressed			
Frequency control	: Microcomputer based 100 Hz step Digital PLL synthesizer Independent Transmit-Receive Frequency Capability			
Frequency readout	: 7 digit LED 100 Hz readout			
Frequency stability	: Within $\pm 1.5$ kHz			
Memory channels	: 3 channels, any inband frequency programmable			
Usable conditions	: Temperature: $-10^{\circ}\text{C} \sim 60^{\circ}\text{C}$ ( $14^{\circ}\text{F} \sim 140^{\circ}\text{F}$ )		Operational time: Continuous	
Antenna impedance	: 50 ohms unbalanced			
Power supply requirement	: 13.8V DC $\pm 15\%$ (negative ground) 3.5A Max.			
Current drain (at 13.8V DC)	: Transmitting		Receiving	
	: SSB (PEP 10W)	Approx. 2.2A	: At max. audio output	Approx. 0.8A
	: CW, FM (10W)	Approx. 3.1A	: Squelched	Approx. 0.6A
	: FM (1W)	Approx. 1.6A		
Dimensions	: 64 mm (H) x 185 mm (W) x 223 mm (D)			
Weight	: Approx. 2.7 kg			

### TRANSMITTER

Output power	: SSB — High 10 W (PEP), Low 1W (PEP); CW — High 10W, Low 1W FM — High 10W, Low 1W
Emission mode	: SSB — (A3J, USB/LSB); CW — (A1); FM — (F3)
Modulation system	: SSB — Balanced modulation; FM — Variable reactance frequency modulation
Max. frequency deviation	: $\pm 5$ kHz
Spurious emission	: More than 60 dB below peak power output
Carrier suppression	: More than 40 dB below peak power output
Unwanted sideband	: More than 40 dB down at 1000 Hz AF input
Microphone	: 1.3K ohm dynamic microphone with built-in preamplifier and push-to-talk switch
Operating mode	: Simplex, Duplex (Any inband frequency separation programmable)
Tone burst	: 1750 Hz $\pm 0.1$ Hz (IC-260A: Not installed)

### RECEIVER

Receiving system	: SSB, CW — Single conversion superheterodyne FM — Double conversion superheterodyne
Receiving mode	: SSB — (A3J, USB/LSB); CW — (A1); FM — (F3)
Intermediate frequency	: SSB, CW — 10.75 MHz; FM — 10.75 MHz, 455 kHz
Sensitivity	: SSB, CW — Less than 0.5 microvolts for 10 dB S + N/N FM — More than 30 dB S + N + D/N + D at 1 microvolt Less than 0.6 microvolts for 20 dB noise quieting
Squelch sensitivity	: Less than 0.4 microvolts
Spurious response rejection ratio	: More than 60 dB
Selectivity	: SSB, CW — More than $\pm 1.2$ kHz at $-6$ dB point; less than $\pm 2.4$ kHz at $-60$ dB point FM — More than $\pm 7.5$ kHz at $-6$ dB point; less than $\pm 15$ kHz at $-60$ dB point
Audio output power	: More than 2W
Audio output impedance	: 8 ohms

# IC-260A/E

## SCHEMATIC DIAGRAM

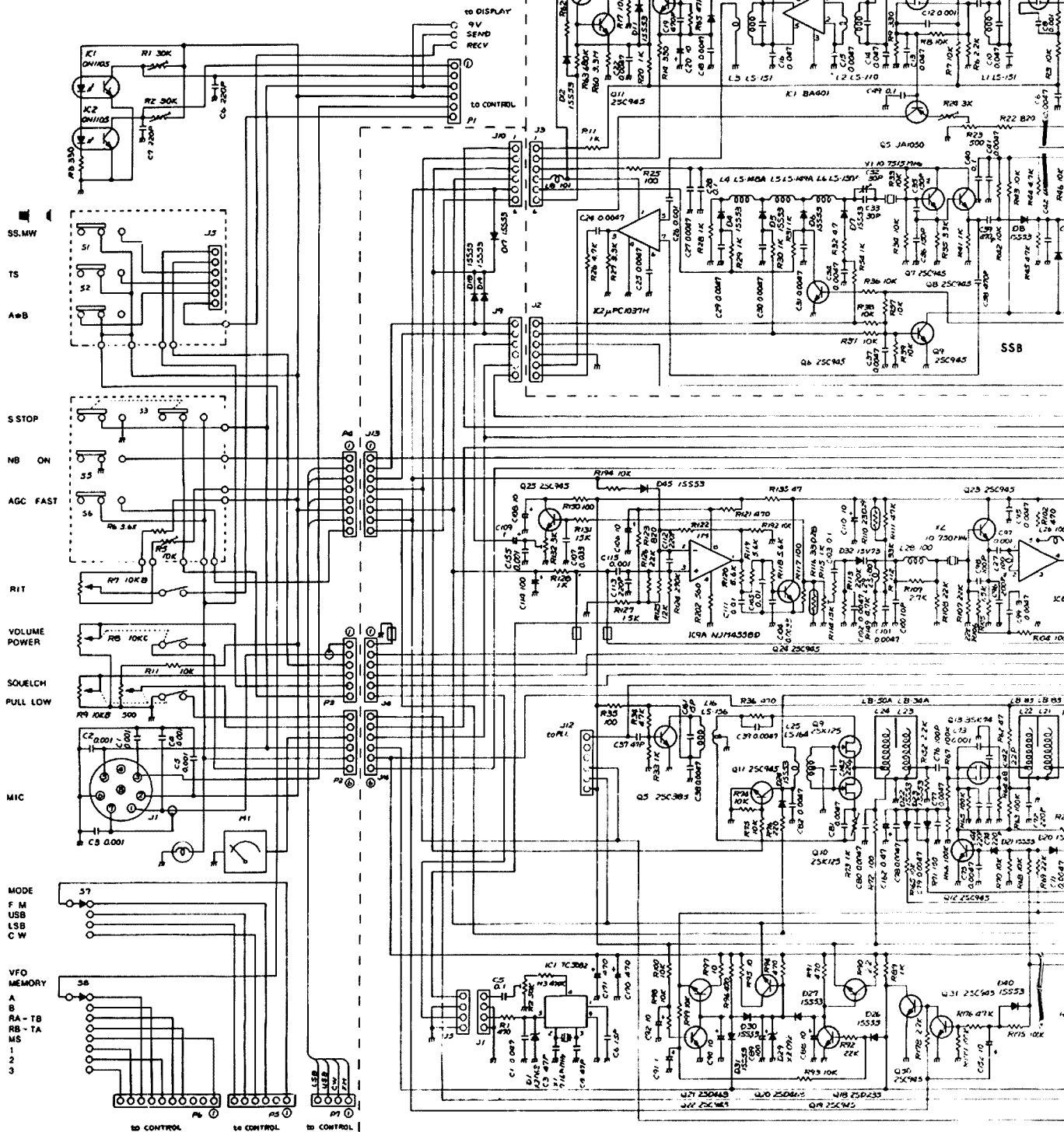



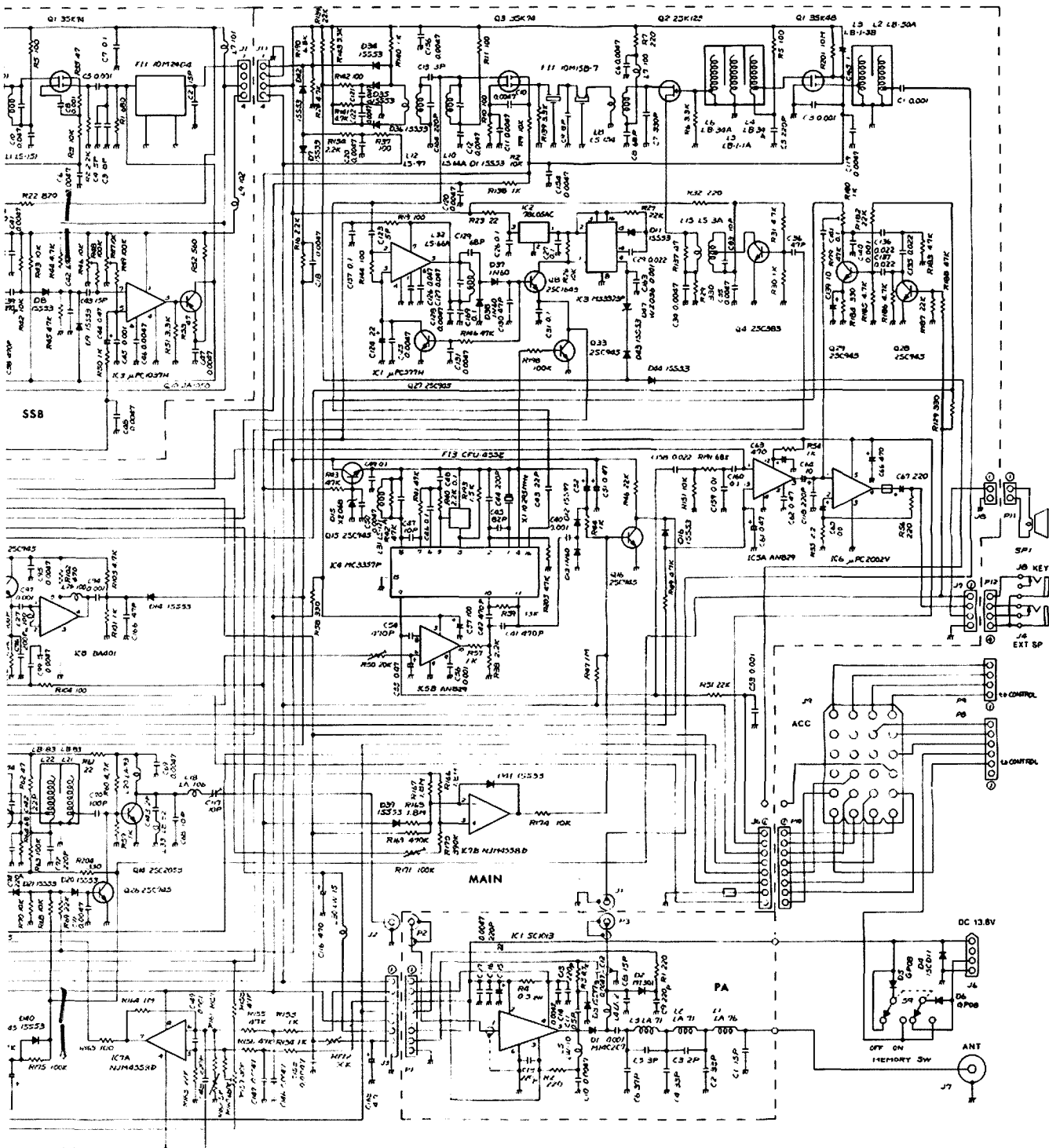

**ICOM** ICOM INCORPORATED

Some components subject to change for an improvement without notice.

A-0239

## FRONT PANEL

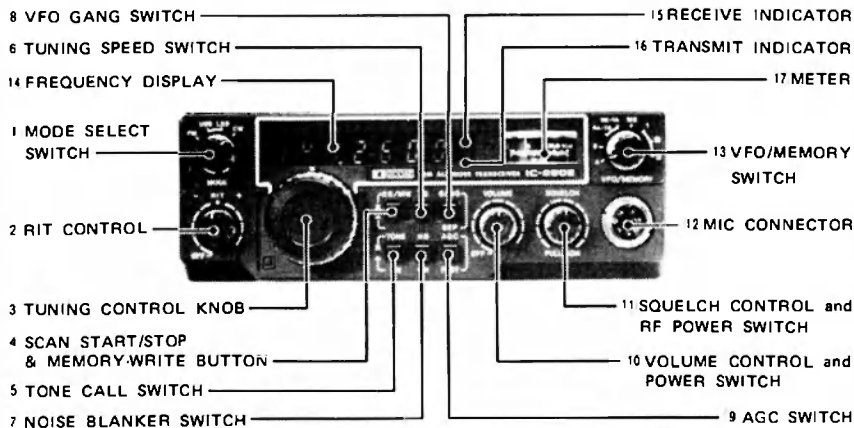
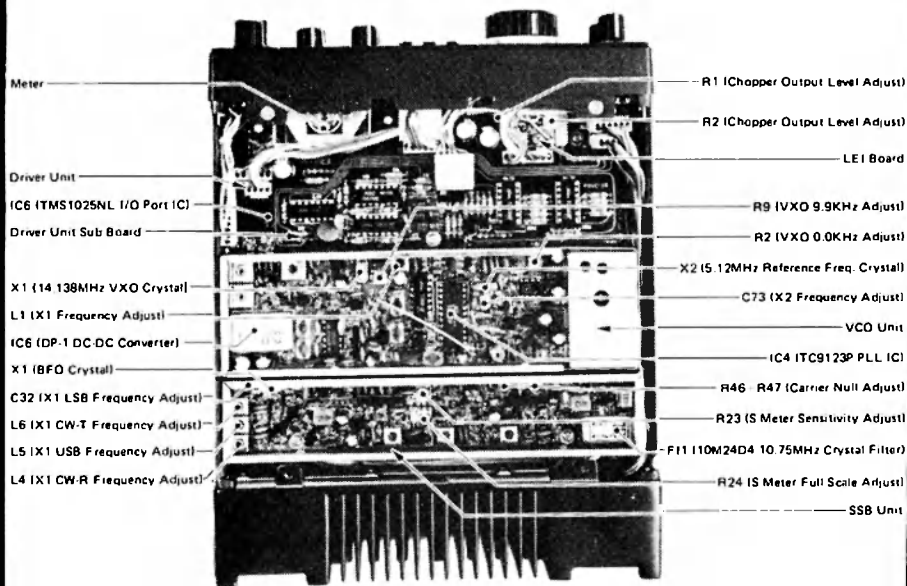
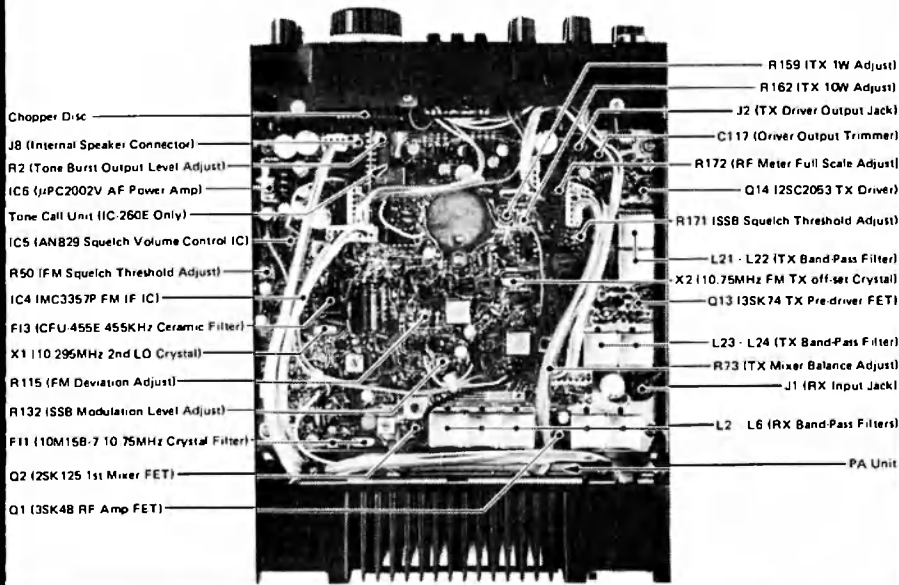

PHOTO 2: Control functions on the IC260A/E



Above and below: Inside the IC260A/E.



Most of the functional controls illustrated on the IC260A/E are self-explanatory but other points are interesting to note. The RIT (Receiver Incremental Tuning) shifts the receive frequency plus or minus 800 Hz of the transmit frequency without altering the display frequency. By pushing the SS/MW button frequencies may be pre-programmed into the three available memory channels and a programmed scan or memory scan commenced. The dual VFO feature allows two independent VFOs to operate or both A and B to operate together with the second VFO following the selected VFO at the same frequency difference initially set up.

In addition when the VFO is switched from one VFO to the other VFO, the frequency indicated on the frequency display just prior to switching goes into a memory inside the CPU. Thus even if "B" VFO is being used, switching to "A" again will enable you to operate at the initial "A" frequency. Switching back from "A" to "B" results in the same operation.

The numbers on the S-meter represent S1 through to S9 and 20 and 60 dB over S9. The RF output level meter functions as a relative output meter and does not indicate the wattage.

When the memory switch is in the ON (up) position, the power to the CPU of the IC260A/E is supplied continuously, even when the POWER switch on the front panel is switched OFF, to retain all the programmed frequencies in the memory channels, the operating frequencies of the two VFOs, etc. When the switch is set at the OFF (down) position, all the power, including that to the CPU, is turned OFF by turning OFF the POWER switch, so that all the programmed frequencies in the memory channels, the operating frequencies of the two VFOs, etc., are erased.

For further information on the Vicom IC260A/E contact the Australian distributors, Icom International, 68 Eastern Road, South Melbourne 3205. Ph. (03) 699 6700. Our thanks to Vicom for the supplied information on the IC260A/E.

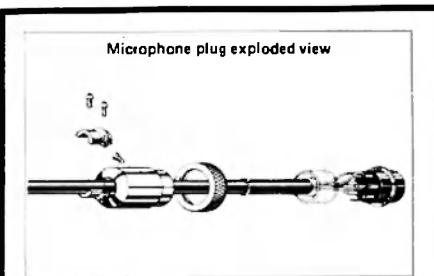
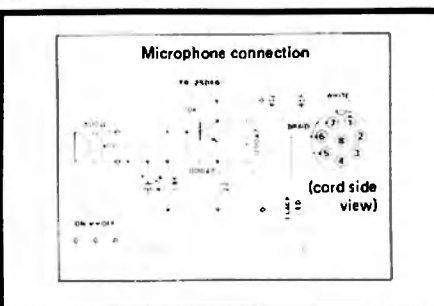

FIG. 1 (above) offers an exploded view of the microphone while FIG. 2 (below) shows actual mic. connections.



Collectors' Corner is aimed at giving you, the reader, a better understanding of the types of equipment available for various applications in Amateur Radio. Your suggestions and comments regarding content in this section would be appreciated to ensure widespread reader appeal.

# HANDY 2M FM/SSB MOBILE!



# ICOM

## IC260A



### FEATURES

- **2m ALL-MODE TRANSCEIVER INCORPORATING A MICROCOMPUTER**

CPU control with ICOM's original programs provides various operating capabilities. No back-lash dial controlled by ICOM's unique photo-copper circuit. Band-edge Detector and Endless System provides out-of-band protection. No variable capacitors or dial gear, giving problem-free use. The IC-260A provides FM, USB, LSB, CW coverage in the 143.8 — 148.2MHz frequency range. Thus the IC-260A can be used for mobile, DX, local calls, and satellite work.

- **MULTI-PURPOSE SCANNING**

Memory Scan allows you to monitor three different memory channels. Program Scan provides scanning between two programmed frequencies. Adjustable scanning speed. Auto-stop stops scanning when a signal is received, in all modes.

- **DUAL VFO'S**

Two separate VFO's can be used either independently or together for simplex operation, and any desired frequency split in duplex operation.

- **CONTINUOUS TUNING SYSTEM**

ICOM's new continuous tuning system features an LED that follows the tuning knob movement and provides an extremely accurate readout. Frequencies are displayed in 7 LED digits representing 100Hz digits.

Automatic recycling restarts tuning at the top of the band, i.e., 145.999.9MHz when the dial goes below 144.000.0MHz. Recycling changes 148.199MHz to 143.800.0MHz as well. Quick tuning is 1KHz steps is available, and fine tuning in 100Hz steps in the SSB and CW modes, and 5KHz steps and 1KHz steps in the FM mode, is provided for trouble free QSO.

- **OUTSTANDING PERFORMANCE**

The RF amplifier and first mixer circuits using MOS FETs, and other circuits provide excellent Cross Modulation and Two-Signal Selectivity characteristics. The IC-260A has excellent sensitivity demanded especially for mobile operation, high stability, and with Crystal Filters having high shape factors, exceptional selectivity.

The transmitter uses a balanced mixer in a single conversion system, a band-pass filter and a high-performance low-pass filter. This system provides distortion-free signals with a minimum spurious radiation level.

- **ADDITIONAL CIRCUITS**

The IC-260A has a built-in Noise Blanker, CW Break-in, CW Monitor, APC, and many other circuits for your convenience. The IC-260A has everything you need to really enjoy VHF operation, in an extremely compact, rugged transceiver. Comes complete with mic, mobile mounting bracket and English manual.

- **BACKED BY VICOM**

90 day warranty and technical/spares support.

### Typical Characteristics (Australian model)

**GENERAL.** Number of semi-conductors Transistor 72, FET 9, IC 44, Diode 90  
 Frequency coverage 143.8000 — 148.1999MHz Frequency resolution: SSB 100Hz steps FM 5KHz steps 1KHz steps with TS button depressed. Frequency Control Microcomputer based 100Hz step Digital PLL synthesiser Independent Transmit/Receive Frequency Capability Frequency Readout 7 digit LED 100Hz readout Frequency programmable Usable conditions Temperature -10 C — 60 C (14 F — 140 F) Operable time Continuous Antenna impedance 50 ohms unbalanced Power supply supplement 13.8V DC ±15% (negative ground) 3.5A Max Current drain (at 13.8V DC) Transmitting SSB (PEP 10W) Approx 2.2A CW, FM (10W Approx 3.1A FM (1W) Approx 1.6A Receiving At max audio output Approx 0.8A Squelched Approx 0.6A Dimensions 64mm (H) x 185mm (W) x 223mm (D) Weight Approx 2.7Kgs Warranty 90 days when purchased from authorised dealers. **TRANSMITTER** Output power SSB High 10W (PEP) Low 1W (PEP) CW High 10W Low 1W FM High 10W Low 1W Emission mode SSB (A3J, USB/LSB), CW (A1), FM (F3) Modulation system SSB Balanced modulation FM Variable reactance frequency modulation Max frequency deviation ±5KHz Spurious emission More than 60dB below peak power output Carrier Suppression More than 40dB below peak power output Unwanted Sideband More than 40dB down at 1000Hz AF input Microphone 1.3K ohm dynamic microphone with built-in preamplifier and push-to-talk switch Operating mode Simplex, Duplex (Anyband frequency separation programmable) **RECEIVER.** Receiving system SSB, CW Single conversion superheterodyne FM Double conversion superheterodyne Receiving Mode SSB (A3J, USB/LSB), CW (A1), FM (F3) Immediate Frequency SSB, CW 10.75 MHz FM 10.75MHz, 455KHz Sensitivity SSB, CW Less than 0.5 microvolts for 10dB S+N+D/N+D at 1 microvolt Less than 0.6 microvolts for 20dB Noise queuing Squelch sensitivity Less than 0.4 microvolts Spurious response rejection ratio More than 60dB Selectivity SSB, CW More than ±1.2KHz at -6dB point Less than ±2.4KHz at -60dB point FM More than ±7.5KHz at -6dB point Audio output power More than 2W Audio output impedance 8 ohms



THE ATTRACTIVE FRONT PANEL

# VICOM

Vicom International Pty. Ltd.

68 Eastern Road  
 South Melbourne  
 Victoria 3205  
 Phone (03) 699 6700

339 Pacific Highway,  
 Crows Nest, N.S.W. 2065  
 Phone (02) 436 2766

Melbourne 8368635  
 Perth 321 7609-4463232  
 Hobart 281500  
 Adelaide 43 7981-2728417  
 Gold Coast 322644  
 Wellington (NZ) 69 7625

Cairns 54 1035  
 Launceston 44 3882  
 Brisbane 341 5377-38 4400

# AMATEUR SATELLITES

Charlie Robinson VK3ACR

## OSCAR 7

The old girl is still chugging along, from the strength of the signals received from the 435.1 MHz beacon (when on Mode A) and the excellent signals when in Mode B, it would appear that it is still going to perform for some time. Although it has been reported that a cell in the battery system has failed and it is in its sixth year, it seems it cannot be deterred.

It has previously been reported that now Oscar 7 is out of the shaded area, that it will no longer be in Mode B continuously but will revert to Mode A on odd days and Mode B on even days.

This did occur late in August but recently it has been noticed that it is not holding true to this procedure.

For the last month Oscar 7 has been favouring Mode A, e.g., one night it may be on Mode B and then the next two nights it is on Mode A, so suggest that we monitor the 435.1 MHz beacon when we do not hear Mode B come up on schedule just to check if it is on Mode A.

However, to help preserve the old girl please keep you up-link ERP at a reasonable level. Let's keep it operating.

## OSCAR 8

Is operating normally.

The latest orbital calendars for Oscar 7 and 8 are available for a business size No. 10 SASE from —

Project Oscar,  
P.O. Box 1136  
Los Altos, Ca. 94022 U.S.A.

## PHASE III B

Preparations are moving forward on the Phase III B project, and inventory of parts, etc., to see what is on hand is taking place.

It is hoped that information more positive will come out of a meeting that was held last month (Aug.). It is also indicated that, although no definite launch opportunities have been defined, there is a strong indication we may be able to get a ride on ESA LO11 around February 1982, but again this is not definite.

There may be other military launches available, we just don't know; every possible effort is being looked into. And whilst on Phase III B, information from a recent Mode J Newsletter indicates that at Cape Kennedy a programme is under way to build the launch pad to accommodate a new improved Delta launch vehicle, that includes a 4 stage. This will no doubt launch a heavy payload. If this happens maybe the amateur space programme would benefit by having additional launch opportunities and possibly at an earlier date. It is understood this is being done because industrial customers want to get their hardware in orbit and find it cheaper to go with a 4 Stage Delta than waiting on shuttle which has had many many delays — maybe we can get aboard.

## OVERSEAS SNIPPETS

Sources report the West German Government has given reasonable assurance to AMSAT Deutschland of financial support for upcoming Phase III B project.

This is fantastic news for the amateur space programme.

AMSAT has received word of co-operation and support of CNES (French equal to NASA). FBZS, inspector-general of CNES, has assured AMSAT of maximum support through ESA.

Another Oscar???? Yes, this is not an amateur satellite in any fashion.

The name Oscar is for a new military programme — OPTICAL SUBMARINE COMMUNICATION by AEROSPACE RELAY, for communication with submarines. AMSAT legal beagles are investigating the

name OSCAR (ours) is protected by copyright. It appears not. We'll see!

Congratulations to Alan VK2RX on his successful night at the Wagga Radio Club. We feel sure that the boys in that Club will benefit a great deal from his informative lecture on amateur satellites and from what I have heard, Alan's lecture dealt with the fundamentals, predictions, acquisition times and how to find them, etc. The interest must have been very rewarding for I understand it was a three and a half hour session.

Thanks, Alan — who knows we may hear a signal through Oscar 7 or 8 from the Wagga area in the very near future. We hope so.

Andy VK3YQX reports that FK8AK has been active on Oscar 8, Mode A, having worked Ed VK2ADJ and a number of ZLs.

One of the most consistent signals on Oscar 7 and 8 is our good friend Frank VK2ZI at Broken Hill. Frank has acquired an electronic talking clock. It sounds really fine — would he be operating in opposition to WWW ???

The Twelfth AMSAT Annual Meeting was held on September 13th, 1980, at the NASA Goddard Space Flight Centre, Maryland, USA. In accordance with the by-laws a ballot for the election of four Directors and two alternative Directors was counted and the successful candidates are as follows:—

1. Tom Clark W3IW
2. Pat Gowen G3IOR
3. Harry Yoneda JA1ANG
4. Rich Zwirko K1HTV
5. John Henry VE2QVO
6. Bill Tynan W3XO

The Australian AMSAT Net is held on the third Sunday in each month at 1000Z on 7065 kHz ± QRM.

Anyone who is interested in amateur satellites is invited to participate. ■

# The Unusual Dangers and Hazards of Radio

Anonymous

I recently acquired a shiny new beam for my tower (I am a radio amateur) and in my haste to erect it and to work the world, I devised a new, improved method of installation.

First, I assembled the beam completely on the ground and then, at the top of the tower, I added a pulley through which I threaded a rope. After meticulous calculations, I estimated that a plastic rubbish bin, if filled with water, would counter-balance my own slight weight and the weight of the beam. To make sure, I added a couple of house bricks to the bin.

Next I tied the rope to the plastic bin half filled it with water, pulled it to the top of the tower and tied the rope to the beam and to the bottom rail of the tower. I then climbed the tower, with the hose, and filled the bin completely.

I descended, stood astride the boom and released the hitch on the tower. The ascent was rather faster than anticipated (it turned out that the bin was oversize). As I rose, I was unable to avoid the descending bin and received a severe blow on the right shoulder, with minor abrasions to the neck and upper arm. Unfortunately, I reached the

top of the tower so quickly that my fingers were drawn into the pulley, resulting in contusions and multiple lacerations. However, I remained calm and continued to hold the rope with both hands.

At that point, the bin hit the ground and split. As the bin emptied, it no longer counterbalanced. My weight and that of the beam, so that I began to descend rapidly. I caught a glancing blow on my left buttock from one of the tower stays and was thrown into the path of the ascending bin, which bruised my right buttock and removed skin from my right leg. I was stopped by falling astride one of the lower tower spreaders and doubled up with the pain which naturally followed. In doing so, my forehead hit the corner of the tower.

At this stage I must have been no longer calm, for it seems that I completely parted company with the beam. With my weight removed, the bin was free to descend and, as it did so, it was upturned by the beam so that the bricks and the remaining water were jettisoned upon my unprotected head.

As I lost consciousness, I was severely bruised by the beam, which now weighed less than the empty bin and so fell back upon me. At least that is how my XYL found me ten minutes later. ■

# QSP

## MODEL CONTROL LICENCES

According to Radio Comm. September 1980 it has been announced in the UK that users of model control equipment, metal detectors and pipe-finders will shortly be freed from the need to have their equipment licensed. There were about 93,000 model control licences in force and about 150,000 licences for metal detector equipment. ■

## USA CHANGES

July 1980 QST contains a note that the FCC has decided to permit standard bandwidth FM, 16F3, from 50.1 to 54 MHz. The present rules allow this only from 52.5 to 54 MHz. Also, ARRL will be petitioning FCC for more amateur privileges on the 160 metre band now that LORN-A on that band is being phased out. ■

## SEANET CONVENTION 1980

A letter from the Philippine Amateur Radio Association Inc. advises that this year the annual Seanet Convention will be held in Manila 27th to 29th November. For information and reservations write to Box 445, Greenhills PO, Metro Manila, Philippines 3113. The daily Seanet is at 1200Z on 14320 MHz. A special prefix call 4D1SEA will be in operation during the Seanet Convention. PARR also draws attention to their UN-DU Award. ■

# THE VK3BWW FORMULA FOR DX SUCCESS!!

## HIGH QUALITY AT LOW COST

### BEAMS

3 EL 10 & 11m .....	\$66.00
3 EL 15m .....	\$73.00
3 EL 20m .....	\$145.00
6 EL 6m .....	\$102.00

### DUOBANDER

3 EL 10m, 3 EL 15m \$135.00

Prices include Gamma match

Our beams are easy to assemble and adjust. Entirely **NEW CONCEPT** — **NO NUTS OR BOLTS.**

Spare parts, elements, booms and gamma matches available.

Add \$3.00 for Pack + Freight

For further information

PLEASE RING (03) 366 7042

**VK3BWW**

**WERNER & G. WULF**

92 LEONARD AVENUE  
ST. ALBANS, VICTORIA 3021

The Australian Radio DX Club has published an Australian Utility Radio Handbook with information of stations that transmit from within Australia. The price of this guide is \$10 and can be ordered from the Club Publications Secretary at PO Box 300, Blackburn, Vic. 3130.

ARDXC has also published many other guides and information to aid the SWL DXer. I recommend that you enquire about these and details about the Club by writing to it at PO Box 227, Box Hill, Vic. 3128, and enclosing a 50c stamp to defray postage. They publish an excellent monthly bulletin — the Australian DX News. It contains a wealth of information for the serious and casual DXer. The Club also conducts a weekly net on Tuesdays at 1200 GMT on 3545 kHz ± QRM; net control is Rob Wagner VK3BVW. Thanks to Rob Williams for supplying details of ARDXC.

At the time of writing, the Iranian-Iraqi conflict is in full swing. The two protagonists are engaged in a full scale war of hyperbole on the airwaves. Teheran can be heard very loudly during daylight hours here on 15084 kHz broadcasting in Farsi, the language of Iran. Its modulation is distorted very heavily most times. However, Baghdad is a little more difficult to receive. I believe it has been heard running in English on 11945 kHz at 2200Z repeated to North America at 0300Z on the same channel.

Well, until next month, 73s from Robin L. Harwood. ■

Charlene are the regulations and theory segments — and she is confident about these. She is studying with Ted Radclyffe's (VK1TR) Novice class and is also receiving very valuable help from Dad — and from Mum (who may be the next candidate!). There's every chance that Charley VK1N?? will be on the air in January 1981.

On the subject of classes, we shall soon be planning our programme for next year. Any would-be amateur thinking about the 1981 exams and who may be interested in enrolling on one of our courses is invited to get in touch with the Division at our PO Box. As before, we shall be running classes for Novice and for full AACP.

### RTTY

In order to expose members to this mode and give them a chance to set up and tune their equipment, a number of local VK1s operated on the mode after the usual Sunday evening broadcast on 21st September. The tests conducted used AFSK — 170 Hz shift — with BAUDOT and ACSII codes. These Sunday transmissions will hopefully be a regular feature. ■

## VK2 MINI BULLETIN

Divisional Council is looking into the feasibility of conducting the Sunday morning broadcasts from Dural. Any decision would be subject to the availability of operators prepared to travel to Dural. Any member who would like to volunteer, either as an announcer or engineer, please write to the Divisional Secretary, Box 123, St. Leonards 2065. Volunteers are also welcome for the broadcasts from Atchison Street.

The Amateur Advisory Committee has recently been re-formed in NSW. This is essentially a "buffer" committee which makes recommendations to the P. and T. Department. P. and T. then issues cautionary notices to amateurs for minor infringements of a technical or regulatory nature.

Clubs cannot be members of the NSW Division, only affiliates. Those clubs which are currently members will not be receiving renewal notices for membership at the end of this year. Affiliated clubs may purchase "Amateur Radio" for club libraries by applying to the Divisional Secretary, the charge being the same for an ordinary member, that is \$22 for 1980. Twenty-six clubs are affiliated with the NSW Division as at 1-10-80.

Avondale ARC, Avondale College, Coorabong 2265.  
Bathurst ARC, Box 343, Bathurst 2795.  
Central Coast ARC, Box 238, Gosford 2250.  
Coffs Harbour ADARC, Box 655, C. Harbour 2450.  
Goulburn ARC, 40 Hume Street, Goulburn 2580.  
Griffith RC, Box 4, Griffith 2680.  
Gunnedah ARC, Gunnedah HS, Gunnedah 2380.  
Hornsby ADARC, Box 362, Hornsby 2077.  
Illawarra ARS, Box 1838, Wollongong 2500.

## SPOTLIGHT ON SWLing

Robin Harwood VK7RH

5 Helen St., Launceston, Tasmania 7250



When listening across the various wavebands, eventually you will hear stations communicating among themselves in a variety of modes. Perhaps an Intercontinental jet winging its way across the vast expanses of the ocean. Or small fishing trawlers exchanging information on weather and yields, etc. Or stations transmitting navigation and meteorological bulletins for aeronautical and maritime facilities. These stations are grouped together as Utilities. As can be gathered, these broadcasts are not designed for general public consumption, and the contents of their traffic are therefore protected by secrecy by International Treaty. It is an offence for any individual to disclose any messages or traffic he may monitor.

## CHANGE OF ADDRESS

\*

If you have changed your address or if you intend shortly to change address —

PLEASE

Notify the Executive Office as early as possible:

Do not leave this to be done when you pay your subscription at the end of the year.

EXECUTIVE OFFICE

P.O. Box 150, Toorak, Vic. 3142

## FORWARD BIAS

### VK1 DIVISION

(Postal Address: WIA (ACT Division) Inc.,  
PO Box 46, Canberra, 2600 ACT)

### OUR CONTENDER FOR YOUNGEST AMATEUR

Eleven-year-old Charlene Dwyer, daughter of Reg VK1BR, has passed the CW part of her Novice exam. Coming up next for

Liverpool ADARC, 105 Willan Drive, Cartwright 2168.

Manly Warringah DRC, Box 186, Brookvale 2100.

North West ARG, "Oringle", Orange Gr. Road, Gunnedah 2380.

Novice ARG, Box 415, Lane Cove 2066.

Orange ARC, Box 1065, Orange 2800.

OTC(S) ARG, Box 321, Maroubra 2035.

Oxley RARC, Box 712, Port Macquarie 2444.

Parkes ADARC, 247 Clarinda Street, Parkes 2870.

Penrith ARC, 81 Newham Drive, Cambridge Park 2750.

South West ARS, Box 1016, Griffith 2680.

Southern Highlands ARS, Telephone Exchange, Bowral 2576.

Summerland ARC, Box 524, Lismore 2480.

St. George ARS, Box 77, Penshurst 2222.

Taree ARC, Box 712, Taree 2430.

Tumut ADARC, 15 Broughton Street, Tumut 2720.

Wagga ARC, Box 71, Koorinal 2650.

Westlakes RC, Box 1, Teralba 2284.

In each edition of AR, details of several affiliated clubs will be published. This month, Summerland, Central Coast and Liverpool.

#### SUMMERLAND AMATEUR RADIO CLUB

**Nets:** Fridays 8 p.m. on 28.54 MHz and repeater channel 6800 using **VK2AGH**.

**President:** G. Douse **VK2AGE**; **Secretary,** D. Raymont **VK2DLR**; **Other Committee,** J. Wicks **VK2DAW**, A. Webb **VK2UC**, A. Chappie **VK2BEV**, R. Virtue **VK2VSW**.

**Repeater:** **VK2RIC**, channel 6800 (4), Lismore.

#### CENTRAL COAST AMATEUR RADIO CLUB

**Net:** Tuesdays 8 p.m. on 3565 kHz using **VK2AFY/P**.

**Meetings:** 8 p.m. 1st and 3rd Fridays, Dandaloo Street, Kariong.

**Classes:** 7.30 p.m. Wednesdays at both Dandaloo Street, Kariong, and Wyong High School, Wyong.

**President:** R. Wells **VK2BVO**; **Vice-President,** J. Pogson **VK2DBC**; **Secretary,** S. Wells; **Other Committee,** L. LeBreton **VK2AKT**, S. Dogger **VK2ZRD/VFV**, L. McNab **VK2DDM**, K. Lidden **VK2YAY**.

**Field Day:** February at Gosford Showground.

**Repeaters:** VHF **VK2 RAG**, channel 6750 (3). UHF **VK2RUG**, channel 4650 — to be changed subject to P. and T. approval to 8075 (438.075 MHz output-435.075 MHz input). Both repeaters at Somersby (near Gosword), 340m above sea level.

**Newsletter:** "Smoke Signals" published monthly.

#### LIVERPOOL AND DISTRICT AMATEUR RADIO CLUB

**Nets:** Sundays 9.30 a.m. on 3580 kHz using **VK2AZD/P**. Mondays 8.30 p.m. on 146.55 MHz using **VK2AZD/P**.

**Meetings:** 7.30 p.m. 2nd Tuesdays, Liverpool Public School, Bigge Street, Liverpool.

**Classes:** 7 p.m. Tuesdays (other than meetings nights), at Liverpool Public School. **AACP** and **NAACP**.

**President:** V. Rochfort **VK2BVR**; **Vice-President,** L. Anderson **VK2VCF/YOU**; **Secretary,** S. Samuel **VK2VVK**; **Other Committee,** J. Dufield **VK2NOD/YRY**, J. Pages **VK2BYY**, P. Johnstone **VK2VXA**.

**Foxhunts:** 4th Wednesdays 7.30 p.m. on 28.3 and 146 MHz, both DF, from Liverpool Swimming Pool, Memorial Drive, Liverpool.

**Field Day:** March.

**Newsletter:** "Bullsheat", available monthly at club meetings.

#### RETIREMENT OF CEC BARDWELL

In 1960 Cec Bardwell **VK2IR**, a life member of the Institute, took over the NSW Division's personal lecture classes for the **AACP** at the request of the late W. Lewis **VK2YB**. Cec conducted both CW and theory classes initially, as well as developing the NSW **WIA** Correspondence Course. At a conservative estimate, over 400 amateurs have achieved their licences as a result of Cec's personal lecture classes. Even large numbers have been involved in his correspondence course world-wide.

In December this year, after twenty years of continuous evening lecture classes, Cec is retiring from lecturing. He has devoted an enormous amount of his time to the classes. He will continue with supervision of the correspondence course.

Cec's services have been of inestimable benefit to the Division and amateur radio generally, both in the number of amateurs he has trained and financially. The grateful thanks of Council and members go to Cec and his wife on his retirement. Cec's final lecture will be on Thursday, 11th December, at Atchison Street, Crows Nest. (Advice of next year's **WIA** personal lecture classes will be given at a later date.)

#### MORSE SERVICE

The NSW Division conducts a slow morse service every night of the week on 3550 kHz commencing at **0930Z**. The station conducting the transmission varies each night of the week, but always signs **VK2BW1/VK . . . QTH**. Below is a list of the volunteers currently participating.

**Monday:** Don **VK3AKN**, Hawkesdale/Vic., 120W dipole.

**Tuesday:** Simon **VK2ADS**, Tambar Springs (near Glen Innes), 120W dipole.

**Wednesday:** Ken **VK2BKE**, Lord Howe Island, 120W dipole.

**Thursday:** Lloyd **VK2BLK**, Oatley (20 km SW of Sydney), 120W dipole.

**Friday:** Mark **VK2DI**, Mt. Colah (25 km N of Sydney), 120W dipole.

**Saturday:** Sue **VK2DKU**, Gundaroo (north of Canberra), 120W dipole.

**Sunday:** Dave **VK2NAW**, Golspie (near Goulburn), 10W dipole.

Speed and form of practice vary from operator to operator. Generally however speeds range from approximately 5 to 14

words per minute, except for Friday night, which is 5 to 20 words per minute. The broadcast finishes at **1030Z**, when **VK5** takes over on 3550 kHz for a further hour of CW practice. Most users of this service are beginners in amateur radio and may not possess a super selective "state of the art" receiver. Please give the frequency a wide berth—remember, we all were learners once. Those of you who have used or are using the service might like to drop a note of thanks either direct to the operators or to the Morse Supervisor (Mark Salmon **VK2DI**), Box 123, St. Leonards 2065.

#### COMING EVENTS

**Sunday, 16th November:**

Blue Mountains Field Day. Write to Box 54 Springwood 2777, for a programme.

**Saturday, 29th November:**

Grand Divisional Auction at 14 Atchison Street, Crows Nest, 2 p.m. sharp. Lots of goodies!

News for inclusion in Divisional Notes must normally reach Box 123, St. Leonards 2065, by the 1st of the month prior to publication. To facilitate the early printing of December and January AR, copy must be at the above address for inclusion in this column by November 3 (December issue) and November 17 (January issue).

#### THIRD PARTY TRAFFIC

After discussions with local P. and T. Officers, Divisional Council cautions members against actively soliciting Third Party Traffic. The necessary changes to regulations have not yet been made. ■

*A Call to all holders of a*

## **'NOVICE LICENCE**

Now you have joined the ranks of Amateur Radio, why not extend your activities?

### **THE WIRELESS INSTITUTE OF AUSTRALIA (N.S.W. DIVISION)**

conducts a Bridging Correspondence Course for the **AACP** and **LAACP** Examinations.

**Throughout the Course, your papers are checked and commented upon to lead you to a SUCCESSFUL CONCLUSION.**

For further details write to:

**THE COURSE SUPERVISOR, W.I.A.**

**P.O. BOX 123, ST. LEONARDS, N.S.W. 2065**

# QRK5

A monthly transmission from the Victorian Division WIA.

Written and co-ordinated by VK3WW, QTHR.

A new procedure for council meetings is being tried out. Basically it requires more reading and writing and a lot less talking.

If successful, council meetings will be shorter and more efficient.

Could we then hope for more candidates for council in 1981?

A major requirement for a nominee will be the ability to read and write in clear unequivocal English and, of course, the willingness to do so.

## WILLY WILLY'S WORDS

It is good to see letters to the Editor discussing the proposal of limited tenure for the Novice licence. I don't intend to take sides in this column, but of course have my own opinion on the subject.

That is the point. Every licensed amateur is entitled to his opinion and to express it.

When writing a case it is good advice to be objective and not emotional, and to read and re-read the other fellow's case and try to understand it. Emotional outbursts—in print or verbally—do nothing but harm the case expressed.

One fact to remember is that all Limited and Novice licence holders owe their existence to the efforts of the WIA.

29th September, 1980.

The Editor,  
Dear Sir,  
It is with some indignation that I write this letter of complaint re the disparaging comments made in your column QRK5 in AR of September 1980.

Having read the column several times, and then allowing myself time to cool down, I offer the suggestion that a better name for the column would be QRK1.

The remarks made about holders of the LAOCP and the NAOCP are, to say the very least, elitist, and in particular, the reference to Novice licensees as "Temporary calls" is offensive.

It has been stated by many that the introduction of the Novice licence gave a shot in the arm to a stagnant amateur radio scene, just as the introduction of the Limited licence gave a boost to VHF usage.

One has only to listen to the Novice sections of the amateur bands to hear them being put to good use, and if they are not used, we will lose them. Perhaps had there been a large number of active Novices to fill up 11m, maybe this band would have still been an amateur allocation.

So what if operating procedure is not always perfect or the jargon in use is not 1920s vintage? The bands are ALIVE and ACTIVE.

Every six months the ranks of the full calls are being swelled by the upgrading of those detested Novices.

It would be appreciated if your columnist got the message to "lay off the Novice".

Yours faithfully, VK3NWO.

The Limited licence was introduced in 1954, at the same time the age limit was lowered from 18 to 16. In 1968 the morse speed was lowered from 14 w.p.m. to 10 w.p.m. Recently after introduction of the Novice licence all theory exams have been presented in multi-choice format.

All this has been achieved by the efforts of the WIA. It is reasonable then to expect all licensees to be members of the organisation that has made their existence possible.

I know you, dear reader, are a member, so try the above information on any non-members—you know it might just help them decide to join the WIA.

## FROM CLUBLAND

Did you read the QSP in the September issue of AR? Briefly—78 per cent of the membership of the EMDRC are members of the WIA. This is a commendable achievement and should kill the unjustified rumour that this club is anti-WIA.

What about Victoria's other clubs? Can any better this figure?

## "GWEN MEREDITH RETURNS"

Lives there a Melbourne 2m FM listener who has never heard of the "BLUE HILLS POWER SUPPLY"??? The concluding chapters of this epic saga are being written and will appear in "AR" in the near future, complete with absolutely superlative pictorials (no not of Gwen Meredith). In the true tradition of all great productions I understand a shortened article was published by a club in a small town a little north of Melbourne, where it was well received.

For younger readers information, "Blue Hills" was a radio serial running for many thousands of episodes, written by Gwen Meredith and broadcast by the ABC.

## LIBRARY NEWS

In addition to the manuals mentioned last month, your library contains a lot of reference texts on solid state devices, valves and other components. A visit any weekday between 10 a.m. and 3 p.m. or on monthly meeting nights will reveal a wealth of reading material from the latest overseas magazines back to the 1929 Admiralty Handbook. Whatever your particular interest there is something for you.

We are trying to complete sets of more recent magazines and would appreciate

donations of any of the following:—

CQ: February-June inclusive, 1977.

Ham Radio: January-June Inclusive, 1976; January-December inclusive, 1977; January-June inclusive, 1978.

Radio Communications: November, December, 1978; August, 1979.

73: January-August inclusive, 1978.

Donations will be acknowledged in this column. Please forward to—

Librarian,  
WIA, Victorian Division,  
412 Brunswick Street, Fitzroy.

## QUESTION TIME

This month nostalgia corner—

Do you remember the series tuned 807 on 2 metres?

What was a UM2?

Have you used a D104?

Could you make a Windom in 15 minutes?

If you can answer 3 out of 4 correctly you are an old-timer or a keen student of amateur radio history.

## A NEW AWARD

The QWAFT Award has been printed. Many thanks to Laurie VK3ALB. It is available to all who have had two-way contact with any five THUGS (Thursday Group Socializers). Full details will appear in the awards column. Anxious applicants should contact VK3WW, VK3AZA, VK3JN, VK3ZFA.

## ADVANCE AUSTRALIAN ANTENNAS

Watch for "Lambda M Squared", an anthology of Australian articles about antennas and accessories.

## NOTE:

There is no prize for counting the "As" in the above sentence.

## ZONE VISITS

In recent months our President Allan VK3BBM has visited a number of zones in Victoria, thus providing close personal communication with country members. Thank you, Allan. That's all for now.

73 Mike.

The logo for the QWAFT Award is enclosed in a rectangular border. At the top, there are 11 numbered circles (1-11) containing various symbols: 1 (mug), 2 (mug), 3 (mug), 4 (mug), 5 (mug), 6 (mug), 7 (mug), 8 (mug), 9 (mug), 10 (mug), 11 (mug). The text "QWAFT AWARD" is written in large, bold, black letters across the top. Below it, "THURSDAY" is written in a stylized font. Underneath that, "GROUP SOCIALIZERS" is written in a similar stylized font. In the center, it says "AWARDED TO SAMPLE WHO HAD TWO-WAY CONTACT CONFIRMED WITH ANY FIVE THUGS". Below this, there are three lines of text: "GREEN--OK---THUGGERY", "RED---WACKO---THUGGERY", and "BLUE---U-BEAUT---THUGGERY". At the bottom, there are 11 numbered circles (1-11) containing various symbols: 1 (mug), 2 (mug), 3 (mug), 4 (mug), 5 (mug), 6 (mug), 7 (mug), 8 (mug), 9 (mug), 10 (mug), 11 (mug).

# SIDEBAND ELECTRONICS ENGINEERING

"THE ANTENNA AND ROTATOR SPECIALISTS"

P.O. BOX 23 SPRINGWOOD NSW 2777

WAREHOUSE 213 HAWKESBURY RD. SPRINGWOOD

TELEPHONE (047) 54 1392

"Business again shows an upward trend after a lax period. Our HY-GAIN 14 element and 8 element 2 metre yagis have arrived and cost less than anticipated. New prices for these antennas — 14 el. \$50, 8 el. \$40."

## ANTENNAS

TET HB35C 10-15-20M 5 el log/yagi 13' boom..... \$415  
CUSHCRAFT A3 10-15-20M yagi 14' boom..... \$325

## HY-GAIN

TH3-JR 10-15-20M 3 el yagi 12' boom..... \$250  
DB10-15A 10-15M 3 el yagi 13' boom..... \$190  
153-BA 15M 3 el yagi 12' boom..... \$120  
18-AVT/WBa 10-80M trapped vertical 21'..... \$125  
8 el 2M yagi 14' boom 15db gain..... \$40  
14 el 2M yagi 16' boom 18db gain..... \$50  
GPG-2 2M 5/8W co-linear 3-4db gain..... \$30  
6M and 2M 1/4W whips..... each \$9

## HELICAL MOBILE WHIPS 10-15-20-40-80M

heavy duty de-luxe models w/adj. tip each..... \$25  
As above ANY TWO WHIPS plus mount & spring..... \$60  
As above FIVE WHIPS plus mount & spring..... \$115  
NOVICE PACK 10-15-80M whips plus mount & spring \$80  
GPV-5 2M base co-linear 2 x 5/8W..... \$55  
OSCAR-2D 2M mobile co-linear 2 x 5/8W..... \$35  
BN-86 balun (for beam buyers only)..... \$25  
HI-Q balun 50 ohm 1KW 1:1..... \$15

## HENRY RADIO FAMOUS LINEARS

2KD-5 2KW PEP 80-10M SSB/CW/RTTY/AM..... \$1000  
1KD-5 1200W PEP 80-10M SSB/CW/RTTY/AM... \$800

## KYOKUTO FM-2025A

The very latest 2M FM from KDK 25W  
10 memory channels plus full scanning etc..... \$340

## ACCESSORIES

SWR meter Hansen twin meter 150MHz..... \$35  
SWR meter single meter 150 MHz..... \$25  
ASAHI Chrome bumper mount..... \$8  
Standard bumper mount..... \$5  
Chrome base & spring to suit ASAHI mount..... \$15  
FERGUSON 240V AC transformer 2 x 9V  
secondaries at 3A..... \$8  
DYNASCAN 820 digital capacitance meter..... \$150  
TRIO DM800 grid dip meter..... \$120

## NOVICE SPECIALS — CONVERSION CRYSTALS

SET OF 8 crystals converts 28.480-28.595 in 5KHz steps.  
Clarifier tuning on Tx & Rx plus info to re-activate 24th ch.  
..... \$32

## ROTATORS & CABLES

CDE BT-1A BIG TALK light duty programmable 4 pos. push  
button plus normal operation..... \$110  
KEN KR-400 medium duty..... \$140  
CDE HAM-1V heavy duty..... \$225  
CDE T2X TAIL TWISTER extra heavy duty..... \$300  
KEN KS-065 stay/thrust bearings..... \$30  
8 core rotator cable per metre..... .80c  
RG-58U coax cable per metre..... .50c  
RG8U foam coax cable per metre..... \$1.20

## TRIO-KENWOOD PRODUCTS

Ring for a competitive price on Trio-Kenwood transceivers.  
TS-180S w/WARC frequencies, TS-120S, TS-520SE, TR-  
9000, TR-2400 etc.

TS-130S HF all band WARC transceiver..... POA  
R-1000 Digital clock receiver..... POA  
SP-100 external speaker R-1000..... \$32  
SP-180 ext. speaker TS-180S w/filters..... \$60  
AT-180 200W ant. tuner/SWR/Power..... \$160  
TV-502 2M transverter..... \$250  
TR-7200G 24 ch 2M FM fitted 6 channels..... \$160  
TR-7625 2M FM transceiver..... \$325

## YAESU MUSEN PRODUCTS

FT-101ZD 160-10m transceiver w/coding fan & AM board  
..... \$850  
FT-707 80-10m transceiver 12v DC SSB/CW/AM... POA  
FP-707 240V 20A power supply..... POA  
FC-707 ATU/SWR meter/dummy load..... POA  
FV-707 Digital VFO memory unit for FT-707..... POA

## COAX CONNECTORS

PL-259 RG-8U & RG-58U types..... .75c  
Cable joiners RG-8U & RG-58U types..... .60c  
GLP right angles RG-58U to SO-239 w/lock nut & weath-  
erproof cap..... \$1.50  
SO-239 4 hole & single hole types..... .75c  
MLS right angle RG-58U to PL-259..... .75c  
In-line mic sockets 3 & 4 pin each..... .60c  
Mic. sockets 3 & 4 pin each..... .75c  
M-ring body mount w/lock nut..... \$1.50

All prices are NET, ex Springwood NSW, on pre-pay-  
ment with order basis. All risk insurance is free of  
charge, allow for freight charges by air, road, rail or  
post, excess will be refunded. Prices are subject to

change without prior notice. All orders cleared on a  
24 hours basis after receipt of order with payment.

Roy Lopez (VK2BRL)



# LETTERS TO THE EDITOR

Any opinion expressed under this heading is the individual opinion of the writer and does not necessarily coincide with that of the publisher.

16 Wandilla Street, Largs Nth., SA 5016  
20-7-80

The Editor,  
Dear Sir,

In regards to the letter published in AR July 1980 by VK3AMG, I agree with one item which is not to degenerate to CB level, as far as the rest is concerned, I suggest that VK3AMG change his call to VK3GOD. I am certain that novice operators would not outlay \$1000 or \$1500 for equipment if the licence was only valid for two years. Unfortunately not all novice operators have the knowledge which he presumably possesses. I for one had an attempt for the limited call but failed; I will try again when I feel that I am ready, irrespective if it takes one, two or five years. I am not in the electronics business and don't mind admitting that I do not know a great deal about it, just enough to obtain my novice ticket. I believe there are a lot of novice operators like myself, but that does not give 3AMG the right to have a shot at us; most novice operators try to do the right thing.

In case 3AMG does not know, there are many phases to the hobby. There are experimenters, builders, DX hunters, wall paper chasers, contest operators, rag chewers, etc, so whether we are in the right or wrong hobby is for the individual to decide, not 3AMG.

I have some friends among the full call licensees who have given me all the assistance I have ever asked for and I am glad they do not all adopt the attitude of VK3AMG. If VK3AMG does not want to associate with novice operators there is plenty of room on the bands where novice operators are not allowed to operate. In any case, in the interest of the hobby, it would be far better to co-operate with each other instead of being at each other's throat.

Yours faithfully,

Bill Vogel VK5NVW.

27 Banksia Street, Joondanna, Perth 6060  
17th July, 1980

The Editor,  
Dear Sir,

I would appreciate it very much if you could publish the following letter in reply to Mr. Jack Mellor VK3AMG in your next issue of Amateur Radio. His letter appeared in Vol. 48, No. 7, of the July issue.

It appears that Jack Mellor has completely lost sight of the fact that amateur radio is a hobby, and that those people who wish to do a hobby usually do so for enjoyment, relaxation and the pursuance of more knowledge in their chosen field.

I have been a novice operator now for a little over a year and when the opportunity arises I read radio and electronic material in a bid to improve my knowledge and understanding in the field of amateur radio.

I despair when I read, quote, "If you cannot make AOC after two years then you are definitely in the wrong hobby". Perhaps Jack Mellor has considerable time on his hands in which to pursue the higher "status" of full licence. Myself, as a full time lecturer, place prime importance in my occupation and profession, but enjoy those moments when I can get on the rig. I am one of those people in the situation where time is a precedent and it will not be for at least three years before I can pursue the higher "status" in my "hobby".

Wake up, Jack Mellor, pat yourself on the back and say to yourself "I did it!". But let us be a little less selfish and remember those other guys who also enjoy the hobby, and sincerely intend progressing towards AOC when their circumstances permit.

Yours sincerely,

Mike Taylor VK6NMT.

VK2ZRD/VFV  
71 Lonsdale Avenue, Berowra Heights 2082  
26-7-80

The Editor,  
Dear Sir,

Several correspondents have written recently on novice licensees and the new bands. VK3AMG says that, having risen to the "dizzy heights of 5 w.p.m.", some novices are content to stay novice. That may well be, however many novices have had a hard time making 5 w.p.m. and many are still trying to obtain a 10 w.p.m. examination pass. Being able to copy 10 w.p.m. or so in the shack is quite a deal easier than passing an examination—many people, prominent as well as insignificant, have not been able to front up to an exam let alone pass it. Many like myself are not going to let 10 w.p.m. beat us, but it takes time. It might have been easy for you, Jack, but I've found it difficult. Many others have quit or didn't even try!

If the new bands are to be exclusive to specialised systems and operators—then require all licensees to sit for an advanced ticket—no exemptions, and then we'll see how some of these guys handle microprocessors, digital technology, advanced solid state theory, etc., not to mention the maths.

73. Stan Dogger.

4 Turner Street, Balmain 2941  
2nd August, 1980

The Editor,  
Dear Sir,

In the July issue of AR, Jack VK3AMG raises an important issue. The Novice classification should be a stepping stone to the AOC, however as Jack points out, not all Novices intend to earn their way to the full call.

I agree with the implied criticism, in my opinion anyone willing to share in the benefits of amateur radio should also assume some responsibility to keep the standard set in earlier days. For this reason I consider it reasonable that a time limit should be set on the Novice licence.

However I think it is important to make the observation that, although the Novice examination is elementary and well within the capabilities of a sixteen-year-old, it is a sizable hurdle for those at the other end of the time scale. Students over fifty years of age have to make a far greater effort than the under thirty year brigade, short retention memory is a very real handicap.

I can think of few activities more suited to the retired generation than amateur radio, and the maturity the older man brings to our hobby will not go amiss as more eleven metre devotees step across the small barrier of the Novice examination.

By all means let us demand evidence of some application by our Novices if they are to remain on the ham bands, but not at the expense of snatching away a worthwhile activity from our senior Novices.

Yours faithfully,

Hat Wise VK2DHE.

PO Box 27, Portland, Vic. 3305  
20-8-80

The Editor,  
Dear Sir,

On the 17th of this month at approximately 7.30 p.m. I was in contact with VK3VUV, VK2VZX and ZL1LN in Christchurch, when VK2BGL came up on frequency and stated that this frequency was to be used for broadcasting the NSW WIA news and without further ado the news was broadcast over the top of us. We did not have a request to shift or time to say 7.3s to our friend in New Zealand. This to me shows the ignorance of some people—probably because we had novice calls.

I have been a member of the WIA Vic. Division for many years and was appalled at the attitude of someone representing the WIA, even if it was in another State.

Would you please publish this for further comment.

Yours faithfully,

John E. Cheaver VK3VNU.

The Editor,  
Dear Sir,

I was very interested to read QSP "The Art of Communication" in the last AR and respectfully suggest that the WIA itself is lacking in the basic interpretation of this necessary commodity, especially in the matter of internal (national) frequency spectrum usage in the amateur frequency allocation.

I refer specifically to RTTY and slow morse operations on 80m. Both are operated under the umbrella of the WIA and yet both operate in the same frequency area 3545-3550 MHz, causing interference to both services. I have heard senior RTTY operators refusing to move because they were "there first" and, after all, "it is the international frequency allocation for RTTY". The operators providing the slow morse service naturally feel angry because they don't want hours of work provided for an amateur service ruined by QRM.

I am only a relative newcomer to amateur radio, but I am very grateful to the service provided by the slow morse organisations of various States for the assistance they provided in upgrading my morse qualifications. I am now into RTTY and enjoy that immensely; I can also appreciate the frustration of the old-timers who have done years of work to foster and develop RTTY in the Australian Amateur Service. They both have a valid complaint. It's not new, if you listen to the VK2TTY on Sunday evenings at 0930Z you will usually even hear the slow morse blokes discussing the QRM that's about to occur.

I believe it is time the WIA stepped in, convened a meeting of the interested parties and, after considering all points of view, issued a rational suggested use of the frequency by both parties. Perhaps an article giving the suggested frequency usage areas for all bands would not go astray and then you could inform me why we only have one suggested 2m FM channel for major city areas. It's hard to get a tone in anywhere on most nights.

I hope this is in the spirit of the July AR QSP "Art of Communication".

Name and address supplied.

Vicom International Pty. Ltd.  
68 Eastern Rd., South Melbourne, Vic. 3205  
11th September, 1980

The Editor,  
Dear Sir,

Vicom would like to express publicly a number of concerns relating to commercial equipment reviews in "Amateur Radio" magazine. The comments have been conveyed to the Executive of the WIA on a number of occasions and relate to the ethics and standards of conducting reviews on commercial equipment. In summary, the areas of concern are as follows:—

(a) The reviews are weighted towards subjective, rather than objective comment.

(b) Technical qualifications of the reviewer are not disclosed.

(c) Any conflict of interest of the reviewer is not declared.

(d) The importer is not necessarily given an opportunity to correct any mistakes of facts—either before or after review.

(e) The overall standard of the review is low, for example there are no proper technical tests, such as on the sensitivity and spurious emissions and no comparison made on a quantitative basis either to the manufacturer's specifications nor with other equipment available on the market.

It is in relation to the last-mentioned matter that I must express particular disappointment at the review of the Icom IC2A transceiver in "AR" September 1980. It is my view that once again much of this review is of a purely subjective nature.

The reviewer makes a very incorrect assumption: that a transceiver without memory and scanning is not a particularly desirable one. In this particular case, Mr. Fisher could not have been so far from fact. Our own marketing information indicates that the incredible popularity of the IC2A comes from its basic simplicity and because of its lack

"bells and whistles" area. We do not think that it is the reviewer's prerogative to make a decision on behalf of the purchaser as to whether or not it is an advantage or a disadvantage to have these features. The second issue concerns the allegation regarding the IC2A's receiver sensitivity.

Unfortunately, the review did not offer any quantitative comment only a general observation completely unquantified.

As a constructive suggestion to improve the standard of reviews, I believe the reviewer should spend more time on fact, such as checking spurious emissions, sensitivity and technical performance against competitors' products and against manufacturer's specifications. He should present all the features of the unit and it should then be left to the reader to use his/her subjective judgement as to whether or not this is the equipment he should be buying.

I would support an argument that the Wireless Institute should become more involved in looking after the consumer interests of its members. In doing so, it should present a balanced, objective and professionally conducted review which would give your members some assistance in their equipment selection. Any subjective interpretation must be undertaken by the reader and not the reviewer.

I understand that other equipment suppliers are equally disappointed with the way reviews have been conducted and I must re-emphasise to the cynic that my Company is more than prepared to accept a review offering criticism of its products provided such criticisms are done in a professional, objective and responsible manner.

Yours faithfully,

Russell J. Kelly VK3NT, Managing Director,  
Vicom International Pty. Limited.

16 Gari Street, Charleston, NSW 2290  
15th September, 1980

The Editor,  
Dear Sir,

My attention has been drawn to a letter in the September 1980 issue of Amateur Radio over the reception of one Arle Bles, in the course of which letter my name is mentioned.

Mr. Bles is not a member of the Institute but his letter amounts to nothing more than a scurrilous personal attack on a VK5 against whom he apparently holds some grudge. The VK5 mentioned in his letter has been a member of the Institute for many years and over the years has given honourable service to the VK5 Division in various ways. I think that it is a disgraceful state of complicated add-ons, which are in the gimmicky

of affairs that a non-member should be given space in order to mount a vicious personal attack on a member.

Turning to the technical aspects of Mr. Bles's letter, I first draw attention to my extensive technical qualifications: B.E., M.I.E.E., Chartered Engineer (C. Eng.), a lecturer in electrical engineering at an Australian university for 25 years. Is there anyone in his senses who imagines that I don't know what I am talking about. Yet Mr. Bles, whose technical qualifications are hard to discover, has the brazen audacity to open up a letter by saying that "the man is completely wrong".

For years I have taken a fatherly interest in the amateur radio movement, and the affairs of the Institute in particular. My letter in the June issue was well-considered and accurate in every detail. If Mr. Bles cannot understand it because the subject matter is too difficult for him, then that is his worry. But Mr. Bles apparently opposes the dissemination of accurate technical information like this because he fears that his business interests will be affected.

To mark my extreme displeasure over this matter and the way that it has been handled I have cancelled my amateur licence and will not renew membership of the Institute. Clearly I am only wasting my time mucking about with amateurs.

Your sincerely,

Colin Yates.

12 Norrils Road, Rowville 3178  
24-8-80

The Editor,

Dear Sir,

Have just had QSO with Woody W6NEY/CCW in CW and asked him what the CCW meant. He replied: "CCW is a new mode of communication, we are using computer control. Bandwidth of filter is 10 Hertz, an article will appear in November QST. Technically speaking it is synchronised pulse code modulation."

To my comment that at a bandwidth of 10 Hz it's a wonder he heard my call, he replied: "CCW can be received as CW by ordinary methods, but with computer control of receiving filter, about 25 dB improvement over ordinary CW. Name Woody. Power 10 watts beaming Japan."

He was coming into this QTH at 589 and gave me a 559 report with 100 watts into a dipole.

This info sounds interesting and may be of some use to you.

Vy 73.

Don Ockley VK3BKU.

FB8XY, D68GA, F0AHY/FC, PJ2KI, F08DO, 5H3FW, VP2MX, HK0FBF, ZC4MT and C31QH.

15 METRES

If you can get through the pile of woodchips (curse the woodpecker) another band in really fine shape, most notable heard and/or worked — HT4DX, UA1PAL (Franz Joseph), OA4QZ, T3AT, F0BGM, CE3CRZ, 83T, ZS3HL, W1DDV/C6A, SV0AP, VS5DD, JZ8CC, TG4NX, CX7BU, C31QH, HC8GI. On phone and for the CW buffs K9EF/8R1 and UA1PAL.

20 METRES

Continues as ever to be a fine DX band plus or minus heavy QRM and manner (non-existent) that have to be heard to be believed, LU3YZ, CE9AF, D68GA, ZD7HH, FB8ZO, C31MK, OJMA, C5ACO, 7X4MO, KC6DC, FY7AG, W4PYH/K8B, J6LFT, all on phone, whilst on CW 9U5AV, FROOZ/J, TF30F and 3B8AS all had fine signals.

40 METRES

Remains in fine shape, particularly if you enjoy CW, FB8ZO, D68XX, JZ8CC, FROFLO/T, T3AZ, 8Q7BB, plus solid Europe and USA paths make for a most enjoyable and reliable brass pounders paradise.

80 METRES

Rapidly improving, even for the novices with insomnia, mainly CW though — FB8ZO, 9J2BO, H44DX, VS5RP, Ws and good European signals really make this rag chew band worthy of more attention.

160 METRES

The band very few people (even me) bother to consider DX-wise still holds some surprises, H44DX and 5W1BJ on Phone, whilst ZK2TW and Ws on CW; perhaps the few stations mentioned may whet a few appetites — let's use it before we lose it!

That's it for the month, a good one by any standards. I'm well and truly ORT for at least a month — this column therefore will rely on contributions — can you afford 22 cents for a quick note to me if you work something interesting? I sincerely hope so.

Many thanks this month to Allan VK2AIR, Reg VK2HM, Marilyn L20118 and Mike VK6HD for their valuable contributions.

73s, Nick.

OTHs YOU MAY HAVE MISSED

V05JC — (new) PSC4, Box 12755 APO, San Francisco 86274.

FB8XY — via F6CUI.

W5JMM/SU — via Home Call.

9M8PW — PO Box 347, Kuching.

9G1TN — PO Box Tema, Ghana.

CE9AF (South Shetland) — via PO Box 13630, Santiago, Chile.

9U5AV — via K5VT.

T3AZ — via JA1VT.

8O7BB — via JA7SGV.

SV0AP — via WB7NCF.

5N0DQG — via W4FRU.

A35TW — via ZL1AZV.

OX3CO — via WB5KGY.

FB8ZO — via F6EYB.

LU3ZY — via LU2CN.

T3AT — via G3XZF.

C31IR — via F6AUS.

5N9GM — Box 1488, Kaduna, Nigeria.

A35RF — via VK3ATL.

HK0AA/AB — via HK3DDD, PO Box 584, Bogota, Colombia.

KC8DC — via AD1S.

A7XE — via DK3GI.

OH0AM — via OH2BBM.

9Q5GB — via W7KTI.

JZ8CC — PO Box 215, Republic of Djibuti.

## QSP

10 METRES — 1928!!

Ross Greenaway VK6DA was having some rebuilding done to his home. Underneath an old lino he found some newspaper clippings of items in "The West Australian" of September 6th and 7th, 1928, in which it was reported that on 5th September, 1928, an amateur wireless record was established in a two-way contact on 10 metres between Mr. M. Howden (then 3BQ) and Mr. H. Austin (probably 6SA). A lot has happened in 50 years. Thanks for the details, Ross.

# YOU and DX

G. (Nick) Nichols VK6XI  
6 Briar Place, Ferndale, WA 6155.

There's an old saying which will be familiar to many, it goes "if it didn't come down last winter, it wasn't big or high enough". You probably think that's a weird way to start a DX article, oh well, in case you haven't caught on, my quad array now resides (like the pixies) at the bottom of the garden — a twisted mangled birdsnest of wood, wire and aluminium and steel. The cause — guy wire failure! Have you checked yours recently? Life expectancy of guy wire is only 3 years maximum.

Rumour has it that the postal pixies are at it again. FROFLO Merick, believes his mail is now receiving the unwanted attention — oh the mail's getting to him but the IRCs and green stamps for return postage are noticeably absent. My only suggestion yet again is to keep the mail plain and as unobtrusive as possible.

### FACT AND/OR FICTION?

The news filtering around the bands is for a major operation in late 1980 or more likely early '81 from YI land, rumoured call sign Y11JY, operation by Jordanian operators possibly JY3ZH, (feel the operation may well be shelved due to problems in this area of the world) — only time will tell whether this one comes off — here's hoping! Also rumoured are operations from HC8, EA9 and M1 — no solid info, but keep your ears open.

A 9U5DS on the bands (mainly 20m) has a really odd beam heading from here? The call sign is legal but operators from this country are only permitted 3 OSOs per week or risk losing their gear — if you hear this one on I suggest you do a quick count of QSOs — more than 3 it's a pirate! Whilst on "slims" also heard particularly on 10m BV2BK — this one is a definite no-no — so don't waste your breath.

For those who worked Steve AABAA and the group (N6ZV, KA6S & FROFLO) during August/September, you may be interested to know a total of 30,000 QSOs were made, call signs used were 3B8ZV, KA6S/3B8, 3B9ZV, AA6AA/3B8, D68XX, D68GA, FR7BP/T and FROFLO/T — the unexpected Trommellin activity was due solely to Steve's fortitude in outlaying \$5000 for air charter from his own pocket — needless to say a token of appreciation — brown, green or whatever when QSLing to ZL1BIL would not go astray.

### ON THE BANDS

10 METRES

A solid band (despite the knockers who say it is unpredictable) great S9 signals into Europe, US Central and South America, stations heard and/or worked during the month and worthy of mention 5N0DQ, 9G1TN, 9M8PW, W5JMM/SU, A35TW,

# IONOSPHERIC PREDICTIONS

Len Poynter VK3BYE

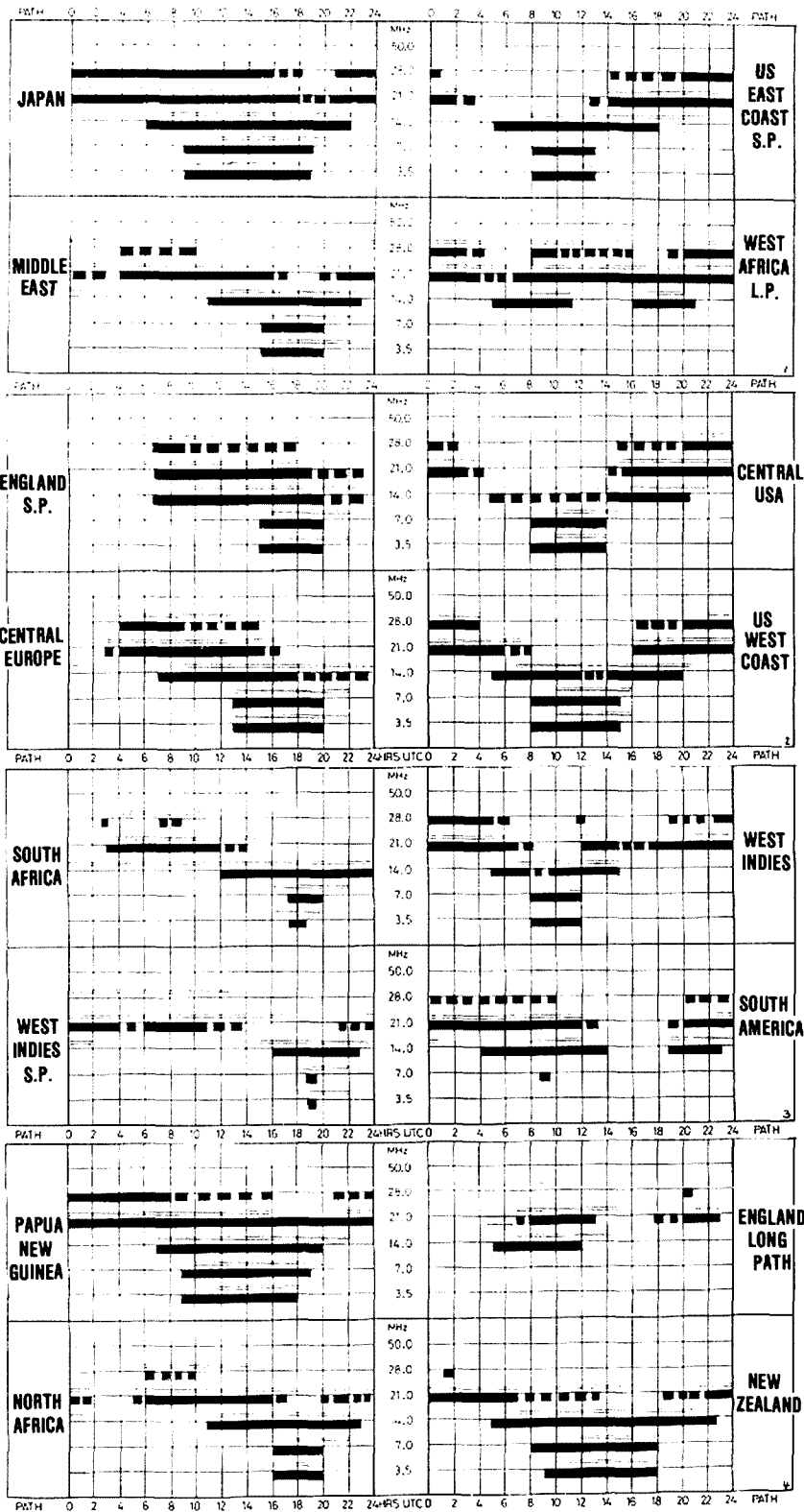

**LEGEND**  
 — FROM WESTERN AUSTRALIA  
 - - - FROM EASTERN AUSTRALIA  
 [Solid line] BETTER THAN 50% OF THE MONTH, BUT NOT EVERYDAY.  
 [Dashed line] LESS THAN 50% OF THE MONTH.

Predictions courtesy Department of Science and Environment IPS Sydney.  
 All times universal UTC (GMT).

## NOTES ON THE PREDICTIONS

The mode of propagation used by IPS in compiling their predictions are reflected in the bar charts used to convert the Graflex symbols into a graphic picture.

When generating the Graflex charts (reproduced in a number of publications) the following symbols are used.

1. "P" — Propagation is possible but probably less than 50% of the days of the month.
2. "M" — Propagation is possible between 50% and 90% of the days of the month.
3. "E" — Propagation is possible by the first F mode on at least 90% of the days of the month unless there is a severe ionospheric disturbance.
4. "M" — Propagation is possible by both first and second F modes. The strongest mode is normally the first mode, but the vertical aerial pattern may influence the mode received.
5. "A" — High absorption, i.e. above the absorption limiting frequency but probably too close to it for good communication.
6. "X" — Complex mixtures of modes including the second E mode.

These are the most significant types we encounter. The full lines or bars on the chart cover 2, 3, 4 taking 5 into account. The broken lines or bars are depicted by 1. 6 is extremely hard to verify and is not taken into account.

The paths from Eastern Australia are based on Canberra. The paths from West Australia are from Perth. Suitable allowance should be made on Eastern paths for geographical differences. Times, as much as 1 hour difference between Victoria and Queensland in band openings occur. Often there is no signal available in one State, whereas the opposite effect occurs in the other State, they get the lot. Marginal differences produced by layer tilt and varying degrees of ionisation can be very frustrating.

Generally the predictions show that time of day when the path should be open between the two areas. All other factors notwithstanding.

## MAGAZINE REVIEW

Roy Hartkopf VK3AOH

(G) General. (C) Constructional. (P) Practical without detailed constructional information. (T) Theoretical. (N) Of particular interest to the Novice.

### Zero Beat June 1980

(Youth Radio Clubs Scheme Magazine.)  
 Catalogue of Constructional Ideas (GN). Direct Conversion Receiver Review (G). Memory Aid Competition (G).

### CQ June 1980

Wave Propagation (G). Discone Antenna (C).

### CQ July 1980

Multi-Band Linear (P). Transmission Line Transformer (G). Six Meire Log Periodic Yagi (C). Pi Network (G).

### HAM RADIO June 1980

"Woodpecker" Noise Blanker (P).

### OST June 1980

Beginners Look at Op. Amps. (N).

### HAM RADIO July 1980

Digital Rotary Dial Mechanism (electronic) (C). Yagi Antenna Design (T). Open Quad Antenna (P). Microwave Frequency Converter (C).

### BREAK IN July 1980

Baudot to ASCII Converter (C).

### BREAK IN August 1980

SPECIAL RTTY ISSUE.

### QST July 1980

Impedance Match Indicator (C). Active Filters (C).

### QST August 1980

Solar Powering a Ham Station (G). Electronic Switch for a Solar Panel (GC). Weather Satellite Reception (C).

**The Advertisers in "Amateur Radio" support the WIA member — give them first preference — and tell them so, too!**

# 1980 Remembrance Day Contest Results

## Winner — VK5 Division

Once again a record number of total entries.

Divisional participation wins the RD Contest.

Support from VK5/8 amateurs was excellent, especially in the Receiving Section.

VK6 was a close second — only 31 more full call logs of average value would have caused a change of places. Note that VK2 has moved into fifth place.

	A	B	C	D	E	E
VK1	37	175	21229	21.1	4488	354
VK2	168	2188	61138	7.7	4694	287
VK3	93	1681	51820	5.5	2867	418
VK4	106	756	72730	14.0	10198	498
VK5/8	199	758	105577	26.3	27717	341
VK6	116	497	78371	23.3	18292	512
VK7	79	202	46028	39.1	18001	390

Above columns:

- A — Full call logs received.
- B — Licences as at 31st March, 1980.
- C — Total points scored.
- D — Percentage participation full calls.
- E — Trophy score from formula.
- F — Average log value.

The following details show the section and the points scored.

Note — Calls with the symbol \* beside them entered both the Phone and CW sections, and this counts as two entries for full calls.

Results by Division in numerical order to follow.

### VK1 PHONE

GB	2051	LF	415	*GM	140
JN	1631	MF	374	RK	130
*NCV	1339	*NAP	348	ZAT	129
MX	1127	TD	344	*DH	126
NAS/		GW	343	RC	101
ZAI	790	*BR	323	NAT	97
*MM	695	DN	310	ZAA	91
RP	653	*WI	305	ZAR	83
DV	628	NDR	301	NDJ	78
NDA	582	ZAH	227	*CC	71
*DA	530	RH	215	NCA	64
NBK/		*NAN	209	ZV	50
ZKL	488	*FT	200	NCB	46
FM	481	*UD	199	AYL	37
NAM	456	ZBJ	198	ZEJ	33
CB	445	NDI	159	KV	29

### VK1 CW

*CC	952	*NAN	184	*DA	132
*DH	722	*WI	172	*GM	118
*BR	260	*FT	164	*NAP	80
*UD	216	*MM	152	NDB	60
ZV	196	*NCV	150		

### VK2 PHONE

DIE	2208	*BFR	1150	VQW	801
DCL	2127	DDO	1124	*BTZ	788
DM	1812	*DIX	1117	DDD	768
DNS	1720	*VWH	1086	DCB	714
*BO	1628	DHG	1057	DBK	669
*AUX	1362	BAM	957	BOD	635
*AOA	1226	BDT	923	*VVC	630
AHV	1192	NYL	810	ASU	622

NW	598	PN	186	*AJH	63
APE	584	VTX	182	*BLK	59
NZ	513	BRU	177	DNT	59
VEO	499	VDF	177	AZS	56
*VUT	457	*DKS	174	*DDN	56
*BSB	450	OH	173	*DGY	56
BOS	445	NYD	171	ZVN	56
DLZ	442	VPQ	169	AVX	55
VAB/		VVU	169	VYP	55
YKD	436	BVO	160	VBX	53
DLH	431	DAV	160	*ABB	52
*DI	413	NRB/		3EF/2	51
AGB	413	ZCI	158	DLG	49
BVR	410	BXQ	157	VMK	49
EY	391	DOL	152	AJO	48
*DEW	380	NWL	148	BWK	48
WW	379	BVU	143	*VMY	48
BB	371	*AZR	142	BXD	47
YU	358	VVV	142	GK	45
AHH	343	RU	140	OC	44
BYS	337	*BNL	134	ZK	44
WT	336	AIM	132	DR	42
VVF	331	VSP	130	AYF	41
BMX	328	AJL	129	BAD	41
DCW	327	BHD	128	DGX	41
BID	318	ARZ	127	WIH	41
NJU	313	*LF	124	*BHO	40
AMV	299	AKY	124	PT	39
VXH	299	AKH	120	*RJ	39
ACK	295	AGZ	118	BFG	39
DAB	292	*IV	115	BUT	37
ASY	289	ARD	113	*AO	36
VCV	287	HZ	106	*JM	35
VTD	274	UC	106	XT	34
XC	248	PAO	101	NZW	34
FM	243	*ALJ	97	CU	33
BVY	242	NV	93	YEZ	32
DNX	229	YSU	87	*AGS	31
BIP	226	VRJ	84	*AQF	31
VA	220	*GT	81	*DBA	31
DHU	215	ZSG	78	DFC	30
*NAW	213	AWX	77	DGW	27
AIC	209	ZZX	77	DLD	24
BCY	207	VKZ	73	PY	22
WA	203	BQK	71	ZEI	21
*WE	196	*BAV	65	DKT	19
DKP	189	*SW	64	YPT	12

### VK2 CW

*AQF	1032	*VVC	207	BBB	62
BAT	944	VM	176	*DBA	60
CX	826	*LF	172	*AO	58
EL	820	*NAW	162	*DDN	58
*DGY	768	DKU	158	*AGS	56
II	510	*BLK	140	*BFR	54
SU	466	*BO	120	*DKS	54
*GT	376	*ALJ	116	*AOA	52
*DI	326	AJO	88	*DEW	52
*BHO	324	*VUT	84	*RJ	50
*BTZ	278	*SW	76	BSG	50
*WE	272	BAV	76	NR	44
*ABB	260	*JM	64	*DIX	40
*AUX	234	*BSB	64	*VWH	40
*IV	222	*AZR	63	*VYM	26
*BNL	216	*AJH	62	*VQW	24

### VK3 PHONE

WP	2306	APC	1233	VPJ	683
CGR	2280	*BYN	1196	VTI	679
BHC	1906	AYF	1189	BPY	671
AOSZ	1899	DML	1040	DS	668
BSH	1709	GJ	1031	SZ	616
NHA	1509	BCK	911	BSR	587
ADW	1400	SM	880	ZL	572
BRM	1375	*XQ	873	VGX	526
WW	1327	ALO	734	ALK	505

*AER	491	YFZ	201	YLN	87
VKZ	481	ZY	189	BCC	84
BRD	459	CX	187	WY	81
BJM	453	ZWI	186	ZBB	77
NDT	436	ZXW	186	*BDH	76
VOL	430	AGH	172	ARJ	74
ZHP	420	DAK	158	NFC	72
LP	404	AGD	153	AMW	71
AVV	397	*BKU	143	BOB	67
BQU	396	VMB	138	KT	64
VST	330	*XB	137	CEE	56
RV	317	*AUO	131	*AMD	55
BLO	316	4ZCO/3	116	AAJ	44
VSE	311	BLE	111	*AEW	33
VB	293	*KS	108	BZO	36
ZYL	266	XH	105	ZIW	35
NIO	263	AL	102	*TJ	34
BPU	256	NWW/		*SV	33
YRY	252	ZOR	99	YNB	30
YRN	248	ZFI	96	*ARS	29
BSP	223	BYA	95	ARA	25
YRP	213	UJ	91	*BOD	21
BMV	210	NIX/		BYK	18
BII	208	ZHC	89	YYQ	12

### VK3 CW

*BKU	758	RJ	368	*BYN	176
KF	724	NZO	352	ANJ	166
*AEW	704	*XB	300	*KS	98
*BOD	648	XF	300	*TJ	72
DG	564	ANI	264	*AER	72
YK	504	FC	258	*XQ	62
*BDH	442	*AUO	226	YL	58
YF	402	*SV	224	FA	36
*AMD	380	*ARS	210		

### VK3 RECEIVING

L30042 E. Trebilcock (CW only) ..... 864

### VK4 PHONE

YS	3165	VBG	671	OA	269
NOD	2742	YT	660	*GH	261
LP	2736	ACC	640	NJV/	
LT	2560	AG	636	ZJV	260
AMB	2557	VBD	633	*WT	230
*LG	2445	NTE/		NXJ	198
UX	2156	ZJP	602	DO	194
OO	1935	NIK	589	LE	190
AOH	1802	NZW	580	AEM	189
NPL/		BG	520	*UG	164
ZMZ	1774	NVG	506	FK	160
ACT	1475	2RP/4	431	VCI	155
KD	1421	FX	419	TS	149
PS	1419	NLL	418	*ABM	149
AEV	1389	VDF	413	ADC	142
LJ	1325	OY	400	ZN	140
NOY	1099	VI	397	HB	133
AGL	1042	EH	383	VCE	125
NWH	1042	AAU	370	ZBV	125
NFR/		*DT	347	ADW	119
ZEZ	1040	VCO	343	NS	118
*YG	948	PJ	337	VFN	114
RT	943	NWJ	335	ABY	113
NAU	897	NUI	323	NTJ/	
JG	835	IZ	322	ZTJ	107
FN	833	NXX	309	XN	100
NHO/		CZ	306	ASP	97
ZMQ	828	NKP/		HM	93
IR	818	ZNI	296	NFU	92
KW	816	NUC/		LA	90
APA	799	ZBL	295	AGZ	87
OX	781	FU	292	NDX/	
*AMH	745	QH	289	ZXD	86
AAK	735	ANZ	287	UJ	84
ZV	726	VCJ	285	GT	70



**COMMENTS BY FEDERAL CONTEST MANAGER**

What a friendly contest it was. Meeting old friends and also making new ones. The Minister's announcement at the start of the contest certainly made one feel that amateurs were not forgotten.

It would appear that unnecessary power in the Novice sections by full calls was not appreciated. Next time how about giving the little bloke a better go?

A log was received from Roy VK5AC, who passed

away shortly after the contest. Born in 1899, he was active right up to the very end.

The comments on logs this year were full of praise for the happy and friendly nature of the contest, although one entrant bitterly complained that his rig blew up after a few hours and he had to withdraw.

**EXTRACTS**

"Had a great time in the contest"—VK7. "To those amateurs who made the supreme sacrifice, I think the contest is an excellent way of remembering them"—VK3. "This year's contest was a lot of fun. It certainly deserves the title of the friendly contest"—VK3.

This is my last "RD" contest as my term finishes next June, and I have enjoyed it very much. A dining room full of letters and then spread out logs has been accepted by my wife, Dorothy, as her contribution to amateur radio. Perhaps we can now have a decent dinner party at home.

See you next year in the "RD" on the 15/16th August, 1981

**CONTESTS**

Wally Watkins VK2DEW  
Box 1065, Orange 2800

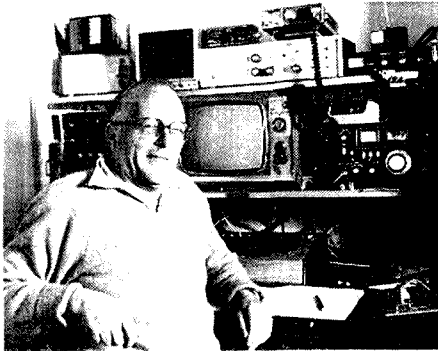

- November:**
- 8/9 EUROPEAN RTTY
  - 9 INTERNATIONAL POLICE CONTEST
  - 9 CZECHOSLOVAKIAN CONTEST
  - 15 DARC 10 METRE RTTY
  - 15/16 AUSTRIAN 160 METRE CONTEST
  - 15/17 ARRL PHONE
  - 29/30 CQ WW DX CW CONTEST +1
- December:**
- 6/11 January ROSS HULL MEMORIAL CONTEST
  - 6/7 SPANISH PHONE CONTEST
  - 6/7 NATIONAL VHF CONTEST +2
  - 6/8 ARRL 160 METRE
  - 13/14 SPANISH CW CONTEST
  - 13/14 HUNGARIAN DX CONTEST
  - 13/14 ARRL 10 METRE CONTEST
  - 28 CANADA PHONE AND CW CONTEST
- January:**
- Up to 11 ROSS HULL MEMORIAL CONTEST
  - 17/18 2ND ANNUAL INTERNATIONAL 160 METRE PHONE

- February:**
- 7/8 JOHN MOYLE MEMORIAL CONTEST
  - 7/8 RSGB 7 MHz PHONE
- +1: CQ WW CW logs to N6AR, Rock Ridge Terr., Canoga Park, CA 91307 by 15-1-81.
- +2: Nat. VHF logs to Geelong ARC, Box 520, Geelong 3220.
- Various rules sent by return mail — SASE to FCM.
- FROM VARIOUS RESULT SHEETS**
- 1979 CQ WW PHONE: 21 MHz VK4VU third world score.
- 1980 Commonwealth Contest: Received Rose Bowl — E. W. Trebilcock BCRS 195.
- Band leaders overseas: 7 MHz VK3APN; 14 MHz VK6AJ.

**CANADA CONTEST**  
The Canadian Amateur Radio Federation is pleased to announce the Canada Contest.

**Time:**  
0001-2359 UTC on 28 December, 1980.

Open to all amateurs, everybody work everybody, 160 to 2 metres, CW and Phone combined.

**Classes of entry:**  
Single operator all band, single operator single band, multi operator single transmitter all band.

**Contacts:**  
All contacts with amateur stations are valid. The same station may be worked twice on each band, once on CW and once on Phone. No cross-mode contacts, and no CW contacts in the Phone bands allowed.

**Exchange:**  
Signal report and consecutive serial number starting with 001. VE1 stations will also send their province (NS, NB, PEI).

**Scoring:**  
10 points for each contact with Canada. 1 point for each contact with others. 10 bonus points for each contact with any CARF official news station using the suffix TCA or VCA. Multipliers are the number of Canadian provinces/territories worked on each band and mode. (12 provinces/territories x 8 bands x 2 modes for a maximum of 192 possible multipliers.)

**Provinces/territories:**  
VO1/VO2, VE1-NB, VE2, VE3, VE4, VE5, VE1-PEI, VE1-NS, VE6, VE7, VE8, VY1.

**Frequencies:**  
Phone: 1810, 3770, 3900, 7070, 7230, 14150, 14300, 21200, 21400, 28500, 50100, 146520.  
CW: 1810, 3525, 7025, 14025, 21025, 28025, 50100, 144100.

**Times:**  
Suggest Phone on the even hours UTC, CW on the odd hours UTC.

**Entries:**  
A valid entry must contain log sheets, dupe sheets and a summary sheet showing a chart of multipliers per band/mode and score calculation. Send your entry with comments to Canadian Amateur Radio Federation, 203-1946 York Avenue, Vancouver, BC Canada V6J 1E3, postmarked before 15 January, 1981.

**Awards:**  
The CARF Canada Contest Trophy will be awarded to the highest scoring single operator entry. Certificates will be awarded to the highest score in each entry class in each province/territory, USA call area, and DX country, and to the highest score from a Canadian non-Advanced Amateur (no Phone on 3.5-21 MHz) and where participation warrants.

**Results:**  
Results will be published in TCA, the Canadian amateur magazine. Non-subscribers may include an SASE for a copy of the results.

**COMMONWEALTH CONTEST 1980**

Conditions, as far as this part of the world was concerned, were a great improvement on anything experienced for many years, and showed that as late as March anyway, Sunspot Cycle 21 was still on the way up. Increased activity was recorded on 21 and 28 MHz and consequently the leading VK score were well up on 1979.

However, the total number of logs submitted was only one more, at 127. Australian entries again increased, to 43, while there were 51 from the UK, 15 VEs, but only 5 ZLs. The "Outposts of Empire" seem to be making a comeback, as ZB2, ZD8, ZE, C5 and 5B4, among other exotic prefixes, also appear in the results.

Scores of the leaders, as of the three top VKs, seem to have increased by about 500 points on those of last year, but our placings slipped to 15, 18 and 23 as against 12, 14 and 19 previously. The general opinion locally was that it was a good contest all round.

- The leaders were:—
- |          |      |           |      |
|----------|------|-----------|------|
| 1. VE7CC | 7293 | 5. VE5RA  | 5691 |
| 2. 9H1EL | 6734 | 6. G3MXJ  | 5679 |
| 3. G3FXB | 6112 | 15. VK4XA | 4813 |
| 4. G3FPQ | 5692 |           |      |

**RECEIVING SECTION**

1. Eric Trebilcock BCRS195 ..... 3435

**AUSTRALIAN SCORES**

15. VK4XA	4813	91. VK3FC	1200
18. VK2BPN	4750	92. VK5KL	1145
23. VK3MR	4268	93. VK2GT	1130
37. VK7BC	3140	96. VK3YL	1090
39. VK3ZC	3105	99. VK1UD	1025
44. VK2AQF	2920	100. VK3KS	1018
49. VK2GW	2600	105. VK5HO	813
52. VK3AEW	2523	107. VK5RG	795
53. VK3XU	2320	109. VK3BOH	670
56. VK7RO	2273	109. VK6RU	67J
60. VK3YK	2120	111. VK1GG/2	665
62. VK3RJ	2055	112. VK4XJ	640
68. VK7CH	1770	113. VK1SU/2	635
69. VK7RY	1680	114. VK7ZO	540
71. VK6AJ	1643	115. VK6RZ	510
76. VK3VF	1570	117. VK2BDU	456
78. VK4LV	1530	119. VK3ABA	380
60. VK3XX	1490	123. VK4SF	265
83. VK6FS	1470	124. VK3SV	250
84. VK3XB	1465	125. VK3CT	240
89. VK5BS	1260	126. VK3AMD	125
90. VK3APN	1210		

Single band entries among the above were:—

- 7 MHz — VK3APN, Overseas leader.
- 14 MHz — VK6AJ, Overseas leader.
- 21 MHz — VK3ABA.
- 28 MHz — VK4XJ, VK4SF.

Other Pacific Area results:—

9. 5W1BZ	5383	63. ZL1AMO	2027
13. ZL2BR	4860	65. P29EJ	1873
28. ZL2TX	3895	86. 9V1TL	1430
57. ZL1HV	2270	101. ZL2MM	1010

**AUSTRALIAN AWARDS**

The Silver Medallion for the leading VK entrant was won by Russ Coleston VK4XA.

The Bronze Medallion for the VK middle placing was won by Peter Nisbet VK3APN.

**HOW THE LEADERS MADE THEIR SCORES**

QSOs/Bonus Areas per band, 80 to 10.

VE7CC	16/15	101/49	204/45	177/42	170/52
9H1EL	38/12	92/22	189/53	156/44	220/36
9H1EL	38/12	92/22	189/53	156/44	220/36
G3FXB	10/10	81/35	152/38	207/40	108/45

VK4XA	8/7	32/25	130/49	117/41	57/34
VK2BPN	15/12	47/36	104/41	88/37	44/37
VK3MR	21/18	57/38	125/28	62/35	30/21

A comparison between these two groups of scoring details tends to indicate that our (VK) best hope for increased scores is more activity on our own continent. A remark by 5W1BZ, "Real thrill to work VP8AI on five bands—back to ZL for 1981", shows what can be worked if one is in the right part of the world!!

**RSGB COMMENTS**

The sunspot maximum years continue to produce conditions which favour stations in the northern hemisphere. Many entrants commented on the good conditions on all bands between Canada and Europe, and on the problems affecting contacts between these areas and Africa, Australia and New Zealand.

With a total of 668 contacts and 203 bonuses, Lee Sawkins VE7CC retains the Senior Rose Bowl for a second year. The Junior Rose Bowl remains in Europe, going to Jeff Morris 9H1EL, who amassed 695 contacts, the highest total of any entrant. Al Slater G3FXB keeps the Col Thomas Rose Bowl yet again (his eighth successive win) and after some years absence G3FPQ returns to the tables in fourth place overall.

Without doubt the key to the Commonwealth Contest is bonus points, and those obtained on the lower frequency bands seem to achieve special importance. It is interesting to compare the way in which stations in various parts of the world assembled their scores. Analysis of the winner's log reflects the excellent openings to Europe that enabled VE7CC to build up his score. The 28 MHz band produced 112 contacts in 4.5h, and 14 MHz 130 contacts in 5h. For the Europeans who spent much of the night scratching for extra bonus points, VE7CC's lower frequency bands list makes interesting reading, especially on 7 MHz where he worked VK2, 3, 4, 5, 6, 7, ZL1, 3, 5W1, VP9, ZD8, C5 and VP8!

The leading UK stations consolidated their positions with considerable emphasis on the lower frequency bands. Both G3FXB and G3FPQ used fixed multi-element beams on 7 MHz, a factor which may well have been worth more on reception than on transmission. The choicer prefixes appearing in their logs for this band included VE1, 7, VP8, VP9, VK2, 3, 4, 7, ZD8, ZK1, ZL1, 2, 3, 5B4, 5W1 and 8R1. Several G stations, including G3FPQ, took advantage of the early evening short-path opening to VK on 3 MHz. G3FPQ's bonus list for this band includes C5, VE1, 2, 3, VK, 7, VO, ZB2, ZD8, ZL2, 4 and 9H1.

9H1EL seems to have successfully resisted the temptation to merely work the always adequate supply of UK stations available on all bands, and he ensured a sufficient supply of bonus points to push himself into second place overall.

Examination of the VK/ZL logs shows a somewhat different perspective of the contest. VK4XA's log for 7 MHz shows that the bulk of activity took place during the Australian early evening period between 0600 and 1030 GMT with openings to the mid-Pacific, VE1, 4, 5 and 7. This tendency to lower frequency bands operation in the evenings (as opposed to the bulk of European activity during the night) is reinforced in the logs of ZL2BR and ZL2TX.

In the single-band sections the only band attracting any significant number of entries was 14 MHz. Overseas, VK6AJ had 127 OSOs and 51 bonuses to give him top place, while at home G3PVA's FT101Z and 2 el quad produced 100 OSOs and 57 Bonuses. The overall single-band leader was ZL1AMO, who scored 301 contacts and 56 bonuses to give him the lead on 21 MHz.

Eric Trebilcock BCRS195, in his 39th "BERU", comes out top this time in his yearly rivalry with Ron Thomas BRS15882. Eric found 163 stations with 131 bonuses against Ron's 167 and 120.

Comments concerning the rules in last year's write-up produced a considerable amount of reaction. The overwhelming feeling is that the rules should be retained in their present form. It is clear that much of the attraction of "BERU" is its uniqueness as a contest—the need for something more than sheer quantity of contacts and the test of the overall station and operator. Equipment, antennas, propagation knowledge, experience and of course stamina, are tested to a level not reached in many events. There are no plans for any rule changes in the immediate future. Needless to say, comment on any aspect of the contest is always welcome.

#### G5WP

It would be inappropriate to close without noting the death of "BERU" stalwart "Rusty" Russell G5WP in May, 1980. Rusty, perhaps the most consistent "BERU" entrant ever, will be particularly remembered for his lower frequency band operations. He was the only UK station since the war to win the "BERU" Rose Bowl. His signals will be missed.

#### BERU 1981

1200Z Saturday, 15th March, to 1200Z Sunday, 16th March, 1981.

#### RULES FOR THE 1980-81 ROSS HULL MEMORIAL CONTEST

#### OBJECTS

Australian amateurs will endeavour to contact as many other amateurs as possible. Entrants must operate within the terms of their licences.

#### PERIOD

0001Z 6th December, 1980, to 2400Z 11th January, 1981.

#### EXCHANGE

RS(T) plus a three figure serial number starting at 001 and increasing by one for each contact, when 999 is reached a start is made again from 001.

#### BANDS

All amateur bands above 30 MHz, however cross band contacts are not permitted. Operation via active repeaters and translators is not allowed.

#### OPERATOR

Single operator only. One transmission only at one time.

#### CONTACTS

Two contacts per GMT day per band with each station providing 10 hours have elapsed since the previous contact.

#### DURATION

- 7 GMT days — not necessarily consecutive.
- 2 GMT days consecutive.

#### SECTIONS

- Phone (AM, FM, SSB, ATV and SSTV).
- CW (CW and RTTY).
- Receiving (any mode).

#### LOG SHEET

It is desirable that complete logs for the whole contest be submitted for cross checking purposes, photo copies are very acceptable.

The following details must be shown: Time GMT, Band, Emission, Stn worked, Tx exchange, Rx exchange, Points, Bonus. Each page must be totalled at the bottom.

#### FRONT SHEET

A front sheet must be attached showing the following information in this order:

Section, call sign, list of 7 best GMT days with daily score and day multiplier, daily total plus 7 day total, list of best 2 GMT days with daily score and day multiplier, daily total plus 2 day total, name and postal address.

#### SCORING TABLE — AUSTRALIA

Distance	52	144	432	576	1296	2304	6up
Up to 100 km	1	2	5	20	30	50	
100-200 km	2	5	10	30	75	100	
200-400 km	10	20	40	50	100	200	
400-800 km	20	35	60	75	150	300	
Over 800 km	10	50	80	100	200	500	

#### BONUS

- For each new call area in Australia, including own call area, 20 points once only per band per GMT day.
- For each prefix worked outside Australia, 40 points once only per band per day.

#### SPECIAL VK6 BONUS

VK6 stations only shall double the final daily score.

#### MULTIPLIER

All stations shall multiply the GMT day score, including the Bonus (a) and (b), by the number of bands used for scoring during that day.

#### SCORING TABLE — OVERSEAS STATIONS

52 MHz — 50 points; 144 MHz — 100 points; 432 MHz — 200 points. For contacts with Australian stations only.

#### AWARDS

A perpetual trophy is awarded annually for competition between members of the Wireless Institute of Australia. The winner's name is inscribed on the trophy and he receives a suitable certificate. The entrant with the highest score in either the 7 day or 2 day division will be the winner and his division will hold the trophy for one year.

Certificates will be awarded to the highest score in both the 7 day and the 2 day divisions. A winner of a 7 day certificate cannot be awarded a 2 day one as well.

Overseas entrants will be awarded certificates on the same basis, one for each call area.

#### SUBMISSION OF LOGS

Entries are to be sent to the FCM, Box 1065, Orange 2800, and postmarked no later than 2nd February, 1981, and endorsed "Ross Hull Memorial Contest".

#### RECEIVING SECTION

Logs must show the same information as a transmitting log except for the second number exchanged. If both stations are heard both can be claimed but on separate lines of the log. Scoring will be as for a transmitting log.

Any scoring contacts can be logged, there is no limit to the number of times that one station can be logged.

The decision of the FCM is final and no correspondence will be entered into.

#### SECOND ANNUAL INTERNATIONAL 160 METRE PHONE CONTEST

##### Sponsored by:

73 Magazine, Peterborough, New Hampshire 03458.

##### Contest Period:

0000Z January 17, 1981, to 2400Z January 18, 1981.

##### Object:

To work as many stations as possible on 160m Phone in a maximum of 30 hours allowable contest time. Multi-operator stations may operate the entire 48-hour contest period.

##### Entry Categories:

- Single Operator, Single Transmitter, Phone only.
- Multi-Operator, Single Transmitter, Phone only.

##### Exchange:

Stations within the Continental US and Canada transmit RS report and State or Province respectively. All others transmit RS report and OX Country.

##### Points:

All valid two-way contacts score five (5) QSO points. A station may be worked only once for contest credit.

##### Multipliers:

1 Multiplier Point — each of the Continental US States (48 maximum).

1 Multiplier Point — each of the Canadian Provinces (13 maximum).

3 Multiplier Points — each DX Country outside Continental US and Canada.

##### Final Score:

Total QSO Points times total Multiplier Points equals Claimed Score.

##### Contest Entries:

Each entry must include log sheets, dupesheet for 100 or more contacts, a contest summary sheet and a multiplier check list.

##### Entry Deadline:

All entries must be postmarked no later than February 21, 1981.

##### DX Window:

Stations are expected to observe the OX Window from 1.825-1.830 MHz as mutually agreed by Top Band operators. Stations in the US and Canada are asked not to transmit in this 5 kHz segment of the band.

##### Disqualifications:

Disqualifications may result if contestant omits any required entry forms, operates in excess of legal power authorized for his given area, manipulates operating times to achieve a score advantage or fails to omit duplicate contacts which reduce the overall score more than 2 per cent.

##### Awards:

Contest awards will be issued in each award category in each of the Continental US States, each Canadian Province and each DX Country.

##### Contest Address:

To obtain information, entry forms or to submit a contest entry, forward an SASE to:

Dan Murphy WA2GZB,  
PO Box 195,  
Andover NJ 07821, USA.

# AMATEUR RADIO IS A RESPONSIBLE SERVICE

LET'S KEEP IT THAT WAY

# AWARDS COLUMN

Bill Verrall VK5WV  
7 Lilac Avenue, Flinders Park, SA 5025

## GOLD COAST AWARD

The Gold Coast Amateur Radio Society offers two awards, the qualifying requirements for which are as follows:

The applicant must submit an extract of his log documenting contacts with not less than six (6) Gold Coast Amateur Radio Society members, one of which must be the Society Station VK4WIG. Any mode and any frequency may be used and the contacts may be made over any period of time.

This award measures 250 mm x 200 mm featuring a photograph of the Gold Coast in blue with printing in red.

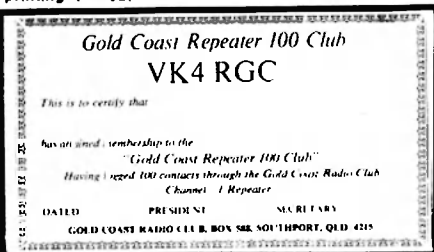

## GOLD COAST REPEATER 100 CLUB

To qualify for membership and the award the applicant must submit an extract of his log documenting not less than one hundred (100) separate contacts with Gold Coast Amateur Radio Society member stations via the 2 metre or 70 cm repeaters. Contacts with the same station at intervals of less than seven (7) days will not be credited for this award.

This award is QSL card size printed on gloss — card colour yellow, with printing in black with surround and callsign in red.

Applications for these awards should be sent to Awards Manager, Gold Coast Amateur Radio Society, P.O. Box 588, Southport, Qld., 4215. The Society has not mentioned a fee, but I suggest that you include sufficient to cover return postage of the award.

The Society also has an awards programme for Ten-Ten International members and this will be described in a later issue.

## WIO (WORKED INDIAN OCEAN) AWARD

This award is offered by the Australia-Chapter 66, of the International Certificate Hunters Club for working stations in and around the Indian Ocean.

### RULES:

1. Work 10 (ten) countries bordering the Indian Ocean plus 5 (five) Islands within the Indian Ocean.
2. QSLs are necessary but should not be sent with the application unless requested by the Custodian.
3. Note Heard Island and Kerguelen Island are in the Southern Ocean and NOT the Indian Ocean. Lesotho-7P8 and Swaziland-ZD5 (3B6) are land locked and are not acceptable for this Award.
4. Cost: \$3.00.
5. Applications should be sent to the Custodian, VK2AIR, 111 Northcott Road, Seven Hills, NSW 2147.

The following are the acceptable islands:

Christmas Island VK9, Andaman Islands VU5, Laccadive Islands VU4 or VU5, Socotra Island VS9, Seychelles VQ9 or S7, Agalega Island 3B6, Comoro Island FB8, Rodriguez Island 3B9, Reunion Island FR7, Juan de Nova FR7, Timor (deleted country) CR8, YB, 8F, New Amsterdam Island FB8, Cocos Islands VK9, Nicobar Islands VU5, Maldives Island

# INTERNATIONAL CERTIFICATE HUNTERS CLUB

## Australia-Chapter 66

AFFILIATE OF THE INTERNATIONAL AMATEUR RADIO SOCIETY

**W.I.O.**  
AWARDED TO  
SPECIMEN COPY

For Meritorious Performance in establishing two-way radio contacts with countries bordering, and islands within, the Indian Ocean as prescribed by the rules governing the Award

Award No. \_\_\_\_\_  
Award No. \_\_\_\_\_  
Mode's \_\_\_\_\_  
Band's \_\_\_\_\_  
Date \_\_\_\_\_  
Custodian \_\_\_\_\_



8Q8, Chagos Archipelago VQ9, Glorioso Island FR7, St. Brandon Island 3B7, Mauritius 3B8, Zanzibar (deleted country) VQ1, Prince Edward and Marlon Islands ZS2, Crozet Islands FB8, St. Paul Island FB8, Tromelin Island FR7

Any other islands within the Indian Ocean boundaries specified and officially accepted by the Wireless Institute of Australia and the ARRL will be accepted for this award.

The award measures 300 mm x 245 mm, printed on light green matt card with darker colours for the edging and map outline and certificate details in dark green.

Good Hunting. ■

## QSP

### 6 METRE BAND — USA

From 14.7.1980 US amateurs were permitted to use standard bandwidth FM voice mission in the 6m band segment 50.1 to 52.5 MHz. Previously this was allowed only above 52.5 MHz. Repeater inputs and outputs are not permitted below 52 MHz but ARRL strongly urged FM operators to avoid using frequencies between 50.1 and 51 MHz and also just above 51.0 and 52.0 MHz when propagation is possible to New Zealand and Australia.—QST August 1980.



# DIVISIONAL NOTES

## VK2

### BLUE MOUNTAINS FIELD DAY

Sunday, 20th November, 1960 is the date to set aside for the Blue Mountains Amateur Radio Club Field Day.

This worthwhile event in the clear air of the mountains gains in popularity each year, last year there being 250 people who popped in to take part in events or simply browse through the exhibits.

The Field Day is conducted in the grounds of the Springwood High School which is situated on the corner of Grose Road and Chapman Parade, Faulconbridge. Grose Road runs off the Great Western Highway just a few kilometres on the Katoomba side of Springwood.

As the exhibitors' areas is under full cover, with ample space, the show goes on hail, rain or shine.

In addition to exhibits, events such as scramble, fox hunts (mobile and pedestrian), ladies radio throwing contest, etc., will be run, together with a raffle and auction.

If you are not going to register for competition in events there is no fee for entry to the exhibition area. Competitors will be provided with free tea and coffee.

Those liking more information or those who would like to exhibit are invited to contact Peter Willis (047) 39 2203, Geoff Swift (047) 39 1144, Terry Ryland (047) 39 2551 or John Belshaw (047) 39 3615 AH (02) 237 3707 Bus.

## VK3

### MOORABBIN AND DISTRICT RADIO CLUB MID-WINTER FIELD DAY JULY 13th RESULTS

#### SECTION A — VHF/UHF

- Phillip Haggood VK3ATI  
Portable at Peters Hill, near Anglesea **35,505 points**
- Robert Harris VK3XQ  
Portable at Wattle Hill, near Yea **29,856 points**
- Robert Jennings VK3AVJ  
Portable at Mt. Worth **25,111 points**

#### SECTION B — 10 METRES

- John Emery VK3UA  
Portable at Mt. Dandenong **109 points**
- Len Mostert VK3NLP  
Portable at Loch **98 points**

The Club congratulates the winners and thanks all who participated, especially the few whom operated on 10 metres.

It is hoped that support for the 10 metre section will be on a very much bigger scale next year.

## VK4

The annual meeting of the Ipswich and Districts Radio Club was held on the 4th of July at the Club building. The following officers were elected to office:—

**President:** Wayne Bryce VK4AB.  
**Secretary:** Neil Harper VK4NLU/ZRI.  
**Treasurer:** Peter Morris VK4NHR.  
**Vice-President:** Ron England VK4NED/ZNS.  
**Station Manager:** Milton Rowe VK4YR.  
**Public Relations:** Bill Jehn.

The subjects are, standing, M. Rowe, seated from left, N. Harper, W. Bryce, P. Morris, Bill Jehn. (Bill has been the public relations officer since the beginning of the Club eighteen years ago.)

Meetings are held on the first and third Wednesday of each month at the Club building in Deebing Street, Denmark Hill, Ipswich. Visitors are welcome.



The Queensland Amateur Radio Association of Railwaymen have recently issued a new award. The award has been established to commemorate



the inception of electric trains in Brisbane metropolitan area by the Queensland Government Railway. To qualify for the award an amateur or listener must either contact or log five contacts with Queensland amateurs who are or were employed by the QGR, one contact to be with a charter member. Contacts after 17th November, 1979, are valid. Any mode or band may be used. Concessions may be given to interstate or overseas stations holding only a limited licence. Applications should contain a copy of relevant entries in the station log verified by a JP or full call amateur and \$1 application fee.

Charter members are Barry VK4ABB, Frank VK4AFW, John VK4NIB, Bruce VK4NIQ and VK4NLU/ZRI.

A net is held for Queensland railwaymen each Tuesday night on 80m. All welcome.

Submitted by Neil Harper VK4NLU/ZRI.

## AROUND THE TRADE

### HIGH QUALITY HAND-HELD TYPE APPROVED

Vicom International Pty. Limited, of Eastern Road, South Melbourne, have been successful in obtaining type approval for two Danish hand-held VHF and UHF transceivers. Ingeniortima Gorm Niros appointed Vicom as their Australasian agents some months ago. The Niros 707 is a compact professional radio telephone to be used in the VHF low/high bands as well as UHF bands. It can be supplied with up to four channels with a power output of minimum 1 watt.

The Niros 707 is supplied in a stainless steel cabinet and meets the Danish Research Centre for Applied Electronics standards for shock, vibration and temperature. The unit is also waterproof and moisture resistant. The Niros Model 707 is supplied with selective calling for both transmitter and receiver. Offering up to 100 codes, the system utilizes the CCIR/ZVEI systems, making it compatible with most current operations.

Sound output of the audio loudspeaker measures 83 dBA at 1 kHz, measured 50 cm from the loudspeaker. This lightweight hand-held unit is also extremely efficient allowing its nickel cadmium batteries to power the unit for 12 hours with a five per cent transmission cycle. Recharging can be accomplished in one hour, with the use of one of the large range of chargers available.

The Niros range of transmission equipment is available now for demonstration from Vicom Inter-

national, 68 Eastern Road, South Melbourne, or the Sydney office, 339 Pacific Highway, Crows Nest, Melbourne (03) 699 6700, Sydney (02) 436 2766.

Redifon Telecommunications and Vicom International have recently signed an agency agreement which appoints Vicom International the sole Australasian Agent for the Redifon Telecommunications range of communications products.

Redifon Telecommunications is a specialist company with more than 40 years experience in the design, manufacture and supply of radio communications and radio navigations equipment for civil, military and naval applications. It has particular expertise in planning, installation and commissioning of complete turn-key systems.

Of particular interest in the range is the Redifon R1000 series of remote controlled HF receivers. This microprocessor controlled receiver (probably one of the most advanced available in the world today) controls all the functions including antenna selection, channel, scanning, mode, bandwidth—the unit even supplies standard RS232 interface for direct connections to communication computers.

For information pertaining to any of the Redifon range of equipment Vicom International can be contacted at their Melbourne Head Office, telephone (03) 669 6700, or the Sydney branch, 339 Pacific Highway, Crows Nets, telephone (02) 436 2766.

# AT LAST!

## THE TYPE 610 BRITISH POST OFFICE designed MORSE CODE KEY

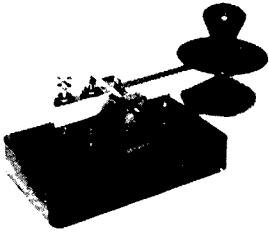

There has never been a better designed Morse Code Key — SOLID, ROBUST and BEAUTIFULLY BALANCED.

**\$31.00** (Post Paid)

"LEARNING THE MORSE CODE" — Cassette Album Training Course. You will progress rapidly using this modern training system.

**PRICE \$20** (Per Album of 3 Cassettes)

**WILLIAM WILLIS & Co. Pty. Ltd.**

98 CANTERBURY ROAD CANTERBURY VIC  
Phone 836 0707

## INTERNATIONAL NEWS

### AMATEUR STATISTICS

According to the latest statistics compiled by IARU from members societies' returns, the countries with the highest number of amateurs are shown as— Japan 399,915, USA 380,000, West Germany 36,055, USSR 26,000, UK 25,000, Argentina 23,500, Canada 18,000, Brazil 17,200, Italy 17,000, Venezuela 11,000, Australia 10,587 and France 10,015; all others are under 10,000. Society memberships are given as:— USA 155,000 USSR 142,000, Japan 109,236, Yugoslavia 54,061, West Germany 38,929, UK 24,000, Brazil 22,000, Spain 14,917, Czechoslovakia 11,986, France and Italy each with 11,800. Annual licence fees in US \$ vary considerably, but of the larger-population countries the rates are given as— USA nil, Japan 1.60, West Germany 20.00, UK 13.00, Canada 15.50, Brazil 1.50, Italy 4.00, France 25.00. Age requirements vary from 21 downwards. High power (1 kW) is allowed in Bulgaria, Finland, East Germany (2 kW), Israel, Ivory Coast, Jordan, Lebanon, Liberia, Yugoslavia, Philippines, Thailand, W. Samoa and most countries of the Americas. Third party traffic is shown as permitted in Ghana, Gibraltar, Israel, Jordan and numerous countries in the Americas. In many countries membership of the national society is a requisite for amateur licensing.

### CCIR

An ITU CCIR Study Group is scheduled to meet in Geneva from 27th November to 19th December to consider various technical questions generated in national CCIR study groups. Because these questions can have an impact on the deliberations at subsequent specialised WARC's (about a dozen are scheduled in this decade), IARU will be represented.

### WARC MOBILE

The ITU has announced a WARC to consider the Mobile Service to be held in Geneva from 2nd March, 1982, for three weeks and three days. Some agenda items will be of concern to the amateur

service and accordingly IARU is arranging for an observer team to attend.

### NZ NEWS

According to Break-In July 1980 the NZART has received letters from their Director of Telecommunication operations advising that steps are in hand to increase the validity of the Novice licence from one to two years. Concern was expressed by NZART that new and used radio equipment could be readily purchased and used by unlicensed operators. The Director advised that the possibility of passing legislation prohibiting the sale of amateur radio equipment to other than licensed amateur radio operators is not favoured at this time for various reasons, including problems of equipment exchange between amateur operators. Another letter from the Director advised a change in the system of re-allocation of call signs. Henceforth a call sign once allocated will be permanently retained by the licensed amateur operator irrespective of where the stations is located — except for progressions Grade III to Grade II. Callsigns are not re-allocated until after two years from the date of dismantling a station for whatever reason. All this was also in recognition of the personal attachment most amateur licensees develop towards the call sign allocated to them.

### IARU MEMBERS

Four new members have been admitted to IARU. These are Montserrat Amateur Radio Society, Federacion de Radioaficionados de Cuba, Radio Society of the Gambia and the Solomon Islands Radio Society. This brings IARU membership up to 111.

## ALARA

AUSTRALIAN LADIES' AMATEUR RADIO ASSOCIATION

YL Activity Day is continuing to be a success. The aims are to meet and get to know YLs normally only contacted briefly in contests, without contest pressure; to have more personal OSOs than are possible in a formal YL net; to meet old and new YL friends without the necessity of making and keeping numerous skeds; and to help an OMs who may need a quick contact for a YL award.

Call "CQ YL" on the hour every hour on the sixth (GMT) day of each month. If it turns out that there are too many people on a particular frequency, feel free to QSY, have your chat, and then rejoin the group. Look for YLs on 3.688, 7.088, 14.288, 21.188, 28.688 MHz.

For those who prefer CW contacts, the frequencies are 28.058, 28.133, 21.058, 21.133, 14.058 and 14.133 MHz.

Our congratulations to:

**Bronwyn VK5NBV**, who gave birth to a 7 lb. 2 oz. boy, her second son.

**Margaret VK3NHD**, who passed her theory exam. She now also has the call sign VK3YYL. Margaret lives on a farm in Echuca, and recently called in at an ALARA meeting in Melbourne. We hope she'll join us again soon.

The two new lull calls in VK5, Vicky VK5FK and Jenny VK5ANW.

Four new members of ALARA are Joy VK2VJV, Josie VK4VAN, Beryl VK2VDS and Yvonne VK3VON. Joy lives in the small town of Yeoval and is the only "ham" there. Josie is a member of the Redcliffe Radio Club; she has three children and three grandchildren. Beryl is from Charlestown; she shares her rig with one son and has a regular sked with the other son in Tasmania. Yvonne is the only licensed YL in the Ballarat area, and she is trying to get YLs interested in taking classes for the novice exam.

The ALARA net is at 0930 GMT at 3.562 MHz every Monday night. Net controller is Geraldine VK2NQI.

The VK4 YL net meets every Tuesday night at 1000 GMT on 3.575 MHz.

YLs interested in joining ALARA should contact Daurel VK3ANL, Box 110, Blackburn 3130.

Maggie VK3NQQ.

# IF YOU'RE NOT BUYING AMATEUR RADIO ACTION



(IT'S AUSTRALIA'S BEST SELLING AMATEUR MAGAZINE)

# THEN YOU'RE NOT KEEPING UP WITH THE LATEST NEWS, VIEWS AND REVIEWS

Please put me down for 12 editions of Amateur Radio Action, starting NOW!

**Rates in Australia - \$14.40 Surface mail overseas - \$18.40 Air mail: To New Zealand - \$A28.70; Malaysia - \$A32.60; Japan - \$A38.45; USA - \$A42.35; UK - \$A46.25**

Herewith enclosed cheque/postal note/money order to the value of:

\$A.....

Name.....

Address.....

Postcode.....

Post to: Amateur Radio Action Subscriptions, Box 628E, Melbourne 3001.

# SILENT KEYS

It is with deep regret that we record the passing of —

Mr. V. R. P. COOK	VK5AC
Mr. K. F. LEE	VK4ALE
Mr. R. F. MUSSETT	VK3AIX
Mr. W. O. D. HARWOOD	VK3SR

# OBITUARY

**KEITH FRANK LEE** VK4ALE  
It is with deep regret that I announce the untimely passing of Keith VK4ALE, age 42 years, victim of a motor accident on 31st August, 1980. Although only a relative newcomer to amateur radio (attaining his novice call VK4NIX at the May, 1978, exam and his full call in December, 1979), he made numerous friends on air, but in the main preferring to talk to a few specialists. At the time of his death he was getting interested in 2 metre sideband from his OTH in the Central Highlands to the coastal areas. He was a foundation member of the Gemfields Radio Group, helping to set up the Group's affiliation with the WIA, Old. Division. On behalf of this Group and other amateurs within the fraternity, I wish to offer our condolences to his wife, Sue, and

his two small children in their tragic loss. We here in the Group will miss a true friend.

GORDON LOVEDAY VK4ZBI/NMJ. ■

**RUSS MUSSETT** VK3AIX  
Here was a true radio ham of a type unknown to the recent newer ham. He used to build the entire rig from the microphone to the aerial — no mean feat in these days.

The signal from his home-made SSB transceiver was second to none, and still is. Fancy winding min. I/F transformers and other small components in the rig.

This was the Russ we knew.

He will be missed by all of us "Oldies" of the North Suburban Amateur Radio Group and he will be remembered by all of us as a true make your own type of ham, very rare in these days of the black box.

How often do we hear of a fellow who, after many unhappy events, reaches retirement, gets a nice new car, has a happy future in his sights only to suddenly die.

We will always remember Russ Mussett VK3AIX.

To his XYL Beryl and their respective families we extend our deepest sympathy.

Basil Rogers VK3ABJ.  
Ted Howell VK3ZKP,  
Historian of NSARG. ■

# 1980 WIA CALL BOOK OUT NOW

**\$2.95 plus post & packing**

\*

Send **\$3.50** for your copy NOW  
To your Division

OR

**MAGPUBS**  
Box 150, Toorak, Vic. 3142  
while stocks last.

- All the latest publishable call sign information.
- Reference data including frequency tables and amateur bands.
- Alternate WIA badge depicted in colour on cover.
- Why not buy the Handbook, Log Books and other items at the same time?

# HAMADS

- Eight lines free to all WIA members. \$9 per 3 cm for non-members.
- Copy in typescript please or in block letters to P.O. Box 150, Toorak, Vic. 3142.
- Repeats may be charged at full rates.
- Closing date: 1st day of the month preceding publication. Cancellations received after about 12th of the month cannot be processed.
- QTHR means address is correct as set out in the WIA 1979 Call Book.

## FOR SALE

TS180S complete with 2nd SSB filter and CW filter, 3 months old, \$1150. Ph. (03) 729 8482 (AH).

Kenwood TS600 6m Multi-Mode Txcvr, \$450. VK2YEV, QTHR. Ph. (049) 49 7546.

KP202 2m, hand held, with nicads and charger, repeater 2, 4, 6 & 8, simplex 40 and 50, Scalar antenna, VGC, \$120 ONO. Leo VK3ZGF, QTHR. Ph. (03) 25 3968.

Kenwood TS120S, \$600; Drake WV4 wattmeter, \$60; Oscilloscope Serviscope 10 MHz Inc. handbook, \$100; Icom IC202, \$150; National video camera and portable recorder and charger, \$500. VK5AS, QTHR. Ph. (086) 29 2174 AH, (086) 29 2199 Bus.

Aide 103 SSB/CW Txcvr, solid state with dynamic mike, 250 watts SSB input, 250W CW, with noise blanker, 100 kHz and 25 kHz calibrator, heavy duty power supply, mint cond., as new, service manual supplied also, \$425. John L20252. Ph. (02) 389 6455 Bus. P.O. Box 505, Bondi Junction, 2022, NSW.

Collins 75A, 4 ham bands Rx, 160-10m in 1 MHz bands, mechanical filters 0.5, 3 & 6 kHz, passband tuning a la TS120 etc., valves tested, completely re-aligned, very stable, uncrunchable front end, includes manual, spare VFO, \$475; Ailas 210X and DD6 digital dial, DD6 doubles as freq. counter to 50 MHz, \$400; Cybernet CB on 10m, exc. performance, \$100; Europa TV Tr, 10m-2m, solid state Rx, 6/40 in PA, useable with most valve HF rigs, e.g. FT901, TS520 etc., \$80. Prices all ONO. Call Ken VK5ZEA. Ph. (08) 51 9689 Bus.

Yassu FT223, 2m FM Txcvr 10W 23 ch. with 12 litted, \$200, as new; Belcom 2m SSB 10W synth. Tcvr, \$200. Ph. Steve (02) 674 2104, after 5.30 p.m.

Kenwood TR-7500, 40 channel PLL, 146-147 MHz, mobile, \$250. VK4ZN. Ph. (075) 32 1885.

Exciter ex FM Tx, 406 to 556 MHz out in 0.5 MHz steps, 4 x 150 and 4C x 250 tubes in sockets, 35W out, no power supply, \$140; Frontier LA6, 6m linear, single 4C x 250, full output with less than 5W input, \$345; Collins 30L1 linear, perfect, \$535. VK1VP, QTHR. Ph. (062) 48 5882 AH.

FT901DM with SP901 Speaker and YO148 desk mic., complete in original packing, \$1385 ONO; TS820 in VGC, \$850; Drake model TR4C Txcvr with AC-4C power supply and 34-PNB noise blanker with spare and RV-4C remote VFO, complete in original pack., \$485 ONO; Linear amplifier Alpha 77DX, pair of 8877's ceramic/metal lridodes in G/G in, output, tuneable 1.8-30 MHz continuous, POA. Greg VK3BIB. Ph. (055) 4630 AH only.

50ft Telescopic TV Tower, no rust, has carried rotator, TH3 tri-bander and dipoles. VK3JY, QTHR. Ph. (03) 836 3841 AH, (03) 347 4850 Bus.

Co-axial Cable Siemens V45466-P4-B5 and V45466 DS-BS, eq. to PT29M and PT20M, double screened 75 ohm, 25c per metre; Capacitors, 1000 uFd, 50V, DCW, 800 uFd, 35V, non polar, 4uFd, 400V oil, 250 uFd, 50V paper oil; 3 gang tuning caps, small size, valves, 4CX125 811 Aa. VK4WR, QTHR. Ph. (071) 41 1315.

TR2200A, hand held, xtals for English-European 2m channels S20, S21, S22, S23 and S24 simplex, repeaters 3, 4, 5, 6 and 7, copy of internet. VHF FM guide, \$70; Phillips UHF radiotelephone, rep. 450-470 MHz, 5W output, all solid state, brand new, rack mounted 21-53V DC supply, easily converted to amateur band or may be a repeater, \$150. VK4ZF, QTHR. Ph. (07) 390 3328.

Oscilloscope 5" AWA, \$60; also Panadaptor T-200, 455 kHz, like new. VK3AIL. Ph. (03) 570 5994 AH. FT7, unmarked, packing, no mobile use, proven good perf. addit. xtal for 10m, \$380; 5A PSU to suit, \$20. VK2ZRD, QTHR. Ph. (02) 456 1577.

IC502, prof. mods., box chassis, 5 kHz geared dial, S-RF meter, var. AGC, S'tone, manual, 5W PEP, Inc. 40W SS final diecast box, \$200; Trio 9R59DPS Rx, VGC, \$85; PRC10 FM Rx 38-55 MHz plus CKT, \$55; TH3JNR, as new manual, balun, box, \$145; 4C x 250R, new, plus nylon Skt., \$40, 829B twin tetrode, new, \$20; 832A twin tetrode, \$5; skls., \$5; 350 pF var. conds., 2.5V rating, \$20; 4 uT, 3KV conds., \$8; trans. 2 x 10-0-10V at 10 amps, \$30; trans. 5V CT/23 amps, \$5; sundry TV trans., EA video game, \$10; conversion xtals, set of 4, suit SE502 CB etc., \$10. Neville VK2QF, QTHR. Ph. (063) 7384-9U, week nights.

2m Hand Held Txcvr, Standard SRC146, VGC, Ch. 40, 50 and 3 rpts., xtals for rpts. 2, 3, 4, 5, 6, 7, 8, telescopic whip and rubber ducky ants., ext. noise cancelling mic., solid leather case, nicads, charger, handbook, \$170. VK3AFW, QTHR. Ph. (03) 579 5600.

Complete Station: FT101E in mint cond., c/w manual and original carton, professionally modified for Novice use, Hidaka VS33 triband heavy duty yagi and Emotator rotator with control unit and cable to suit, all in perfect as new working order, lot \$1095; genuine reason for sale. Mario VK3NZF, QTHR. Ph. (03) 311 8936 AH, (03) 68 3204, etc. 42 Bus.

Frequency Counter, 100 kHz to 500 MHz, in-built pre-scaler, input level meter and dual regulated power supply, \$105; Heath IM17 FET multimeter, with PK3 RF probe, \$40. VK2WD, QTHR. Ph. (02) 427 6080.

FT-7 Txcvr., as new cond., original, no mods., comes complete with 2 xtals for 10m, i.e. 28.0 to 29.0 MHz, genuine reason for sale, \$400. VK1DX, ex VK1NAI, QTHR. Ph. (062) 68 2430.

Communications Receiver, STC type A679-H, frequency range 1.5-24 MHz, continuous coverage in four bands. VK2LK, QTHR. Ph. (02) 635 6874.

RF550 Speech Processor, \$100, or exchange for radio gear. Wanted: Cat's whisker detector in glass tube. VK6GE. Ph. (09) 349 7247.

Kenwood 2m Multimode TS700SP digital, VOX, blanker, selectable sideband and selectable RPT offset, etc., used 1 hour only, definitely showroom cond., extremely low price. VK2AAM. Ph. (049) 2 0321 Bus., (049) 43 8910 AH.

Astro 200 HF Txcvr., fully synthesised, 80 to 10m, must sell, \$500, ONO; Kenwood TR7625, new cond., with noise cancelling mic., \$300. Bob VK4AWK, 67 Wilks Street, Cairns 4870. Ph. (070) 54 2385.

Kenwood TR7400A Txcvr., 2m, 250 watt, mobile, digital, \$250; complete, plus two antennas, lots of coax. VK2CE, QTHR. Ph. (02) 871 7758.

Swan 240 Txcvr., with AC power supply, maintenance manual, spare output valve, 20, 40 80m, \$150; 2m AWA carphone Jr. MR6 with xtals simplex 40, ch. 2, 3, 4, 5, 6, 8, \$50. VK3ZGS, QTHR. Ph. (054) 46 8795.

Ken KP202, 2m, hand-held, ch. 40, 50, repeaters 2, 3, 4, 5, 6, 7, 8, nicads, charger, 1/4 wave and helical ant., \$150. VK2ASI, QTHR. Ph. (067) 65 7947 AH.

**ALBANY****LOCKYER LAUNDRETTE**

32 SOUTH COAST HIGHWAY  
(Off the Roundabout)  
7 WASHERS and 4 DRYERS  
Support a Local Amateur  
VK6NQ

Kenwood TS120V and TL120 AMP, 100W output, both as new in cartons with manuals, \$595. VK3UJ, QTHR. Ph. (03) 874 5332.

Type N Coaxial Connectors and lengths of RG-8 cable, swap for transmitting type variable capacitors.; VK3XU, OTHR. Ph. (03) 725 0824.

Estate Late VK4ALE: Kenwood TS520S tcv. with AT200, mint cond., with h'book, \$700; Kenwood TS120V tcv., h'book, mint cond., \$500; Kenwood TR9000 tcv., multi-mode, 2m, used twice; \$550; Hi-mound key, \$25; High Gain 5 CB converted to 28 MHz, \$100; SWR meter to 150 MHz, \$20; "O" meter, "Practical Wireless", h/brew, \$30; Yaesu gutter mount, 2m, plus 80m whip, 40; small quantity "73" at \$1. each; AR complete from 1978; ARA and Practical Wireless, others; 38 to 56 MHz FM tcv., with tuner unit, 24V DC, \$20; Sundries, PL259 connectors, many odds and ends for junk box. Write to VK4ZBI/NMJ, QTHR.

Yaesu FR100B Rx., 160 through 10m, with FM detector, in good working order, complete with h'book and all modification details, \$200; Yaesu FL200B transmitter, 80 through 10m, not working on 10m and audio needs attention, otherwise okay, complete with h'book and all modification details, \$150; Rx and Tx are complete with a moderate number of spares. R. Champness VK3UG, OTHR. Ph. (057) 62 1454 AH.

Yaesu FT-7B Txcvr., had very little use, covers 10-80m, has been professionally tuned over all bands, approx. 70 watts actual output, \$520. Ph. John (054) 84 1777 alter 5.30 p.m. QTHR.

Yaesu FT707, FP707 and Y0148 Desk Mic., as new, forced sale, cost over \$1000, sell \$900, ONO; Yaesu FDX100 80-8m and 3 aux., 140W input, take \$350; Star SR700A AM Rx., and 5 aux., v/selectivity and notch filter, \$120. VK2AOV, QTHR. Ph. (060) 21 4811.

Kenwood TS-120V with mobile bracket, owner and workshop manuals, mic., \$500, ONO. B. Willis VK4ABY, Kent Street, Forest Hill, Q. 4342. Ph. (075) 65 4354.

FT277R Memorizer, 800 channels, exc. cond., complete with mic., manual, mobile mount and hardware, sell for \$270. Contact John Brereton VK5NHB, QTH.

Kenwood TS180S, new, \$180; TR9000, new, \$475; TR2400, new, \$300; VFO 120, new, \$120; AT120, new, \$90; FDX400, mint, \$350; FT7, as new, \$350; Drake TR4B, spotless, AC and DC supplies, \$500; TS120S, new, \$630. Ph. Cliff (065) 52 4477 Bus., (065) 59 1508 AH.

Welmecc Tape Gear, comprising tape punch and reader, configured for ASCII but may be modified for Baudot, heavy duty power supply and keyboard with diode encoder (ASCII), \$80. VK5BI, QTHR. Ph. (08) 45 6140 AH, (08) 45 0023 Bus.

GE Galaxy 5 HF Txcvr., 80 through 10m, 300W PEP, new finals filled, may be heard on air, complete with PS, instructions, etc., \$260, ONO. Hans Smit VK5XY, QTHR. Ph. (08) 74 2350.

Swan 400 Txcvr., external VFO (spare valves), \$250, ONO; Yaesu FT75 with VFO, AC and DC power supply (spare valves), \$300; Taylor 32B CRO 5 in., suit RTTY, \$50, ONO. VK6XO, QTHR. Ph. (099) 21 0137 Bus., (099) 21 2271 AH; will return calls.

Communications Power Incorporation Linear, type HF150, band switching, built-in RX pre-amp, used very little, \$95. VK4AAJ, 15 Bettina Street, MacGregor 4109. Ph. (07) 349 6684.

AR240 Fast Charger, charges flat nicads in 4 hrs. then trickle charges, operates from 12V DC, base or mobile, as new, \$30, ONO. Ray VK1ZJR/4, 1 Heather Street, Silkstone, Qld. 4304. Ph. (07) 33 7338 Bus.

Hallcrafters HT32A Tx and SX101 Rx, plus power supply, VG cond., \$450. VK3NOJ, QTHR. Ph. (03) 735 4989 after 1900h.

Amateur Radio Station comprising Swan hybrid Txcvr., model 750CW-SS16B, 550W PEP SSB/360W CW, 3.5 to 29.7 MHz, fitted ultra selective 16 pole SSB IF filter, shape factor 1.28 response, active 80/100 Hz CW filter, crystal calibrator 25 or 100 kHz, CW audio sidetone, PTT or VOX select, this rig only model in VKland, separate combined power supply and speaker unit 230XC, plus Shure 444 desk type mic., also relevant handbooks and comprehensive kit of support spares supplied by Swan, comprising full complement of lubes, resistors, diodes, integrated circuits, dial lamps, resistors, selected capacitors, relays and essential front panel controls, first class cond., two years old, cost \$1300 total, will accept \$750, ONO, free delivery Sydney/Newcastle areas, otherwise buyer pays freight onwards. VK2BFJ, 90 Wyong Road, Killarney Vale, NSW 2261. Ph. (043) 32 5758 (Central Coast) any time.

Lafayette HA800B Rx., all solid state, dual freq. conversion, amateur bands, 80 to 6m, AM, SSB, CW, standby, remote, built-in power supply, 240V, original carton and handbook, in excellent cond., \$110. VK2VHP, QTHR. Ph. (02) 84 2195 alter 7 p.m.

Yaesu FT101B Transceiver, had little use, in exc. cond., complete with spare set of finals, manual, leads and orig. packing, \$595. Colin, QTHR. Ph. (03) 876 1987.

Drake MN2000 ATU, as new, with built-in SWR/watt meter, will handle 2 kW. \$230. VK3PR, OTHR. Ph. (056) 62 2711.

Swan Cygnit 300B HF Txcvr., in good cond., with mic., DC power supply, manual, in orig. carton, no mods., \$490 or best offer. K. Blume VK2BJK, QTHR. Ph. (02) 449 1598.

Shack Cleanout: Type 3MK2 Tx and Rx, BC453, BC454 (both modified), condensers fixed and variable and coils ex TU7 units, silvered tank coils, inc. VHF, coil formers, meters, power chokes, coax plugs and sockets, mic. plugs and sockets (some new), relays, knobs, dials, AT5 cables, obs. lubes, resistors, terminals, etc. VK3XB, QTHR. Ph. (03) 288 4686.

Icom IC245 tunable 12V 2m FM transceiver, \$285; Hanson VTVM, \$35; Vinten MTR 13 with 2, 4 and 8, 40, 50 and V, \$40. VK3OH, OTHR. Ph. (03) 277 4623.

Uniden 2020, good cond. Ph. (03) 791 2947 AH.

Yaesu FT101 with blower, as new, only used now and again when portable, complete with mic. both power leads and instruction manual, \$525. Bert VK3BH, QTHR. Ph. (03) 80 1204.

Drake TR4CW 300W 1/P noise blower, rem. VFO, AC power supply, speaker; Yaesu FT7 20W DC 1/P, all equipment in orig. boxes and with manuals, all in mint cond. VK2BLU, OTHR. Ph. (02) 85 4770. Eddystone, Model 750 Double Conversion Rx, 480 kHz to 32 MHz, exc. cond., complete with S meter, spare set of valves and handbooks, \$120. VK3VF, OTHR. Ph. (03) 723 3554.

Yaesu FT101E, 1 year old, in very good cond., with all books, cables and packing, must sell, \$600, ONO. Ken VK3AKK, Ph. (03) 688 9295 Bus. (free STD call).

Frequency Counter, by non-linear systems, as new, ranges 0-10, 10-60 MHz, with prescaler (provided but unfinished), 250 MHz prescaler requires 1 integrated circuit, unit is portable, small, digital and includes nicads and charger, \$200, ONO. VK4NGK/ZOZ, QTHR.

## ADVERTISERS' INDEX

AUDIO TELEX	44
AMATEUR RADIO ACTION	40
BAIL ELECTRONICS	43
DICK SMITH ELECTRONICS	2
CFS	6
NSW DIVISION WIA	28
SCALAR INDUSTRIES	7
SIDEBAND ELECTRONIC ENGINEERING	30
VICOM PTY. LTD.	4, 25
WILLIAM WILLIS	40
W. & G. WULF	27

**SHUTE HARBOUR**

## MOTEL & Licensed Dining Room

SHUTE HARBOUR, Q. 4800  
PHONE (079) 46 9131

DAVID McINERNEY

TS520 and VFO, \$500; Vinten MTR12, 52.525 FM, \$20; 7 ft. 80m helical, \$20; Kyoritsu SWR meter, \$5. VK3CR, 31 Myola Street, Carrum 3197. Ph. (03) 772 4570.

TH3 Antenna, c/w balun and 15m new RG-213 cable and UHF plugs fitted, \$160. Graeme Barrett VK-L60287, PO Box 266, Narrogin, WA 6312. Ph. (098)81 1671.

**WANTED**

Swap FRG-7, good cond., for a heavy duty rotator and accessories. Contact M. A. Martin VK3VSM, 19A Mason Street, Regent 3073. Ph. (03) 470 1256, ask for Max, between 3-7 p.m. All enquiries considered.

General Coverage Receiver, 0.5-30 MHz, FRG-7 or similar. Price and particulars to VK3AMT, QTHR. Ph. (059) 86 2601.

Kenwood TS600(A) 6m all mode Tcvr. Contact Neville VK2QF, QTHR. Ph. (063) 7384-U, week nights.

FTV650 or similar commercial 6m transverter, will consider faulty unit at reasonable price. Details by mail please. VK3AFW, QTHR.

Daiwa 2m FM Receiver, prefer some xtals filled, especially ch. 3 and 7, also want 70 cm module to suit Yaesu FTV-901R V/U transverter. Geoff VK2AZT. Ph. (069) 42 1392 with prices.

Old Traeger TM2 Transceiver information and schematic diagram for Cybernet (PLL) Bushranger CB. Require mobile rig or 11b-80m-10m transverter (schematic OK). E. Greenfield VK6NIE, C/- Salvado College, New Norcia, 6509.

Xtals to suit Yaesu FL-50, 3.5 MC, 8672.4 KC — 8872.4 KC 7 MC 12.172.4 KC — 12272 KC 14 MC 8.827.6 KC — 9.127.6 KC 21 MC 15.827 KC — 16127 KC 28 MC 22827.6 KC — 23327.6 KC. Jack VK5JT, QTHR.

High Tension Transformer, suitable for 400W PEP linear. Keith VK6NGU/4. Ph. (07) 262 3555 AH.

FV101B External VFO, complete with cables, suit FT101E, must be top cond., details and price Doug VK2BKT, QTHR. Ph. (02) 48 1911.

Young almost penniless new Novice needs a simple transmitter or transceiver for work on 80m, other bands if possible. Contact R. Champness VK3UG, QTHR. Ph. (057) 62 1454 AH.

Does anyone have information converting the MTR 25/A AWA highband carphone to 2m? Ph. (02) 73 2662 AH.

**TRADE HAMADS**

Alpha Linear Amplifier 76PAE, uses 3 EIMAC 8874 tubes, 1-30 MHz, maximum legal power plus, \$2095; Ham III CDE antenna rotator with 100 ft. Belden cable, \$225; Shure 404C hand-held mics., \$50 ea. James VK2JO, GPO Box 5076, Sydney 2001. Ph. (02) 799 5566 or (02) 36 7756.

Datong Morse Tutor. VK2DET, Corrimal, NSW. Ph. (042) 84 3400.

**WANTED KNOWN**

Evening Classes in Japanese Conversation. For further information contact Bruce VK3BWX. Ph. 772 1975.

# UNITY IS STRENGTH



**TH5DX**

**10-15-20 METERS**

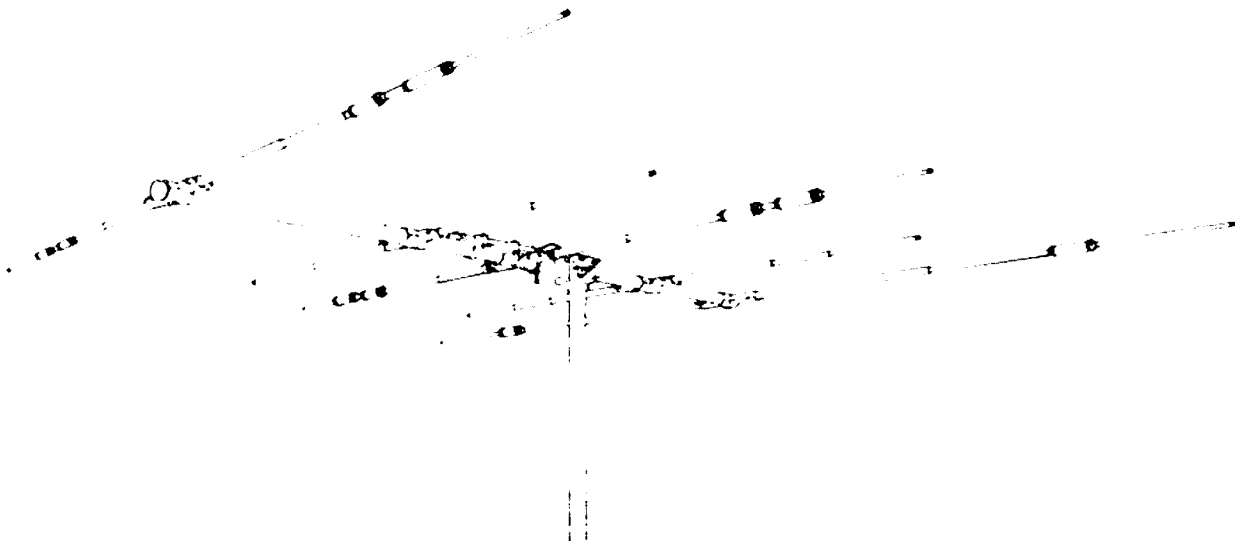

We are proud to introduce the newest member of our famous Thunderbird line of Tri-Band antennas. The TH5DX offers outstanding performance on 20, 15 and 10 meters. It features 5 elements on an 18 foot boom, with 3 active elements on 15 and 20 meters and 4 active elements on 10 meters. The TH5DX also features separate air-dielectric Hy-Q traps for each band. This allows the TH5DX to be set for the maximum F/B ratio and the minimum beam width possible for a Tri-Band antenna of this size. Also standard on this antenna are Hy-Gain's unique Beta-match, rugged Boom-to-mast bracket, taper-swaged elements and improved element compression clamps.

Boom length..... 18 feet  
 Longest Element..... 31 feet  
 Turning Radius..... 18 feet  
 Surface Area..... 6.4 sq. feet  
 Wind load..... 164 lbs  
 Weight..... 50 lbs

VSWR at resonance..... less than 1.5:1  
 Power Input..... Maximum Legal  
 Input Impedance..... 50 ohms  
 -3dB Beamwidth..... 66° average  
 Lightning Protection..... DC ground  
 Forward Gain..... 8.5dB  
 Front-to-Back Ratio..... 25 dB

**WRITE OR CALL FOR A FREE BROCHURE AND THE NAME OF YOUR NEAREST HYGAIN DEALER  
 SOLE AUSTRALIAN DISTRIBUTOR**

**AUDIO TELEX COMMUNICATIONS  
 PTY. LTD.**



**MELBOURNE:**  
 7 Essex Road,  
 MOUNT WAVERLY 3149  
 Tel: 277 5311

**BRISBANE:**  
 394 Montague Road  
 WEST END 4101  
 Tel: 44 6328

**SYDNEY:**  
 1 Little Street,  
 PARRAMATTA 2150.  
 Telephone 633 4344

# amateur radio

JOURNAL OF THE WIRELESS INSTITUTE OF AUSTRALIA



VOL. 48, No. 12

DECEMBER 1980

## ***FEATURED IN THIS ISSUE:***

- ★ **TEN TURN CHOPSTICK HELICAL — A HIGH GAIN ANTENNA FOR SATELLITE WORK**
- ★ **A REVIEW OF THE IC720 HF TRANSCEIVER**
- ★ **PROJECT ASERT — VHF PROPAGATION BETWEEN ALBANY AND ADELAIDE, 1979-80**
- ★ **RON WILKINSON ACHIEVEMENT AWARD**
- ★ **A MAN AND HIS HOBBY — VK3ACR**

# THE RECEIVER

## NEW YAESU FRG 7700

MORE FEATURES THAN THE 7000 —

and it's **CHEAPER!!**



Cat. D-2840

Freight \$6  
Below cost anywhere in Aust.

**WIN A TRIP TO HONG KONG CONTEST BUY NOW AND ENTER!**

First the incredibly popular FRG-7. Then the FRG-7000. Now a brilliant new all mode, general coverage receiver with all the features the keen amateur or short wave listener really needs.

Digital Display — reading from 150kHz to 30MHz! This also doubles as a highly accurate crystal controlled clock.

Wide dynamic range. Selectable AGC. All mode (including FM and 3 widths of AM). Optional twelve memory channels with backup. A remarkable piece of solid state engineering — and it is actually cheaper than the FRG-7000 (and many other 'similar' receivers on the market). Ask to see one soon at your nearest Dick Smith store or reseller. . . . .Magnificent!

**\$525**

OR FROM \$55 DEPOSIT AND \$25.74/MONTH (24 MONTHS)

Memory Unit extra



### NEW FT480

- All mode 2 metre SSB/CW/FM!
- Microprocessor controlled
- Digital display!
- 30 watts PEP

**\$543<sup>00</sup>**

OR FROM \$63 DEPOSIT AND \$26.28/MONTH (24 MONTHS)

This is the one they're all talking about: the fabulous new 2 metre all-mode transceiver from Yaesu. Offering outstanding performance and ease of controls, it must be the transceiver of the eighties! Cat D-2887

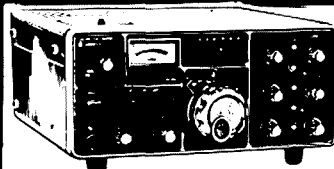

### SAVE ON FT625!

ALL MODE 6M

WAS \$795.00 . . . NOW ONLY

**\$695<sup>00</sup>**

OR FROM \$75 DEPOSIT AND \$20.48/MONTH (48 MONTHS)

We've knocked an incredible \$100 off the price of these popular all-mode 6 metre rigs. There's still plenty of good DX out there on 6 — and the FT-625 is just the transceiver to get it! Cat D-2886

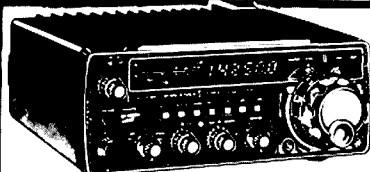

### NEW FT707

- All HF bands!
- AM/SSB/CW!
- Tiny Size!
- True digital display
- New WARC bands!

**\$755<sup>00</sup>**

OR FROM \$85 DEPOSIT AND \$22.86/MONTH (48 MONTHS)

They've been pretty hard to get, and small wonder! The superb FT-707 packs a huge punch from its tiny size: 240W DC! It's the ideal rig for mobile, base or portable work. Cat D-2869

### SUPERB FT-207

- Microprocessor controlled hand held giving full 144-148 band!
- Digital display.

**\$358<sup>00</sup>**

OR FROM \$38 DEPOSIT AND \$17.52/MONTH (24 MONTHS)

For today's active ham, this is the set to take with you. Takes up virtually no room, but really gets out! Make contacts wherever you go with the FT-207R

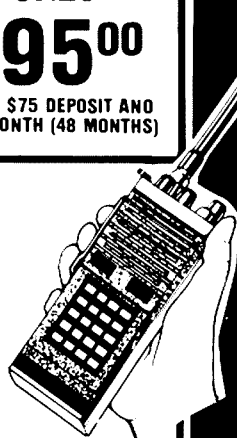

INCLUDES DMS AND POWER SUPPLY!

### NEW FT107M

- The ultimate!
- WARC bands
- All solid state
- Variable IF bandwidth!
- Speech proc.

**\$1278<sup>00</sup>**

OR FROM \$138 DEPOSIT AND \$38.32/MONTH (48 MONTHS)

It must be every amateur's dream to own one of these! You can — and take full control of the bands. Whatever you want from your transceiver, the FT-107 offers it! Cat D-2871

### BUDGET FT-101Z

We throw in a digital display kit worth over \$100! This turns the FT-101Z into an FT-101ZD!

More hams have 'cut their teeth' on one of the famous '101' series than any other rig! Rugged and reliable, with all the features you really need. Cat D-2862

OR FROM \$85 DEPOSIT AND \$23.19/MONTH (48 MONTHS)

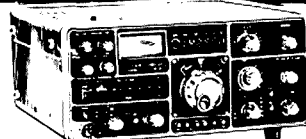

**\$775<sup>00</sup>**

WITH BONUS DIGITAL DISPLAY WORTH \$139!!

ANY TERMS OFFERED ARE TO APPROVED, PERSONAL APPLICANTS ONLY. ORDER BY MAIL: USE YOUR BANKCARD!

# DICK SMITH ELECTRONICS

**NSW** 125 York Street SYDNEY 250 3377  
818 George Street BROADWAY 211 3777  
162 Pacific Hwy GORE HILL 439 5311  
30 Grose Street PARAMATTA 693 1133  
613 Princes Hwy BLAKEHURST 546 1744  
147 Hume Hwy CHULLORA 642 8922  
531 Pittwater Road BROODVALE 93 0441  
145 Parramatta Rd AUBURN 648 0558

**VIC** 263 Keira Street 399 Lonsdale Street 856 Bridge Road  
**QLD** 166 Logan Road 842 Gympie Road 96 Gladstone Street  
**ACT** 60 Wright Street  
**SA** 414 William Street  
**WA**

**WOLLONGONG** 28 3800  
**MELBOURNE** 67 9834  
**RICHMOND** 428 1614  
**BURANDA** 391 6233  
**CHERMESIDE** 59 6255  
**EYSHWICK** 80 4944  
**ADELAIDE** 217 1952  
**PERTH** 328 6944

**bankcard**  
welcome here

SHOPS OPEN 9AM to 5:30PM  
(Saturday: 9am till 12 noon)  
BRISBANE Half hour earlier  
ANY TERMS OFFERED ARE TO APPROVED APPLICANTS ONLY  
RE-SELLERS OF DICK SMITH PRODUCTS IN MOST AREAS OF AUSTRALIA.



MAIL ORDER CENTRE: PO Box 321, NORTH RYDE NSW 2113. Ph 888 3200. PACK & POST EXTRA.

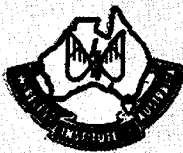

# amateur radio

DECEMBER 1980

VOL. 48, No. 12

PRICE: \$1.20

Registered Office:  
3/105 Hawthorn Road,  
Caulfield North 3161.

EDITOR:  
BRUCE BATHOLS\* VK3UV

PRODUCTION MANAGER:  
MARK STEPHENSON VK3PI

TECHNICAL EDITORS:  
BILL RICE\* VK3ABP  
EVAN JARMAN\* VK3ANI  
RON COOK\* VK3AFW  
GIL SONES\* VK3AU1

CONTRIBUTING EDITORS:  
BOB ARNOLD VK3ZBB  
G. NICK NICHOLS VK6XI  
ROY HARTKOPF\* VK3AOH  
RON FISHER\* VK3OM  
ERIC JAMIESON VK5LP  
LEN POYNTER\* VK3BYE  
BILL VERRALL VK5WV  
WALLY WATKINS VK2DEW

DRAFTING:  
NEIL OSBORNE\* VK3YE1  
PETER KIMBER  
SUZY ZLOCH

BUSINESS MANAGER:  
PETER DODD VK3C1F

\*Member of Publications Committee

Enquiries and material to:  
The Editor,  
PO Box 150, Toorak, Vic. 3142

Copy is required by the first of each month. Acknowledgement may not be made unless specially requested. All important items should be sent by certified mail. The editor reserves the right to edit all material, including Letters to the Editor and Hamads, and reserves the right to refuse acceptance of any material, without specifying a reason. Material should be sent direct to P.O. Box 150, Toorak, Vic., 3142, by the 25th of the second month preceding publication. Phone: (03) 528 5962. Hamads should be sent direct to the same address by the 1st of the month preceding publication.

Trade Practices Act: It is impossible for us to ensure that advertisements submitted for publication comply with the Trade Practices Act 1974. Therefore advertisers and advertising agents will appreciate the absolute need for themselves to ensure that the provisions of the Act are complied with strictly. Readers are reminded that, when buying, obtaining or receiving goods from overseas including goods listed in advertisements by overseas organisations in this Journal, Customs import duties and Sales Tax may be levied on the goods at the time of importation. These amounts, if any, are payable by the purchaser unless the terms of sale state otherwise and the seller has made specific provision to this effect in his quotation to the buyer or unless other prior arrangements are in force between the buyer and the seller.

Typesetting: MUELLER GRAPHICS PTY. LTD.  
1a Levanswell Road, Moorabbin, 3189  
Tel.: 553 0292

Printers: WAVERLEY OFFSET PUBLISHING  
GROUP  
Geddes Street, Mulgrave 3170

## CONTENTS

### TECHNICAL

A Review of the IC720 HF Transceiver	20
Further thoughts on the Kenwood R1000	19
Project ASERT: VHF Propagation between Albany and Adelaide, 1979-80	11
The Ten Turn "Chopstick" Helical — A High Gain Antenna for Satellite Work	8

### GENERAL

A Bit of Victorian History	13
A Man and his Hobby — VK3ACR	12
Chinese Study Amateur Radio	32
Margaret, 70, becomes Amateur Operator	22
New Zealand's New 2 Mx FM Repeater Band Plan	27
Queensland Amateur Radio Display	28
The Royal Naval Amateur Radio Society, Past, Present, Future	26
Rally II — WICEN Exercise	24
Ron Wilkinson Achievement Award	46
Standards	51
The Physics and Chemistry of Fire	29
World-Wide Communications from Hand-Held and Man-Pack Transceivers	16

### DEPARTMENTS

ALARA	57
Amateur Satellites	39
Around the Trade	56
Awards Column	40
Commercial Kinks	45
Contests	54
Divisional Notes	51
Editor's Desk	5
Forward Bias	46
Hamads	58
International News	38
Ionospheric Predictions	54
Letters to the Editor	52
Main QSP	5
Novice Notes	34
Obituaries	57
QRK5	48
QSP	6, 12, 22, 27, 30, 45
Repeater News	38
Silent Keys	57
Spotlight on SWLING	49
Stolen Equipment	51
Technical Correspondence	55
VHF-UHF — an expanding world	36
VK2 Mini Bulletin	47
WIANEWS	6
You and DX	53

ADVERTISERS' INDEX	58
--------------------	----

## Cover Photo



Pictured this month is the ever-smiling Charlie Robinson VK3ACR in his well-equipped shack. Turn to page 12 to learn more about this man and his hobby.



Wherever you want your signal to go—DAIWA has the ham equipment to get it there precisely! DAIWA's world-wide reputation for quality and advanced technical design is the result of research and of *knowing* exactly what users want.

VICOM knows what Australian amateur radio users want, too—and that's why we're proud to present this selection of DAIWA gear.

Whichever model you choose, your quality DAIWA rotator is housed in

weather-sealed aluminium housing. The reduction gearing has been precisely designed for dependable and virtually silent operation. Vertical load: 200 kg. Power consumption: 40VA. Motor: 24V. Power source: 230V. Cable: 6 core.

# Daiwa gets you going in the right direction!

## 360° ANTENNA ROTATORS

**DR7500:** Rotation time: 60 secs.  
Rotation torque: 500 kg/cm. Braking torque: 2000 kg/cm. Weight: 5.5 kg.

**DR7600:** Rotation time: 64 secs.  
Rotation torque: 600 kg/cm. Braking torque: 4000 kg/cm. Weight: 5.6 kg.

## PRE-SET CONTROLLER

Models DR7500X,  
DR7600X  
Easy to use, direct dial setting.

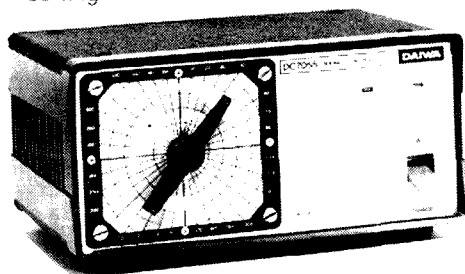

## ROUND CONTROLLER

Models DR7500R,  
DR7600R  
Complete with world map and easy-to-read bearings.

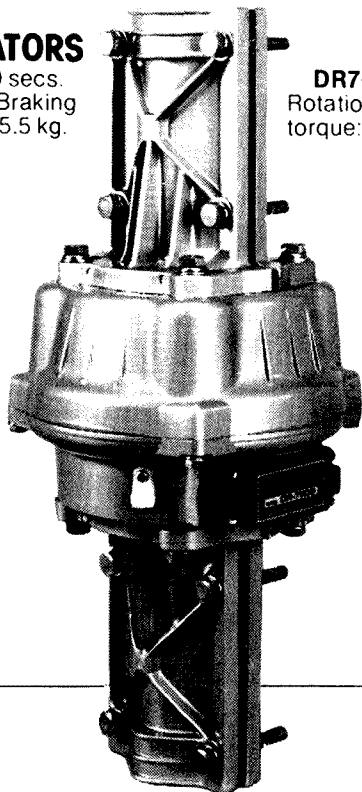
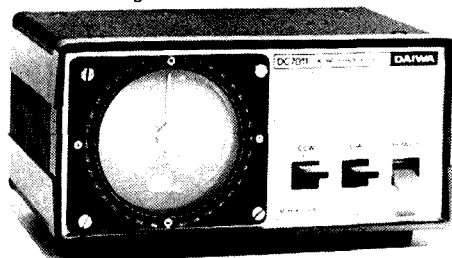

## Coaxial switches

Models CS401 & CS201  
Professionally engineered cavity construction. CS401 offers four position switching; CS201 offers two position switching. Both offer excellent isolation between terminals. Impedance: 50ohms. Power rating: 2.5KW PEP, 1kW CW. Max. Frequency: 500MHz. Connectors: SQ239.

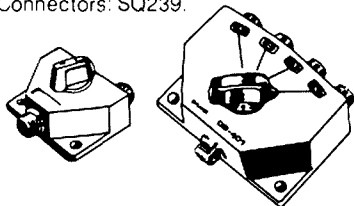

## HF FILTERS

Frequency	FD-30LS
Cut-off frequency	1.8-30MHz
Power Rating	32MHz
Insertion Loss	100w CW
	less than 0.5dB
Dimensions	140x27x42 mm
Weight	160 g

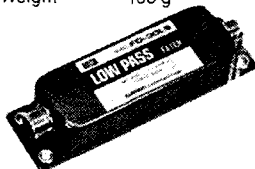

## RF speech processors

Models RF550 & RF660  
Installed between mic. and transmitter, they increase talk power and provide splatter-free operation. RF clipping assures low distortion.



Frequency response: 300-3000Hz at 12dB down. Talk power: Better than 6dB. Clipping threshold: Less than 2mV at 1kHz. Bandwidth: 2200Hz at 6dB down. Distortion: Less than 3% at 1kHz, 20dB clipping. Output level: 80mV (RF550); 50mV (RF660). Power requirement: 230V (RF550); 13.5V, 50mA (RF660).

## Vicom International Pty Ltd

68 Eastern Road,  
South Melbourne, Vic. 3205.  
Phone (03)6996700

339 Pacific Highway,  
Crows Nest, N.S.W. 2065.  
Phone (02)4362766

Brisbane 352522; 3415377  
Townsville 7722633

Wollongong 291455  
Cairns 541035

Adelaide 437981

Wagga 21215  
Melbourne 8368635



QSP ···· QSP ···· QSP ····

## SATELLITE CO-OPERATION

At the time our President, Peter Wolfenden, invited me to prepare the editorial for the December edition of "Amateur Radio", I was proposing to attend a conference in London of national organisations affiliated with AMSAT (Amateur Satellite Corporation). Unfortunately, this conference was cancelled at the last minute and I am therefore unable to comment on the somewhat strained relationships between AMSAT in the USA and other national satellite groups.

In many countries of the world, amateurs interested in satellite operations have formed their own working groups; in some cases these groups have only a minimal affiliation with their national amateur radio body.

In Australia, satellite enthusiasts have been more fortunate. Through the formation of Project Australis and the ultimate launch of OSCAR 5—a satellite constructed in Australia—we have at all times been a part of the Wireless Institute. I say we are fortunate because I firmly believe that in all activities connected with our hobby we must have a focal point of communications with our national amateur body. Through the WIA, we have liaison with the international amateur organisation—the IARU—and with national and international regulatory bodies.

The close association between amateurs interested in satellite operations and our Institute came very much to the fore during the WARC 79 Conference when the WIA and in turn, our Postal and Telecommunications Department, fully supported the allocation of specific segments of the radio frequency spectrum to amateur satellite operation.

The role of the Australian amateur in satellite operations and the support given by the Wireless Institute has probably never been fully appreciated internationally. Nevertheless, we have the satisfaction that our interests have proceeded in a friendly and co-ordinated manner, and I hope this situation will continue in the years to come.

My message at the close of 1980 is that all amateurs should recognise the role played by the Wireless Institute on behalf of all facets of our hobby, for without this co-ordination we can easily lose many things that are so dear to us.

**R. C. ARNOLD VK3ZBB,**  
Satellites and Special Projects Co-ordinator. ■

## EDITOR'S

## DESK

Our magazine at times tends to be a little parochial in contents, we get very little news of happenings from the warmer climates.

I guess amateur radio activities do exist in Darwin, Perth, Brisbane and the outback, but on reflection of this year's publication, one might be forgiven if you thought that we deliberately held back information from these areas — how about it you distant amateurs, can we have some input of what is happening in your areas — PLEASE!!!

Our change-over to the new printing system went smoothly and without too many headaches — AR is now printed fully Web offset, except for the

covers. As I indicated during the year, we can make use of spot colour more readily, and hopefully we can utilise this during the ensuing months to improve the presentation. Colour printing increases costs of production dramatically, so we have to be frugal in our use of it with our limited resources.

We welcome to our team Mr. Bill Baly, who has taken over the onerous task of AR production in the place of Mark Stephenson VK3PI. Mark served us well in the time he was with us, and he has now left for greener pastures — thanks for the good work Mark.

Subscription renewal time is with us again, and at this time of the year it certainly hits the hip pocket a little harder when we also have our Christmas and holiday season expenses to contend with.

Subscription rates have had to be raised once again to cover the ever increasing costs of AR production, brought about by CPI wage rises. This also affects our administrative staff, OSL postages, repeater maintenance, and licence fees, etc., etc. The list goes on and on.

The WIA and its services to members cannot be measured in the receipt of a magazine alone, it exists primarily to protect your interests as far as possible, and to instigate improvements and regulatory changes with representations to the nation's administrators.

We have succeeded in some areas, lost in others, but many submissions are in the pipe-line. We need a united approach to fulfil our aims and to maintain existing services.

Unfortunately, we have many "knockers", those amateurs who sit back and criticize and don't lift a finger to help.

If the Amateur Service is to withstand the pressures of outside interests on our bands, we must be united. Amateurs together must work together.

If you are interested in the future of our hobby, and as a thinking Amateur Radio enthusiast, ask yourself:—

1. Can I afford NOT to be a member of the WIA?
2. What can I do to obtain new members?
3. How can I assist the voluntary members already working to protect my hobby interests?

Let's have some positive response to continue the important tasks ahead.

With these few thoughts for the festive season, and on behalf of the Publications Committee, I wish all readers a Merry Christmas and a Happy New Year, and look forward to our members' continued and greater support to AR and the WIA.

Bruce R. Bathols VK3UV, Editor. ■

**JOIN A NEW MEMBER — NOW!**

# WIANEWS

## 23 cm BAND

Here is the text of letter RB4/4/4 of 8th October received from the Operations Branch of the Postal and Telecommunications Department in Melbourne —

"Reference is made to your representations concerning the use of F5 emission by Amateur operators within the band 1215-1300 MHz.

Noting that the Amateur service is accorded secondary status in this band the Department has carried out a number of negotiations with other users whose services might be subject to interference from the proposed Amateur operations. Resulting from these negotiations, the Department is prepared to allow the use of F5 by AOC and AOLCP Amateurs in the band concerned on a trial basis for a period of six months.

Amateur operators using or intending to use the 12-15-1300 MHz band should note the existence of Radar facilities operated by the Department of Defence and the Department of Transport, and that is most important to avoid interference to these services.

I trust that you will publicise this matter through the normal methods available to the Institute."

The possibility of a band plan (to comply with Institute policy) for 23 cm was discussed at the October meeting of the VHFAC. Further research is necessary before a suitable plan can be prepared prior to publication for general comment. It should be remembered that the lower portion of this band below 1240 MHz was not allocated to the amateur service at WARC 79.

Having obtained a limited concession for F5 on 23 cm, work will proceed to press for this mode on the higher bands, especially the 5 cm band.

## JOINT COMMITTEE

An amendment (188 of 1980) to the W/T Regulations came in for discussions in relation to three year licences, a combined LAOCP/NAOCP licence and collection of amateur station licence fees on commission. The first item remains uncleared because it involves accounting and Treasury procedures which the Department has to clarify. The second item definitely appears to be a probability but no details of its application can be obtained. The third item is considered doubtful in relation to its application to the amateur service having regard to the wording of the amendments. Further details are awaited.

The Handbook came in for a share of the time as several amendments, some quite minor, are foreseen as necessary. The grant of third party concessions is a major item, particularly in relation to emergency traffic and WICEN training exercises. The Department sees a need to spell out the NAOCP theory syllabus

# WIANEWS

in greater detail and discussions with them will be held in due course.

It was learnt that some aspects had been cleared with the Broadcasting Control authority regarding the Institute's long-standing application for the use of the 50 to 50.15 MHz of the IARU R3 6 metre amateur band. Pressure was exerted for the grant now of whatever is possible. A reply is anxiously awaited.

A special prefix, possibly from the VZA-VZZ or VHA-VNZ blocks for the use of amateurs during the 1988 Bicentenary celebrations was again discussed. Unfortunately VZ plus a numeral is already in use for land mobiles.

A letter from the Department is awaited restoring to "C" calls merely the change of State numeral when moving from one State to another.

Conditions applicable to beacons were clarified. The reduction of licence fees for pensioners promised some years ago had been vetoed but the Institute stated a fresh application would be submitted.

## EXECUTIVE NEWS

Mr. L. G. Baly was appointed at a Selection Committee of the Executive to replace Mr. Mark Stephenson VK3PI on his resignation.

The new International diamond style of WIA membership badges are now available. This style of badge does not replace the existing badge. It was designed specifically for the use of Institute members travelling overseas where this type of logo is readily recognisable even at a distance. Many members will naturally wish to wear this badge in Australia too.

A short submission was made to the Cable and Subscription TV Services Enquiry on the lines that proposed frequencies should not be selected in or close to amateur service bands.

## CHANNEL 0

Much time was devoted in October to matters relating to the establishment of Channel 0 Multicultural Services station late in the month. Subsequent observations that the service on UHF Channel 28 might have been given low priority did not escape notice in connection with the publicity given to this service and to its inception in Melbourne and Sydney.

## GENERAL

Intentions in the USA to seek extensions to the phone segments of 20 and 40 metres for US amateurs were viewed in many quarters as detrimental to amateur stations outside the USA.

The Executive wishes to acknowledge with grateful thanks the following donation to the WARC 79 (and ongoing) fund —

Dalby and Dist. A.R.C. .... \$10.00

## PENSIONERS

\*

If you believe you are entitled to a WIA pensioner grading —

PLEASE clear this matter direct with

**YOUR DIVISION**  
as early as possible.

Your subscription rate is based on your WIA grade — check your AR address label.

## QSP

### CITIZEN'S BAND — AGAIN!

In recent weeks some 10,000 CB radios have been smuggled into the country, and as a result the amount of police activity to find this gear — and prosecute the operators — has considerably increased. This is particularly the case in London and Essex where there have been countless instances of bona fide amateurs being delayed or held while gear and status are checked. In an attempt to minimise this disruption in their neck of the woods, Harlow and Bishops Stortford amateurs arranged a meeting with the local police, the result of which was an agreement that local amateurs will carry a copy of the front sheet of their licence, their driving licence and/or RSGB card; club secretaries will give the police a list of local names, addresses and call signs; and there will be a copy of the Call Book in the police station.

This is what has happened in Harlow: we hope it will serve as an example of what can be done if things become difficult elsewhere.

We have no particular axe to grind for or against CB, but at the same time it must be pointed out that if it had not been for the arrant twaddle published by the so-called "Citizen's Band Association", smuggling of CB sets on this scale would never have happened. The result is that many an innocent lorry driver, say, is now about £200 lighter and awaiting the dealings of Justice — because someone told him it was "all right"; and any ham who has bought one can ponder the fact that he has broken the law and been ripped off. — Editorial, Short Wave Magazine, April 1980. Submitted by Steve Mahony VK5AIM.

# UNITY IS STRENGTH

# SCALAR

# CHRISTMAS SUGGESTIONS

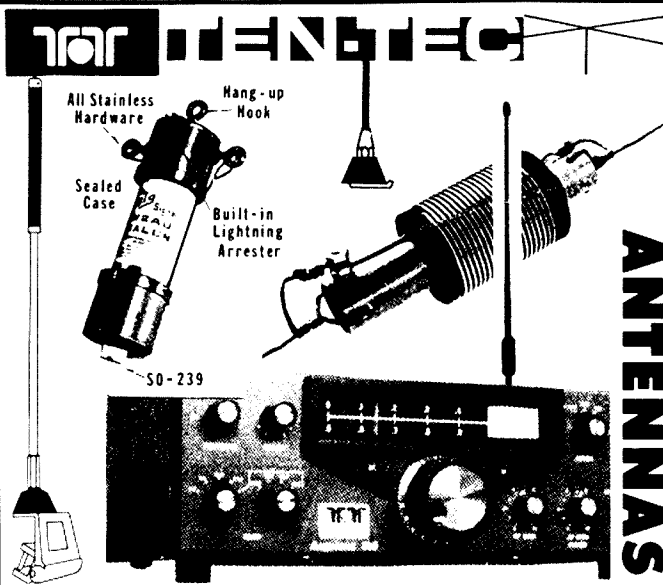

SC22DX	5 Band Vertical.....	<b>\$129.00</b>
SC33DX	3 Band Beam.....	<b>\$270.00</b>
W2AU	Dipole Balun.....	<b>\$34.50</b>
REYCO	HF Dipole Traps.....	<b>\$43.15</b>
INTERFILTER	Low Pass.....	<b>\$74.75</b>
GSA46	6dB 70cm Colinear...	<b>\$100.65</b>
GSA24	3dB 2m Colinear.....	<b>\$150.95</b>
Y309	9 ele. 2m Yagi.....	<b>\$284.65</b>
Y409	9 ele. 70 cm Yagi...	<b>\$155.25</b>
DX-15	VHF/AM Splitter.....	<b>\$55.20</b>
DELTA 580	Ten Tec Transceiver	<b>\$1200.25</b>
ARGONAUT 515	Ten Tec QRP.....	<b>\$606.49</b>
OMNI-D	Ten Tec Transceiver	<b>\$1617.92</b>
SCA26T	2m Helical 5/8.....	<b>\$12.90</b>

Please ask about our range of Marine and Commercial Antennas and accessories.

SCA21T	2m S/S Mobile.....	<b>\$4.15</b>
SCA40T	70cm Gain Mobile.....	<b>\$13.10</b>
SCA25T	2m 5/8 Mobile.....	<b>\$12.90</b>
HA600T	6' HF Helicals.....	<b>\$39.70</b>
C60	Trunkmount Base.....	<b>\$6.90</b>
C54	Guttergrip Base.....	<b>\$17.25</b>
MGB	Magnabase.....	<b>\$50.00</b>
MB	VHF Mount.....	<b>\$3.65</b>
OB	UHF Mount.....	<b>\$5.20</b>
M27B	Heavy Duty Mount.....	<b>\$6.70</b>
MS	S/S Mobile Spring.....	<b>\$9.10</b>
MK	Knock-Down Knuckle.....	<b>\$9.60</b>
HJA	Hemijusta.....	<b>\$9.50</b>
INS-3	3" Porcelain Insul.....	<b>\$2.40</b>

**WORLD'S LEADING HAM BALUN**  
**W2AU**  
 the BIG signal®

MODEL OB UHF BASE.  
 (Patent 499, 636) Designed for correct termination of cable at UHF frequencies.

**AUSTRALIAN MADE**

Frank Welsh  
 Mike Kilpatrick  
 Ron Smith  
 Brian Robinson

VK3BPV  
 VK2DJP  
 VK2DCK  
 VK4NQG

Prices include Sales Tax. Freight from factory is additional.  
 Note that these prices are not applicable in W. Aust.

★ **BANKCARD AND MAIL ORDERS WELCOME** ★



## SCALAR GROUP

NSW: 328 Kingsgrove Rd, Kingsgrove, 2208. tel: (02) 502 2888  
 VIC: 20 Shelly Avenue, Kilsyth, 3137 tel: (03) 725 9677  
 QLD: 8 Ferry Road, West End, 4101 tel: (07) 44 8024  
 W.A. Unit 5/319 Pearson St., Osborne Park, 6017 tel: (09) 446 4657

# The Ten-Turn "Chopstick" Helical: A High Gain Antenna for Satellite Work

Colin Richards 9M2CR  
Submitted by Wal Webster VK2EW

Forward gain, forward gain, forward gain: that's the ceaseless search in satellite work. It's a task that jumps to the forefront with the approach of a new breed of satellite — Phase IIIA.

Phase IIIA will be put into a "pseudo-synchronous" orbit — which means that it will offer many of the advantages of commercial synchronous satellites. It will swing around the bottom of the globe at a low perigee of 1500 km and then hurtle out to an apogee of 36000 km — and (here's the bonus) — its movement relative to an earth station for the 4 hours spanning this apogee will be small. So that for 4 hours there will be an almost-stationary satellite up there, covering half the globe. For the first time, radio amateurs will be able to communicate on a world-wide basis using VHF + UHF, thus skipping many of the baneful problems of HF propagation. What's more, Doppler shift at the apogee will be very slight — so that the skilful searching and re-tuning so essential with low-orbit satellites will no longer be required.

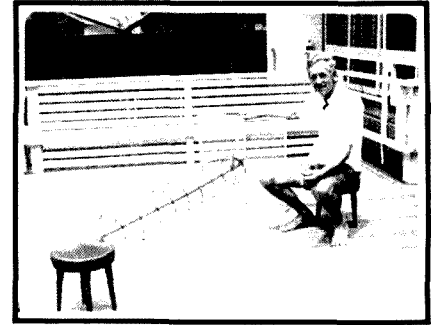

PHOTO 1: Colin 9M2CR with the completed project.

But there is a price to be paid for these advantages! Path length at apogee is virtually the same as that for commercial synchronous satellites. They counter this path loss by using giant 30-metre dishes, and low-noise amplifiers on receive, cooled in liquid helium. No amateur can compete with this! But latest estimates for Phase IIIA suggest that we can get by with an ERP of 500 watts — a tolerably modest figure. Of course, a 500 watt final is out of the question for most amateurs — so we have to get our gain elsewhere — notably from the antenna system.

Phase IIIA Uplink will be centred on 435.215 MHz, and will require clockwise circular polarisation. So — how to make a high-gain antenna with circular polarisation which can be hoisted into the air and pointed in the right direction without too much trouble? That is the question. Long John Yagis — crossed and phased — could offer one solution: but at 435 that phasing harness could present problems, while impedance matching is also a chore.

So . . . why not a helical? Here we have neatness, high gain, wide bandwidth and circular polarisation — all in one. Scanning the handbooks for design info on helicals showed that a ten-turn helix looked promising: a gain of 15 dB would persuade my 10-watts output to masquerade as 300 watts, and a beam-width of 36 degrees ought not to be too finicky to point. The boom length at 435 MHz would be about 6 feet, with a reflector 28 inches square — these seemed manageable dimensions. But what to use for the helix, how to form it, how to keep it in shape? All pertinent questions at this particular QTH — with the nearest parts or material stores some 70 miles away.

The boom was no problem. A 6 ft. 4 in. length of 1 by 1/2 in. meranti timber, good and straight, looked just about right — with the 1 in. edge vertical to avoid any bending (as it happened, the antenna itself turned out to be feather-light and easily supported by the 1 by 1/2 in.). But what about the helix, and what about the spacers?

Copper tubing was unobtainable: in any case it would have been expensive, heavy and difficult to shape. Someone, somewhere had mentioned using coaxial cable: so why not RG58? The outer screen would simulate a tubular conductor: the inner conductor is not needed but could be soldered to the screen at each end. Good grade coax has a tinned, close-mesh screen with an excellent weatherproof sheath. What could be better? We promptly hunted out a 25 foot length.

Spacers were now the problem. Most handbooks showed 3 spacers per complete turn of the helix, each spacer being set at a 120-degree angle to the last. Since the boom was rectangular, it seemed more sensible to opt for 4 spacers per turn, and to put them at 90-degree settings. The original plan was to use 1/4 in. diameter plastic rod or wood dowel for the spacers, but nothing remotely resembling such material was available locally. Pondering the problem over a tasty meal of Fuyong egg, crispy chicken and Cantonese bean curd — I suddenly saw the answer — there in my right hand: chopsticks! Why not?

Chopsticks are available in a wide variety of designs and material in Malaysia: we chose simple, wooden, everyday chopsticks (not bamboo) — undecorated — sold in bundles of 20 to 25 US cents a bundle. As with most chopsticks, the lower half is of circular, tapered cross-section — merging into a rectangular shape for the upper half. It couldn't be better! We marked the boom at 1.7 in. intervals and drilled holes 3/16 in. diameter — consecutively at right angles for its entire length. The boom was long enough to allow 3 to 4 in. to stick through the reflector, for clamping purposes. A 3.4 in. piece of the same boom material (1 by 1/2 in.) was fixed to the boom at the reflector end,

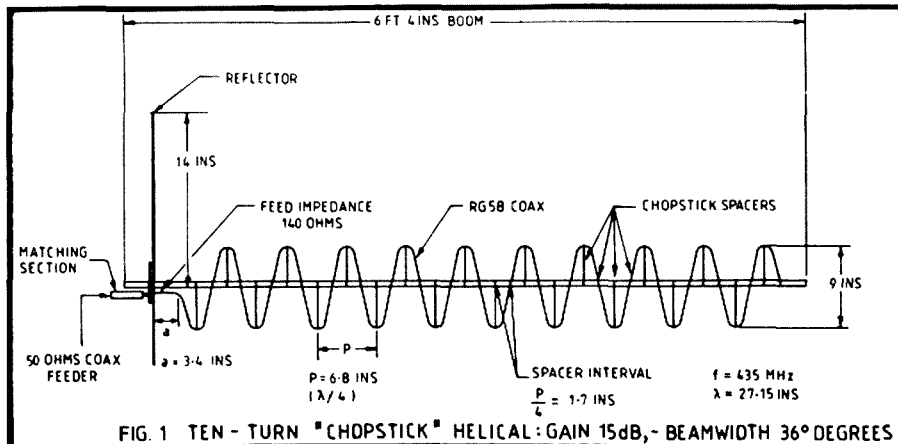

FIG. 1: Ten-Turn "Chopstick" Helical: Gain 15 dB, Beam width 36 degrees.

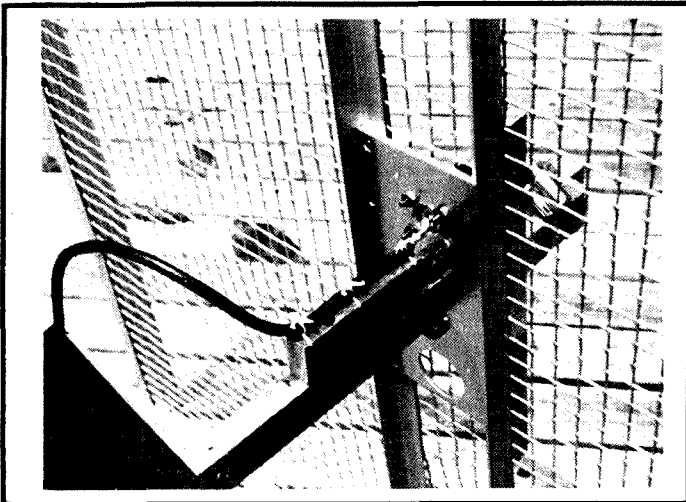

PHOTO 2: Termination of helix and mounting bracket and reflector (see also FIGURE 2).

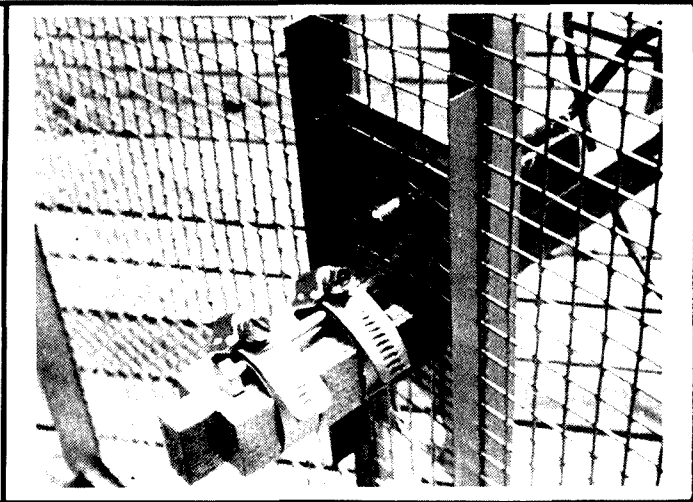

PHOTO 3: Securing the boom to the reflector (see also FIGURE 5).

and the 1.7 in. intervals were measured from this. All this can be seen clearly from the diagram.

A drop of glue was put into each drilled hole, and the chopsticks were pushed in one by one until they wedged tight. We

did a double-check to make sure that we were putting them in with a clockwise spiral, as viewed from the reflector forward (that is, from the back of the beam). When giving the final push, each chopstick was twisted so that the square sides were roughly in line with the path that the RG58 helix would take. This made it easier to file a small U-shaped depression in the top, to allow the RG58 to sit in neatly. Chopsticks are generally about 10 inches long, and when pushed through the boom about 4 inches protruded on the other side. These bits were carefully sawn off. The helix diameter is 9 inches, so a mark was made on the last 4 spacers at each end of the boom, at a point  $4\frac{1}{2}$  inches from the centre-line of the boom. A fine hole was drilled at these marker points, and thread strung along from first to last spacer in each of the 4 rows. This enabled the other spacers to be marked, to show where they should be cut off. After trimming, the tops were filed into a U-shaped depression in line with the helix path. A small hole was then drilled, an eighth of an inch below the tip, so that a piece of waxed thread could be used to bind the RG58 in place.

FIGURE 2 (below): Details of mounting bracket on reflector (front view).

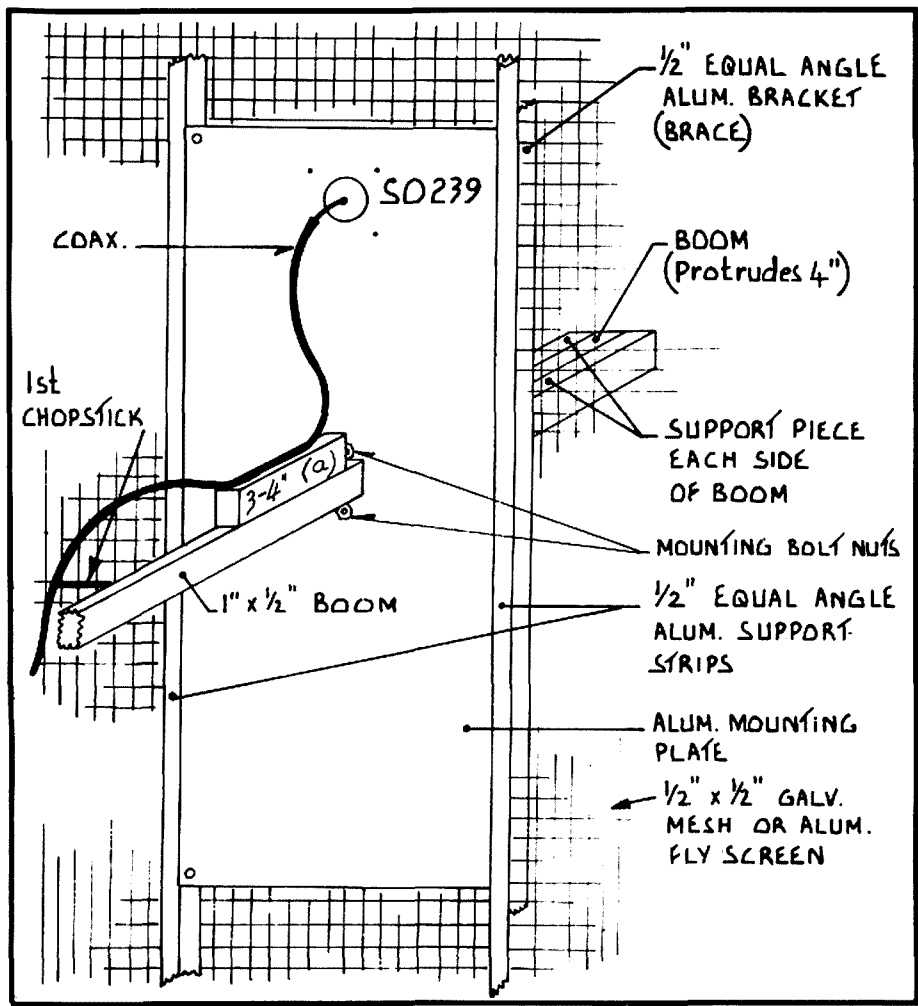

One end of the 25 foot length of RG58 was bared for half an inch, the sheath and dielectric removed, and the screen and centre conductor twisted together and soldered. Starting with this end, the RG58 was bound to the short straight end section (3.4 inches) next to the reflector position. The soldered tip was placed so that it would mate with the centre terminal of an SO-239 socket which would be mounted on the back of the reflector. The RG58 helix was then wound carefully around the spacers, one at a time, binding in each spacer before moving to the next. In this way it was possible to ensure that an even, circular spiral was created—with no bulges or flat sections. As we neared the tenth turn, there was about 8 inches of RG58 surplus. This was cut off, the end trimmed, and the outer screen and inner

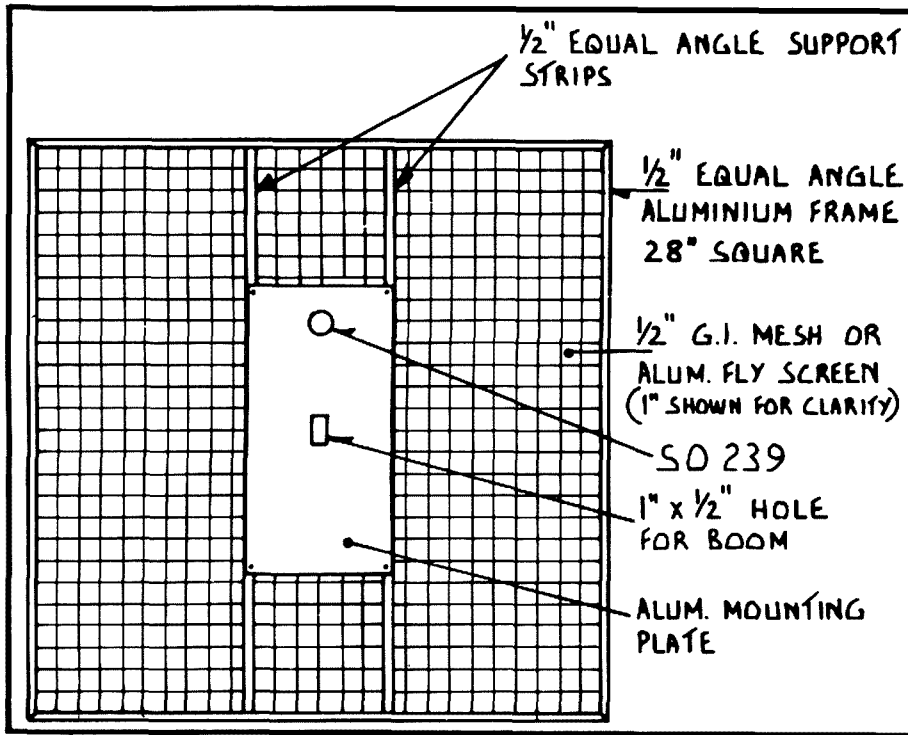

FIGURE 3: Details of reflector.

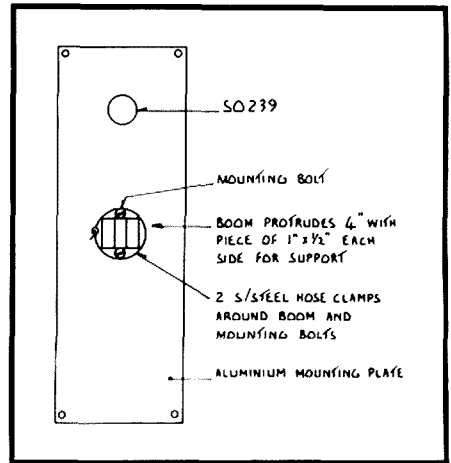

FIG. 4: Back view mounting plate.



PHOTO 4: Helix attached to the "Chopsticks" spacers.



PHOTO 5: Final installation.

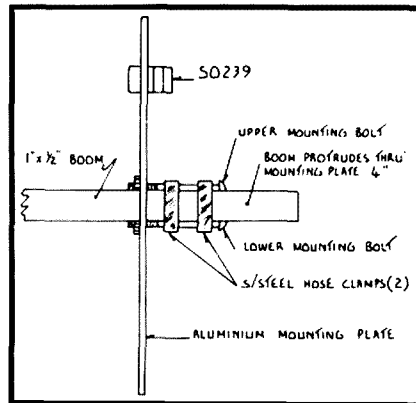

FIG. 5: Side view mounting plate.

There still remained the question of matching to a 50-ohm feeder. The feed impedance of a helical antenna of this design is near enough 140 ohms (this stays the same, by the way, regardless of the number of turns in the helix). A quarter-wave matching section should therefore have an impedance of about 84 ohms. The nearest coax is RG62, which has an impedance of 93 ohms. A quarter wavelength at 435 MHz is 6.8 inches and the velocity factor brings this down to 5.7 inches (there's a trap here: solid dielectric coax like RG8 or RG58 has a velocity factor of 0.66, but RG62 is partly air-spaced and the factor is 0.84). After many 'cuts and tries', the SWR was brought down to 1 : 1.1. So this time the antenna

was really hoisted in the air and put to work. Results? When used as an Uplink antenna on Oscar 7, Mode B, signal reports have been encouraging: downlink on Mode J I can copy stations right down to the horizon. I think it works! ■

**AMATEUR RADIO IS A RESPONSIBLE SERVICE**

**LET'S KEEP IT THAT WAY**

# Project ASERT: VHF Propagation between Albany and Adelaide, 1979-80

C. J. Hurst VK5HI

With the forthcoming southern summer and the associated anomalous propagation (Ref. 1), that all VHF and UHF operators now accept as the norm, the results of the observations made of the Albany beacon VK6RTW on 144.5 MHz from the Adelaide area during the period 1st October, 1979, to 31st March, 1980, are now presented to further whet your enthusiasm.

Following the results of recordings made from January to March 1979 (Ref. 2) it became apparent that a more precise system to differentiate signal from noise was necessary so as to ensure that the results obtained were correct. To this end the writer developed an audio detection system to confirm the presence of signal. Fortunately VK6RTW exhibits excellent frequency stability thus allowing the use of a narrow band audio detector. An NE567 PLL tone decoder chip plus associated circuitry was configured to interface the single channel "Rustrak" recorder (Ref. 3) to the AVC and audio of the station receiver. In the event of a signal being detected a nominal 1900 Hertz Audio Tone is generated to:—

1. Latch up the tone decoder.
2. Initiate a timer for a 15 second period to—
  - 2.1 Disconnect AVC voltage from recorder.
  - 2.2 Connect a reference voltage to the recorder as an "event" indicator. (Simplistic approach in converting single channel to dual channel recorder.)

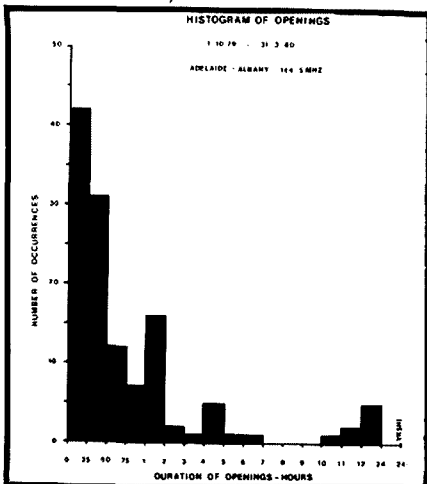

FIGURE 1

SIGNAL STRENGTH RELATIVE FREE SPACE	1979			1980			1979 / 80 TOTAL
	OCTOBER	NOVEMBER	DECEMBER	JANUARY	FEBRUARY	MARCH	
0 dB							
-5							
-10			1.0				1.0
-15			2.5				2.5
-20			9.5	1.5			11.0
-25	4.5		15.0	8.0		1.5	29.0
-30	11.0		21.0	18.5		2.5	53.0
-35	16.0	0.5	28.5	28.5	1.5	6.0	81.0
-40	23.5	0.5	41.5	46.0	4.0	13.0	128.5
THRESH.-55	23.5	3.25	65.75	74.0	13.75	41.5	221.75

## DURATION OF SIGNAL (Hours) v SIGNAL STRENGTH

ALBANY - ADELAIDE 144.5 MHZ

TABLE 1

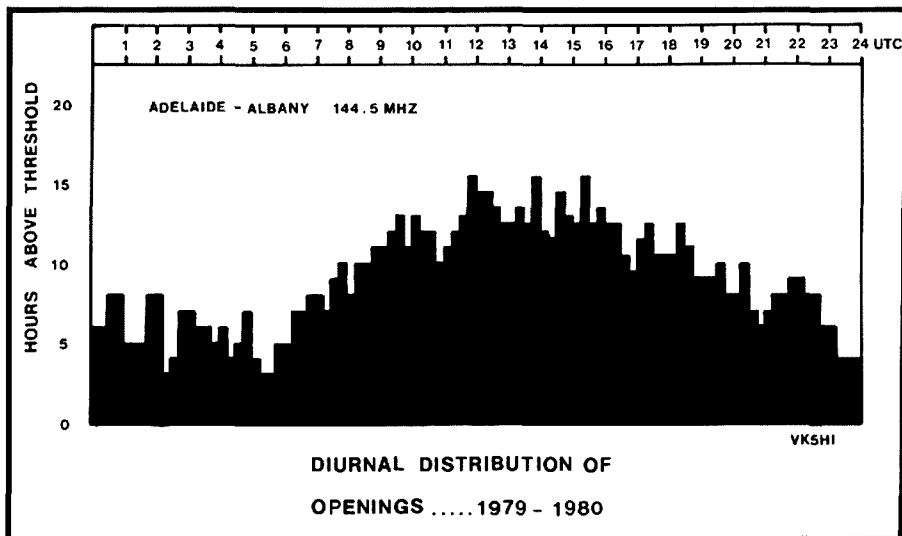

FIGURE 2

- 2.3 Turn on a tape recorder.
3. At the conclusion of the 15 second period a further timing period of 2 minutes 45 secs. is commenced. During this period only the receiver AVC voltage is charted.
4. Reset decoder and timers.

If the signal is still present the process is repeated. The resultant chart thus shows under signal conditions the receiver AVC

voltage and a series of "event dots". The reference voltage for the "dots" is such to ensure 95 per cent full scale deflection. (Maximum signal equivalent to 0 db = 90 per cent FSD).

A bonus from the use of this system is that a signal which is 44 decibels down on the free space 0 dB signal is detectable. Due to the receiver system, a reliable dynamic range of only 40 dB in detectable



AVC variance is available again referenced to 0 dB free space. 0 dB free space signal level has been calculated to be 20 microvolts into 50 ohms for the total system (Ref. 4).

In this report no theoretical derivations on the results will be presented. The results have been graphed and tabulated as follows:—

1. Histogram of openings.
  2. Diurnal distribution of openings.
  3. Duration of signal vs. signal strength.
- Additionally, to complete the summary

for the period under review, 1/10/79 to 31/3/80, the following statistics have been derived:—

1. Signals were above threshold on 34 separate days, i.e. 18.6 per cent of days monitored.
2. Signals were above threshold a total of 221.75 hours, i.e. 5.5 per cent of hours monitored.

#### REFERENCES

- (1) BAKER: Slow fading signal strength distributions for sea path tropospheric radio links in the Australian Bight re-

gion WRE — Technical Note — A250 (AP).

- (2) Amateur Radio, April 1979, page 23.
- (3) The Rustrak Recorder utilises an impact stylis contacting a pressure sensitive paper every two seconds. The resultant graph is a conglomerate of dots. Nonetheless an excellent recorder for this application.
- (4) Calculated using the total free space transmission loss between the terminals of the transmitter and receiver. (Also included in Ref. (1) above.)

# A Man and his Hobby — VK3ACR

Neil Town VK3ANK

Charlie Robinson VK3ACR as an amateur is very professional. (See cover photo.)

Stepping into VK3ACR's shack you won't find a gleaming polished-wood set-up. Instead you will see a host of transmitters and receivers from earlier days adapted and modified to still serve usefully in the latest trends of the modern-day amateur.

Charlie has spent all his adult life spare time experimenting, building and operating amateur radio equipment. His back yard shack in Boronia, Victoria, is a maze of dials, knobs, meters, and bits of wire, lovingly stored for the time they may once again be put into use.

There's his old morse key, which he first started pounding way back in 1936 as VK7KR in Launceston. There's his latest piece of home-made gear, ultra low frequency, which will react to a bunch of keys being rattled across the street more than 100 metres away. And there's his old Mark II, Type III, which he has adapted to rag chew on the 160 band.

In true bower-bird style Charlie hates to throw anything out. As he updates his equipment, the older gear, if it can't be coupled to an UHF transverter or converter, is gently put aside where it can be seen and never forgotten.

Now retired, he may be found almost any time of the day busy with his bits and pieces, experimenting, testing, or shooting a beam through a satellite as he contacts his AMSAT friends.

Could you pick them? Some of the 46 items or so that keeps VK3ACR on the air.

1. 40 kHz dish.
2. Audio CRO.
3. Solotron 3 in. CRO.
4. Signal generator.
5. Transmatch.
6. Power supply IC22.
7. IC22.
8. SWR meter.
9. Monitor CRO for RTTY.
10. Creed 78 teleprinter.
11. RTTY demodulator.
12. VFL converter, 5 kHz to 500 kHz.
13. FT 101ZD.
14. Auto CQ and signing device.
15. 432 MHz to 1296 MHz wave meter.
16. ATV converter.
17. Micro module, 432 MHz to 434MHz, transverter.
18. Forest phone.
19. KW 2000E trans-

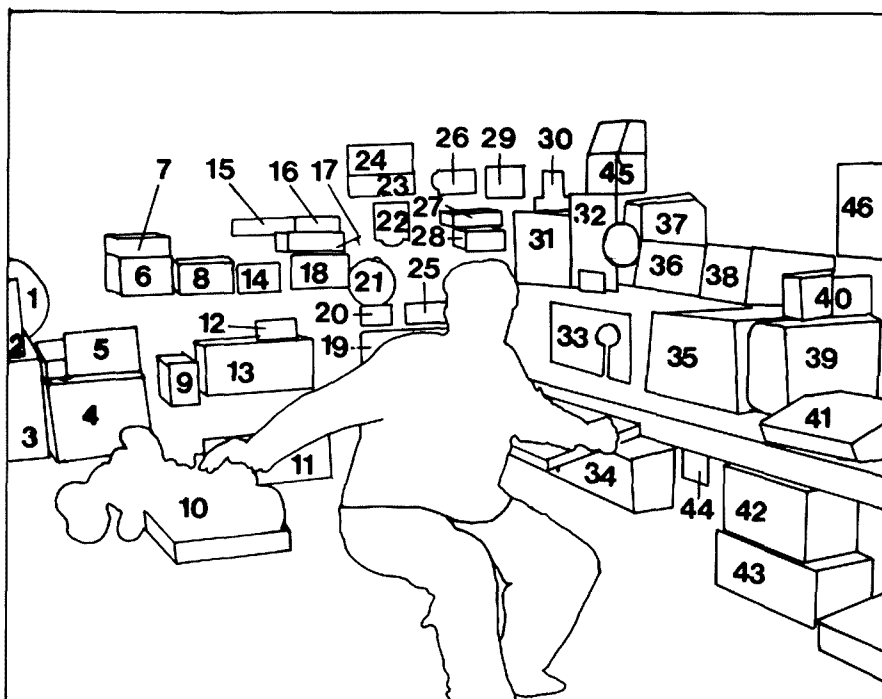

20. Two-tone oscillator.
21. World time clock.
22. Coax switch.
- 23 and 24. Aerial tuner for 1.8 megs.
25. SWR meter for KW2000E.
26. Digital clock.
27. Micro module, 432-436 MHz, transverter for satellite.
28. 432 SWR meter.
29. Barometer and thermometer.
30. Home-brew 432 linear amplifier.
31. Type 3, Mark 2, for 1.8 MHz AM.
32. Two metre transverter sideband.
33. BC348.
34. Junk box.
35. KW Viceroy transmitter.
36. FT200 transceiver.
37. P45 television receiver.
38. Power supply for FT200.
39. Power supply KW Viceroy.
40. SWR meter (spare).
41. Keyboard for computer.
42. Two metre linear amplifier for SCR 522.
43. SCR 522 vintage two metre transmitter.
44. Switch control for rotator on TH3.
45. 100 watt linear 144 amplifier.
46. Rotator indicator for TH3.

## QSP

### EXAMS

A comment in Presstop of Ham Radio September 1980 indicates that the USA's FCC exam pass rate has been climbing steadily in recent months after having remained fairly constant for years, according to an analysis. The FCC's rules apparently have no provisions for protecting the security of its examinations. A publisher selling exact question and answer sheets in study material is given as the only apparent reason for the shift which is the cause of concern in both FCC and amateur circles. "There is considerable feeling," says the comment, "that the increased pass rates are due mainly to memorization rather than understanding, which would result in unqualified applicants receiving amateur licences and the licence itself being cheapened as a result." Another item shows that US amateurs totalled 385,625 at the end of June, which reflected twice as much growth in the first six months of 1980 as it did in the whole of 1979.

# A Bit of Victorian History

J. A. Adcock VK3ACA

At the December 1979 general meeting of the Victorian Division, we held an **Historical Night** to which two of our "founding fathers" were invited, namely **W. K. Witt** and **T. F. O'Shannessy**. Both these gentlemen were present at the inaugural meeting of the foundation society of this Division. Following the December meeting, Mr. Witt, who was 87, passed away on 26-2-80.

The following information was prepared as background and was handed out at the meeting.

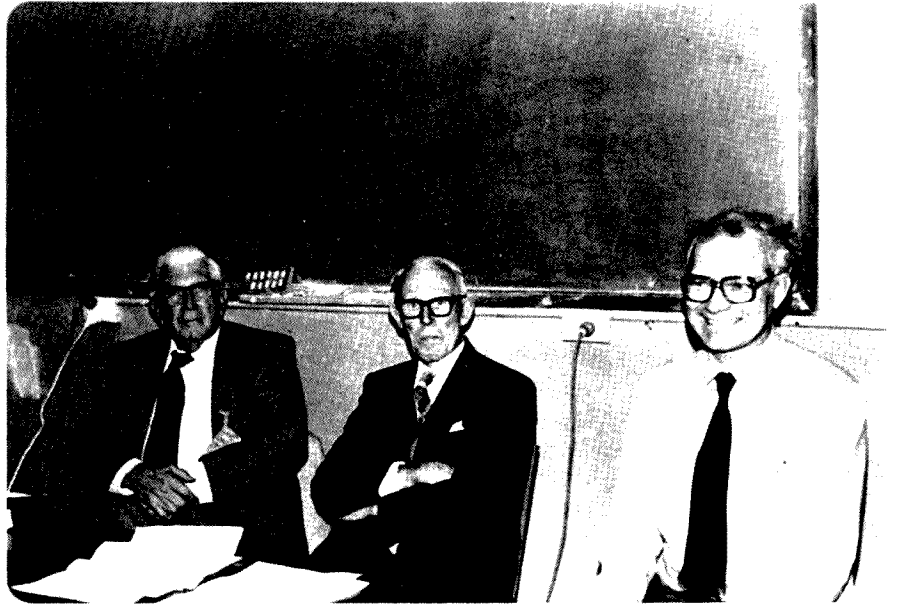

Left to right: Guests of Honour, Mr. Witt, Mr. O'Shannessy and John Adcock VK3ACA, who introduced the speakers.

Extracts from the original minute book.

## THE INAUGURAL MEETING OF THE AMATEUR WIRELESS SOCIETY OF VICTORIA

Melbourne, 30th November, 1911.

A Public meeting was held at the Esparanto Hall, 152 Elizabeth Street, Melbourne, where it was decided by the gentlemen present to form a Society, so as to draw together all gentlemen who were interested in Wireless Telegraphy and by the exchange of views, etc., to encourage and assist experiments in this extremely interesting branch of science.

### RESOLUTIONS

1. It was resolved that the name of the Society should be "*The Amateur Wireless Society of Victoria*".
2. President, Mr. M. A. H. Ryan; Treasurer, Mr. J. Wilson; Secretary, Mr. F. E. Moor.

Further resolutions included a committee of six and a complete constitution.

### GENERAL MEETING

The first general meeting was held on 13th December, 1911.

From January 1912 meetings were held in the Oxford Chambers, 437 Bourke Street.

### ANNUAL GENERAL MEETING

20th November, 1912.

President, Mr. Ryan; Vice-President, Mr. Cole; Secretary, Mr. Witt; Treasurer, Mr. McHenry; Committee, Messrs. O'Shannessy, Culliver, Devenport, Strickland, McGregor, Lindow.

### EXTRAORDINARY COUNCIL MEETING

10th April, 1913.

It was resolved that in the opinion of the Council it is expedient and in the best interests of the Society to change the name, and that it be recommended to the General Meeting to be held on 1st May, 1913, that the name be altered to "*Wireless Institute of Victoria*".

### GENERAL MEETING

Thursday, 1st May, 1913.

A lecture on his experiences in experimental wireless was delivered by Mr. H. W. Jenvey.

Special business: After some discussion it was moved J. S. Arcklan, seconded N. Culliver that in future this Society be known as "*Wireless Institute of Victoria*". Carried unanimously.

Mr. Perry, Hon. Secretary of the "Wireless Institute of New South Wales", was present at the meeting at which he demonstrated a "wave meter"!

### ANNUAL GENERAL MEETING

30th October, 1913.

Elected Office-bearers: President, Mr. G. F. V. Cole; Vice-Presidents, Mr. T. F. O'Shannessy, Mr. W. K. Witt; Hon. Treasurer, Mr. A. McGregor; Librarian, Mr. D. Harrison; Auditors, Mr. J. Welch and Mr. L. Birchall; Council, Messrs. C. V. Gallagher, D. Harrison, H. Lindow, J. Strickland.

Since the Secretary resigned and no other was forthcoming, the appointment was postponed.

The meeting was informed that the Book of Calls (Call Book) would go to print immediately upon receipt of an amended list from the PMG.

### GENERAL MEETING

November, 1913.

Mr. McHenry appointed Secretary.

### GENERAL MEETING

1st December, 1913.

The Secretary informed the meeting that full permission for the erection of an aerial and installing electricity in the Club Room had been obtained from the people in charge of the Oxford Chambers.

### GENERAL MEETING

11th August, 1914.

In connection with recent developments re disconnecting, dismantling and finally storing all gear in local PQ, a long discussion ensued and questions were asked and answered. It was decided to hold together as an Institute to ensure the return of apparatus and right to experiment further after war and trouble over.

### ANNUAL GENERAL MEETING 1914

There does not seem to have been one, but during 1914-1915 there were several changes of Secretary.

## GENERAL MEETING

February, 1915.

The following members were in active service: Messrs. W. K. Witt, A. McGregor, L. Robertson, Kenpling, Hughes, Keating, Israel, Jamieson.

## THE LAST RECORDED MEETING

9th March, 1915.

## APRIL 1st 1919

(From "Land, Sea and Air", May 1919.)

An inaugural meeting of the Wireless Institute of Victoria was held at the Marconi School of Wireless, 422 Little Collins Street.

The meeting had been convened by Mr. W. K. Witt at the request of the Honorary Secretary of the Wireless Institute of New South Wales (Mr. Malcolm Perry) and many others.

Provisional Committee: Messrs. Conry, Nightingall, Tatham and W. Witt.

## INTRODUCTION

By J. A. Adcock VK3ACA, who acted as moderator of the meeting.

"It is not often that you have the opportunity to create an historic occasion.

It should be pointed out that the history to be discussed here refers only to the origin of the Wireless Institute of Australia, Victorian Division, as a single society. The federal organisation of the Wireless Institute of Australia did not come about until after 1920, although it was considered much earlier.

A great deal of historical record would never have been known if it were not for the rediscovery of the original minute book. Its discovery and some details of its contents were published in Amateur Radio, August 1970, under the title 'The History of Amateur Radio and the Wireless Institute of Australia'. Reference was made in the article to the inaugural meeting being held on 30th November, 1911.

One of the most puzzling features of the minute records is that this Society was inaugurated on 30th November, 1911, and not in 1910 as is commonly believed. The idea that the Institute commenced in 1910 is so strong that it probably has some foundation. We know for certain that the Wireless Institute of New South Wales was operating quite early and it is possible that it did commence in 1910. Maybe one day someone could search the NSW newspapers for a clue.

One interesting observation on the minutes is why the name of the Society was changed from the 'Amateur Wireless Society of Victoria' to the 'Wireless Institute of Victoria'. There is no indication in the minutes as to why it was changed. I believe it was changed to bring it into line with the 'Wireless Institute of New South Wales'. It will be noted that the Secretary of the 'Wireless Institute of New South Wales' was present at the meeting the name was changed.

Mr. Witt was Secretary of the Institute in 1912 to 1913. He is a personal friend of the Seddons (VK3ACS) and was a guest at a recent Annual Dinner of the Institute. He was a radio operator in the Navy during the first World War. Following the war he was responsible for re-convening the 'Wireless Institute of Victoria' but was not actually engaged in amateur radio after that time. More recently he has been in business as a timber importer in Williamstown.

Mr. O'Shannessy was re-discovered about the time of the formation of the Old Timers' Club. Mr. O'Shannessy was prominent on committees before the first World War. He is founder of the company 'Commonwealth Power Equipment Pty. Ltd.', who manufacture commutators and is still active in the business.

It is remarkable for us to have these people present at this meeting, but it must be more remarkable for them to come back after 68 years and find the organisation they founded still going."

## MR. WITT'S TALK

"First I would like to straighten out a point made in the introduction concerning the word 'Amateur' in 'Amateur Wireless Society of Victoria'. We felt, at that time, that the name was not sufficiently dignified and therefore the council decided, in April 1913, without any prompting from New South Wales to change the name to 'The Wireless Institute of Victoria'.

I feel somewhat apologetic talking to all you scientific experts about radio telegraphy, because the days when we were actively engaged in it were very much like the days of the discovery of the wheel by prehistoric man. People in those days like myself were all in a state of ignorance. There were few who knew much about it and there was not much literature. At the same time we were not really pioneers, let's face the fact that wireless telegraphy was a practical thing in those days. We made our equipment and were amazed to find that we received signals. Transmitters used Ford coils as spark transmitters and coherers as receivers.

The original idea to get people together interested in radio telegraphy I believe came from a man called P. H. Macilroy, who had a shop in Swanston Street (later known as Homecrafts) in 1910. *I know he did call a meeting some time before November 1911.* (Author's comment: Could there have been an earlier Society; does anyone have any record of this?)

## MR. O'SHANNESY'S TALK

"When I was invited to give a lecture to this meeting, I threw my memory back to those days of awe-inspiring experiments when there was little known about the new wonder wireless telegraphy. There were no books relating even remotely to the subject and only an odd article in 'Scientific America' which more often than not would provide 'advice' which could send you 'up a gum tree'.

Tesla and the rest of them had their ideas but just as my dad as a lad could never visualize man in flight, so I could not accept the thought as any more than a thought that my generation or the next would hear voice, music or any sound other than the dot dash of morse signals coming over the air. Our present TV was entirely out of the question.

The 'singing arc' did offer some possibility of sound transmission but nobody seemed to give it serious thought.

The reception of DOT DASH without wires was an exciting adventure. Transmission and reception became the supreme aim of many a lad in and around the early years of the nineteen hundreds.

Lodge and Muirhead were experimenting in England and with two miles between stations they were endeavouring to increase this distance by improved technique rather than by increased power input. Marconi paid them a visit and decided to follow up with a much more powerful plant.

I saw no evidence of creativity in Marconi. All he did was to use Lodge Muirhead ideas on a grand scale and exchange messages with a ship 200 miles out at sea. 'A world-rocking discovery by Marconi?'

In my neck of the Woods I had a pal named Culliver in East Melbourne and he could communicate with me in Richmond, a distance of less than one mile. We wore out many pairs of shoes running between stations when reception was on the blink and we did not know why. Gradually our know-how improved and amateur stations were springing up all around Melbourne. Nightingdale in Garden Vale had a high power plant but got into trouble when his wonderful aerial mast fell on a neighbour's roof.

Culliver and I built a box kite, 10 ft. by 8 ft. by 4 ft., with window-sash cord carrying a wire to 'high' altitudes. A real Faraday effort.

The Richmond paddock was our flying ground on a Sunday morning and cyclists would pedal from St. Kiida and elsewhere to see what they thought was a first aeroplane.

The Curator of Parks took a dim view when we lopped the limbs off some of his trees. In even a moderate wind we could not hold that kite unless we lashed the cord on to the post and rail fence.

When Culliver flew the kite with advertisements over the Richmond race-course, he pulled the chimney pots off the local bank, and this did not make anybody very happy.

Then a time of great excitement. We made contact with a ship at sea. The 'Ballarat', which I thing was later sunk by enemy action in World War 1.

The wireless operator made an appointment to visit Culliver's plant when he reached port and, wonder of wonders, he was so impressed that he presented us with a Marconi Coherer.

When we later tried out the Coherer we found that it did not match up with our own. Marconi, as you no doubt know, used iron particles in a vacuum tube and a small vibrating hammer to separate the particles after each signal.

With no vacuum available I was faced with using particles in air, so I chose aluminium filings which would oxidize very rapidly. They did the job first class and did not require a hammer.

We also had a Muirhead detector which had a small steel wheel with sharp edge turning in a well of mercury. Quite a good idea and like the Coherer it could carry enough current to activate a relay which in turn operated a tape machine.

Add crystal and cat's whisker and ear-phones for long distance reception and you have a picture of wireless of those times.

So many 'untuned' stations were hitting the air that we saw need for exercise of some control. The Amateur Wireless Society was formed and in due course we sent a deputation to the then Director of Telegraphs, Mr. Balsilli. The result was registration of all wireless experimenters and an issue of call signs.

At our meetings of the Amateur Wireless Society we would exchange know-how and let our imagination run riot. Many original theories were given the light of day and some have yet to receive scientific appreciation. I have always supported the Idea of Study Circles as an important part of technical societies. These Study Circles can delve into the unknown, and who of us can say that he has not some ideas and theories which could be as useful as Newton's apple. Why are we so lazy that we leave bright ideas to the other chap.

X-ray came in for a share of attention in those early days and discussions were so animated that at close of meetings we would continue debate on the kerbside till a late hour. With, of course, an eye out for the last tram home.

When we learned that experimenters in other States were getting together I was appointed to visit Sydney. With little money in those days, I lodged at the People's Palace, so before attending the meeting in Sydney I called at the Wentworth to get the lay of the land. After the meeting I was escorted to MY hotel, the Wentworth of course, and later I sneaked out and made my way to the People's Palace. One must never let the team down.

I mentioned my pal Culliver. He was a dedicated experimenter who had the urge to spend on materials rather than on food for his family. A drink addict had nothing on Norman Culliver.

Perhaps I had much the same measure of enthusiasm but the fates ordained that I obtain a job with the India Rubber Gutta Percha and Telegraph Works, 'Silvertown'. This job took me away from home and ended my experiments. It was many years before I returned home.



A section of the audience at the meeting.

'Silvertown' was an English firm engaged on the erection, installation and operation of electric supply stations in various country towns in Victoria. Dandenong, Daylesford, Euroa, Horsham, Korumburra, Nathalia, Nagambie, Rushworth, Shepparton. All were towns with go-ahead Councils.

I could relate many an anecdote but space is limited. You will gather an idea of our attitude of mind in those days if I give you an account of a grand opening of a power house by the leading lady of the land, the wife of the Shire President. She had the privilege and the honour of cutting the ribbon and releasing the main switch which gave light to the town. This was of course followed by much cheering, the band played and many of the locals would get well drunk. Well, on one of these occasions the Consulting Engineer, Mr. Christie, of Christie and Gardiner, arrived by train for the grand opening and he was really hostile because our chief, Scott, a tough engineer from England, had missed the train at Spencer Street. Christie had seen Scotty arrive at the platform just as the gate was slammed shut.

Scotty was on that train all right. He had grabbed a motor bike and caught the train at Seymour. For that grand opening it was decided that the silver scissors usually kept for the job should be gold-plated.

This would give tone to the occasion and they would be used on later jobs as required. Christie, however, did the wrong thing. He presented the Lady of the Town with the scissors as a souvenir of the occasion. We looked at each other in consternation. Scotty would surely give us a real trouncing if we parted with those scissors. So the following day he read in the local paper that the celebration was a splendid effort except that somebody had perloined the presentation scissors.

I am drifting from my theme, Mr. Chairman, and my time is running out.

When each of you are "Old Timers" you will know that the designer is not yet born who can foresee every problem associated with a new idea.

My time has run out. I thank you for your attention."

#### DISCUSSION

*Question:* What range did you achieve in those days?

*O'Shannessy:* We used to occasionally get reports of signals received over long distances but usually only a few miles around the suburbs; to get Wilson's Promontory or a ship was a real achievement!

*Question:* What wavelength was used?

*Mr. Witt:* We were supposed to operate on 400 metres, but no one knew exactly

where they were. Quite often they would be called by VIM and be asked to keep quiet. I made a hot wire ammeter which worked reasonably well for something excited by a Ford coil. As far as distance was concerned, the circle of operators was very small, perhaps over a distance of 2 or 3 miles. During the first World War many freak conditions were observed, and who was to say what our range was in the early days?

(Mr. Witt reiterated that amateurs in his time were really late in entering the field. There were many operators before his time, for example G. W. Selby in 1897 and H. W. Jenvy, who was operating before 1900, and they were getting quite practical results.)

*Question:* How did people become amateur operators in those days?

*Mr. Witt:* Things were pretty free and easy, as you can imagine. When Mr.

Valsill became Director-General of Wireless I guess we made ourselves known to him and he set the rules. It was all morse code, of course, and some of us went to school and gained a certificate in morse, but to obtain a licence it was necessary to demonstrate that you had the necessary skill.

*Question:* What sort of call signs did they issue in those days?

*Mr. Witt:* All call signs were three letter starting with X. (Author's comment: All call signs issued by 1914 were listed in "Amateur Radio" August 1970, page 10.)

*Question:* Mr. Witt, can you remember when the electronic valve was first used?

*Mr. Witt:* I can remember in Rabaul, during the war, we had what we believed was the first electronic valve and that was in 1917. We used to get news from Germany every day using this valve.

*Question:* What were your best distance records?

*Replies:* Probably from Melbourne to Wilson's Promontory; we could not get Sydney. On receiving, we used to receive Macquarie Island. The best I did during the war was Adelaide and Melbourne from Madang on 600 metres, but these were freak conditions.

*Question:* Someone made reference to New South Wales. Do either of you have much knowledge of what was doing in New South Wales?

*Mr. Witt:* I have got some information which states that the Wireless Institute of New South Wales was about six months earlier than us.

*Mr. O'Shannessy:* I believe that in Sydney a lot of amateurs were concerned about lightning as a lot of aerials had been struck. ■

# World-Wide Communications from Hand-Held and Man-Pack Transceivers

Sam Voron VK2BVS

2 Griffith Avenue, East Roseville, NSW 2069  
Phone (02) 407 1066 (7 to 9 p.m. nightly)

## PART ONE

**Walking along the streets of Sydney experimenting with different hand-held and man pack transceivers; enjoying amateur radio out in the fresh air. Meeting lots of interesting people and showing them the fun of the hobby; trying various antennas, matching systems and power sources. These are some of the fascinating aspects of trying to achieve world-wide communications while pedestrian with a hand-held transceiver.**

Several of today's small HF transceivers can be adapted for this purpose. We will look at the Palomar PTR130K, the Yaesu FT7 and FT7B as well as modern day military back pack units.

### THE PALOMAR ELECTRONICS

**CORPORATION PTR130K TRANSCEIVER**  
When this transceiver became available I thought it to be the ultimate dream for hand-held pedestrian use.

The unit is no larger than an SSB CB transceiver (Width: 17 cm, 6½ inches. Height: 7 cm, 2½ inches. Depth: 30 cm, 12 inches.)

Continuous transmit and receive from 100 kHz in the low frequency band right up to 30 MHz at the top of the high frequency spectrum.

Frequency selection via a push button keyboard mounted on the front panel of the transceiver.

All mode operation LSB or USB with or without compression, AM, FM or CW with break-in and side tone.

A squelch control which functions on all modes, including SSB.

A digital frequency readout.

An S-meter calibrated up to +40 dB over S9 and power output calibrated to 100 watts RF output.

A check list enclosed with the unit I received gave the following hand-written specifications:—

Receiver sensitivity for 10 dB S/N and transmit CW output:—

Freq. (MHz)	Receive (for 10 dB S/N on SSB)	Out (W)
1.8	.76 uV	44
3.5	.27	44
7.1	.22	82
14.2	.22	92
21.2	.22	69
28.5	.21	60

### OBSERVED PERFORMANCE

Selectivity appeared quite reasonable compared to my FT901 base station transceiver.

Transmit quality on AM could be improved and transmit deviation on FM could be increased.

Receiver audio quality on AM and FM was excellent. An acoustic feedback problem on SSB receive was due to the small loudspeaker used; this was replaced by a

larger speaker, which required widening of the speaker enclosure area. This solved the problem and gave excellent SSB receive quality.

SSB transmit quality with and without compression was also quite good.

The S-meter action on SSB is quite clever with the average level of the varying signal strength being used to indicate the S reading. Instead of jumping up and down, the S-meter readings resemble those of an AM signal.

The keyboard functions permit frequency selection and at any increment from 100 Hz upwards. This enables scanning (SC button) or step (ST) frequency selection in 9 kHz increments across the medium wave broadcast band or 5 kHz across the international short-wave band or 10 kHz across the marine band or 100 Hz, providing the impression of continuous tuning across any amateur band. Selection of 25 kHz, 1 MHz or any other spacing is provided for by simply entering your requirement on the keyboard. Selection of frequency can be programmed to go either up or down and a RIT (receiver incremental tuning) control provides fine tuning of ± 2 kHz.

Cross-frequency or cross-band operation is easy. For split operation (duplex) separate receive and transmit frequencies can be entered on the keyboard so that, for example, one may transmit on 1.8 MHz and receive on 28 MHz.

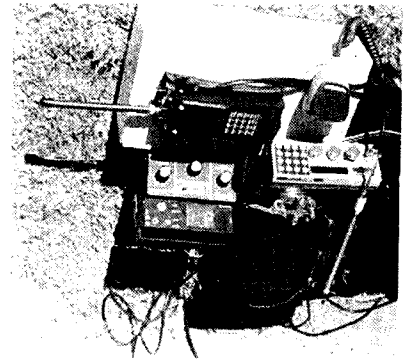

The Palomar PTR 130K compared with the size of the Yaesu FT207 VHF handheld.

The Palomar PTR 130K all mode 100 kHz to 30 MHz transceiver. Its size can be compared with the microphone and the morse key mounted on the adapted over-the-shoulder case.

#### THE PROGRAMME CONTROL KEYBOARD

16 push buttons are provided on the keyboard. Numbers 0 to 9 are frequency selection.

**TX:** Transmitter update/split operation.

**UP:** Move up in frequency.

**DN:** Move down in frequency.

**SC:** Scanning mode (moves frequency up or down at a slow or fast rate which can be preset by an internal variable potentiometer. For example, one can scan at two steps per second as long as "SC" button is depressed.)

**ST:** Step in frequency (moves frequency up or down one step each time the "ST" button is depressed).

To enter 14.200 MHz and move up by increments of 100 Hz one would press the "up" button (display does not change). Then set the increment rate which would be 100 Hz or 1, the display then reads 1. Next, depress the "ST" or "SC" button to move frequency.

The display will read 14.2001 if "ST" button is depressed once. Similar procedure is used to move down frequency.

To operate split frequency, enter the transmit frequency (say 1.8000 MHz) and depress "TX" button. Then enter the receive frequency (say 26.5000 MHz). When the microphone button is depressed the transmit frequency will be displayed.

For simplex operation, select the desired receive frequency, depress the transmit button and the set receives and transmits on the same frequency.

#### TRANSCIEVER CONSTRUCTION

Five double-sided printed-circuit boards make up the unit. The synthesiser board,

the linear board, the filter board, the front panel display board and the power amplifier board.

Construction of each board is beautiful, resembling the workmanship and technology that goes into American made home computers.

The high reliability and low failure rate of this production method seems verified after some six months field operation.

#### THE SYNTHESISER BOARD

Is responsible for generating all frequencies between 100 kHz and 30 MHz. Contains the phase lock loop circuit. Extensive use of integrated circuits prefixed by SL, SCL and MC are used. The scan rate is variable from potentiometer VR1 and transceiver frequency can be calibrated to the digital frequency readout by adjustment of the trimmer capacitor across the 990 kHz crystal. Both these adjustments are located on this board.

#### THE LINEAR BOARD

Contains the circuitry to process the 100 kHz to 30 MHz RF so that SSB, AM, FM and CW transmit and receive facilities are available. Collins mechanical filters are switched in and out of circuit in a unique way — not by relays but by 4066 integrated circuits located at the input and output of each filter. The well known TA7205 audio IC is employed together with the SL series communications ICs.

#### THE FRONT PANEL DISPLAY BOARD

Provides for the 6 digital displays as determined by the interaction between the keyboard and the synthesiser board. This board also contains the S-meter calibrate potentiometer VR401 and the transmitter power output calibrator potentiometer VR402.

#### THE POWER AMPLIFIER BOARD

A broadband (no tuning required) power amplifier stage uses two power FETs driving two bipolar power transistors biased to permit linear all-mode power amplification across the entire high frequency band with some drop-off in performance on the medium frequency range down to 500 kHz.

#### THE FILTER BOARD

Five double section low-pass filters are switched in and out of circuit so that no matter what frequency is selected maximum attenuation of unwanted harmonics is achieved. The synthesiser board controls which low-pass filter will be switched between the output of the power amplifier and the antenna.

#### FRONT PANEL SWITCHING

All modes of operation (FM, AM, CW, LSB, USB, LC, UC) are selectable from a single 3-pole 7-position switch.

A standard 4-pin microphone socket is located to the left of the front panel; moving to the right is the on/off volume and squelch control on a double shaft; then the mode selector, followed by the RIT control and the keyboard on the right-hand side of the unit.

#### BACK PANEL

Contains the 100 watt heatsink, morse key and external speaker sockets.

#### MODIFYING THE PALOMAR FOR "HAND-HELD" USE

(1) Add an on/off switch on the back panel to switch off meter lamp and digital display to conserve current.

(2) Add a 470 ohm preset pot between source and earth of the first power FET in the power amplifier board. Adjust for 1 watt output. Add a switch on the back panel to select between 1 watt (with pot) and 100 watts (shorting out the pot).

(3) Cut in half two of Dick Smith's CB carry cases, fit the halves over the Palomar for a perfect fit and apply Araldite. You now have a carry case complete with shoulder strap and antenna side mounting brackets.

(4) Mount the 5 foot centre-loaded telescopic CB whip on the side brackets provided. Drop the top section down by 1



**Tony VK2NFS from Sydney takes our Palomar HF hand-held while on holidays in Brisbane. The bag on the right contains Gel type rechargeable batteries.**



**A size comparison between the Palomar transceiver PTR130 and a typical SSB CB radio, the Hy-Gain V set up for operation at the local park.**

inch. It's now resonant on 28 MHz. Note: No ground plane is used, the antenna wire simply plugs in to the centre of the PL259 socket. I was horrified when I learned this was Dick's recommended method for his "CB carry case", but it works! Walking to the bus stop I worked a ZL on 28.5 MHz who couldn't believe I was running 1 watt and walking along the street at the same time! Coverage all over Sydney is great; I have even QSO'd inside a train with nearby novices.

The cost of the unit is a few hundred more than my FT901DM. However, considering its wider scope, despite the few criticisms mentioned, I would have probably been willing to pay \$300 for what this unique transceiver will do.

Since these experiments an experience of a lifetime has come my way. On a flight from Sydney to Surfers Paradise I asked the stewardess of our 80-seater jet liner if I could use my 2 metre hand-held on board the aircraft. She returned and said the pilot will let me use his radio (receive, I thought). I walked up front with a grin on my face, up the aisle, and into the cockpit. To my shock and great excitement the pilot gave me the aircraft radio microphone and said "Go for your life!" The aircraft radio was just like my Palomar but only covered 2 to 30 MHz continuous and was 400 watts SSB and 150 watts AM. There I was aeronautical mobile at 33,000 feet calling CQ on all band 80 to 10 metres; of course I was very sad the set didn't go down another 200 kHz into the 1.8 MHz band. But next time I'll plug my Palomar into their antenna!

Thinking about possible misuses of this equipment, I was told that some pilots dialled up the CB band during long flights across Australia and chatted to the truckies

below. Well, I guess if a pilot is seen as a responsible user of such equipment then the difference between him and the irresponsible user is that he uses the equipment with commonsense, whereas the other responds to whatever whim takes his fancy.

I certainly remember the sense of pleasure and excitement learning about this type of technology and am thankful to have been able to explore the ins and outs of the Palomar before fate shut its door in our faces.

The PTR130K is no longer available, as the head of the company died and the company folded after many years of operation. Note that Palomar Engineering, a company with a similar name, is not related to Palomar Electronics Corporation, and continues to operate. Stories of another company picking up the rights to produce the unit, and possible stocks of already manufactured units are being investigated by the author in the hope of once more making this unit available for amateur experimentation.

By the time this article reaches print the situation should clarify.

In the meantime those who were lucky enough to obtain a unit (a photo in a recent QST shows an American amateur using the Palomar in a Peking hotel room, together with a narrow band voice modulation adaptor) will be pleased to learn that David Olson N6BSD of 4419 Donald Avenue, San Diego, California, USA 92117 has had experience in the servicing of these units if that should become necessary in the future.

I feel that, like pilots, this ability to explore the entire waveband in times of emergency and need is a facility which amateurs can maintain in their unique



**Working cross-band from 2 metres to HF hand-held, using the Palomar under licensed supervision at the ANZAC Parade march in Sydney.**

position as explorers of the airwaves, as communications experts, and as responsible individuals available to serve the community at all times. Looking at the new products on the horizon it seems that the Palomar concept is what two-way radio technology is coming to. It can't be long now before the first HF hand-held similar to the 800 channel 2 metre hand-helds will become available, launching a new era of portable hand-held MF and HF amateur operation. ■

(To be continued)

# Further Thoughts on the Kenwood R1000

Ron Fisher VK3OM

Since writing the review on the R1000 receiver published in the February issue of Amateur Radio, I have now obtained my own receiver and, with several weeks use, I have come up with a few points perhaps of interest to both owners and prospective owners of these excellent units.

One point noted in the original R1000 but not mentioned in the review was the extraordinarily long decay time on the AGC when in the AM mode. This had the effect of blocking the receiver for several seconds when tuning off a strong broadcast signal. In fact with a signal reading S9 + 40 dB it took 15 seconds for the receiver to fully recover. In the SSB mode by contrast the AGC recovery was only about five seconds. This effect was mentioned to the distributors who claimed that this particular receiver was set up for the European market where the long AM AGC recovery was required for some particular reason. They stated that receivers imported for Australia would have a more suitable AM AGC. This does not appear to be so.

A look at the circuit shows an additional 4.7 mF capacitor is switched into the AGC line in the AM wide and narrow functions. The solution to the problem is to simply remove this. For those reluctant to attack their new R1000 with the soldering iron let me explain further. Perhaps Kenwood had an idea that the long AGC delay would not suit everyone, thus conveniently connecting the capacitor back to the main printed circuit board via two pin plastic encased plug. Just pull out the plug. To help you find it, refer to the internal view in photo 1. It is the only two pin connector in the area and it should be noted that apart from the AGC time constant, now the same for SSB and AM, there is no other change to receiver performance.

Last point is the noise blanker. As readers would no doubt have noted, I did not rate the blanker as over effective. However since using my own R1000 I have found it to be rather better than the blanker in the review receiver. In fact it is even effective on many electrical appliance noises that seem to plague suburban locations.

In conclusion, I can see that many modifications and adaptations will be thought out for the R1000. If you have any thoughts let us know. ■



PHOTO 1:  
The latest in the Kenwood line of receivers — the R1000 features digital readout and coverage from 200 kc to 30 MHz.

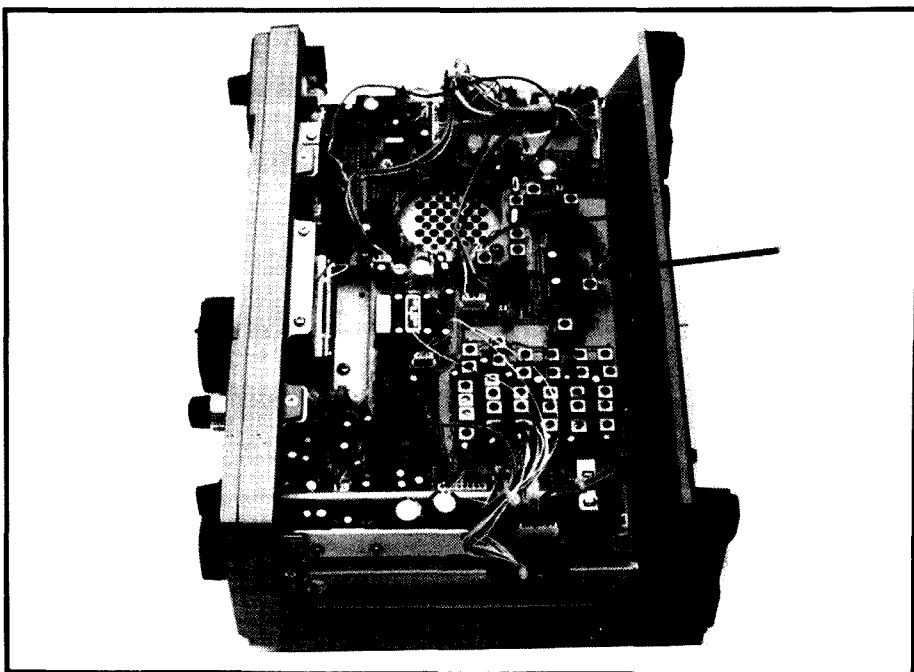

PHOTO 2:  
Internal view of the R1000. The two pin plug referred to in the text is arrowed.



# A Review of the ICOM IC 720 HF Transceiver

Ron Fisher VK3OM

**ICOM's latest entry in the HF transceiver market, the IC-720, follows the same physical format as its predecessor, the IC-701, but has been changed electrically in many interesting ways.**

Let's take a close look at just what the 720 is capable of. Like most of the new arrivals on the market, the 720 provides coverage of all amateur bands, including the new WARC 79 bands at 10, 18 and 24 MHz. However in addition to this, the 720 provides full general coverage receive facilities from about 50 kHz to 30 MHz with provision for AM, SSB, CW and RTTY reception. All of this is packed into a package essentially the same size as the older IC-701. The unique tuning system of the 701 has been improved and refined in the 720. The synthesised VFO is of course still employed but now provides greater flexibility.

While the general specifications are similar to the IC-701, let's look at the 720 and see just what ICOM claim for it. Firstly, they manage to fit 104 transistors, 17 FETs, 244 diodes and 55 ICs, plus one CPU. Quite a box full. As the photographs show, the general appearance is similar to the older 701 and is quite compatible with the current range of ICOM VHF gear such as the IC-251 and IC-551 and also the older IC-211. ICOM are to be congratulated for their policy of keeping appearance compatible with changes of model. Amateur band coverage from 1.8 to 2.0 MHz, 3.5 to 4.1 MHz, 6.9 to 7.5 MHz, 9.9 to 10.5 MHz, 13.9 to 14.5 MHz, 17.9 to 18.5 MHz, 20.9 to 21.5 MHz, 24.5 to 25.1 MHz and 28.0 to 30.0 MHz. The general coverage receive facility provides 31 MHz segments from 0 to 30 MHz. Reception actually starts at about 50 kHz, a shade lower than the specified 100 kHz. The transmitter is rated at 200 watts power input on all modes except AM, which is rated at 40 watts output (carrier). As mentioned earlier, the tuning has been improved to a marked degree and now has three tuning rates — one, ten and one hundred kHz per tuning knob revolution. The synthesised VFO is producing output in 10 Hz, 100 Hz and 1 kHz steps to provide the above tuning rates.

The frequency readout is now a very readable blue and as well as indicating frequency also indicates the mode status of the transceiver. Upper or lower sideband is indicated with a LED U or L. AM,

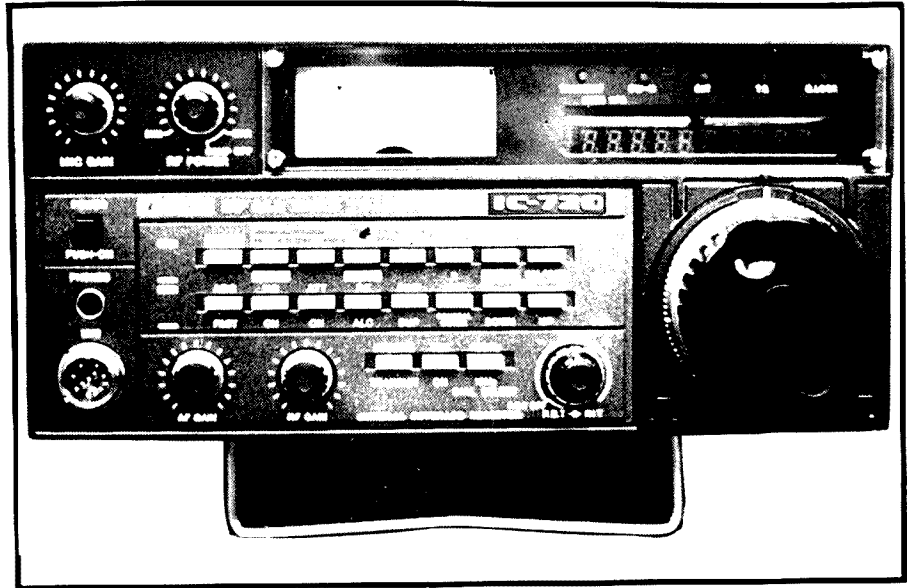

**PHOTO 1: Although essentially the same in size as the older IC701, the IC720 incorporates many more features for the enthusiastic HFer.**

CW and RTTY are likewise indicated with an appropriate LED display. The 720 also selects the correct or commonly used sideband for each band automatically.

The band change method is quite unique and does not use a band switch at all. Three push buttons select the required frequency, one giving either amateur or general coverage, the other two pulse the transceiver either up or down one amateur band or 1f in the general coverage mode, up or down in one MHz steps. This band change system, along with the two separate VFOs, can give some interesting combinations. For instance it is possible to set up the transceiver on two entirely different amateur bands and listen to two contacts in sequence just by selecting the appropriate VFO. You can in fact keep an ear on your 80 metre net while you are in contact with a DX station on 20 metres. As the bands are changed, the correct front end filters are switched by the motor band change system. Very neat.

The receiver uses a quadruple conversion chain. The first is an up conversion to 39.7315 MHz then to 9.0115, to 10.75 and then back to 9.0115 MHz. These last up-down changes are to provide the variable receiver selectivity by using two filters and a variable heterodyne frequency. The transceiver we had for review had filters for SSB, CW and AM installed. I believe that 720s sold in Australia will have these filters installed as standard.

ICOM have gone to considerable trouble to provide first class receiver front end performance. The receiver RF stage is a wideband push-pull device and the first mixer is a special double balanced type.

I noted with interest that ICOM have dropped their Hang AGC system previously rated highly in the IC-701 transceiver and have gone to a standard slow decay AGC system.

On transmit an effective RF speech processor is again used. Other features of



PHOTO 2: Close-up view of the IC720, showing function switches for the receive and transmit modes.

the 701 include a thermostatically controlled fan for the final transmitter stage, an automatic switch-off receiver offset tuning and the built-in SWR meter. One feature missing is the clutch release on the main tuning knob. The tension on the knob can be adjusted with a set screw from under the cabinet, but the old feature so well liked by IC-211 and IC-701 owners is gone.

Several controls are located under a small hatch in the top of the cabinet. These are CW monitor level control, frequency set, VOX delay set, SWR meter switch, RF out/collector current switch, CW delay control to set break in time delay, anti-VOX control, VOX gain control and SWR sensitivity set control. Rear panel controls include a multi-pin socket for connection to an external control unit. It appears that the earlier RM-2 or RM-3 are not compatible and as yet a suitable unit has not been released by ICOM. Most of the other connectors are standard with the exception of a low frequency antenna socket for use on the broadcast band and lower. The input to the 720 receiver is bridged through two connectors to allow a pre-amp to be inserted.

**THE IC-720 ON THE AIR**

Some of the excellent features have already been mentioned, however the 720 takes a little getting used to but once mastered the transceiver is delightfully easy to use. Setting up the transmitter audio gain controls was the most difficult. It seems that the ALC reading on the meter should only just move. The first few times on the air, I tried to talk it up to the end of the scale with resultant reports of slight distortion. While talking about the meter, this has been improved to the point

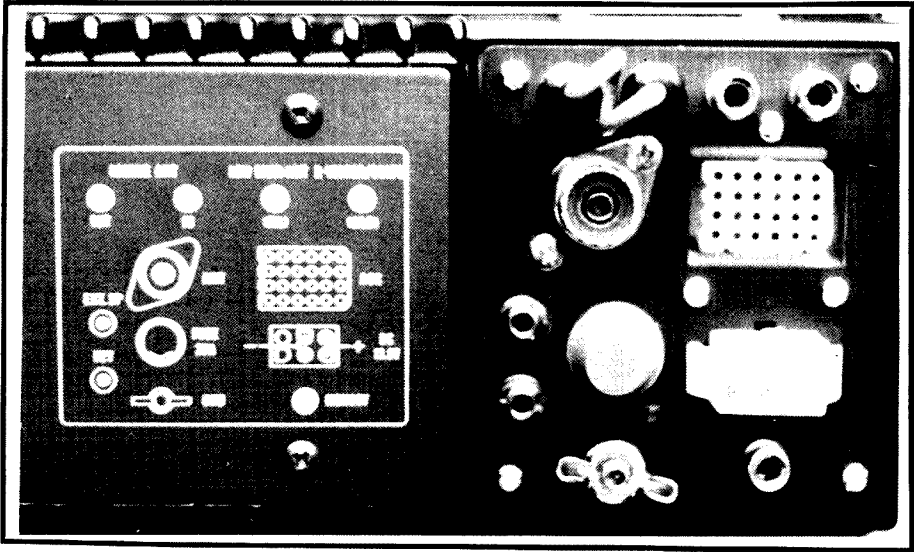

PHOTO 3: Rear view of the IC720.

where I can read it with ease. The old 701 meter was cluttered and difficult to read. Also note that ICOM have dropped their automatic dial light dimmer, not a great loss.

I found the 10 kHz per knob revolution the ideal speed. The synthesiser tunes in 100 Hz steps at this rate. The 1 kHz per revolution is ultra slow and ideal to set the pitch of the signal where required. The 100 kHz per revolution speed is selected with a push button under the tuning dial and is ideal for rapid shifting up and down the band.

I note that the electret desk microphone is no longer supplied as standard. I believe this will be available as an optional extra in the future. A standard PTT micro-

phone with curly cord is included. If you think that you might use your SM-2 desk microphone, sorry, they now use an eight pin connector. Perhaps this means that some time in the future a scanning type microphone will be available. In fact, perhaps its strange that the 720 does not at the moment have any provision for scanning!

Power output was checked on all the amateur bands, including the WARC 79 allocations and was found to be variable. Maximum output was on 160 and 80 metres with exactly 100 watts. Power dropped as the frequency increased with a minimum of 50 watts on the 24 MHz band and strangely up to 65 watts on ten metres. It is always hard to know if this is normal or not, as at the time of testing the IC-720, our test unit was the only one in the country. Bearing in mind the preceding statement, it was interesting to note that using the general coverage receiver, WWV had a transmission on 9, 10 and 11 MHz.

The 720 is available with a choice of AC power supplies, a heavy duty type incorporating no transformer and a light duty type which has a fully regulated trans-

former. The latter type was supplied with our review model and incorporated its own cooling fan for the heatsink. However what has happened to the speaker ICOM used to put in the front of their power supplies? Gone! Now you have to buy an external speaker at extra cost, of course. There is a speaker in the top of the 720 cabinet, but quality from this is just not acceptable.

I plugged in a medium sized external speaker and the quality improved immediately — but up came a very noticeable hum, not audible on the internal speaker of the 720.

**INSTRUCTION BOOK**

I can only guess that the instruction book will be OK. As this 720 was rushed out from Japan for early evaluation, it had the

Japanese Instruction book with It, plus a draft copy of the English language edition. I will comment further when the normal book becomes available.

**CONCLUSIONS**

The 720 is a complex piece of gear — even more so than the 701. It of course

remains to be seen just how reliable the rig is. The early 701s did not enjoy a good reputation in this respect. However it is fair to say that VICOM, ICOM's local agent, have provided excellent service and have in many cases provided free service well outside of the normal warranty period. I hope that in the future I

might have the opportunity to look at the 720 again to see how it is shaping up in normal production.

Our review 720 was provided by VICOM International of 68 Eastern Road, South Melbourne, to whom all enquiries should be directed. ■

# Margaret, 70, becomes Amateur Operator

— Courtesy of the Manning River Times.

There was a time when Mrs. Margaret Gerity VK2BQG, of Wootton Crescent, Taree, couldn't stand the sight or sound of a radio. She married Lester Gerity, an amateur enthusiast, in 1954.



However, until recently, Margaret avoided all contact with the radios and paraphernalia.

Now, aged 70, Margaret has studied for and won her full call amateur radio operator's licence.

"Now I'm really keen," says Margaret.

She says she took it up when they moved from Bennett's Head, Forster, to Taree, a few years ago.

"I had broken my ankle so I couldn't play sport, and it seemed a good way to meet people," she said.

She took a year of free tuition with Geoff Hunziker of the Taree Amateur Radio Club and then in 1978 began a technical college course in radio operation.

"When I started in 1977 I was blind and dumb and deaf to everything, then I started to cotton on," she said.

Margaret received her novice certificate two years ago. Lester, 73, is an old hand in the radio hobby, having received his first call code in New Zealand in 1928.

A former ships' operator, he is now a director of the Taree Amateur Radio Club. Margaret is a former secretary of the club.

Margaret studied for her certificate with enthusiasts of all ages, from school boys to engineers.

She says she loves the people you meet through radio, and is particularly fond of Morse Code, hoping to become really skilled in sending and receiving it. ■

## Solid Status

Ⓜ Ⓜ — BUT HENRY! WHAT REASON DO YOU HAVE TO EVEN THINK THAT I HAVE BEEN UNFAITHFUL?

Ⓜ Ⓜ Ⓜ Ⓜ

TI CASSO

## QSP

### MALICIOUS INTERFERENCE

The July meeting of the ARRL Board of Directors considered a report of the ad hoc Committee on Interference which covered, among other things, the response to the March editorial in QST on the problem of malicious interference possibly causing a crisis in amateur radio. The Board set up an interference task force to co-ordinate an educational programme, to provide a reference manual and guidelines and to provide liaison at the national level. The overall objective was stated to be the encouragement of the amateur radio service "to continue to justify its reputation as a self-policing service by the reduction or elimination of all types of interference on amateur frequencies".—QST September 1980.

An article by Doc Omelin in Worldradio September 1980 comments "When radio amateurs cry for help, they are admitting that we are no longer able to be self-policing". The problem of proving "maliciousness" is seen as a difficulty when read with "harassment", "carelessness" or "inadvertance". "All of us," he writes, "should make sure that we are not interfering with other stations in any way that might be considered 'malicious'. Above all, don't get involved in hassles with amateurs who you think might be causing 'malicious' interference." ■

**JOIN A NEW MEMBER — NOW!**

TALK TO THE PEOPLE WHO KNOW WHAT TALKINGS ABOUT



YAESU CPU-2500R  
2m FM transceiver



# GFS... SUPPLIERS OF MOST OF YOUR COMMUNICATIONS NEEDS INCLUDING YAESU, DENTRON, MFJ, JIL, ETC.

PHONE: (03) 873 3939  
CABLE: "COMIMPORTS"  
MELBOURNE  
TELEX: AA 38053 GFS

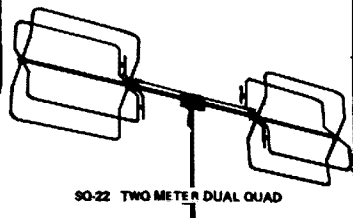

### PUBLICATIONS

Kit Of Maps Incl. World Map, US Map & Atlas with call prefixes and zones. Centred on Melbourne. United States Call listing. Call Listing of the World.

6.00  
1.00  
19.50  
18.50

MODEL	DESCRIPTION	R. RETAIL
FT 107M	TCVR. with DMS & AC Power supply	1385.00
FT 107	TCVR. with AC Power supply only	1230.00
FT 107	HF TCVR. OC Power supply only	1150.00
FT 107	S.S. HF TCVR 240 watt	795.00
FT 901DM	HF Transceiver with memory	1249.00
FT 901D	Same as FT-901 DM but no memory	1175.00
FT 101ZD	HF Digital Transceiver	950.00
FT 101Z	HF Transceiver	779.00
FT 225RD	Digital FT-225R	975.00
FT 625RD	Digital FT-625R	995.00
FT 720RVAI	10 watt 2m x FM Transceiver	479.00
FT 720RVH	25 watt 2m x FM Transceiver	499.00
FT 720RV	10 watt 70cm FM Transceiver	625.00
FT 720	UHF Deck only	393.00
FT 7B	Economical HF Transceiver	649.00
FT 227RB	2Mx 800 Ch. FM Transceiver	385.00
CPU 2500R	2Mx 25 watt Synthesized Transceiver	525.00
FT 207R	Handy 2Mx Transceiver Inc. Nicad battery and NC9C charger	349.00
FT 480R	2Mx SSB FM Transceiver	585.00

RECEIVERS		
FRG 7000	Digital HF Warty Loop Receiver	575.00
FRG 7100M	Digital HF Rcv with Memory	672.00
FRG 7700	Digital HF Rcv without Memory	528.00
FRG 7	HF Warty Loop Receiver	339.00

INTEGRATED ACCESSORIES		
FV 707DM	Digital VFL for FT 707	300.00
FV 107	VFO for FT 107	185.00
FC 107	Antenna Coupler for FT-107	160.00
DMS	Memory Unit for FT-107	145.00
FV 01	External VFO for FT 901 series	399.00
MR 7	Base Mounting Rack for FT 707	28.00
MB 7	Mobile Bracket for FT-707	26.00
FC 902	Antenna Coupler for FT 02 series	215.00
FC 707	Antenna Coupler for FT 707 series	155.00
SP 901	Speaker for FT-901 series	58.00
YR 901	CW/RTTY Ready for FT-902 series	75.00
FL 2100Z	Linear AMPLIFIER for FT-901/101Z	620.00
FL 110	Sold state 240W amp	269.00
Diq Readout		
IFT 101Z1	Mobile	150.00
YC 7B	Diq Readout for FT-7B Transceiver	140.00

MICROPHONES & STATION ACCESSORIES		
YD B44	Desk Mic for Yaesu Transceivers	49.00
YD 148	Desk Mic for Yaesu Transceivers	49.00
YD B45	Hand Mics for Yaesu Transceivers	19.00
YE 7A	Hand Mics for Yaesu Transceivers	19.00
YM 35	Hand Mics for Yaesu Transceivers	30.00
YM 37	Hand Mics for Yaesu Transceivers	19.00
YM 24	Hand Mics for Yaesu Transceivers	32.00
YM 55	Headphones for Yaesu Transceivers/Receivers	19.00
FF 501DX	Low Pass Filter 1Kw PEP	39.00
QTR 24D	Wait time clock	44.00
TEST INSTRUMENTS		
YC 500J	Frequency Counter 30Hz to 500MHz	330.00
YP 150	Dummy Load/Watt meter 0-150 Watts	99.00
YC 1000L	Logging Data Processor/Counter	POA

YAESU EQUIPMENT FT-901/101Z ACCESSORIES		
CW Filter	For Yaesu Transceivers	55.00
AM Filter	For Yaesu Transceivers	55.00
Keyer	For Yaesu Transceivers	48.00
Memory	For Yaesu Transceivers	72.00
DC DC	For Yaesu Transceivers	86.00
FM Unit	For Yaesu Transceivers	58.00
Fan	For Yaesu Transceivers	38.00
Battery/Motkr	For FRG 7	10.00
PB 1292	INH for FT 101Z	45.00
FT 101E	DC/DC Converter	60.00
Denso	Electrical Jointing compound	2.90
POWER SUPPLIES		
FP 701	AC power supply for FT 707	198.00
FP 107E	External AC power supply for FT 107	195.00
FP 107I	Internal AC power supply for FT 107	185.00
NC 3	FT 207R Acc. Quick charger/adaptor	78.00
FNB-1	Nicad battery charger	29.00
FBA-1	Battery pack charger/adaptor	5.75



MFJ 949 Deluxe Vess Tuner II

ANTENNAS SWISS QUAD SERIES BY Y.E.T.		
SO 20M	20MX 10dBd gain (Elements loaded)	379.00
SO J15	15Mx 12dBd gain	169.00
SO J10	10Mx 12dBd gain. Swiss quad	159.00
SO J61	6MX x 10dBd gain. Swiss quad	119.00
SO J22	2M x 2 15dBd gain. Swiss quad	99.00
SO J22 x 4	2Mx x 4 17dBd gain. Swiss quad	189.00
SO J24	2Mx x 4 18dBd gain. Swiss quad	219.00
SO-007	70cm x 2 15dBd gain. Swiss quad	99.00

A.S.E. HF ADJUSTABLE MOBILE WHIPS		
G-80	60MX Heavy duty helical 7ft long.	39.00
G-40 to G-10	40-10MX H.D. Helicals 6ft long.	34.00
G-80	80MX Heavy duty helical Whip 8ft.	59.50
G-BM	Bumper Mount for A.S.E. Helicals.	18.50

BROADBAND UMF/UHF ANTENNAS		
Scan X	65-520MHz Discone 3dB gain for receivers only.	39.00 (35 + S.T.)
GDX 1	80-480MHz Discone for Tx and Rx use.	89.00 (81.25 + S.T.)
Gingoo	144-170MHz 9dB gain vertical.	54.00
HOKIN		
HFS DX	80-10MX Treped vertical; no guys Self supporting with self supporting rods.	138.00
GSS	Deluxe Gutter Mount will take most antenna bases.	10.00
J 1F	Rubber Duck Helical for 146-170MHz with PL-259 base.	10.00

ATN ANTENNAS		
28 30 3	10'11" 1MX 3el Yagi 8dB gain.	80.00
28 30 5	10'11" 1MX 5el Yagi 9.5dB gain.	135.00
28 30 6	10'11" 1MX 6el Yagi 10dB gain.	175.00
5 15 3 5	6MX 3el Yagi 9.7dB gain.	85.00
5 15 3 8	6MX 6el Yagi 12 dBd gain.	130.00
5 15 3 11	6MX 11el Yagi 14.6dB gain.	165.00
144-148 8	2MX 8el Yagi 12.5dB gain.	45.00
144-148 11	2MX 11el Yagi 14.5dB gain.	55.00
144-148 16	2MX 16el Yagi 14.8dB gain.	70.00
420-470 6	0.7MX 6el Yagi 8dBd gain.	30.00
420-470 14	0.7MX 14el Yagi 13.7dB gain.	45.00
432-16L8	0.7MX 16el Yagi 14.8dB gain.	90.00
47-7	CB 7el Yagi 11dB gain.	40.00
47-11	CB 11el Yagi 17.2dB gain.	50.00
R 12 27-29	J wave vertical for 28MHz.	38.00
580 14	0.5MX ATU Yagi 15.3dB gain	50.00
C 20 30 1	Adjustable Dipole	33.00

ATN BALUNS		
3 150 1 1 200	200 Watt 3 150MHz 1:1.	10.00
100 600 1 1 200	200 Watt 100 600MHz 1:1.	12.00
3 150 4 1 200	200 Watt 3 150MHz 4:1.	12.00
3 100 1 1 1KW	1KW 3 100MHz 1:1	20.00
3 100 4 1 1KW	1KW 3 100MHz 4:1	25.00

ATN POWER DIVIDERS (Uses "N" type connectors)		
140 150 2	Couples 2 x 50 OHM Antennas	40.00
140 150 4	Couples 4 x 50 OHM Antennas	50.00
400 470 2	Couples 2 x 50 OHM Antennas	38.00
400 470 4	Couples 4 x 50 OHM Antennas	48.00

INSULATORS FOR THE HOME		
Type 1	H to J or 5/8" et to 2" boom	4.00
Type 2	H 3/8" et to 1" boom for O.E.s.	1.00
Type 3	H 3/8" et to 1" boom for Para ela.	0.70

TRAPPED DIPOLE ANTENNA		
A 2480	60 ft long 80/40/20Mx Dipole	59.00

MODEL	DESCRIPTION	R. RETAIL
DENTRON PRODUCTS		
QTR-2000L	2KW Linear Amplifier	1495.00
MLA-2500B	2KW Linear Amplifier	1235.00
Clipperton-L	2KW Linear Amplifier	889.00
GLA-1000	1KW Linear Amplifier	466.00
MT-3000A	3KW Antenna Tuner	460.00
MT-2000A	3KW Antenna Tuner	269.00
JR-Monitor	Baby Antenna Tuner	98.00
Big Dummy	1KW Oil Cooled Dummy Load	43.00
MFJ-982	1.5KW Ant. coupler/SWR/power meter 6 pos. Co-Ax SW for bel end un bal line (inc. balun)	242.00
MFJ-981	1.5KW Ant. coupler/6pos. Co-Ax SW for bel and un bal line (inc. Balun)	209.00
MFJ-949	300W Ant. coupler/SWR/Power meter Dummy load/Co-Ax SW for bel and un bal line (inc. Balun)	199.00
MFJ9418	300W Ant. coupler/SWR/Power meter Co-Ax SW for bel and un bal line (inc. Balun)	165.00
MFJ-943	210W Ant. coupler for bel and un bal line (inc. Balun)	125.00
MFJ-901	200W Ant. coupler for bel and un bal line (inc. Balun)	99.00
MFJ-900	200W Ant. coupler for un bal line (no balun)	89.00

OTHER MFJ PRODUCTS		
SSB/CW FILTERS		
MFJ-752	Dual Tunable active SSB/CW Filterinc Peak/Notch. Noise limiters and two variable freq. filters.	155.00
MFJ-751	Tunable active SSB/CW filter.	125.00

KEYERS		
MFJ-484	Grandmaster Keyer. 400 character memory plus many more features.	233.00
MFJ-408	Electronic Keyer with speed meter.	155.00
MFJ-481	Memory Keyer, stores 2 x 50 character message 8-50WPM.	155.00
MFJ-402	Econo Keyer, built in paddle, weight end speed control 8-50 WPM solid state keying.	83.00
LSP-520x11	Super Logarithmic speech processor 30dB dynamic range & 3 active filters.	97.00
MFJ-202	Antenna Noise Bridge, wide range 0-250 OHMS - 150pf x c 1-100MHZ.	89.00
MFJ/MX-1	Morse Code Manipulator.	55.00

MISCELLANEOUS		
MFJ-410	Morse Processor, morse code tutor sends unlimited random code in random groups	132.00
LSP-520x11	Super Logarithmic speech processor 30dB dynamic range & 3 active filters.	97.00
MFJ-202	Antenna Noise Bridge, wide range 0-250 OHMS + 150pf x c 1-100MHZ.	89.00
MFJ/MX-1	Morse Code Manipulator.	55.00

ANTENNA ROTATORS		
EMOTATOR		
103SAX	Medium Duty Rotator. 240V.	179.00
502SAX	Heavy Duty Rotator. 240V	269.00
1102MXX	Extra Heavy Duty. 240V	379.00
1211	Mount Clamp for 103SAX	20.00
1213	Mount Clamp for 502SAX	33.00
1315	Mount Clamp for 1102MXX	50.00
303	Mount Bearing	33.00
301	Mount Bearing Double section	45.00

TOWERS		
G20V1	6m Single section self supporting.	95.00
G20V2	6m Double section self supporting.	108.00
GM20	6m Tubular 2" mast	29.00
G20B	6m heavy Duty Box Base for G-20V1/2	169.00
G10B	3m heavy Duty Box base for G20V1/2	159.00
GM-15	4.5m Tubular 1 1/2" mast.	21.00

YAESU MUSEN PRICES ARE RECOMMENDED RETAIL ONLY. DROP IN AND WE WILL GIVE YOU A VERY COMPETITIVE QUOTE.

G.F.S. ELECTRONIC IMPORTS 15 McKEON ROAD, MITCHAM, 3132. (03) 873 3939

# Rally II – WICEN Exercise

R. E. Cordukes VK4CD

Last June, the Townsville Amateur Radio Club, with the help of SES, combined forces for a WICEN exercise to provide radio communications for the Townsville Sporting Car Club's rally held during the Townsville Pacific Festival week.

The purpose of the exercise was to provide amateurs with the opportunity to set up radio stations in remote situations, to operate for extended periods, to compile accurate messages and reports, and to send, relay and receive these messages and reports.

The car rally was to start in Townsville at 1500 GMT on Saturday, 14th June, 1980. The first car was due to finish at 0615 GMT on Sunday. During these 15 hours, competitors would pass through more than 30 checkpoints as they sped over forestry roads and trails 180 km north to Cardwell.

## PREPARATIONS

Bill VK4XZ assumed command of planning the communications network. His task was to find two radio systems that could operate from each checkpoint to headquarters in Townsville. Traffic congestion from the 30 checkpoints had to be avoided, and an alternative system had to be available in case of failure of one system. Two reconnaissance parties experimented from the various checkpoints some weeks before the exercise. The results of these showed the following:—

HF, 3.605 MHz, or SES HF, 3.732 MHz, was the logical first choice. The range of about 200 km from Townsville and the possibility of erecting dipoles with ease confirmed this frequency to be suitable.

VHF was selected as the second system. This was a very interesting challenge. How could VHF be effective and reliable over 200 km? Direct QSOs could be made with Townsville on 146.5 MHz from about 30-40 km to the north. This would be suitable for the nearby checkpoints.

Mario VK4MS very quickly put the answer together. He built a double VOX system that would allow direct QSOs with Townsville over the 200 km. Control points would transmit on 146.5 MHz, Mario would receive this at his QTH at Ingham and automatically retransmit on UHF, 432 MHz, to Townsville, 120 km to the south. The operator at Townsville would reply on UHF and be received by the original station on VHF.

It was a simple system, and it worked. This overcame the need for any relay system for reports. In effect it meant that a second reliable system was the second choice.

Some control points could also use VHF and UHF direct, others could use SES VHF, 168 MHz, and UHF, 459 MHz.



PHOTO 1: SES and WICEN control point at Ingham.



PHOTO 2: Bob VK4NMV and Ian VK4NFU compiling reports at a checkpoint.

Another VHF system that was available was via the Cairns repeater, VK4RCA, on Mt. Bellenden Ker ("She's a beaut, Mate!").

Operators in the Cardwell area had access to the repeater, 170 km to the north. This is also easily accessible from Castle Hill

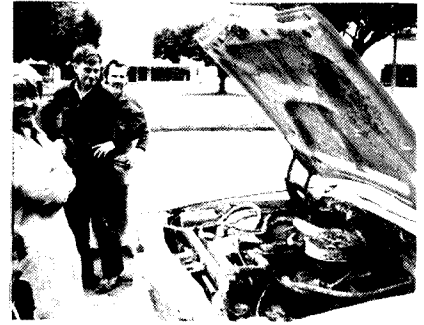

**PHOTO 3** (left) shows a comfortable operator operating portable with his make-shift shack, Robert VK4ZRK. **PHOTO 4** (above) from left to right, pictures Evelyln VK4EO, Charlie VK4BQ and Rob VK4NVO looking tired but happy at the mud in their car.

**PHOTO 5** (below) shows a rally car arriving at a checkpoint.

in Townsville, 350 km south. So such a link would travel north then south to Townsville.

#### **THE RALLY**

The difficulties of providing communications had been overcome. The success now rested on the radio operators' skills. All were briefed on procedures for sending and receiving messages. Checkpoints were allocated, and the car rally was under way.

Throughout the 15 hours of the rally more than 60 transceivers were used to pass over 1200 reports and messages. All systems worked with success.

There were a few minor difficulties. Charlie VK4BQ and Evelyn VK4EQ spent two hours bogged down on a forestry road. Charlie used all his skills to prise his car out of the mire, only to sink down again a little further up the road. Finally at about 2100 hours, a four-wheel drive vehicle pulled him out and dragged him to his checkpoint. After lighting a fire to warm up their cold, wet and muddy feet, Charlie and Evelyn erected a dipole and were on air 15 minutes before the first car arrived.

There were generators that were a little stubborn to start and antennas that fell down. But these difficulties were easily overcome.

At all times, headquarters in Townsville was kept informed of the position of the car rally competitors. The only vehicles that got lost were a couple of service vehicles. One of these hit a bridge while trying to reach the crew. The only injuries were damaged cars and morale.

At 1000 hours on Sunday, Bill VK4XZ declared the exercise complete. All



vehicles were safe and accounted for. Some had limped into Townsville, some were towed, and others were pulled on trailers. Twenty-four of the 36 competitors reached the finishing line.

The tired and weary operators from TARC and SES straggled back to Townsville knowing that Rally II had been a success. A debriefing session later in the week concluded that the planning, the reconnaissance of the area, the flexibility

of amateur radio, and the willingness and co-operation of participants had brought about this success.

A final comment must be directed to the goodwill engendered between both SES and Amateur Radio Club members. Without this the operation would have failed. Throughout the 1200 manhours of the more than 60 members the foundation of a successful Rally III is certain.

R. E. Cordukes VK4CD. ■

# The Royal Navy Amateur Radio Society, Past, Present, Future

Terry Clark VK2ALG  
P.O. Box 537, Albury, N.S.W. 2640

The Royal Naval Amateur Society was formed in 1960 by radio amateurs who were then serving members of the Royal Navy. Most belonged to that noble breed of men, the CPO TEL. That is Chief Petty Officer Telegraphist. The first meeting took place in the PO's Mess at HMS MERCURY, which is the RN's signal school, just north of Portsmouth in England. In order that the Society could be established as a "Naval" Society, their Lordships at the Admiralty laid down the stipulation that all members and former members of the Royal Navy should be eligible, even though they were not in or form the communications branch.

Hence membership of the RNARS was open to all serving and former members of the RN who had an interest in amateur radio, or just listening to short-wave broadcasts. This has turned out as a good ploy to enable membership to be given to interested parties who are not licensed radio amateurs.

The Royal Marines are also part of the RN, and hence eligible for membership. So, too, are the girls of the WRNS and the members of the Royal Fleet Auxiliaries (the merchant ships which supply the fleet) and the Royal Naval Wireless Auxiliary. Plus, of course, the wavy-navy lads of the RNVR and later the RNR.

Thus the membership grew at a steady rate. Later on the British Merchant Navy people were also permitted into the Society as Associate Members, as well as civilians who had been employed by the Navy — such as civilian instructors and Navy Dockyard personnel.

At this stage the Society was a solely British organisation. But this was not to last. A great decision was made in the late 60s to admit the Commonwealth Navies and Merchant Navies. A further broadening of membership took place in the early 70s when all Western Bloc Navies and Merchant Navies were encouraged to join. Membership classifications were revised, the only difference being Corporate Members who were British and Commonwealth; all other nationalities being classed as Associate Members. No difference in membership grade was shown between Naval and Merchant Navy personnel, the only difference being allegiance to Her Majesty the Queen. At no time was there any difference shown to licensed amateurs and short-wave listeners.

So from being a purely Royal Naval Society the organisation has grown into a truly international Society of former seafarers. The name has remained the same as The Royal Naval Amateur Radio Society and indeed we are still based at the RN Signals School at HMS Mercury.

One of the earliest members was a naval doctor, Lt. S. J. (Jim) Lloyd. His Society numbers is RNARS 0049, and he joined within the first year of forming the Society. Currently, Surgeon Rear-Admiral S. J. Lloyd, OA, QHS, RAN, Jim is well known on the amateur bands as VK1CDR, formerly VK3CDR.

Membership in Australia was slow to begin with, mainly being members from England who had emigrated to Australia. Then we began to get applications from former RN personnel who had also migrated here. There is no equivalent organisation for ex RAN radio amateurs and there was a fair amount of bias against the "pommy" RNARS.

In December 1978 the isolated members of the Royal Naval Amateur Radio Society in Australia got in touch with each other. There were only 18. They arranged to hold a radio "net" every Monday night on 3613 kHz and keep in touch. Publicity was sought and received in amateur radio journals and naval magazines seeking new members and trying to point out the fact that the Society was open to serving and former members of the Royal Australian Navy and the Australian Merchant Navy.

As a result we now (April 1980) have 114 members in Australia, with further applications in the pipeline being processed. A majority of these members are ex RAN and several are still serving in the Royal Australian Navy. Not all these are licensed radio amateurs; we have our share of SWL members.

The Society has approximately 1,000 members spread world-wide. They represent most major navies and merchant navies. The largest "group" outside the UK is here in Australia, followed by 65 in the USA, 38 in Europe, 28 in Canada, 23 in New Zealand and 16 in South Africa. Members are also located in Japan, Hong Kong, Solomon Islands, Ocean Island, and the Falkland Islands.

When the Edinburgh class (6 in. guns) cruiser HMS Belfast was presented to the British Nation for use as a naval museum

the Society approached the Belfast Trust with an idea of assisting in the radio side of things. The RNARS was given the Bridge Wireless Office and has restored the naval equipment and established a permanent exhibition amateur radio station, and HMS Belfast, thanks to the RNARS, is now well known on the airwaves. Her call sign is G4HMS.

Recently the British Home Office, which controls amateur radio in the United Kingdom, allocated three special call signs with special GB prefixes to the Society. These are to be used only on special occasions. HMS Belfast uses GB2RN (phonetically Great Britain Two Royal Navy) whenever the ship is open to the public. The headquarters station G3BZU at HMS Mercury uses GB3RN on open days in Portsmouth Naval Dockyard. The third GB call sign has been allocated to the RNARS station at Yetovill Naval Air Station, GB2FAA (phonetically Great Britain Two Fleet Air Arm).

In October 1979 and because of the growing membership in Australia, the Australian Branch was formed. This exists within the world-wide Society, but does give a form of national feeling within the members down-under. The Manager of the Australian Branch is Terry Clark VK2ALG, in Albury, NSW; the Treasurer is Chris Dodd VK6DV, in Perth.

The world-wide Society publishes a quarterly newsletter and now the Australian Branch publishes its own newsletter at a small additional levy on Australian members. This journal is called the AUSTRALIAN SIGNAL and is edited by Mike Thorne VK3BKK in Melbourne, and is posted to all Australian Branch members. It is solely concerned with the Australian Branch and activities within Australia.

In 1979 a very special person, Mrs. Florence McKenzie, OBE, Mrs. Mac to her friends, was made an honorary member of the RNARS. The only station operating from a Naval shore establishment, VK2BNR at HMAS Nirimba, near Sydney, is also part of RNARS. It is not only the men that

are welcome. Serving and former members of the WRANS are most welcome, and two of our most active members in Australia are former Navy girls.

Because of the experience of the RNARS in restoring the Bridge Wireless Office on board HMS Belfast, the Maritime Trust of Australia were more than glad to accept the offer of the Australian Branch to carry out a similar project on board HMAS Castlemaine.

The task ahead of us will be a long and hard one. When the Navy handed over HMAS Castlemaine in 1974 they had completely stripped the W/T Office of all equipment and cut all cables. Like Mother Hubbard, the office was bare.

A meeting of our Victorian members was called on board the ship on Friday, February 1, 1980. At that meeting a group within the Australian Branch was formed to oversee the project. The group, known as the "RNARS HMAS Castlemaine Group", is under the chairmanship of Mike Thorne VK3BKK. Two other members should also be mentioned. The project comprises of two overlapping jobs. Restoration of the W/T Office to its former glory is being handled by John Powell VK3CIE, and the installation of the amateur radio station is being looked after by Jeff Fletcher VK3NLG.

Most of the original equipment from HMAS Castlemaine has been located and is currently being restored before being re-installed.

The ship has received a new licence to transmit. Her call sign was originally VK3BZU. However, thanks to the generosity of the Minister of Posts and Telecom-

munications, HMAS Castlemaine has received a permanent call sign from the repeater "R" series. Her call sign is now VK3RAN (phonetically Victor Kilo Three Royal Australian Navy).

HMAS Castlemaine, using the VK3BZU call sign, has been on the airwaves, though operation has been somewhat spasmodic owing to the need to spend more time working in the W/T Office than operating. However, regular skeds are held between the two preserved warships, HMS Castlemaine and HMS Belfast. Communication has also been made, causing utter confusion, with our headquarters at HMS Mercury. This was because both G3BZU and VK3BZU tended to confuse a few of the unwary.

To date HMAS Castlemaine has worked all continents using a temporary long wire aerial from the temporary shack in the Chart Office (whilst the W/T Office was being painted) up to the yardarm then down after to the ensign staff. An unusual problem was that the wire passed directly above a 40 mm Bofors anti-aircraft gun and the direction the barrel was trained did affect the SWR. However, once the board-band aerials are rigged it will remove the necessity of tuning the aerial with a Bofors gun!

VK3RAN will be operated whenever HMAS Castlemaine is open to the public, which is every weekend plus public holidays and Navy Days. RNARS members will be on hand to explain the various items of equipment in the W/T Office and Naval communications in general.

We anticipate a slight problem with the new call sign of being accused of being

pirates. However we will be operating under the Australian Naval Ensign, not the Jolly Roger. The only ships permitted to use that flag were submarines on offensive patrol during the war. Hopefully, through "Amateur Radio", the significance of VK3RAN will be explained to all amateurs.

Please note: Contacts with VK3RAN will now count double points for the Endeavour Award.

For the future, HMAS Diamantina will be going to Brisbane and be operated as a naval museum by the Queensland Maritime Museum Association. RNARS will be restoring and operating from the W/T Office of HMAS Diamantina. There will then be three preserved warships on the amateur bands:—

Cruiser HMS Belfast G4HMS, GB2RN.

Corvette HMAS Castlemaine, VK3RAN.

Frigate HMAS Diamantina, VK4??? (possible VK4RAN).

All of these amateur stations are manned by former Navy operators and members of the Royal Naval Amateur Radio Society.

If any readers would like more details on the RNARS they should write to the Australian Branch Manager, RNARS, Box 537, Albury, NSW 2640, or to our headquarters, RNARS, HMS Mercury, Leydene, Portsmouth, England, UK.

The Australian Branch nets are on Mondays at 1030 GMT on 3613 kHz SSB, and Tuesdays at 1030 GMT on 3527 kHz CW. Please note: 2m style operation is used — leave a pause before transmitting to allow other stations to check into the nets. Please be patient on the Monday night SSB net. With over 30 stations on net you must be prepared to wait for your turn. ■

## New Zealand's New 2 Mx FM Repeater Band Plan

In about 1970 New Zealand introduced FM repeaters to the two-metre band. The plan had seven FM repeater channels with inputs above 146.2 and outputs below 145.8 MHz and a 700 kHz split. All this is to change.

At Greymouth, New Zealand, in late May, the Annual General Meeting of the New Zealand Association of Radio Transmitters (NZART) approved a plan which will shift the FM repeaters to the band 146 to 148 MHz and use 600 kHz offset. The change may take two years to complete.

This move is very welcome — the standardisation of offset throughout the world is at last almost complete. It will assist trans-Tasman travellers and communication and strengthen the ties between amateurs on both sides. No need to change crystals when visiting now!

The plan has provision for fifteen repeater channels on 50 kHz spacing — the same 50 kHz channels as in the Australian plan. Channels are to be named by three digits only, again the same as the Australian system but with the final figure dropped off.

Simplex channels are to use 50 kHz spacings but offset by 25 kHz. This is so that intermodulation products originated by simplex operation will fall between repeater inputs. Simplex channels will be identified by four-digit numbers.

New Zealand is very much smaller than Australia and yet has nearly 40 repeaters. The topography is such that many repeaters are needed in some areas to get satisfactory VHF coverage. So the problem of intermodulation is probably of more concern than in Australia.

A mixture of old and new systems may exist for about 12 months. If you intend to visit New Zealand and take your rig with you, a note to the Chairman of the NZART Frequency Management Working Group, c/- Box 40-212 Upper Hutt, New Zealand, will bring you up-to-date information on the sites of the old and new repeaters. ■

## QSP

### NICADS

In June/July 1980 Rad. Comm. Technical Topics, Pat Hawker refers to a series of experiments carried out by G3KQR on a large batch of second-hand nicads. It was noted that old cells had lost weight due to gassing and loss of fluid. The gassing vent in the sealed cells is under the positive terminal. Access is gained with a hypodermic thrust vertically through the top, through the rubber (which self-seals) and into the cell. Alternation suction and pressure will allow topping up to be done using distilled water — old cells used as much as 3 ml of water. Hundreds of cells were given a new lease of life in this manner. There seems to be no practical way to replace any loss of hydroxide which would probably result in a medical emergency rather than a revitalised battery. ■

### ANTI-SLIP MATERIAL

Ever tried holding an assembly while both hands are busy soldering or unsoldering a connection? In June/July 1980 Rad. Communication "New Products" is described an elastomer named "Stop Slip" put out in flexible mats of two thicknesses, 1 mm and 2mm, up to 1 metre square or in rolls in green, red or yellow for 2 mm and blue for 1 mm thickness. It possesses an incredibly high coefficient of friction, so much so that any flat object placed on a mat will stay in place even when the mat is tilted almost to vertical. It holds small components so that they cannot inadvertently blow away and it offers a scratch-preventive surface to work on. Tackiness is inherent, it does not gradually decrease and is not affected by repeated wet mopping. ■



# Queensland Amateur Radio Display



**PHOTO 1 (right)** shows the amateur radio station in action. At left is Angus VK4NPL/ZMG and at right Jack VK4AGY. **PHOTO 2 (below)** shows an overall view of the station with Barry VK4NAD/ZSB in the background.



**PHOTO 3:** Part of the static display incorporating a vintage receiver, modern communications receiver, home brew gear, converted transceiver and special hand-outs.



**PHOTO 4:** Part of the active display incorporating a home computer with Barry VK4NAD/ZSB at controls.



**PHOTO 5:** Long distance work has always captivated the hearts of these interested in amateur radio. The QSL cards demonstrate the wide range of countries workable through amateur radio.

The Wireless Institute of Australia, Queensland Division, held a very successful Amateur Radio Display in the Queensland Museum from Sunday, 14th September, to the 20th, under the guidance of Jack VK4AGY. Several hundred persons inspected both the active and static displays which consisted of a working mobile amateur radio station, home computer, home-brew gear, video film show, vintage receiver, World War II equipment and test gear, converted transceivers (both hand and home base), exotic and rare QSL cards, photos depicting amateur radio activities and a typical radio club magazine. ■

Photos by David VK4AFA

**SUPPORT OUR  
ADVERTISERS**

# The Physics and Chemistry of Fire

**Fire or combustion is normally the result of fuel, oxygen and an initial source of heat combining in suitable quantities. The consumption of a material by fire is a chemical reaction in which a heated substance is combined with oxygen. Heat, light, smoke and toxic gases are produced.**

The net production of heat by a fire involves both heat producing and heat consuming reactions, with more heat being produced than is consumed.

Heat is required:

— to produce vapours and gaseous decomposition products at the surfaces of solids and liquids. Actual combustion involves gases or vapours ultimately mixed with oxygen molecules.

— to break up the molecules of oxygen and flammable vapours and gases.

Heat is produced:

— when new molecules are formed; these are some of the products of combustion.

## THE PRODUCTS OF COMBUSTION

Heat, light, smoke and toxic gases are produced by fire. In a very hot, well ventilated fire, combustion is complete. All the carbon is converted to carbon dioxide, all the hydrogen to steam, and oxides of various other elements such as sulphur and nitrogen are produced.

This is not the case in most fires where some of the intermediate products, formed when large complex molecules are broken up, persist. Examples are hydrogen cyanide from wool and silk; acrolein from petroleum; acetic acid from timber or paper; and carbon or carbon monoxide from the incomplete combustion of carbonaceous materials. As the fire develops and becomes hotter, many of these intermediates, which are often toxic, are destroyed, e.g. hydrogen cyanide is decomposed at 538°C.

Small airborne particles of partially burnt carbonaceous materials form smoke, which is often thickened by steam.

## THE FIRE TRIANGLE

Fire has three essential ingredients: fuel, oxygen and heat—the so-called fire triangle.

Fire occurs where these elements occur together. If one or more of the elements of the fire triangle is removed, the fire will be extinguished. This can be done by:

— cooling the fire to remove heat, usually with water,

— starving the fire of fuel,

— smothering the fire by limiting its oxygen supply.

One means of smothering a fire is to drive away the oxygen containing air from the vicinity of the fuel and to replace it with carbon dioxide or other gases which will not support combustion.

Another technique is to apply a dry chemical powder in the form of a cloud or one of a special group of vaporizing liquids called halons. These extinguish fire by interfering with the chemical reactions of the flame.

## HOW FUELS BEHAVE IN A FIRE

### Solids

Ordinarily, combustible solids do not combine directly with oxygen when they burn. They give off vapour and gaseous decomposition products when they are heated, and it is the vapours or gases which actually burn in the characteristic form of flames. Thus, before a solid can be ignited it must be heated sufficiently for it to give off flammable concentrations of vapours. Glowing, which is combustion in the solid state, is characteristic of materials in the final stages of a fire's decay when the flammable gases and vapours have been burnt away, or when the production of the gases and vapours have been suppressed, e.g. tobacco is treated to inhibit flaming.

Solids with larger surface areas in relation to their volume exposed to heat and oxygen in the air burn more readily than those which are more compact.

Textiles as fibres or fabrics, foamed rubber, foamed plastics, thin sheets of plastic, paper and corrugated cardboard, combustible dusts and shavings, are all common examples of materials with large surface areas in relation to their volume. Materials with relatively small surface areas also burn readily when involved in a well established fire.

Combustion is self-propagating; burning materials produce heat which causes more of the solid to evaporate or decompose and be ready to burn, until either the fuel or oxygen is exhausted, or the fire is extinguished in some other way.

### Dusts

Combustible dusts are particularly hazardous; they have a very high surface area to volume ratio.

When finely divided as powders or dusts, solids burn quite differently from the original material in bulk. Dust and fibre deposits can spread fire across a room or along a ledge or roof beam very quickly. On the other hand accumulations of dust can smoulder slowly for long periods giving little indication that combustion has started until the fire suddenly flares up, possibly after the premises have been closed for the night.

Many combustible dusts produced by industrial processes are explosible when they are suspended as a cloud in air. Even a spark may be sufficient to ignite them. After ignition, flame spreads rapidly through the dust cloud as successive layers are heated to ignition temperature. The hot gases expand and produce pressure waves which travel ahead of the flame. Any dust lying on surface in the path of the pressure waves will be thrown into the air, and could cause a secondary explosion more violent and extensive than the first.

### Liquids

As with solids, a vapour has to be produced at the surface of a liquid before it will burn.

Many common flammable liquids give off flammable concentrations of vapour in air without being heated, sometimes at well below room temperatures. Petroleum spirit, for example, gives off ignitable vapours at all temperatures above approximately -40°C. The vapours are easily ignited by a small spark of flame. Other liquids, like solids, need to be heated to a point when sufficient vapour is produced. Examples in this category are fuel oil and white spirit.

The rate of vapour evolution is also related to the surface area of liquid exposed. For any flammable vapour there are maximum and minimum concentrations of vapour in air beyond which it cannot burn. When the mixture of air and vapour is too weak there is insufficient fuel for burning; when the mixture is too strong, there is insufficient oxygen.

If the density of a vapour is greater than air, as is normally the case, flammable concentrations may collect at low levels,

### PROPERTIES OF SOME COMMON FLAMMABLE LIQUIDS

	Flammability limits % by volume in air	Flash point °C	Vapour density (air = 1)	Autoignition temperature °C
Acetone	2.6 -12.8	-18	2.00	535
Benzene	1.4 - 7.1	-11	2.77	560
Carbon disulphide	1.25-44.0	-30	2.64	102
Ethyl acetate	2.2 -11.4	-4	3.04	460
Ethyl alcohol	3.3 -19.0	+13	1.59	365
Hexane	1.2 - 7.5	-22	2.97	233
Pentane	1.5 - 7.8	-49	2.48	285
Petroleum spirit	1.3 - 6.0	-43	3.0-4.0	250-400
Toluene	1.3 - 7.0	+4	3.14	535
White spirit	1.1 - 6.0	+38	3.9	232

### PROPERTIES OF SOME COMMON FLAMMABLE GASES

	Flammability limits % by volume in air	Vapour density (air = 1)	Autoignition temperature °C
Acetylene	2.5-100	0.91	305
Ammonia	15.0-28.0	0.58	630
Pentane (commercial)	1.8- 9.0	1.9-2.01	410
Carbon monoxide	12.5-74.0	0.97	570
Ethylene	2.7-36.0	0.98	425
Formaldehyde	7.0-73.	1.0	424
Hydrogen	4.0-75.0	0.07	585
Methane	5.0-15	0.55	538
Propane (commercial)	2.2-10.0	1.4-1.56	450

### PROPERTIES OF SOME COMMON COMBUSTIBLE SOLIDS

Material	Ignition temperature °C	Autoignition temperature °C
Wool	200	—
Paper/newsprint	230	230
Pine	220-230	—
Cotton	230-266	254
Polymethyl methacrylate (perspex)	280-300	450-462
Rigid polyurethane foam	310	416
Polyethylene	341	349
Polystyrene	345-360	488-496
Polyester (glass fibre filled)	346-999	483-488
Polyvinyl chloride	391	454
Polyamide (nylon)	421	424
Phenolic resins (glass fibre filled)	520-540	571-580

e.g. at floor level or in basements, and can travel considerable distances to a source of ignition and flash back.

#### Gases

Gases are commonly stored in cylinders under pressure. In some cases the pressure is great enough to liquefy some

or most of the gas. Very unstable gases cannot be stored in this way, e.g. acetylene, which is liable to decompose violently, is dissolved in acetone in cylinders.

When compressed gas is released from a container, it expands rapidly. Therefore

even small leaks release relatively large quantities of gas, which is already in the state for combustion to occur. If liquefied gas cylinders are not stored and used upright, defective valves may leak liquefied gas which produces even greater volumes of gas on decompression.

#### FIRE PROPERTIES

**Fire point**—the lowest temperature at which a liquid gives off sufficient flammable vapour to produce sustained combustion after the removal of the pilot source.

**Flash point**—the lowest temperature at which a liquid produces enough vapour to produce a flash on the application of a small pilot flame.

**Ignition temperature**—the temperature to which material has to be treated for sustained combustion to be initiated from a pilot source.

**Autoignition temperature**—the temperature at which the heat evolved by a material decomposing under the influence of heat is sufficient to bring about combustion without the application of an external source of ignition; this tends to be higher than the ignition temperature.

**Flammable limits**—the flammability (or explosivity) limits are the minimum and maximum concentrations of gas or vapour in air which can be ignited and sustain a self-propagating flame.

**Spontaneous heating**—this is a biological or chemical reaction in which heat is evolved at normal ambient temperatures. In some instances, this heating effect is sufficient to lead to spontaneous combustion. Spontaneous combustion can result from:

- combinations with atmospheric oxygen, e.g. vegetable and animal oils finely dispersed on fabrics.
- the action of micro-organisms, e.g. in hay. Moisture is essential to the heating of vegetable matter by micro-organisms. Micro-organisms are killed by temperatures of about 75°C or above, but once this temperature has been reached atmospheric oxidation can proceed and continue spontaneous heating until the ignition temperature is reached.

Reprinted from International Civil Defence, No. 294, December 1979. ■

## QSP

#### SECURITY

The amateur works hard to get a licence and then sets out to buy expensive equipment or makes and assembles, also at considerable cost.

He then sets out to advertise by erecting a tower, high masts and aerials to tell anyone who sees them that he has radio gear.

It's so easy for the criminal type to locate and spot the pickings, and now with CBers chasing higher power, other bands, etc., the demand for hot radio equipment is a constant threat. How many amateurs go to any trouble at all to protect their equipment, or do they say it won't happen

to me? Even to just list serial numbers and to place the fist in a safe spot is the first essential job so that the equipment can be traced and identified. Next time you go around and lock up for the one or two days away, just think how easy it would be for the criminal to get into your shack. What an unpleasant thought to arrive home to find your favourite piece of gear gone. Any amateur has the know how and the ability to make up and install a simple alarm. Why spend hundreds of dollars on equipment and not give it some protection? Magnetic switches and other types of bugs are readily available and a simple control and siren can easily be made. Even a light left

burning at night or a radio playing can be a deterrent well worth the effort.

Keith 3ASS. From Western Zone News No. 3. ■

#### BUYING OR SELLING GEAR?

# HAMADS

MAKE IT HAPPEN FAST



**A Merry  
Christmas**  
and  
**Prosperous  
New Year**



**AMATEUR RADIO IS A  
RESPONSIBLE SERVICE**

— . — . — . — . —  
**LET'S KEEP IT THAT WAY**

**THE VK3BWW  
FORMULA FOR  
DX SUCCESS!!**

**HIGH QUALITY  
AT LOW COST**

**BEAMS**

3 EL 10 & 11m .....	\$66.00
3 EL 15m .....	\$73.00
3 EL 20m .....	\$145.00
6 EL 6m .....	\$102.00

**DUOBANDER**

3 EL 10m, 3 EL 15m **\$135.00**

Prices include Gamma match

Our beams are easy to assemble and adjust. Entirely **NEW CONCEPT** — **NO NUTS OR BOLTS.**

Spare parts, elements, booms and gamma matches available.

Add \$3.00 for Pack + Freight

For further information

PLEASE RING (03) 366 7042

**VK3BWW**

**WERNER & G. WULF**

92 LEONARD AVENUE  
ST. ALBANS, VICTORIA 3021



**1981**

**SUBSCRIPTIONS**



- You will soon be receiving subscription notices for 1981. Note you can re-use the envelope.
- For those who have recently joined or have other credits from previous year, the amount payable as shown on the subs takes you through to 31-12-1981.
- If you pay by **MONEY ORDER**, please do **NOT** cross it because it costs 50 cents to clear it through the bank account.
- **PENSIONERS** — Obtain prior clearance from your Division for pensioner status — if you think this could take too long, pay the Divisional pensioner rate to keep AR coming to you. The Executive office has no authority to alter you to pensioner grade.
- **STUDENTS** — To qualify for the lower student rate read and complete the form enclosed with your subs notice, have it authenticated and return it with your payment (do not delay beyond the end of January). If you are no longer a student please pay the amount shown in the subs notice.
- **PLEASE PAY EARLY TO AVOID THE AUTOMATIC CUT-OFF OF YOUR AR EARLY IN 1981.**
- Please ensure your AR address label shows your correct address and call sign.
- Should you, by any chance, not receive a subscription notice, or your address be different from that shown on label, please notify the office at once.

**WIA**

PO Box 150, Toorak 3142.



*A Call to all  
holders of a*

**'NOVICE  
LICENCE**

Now you have joined the ranks of Amateur Radio, why not extend your activities?

**THE WIRELESS INSTITUTE  
OF AUSTRALIA  
(N.S.W. DIVISION)**

conducts a Bridging Correspondence Course for the AOCF and LAOCF Examinations.

**Throughout the Course, your papers are checked and commented upon to lead you to a SUCCESSFUL CONCLUSION.**

For further details write to:  
**THE COURSE SUPERVISOR,  
W.I.A.**

P.O. BOX 123,  
ST. LEONARDS, N.S.W. 2065

**SPEAK THE  
JAPANESE  
YOU HEAR ON  
15 METRES!**

The highly successful Japanese conversation guide for amateurs QSO JA NOW! With words, pronunciations, phrases and QSO language. **32 PAGE BOOKLET \$3.30 POSTED**

**COMPANION CBO CASSETTE** Pronunciation exercises, practice phrases and actual QSOs. **5.40 POSTED**

**BOTH BOOK AND CASSETTE POSTED ONLY 7.95**

FROM: WESTLAKES AMATEUR RADIO CLUB  
BOX 1, TERALBA 2284

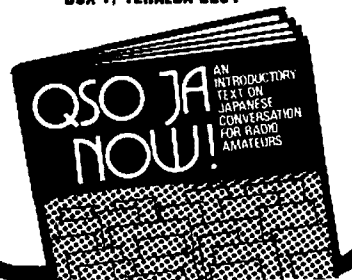

# Chinese Study Amateur Radio

Mr. Cheng Ping, the Secretary-General of the Association of Radio Sports of the Peoples Republic of China, Mr. Wong Xun, the Assistant Secretary-General of the Association of Radio Sports, and Mr. Yu Zai Qin, a member of the China National Federation of Sports, were guests at the Amateur Radio Festival 1980, which was held at Marumi, Tokyo, from the 22nd to

the 24th August under the sponsorship of JARL.

The Chinese visitors spent almost three days at the Festival inspecting exhibits of amateur radio equipment and seeing amateur contests and competitions.

Naturally they met many Japanese radio amateurs and also visitors from Australia, Sweden and the United States. They also

spent some days visiting amateur stations in Tokyo, Osaka and Kyoto.

They told their Japanese hosts that in the Peoples Republic of China emphasis is placed upon the acquirement of Morse code skills and fox hunting.

The Association of Radio Sports of the Peoples Republic of China is an affiliated organisation of the China National Federation of Sports. ■



Mr. Cheng Ping, Secretary-General of Association of Radio Sports of the Peoples Republic of China, operating a VHF transceiver at the home of Mr. Shozo Hara, President of JARL.



Mr. Shozo Hara JA1AN, President JARL, with Mr. Cheng Ping, Mr. Wong Xun and Mr. Yu Zai Qin from Peoples Republic of China, operating at the Amateur Radio Festival 80 in Tokyo, in August.



A Morse code class in Peking.

## 1980 WIA CALL BOOK OUT NOW

**\$2.95 plus post & packing**

\*

Send **\$3.50** for your copy **NOW**  
To your Division

or

**MAGPUBS**  
Box 150, Toorak, Vic. 3142

while stocks last.

- All the latest publishable call sign information.
- Reference data including frequency tables and amateur bands.
- Alternate WIA badge depicted in colour on cover.
- Why not buy the Handbook, Log Books and other items at the same time?

# FOR A **BIG** SIGNAL STEP UP TO A CHIRNSIDE TRI-BAND OR DUO-BAND MONO BAND TRAP VERTICALS MOBILE HELICALS



"Australian Made"

**CE-35. Triband Beam for just \$279**

19' boom 8.5DB gain.

### YAESU EQUIPMENT

FT-101Z HF transceiver inc. AM & WARC .....	\$695
FT-101ZD Digital transceiver inc. AM & WARC .....	\$POA
FT-707 HF SSB transceiver inc. WARC .....	\$POA
FP-707 power supply inc. speaker .....	\$189
FC-707 antenna coupler inc. dummy load .....	\$149
FV-707 VFO inc. 12 memories & scanning .....	\$279
FL-2100Z 1.2KW linear amp .....	\$589
YO-901 Monitorscope inc. pan adaptor .....	\$469
FV-101Z ext. VFO for FT-101Z .....	\$179
FT-101Z-ZD Workshop manual .....	\$25
FT-107DMS inc. AC power supply .....	\$POA
FT-107M inc. AC power supply .....	\$POA
FV-107 External VFO .....	\$139
FC-107 antenna coupler .....	\$179
FT-207RA 2M handheld transceiver inc. nicad, charger, carrying case etc .....	\$309
NF-B1 spare nicads for FT-207RA .....	\$25
NC-3 Base charger & power supply .....	\$69
YM-24 ext. seaker mic for FT-207RA .....	\$32
YM-35 scanning hand mic for FT-707/FT-107 .....	\$29
YM-37 Non scanning hand mic FT-707/FT-107 .....	\$21
YE-7A hand mic for FT-101Z .....	\$20
YD-148 Desk mic for FT-101Z .....	\$45
YM-34 Desk mic for FT-707/FT-107 .....	\$45
FT-480R 2M all mode transceiver .....	\$POA
FRG-7 Communications receiver .....	\$309
FRG-7000 Digital communications receiver .....	\$489
FRG-7700 Digital communications receiver inc. memories etc .....	\$POA

Plus many more.

### General accessories

"Western" 5 pos. coax switch .....	\$35
Daiwa 2 pos. coax switch .....	\$23
CN-620A Daiwa SWR/power meter (X-needle) .....	\$95
CNW-418 Daiwa antenna coupler inc. SWR/Pwr. meter .....	\$170
RF-660 Daiwa speech processor .....	\$114
AF-306 Daiwa audio active filter .....	\$77
IC-22S Icom 2M transceiver .....	\$279
IC-260A Icom 2M all mode transceiver .....	\$579
Hi-Q Balun 1:1 2Kw balun for beams, dipoles etc .....	\$18

**SPECIAL FT-101Z Inc. AM & WARC BANDS...\$695**

### MULTY BAND BEAMS.

CE-36 6el Tri-band beam 22'6" boom .....	\$319
CE-35 5el Tri-band beam 19' boom .....	\$279
CE-33 3el Tri-band beam 14' boom .....	\$249
CE-52 5el duo-band beam 15-10M 19' boom .....	\$195
CE-42 4el duo-band beam 15-10M 13' boom .....	\$149
CE-5B 80-10M trapped vertical 30' long .....	\$99

### MONO BAND BEAMS

CE3-10 3el 10M beam 9' boom 8.5DB gain .....	\$59
CE4-10 4el 10M beam 13' boom 9.5DB gain .....	\$79
CE5-10 5el 10M beam 19' boom 10DB gain .....	\$99
CE6-10 6el 10M beam 24' boom 11.5DB gain .....	\$119
CE3-15 3el 15M beam 13' boom 8.5DB gain .....	\$79
CE5-15 5el 15M beam 22'6" boom 10DB gain .....	\$119
CE3-20 3el 20M beam 14' boom 8.5DB gain .....	\$129
CE4-20 4el 20M beam 19' boom 9.5DB gain .....	\$149
CE5-6 5el 6M beam 11DB gain .....	\$59
CE5-2 5el 2M beam 9DB gain .....	\$23
CE8-2 8el 2M beam 12DB gain .....	\$32
CE10-2 10el 2M beam 13DB gain .....	\$40

### MOBILE HELICALS

CH-80M .....	\$23	<b>SET OF ALL FIVE INC. BUMPER MOUNT FOR JUST \$100.</b>
CH-40M .....	\$23	
CH-20M .....	\$23	
CH-15M .....	\$21	
CH-10M .....	\$21	
Bumper mount to suit .....	\$9	

Helicals from 80M to 20M feature stainless steel tip rod for easy adjustment. Excellent quality.

Send stamped SAE for brochures.

### DAIWA ROTATORS

DR-7500R medium duty "R" .....	\$199
DR-7500X medium duty "X" .....	\$185
DR-7600R heavy duty "R" .....	\$279
DR-7600X heavy duty "X" .....	\$265
6 core control cable .....	\$1 per M

We also stock a good range of coax cable, connectors and many other accessories.

Check our antenna, rotator package deal prices.

FOR YOUR REQUIREMENTS RING, WRITE OR CALL (COUNTRY ENQUIRIES WELCOME)

**MELBOURNE'S LEADING AUTHORIZED YAESU DISTRIBUTOR.**

CHIRNSIDE ELECTRONICS, 26 Edwards Road, Chirnside Park, Lilydale, 3116. Phone (03) 726 7353

# NOVICE NOTES



Edited by Ron Cook VK3AFW

## BUYING A SECOND-HAND TRANSCEIVER

So you have just received your new licence; now what to do about a station? Before proceeding further let me say that the transceiver is the second most important piece of equipment — the most important is the antenna. This should be as big and as high as your budget, family, neighbours and the local council will allow. Having extended yourself to erect a good antenna system you will probably find that a new state-of-the-art transceiver is beyond your means. Now what to do? You could build a simple CW rig and a direct conversion receiver such as those in AR September 1980 and December 1978. If this is for the moment beyond your expertise (and I doubt that) then you could try visiting a kindly uncle who may lend you a spare rig. Failing that then there is the second-hand market.

## WHERE TO LOOK

There are two places to look, the surplus stores and advertisements such as HAMADS in AR. There is very little military equipment on the disposal market suitable for the novice. Conversion of military, CFA, marine and CB equipment requires detailed information on the procedure and often the result is not as good as a commercial amateur bands rig. So, back to HAMADS. With the recent large sales of all solid-state rigs there must be thousands of old valve and partly solid-state rigs in VK that are just gathering dust. They may be up to 15 years old and so can be bought at very reasonable prices. With a little work they can all be made to work "just like new"; some of the all-valve units will benefit from a preamplifier on 28 MHz. You might even find a set less than a year old.

## WHAT IS AVAILABLE

To try and see what may be available in the future I made a survey of HAMADS over the last 12 months. I have excluded

rigs with an average price exceeding \$600 and have tabulated the results. The reason for the \$600 limit is that new novice transceivers can be bought for about this sum.

Nearly 60 per cent of the transceivers in the survey were from Yaesu. Kenwood was the next with about 14 per cent. The most popular sets were the FT200, FT101 and the TS520, in that order. Uniden weighed in at just over 5 per cent and Atlas was last at just under 2 per cent. Only a few of the sets are current models and most give full coverage of 80 through to 10m and use two output and one driver valve in the transmitter. Most sets were offered with operation from an AC supply and some such as the three most popular sets (see above) also came with a DC-DC supply. Generally the PEP outputs exceed 100 watts so modification of the final stage is required. The agents for the set can give details and are usually quite happy to do so. It is often just a matter of changing one wire and removing one valve.

## HOW MUCH?

For \$250 or less there is the Galaxy III, which could be up to 16 years old and covers 80, 40 and 20m only, or an FT400, which could be up to 12 years old. I also noted an elderly Hallicrafters HT37 5-band transmitter for \$130, which is a bargain for the operator with an FR7, etc.

From \$250 to \$350 there were FT200s, Galaxy Vs, a Heathkit SB100, Swan 350s and 500s and an FT75 and an FT7.

In the \$500 and down range there were early models of FT101 and TS520, FTDX401/560, Uniden 2020, Atlas 215, TS120Vs, an FT75B and FT201.

## HOW TO BUY?

If you see a promising item don't delay. The seller may have advertised elsewhere and spread the message by word of mouth. The fastest method is an STD call. Establish whether the rig is still available. Leave your number if the set has been sold but not paid for — these deals sometimes fall through. Check the general condition of the rig. Has it any faults at all? Ask about

## SURVEY OF TRANSCEIVERS IN HAMADS OCTOBER 1979 - OCTOBER 1980

Brand	Model	Average Price \$	Lowest Price \$	First Year Advertised	Power Input Watts PEP	Bands
Yaesu	FT200	360	270	1969	300	5
"	FT100	375	375	1967	120	5
"	FT101	475	450	1970	260	7½
"	FT101B	528	475	1973	300	7½
"	FT101E	654	550	1975	260	7½
"	FR/FL400	513	500	1968	300	5½ +
"	FT400	390	250	1968	500	5½ +
"	FTDX401	525	450	1971	560	5½ +
"	FTDX560	437	400	—	560	5½ +
"	FT7	397	350	1978	30	5
"	FT7B	520	520	1979	100	5
"	FT75	295	295	1972	50	5
"	FT75B	413	375	1974	120	5
"	FT201	400	400	1974	260	5
Kenwood	TS520	540	450	1974	200	5
"	TS520D	500	500	—	—	5
"	TS520S	603	550	1977	200	6
"	TS120V	557	460	1978	30	5½
Uniden	2020	562	450	1975	180	6½
Galaxy	III	282	215	1964	300	3
"	V	352	280	1965	300	5
Heathkit	SB100	300	300	—	180(?)	5(?)
"	SB101	600	550	1972(?)	180	5
"	SB301/401	600	600	1972(?)	180	5
Drake	TR4C	669	550	1975(?)	300	5
Swan	350	350	350	1964	400	5
"	500	383	350	1967	400	5
Atlas	215	562	475	1975	200	5

(no 10m)

## NOTES

1. Brands appear in order of total number of sets advertised.
2. Models and brands with an average price over \$600 have been excluded.
3. The dates in the fifth column are indicative of the first year of sale in Australia only.
4. The data in the last two columns should be taken as a guide and may not be truly descriptive of a particular set. E.g. later versions of the Galaxy V had rated inputs of 500W PEP.

the specification and general description: frequency coverage, power, modes, sensitivity, selectivity, stability, cross-modulation, image rejection, power supplies and accessories are all important. Decide whether you are really interested and if possible arrange a demonstration. If the seller is out of town then perhaps he can come up on a test schedule for you. If all is well find out who pays freight and insurance. Is the price firm? It usually is unless "ONO" is stated. A reduction between \$10 and 10 per cent of the price could be expected if this is so, particularly if the set has been on the market for some time.

If the set needs repairs that you cannot handle remember that service charges are around \$20 per hour and, when parts are added, a bill of \$100 can be run up for anything other than straightforward repairs. Servicing shops sometimes insist on replacing all aged valves before giving a guarantee on their work.

Be wary of buying a rig that has been "improved" by the owner. Establish his competence and inspect the workmanship. Some early rigs did need modification and most have been well done but I have seen some dreadful acts of butchery performed in the name of modification or even repair.

#### AN IMPORTANT STEP

When you get your bargain at home sit down and read the handbook before doing anything else. This will tell you how to

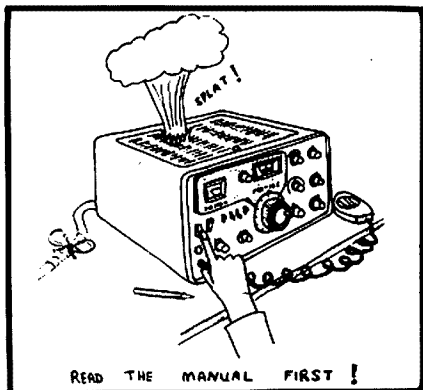

test the set and help you to get it on air with a minimum of trauma.

#### CLEANING UP

Many old rigs are dirty and look a bit battle-scarred. A run over with a vacuum cleaner followed by a wash in hot soapy water with a paint brush and toothbrush will remove the grime from inside and around the chassis. Dry the set with a hair dryer. Wax deposits on the chassis can be removed with a piece of wooden dowel sharpened to a chisel shape. Make sure the rig has dried thoroughly before applying power. Lubricate the dial mechanism with a little grease and a small drop of oil.

The case should be scrubbed up too. A fresh paint job using a pressure-pack can of automotive paint will work wonders. The

front panel could be given the treatment as well but will involve removing or covering the dial, S-meter, etc. If the front panel lettering is not engraved it might be as well to be satisfied with a good wash.

Some of these rigs have noticeable VFO drift in the first hour, particularly in the first 15 minutes. You could develop the habit of spending the first 15 minutes in the shack tuning around so as to avoid drifting off your QSO frequency. It is a good habit to acquire anyway, as it allows you to gauge band conditions and see who is about.

In closing I would like to remind you, the reader, that I want to see your contributions for this column. ■

### CHANGE OF ADDRESS

\*

If you have changed your address or if you intend shortly to change address —

#### PLEASE

Notify the Executive Office as early as possible:

**Do not leave this to be done when you pay your subscription at the end of the year.**

#### EXECUTIVE OFFICE

P.O. Box 150, Toorak, Vic. 3142

## THE 1981 HAM DIARY.

### The most 'referred to' gift you can give any enthusiast!

Day-by-day Full Size Diary Pages

Comprehensive Tables compute Great Circle Distance and Bearings for all major world locations from each Australian capital city

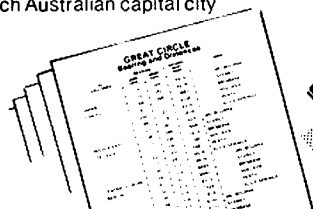

Formulae Pages Provide Calculations for 21 Major Tasks—ranging from impedances to transformer relationships

3 pages Graphically Chart Reactances, Capacitances, Inductances from 1Hz to 1gHz

Antennae Radiation Angle/Distance Charts for both VHF and UHF

Conversion Tables for Volts, dBm, Watts

3 Complete Pages of Logic Data T-Pad Calculator

Complete Alphabetical Address and Phone Number Section

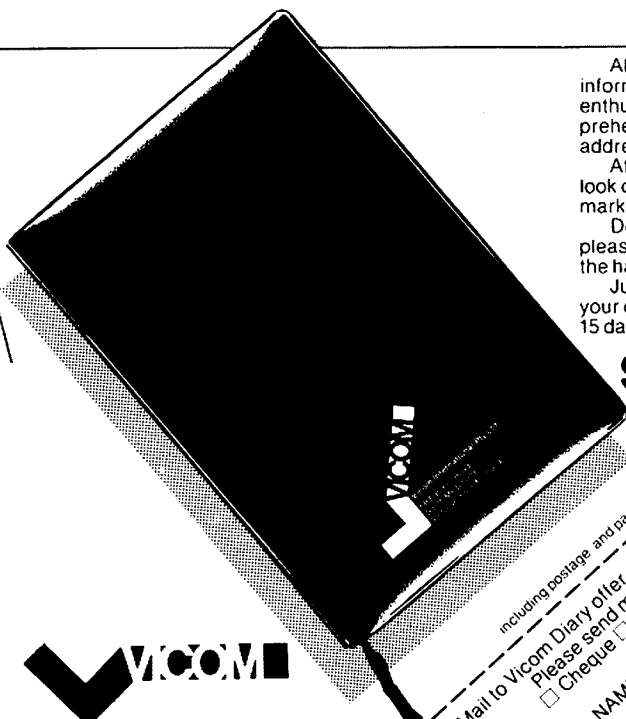

All the practical, easy-to-follow information that every 'ham' enthusiast needs—plus a comprehensive day-by-day diary and address book combination.

Attractively bound in soft, leather look covers. Complete with bookmark. Measures 19 cm x 13 cm.

Don't miss this opportunity to give pleasure and practical assistance to the ham enthusiasts you know.

Just fill in the coupon and mail your order today (please allow 15 days for delivery).

**\$9.90**

(Mail to Vicom Diary offer, 68 Eastern Road Stn, Melbourne Victoria, 3205)  
 including postage and packaging for delivery in Australia  
 Please send me  
 Cheque  Money order for \$  
 NAME \_\_\_\_\_  
 ADDRESS \_\_\_\_\_  
 PICODE \_\_\_\_\_





# VHF-UHF

*An expanding world*

Eric Jamieson, VK6LP



Forrester, S.A. 5233

## VHF/UHF BEACONS

Freq.	Call Sign	Location
50.005	H44HIR	Honiara
50.055	ZL1UHF	Auckland
50.100	KH6EQI	Pearl Harbour
50.105	KC4AAD	McMurdo, Antarctica
50.110	KH0AB	Saipan
50.144	KC6NI	Ponape, Caroline Is.
51.999	YJ8PV	Vanuata
52.150	VK5KK	Arthurton *
52.200	VK8VF	Darwin
52.250	ZL2VHM	Palmerston North
52.300	VK6RTV	Perth
52.330	VK3RGG	Geelong
52.350	VK6RTU	Kalgoorlie
52.400	VK7RNT	Launceston
52.435	VK3RWW	Hamilton *
52.440	VK4RTL	Townsville
52.450	VK2WI	Sydney
52.500	JA2IGY	Mie
52.500	ZL2VHM	Palmerston North
52.510	ZL2MHF	Mt. Climie
52.800	VK6RTW	Albany

52.900	VK6RTT	Carnarvon
53.000	VK5VF	Mt. Lofty
144.010	VK2WI	Sydney
144.162	VK3RGI	Gippsland
144.400	VK4RTT	Mt. Mowbullan
144.475	VK1RTA	Canberra
144.500	VK6RTW	Albany
144.600	VK6RTT	Carnarvon
144.700	VK3RTG	Vermont
144.800	VK5VF	Mt. Lofty
145.000	VK6RTV	Perth
147.400	VK2RCW	Sydney
432.400	VK4RBB	Brisbane
432.450	VK3RMB	Mt. Bunningyong *
10.3 GHz	VK6RVF	Perth *

\* Denotes new listing.

In what must be quite a spate of new beacon activity we have four new beacons added to the list this month. Firstly, David VK5KK advises he has received official approval to operate his beacon on a 24 hours basis on 52.150 MHz. It runs 14 watts to a 6 element beam pointing generally north-east and will be on continually except for when David is actually operating on 6 metres himself. Reports of reception would be appreciated to PO Box 3, Arthurton, SA 5572. By the way, Arthurton is on Yorke Peninsula, north of Maitland.

The next beacon to mention is VK3RWW being operated by Steve VK3OT from Hamilton, and is presently running on 52.435 MHz with 25 watts to an antenna consisting of four dipoles. Steve would

also welcome reports. In addition, Steve hopes to have another beacon on 432.435 MHz running before Christmas 1980. This will be a welcome addition to the band.

The third beacon has been confirmed as being in operation by a letter from Dick Forrester VK3VU, President of the Ballarat Amateur Radio Club, who advises the beacon is now fully operational, on 432.450 MHz, with a power of 10 watts into a pair of crossed dipoles situated on the top of Mt. Bunningyong about 8 km south-east of Ballarat. Reception reports to Box 600, Ballarat, Victoria 3350.

Advice of the fourth beacon is contained in the pages of "The Western Australian VHF Group Bulletin" and reads as follows:

*A permit has been issued by the P. and T. Department to the VHF Group for the operation of an X Band beacon in the 3 cm Amateur Band, the call sign being VK6RVF.*

*The unit was installed on Saturday, 6th September, by Will VK6UU, Trevor VK6ZCB, Roger VK6NR and Colin VK6CM. It is located on the top of the existing tower holding the Channel 2 repeater, at 250 feet.*

*The beacon was built by Colin VK6CM, and consists of a free running temperature compensated Gunn diode oscillator with an output power of 15 mW feeding into a 17 dB Horn antenna giving an ERP of approximately 1 watt. Frequency of operation is 10.3 GHz. The*



# THE STORE WITH IT ALL

TAPES  
SOFTWARE

## FLESHER CORP

TR128  
RTTY REGENERATIVE  
SPEED CONVERTOR

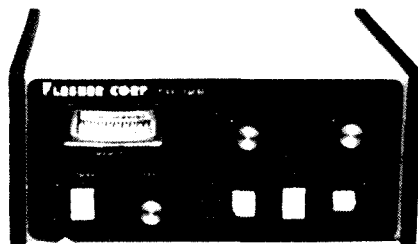

ALSO: TU170 TERMINAL  
UNIT WITH AUTO  
START

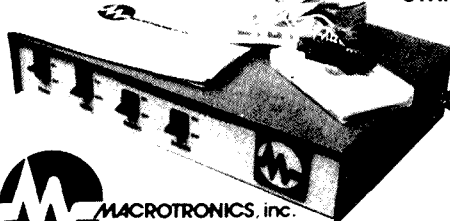

MACROTRONICS, inc.

M650 DELUXE RTTY AND MORSE INTERFACE - Complete with software - for Commodore, Apple, Tandy, Sorcerer and others.

# 2 METERS SPECIALS

- FT 225R \$699
  - NDI HC-1400 \$339
  - FT 227 RB \$339
  - IC 215 \$199
  - IC 280 - complete with extension Cable Kit \$399
- While current stocks last.

\* Dealer Enquiries Welcome

## RTTY & CW

We stock and service a comprehensive range of amateur gear, including antenna systems, test gear and auto start units - come and see our display.

BOOKS  
MORSE

# CW

## ELECTRONICS

Cnr MARSHALL Rd & CHAMBERLAIN St,  
TARRAGINDI - BRISBANE. Tel: (07) 48 6601 P.O. Box 274,  
SUNNYBANK, QLD. 4109 AH: Brian (07) 341 4767 Telex: AA 40811

Gunn oscillator consists of a varactor tuned cavity, frequency control and audio ident being supplied to the varactor. Identification approximately every 20 seconds with no key down period.

It is intended to illuminate the Perth Metropolitan Basin and is being received with fair signal strength from rockingham to Nedlands, whilst Colin is working at present on a new antenna designed to give improved coverage.

Only two known transceivers are currently in operation, but more are expected as the beacon becomes more widely known. The last time tests were carried out cross country, a distance of 32 km with a signal strength of 5/9+ in both directions was achieved, which incidentally constitutes a state record, however Roger and Colin will wait until this is extended before applying for recognition.

Further information on the beacon can be obtained by telephoning Colin during business hours on 380 3193.

It's good to see beacons being established on bands other than the most populated, and the 3 cm beacon in the west now joins the one which has been in use on that band in New Zealand for some time, on 10.37 GHz. Being 70 MHz apart it is unlikely they will interfere with one another!

I note also work is progressing on the 2 metre beacon being constructed by the South East Radio Group on Mt. Gambier, SA. The identifier and control logic board is now complete and working. The SERG Newsletter advises negotiations for the proposed site are now complete and the beacon will be located on private property adjacent to the main Nelson Road and approximately 20 km from Mt. Gambier.

Reports are also to hand of the possibility of a VK9ZG beacon from Willis Island on 52 MHz, and moves are afoot to try and do something about a beacon for the Antarctic regions in 1981. More on this later.

#### CHANNEL 0

Well, it has happened. Channel 0 in Melbourne is in full swing again with Ethnic Television. Several of my spies in the Melbourne area telephoned to say the thing had started up again on 13-10, with the sound carrier this time being centred on 51.791 MHz, and putting more "crud" on the 52 MHz amateur band than had ever been received before on the old Channel 0. It seems the transmissions are designed primarily for the Melbourne area only, and is operating simultaneously with Channel 28 on UHF. From reports so far received it seems the potential for causing interference with the present set-up will be greater than previously because of the lower power being used by the transmitter, thus allowing 6 metre operators to affect a greater number of TV receivers due to less control by the receiver AGC system.

If the operating hours remain as I was originally informed, about 5 to 7 hours a day ending about 11 p.m. local at night, this will make it very difficult for the Melbourne boys to participate in any of the afternoon type TEP which may occur from time to time, and arrives around 5 p.m. local, and earlier contacts may also be out of the question if the things runs test patterns for hours. I wonder how Sydney is faring, and how long before the other States will be hammered into submission by an escalation of Channel 0 transmitters?

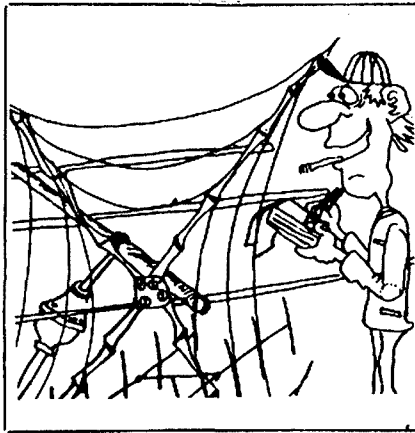

"Look here what the storm has brought me: 1 quad, 2 Yagis, six over six . . ."

From QST October 1979.

#### EQUINOX AND SIX METRES

A few things happened during the September/October equinox. Most have never been reported to me, but as one unable to listen much on 28885 for a variety of reasons, they will go on being unreported for the time being. However, from the VK5 angle anyway, it is noted in information from Gerry VK5AGM at 10-10 produced JR7 and 15 JA8s between 0220 and 0300Z. On 13-10 0320Z VK6WD and VK6BV. 14-10 13 JAs in areas 1, 2, 3, 4 and 5 between 1310 and 1400Z. 16-10 0240Z five JA7/8. 21-10 50 MHz JA at night.

One of the better openings was probably that on 24-10 in which I shared and worked 30 JAs in areas 1, 2, 3, 4, 6 and 9, between 1209 and 1317Z, with signals mainly 5 x 9.

Peter VK5ZPW from his prime location at Angaston was fortunate to work the DXpedition C21NI at Nauru on 14-9 at 2320Z on 6 metres, also C21NI believed to have worked some VK2s and ZLs. Apparently Peter heard the Nauru station for 3 minutes at 5 x 9! And that was it.

Gerry VK5AGM has been making good use of CW to work JAs and on 11-9 worked 5 around 1005Z at S1. JAs also noted into VK6 on 10-9. Gerry also reports W6 were hearing ZL TV on 27-9. Also HL9WI is now W6HTH/KH6 and working a number of stations in the Pacific areas.

Broken Hill has been showing some interest in 6 metres, and Peter VK5ZPW worked to there on 52.050 on 5-9 and 27-9 to VK2Z1.

KH6IAA heard and worked in Adelaide on 24-10 around 1000Z prior to the large JA opening.

John VK5ZBU has written advising of a letter from Art WA1EXN in Maine, USA, with the following information:

Art is setting up a part-time beacon on our part of the 6 metre band, on 52.090 to be precise, his operating times being 1000 to 1200Z and 2200 to 2400Z. Power 100 watts to 11 element beam, with 600 watts in reserve if required! Both Arthur and Andy, his foster son, who is VE1ASJ and the operator of the VE1SIX beacon, will be on the alert for any openings.

Art operates mainly 6 metres these days, and worked many VKs back in 1948 as J5AAW. He often worked 8P6EN, who was of course our old pal Alan VK5IR when Alan was in Barbados some years ago, also on 6 metres. So now you, the multitudes, know there is someone interested in working you from Maine, perhaps there will be another peak for you to do it!

Thanks, John.

#### ON THE OCEAN WITH TWO METRES

Eric Trebilcock L3-0042/BERS-195 has sent me a letter he received from the Amateur Radio Association of Bahrain in the Arabian Gulf, from which I have taken the relevant extracts as some VK amateurs do actually sail the seas in ships and might be carrying 2 metre equipment with them!

The Chairman and Repeater Keeper advises:

"We would like to draw your attention to the fact that we have a VHF Repeater operating on Channel R6 145.750 Tx-145.150 Rx accessed by the normal 1750 c/s tone burst. The aerial height is 220 feet a.s.l. running 20 watts output for 3 microvolts sensitivity through a single 5 dB collinear aerial.

Operation and coverage have been excellent over the last year since initial installation and amateurs sailing on vessels in the Gulf have been working over a distance of 300 miles.

We would welcome any new users to the repeater as currently there are only the following licence members active on the system: A9XBW, A9XCF, A9XCX and myself A9XBE. Yours faithfully, S. K. STREET, PO Box 22381, MUHARRAO, BAHRAIN, ARABIAN GULF.

So go to it you intrepid travellers!

#### TWO METRES

Peter VK5ZPW has been successful working Broken Hill on 2 metres as well, when he contacted VK2Z1, VK2BY and VK2ADJ using both FM and SSB. Peter also advises the Broken Hill boys have 432 MHz capability so looks as though we will have to do something about that band soon.

Noted also on 16-10 that Kevin VK7ZAH was working to VK3YNB, VK3YUZ and

others. on 21-10 Steve VK3OT worked here on both six and two metres, but signals were several S points stronger on 6 than 2 at 0015Z. But earlier than that Steve reported the VK5VF beacon on 2 metres had been very strong, and signals from Adelaide area were better than when I got in on the act. On 20-10 VK5ZEM to VK3BHS both on SSB and FM.

Can anyone confirm the report received that a Melbourne FM station (commercial), 3FOX, had been heard in Argentina during October? No other details are available at this time.

Whilst conditions may not have been over-bright for 2 metres on the Australian scene, it seems the operators in the United Kingdom have been having a ball, as outlined in some information sent to me by Steve VK5AIM, and taken from Short Wave Magazine. They have had several Es openings, plus auroral, and they made good use of the Perseids meteor showers.

They had good openings across to Sweden on 11-7, which is in the middle of the northern hemisphere summer, followed by openings to Italy and Spain and Malta, from 1715 to 1745Z, followed after 1800Z with stations in C3, CT, etc.

As an indication of what interest can be engendered when you are surrounded by other countries rather than the isolation which exists in VK, it is noted that the top scoring station in the three band annual VHF table is G4CMV, who has worked 28 countries on 2 metres, G4IGO 24 countries, G3BW 23 countries. So despite their lack of 50 MHz in Europe it looks as if they have a lot of fun on the international 2 metre band.

## CONTESTS

You may have this issue in time to remind you of the VHF Field Weekend being sponsored by the Geelong Amateur Radio Club, using the rules of the Ross Hull Memorial Contest as a basis for operation, and being conducted over the weekend of 6th and 7th December. This weekend also coincides with a similar VHF Field Weekend in New Zealand.

The Ross Hull Memorial Contest will be conducted from 6th December to 11th January, 1981. For some years now very few people have sent in any logs; why not give further support to this worthwhile contest and submit a log, the Contest Manager will accept photocopies of your log providing they are neat.

## LOCATOR SYSTEM

I have not received one letter either in support of or against the suggested QTH Locator System recently published in this column. Am I to conclude we have no objections, and advise the originators in London to include us in their thinking for the future? If you have anything worthwhile to say on the matter I would be pleased to hear from you. I do have to send a letter to London in time for their Conference in 1981.

## TECHNICAL TIP

It is not so much a technical tip this month as an "appearance tip". When you are constructing a piece of equipment of which you will no doubt be justly proud, why not spend a little extra time and ensure all the slots of the front panel screws in particular, but all external screws in general, have their slots pointing in the same direction? It only requires a thought at the time, and perhaps a little extra, or less, pressure with the screwdriver to ensure the slot is the same in each case. I find the slots look best horizontal, but that may only be me.

The second item concerns the use of Dymo or similar labelling tape which is often used to label the controls and meters of your finished equipment. To avoid having that very stuck on look, try to use tape with a background colour the same as that of the panel, i.e. if your panel is black then use black tape, if grey use grey tape, and so on. The white printing in each case will stand out quite well, but the background will not be readily noticed, and it makes for a much neater finished job.

## CLOSURE

Generally speaking a bit poor for the equinoxial period, but a few highlights as mentioned in the column. With the summer Es season now coming up, let's hope for some excitement somewhere!

Best wishes for Christmas and a happy New Year to all my readers as this issue commences the 12th year of my association with the column. Thank you also to my many contributors, and for the support of the editor and editorial staff.

Closing with the thought for the month: "The average man has five senses. The successful man has six—touch, taste, sight, smell, hearing—and common."

73. The Voice in the Hills. ■

## REPEATER NEWS

The following information has been supplied by Peter Mill VK3ZPP, reference 70 cm repeaters in Victoria.

### REPEATERS ALLOCATED IN VICTORIA

- 438.225 VK3ROU Mt. Dandenong, Melbourne.
- 438.375 Reserved Ballarat Area.
- 438.525 VK3RAD Melbourne Suburbs. VK3RNU Mt. Stanley.
- 438.675 VK3RMU Melbourne Suburbs. (Reserved Hamilton, Western Victoria).
- 438.625 Vic. Division WICEN Group.
- 439.275 VK3RCU Mt. Macedon, Melbourne.

The Eastern Zone have requested an allocation but as yet have not confirmed one of the options presented to them. ■

## INTERNATIONAL NEWS

In a letter from Mr. Shozo Hara, JA1AN, President of JARL, he advised that by invitation three Chinese members from the Association of Radio Sport in Peking arrived in Japan for a week's visit from 20th August and attended the JARL Ham Festival, which attracted 3,400 visitors.

JARL presented the Association with more than 10 sets of various items of equipment to assist with the commencement of amateur activity in China.

Incidentally JARL reports that a station BY1PK on air 19th October was not legitimate. Close liaison exists between JARL and the Chinese Association. The latter are anxious to commence amateur operations in China at the earliest possible date.

Photographs are reproduced here for interest.



Mr. Wong Xun (Asst. Sec.-Gen. ARS) in Peking, JA1AN, Mr. Cheng Ping (Sec.-Gen.), SM6CPI, interpreter.



Left to right, seated: JA1AN, Mr. Cheng Ping. Standing, foreground: Mr. Takagi of Yaesu JH3ND, Mr. Wong Xun, Mr. Yu Zai Qin, Mr. T. Saiko JA1AA, Sec.-Gen. of JARL.

It is reported from other sources that donations of amateur gear have been made to at least two societies in independent nations in the Pacific area. ■

## INTRUDER WATCH

DURING DAYLIGHT SAVING TIME  
THE INTRUDER WATCH NET ON  
3540 kHz WILL OPERATE FROM  
8.30 p.m. E.A.S.T. PLEASE JOIN

# AMATEUR SATELLITES



R. C. Arnold VK3ZBB

Many thanks to Charlie VK3ACR for continuing the satellite notes during my absence overseas.

As Charlie mentioned, the newly-elected Directors of AMSAT include Pat Gowen G3IOR and Harry Yoneda JA1ANG, and it is encouraging for us to have two international directors who can express the views of amateurs outside the USA and Canada. I think we can take it that Harry is "our Director", as we have frequent contact with him via the AMSAT Pacific net which is held each Sunday at 1100 UTC on 14.275 MHz. If you are interested in joining this net, Harry will be looking for VK and ZL stations from around ten minutes before the above time. Harry is also active on frequencies between 28.877 and 28.880 MHz at 2200-2300 UTC on Fridays and Saturdays and between 0900 and 0930 UTC on Saturdays and Sundays.

Since I returned I have noted several new call signs operating through the satellites and to them I would say that AMSAT would welcome you as a member. By doing so you would assist our cause and help defray the cost of future satellites. Annual membership of \$US20.00 or Life Membership of \$US200.00 can be sent to AMSAT at PO Box 27, Washington, DC 20044, USA.

Whilst speaking about activities in the USA, I would also mention membership of Mode J Club, which is available to any amateur who has worked at least eight stations on Mode J of OSCAR 8. No QSL needs to be submitted, just send a list of stations worked to Larry Roberts W9NXC, 3300 Fernwood, Alton, Illinois, 62002, USA. Membership is \$US3.00, but if you require your Newsletter delivered airmail I suggest an additional \$US1.00 per month would be appropriate.

Both OSCARS 7 and 8 have been working satisfactorily although AO7 has been mode slipping from time to time; it is therefore necessary to listen every night to find out which mode the satellite is on.

Harry sends the following report: "I have been reading AO7's telemetry a great deal recently, and have been highly impressed with its 'good health' long beyond its 'life-

time' Among the bank of nicad cells that are connected in series to make up the approx. 14 volt battery, some appear to have 'shorted' themselves out, and at least one cell has 'opened' up. Well, thanks to this open (or near open nicad) cell, the 'bird' can function — as long as the solar panels can create electric power. If and when this open cell shorts itself out, then we're in great trouble. AO7 then will cease to operate. So, please use AO7 with care — which means do not use excessive up-link power, and 'read' the telemetry from time to time, and when you find that the 'bird' is suffering from lack of power, please refrain from using it for general QSOs. To those who don't like copying CW, here's a hint. Listen to the very last telemetry channel just before the two 'His' come. If the last channel (it is called channel '6D') says 650 or 651 then AO7 is doing okay and you can use it for general QSOs. If '6D' reads other than 650 or 651 you'd better wait and see. Recent readings tell me that when '6D' is 651, then the bus-voltage is approx. 13.3 volts. However, whenever the bus-voltage drops close to 10 volts, then the 650 or 651 goes 'haywire' and eventually the entire telemetry readings go haywire too (starts to send meaningless figures). Telemetry copying is a lot of fun, so do it and I'm sure you'll get interested more and more, with a much deeper understanding of what it's all about. You can 'feel' the spin of the satellite, you can know what temperature the battery is at, how many watts the transponder or beacon (435 MHz beacon) is delivering and much more info can be collected and later analyzed. Incidentally, when AO7 is in mode A, the 435.1 MHz beacon can be heard on most orbits (passes). It is in FSK (F.) using Morse most of the time."

For the time being, OSCAR 8 is shut off on each Wednesday in order to recharge its batteries, although it may be on occasionally to provide selected amateurs with facilities for experimentation.

The following information from W6XN gives the orbital parameters for December 1980:—

#### AO7:

$$T = 114.94732 - 1.806 \times 10^{-7} \times N$$

(min/orbit)

$$I = 28.7373 \text{ (degrees)}$$

#### AO8:

$$T = 103.22483 - 1.711 \times 10^{-6} \times N$$

(min/orbit)

$$I = 25.809827 - 5.8 \times 10^{-6} \times N$$

(degrees)

T = orbital period; I = angular increment; N = orbit number.

On this topic I received a most interesting letter from Ian VK2YIY who, with great mathematical precision, has been determining the orbital period for OSCAR 8. He tells me that on orbit 13207 the orbital period was 103.2020 minutes, which I believe agrees with the above data. Ian advises that a recent burst of solar activity has again varied the orbital time and he

is pursuing his calculations with a view to obtaining even greater accuracy.

These reported changes make long-term prediction of satellite appearances difficult and I suggest that each State Liaison Station provides its weekly broadcast with times of acquisition for each capital city. This will enable newcomers to find a satellite with reasonable accuracy. I would particularly thank Andy VK3YQX for his contribution in this regard and to other State Liaison Stations which provide like information.

I was sorry to hear that Frank VK2ZI in Broken Hill has been off the air due to technical difficulties, and we look forward to seeing Frank again when repairs have been effected. Frank epitomises the amateur spirit, as although he is blind, he still manages to make perfect QSOs via the satellites.

At a recent Congress organised by the Australian Computers' Society, a paper was presented by Stuart King ZK1AA on the matter of satellites communications in developing countries. Stuart quotes the AMSAT satellites service as a relatively cheap way of communication via satellites on VHF frequencies, and for those who are able to obtain a copy of his paper I commend it as good reading. I hope we may be able to obtain permission to reprint this paper in "Amateur Radio" in due course. ■

## AT LAST!

### THE TYPE 610 BRITISH POST OFFICE designed MORSE CODE KEY

There has never been a better designed Morse Code Key — SOLID, ROBUST and BEAUTIFULLY BALANCED.

**\$31.00** (Post Paid)

"LEARNING THE MORSE CODE" — Cassette Album Training Course. You will progress rapidly using this modern training system.

**PRICE \$20** (Per Album of 3 Cassettes)

**WILLIAM WILLIS & Co. Pty. Ltd.**  
98 CANTERBURY ROAD CANTERBURY VIC  
Phone 836 0707

# Awards Column

Bill Verrall VK5WV  
7 Lilac Ave., Flinders Park, S.A. 5025

In my first annual report back in February 1980, I commented that I was disappointed by an apparent lack of interest in the VHF awards available from the WIA.

I am still not receiving enough applications for these awards. Therefore, the rules are published herein with the hope that this will stir some action into our VHFers during the current DX season.

Both these awards require some consistent effort to qualify and this should now be easier than it was during the old AM days in the early 60s when I obtained both awards. The technology now available to VHFers is far superior to the pair of 807s with 120 watts input on AM I used to run!

However, that was a lot of fun as we replaced our 807s at two or three monthly intervals when they became too tired to put out enough steam on 6 metres. Does anyone remember the "Mustard Pot", where we could purchase new 807s in dozen lots at five shillings each?

Perhaps some operators are discouraged by the requirement to obtain QSL cards. Whilst most of us do not bother to QSL contacts with other VKs, I will always QSL direct or via the bureau if requested, particularly if my card is required for an award. So let me see a few more applications for our own WIA awards next year!

## DESCRIPTION

Both awards are printed in two colours on high quality paper with motif and surround in maroon and printing in black. The WAS measures 245 mm x 180 mm and the VHFCC 155 mm x 205 mm.

I wish all readers my best compliments of the season and good luck in your wall-paper collecting during 1981.

## WORKED ALL STATES (AUSTRALIA) AWARD

Rules as amended 1.1.79.

## OBJECTS

- 1.1 This Award has been created in order to stimulate interest in the VHF/UHF bands and is of a high standard to fully acclaim the proficiency of the recipients on their achievements.
- 1.2 This Award, to be known as the "Worked All States (Australia) Award", will be issued to any amateur in Australia or overseas who satisfies the conditions following.
- 1.3 A certificate of the Award will be issued to applicants who show proof of having made two-way contact with the specified areas of the Commonwealth of Australia. Additional credit will be given for proof of contact with overseas countries, viz., New Zealand or Papua New Guinea. Countries, for the purpose of this Award, are set out in the Australian DXCC Countries List.

## REQUIREMENTS

- 2.1 Contacts must be made on the VHF/UHF bands 52 MHz and above (Bands 8 and 9). Contacts made on 50-52 MHz prior to 1/4/64 will count towards the 52 MHz Certificate.
- 2.2 One verification from each of the following areas of the Commonwealth of Australia is required —
  - (a) Australian Capital Territory.
  - (b) New South Wales.
  - (c) Victoria.
  - (d) Queensland.
  - (e) South Australia.
  - (f) Western Australia.
  - (g) Tasmania.
  - (h) Northern Territory.In all, eight verifications are required.
- 2.3 It is possible under these rules for one applicant to receive one Award for each of the authorised bands between 30 and 3,000 MHz.

## OPERATION

- 3.1 All contacts must be two-way contacts on the same band and crossband contacts will not be allowed.
- 3.2 Contacts may be made using any authorised type of emission for the band concerned.

*Wireless Institute of Australia*  
**Certificate OF AWARD**

GRANTED TO \_\_\_\_\_

ON HAVING ESTABLISHED TWO  
WAY RADIO COMMUNICATION  
WITH ALL STATES OF AUSTRALIA  
ON MEGACYCLES

\_\_\_\_\_ FEDERAL PRESIDENT  
\_\_\_\_\_ FEDERAL SECRETARY  
\_\_\_\_\_ DATE OF ISSUE

Certificate No. ....

3.3 Portable operation will be permitted provided that the portable location shall be in the State in which the licence was granted and in the call area in which the licence was granted in the case of overseas operation.

3.4 All contacts must be made in accordance with the Regulations laid down in the "Handbook for Operators of Radio Stations in the Amateur Service" or its successor for Australian stations, or in accordance with those Regulations applying in the country of the applicant in the case of overseas stations.

#### VERIFICATIONS

4.1 It will be necessary for the applicant to produce verifications in the form of QSL cards or other written evidence showing that two-way contacts have taken place.

4.2 Each verification submitted must be exactly as received from the station contacted, and altered or forged verifications will lead to the disqualification of the applicant.

4.3 Each verification submitted must show the call sign of the station, date and time of contact, type of emission and frequency band used, the report and the location or address of the station at the time of contact.

4.4 A check list must accompany every application setting out the details for each claimed station in accordance with Rule 4.3. If any contacts were made whilst portable, this must be stated and the portable location given. The applicant must also state whether or not they are a member of the WIA.

4.5 In lieu of forwarding QSL cards or other written evidence as set out in Rules 4.1 to 4.4 above, a list giving the details set out in Rule 4.3, certified by the Awards Manager, Secretary or Council Member of an affiliated Society, or two licensed amateurs known to the applicant, should accompany each application.

#### APPLICATIONS

5.1 Applications for membership shall be addressed to the Federal Awards Manager of the WIA accompanied by the verifications and check list with sufficient postage enclosed for their return to the applicant, registration being included if desired.

5.2 A nominal charge of \$1, which shall also be forwarded with the application, will be made for the issue of the certificate to successful applicants who are non-members.

5.3 Successful applicants will be listed periodically in "Amateur Radio". Members wishing to have their verified country totals listed over and above those submitted at the time of application for membership, will notify these details, in writing, to the Federal Awards Manager.

5.4 In all cases of dispute, the decision of the Federal Awards Manager and two officers of the Federal Executive WIA in the interpretation and application of these Rules shall be final and binding.

5.5 Notwithstanding anything to the contrary in these Rules, the Federal Council of the WIA reserves the right to amend them when necessary. ■



#### AUSTRALIAN VHF CENTURY CLUB AWARD

Rules as amended 1.1.79.

#### OBJECTS

1.1 This Award has been created in order to stimulate interest in the VHF bands in Australia, and to give successful applicants some tangible recognition of their achievements.

1.2 This Award, to be known as the "VHF Century Club Award", will be issued to any Australian Amateur who satisfies the following conditions.

1.3 Certificate of the Award will be issued to the applicants who show proof of having made one hundred contacts on the VHF bands, and will be endorsed as necessary for contacts made using only one type of emission.

#### REQUIREMENTS

2.1 Contacts must be made in the VHF Band (Band 8) which extends from 30 to 300 MHz, but such contacts must only be made in the authorised Amateur Bands in Band 8.

2.2 In the case of the authorised bands between 30 and 100 MHz, verifications are required from one hundred different stations, at least seventy of which must be Australian. The Amateur Bands 50 to 54 MHz and 56 to 60 MHz

will be counted as one band for the purposes of the Award.

2.3 In the case of the authorised Amateur Band between 100 and 200 MHz, verification from one hundred different stations are required.

2.4 It is possible under these rules for one applicant to receive two certificates, one for each of the authorised Amateur Bands nominated in Rules 2.2 and 2.3.

2.5 The commencing date for the Award is 1st June, 1948. All contacts made on or after this date may be included.

#### OPERATION

3.1 All contacts must be two-way contacts on the same band, and crossband contacts will not be allowed.

3.2 Contacts may be made using any authorised type of emission for the band concerned.

3.3 Fixed stations may contact portable/mobile stations and vice versa, but portable/mobile station applicants must make their contacts from within the same call area.

3.4 Applicants, when operating either portable/mobile or fixed, may contact the same station licensee, but may not include both contacts for the same type of endorsement.

3.5 Applicants may only count one contact for a station worked as a limited licensee with a Z or Y call sign who is subsequently contacted as a full AOC holder.

3.6 All stations must be contacted from the same call area by the applicant (except as below), although if the applicant's call sign is subsequently changed, contacts will be allowed under the same call area.

If the applicant moves to another call area, contacts must be made from within a radius of 150 miles of the previous location to qualify for award purposes. If the distance of the new location from the old exceeds a radius of 150 miles, a separate application for a new award must be made claiming only contacts made from the new location.

3.7 All contacts must be made when operating in accordance with the Regulations laid down in the "Handbook for the Guidance of Operators of Amateur Wireless Stations" or its successor.

**VERIFICATIONS**

4.1 It will be necessary for the applicant to produce verifications in the form of QSL cards or other written evidence showing that two-way contacts have taken place.

4.2 Each verification submitted must be exactly as received from the station contacted, and altered or forged

verifications will be grounds for disqualification of the applicant.

4.3 Each verification submitted must show the call sign of the station worked, the date and time of contact, type of emission and frequency band used, the report and the location or address of the stations at the time of contact.

4.4 A check list must accompany every application setting out the following details:

4.4.1 Applicant's name and call sign, and whether a member of the WIA or not.

4.4.2 Band for which application is made, and whether special endorsement is involved.

4.4.3 Where applicable, the date of change of call sign and previous call sign.

4.4.4 Details of each contact as required by Rule 4.3.

4.4.5 The applicant's location at the time of each contact if portable/mobile operation is involved.

4.4.6 Any relevant details of any contact about which some doubt might exist.

4.5 In lieu of forwarding QSL cards or other written evidence as set out in Rules 4.1 to 4.4 above, a list giving the details set out in Rule 4.3, certified by the Awards Manager, Secretary or Council Member of a Division of the Wireless Institute of Australia, or

two licensed amateurs known to the applicant, should accompany each application for membership or adjustment of verified country totals.

**APPLICATIONS**

5.1 Applications for membership shall be addressed to the Federal Awards Manager of the Wireless Institute of Australia, accompanied by the verifications and check list with sufficient postage enclosed for their return to the applicant, registration being included if desired.

5.2 A nominal charge of \$1, which shall also be forwarded with the application, will be made for the issue of the certificate to successful applicants who are non-members of the Wireless Institute of Australia.

5.3 Successful applicants will be listed periodically in "Amateur Radio". Members of the VHFCC wishing to have their verified totals, over and above the one hundred necessary for membership, listed will notify these totals to the Federal Awards Manager.

5.4 In all cases of dispute, the decision of the Federal Awards Manager and two officers of the Federal Executive of the WIA in the interpretation and application of these Rules shall be final and binding.

5.5 Notwithstanding anything to the contrary in these Rules, the Federal Council of the WIA reserves the right to amend them when necessary. ■



**WOOMERA AMATEUR RADIO CLUB  
THE VK5 WHISKY CHARLIE (VK5WC)  
AWARD**

1. The title will be the "VK5WC" Award in commemoration of the 25 years the club has been in existence, the first 23½ of which VK5WC was the only call sign authorised to be used within the community.

2. The design of the Award will be similar to the unusual Club QSL card, printed in several colours on good quality white indestructible parchment.

3. The Award to be open to any licensed amateur radio station in the world, irrespective of class of licence held by the operator, after satisfying the conditions and the payment of the prescribed fee.

4. The conditions to be the satisfactory exchange of traffic with financial members of the club as described in paragraph 5. This is to be in the form of a certified log entry signed by the claimant and countersigned by two other licensed amateur radio operators, or in the case of an isolated claimant, by a justice of the peace or notary public. In case of dispute, local log entries at Woomera shall be accepted as proof conclusive of whether or not a contact took place.

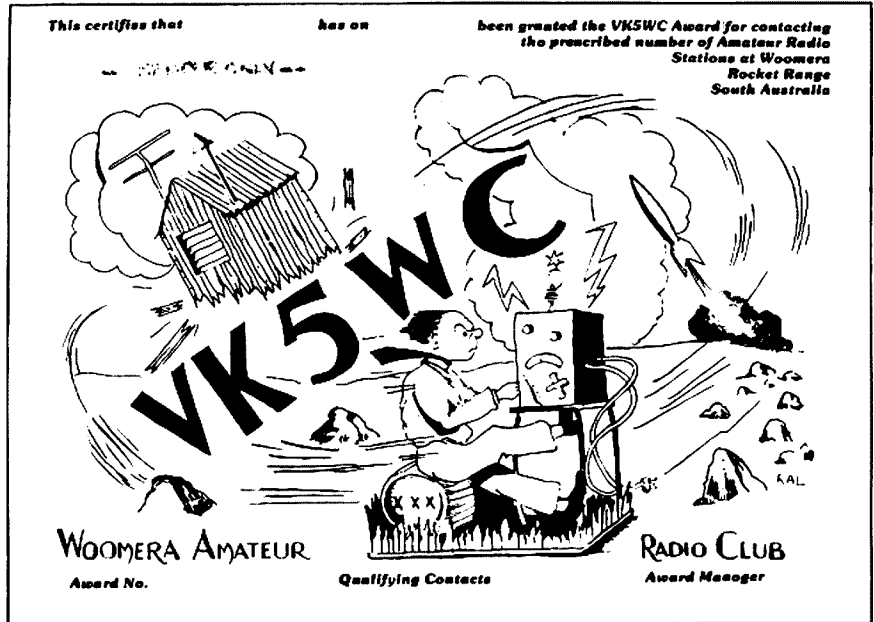

5. The number of Woomera stations to be worked shall be:  
 (a) the Club station VK5WC and two club members, or  
 (b) four different Woomera stations.

Club members shall only qualify for the granting of the Award if when they are worked by a claimant they are within the Woomera community or a geographical area bounded by Anda-

mooka in the north-east, Wirrappa in the south-east, Wirraminna in the west and Roxby Downs in the north-west.

6. Any authorised frequency or band, including crossband and VHF, UHF or satellite repeater, and any mode or combination of modes for which the stations concerned are licensed are permissible. Contacts may be claimed retrospective to 3rd May, 1978, which is the date the use of individual call signs was authorised within the Woomera "village" community.



**VK1 AWARD  
NEW OPERATING AWARD**

The WIA (ACT Division) Inc. has released details of its new amateur radio award, "The VK1 Award".

The Award, which has been sponsored by AW Designs Pty. Limited, one of Australia's leading printed circuit board designers, has the aim of increasing interest in the VK1 prefix, and in promoting Canberra and Australia internationally.

As there are only 300 VK1 licensees, the award will not be an easy one to achieve, particularly on some bands and modes.

The station which had the honour of achieving award certificate No. 1 was the Danish amateur Egil Bohn 0Z4BO, who is well known for, among other things, giving considerable assistance to Australian novice stations in contacting some of the rarer European DX stations.

Applications for the award should be forwarded to:

**The Awards Manager,  
Wireless Institute of Australia  
(ACT Division),  
P.O. Box 46,  
Canberra, ACT 2600,  
Australia.**

Full details of the rules governing the award are as follows:

1. The VK1 Award is available to any licensed radio amateur who submits details of valid radio contacts with VK1 stations.
2. The number of contacts required is: On HF: 20 for VK station, 10 for others. On VHF: 10.
3. Contacts via terrestrial repeaters shall not be valid for this award.
4. Proof of contacts: a log extract is required, showing for each contact the GMT date and time, band, mode of emission, call sign worked and reports or ciphers exchanged.
5. Endorsements for specific bands and modes are available on request.
6. Contacts made from 1 January, 1978, are valid for this award.
7. Applications for the award shall include five IRCs or \$A2.00 to cover costs. Certificates will be posted by ordinary mail.

7. Claims for the Award are to be submitted in writing to the Award Manager, Woomera Amateur Radio Club, PO Box 538, Woomera, South Australia 5720, accompanied by \$2.50 in Australian currency or equivalent, preferably by bank cheque payable to the Woomera Amateur Radio Club, Award Account.

**GENERAL INFORMATION**

It is hoped to produce a special version of this Award as a limited edition to celebrate the club's actual jubilee, and details will be advised later.

There will be many Australian and overseas amateurs who would have operated the club station during the last 25 years and we feel that some of them may wish to recall their association with us and have a jumbo size QSL card.

At present (October 1979) the following members are active on the HF bands: VK5OL (President), VK5MQ (Past President), VK5LA, VK5SZ, who will be departing in a couple of months, and VK5DQ (PRO/Award Manager).

**THE WIRELESS INSTITUTE OF AUSTRALIA**

**A.C.T. DIVISION**  
Founded by the Canberra Radio Society

**This is to Certify that**

-----

**has completed the requirements**

**for the**

**VK1 AWARD**

<b>CERTIFICATE NUMBER</b> <hr style="border: 0; border-top: 1px solid black;"/>	<b>DATE</b> <hr style="border: 0; border-top: 1px solid black;"/>
<b>ENDORSEMENTS</b> <hr style="border: 0; border-top: 1px solid black;"/>	<b>PRESIDENT</b> <hr style="border: 0; border-top: 1px solid black;"/>

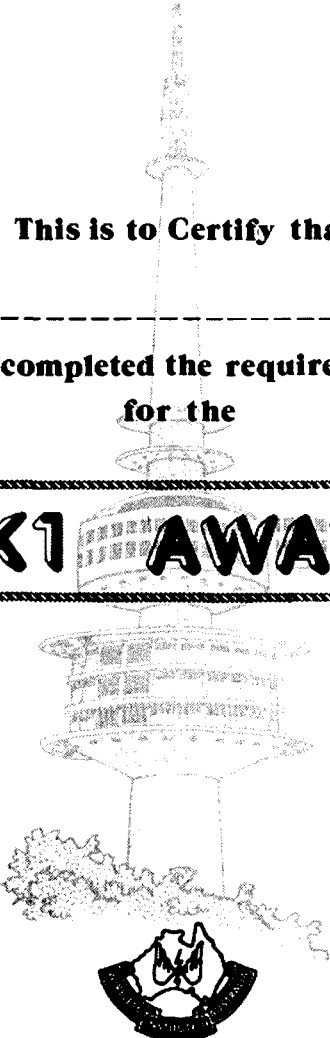

8. The award is also available to short-wave listeners, whose log extracts shall include the call sign of the station con-

tacted by the VK1 station heard, and the report or cipher issued by the VK1 station.



# baïl

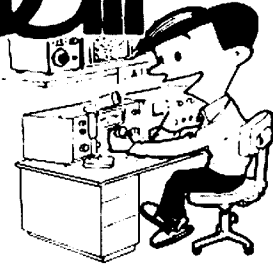

## YAESU THE RADIO

Introduces the ultimate professional  
general coverage, all mode  
Communications Receiver, FRG-7700

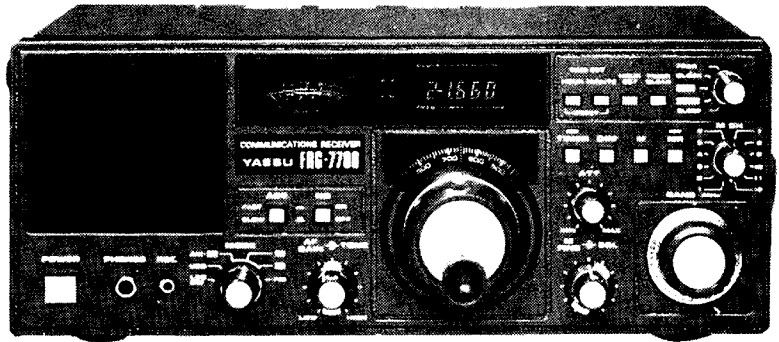

### ● GENERAL COVERAGE

The model FRG-7700 is a high-performance, all solid state, communications receiver designed to cover the low, medium and high-frequency spectrum from 0.15 MHz to 29.999 MHz.

### ● ALL MODE CAPABILITY

A unique feature of the FRG-7700 is its all mode capability — SSB (USB, LSB), CW, AM, and FM. The FM mode is especially useful when the FRG-7700 is teamed with a VHF converter.

### ● DIGITAL FREQUENCY/TIME DISPLAY

The FRG-7700 digital display unit allows you to display the operating frequency or time. Just turn a knob for selection of the desired function.

### ● TWELVE MEMORY CHANNELS (OPTION) WITH BACKUP

As many as twelve memory channels may be programmed for instant return to a favourite station. The memory unit stores the entire frequency, which means you never have to change the bandswitch when switching channels. A backup feature is provided to hold the memory circuits when the FRG-7700 is turned off.

### ● LSI CLOCK TIMER

If you want to record a program, but have to be away from your station, the FRG-7700 will do it for you. The

built-in digital quartz clock contains a timing feature that activates the receiver and internal relay contacts. Set the time you want to start and stop recording, hook up your tape recorder, and your FRG-7700 will do the rest.

### ● WIDE DYNAMIC RANGE

The FRG-7700 is an up-conversion superheterodyne receiver, incorporating a 48 MHz first IF. The up-conversion technique and the individual filter networks in the front end eliminate most image problems, allowing you to receive weak signals. A high "loss" JFET balanced mixer is utilized in the FRG-7700 to provide wide dynamic range for protection from cross modulation.

### ● CONVENIENCE FEATURES

Selectable AGC, memory fine tuning, DIM switch for dimming the digital display, advanced noise blanker, and a variable RF attenuator provide the convenience you need for efficient operation. The front panel controls and switches are arranged in a logical manner, so you won't have to fumble for a knob when you need it quickly.

Call or write for a coloured brochure.  
Mail orders are despatched within 24 hours  
of receipt of your order.

(Subject to  
availability  
from stock.)



YAESU



**ELECTRONIC SERVICES**  
**STAN ROBERTS VK3BSR**  
38 Faithful Street,  
WANGARATTA 3677  
Telephone: (057) 21 6260  
Telex: Teletra AA56860

### AUTHORISED DISTRIBUTORS

**VICTORIA**  
CHIRNSIDE ELECTRONICS. . . . . (03) 726 7353  
COOLIN COMMUNICATIONS (Moe) . . . . . (051) 27 4516  
G.F.S. ELECTRONICS. . . . . (03) 873 3939  
IMARK. . . . . (03) 329 5433

**N.S.W.**  
EMTRONICS. . . . . (02) 398 6378  
INVERELL. . . . . (067) 22 1300  
WAGGA WAGGA. . . . . (069) 21 2125

**QUEENSLAND**  
C.W. ELECTRONICS. . . . . (07) 341 5377

**S.A.**  
COMPUCOM PTY. LTD. . . . . (08) 43 7981  
FARMERS RADIO. . . . . (08) 293 2155

**W.A.**  
PATCOM COMMUNICATIONS. . . . . (095) 35 4592

**TASMANIA**  
HOBBY ELECTRONICS. . . . . (002) 43 6337  
V. K. ELECTRONICS. . . . . (004) 31 1708

And other regional centres.

# COMMERCIAL KINKS

RON FISHER  
VK3OM

## AN EXTRA MEMORY AND TRUE ANTI-REPEATER MODE FOR THE YAESU FT-227R

Several months ago we published in this column a popular modification for the FT-227R to provide reverse repeater operation. A recent letter from Ken Ray VK1ZKR tells of a new modification he has devised to provide for reverse repeater operation without the loss of the panel selected +600 kHz transmit facility. Ken also shows how to get one extra memory channel. Take your pick of the modifications, but Ken's approach is certainly a novel one. Over to you Ken.

The FT-227RB 2 metre rig has four memories, however, the fourth is only available as a transmit memory. This was intended to be used to provide a variable offset, as whenever this memory is selected this gives the transmit frequency, with the dial frequency being the receive frequency.

I found that this feature was of little use, and an extra "standard" memory would be much better. The modifications required to do this modification are quite simple, and require only three changes to the function switch S8. See diagram below,

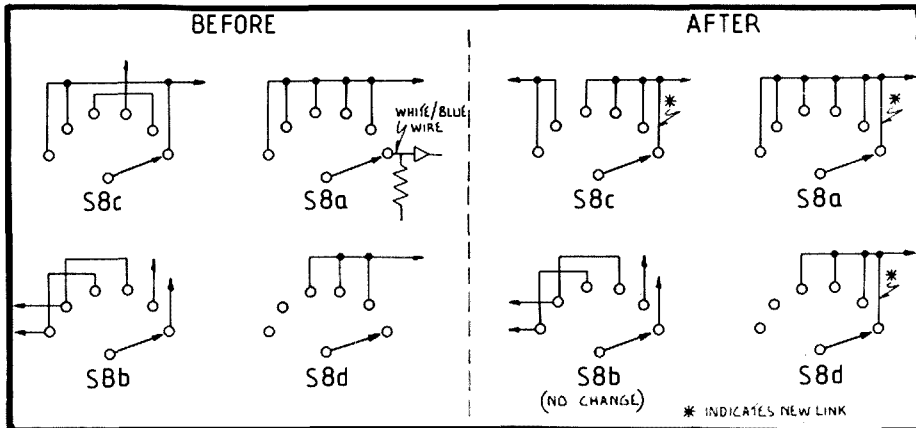

FIGURE 1: Extra memory switching for the FT-227R.

and a quick check with the complete circuit diagram would be useful to understand just what is happening.

## TRUE ANTI-REPEATER MODE FOR THE FT-227RB

There have been a number of articles written on how to "invert" the Yaesu FT-227RB 2 metre rig. However, most of the methods used require the dedication of one memory or the loss of some other features. The method shown here is very simple, and doesn't take away any of the existing facilities. To understand how the method works, some knowledge of the frequency generation process is needed.

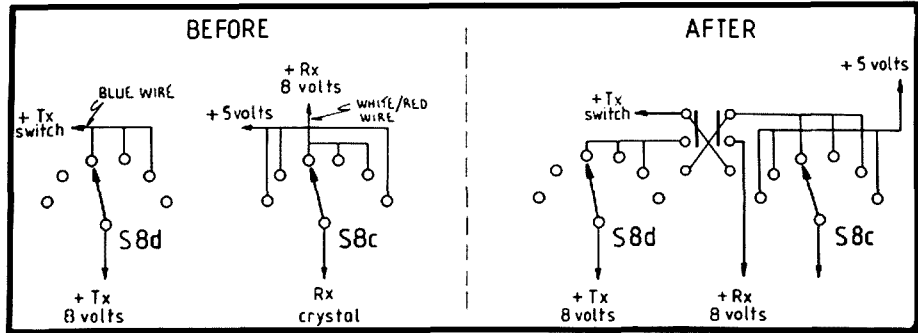

FIGURE 2: Modifying the FT-227R for anti-repeater operation.

The transmit offsets are determined by switching crystals in the heterodyne oscillator and there are six possible crystals that can be selected. These six crystals can be considered to be in two banks of three, the appropriate bank being selected by the "5 up" switch. Each set of three corresponds to the receive frequency and the two possible transmit frequencies, 600 kHz above and below this. Depending on the position of the "5 up" and "+Tx" switches, and whether transmitting or receiving, the correct crystal is selected.

Diode switching is used and, in particular interest to this exercise, there are two control voltage lines called Tx 8V and Rx 8V, and are selected by the PTT relay. To obtain a true anti-repeater facility, a DPDT switch can be used to change these lines around to select the opposite crystal. Such a switch is available for use, the "Tone Burst" switch located on the bot-

tom in the manual and the rig, is time well spent. Because only DC is involved here, no special constructional methods, apart from good electronic practice, is required.

In operation, changing the switch will do exactly what is needed — interchange the receive and transmit frequencies. It will do this for either offset, because the "+Tx" switch becomes a "+Rx" switch in the reverse mode. On simplex it has no effect. A quick flick of the switch allows monitoring of the repeater's input frequency and is a rapid way of checking the ability of working the other person directly, leaving the repeater free for others.

I have used this for a few months now and have found it extremely useful, especially when mobile, as I don't even have to take my eyes off the road. No doubt it would be possible to adapt this to other rigs using a similar offset selection. ■

## QSP

### RADIATION

An article in September 1980 QST by W5EDZ the ARRLs Add Hoc Committee on the Biological Effects of Radio Frequency Energy defines the definitions of ionizing and non-ionizing radiation. Ionization occurs when radiation displaces an electron from an atom. These electrons may, in turn, ionize other atoms. Radiation with short wavelengths and high energy (such as X-rays and gamma rays) contain sufficient energy to cause ionization. Radiation with longer wavelengths and less energy (such as ultraviolet infrared and radio frequencies) do not possess enough energy to produce ionization. Because of possible confusion between the two types of radiation, the writer suggests that the words "non ionization radiation" be replaced with either "electromagnetic energy" or "radio frequency energy". Because it has always been there, we are more or less immune to any kind of natural radiation that normally reaches us from space (cosmic rays, light, radio waves, etc.) and from background radiation (from rocks, etc) — some of these are benign or even beneficial whilst other are definitely harmful. On the other hand there is also man-made radiation (includes radio and radio waves) forming an increasingly large portion of the total radiation. ■

### EXPEDITION TO THE PHILIPPINES — VACANCY

A letter from Brad Warren of Traditional Explorations of PO Box C342, Clarence Street, Sydney 2000, advises the Institute that a group, with a Press representative aboard, will be sailing from Cairns to Manila in a small catamaran in April next year. The group are seeking the services of an expert radio operator to accompany the expedition. If you are interested write direct or telephone Mr. Warren on (02) 29 5871 Bus. or (02) 827 2849 AH for further details. ■

tom panel. This is not needed unless you wish to prefix each over with a blast of 1800 Hz! The tone burst can be permanently disabled by removing both wires to the switch and connecting the brown wire to a convenient earth point, such as the black wire on the adjacent scan select switch.

This switch is then rewired as a change-over switch, and the two voltage lines are tapped into at the memory select switch (S8). See the diagram for the modified wiring. Wire colours were as in my rig and may not be the same in all others. A few minutes spent tracing the circuit,

# Ron Wilkinson Achievement Award

# FORWARD BIAS

## VK1 DIVISION

(Postal Address: WIA (ACT Division) Inc.,  
PO Box 46, Canberra, 2600 ACT)

## VK1 DIVISION

### NEW MEMBERS

We welcomed three at the meeting on 27th October — Ian Fraser, Jeff Gibson and Mike Johnson VK1ZMJ.

### VK1 AWARD

Yes, at last we have one!! The printing is complete, we have the certificates, we've written the rules and opened the register. The first three certificates have in fact already been sent to long-standing and patiently waiting claimants, and the honour for Certificate No. 1 goes to Egil Bohn OZ4BO. Numbers 2 and 3 have been sent to Olle Ekblom SM0KV and Yozo Kishikawa JH3KAI. So, Egil, Olle and Yozo, should you get to see this, congratulations and 73 from our President and Committee.

Full details of the award and the rules appear elsewhere in this issue.

### JOTA 1980

The 23rd International Jamboree-on-the-Air took place over the weekend of 18th and 19th October. The indefatigable Gus Napier VK1NBO, who co-ordinated the VK1 part of the programme, is writing his report and this will appear in the next AR. The monumental task for Gus has been to produce, for the Scouts, a composite log of all the contacts made during 48 hours of operating at the three VK1 stations. In short, JOTA was even more successful than last year, with many more boys and girls participating. Already Gus has JOTA 1981 in mind and he's developing ideas for improving the operating side of the programme.

### AGM

Early yet, but the Division's Annual General Meeting will be held on 23rd February, 1981, and that means elections for office-bearers. On the other hand, it's not really too early to start thinking about all this because nominations will soon have to be lodged with the Public Officer. We plan to have nomination forms available very soon. ■

---

**ICOM, KENWOOD OWNERS.** If you are not receiving our separate monthly newsletters, your equipment is not tuned to a wealth of information. "Our Second Big Year" Details 2 IRCs. Users International Radio Clubs, 606A Brack Road, Fort Pierce, FL 33450, USA.

---



# RON WILKINSON ACHIEVEMENT AWARD

Presented to: .....

in recognition of outstanding achievement in: .....

Federal President

"Nothing great was ever achieved without enthusiasm."

Nominations for the WIA sponsored Ron Wilkinson Achievement Award should now be submitted to the Executive Office, PO Box 150, Toorak, Victoria 3142, for consideration.

The award is given to any amateur for a special achievement in any facet of amateur radio.

Examples of the scope of achievement which may be taken into consideration are as follows:—

Outstanding communication achievement, or QRP, etc.; article for Amateur Radio magazine; holder of Australian DXCC; development of State of the Art techniques; involvement in Institute affairs; microwave activity; involvement in WICEN, education, clubs or similar; achievement in using amateur satellites; notable public serving.

These are examples only, the award is extended to cover the whole range of amateur radio activities.

### THE AWARD

The award is made up of:—

1. A certificate.
2. \$50 cash.
3. Books from "Magpubs" to the value of \$50.
4. WIA subscription paid for one year.

It is funded from the interest from the donation of Mrs. Mary Wilkinson, widow of the late Ron Wilkinson VK3AKC, and supplemented by Institute funds if required.

### METHOD OF SELECTION

1. Available only to amateurs from VK call areas.

2. Preference will be given to WIA members.
3. Individual amateurs may nominate or make a personal application to the President of their Division by 31st October each year. This time limit is now extended to 31st December to allow for late applications for 1980 only.
4. The President of the Division is then to forward the most meritorious applications/nominations to the Executive, only after satisfying himself that the applications/nominations are worthy of consideration.
5. Executive will nominate the recipient of the award by 31st January, subject to Federal Council agreement if considered necessary.
6. The award will be announced in "Amateur Radio" for March.
7. In the event of no nominations forthcoming, the Executive may select a recipient/s.

Further details may be obtained from the March 1978 issue of "Amateur Radio".

If you consider yourself or another amateur a suitable recipient for the award, please forward your application/nomination to your Divisional office **NOW**.

Division Presidents are requested to forward their recommendations to the Executive office by 20th January 1981. ■

---

**The Advertisers in "Amateur Radio" support the WIA member — give them first preference — and tell them so, too!**

---

# VK2 MINIBULLETIN

## NOTICE

The Annual General Meeting of the Wireless Institute of Australia, New South Wales Division, will be held at 10 a.m. on Saturday, 28th March, 1981, at 14 Atchison Street, Crows Nest, NSW. Agenda items for this meeting may be submitted to the Divisional Secretary up to 10 a.m. on Thursday, 26th February, 1981. Nominations for election to Council of the New South Wales Division will close at 10 a.m. on Saturday, 7th March, 1981. Nomination forms may be obtained by writing to the Divisional Secretary, Box 123, St. Leonards 2065.

(Sgd.) SUSAN BROWN,  
Secretary WIA NSW Division.

## READERS FOR THE BLIND

The Royal Blind Society of New South Wales need readers who are knowledgeable in the fields of amateur radio and electronics. The Society has many services for visually handicapped persons catering for their particular needs, including a large braille and talking book library and also a special request service for clients who want something read that is not of general interest. Volunteers are needed to read books, magazines, articles, etc., on to cassette in their own homes on their own cassette recorders. At present, there is a big demand for magazines like "Amateur Radio", "Hi Fi and Music", "Electronics Today International" and "Eelectronics Australia". If you can help, contact Gwenda Ferrett on Sydney 747 622, ext. 31, or write to Royal Blind Society of NSW, Box 176, Burwood 2134.

## 68%

Did you receive a mark of 68% at a recent AOCF or NAOCP exam? If so, we would appreciate a photocopy of your exam results. Please send to Box 123, St. Leonards 2065.

## NSW WICEN CONFERENCE

The 3rd annual NSW WICEN Co-ordinators' Conference was held in Sydney on Saturday, 1st November, at the 729 Club, Crows Nest. This conference provides an opportunity for the 12 Regional Co-ordinators to discuss their problems, exchange ideas and make recommendations to the NSW WICEN Committee which organises WICEN in this State.

The NSW Divisional Council donated \$100 towards the cost of running this conference. A total of 18 committee members and co-ordinators were present, together with contributions from Athol Tilley VK2BAD (Divisional President, who opened the conference), Ray Gill VK2BRF (Chairman, Volunteer Rescue Association Radio Committee), Sam Voron VK2BVS (Covener

of the first Australian Third Party Traffic Net) and Harold Wright VK2AWH (Observer from Lismore).

During the year, NSW WICEN has received recognition for its activities from the Minister for Services and the Statutory Authorities charged with the control of emergencies. One significant activation was the bushfires over the 1979 Christmas period which were reported in AR and other magazines. Although much has been achieved during the year, more effort is required at the local level to make the police and other authorities aware of WICEN's capabilities.

Two WICEN Newsletters were produced and members should ask their local co-ordinators to see a copy, as costs prohibited the production of them in large numbers.

As a result of the increase in cost of distributing information, the annual membership fee for 1981 has been set at \$5 for both WIA members and non-WIA members alike. This falls due on 31st December, 1980, and should be paid to your Regional Co-ordinator.

WICEN members are covered by an accident insurance policy when on exercises and the amount of cover provided has been increased slightly this year. The benefits are generally greater than those provided by the SES. A grant from the Department of Sport and Recreation enabled the purchase of 300W and 1 kW motor generators. This grant was made possible as a result of NSW WICEN's membership of the NSW VRA.

Plans are progressing for the establishment of an emergency 2m repeater in Sydney and negotiations are being finalised for the site. An offer of equipment for a portable repeater has also been received.

No difficulties were experienced in gaining P. and T. Department (now Department of Communications) approval for the 28 exercises which were held and the 6 which were cancelled or deferred. It is hoped that a State-wide message handling exercise will be held next year.

This year there were over 160 financial WICEN members, an increase of over 50 per cent, and the increased size and complexity of the organisation has resulted in an increase in the amount of paper work required.

A weekly WICEN net is held on 3617 kHz  $\pm$  QRM each Thursday at 2130 hrs local to enable an interchange of ideas between co-ordinators and also from any other amateurs. This net is achieving its aims.

The conference expressed its concern that the P. and T. Department appeared to be adopting a discriminating attitude towards WICEN exercises by allowing amateurs to pass non-commercial 3rd party traffic while still requiring prior permission for WICEN exercises. The NSW WICEN Committee will be making further approaches to the P. and T. (Department of Comms.) on this issue.

The information required on a message form used by any amateur who handles 3rd party traffic for the public is very similar to that appearing on message forms currently used by WICEN (see AR April 1979) and hence a standard 3rd party message format will be proposed.

The WICEN organisational structure and membership levels as proposed in the second newsletter were accepted as a guide to the further development of NSW WICEN development at the regional and local level; however it was recognised that all of the features described might not be implemented immediately and local conditions would have to be taken into account.

All WICEN members will soon be issued with a cloth backed ID card. However, the only form of ID that will be recognised by the NSW Police for WICEN during an emergency is the sealed photographic card issued by the VRA. The costs involved in having photographs taken by the official photographer are considerable and could be as high as \$9. As a result, this card will be optional for those who wish to bear the additional cost.

With the increasing cost to the WICEN member for membership and the cost of attending exercises, the WICEN Committee is to investigate the possibility of obtaining sales tax exemption and registration as a charitable organisation for WICEN.

A large number of issues were actively discussed at this year's successful conference and consideration will be given to holding next year's in a country region.

David MacKay VK2ZMZ,  
Secretary, NSW WICEN.

## THIRD CONFERENCE OF THE CLUBS

The Third NSW WIA Conference of Clubs was held at Parramatta Leagues Club on Sunday, 2nd November. Eric Bierre VK2BEK was elected Chairman and Ross Wilson VK2BRC Secretary of the Conference. Thirty-five members of the NSW WIA attended the Conference. The following delegates represented fifteen affiliated clubs (the number after each club is the vote, based on 10 WIA members per vote) — Neville, 2DR Bathurst, 2; Barry, 2DBA Goulburn, 2; Guy, 2BBF, Hornsby, 2; Geoff, 2ZHU Illawarra, 6; Val 2BVR, Liverpool, 3; Bob, 2AWA Manly Warringah, 3; Kevin, 2BKG Mid South Coast, 5; Mike, 2NKH/YFI, Novice, 2; Peter, 2TK Orange, 2; Bill, 2WD Oxley, 3; John, 2BXD South West, 4; Ed, 2AQF St. George, 7; Geoff, 2BGF Taree, 2; Russ, 2AZR Wagga, 3; David, 2BWK Westlakes, 7. There were also 11 observers from the above clubs and Summerland, and 8 spectators, including 4 members of Divisional Council and representatives from Castle Hill RSL RC and Crestwood ARC.

Among the many topics discussed at the conference were the following — personalised numbers plates for amateurs; operators using foul language on amateur bands, in particular 2 metres; the point

scoring system in contests, especially the John Moyle FD; fee increase for amateurs; combined fee for NAOCP/AOLCP licenses; on air liaison nets; new HF bands; Institute membership levels; 6 metre band; "gentlemen's agreement" on amateur bands; inter-club contests within the John Moyle FD; the role of the conference within the WIA; publicity for amateur radio; 160 metres for novices; car badges for WIA members; changes to Morse exams; and callbooks. The Divisional President also presented a written report and answered questions on actions taken by council as a result of the 1st and 2nd conferences.

A ballot for 2 UHF transceivers was conducted. The successful clubs were Westlakes (metropolitan) and Summerland (country). At the conclusion of the conference, Keith Howard VK2AKK presented the Novice Contest Trophy, on behalf of Westlakes ARC, to the Divisional President, who accepted it on behalf of the Federal Contest Manager.

The Secretary of the Conference, Ross 2BRC, kept comprehensive minutes of the meeting, and any member who would like a copy is invited to send a foolscap SAE to the Divisional Secretary, NSW WIA, Box 123, St. Leonards 2065.

#### COUNCIL REPORT

Contrary to previous advice, council is proceeding with the steps to alter Article 82 as directed at last May's EGM. At the council meeting of 17th October last, two clubs were accepted for affiliation. Welcome to Mid South Coast Amateur Radio Club and Moree and Districts Radio Club. Council adopted by-laws for the election of council and for the termination of affiliation of clubs. Send SAE for a copy. In future, all divisional communications will use the 4 figure channel numbering systems for VHF and UHF FM frequencies as adopted at federal conventions.

As from 1st January, 1981, the fees for handling non-members' QSL cards will be increased to 5c per card. Council will be submitting a proposed alteration to Article 48c to the Corporate Affairs Commission for approval by the Attorney-General. If the proposed change is approved by the Attorney-General, it will then be submitted at the next Annual General Meeting of the division for approval by members. The proposed change is that the closing date for nominations for election to council be moved forward seven days, from 21 days to 30 days before the AGM. This change would eliminate the need for two postings to members, one with agenda items and one with the ballot.

Council approved the installation of two control consoles for engineering and studio facilities at Dural and the replacement of the valve 6 metre FM transmitter with a solid state unit. Thanks must go to the Dural committee for undertaking this work, in particular Jeff VK2BYY and Doug VK2ZYM.

The \$500 from the Dick Smith Auction will be invested in debenture stock and

the interest derived used to provide prizes for Amateur Radio Study Weekends conducted by the Education Service.

#### SWARS 28th CONVENTION

Conducted over the last weekend in October at Griffith, the convention had its usual excellent trade displays and events of interest for all the family. Approximately 150 attended the Hawaiian dinner dance on the Saturday evening. The dinner, hosted by the Griffith ARC and ably assisted by the Wagga "animals", was very enjoyable. Somehow the organisers forgot about daylight saving, and timed the first foxhunt on Sunday morning to start at 8 a.m. (actually 7 a.m.!). The faithful hounds were out in force, however, despite some sore heads.

The prize winners for the weekend were: 2 metre scramble, Jeff 2YNY; 80 metre mobile, Charlie 3VEJ; Saturday foxhunts, Alan 2YSU; Sunday foxhunts, Jeff 2YNY; overall foxhunts, 1st Jeff 2YNY, 2nd Sue 2BSB; women's quiz, Cathy Lambert; CW receiving, 1st Sid 2SW, 2nd Russ 2AZR; antenna gain contest, Graeme 2DGW; raffle (a \$350 2 metre transceiver donated by Peter 2ZXL), 2CAS.

Watch out for next year's convention, some time in October.

Sorry, no room this month for club details. Will put in extra next month.

#### COMING EVENTS

22nd February: Gosford Field Day.

28th March: AGM, 14 Atchison Street, Crows Nest.

Susan Brown, Secretary NSW WIA. ■

#### POST SCRIPT

##### SURPLUS EQUIPMENT

Just as these notes were being compiled the Division's disposal personnel received an offer of some black and white video cameras and ½ in. reel to reel videocorders. In order to determine interest details were given on the broadcast on 2nd November, as well as information sheets to some clubs and the delegates to the C of C. The result of the survey indicated that the interest was there and steps are being taken to accept the offer, in part.

We will be accepting the tape recorders and the survey indicates that a ballot is likely. A percentage of the equipment will be held for those members who did not hear about the offer from other sources. Hoping that this issue is delivered on time, the expected ballot will close on the 16th December. To apply, VK2 members write to the Secretary, WIA NSW Division, PO Box 123, St. Leonards 2065. Enclose cheque to the value of goods. Our usual terms for surplus sales apply. Items sold as is, for members own use, and not for resale.

The tape recorders have been used in an education dubbing service and have been maintained under contract. They were withdrawn from service because the format is no longer used. They are "Sony AV-3600CE videocorders", CCIR monochrome videotape recorders. ½ in. reel

to reel tape is used. Tape is available, we understand, from both new and second-hand sources and should be worth approx. \$20 for an hour reel. Cost will be eighty dollars (\$80) ex Atchison Street. Delivery extra, at your cost. Please indicate delivery method preferred. A photocopy of the service manual will be supplied. Size 408 mm w., 231 mm h., 335 mm d. Weight 16.5 kg. 240V AC.

The cameras are not as interesting on a closer investigation. They are new but do not include either a lens or viewfinder. The standard lens used is a f1.8, C mount. The viewfinder (not supplied) is electronic — small tube — in a housing the same size as the camera and mounts on top. Camera size 110 w. x 120 h. x 330 d. mm. Weight 3.55 kg. We understand that a few may be available at \$120 (one hundred and twenty dollars), ex Atchison Street. Remember it is a bare camera.

Type Sony AVC-3250. Black and white. Designed for use with the videocorders and/or for use with closed circuit monitoring, etc. If interested please enclose a separate cheque if you are applying for a recorder. A copy of the manual would be available.

The Broadcast operators and the Dural team would like to wish all Members all the best for Christmas and the New Year. So that they can have a break there will be no morning or evening voice broadcasts on December 28th and January 4th.

The University of NSW Amateur Radio Society will be conducting their usual Christmas study course this year. They will be meeting at Atchison Street. Commencement about the middle of the month. Details on the broadcasts. ■

## QRK5

A monthly transmission from the Victorian Division WIA.

Written and co-ordinated by VK3WW, QTHR.

#### WILLY WILLY'S WORDS

To all readers, friend and foe alike, may I wish you a very Merry Christmas and Prosperous New Year. The same wishes extend especially to my fellow scribes in other Divisions.

#### FEE RISE

Yes the note in October AR is now a fact and fees will rise to \$30 in the new year. General opinion voiced on 2 metres is in favour of the rise — one comment was that it is worth \$30 just to use the repeaters. It is to be hoped that there is no silent majority that will say nothing and just not renew membership.

#### BUSY — BUSY

An old saying about getting a job done by giving it to a busy man has once again been proven. Peter VK3ANX, who is chair-

man of the Broadcast Committee and also the State Co-ordinator for WICEN, produced the following notes on WICEN activities within 24 hours of being asked.

### WICEN ON THE MURRAY RIVER

This Christmas, as usual, the Victorian WICEN team will join forces with 2,000 other masochists for the Red Cross Murray River Canoe Marathon. This year over 300 canoes are expected to take to the water at Yarrowonga on December 27th and paddle their way down to Swan Hill for New Year's Eve. The Marathon relies heavily on reliable communications for the efficient running of the event and, more importantly, for the safety of competitors.

For each of the five days of the event WICEN provides communications between 6 check points, 6 safety boats and 3 or 4 key personnel. Check points require 80 metres off a dipole and 2 metres on the common simplex frequencies. Portable generators and after-burners and beams for 2 metres are optional luxuries. Boat stations are provided with a source of 12 volts and expected to provide their own 2 metre rigs, aerials and leads. Other stations are normal 2 metre mobiles with 80 metre mobile as a luxury extra.

All operators are expected to fend for themselves for the 5 days, however the organisation does provide camping sites for all officials and meals can be provided if organised in plenty of time.

The WICEN team comes from all over Victoria and usually attracts a few starters from interstate. There are never too many operators and the Victorian team extends a hearty invitation to all Victorian and neighbouring amateurs to come and lend a hand. Red Cross describe the Marathon as "The Great Experience" and although they are aiming this pitch at canoeists it is just as big an experience for WICEN and the other officials. The hours are unforgivable, the atmosphere is incredible and the effort is in an excellent cause. You may never come again (or you may be hooked), but a Marathon will give you something to talk about for a long, long time.

VK3 WICEN places no heavy qualification on operators and is able to find a job for everyone from the almost qualified to the all frequencies/all modes WICEN expert. All starters will be given a role according to their experience.

If you are interested in participating, contact the State Co-ordinator, Peter Mitchell VK3ANX, QTHR, or phone (03) 592 8179. If you are going to require Red Cross catering, make it soon.

### THANK YOU!!

John VK3NUI sent me some interesting mods for the receiver in the FT7. Thanks, John. I have sent copies interstate and to our "Novice Notes" editor. I have heard that the transmitter final can be fitted with more powerful transistors and a few simple mods to upgrade power to about 50 watts, but have no details as yet.

Alan VK3SM sent in a magazine dated November 1928. The feature article was the "Pentode Three", a great receiver, they claimed. The price of parts was very high in those days compared with the average wage. The old-timers didn't get it as easy as we do today. Thanks, Alan, for some nostalgic reading.

### DEADLINES

Due to the holiday season notes for January 1981 have already been submitted and I will need any copy for February by 15th December at the latest.

73. Mike VK3WW. ■

## SPOTLIGHT ON SWLing

Robin Harwood VK7RH

5 Helen St., Launceston, Tasmania 7250

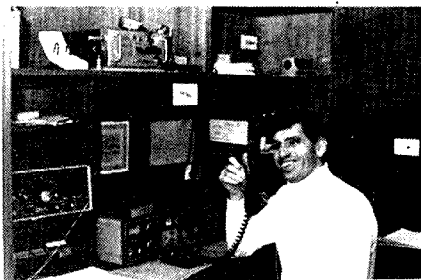

Well, another year has drawn to a close. In retrospect, 1980 has been quite a mixed bag as far as short-wave listening. The Sunspot Peak has passed and higher frequency signals will now slowly deteriorate. Already the number and frequency of ionospheric disturbances and drop-outs have increased over the past few weeks. It is interesting to note that there are unusual propagation patterns that precede these disturbances with signals being observed from areas and regions not normally heard at that hour. For example, signals from Europe on the long path being monitored on the 21 MHz band at 2300Z, up to seven hours before long path transmissions are usually heard. Also WWV has status reports on Ionospheric and Geomagnetic Conditions at 18 minutes past the hour.

At the end of this month, the BBC is planning to end its popular programme for SWLs, DXers and those interested in electronics, the World Radio Club. Over the many years this programme has been aired, it has brought news of developments within electronics, as well as assisting the listeners with tips to aid them in their hobby. It also provided weekly news on what is happening in the international broadcasting scene from the BBC's Monitoring Service.

No reasons have been stated yet why it is being taken off. However, the BBC has been rationalizing its programming over the past few months. It is to be hoped that they will reconsider their decision as it is one of the most popular and informa-

tive of all the programmes for the SWL and the DXer. In January this year, Radio Australia also discontinued its programme "Club Forum", which included news and reports from the DX scene in Australia as well as the observations of overseas listeners of Radio Australia.

This highlights the strained relationship between the international radio stations and DX Clubs and individuals. More stations are altering or discontinuing the practice of issuing QSL cards for the verification of reports. The main reason being advanced for this is that financial and manpower shortages of the various organizations have led to a rationalization of available resources. Hence they see no pressing needs to issue thousands of individual QSL cards.

The mass production of simple and rather cheap transistor radios led to a very substantial increase in listening audiences and mail volume during the mid-sixties. The majority of the audience then, as now, is mainly listeners. The DXer still has a contribution to play as the average listener does not have the sophisticated equipment or possess the specialized knowledge of propagation or frequency usage, etc.

In the mid-seventies with the release of solid state receivers such as the Yaesu FRG-7 and Drake SSR 1, together with an explosion in things electronic, particularly in Japan, saw an increase in reports for verification. As the quantity of reports increased, their quality decreased.

Many international broadcasters have entered into co-operative agreements to use their monitoring facilities to assess the signals. So the DXers' reports were not needed.

This situation points up the difference between the SWL and the DXer. The European DX Council (EDXC) defined a short-wave listener as one who listens to programmes or message content from radio stations. They also define a DXer as one who listens for the station without regard to programme content. He will also report reception of the station and endeavour to have the report verified. A DXer can be an SWL, but conversely an average listener is not a DXer. An SWL can be regarded as passive, and a DXer can be regarded as active listeners.

The broadcaster is aiming for a wider audience of listeners and not for random listening by the DXer. It is an individual pursuit and basically a personalized activity. For further reference on these points, I recommend that you consult a pamphlet published by the Australia Radio DX Club on "Verification Standards" and also a "Guide to DXing", both compiled by Bob Padula, a noted DXer.

Well, that is all for this month. May I wish you a Happy Christmas and a Prosperous 1981. 73s from Robin L. Harwood. ■

# SIDEBAND ELECTRONICS ENGINEERING

"THE ANTENNA AND ROTATOR SPECIALISTS"

P.O. BOX 23 SPRINGWOOD NSW 2777  
WAREHOUSE 213 HAWKESBURY RD. SPRINGWOOD  
TELEPHONE (047) 54 1392

## DO YOU OBJECT TO HUGE PRICE INCREASES?

If so, read on. We offer a 5% or better price reduction from now until 31st January 1981. Offer applies to all current stocks except for a few Trio-Kenwood items. For previous prices see November AR and ARA Vol 3 Issue 6.

### ANTENNAS

TET HB35C.....	was \$415	now \$390
CUSHCRAFT A3.....	was \$325	now \$290
HY-GAIN TH5-DX.....	RRP \$447	now \$420
HY-GAIN TH3-JR.....	was \$250	now \$237
HY-GAIN 18-AVT/WBa.....	was \$125	now \$115
HY-GAIN 8el 2M.....	was \$40	now \$37
HI-GAIN 14 el 2M.....	was \$50	now \$47
HY-GAIN GPG-2.....	was \$30	now \$25
<b>HELICALS</b> .....	were \$25	
10-15-40-80M w/adjustable tip.....		now \$20
20M w/adjustable tip EXTRA SPECIAL.....		now \$15

### CONNECTORS & ACCESSORIES

PL-259.....	were .75c	now .50c
GLP Rt angle.....	were \$1.50c	now .75c
MLS Rt angle.....	were .75c	now .50c
CABLE JOINERS.....	were .75c	now .25c
M-RING body mount.....	were \$1.50c	now .75c
SWR METER.....	was \$25.00	now \$20.00
ASAHI Bumper mount.....	was \$8.00	now \$6.00
STANDARD Bumper mount.....	was \$5.00	now \$3.00
SPRING MOUNT.....	was \$15.00	now \$13.00
240V/2 x 9V transformer.....	was \$8.00	now \$6.00

### ROTATORS

CDE T2X.....	was \$300	now \$285
CDE HAM-IV.....	was \$225	now \$210
CDE BT-1A.....	was \$110	now \$100
KEN KR-400.....	was \$140	now \$130
KS-065 BEARING.....	was \$30	now \$25

### HENRY LINEARS

2KD-5 2KW.....	was \$1000	now \$950
1KD-5 1200W.....	was \$800	now \$750

### YAESU MUSEN PRODUCTS

FT-101ZD W/FAN.....	was \$850	now \$810
FT-707 SERIES.....		POA

### CABLE

RG-8U COAX PER METRE.....	was \$1.20	now \$1.10
RG-58U COAX PER METRE.....	was .50c	now .45c
CONVERSION XTALS.....	were \$32.00	\$26.00
BN-86 BALUN.....	was \$25.00	now \$23.00
HI-Q BALUN.....	was \$15.00	now \$14.00
SHINWA 10W UHF 3 CH 450-477 MHz COMMERCIAL TRANSCEIVER NEW.....		\$375.00

## STOP PRESS!

LATE SEPTEMBER – HUSH HUSH MEETING INTER-STATE AMATEUR RADIO DEALERS HELD SYDNEY STOP SYDNEY DEALERS EXCLUDED STOP "SMALL WONDER" SYDNEY DEALERS INCENSED STOP **OCTOBER 1** – PRICE INCREASES ANNOUNCED STOP TS-130S NOW \$847 STOP **NOVEMBER 1** – SYDNEY DEALERS TO THE RESCUE STOP SOON AVAILABLE FROM SYDNEY DEALERS ONLY AT PREVIOUSLY QUOTED PRICE:

## TS-130S \$750

KEN WOODHOUSE – VK2TKA?

EAT YOUR HEART OUT!

## TRIO-KENWOOD EQUIPMENT

R-1000 RECEIVER.....	RRP \$541	now \$480
TR-7200G TRANSCEIVER 2M.....	was \$160	now \$150
TR-7625 TRANSCEIVER 2M.....	was \$325	now \$315
R-599 RECEIVER W/SPEAKER.....		now \$325
VP-1 MOBILE ANT. MOUNT.....	RRP \$45	now \$35
MC-501C MICROPHONE.....	RRP \$31	now \$25
SP-180 SPEAKER W/FILTERS.....	RRP \$73	now \$60
TV-502 TRANSVERTER.....	RRP \$326	now \$250
RD-300 DUMMY LOAD.....	RRP \$87	now \$75
LF-30A FILTER.....	RRP \$35	now \$30
DK-520 ADAPTOR.....	was \$10	now \$5

All prices are NET, ex Springwood NSW, on pre-payment with order basis. All risk insurance is free of charge, allow for freight charges by air, road, rail or post, excess will be refunded. Prices are subject to change without prior notice. All orders cleared on a 24 hour basis after receipt of order with payment.

Proprietor – ROY LOPEZ (VK2BRL)

# AMATEUR RADIO ACTION

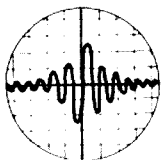

is the **NEW GENERATION**  
amateur magazine.

- ★ Comprehensive DX notes
- ★ Propagation forecasts
- ★ Very technical - and not so
- Technical articles
- ★ Useful projects

Here are just a few of the articles which have appeared in recent months

- ★ Fixed wire beams
- ★ Case for UHF beacons
- ★ 80W linear for 6m
- ★ Wilson System Three review
- ★ Spratly DX exclusive
- ★ Backyarders - good or bad?
- ★ A.T.V. Special
- ★ SWL notes

Average page content is 80 pages - at \$1.20 an issue that's good value.

Please put me down for 12 editions of Amateur Radio Action, starting NOW-  
Rates in Australia — \$15.60.  
Sairaca mail overseas — \$21.00, not including New Zealand — \$23.40.  
Airmail: To New Zealand — \$31.80. Indonesia & Malaysia — \$33.00. Japan & India — \$38.40. U.S.A. — \$43.80. U.K. & Europe — \$47.40.

Herewith enclosed cheque/postal note/money order to the value of:

\$A .....

Name.....

Address.....

Postcode.....

Post to: Amateur Radio Action Subscriptions, Box 628E, Melbourne, 3001.

## DIVISIONAL NOTES

### VK3

#### VK3 DIV NOTES — — — TWO METRE FOX HUNT

The two metre fox hunt VICOM competition for the year 1979-1980 was won by the VK3BMV-VK3BRY team in a thrilling finish. A knockout tie-breaker was required to separate the three contenders.

The prize was presented by Russell Kelly VK3NT, managing director of VICOM, at the September Victorian Division General Meeting. The prize of an ICOM IC22S was also the 400th IC22S handled by VICOM. Also the initiative taken by VICOM in sponsoring the competition has been taken up both interstate and overseas by ICOM dealers. ■



The winning team.



Russell Kelly presenting the prize.

Photos by Dale VK3AAE

## CURRENT OFFICIAL AMATEUR SERVICE HANDBOOK

STILL AVAILABLE

\$3.60 plus 230g post.

- ★ If amendments come through, they will be meaningless unless you have a copy of the book.
- ★ Besides, every amateur should have one.

Write to your Division or to

MAGPUBS  
Box 150, Toorak 3142

## "Standards"

One of the first things we learn in dealing with electricity is Ohms Law. The three basic units Volts, Amperes and Ohms are familiar to all amateurs. Less well known, perhaps, are the people responsible for the discoveries so important to us today. Reference to the World Book Encyclopedia tells us that Count Alessandro Volta (1745-1827), born in Italy, won fame as the inventor of the electric battery and the condenser . . . the "Volt" was named after him. Andre Maria Ampere (1775-1836) was a French mathematician who discovered the laws of electromagnetism in the 1820s. Georg Simon Ohm (1787-1854) was a German physicist who discovered the mathematical law of electric currents called "Ohms Law" in 1826. Heinrich Rudolph Hertz (1857-1894) was also a German physicist who, following the work of Maxwell, opened the way for the development of radio, TV and radar with his discovery of electromagnetic waves between 1886 and 1888. These and thousands of others through the years have been responsible for the development of electronics to the degree of sophistication we have today. With every new invention, standards are adopted as a means to measure and compare. The standard Ohm is defined as the resistance, at 0°C, of a column of mercury 106.300 cm long and weighing 14.4521 grams. An unvarying current which passes through a solution of silver nitrate of standard concentration at a fixed temperature and deposits silver at the rate of 0.001118 gram per second is equal to one Ampere, or  $6.25 \times 10^{18}$  electrons per second passing a given point in a circuit. "Standards" are an integral and essential part of our lives. National Bureaux of Standards now exist by Government decree in all developed countries and there we can check our instruments, and other measurements, with sub-standards which are regularly compared with ultimate standards carefully maintained and guarded in various parts of the world. The standard metre was defined by International agreement in 1960 as 1,650,763.73 wavelengths of the orange-red light produced by artificially excited atoms of Krypton-86 (an isotope of the element Krypton). This standard for the metre replaced the platinum-iridium bar that had previously served as the International standard of length. So we are surrounded by standards: measurement of distance, time, weight, volume, sound, light, etc. Other standards are important for our everyday living.

Because we are a gregarious society we must of necessity develop social standards, and live within them for harmonious relationships. Some people measure by the Ten Commandments, some by the Golden Rule, some by the laws of the land. Regulations that govern our lives are oft-times irksome, but unless we elect to live on a desert island, are mostly for our common good. Perhaps more than other people, with our communication potential, locally and internationally, amateurs, with a large audience of listeners, can well set a standard of behaviour which can either denigrate or elevate our hobby.

John VK2BTQ — From "Lyrebird" Spring 1980. ■

## STOLEN EQUIPMENT

Recently a large quantity of equipment was stolen from Willis Trading in Perth. It is thought that the stolen equipment may come East to be sold.

Included in the robbery were: Kenwood TS600 6m transceiver, S/N 610380; Icom IC251A, 2m all mode, S/N 10910587; Yaesu FT707 TF transceiver, 0H030451; Kenwood 100W amplifier TL120, S/N 800009; Kenwood R1000 receiver, S/N 1001024; UHF hand-held scanner, Hamdie; 50 ohm dummy load; several multimeters, Fluke; Kenwood grid clip meter; BSR turntable, P157; auto telephone dialer, Nidac 344, PDE/1; Icom IC2A 2m hand-held; two Emotator rotators, models 502 and 103.

Should you be offered any of the above equipment report the matter to your local police or Willis Trading in Perth, Western Australia.



# LETTERS TO THE EDITOR

Any opinion expressed under this heading is the individual opinion of the writer and does not necessarily coincide with that of the publisher.

55 James Street, Latrobe, Tasmania 7307  
9-10-1980

The Editor,

Dear Sir,  
I would like to reply to the letter from VK2ARN on page 46 of the October issue of AR.

I agree it is fairly easy to obtain a licence to break into Amateur Radio. Many people like myself may never have been able to break into Amateur Radio until the introduction of the NAACP.

I also agree that operators at this lower level should treat Amateur Radio with the greatest respect and decorum. I am of the opinion that the Novice requirements for CW should be 10 w.p.m., and for the AACP the speed should be 12 w.p.m., which would then enable an operator to obtain a reciprocal licence in ZL.

With regard to the latter part of VK2ARN's letter, I fully agree with what he has to say, although it may be a little late now.

I think that EVERY retailer of communication equipment should only sell to a person who can produce the necessary licence to operate — or to a person who can produce information that he or she is awaiting a licence. The retailer should then have to forward a full report to their Radio Branch, giving full details of the transaction.

This may prevent equipment falling into the wrong hands.

Yours faithfully,

J. Davis VK7NOW.

8 Belfast Road, Brunswick 3056

The Editor,

Dear Sir,  
I enjoyed reading the article "Why ASCII" in AR October, 1980. However, I was disturbed to read at the end of the article a misleading definition of the transmission rate unit — the baud. The baud is in fact NOT the same as bits per second as implied by the article. Actually the definition of the baud is as follows:

The baud is a unit of signalling speed equal to the number of discrete conditions or signal events per second.

Therefore, the baud is the same as bits per second ONLY if each signal event represents exactly ONE bit.

For example, consider the bit combinations 11, 10, 00 and 01. These are referred to as "dibits". If these were transmitted at a rate of 1200 dibits per second, then we have a transmission rate of 1200 baud and a bit rate of 2400 bits per second.

I hope that the above clarifies the difference between baud and bits per second.

73. Ian Palmer VK3YIP.

September 16

The Editor,

Dear Sir,  
Jack Mellor's repugnant remarks against the novices (July AR) is, unfortunately, typical of an unfortunate minority within our community who gain pleasure by stirring, especially if it is against the underdog or others considered by him to be inferior.

The two letters in September AR (John Dowsett VK6NJD) and Alan Stubbly VK3NWV) show the contempt the novices had for his despicable remarks.

However the more the novices reply to the irresponsible Mellor the happier he will be.

With respect, Mr. Editor, may I suggest you close the correspondence as, like "The Sullivans", it will continue for a long, long time.

Mellor fits into that category defined by the former deputy provost marshal of the RAAF and

once chief of the Victoria Police CIB, Group Captain Ted Rosewarne:

- "A bully is always a coward" and
- "Ignore him and he'll die".

I have seen and experienced the best and the worst in this world during more than 40 years in journalism. Mellor's in the latter category and I feel so sorry for him. He will have few friends, he will always be lonely and as the twilight of his years come on him his life will be a misery.

The novices have been a credit to our hobby and they have been an inspiration to many trying to make our ranks.

73. Roth Jones VK3BG

8 Dexter Drive, Salisbury East SA 5109  
16th September, 1980

The Editor,

Dear Sir,  
I recently forwarded to you a letter outlining the QLS policy for operations by Alex VK9CCT from Cocos Keeling Island. These operations are, as previously stated, carried out on an "opportunity" basis. Since writing the above letter we have made arrangements to have a "QSL Manager" appointed to handle cards for the USA, Canada and other American possessions.

This will allow, in most cases, for operators in these areas to obtain their QSL card for the cost of two-way mail within the USA, which I believe will amount to no more than 30 cents. This will most certainly result in quite a saving for those operators concerned, especially when compared with the method of having to send their cards all the way to Australia.

The QSL Manager for VK9CCT for North America (i.e. USA, Canada and USA possessions such as for example KG6) will be Bob WA9WWT, who will be assisted in the task by Doc KB9EZ and Jim WA9TNC. Both Alex and I are most appreciative of the generous offer by these three gentlemen to carry out this QSL chore, which will take quite a load from our shoulders. I am sure that the North American boys would like me to publicly thank them for being so prepared to undertake this task in the real spirit of amateur radio, as by helping in this way they will be doing a good turn for so many operators.

The QSL information for VK9CCT will therefore be as follows: Bob Polhamus WA9WWT, 703 N Brentwood Lane, Muncie, Indiana 47304.

I would like to emphasise that this QSL information does not apply for stations outside of North America, who should continue to send their QSL cards via VK5QX, the address information being: Ian J. Hunt VK5QX, 8 Dexter Drive, Salisbury East, SA 5109.

It is hoped that Alex will be able to continue his operations from Cocos Keeling Island from time to time as circumstances permit. In the meantime we are working on ways to improve the efficiency of both the station and methods of operation, particularly bearing in mind the very short duration of each of his visits there.

73. Ian VK5QX.

1 Hillside Crescent, Epping, NSW 2121  
September 10th, 1980

The Editor,

Dear Sir,  
This isn't an irate letter, nor is it a reply to Mr. Jack Mellor's broadside. He has been sufficiently dealt with.

But I would in a friendly way ask that the Novice licence not get a nick-name such as "Temporary Call" as suggested in QRK5 in the September issue of AR.

Some of us will never get a full call because of senility. I'm 77 years old, had quite some difficulty getting my Novice three years ago. I understand the theory perfectly, but cannot retain the details for exam purposes. The human brain cells decay in old age and no amount of study makes up for the lack of them. I know that you'll be showered with letters from exceptional people!

Having a Novice call is like being a bird let loose from a cage. When I'm finally located in an aged persons' home, I can never be lonely, but can speak to the world.

It would be a tremendous deprivation if people like me were to lose this privilege through the thoughtlessness of younger fry who are lucky enough to have unimpaired brains.

Please, not the nick-name of Temporary Call!

Yours faithfully,

Norman Blake VK2NDG.

40 Hardwicke Street, Balwyn, Vic 3103  
14th September, 1980

The Editor,

Dear Sir,  
The letters published in September AR in reply to VK3AMG's comments on licence tenure present very divergent views on the purpose of amateur radio.

Omitting the vituperation which unfortunately each of the writers have engaged in, it is clear that Mr. Stubbly supports "a most friendly world-wide fraternity" (characteristic of most amateurs for many years) and suggests a statement of policy by the WIA on licensing generally.

In the other letter, Mr. Dowsett has unwittingly confirmed VK3AMG's comments about degenerating standards of operation. If the ability to "knock off" other calls, whether by "legal" or other means, is one of the pleasures (?) which attract some people to amateur radio, then the enjoyment which the hobby has provided for a very long period will eventually be destroyed.

If Mr. Dowsett has succeeded in producing a "super" antenna suitable for home-brewing, perhaps the Editor could conclude this regrettable "hornet's nest" by inviting VK6NJD to prepare an article for AR so that amateurs wishing to preserve the concept of friendly communication may share the benefits of his ingenuity.

Yours faithfully,

R. Goslin VK3SV.

We are always receptive to new articles.—Ed.

PO Box 313, Morphett Vale, SA 5162  
30th August, 1980

The Editor,

Dear Sir,  
I would like to comment on the letter from J. Bush in the August issue regarding the possible misuse of technical modifications by CBRS operators.

I can sympathise with the reasons behind the letter, but feel that I can contribute some information pertinent to the writer's thoughts which may allay his worries.

What is not generally known is that there has been a large number of mostly overseas publications — one in fact called "Secret CB" — in existence over a number of years, describing in detail many "clandestine" modifications, all of which are naturally illegal in the CB Radio Service.

Let us remember that there are many extremely capable technical people involved in the CBRS both as operators and as modifiers, and JB (and others who share his point of view) need not worry unduly as mods that eventually are submitted to AR and other publications have in all probability been in use illegally in one form or another for a long time.

Some twelve months or so ago I tuned just below 28 MHz and listened, and heard an American and an Australian having an amateur-type QSO; it appears that more than one American is happy to drop his official amateur call sign, QSO down and out of band, and conduct a DX QSO.

May I emphasise that I do not defend the situation; merely I draw attention to the fact that it exists. We would be wise not to put our heads in the sand.

Which brings me to the P & T's request for inputs to their regulatory enquiry into the CBRS, and the official WIA attitude. I support the WIA wholeheartedly, but I feel that it is unrealistic to think that the CBRS on 27 MHz will cease on 30th June, 1981, for several reasons, four of which are:

(1) Lobbying by those with a vested financial interest created the situation where unlawful usage of the band had to be approved, and although sales volume has dropped off a lot, there will still be

The Editor,

Dear Sir,

The Contest Manager and assistant for the VK/ZL Oceania, when conducted by the WIA, take this opportunity to answer some criticism and present some facts. At the 1980 Convention a sample of logs were shown to help Councillors appreciate the various ways in which logs are presented for checking. Your Councillor will vouch for the great range of legibility and accuracy of the logs. However, they are not ruled out of the contest unless, as my assistant put it, "even my chemist couldn't read it". Logs where the scoring was wrong were re-scored and no loss of points occurred. We feel that a high scoring log does not excuse the operator from writing out a legible log entry. Both people concerned with log checking have quite a number of contest certificates to show "a high level participation" in contests. If the signal exchange as ACKNOWLEDGED by both operators, there is sufficient time to write down the details of the signal exchange clearly. Perhaps some operators need more practice in remembering to carry out the previous comment?

There is no need to re-copy your log, a carbon copy you keep, just send us the original. We need to see if any attempt has been made to remove duplicates, so the need for the original. What's the value of a high scoring log if duplicates are not removed?

Overseas logs usually do not have these problems, possibly because most overseas contests carry a penalty if the log has duplicates and the operators are used to this fact. Our next set of rules will carry a similar penalty.

Blatant cheating doesn't seem to occur in VK/ZL entries, but we do receive some from overseas. After 12 years of checking logs we find experience is a fine teacher and, with the help of our sister organisation overseas, most "chealers" are found out.

Now, why the delay in publishing the results? Quite simply, it's a long, time-consuming, tedious task of log checking and compiling results. Remember how long it took to write out your log, then multiply that by some figure between 400-500 (logs entered in contest) and you arrive at a figure possibly close to what we put into the contest checking (our SPARE TIME!). Results are sent to AR, who will publish as space permits. Certificates are not sent out until the results have been published for at least a month. This way we may be notified of our mistakes before the certificates

are printed, enveloped and posted. Certificates take about half an hour each to write out, envelope and address.

Like every other contest organisation, no communication will be received by the winners other than the reception of their certificates. VK/ZL winners are quite lucky, ZL2GX for the NZART, and the WIA get the certificates to the winners before the following contest. Yesterday I received my IARU Radiosports Certificates, 14 months after the contest!

In a recent letter by VK5MS, he says that "We should reserve our energies for useful contribution to our tasks, and maybe we are too busy involved in some DX nets where contacts are arranged". If the intent was to say we should give more time to the contest management than we already do, then the simple answer is that we are not prepared to do so.

The Federal Contest Manager at the 1980 contest said how he spent around 200 hours on the RD log check. I feel that he underestimated and, besides, the VK/ZL is more involved. Should anyone wish to take over the running of the contest, it will be gladly handed over with our blessings.

The rules of the 1979 contest have been appraised and found to lack incentive to work all bands; this we agree. "1980" rules have changed you may have noticed, and compared to 1979 the 1981 rules could be different again. It will pay to read them closely, and so take advantage of our efforts to enhance the contest.

Close liaison between ZL2GX of the NZART and myself exists, and between us we strive to keep the VK/ZL to the forefront on the international scene. But please let us know what rule changes you want, as even with the logs, we receive very little feedback.

One final comment, or two: letters to the contest organisers are appreciated and will be answered, and the pay of the VK/ZL contest committee is inadequate.

73s, Neil VK6NE, VK/ZL Contest Manager for WIA.

## THE ANNUAL INDEX and the FIVE-YEARLY INDEX of Amateur Radio Articles will be published early in the new year.

pressure by those who put their money where their mouths are. I personally felt at the time that the short-term 27 MHz allocation was unrealistic and the bandwidth equally useless, so possibly both of these decisions were made as a sop to those the band was taken from — us.

(2) The huge number of licensed sets and even larger number of unlicensed ones would all become pirates overnight if the service were disbanded and this obviously would create an even worse monster than in June 1977.

(3) The CBRS operators are asking for an expansion in the number of authorised channels. I personally do not know what spectrum usage officially exists between CB channel 18 (Australian) on 27.225 MHz and 27.995 MHz, but apart from CB pirates it must be pretty vacant land or else we would have heard screams from commercial users. I ask myself what hurts the amateur radio service if further channels are allocated.

From comments in AR several years ago, one gathers that the ISM band was allocated here in Australia to the amateur service purely so that it could be occupied by someone. Why do we want it back? Are we going to use it? I doubt it. Remembering the 1976-77 "hate-CBER" furor, my thoughts are that many of our "gentlemanly" licensed amateur "brothers" used it to jam the dastardly pirate users, even to the extent of WIA broadcasts being relayed. This does not mean that illegal operators should get away with it, but they are (most of them anyway) legal now. There is no doubt that it will still be occupied, regardless of legislation, after the cut-off date, so isn't it better sense to help retain its use legally by supporting them, than to try to force them to become pirates again?

Personally I am happy with 10 and 15 metres (I can hear some readers saying "Bully for him, I'm not"), and providing that anarchy doesn't prevail on 11, why not support a motion to let them retain it beyond June 1981?

(4) The CBRS appears, from comments in "another place" (parliamentary language for the rival assembly) to be settling down, and those who confine their operation to a mere 36 SSB channels actually call the others pirates. Retention will still produce a source of supply of new amateur operators in the future, although not to the extent that the period 1976-1979 did.

Having aired my views, I now cringe in my shack, waiting for the flack to fly from those who oppose change.

C. R. W. Ashton VK5DQ.

Licensed 1972. Never pirated on any band. ■

# YOU and DX

G. (Nick) Nichols VK6XI  
6 Briar Place, Ferndale, WA 6155.

The Christmas/New Year period with its numerous gazetted holidays will no doubt give many of us additional opportunities to work the bands. DX wise conditions should be excellent, whilst Cycle 21 has reached and passed its peak, 10 metres reflects none of this down-turn and despite its many knockers continues to be reliable and an often quite surprising band on which to chase DX. For this and the coming couple of months the north polar path should prove interesting early in the mornings, whilst for the insomniacs good paths either long or polar should occur into the North American and Caribbean areas.

### FACT AND FICTION

Abu Ali J20/A, mentioned in October AR, now confirmed and unless some unforeseen delays occur, December 5th should see commencement of operation.

N2KK/6 continued his jaunt around the Indian Ocean, J28 and possibly ST activity late last or early this month.

Rumours of a 3C1 activity by Spanish amateurs — no other details known.

Possible activity (this is a real slim one) of 3X activity by a VK4 novice — has permission to operate but that elusive piece of paper is proving a problem.

### PIRATES

BV2BK is a no-no: A2PR, AR2P and other weird combinations must use time travel, forget his location, name and when questioned goes QRT — without doubt a no-no. VP8MZ, VP8JO are not licensed, MZ being absent-minded about location — beam headings, time, mode on these two to VP8AI please.

### 10 METRES

Excellent conditions prevailing, watch however for the usual openings, short in duration, which often yield the choicest DX, crooked path particularly into the South American continent appears to be the rule rather than the exception, due east and slightly north of east together with north polar headings may also be of value.

On CW HS1AMX, AH2AD, FK8DD, N7ET/DU6 and P29SU all appeared on a regular basis whilst on phone at good strength the following were heard and/or worked 3B8DB, 3B8RS, ZK1CE, A9XDB, 3D2UR, HB9AOX/5N6, S79NLB, KZ70/UP9, Fw8SC, W6KG/SV9, FOODX, KA6HIQ/KH3, LU4MDX, CX3BBH, EA6ET, VS5RP, ZF1SB, FM7BX, H18XGC, T3LA, KC6YC and ZR (both Eastern and Western Carolines), 8Q7AV and AZ and JT1AN (regularly on W7PHO net on 28.570 at 00.00Z).

### 15 METRES

Surprisingly quiet, even the woodpecker is notable by its absence, usual solid propagation long path to Europe, some good opportunities to work into the African and Caribbean areas also.

On CW KG4KK, VP9JM, PY1DUB, YB5ANT, 7X2MB, VS5RP and VK9NC appeared with regularity whilst on phone T3AZ, YS1MS, P29AB, VP8WA, ET3PG, S79NLB, 9M8PW, EA9GS and HK0FBF had fine signals.

### 20 METRES

As usual, loaded with plenty of DX but plagued with ORM (it's high time a maximum power limit below 500 watts was imposed world-wide); on CW the "gentlemen's" mode (take that with a grain of salt, the tactics, manners, etc., are at times unbelievable — VKs included) under the ORM and breaking stations could be heard the following: CP3CN, LU3KA, TG9AC, YV5TT, VP5SSA/HK1, GU5DQT, TF3JO and 3B8DB. Whilst on phone (at least some sanity prevailed on this mode — for a change!) J7SE, J6LT, PY7/PO/PYO, CEGAL, PJ2CZ, 4U11TU, VP8ZR, M1B, VP2EA, 7P8PI, FM0FJE, FY7AN, CR9B and WB4ZNH/5X5 were available for the patient listener.

### 40 METRES

Some really fine DX on this band, but many of the rarer ones working split and listening up out of our segment (and since when have VKs been permitted out of band to tell these stations to listen on their transmit frequency — I feel that's taking DXing too far — I'm sure the authorities will also).

On CW A4X1H, A9XCE, DJ1US/ST3, T2AAE, C3AE, VQ9MM, VU21R, ZE1DK, S24YV and AH2G were in demand, whilst on phone A35FB, CT2AK, EA6CP, FM7AV, F00DX, N2BA/H18, JD1ALK, OX3ZN, PJ2CC, PJ9EE, 457KK and numerous Europeans were in demand.

# IONOSPHERIC PREDICTIONS Len Poynter VK3BYE

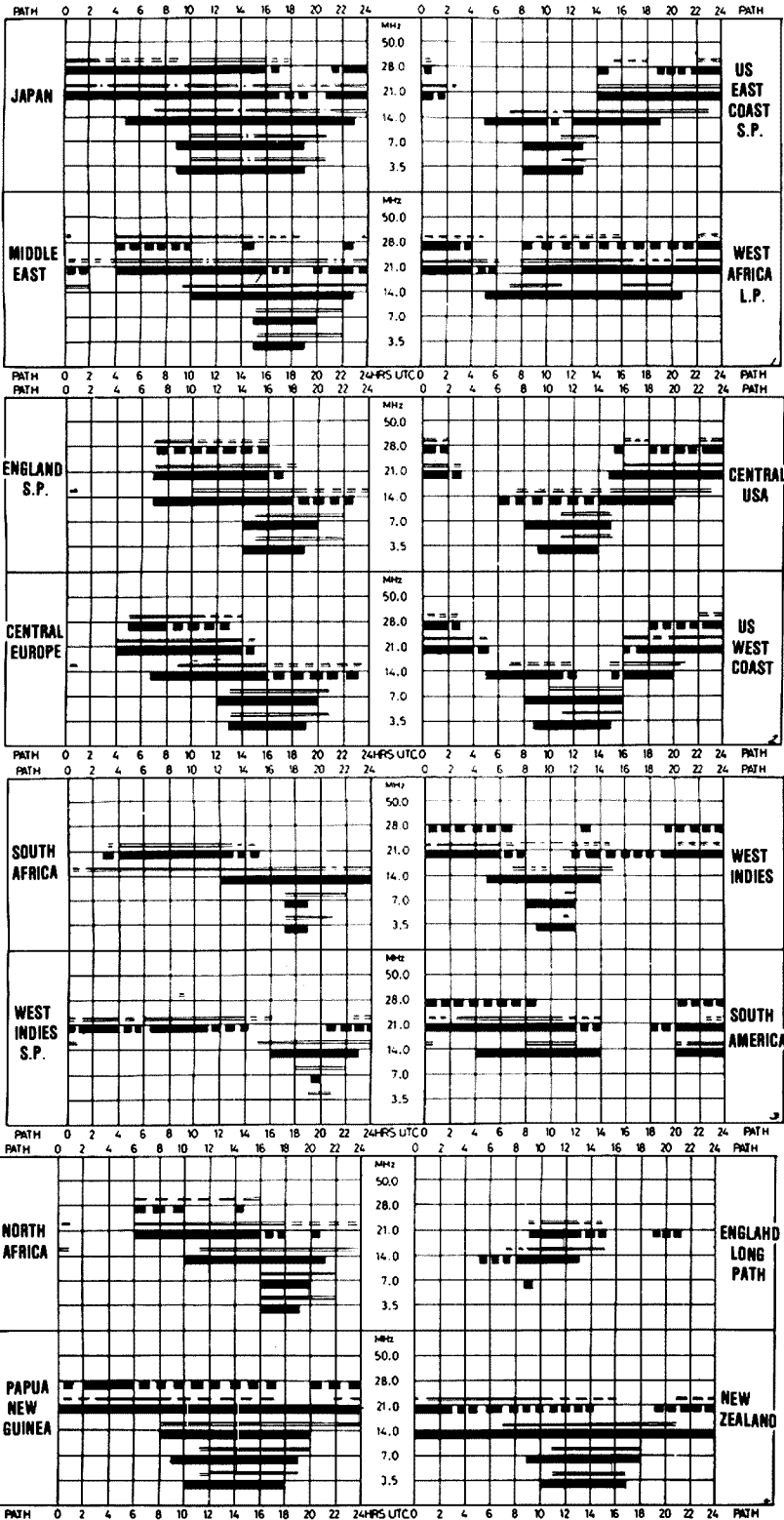

**LEGEND**  
 — FROM WESTERN AUSTRALIA.      BETTER THAN 50% OF THE MONTH, BUT NOT EVERYDAY  
 — FROM EASTERN AUSTRALIA      LESS THAN 50% OF THE MONTH.  
 (unlabeled)

Predictions courtesy Department of Science and Environment IPS Sydney.  
 All times universal UTC (GMT).

## 80 METRES

Patchy to say the least, 4S7KK on phone plus weak USA and European — frustrating — you can hear them but the ORM over there is so heavy they don't stand a chance of hearing us — any suggestions on how to build a three element quad for this band . . . ? On CW things were a lot brighter, Europe, including UL7BPE, UH8EAA, plus DL, OK, OH and Y2 were available but band openings were short, irregular and when they occurred the problem of getting through the ORM was always present. KP4KK/DU2, Ws and Pacific Islands were easier to work. Give this band some attention this and the coming two months and you should be rewarded.

My thanks this month to VK2AIR, VK6HD, SWL-VK2-0118, L3-0042 for their valuable contributions — they are much appreciated.

Merry Christmas, drive carefully, and hope to C U next year.

### QTHs YOU MAY HAVE MISSED

- K2TO/VP9 — via Home Call.
- G3AAE/VP9 — via Home Call.
- A9XDB — PO Box 26180, Bahrain.
- KC6VC — via W7EJ.
- KC6ZR.
- 8Q7AZ and AV — Four Winds, Male, Republic of Maldives.
- S79NLB — Box 234, Mahe, Seychelles.
- 3B8DB — via K5BDX.
- SV0AT — via AF4B.
- HB9AOX/5N6 — via HB9WU.
- CR9B — via WA3HUP.
- PV0ZDX — via WA4VDE.
- PY0OD — via WA4MDS.
- GUSDXT — via DJ5PA.
- HK0BKX — via WB4QFH.
- T3AT — via G3XZF.
- FOODX — via K1MM.
- 8R1RBF — PO Box 684, Georgetown, Guyana.
- W4PYH/KH8 — PO Box 1202, Pago Pago, American Samoa.

Many other OSL routes are available but far too numerous to list. If you need assistance with anything listed I will be pleased to help where possible.

## CONTESTS

Wally Watkins VK2DEW  
 Box 1065, Orange 2800

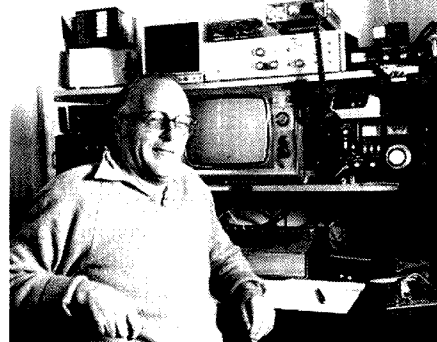

### December:

- 6-11 January ROSS HULL MEMORIAL CONTEST
- 6/7 SPANISH PHONE CONTEST
- 6/7 NATIONAL VHF CONTEST\*
- 6/8 ARRL 160 METRE CONTEST
- 13/14 SPANISH CW CONTEST
- 13/14 HUNGARIAN DX CONTEST
- 13/14 ARRL 10 METRE CONTEST
- 18 CANADA PHONE AND CW CONTEST

### January:

- Up to 11 ROSS HULL MEMORIAL CONTEST (VHF)
- 17/18 2nd ANNUAL INTERNATIONAL 160 METRE PHONE

### February:

- 7/8 JOHN MOYLE MEMORIAL CONTEST
- 7/8 RSGB 7 MHz PHONE CONTEST

### NOTE:

\* National VHF logs to Geelong ARC, Box 520, Geelong 3220.

# TECHNICAL CORRESPONDENCE

14th August, 1980.

The Editor,

Dear Sir,

This began as just a letter intended for technical correspondence, however I feel that it may have turned into something more suitable as an "article".

I wish to make the following comments regarding the article on antenna comparison tests produced by Rodney VK3UG for August AR.

Whilst I would admire his enthusiasm for experimentation and his desire to learn more by practical experience, I do feel that he may have fallen into some traps set for the unwary.

The measurement of antenna patterns is quite a specialised subject and requires, amongst other things, a properly set up antenna measuring range and a proper understanding of the techniques involved.

I will explain further by making specific comments:—

## 1. ILLUMINATION OF ANTENNA UNDER TEST

(a) This should be done using a directional antenna if at all possible so as to obviate reflections from other objects.

(b) The nature of the intervening ground surface should be constant both as regards its composition (gravel or grass lawn, etc.) and its flatness. Perhaps better described as consistency.

(c) Height of the respective antennas is important and should be adjusted to provide a maximum signal produced due to both ground reflected wave and direct wave reinforcing each other. (This is the well known ground reflection technique as used on many antenna ranges.) Distance of the transmitting and receiving antennas apart is also very important, as this governs the fields necessary for the antennas and is a simple matter of geometry, but based on wavelength. It is also important to ensure that the distance is such that measurements are made in the "far field" of the radiation. (Also dependent on frequency.)

## 2. ISOLATION OF THE ANTENNA UNDER TEST

This is usually achieved by mounting of the antenna at the required height on some form of dielectric support. Materials such as polystyrene foam, fibreglass, wood, etc., are commonly used. This is done to isolate the antenna under test from the influence of the surrounding environment. Another commonly encountered practice is to cover any likely reflecting nearby objects with radar absorbing material (RAM) specifically designed for such purposes and also used without exception for the lining of RF anechoic chambers. Thus the antenna under test can be investigated with a reasonable assurance that measurements will not be clouded or ambiguous due to outside influences. The total surrounding area should be as clear as possible of any other objects.

## 3. GROUND PLANES

No such thing as a perfect ground plane exists in practice. Theoretically it should be perfectly conducting and infinite. For serious tests either an extremely large sheet of metal, several wavelengths in diameter, should be used or at the very minimum a set of radials numbering no less than, say, 32 should be employed. The radials should be of an absolute minimum length of  $\frac{1}{4}$  wavelength and preferably even longer. The more radials the better. Bending of the radials to produce a "match" for the reference antenna obviates the use of this ground plane for the rest of the measurements. Simply substituting the  $\frac{3}{4}$  wavelength vertical for the  $\frac{1}{4}$  wave vertical is not satisfactory under these conditions. Improving the impedance match will produce an increased reading at the detector, however the pattern and gain of the antenna will not have changed.

## 4. TILTING OF ANTENNAS

This approach is totally unsatisfactory. The only acceptable methods would be to move the complete structure of the antenna under test, still on its dielectric supports, through angular increments,

each time rotating same on a suitable turntable until a complete picture of the radiation pattern can be built up. With each rotation of the antenna you would have to produce a continuous recording of the amplitude of the received signal, and the number of increments of angular movement you were prepared to carry out would determine the total amount of detail obtained for building up the final picture of the radiation pattern. I can assure you from first hand experience that this can be a most time consuming and at times laborious task with possibly many attendant problems. A strong wind blowing usually means the abandonment of such work. It may be possible to use the antenna under test as a transmitting antenna and determine the radiation pattern by use of a suitably designed probe moved through a 90 degree sector, i.e. from immediately above the antenna down to ground level. This technique does have both physical and technical disadvantages bearing in mind near field effects, ground reflections, the need to keep the probe on an arc of constant distance from the phase centre of the antenna under test, polarisation, etc.

Incidentally, a viewing of the tape of "Dud" Charman's demonstration entitled "Aerial Circus", available through the Federal Videotape Co-ordinator, will make some of these facts come alive before your eyes.

Tilting of the antenna with respect to the ground plane will invalidate the measurements immediately, due to the number of changes which can take place, e.g. impedance changes, the inevitable reflections producing disturbances to patterns, etc.

## 5. TESTS IN OTHER ENVIRONMENTS

Much of the above would of course indicate that such tests as placing the antenna(s) above the house roof, on top of vehicles, etc., will not provide true indications of patterns produced by any particular antenna design as would be expected from them in a "true space" environment. This is of course often the situation we would like to discover when carrying out our antenna measurements, however you will no doubt note my comment towards the end of this article. Serious work of this nature can only be done using a large and properly set up antenna range which can be most expensive in terms of both real estate and facilities. Such facilities are usually only available at such places as large Government research organisations, well established universities or large commercial concerns specialising in antennas. Another technique adopted is to model antennas to a much higher frequency and carry out tests on them in a specially designed RF anechoic chamber, which again attempts to simulate the condition of an antenna operating in a "free space" environment.

## 6. GENERAL COMMENTS

The overall height, that is length, of the antenna is not necessarily a factor as the antenna is supposed to perform a function dependent on its particular design, i.e. it is a  $\frac{1}{4}$  wave,  $\frac{1}{2}$  wave or  $\frac{3}{4}$  wave antenna, etc., and thus is resonant in one way or another, in other words the antenna has to perform the necessary function for which it was designed. Matching to such antennas is yet another subject.

Reflections of the transmitted signal play a major part in performance over any given path, and please bear in mind that throughout this article it has been assumed that we are referring in the main to antennas used at VHF, UHF, etc. That is not to say that much of the information contained herein does not apply to antennas for use at HF, and in fact most of what one can say about antennas applies universally irrespective of frequency. However specifically referring to VHF and above, even with apparent line of sight conditions, reinforcing or cancelling effects can occur. I suggest that the textbooks could be consulted regarding "Fresnel" effects. You can pick a site way up on top of a mountain and be able to see the top of another mountain equally as high in the distance. What a really beautiful situation for a VHF contact with a station on top of the other mountain, but do you really know or have you ever considered the effect of the rest of the topography between your beautiful mountain top and the other, and what that smaller mountain below you and in between can do to the signals over what would seem to be a perfect path? Don't let me

deceive you from selecting mountain top sites, especially for VHF Field Day Competitions, but I can assure you that it's not always what it may seem at first glance.

To return to the article referred to previously, Rodney does appear to contradict the basis of his tests described earlier on in his article when he states that an antenna on a vehicle bending back whilst in motion will cause the radiation pattern to alter. This is quite true as explained above, but is also however a most complicated phenomenon and would present a most difficult situation for analysis with vehicles in motion. Aircraft of course travel at much higher speeds than motor vehicles, but if you examine the majority of antennas on aircraft you will see that they are not only built to present a most rigid construction, but they are also aerodynamically designed. I do not think that anybody has really bothered to consider antennas aerodynamically for ground vehicle use and maybe it is not necessary to do so. Some comments from the article in question might indicate that this aspect of things may after all be a matter of concern, but I do agree with Rodney that the judicious use of a length of nylon fishing line can pay off, and I have used it to good effect with HF antennas mounted on my vehicle. If the antenna is still standing up straight and true it may not look to the "boys in blue" that you are going so fast after all. Hi!

Experience would indicate that the occurrence of "mobile flutter" has as a rule very little to do with actual movement of the antenna with respect to the vehicle as it occurs commonly at constant speed situations. This does not excuse poor installations where a bad connection exists in the system. Mobile flutter is most usually due to the rapid changes in the propagation path caused by movement of the vehicle in respect of other reflecting object.

By all means do all you can to suppress electrical and ignition noises from the vehicle in which any radio installation is employed irrespective of the frequency of operation of the radio equipment. Suppression of vehicle electrical systems can also become the subject of much specialisation.

The mounting of any antenna is most important and despite all the sophisticated tests which may be carried out on the best equipped antenna range one is always subject to the environment of the final point of installation of the antenna, be it on a tower, a vehicle or any other objects.

The subject of preventing currents from flowing on the outside of coaxial lines one would also wish to treat separately. Suffice to say I could mention baluns, RF choking systems of many different types, adjustments of skirts on coaxial dipoles, etc., etc. Again a subject which can become quite complicated.

Still another comment, referring back to two paragraphs before this one! The design, matching, pattern measurements and all the other aspects of antennas is a "precise" science based in the end on completely empirical methods! The formula for success with antennas could well be defined as E = SIAS. E — efficiency. SIAS — Suck it and see! If it works for you, use it!

I would not however be prepared to conclude this treatise without stating that I feel that Rodney's contribution is worthwhile both from the aspects previously mentioned and also that such contributions may cause some other interested experimenters to at least stop and think. Despite any of the foregoing, please do not take the attitude that you must have an expensive or unattainable facility available to you to carry out your own useful experiments. And certainly don't just keep the results to yourself! Have them published in "Amateur Radio". You may learn more and also help others to learn more by doing so.

By the way, is anyone else interested in producing yet another article on the subject of "VSWR" and its effects?

Ian J. Hunt VK5QX. ■

# HELP WITH INTRUDER WATCHING

# AROUND THE TRADE

## IFR-2000 TRANSMISSION TEST SET

The IFR Incorporated Company of Wichita, Kansas, through their Australian distributor Vicom International Pty. Limited, of South Melbourne, have released a transmission test set, the IFR-2000. This is a complete ATE system designed to provide complete stimulus/response testing automatically. Measurement of AM, FM and SSB to 1 GHz is all possible from this unit. Standard features include:

1. A digitised spectrum analyser/oscilloscope display with 256 x 1024 resolution with two stored wave forms. Two wave forms (one stored, one real time or two stored) may be displayed simultaneously.
2. 200 kHz to 1 GHz generator coverage.
3. 60 kHz to 1 GHz receiver coverage with optional preamp installed.
4. IFR developed "eze test" BASIC interpreter.
5. Dual tone audio generator sine, square and ramp outputs.
6. 16K of static RAM.
7. 1 DC-00A cartridge drive. Optional equipment is a second DC-100A cartridge drive for data and programme storage (1.24 MBYTES total) and IFR bus controller, two channels of D/A and 32 channels A/D conversion and also expandable to 32K of user RAM.

All the functions of the IFR-2000 are under micro-processor control except speaker volume, CRT intensity and focus. The measurement functions include percentage AM, deviation, power to 100 watts, sub-audible AF and RF frequency, as well as frequency error. The receiver features three programmable band widths, plus LSB and USB.

The automatic testing function is suited for production line testing, the testing of radios and communications systems in the field or repair workshops, as well as general programmable automatic telecommunications purposes. The IFR system offers advantages in that customs software packages are available to customers requirements and general turn-key systems.

## HITACHI PROFESSIONAL SERIES OSCILLOSCOPES 20 AND 35 MHz DUAL TRACE MODELS

Hitachi Denshi Ltd. have released for sale in Australia two new Professional Series Oscilloscopes.

The two new models are the V202, a 20 MHz dual trace, and the V352, a 35 MHz dual trace model. Both the V202 and the V352 are rated at + 3 per cent basic accuracy voltage (vertical) and time (horizontal) axis. The accuracy combined with the 1 mV per division sensitivity and the fast sweep range .2uS to 0.2S in 19 steps will ensure that these CROs have particular appeal to the professional engineer, computer technician and the workshop serviceman.

The new oscilloscopes are attractively packaged with a carry handle that doubles as a tilt stand and protects the face of the CRO and a rectangular CRT with internal graticules developed especially by Hitachi for the new series of oscilloscopes.

Standard Components Pty. Ltd., the Australian agents for Hitachi Denshi Oscilloscopes, will sell the V202 for \$665 and the V352 for \$1059. Considering the specifications and quality of both these new oscilloscopes it appears that Hitachi have set their sights on a sizable share of the Australian oscilloscope market.

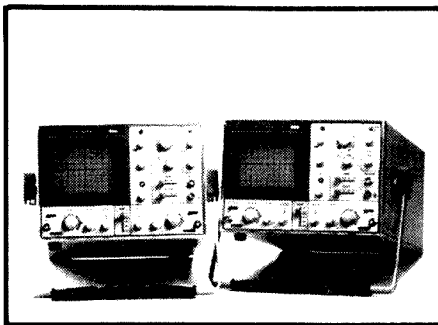

## AUSTRALIAN MARITIME COLLEGE

# MARINE RADIO OFFICERS

A two-year full-time course leading to a nationally accredited

### ASSOCIATE DIPLOMA IN MARINE RADIOCOMMUNICATION

for those wishing to become Marine Radio Officers will be commencing at the Australian Maritime College in February 1981.

The normal entry requirement is satisfactory completion of three subjects at HSC level, in mathematics, a science subject and English. Equivalent qualifications and mature age applicants may be considered.

Employment prospects on successful completion of the course are good since the College offers the only courses available in Australia for Marine Radio Officers, and numbers are geared to projected demand. Further opportunities are likely to exist ashore for experienced, well qualified Radio Officers in the communications field.

Subject to demand, for those who do not meet the above entry requirements, consideration may be given to offering a lower level course leading to a General Certificate—the minimum statutory qualification for a Radio Officer.

For further information and application forms contact:—

The Admissions Officer,  
Australian Maritime College,  
P.O. Box 986,  
Launceston 7250  
Tasmania  
Telephone: (003) 26 3155

## WICEN

R. G. HENDERSON,  
Federal WICEN Co-ordinator.

On going back through my old ARs I find it is two years since I produced a review style column for WICEN, so it is time for an update.

### MISSION

The agreed mission for the Wireless Institute Civil Emergency Networks (WICEN) is to provide a pool of trained licensed operators with equipment, available for deployment to aid communications in an emergency.

### TRAINING

An outline WICEN training course was given in the January 1979 AR and details of many of the course topics appear in subsequent issues, as below:

Date time groups and time zone prefixes	Feb. 79
Writing a formal message	Mar. 79
Sending formal messages over radio	Apr. 79
WICEN emergency plans contents	June 79
Records and logs	June 79
Map reading	Aug. 79
WICEN formalities	Aug. 79
Planning a WICEN exercise	Sept. 79
Pro-words for radio use	Oct. 79
Emergency service voice procedure	Dec. 79, Jan. 80, Mar. 80

### GENERAL DESCRIPTION

A general description of WICEN was given in the July 1980 AR column.

### JOINING WICEN

If you wish to join WICEN and prepare yourself to use your hobby in the aid of others in an emergency, contact your Divisional WICEN Co-ordinator for further details. Their names and addresses are:—

ACT: R. APATHY VK1NAS/ZAI, QTHR.  
NSW: H. FREEMAN VK2NL, PO Box 123, St. Leonards NSW.  
VIC.: P. MITCHELL VK3ANX, QTHR.  
QLD.: K. AYRES VK4KD, QTHR.  
SA: A. RAFTERY VK5BW, QTHR.  
WA: S. JENKINS, 12 Fagan Street, Yokine, WA 6060.  
TAS.: A. BOON VK7AW, QTHR.  
NT: T. CONNELL, VK8CO, QTHR.

### WICEN HISTORY

It is time a brief history of WICEN was compiled, starting at, say, the late forties when the WIA had a Civil Defence Network. If you can contribute with some notes on the early days of WICEN in your area, I would be pleased to receive them and compile a short history of our activities.

# WIA 1980 CALL BOOK

- COPIES ARE STILL AVAILABLE
- WRITE FOR ONE NOW BEFORE STOCKS RUN OUT.

Send \$2.95 plus postage for 240g to your Division or direct to:

MAGPUBS  
Box 150, Toorak 3142

# SILENT KEYS

It is with deep regret that we record the passing of —

Mr. W. E. BOVIS	VK7ED
Mr. W. BORNHOEFF	L50540
Mr. E. B. GIDDINGS	VK3ANQ
Mr. A. E. PARKER	VK4ZJS
Mr. D. M. MITCHELL	VK4NYN
Mr. E. J. CRUISE	VK7EJ
Mr. Q. L. B. WELLS	VK3TW
Mr. V. R. P. COOK	VK5AC
Canon H. A. STIRTON	VK3VOY

# OBITUARIES

HORRIE STIRTON VK3VOY/L31188

The many friends of Canon Horace Albert Stirton (Horrie) who met him on 3.582 MHz at 9 a.m. and 5.45 p.m. daily will mourn the loss of a fine man who overcame very many problems of ill-health and obtained his Novice Certificate in spite of those problems. He was a short wave listener for some years and was encouraged by Gilbert Hughes, DRI Bendigo, to try for his NAACP and after several bouts of illness which forced him to not only retire from his work in the Church of England but delayed his studies in the field of radio. His greatest moment was when he received his Novice ticket and could talk with those he had heard many times around the airways. Because of his state of health he moved to Phillip Island and when he was not in hospital he found great pleasure in amateur radio, talking to the "boys", most of whom were in excess of 80 years of age, and when he was unable to talk then just to listen to the good natured banter among the geriatric net each morning.

He made his last transmission on Thursday evening, 18th October, entered hospital the next evening and passed on to

the meeting place of all old amateurs around 4 a.m. on Saturday, 18th October, 1980. So long Horrie.

VK3DOV, AUV, NNC, NEG, NEP, VRO, VEN, NJM, &c. ■

ROY COOK VK5AC

Roy passed away on 26th August, 1980, at the age of 81, after a short illness. He was a real old-timer, having been associated with station XVN in 1913 and continued active up to, and including, the recent RD contest. He served in Army Signals during World War 1. He was appointed one of the original councillors on the formation of the SA Division of the WIA in November 1919, and was granted his experimental licence in 1921, with the call sign 5AC, which subsequently became ASAC, OASAC and VK5AC. His employment with the Department of Customs and Excise provided opportunities for personal contact with ships' radio officers who co-operated with him in ship-to-shore contacts and also helped in importing radio components from overseas.

In 1924 he was providing Morse Practise Broadcasts on 200 metres and one of his early transmitters is preserved in the South Australian Telecommunications Museum.

More recently, he had been operating an FT220 and, although confined to a wheelchair, still managed to keep in touch with his many friends. He will be sadly missed.

Gerry Preston VK5P. ■

ERIC BOYNTON GIDDINGS VK3ANQ

We were all saddened to hear of the passing of Eric VK3ANQ on the 31st August, 1980, at the Warrnambool Base Hospital. Eric Boynton Giddings was born on the 29th March, 1906, at Hamilton, Victoria. He then, with his parents, moved to Warrnambool, where he met and married Beryl Reeves on the 13th January, 1934, at Warrnambool. They had three children, in order, Judy, Ross and Ralph.

Eric took an early interest in radio and from the early 20s as a SWL logged and QSL-ed many early amateur operators throughout the world. He obtained his AACP certificate on the 22nd May, 1953, and made the first contact as VK3ANQ with VK3EQ on 144.00 on the 28th May, 1953.

A dedicated VHF operator, Eric helped many a 2m amateur by providing regular contacts from his home built AM station. In the fast few months of his life he obtained a SSB transceiver, renewing contact with many of his friends and making new ones.

His involvement with amateur operators and SWLs is shown by his willingness to work and take office through the various local amateur organizations. From 10-4-54 to 30-4-55 he was Secretary for the South-Western Zone and in 1966 was elected President of the zone, supported by his XYL Beryl, who for many years was appointed auditor for the South-Western Zone. He was also an active member of the Old-Timers' Club, supplying news for the Western Zone Newsletter. In February, 1975, Eric was one of the foundation members of the Warrnambool Amateur Radio Club, serving as Vice-President from May 1976 and was elected President in May 1977. A dedicated member of the WARC, he was always first to the club rooms to open up and prepare for the meetings; he was also the last to leave.

Eric is survived by his XYL Beryl, his daughter Judy (XYL 3FX), his sons Ross and Ralph. The respect of the local amateurs for Eric was evident at his funeral at Warrnambool on the 3rd September, 1980, when 27 local amateurs attended. Friend and fellow amateur Cos VK3YW conducted the service at Christ Church and the Warrnambool cemetery.

May I as a long time friend with all other amateurs who knew Eric personally and through amateur radio operating, express our deepest sympathy to his wife Beryl and family for the loss of their husband and father.

John VK3TN. ■

# ALARA

AUSTRALIAN LADIES' AMATEUR RADIO ASSOCIATION

The October meeting of ALARA was at the home of Mavis VK3KS. Nine members were present. The new constitution was discussed and a draft drawn up. This will be published in the next newsletter for comment, before being finalised. The next meeting will be held on November 15th. It was decided to postpone the annual meeting until next year.

Discussions on the ALARA award were deferred and these will be reviewed shortly. Some teething problems are being experienced but hopefully Mavis VK3KS, the new Awards Manager, will be able to cope with these.

Membership of ALARA continues to increase and we welcome new members. Enquiries to the Secretary, PO Box 110, Blackburn 3130.

Girls, remember the ALARA sked is on Monday night, 3565 ± QRM, at 2030 EAST. Geraldine VK2NOI, net controller, will be pleased to welcome new girls. YLs only until 2130 EAST, then others can join in for points to ALARA awards.

YL Activity Day on the sixth day of each month is gaining popularity! Frequencies to look for on the hour Z are 14.288, 21.188, 21.386, 28.586 and 28.686. Call CQ YL and find someone new to chat with.

In October an ALARA member, Elizabeth YB0ADT, and OM Reg were visiting Australia; while in Melbourne some of the girls met Elizabeth. She was presented with her ALARA award by Mavis VK3KS. Also a memento — an ALARA teaspoon, was presented.

Elizabeth and Reg were stationed in Jakarta for the past two years. While there Elizabeth was very active on SSB and also CW. Her radio life began in Norway when, on leaving school, she got a second class licence. For four years she worked as SPARKS in the Norwegian Merchant Navy. Elizabeth met Reg, a Canadian, and they have been married 25 years. Calls Elizabeth have held have been EP2EA, VE7BIP and YB0ADT. Also the call of VK6AYL/M while in Australia. After a trip to New Zealand they are returning to Canada to settle down to lots of amateur radio.

Congratulations to all the girls who have passed exams this year and do hope we hear you on the nets before too long.

To those who are still studying every good wish for the exam when you do sit and hope the results are successful for you all.

Would like to wish everybody a very merry Christmas and a happy and prosperous New Year, with plenty of DX.

Cheers and 73. Margaret VK3DML. ■

# Happy Christmas and Prosperous New Year

## HINT HINT

Your Division and Magpubs have stocks of amateur reference books, membership badges (both varieties), log books and many good items.

IF YOU FEEL UNABLE  
TO BUY A CERTAIN  
ITEM, WHY NOT A

## HINT

ABOUT A CHRISTMAS PRESENT!

Magpubs, Box 150, Toorak 3142

Your Advertisers support you  
— Support your Advertisers

# HAMADS

- Eight lines free to all WIA members. \$9 per 3 cm for non-members.
- Copy in typescript please or in block letters to P.O. Box 150, Toorak, Vic. 3142.
- Repeats may be charged at full rates.
- Closing date: 1st day of the month preceding publication. Cancellations received after about 12th of the month cannot be processed.
- QTHR means address is correct as set out in the WIA 1979 Call Book.

## FOR SALE

**TS700S 2m All Mode Txcvr.**, digital readout, built-in VOX, etc., with mic., \$550; also FT301, FV301, FP301 HF Txcvr., ext. VFO and power supply, 200W, incl. mic., \$1100 for all three units. Offers considered. S. Greening VK2ADP, QTHR. Ph. (02) 398 2951 AH.

**TS520S** with CW filter fitted and VFO 520 ex VFO, in as new cond., with operator's and workshop manuals, \$700. VK3PR, OTHR. Ph. (056) 62 2711.

**Yaesu FLDX 200 Linear Amplifier**, very good cond., \$250; brand new 6KD6 tubes available at good price. M. Evered VK3AVO, QTHR. Ph. (03) 544 4109.

**Swan 350 Txcvr.** with AC power supply, VOX, CW, break-in unit, mic., very good cond., \$300. VK2ML. Ph. (02) 50 7239.

**Kenwood MC 50 Desk Microphone**, in box, bought new, never used, \$40. Bill L20121, QTHR. Ph. (02) 477 2717.

**Nikon:** FM camera, immac. cond., compact, with 50 mm 1/1.8 lens and case, \$350; 100 mm 1/2.8 series "E" lens, with hood, \$110; 35 mm 1/2.5 series "E" lens with hood, \$100; SB-9 auto-flash, compact, with case, \$50; FB-16 compartment case (suit above equip.), \$40. Contact J. Bush L20142, PO Box 124, Dulwich Hill, NSW 2203.

**FL2000B Linear Amplifier**, 1.2 kW, 572B x 2, \$350; Barlow Wardley XCR30 Rx, \$200; FT101B DC supply fan, new driver and linals, \$550; FT7, brand new, \$400; FL110 linear amp., 160-10m, brand new, \$200; FT200 AC supply and DC acitron mobile supply, \$350; R210 comm. Rx, 2-16 MHz, AC supply and speaker, CW filter, \$80; HB 20m linear amp., 813X2, 6.6 HD power supply (spares), 2 kW, \$200; 813 x 2 6.6 HD power supply (spares), 2 kW, \$200; HB 20m linear amp., 4/1000A, AB2 GC, 4 kW, self-contained unit, HDV power supply, 6 kV, spare tube, commercial app., \$800, or swap for TL922 linear. Laurie VK3AW, QTHR. Ph. (03) 378 1429.

## MOE

### CODLIN COMMUNICATIONS

84 ALBERT ST. (051) 27 4516

Everything for the Amateur

KEN VK3DKC BRUCE VK3VRE

**Collins S-line 75S-3 Rx**, NB, notch, CW filter, \$600; 32S-3 Tx, \$600; transceiver/split operation; Datong ASP push-button speech processor, \$200; Collins power supply, \$200; 500 kVA 100V transformer, \$100. George VK1GB, QTHR. Ph. (062) 47 3296 or 54 1985.

**UHF FM Carphones**, Willis U10 autophones, compact solid state units that cover the 70 cm band with no modifications, circuit diagram and tune-up info included, \$100; Yaesu FT DX 100 Txcvr., good cond., \$300, ONO. VK3CCM, QTHR. Ph. (051) 44 3485 AH.

**Shack Clearance**, reasonable offers accepted: FRDX-400 and FLDX-400 Txcvr., \$365; C42 6m FM Txcvr., with AC PSU, \$60; B47 6m FM Txcvr., with AC PSU, \$50; Lafayette KT-100 gen. coverage Rx, \$100; Realistic DX-160 gen. coverage Hx, \$120; Eddystone 750 gen. coverage Rx, \$160; Eddystone 770R VHF Rx, 19-165 MHz, \$250; model 15 TTY, \$40; 850 Hz TTY TU, \$50. VK3ZUX, QTHR. Ph. 615 3641 Bus., (03) 781-2797 AH.

**Trio TS510**, power supply and VFO, 10m does not work, all other bands OK, \$195. Bob VK3GQ. Ph. (03) 306 8336.

**Vertical Antenna**, Bullernut, 80 through 10m, HF5V3 trapless 26 ft. high, low VSWR on all bands, 1.2 to 1, suit person with limited space, e. cond., \$120, ONO; 3 el. quad, duo band, 10-15m, homebrew, sturdy aluminium construction with hollow fibreglass spreaders, light and robust, low VSWR on both 10-15m, gamma matched, very good FB ratio over 20 dB, also two balanced feedlines approx. 25m RG58 for both 10-15m, boom length 11 ft. with boom to mast clamps, \$220, ONO; converted CB, 10m, Airhawk/Contact as per ARA Vol. 2, covers 27.945 to 29.010 MHz, 12W PEP with 5 kC steps, slight problem with transmit, \$120, ONO; Fujica 35 mm camera, model ST107, in exc. con., robust, cost \$240, sell \$140. VK3VDI, QTHR. Ph. (03) 314 2027 6-9 p.m.

**Denron Super Tuner**, 160m through 10m, will accept all lead lines, \$110; Electronic Australia magazines, may 1971 to June 1980, five copies missing, \$30 the lot. VK2DET, Corrimal. Ph. (042) 84 3400.

**Yaesu-Musen FL-2100B Linear Amplifier**, near new, \$400. John Tilley VK1FT, QTHR. Ph. (062) 80 6481 Bus., (062) 86 2364 AH.

**Yaesu FRG-7 Rx**, exc. cond., .5-30 MHz general coverage, \$270; liner S878P PLL CB, suit conversion to 10m, \$80. Mark VK3PI. Ph. (03) 478 8726.

## SHUTE HARBOUR

### MOTEL & Licensed Dining Room

SHUTE HARBOUR, Q. 4800  
PHONE (079) 46 9131

DAVID McINERNEY

**Icom Model 502 6m SSB Txcvr.**, 52-53 MHz, good cond., \$130, ONO. VK5ZGH. Ph. (08) 270 3452.

**Collins 618S HF Txcvr**, shockmount 350 S-1 or 3, power supply 416W-1, shockmount 350T-1, antenna tuner 180L-2 or 3, shockmount 350D-3. VK3BFB, QTHR. Ph. (03) 93 1638.

**QM 70 High Power 28/144 Transverter**, 2 ranges 144-146 and for satellites 145-7-147.7 MHz, separate Rx and Tx inlets, all modes, \$120; matching 240V power supply, selectable HT 600 and 900V, \$70, or will swap and pay difference for a dual beam CRO, 1 mV/cm, DC to 12 MHz or higher. J. Aust VK4ABJ, PO Box 247, North Rockhampton, Q. 4701. Ph. (079) 28 1105.

**HyGain TH3 Mk. 3 Antenna**, 10-15-20m, 14 ft. boom, 3 element, \$225; rotator 502 CXX, heavy duty, 240V, \$240; mast clamp for 502 CXX, \$30; all new, original packaging; or as one lot, \$480. Alan L30845, QTHR. Ph. (03) 89 6408.

**Drake SPR4 Rx 160-10** with noise blanker, solid state, good working order, \$280, ONO; crystal 10 MHz, suit 2 MHz IFRI-Z-6 Rx, simplex S40-49-51, \$5. VK3YNB, QTHR.

**Kenwood TS520S**, CW filter fitted, \$580 firm; as new, original packaging. VK3ACA, QTHR. Ph. (03) 578 2056.

**Army No. 11 4.2-7.2 MHz Txcvr**, in working cond. with meter, mic., phones and all plugs; Army No. 11 power supply unit, genemotor, etc., to suit above; aerial coupling unit for Army No. 11; wireless set No. 208 Mk. II 2.4-3.6 MHz Txcvr, in working cond., complete; Pioneer dynamotor, 12-18V in, 450V out. Best offers. VK2FD, QTHR. Ph. (063) 68 7235.

## ADVERTISERS' INDEX

AUDIO TELEX	60
AMATEUR RADIO ACTION	51
AUSTRALIAN MARITIME COLLEGE	56
BAIL ELECTRONICS	44
CHIRNSIDE	33
CW ELECTRONICS	36
DICK SMITH ELECTRONICS	2
CFS	23
NSW DIVISION WIA	21
SCALAR INDUSTRIES	7
SIDEBOARD ELECTRONIC ENGINEERING	50
VICOM PTY. LTD.	4, 35, 59
WESTLAKES RADIO CLUB	31
WILLIAM WILLIS	39
W. & G. WULF	31

**Tuno 7000E Communications Computer**, exc. cond., send and receive CW, RTTY and ASCII, split screen and variable speeds in sending mode. \$790. Steve VK3VNI. Ph. (059) 71 2843.

**Siemens 100 Teleprinter**, \$300 (no keyboard); 6m amplifier, 25 watts, AM-4306/GRC, \$25; Tram XL5, modified 10m, plus 2 antennae, \$150. Roger VK2DNX (ex VK2ZWY). Ph. (02) 546 1927.

## ALBANY

### LOCKYER LAUNDRETTE

32 SOUTH COAST HIGHWAY  
(Off the Roundabout)

7 WASHERS and 4 DRYERS  
Support a Local Amateur

VK6NQ

**Kenwood TS520**, DG5 readout, BS5, SP520 speaker, \$600; IC212 (215) nicads, 10 channels, \$250; Drake MN4 ATU, \$100; good cond. John VK2WW, QTHR. Ph. (02) 546 1927.

**KW "Viceroy" Mk. III Tx**, 180W PEP, \$150; KW "Vespa" Tx, 90W PEP, \$75; Trio 9R 59DS comm. Rx, \$75; all in good order and complete. Write VK4NUY, 14 Cooradilla Street, Jindalee 4074.

**SWLs:** Australia's national "Southern Cross DX Club" has the latest from the everchanging world of international shortwave, medium wave and amateur bands, in our monthly publications "DX Post". For a sample copy of "DX Post" and details of subscription, send a 28c stamp to the Membership Secretary, Grantley Williams, 19 Wicklow Avenue, Athelstone, South Australia 5078.

**FT-227R Memorizer**, 800 ch., exc. cond., complete with mic., manual, mobile mount and hardware, sell for \$220. Contact John Brereton VK5NHB, QTHR.

**Heathkit SB-301 Rx**, AM, SSB, CW, RTTY, with 3 filters, SB-600 speaker, SB-540 frequency display, all in exc. cond., as new, with service manuals, \$750 the lot. Write to G. Himolij, 118 Wilson Road, Newcomb, Geelong, Vic. 3219.

**Leader LSG-11 RF Signal Generator**, perfect cond., \$55. Roy Hartkopf VK3AOH, QTHR.

**Europe B Transverter**, 144-148m, perfect cond., complete, \$190. J. Lee, MS 30, Chinchilla, Q. 4413. Ph. (074) 65 8183.

## WANTED

**Tower**, 50, 60, 70 or 80 ft., preferable sections, with guide wires; also CB radio, preferable Uniden type (President, Ferris), at reasonable price. Danny VK2VCV. Ph. (02) 588 4414.

**DG5 Digital Readout** for TS520S. VK1RH, QTHR. Ph. (062) 58 7904.

**240V-110V Transformed** for model 15 teletypewriter with synchronous motor, must be rated at 4A; also require any details of G5RV aerial. Terry Robinson L31105, QTHR. Ph. (054) 27 1574.

**Teleprinter Mod. 15** or similar. J. Lee, MS 30, Chinchilla, Q. 4413. Ph. (074) 65 8183.

**Cooling Fan** for FT101. VK6NPW, 23 Wadell Road, Palmyra, West Australia 6157.

**Swan MB80A** or MB80 Monobander Txcvr. Details to VK3CCE, QTHR. Ph. (03) 509 1667.

**Filter** for Heppburn Building Blocks, 10.7 or 9 MHz, reasonable offer, Hy-Q, Pye, KVG, etc. John VK3VGP, 1 Cambridge Street, Seaholme, Vic. 3018. Tektronix Plug-in, type L or IAI ETL, manual, information on varian rubidium frequency standard type V4700. VK2ARD, QTHR. Ph. (064) 82 2183.

**HyGain 143VQ** (not 14AVQ/WB) measurements. Mai Sinclair VK2BMS, 52 Fourth Avenue, East Willoughby, NSW 2068. Ph. (02) 407 0261 Bus., (02) 95 2362 AH.

## TRADE HAMAD

**Amidon Cores** — Iron-powder and ferrite, enlarged range available for tuned/wideband and suppression applications in Rcvrs/Trans., large SASE for data/price list. Closed for business during November. RJ & US Imports, Box 157, Mortdale, NSW 2223.

It's the kind of innovation and quality you'd expect from ICOM—and from VICOM, too.

Here are all the features you've always wanted, ingeniously concentrated into the space of not much more than the size of a 2 dollar note.

- 800 T/R synthesized channels
- 1.5 watt output (with special High/Low Battery Saver switch to reduce to .15 watt)
- Built-in speaker. Built-in mic.
- ICOM quality receiver performance. (2uV/20db typical)
- Slip-on/Slip-off Nicad Battery Pack. (3 sizes available to suit your needs.)

- 250mA is standard). Uses easy-to-carry snap-on packs for extended trips
- The size of the unit varies with the size of the HT, ranging from 116 mm to 175 mm
- Optional Desk charger, Speaker/mic. available
- Backed by VICOM's 90 day warranty.

# Get 800 channels into the palm of your hand!

## icom's amazingly compact 2 metre Handie-Talkie

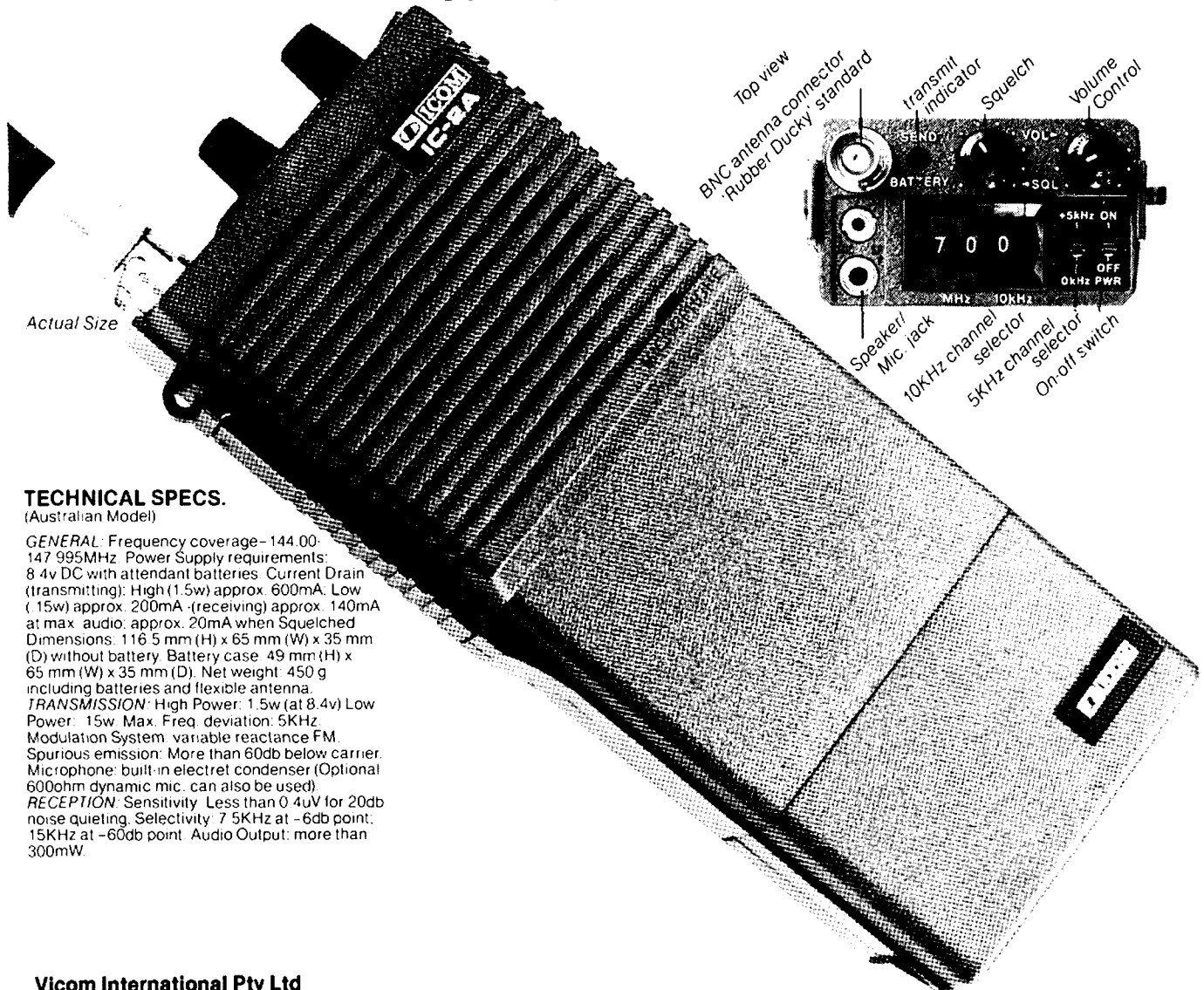

### TECHNICAL SPECS.

(Australian Model)

**GENERAL:** Frequency coverage—144.00-147.995MHz. Power Supply requirements: 8.4v DC with attendant batteries. Current Drain (transmitting): High (1.5w) approx. 600mA. Low (.15w) approx. 200mA. (receiving) approx. 140mA at max. audio: approx. 20mA when Squelched. Dimensions: 116.5 mm (H) x 65 mm (W) x 35 mm (D) without battery. Battery case: 49 mm (H) x 65 mm (W) x 35 mm (D). Net weight: 450 g including batteries and flexible antenna.

**TRANSMISSION:** High Power: 1.5w (at 8.4v) Low Power: .15w Max. Freq. deviation: 5KHz. Modulation System: variable reactance FM. Spurious emission: More than 60db below carrier. Microphone: built-in electret condenser (Optional 600ohm dynamic mic. can also be used).

**RECEPTION:** Sensitivity: Less than 0.4uV for 20db noise quieting. Selectivity: 7.5KHz at -6db point. 15KHz at -60db point. Audio Output: more than 300mW.

### Vicom International Pty Ltd

68 Eastern Road,  
South Melbourne, Vic. 3205.  
Phone (03)6996700

339 Pacific Highway,  
Crows Nest, N.S.W. 2065.  
Phone (02)4362766

Brisbane 352522; 3415377  
Townsville 7722633

Wollongong 291455  
Cairns 541035

Adelaide 437981

Wagga 212125  
Melbourne 8368635







# TH5DX

## 10-15-20 METERS

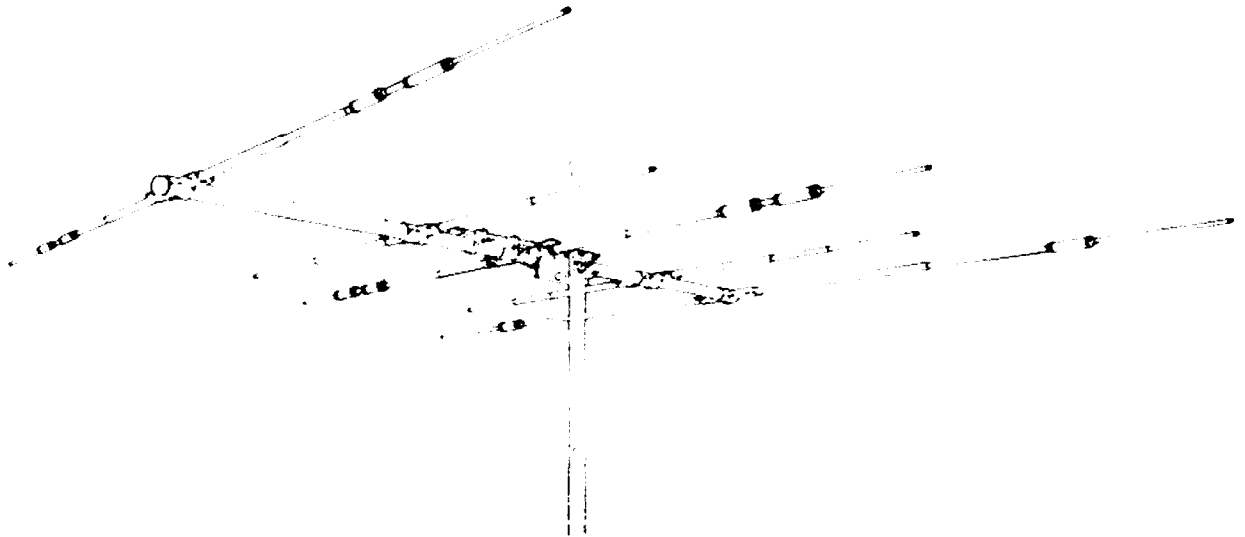

We are proud to introduce the newest member of our famous Thunderbird line of Tri-Band antennas. The TH5DX offers outstanding performance on 20, 15 and 10 meters. It features 5 elements on an 18 foot boom, with 3 active elements on 15 and 20 meters and 4 active elements on 10 meters. The TH5DX also features separate air-dielectric Hy-Q traps for each band. This allows the TH5DX to be set for the maximum F/B ratio and the minimum beam width possible for a Tri-Band antenna of this size. Also standard on this antenna are Hy-Gain's unique Beta-match, rugged Boom-to-mast bracket, taper-swaged elements and improved element compression clamps.

Boom length..... 18 feet  
 Longest Element..... 31 feet  
 Turning Radius..... 18 feet  
 Surface Area..... 6.4 sq. feet  
 Wind load..... 164 lbs  
 Weight..... 50 lbs

VSWR at resonance..... less than 1.5:1  
 Power Input..... Maximum Legal  
 Input Impedance..... 50 ohms  
 - 3dB Beamwidth..... 66° average  
 Lightning Protection..... DC ground  
 Forward Gain..... 8.5dB  
 Front-to-Back Ratio..... 25 dB

**WRITE OR CALL FOR A FREE BROCHURE AND THE NAME OF YOUR NEAREST HYGAIN DEALER  
 SOLE AUSTRALIAN DISTRIBUTOR**

AUDIO TELEX COMMUNICATIONS  
 PTY. LTD.



**MELBOURNE:**  
 7 Essex Road,  
 MOUNT WAVERLY 3149  
 Tel: 277 5311

**BRISBANE:**  
 394 Montague Road  
 WEST END 4101  
 Tel: 44 6328

**SYDNEY:**  
 1 Little Street,  
 PARRAMATTA 2160.  
 Telephone 633 4344