

# Amateur Radio

January 1997

Volume 65 No 1



*Journal of the Wireless Institute of Australia*



*Full of the latest amateur radio news, information and technical articles including...*

- **A Shielded Loop for 160 Metres**
- **Hybrid Antennas**
- **A Dip Meter Using Lambda Negative Resistance**

**Plus** *lots of other articles, amateur radio news and special interest columns*

# DAYCOM

We wish all our customers a happy Christmas and may 1997 be all you wish for!

Get it first at Daycom!



**IC-756 HF + 6m 100W, auto-ATU, DSP**  
If you missed our Icom Day at the end of November you missed the opportunity to see the all new IC-756. It was pretty hard to see anyway with the crowd always around it!

- All bands 160-6 metres
- 100W output on all bands
- Auto ATU works on all bands
- Dual watch receivers
- Spectrum Scope (just like the IC-781!)
- Dual Pass-Band Tuning
- Adjustable threshold DSP noise reduction
- Audio Peaking Filter
- Automatic Notch filter
- Built-in CW memory keyer
- 100 alphanumeric memories

Some of the reactions; "how much will you give me for my FT-1000 as a trade-in?", "Probably the most innovative radio since the IC781 hit the market!", "This is really a radio for all reasons, easy to use but with all the features a contestor or DXer needs."

Limited quantities available mid-December, call to secure yours now:

## \$3999

IC-2710H Dual Band mobile



The very latest in dual band mobile convenience - removable front panel, remote control microphone & lots of options including PC cloning of radios!

## \$1250



HF multiband beams



Model	A4S	A3S	A3WS
Frequency	28.35-3.3	28.35-14	28.18
Number of elements	4	3	3
Forward gain, dBd	6.0	5	8
Front to back ratio, dB	16	14	14
Power, watts PEP	2000	2 000	2000
Boom length, metres	5.48	4.27	4.27
Longest element, mtrs	9.75	8.45	7.06
Turning radius, mtrs	5.49	4.72	4.4
Max mast size, mm	50	50	50
Wind load, square metres	51	47	38
Weight, kg	16.8	12.3	10.24
Price (inc tax)	\$1099	\$916	\$689



introduutory special price:  
**ICOM \$3400**

The **NEW** Icom R-8500 receiver is here now! It covers 100kHz to 2000MHz (no breaks) has 1000 memories and a host of features you wouldn't think possible at just \$3750. Get the full story, call for a brochure or look on the WEB at <http://www.daycom.com.au/>

**MEJ** Performance you can afford!



- MFJ1270C 1200bps VHF/UHF packet \$249
- MFJ1276 HF/VHF/UHF packet+PACTOR \$349
- MFJ1278B 10 mode multi-mode controller \$599
- MFJ1278B-DSP DSP added to MFJ1278B \$759
- MFJ Packet options and accessories**
- MFJ780 DSP add-in card for MFJ1278B \$219
- MFJ781 External DSP for any TNC \$279

## Kantronics



- KPC-3 1200bps VHF/UHF packet \$249
- KPC-9612 1200/9600bps dual port packet \$459
- NEW KPC-9612+ coming - run out special \$395!**
- KAM+ Deluxe multi-mode \$669**

**NEW Vibroplex prices**



- Original** The standard mechanical Grey wrinkle finish \$219  
Chrome plated base \$249
- lambic** for use with electronic keyers Grey wrinkle finish \$219  
Chrome plated base \$249
- Vibrokeyer** a single lever paddle for keyers Grey wrinkle finish \$190  
Chrome plated base \$239
- Brass racer** the latest in lambic keying Keyer only (wood base) \$139  
With electronic keyer \$260

Vibroplex is only part of our great range of CW keys and keyers, call for details of other fine products we have in stock!

**MFJ Antenna Tuners**

- MFJ901B 200W Versatuner \$149
- MFJ910 Mobile antenna matcher \$45
- MFJ921 2 mtr 300W tuner \$155
- MFJ924 70 cm 300W tuner \$155
- MFJ931 Artificial ground tuner \$169
- MFJ941E 300W compact GP tuner \$230
- MFJ945E 300W mobile tuner \$209
- MFJ948 Deluxe 300W (no D/L) \$270
- MFJ949E Deluxe 300W \$299
- MFJ962C 1.5kW tapped inductor \$525
- MFJ971 200W Portable tuner \$190
- MFJ986 3kW Diff-T roller inductor \$629



MFJ989C 3kW Deluxe roller inductor \$735

**ARRL 1995 Publications CD-ROM**



A whole years QST, QEX and NCJ magazines in a single CD-ROM - how convenient! With power full reader technology the diagrams and photos appear in separate windows. Fully searchable text. Requires 386 or better with Windows 3.1 or later.

## \$45



**HAMCALL 1996**

Our most popular callbook CD-ROM with Windows, DOS and MAC search engines. Much new information this year including photos of many amateurs!

## \$45

**TKIT** The NEW Heathkit!



Help reclaim this fascinating band! Six metres is the VHF DX band and even now offers regular overseas contacts with just a little effort. The TT1208 kit is the ideal, low cost way, to get going on 6 metres and find out what only the elite have known for years!

- Requires 3-5W input on 20 metres
- Extremely simple hookup and operation
- Sensitive, low noise 50-54MHz front end
- Fast, silent PIN diode TR switch for QSK & data
- 8W output on 6 metres
- Requires 12-15V DC 3A power supply
- Simple switching between HF and 6 metres
- Rugged steel case

**TT1208** 8W 6 metre transverter **\$199**

**DAYCOM** Communications Pty. Ltd.  
44 Stafford Street, Huntingdale 3166

Bankcard, MasterCard  
& Visa all welcome

Phone (03)9543-6444  
FAX (03)9543-7238

# Amateur Radio



## Journal of the Wireless Institute of Australia

Vol 65 No 1

ISSN 0002-6859

January 1996

*Amateur Radio* is published by the Wireless Institute of Australia, ACN 004 920 745 as its Official Journal, on the last Friday of each month.

### Editorial

#### Editor

Bill Rice VK3ABP\*

#### Production Manager

Bill Roper VK3BR

#### Senior Technical Editor

Peter Gibson VK3AZL\*

#### Technical Editors

Evan Jarman VK3ANI\*

Gil Sones VK3AUI\*

#### Contributing Editors

Ron Fisher VK3OM\*

Roger Harrison VK2ZRH

#### Proof Readers

Allan Doble VK3AMD

Jim Payne VK3AZT

Graham Thornton VK3IY

John Tutton VK3ZC

\*Publications Committee member

### Production

#### Administration, Advertising, Drafting, Production

vk3br Communications Pty Ltd

3 Tamar Court, Mentone VIC 3194

#### Typesetting and Printing

Industrial Printing and Publishing Pty Ltd

122 Dover Street, Richmond, VIC 3121.

#### Mail Distribution

Mail Management Australia Pty Ltd

6 Garden Boulevard, Dingley VIC 3172

#### New Advertising

Eyvonne & Keith Tootell

Union Publicity Service Pty Ltd

PO Box 282, Toongabbie NSW 2146

Telephone: 1800 654 181 - 02 9831 1299

Fax: 02 9831 6161

#### Amateur Radio Correspondence

All contributions, correspondence, Hamads

and queries concerning the content of

Amateur Radio should be sent to:

Amateur Radio

vk3br Communications Pty Ltd

3 Tamar Court, Mentone VIC 3194

E-mail: vk3br@c031.aone.net.au

Phone and Fax: (03) 9584 8928

Mobile: 0418 534 168

Business Hours: 9.30 am to 3.00 pm weekdays

#### Amateur Radio Delivery

All correspondence and queries

concerning the delivery of

*Amateur Radio* should be sent to:

Amateur Radio

WIA Federal Office

PO Box 2175

Caulfield Junction VIC 3161

#### Registered Office:

3/105 Hawthorn Road

Caulfield North VIC 3161

Telephone: (03) 9528 5962

Fax: (03) 9523 8191

Business Hours: 9.30 am to 3.00 pm weekdays

#### Editorial and Hamads Deadlines

February 13/01/97

March 10/02/97

April 10/03/97

Delivery of AR: If this magazine is not received by the 15th of the month of issue, and you are a financial member of the WIA, please check with the Post Office before contacting the registered office of the WIA.

© Wireless Institute of Australia 1997

## CONTENTS

### Technical

A Shielded Loop for 160 Metres \_\_\_\_\_ 7

*Ian Berwick VK3ALZ*

Hybrid Antennas \_\_\_\_\_ 10

*Ralph Holland VK1BRH*

A Dip Meter Using the Lambda Negative Resistance Circuit \_\_\_\_\_ 15

*Lloyd Butler VK5BR*

Technical Abstracts \_\_\_\_\_ 24

*Gil Sones VK3AUI*

### General

Amateur Radio Annual Index 1996 \_\_\_\_\_ 20

*Bill Roper VK3BR and Bill Rice VK3ABP*

### Columns

Advertisers' Index \_\_\_\_\_ 56

ALARA \_\_\_\_\_ 26

AMSAT Australia \_\_\_\_\_ 27

Awards \_\_\_\_\_ 30

Club Corner \_\_\_\_\_ 26

Contests \_\_\_\_\_ 32

#### Divisional Notes

VK1 Notes \_\_\_\_\_ 35

VK2 Notes \_\_\_\_\_ 35

VK3 Notes \_\_\_\_\_ 36

VK6 Notes \_\_\_\_\_ 36

VK7 Notes \_\_\_\_\_ 37

Editor's Comment \_\_\_\_\_ 2

Hamads \_\_\_\_\_ 54

HF Predictions \_\_\_\_\_ 52

How's DX? \_\_\_\_\_ 38

Over To You \_\_\_\_\_ 41

Packet World \_\_\_\_\_ 42

Pounding Brass \_\_\_\_\_ 44

QSP News \_\_\_\_\_ 9

Repeater Link \_\_\_\_\_ 46

Silent Keys \_\_\_\_\_ 51

Spotlight on SWLing \_\_\_\_\_ 47

VHF/UHF - An Expanding World \_\_\_\_\_ 48

WIA News \_\_\_\_\_ 3, 25, 55

WIA - Divisional Directory \_\_\_\_\_ 56

WIA - Federal Directory \_\_\_\_\_ 2

### Cover

One of the highest repeaters in Australia, the VK2RMS 2 m repeater is situated on "Bald Hill" at 1765 m overlooking Lake Eucumbene in the Snowy Mountains. The antennas are mounted on a Nally tower, the equipment is housed in a metal cabinet with 30 W output, and it is solar powered with 350 amp hours of battery capacity. The snow does not seem to affect the solar power. Sponsors of the repeater are Glen VK2JPR, David VK2XKE, and Rod VK2TWR, who submitted the photograph.

*The photo by Bruce Davey was taken from a helicopter.*

### BACK ISSUES

Available, only until stocks are exhausted, at \$4.00 each (including postage within Australia) to members.

### PHOTOSTAT COPIES

When back issues are no longer available, photocopies of articles are available to members at \$2.50 each (plus \$2.00 for each additional issue in which the article appears).

The opinions expressed in this publication do not necessarily reflect the official view of the WIA, and the WIA cannot be held responsible for incorrect information published.

## Amateur Radio Service

A radiocommunication service for the purpose of self-training, intercommunication and technical investigation carried out by amateurs, that is, by duly authorised persons interested in radio technique solely with a personal aim and without pecuniary interest.

## Wireless Institute of Australia

The world's first and oldest National Radio Society  
Founded 1910

Representing the Australian Amateur Radio Service -  
Member of the International Amateur Radio Union  
Registered Federal office of the WIA:  
3/105 Hawthorn Rd, Caulfield North, Vic 3161

All Mail to:

PO Box 2175, Caulfield Junction, VIC 3161  
Telephone: (03)9528 5962 Fax:(03) 9523 8191

Business Hours: 9.30 am to 3.00 pm on weekdays

**Federal Secretary**  
Peter Naish VK2BPN

### COUNCIL

<b>President</b>	Neil Penfold	VK6NE
<b>VK1 Federal Councillor</b>	Richard Jenkins	VK1RJ
<b>VK2 Federal Councillor</b>	Michael Corbin	VK2YC
<b>VK3 Federal Councillor</b>	Brenda Edmonds	VK3KT
<b>VK4 Federal Councillor</b>	Ross Marren	VK4AMJ
<b>VK5 Federal Councillor</b>	Grant Willis	VK5ZWI
<b>VK6 Federal Councillor</b>	Bruce Hedland-Thomas	VK6OO
<b>VK7 Federal Councillor</b>	Jim Forsyth	VK7FJ

### EXECUTIVE

Peter Naish  
Lance Bickford  
Rowland Bruce  
Neil Penfold

VK2BPN  
VK4ZAZ  
VK5OU  
VK6NE

### FEDERAL CO-ORDINATORS

<b>AMSAT:</b>	Graham Ratcliff	VK5AGR
<b>Awards:</b>	John Kelleher	VK3DP
<b>Contests:</b>	Peter Nesbit	VK3APN
<b>Education:</b>	Brenda Edmonds	VK3KT
<b>EMC and Standards</b>	Roger Harrison	VK2ZRH
<b>FTAC:</b>	John Martin	VK3KWA
<b>Historian:</b>	John Edmonds	VK3AFU
<b>IARU:</b>	David Wardlaw	VK3ADW
<b>Int'l Travel Host Exch:</b>	Ash Nallawalla	VK3CIT
<b>Intruder Watch:</b>	Gordon Loveday	VK4KAL
<b>ITU Conference and Study Group:</b>	David Wardlaw	VK3ADW
<b>Media:</b>	Roger Harrison	VK2ZRH
<b>QSL Manager (VK9,VK0):</b>	Neil Penfold	VK6NE
<b>Radio Sports:</b>	Wally Watkins	VK4DO
<b>Videotapes:</b>	Bob Godfrey	VK4BOB
<b>WICEN:</b>	Leigh Baker	VK3TP

### SMA LIAISON TEAM

Roger Harrison	VK2ZRH
David Wardlaw	VK3ADW
Neil Penfold	VK6NE

# Editor's Comment

## Changes in the System

In last month's issue it was reported in *WIA News* (December, page 8) that the Federal Executive had been directed by Council in May to investigate "outsourcing" the production of *Amateur Radio* magazine. This was also briefly mentioned in the *Editor's Comment* for the October 1996 issue, and was implemented by an advertisement in September calling for tenders.

Five tenders were received and, after careful comparison, the one selected was from a company formed for the purpose by our erstwhile Production Editor, Bill Roper VK3BR. Bill's tender was not only for production, printing and mailing, but also for administration, which involves negotiation with contributors and advertisers, hitherto a function of the Federal Office. Time will tell how significant is the cost reduction which may be achieved, but there is no question that Bill is uniquely qualified to achieve savings if savings are possible.

An obvious consequence of the administrative changes is that our address for submission of written material has also changed, and becomes: Amateur Radio, vk3br Communications Pty Ltd, 3 Tamar Court, Mentone 3194. Much material is already received by e-mail, for which the address is unaltered. All these changes are set out in our new masthead on page 1. We hope all can be implemented with minimal administrative "hiccups".

**Bill Rice VK3ABP**  
Editor

### CONTRIBUTIONS TO AMATEUR RADIO

*Amateur Radio* is a forum for WIA members' amateur radio technical experiments, experiences, opinions and news. Manuscripts with drawings and/or photos are always welcome and will be considered for possible publication. Articles on computer disk are especially welcome. The WIA cannot assume responsibility for loss or damage to any material. "How to Write for Amateur Radio" was published in the August 1992 issue of *Amateur Radio*. A photocopy is available on receipt of a stamped, self addressed envelope.

## WIA News

Roger Harrison VK2ZRH, Federal Media Liaison Officer

# 1997 Membership Campaign Provides Attractive Incentives for Recruits and Renewals

A nationwide membership recruitment and retention campaign for 1997 kicks off this month, offering separate incentive prizes for new recruits and renewing members. The campaign runs throughout 1997, from 1 January through 31 December.

Each month, from January through December, new members joining in a given month will go into a draw to win a magnificent Fluke Model 12B hand-held digital multimeter, worth \$195. Twelve multimeters are to be won by twelve lucky new members joining in 1997. New recruits may subscribe to any grade of membership to be eligible. The winner for each month will be drawn, and the prize presented, in the following month. That is, the winner from January's new members will be drawn in February, and a Fluke 12B multimeter presented to the winner that month, and so on.

Members whose annual renewals fall due between 1 January and 31 December, and who renew on time, go into a draw to win a fabulous Kenwood TM-733A dual-band 2 m/70 cm FM mobile transceiver, worth \$1255. All grades of membership are eligible, and life members and those on three-year subscriptions are included automatically. The winner will be drawn and the prize presented in January 1998, or the nearest available opportunity after that.

New recruits in 1997 are not eligible to enter the draw for the Kenwood transceiver. They'll have to wait for the next membership retention campaign.

WIA Federal President, Neil Penfold VK6NE, said: "I urge all the Divisions

and affiliated clubs to get behind the 1997 Membership Drive, to publicise it at every available opportunity - at meetings, field days and conventions, on broadcasts and nets, in club newsletters and any mail-outs. I encourage all members to recruit new members for their Division, the chances of recruits winning a Fluke digital multimeter are quite good!

"With important World Radio Conferences being held this year and in 1999, and considerable changes happening in radiocommunication in Australia, which have the potential to affect amateur radio, membership of the WIA at this time is vitally important to help preserve those privileges fought for and won in the past, and to improve our conditions and privileges in the future," he said.

"It was the WIA which lobbied for and negotiated improved privileges and operating conditions for Australian amateurs, introduced in 1995. It was the WIA which successfully lobbied the government to reduce a proposed massive increase in licence fees in 1995.

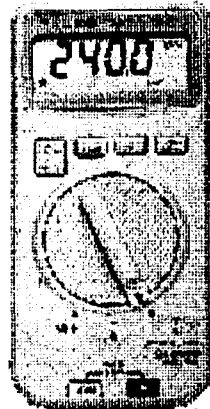
"This campaign's prizes aside, there are many advantages to becoming, and remaining, a member of your WIA Division. For example, the Institute's monthly journal, *Amateur Radio*, is the only monthly magazine devoted entirely to amateur radio. Receiving *Amateur Radio* magazine is an exclusive benefit of membership. Divisions offer low-cost QSL bureau services, discounted publications and other services to help members enjoy their hobby more," he said.

The twelve Fluke Model 12B digital



YOUR HOBBY YOUR VOICE  
Representing Radio Amateurs - Since 1910

RECRUIT A MEMBER & THEY COULD WIN!  
THIS GREAT FLUKE 12B DIGITAL MULTIMETER WORTH \$195



THERE'S A WINNER EVERY MONTH FOR 1997  
12 PRIZES TO BE WON

This latest hand-held DMM, from the world-leading maker of digital test instruments, has advanced features yet is simple to use. Ideal for tyro & veteran.

#### The Fluke 12B measures:

- ac and dc voltage (with auto-selection)
- resistance & capacitance (.001-1000 $\mu$ )

#### The Fluke 12B features:

- 4000-count liquid crystal display
- simple rotary dial
- diode and continuity testing
- indicates intermittent opens & shorts
- 2-year warranty

Fluke 12B prizes generously donated by Philips Test & Measurement.

Each month's prize is awarded by way of a draw among newly recruited members each successive month and presented to the winner at the earliest opportunity following the draw.

To sign up a new member, use the back of your AR magazine address leaflet - or clip the coupon, have them fill it out and send it now.

SEND TO YOUR DIVISION'S ADDRESS, SHOWN ON PAGE 56.

✂ Please send me a membership application.

NAME .....

ADDRESS .....

..... P/code .....

Call Sign (if any) ..... [AR 1-11/97]

multimeters, worth \$2340 in total, have been generously donated by Philips Electronics Australia's Test and Measurement division. The Fluke 12B measures AC and DC voltage (with auto-selection above 4.5 V), resistance and capacitance (.001-1000  $\mu$ F). The instrument features a simple rotary dial, a 4000-count liquid crystal display, and diode and continuity testing. Its "continuity capture" feature indicates intermittent open and short circuits. It comes with test leads and a two-year warranty. Fluke is the world's pre-eminent manufacturer of digital test instruments and the Model 12B is from their recently-released range of hand-held instruments.

Every newcomer to electronics and amateur radio needs a good multimeter, and every seasoned enthusiast could always do with another one!

The TM-733A dual-band FM transceiver, kindly donated by Kenwood Electronics Australia, offers both FM voice operation as well as 1200 and 9600 baud connection for a digital modem or terminal node controller (TNC) for packet radio operation. The rig provides 50 watts output on the 2 m band and 35 watts output on the 70 cm

band. Ten watt and 5 W settings are also available. The TM-733A features simultaneous dual-band VHF-UHF reception, as well as dual-channel reception on VHF or UHF. The front panel features a large, high visibility liquid crystal display showing VHF and UHF operating frequencies and key operational functions. The frequency synthesiser features selectable frequency steps of 5, 10, 12.5, 15, 20 or 25 kHz. There is auto repeater offset for 2 m, and switches to set repeater-reverse and repeater offset. To optimise reception under different conditions, you can select high sensitivity to cope with weak signals, or "high intercept point" to cope with strong-signal, adjacent channel interference.

The TM-733A has 70, 6-in-1 multi-function memory channels. A multi-scan reception function provides for scanning a full band, memory channel scanning, "MHz scan", etc. The TM-733A operates from 13.8 Vdc and is ideal for mobile, portable or home use by amateurs holding any grade of licence. For any not-yet-licensed Associate member who may win the transceiver, the WIA trusts that they will make responsible use of the equipment.

commences transmission one minute after 4U1UN. JA2IGY is readily copied in Australia.

The New Zealand five-band HF beacon, ZL6B, arrived in the country late last year and was anticipated to be on-air by now. It has time slot 5, commencing 40 seconds after 4U1UN.

A transmission consists of the call sign of the beacon sent at 22 words per minute, followed by four one-second dashes. The call sign and first dash are sent at a power of 100 watts. The remaining dashes are sent at 10 watts, 1 watt and 0.1 watts. The 10 dB power steps are precise, and are useful for judging band propagation conditions (how much or how little power can be used for a given signal-to-noise ratio), or for S-meter calibration.

As of early December last year, a total of 12 five-band HF beacons were operational: 4U1UN UN (New York), VE8AT Canada, W6WX California, KH6WO Hawaii, JA2IGY Japan, ZS6DN South Africa, 5Z4B Kenya, 4X6TU Israel, OH2B Finland, CS3B Madeira, LU4AA Argentina, and YV5B Venezuela. New Zealand (ZL6B) has received their equipment, as has Sri Lanka (4S7B). Equipment for Peru (OA4B) was ready to ship late last year. A site for a station in the People's Republic of China (BY) is being located. The Heard Island beacon (VK0IR) is using the time slot which will eventually be used by a Russian beacon.

Equipment used at each beacon site consists of a Kenwood TS-50S transmitter, a Cushcraft R-5 vertical antenna, a Trimble Navigation Accutime GPS receiver (satellite global positioning system, for accurate timing), and a controller built by the project coordinators, the Northern California DX Foundation (NCDXF). The International Beacon Project is a cooperative venture between the NCDXF and the International Amateur Radio Union. Further information and regular updates are obtained from the NCDXF's Internet site at [www.ncdxf.org/beacon.htm](http://www.ncdxf.org/beacon.htm) or the NZART's Internet site at [www.nzart.org/nzart/ar\\_ww/iaru/beacon.html](http://www.nzart.org/nzart/ar_ww/iaru/beacon.html)

## International HF Beacon Project Progresses

The HF beacon, which will become the Australian link in the five-band International Beacon Network chain, was licensed in early December, being issued the call sign VK6RBP. The equipment is expected to arrive in Australia from California early this year, and will be installed at the Roleystone repeater site of VK6RHF/VK6RAP.

Meanwhile, this month the Heard Island DXpedition is expected to activate a temporary five-band HF beacon, VK0IR, during their stay on the sub-antarctic island.

The HF beacons transmit on five bands in sequence, ten seconds on each band, over a 50-second period. The

frequencies are 14.100, 18.110, 21.150, 24.930 and 28.200 MHz. The 18 planned beacon stations in the International Beacon Project (IBP) network each have an allocated 50-second time slot in the three minutes necessary for all to transmit. The transmission sequence repeats every three minutes. The first beacon in the sequence list (time slot 1) is 4U1UN, atop the United Nations tower in New York.

The Heard Island beacon, VK0IR, has time slot 8, immediately following JA2IGY, located near Tokyo, Japan. JA2IGY is presently only licensed to transmit on 14.100 MHz, and

# Well-known Amateur, Neville Williams VK2XV, SK

Electronics publishing industry identity. Neville Williams VK2XV, passed away early in November. He was known to many amateurs, and many in the electronics and broadcasting industry, for his long association with *Electronics Australia*.

Born in 1911, his interest in technology was awakened as a young boy from being around the picture theatre set up by his grandfather and father in the country town where the family lived. Neville completed his education in Sydney and joined a wireless receiver manufacturer, later moving to the Amalgamated Wireless Valve Co (AWV), where he worked on the production of data sheets and the publication which became the radio industry's "foundation text", *The Radiotron Designers Handbook*, edited by Fritz Langford-Smith.

For two years before joining *Radio and Hobbies in Australia* in 1939, Electronics Australia's forerunner, Neville contributed regular articles. Soon after Neville joined the magazine, the then Editor, John Moyle, left for war service leaving Neville in the Editor's chair for the duration.

When television came to Australia in 1956, Neville was ready with a build-your-own TV set project, which was published in the magazine. He returned to the Editor's chair following the death of John Moyle in 1960 (whom the WIA annual National Field Day commemorates). The magazine became *Radio, TV and Hobbies in Australia*, in keeping with developments, and then Electronics Australia in the 1960s, recognising the impact of the then-burgeoning solid-state technology.

During the early 1970s, Neville instigated a number of new publications. *Modern World*, which had only a short life owing to insufficient advertising support, then two trade journals: *Electronics News* followed by *Broadcast*

*Engineering News*, both of which are still vigorous, industry-leading publications more than 20 years on.

Neville retired in 1983, but continued making regular contributions to *Electronics Australia*, *Silicon Chip* and other

## Spectrum on the Auction Block

In November, the Spectrum Management Agency (SMA) advertised in the national press inviting applications from people and organisations interested in participating in the first issue of spectrum licences in Australia, which will involve the auction of licences for two, 4 MHz wide bands at 500 MHz. Registration for this first spectrum licence auction closed in December and the auction process is anticipated to take place early this year.

The two bands involved are 501-505 MHz and 511-515 MHz. They have been divided into a range of bandwidths, from 12.5 kHz to 1 MHz, both bands being available for licensing in 17 geographical areas across Australia. Prospective licensees will be able to bid for spectrum usage by band, bandwidth and geographical area. Some 900 separate licence "lots" will be available for purchase at auction.

Successful bidders will be able to determine the use of the spectrum within the band and geographical region set by the core conditions of the spectrum licence. Licensees will be able to trade the licences, as well as sub-let channels or bands in any or all geographical areas set by the licence.

Bidding will be conducted Australia wide on a computer-system hookup. Interested bidders who don't have a computer are able to make telephone bids. The multiple-round-simultaneous auction system was devised by the US's Federal Communications Commission

publications, contributing a last story to EA shortly before his death. Neville is survived by his wife and their children. Among those at his well-attended funeral was audio and broadcast industry identity, Neville Thiele, retired electronics industry identity, Geoff Woods, long-time EA amateur radio columnist, Pierce Healy VK2APQ, current EA Editor, Jim Rowe VK2ZLO, and retired ex-EA staffers, Phil Watson VK2ZPW and Ian Pogson VK2AZN. Attending for the WIA, was Roger Harrison VK2ZRH.

(FCC). Money paid by successful bidders goes to government revenue. Spectrum licences have a term of 10 years, without automatic renewal, when they may be auctioned again.

This first spectrum licence auction is being viewed as a "practice run" for further auctions of spectrum likely to be highly valued by telecommunications carriers following deregulation of the industry from 1 July 1997, when coming changes to the Telecommunications and Radiocommunications acts take effect.

Also last year, the SMA sought public comments on proposals to release spectrum near 1.8 GHz to provide for new telecommunications services from 1 July 1997.

The introduction of spectrum licensing, initiated by the 1992 Radiocommunications Act, has not been without some controversy while being cautiously welcomed by industry. The 10-year licence term is widely considered as too short, pressuring licensees to use the least-cost technology in order to maximise their financial return within the 10-year term. The lack of certainty of renewal occasions similar pressures. Both these things do not encourage efficient use of spectrum, according to industry criticism. In addition, there were questions over the technical framework, settlement of interference disputes and compulsory registration of equipment.

# Meeting Date Set to Present Licensing Submission to Minister

The WIA will meet with the Minister for Communications and the Arts, Senator Robert Alston, on 12 February to present the completed submission on Amateur Radio Service licensing.

WIA Federal President, Neil Penfold VK6NE, faxed a letter to Senator Alston on Monday, 2 December last, the day Parliament resumed after the November recess. In his letter to the Minister, the President said: "I am writing to seek a meeting to present the completed submission to you at the earliest available opportunity, particularly in

view of the foreshadowed changes to the Radiocommunications Act."

The Minister's office replied two days later on Wednesday, 4 December, setting the meeting date for 12 February. It will be held at the Minister's electoral office in Melbourne. This will be in the week following the Federal WIA Extraordinary Convention, being held over the weekend of 8-9 February.

Copies of the finalised submission have been sent to each Division for consideration before it is presented to the Minister.

## New Devices Class Licensed for 13 cm and 6 cm Bands

Radio transmission systems used in "wireless" data and computer network systems, operating in the 2400-2483 and 5725-5875 MHz ranges, have been provided a Class Licence by the Spectrum Management Agency. These are in the 13 cm and 6 cm amateur band allocations, but amateurs have access to these bands only on a secondary basis.

The SMA said the new Class Licences were introduced to support growing demand for short-range devices used in radio local area networks,

wireless PABXs, barcode reader and point-of-sale network applications. The new Class Licences cover equipment using spread spectrum transmission, with transmitter powers of 200 mW in the segment 2463-2483.5 MHz, 4 W in 2400-2463 MHz, and 1 W in the 5725-5875 MHz band.

The 2400-2450 MHz band is designated an Industrial, Scientific and Medical (ISM) services band, while the primary service on the 5725-5850 MHz band is radiolocation, with amateurs as

secondary; 5850-5925 MHz is for fixed and fixed-satellite services. It seems 5725-5850 MHz is a recent ISM allocation.

While the SMA said, "The licence was developed in close consultation with industry representatives seeking to introduce these products in Australia and incumbent spectrum users, in order to establish a basic interference management regime within the licence that would satisfactorily manage the potential for interference between all spectrum users in these bands," the WIA did not hear of them until the new Class Licences were announced.

Meanwhile, a European ISM band allocation at 433 MHz has brought UK car owners and dealers considerable consternation because continental cars sold in Britain had wireless key fobs which had people locked out of their cars when strong UHF transmissions blocked the radio key fob signal.

These radio activated key entry (RAKE) devices were allocated 433.92 MHz in Europe. In the UK, this is in the amateur 70 cm band, while closely adjacent bands are used by mobile radio networks and the Ministry of Defence. It was reported in the middle of last year that people were finding themselves locked out of their new cars all round the country.

A committee has been set up to deal with the problem, called the RAKE committee. Members include the Radio Society of Great Britain, the Royal Auto Club, the Society of Motor Manufacturers and Traders, and the Electronic Vehicle Security Association. WIA News expects to publish developments on the RAKE's progress later in the year.

ar

### ELECTRONIC SURPLUS STORE FOR SALE

\*Used Signal Generators \* Frequency Counters  
\* Multimeters \* Oscilloscopes  
\* Rectifier Testers \* C.B. Radios  
\* Plus Lots More

ALL AT CHEAP PRICES

26 CARDIGAN STREET, CARLTON VIC. 3053  
PHONE: (03) 9663 6607 FAX: (03) 9663 5468

### Valves

Rectifiers, RF & AF amplifiers  
RF Finals, YES! EVEN 807's  
W. Spedding VK2NLS

speddo@ozemail.com.au

Phone: (068) 45 1104

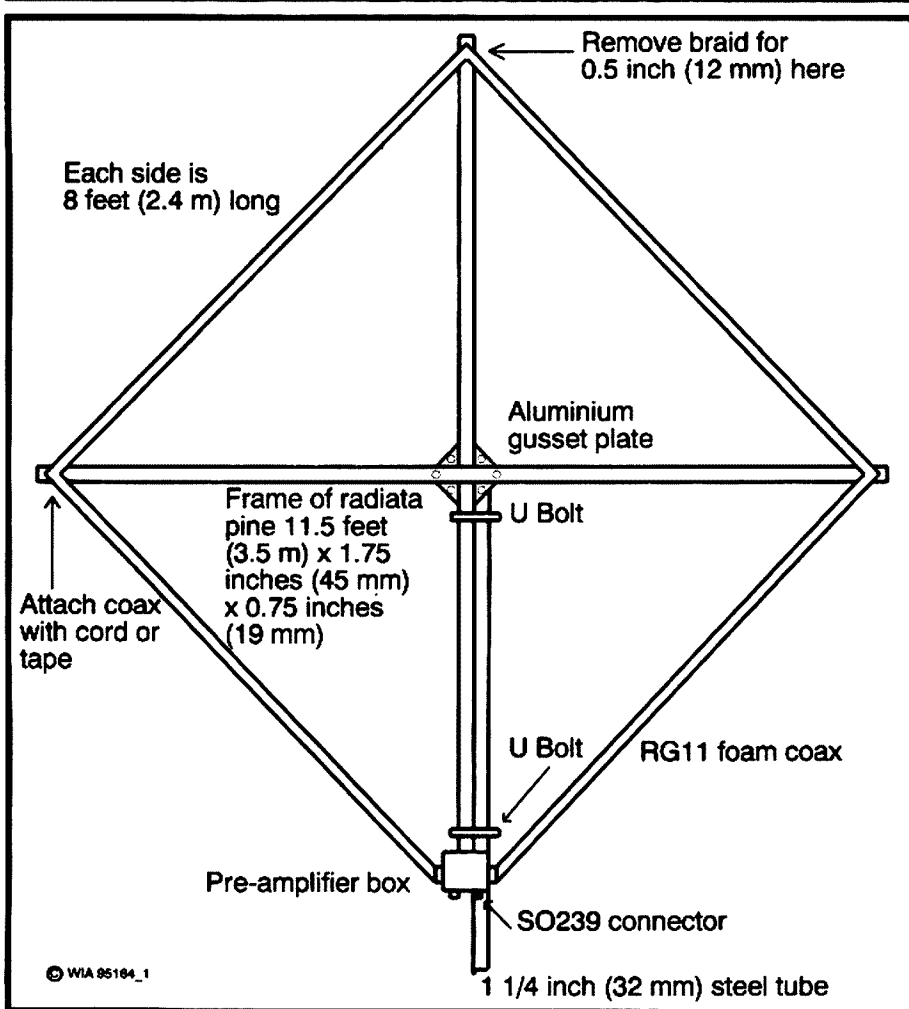
Fax: (068) 45 4210



## Antennas

# A Shielded Loop for 160 Metres

Ian Berwick VK3ALZ\* describes a compact receiving antenna for 160 metres.



**Figure 1 - Shielded loop construction.** Pine timbers should be thoroughly painted with UV resistant paint to prevent deterioration. This timber is available at most hardware stores.

The shielded loop is not new. It is described in the *ARRL Antenna Handbook*. However, I have made a study of it in order to maximise its performance.

There are two factors which are the key to loop performance. These factors are:

1. The area enclosed by the loop. The enclosed magnetic flux (and hence

the received signal), increases with this area.

2. The preamplifier. The loop is a resonant circuit and any induced voltage is magnified by the loop Q. We do not want the preamplifier input impedance to load the resonant circuit and hence reduce the Q. The signal level will be low in any case and so the preamplifier has to provide gain.

The loop, of necessity, will be some distance from the receiver. Therefore, the preamplifier output will typically have to drive up to 100 feet of coaxial cable. An emitter follower is required. Also, a high pass filter is required at the input to eliminate cross modulation due to high powered AM broadcasters.

Reverting to 1. above, the loop perimeter cannot be increased indefinitely. At a certain length, depending on the cable, the loop becomes self resonant at 160 metres. For the commonly available foam dielectric cables, this length is about 30 feet (9.144 metres).

The above requirements are incorporated into my design.

Briefly, the preamplifier consists of a dual gate FET tuned amplifier followed by a boot-strapped emitter follower. There is an elementary high pass filter at the input. The loop sees an impedance of approximately 20 kilohms, whilst the boot-strap reduces the loading on the FET tuned circuit.

The loop should be mounted 20 feet or more above ground level and be clear of metal structures. It should also be rotatable through 180 degrees. It is a great advantage to mount a compass on the rotator shaft as the loop can be more easily used as a direction finder for intruders. For further information, refer to my article on the *Adcock Finder* for the 10 metre band (*Amateur Radio*, March 1993, p17).

## Loop Design Equations

A:

$$C = \frac{736 * E * S}{\text{Log}_{10}(D/d)}$$

where

C = pF

E = dielectric constant

D = inner diameter of outer in inches

d = outer diameter of inner in inches

S = perimeter length in feet

B:

$$L = 1.9 * S * ((7353 * \text{Log}_{10} \frac{96S}{\pi * d}) - 6.386) * 10^{-8}$$

where

L = microhenries

This equation is for a circular loop. For a square loop, reduce L by 27 percent.

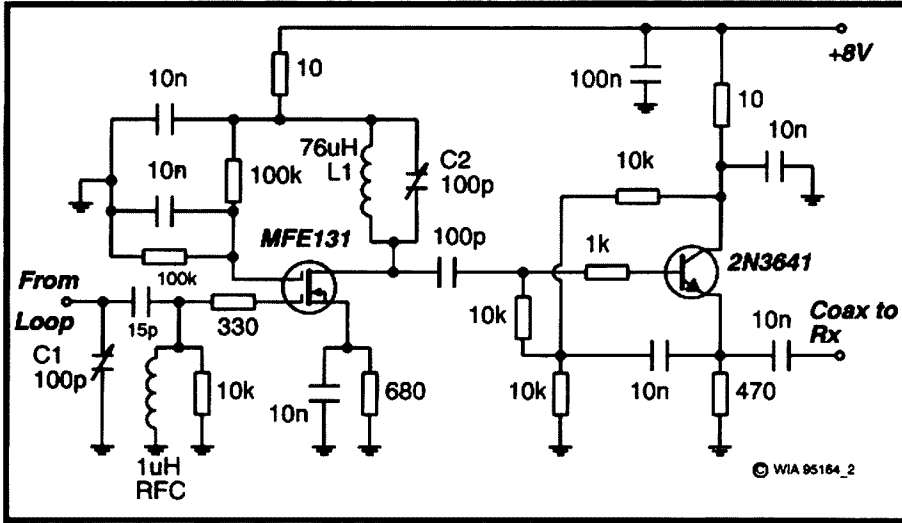


Figure 2

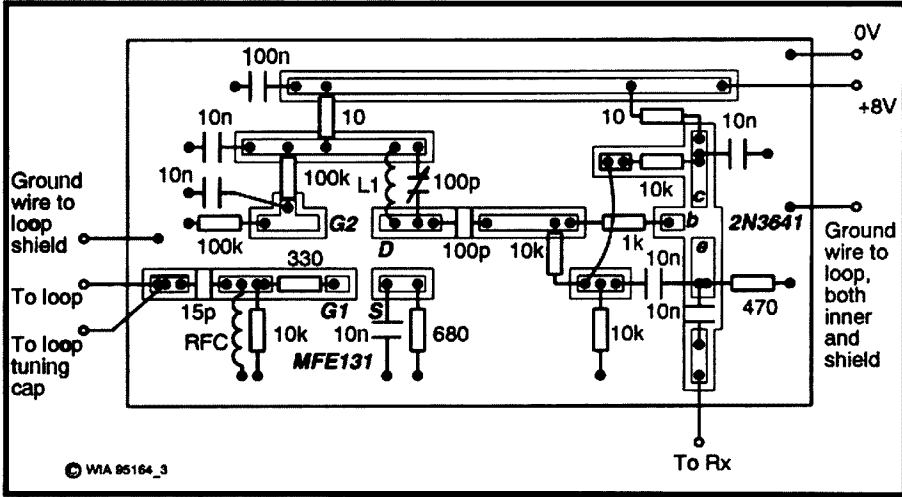


Figure 3

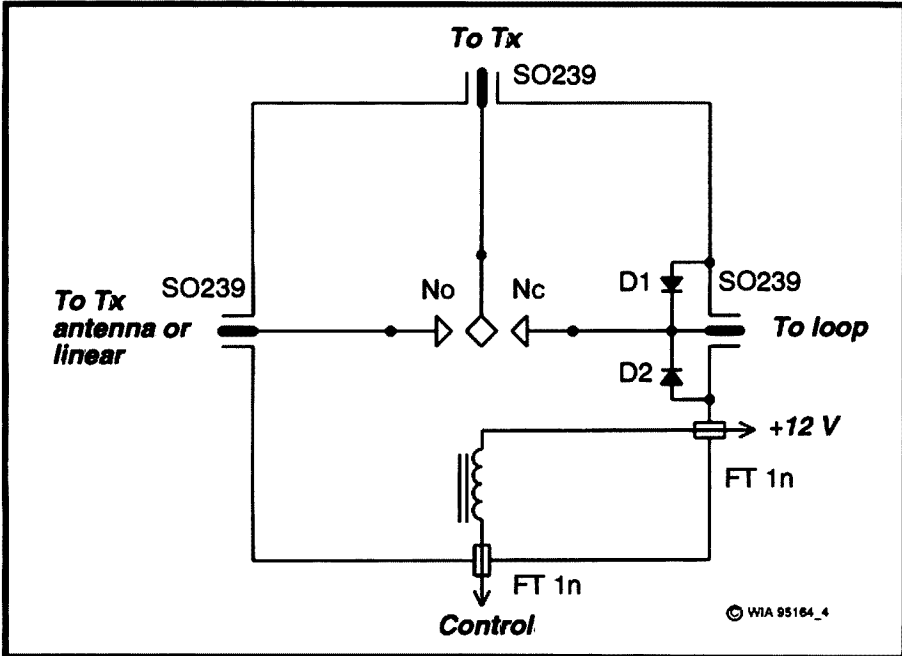


Figure 4

**DIAGRAM CAPTIONS**

Figure 2 - 160 m shielded loop preamplifier. 1 mH ex Dick Smith. L1 - wind on Amidon T68-2 core. C1 has to be an air variable, tunable from outside the box. For long runs of feeder coax, replace the 2N3641 with a larger transistor (100 mA 1c or more) and reduce R1 to 270 ohms. Resonate L1 C2 at 1840 kHz. Resonate loop at 1820 kHz with C1. This yields a passband flat within 4 dB over the 160 m band.

Figure 3 - PC board for the loop preamplifier. The 2N3641 mounts on the rear of the board - all other components can be on top. The PC board mounts in a 7" x 4.75" x 3" diecast box, along with C1 and three SO239 connectors.

Figure 4 - Switch box circuit. Back to back diodes (D1, D2 - EM401 or equivalent) protect the preamplifier in the event of a relay failure. The box is ex Dick Smith (catalogue No H2305), and the antenna change-over relay is also ex Dick Smith (catalogue No P8010).

C:

$$F = \frac{10^9}{2 * \pi * \sqrt{LC}}$$

where

L = microhenries

C = pF

F = Hz

F has to be greater than the maximum working frequency by about 10 kHz.

**Method for Using Design Equations**

1. Select a cable, say RG11 foam.
2. Make an estimate of S.
3. Compute C and L using equations A and B.
4. Substitute C and L in equation C to find F.
5. If F is too low, reduce S. If F is too high, increase S. Then try again.
6. Continue adjustments until F is correct.
7. If dissatisfied with S, try another cable.

\*107 Loongana Avenue, Glenroy VIC 3046

ar

**Have you advised the SMA of your new address?**

## QSP News

### Change to Apparatus Licences

The Spectrum Management Agency is planning to change the way in which licence conditions are imposed on Aircraft, Aeronautical and Amateur licences. It is proposed that Technical Licence Specifications will be replaced by Radiocommunications Licence Conditions Determinations. The new approach will require the revocation of the existing Technical Licence Specifications attached to these licences. The Spectrum Management Agency invites public comment on the revocation of the Technical Licence Specifications in accordance with section 180 of the Radiocommunications Act 1992.

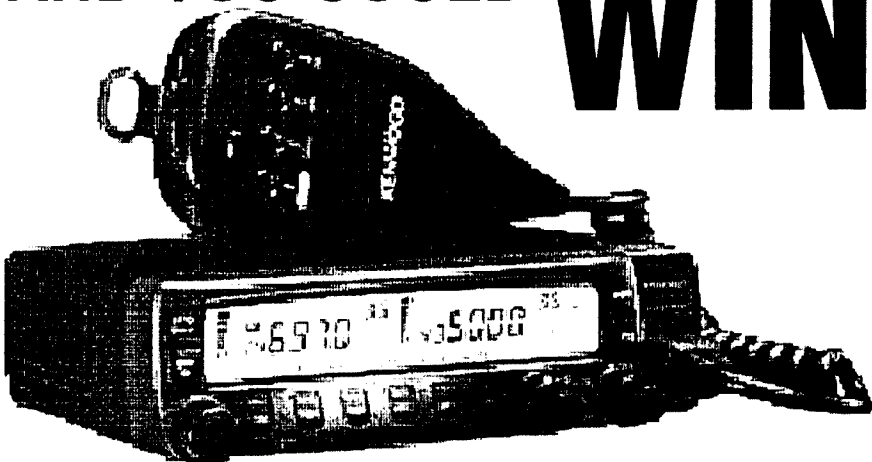
Amateur licence conditions are specified in a number of Technical Licence Specifications and in the *Radiocommunications (Licence Conditions) Determination No 1 of 1995* (formally conditions in the *Radiocommunications Regulations*). It is intended that they be included in a single Radiocommunications Licence Conditions Determination which will consolidate all conditions into one document. The licence conditions will remain essentially unchanged apart from some minor changes to clarify an existing condition or to correct typographical errors.

The new Amateur Radiocommunication Licence Conditions Determination will consist of one part that has common conditions and additional separate parts for each category of amateur station. Amateur licensees will be notified of the parts relating to their licence at the time the licence is renewed or updated. Licensees with multi-year licences will be advised in advance of the renewal of their licence.

The Spectrum Management Agency expects the Amateur Radiocommunications Licence Conditions Determination to be in place by early 1997. Copies of the Amateur determination will be available from any Spectrum Management Agency office shortly after it is gazetted.

Please send written comments to: Ray Wyeth, Business Directions Group, Spectrum Management Agency, PO Box 78, Belconnen ACT 2616. The closing date for comments is 31 January 1997.

# RENEW YOUR MEMBERSHIP AND YOU COULD WIN



**This outstanding KENWOOD TM-733A dual-band 2m/70cm FM/packet rig worth \$1255**

● 50 watts on 2m ● 35 watts on 70cm  
Simultaneous dual-band VHF-UHF reception  
Data connection for 1200/9600 baud packet radio

**All you have to do is renew your Division membership when it falls due.**

### MORE TM-733A FEATURES

- Switchable 10 W/5 W RF output
- 13.8 Vdc operation
- Large, high-visibility LCD panel
- Dual-channel Rx on VHF & UHF
- Automatic band change
- Multi-scan reception functions
- 70 multi-function memories
- Selectable frequency steps
- Audible frequency identification
- Auto repeater offset on 2m
- Repeater reverse & offset switches
- Tone signalling (DTSS).

TM-733A prize kindly donated by Kenwood Electronics Australia P/L, PO Box 504, Homebush 2140. Ph: (02) 9746 1888. Fax: (02) 9746 1509.

### WHO'S ELIGIBLE?

- members whose renewal falls due between 1/1/97 and 31/12/97
- current members who are on a 3-year membership
- life members
- all membership grades

The prize will be awarded by means of a draw, the result to be published and the prize to be presented to the winner at the first available opportunity early in 1998.



YOUR HOBBY YOUR VOICE

## Antennas

# Hybrid Antennas

*Have you ever wondered where your favourite antenna radiates? Ralph Holland VK1BRH\* provides some food for thought.*

### Introduction

Hybrid antennas are composed of elements that emit a mixture of horizontal and vertical polarisation. Radiation from these antennas has different mixtures of horizontal and vertical polarisation at different azimuth and/or elevation angles. Hybrid antennas have been reported to have a tendency towards omni-directional radiation patterns. This article presents computer simulations of some simple hybrid antennas.

### Simulation Parameters and Graphs

The simulations were performed by NEC-2 (Ref 1) for antennas composed of 1.22 mm loss-less wire elements at 14 MHz above average ground and sea water. Two ground parameters were specified for the simulations: relative dielectric constant and conductivity in millisiemens per metre; these are represented (in that order) in enclosed square-brackets. Eg [13,5] represents average clay soil, while [80,5000] represents sea water (Ref 2).

The graphical results show radiation efficiency and feedpoint impedances for various displacements; displacement is the term used for the distance between

the lowest point of the driven element and the ground.

In addition, three-dimensional antenna radiation patterns have been plotted for the total gain, which involves the summation of the response to both horizontally and vertically polarised signals. This gives a realistic indication of the HF antenna performance, as ionospheric propagation causes mixed polarisation. The graphs show the gain between 90 and 10 degrees elevation (inclusive), in steps of 10 degrees, across the full range of 0 to 360 degrees of azimuth, in five degree increments.

### Half-wave Sloping Dipole (Sloper)

The basic half-wave sloper is a half-wave dipole inclined 45 degrees to the ground and is probably the simplest of all the hybrid antennas. When the sloper is fed in the centre its feedpoint resistance is greater than 75 ohms. This antenna has been reported as having a near-omni-directional radiation pattern based on measurements by several authors (Ref 3).

Fig 1 shows the efficiency of a sloping dipole as the displacement is varied. Fig 2 shows the feedpoint impedance of the sloper versus the

displacement for average ground [13,5]. Notice that it is quite inductive and hence can be shortened, with consequent reduction in feedpoint resistance.

Fig 3 illustrates the radiation pattern for the sloper displaced 0.09 wavelengths above average ground [13,5]. Fig 4 illustrates the radiation pattern for the sloper displaced 0.09 wavelengths above sea water.

### The VK3AM Marine Hybrid

This antenna is a bent half-wave dipole (Ref 4). The driven element is shaped like an L, with each side being one quarter of a wavelength. The antenna is oriented so the end of the bottom of the L points to 0 degrees azimuth (ie lies on the X axis), the remainder is vertical.

Fig 5 illustrates the radiation efficiency over average ground [13,5] and sea water [80,5000] at 14 MHz. Fig 6 demonstrates the variation of the feedpoint impedance with displacement for average ground [13,5]. The initial peak in the feedpoint resistance is almost eliminated when simulating over sea water and the resistance and reactance were substantially the same as the poorer ground.

Fig 7 illustrates the radiation pattern, for the hybrid at 0.09 wavelengths displacement for average ground [13,5]. Note that there is a severe hole in the pattern centred around 180 degrees azimuth. The hole is on the left-hand-side looking directly at the L. This hole, although it is reasonably severe, probably is not as bad as it looks.

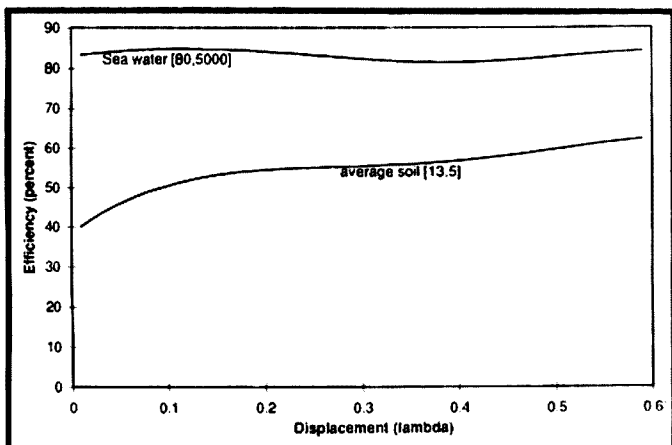


Figure 1 - Efficiency of sloping dipole.

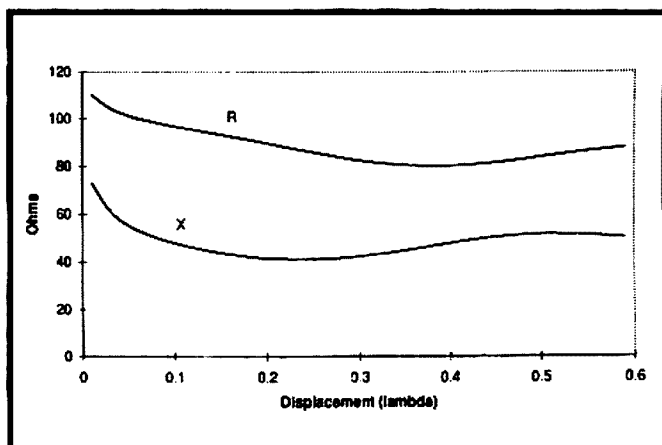


Figure 2 - Feedpoint impedance of sloping dipole

because at 10 degrees elevation the pattern recovers with -5 dBi gain.

Fig 8 illustrates the radiation pattern when the hybrid is displaced 0.09 wavelengths above sea water, a near-perfect ground [80,5000]. The low elevation pattern is remarkably ideal. Consequently, the elevation axis has been inverted (compared with Fig 7) to prevent obscuration of the lower gain at higher elevations. Notice that there are now two holes in the radiation pattern (0 and 180 degrees); but the holes appear at high elevations and are not severe.

This antenna would certainly be a good marine antenna since it has good low angle radiation, it is omnidirectional, and is reasonably efficient above sea water.

**V Antenna**

The traditional V antenna is mounted horizontally and each side is several wavelengths long. A less traditional V antenna has been modelled where each leg is only one quarter of a wavelength long and this antenna is mounted vertically.

Fig 9 illustrates the efficiency of the V antenna mounted above average ground [13,5] and above sea water [80,5000]. Notice that this antenna has slightly better efficiency than the Marine Hybrid (L).

Fig 10 shows the variation of feedpoint impedance with displacement above average ground. Fig 11 shows the radiation pattern for the antenna displaced 0.09 wavelengths above average ground, while Fig 12 shows the radiation pattern when mounted 0.09 wavelengths above sea water.

In Fig 11 notice that above average ground the gain varies between 5 dBi to -6 dBi from elevation angles of 90 down to 10 degrees (less than 2 S-points variation). In Fig 12 notice that the gain is higher at most elevations, except two holes appear in the same fashion as the pattern for the VK3AM Marine Hybrid. Again the holes are severe, but the pattern recovers at the elevation of 10 degrees where it is 10 dB down (1.7 S-points).

This antenna is relatively poor for DX compared to the VK3AM Marine Hybrid operating over sea water as the holes in the V antenna's radiation pattern appear at relatively low

elevations and the gain at low elevations has been reduced

**Half-wave Inverted L**

This simulated inverted L is not the traditional-type antenna that is used on low-bands but rather a half-wave inverted L which is fed at the apex. The feedpoint impedance will be close to 50 ohms.

Fig 13 illustrates the efficiency of this configuration versus mounting displacement above average soil and sea water. Fig 14 illustrates the feedpoint impedance for the antenna above average soil. Note that this antenna, too, has a feedpoint impedance largely independent of mounting height and consequently soil parameters.

Fig 15 displays the radiation pattern for the antenna mounted 0.09 wavelengths above average soil. Fig 16 displays the radiation pattern when the antenna is mounted 0.09 wavelengths above sea water. This antenna has less than 3 dB variation over its entire radiation pattern.

**Inverted V**

This inverted V antenna is a half-wavelength long and mounted at varying displacements above ground and fed at the apex. The feedpoint resistance should be around 50 ohms.

Fig 17 illustrates the efficiency of the antenna mounted at various displacements. Fig 18 demonstrates how the feedpoint impedance is relatively independent of the height above ground.

Fig 19 shows the radiation pattern when mounted 0.09 wavelength above normal ground [13,5]. Fig 20 shows the

radiation pattern when mounted 0.09 wavelengths above sea water [90,5000].

**Summary**

A summary of the total gain patterns has been provided in Table 1.

**Conclusions**

All these hybrid antennas have feedpoint impedances which are relatively independent of the ground parameters and mounting height.

The radiation patterns from some hybrids are almost omni-directional; most hybrids have near circular radiation patterns at higher elevations. The VK3AM Marine Hybrid and the Inverted L have good performance at low elevations over sea water.

Most of the hybrid antennas, however, have holes or dips in their radiation patterns; these variations can be smoothed out or eliminated by feeding identical elements at 90 degrees in phase quadrature (commonly called turnstile configuration). Such turnstile antennas will exhibit circular polarisation throughout their entire hemi-spherical radiation pattern.

**References**

- 1 *Computer program NEC-2*, G J Bourke, Lawrence Livermore National Laboratory, 1984.
- 2 *Short Vertical Antennas and Ground Systems*, Ralph Holland, Amateur Radio, October 95.
- 3 *The ARRL Antenna Book, 15 Edition*, Publisher: ARRL, 1988.
- 4 *HF Antennas for All Locations*, by L A Moxon, G6XN, on page 154, publisher RSGB.

\*8 Hardy Place, Kambah ACT 2902

Antenna	Ground	Max. Gain dBi	-3 dB Elevation	-6 dB Elevation	-9 dB Elevation	-12 dB Elevation
Sloper	[13,5]	> 2	70	52	40	10
Sloper	[80,5000]	> 3	57	10		
VK3AM L	[13,5]	0	85	70	60	50
VK3AM L	[80,5000]	> 4.5	<=30	<=45		
V	[13,5]	> 5	60	47	40	20
V	[80,5000]	> 8	60	50	45	40
Inverted L	[13,5]	> 2.5	90	40	12	
Inverted L	[80,5000]	> 3.5	<= 10			
Inverted V	[13,5]	> 4	60	40	30	10
Inverted V	[80,5000]	> 6	55	20	< 10	

**Table 1 - Summary of total gain.**

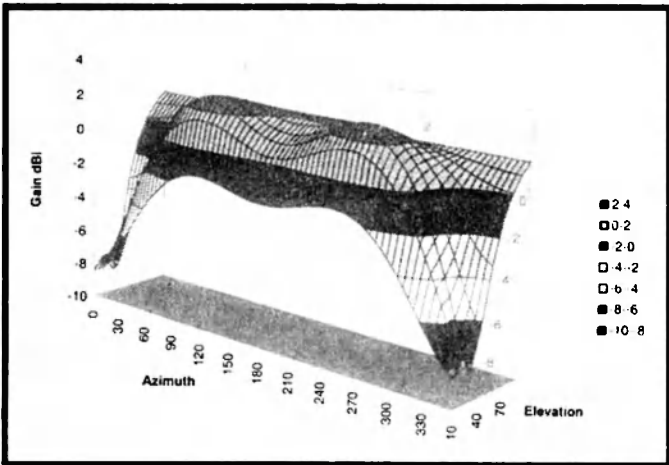


Figure 3 - Radiation pattern of sloping dipole 0.09 wavelength above average ground [13,5].

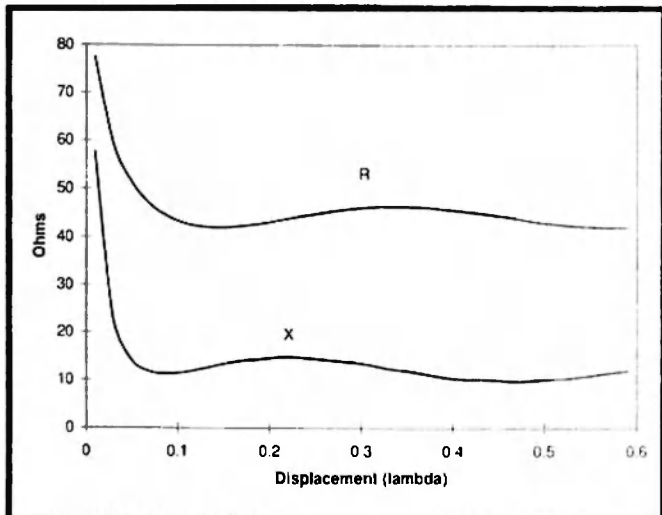


Figure 6 - Feedpoint impedance of VK3AM Marine Hybrid.

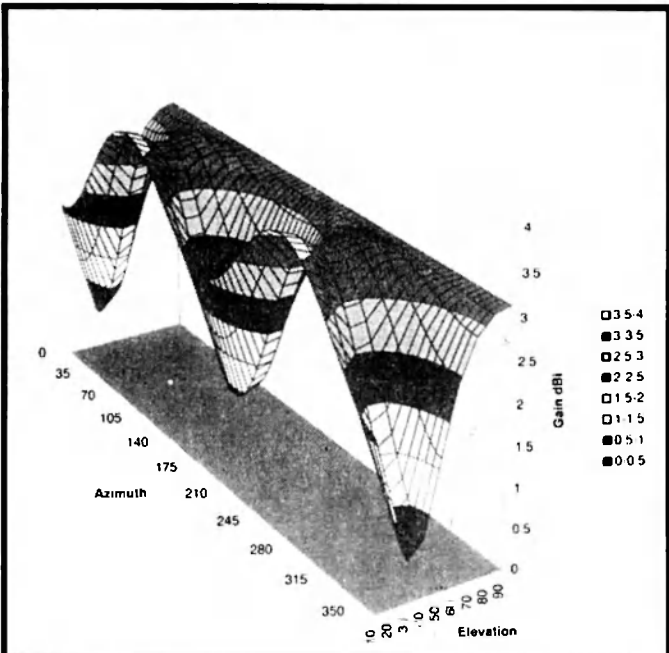


Figure 4 - Radiation pattern of sloping dipole 0.09 wavelength above sea water.

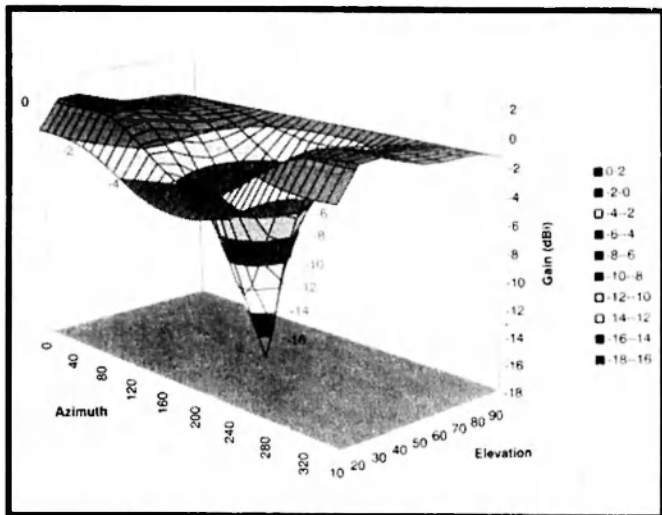


Figure 7 - VK3AM Hybrid Marine antenna 0.09 wavelength above average ground [13,5].

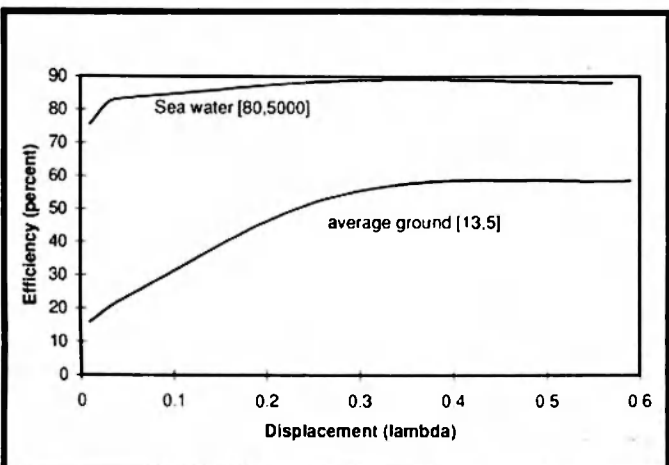


Figure 5 - Efficiency of VK3AM Marine Hybrid.

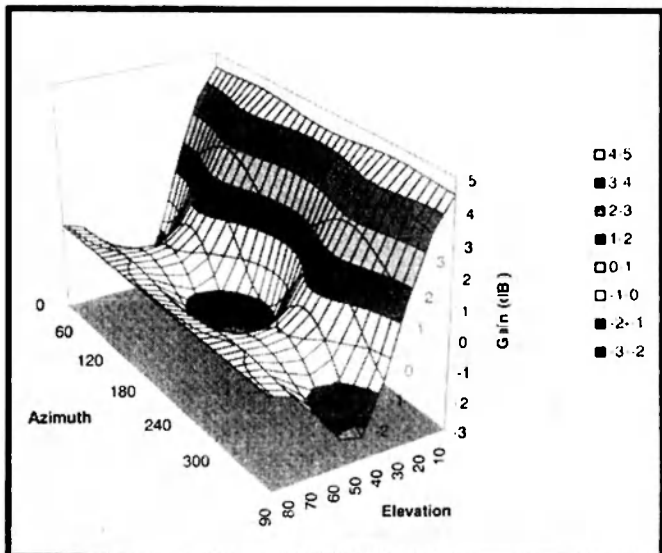


Figure 8 - VK3AM Marine Hybrid 0.09 wavelength above sea water [80,5000].

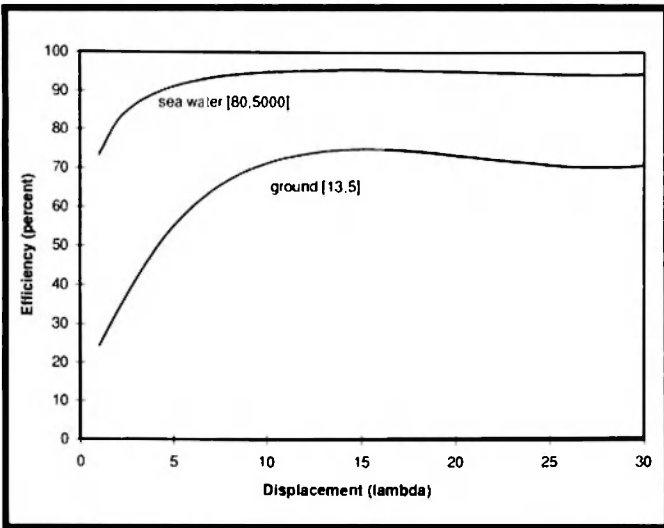


Figure 9 - Efficiency of V antenna.

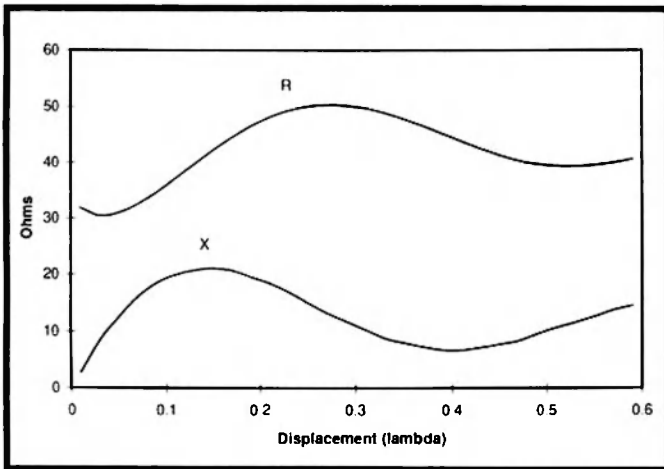


Figure 10 - V feedpoint impedance.

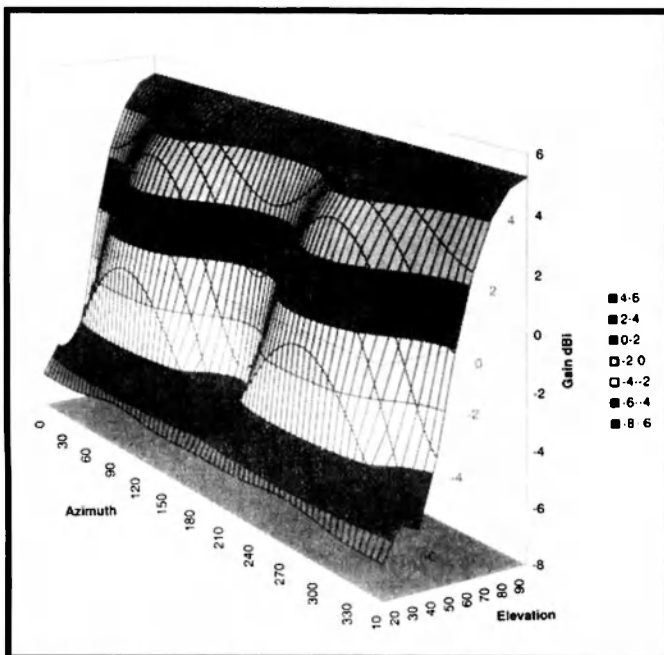


Figure 11 - V antenna 0.09 wavelength above average ground [13,5].

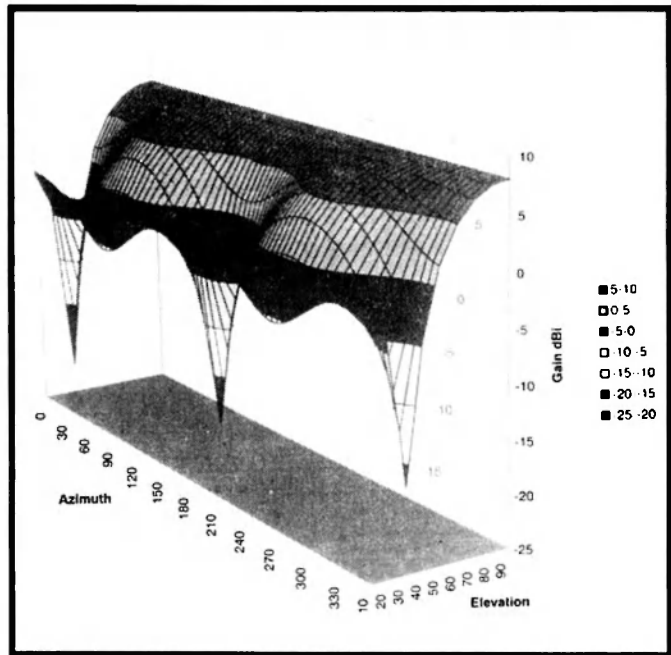


Figure 12 - V antenna 0.09 wavelength above sea water [80,5000].

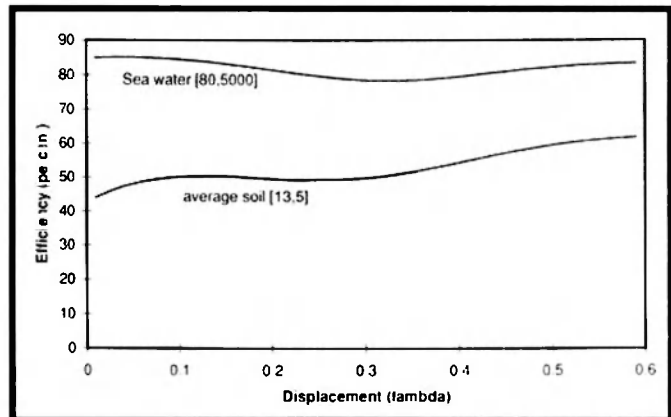


Figure 13 - Efficiency of half-wave inverted L.

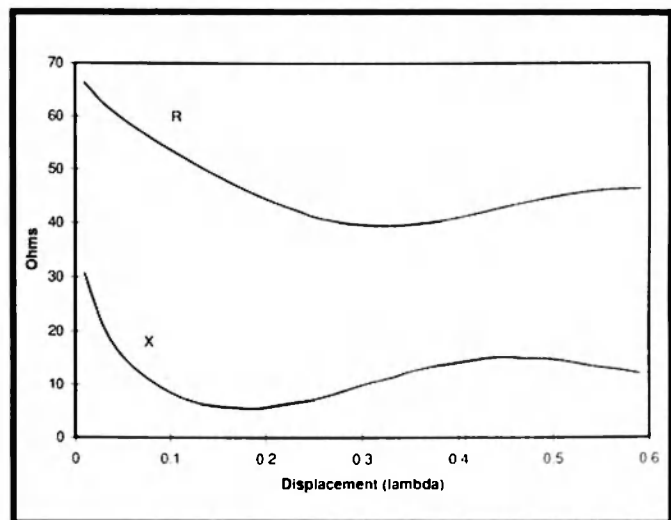


Figure 14 - Feedpoint impedance of half-wave inverted L fed at the apex above average ground [13,5].

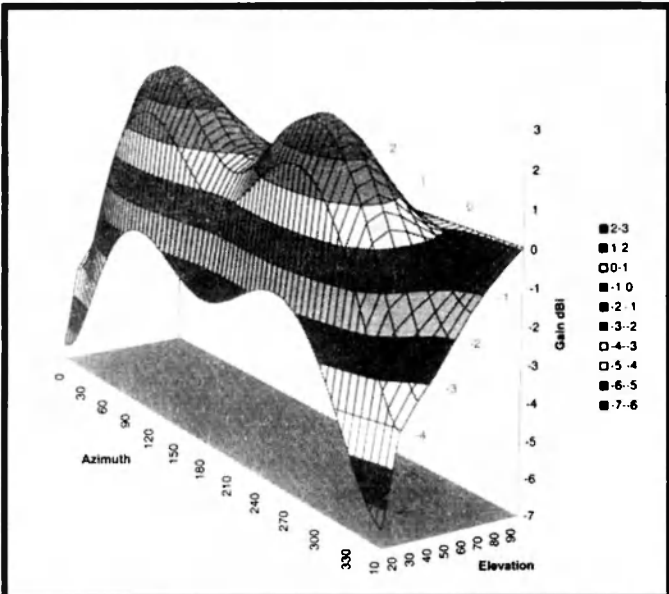


Figure 15 - Radiation pattern of half-wave inverted L above average ground [13,5].

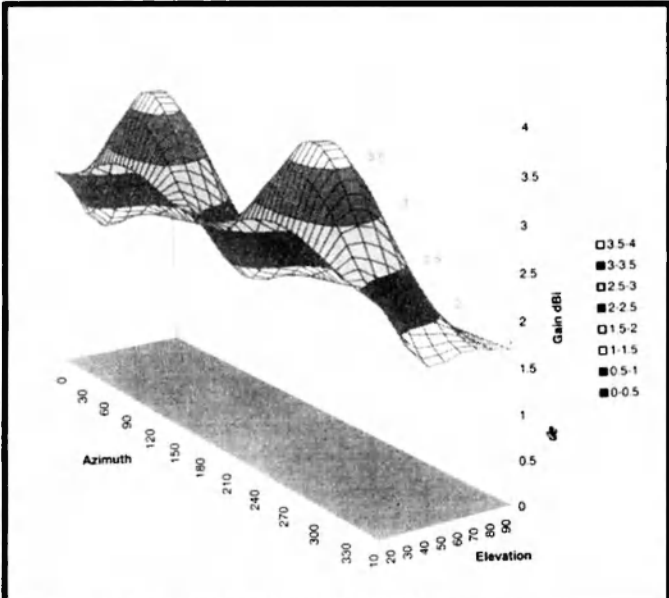


Figure 16 - Radiation pattern of half-wave inverted L above sea water [80,5000].

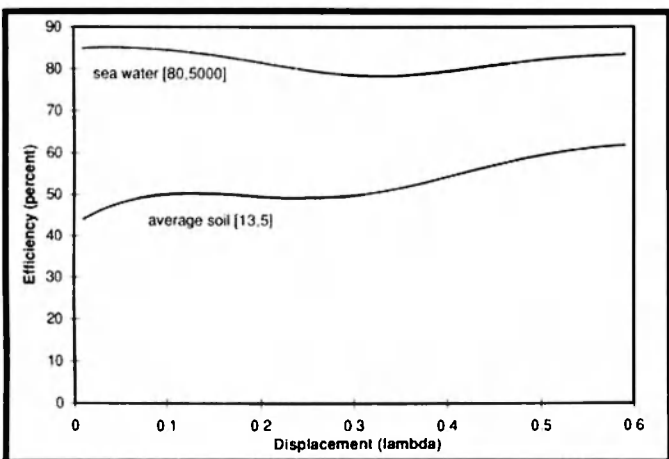


Figure 17 - Efficiency of inverted V

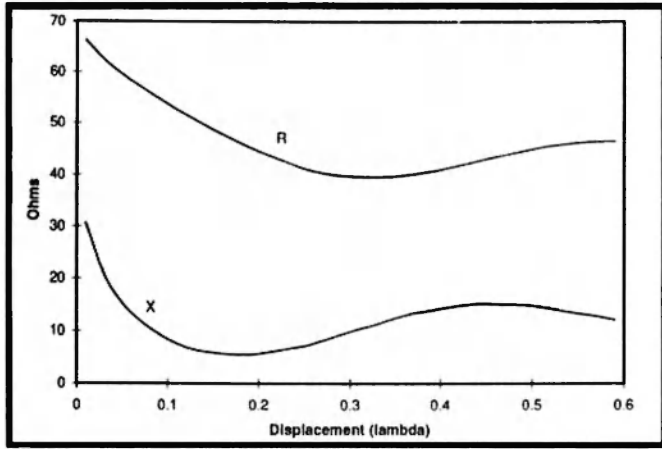


Figure 18 - Feedpoint impedance of half-wave inverted V dipole at 14 MHz above average soil [13,5]

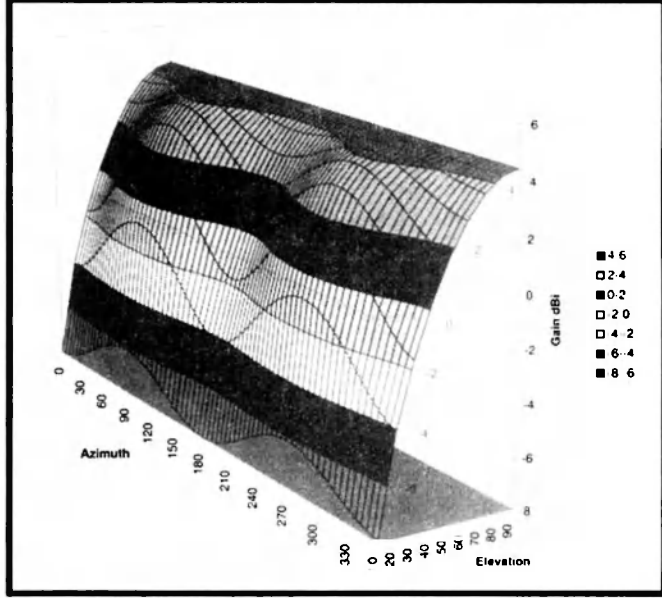


Figure 19 - Radiation pattern of half-wave inverted V above average ground [13,5].

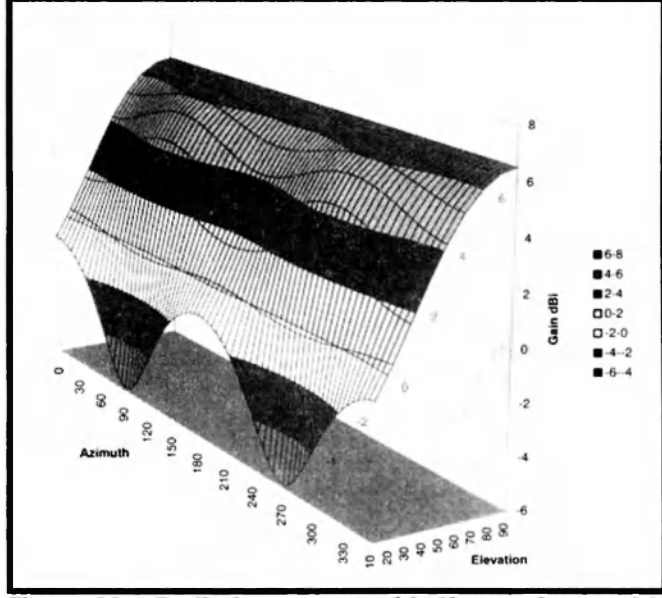


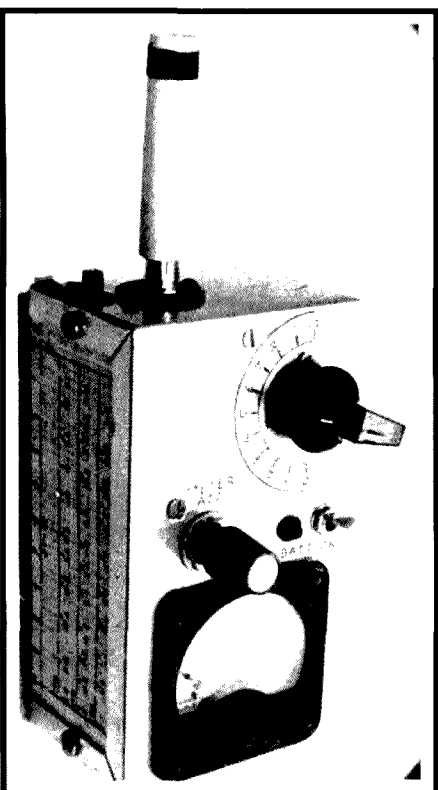
Figure 20 - Radiation pattern of half-wave inverted V above sea water [80,5000]



## ■ Test Equipment

# A Dip Meter Using the Lambda Negative Resistance Circuit

Lloyd Butler VK5BR\* describes a very useful piece of test equipment.



The lambda dip meter.

### Introduction

In the November 1995 issue of *Amateur Radio* I discussed negative resistance and oscillator circuits which made use of the negative resistance characteristic. One type of circuit discussed used the tunnel diode and, as a further application of this diode, many radio amateurs will remember the tunnel diode dip meter kit available in past years from the Heath Company.

These days the tunnel diode is a scarce item, probably unobtainable from the normal electronic suppliers. An alternative solid state negative resistance circuit can be achieved by interconnecting an N channel junction

field effect transistor (JFET) with a P channel JFET. This has been called the Lambda circuit because its characteristic curve looks something like the Greek upper case lambda (an upside down V Ed).

There have been various dip meter circuits published in radio amateur handbooks and in past issues of *Amateur Radio*. However, we haven't had one in *Amateur Radio* for some time and I thought I would introduce one around the concept of the lambda circuit. An advantage in using the negative resistance type of circuit, compared to one such as the Hartley, is that two terminal plug-in coils can be used.

I will first discuss the operation of the lambda circuit, then lead up to how an arrangement for the dip meter was devised.

As assembled, and using a range of six plug-in coils, the dip meter operates over a frequency range of 1.6 to 150 MHz. It can also be switched to operate as an absorption meter.

### Lambda Negative Resistance Circuit

Field Effect transistors can be classified between those which operate in the enhancement mode and those which operate in the depletion mode.

Enhancement mode means that the FET must be biased on to set the operating point for use as an amplifier (much like biasing a bipolar transistor). Depletion mode means that it must be reverse biased, or biased off, to set the operating point (as in a valve amplifier). The Junction FET or JFET operates in the depletion mode and, to reverse bias a JFET stage, it is only necessary to insert an appropriate value of resistance in

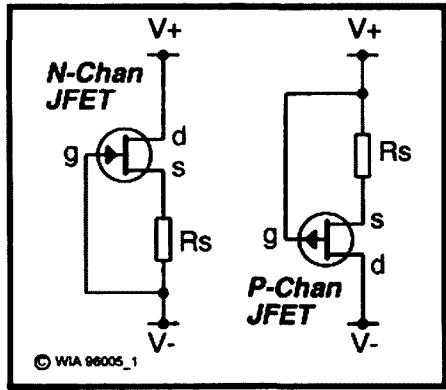


Figure 1 - Self bias, N Channel and P Channel JFETs.

series with the source electrode (much like cathode bias in a valve stage).

Fig 1 shows a P channel JFET and an N channel JFET, each with a source bias resistor Rs. The only difference between the two circuits is the polarity in connecting to the supply rail. Voltage is developed across Rs and applied across the gate-to-source junction in reverse or depletion polarity. Due to the reverse feedback, the drain current is stabilised at a value determined by the value of Rs.

Now, instead of Rs in the P channel JFET, let's replace it with the source and drain of the N channel JFET; and instead of Rs in N channel JFET, let's replace it with the source and drain of the P channel JFET. We now get the circuit of Fig 2, and this is our lambda circuit. Connected in this way, the two transistors interact with each other and produce an interesting characteristic.

The curve of Fig 3 shows the drain current versus drain-to-source voltage, which I plotted for an N channel MPF102 transistor and a P channel 2N4342 transistor connected in the lambda circuit. Up to point A, the drain current increases as the voltage is

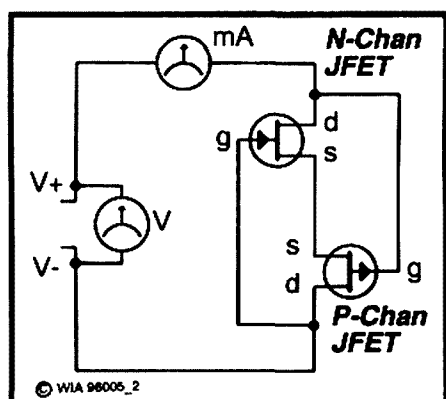
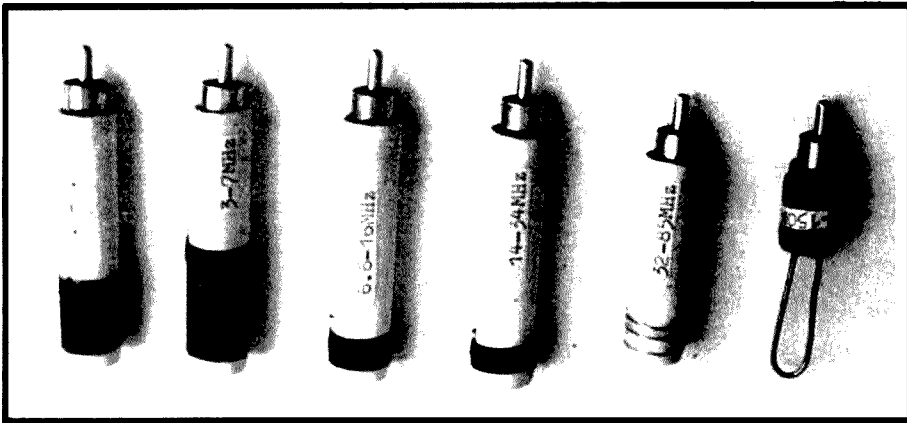


Figure 2 - The lambda negative resistance circuit.



**Coils for the lambda dip meter.**

increased. Beyond point A, the current then decreases, with further voltage increase creating a negative slope and the negative resistance region A-C. The amount of resistance can be scaled off by taking the ratio of voltage change to current change along curve A-C and this is a value of around minus 600 ohms.

To make a negative resistance oscillator, we simply connect a tuned circuit in series with the lambda circuit, and the drain-to-source supply, and set the supply voltage at, say, point B, around four volts. Provided the parallel resistance of the tuned circuit at resonance is somewhat greater than 600 ohms, the circuit will oscillate and the oscillator circuit formed becomes the basis for our dip meter.

In principle, it is similar to the tunnel diode dip meter, but different because it requires around four volts as compared to the tunnel diode voltage of somewhat less than one. For more detail on the

theory of negative resistance oscillators, I refer you to my article in November 1995 *Amateur Radio*.

**Dip Meter Circuit**

The circuit of the dip meter is shown in Fig 4. In my circuit I have used an N channel MPF102 (V1) and a P channel 2N4342 (V2). I was hoping to make my unit work well up into the VHF region, and there were a number of readily available and suitable N channel JFET transistors which could have been used. I selected the MPF102 because I happened to have these. P channel JFETs seem to be more scarce and the only one I could find in the catalogues of the usual retail outlets was the 2N4342.

I was a bit dubious about using the 2N4342 as it was shown in my data sheets as a general purpose transistor and there was nothing to indicate how it might perform at high frequencies. With little else to choose, I bought some of

these and gave them a try in the lambda oscillator circuit. As it turned out, I was able to make the circuit work at frequencies as high as 200 MHz.

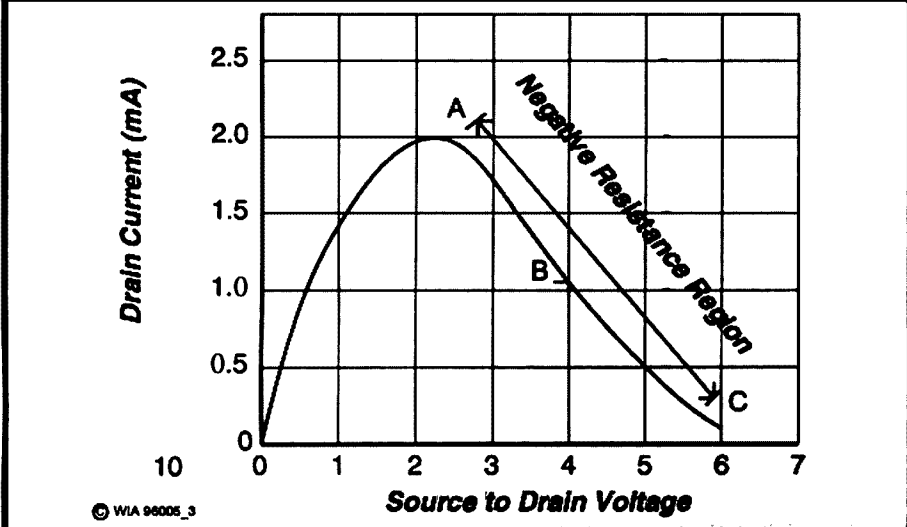
To cover the tuning range in conjunction with plug in coils, a 100 pF variable capacitor (C2) is used. The only limitation is that, on the top VHF band, the maximum setting of this capacitance must be limited to about 45 pF, as the circuit, at these frequencies, will stop oscillation if too much capacitance is used.

The dip meter operates from a 9 V battery and the supply to the lambda circuit is stabilised by 5.1 V zener diode ZD1. To set the correct operating point, the lambda circuit supply is adjusted to 4 V with trimpot RV1. A switch, SW1, can be used to disconnect V1-V2 so that the unit can operate in an absorption mode. Components C1, SW1, V1, V2, and C2 are all part of the oscillator circuit and, as it operates up to VHF, the lead lengths to these components must be short and earthing carefully commoned. Interconnecting the MPF102 and 2N4342 works out quite well. Turn one 180 degrees to the other and the three leads on one connect directly across to the three on the other.

The idea of the dip meter is, when its oscillator coil is placed near another tuned circuit, that circuit absorbs some of the energy from the oscillator causing a dip in oscillation level when resonance of the other circuit is found. Monitoring of the DC load current to detect a dip is often used with class C oscillators. However, the lambda oscillator works essentially in a class A mode and its load current does not vary greatly with change in level of oscillation.

To detect a dip in the oscillation level, the output voltage across the tuned circuit is monitored using a detector circuit which converts the RF voltage to a direct current to actuate a micro-amp meter or milli-amp meter. To prevent the detector loading the tuned circuit, it is coupled via a source follower stage V3, another MPF102 FET.

Two detector circuits are shown. If a 50 or 100 micro-amp meter is available, circuit A does the job. For a 1 or 2 milli-amp meter, an additional current amplifier, V4, is needed and circuit B is used. In each case, the signal is rectified



**Figure 3 - Current plotted against voltage for the lambda circuit (JFETs MPF102 P Channel and 2N4342 N Channel).**

and filtered by voltage doubler C5, D1, D2, C6 and the following load resistance. For V4, almost any small signal silicon bipolar NPN transistor is suitable.

In explanation of one part of circuit B, the voltage developed across diode D3 forward biases the base of V4 to compensate for the residual voltage step set by its base-emitter junction. RV2 adjusts the sensitivity of the meter circuit so that it can be set at a suitable reading level.

Load current from the 9 V battery is approximately 14 mA.

**Dip**

As pointed out earlier, the oscillator will work provided the shunt resistance of the resonant tuned circuit is somewhat greater than the negative resistance value of 600 ohms. Tuned circuits of even quite low Q factor have a shunt resistance of much higher than this and, hence, almost

any practical inductor can produce oscillation. In effect, the feedback is greater than need be but the AC voltage developed is controlled because the voltage swing is limited by the extremities A and C on the curve in Fig 3.

As an oscillator source this is good, but it is not so good when looking for a dip in output level when some of the energy is absorbed by a circuit being measured. With so much feedback, the circuit is still able to deliver the full signal swing when energy is absorbed and, hence, there is little dip shown.

To produce a good dip, the shunt resistance of the tuned circuit is lowered to a point where the circuit just oscillates nicely and a little above the value which would stop oscillation. To achieve this condition, a resistor is shunted across the tuned circuit. As the optimum value of the resistor was found to be different for each band, the appropriate resistor for

each coil is fitted at its base as part of its plug-in module. The selected value varies from 1.6 kilohm to 4.7 kilohm and no resistance at all for the top VHF band.

**Coils**

In making up the coils, I was influenced by the style of construction used in the Heathkit meter. A long length of small diameter tube of some form of insulating material is used. At one end, a concentric RCA type plug is fitted which mates with an RCA socket mounted on the dip meter case. At the other end, the coil is wound and the coil leads are wired back to the plug. The long thin form of module makes it convenient to poke in close to the coil to be dip tested.

Finding a source of supply of small diameter insulating tube seemed to be a problem. Eventually I found a source of 0.5 inch (12.7 mm) diameter polystyrene tube at a local hobby train shop and this was ideal for the job. For the four coils

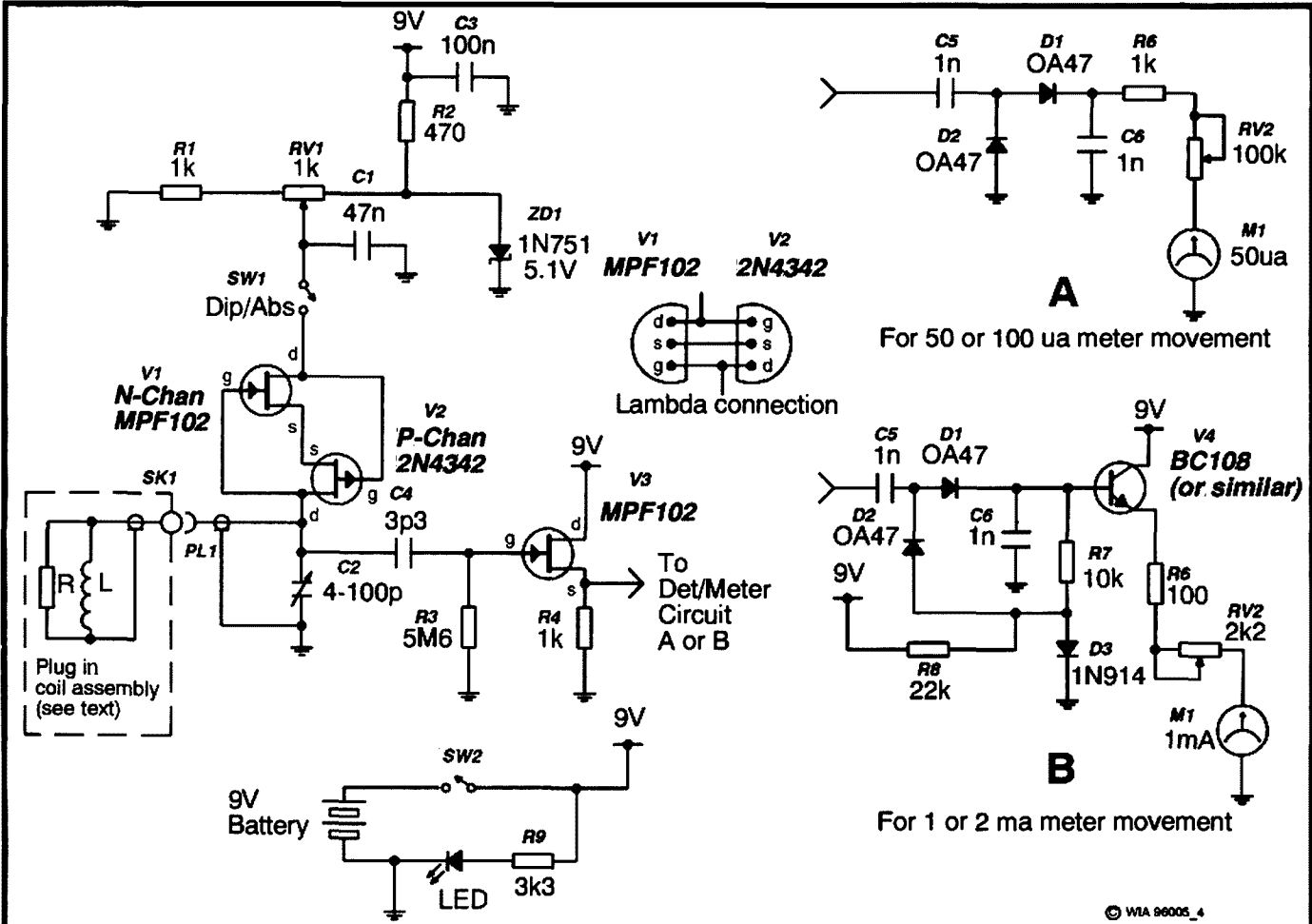
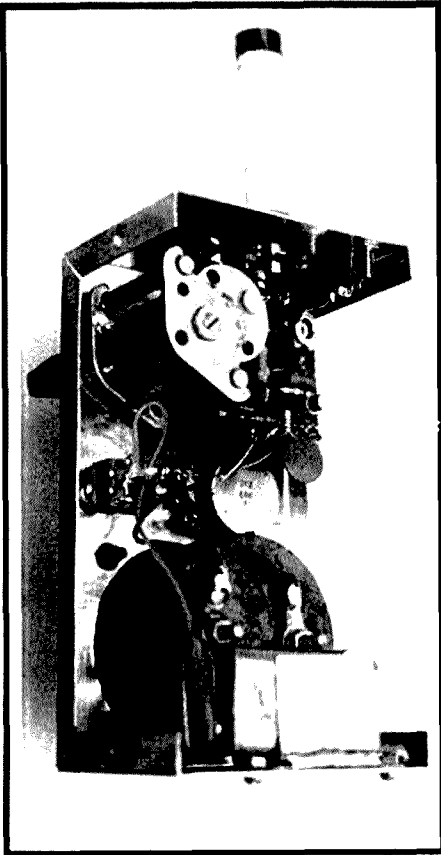


Figure 4 - Circuit diagram of the lambda dip meter. SK1 - PL1 are RCA type concentric plug and socket. The RV1 trimpot is set to 4 V



**The lambda dip meter with the cover removed.**

which covered 1.6 to 34 MHz, I cut the tubing to a 57 mm length. For the 32 to 85 MHz coil, where the length of the wire from coil to plug was an accountable part of the total inductance, I reduced the tube length to 46 mm. For the highest VHF band, there is no former and the inductor is just a wire loop.

Coils are wound on the tube with the active end 3 mm from the tube end. The winding detail is shown in Chart 1. The ends of the coils are passed to the inside of the tube through holes drilled in the tube. A small amount of fast Araldite (*trade name of Ciba-Geigy Corp*) fixes the end turns in place.

I stress the small amount as I tried smothering one in Araldite and found that the stray capacitance increased sufficiently to reduce the tunable range.

The RCA plastic plug cover is discarded and the resistor is soldered across the plug terminals. The leads from the coil, cut a little long, are also soldered across the terminals with the far end of the coil connected to the centre pin and the near end to the outer sleeve.

The remaining part of the plug

assembly, with resistor and wires attached, is pushed into the tube as far as it can go without covering the plug connecting section. If necessary, the insulating material around the plug can be filed down to fit the tube. One version of the RCA plug I had on hand fitted nicely, but a new more recently purchased version had to be filed. The plug is cemented in the tube with Araldite.

### Absorption Mode

With no shunt resistors across the coils, the instrument is very sensitive and has sharp tuning when operating in the absorption mode. Unfortunately, the need to add the resistors for the dip mode reduces the sensitivity and broadens the tuning in the absorption mode. The effect is most noticeable on the lowest two frequency bands. This is an unfortunate disadvantage, but one could easily make some extra coils without the resistor for absorption use on the low frequency bands.

In an effort to improve sensitivity in the absorption mode, I experimented with another scheme. The idea was to leave the lambda circuit in place for absorption mode and switch in a further shunt resistance sufficient just to stop the circuit from oscillating. The circuit then operated as a regenerative amplifier, increasing the sensitivity and raising the effective Q to make it sharper. A shunt resistance value of 2700 ohms was found to be suitable at HF but this had to be decreased to 1800 ohms at VHF to stop oscillation.

The idea worked quite well for HF, but it introduced a problem for the dip meter mode at VHF. The problem was introduced by the switch which switched out the extra resistor during dip operation. The few picofarads stray capacitance of the switch represented quite a low reactance at VHF. Hence, at these frequencies, the extra resistor wasn't really switched out and it upset VHF oscillation. Perhaps a low capacitance plug-in link in place of the switch might have been the answer, but I haven't persisted further with any tests along those lines. Anyway, I thought it was worth mentioning as a workable idea for an instrument limited to at least the HF range.

### Components and Assembly

The transistor circuit components were mounted on a small piece of matrix board of the type that has printed pads at each hole. Interconnection was then hard wired between pads. I stressed earlier the need for short leads around the oscillator circuit. Tag pins connected with short straps to the lambda FET stage, and at the edge of the board, were soldered directly to the RCA socket mounted on the dip meter box housing.

At VHF a common earth can be tricky. I had the oscillator circuit earthy end connected to the dip meter case at the RCA socket. It was also connected to case via the frame of the tuning capacitor. I initially experienced some form of anti-resonance with a drop out of oscillation near the middle of the 32-85 MHz band. I added a further common from the negative battery connection on the card to the case and the problem disappeared. At HF, wiring is not critical but, as frequency is increased into the VHF region, every wire strap is an inductance which might have to be taken into account.

Most of the main components used in the dip meter I had on hand. The small aluminium box measuring 134 mm x 75 mm x 55 mm was recycled from a past project and had originally been purchased from Dick Smith Electronics.

The miniature variable capacitor (measured capacitance range of 4 to 100 pF) and the meter were other recycled components. The meter was an old one, 56 mm square with a FSD of around 2 mA and an RF amp scale. I had a nice 50 micro-amp meter but it was too large to fit into the box, so I used the smaller 2 mA one with the extra circuitry B shown in Fig 4. The meter is only an indicator and what is shown on the calibrated scale is unimportant.

Whilst I have personally used a few recycled components, those specified can be found in the catalogues of the retail electronics shops. The only questionable item is the 100 pF variable capacitor, which is a component often more easily obtained from a disposals source.

A value for the resistor across each coil has been nominated. However, in repeating the circuit construction, it is possible that the optimum value might

## Chart 1 - Coil Winding Data

1.	1.6 to 3.6 MHz	110 turns 40 B&S close wound Shunt resistor 1700 ohms
2.	3 to 7 MHz	68 turns 28 B&S close wound Shunt resistor 1600 ohms
3.	6.6 to 15.5 MHz	21 turns 28 B&S close wound Shunt resistor 2000 ohms
4.	14.3 to 35 MHz	8.5 turns 28 B&S close wound Shunt resistor 2000 ohms
5.	32.3 to 86 MHz	3 turns 22 B&S spaced to 8 mm long Shunt resistor 4700 ohms
6.	70 to 155 MHz	Wire loop 20 SWG TCC Length from plug terminals - 45 mm Loop width - 6 mm (av) No shunt resistor

vary with the spread of characteristics of the two JFETs in the lambda circuit. The value might also be different if the design of the coil is changed resulting in a different coil Q. Low level of oscillation, or no oscillation at all, could indicate that the value is too low. Little indication of a dip when coupled into a resonant circuit could indicate that it is too high.

### Calibration

To make the instrument useful, it must be calibrated on each tuning range against a calibrated frequency source or a calibrated frequency measuring device. The frequency source might be a signal generator or even another calibrated dip meter. The frequency measuring device might be a frequency counter or the radio shack tunable receiver.

Using a frequency counter, I found the easiest way was to place a one turn loop, connected to the counter, near the dip meter coil and then read off the frequency. Using the receiver, it is simply tuned in to find the dip meter signal. If the calibration of the receiver is not too reliable and a calibrated signal generator is available, just use the receiver as a monitor and reference the dip meter signal against that of the signal generator. There are various other alternative ways of doing the job.

The tuning dial must have some sort of scale and ideally the scale should show frequency calibration for each band. My box did not allow room for all this and I glued on a scale marked 0 to 10. The frequency scales were then plotted against the decimal scale on graph paper and glued to the sides of the box cover, three frequency bands on each side.

### Summary

The lambda negative resistance circuit and its application in a dip meter has been described. Using an MPF102 and 2N4342 JFET combination, a frequency range of 1.6 to 150 MHz has been achieved. The circuit will oscillate using almost any practical inductive coil but, to get a good dip when power is absorbed from the coil, it must be carefully loaded with resistance to produce a tuned circuit of the right resonant shunt resistance.

The loading resistors reduce sensitivity and broaden the tuning when the meter is switched to the absorption mode. This mode is a secondary function but the loss of sensitivity is a disadvantage. The sensitivity can be improved by using separate unloaded coils or operating in the dip mode with the lambda circuit loaded down further below the point of oscillation.

Two metering detector circuits have been included, one for a 50 micro-amp movement and the other with additional DC amplification for a 1 or 2 mA movement.

The dip meter is a useful instrument to have in the radio shack, particularly for those radio amateurs who build or tune up their own transmitting and receiving equipment. A discussion on the uses of the dip meter has not been included as this is well written up in amateur radio manuals.

### Footnote

The MPF102 and 2N4342 FET transistor pair used to obtain the curve of Fig 3, and used in the dip meter tested, were selected at random. Since writing the article, I have tested a number of

other individual pairs of the transistors and have noted that, whilst each pair exhibited the negative resistance characteristic, there was a considerable spread of results relative to the curve shown in Fig 3. In fact, one particular combination had a maximum current at point A of less than 1 mA and did not want to oscillate too freely.

What I am saying is that, whilst my pair worked fine right from first go, it might be necessary to substitute one transistor or the pair if any oscillation difficulty is encountered. Also, if a voltmeter and milli-amp meter are available, it is not too difficult to set up the test circuit of Fig 2 to have a look in advance at the characteristic, and hence suitability, of any pair selected.

### References

1. Lloyd Butler VK5BR - *Negative Resistance Revived - Amateur Radio*, November, 1995.

2. Samuel Dick - *Exploring Negative Resistance: The Lambda Diode - Elektor Electronics*, January, 1992.  
18 Ottawa Avenue, Panorama SA 5041

ar

## COM-AN-TENA

(formerly A. J & J Coman Antennas)

6M std 6 ele 40 mm boom	\$216
2M co/linear 2 5/8 7dbd	\$ 97
12 ele 2M broad B/width	\$135
6M 4 ele delta loop	\$221
6M 5/8 vertical - radial	\$157
6 ele 6 M N.B.S. 50 mm Boom	\$310
Duo 10-15 M	\$305
3 ele 15 M	\$214
3 ele 20 M	\$351
20 m log-yag array 11.5 dbd	\$765
M B Vert NO TRAPS 10-80 M	\$275
Tri band beam HB 35 C 5 ele	\$690
40 M linear loaded 2 ele	\$536
13-30 M logperiodic 9 ele	
all stainless/steel fittings	\$891
70 cm beam 33 ele 19.9 Dbi	\$228
2/3 cm slot fed 36 ele brass cons	
s/solder-assembled, 18 dbd	\$170
80 m top load/cap/hat vert.	\$260
Tri band 6 ele 6M boom	\$860
2 m 144.100 2.2 wavelength boom	\$145

When no answer on factory phone  
call on mobile 0419 542 437

Call ANDY COMAN VK3WH,  
LOT 6 WEBSTERS ROAD,  
CLARKFIELD 3429  
PHONE (03) 5428 5134

# Amateur Radio Annual Index 1996

Bill Roper VK3BR and Bill Rice VK3ABP\*

A tremendous amount of absorbing reading was published in the WIA monthly journal *Amateur Radio* during 1996, including WIA amateur radio news, members' experiments, construction projects and experiences, and special interest columns.

If you see an item in this 1996 annual

index which you want to read, and you cannot locate, or do not have that particular issue of *Amateur Radio*, back issues of the magazine are available from the WIA Federal Office to current members at \$4.00 each, which includes postage in Australia.

If a back issue is no longer in stock,

photocopies of articles are available to current members at \$2.50 each (plus \$2.00 for each additional issue in which the article appears).

The WIA is always looking for technical and general interest articles from members. For further details on how to write and submit an article about your latest construction project, experiment or amateur radio experience, refer to page 18 of the August 1992 issue of *Amateur Radio*, or contact Bill Roper VK3BR at 3 Tamar Court, Mentone VIC 3194, telephone (03) 9584 8928 during business hours, or Internet e-mail [vk3br@c031.aone.net.au](mailto:vk3br@c031.aone.net.au)

TITLE	AUTHOR	ISSUE	PAGE
<b>Administration</b>			
Canadian Authorities Delegate Some Admin Ops to Amateur Co	WIA News	Oct	06
Exposure Draft of Submission	Roger Harrison VK2ZRH	Apr	28
Federal Council Plans for 1997 and Beyond	WIA News	Dec	06
Government Proposes Changes to Radcoms Act: New Authority	WIA News	Sep	03
IARU Committee Looks at Future of the Amateur Radio Service	WIA News	Jul	03
IARU Region 1 Meeting	David Wardlaw VK3ADW	Nov	04
Impact on Some Services (Beacon and Repeater Fees)	WIA News	Dec	03
Minister Agrees to Meet With WIA About Licensing Submission	WIA News	Aug	03
Multi-year Licence Fees (Correction)	WIA News	Aug	05
Multi-year Licences and Late Payment Penalties Introduced	WIA News	Jun	03
Pressure from Broadcasters on HF Bands	WIA News	Jan	42
Spectrum Manager Responds to Licensing Submission	WIA News	May	03
Spectrum Tax Rises But Licence Fees Fall	WIA News	Dec	03
Submission on Licensing Circulated to Parliamentarians	WIA News	Apr	03
Submission on Licensing: Concerns and Questions Addressed	Roger Harrison VK2ZRH	May	19
Tariffs: Minister Replies to WIA	WIA News	Oct	07
Tariffs: President Calls for Letter Campaign to Parliament	WIA News	Aug	04
Victory for Amateur Radio at WRC	WIA News	Jan	25
Why the Members are at the Top	WIA News	Feb	32
WIA Federal 1995 Annual Reports		Jul	18
WIA Federal to Embark on Marketing Campaign	WIA News	Mar	04
WIA November Meeting with SMA	WIA News	Jan	50
WIA Submission to Department of Communications and the Arts	WIA News	Oct	10
WIA Talks with SMA Resolve Some Issues	WIA News	Aug	51
World Radio Conference Strategies Decided	David Wardlaw VK3ADW	Dec	04
<b>Antennas, Towers, Lines, Etc</b>			
A Rotary Clothes Hoist 20 Metre Ground Plane Antenna	Neville Chivers VK2YO	Jul	25
All Band Vertical	Keith Rehe VK4KL	Mar	10
An Optimised Sloper for 80 Metres	Felix Scerri VK4FUQ	Aug	16
Antenna Comparison	Technical Abstracts	Sep	19
Beer-Can Antennas	Sakari Mattila VK2XIN	May	16
Bytes and Pieces (Miscellaneous Antenna Information)	Random Radiators	Dec	18
Compact HF Antenna	Random Radiators	Aug	19
Diplexers	Technical Abstracts	Jul	14
Helix Antenna Design Development from John Kraus W8JK	AMSAT Australia	Feb	21
Homebrew Ladder Line	Technical Abstracts	Nov	15
Horizontal Antennas Above Real Ground	Ralph Holland VK1BRH	Oct	22
Horizontal Half-wave Dipole Above a Counterpoise	Ralph Holland VK1BRH	Nov	12
How to ... Load Up a Tree or Confuse Your Contact	Steve Bushell VK3HK	Mar	19
Output Balance on the Z Match	Lloyd Butler VK5BR	Apr	10
Problems with Coaxial Connectors	Random Radiators	Aug	19
Simple and Effective Two Band ATU	Random Radiators	Mar	15
Some Useful Wire Antennas for HF - Part 1	Rob S Gurr VK5RG	Mar	22
Some Useful Wire Antennas for HF - Part 2	Rob S Gurr VK5RG	Apr	06
Some Useful Wire Antennas for HF - Part 3	Rob S Gurr VK5RG	May	11
Strip Yagis	Technical Correspondence	Sep	51
The ARRL Compendium Vols 1, 2, 3 & 4 (Book Review)	Evan Jarman VK3ANI	Jun	18
The Ground Plane Antenna	Adrian Fell VK2DZF	Jan	07
The LENFO Revisited	Ian Berwick VK3ALZ	Sep	14

TITLE	AUTHOR	ISSUE	PAGE
The Maryborough Amateur Radio Club and JOTA	Col Paton VK4BCP	Nov	17
The VK4FUQ Two Metre Strip Yagis	Felix Scerri VK4FUQ	Jun	12
The Z Match Using a Toroidal Core Coil	Lloyd Butler VK5BR	Sep	11
Triband Trap Beams Again	Random Radiators	Oct	20
Vertical Antenna Classics (Book Review)	Bob Tait VK3UI	Sep	26
VHF Antenna in a Lunchbox – The Magnetic Loop on Two Metres	Lloyd Butler VK5BR	Jan	04
When a Tower Ain't a Tower	WIA News	Feb	09
<b>Awards</b>			
Amateur Radio Awards 1995	QSP News	Feb	18
Australia Day Honour for Amateur	Don Hopper VK7NN	May	23
City of Wagga Awards		Nov	25
International Award for Australian Amateur	WIA News	Sep	06
OAM for VK7RN	Editor's Comment	Jul	02
OAM for VK7RN	VK7 Divisional Notes	Jul	36
RSGB IOTA Awards Program		Nov	25
VI7SRAAF		Jan	31
WIA DXCC Listings		Aug	30
Wilkinson Award (VK5NY and VK6KZ)	WIA News	Mar	03
ZL 2000 Award		Dec	24
ZP Awards Program		Sep	33
<b>Book Reviews</b>			
Australian Amateur Radio Call Book 1997	Bill Rice VK3ABP	Dec	18
Practical Packet Radio	Gil Sones VK3AU1	Sep	24
Practical Transmitters for Novices	Evan Jarman VK3ANI	Mar	17
Shortwave Listening on the Road	Danny Vits VK3JDV	Aug	23
Test Equipment for the Radio Amateur	Bob Tait VK3UI	Jan	18
The ARRL Compendium Vols 1, 2, 3 & 4	Evan Jarman VK3ANI	Jun	18
Vertical Antenna Classics	Bob Tait VK3UI	Sep	26
<b>Computers and Programs</b>			
CAD Drawing	Repeater Link	Nov	42
Maidenhead Locator Program	John Martin VK3KWA	Dec	16
TST Host	Packet World	Jul	41
<b>Contests</b>			
11th Australasian CW and Phone Sprints		Jun	26
1996 Remembrance Day Contest Opening Address		Sep	17
20th West Australian Annual Contest		Jun	27
Addendum to Ross Hull Contest Rules		Jan	34
ALARA Contest Rules		Oct	32
ANARTS WW RTTY Contest 1995 Results		Jan	34
Commonwealth Contest 1995 Results		Jan	35
Commonwealth Contest 1996 Results		Nov	31
First South Pacific 160 m Contest Results		Dec	27
Jack Files Memorial Contest 1996 Results		Nov	31
John Moyle Contest 1996 Rules		Feb	25
John Moyle Field Day Contest 1996 Results		Aug	32
Maidenhead Locator		Mar	35
Remembrance Day Contest 1996 Results		Dec	30
Remembrance Day Contest 1996 Rules		Jul	33
Ross Hull Contest 1995-6 Results		May	33
VHF-UHF Field Day 1996 Results		May	34
VK Novice Contest 1996 Results		Oct	33
VK-ZL-Oceania DX Contest 1996 Rules		Aug	33
VK/ZL/O DX Contest 1995 Results		Apr	25
WIA VK Novice Contest 1996 Rules		May	32
<b>Digital Communications</b>			
A Radio Amateur's Guide to the World Wide Web	Richard Murnane VK2SKY	Jul	21
Getting on the Net	Will McGhie VK6UU	Aug	21
Internet	Repeater Link	Oct	47
Internet Repeaters	Repeater Link	Dec	46
NET/ROM	Packet World	Aug	44
Practical Packet Radio (Book Review)	Gil Sones VK3AU1	Sep	24
ROSE – A Brief Overview	Packet World	Nov	38
TCP/IP and AX25 Protocols	Packet World	Jun	40
TST Host	Packet World	Jul	41
<b>EMC</b>			
Changing Frequency	Repeater/Link	Mar	46
EMC Highlighted at Sydney Conference and Workshops	WIA News	Jul	05
EMC Standards and the Homebrewer	WIA News	May	10
EMC Standards Compliance Deadline 1 January	WIA News	Jan	17
Government Study into Electromagnetic Energy Health Hazards	WIA News	Dec	05

TITLE	AUTHOR	ISSUE	PAGE
Interference on 160 m Notified to SMA	WIA News	Oct	05
Pager Notch Filter	Technical Abstracts	Nov	14
Reprieve for 6 m from Radar Interference	WIA News	Jul	04
US RF Safety Standards Affect American Amateurs	WIA News	Sep	32
<b>Equipment Reviews</b>			
Alinco DX-70 HF/6 Metre All Mode Transceiver	Ron Fisher VK3OM	Mar	05
Dick Smith D-3800 Power Supply	Ron Fisher VK3OM	Jul	16
ICOM IC-2350H Dual Band FM Transceiver	Paul McMahan VK3DIP	Feb	10
Kenwood TS-870 All Mode HF Transceiver	Ron Fisher VK3OM	May	06
The Yaesu FT-1000MP All Mode HF Transceiver	Ron Fisher VK3OM	Aug	07
Yaesu FT-3000M (VHF/UHF Transceiver)	Paul McMahan VK3DIP	Dec	08
Yaesu FT-8500 Dual Band FM Transceiver	Paul McMahan VK3DIP	Nov	09
Yaesu FT-900 All Mode HF Transceiver	Ron Fisher VK3OM	Jul	06
Yaesu FT51R Dual Band Handheld Transceiver	Ron Fisher VK3OM	Jun	13
Yaesu MD-100A8X Desk Microphone	Ron Fisher VK3OM	Oct	16
<b>History</b>			
A Decade of Change	WIA News	Feb	16
A Visit to Newt W1BCR	George Cranby VK3GI	Aug	23
Frank Hine VK2QL	Susan Hine	Apr	17
HF DF	Lee Hitchins VK6HC	Mar	18
Mission Accomplished (Os Mingay)	Wilbur Wright	Sep	24
More Early Women in Radio in Australia	Christine Taylor VK5CTY	Nov	16
Our Mrs Mac	Christine Taylor VK5CTY	Feb	14
Television 110 Years Ago!	Bill Rice VK3ABP	Feb	12
The Maunder Minimum	Paul Clutter VK2SPC	Oct	21
<b>Miscellaneous Technical</b>			
Benchner Paddle History, Mechanics and Adjustments	Pounding Brass	Nov	41
Buzzer Noise Source	Technical Abstracts	Apr	18
Choice of Toroid Cores	Technical Correspondence	Dec	47
Connector Troubles	Technical Abstracts	Mar	13
Conversion Chart (dB, power, etc)	Technical Abstracts	Aug	18
CTCSS Decoder (NE567)	Repeater Link	Sep	45
Dick Smith D-3800 Power Supply (Review)	Ron Fisher VK3OM	Jul	16
Flashover Protection	Technical Abstracts	Jun	16
Golden Section Morse Key Construction (Part 1)	Pounding Brass	May	46
Golden Section Morse Keys	Pounding Brass	Jul	50
Improved Stopband of Crystal Lattice Filters	Technical Abstracts	Mar	14
"Miser's" 13.8 V 10 or 20 A Power Supply	Drew VK3XU and Ray VK3RD	Dec	11
Simple ACS Reception	Technical Abstracts	Mar	13
Solar Panel Detector	Repeater Link	Dec	45
Some Thoughts on "Ham Band" Audio	Felix Scerri VK4FUQ	Jul	50
VFO Stabiliser Circuit	Technical Abstracts	Oct	18
VFO with ALC	Technical Abstracts	Jan	13
<b>Operating</b>			
1995 WIA Victorian Fox-Hunting Championships	Jack Bramham VK3WWW	Mar	11
A Day on an Antarctic Island	Ralph K01R and Stephen VK2PS	Sep	21
Australia Day Honour for Amateur	Don Hopper VK7NN	May	23
Heard Island DXpedition Put Back 12 months	WIA News	Jan	30
Incident at Tarawa	"Blue" Easterling VK4BBL	Jun	19
Is Your Mobile Gear Insured?	Michael Krochmal VK3KRO	Apr	12
Lost in Ballarat	Alex Edmonds VK3BQN	Jul	24
Radio Sports (ARDF) Comes to Townsville	Iain Morrison VK4IGM	Sep	07
Satellite Frequency and Mode Update	AMSAT Australia	Jan	26
Six Monthly Amateur Radio Satellite Frequency & Mode Update	AMSAT Australia	Aug	26
Success for Region 3 Direction Finding Championships	WIA News	Aug	05
The Maryborough Amateur Radio Club and JOTA	Col Paton VK4BCP	Nov	17
The South East Radio Group (SERG) Annual Convention	Alex Edmonds VK3BQN	Mar	20
VK2COF Aeronautical Mobile	David Coffey VK2COF	Nov	19
What to Look For in a Paddle	Pounding Brass	Oct	45
WIA DXCC Standings	Awards	Feb	22
<b>People</b>			
Australia Day Honour for Amateur	Don Hopper VK7NN	May	23
Frank Hine VK2QL	Susan Hine	Apr	17
Mission Accomplished (Os Mingay)	Wilbur Wright	Sep	24
Our Mrs Mac	Christine Taylor VK5CTY	Feb	14
RAOTC Special VK6GM 92nd Birthday Celebration	Clem Patchett VK6CW	Mar	09
Two Friends, a Cat and a Classic Wooden Boat	Maxine Godley	Jun	20
VK2LAD	Cover	Jan	01
<b>Places</b>			
Croker Island NT - VK8	How's DX	Jun	34



TITLE	AUTHOR	ISSUE	PAGE
Heard Island VK0	How's DX	Apr	33
International Travel Host Exchange	Ash Nallawalla VK3CIT	Mar	25
Lacepede Islands - VK6ISL - OC-214	How's DX	Jul	36
Macquarie Island	How's DX	Jan	39
Macquarie Island VK0WH	How's DX	Feb	34
Sable Island - CY0AA	How's DX	Jun	34
<b>Propagation</b>			
Bottom of the Cycle?	How's DX	Jun	34
Cycle 22 Minimum?	How's DX	Dec	37
Ionospheric Update	Evan Jarman VK3ANI	Feb	51
Ionospheric Update	Evan Jarman VK3ANI	May	47
Ionospheric Update	Evan Jarman VK3ANI	Aug	46
Long-Distance VHF Ducting Opportunities from Australia	Ernil Pocock W3EP	Aug	12
Progress of Cycle 23	VHF/UHF An Expanding World	Mar	51
Propagation and Ionospheric Data on the World Wide Web	WIA News	May	15
Solar Cycle Minimum Near	WIA News	Feb	30
Sunspot Cycles	How's DX	May	38
The Great Tropospheric Opening (Part 1)	VHF/UHF - An Expanding World	Apr	48
The Great Tropospheric Opening (Part 2)	VHF/UHF - An Expanding World	May	48
The Maunder Minimum	Paul Clutter VK2SPC	Oct	21
<b>Receivers</b>			
Experimental Receiver for Two Metres FM Using a Car Radio	Peter Parker VK1PK	Jul	10
Receiving Converter for 6 Metres	Drew Diamond VK3XU	Oct	08
<b>Regulations</b>			
80 m DX window	WIA News	Jan	50
Autopatch	Repeater Link	Jan	44
Changes to High Power Operations	WIA News	Dec	07
FM on the HF Bands	WIA News	Mar	04
New Licence Conditions	WIA News	Aug	16
Overseas Visiting Amateurs Can Pay Lower Licence Fee	WIA News	Oct	21
Progress on Special Olympic Callsigns	WIA News	Oct	05
Understanding Our New Licence Conditions	John Martin VK3KWA	Feb	04
Working Group Tackles 80 m DX Window Expansion	WIA News	Oct	27
<b>Repeaters and Beacons</b>			
Autopatch	Repeater Link	Jan	44
Changing Frequency	Repeater Link	Mar	46
CTCSS Decoder (NE567)	Repeater Link	Sep	45
CTCSS Encoder	Repeater Link	Jul	46
CTCSS Encoder Mk 2	Repeater Link	Aug	48
Internet Repeaters	Repeater Link	Dec	46
Link Timer	Repeater Link	Apr	45
VK5VF VHF/UHF/SHF Beacons	Eric Jamieson VK5LP	Feb	48
<b>Test Equipment</b>			
A Cheap QRP RF Power Meter	Random Radiators	Aug	20
Buzzer Noise Source	Technical Abstracts	Apr	18
Noise Generator	Technical Abstracts	Oct	19
RF Impedance Bridge	Technical Abstracts	Oct	19
Test Equipment for the Radio Amateur (Book Review)	Bob Tait VK3UI	Jan	18
<b>Transceivers</b>			
Alinco DX-70 HF/6 Metre All Mode Transceiver (Review)	Ron Fisher VK3OM	Mar	05
Comparison of 2 Metre Handhelds	Technical Abstracts	Aug	17
Comparison of Dual Band Handhelds	Technical Abstracts	Jan	14
Dual Band Mobile Comparison	Technical Abstracts	Apr	18
ICOM IC-2350H Dual Band FM Transceiver (review)	Paul McMahon VK3DIP	Feb	10
Kenwood TS-680S HF/6 m Transceivers (35-45 MHz reception)	Technical Correspondence	Oct	36
Kenwood TS-870 All Mode HF Transceiver (review)	Ron Fisher VK3OM	May	06
"Little Mate" CW Transceiver for 3.5 and 7 MHz	Drew Diamond VK3XU	Jun	05
The Yaesu FT-1000MP All Mode HF Transceiver (Review)	Ron Fisher VK3OM	Aug	07
Use of IC-735 HF Transceiver for QRP Operation (Try This)	Simon Buxton VK2EII	Aug	24
Yaesu FT-3000M (VHF/UHF Transceiver) (review)	Paul McMahon VK3DIP	Dec	08
Yaesu FT-8500 Dual Band FM Transceiver (review)	Paul McMahon VK3DIP	Nov	09
Yaesu FT-900 All Mode HF Transceiver (Review)	Ron Fisher VK3OM	Jul	06
<b>Transmitters</b>			
A Micropower Two Metre FM Transmitter	Peter Parker VK1PK	Nov	06
Basics of Transmitters - Part One	Novice Notes	Oct	41
Basics of Transmitters - Part Two	Novice Notes	Dec	40
The Garran 40 m CW QRP Transmitter	Peter Parker VK1PK	Jan	10

\*3 Tamar Court, Mentone VIC 3194  
Internet e-mail: vk3br@c031.aome.net.au

■ Technical

# Technical Abstracts

Gil Sones VK3AUI\*

## Quadrifilar Helix Antenna

In August 1996 *QST*, Eugene F Ruperto W3KH described the construction of Quadrifilar Helix aerials. These are used to provide a fixed aerial which provides good omnidirectional sky coverage for receiving satellite signals. This is of use for receiving signals from low earth orbit weather satellites and amateur satellites using Molniya type orbits. The antenna is circularly polarised and a 140 degree beam width is claimed with useful signals received to within 10 degrees of the horizon. This allows a fixed antenna to provide useful signals from most passes of a satellite. The antenna is circularly polarised so you must pick the correct polarisation rotation.

The antenna construction is shown in Fig 1. The polarisation is set by the winding of the helices. For right hand circular polarisation the helices are wound counterclockwise as viewed from the top. Similarly, for left hand circular polarisation the helices are wound clockwise as viewed from the top. This is different from conventional axial mode helix construction.

One of the helices is the phasing line and is made from RG8/RG213 coaxial cable. The other wires are #10 which is approx 3 mm diameter. The connections at top and bottom are shown in Fig 2. The central support is two inch diameter schedule 40 PVC pipe. The cross supports are half inch diameter PVC tubing. The PVC tubing was initially tested for suitability by subjecting samples to a one minute test in a

microwave oven. If there is no significant heating then they are OK to use. It would be prudent, however, to place a beaker of water inside the microwave oven with the samples to provide some loading for the oven. If the sample heats significantly, then look for some alternative PVC pipe.

The antenna dimensions for both weather satellite use and amateur use are given in Table 1. The loops are different lengths to provide correct phasing. One has positive reactance and the other has negative reactance making up the feed impedance and achieving the correct phasing.

For those interested in this form of antenna, the *QST* article gives some references. The RSGB Handbook shows alternative feed arrangements for this type of antenna but without detailed practical constructional information.

### Replacement 572Bs for Yaesu FL2100

Replacement of the valves in the Yaesu FL2100 series linear amplifier has been somewhat difficult. The original valves have become scarce and expensive. However, replacement 572Bs have become available from another source, manufactured in Russia. These are branded Svetlana and the address of the Svetlana distributor in the USA is Svetlana Electron Devices Inc, 3000 Alpine Road, Portola Valley, California, 94028, USA. There are local distributors and the 572B is listed by Daycom Communications Pty Ltd.

In *Technical Topics* in the October 1996 issue of *Radio Communications*,

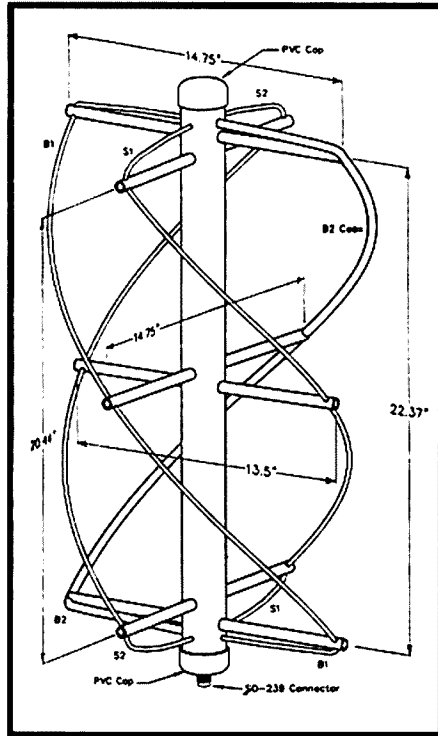


Fig 1 - Quadrifilar Helical Antenna, identifying the individual legs.

Pat Hawker G3VA provides some information he received in a letter from George Badger W6TC of Svetlana concerning the replacement of 572Bs in Yaesu linears. The Svetlana 572Bs have slightly higher gain than the original 572Bs which can result in oscillation in the standby mode. The bias in the Yaesu FL2100 series needs to be increased for the Svetlana replacements to avoid this problem.

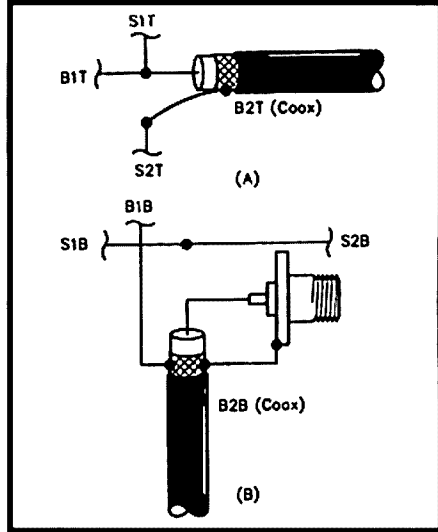
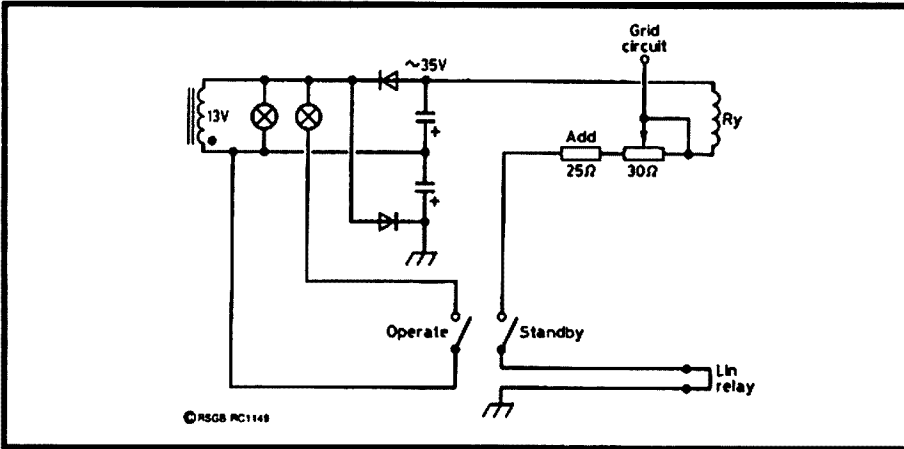


Fig 2 - Element connections to the QHA: (A) shows the connections at the top; (B) shows the connections at the bottom.

Freq MHz	Wavelength inches	Small Loop			Big Loop		
		Leg Size	Diameter	Length	Leg Size	Diameter	Length
137.5	85.9	0.508	0.156	0.238	0.560	0.173	0.26
146	80.9	43.64	13.4	20.44	48.10	14.86	22.33
436	27.09	41.09	12.6	19.25	45.3	14.0	21.03
		13.76	4.22	6.44	15.17	4.68	7.04

All dimensions are given in inches as in the *QST* article.



**Fig 3 - Modified FL2100B bias circuit for Svetlana 572Bs**

George W6TC has modified an FL2100B to provide a higher voltage cut-off bias which is then stable as the amplifier valves are fully cut-off in the standby mode. He obtained the higher bias voltage by changing the bias supply to a voltage doubling rectifier circuit.

The voltage is then sufficient to cut the 572Bs off in standby. A resistor was placed in series to limit the relay current in the relay which uses the same supply.

The modified circuit is shown in Fig 3.

## Noise Assisted Reception

Also in the *Technical Topics* column in *Radio Communications* for October 1996, Pat Hawker G3VA draws attention to an article in the *New Scientist* of 1 June 1996, by Kathryn S. Brown. The article outlines a hypothesis that, to pick up a faint message, the background noise can be a help rather than a hindrance.

The idea is that on the verge of detection the background noise assists the recognition of the weak signal which in effect rides on the noise. The system is non-linear at this time and the signal in the presence of noise can be detected.

The idea first appeared in 1981 in an entirely different field which was the melting of ice floes.

*\*C/o PO Box 2175, Caulfield Junction VIC 3161*

ar

## WIA News

### Band Plans, Beacons and Bad Habits

With the summer DX season in full swing on the VHF-UHF bands, it's time to remind operators to keep the beacon segments of the bands clear at all times, and to reinforce the reasons why we have band plans.

The band plan arrangements help avoid mutual interference between otherwise incompatible modes and operations. On each band from six metres down, a segment is set aside by "gentlemen's agreement" for narrow band modes and weak signal operation. Other segments are set aside for FM and repeaters, packet radio, etc.

On two metres, for example, the segment for narrow band modes and operations is from 144.000 MHz to 144.700 MHz. The first 50 kHz is for moonbounce only, the next 50 kHz for CW and RTTY (FSK). The narrow band voice modes and CW share the segment from 144.100 MHz to 144.240 MHz. Then follows a "guard band" to 144.300 kHz, to accommodate the New Zealand 2 m beacons. Australian beacons are accommodated in the 144.400-144.600 kHz segment.

Unfortunately, some unwitting or

uncaring FM operators are using that part of the 2 m band below 144.700 MHz. FM stations have been noted using the 144.100 MHz National Primary (narrow band) Calling Frequency for cross-town chit-chat. Other FM operators have been noted operating in the 144.400-144.600 MHz beacon segment. Stations pursuing weak signal and long distance operation find it particularly frustrating and annoying to hear FM stations on top of a beacon frequency. Just because an FM station in the Blue Mountains cannot hear the VK5VF 2 m beacon is not a good reason to operate on the beacon's frequency or anywhere in the beacon segment of the band.

Beacons serve a variety of useful purposes: to provide an effective indicator of propagation conditions (including weak signals), and to provide a constant "reference" signal for operators in its local area. It is just as important to have beacon frequencies free of interference when a band's NOT open, as when it is open.

There would be loud complaint if SSB or CW operators moved into the channelised FM and repeater segments and operated without regard to others.

Courtesy and respect for the band plan, which preserves the rights and interests of operators who pursue differing modes and operating practices, needs to be observed for the sake of peaceful coexistence. It takes little effort to be a "good neighbour". FM is not compatible with narrow band modes and weak signal operation, even though DX is frequently worked in the FM segments when conditions are good.

### New Members

The WIA bids a warm welcome to the following new members who were entered into the WIA Membership Register during the month of November 1996:

L21030	Mr C Donnelly
L30944	Mr H Szapirko
L30945	Mr J Austen
L60352	Mr J Timmers
L60358	Mr E Schipp
L60360	Mr M A Hynds
VK2MDS	Mr M D Smyth
VK2MPN	Mr B Dawson
VK3LJH	Mr L Hands
VK3ZMT	Mr M R Brighton
VK5ZHW	Mr R H Clogg
VK6PDV	Mr R S Duncanson
VK7BW	Mr B Welch

---

---

# ALARA

Sally Grattidge VK4SHE\*, ALARA Publicity Officer

---

---

## Happy New Year Everyone!

Only 1080 days to the next century (someone is sure to tell me that is wrong)! 1996 was a great year for ALARA, the highlight being the Meet in Perth which will be long remembered by all those who made the journey West to be there, and those who came from other directions.

Don't forget membership subscriptions are due this month. Details are in the October *Newsletter*, so do it NOW, and stock up on ALARA badges, charms, teaspoons, sugar spoons, stickers, bookmarks and notepaper at the same time. Send to our Treasurer Margaret Schwerin VK4AOE, PO Box 758, Dalby, Qld 4405.

## Contest

The ALARA Contest was held Saturday, 9 November, with conditions on 80 m surprisingly good for that time of year. Results will be published shortly. If you have not put your log in, it is too late now. Nice to hear lots of ZLs; and Aimee FK8FA was there, of course, giving us all a bit of DX and getting a good score.

## International YL Meet

During the Berlin World '96 meeting it was decided to have the next International YL Meet in 1998 in California USA. However, as the YLRL 60th Anniversary will be in 1999 and the Convention will be held in California, it was decided to have a different location for the 1998 YL Meet.

The YL '98 Meeting will now take place in Norway in Longyearbyen, Svalbard, from 20-24 August 1998. Longyearbyen is a town situated at 78 degrees north on Spitzbergen, belonging to the group of islands called Svalbard.

Accommodation and meetings will take place at the Svalbard Polar Hotel, a modern conference hotel of high standard with all facilities and excellent cuisine.

The program will include sightseeing trips with ample time for leisurely strolls and tax-free shopping. There will be an opportunity to operate amateur radio from the shack of the Svalbard Group of NRRL (Norwegian Radio Relay League) using the rare and popular prefix JW.

Besides the joy of being together with other YLs enjoying our fine mutual hobby, there will be the unique experience of wild, beautiful and pure arctic nature not far from the North Pole in daylight round the clock (dig out the thermal undies girls, this sounds great!).

If you are interested in joining the Svalbard Polar YL '98 Meeting, please write

to the following address and you will be sent a formal invitation with further information and prices: Svalbard Polar YL '98, c/o Ruth Tollefsen LA6ZH, PO Box 17, Tveita, N-0617, Oslo, Norway. Other organisers are Unni Gran LA6RHA and Turid Bjerke LA9THA.

If you are really into forward planning, the Korean Ladies Amateur Radio Club are planning to host the International YL Forum in Seoul for the millennium, so pencil that in your year 2000 calendar.

## Packet YL Group

A group of YLs from all over the world are looking for "OC Gals" to join them. Send a packet to Phyllis KAIJC @ WA2LKI.#VEN.FL.USA.NOAM to find out more.

## 14th BYLARA Contest 1997

**Date:** Thursday, 13 February, 1900 to 2200 UTC; Saturday, 14 February, 1000 to 1300 UTC. **Bands:** 14.250 to 14.280, 21.350 to 21.400, 28.350 to 28.410, and 28.650 to 28.700 MHz. HF Phone, VHF Phone, mixed HF/VHF Phone and SWL.

Call "CQ BYLARA Contest", OMs work YLs only, YLs work everyone. Log: Callsign, RS Serial Number (start 001 each day). **Score:** YL BYLARA member = five points, YL non-member = three points, OM Associate member = two points, other OM = 1 point. Each day is a separate entry total. Only one period of operation counts for each entry, but logs from non-scoring day are welcome as check logs. More than one section may be entered. National Society log sheets showing claimed score and declaration that entrant has abided by licence regulations. IARU band plans and above rules, are to be received by 4 April 1997. Send to: Ella Tugwell G0FIP, 67 Upper Kingston Lane, Shoreham by Sea, Sussex BN436TG, England.

---

---

## Club Corner

### Radio Amateurs Old Timers Club (RAOTC)

Members are reminded that there will not be an RAOTC broadcast in January. The next broadcast will be on Monday, 3 February. The times and frequencies will be the same as for the November and December broadcasts last year, as listed on page 31 of the No 17 (November) issue of OTN (which

## Perth Again

Little items of interest keep filtering through - here are some of them.

ALARA was given a beautiful wooden plaque with 21st greetings from NZART, and ALARA President Christine VK5CTY was made an honorary member of NZART for the duration of the Meet.

The Birthday cake was ceremonially cut by Norma VK2YL, ALARA's first President.

Raija SM0HNV came to Australia specially for the meet after reading about previous Meets in the Newsletter. Sweden does not have a YL organisation at this time, the nearest one being Finland.

Three dolls attended the Meet - VK6DOL made by Norma VK6PNS, VK5GAL made by Meg VK5AOV and VK4TED a well-dressed teddy brought by Robyn VK4RL. The walking muppet VK3EMU was also there attending his third ALARAMEET. VK5GAL crossed the Nullarbor sitting behind the car windscreen so can claim to have seen quite a lot of Australia.

The two sections of ALARA's History (not to be confused with Michael Jackson's) were available for sale at the Meet, and those who missed out can obtain them from Christine VK5CTY. Part One goes from the beginning in 1975 to 1989, and Part Two covers the years 1990 to 1995.

Betty ZL1UBZ, Bob ZL1BBZ, Marion ZL3TVF and Lester ZL1VF travelled to Perth via England and Scotland where they had purchased tartan glengarries with bright red hair hanging lankly below them. These were worn on several occasions, turning heads on the streets of Perth.

Other long path travellers were Helene VK7HD and Peter VK7PR who came from Hobart via Queensland and the Northern Territory.

A word of warning - don't get into a bus with New Zealanders unless you are prepared to sing! They even produce laminated sheets with all the words, so you have no excuse for not joining in.

*\*Clu PO Woodstock, QLD 4816  
Tel: 077 788 642*

ar

---

---

members should have received in late November).

A number of circumstances beyond our control caused the late production of this issue of OTN. However, we have received many favourable comments about it, and can only keep up the standard we strive for if members continue to send in their contributions, either to our secretary, Arthur Evans VK3VQ, or myself. We are both QTHR.

Allan Doble VK3AMD  
President

ar

# AMSAT Australia

Bill Magnusson VK3JT\*

## National co-ordinator

Graham Ratcliff VK5AGR

Packet: VK5AGR@VK5WI

## AMSAT Australia net:

Control station VK5AGR

Bulletin normally commences at 1000 UTC, or 0900 UTC on Sunday evening depending on daylight saving and propagation. Check-ins commence 15 minutes prior to the bulletin.

Frequencies (again depending on propagation conditions):

Primary 7.064 MHz (usually during summer).

Secondary 3.685 MHz (usually during winter).

Frequencies +/- QRM.

## AMSAT Australia newsletter and software service

The newsletter is published monthly by Graham VK5AGR. Subscription is \$30 for Australia, \$35 for New Zealand and \$40 for other countries by AIR MAIL. It is payable to AMSAT Australia addressed as follows:

AMSAT Australia  
GPO Box 2141  
Adelaide SA 5001

## Goodbye to an Old Friend

OSCAR 13 is no more. It was launched on 15 June 1988 and the electronics ceased to operate on 24 November 1996. In that time it had become part of the amateur satellite community's way of life. It was one of the most consistent performers in the AMSAT fleet. Its transponders were a dream to operate and in many ways, for example the "S" mode transponder, it pointed the way to the future. DXCCs were not unheard of among the thousands of regular users.

Some amazing performances were chalked up during the ZRO tests. Signals as weak as 27 dB below the beacon were copied by some operators. Due to problems with the orbit, the job of the control team was quite demanding and Graham, Peter, Ian, Stacey and Karl are to be congratulated on a job well done.

Graham reported that the engineering beacon ceased transmitting during the Q block time-stamped AMSAT Day Number 6902, ie 24 Nov 96 @ 05:38:16 approximately MA 31 or 32 on Orbit Number 6481. Graham confirmed this loss of signal with Elgar VK5ED who was also monitoring the telemetry when the

transmission stopped. Further attempts to command AO-13 were unsuccessful.

It had been predicted for some time now that it would re-enter the earth's atmosphere and burn up in the first week of December. At the time of writing it is still aloft. The perigee heating was extreme in the few days just before the beacon went dead and no doubt soon afterwards bits would have started breaking free. There was some evidence that the solar cells had already begun to break up. In the days immediately prior to the end the beacon carried some interesting messages. Two were of particular interest and well worth recording here.

*M QST de AO-13 BIRTH ANNOUNCEMENT. 1996 Nov 20 0240 EST. My child, P3D, began "thinking" today when its IHU was activated. I'm glad I lived long enough*

*to learn of this wonderful event. I wish P3D a long, functional life. Do not grieve for me when I'm gone. I'm only metal, plastic, & sand. My "life" came from enriching the lives of those who built, commanded & utilised me, and it's been a good "life". Danke Karl, et al. No regrets. The baton will soon be passed. AO-13 signing off...*

And:

*N QST, \*\* AO-13 Only One Solar Panel Still Working \*\* After AO-13's last perigee (6479/6480) only solar panel #5 is still working. Therefore, all transponders have been switched off to conserve power. The Engineering Beacon will be left running with the Hi-gain antennas from MA 20 to MA 200 and with the Lo-gain (omnis) from MA 200 through perigee to MA 20. Peter/DB2OS James/G3RUH Graham/VK5AGR Stacey/W4SM*

One orbit later the beacon stopped transmitting. AO-13 was dead!

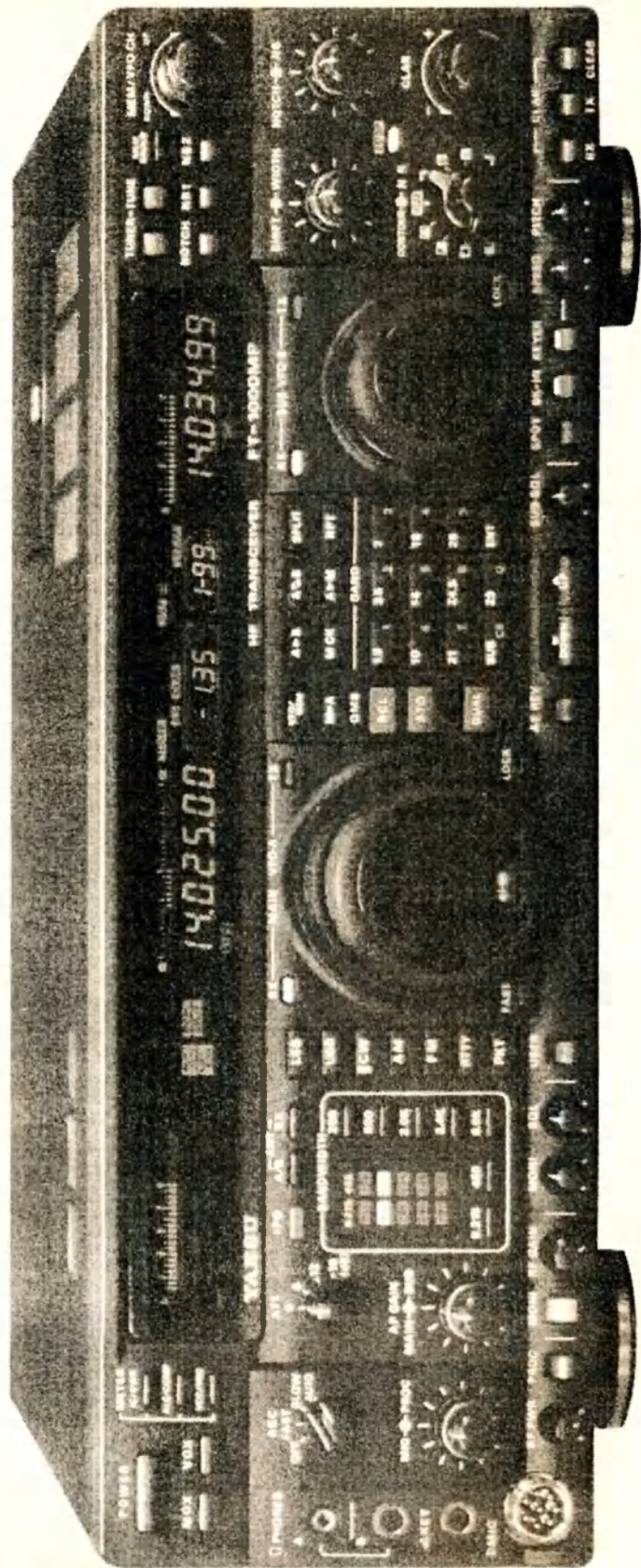
## Six Monthly Amateur Radio Satellite Update

Here is a list of current amateur radio satellite frequencies and modes.

Full details of the RS satellites' many modes and transponders appeared in the January 1995 AMSAT Australia column.

Satellite	UPLINK (MHz)	DOWNLINK (MHz)
<b>Oscar 10 (AO-10)</b>		
General Beacon (Carrier only)		145.808 (approx)
Mode B (SSB,CW-Inverting)	435.030-435.180	145.825-145.975
<b>Oscar 11 UoSAT-2 (UO-11)</b>		
Beacon (1200 AFSK,FM) telemetry/bulletin		145.826
Beacon (1200 AFSK,FM)		435.025
Beacon (1200 AFSK,FM)		2401.500
<b>Radio Sputnik 10 (RS-10)</b>		
Mode A (SSB,CW-Inverting)	145.86-145.90	29.360-29.400
Beacon/Robot (CW)		29.357
Beacon/Robot (CW)		29.403
Robot Mode A (CW)	145.82	29.357 or 29.403
<b>Radio Sputnik 12 (RS-12)</b>		
Mode A (SSB,CW-Inverting)	145.91-145.95	29.410-29.450
Beacon/Robot (CW)		29.408
Beacon/Robot (CW)		29.454
Robot Mode A (CW)	145.831/840	29.408 or 29.454
<b>Radio Sputnik 15 (RS-15)</b>		
Mode A (SSB,CW non-invert)	145.858-145.898	29.354-29.394
Beacon (CW)		29.352.5
<b>AMSAT-OSCAR-16 (AO-16) Callsign = PACSAT</b>		
Mode J (1200 BPSK BBS,FM-SSB)	145.90/92/94/96	437.025 or 437.050
Mode S (1200 BPSK BBS,FM-SSB)		2401.1 or 2401.1428
<b>AMSAT-OSCAR-17 (DO-17) (Dove)</b>		
Beacon 1 (1200 bps AFSK,Digital Voice,FM)		145.82516
Beacon 2 (1200 bps AFSK,Digital Voice,FM)		145.82438
Beacon 3 (1200 BPSK,Digital Voice,SSB)		2401.2205
<b>AMSAT-OSCAR-18 (WO-18) (Webersat)</b>		
Mode J (1200 BPSK,RC,SSB)	144.30-144.50	437.075 or 437.10
ATV (TV,AM)	1265.000	
<b>AMSAT-OSCAR-19 (LO-19) Callsign = LUSAT</b>		
(1200 PSK,FM-SSB)	145.84/.86/.88/.90	437.15355 or 437.1258
<b>UoSAT-OSCAR-22 (UO-22)</b>		
Broadcast Callsign	= UOSAT5-11	

# FT-1000MP



# YAESU is about to turn the world of HF Transceivers on its head!

**Dedicated to the memory of JA1MP, the founder of Yaesu Musen, we are proud to announce the release of Yaesu's latest high performance HF base transceiver, THE NEW FT-1000MP.**

Based upon the legendary performance of the FT-1000 which, for more than half a decade, has been highly acclaimed by the world's top DXers, Yaesu has created a new 100W HF masterpiece built upon proven RF design and the introduction of a new technology to the Amateur marketplace: Enhanced Digital Signal Processing (EDSP). Teamed up with Direct Digital frequency synthesis, an outstanding receiver section featuring a high intercept front-end and a wide variety of IF filters (including a Collins Mechanical Filter), the FT-1000MP's exclusive EDSP facilities provide an impressive array of IF-based noise-reduction and interference rejection filters for enhanced receiver performance, as well as flexible tailoring of the transmitter for outstanding signal clarity.

The performance of digital processing systems is highly dependent on the quality of software inside the transceiver, and here Yaesu's experience with software design really shines through. Yaesu's IF-based EDSP provides 4 random-noise filtering protocols, audio enhancement with 4 equalisation programs for Tx and 3 for Rx, and an automatic notch filter which identifies and eliminates multiple interfering carriers or heterodynes. Front panel selectable EDSP filter contours (Low, Mid, or High-Cut responses; or Bandpass) aid in QRM rejection, providing improved signal-to-noise ratios and razor sharp selectivity. A comprehensive menu system allows you to easily hear the effect of various EDSP settings, so you can choose the best selection for your operating conditions.

In keeping with the improvements that the EDSP facilities provide, the FT-1000MP also provides new features such as selectable flat response or optimised receiver front-ends, 3 antenna connectors (2 main antennas and an Rx-only socket), selectable tuning steps as small as 0.625Hz, and a Shuttle-jog tuning knob for fast QSY operation. For optimised transmit audio, different SSB IF offsets can be set for both normal and RF speech-processed transmissions, and can be used in conjunction with the Tx EDSP functions. Separate bar-graph S-meters are provided for each receiver, and even a synchronous detection system is used for better AM reception on the Shortwave bands.

Standard features include SSB/CW/AM/FM operation, an in-built AC power supply and Automatic antenna tuner, 13.5V DC socket, dual-mode noise blankers, 500Hz CW and 6kHz AM IF filters, full break-in CW, an in-built electronic keyer with memory, a multi-colour high resolution display, an RS-232 computer interface, and a MH-31B8 hand microphone.

With the new FT-1000MP now available, why not call us for a copy of Yaesu's 12-page colour booklet explaining more about the FT-1000MP's new level of HF performance and design excellence. We're sure you'll soon agree that the world of HF transceivers has just taken a giant leap forward.

Cat D-3400

**2 Year Warranty**

**\$4495**

**For further information, orders or the location of your nearest store call:**  
**Outside Sydney (local call charge) 1300 366 644**  
**Or Fax: (02) 9805 1986**

B 2542 Rev  
**DICK SMITH**  
**ELECTRONICS**

BBS Callsign = UOSAT5-12  
Mode JD (9600 Baud FSK,FM) 145.90/975 435.120

#### KITSAT-OSCAR-23 (KO-23)

Broadcast Callsign = HL01-11  
BBS Callsign = HL01-12  
Mode JD (9600 Baud FSK,FM) 145.85/90 435.175

#### KITSAT-OSCAR-25 (KO-25)

BBS Callsign = HL02-12  
Broadcast Callsign = HL02-11  
Mode JD (9600 Baud FSK,FM) 145.870 436.500

#### ITAMSAT-OSCAR-26 (IO-26)

Mode JD 1200 baud PSK  
Callsign = ITMSAT 145.875 435.867  
145.900 435.822

#### JAS-2 Fuji-OSCAR-29 (FO-29)

Callsign: 8J1JCS  
Analog mode Output power: 1 W  
Uplink passband: 145.900 – 146.000 MHz  
Downlink passband: 435.800 – 435.900 MHz  
Digital mode 1200 bps BPSK  
Uplink frequencies: 145.850, 145.870, 145.890, 145.910 MHz  
Downlink frequency: 435.910 MHz  
9600 bps FSK  
Uplink frequency: 145.870 MHz  
Downlink frequency: 435.910 MHz  
Digitaltalker: FM voice, max 25 seconds  
Downlink frequency: 435.910 MHz, output power 1 W  
CW tlm: 435.795 MHz, 12 WPM.

#### Mexico-Oscar-30 (MO-30)

Uplink frequencies: 145.815, 145.835, 145.855, 145.875 MHz  
Downlink frequency: 437.306, 437.138 MHz  
Modulation types are the same as AO-16, LU-19, WO-18 and IO-26

As always, the list is as accurate as I can determine at the time of writing. Please let me know of any errors or omissions.

\*RMB 1627, Milawa VIC 3678  
CompuServe: 100.352.3065  
Internet: 100.352.3065@compuserve.com  
E-mail: vk3jt@amsat.org

ar

band. All amateur bands (3.8 MHz is included in 3.5 MHz).

(2) Modes: Only contacts made within the same mode, CW, AM, SSB, FM, SSTV, RTTY, ATV.

(3) Satellite: Only contacts made through amateur satellites.

(4) QRP: Only contacts made through transmitters with a final input of one watt or less.

6. Only contacts/receptions made on or after 29 July 1952 will be acceptable, except Haca Haga on or after 1.1.1970; for satellite on or after 15.12.1972; for SSTV on or after 10.4.1973; for RTTY on or after 08.8.1968; Okinawa Prefecture on or after 15.5.1972; VU-1000 on or after 29.7.1977; deleted Cities/Guns before the date of deletion mentioned in the JCC/JCG list.

7. Only contacts with land stations (including mobile stations on a river or lake) will be acceptable. Those with maritime and aeronautical stations, however, will be acceptable for the 50 MHz-100; 144 MHz-100; 435 MHz-100; 1200 MHz-10, -50, -100; 2400 MHz-10, -50, -100; 5600 MHz-10, -50, -100 and VU-1000 awards.

8. Only contacts with amateur stations authorised by the administration will be acceptable. Contacts with Far East Military Auxiliary Stations in Japan will not be acceptable.

9. All contacts must be made on land (river/lake) within the same call area or, if no call area exists, within the same country.

10. All correspondence must be sent to: Japan Amateur Radio League, Award Desk, 1-14-2 Sugamo, Toshima, Tokyo 170, Japan.

#### All Japan Districts (AJD)

May be claimed for having contacted/heard, and received a QSL card from, an amateur station located in each of the 10 call areas of Japan (1-0).

Worked All Japan Prefectures Award (WAJA) Heard (HAJA)

May be claimed for having contacted/heard, and received a QSL card from, an amateur station located in each of the 47 prefectures of Japan. A list of QSL cards/contacts should be arranged in order of WAJA reference number. However, names of prefectures may be omitted.

#### Japan Century Cities (JCC) SWL-JCC

May be claimed for having contacted/heard, and received a QSL card from, an amateur station located in each of at least 100 different Cities of Japan. JCC-200, -300, -400, -500 and -600 will be issued as separate awards. A list of QSL cards should be arranged in order of JCC reference number. However, names of Cities may be omitted.

requirements of the award concerned. The form of list will be specified, when required, in the rules of each award.

3. Each list must be accompanied by a statement from the applicant's National society, or from any two amateurs other than the applicant certifying that the QSL cards listed are in the possession of the applicant, and that the items on the cards are correctly listed. If such a statement is not available, the applicant must submit all the QSL cards concerned.

4. A fee of eight IRCs or \$US4.00 will be charged per award. An additional two IRCs will be charged for airmail delivery regardless of the number of awards claimed. If QSL cards are submitted, sufficient funds for return postage will also be required.

5. Applicants can request a maximum of three of the following four endorsements :-

(1) Bands: Only contacts within the same

## Awards

John Kelleher VK3DP - Federal Awards Manager\*

Please note that, as from this date, all copy for this column, including DXCC upgrades and applications for awards should be sent directly to my call-book address (as at end of Awards column). This does not include fax and e-mail which will be handled as before. This action has been taken to increase efficiency, and to speed up handling of all correspondence relating to awards in general.

In response to several enquiries regarding the JARL Awards program, here are the details of all awards issued by JARL.

#### JARL Awards

##### General Rules.

1. JARL awards will be issued to amateur stations and SWLs.

2. Each claim must be accompanied by a QSL card list furnished with the call signs of stations worked/heard, dates, bands and modes of the contacts meeting the



## Japan Century Guns (JCG) SWL-JCG

Same as the rules for JCC with cities replaced by "guns". But what is a "gun"? Japan has, as administrative districts, 47 prefectures, which are divided into cities, towns, and villages. A "gun", not being an administrative district, is a regional congregation of towns and villages.

In addition, the following awards will be issued. They may be claimed for having contacted/heard and received a QSL card from each of the different stations of the number required, on the frequency band concerned: 50 MHz-100; 144 MHz-100; 435 MHz-100; 1200 MHz-10, -50, -100, -200, -300; 2400 MHz-10, -50, -100, -200, -300; 5600 MHz-10, -50, -100, -200, -300.

## VU-1000 SWL-VU-1000

May be claimed for having contacted/heard, and received a QSL card from, each of at least 1000 different amateur stations on the 50 MHz, 144 MHz and/or 435 MHz bands. For contacts exceeding 1000 different stations, VU-2000, -3000, etc will be issued. A list of QSL cards should be arranged in alphabetical order of prefix, followed by suffix.

## Worked All Cities Award (WACA) Heard (HACA)

May be claimed for having contacted/heard, and received a QSL card from, an amateur station located in each of the Cities of Japan that are in existence on the day when the final contact claimed for the award is made. A list of QSL cards should be arranged in order of JCC reference number. However, names of cities may be omitted.

## Worked All Guns Award (WAGA) Heard (HAGA)

Same as for WACA, with cities replaced by guns.

## Asian DX Award (ADXA) SWL-ADXA

May be claimed for having contacted/heard, and received a QSL card from, an amateur station located in each of at least 30 Asian countries including Japan. DXCC countries are standard, the Asian ones grouped in the Asian Countries List. A list of QSL cards should be arranged in order of the listing of the Asian Countries List.

## Asian DX Award Half (ADXA-Half) SWL-ADXA-Half

Same as the above, except that contacts are required from only 15 Asian countries, including Japan.

## Heard All Continents (HAC)

May be claimed for having heard, and received a QSL card from, an amateur station located in each of the six continents.

The continental boundaries for IARU's WAC are standard, with a few exceptions in Asia which are shown in the Asian Countries List.

## Amateur Satellite "Fuji"

Applicants should make contact with 10 different amateur stations through the amateur satellite "Fuji" (only contacts in CW or SSB mode), and should obtain QSL cards from those stations. Amateur Satellite JAS-1 (Fuji, FO-12 8J1JAS) was launched at 2045 UTC on 12 August 1986.

## Asian Countries List for ADXA

A4 Oman  
A5 Bhutan  
A6 U Arab Emirates  
A7 Qatar  
A9 Bahrain  
AP Pakistan  
BV Taiwan  
BY China  
EP Iran  
HL Sth Korea  
HS Thailand  
HZ Saudi Arabia  
JA Japan  
JD1 Ogasawara Isl  
JT Mongolia  
JY Jordan  
OD Lebanon  
S2 Bangladesh  
TA2-8 Turkey  
UA9/0 Asiatic Russia  
UD-4K Azerbaijan  
UF-4L Georgia  
UG-EK Armenia  
UH-EZ Turkmenistan  
UI-UK Uzbekistan  
UJ-EY Tadjhikistan  
UL-UN Kazakhstan  
UM-EX Kirghizia  
VS6-VR2 Hong Kong  
VU India  
VU Andaman & Nicobar Isls  
VU Laccadive Isls  
XU Kampuchia  
XW Laos  
XX9 Macao  
XZ Myanmar  
YA Afghanistan  
YI Iraq  
YK Syria  
ZC4 UK bases on Cyprus  
IS Spratly Isls  
3W/XV Vietnam  
4S Sri Lanka  
4X Israel  
5B Cyprus  
7O Yemen  
8Q Maldive Isls  
9K Kuwait  
9M2 West Malaysia

9N Nepal  
9V Singapore

## Japanese Prefecture/Number List

JA8  
01 Hokkaido  
JA7  
02 Aomori  
03 Iwate  
04 Akita  
05 Yamagata  
06 Miyagi  
07 Fukushima  
JA0  
08 Niigata  
09 Nagano  
JA1  
10 Tokyo  
11 Kanagawa  
12 Chiba  
13 Saitama  
14 Ibaraki  
15 Tochigi  
16 Gunma  
17 Yamanashi  
JA2  
18 Shizuoka  
19 Gifu  
20 Aichi  
21 Mie  
JA3  
22 Kyoto  
23 Shiga  
24 Nara  
25 Osaka  
26 Wakayama  
27 Hyogo  
JA9  
28 Toyama  
29 Fukui  
30 Ishikawa  
JA4  
31 Okayama  
32 Shimane  
33 Yamaguchi  
34 Tottori  
35 Hiroshima  
JA5  
36 Kagawa  
37 Tokushima  
38 Ehime  
39 Kochi  
JA6  
40 Fukuoka  
41 Saga  
42 Nagasaki  
43 Kumamoto  
44 Oita  
45 Miyazaki  
46 Kagoshima  
47 Okinawa

\*4 Brook Crescent, Box Hill South, VIC 3128  
Phone (03) 9889 8393

ar

# Contests

Peter Nesbit VK3APN - Federal Contest Coordinator\*

## Contest Calendar January - March 97

Jan 4-5	ARRL RTTY Roundup	(Dec 96)
Jan 10-12	Japan International DX CW (Low Band)	(Dec 96)
Jan 11-12	VHF/UHF Field Day Contest	(Dec 96)
Jan 19	HA DX CW Contest	(Dec 96)
Jan 24-26	CQ WW 160 m DX Contest	(Dec 96)
Jan 25-26	UBA (Belgium) SSB DX Contest	(Dec 96)
Jan 25-26	REF (France) CW DX Contest	
Feb 1-2	YU DX Contest	
Feb 8	Asia-Pacific CW Sprint	
Feb 8-9	PACC CW/SSB DX Contest	
Feb 8/9	Spanish RTTY Contest	
Feb 15-16	ARRL DX CW Contest	
Feb 21-23	CQ 160 Metre SSB Contest	(Dec 96)
Feb 22-23	RSGB 7 MHz CW Contest	
Feb 22-23	UBA (Belgium) CW DX Contest	(Dec 96)
Feb 22-23	REF (France) SSB DX Contest	
Feb 23	High Speed CW Contest	
Mar 1/2	ARRL DX SSB Contest	
Mar 8/9	Commonwealth Contest (CW)	
Mar 15/16	WIA John Moyle Field Day	
Mar 15/16	Bermuda Contest	
Mar 15/16	BARTG RTTY Contest	
Mar 29/30	CQ WPX SSB Contest	

closely-matched teams are going to be operating in unfamiliar surroundings, where the chance for making mistakes is above normal, the final separation between at least some of the teams may be marginal, and the penalty for logging errors severe. It seems to me a "work - and log - 'em all" approach will be especially important in the IARU contest. It also seems that the judges should make it clear to all concerned - team members and the rest of us alike - what the policy is on duplicates, especially where penalties are involved, so that we can all do our best to minimise their impact. I'd hate to think the difference between one spot and the next in the final WRTC standings was the result of a logging error. I'd feel even worse if the error was partially my fault - and preventable."

Interesting stuff. Unfortunately, this is one of those grey areas where the outcome depends a lot on the thoroughness of log-checking. I must admit to a lot of personal nervousness when CT prints "DUPLICATE" in the log and assigns zero points, for the same reasons as Walt. I've long thought that contest logging programs should print a cross reference between duplicate QSOs with the same station, and am surprised it hasn't been done yet.

In the meantime, one can minimise the chances of having QSOs and/or multipliers struck out by including a "dupe" sheet with the log (an alphabetical list of stations worked), because log-checkers will usually check that sheet for other QSOs with the same country, before deleting the multiplier. For hand written logs, for any stations which are worked more than once, one should add the time or QSO number of all other QSOs with the same station to each such QSO, so that they are all cross-referenced together.

Hopefully, such a feature will eventually become standard in CT and other contest logging programs. In the meantime, we ought to add the extra information to our logs where possible, or else keep our fingers crossed. Fortunately the great majority of log-checkers are pretty reasonable people.

For information this month, many thanks to VK2BQS, VK5OV, AC10, OE4BKU, PA3BFM, VS6BG, ZL1BVK, Radio Communications, CQ, and QST. Until next month, good contesting!

73s, Peter VK3APN

## Asia-Pacific CW Sprint

1230-1430z Saturday, 8 Feb  
1230-1430z Saturday, 14 June  
1230-1430z Saturday, 18 October

In this series of sprints, the object is for stations in the Asia-Pacific region to work as many stations worldwide as possible within two hours, on 20 and 40 m CW. Output power is limited to 150 W. Exchange RST + serial number, and count

## Work Them Dupes!

Whilst clearing the clutter off my hard disk recently, I came across a piece by Walt AC10, downloaded from the "cq-contest" reflector several months ago. Although aimed at the IARU Contest, it could apply to any other contest. Here it is, in Walt's own words: "Until recently, I've been a "clean log" person. Yes, I'd work a dupe even though my computer was beeping insistently at me, but I wouldn't bother putting the QSO in my log the second time. The comments and collective wisdom on this reflector, however, has made me switch to the oft-recommended "log everything" policy.

"One incident, late in the WPX Contest, drove the wisdom of the "work - and log - them dupes" approach home rather forcibly. The stage was set during the first night of the contest, when the QRM on 40 was just incredible. As a low power entrant, I was S&P'ing at the time, and was amazed at how many times TWO stations would come back to my call. Even though I carefully responded with "HA1XYX 599063", more often than not I'd still get a "QSL" from both stations - and usually never did find out who station #2 was.

"Cut to the chase. It's the last half hour of the contest. I'm trying to push the score meter over The Last Hurdle. Multipliers are worth their weight in gold. I find one: the only station in the contest I've heard from

this country (and a really good op, too; the call's unimportant). I call. The response: "AC10 QSO B4". Aargh - the guy is absolutely, positively NOT in my log (he was probably one of those first-night doubles). I try desperately to nab the mult, and send "NOT IN MY LOG; PSE DUPE ME". The DX station proceeds to send me the time of our (non-)QSO, the serial number he sent me, and the number I "sent" him. Heck; he could have also told me my mother's maiden name - he was still NOT in my log. A simple re-QSO on his part would have saved all that time and trouble (and I'm not sure I ever did make it into his log that second time...)

"Then I got to wondering: What do the log-checkers do in cases like this? The first QSO was logged by the DX station; in error, to be sure - but I was still in HIS log. The second QSO, though, was the only valid one on both ends. I recalled K3ZO voicing some very real frustration after a recent ARRL contest; he logged the wrong power for his first French QSO, and the log-checkers deleted not just the contact - but the whole French multiplier (even though Fred had worked several dozen French stations on that band!) So, how can the other station manage the situation so that if the first QSO is busted but the second one is valid, he still gets credit for the "AC1" mult?

"This is especially important given the fast-approaching WRTC competition. 52

one point per valid QSO. The called station (usually the CQer) must QSY at least 1 kHz after a QSO. The multiplier is the total number of prefixes, per WPX rules (ie each prefix once only, not once per band). Final score equals valid QSOs x multiplier. Post your log to: James Brooks, 15 Balmoral Road #03-08, Singapore 259801, Singapore, postmarked within seven days, or e-mail to [9v1yc@equator.lugs.org.sg](mailto:9v1yc@equator.lugs.org.sg) within 72 hours.

### **PACC CW/SSB DX Contest**

1200z Sat to 1200z Sun, 8/9 Feb

This is a very popular European contest, with phone and CW held on the same weekend. The object is to work as many Dutch stations as possible on 160 to 10 m, excluding the WARC bands. Categories are single and multi-operator; SWL. Only CW contacts are eligible on 160 m. Stations may be worked only once per band, regardless of mode.

Exchange RS(T) plus serial number; Dutch stations will RS(T) plus a two letter province code. Possible codes are: DR, FR, GD, GR, LB, NB, NH, OV, UT, FL, ZH, and ZL. Score one point per Dutch QSO. Contacts must be confirmed by TU, OK or QSL. Final score equals the total QSO points times the total Dutch provinces worked from each band (max 72). Mail logs with summary sheet and declaration by 31 March to: Frank E van Dijk PA3BFM, Middellaan 24, NL-3721 PH Bilthoven, The Netherlands. Certificates will be awarded to the top scoring stations in each category and country, including second and third places where justified.

### **Spanish RTTY Contest**

1600z Sat to 1600z Sun, 8/9 Feb

The object is to contact as many stations worldwide as possible, on RTTY, 80 to 10 m. Categories are single operator (single/muhiband); multioperator single transmitter; SWL.

Exchange signal report and CQ zone. Spanish stations will send signal report and province. On 10/20 m score one point per QSO with stations inside your WAC continent, and two points with stations outside your WAC continent. On 40 and 80 m, the QSO points are tripled. QSOs between stations in the same country can be claimed for multiplier credit, but not QSO points. The multiplier is the sum of the DXCC countries and Spanish provinces (max 52) per band. The final score is the total QSO points times the multiplier.

Send log, summary and declaration within 30 days to: EA RTTY Contest, c/o EA1MV Antonio Alcolado, PO Box 240, 09400 Aranda de Duero (Burgos), Spain.

### **ARRL DX Contest**

CW: 0000z Sat to 2400z Sun, 15/16 Feb

SSB: 0000z Sat to 2400z Sun, 1/2 Mar

There is always plenty of activity in this popular contest. The CW section runs on the third full weekend in February each year, and the phone section on the first full weekend in March. The object is to work as many W/VE amateurs as possible on 1.8-30 MHz. Categories are single operator (single band, all band, all band QRP max 5 W O/P, and all band assisted); Multioperator (single Tx, two Txs, and unlimited). In the single and two Tx categories, once a transmitter has begun operation on a band it must remain on that band for at least 10 minutes. Listening time counts as operating time.

Exchange RS(T) and a three digit number indicating approx output power. W/VE stations will send RS(T) and state/province. Score three points per W/VE QSO. The multiplier is the sum of US states and District of Columbia (DC) (except KH6/KL7), NB (VE1), NS (VE1), PEI (VE1 or VY2), PQ (VE2), ON (VE3), MB (VE4), SK (VE5), AB (VE6), BC (VE7), NWT (VE8), YUK (VY1), NF (VO1), and LAB (VO2) worked to a maximum of 63 per band. The final score equals the total QSO points times the multiplier.

Entries with more than 500 QSOs must include crosscheck (dupe) sheets. Logs on DOS disk are welcome in lieu of a paper log, providing a paper summary sheet showing usual info is included. Multioperator entries must list all operators. Entries must be postmarked within 30 days after the last contest or they will be classed as checklogs (no exceptions)! Mark the envelope CW or Phone, and send the log to: ARRL Contest Branch, 225 Main Street, Newington, CT 06111, USA. Certificates will be awarded to the top scoring stations in each country and category, and plaques to the top worldwide and continental stations.

### **RSQB 7 MHz CW Contest**

1500z Sat to 0900z Sun, 22/23 Feb

The object of this contest is to contact as many British Isles stations as possible on 40 m CW. Exchange RST plus serial number starting at 001; UK stations will add their county code. Oceania stations score 30 points per QSO, and the final score is the total QSO points times the number of UK counties worked. Include a summary sheet showing all standard details, plus a checklist if more than 80 QSOs are made. Send logs to arrive by 14 April to: RSGB HF Contests Committee, c/o S V Knowles G3UFY, 77 Bensham Manor Road, Thornton Heath, Surrey, CR7 7AF, England. Airmail is recommended, as late logs may be treated as check logs. Certificates will be awarded to the leading entrants in each overseas section.

### **REF (France) SSB DX Contest**

0600z Sat to 1800z Sun, 22/23 Feb

This contest takes place on the last full weekend of February each year. The object is to work as many stations in France and French overseas territories (F, T, DA), as possible on 80-10 m SSB. Categories are single operator; single and multiband; and multioperator. Exchange RS(T) plus serial number, F stations will add their Departement. Score one point per QSO with eligible stations in the same continent, and three with stations in a different continent. Multipliers are Departements, FFA and DOM-TOM. F6REF/00 counts as an additional multiplier. The final score equals total QSO points x total multiplier. Send log to arrive within six weeks to: REF Contest, PB 2129, F-37021 Tours Cedex, France.

### **High Speed CW Contest**

0900-1100z and 1500-1700z, Sunday, 23 Feb

This interesting contest is organised by the High Speed CW Club, and runs on the last Sunday in February. Bands are 80-10 m, and categories are HSC Members, non-members, QRP, and SWL. Exchange RST + HSC number or serial number. Score one point per QSO with own continent, and three points for DX. Each DXCC country per band counts as a multiplier.

**ICOM**

Clearly Ahead



# "VK3LZ calling!"

More sound information from your friends at Icom

## **NEW ICOM FLAGSHIP TRANSCEIVER ARRIVES!**

The IC-756, our exciting new flagship HF/50MHz all mode transceiver is here. State-of-the-art is an overused expression we know, but this is one unit that fits that bill exactly! The IC-756 offers an array of today's most wanted features, including

- 4.9" Multifunction LCD
- DSP
- Twin PBT
- Dual Watch
- Auto Antenna Tuner built in
- Auto Notch Filter

Be sure to place your order without delay as the IC-756 is sure to create tremendous interest among enthusiasts.

## **ICOM ARE MOVING!**

Thanks to the tremendous support and confidence in the quality of Icom from our Australian market, business has grown... and we've outgrown our existing premises.

As of January 6, 1997, we'll be located at:  
290 -294 Albert Street  
Brunswick, Victoria 3056.

"...73"

Contact me at Icom on  
free call 1800 338 915  
ph: 9387 0666  
fax: 9387 0022

ACN 006 092 575

Final score equals points times multiplier. Maximum output power is 150 W, and stations can be worked once per band and period. Send logs within six weeks to: Frank Steinke DL8WAA, Trachenbergerstra-e 49, D-01129 Dresden, Germany.

### Results of 1996 Australasian Sprints

Presented by David VK5OV

Entries for the 11th Australasian Sprints totalled 12 CW, including two Novice class operators, and 23 phone, including an SWL. These represented about 20% of the callsigns recorded. My thanks to those who sent their logs, and especially to that most welcome group of regular entrants.

The Adelaide Hills Amateur Radio Society and the SA/NT Division of the WIA congratulate the overall winners, VK1WI representing the ACT Division of the WIA (operated by Jim Miller VK1FF), and Barry Chammen VK5KCX, who was successful at last in the phone section after a couple of very near misses. Congratulations also to Joe Burford VK5NOT in the CW section, and the leading scorers in the individual call areas.

The results are shown below. Certificate winners are denoted by asterisks:

<b>CW:</b>	
VK1WI **	33
VK2AIC *	15
VK3DXI *	24
VK3APN	19
VK3NCY	8

VK4OD *	10
VK5AFO *	22
VK5NOT *	19
VK5PO	17
VK5XE	15
VK6AF *	15
VK8AV *	24
<b>Phone:</b>	
VK1WI *	51
VK1FF	27
VK1PK	20
VK3IO *	41
VK3DXI *	41
VK3MSL	15
VK3OZ	12
VK4LAA *	3
VK5KCX **	67
VK5PO	59
VK5DL	41
VK5NOS	35
VK5YX	31
VK5TY	23
VK5KGS	21
VK5GMH	19
VK5PEB	15
VK6BIK *	14
VK8AV *	42
ZL1BVK *	35
ZL1AFQ	21
ZL3GL *	18
I. McGovern *	44

### Results of Waitakere Sprint

(Certificate = \*)

<b>Phone:</b>	
VK4PCB *	52
VK4CRO *	44
VK2XT *	39
VK5NFJ	30
VK5OV	11
<b>CW:</b>	
VK5NFJ *	8

### Results of 1996 PACC Contest

(Callsign/QSOs/Mult/Final Score)

VK2APK*	42	17	714
VK4XA	22	12	264
VK4TT	14	8	112
VK3APN	6	4	24

### Results of 1996 ANARTS RTTY Contest

Presented by Jim, VK2BQS

**World Plaque Winners:**

Single Operator	UT0I	4,198,658 pts
Multioperator	RK9CWA	5,389,360 pts
SWL	ONL383	271,065 pts

**Single Operator:**

(Callsign/Final Score/QSOs/Mult/Continents/  
VK Bonus)

# = World Plaque, \* = Continental Winner

UT0I #	4,198,658	448	117	6	1400
UR7E	3,346,276	354	116	6	1300
VK2KM *	3,319,422	194	79	6	n/a
ABSKD *	3,286,828	541	119	6	1000
UN5PR *	2,622,592	265	106	6	1000
N1RCT	2,079,062	381	89	6	200
UA4LL	1,874,058	282	97	6	600
WA6VZI/7	1,841,545	264	77	6	1400
N6GG	1,569,720	215	74	6	2400
G4BWP	1,289,940	201	78	6	600
SM3KOR	1,041,312	217	63	6	300
I2HWI	982,750	170	75	6	400
ZL2JON	941,724	121	57	4	5100
OI3LQK	834,740	236	66	5	500
RA0FU	832,332	141	67	6	1800

OK2SG	822,012	145	76	6	300
US9QA	815,450	212	75	6	500
OH2LU	765,672	166	66	6	600
DL7VOG	664,300	141	54	6	100
WD0CHW	617,744	175	54	6	200
CE8SFG *	611,000	90	40	5	-
IK0HBN	571,325	148	65	5	300
G5LP	510,550	141	83	6	100
VK5AI	454,935	74	39	5	n/a
K14MI	454,340	143	62	5	500
AH6JF	449,320	134	43	4	400
KA2CYN	416,725	118	55	5	100
VE6KRR	400,496	96	44	6	800
4X6UO	391,155	120	43	5	700
OK2BXW	357,310	102	41	5	200
KD6TO	323,590	124	34	5	1100
SP9LKS	285,892	96	52	6	100
JH1HRJ	270,672	63	33	6	600
VK2CTD	250,880	64	32	4	n/a
JA1SJV	247,220	65	36	5	1700
WA4JQS	220,030	85	34	5	900
ER5AA	215,975	91	53	5	-
K7WUW	211,360	79	36	5	400
K6HGF	197,348	111	34	4	1100
WA0ACI	163,280	102	41	5	100
JA9DDF/2	162,952	45	26	6	400
KE7GH	145,700	85	33	4	500
W9FFQ	140,015	89	41	5	-
VK3DXI	123,215	38	19	5	n/a
YL2KF	119,038	68	43	6	100
SP3RBT	112,140	59	35	6	-
JH3WKE	102,200	42	25	4	500
VE8NC	101,136	51	29	4	100
OM3PR	94,185	60	39	5	-
VK2DPM	93,900	37	15	5	n/a
SP3FAR	86,284	40	27	6	100
VE6FR	84,475	42	25	5	600
VK2BQS	71,536	36	17	4	n/a
KD2YG	63,564	45	24	4	300
N2LEB	60,900	46	29	4	-
SM3LGO	53,028	44	27	4	-
AA9RR	52,904	58	34	4	-
HB9DBK	50,746	27	23	6	100
W2JGR/0	43,500	39	20	5	100
SM6APB	34,560	26	18	5	-
SM4RGD	32,373	55	33	3	-
SP2EIW	31,220	70	35	2	-
LA7AJ	24,048	27	18	4	-
SP2FN	18,600	29	20	5	-
DJ2YE	13,430	27	17	5	-
KB9KWL	12,672	37	16	3	-
VK2AIC	11,040	17	10	2	n/a
VK3EBP	6,146	12	7	2	n/a
DF5BX	3,744	15	13	3	-
SP2UUU	992	15	8	2	-

Check Log F/OH2LU  
**Multioperator:**  
RK9CWA # 5,389,360 431 140 6 1,600  
AA5AU \* 3,965,922 426 123 6 3,600  
IK2BUF \* 2,816,144 315 114 6 800  
OH0JWH 2,558,460 380 110 6 300  
VK6GOM \* 2,082,785 181 71 5 n/a  
VE3FJB 397,200 108 45 6 300  
VE3UR 133,012 110 36 4 -  
SWL:  
ONL383 # 271,065 96 51 5 -  
ONL3997 11,424 30 17 3 -  
Note: A detailed report has been sent to all entrants.

\*PO Box 2175, Caulfield Junction, VIC 3175  
pmesbit@melbpc.org.au

ar


# For All Your Requirements

AUTHORISED DEALER:

# ICOM

# KENWOOD

AMATEUR ■ COMMERCIAL  
MARINE COMMUNICATIONS



## Tower Communications

Shop 3, 443 Albany Highway  
Victoria Park, WA 6100  
Telephone (09) 470 1118  
Facsimile (09) 472 3795

# Divisional Notes

## Forward Bias - VK1 Notes

Peter Parker VK1PK

### Technical Symposium Draws Many

Amateur radio direction finding, packet gateways and microwave techniques. These were just some of the attractions at November's VK1 Technical Symposium. Organised by Mike VK1KCK, the Canberra Amateur Packet Radio Group and several other helpers, attendance was well up on last year with 48 amateurs present. Other presentations included getting the most out of your packet radio TNC, HF receiver design and complex numbers. As well, there were talks on TCP/IP, HF digital operation, local area networks, future modulation techniques and DX clusters. An amateur positioning system was demonstrated, and attendees could test their equipment on an RF test station. John Day from Daycom Communications Pty Ltd was also there, with a well-stocked table of books and station accessories. It might be of interest to note that of the fourteen equipment suppliers written to, just two replied, and of those only one could attend.

### Man Convicted of Ginini Theft

The adult involved in last year's theft of repeater equipment from Mount Ginini has been found guilty. Appearing in the Canberra Magistrates' Court on Tuesday, Mr Gary Cooper was convicted of aiding and abetting the theft of equipment from Mount Ginini. The equipment stolen included the UHF Channel 7 CB repeater operated by Outward Bound, and the two metre voice and packet radio repeaters, owned by this Division.

Gilbert Hughes VK1GH, who was at the trial, advises that Mr Cooper had initially pleaded not guilty. However, at Tuesday's trial he changed his mind, pleading guilty to two of the three charges laid. Mr Cooper was not acting alone. One juvenile was convicted in the Children's Court last year in relation to the theft.

Because of the crime's severity, the case has been referred to the Supreme Court for sentencing in early 1997. The matter of compensation will be considered at this time.

### Canberra Rally

As has become the custom in Canberra, amateurs provided communication for the annual Rally of Canberra held in mid-November. Despite early difficulties in attracting volunteers, it came good in the end with some 50 local and interstate amateurs taking part.

### Raffle Drawn

The raffle for the Chirside Yagi was drawn at the November General meeting. Congratulations to Eric VK1EP who had the lucky ticket.

### Sprint Success

VK1WI topped the country in last July's Australasian CW Sprint. November's Committee meeting heard that Jim VK1FF, who operated as VK1WI, made 33 contacts in the hour-long 80 metre CW contest. For its efforts, the Division received a handsome plaque from the Adelaide Hills Amateur Radio Society, and the WIA VK5 Division, the joint sponsors of the annual sprint.

### AGM Next Month

This year's Annual General Meeting of the WIA (ACT Division) will take place at 8 pm on Monday, 24 February at the Griffin Centre, Civic. It is understood that several committee members will not be re-nominating. If you have thought about becoming involved in the running of the Division, 1997 could be the year for you.

### VK1KCM BBS Returns

The VK1KCM BBS system is now back on the air. Carl VK1KCM reports that, while it shouldn't seem much different to users, there have been MAJOR changes in the system, not just the location change.

The BBS is now located in Kambah, on the foothills of Mt Taylor. The 147.575 MHz 1200 baud port has a 3 dBd gain vertical at 20 feet. The 144.800 MHz 4800 baud port has a 5/8th wave on the gutter. Radios are the same as they were before.

The BBS is now running on a 386SX at 33 MHz with 8 Mb RAM and 40 Mb of hard disk. The radio ports are now connected to a 386DX40 running Linux 2.0.24 and Kernel AX.25. It is planned for other services to start appearing on the Linux box and the gateway machine (a 486DX33 running FreeBSD).

There is a serial link between the BBS machine and the Linux box ('cause the ethernet link is having problems). An rxecho daemon running on the Linux box echos packets between the radios and the BBS so it can be accessed directly by users on both frequencies.

To connect to the VK1KCM BBS connect to VK1KCM-0. The node may or may not be available on VK1KCM-1.

### VK2 Notes

Peter Kloppenburg VK2CPK

The bonds between affiliated clubs and the NSW Division of the WIA were re-established and strengthened during the Conference of Clubs that was held on 9 and

10 November 1996.

Of the 41 clubs affiliated with the NSW Division of the WIA, 17 were represented at the conference. Most clubs had sent two club members and total attendance ranged from 50 to 70 people, including guests and visitors. The Divisional Council was represented in full, with most councillors making presentations about their respective portfolios and other associated activities.

As it had been a while since the last conference, Council had decided to start from scratch and make presentations about what it does and how it does it. The agenda for the conference covered a two-day event, comprising presentations, discussions, and speeches by invited guests. Westminster rules of debate were adhered to, just like any normal Council meeting. Meals were provided free, and there was plenty of opportunity for informal discussions between Councillors and attendees.

The Spectrum Management Agency (SMA) was represented by Mr Vlies, acting manager of the North Sydney branch. After talking about his background in radio communications, he spoke at length about the SMA and the changes that the rapidly increasing demand for radio spectrum places upon it. He also pointed out that the radio spectrum is a national resource owned by the



**AMATEUR  
TRANSCIVER  
RADIO CENTRE**

**BEST LEADING RANGE ON  
DISPLAY OF LATEST  
AMATEUR HF - VHF - UHF  
TRANSCIVERS AT  
COMPETITIVE PRICES**

**'AUTHORISED DEALER FOR**

**KENWOOD ALINCO**

**cushcraft**

**ICOM**

**WEEKLY SPECIALS THROUGH-  
OUT CHRISTMAS AND NEW YEAR  
EXPAND YOUR COLLECTION**

**PHONE/FAX  
(02) 9896 2545**

**141 GILBA ROAD,  
GIRRAWEE, NSW 2145**

community, a resource that has to be controlled and maintained just like a park or a waterway. Hence, the principle of the user pays!

Another guest speaker was Ms M Friend, representing Select Insurance Brokers. As most of you know, affiliation with the WIA entitles the club to group insurance for public liability. This means that the premium for such insurance is much lower than would normally be the case. Ms Friend spoke in particular about how this insurance covers volunteer workers of clubs. She quoted examples of when the cover applies and when it does not. Any club member who has queries on this subject should contact the WIA office in Parramatta.

The subject of Policy and Strategy was introduced by Mr Jensen, Vice-President of WIA NSW. His committee is working on a policy and strategy for the NSW Division that will take it into the next century. Mr Jensen spoke about the urgent need to plan for a rapidly changing perspective of amateur radio, such as in the growing usage of packet radio, satellite operations, digital communications, and competing interests such as Internet with voice options. He said that the Institute will do more to publicise its image with the younger generation through talks and demonstrations of amateur radio at schools and colleges. His committee had formulated a plan of action for the WIA to follow, and he distributed copies of it to those present at the conference. He urged everyone to discuss its contents and comment on it as soon as possible.

Our New South Wales Technical Advisory Committee (NTAC) was represented by Mr G McGrorey-Clark. Geoffrey gave details of how his committee works and how it deals with submissions from clubs for new frequency allocations for repeaters and links. He stressed the importance of correctly filling in forms and providing all the data asked for in the forms.

On Sunday it was Mr P Naish, Federal Secretary of the WIA, to take the opportunity to speak about his portfolio. Peter gave background information about the administrative operations that he is involved with at the Federal Secretariat. He also provided an insight into the structure of the secretariat, who owns it, who contributes to it, and who are its members. Furthermore, he identified members of the Federal Executive and explained what their purpose is.

Following Peter, was Mr K Westerman, Chairman, Conference of Clubs. Ken had been very busy lately, organising the conference, writing all the letters and making all the telephone calls. Ken made a short speech about the purpose of the conference and how it could benefit the clubs. He invited the representatives to consider how to build

on the success of this conference with suggestions about the structure and purpose of the next one in May 1997.

Many subjects were discussed and spoken about in these two days and from the feedback we can conclude that the conference was a success and enjoyed by all who attended. Council hopes that next year more clubs send representatives to the Conference of Clubs, an opportunity too good to miss.

### **VK2 Web Page Moves**

The VK2 Divisional Web page has been relocated to another site, following a change in Web traffic pricing policy at our current Internet Service Provider. In early December the Division received a generous offer to host the VK2 Web page from Dr Tony Farrow VK2TJF at Macquarie University's Department of Mathematics, Physics, Computing and Electronics.

The Web page, which has received about 2500 visits since we started counting them in June, has proved very popular with Internet "Web surfers", including amateurs from all over the world. The resulting ten megabytes of traffic generated each week by these visits became a liability when our service provider decided to charge us by the kilobyte!

The new URL for the Web page is <http://marconi.mpce.mq.edu.au/wia>

The existing Divisional e-mail address, [wiansw@sydney.dialix.oz.au](mailto:wiansw@sydney.dialix.oz.au) remains unchanged for the time being, and the old Web page URL will redirect browsers to the new Web page for a while, to give everyone a chance to update their Web browsers.

Many thanks to Tony, and Craig Pattison VK2BTQ, who did the necessary work at Macquarie University to establish the new Web page, and of course to the University's Department of Mathematics, Physics, Computing and Electronics for hosting the Web site for the Division.

**Flash!** The callbook for 1997 is available now! Members \$13, plus P&P \$2.30.

### **VK3 Notes**

*Barry Wilton VK3XV*

#### **Repeater Licences**

WIA Victoria is actively involved in the national debate concerning the future cost of repeater licences and has fully examined the effect the increased charges imposed by the SMA will have on the Victorian repeater network.

We are hopeful that through proper negotiation at the appropriate level, the SMA may reconsider its decision to charge for repeater licences on an "assigned frequency" basis.

There are several aspects which deserve consideration, and further discussion will

include legal implications, regulation, and cost effectiveness to the SMA.

Regardless of the final outcome of any negotiations, the overall cost of repeater licensing will more than double from the current figure, and a reduction in the number of repeaters supported financially by WIA Victoria appears to be inevitable in the near future.

WIA Victoria will endeavour to maintain a backbone of repeaters throughout the state; and others will be offered to interested clubs and groups on a local basis, and WICEN will possibly take control of others for emergency use only.

### **Membership Subscriptions**

Many members will have received their membership renewal notices for 1997 and noted the change to a common renewal date of 1 July.

This change was made as the result of a decision by the Federal Council in an attempt to reduce operational costs of the Federal Secretariat.

The WIA Victoria Council appreciates the need for a major reduction in expenditure at Federal level, and is committed to securing better management of the funds WIA Victoria members contribute.

The Council is concerned, however, that the implementation of this change by the Federal Secretariat may cause undue confusion and inconvenience to members, and in that instance the Council may take alternative action in relation to the collection of subscription renewals in the future.

### **Disposals Equipment**

WIA Victoria has been actively seeking and tendering for good equipment to be made available to members at bargain basement prices. We currently have a number of Philips FM92 UHF Transceivers which are fully synthesised (99 channel) and are easily converted to the 70 cm band. Low band VHF Philips 828s are also available for only \$10.00.

### **VK6 Notes**

*John R Morgan VK6NT*

#### **Divisional News**

The President and Council send their best wishes to all VK6 radio amateurs and listeners, for a happy and DX-full new year.

In the business section of the November GM, mention was made of the VK3 Division's concerns about the conduct of Federal WIA affairs. Will VK6UU then commented on the recently introduced scale of fees for beacons and repeaters. Despite the removal of the "\$91 SMA study component", the rise to \$50 per frequency could result in inability to pay for some services, as the total licence fee bill for

WARG, for example, would rise to about 50% of its present annual income. The President of the Federal WIA, Neil VK6NE, outlined the approach being taken by the Federal WIA towards an endeavour to have the SMA reconsider the heavy new impost on these community services.

Following the business part of the meeting, Wal VK6KZ led a discussion entitled "The Future of the WIA". Only time will tell whether anything will come of this exercise, but the process has started in a most workmanlike manner, and promises tangible improvements in the management of our hobby, at least in VK6. Recordings of parts of the discussion were included in recent Divisional broadcasts.

General Meetings are held on the third Tuesday of each month in the Board Room, 3rd Floor, CWA House, 1174 Hay Street, West Perth, commencing at 8 pm. Usually, there is no meeting in December. All interested persons (members and non-members, licensed or listener) are invited to attend, and will be plied with free coffee and biscuits.

#### WA Repeater Group

WARG's chairman, Ralph VK6KRB, reports that the re-location of the peripatetic 2 m repeater VK6RPD (146.950 MHz) is progressing well, and may be complete

before these VK6 Notes are published. The new site is in Attadale, at the elevated QTH of Don VK6UT (whose son Mike VK6JMT is a well-known repeater-builder). Note that, as part of the re-location, the machine's callsign is to be changed to VK6RFM, to reflect its primary task of reaching the parts of Fremantle which other repeaters cannot reach!

#### If You Have Material ...

Material for inclusion in this column may be sent to VK6NT @ VK6ZSE.#PER.#WA. AUS.OC, or to PO Box 48, Beverley WA 6304, or via telephone on (09) 291-8275.

#### "QRM" News from the Tasmanian Division

Robin L Harwood VK7RH

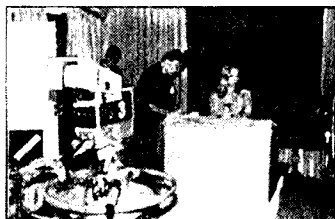
This month is rather quiet with very little activity on the Divisional front. No regular monthly meetings of the Branches have been scheduled. However, I believe that the Domain Activity Centre will still be open on Wednesday afternoons from 12 noon to 4 pm. The Northern Branch are holding an informal get-together with members on the east coast on Sunday, 11 January from 11 am. The venue will be the QTH of Paul Godden VK7KPG in Scamander. I am certain there will be a talk-in on either the

146.900 or 146.725 MHz repeaters if you are looking for directions.

All three branches will be holding their Annual General Meetings next month and, in accordance with their Rules, nominations for Branch positions should be handed in 21 days prior to the scheduled date for the AGM with any notices of motion to be in 28 days prior to the Meetings. The dates are: Southern Branch, 5 February 1997 at 2000 hours at the Domain Activity Centre; Northwestern Branch, 11 February 1997 at 1945 hours at the Penguin High School; and Northern Branch, 12 February 1997 at 1930 hours at the Launceston Institute of TAFE, Alanvale Road, Newnham, Block "C".

Also, the Divisional Annual General Meeting will be held on 22 March 1997 at the registered office of the Division, the Domain Activity Centre, Hobart. It will commence at 1400 hours. Nominations for Divisional Council should be in the hands of the returning officer 21 days prior to the AGM and those proposing and seconding the nomination must be current financial members. The address where these should be sent is in the WIA Divisions directory on page 56 of this magazine. Notices of motion also must be lodged 28 days prior to the meeting to the secretary at the same address.

ar



# Radio and Communications

INCORPORATING AMATEUR RADIO ACTION AND CB ACTION

Published by  
**ACP SYME  
MAGAZINES,**  
PO Box 119,  
Oakleigh,  
Vic 3166  
(03) 9567 4200

Ever wondered how you might improve the lot of amateur radio? Yep, you could try introducing *more* amateurs to the hobby — and that's exactly what the folk at the Gladesville Amateur Radio Club have been doing with great success — via amateur TV! We have the full story of this great venture for you this month, plus loads more, such as...

- Review: AEA DSP-232. Put DSP inside a top multi-mode packet radio TNC and wait for the plaudits...
- Slow-scan TV. More about SSTV with a look at the various modes. How can you tell which is which?
- Review: Icom IC-R8500. Here's a DC to Daylight shack receiver which gives affordable performance.
- A little Christmas reading... we review the magnificent ARRL Handbook plus a few other great books.
- The Heard Island DXpedition — a last-minute update. Look for VKØIR January 15 to 29. Good luck!
- Modifications: a most popular column. This month we concentrate on a couple of Kenwoods...
- The Best IOTA column in Region 3, *three* DX columns and more... all the best regulars every month!

Don't miss out — **RADIO and COMMUNICATIONS** is great reading for amateurs!  
**Check your local newsagent today!**

(PS. We also have the biggest collection of radio-oriented Classified adverts in the country. There's lots of them because they work so well. Ask your newsagent to keep a copy for you each month, or ring 1800 25 2515 for subscription details. Hurry — you might miss something!)

cc

---

---

# How's DX

Stephen Pall VK2PS\*

---

---

For some people the reason of moving from the old year into the new year is hope! Hope that the new year will bring "more" of everything. Better luck, more money, better health, more happiness, and all sorts of things which humans wish to each other and to themselves.

We radio amateurs, especially those who favour the HF bands and are looking for contacts in far away places, wish and hope for improved propagation on the bands. Propagation at the present is in the doldrums, in between two cycles, and every day brings us surprises and disappointments.

Since early November the 10 cm flux, which is one of the indicators of the sun's activity, has started to climb above the usual index of 69. Index numbers were increasing from 70 to 72 to 74 to 75 to 83 to 91 to 100 and, on 27 November, even reached 104. Jubilant voices were heard on many bands: "here is the beginning of the new Cycle 23!"

Is this so? Not quite, according to Dr Richard Thompson a solar scientist with the IPS Service. I consulted him again to seek an explanation for the sudden rise of the flux numbers. He said: "*The sunspot regions that we presently see on the sun all still belong to the old cycle, except one, which is part of the new cycle. I think that the sudden rise of the flux is a one-off situation, but it is significant that a couple of the old cycle sunspots have grown reasonably large which could indicate some improvement in propagation.*" So let's hope for better propagation in 1997.

The Heard Island DXpedition, which will start in a few days, will put this "hope of better propagation" to a severe test. Will the DXpedition reach the magical 100,000 QSOs in two weeks operation? Only the future will tell.

Until then have a happy, prosperous and healthy New Year!

## Heard Island VK0IR

This is the month, the first one in the new year, for which many thousands of DXers all around the world have waited for many years. The third most wanted DXCC country, according to the 1995 survey, will come on air after 14 years of silence. Many older DXers still remember the exciting weeks of 1983.

The team of DXers, specially chosen for their communication and other skills, assembled shortly after Christmas on Reunion Island. From there they sailed towards their destination in the French Antarctic ship "Marion Dufresne" bound for Crozet, Heard and Kerguelen islands. They will depart Reunion on 3 January and are expected to be on Crozet on 8-9 January, and

arrive on Heard Island on 12 January. They will depart Heard Island on 28 January, arrive on Kerguelen on 30 January and back to Reunion on 5 February.

The latest list of the team (there were a few changes) includes EA8AFJ Michel Sabatino, HB9AHL Willy Rusch, HB9AFI Curt Wetter, KOIR Ralph Fedor, K4UEE Bob Allphin, K9AJ Mike McGirr, KK6FK Bob Schmieler, N6EK Bob Fabry, N6MZ Michael Mraz, OE9AMJ Arno Metzler, ON6TT Peter Casier, PA3DUU Arie Nugteren, RA3AUU Igor (Harry) Booklan, VK2JDM (former VK2TQM) David Muller, W8FMG Wes Lamboley, W0GJ (WA0PUJ) Glenn Johnson, WA3YVN Al Hernandez, 9VIYC James Brooks and NP4IW Carlos Nascimento.

## Callsigns

The expedition will use the following callsigns. Reunion Island, TOOR; during the sea voyage, FOOR/mm; on Crozet, TX0K; on Kerguelen, TX0C; and on Heard Island, VK0IR. From the first day of landing, while setting up camp and before the activity starts, the NCDXF beacon will run from the island as VK0IR with an R5 vertical. It will transmit on 14,100, 18,110, 21,150, 24,930 and 28,200 kHz. It will transmit for ten seconds on each band every three minutes. The VK0IR transmission on twenty metres is at one minute and ten seconds after the hour and every three minutes after that. The transmissions on the other bands follow every ten seconds with the ten metre transmission starting at one minute and fifty seconds after the hour and every three minutes after that. On each frequency it sends VK0IR in CW at 100 W in a decreasing power system.

Through the whole operation on Heard Island, from just before sunset to just after sunrise, when the band is not used, a special 160 metre beacon will run on 1.826.5 kHz with full legal power on a monoband top-loaded vertical.

Talking about the sunset and sunrise times on the island, this data is useful for the DXer (all times in UTC): 7 January, sunrise 2257, sunset 1532; 13 January, sr 2308, ss 1521; 21 January, sr 2314, ss 1520; 27 January, sr 2333, ss 1504.

## Pilots

During the whole of January selected radio amateur stations, called "pilots", will stand-by on all the bands and will monitor and provide feedback, comments or ionospheric predictions and other useful information to those on the island. This contact with the island will be made via e-mail, packet BBS to the PACSAT satellite with a gateway in Europe. In the same way local news will be

sent from the island to the pilots for general distribution and information either via PACSAT or via Internet and/or the Inmarsat telephone service. The callsigns of the pilots and their area of feedback are Isao JHIROJ (Japan); Randy KOEU (US Midwest, Central); Don NIDG (US Eastcoast); John ON4UN (Europe and pilot coordinator); Bob W0EK (US Midwest, North); Jay W2IJ (US Westcoast and Oceania); and Scotty W4WW (US Midwest, South).

## Operating Frequencies

The following operating frequencies will be used: CW - 28.024, 24.089, 21.024, 18.074, 14.024, 10.104, 7.007, 7.022, 3.507, 3.522, and 1.826.5 MHz; SSB - 28.475, 24.945, 21.295, 18.145, 14.195, 7.065 (EU), 7.065 (non EU), 3.799 (EU-JA-VK; receiving down in SSB for VK on 3798), and 3.799 MHz (US, receiving down in SSB); RTTY - 21.085, 18.105 (if 17 m proves to be the best band to one continent), 14.085, 10.140 (if this is the best band for one continent), or 7.030 (if this is the best band).

The expedition will use split frequencies, maximum 25 kHz on SSB and maximum 15 kHz on CW. They will not work anybody outside the split window. Please listen for instructions. The expedition will use directed calls to "continents". There are three continents in their books, Asia/Pacific, Europe/Africa/Middle East, and the Americas. I have approached the Czar of Radio Operations (the title is their designation, not mine!), Peter ON6TT, to have a new call area established "for VK/ZL only". Whilst Peter is fully aware of our problem concerning the powerful JA and USA stations he decided to stick to the already specified "continents".

However, in a fax dated 21 October he said: "*We will need to take care that one part of the area is not completely covering the other: YB, DU, BY and VK/ZL will need to be treated separately from JA. I will edit the manual and stress this explicitly and will take VK/ZL as a typical example.*" Accordingly, the manual was altered on 22 October.

Another matter has also arisen about the listening frequency in the 75 m "DX Window". Originally the listening frequency for the VKs was on 3795, right next to the prohibited frequency of 3794 plus 1 kHz. Being aware of the lower sideband problem on SSB with the legal power of 400 watts, I suggested to Peter ON6TT to move the listening frequency nearer to the transmitting frequency. This was agreed on 27 November and VK0IR will now listen for VKs only on 3798. Please be extremely vigilant and attentive for instructions when operating in the DX Window. Incidentally, the Heard Island DXpedition is well aware that the maximum legal power on any Australian Territory is 400 W PEP on SSB. I do not think



that it is necessary to mention it, but I assume that it will be common courtesy to give priority to VK0IR when they are working in the DX Window.

#### Australian Participation

The only VK participant in the Heard Island DXpedition is David Muller ex VK2TQM. David is a valuable member of the expedition on the technical side. However, despite his busy professional schedule, he managed to pass the basic Morse examination held recently and he is now the proud owner of the combined call of VK2JDM which will give him limited access to the 80, 15 and 10 metre bands

The expedition still needs quite a few dollars to complete its budget. David did an excellent job in inducing people to donate money towards the expedition's costs. The VK2 Division made a donation of \$150 for the project; a few amateur radio clubs in NSW and other organisations have also donated a variety of sums or useful commercial goods. But there is still need for more donations, however small. Here is an idea which will give you not only a permanent memento of this expedition, and every true DXer should obtain one, but the profits from this VK-originated idea will boost the expedition funds.

Private Commemorative envelope covers will be produced in Australia with two different Heard Island logos and Antarctic stamps. Each standard cover will be autographed by one of the expedition members. Special limited release covers will be autographed by all members of the DXpedition. These covers cost from \$7.00 (autographed by one expeditioner) to \$35.00 (cover autographed by all the expeditioners). Postage and handling charge is an additional \$3.00. All the orders and payments will be handled by David Muller after he returns from Heard Island. Send your order, payment and/or donation to: Heard Island Expedition, Locked Bag 29, PO Rydalmere, NSW, 2116, Australia. In the meantime I have a number of blank order forms with all the details and prices. If you wish to receive such an order form, send a self-addressed and stamped business size envelope to my address at the foot of this column.

Finally, one more important piece of information. The QSL Manager for the DXpedition is W4FRU John H Parrott Jr, PO Box 5127, Suffolk, Virginia, 23435 USA. Send your card with a self-addressed, return envelope and return postage.

Many of us need Heard Island as a new DXCC country. Please be reasonable, patient and tolerant towards your fellow amateurs in the big pile-up. Listen and follow the instructions of the operators. If they call for North America, they will not answer your call, because you are in the Oceania region.

I wish them good luck and good weather

conditions. My wish to the readers of this column is that I hope you will be able to work them.

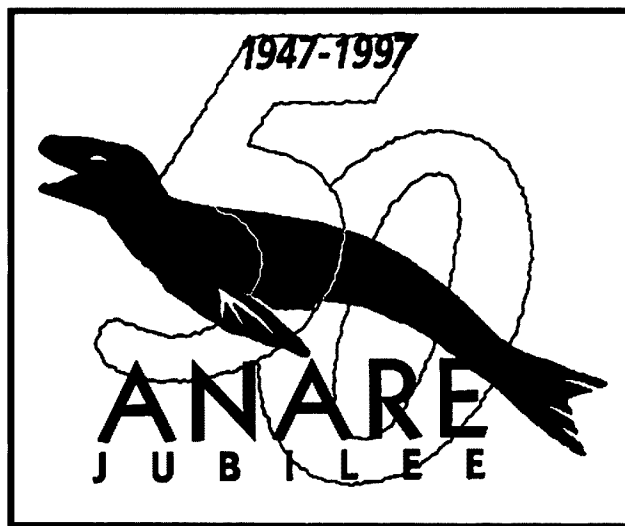
#### Macquaria Island VK0TS VK0WG VK0KBB

Warren VK0WH, having completed his tour of duty, left Macquarie Island mid November. Many DXers, for whom he was the first contact with Macquarie Island, and the DX community at large, thank him for his cooperation, assistance and understanding of the "need" of his activity.

The summer months, from late October to the end of March, are busy times on Macquarie, as they are on all Antarctic ANARE (Australian National Antarctic Research Expeditions) bases, Casey, Mawson and Davis. The long-term "wintering" crews are replaced with new personnel plus a number of small scientific groups who are at various bases only for the "summer" season for 3-4 months. This is the time when the bases are a hive of activity and accommodation space is stretched to the limit. This is also the time when amateur radio takes a "backseat" in the scheme of things. However, 1997 appears bright for amateur radio on Macquarie Island.

I am happy to confirm that in 1997 we will have three amateur radio operators on the island. Tom VK0TS is Communications Technical officer, Eric VK0KBB is in the engineering section and Graham VK0WG is attached to the meteorology unit at the base. All three have been employed by the ANARE since July 1996 and in the past few months were undergoing intensive practical training in Hobart for the task ahead. This included field training, fire fighting, rough surf board training and many other specialist courses. They arrived on the island on the Aurora Australis Voyage 3 in early December 1996. There is not much time for ham activity as the changeover and resupply of bases means long working hours and little spare time.

Tom VK0TS is from Canberra and was working as a satellite laser ranging electronics technician and operator in Ororal Valley. He is 25 years old, commenced employment as Communication Technical Officer with the Antarctic Division in July 1996 and had been training in Sydney and Hobart. The communication network at Macquarie is complex. The main link to the rest of the world is the ANARESAT satellite link with Inmarsat and HF as a backup. He will be maintaining this equipment with the Chief Communication Technical Officer. Tom plans to be active on HF on both CW and



SSB. He will be concentrating on the 80 and 40 m bands to other Antarctic stations and to Australia. I asked him to try to be active also on the DX bands; hopefully he will see his way clear to accede to our plea. The winter commences in April, when the Macquarie island population decreases to 18 solitary souls, and the island will have no ships' visits until October 1997. This is the period when there should be some amateur activity from the island.

Incidentally, ANARE celebrates 50 years of activity in 1997, as the first official research station was established on Australian Antarctic territory in 1947.

#### Future DX Activity

\* Ed K8VIR plans to be active from FW, VK9, YJ, ZK2 and ZL7 during the next few months.

\* Axel DL6KVA will visit Azerbaijan 4K and will be active from the station of Vlad 4K9W.

\* Peter ON6TT, who was active as 5X1T, left Uganda to prepare himself for the Heard Island DXpedition.

\* Eric FT5ZG was on his way to Amsterdam Island FT5Z on 5 November. He passed through Crozet and Kerguelen and was to arrive at Amsterdam at the time of writing of these lines (25 November). He will be using a TS-450SAT with an R5 antenna and no amplifier. His length of stay will be one year (although other sources say he will be there for only four months) and he will work as a transmission officer and postman. QSL manager is F5RQQ Jean Marc Vigilier, 14 Rue de Paul Helbronner, 38000 Grenoble, France.

\* Matt DL3KUD will be active from the Azores from 30 December to 12 January as CU8/DL3KUD from Flores Island (IOTA EU-089). Activity will be on CW only on all HF bands. QSLs will be answered via the Bureau, no direct cards please.

\* Pedro HK3JJH hopes to be active on 22 December or January 1997 from HK0

Serrana Bank (IOTA NA-133). These operations will last only six to eight hours.

\* Mike N17T intends to be active from Mongolia as JT1FBT in January 1997. QSL to home call.

\* Dave WA5IKQ is active from Bosnia-Herzegovina as T9/WA5IKQ. His QSL manager is KH6BZF.

\* Mako JA1OEM, a 70 year old Japanese amateur, will be active until mid January from Suriname (PZ) and French Guinea (FY). Planned call signs are PZ1HD and FY/JA1OEM. QSL to home call.

\* Boris IK4RSR will be in Colombia in January and will be active as HK0/IK4RSR from the islands of San Andres (NA-033) and Providencia (NA-049).

\* Starting in December and continuing during 1997, Mark SP3GVX will be active from the station HF0POL, located at the Antarctic Polish Base Henryk Arctowski on King George Island (62° 10' S, 58° 32' W). He will operate mainly on the low bands. QSL to SP3FYM.

\* Eric F5CCO was supposed to be active from French Polynesia. His trip was cancelled due to pressure of work.

### Interesting QSOs and QSL Information

\* ZF8BS - Bruce - 10140 - CW - 0720 - Oct (E). QSL via AA66KX Bruce B Sawyer, 15430 Bohlman Road, Isaratoga, CA-95070 USA.

\* FW2EH - Dick - 10104 - CW - 1304 - Oct (E). QSL via DJ2EH Dieter Hornburger, Semmelgasse 3, D-96317, Kronach, Germany.

\* FR5ZU/T - Jaques - 14164 - SSB - 0551 - Oct (E). QSL via VE2NW Zareh Amadouy, 18 Nisko, Dollard des Ormeaux, Quebec H9G 2R5, Canada.

\* XX9X - 14205 - SSB - 0723 - Oct (E). QSL via OH2BH Martti J Laine, Nuottaniementie 3D 20, 022330 Espoo, Finland.

\* T77BL - Luca - 14007 - CW - 1349 - Oct (E). QSL via Gianluca Bernardi, Via N Gavelli 7, RSM-47031, Serravalle D2, Republic of San Marino (Italy).

\* XY1HT - Stig - 14195 - SSB - 1212 - Oct (E). QSL via JA8RUZ Toshikazu Kawanishi, Box 166, Asahikawa, Hokkaido 070-91, Japan.

\* 9N1SON - Jack - 14215 - SSB - 1058 - Nov (E). QSL via W4SON Jack W Rucker, Box 837, Jamaica, NY-11430, USA.

\* TR8XX - Jean - 7008 - CW - 0628 - Nov (E). QSL to Jean Claude Lupin, Box 4069, Libreville, Gabon, Africa.

\* 5Z4BZ - Michel - 14039 - CW - 0544 - Nov (E). QSL via The Manager, PO Box 41784, Nairobi, Kenya, Africa.

\* KH8/N5OLS - Don - 3799 - SSB - 1046 - Nov (E). QSL to Don Barclay, PO Box 250, Pago Pago, AS-96799, USA.

\* BD5QE - Qiu - 21030 - CW - 0408 - Nov (E). QSL to Qiu, PO Box 519, Fuzhou, Peoples Republic of China, Asia.

\* 3Z6AEF - Wald - 14037 - CW - 1333 - Nov (E). QSL via Polish QSL Bureau.

### From Here and There and Everywhere

\* What a way to celebrate a birthday! The well known DXer, Martii Laine OH2BH, attained the half-century mark in November. To celebrate the event he and a number of his DX operator friends congregated on Nauru Island, manned four stations using the collective call sign C21BH, and were very active on all the bands between 20 and 27 November. QSL to OH2BH (address in previous section of this column - see XX9X).

\* All QSLs for EY1ZA, EY5OV, EY2Q, EY8CQ/R30, EY8AB, UJ8JCQ, and RJ8JAB must be sent via EY8CQ to Alex Rubtsov, Box 32, Moscow, 117449, Russia or via the Tajik Amateur Radio League QSL Bureau.

\* If you are a devotee of Internet and your pocket allows it, look for DX news on the DXers UseNet group. The address is rec.radio.amateur.dx

\* To celebrate the 1500th anniversary of the baptism of Clovis, a Frankish King, who was the first powerful ruler of the Merovingian dynasty, the founder of the French state and who defeated the last great Roman Army in Gaul, TM6CLO was active from 16-25 December only on CW. QSL via F5WA.

\* The CY0AA QSL cards from the 18 June to 6 July activity are starting to arrive in the mail.

\* PA3ASC reports that Dutch amateurs can now operate on 160 metres from 1.810 to 1.850 MHz.

\* DPIKGI was the first and last amateur radio activity from the German Ardley Antarctic Base which will be closed early in 1997. The new base (Dallmann station) will be located at Juban Argentine base. The Gerge Foster base has been entirely dismantled.

\* If you worked D44AB on 40 and 80 metres CW, it was a pirate. The genuine Daniel D44A8 does not work CW and has no antennas for those bands.

\* Argentinian Novices can now use 3.7 to 3.75 MHz and 28.300 to 28.350 MHz on SSB.

\* Bad news from Cape Verde. Daniel D44AB told Eric F5CCO that the Government of Cape Verde has placed a cost of \$US351 on an amateur licence. Daniel wants information from other amateurs about the cost of the licences in their respective countries.

\* It seems the Russian authorities issuing radio amateur licences have a soft spot for veteran amateurs. From 15 November until

10 December, RW9SG (ex-UW9SG) has operated as UE9SAA to celebrate his 50th birthday and 35 years of amateur activity.

\* Warren VK0WH has corrected the total number of QSOs made from Macquarie Island (November '96 *Amateur Radio*). The total number was around 1200, and not 2500 as previously published.

\* By the time you read this, the many problems concerning the VU2JPS equipment which was sent to Mani in August last year should have been solved. Jim VK9NS and HIDXA had several problems battling the "red tape of bureaucracy". Import duties, customs, transport, transfers and lots of "as soon as possible may be tomorrow" were the standard problems which delayed the receipt of the equipment.

\* Gary VK8GW is moving to Brunei and hopes to be active from there soon.

\* According to JA DX News an operation is being planned for April from Spratly Islands. JA9AG plans to operate as 9M0A or 9M0S.

\* Jean Claude J28JA closed down his station on 26 August at 0225 UTC. Any contacts made after that date and time were with a pirate.

\* QSL with AH8A is only direct and not via a QSL manager. Send your cards to William E Faulkner, PO Box 2567, Pago Pago, American Samoa, 96799-2567, USA.

\* The Amateur Radio Association of Bahrain (ARAB) Club station A92C is on the air again, on the second and last Tuesday of each month for several hours starting from 1700 UTC.

\* Antoine 3D2AG has not been heard in the past year or so. Antoine is doing his last year of studies in marine biology and hopes to be more active in the near future.

\* According to the DXCC press release dated 6 November 1996, the number of unprocessed applications at the end of October was 604 (46,284 QSLs). They received 340 applications (25,602 QSLs) for endorsements and new awards during the month.

### QSLs Received

OI/O/OH3TY (3 w OH3TY); A92GD (3 w K1SE); FY5YE (3 w W5SVZ); OX3SA (2 m op); CY0AA (5 m WD8SDL); VP9KK (3 w - KIEFI).

### Thank You

Many thanks to my supporters who regularly supply me with news and information which makes this column possible. Special thanks to VK2XH, VK2JDM, VK2KFU, VK2TJF, VK8AV, VK9NS, VK0TS, WIA L40370, ON6TT, IPS Sydney, ARRL DX Desk, *QRZ DX*, *The DX Bulletin*, *The DX News Sheet*, *The 425 DX News* and *GOLIST QSL Managers list*.

\*PO Box 93, Dural NSW 2158

af

---

---

## Over to You – Members' Opinions

*All letters from members will be considered for publication, but should be less than 300 words. The WIA accepts no responsibility for opinions expressed by correspondents.*

---

---

### Help With Atlas

I want to use the pages of *Amateur Radio* to make a plea for help from other amateurs. I have an old HF rig which has what I think is an AGC problem.

The rig is an Atlas 210X and the fault manifests itself in a zero reading of the S meter on receive. This is true even for strong local signals. Attempts to adjust the zero point of the S meter still leave me with zero deflection for all signals. The RF gain control has no effect. Associated with this is a distortion on all signals which ruins the usually excellent audio this set produces.

If you have an Atlas 210X and have had a similar problem with the rig, or even if you know of someone in Australia who can provide advice or service on these older rigs, I'd appreciate a call. I am QTHR in the last couple of call books or you can phone me on (06) 258 1228 most evenings. If you have e-mail access I can be reached at [rjenkins@pcug.org.au](mailto:rjenkins@pcug.org.au) or if you have packet I can be reached at [vk1rj@vk1bbs.act.ans.oc](mailto:vk1rj@vk1bbs.act.ans.oc)

I am keen to get this old rig going again, so if you can help, please drop me a line.

**Richard Jenkins VK1RJ**  
PO Box 101  
Charnwood ACT 2615

### Thanks from 9V1

Thank you very much for sending me a copy of the October issue of *Amateur Radio*, which includes the item about Singapore's Quarter Century Old Timers, and for the return of the photo. Please also convey my thanks to all concerned. I must apologise for the delay in writing as I was out of Singapore.

I have received several letters from VK ham friends mentioning the write-up and photo and they were glad we are still active after all these years, especially from the VKs who had not heard from us for some time.

There are only two minor corrections, that of Ong Huck Jin 9V1RA and my address at 63 Jalan Ma'mor #01-59 Singapore 320063, but I am sure the photo said a thousand words and brought back fond memories for our friends now living in Australia.

I had the opportunity of visiting Australia about two years ago, making leisurely visits to all the coastal towns and cities from Melbourne in the south to Cairns in the north. I was happy to be able to meet several ham friends, particularly in Sydney as I was studying there way back in the early sixties. My mother and two sisters have been living in Australia for over ten years and my visit was especially a happy get-together.

Hope all you good folks are keeping well.

**Joe Seah 9V1NQ**  
ar

### Blinkers Again!

In *Amateur Radio*, October 1996, Frank Weber VK2XVJ seems to accuse me of wearing blinkers with regard to my view that it is unacceptable and dangerous to allow radio amateurs without knowledge of CW on to the HF bands, particularly the lower HF bands which are shared with professional users.

The main part of my argument that Frank seems to have conveniently ignored, in favour of pedantic criticism of my use of the term "LF bands" for 1.8, 3.5 and 7 MHz, is we share these bands with commercial and government users who often use CW as identifying beacon-type signals.

I find it astounding that VK2XVJ, involved with the NSW Emergency Services, refuses to acknowledge the dangers of letting loose people who have no knowledge of CW on to frequency allocations where this is still a used mode. I am sure that he would acknowledge the dangers of letting someone who knew nothing about firefighting near a bushfire!

To put it bluntly, causing interference to a commercial or government user on a shared

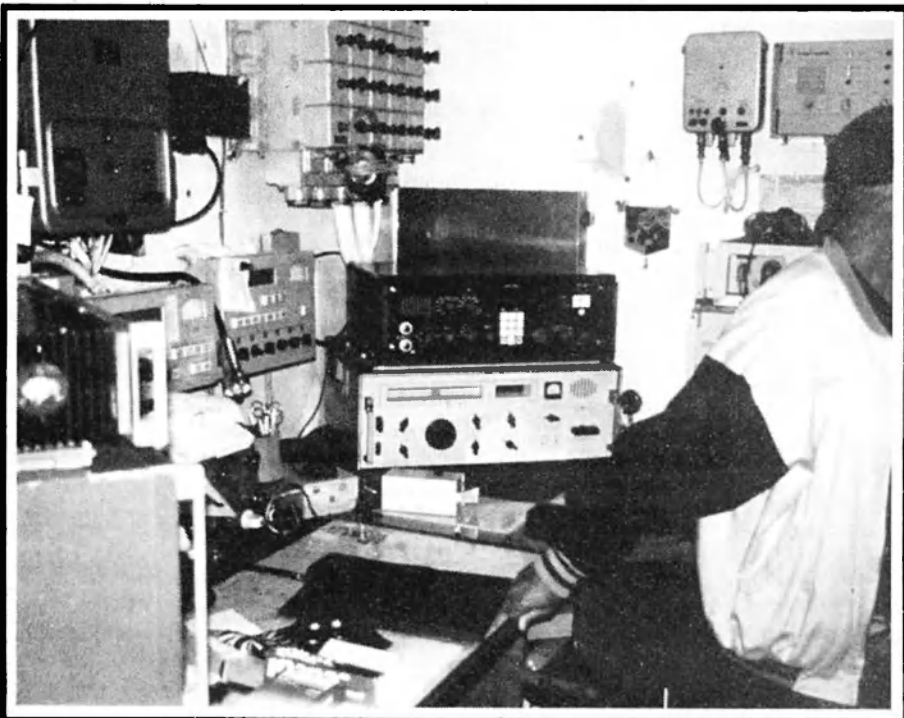
band might have personal or economic costs – nothing as severe as a loss of life, let us hope – and could cost radio amateurs and the WIA dear as far as our image in the wider community is concerned.

That, simply, is my point. I do not doubt VK2XVJ's skills and credibility as a phone operator and congratulate him on his bravery and certificate of appreciation from the NSW Premier. I am a WICEN volunteer myself and hope I acquit myself as well in an emergency as he obviously has.

However, Frank, I do feel you should take *your blinkers off!* CW is still widely used by commercial and professional users as well as radio amateurs – most of the 150,000 ships around the world still use CW, including the largest "tall ship" in the world, the SS Kruzenshtern.

Don't beat us, join us. After dealing with bush fires, CW should be a breeze and a lot more fun!

**Steve Ireland VK6VZ**  
PO Box 55  
Glen Forrest WA 6071



**The radio room of the SS Kruzenshtern, the world's tallest "tall ship", taken on a visit to Fremantle during winter 1996. Note the electronic "bug" key. The 5000 tonne Kruzenshtern, a four masted, square rigged barque, belongs to the Russian Academy of Fishing.**

---

---

# Packet World

Grant Willis VK5ZWI\*

---

---

## Understanding What the Computers Are Doing in a Packet Connection!

or

## What Do All Those Headers Mean?

### 1.0 Introduction

Have you ever wondered what all the different packets actually mean when you connect to someone on packet radio? This short description should give you a clue as to what is going on. Being able to understand, even in a limited way, what you are seeing when monitoring a packet channel, can help you diagnose problems in your packet station. So, first up, let's look at the types of packets that are commonly seen.

### 2.0 Basic Packet Types

#### (1) Controlling Connections – Connect and Disconnect Requests and Acknowledgments

Connect Request packets are sent by the calling station to initiate a packet link between two stations. Connect Requests are answered by the station being called with "UA" packets, known as "Un-Numbered Acknowledgments". These packets tell the calling station that the station being called accepts the connection. They are un-numbered because there is no packet sequence number, unlike "Information" packets discussed later. The only other packet type that will result in a "UA" packet being sent is in response to a Disconnect Request Packet. There are two types of disconnect packets. The first type is used when two stations are already connected and one station wishes to disconnect from the other. In that situation, a DISC packet is sent, which is replied to with a UA.

#### Example 1

Connect Request Packet Format

[callsign] to [callsign] ctl SABM+

Disconnect Request Packet Format:

[callsign] to [callsign] ctl DISC+

Un-Numbered Acknowledgment Packet format:

[callsign] to [callsign] ctl UA-

The other type of disconnect packet is a DM packet, which is the equivalent of a Busy Signal. This occurs when station C tries calling station A who is already connected to station B. In this case, station A will send back a busy packet to station C and then carry on communicating with station B.

#### Example 2

Busy Signal Format

[callsignC] to [callsignA] ctl SABM+

[callsignA] to [callsignC] ctl DM-

[callsignA] to [callsignB] ctl I01+

{packet message continues to station B from A, C Sees Busy Signal}

[callsignB] to [callsignA] ctl RR01-

Depending on the packet programs that other stations are running, some will report to their operators that someone tried to connect to them when they respond with a busy DM packet, while other programs will just respond to the remote station and not notify the operator.

#### (2) Sending Packet Data – Information Frames

Information or Data packets are used to exchange the actual information between two stations. They can vary in length between one and 256 bytes or characters of information.

One of the problems in a packet radio type system is to make sure that the data arrives in the right sequence. To solve this, Information Packets are numbered, so that when they are received they can be reassembled in the right order and, if one packet is missed, the missing one can be determined and the receiving station can ask it to be repeated. In Amateur Packet Radio, the packets are numbered from 0 to 7, and a maximum of seven packets can be sent in any one transmission. After seven packets are sent, the sending station must receive an acknowledgment from the receiving station saying that they all were received so that the next seven packets can be sent. If there are errors, processes to correct any errors are begun.

#### Example 3

Information Packets look like:

[callsign] to [callsign] ctl I00v

The cat sat on the mat

[callsign] to [callsign] ctl I01v

The cow jumped over the moon.

[callsign] to [callsign] ctl I02v

The lazy fox jumped over the old dogs back

[callsign] to [callsign] ctl I03+

Do what you want to do, be what you want to be.

#### (3) Verifying Data was sent correctly – Acknowledgments, Rejects and other things

After a maximum of seven packets are sent, the receiving station must send back an acknowledgment. If no acknowledgment is received within a specific timeout period (called the FRACK timeout or frame (another name for packet) acknowledgment timeout), then the sending station will POLL the receiving station with an acknowledgment packet containing the packet number from the past packet received by the sending station.

#### Example 4

Acknowledgment or Receive Ready Packets

[callsign] to [callsign] ctl RR02-

Receive Ready packets contain the packet number of the last successfully received piece of data from the sending station plus one.

#### (4) Packet Acknowledgment – REJECTED frames

#### Example 5

REject packets look like:

[callsign] to [callsign] ctl REJ01

If a frame gets missed by the receiving station, or there is an error in decoding the frame, then the packet is rejected and every frame after the reject is discarded.

Reject packets are sent when an error is detected. They contain the fact that there was a rejected packet, and they also inform the sending station of the last successfully received packet. In the case of the example below, the packet that was missed was number two. The last successfully received packet was packet one; so, because an error was detected, a reject frame was sent with it's number set to two, which tells the transmitting station to start sending the missed packets again, from packet number two onwards.

#### Example 6

[callsignA] to [callsignB] ctl I00v

The cat sat on the mat

[callsignA] to [callsignB] ctl I01v

The cow jumped over the moon.

[callsignA] to [callsignB] ctl I03+

Do what you want to do, be what you want to be.

[callsignB] to [callsignA] ctl REJ02v



clear. This value was usually in mS and typically is best set between 320 and 500 mS. Shorter times are possible, but they also make your station hog the frequency, to the exclusion of other users.

SLOTTIME/PPERSIST work together to set up a more random channel access timer. PPERSIST is a probability factor, defined as a fraction of 256; ie a PPERSIST value of 64 gives a probability of 0.25 (64/256). The probability sets the likelihood that, given a clear channel, you will actually key up your transmitter. A test to see whether there is a clear channel is performed by your TNC every "slottime" milliseconds. To allow for all users on a frequency, the software authors recommend that SLOTTIME be set to the same value as TXDELAY. I have found this doesn't always yield the best results. Typically values around 150-250 mS have been found to work best.

The best values for PERSIST are around 40, which gives a reasonable compromise between efficiency and channel sharing.

Indeed, the probability factor is supposed to be selected based on  $1/(number\ of\ simultaneous\ users + 1)$ .

#### 4.0 Conclusion

Hopefully, I have given some clues as to things to look for when watching your packet station's behaviour on air. The efficiency of the channel you are using for all stations can be drastically affected by how well your station is adjusted. You can become a channel hog, or always find your own station being disconnected, all through poor parameter settings. Unless you have some basic understanding of what the various packets you monitor are doing, it can be very difficult to decide on what is the most effective parameter to adjust.

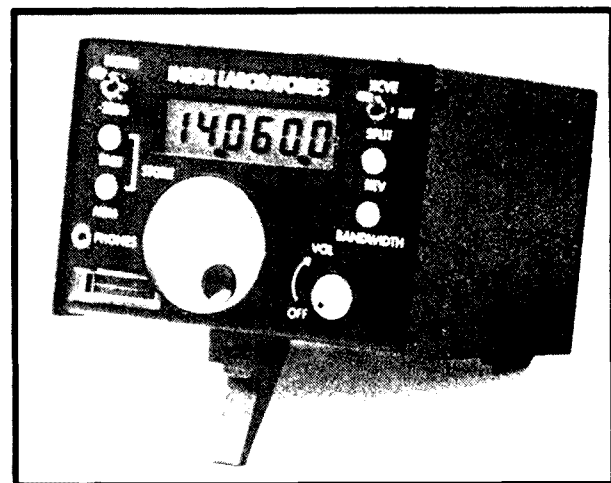
If you continue to run into problems, try contacting one of your local amateur radio clubs, or packet BBS operators. They should be able to give some assistance if you are having problems.

\*C/o GPO Box 1234, Adelaide SA 5001  
Packet: VKSZWI @ VKSTTY.#ADL.#SA.AUS.OC  
Internet: gwillis@dove.mtx.net.au

ar

## Pounding Brass

Stephen P Smith VK2SPS\*



**QRP Plus transceiver.**

In 1995 I read an interesting article in a *CQ Magazine* in relation to a new QRP transceiver that was soon to be released by the American Company "Index Laboratories". The transceiver was to be called the "QRP-Plus".

The features offered in this transceiver were similar to those in medium priced base station units. Some of the features included general coverage receiver tuning from 1.8 to 30 MHz in either SSB or CW; all band transmit 160-10 m SSB and CW; full break-in operation and built-in iambic keyer; SCAF filters; variable bandwidth, and RIT and split frequency operation, just to name a few.

I have a number of home-built units that cover various bands but nothing compared to what the QRP Plus has to offer. I made a quick decision and parted with my FT-101 which helped to cover the cost, etc. Several weeks later, after corresponding with Index

Laboratories, I received my new QRP Plus transceiver.

The QRP Plus comes with a well laid out, easy to read, 24 page instruction booklet, some 3.5 mm plugs for either key or keyer connections, and a spare fuse and power cord for connection to a 12 V or 13.8 V DC supply.

#### Power

The QRP Plus can run from a 12 volt battery for portable use, or a 13.8 V DC supply for base station operation. The supply

should be able to supply 1.5 A or more at 12 V DC for full rated output power. The unit can be damaged if the voltage exceeds 15 V DC and will shut down if the supply drops below 11 V DC.

Reverse connection of the power cable will not damage the unit but will blow the protective fuse located at the rear of the unit. The fuse is a standard 3AG 4 amp fast-blow, common in most electronic stores.

#### Antenna

Antenna connection is a standard SO-239 connector located at the rear. Whilst most

solid state transceivers usually reduce output power when looking into a high VSWR to save the output transistors from damage, this is not so with the QRP Plus, as stated by the manufacturers. In any case, I wouldn't recommend it. If in doubt use a tuner.

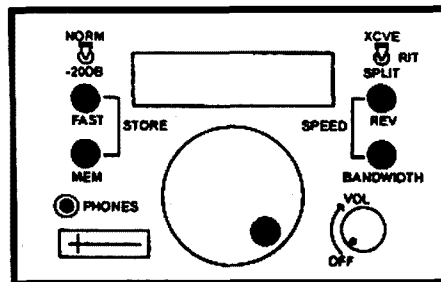
#### Front Panel

The layout of the controls is neat and, after a little practice, they are easy to use. The OFF/VOL control switches the unit on or off, and also controls the loudness of the received signals into the speaker which is mounted in the top of the case. When the unit is first switched on, the serial number is displayed for about three seconds before the frequency of operation is displayed.

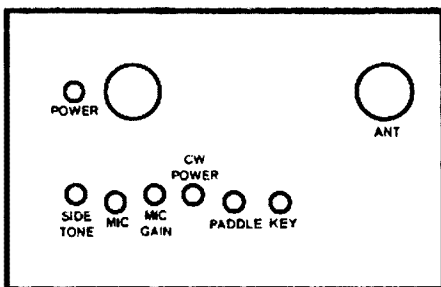
I did find the volume to be somewhat lacking in strength especially in the presence of background noise. However, I found using Walkman style headphones improved reception greatly.

Tuning from one frequency to the next is achieved by holding down the memory button and rotating the main dial until the desired frequency is reached. Holding the bandwidth button sets the receiver bandwidth from 2.4 kHz down to less than 400 Hz by rotating the main dial. Pushing BANDWIDTH and REV buttons simultaneously sets key speed from 10 wpm to 45 wpm. If you are subjected to interference the attenuator will be of great help as it has about -20 dB of attenuation. Under general conditions the switch is left in the upright position, NORM for normal.

Normal tuning rate was measured at about 4 kHz per revolution. To increase the tuning rate to more than 100 kHz per revolution, the fast button is pressed and held while rotating the main dial. The earphone socket is mounted on the front panel and takes a



**Front panel layout of the QRP Plus.**



**Rear panel layout of the QRP Plus.**

standard 3.5 mm stereo plug. Standard Walkman headphones were used for most of the tests.

The QRP PLUS comes with 20 memories as standard with some pre-set at the factory. To set a memory, you go to the band in question (as outlined before) push and release the MEM (memory) button, tune in the frequency you wish to store, then depress and hold the FAST button while pushing the MEM button. This is all that's needed to store a frequency. After a little practice this operation becomes second nature.

The "S" meter acts as a power meter on transmit and a signal meter on receive. At the top right is the XCVE, RIT and SPLIT switch which is a handy little item to have. In the XCVE position the unit transmits and

receives on the same frequency. In the RIT position the transmit frequency remains fixed while the receive frequency can be varied. If you wish, push the REV button while in the RIT position and the transmit frequency will be displayed and can be tuned while the receive frequency remains fixed (XIT). To change from SSB to CW it is just a matter of depressing the FAST button while holding down the BANDWIDTH button and vice versa.

### Rear Panel

The rear panel contains the sidetone level adjustment which sets the CW pitch, as well as the power output control which varies the output from about 500 mW to just over 7.5 watts. Input sockets for a standard straight key, paddle and microphone all take the standard 3.5 mm plug. The microphone gain control is also on the rear panel.

### Power Output

Power output was measured with the following results:

Freq MHz	O/P Pwr	Tx Current	Rx Current
1.8	4.8 W	304 mA	33-35 mA
3.5	5.0 W	306 mA	33-35 mA
7.0	4.5 W	314 mA	33-35 mA
10.1	5.5 W	335 mA	33-35 mA
14.0	5.0 W	351 mA	33-35 mA
18.1	5.0 W	359 mA	33-35 mA

21.0 4.5 W 330 mA 33-35 mA  
28.0 3.0 W 279 mA 33-35 mA

The QRP Plus measures (L) 16 cm x (W) 14 cm x (H) 12 cm.

### On Air

On air tests with other amateurs proved successful with a clean chirp-free signal to most Northern States. I was extremely pleased with the units handling ability and can recommend it to QRP operators as a quality transceiver.

With a price tag of \$US695 it is not a cheap item. A new version has just been released with some modifications. Enquires can be made to: Index Laboratories, 9318 Randall Drv NW, Gig Harbour, WA, USA 98332, or phone 206-851-5725.

The only down side to this unit I found to be the lack of volume from the speaker; no microphone (has to be purchased separately - takes the commonly available speaker microphone of the type sold for use with FM handhelds); the "S" meter has no display light and one has to bend down to be able to read it.

Next month a look at the MFJ Grand Masters II Contest Memory Keys.

\*PO Box 361, Mona Vale NSW 2103

ar

## PRESS RELEASE

### MINI-CIRCUITS DESIGNER'S GUIDE

To encourage Radio Amateurs to build and develop their own communications equipment, Mini-Circuits USA are offering, free of charge, their RF/IF Designer's Guide.

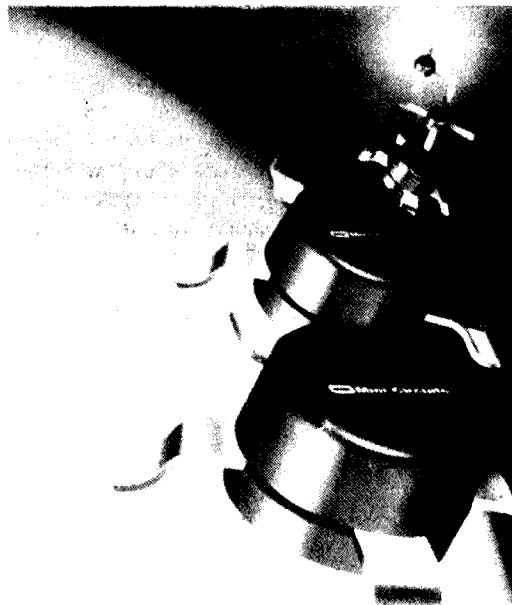
Mini-Circuits manufacture an extensive range of mini-modules, such as RF Amplifiers, Frequency mixers, Power splitters, Filters, Detectors, Attenuators, etc. Circuits are available in various case style packages to suit applications from surface mount to external equipment mounts.

Typical Mixer frequency range from 10kHz to 4.3GHz, making them ideal for engineers interested in LF to SHF work.

If you would like a free copy of RF/IF Designer's Guide, contact Mini-Circuits Australian representatives and stockists.

Clarke & Severn Electronics,  
PO Box 1, Hornsby NSW 2077  
or 02 9482 1944.

## LOW COST ERA AMPLIFIERS PROVIDE LONG TERM RELIABILITY



Next generation technology and economy are built into Mini-Circuits new series of drop-in and surface mount MMIC amplifiers. The ERA-1 through ERA-5 (and SM versions) are designed to provide generous levels of inexpensive signal gain, and wide dynamic range for applications to 8GHz (usable to 10GHz). And you can count on ERA's reliability for the long-run! At a junction temperature of +185°C, mean time to failure (MTTF) is more than 10 years. A junction temperature of just 5°C less results in an improvement factor of four in MTTF! ERA amplifiers provide the long-term, trouble free operation you can bank on.

**Mini-Circuits from Clarke & Severn Electronics**  
**PO Box 1, Hornsby NSW 2077**  
**Phone: (02) 9482 1944 Fax: (02) 9482 1309**

---

---

# Repeater Link

Will McGhie VK6UU\*

---

---

## Alaska

The article about getting on the Internet continues to generate considerable e-mail. One of particular interest was from an Alaskan amateur. It appears *Amateur Radio* is even read in Alaska!

In part the e-mail was a request to reproduce the particular article in the local amateur magazine. Now that's coverage for *Amateur Radio* magazine. I don't know many details about how *Amateur Radio* is received in Alaska, but I'm attempting to find out. The original e-mail was brief; possibly the detail came from a third party, who was on holidays.

## More Fee Rises

As of writing, the fee structure for repeaters and beacons has changed. We were still trying to come to terms with the previous changes and subsequent increase, when along comes another. Please note the comments that follow are mine, with input from other concerned amateurs, and may not always be entirely accurate, or necessarily have a total grasp of the situation. But it is my opinion on what I believe to be the current situation.

Just over two years ago, repeaters, beacons and digipeater sites were charged on a \$37 per callsign per site basis. Any number of transmitters that were all at the same site, and shared the same callsign, attracted a \$37 fee in total. Some of our sites in VK6 had several systems, but the total fee per site was \$37.

Then a big change! No longer could you licence several systems under the one call and expect to pay the single fee of \$37. The common callsign could remain, but each transmitter would now cost \$24 per year. Our largest site in Perth has some 10 transmitters, hence the fee went from \$37 to \$240. But now it is to increase to \$500!

Why are the licence costs going through the roof? The information from the SMA explaining the fee increase can be simplified to recovering costs and making money for the government. Now you cannot argue the "making money for the government" issue easily. It is a political decision and would have to be fought at a political level. I imagine the SMA probably have little control over this.

On the first point, recovering cost, we are told this at every increase in licence fees. But the latest fee increase is over 100%! Have costs gone up over 100% since the previous licence fee rise to \$24? In the space of less than two years, licence fees for repeaters and beacons have gone from \$24 to \$50.

One must speculate, in the absence of detailed information, that either the rise to \$24 did not reflect the true costs the SMA incurred in licensing repeaters and beacons, or the

Government wants more, or the SMA came up with the wrong \$24 figure two years ago. And is this the last rise of such magnitude? Will the licence fees for repeaters and beacons go up to \$100 in another year or two? Is this \$50 fee the final true cost recovery figure? It would not be unfair to have limited faith in the SMA's ability to do its sums, based on all the changes.

## WIA

"Where is the WIA in all this?", I hear you say. The first news came in a brief memo from the SMA simply announcing the new fee scale without prior consultation. It took a follow-up memo to "explain" the reasons for the fee increase.

The Institute is currently gathering, as a matter of urgency (or by now has gathered), data on the severe impact that the new fee structure will have on Amateur Community groups that provide Repeater and Beacon Services. Armed with this information, the WIA is to seek consultation with the SMA on ways to quickly achieve a sensible, affordable, technically based solution in this matter.

## Memos

What was in these memos? I have the explanatory one in front of me, entitled "Revised Licence Fees and Charges". In part, the explanation for the fee rise is changes to the consumer price index (2.7%) and to recover costs associated with Australia's membership of the ITU. The percentage increase for ITU participation, the memo states as 1%. Not a big increase so far. The next reason given for the fee rise is "A Government decision to fund a program of research and public information on health issues associated with electromagnetic emissions". Cost 1% on most licences. Still no big increase yet.

Reason four is "Changes to the fee structure arising from the post-implementation evaluation". An example is given to explain this "Yes Minister" language. "There have been some amendments of bandwidth ranges in the fee structure to promote spectrum efficiency and better reflect spectrum planning arrangements". No percentage mentioned in this one, and what has this to do with amateur bands, anyway? It does not matter if amateur transmissions are spectrum efficient or not. I can't see how this equates to a fee rise for repeaters and beacons.

And the final one, and it is a big open ended one! "Actual costs incurred by the SMA." It is worth quoting this one in full. "The charges for SMA tasks such as issuing or renewing, which were set in April 1995, were based on

best estimates of the average time taken to perform these tasks. Following detailed surveys of the time taken to issue or renew each licence type, the charges have now been accurately set on the basis of the actual time taken. The SMA has also moved to standard charging for licence issue wherever possible to provide licensees with greater certainty when applying for new licences." One could spend a lot of time examining this statement.

The first part that sticks out is "The charges for SMA tasks such as issuing or renewing, which were set in April 1995, were based on best estimates of the average time taken to perform these tasks." Best estimates I gather proved to be a poor best estimate. If all the previous explanations as to the fee increase, such as ITU participation, only amount to a few percent, then the "best estimates" was out by almost 100%. What faith can we have in the new estimate? Will we see another revision of the "best estimate" some time down the track?

Further, part 5 says, "Following detailed surveys of the time taken to issue or renew each licence type, the charges have now been accurately set on the basis of the actual time taken." Does this mean that the previous licence fee for repeaters and beacons of \$24 was not accurately set on the basis of the actual time taken? So how was the original \$24 worked out?

And the last part of part 5 says "The SMA has also moved to standard charging for licence issue wherever possible to provide licensees with greater certainty when applying for new licences." What does "greater certainty when applying for new licences" mean? Were we amateurs uncertain when applying for new licences? "Yes Minister!"

## Five Year

The five year option is reported to result in savings. In the Repeater Group's situation of having to pay about \$1,100 per year, the five year licence fee, even though cheaper, exceeds the total funds the group have available, so it is not an option. In our situation the cost for five years is \$3,740! I know I would be very reluctant to pass on any extra money, even if it may result in long term savings. In these times of constant change with licensing fees, who knows what the future holds? I would rather spend my time fighting the current new fee.

In VK6 we are now looking at over half of the Repeater Group's annual income of about \$2,200, being spent on licence fees! That is a lot of money. The local VHF Group in VK6, who maintain the beacons, look like paying all their yearly income on licence fees!

And on the now departed \$91 per hour new licence fee, don't think this is a major cost saving for repeater and beacon sites. It only takes three years for the new \$50 flat fee to



overtake the previous \$91 per hour plus \$24 per year from that point on.

Yet another question is, what costs are involved for a change of location or call sign of an existing repeater or beacon under the latest changes?

### Changing a Word

Also of interest is a change in wording in the way a licence is defined. A licence was required per transmitter, now it is per transmitter frequency. A small play on words you might think, but it does result in increased cost to the amateur community. For example, a digipeater may be required to change frequency, as was the situation in VK6 to forward traffic. Under the previous fee system it was \$24 per year; under the new system it is \$100 per year. Subtle but costly!

Added to this is the incredible cost of licensing the new International HF Beacon for VK6. This HF beacon operates on a time sharing basis on five bands from 20 metres to 10 metres. Now, it is one transmitter at one location, but the cost to licence this beacon for the first year is \$250! That's right, five frequencies times \$50, yet it is only one transmitter. How a slight change in wording can be so costly!

I don't accept this fee rise, and I don't accept the reasons given. If the fees for repeaters cannot be set at a proper level, then new and existing repeater systems will be reduced and amateurs will be burdened. And why do we have fees for beacons and repeaters in the first place? In all other services, other than amateur radio, it is obvious that there has to be frequency planning and interference minimisation. But with amateur radio I cannot see this having relevance. Any amateur can operate on any amateur band that his or her licence allows without requiring frequency planning by the SMA. To further point out the inconsistency, licensed portable repeaters can be set up anywhere for a period of one week without notifying the SMA. That's right, a portable repeater can be set up and operated without any frequency co-ordination for up to one week, yet a permanent one cannot. This is technically inconsistent if interference concerns are the primary concern.

### Reaction

What reaction has there been so far from amateurs directly involved in the management of repeaters and beacons? Most condemn the rises but a few see advantages. These advantages are based on specific examples, usually involving large up-front new licence fees. One packet bulletin I saw mentioned an installation fee of over \$300. Under the new system the fee would only be \$50. No doubt, it is a big difference. But it is the \$300 fee that is to be queried. This was on a site in VK2 with no other services. This fee

level has not been the experience in VK6, with \$91 being the usual fee.

However, it is important to look beyond the isolated situation and ask what is the effect on amateur cost overall. The number of repeaters in service is about 620. This equates to a cost increase from the \$24 system to the \$50 system, of \$14,880 to \$31,000. That is, for repeaters alone, an extra \$16,120 in yearly licence fees. With the previous fee structure, if 10 new repeaters on average go into service each year, the annual cost due to the \$91 per hour could be as low as \$910, or perhaps as

high as \$3,000. This is a poor trade-off. I don't know if the 10 new repeaters per year is an accurate figure, but I do believe the new fee structure will cost amateur radio a lot of money.

All in all, a poor show! These fee rises, coupled with the long delay in the "new repeater regulations" and the silly regulations that apply to repeater systems that prevent clever experimentation, have to be challenged long and hard.

\*21 Waterloo Crescent, Lesmurdie 6076  
Packet: VK6UU @ VK6BBR  
E-mail: will@vale.farvc.com.au  
ar

## Spotlight on SWLing

Robin L Harwood VK7RH\*

The propagation conditions are rapidly improving, judging by recent monitoring over the shortwave bands. The higher frequencies are starting to open up after their solar slumber. The 14 MHz CW allocation really burst into life over the weekend of 23-24 November during the "CQ Worldwide" CW contest. The conditions were excellent with propagation holding up well over the entire period. European and American operators were well heard here, mixing with the Asian and Pacific regions. As a lover of the key, it was pleasing to hear the CW portion crammed full of feverish activity, yet frustrating that I was not able to participate. Although propagation remained good, activity on the above segment dropped off dramatically after the "WW" concluded. Never assume that the band is dead, simply because you can't hear anybody there. Just call CQ and be amazed.

I noticed that the United Arab Emirates Radio in Dubai is no longer broadcasting in English. I often tuned in to get the 0530 news on either 21700 or 13685 kHz but now they only use Arabic. To balance this out, I believe that Amman in Jordan has increased their English output between 1300 and 1700 UTC, but I do not know their frequency in the 25 metre band.

In December a significant milestone in the history of radio went by almost unnoticed. It was on Christmas Eve 1906 that one of the first transmissions of speech over wireless took place in Boston. The gentleman concerned was a Canadian researcher, Professor Fessenden, and it was on about 88 kilohertz. I recollect reading about this in a reading primer when I was in primary school. It described the effect of hearing speech for the first time and the incredulous reaction from the wireless operators at sea. I would like to see this article again as it was a catalyst to my involvement in radio listening. Can anybody please assist me in tracking the article down?

Recently, while I was tuning above the twenty metre band, I came across one of those signals which are referred to as "Numbers stations". These stations broadcast strings of five figure groups, usually read out by a female announcer and repeated twice, "27454 27454 79328 79328", etc. These stations have been around since the Second World War and are engaged in intelligence work. The signal that attracted my attention was on 14487 kHz at 1225 UTC and was in English with a very prim and proper pronunciation which easily identified the source of the transmission. However, it was not the actual content of the messages that was significant but the deliberate jamming that had been thrown up at the signal. The nature of this deliberate interference is identical to that I have heard emanating from the Middle East on Farsi and Arabic broadcasts from the VOA and the BBC.

I have been informed by e-mail that the source of the transmission is Cyprus from an RAF base whilst the jammers are in Iraq or Iran. I would have thought that if these cypher signals are secure, they would have moved their frequencies about to avoid this jamming but they are still persisting on the same channel. I could only put up with it for a few minutes, yet they were still going 90 minutes later.

Incidentally, one of the last remaining press services on RTTY has closed down on shortwave. On 31 December the Xinhua Newsagency in Beijing went to satellite and the Internet, thus leaving only North Koreans as the remaining newsagencies on RTTY. It is a far cry from when I first commenced reading RTTY in 1983, when press copy was easily received. Now all you can find are the thoughts of a dead political leader! C'est la vie!

\*5 Helen Street, Newstead TAS 7250  
VK7RH@VK7BBS.LTN.TAS.AUS.OZ  
Internet e-mail: robnoy@tassie.net.au

ar

# VHF/UHF - An Expanding World

Eric Jamieson VK5LP\*

All times are UTC.

## VK Six Metre Activity

Overall, there appears to have been a slow start to the Es season. A number of contacts have been made across various State boundaries, as listed in these notes, but no sustained operation for long periods. Despite this, I have a feeling that we are in for a good Es period during summer and that those conditions may continue later than the usual cut-off sometime in January. Certainly that has been the case in the Northern Hemisphere where openings have occurred as late as November (our May equivalent).

From Glenn VK4ZTL: 13/11: 0930 VK3CNX 5x9, 0940 VK3DUT 5x7, VK3XQ 1018 5x7, VK5HS 1101 5x5-7. VK3s noted on 52.525 from 0900. 14/11: 2306 VK3DUT, 2320 VK7RNW/b 5x5, VK1MJ 2330 5x9 on 29.600 FM. 1320 ZL1TDA 5x9 using local repeater in Auckland on 146.625 FM. 1333 ZL1WTT 5x9 via 146.700 ZL repeater. 1340 ZL1QF 5x9 via 146.700 also. 15/11: 0010 VK2AIF 5x9 on 50.120.

John VK4KK advised that on 14/11 an early morning opening on six brought VK5s working VK4s with Hugh VK5BC working Ron VK4BRG at 2130.

*[Comment: I have noted Ron's beacon on 50.077 MHz almost daily throughout November, usually from 0100 for several hours, signals varying from S1 to S9, but little else ... de VK5LP.]*

Steve VK3OT phoned to say the first signs of E Layer summer for 1996 occurred around 0800 on 15/11 with 28.230 ZL/b 559, 45.260.9 +/- and 45.2396 +/- TV video from east, signals 559 to 599 with QSB. No sound on 50 MHz at time of message.

## New Zealand

Cliff Betson ZL1MQ writes from New Zealand that, apart from the odd appearance of beacons, signals from VK have been scarce. Contacts so far have been: 23/10: ZL3AAU to VK2FZ/4; 5/11: ZL3NE/1 to VK4AFL; 8/11: ZL2AGI and ZL2KT to VK2DN, ZL3NE/1 to VK4AFL, VK4APG; 9/11: ZL3NE/1 to VK2DZ, VK2NZ, VK2GF, VK4GP, VK4KFQ, VK4JSR and VK4AFC.

Cliff also wrote: "With the advent of another channel for TV3 on VHF there was concern amongst six metre operators that the obsolete Ch 1 was to be used. However, the allocations are Auckland Ch 9 (H), Wellington Ch 10 (V), Christchurch Ch 11 (H), Dunedin Ch 11 or 13. Repeater

channels on 2, 5, 7, 9, 10, 12 and 13, the latter two being new to TV.

"There is also an allocation of a TV channel for Multi-plex TV which, on the present standards, is 8 MHz wide and accommodates four TV stations in that bandwidth, and would require a new TV set or an adaptor for present TV sets."

Amateurs in areas where Ch 9 operates will need to be aware that the fourth harmonic from 50 MHz lands very neatly in the passband of that channel with consequent risks of TVI. Some will find they will need to operate with reduced power to minimise such problems. Areas where Ch 9 is strong will not be greatly affected but, from about 100 km outwards from the station, ten watts at 50 MHz will be as much as many TV sets will tolerate. Just thought you would like to know!

## Confirmation of 5.7 GHz Record

Last month I reported the contact between Al VK6ZAY/6 and Alan VK6ZWZ/6 with the possibility that it was an Australian record. John VK3KWA now confirms he has accepted the contact as a new VK6 and national record, the amended distance being 236.0 km.

Bob VK2DN advised that: "On 8/11 around 0608 six metres arrived for this season in Blaxland, and I worked a number of ZL2 stations in Hastings.

"On 9/11 ZL TV was over S9 for about 14 hours. I worked ZL3NE in Auckland and copied the ZL3SIX beacon at good strength. I heard several VK4s about lunchtime at S9 working VK2s and Bob ZL3NE said he had worked some VK4s. He also said he had heard a CW station with 9.. briefly to north, but couldn't pick if it was a JA9 or a VK9."

VK3SIX/b at Hamilton on 50.0535 is no longer available to me at Meningie as a weak signal beacon due to a computer birdie, from somewhere in the town, which is S5 on the frequency. There is another very strong computer birdie on 50.112 but so far 50.110 remains clear. In total, there are at least fifteen such birdies between 50.000 and 50.200 ranging in strength from S2 to S8. All can be peaked by rotating the antenna.

With the school holidays soon upon us the trouble can only become worse! Then, of course, there is the strong signal from a baby-minder varying from 49.750 to 49.830. So much for the limited coverage of such unlicensed devices; the one I hear is about one km from me.

## DXpedition to VK3

David VK5KK sent an e-mail to say: "After being granted a visa from the VK3s, enabling me to take microwave gear across the VK5-VK3 border, Scheryl and I planned to make a trip to Mt William (1197 m asl) to see just how well that site worked without propagation on ALL the amateur SHF bands (yes, that's right, 3.4, 5.7, 10 and 24 GHz!). With the co-operation of Alan VK3XPD, Russell VK3ZQB, Trevor VK5NC and Colin VK5DK, an enjoyable two days was had by all with a total of four State records and one National record (5.7 GHz) broken in this period.

"Equipment as follows: 3.4 GHz, 4 watts to 600 mm dish; 5.7 GHz, 8 watts to a 600 mm or 1200 mm dish; 10 GHz, 1 watt to a 600 mm dish; 24 GHz 40 mW to a 400 mm dish. All others contacted used similar power levels and dish sizes.

"Day one 6/11/96. After driving from Adelaide we lugged three dishes and three transit cases into position on Mt William for the first round of contacts with Alan VK3XPD portable at Mt Dandenong, 595 metres asl.

"Path distance = 259 km. Take-off to Mt Dandenong from Mt William is best described as ideal with a 900 metre drop a few hundred metres in front! Contact was established with VK3XPD/3 at 0640 on 3456.1 MHz with 5x4 SSB signals both ways. This was followed by a contact with VK3XPD/3 at 0716 on 5760.1 MHz with 5x3 SSB signals both ways. Both contacts established new VK3 State records, with the 5.7 GHz contact being a new National record.

"Having also lugged my 1.2 metre dish to the summit, a second contact was made at 0734 with the larger dish on 5760.1 MHz, signals 5x9 both ways. The contact was made even more interesting by the 25-35 knot winds that had sprung up! This made the standard tripod mount unusable, leaving VK5KK to hold the "baby" with a 1 degree beamwidth! Finally, at 0745, contact was made with VK3XPD/3 on 10368.1 MHz SSB with 5x1 signals. At this stage Mt William was submerged in a rain cloud, probably accounting for the lower comparative signal levels on 10 GHz. The wet conditions and temperature drop from 24 degrees to 5 degrees was a good test for the temperature stability of the microwave transverters!

"Contact was also made with Trevor VK5NC and Colin VK5DK on 144 MHz during the tests. After the successes with VK3XPD/3, Trevor VK5NC decided to go out portable to The Bluff, about 20 km west of Mt Gambier. The Bluff is about 280 metres asl, distance 198 km to Mt William. I decided to shift from the summit, down about 100

metres on the access road to gain some shelter. Weather conditions were wet at both ends. The first contact, with VK5NC/5, was established quickly, at 0910 on 3456.1 MHz with 5x6-7 signals on SSB both ways. This was followed by a contact with VK5NC/5 on 5760.1 MHz with 5x7-9 SSB signals both ways. The 1.2 m dish produced 5x9+ signals as expected! The contact on 5760 established a new VK5 State record. And at 0944, a contact with VK5NC on 10368.1 MHz produced 5x7-5x5 signals on SSB.

"On surveying the VK5NC/5 - VK5KK/3 path next day (I couldn't see 200 metres during the contacts) it was found to be anything but favourable with a series of ranges blocking the horizon in that direction at 5 and 15 km distance. The signals and lack of QSB on the VK5KK - VK5NC path was most notable. With calculated portable ERPs ranging between 1 kW (10 GHz) and up to 10 kW (5.7 GHz) being used by all three stations, it looks like weather conditions are optional on these paths.

"Day two 7/11/96. After finishing our round of contacts the night before, Alan VK3XPD and Aileen drove to Stawell for the next stage of our DXpedition ... 24 GHz. Equipment for 24 GHz consists of two identical 40 mW Gunn diode/mixers transceivers using wideband FM receivers and 400 mm dishes. The technology diverges somewhat from that of the lower bands, but you have to start somewhere!

"VK5KK went portable to Mt William again, this time with good weather and visibility for about 40 km. Our efforts concentrated on paths North East from Mt William, as it was decided that this was probably the best path and perhaps the driest. Water vapour absorption, at 24 GHz, can easily exceed 1 dB per km with medium to heavy humidity.

"VK3XPD/3 made first contact with VK5KK, on 24.150 GHz, from Stawell over 31 km, at 0030 with 5x9 signals. A series of contacts, between VK5KK/3 and VK3XPD/3 from various sites, pushed the distance out to 61 km with 5x8 signals from a hill near Landsborough at 0216. Atmospheric conditions precluded visibility over the path. A further attempt from Mt Bolangum, at 71 km, was not successful.

"A notable "ragchew" for the day was with Russell VK3ZQB/3 at Tower Hill near Pt Fairy, on 10368.1 MHz at 0440. Signals were 5x9++ over a distance of 116 km, the path being non line-of-site, takeoff from Mt William being blocked by the Grampian Ranges to the south. We both agreed we will shift off the Call Channel next time!

"Day three 8/11/96. Same as the day before, but conditions a bit drier with clear visibility to 60 km. Contacts were attempted

on 24 GHz over the same path as the last two attempts on 7/11 (61 km and 71 km). Immediate contact was made over the Landsborough path at 2355. Progressing to Mt Bolangum, Alan VK3XPD/3 established contact with VK5KK/3 at 0025 with 5x8 signals over 71 km. This is a new VK3 State record. Further attempts over 75 km did not produce any contacts, due to both topography (less than ideal takeoff to Mt William) and water vapour absorption.

"We are all still learning about 24 GHz. Some interesting varying QSB effects (short term variations of >10 dB, a bit like mobile flutter sometimes) caused by wind effects along the path underline the effect of humidity. It has already been suggested that a hygrometer would be a useful addition to a portable 24 GHz station! It is estimated that the relative humidity was in the region of 50 - 60 %, over both days. Patches of moisture haze to above 1200 metres could be seen to rise from the large tracts of vegetation as the morning progressed. Further repeats of the exercise in summer should quantify the effect of this moisture.

"No doubt, this summer will see all of the above eclipsed ... more a tribute to the dedication and cooperation developing amongst a small group of active microwave experimenters in VK3 and VK5.

"A lot happened including a few ragchews with VK3ZQB and VK5DK, so we didn't become too lonely on Mt William."

As readers can note, microwave activity is on the increase in VK with amateurs in VK2, 3, 4, 5 and 6 making special efforts to extend the distances worked on those bands. I would like to hear what is currently taking place in VK2 and VK4 please.

### Internet Six News

From the On-line Six Meter Magazine and Geoff GJ4ICD. 1/11/96: CT1WW now a Silent Key: Geoff GJ4ICD reports that: "CT4KQ has reported the passing away of Tiago CT1WW Tiago was an avid VHF DXer and many people worked him on 50 MHz and 144 MHz, I had personally built him equipment in the early eighties for VHF and knew him well. Tiago was also responsible for the 50 MHz beacon CT0WW. I am sure we will all miss him."

3/11: TEP in JA: JA1VOK reports: "Today I heard 45.24/45.25/45.26 ZL Ch.1 video at 0339-0600 for the first time this autumn. 45.25 was up to S9 around 0500, and ZL(?)KW (believed to be ZL1AKW) was heard on 50.110 CW in JA3 at 0455 in spite of Solar Flux of 69, A Index 2 and K Index 0 at 0300! JA3JTG (PM75) worked VK4TZL at 0509. VK4LE (QG45) was worked by JH1WHS (PM95) at 0506, JA1VOK (QM05) at 0513 and other JA1s until 0530 by Afternoon Type TEP for the fifth VK opening

this autumn."

5/11: Es in US up to 88 MHz: Pat WA5IYX and Dave N5JHV reported: "Es to 88 MHz around 2300, with six metres double hop to east (EM90) around 0015, then switched south. Began hearing TI2NA/b about 0030, then worked T15NE with very weak signals on 50.110. XE1KK/b still in at 0115."

6/11: European new 50 MHz activity centre frequency. Changes to the Region 1 Bandplan now indicate the SSB centre of activity on 50 MHz has been moved to 50.150; hopefully this will improve the situation on the DX window of 50.110 MHz.

16/11: Es continues to be worked in Europe. GM7 to SP2, IK2 to IK0, G4 to SM3, GW0 to ES0 and ES6.

16/11: Widespread Es in US involving 1, 2, 3, 4, 5, 8, 9 and 0 districts. WA5UUD to VE3WHS. [Rather late for this degree of Es ... VK5LP.]

### More News from VK

Adam VK3ALM reports:

"9/11: 0305 ZL TV. all offsets (45.240 .250.260) - weak. 10/11: 0203 VK4JSR 5x9. 12/11: 0350 VK4ABP/b Longreach beacon. 12/11: 0350 VK4WTN Hervey Bay. Es first noticed with central North QLD then moved South 300 km over two hours. 12/11: 2340 VK4ABP Longreach beacon QG26 539 1610 km; 2348 VK4ALM Rockhampton QG56 5x9 1700 km. 13/11: 0035 VK3SIX Wannon beacon QF12 519 on backscatter from VK4 bearing. 13/11: 0040 VK4AFL Brisbane QG62 5x9 1375 km;

0045 46.250 S9 Video VK2 translator? 0110 VK4RGG Gold Coast beacon QG62 599 1300 km; 0124 VK4GPS Mt Tamborine QG62 5x9 1300 km; 0129 VK4XJ Brisbane QG62 1350 km; 0130 VK5WI 10 m beacon PF95 559 - 6 m beacon not heard."

John VK4FNQ reports: "1/11: 2340 weak TV signals on 46 MHz. 10/11/96 0000 VK4RGG/b 519; 0007 VK8RAS/b 319 in/out; 0130 weak 46 MHz TV. Toowoomba; 0800 VK8RAS/b 599 very heavy QSB. 14/11: 2200 TV on 46 MHz. 13/11/96 2258 VK2BA worked VK4BRG 5x9+ also 57 MHz TV video; 2320 VK3SIX bcn 419 in/out; 0059 VK4AFL call CQ."

Ron VK3AFW reports: "Erected a 6 metre dipole on 16/11 for use with rig loaned to me by Andrew VK7XR. Worked Adrian VK2FZ/4 on 6 m Sunday am and had a good chat. Set up a MS sked for Monday am. Heard him in the first 15 seconds - six minutes in, his signal was so strong that I thought a local had broken in. The burn lasted for a minute.

"Then at 1911:30 another big burn of 20 seconds. Two QSOs in 15 minutes on two meteor showers. We continued for the full hour and I heard several complete sets of



**From left, Chip Angel N6CA, Roger Bowman VK5NY, Wally Green VK6WG and Walter Howse VK6KZ are all world record holders in the UHF and microwave bands. This photo was taken at the recent Microwave Update in Phoenix, Arizona. It's unusual to have so many world title holders together. Missing is Paul Lieb KH6HME, the Hawaiian end of so many records shared with N6CA. VK5NY and VK6WG had to travel half way around the world to meet for the first time. Photo from VK5NY.**

callsigns but no burns greater than five seconds.

"16/11: 2155 144.200 VK2BIT 5x1 5x1 via aircraft enhancement; 2316 50.120 VK4ZTL 5x9 5x5 VK3AFW 3 W and dipole\*; 2355 50.120 VK4AR 5x9 5x6 VK3AFW 40 W and dipole\*. 17/11: 0001 50.135 VK2YHN 5x6 5x6/7; 0034 50.059 VK4RGG/b 539; 0053 50.120 VK4KR 5x6/8 5x8/9; 0100 50.120 VK2FZ/4 5x5 5x8/9; 1906 144.200 VK2FZ/4 5x9 5x7/9 60 second m/s burn; 1911 144.200 VK2FZ/4 5x7 5x1 20 second burn; 2110 144.080 VK7XR 519 539 – not completed due to QSB (\* wire dipole set at 45 degrees angle, centre 10 m above ground)."

Ron added: "Adrian VK2FZ/4 on 14/11 worked ZL via tropo on 144 and 432 MHz. No one was available to attempt 1296 MHz.

"Adrian recently worked K5GW via EME and hears a number of US and European stations on 144 and 432 MHz via the moon.

"Via aircraft enhancement, Adrian regularly works VK2DVZ, 550 km on 144, 432 and 1296 MHz, VK2ZAB, 780 km on 144 and 432, also 1296 until Gordon removed his antenna; VK2BE, 800 km on 1296 MHz. Adrian comments that there is little activity north of Brisbane except on FM, vertical polarisation and repeater operation."

John VK3ATQ reports that: "The morning six metre net is now operating on 50.120 MHz. Norm VK3DUT is operating

from his new QTH at Lakes Entrance and working ZLs with a three element beam. Brendon VK7JB has also joined the net, using a homebrew solid state 100 watt amplifier and a six element NBS design Yagi. He is received well in southern VK3 via normal tropo scatter."

My long time friend Clarry Castle VK5KI, says various beacons are indicating 50 MHz is often open despite the absence of other stations, and believes we could be headed for a good Es season. Heard so far: 14/11: 0245 VK7RAE/b 599, 15/11: 0100 VK7RAE/b 589, VK4RGG/b 579, 17/11: 0100 VK8RAS/b 589; 0430 VK6RPH/b 559; 0440 VK6RO in QSO with a VK5 3x3.

### Microwaves in Europe

Sam Jewell G4DDK reports: "The excellent lift on the evening of 22/10 produced some good QSOs on the higher bands. From the east coast the lift was towards the south, tending to favour the western side of France, with some tremendous signal levels here in Felixstowe. I worked three French stations on 2320 MHz; two down into IN97 and one in JN19.

"On 10 GHz I had my annual contact with HB9AMH/p in JN37 at 684 km and 5x5 both ways. I also managed a contact with F6DKW in Paris on 10 GHz with 5x9 signal both ways. F5HFYs beacon from JN18 on 10368.044 was a consistent 5x9+ most of the evening. "Gotaway" of the evening was

EA2LP in IN93 on 1296 MHz, who was heard replying to G3LQR, but who failed to complete the QSO. Now that would have been a nice QSO. There were plenty of 432 MHz QSOs into EA, but not too many on 1296"

### Part Loss of 10 GHz in UK

A report from Ian GM0ILB notifies that The Radiocommunications Agency has announced that, as from 1 April 1997, UK amateurs will no longer have access to the band 10.150 to 10.300 GHz, as this will be required by Radio Fixed Access services. The present allocation is 10.000 to 10.500 GHz.

### Europe

Ted Collins G4UPS said that the Namibia beacon V51VHF was heard over a wide area of the UK on 16/10 from 1530 to 1639. Around 1600 Brian G3HBR telephoned Ron 7Q7RM (Malawi) and Ron said the European TV had a rather strange aurora type sound. The 7Q7SIX beacon was operating but not heard in the UK. G3HBR and G4UPS did work 7Q7RM on 28.885 MHz but nothing heard on six metres. [Appears to have been a mixture of aurora and TEP ... de VK5LP.]

### Closure

As I write these notes during the last week in November, the six metre Es on a large scale appears very elusive. I am hopeful that more can be reported next month.

When I began writing for *Amateur Radio* in 1969 these notes were prepared on an ordinary ribbon typewriter using carbon paper for copies. Then, in the 1970s, I advanced to an IBM electric typewriter using a carbon ribbon and a photocopier for copies.

About 1985 I invested in my first computer, an Osborne I CP/M machine using 360 k disks in A and B drives but no hard disk. The printer was a Brother daisy-wheel typewriter adapted for computer printout. In late 1989 a change was made to a new fangled XT computer with a 20 meg HDD and 5.25" floppy disk drive and a 24 pin dot matrix printer.

This was later followed by a Ritron 486DX33-LB with 212 meg HDD and both 5.25" and 3.5" floppy drives, with the later addition of an ink-jet printer and a scanner; so, for the past three or four years, my notes have been submitted on a 3.5" disk. This computer is now facing possible (or probable) replacement.

This month I start a new era in that my notes will be forwarded via e-mail. A test-run with Bill Roper indicates that such a method is quite successful – so much for modern technology.

Incidentally, I am very pleased to note that Bill Roper will continue to produce *Amateur Radio* for the next two years, having been awarded the contract by the WIA. Best wishes Bill and, thanks for a job well done.

Closing with two thoughts for the month:

1. No one has yet programmed a computer to be of two minds about a hard

problem or to burst out laughing; and

2. Manufacturers may be able to make the car safer in collisions, but there seems to be no way to redesign pedestrians.

*73 from The Voice by the Lake.*

\*PO Box 169, Meningie SA 5264

Fax: (085) 751 043

Packet: VK5LP@VK5WL#ADL.#SA.AUS.OC

E-mail: vk5lp@ozemail.com.au

ar

## Silent Keys

*Due to space demands obituaries should be no longer than 200 words.*

The WIA regrets to announce the recent passing of:

J N (John)	Segelov	VK2YKK
B J (Ben)	Weideman	VK3AUW
H J K	Heitsch	VK4HK
A C (Al)	Rechner	VK5EK
H G	Burniston	VK5NJG
R W (Elliott)	Peterson	VK6PW

### Al Rechner VK5EK

Al VK5EK sadly passed away on 14 November following several years of serious illness.

His job as a bank officer and later as a bank manager required him to work in various parts of the state, ranging from Crystal Brook to Mt Gambier, where he made many friends, frequently resulting in the promotion of amateur radio.

Al's enthusiastic approach to his hobby coupled with his unique personality, and renowned ability to manufacture home brew antennas and other equipment, became legendary.

In retirement his specially selected QTH at Old Noarlunga gave him substantial advantage in the pursuit of amateur radio as his main interest.

As a licensed amateur pilot Al also enjoyed flying, having owned his own aircraft at one stage. Astronomy and photography were among other interests at which he excelled.

During his retirement Al gave much of his time voluntarily to the Investigator Science and Technology Centre, where he regularly lectured and demonstrated equipment to groups of school children and others in relation to various scientific subjects.

Al was an active amateur to within days of his death, and I join with the following who were in regular contact with him, in expressing sincere condolences to his family: Peter VK5ZPS, Udo VK5KAZ, Graham VK5JD, Col VK5RO, and Dean VK5BDS.

Barry Cleworth VK5BQ

### Elliott Sydney Trigwell

Many of the VK6 fraternity mourn the passing of Elliott Sydney Trigwell (affectionately known as Trig).

Trig was born on 17 April 1918 in Bunbury, WA and was educated in Donnybrook WA, completing his education at Bunbury High School.

Leaving school at the age of fifteen, he started a long and successful career with the then Postmaster General in Telecommunications. Trig had always been interested in the technical side of radio so he considered himself lucky to have a career that was also a great hobby.

Trig served his country in the Royal Australian Air Force during the war and was posted overseas to New Guinea. He resumed his career with the PMG's Department after the war and, in the Geophysical Year of 1957, was lucky to be chosen to work and study at the Davis Radio Base in Antarctica with four others. He became the official photographer and Officer-in-Charge and even had an island named after him, Trigwell Island.

The highlight of this expedition was the honour bestowed on him by Her Majesty, Queen Elizabeth in 1961, the Polar Medal for Good Service, which was presented by her Majesty on her visit to Perth.

Trig became the Superintendent of the Radio Branch in WA and is fondly remembered by many WA hams for his helpful advice and consideration in his dealings with the amateur fraternity.

Trig was well qualified and eligible to take out an amateur licence, and held the call sign VK0AT during the time he spent in Antarctica.

After his retirement he maintained his close association by regular attendance at the Old Timers' functions.

Vale Trig.

Clem Patchett VK6CW

ar



HF-VHF-UHF MOBILE ANTENNA  
HF-VHF-UHF BASE ANTENNA  
CB-MARINE-AIRCRAFT

Monoband to Multiband  
Convert Now, to the all

New!

**PERTH PLUS**

HF Mobile antenna

with 60-40-30-20-17-15-12-10-6-2m Included

Also stock

Coaxial Cables & Fittings  
HF Spring Bases, Trunk and Gutter Mounts.

Outbacker OBB "Classic"  
Outbacker "Junior plus"

Split Models  
Helical Dipoles  
Long wire Dipoles  
Baluns

★ **Free!**

With Every Perthplus Purchase.

1 x AmSoft CD-ROM  
'94 Callsign Database

Write current stocks list

Now available from:

**MELBOURNE**  
Daycom Communications  
Ph 03 6438444

**ALICE SPRINGS.**  
Farmer Electronics  
Ph 089522388

**DARWIN.**  
Integrated Technical Services.  
Ph 089-81 6411

**SYDNEY.**  
Andrews Communications  
Ph 02 6369060

**PERTH.**  
Tower Communications  
Ph 4701118

**ADELAIDE**  
Johnston Electronics  
Ph 08 2871061

PERTH - Model

<http://intercon.com.au/outbacker>

TERLIN AERIALS  
5 Yampi Way  
Willetton W.A. 6155

Ph +61 (09) 3545444  
Fax +61 (09) 3545455

NEW VIDEO

Send \$ 5.00 for a 15 minute informational video  
Refundable with every antenna purchase.

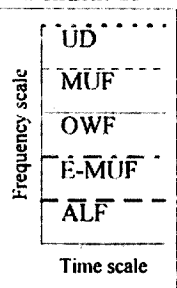
**Adelaide-Jakarta** 307  
Second 3F14-22 3E3 Short 4566 km

**Brisbane-Amsterdam** 325  
First F 0-5 Short 16192 km

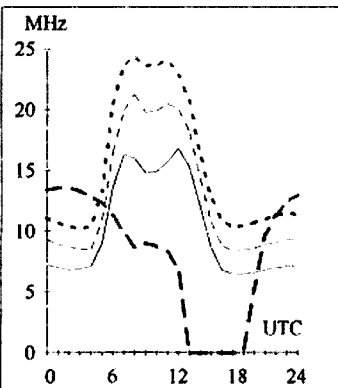
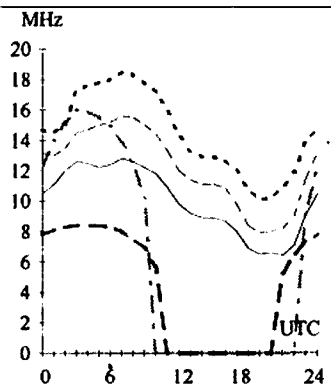
# HF Predictions

Evan Jarman VK3ANI

**T Index: 15**



These graphs show the predicted diurnal variation in key frequencies for the nominated circuits. They also indicate a possibility of communication (percentage). The frequencies identified in the legend are:  
 Upper Decile (10%)  
 Maximum Useable Frequency (50%)  
 E layer MUF  
 Optimum Working Frequency (90%)  
 Absorption Limiting Frequency  
 The predictions were made by one of the Ionospheric Prediction Service Stand Alone Prediction Systems. The T index used is shown above the legend. The Australian terminal azimuth (degrees), path length (kilometres) and propagation modes are also given for each circuit. ar

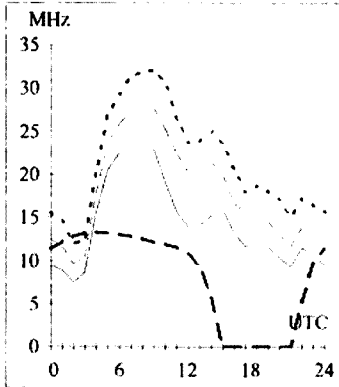
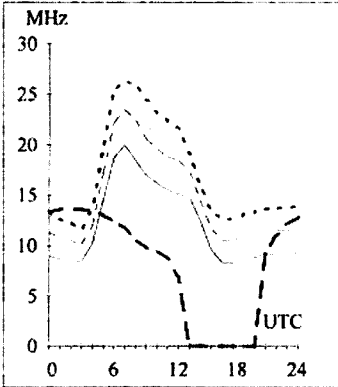
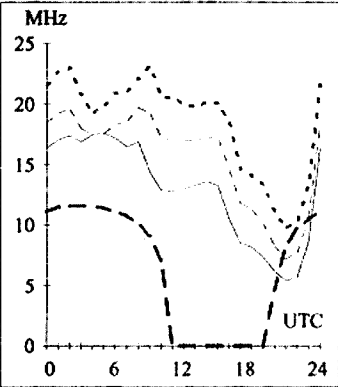
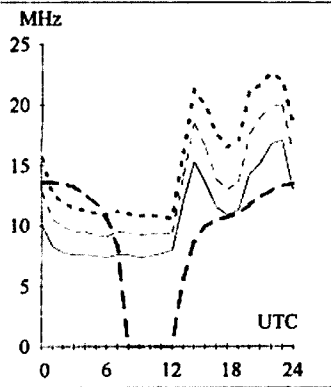


**Adelaide-Montreal** 57  
First F 0-5 Short 17062 km

**Brisbane-Bangkok** 302  
First F 0-5 Short 7281 km

**Canberra-Berlin** 313  
First F 0-5 Short 16064 km

**Darwin-Cairo** 298  
Second 4F2-6 4E0 Short 11609 km

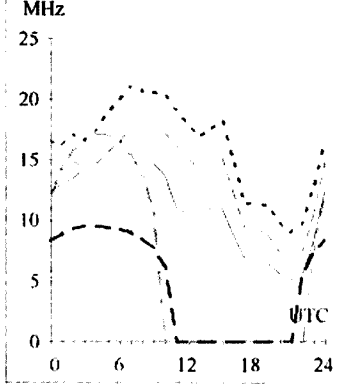
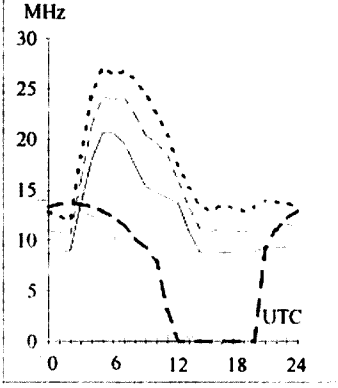
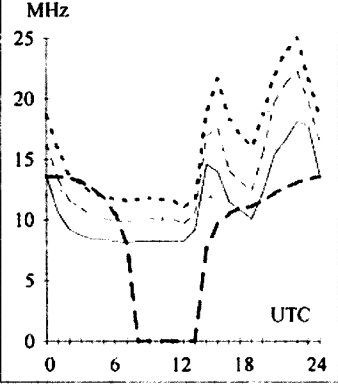
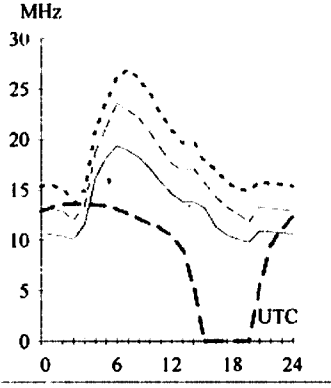


**Adelaide-Oslo** 294  
First F 0-5 Short 15632 km

**Brisbane-Boston** 56  
First F 0-5 Short 15722 km

**Canberra-Moscow** 317  
First F 0-5 Short 14481 km

**Darwin-Kuala Lumpur** 296  
Second 2F10-21 2E1 Short 3656 km

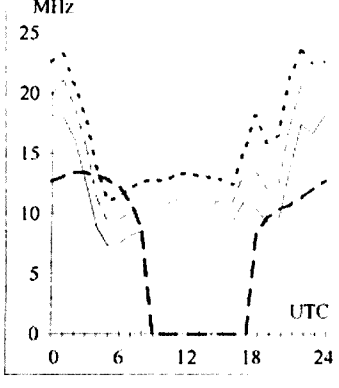
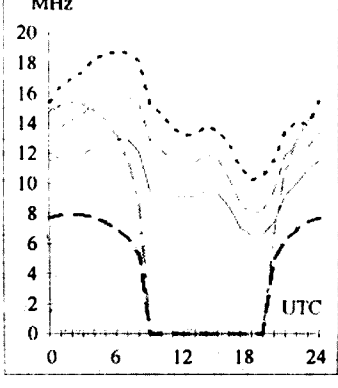
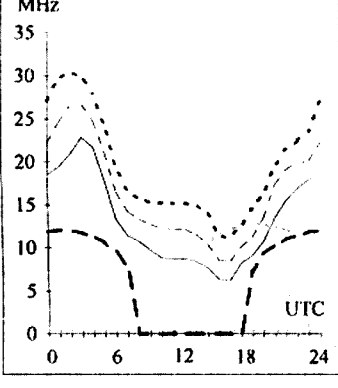
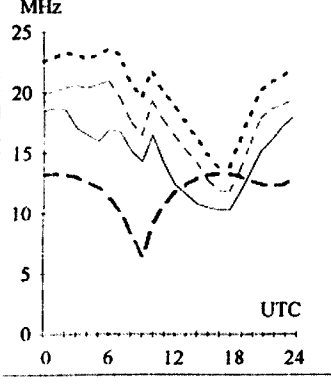


**Adelaide-Santiago** 155  
Second 4F3-6 4E0 Short 11818 km

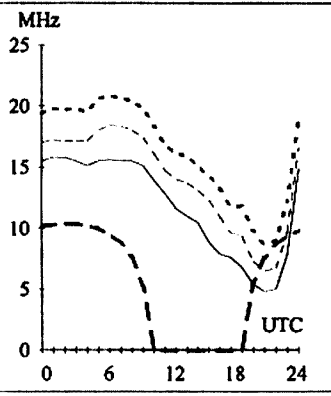
**Brisbane-Honolulu** 49  
Second 3F5-10 3E0 Short 7568 km

**Canberra-Port Moresby** 355  
Second 2F15-23 2E4 Short 2870 km

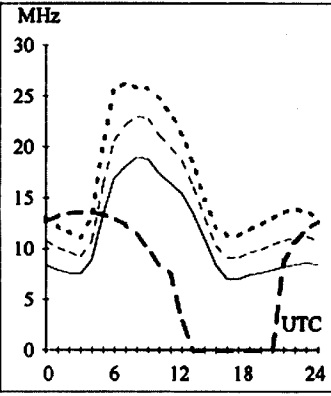
**Darwin-Seattle** 44  
First F 0-5 Short 12283 km



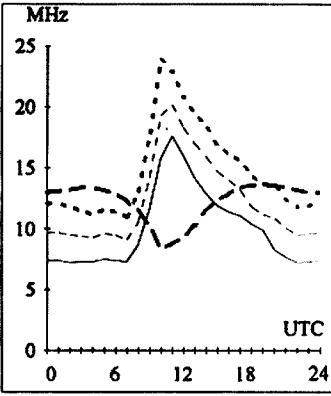
**Hobart-Hanoi** 320  
Second 4F8-15 4E0 Short 8277 km



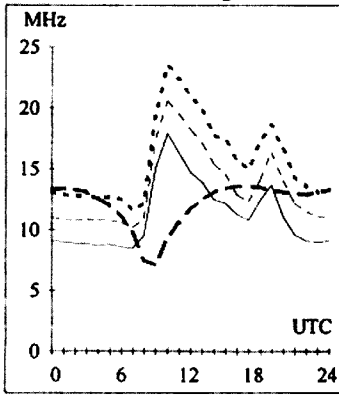
**Melbourne-Helsinki** 321  
First F 0-5 Short 15205 km



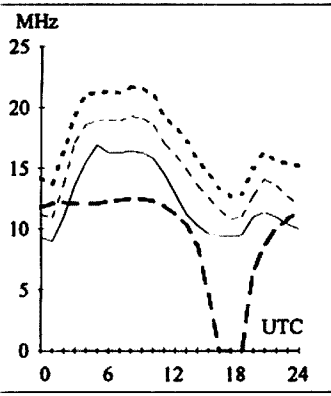
**Perth-Copenhagen** 139  
First F 0-5 Long 26331 km



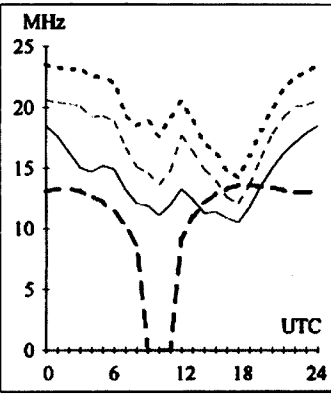
**Sydney-London** 139  
First F 0-5 Long 23032 km



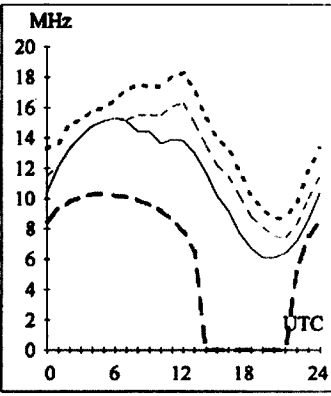
**Hobart-Harare** 239  
Second 4F4-9 4E0 Short 10649 km



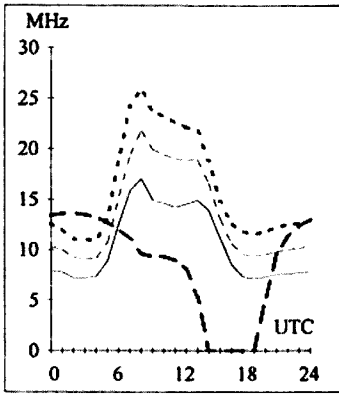
**Melbourne-Lima** 133  
First F 0-5 Short 12949 km



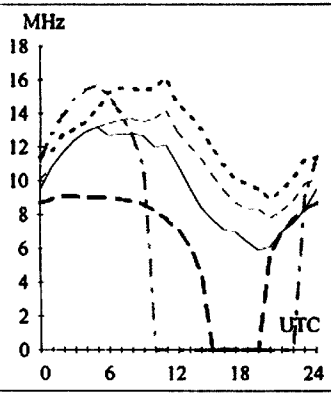
**Perth-Heard Is.** 222-72  
First 2F8-16 2E0 Short 4103 km



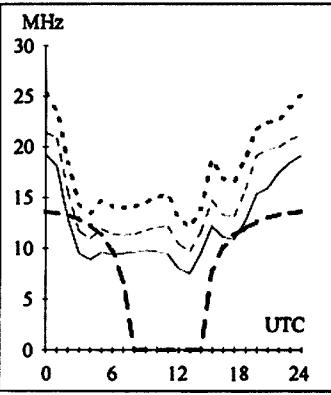
**Sydney-London** 319  
First F 0-5 Short 16992 km



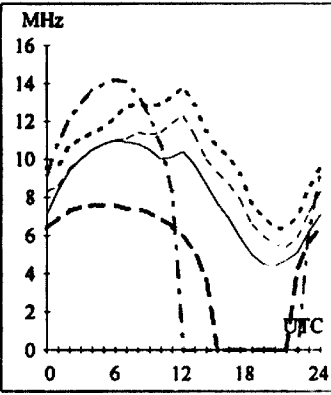
**Hobart-Heard Is.** 231-109  
Second 3F11-20 3E1 Long 5359 km



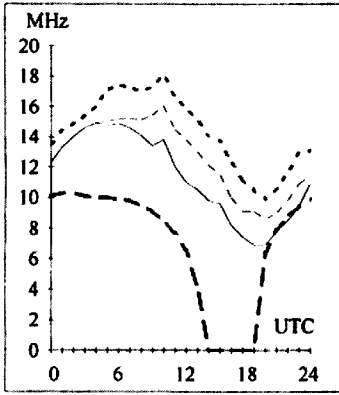
**Melbourne-Los Angeles** 65  
First F 0-5 Short 12771 km



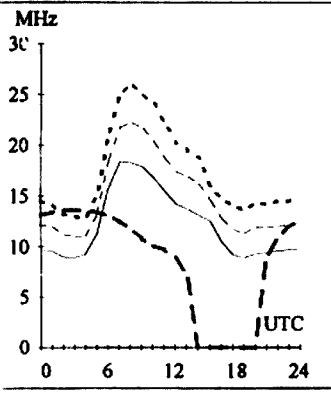
**Perth-Heard Is.** 222-72  
Second 3F16-26 3E4 Short 4103 km



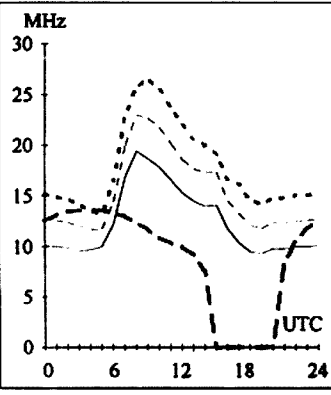
**Sydney-Heard Is.** 225-103  
Second 3F8-15 3E0 Short 6281 km



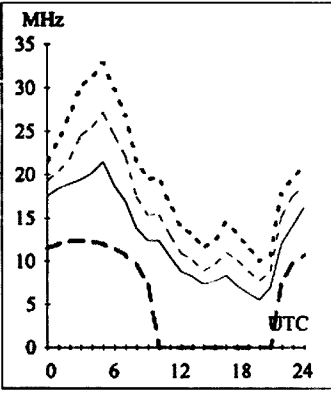
**Hobart-London** 303  
First F 0-5 Short 17404 km



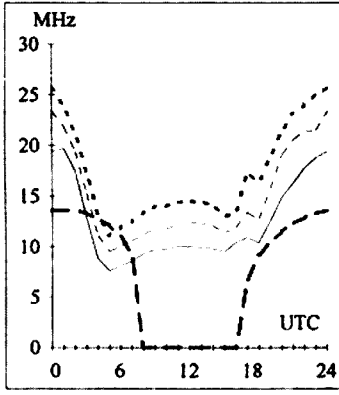
**Melbourne-Paris** 305  
First F 0-5 Short 16792 km



**Perth-Tokyo** 20  
Second 3F4-9 3E0 Short 7923 km



**Sydney-Vancouver** 45  
First F 0-5 Short 12501 km



# HAMADS

## TRADE ADS

### • AMIDON FERROMAGNETIC CORES:

For all RF applications. Send business size SASE for data/price to RJ & US Imports, PO Box 431, Kiama NSW 2533 (no enquiries at office please ... 14 Boanyo Ave Kiama). Agencies at: Geoff Wood Electronics, Sydney; Webb Electronics, Albury; Assoc TV Service, Hobart; Truscotts Electronic World, Melbourne and Mildura; Alpha Tango Products, Perth; Haven Electronics, Nowra; and WIA Equipment Supplies, Adelaide.

• **WEATHER FAX programs** for IBM XT/ATs \*\*\* "RADFAX2" \$35.00, is a high resolution shortwave weatherfax, Morse and RTTY receiving program. Suitable for CGA, EGA, VGA and Hercules cards (state which). Needs SSB HF radio and RADFAX decoder. \*\*\* "SATFAX" \$45.00, is a NOAA, Meteor and GMS weather satellite picture receiving program. Needs EGA or VGA & WEATHER FAX PC card, + 137 MHz Receiver. \*\*\* "MAXISAT" \$75.00 is similar to SATFAX but needs 2 MB of expanded memory (EMS 3.6 or 4.0) and 1024 x 768 SVGA card. All programs are on 5.25" or 3.5" disks (state which) plus documentation, add \$3.00 postage. ONLY from M Delahunty, 42 Villiers St, New Farm QLD 4005. Ph (07) 358 2785.

• **HAM LOG v.3.1** - Acclaimed internationally as the best IBM logging program. Review samples....AR: "Recommend it to anyone"; The Canadian Amateur: "Beyond this reviewer's ability to do it justice. I cannot find anything to improve on. A breakthrough of computer technology". ARA: "Brilliant". Simple to use with full help, the professional HAM LOG is immensely popular (now in its 5th year), with many useful, superb features. Just \$59 (+ \$5 P & P), with a 90 page manual. Special 5 hour Internet offer. Demos, brochures available. Robin Gandevia VK2VN (02) 369 2008 BH fax (02) 369 3069.

Internet address rhg@ozemail.com.au.

## FOR SALE ACT

Hewlett Packard sig gen, 612A 450-1230 MHz, 618C 3.8-7.6 GHz, 606A 50 kHz- 65 MHz. RF millivoltmeter 411A, 3406A, 410C. Digital Multimeter 3476B. Avo- 8, Avo-73. Klystron power supply 715A. RF Bridge GR-1606A. Mod meter TF- 2300B. Peter VK1CPK, 30 Chirnside Circuit, Kambah ACT 2902 (06) 231 1790.

## FOR SALE NSW

Yaesu FT-901D txcvr, FV-901DM scanning VFO 40 memory, YO-901 multi-scope, YM-34 desk mic, \$900 ono. Yaesu FT-209RH 2 m handheld, never used, PA-3 car adapter/charger, MH-12 speaker mic, \$450. Yaesu MD-1B8 desk mic, unused, \$100. Hi-Mound MK-701 telegraph key, unused, \$100. Palomar TX-200 HF 80-10 m linear amp, \$250 ono. Tokyo Hy-Power HC-2500 heavy duty ATU; \$500 ono. Home-made ATU, \$150. All items good condition. Peter VK2DBI QTHR (063) 675 095.

Deceased Estate. Yaesu FT-757GX, sn, 4G

092522, hand and desk mic. IC-22S, sn 11064. WELZ SP250 SWR/Pwr meter, sn 251016. Home brew PSU. Kenwood dummy load. 18AVT vert antenna. \$1000 the lot. LAO. Jim VK2DPU QTHR (02) 9629 1429.

TS-711B, 70 cm all mode, as new condn, \$1100. TS-700SP, digital readout, all mode 2 m, \$650. Uniden 2510, all mode, 10 m, \$400. Kantronics KPC-3, 32 k version, latest, new, not going into packet. All items are in as-new or top condn. All items include h/books, circuits, boxes. Prices or near offer. A Walsh VK2TBW (048) 61 2092 fax (048) 61 1536.

6 position co-ax switch, \$10. 50 ohm 500 watt dummy load. 1.5 kg. \$5. 6 silver plated N in-line sockets, new, \$5 each. Kenwood DM81 dip meter, 0.7-250 MHz, inductive and capacitive coupling, solid state, for indoor/outdoor measurements, \$75. Advance signal generator type B4B7, continuous coverage 1 kHz to 30 MHz, with leads, \$150. 2 of 350 µF, HV, ceramic insulated, tuning cap, \$10 each. 2 gang 15 µF, wide spaced tuning cap, vernier tuned, \$5. Large, wide spaced, silver plated, roller inductor, \$40. Medium sized roller inductor, ceramic, \$30. 2 gang 5 µF tuning cap, \$10. Single 15 µF wide spaced tuning cap, \$5. 2 of 50 mm 9:1 vernier dial, \$10 each. Adjustable Variac xfomer, 10-300 V 2 amp, \$50. 240/110 V 200 VA xfomer, \$40. Homebrew ATU, \$15. Jack VK2AZP QTHR (02) 9476 4013.

## FOR SALE VIC

Kenwood TL-922 1.2 kW PEP all band linear with set of new 3/500Z tubes and handbook, EC, \$2500 ono. Icom IC-7000 all mode receiver covering 25 to 1300 MHz, handbook, EC, \$1200 ono. Star LC24-15 wide carriage 24 pin dot matrix printer with tractor feed, never used and in pristine condn, with manual and cables, \$200 ono. Harold VK3AFQ (03) 9596 2414.

Kenwood TS-930S HF txcvr, professionally modified to include switchable narrow SSB filtering, complete with mic, handbook and workshop manual, unmarked as new condition, \$1495. VK3BR QTHR (03) 9584 9512

Hy-Gain 204BA beam antenna, complete with all hardware, balun and instruction manual, as new condn. \$300. Reg VK3LS QTHR (03) 9379 3619.

Yaesu FT-470 dual band handheld, in vg condn with service h/book, spare battery, charger and carry case, covers 140-174 MHz and 430-500 MHz, \$500. Phone (03) 5152 4027 and ask for Ian. Rob VK3DEM.

Radio transmitter, pre-1980, in steel cabinet 635W x 340D x 1900H, 2 doors, 6 shelves, ex VK3KC, \$330. Beverley Williams (03) 9376 5573

## FOR SALE QLD

Yaesu FL-2100 linear amp, manual, little used, good condn, \$650. VK4EB (07) 5546 6164.

TET 443DX 40/20/15/10 4-el Yagi, boxed ready to ship, incl balun, \$350. Or swap for 20 m monoband Yagi or log periodic. VK4EET QTHR (07) 3801 3200.

Radiotron Designer's Handbook, 4th edition 1955, \$50. Drake's Cyclopeda of Electronics 1933, \$35. Leader LDM815 GDO, \$80. 3000 miniature, octal, metal receiving valves, \$700. Peter Hadgraft VK4APD, 17 Paxton St, Holland Park, Qld 4121 (07) 3397 3751 AH.

## FOR SALE SA

GME Electrophone 11 amp regulated power supply, sn 5129340, as new, \$125. Hank VK5NCA (08) 8272 7435.

## FOR SALE TAS

Yaesu FT-747GX, Rx 500 kHz to 30 MHz, Tx 160 - 10 m, built-in CW, SSB, and AM filters, as new condn, boxes, manuals, etc. Allen VK7AN (03) 6327 1171 Mobile 018 134837.

## WANTED NSW

Manual and circuit for Kenwood TS-900, all photocopy and postage expenses paid. Also looking for Icom IC-735 or similar solid state rig, must be unmodified and in original condn. Stan VK2BRZ QTHR (044) 417 061

McDonald Pendograph and Automorse keys. Also any books or manuals on the above keys, photocopies OK. Pay top dollar for good condn keys. Steve VK2SPS (02) 9999 2933 after 6.00 pm.

Philips sweep and marker generator type GM28775 instruction manual, or any operation information, all expenses paid, etc. Maurie VK2OW QTHR (02) 9838 1834.

## WANTED VIC

Owners manual/circuit diagram for KUWANO electronic voltmeter, model VP- 109, all costs met plus \$5.00 bonus. Reg VK3CCE QTHR.

FM747 UHF and Weston VHF FM661, in working order or not, also any information sheets. Stan VK3SE QTHR (03) 5332 2340 evenings.

DM5 desk mic or similar with pre-amp to suit much loved and faithful Icom 720A. Arthritis in fingers making handheld mic use difficult. Ron VK3LPM (03) 5368 9477.

## WANTED QLD

4 or more el 20 m Yagi or 8 el log periodic antenna, in good condn, cash or swap TET 443DX 4 el 40/20/15/10 m Yagi. Eddie VK4EET QTHR (07) 3801 3200.

Bird Thurline RF directional wattmeter model 4311, 4314 or similar, amp not necessary, plug in modules optional. Graham VK4FGB QTHR (070) 541 448.

## WANTED WA

Power transformer for Yaesu YO-901 multiscope, must have primary windings for 234 volts. Bob VK6ABS QTHR (090) 754 136.

## MISCELLANEOUS

• THE WIA QSL Collection (now Federal) requires QSLs. All types welcome especially rare DX pictorial cards special issue. Please contact Hon Curator Ken Matchett VK3TL, 4 Sunrise Hill Road, Montrose Vic 3765, Tel (03) 728 5350.

ar



## WIA News

### A Role for Ham Radio on the Space Station

During November, amateur radio delegates from eight countries met at the NASA Johnson Space Centre in Houston, Texas, to lay the groundwork for plans to include a permanent amateur radio station aboard the International Space Station and to be operated by crew members, according to The ARRL Letter of 29 November 1996.

Delegates to this meeting came from Canada, France, Germany, Great Britain, Italy, Japan, Russia and the United States. The delegates jointly developed a draft memorandum of understanding to

promote the development of amateur radio on the International Space Station, to be known as ARISS.

An ARISS group will provide for the planning, coordination and performance of amateur radio projects on the space station, similarly to the way the SAREX Working Group currently coordinates amateur radio activities on many space shuttle missions. Amateur Satellite Corporation (AMSAT) and International Amateur Radio Union (IARU) organisations in each of the eight countries are to review and consider approving the memorandum of understanding.

## Andrews Communication Systems

(EST. 1976 - ACN 001 968 752)

### NEW

- ★ IC-756 HF+6M, DSP, LCD
- ★ IC-R10 HANDHELD SCANNER
- ★ WS-1000E CUTE SCANNER
- ★ DX-70TH HF+6M 100W
- ★ DJ-191 SLIM 2M HANDHELD
- ★ DX-1600 HF LINEAR AMP
- ★ AR-7000 DSP, LCD, SCANNER

*Due now or soon*

**PLENTY OF ALINCO RADIOS IN STOCK**

*Call us now*

**(02) 9636 9060** or (02) 9688 4301

SHOP 8, 41 BATHURST ST, GREYSTANES,  
N.S.W. 2145. FAX (02) 9688 1995

**When you buy something from one of  
our advertisers, tell them you read  
about it in the WIA Amateur Radio  
magazine**

## Hamads

Please use a separate form for For Sale and Wanted items, and be sure to include your name, address and telephone number (including STD code).

- Eight lines per issue free to all WIA members, ninth line for name and address. Commercial rates apply for non-members.
- Deceased estates Hamads will be published in full, even if the ad is not fully radio equipment.
- WIA policy recommends that the serial number of all equipment offered for sale should be included in the Hamad.
- QTHR means the address is correct in the current WIA Call Book.

State .....

- Ordinary Hamads from members who are deemed to be in general electronics retail and wholesale distributive trades should be certified as referring only to private articles not being re-sold for merchandising purposes.
- Commercial advertising (Trade Hamads) are pre-payable at \$25.00 for four lines, plus \$2.25 per line (or part thereof), with a minimum charge of \$25.00.
- Copy typed or in block letters, by the deadlines shown on page 1 of each issue of *Amateur Radio*, to:  
Postal: 3 Tamar Court, Mentone VIC 3194  
Fax: (03) 9584 8928  
E-mail: vk3br@e031.aone.net.au


Please check one box:       For Sale       Wanted       Miscellaneous

**Not for publication:**

Name: \_\_\_\_\_ Call Sign: \_\_\_\_\_ Address: \_\_\_\_\_

# WIA Divisions

The WIA consists of seven autonomous State Divisions. Each member of the WIA is a member of a Division, usually in their residential State or Territory, and each Division looks after amateur radio affairs within its area.

Division	Address	Officers	Call Sign	Weekly News Broadcasts	1997 Fees
VK1	ACT Division GPO Box 600 Canberra ACT 2601	President Philip Rayner Secretary John Woolner Treasurer Bernie Kobier	VK1PJ VK1ZAO VK1KIP	3.570 MHz LSB, 146.950 MHz FM each Sunday evening commencing at 8.00 pm local time. The broadcast text is available on packet, on internet <a href="http://aus.radio.amateur.misc">aus.radio.amateur.misc</a> newsgroup, and on the VK1 Home Page <a href="http://email.nla.gov.au/~cmakin/wiaact.html">http://email.nla.gov.au/~cmakin/wiaact.html</a> From VK2WI 1.845, 3.595, 7.146*, 10.125, 24.950, 28.320, 29.120, 52.120, 52.525, 144.150, 147.000, 438.525, 1281.750 (* morning only) with relays to some of 14.160, 18.120, 21.170, 584.750 ATV sound. Many country regions relay on 2 m or 70 cm repeaters. Sunday 1000 and 1930. Highlights included in VK2AWX Newcastle news, Monday 1930 on 3.593 plus 10 m, 2 m, 70 cm, 23 cm. The broadcast text is available on the Internet newsgroup <a href="http://aus.radio.amateur.misc">aus.radio.amateur.misc</a> , and on packet radio.	(F) \$72.00 (G) (S) \$58.00 (X) \$44.00
VK2	NSW Division 109 Wigram St Parramatta NSW (PO Box 1066 Parramatta 2124 Phone (02) 9689 2417 Freecall 1800 817 644 Fax (02) 9633 1525	President Michael Corbin Secretary Eric Fossey Treasurer Eric Van De Weyer (Office hours Mon-Fri 11.00-14.00 Sat 1000-1300 Mon 1900-2100) Web: <a href="http://marconi.mpce.mq.edu.au/wia">http://marconi.mpce.mq.edu.au/wia</a> e-mail address: <a href="mailto:wiansw@sydneydialix.oz.au">wiansw@sydneydialix.oz.au</a> Packet BBS: VK2WI on 144.850 MHz	VK2YC VK2EFY VK2KUR	VK3BWI broadcasts on the 1st Sunday of the month, starts 10.30 am. Primary frequencies 1.840 AM, 3.615 LSB, 7.085 LSB, and FM(R)s 146.700 Mt Dandenong, 147.250 Mt Macedon, 147.225 Mt Baw Baw, and 2 m FM(R)s VK3RMA, VK3RSH and VK3ROW. 70 cm FM(R)s VK3ROU and VK3RGL. Major news under call VK3WI on Victorian packet BBS.	(F) \$66.75 (G) (S) \$53.40 (X) \$38.75
VK3	Victorian Division 40G Victory Boulevard Ashburton Vic 3147 Phone (03) 9885 9261 Fax (03) 9885 9298	President Jim Linton Secretary Barry Wilton Treasurer Rob Hailey (Office hours Tue & Thur 0830-1530)	VK3PC VK3XV VK3NC	1.825 MHz SSB, 3.605 MHz SSB, 7.118 MHz SSB, 14.342 MHz SSB, 28.400 MHz SSB, 29.220 MHz FM, 52.525 MHz FM, 146.700 MHz FM, 147.000 MHz FM, 438.525 MHz (Brisbane only), regional VHF/UHF repeaters at 0900 hrs Sunday. Repeated on 3.605 MHz SSB & 147.000 MHz FM, regional VHF/UHF repeaters at 1930 hrs EAST Monday. Broadcast news in text form on packet under WIAQ@VKNET.	(F) \$75.00 (G) (S) \$61.00 (X) \$47.00
VK4	Queensland Division GPO Box 638 Brisbane QLD 4001 Phone (074) 96 4714	President Geoff Sanders Secretary John Stevens Treasurer John Presotto e-mail address: <a href="mailto:wiaq@tmxbris.mhs.oz.au">wiaq@tmxbris.mhs.oz.au</a>	VK4KEL VK4AFS VK4WX	1827 kHz AM, 3.550 MHz LSB, 7.095 AM, 14.175 USB, 28.470 USB, 53.100 FM, 147.000 FM Adelaide, 146.700 FM Mid North, 146.800 FM Mildura, 146.825 FM Barossa Valley, 146.900 FM South East, 146.925 FM Central North, 147.825 FM Gawler, 438.425 FM Barossa Valley, 438.475 FM Adelaide North, ATV Ch 35 579.250 Adelaide. (NT) 3.555 USB, 7.065 USB, 10.125 USB, 146.700 FM, 0900 hrs Sunday, 3.585 MHz and 146.675 MHz FM Adelaide, 1930 hrs Monday.	(F) \$75.00 (G) (S) \$61.00 (X) \$47.00
VK5	South Australian Division 34 West Thebarton Rd Thebarton SA 5031 (GPO Box 1234 Adelaide SA 5001) Phone (08) 8352 3428 Fax (08) 8264 0463	President Peter Watts Secretary Maurie Hooper Treasurer Charles McEachern	VK5ZFW VK5EA VK5KDK	146.700 FM(R) Perth, at 0930 hrs Sunday, relayed on 1.825, 3.560, 7.075, 14.116, 14.175, 21.185, 29.680 FM, 50.150 and 438.525 MHz. (X) Country relays 3.582, 147.350(R) Busselton and 146.900(R) Mt William (Bunbury). Broadcast repeated on 146.700 at 1900 hrs Sunday, relayed on 1.865, 3.563 and 438.525 MHz; country relays on 146.350 and 146.900 MHz.	(F) \$66.75 (G) (S) \$48.60 (X) \$32.75
VK6	West Australian Division PO Box 10 West Perth WA 6872 Phone (09) 351 8873	President Cliff Bastin Secretary Christine Bastin Treasurer Bruce Hedland-Thomas	VK6LZ VK6ZLZ VK6OO	146.700 MHz FM (VK7RHT) at 0930 hrs Sunday relayed on 147.000 (VK7RAA), 146.725 (VK7RNE), 146.625 (VK7RMD), 3.570, 7.090, 14.130, 52.100, 144.150 (Hobart) Repeated Tues 3.590 at 1930 hrs.	(F) \$74.00 (G) (S) \$60.00 (X) \$46.00
VK7	Tasmanian Division 5 Helen Street Newstead TAS 7250 Phone (03) 634 42324	President Andrew Dixon Secretary Robin Harwood Treasurer Terry Ives	VK7GL VK7RH VK7ZTI	Membership Grades Full (F) Pension (G) Needy (G) Student (S) Non receipt of AR (X)	Three-year membership available to (F) (G) (X) grades at fee x 3 times
VK8	(Northern Territory is part of the VK5 Division and relays broadcasts from VK5 as shown received on 14 or 28 MHz).				

Note: All times are local. All frequencies MHz.

## ADVERTISERS' INDEX

Amateur Transceiver Radio _____	35	W Spedding VK2NLS _____	6
Andrews Communication Systems _____	55	Terlin Aerials _____	51
Clarke & Severn Electronics _____	45	Tower Communications _____	34
Com-an-tena _____	19	WIA Recruitment _____	3
Daycom _____	IFC	WIA Membership Retention _____	9
Dick Smith Electronics _____	28, 29, IBC	<b>Trade Hamads</b>	
Electronic Surplus Store _____	6	M Delahunty _____	54
ICOM _____	OBC, 33	RJ & US Imports _____	54
Radio and Communications _____	37	HAMLOG - VK2VN _____	54

### TRADE PRACTICES ACT

It is impossible for us to ensure the advertisements submitted for publication comply with the Trade Practices Act 1974. Therefore, advertisers and advertising agents will appreciate the absolute need for themselves to ensure that the provisions of the Act are complied with strictly.

### VICTORIAN CONSUMER AFFAIRS ACT

All advertisers are advised that advertisements containing only a PO Box number as the address cannot be accepted without the addition of the business address of the box-holder or seller of the goods.

# Tough, Compact, Economical

## Yaesu FT-50R 2m/70cm Handheld

For the foremost in top performing, durable, and economical dualband handhelds, there's now only one choice, Yaesu's amazing new FT-50R!

Manufactured to rigid commercial grade standards, the FT-50R provides 2m and 70cm band transceive coverage plus an amazingly wide receiver range (76-200, 300-540, 590-999MHz\*), all in a compact package with water resistant construction that's tough enough to meet the USA MIL-STD-810 rating for shock and vibration resistance, yet is easy to hold and use.

Measuring just 57 x 99 x 30mm (WHD) with the supplied FNB-40 650mA/H Nicad pack, the FT-50R provides 2.0w RF output on the 2m and 70cm bands as standard, and can provide up to 5.0w output when operated from a 12v source (optional Nicad battery or vehicle lead). It also provides 112 memory channels including two Home memories, an Alphanumeric display for channel naming (ie. repeater locations or call signs) with Omni-glow backlighting, and CTCSS encode for accessing repeaters that require a tone input. Selectable AM/FM receive modes allow for greater flexibility during extended receive operation.

For ease of use, the FT-50R provides super loud speaker output, an Auto Range Transpond System to determine if you are in range of another ARTS equipped transceiver, a Dual-watch system for monitoring sub-band activity, and four Battery saver systems for longer operating times. A selectable LCD voltmeter also allows you to monitor battery performance under load so you can estimate remaining battery life. You can also use the FT-50R with the optional ADMS-1C Windows based PC software/interface to quickly program features or clone programming to other compatible Yaesu radios.

The FT-50R is tough, easy to use, and one of the most economical dualband handhelds you can buy. There's now only one choice, the FT-50R from Yaesu.

(\* Cellular blocked)

D-3655



# \$599

2 year warranty



OUR WIDE BAND RECEIVER RANGE IS NOW EVEN WIDER.

ICOM FA-BOIRE



Our wide band receivers give you the world. Starting with our new IC-R10, an exciting upgrade of the popular IC-R1 which led the way in handheld receivers. The IC-R10 has a wide frequency coverage of 0.5 MHz to 1300 MHz and is an all mode (FM, WFM, SSB, CW, AM) unit. Features such as a real-time bandscope function, making it easy to find busy frequencies, are firsts for handheld receivers.



IC-R9000

Our top of the range IC-R9000 covers 100 kHz-1999.8 MHz in all modes



IC-R8500

and features Icom's unique CRT display, intelligent scan functions and an amazing 1000 memory channels, in a unit that delivers superb high frequency stability, even in the GHz range.

The IC-R8500 is another exciting newcomer with a frequency range of 0.1 to 2000 MHz, excellent frequency stability, and outstanding high receive sensitivity characteristics. With an RS-232C interface allowing direct connection to a PC, the new IC-R8500 is truly a state-of-the-art communications receiver.

Our mobile IC-R100 is packed with features and covers the 100kHz-1800 MHz range in AM, FM, and WFM modes with multi-function scanning and 100 memories with 20 scan edge channels. With the expanded Icom range of communications receivers... the world's radio signals have never sounded so good. Talk to your Icom dealer today for the full technical story.



IC-R100

CALL FREE: 1800 338 915  
290 -294 Albert St Brunswick Victoria 3056  
Ph: (03) 9387 0666 Fax: (03) 9387 0022

**ICOM**  
Clearly Ahead

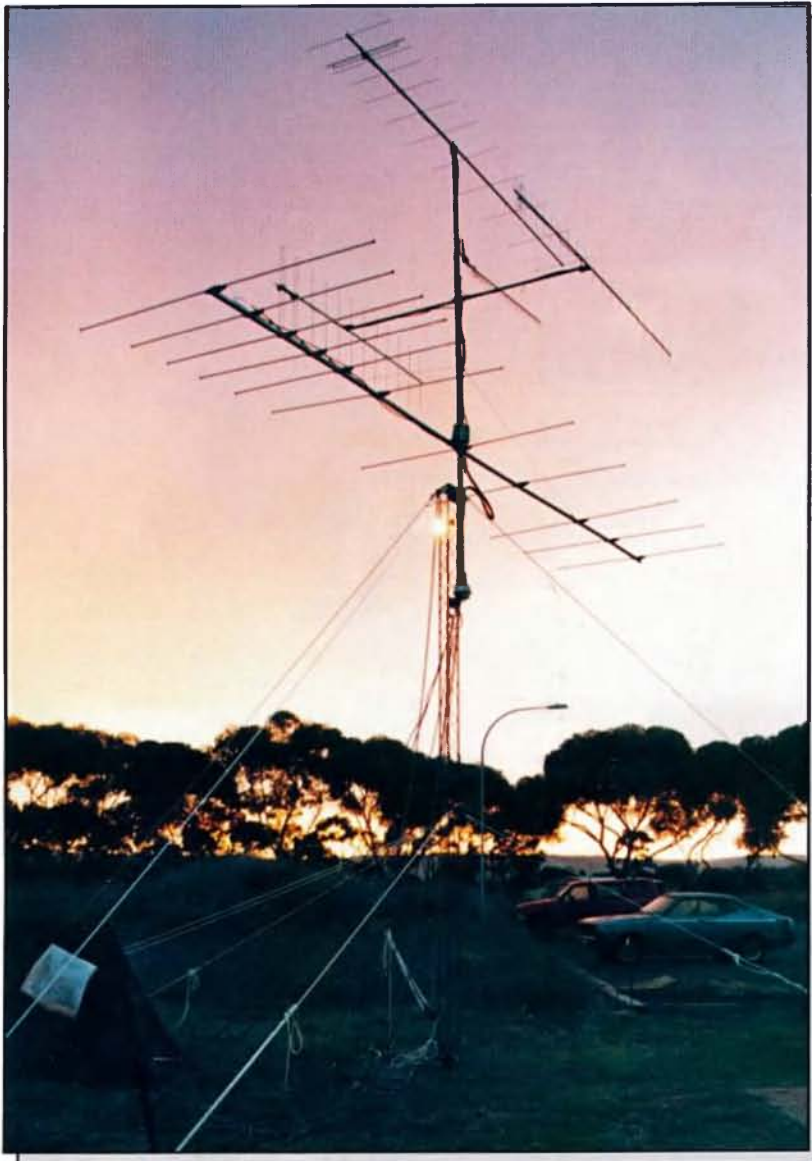
# Amateur Radio

February 1997

Volume 65 No 2



***Journal of the Wireless Institute of Australia***



## **IN THIS ISSUE:**

- \* 144 MHz Meteor Scatter in the Southern Hemisphere**
- \* Review of Yaesu FT-10R 2 Metre Handheld FM Transceiver**
- \* Combined Speech and CW Filter Using a Single IC**

## **Plus**

***lots of amateur radio news, information, other articles and special interest columns.***

It's here - now, at Daycom!



### IC-756 HF + 6m 100W, auto-ATU, DSP

If you missed our Icom Day at the end of November you missed the opportunity to see the all new IC-756. It was pretty hard to see anyway with the crowd always around it!

- All bands 160-6 metres
- 100W output on all bands
- Auto ATU works on all bands
- Dual watch receivers
- Spectrum Scope (just like the IC-7811)
- Dual Pass-Band Tuning
- Adjustable threshold DSP noise reduction
- Audio Peaking Filter
- Automatic Notch filter
- Built-in CW memory keyer
- 100 alphanumeric memories

Some of the reactions: "how much will you give me for my FT-1000 as a trade-in?", "Probably the most innovative radio since the IC781 hit the market!", "This is really a radio for all reasons, easy to use but with all the features a contestor or DXer needs."

In stock now, call to secure yours:

## \$3700

IC-2710H Dual Band mobile



The very latest in dual band mobile convenience - removable front panel, remote control microphone & lots of options including PC cloning of radios!

## \$1250



## ICOM \$3400

introductory special price:

The **NEW** Icom R-8500 receiver is here now! It covers 100kHz to 2000MHz (no breaks) has 1000 memories and a host of features you wouldn't think possible at just \$3750. Get the full story, call for a brochure or look on the WEB at <http://www.daycom.com.au/>

## MFJ Performance you can afford!



- MFJ1270C 1200bps VHF/UHF packet \$249
- MFJ1276 HF/VHF/UHF packet+PACTOR \$349
- MFJ1278B 10 mode multi-mode controller \$599
- MFJ1278B-DSP DSP added to MFJ1278B \$759
- MFJ Packet options and accessories
- MFJ780 DSP add-in card for MFJ1278B \$219
- MFJ781 External DSP for any TNC \$279

## Kantronics



- KPC-3 1200bps VHF/UHF packet \$249
- KPC-9612 1200/9600bps dual port packet \$459
- NEW KPC-9612+ coming - run out special \$395!
- KAM+ Deluxe multi-mode \$669

## MFJ Antenna Tuners

- MFJ901B 200W Versatuner \$149
- MFJ910 Mobile antenna matcher \$45
- MFJ921 2 mtr 300W tuner \$155
- MFJ924 70 cm 300W tuner \$155
- MFJ931 Artificial ground tuner \$169
- MFJ941E 300W compact GP tuner \$230
- MFJ945E 300W mobile tuner \$209
- MFJ948 Deluxe 300W (no D/L) \$270
- MFJ949E Deluxe 300W \$299
- MFJ962C 1.5kW tapped inductor \$525
- MFJ971 200W Portable tuner \$190
- MFJ986 3kW Diff-T roller inductor \$629



MFJ989C 3kW Deluxe roller inductor \$735

## ARRL 1995 Publications CD-ROM



A whole years QST, QEX and NCJ magazines in a single CD-ROM - how convenient! With power full reader technology the diagrams and photos appear in separate windows. Fully searchable text. Requires 386 or better with Windows 3.1 or later.

## \$45



## HAMCALL 1996

Our most popular callbook CD-ROM with Windows, DOS and MAC search engines. Much new information this year including photos of many amateurs!

## \$45

## New books for your library!

### Antennas and Transmission Lines



### Antennas & Transmission Lines

This book of 37 chapters gives you lots of well explained theory, not too much mathematics and lots of practical examples with plenty of 'how-to' added. Great as a handy reference or a useful home study text.

MFJ3305 \$40

### Practical Receivers for beginners



Build a DC receiver for 80 & 20, or the "Super-7" for 40, maybe even a simple 50MHz FM receiver, they're all here in this wonderfully practical new book from the RSGB! Great projects, plenty of good practical advice.

BR79 \$33



### Instant Morse the CD-ROM!

Here it is in one easy package - a complete multimedia Morse code teaching package with training software and lots of other info. Requires Windows 3.1 and Sound Blaster compatible sound card.

BR492 \$99

### Ferromagnetic Core Design & Application Handbook



### Ferromagnetic Core Design & Application Handbook

This classic book gives you everything you need to know to design with and use ferrite and iron powder cores. From the pen of the master - Doug DeMaw W1FB. A must have reference for every hobbyist or professional

MFJ3506 \$40

## TKIT The NEW Heathkit!



Help reclaim this fascinating band! Six metres is the VHF DX band and even now offers regular overseas contacts with just a little effort. The TT1208 kit is the ideal, low cost way, to get going on 6 metres and find out what only the elite have known for years!

- Requires 3-5W input on 20 metres
- Extremely simple hookup and operation
- Sensitive, low noise 50-54MHz front end
- Fast, silent PIN diode TR switch for QSK & data
- 8W output on 6 metres
- Requires 12-15V DC 3A power supply
- Simple switching between HF and 6 metres
- Rugged steel case

TT1208 8W 6 metre transverter \$199

# Amateur Radio



## Journal of the Wireless Institute of Australia

Vol 65 No 2

ISSN 0002-6859

February 1997

Amateur Radio is published by the Wireless Institute of Australia, ACN 004 920 745 as its Official Journal, on the last Friday of each month.

### Editorial

#### Editor

Bill Rice VK3ABP\*

#### Production Manager

Bill Roper VK3BR

#### Senior Technical Editor

Peter Gibson VK3AZL\*

#### Technical Editors

Evan Jarman VK3ANI\*

Gil Sones VK3AUI\*

#### Contributing Editors

Ron Fisher VK3OM\*

#### WIA News Editor

Roger Harrison VK2ZRH

#### Proof Readers

Allan Doble VK3AMD

Jim Payne VK3AZT

Graham Thornton VK3IY

John Tutton VK3ZC

\*Publications Committee member

### Production

#### Administration, Advertising, Drafting, Production

vk3br Communications Pty Ltd  
3 Tamar Court, Mentone VIC 3194

#### Typesetting and Printing

Industrial Printing and Publishing Pty Ltd  
122 Dover Street, Richmond, VIC 3121.

#### Mail Distribution

Mail Management Australia Pty Ltd  
6 Garden Boulevard, Dingley VIC 3172

#### New Advertising

Eyvorne & Keith Tootell

Union Publicity Service Pty Ltd

PO Box 282, Toongabbie NSW 2146

Telephone: 1800 654 181 - 02 9831 1299

Fax: 02 9831 6161

#### Amateur Radio Correspondence

All contributions, correspondence, Hamads and queries concerning the content of

Amateur Radio should be sent to:

Amateur Radio

vk3br Communications Pty Ltd

3 Tamar Court, Mentone VIC 3194

E-mail: vk3br@c031.aone.net.au

Phone and Fax: 03 9584 8928

Mobile: 0418 534 168

Business Hours: 9.30 am to 3.00 pm weekdays

#### Amateur Radio Delivery

All correspondence and queries concerning the delivery of

Amateur Radio should be sent to:

Amateur Radio

WIA Federal Office

PO Box 2175

Caulfield Junction VIC 3161

#### Registered Office:

3/105 Hawthorn Road

Caulfield North VIC 3161

Telephone: 03 9528 5962

Fax: 03 9523 8191

Business Hours: 9.30 am to 3.00 pm weekdays

#### Editorial and Hamads Deadlines

March 10/02/97

April 10/03/97

May 07/04/97

#### Receipt of Amateur Radio by Mail

March issue will be delivered to Australia Post on 04/03/97 for mailing to members.

If this magazine is not received by the 15th of the month of issue, and you are a financial member of the WIA, please check with the Post Office before contacting the registered office of the WIA.

© Wireless Institute of Australia 1997

### CONTENTS

#### Technical

144 MHz Meteor Scatter in the Southern Hemisphere	8
<i>Michael J Farrell VK2FLR</i>	
Equipment Review - Yaesu FT-10R 2 m Hand Held Transceiver	14
<i>Ron Fisher VK3OM</i>	
A Combined Speech LP Filter and CW Filter Using a Single IC Package	16
<i>Lloyd Butler VK5BR</i>	
Random Radiators	19
<i>Ron Cook VK3AFW and Ron Fisher VK3OM</i>	

#### Columns

Advertisers' Index	56	Ionospheric Update	51
ALARA	21	Morse Practice Transmissions	45
AMSAT Australia	22	Novice Notes	37
Awards	24	Over To You	40
Club Corner	26	Pounding Brass	41
Contests	27	QSP News	23
Divisional Notes		Repeater Link	42
VK1 Notes	32	Silent Keys	49
VK2 Notes	32	Spotlight on SWLing	44
VK6 Notes	32	Technical Correspondence	45
VK7 Notes	32	Update	45
Editor's Comment	2	VHF/UHF - An Expanding World	46
Education Notes	33	WIA News	3, 7, 18, 25
Hamads	54	WIA - Divisional Directory	56
HF Predictions	52	WIA - Federal Directory	2
How's DX?	34		

#### Cover

The South Australian South Coast Amateur Radio Club has operated a number of field day stations over the past several years. This is part of the antenna system used by the VK5TTY contest station in the 1993 Remembrance Day contest.

(Photo by Peter VK5TZX)

#### BACK ISSUES

Available, only until stocks are exhausted, at \$4.00 each (including postage within Australia) to members.

#### PHOTOSTAT COPIES

When back issues are no longer available, photocopies of articles are available to members at \$2.50 each (plus \$2.00 for each additional issue in which the article appears).

The opinions expressed in this publication do not necessarily reflect the official view of the WIA, and the WIA cannot be held responsible for incorrect information published.

# Amateur Radio Service

A radiocommunication service for the purpose of self-training, intercommunication and technical investigation carried out by amateurs, that is, by duly authorised persons interested in radio technique solely with a personal aim and without pecuniary interest.

## Wireless Institute of Australia

The world's first and oldest National Radio Society  
Founded 1910

Representing the Australian Amateur Radio Service -  
Member of the International Amateur Radio Union  
Registered Federal office of the WIA:  
3/105 Hawthorn Rd, Caulfield North, Vic 3161

All Mail to:

PO Box 2175, Caulfield Junction, VIC 3161  
Telephone: 03 9528 5962 Fax: 03 9523 8191

Business Hours: 9.30 am to 3.00 pm on weekdays

Federal Secretary  
Peter Naish VK2BPN

### FEDERAL OFFICE STAFF

June Fox Book Keeper  
Sue Allan Membership Secretary  
Rita Trebilcock VK3NRT Examinations Officer

### COUNCIL

President	Neil Penfold	VK6NE
VK1 Federal Councillor	Richard Jenkins	VK1RJ
VK2 Federal Councillor	Michael Corbin	VK2YC
VK3 Federal Councillor	Brenda Edmonds	VK3KT
VK4 Federal Councillor	Ross Marren	VK4AMJ
VK5 Federal Councillor	Grant Willis	VK5ZWI
VK6 Federal Councillor	Bruce Hedland-Thomas	VK6OO
VK7 Federal Councillor	Jim Forsyth	VK7FJ

### EXECUTIVE

Peter Naish VK2BPN  
Lance Bickford VK4ZAZ  
Rowland Bruce VK5OU  
Neil Penfold VK6NE

### FEDERAL CO-ORDINATORS

AMSAT:	Graham Ratcliff	VK5AGR
Awards:	John Kelleher	VK3DP
Contests:	Peter Nesbit	VK3APN
Education:	Brenda Edmonds	VK3KT
EMC and Standards	Roger Harrison	VK2ZRH
FTAC:	John Martin	VK3KWA
Historian:	John Edmonds	VK3AFU
IARU:	David Wardlaw	VK3ADW
Int'l Travel Host Exch:	Ash Nallawalla	VK3CIT
Intruder Watch:	Gordon Loveday	VK4KAL
ITU Conference and Study Group:	David Wardlaw	VK3ADW
Media:	Roger Harrison	VK2ZRH
QSL Manager (VK9,VK0):	Neil Penfold	VK6NE
Radio Sports:	Wally Watkins	VK4DO
Videotapes:	Bob Godfrey	VK4BOB
WICEN:	Leigh Baker	VK3TP

### SMA LIAISON TEAM

Roger Harrison VK2ZRH  
David Wardlaw VK3ADW  
Neil Penfold VK6NE

# Editor's Comment

## Analogies

What I am about to say may be considered heretical in some places, and I must state at the beginning that it is my own thought on the subject and does not reflect WIA Policy.

In last month's issue (January 1997, page 35) in the VK2 Divisional Notes, a spokesman for the Spectrum Management Agency was quoted. Defending "user pays" for use of the spectrum, he likened it to "a resource that has to be controlled and maintained just like a park or a waterway".

But is this really so? Parks are man-made, or at least developed or rendered accessible by human effort. Waterways (canals, rivers, etc) are even more so. Locks, bridges, wharves, and navigation aids all add man-made facilities or improvements. Consequently, it seems reasonable that there should be fees, tolls or charges of some kind imposed on the users.

Is there anything man-made about the spectrum? Certainly it can be "polluted" by human activity, analogous to waterways, but man has played no part in its evolution. Equipment to make use of the spectrum is certainly a human artefact, BUT NOT THE SPECTRUM ITSELF!

In a similar way, the atmosphere or the regular availability of sunlight are better examples of naturally-provided benefits over which we have no control and for which we make no charge. Although, once upon a time, the UK imposed a tax on the size of windows in buildings; and the taxpayers responded by bricking up the windows! We do pollute the atmosphere, and in turn this may reduce the quality and quantity of our sunlight. We are attempting, not very successfully, to control such pollution by licensing polluters and restricting their output.

Perhaps, if we must tax people for using naturally-provided resources, it should be only on the basis of how much they are capable of damaging those resources. But note well that so-called "electronic pollution" does no permanent damage; unlike sulphur dioxide in the air, CFCs in the ozone layer, or sewage in the rivers.

Could it be that resource rental tax on the spectrum is based on a bad analogy which, like all analogies, breaks down somewhere, but rather sooner than most? Would not the atmosphere be a better analogy, and one for which we make or pay no charge?

Bill Rice  
VK3ABP

## CONTRIBUTIONS TO AMATEUR RADIO

*Amateur Radio* is a forum for WIA members' amateur radio technical experiments, experiences, opinions and news. Manuscripts with drawings and/or photos are always welcome and will be considered for possible publication. Articles on computer disk are especially welcome. The WIA cannot assume responsibility for loss or damage to any material. "How to Write for Amateur Radio" was published in the August 1992 issue of *Amateur Radio*. A photocopy is available on receipt of a stamped, self addressed envelope.



## ■ WIA News

Roger Harrison VK2ZRH, Federal Media Liaison Officer.

# WIA Submission Gains Permission to Use AX Prefix For Australia Day Weekend

For the first time, Australian amateurs were this year permitted to use the AX prefix in lieu of VK over 26-27 January, the Australia Day weekend. As advice of permission was only received on 10 January, it was too late to announce in January's issue, but the news was posted to the packet radio network and sent to all Divisions for their broadcasts, on the same day. Now the hubbub is over, the story can be told.

Following SMA rejection of a WIA request that Australian amateurs be permitted to use the AX prefix in lieu of VK for Australia Day last year, the Institute's SMA Liaison Team raised the issue at a meeting with the SMA last June. The SMA, while agreeing that Australia Day was significant, said because it was an annual event, it did not warrant the use of special event call signs. The SMA asked the WIA to compile a list of special events that were regarded as justifying the issue of special call signs as this would help the SMA and the WIA to come to some agreement on the issue.

In response, the SMA Liaison Team spent some considerable time and effort researching the field of special events and the criteria for justification of the use of special call signs to celebrate such events. Needless to say, it's a vast field. Last year, NSW Division Special Projects Officer, Stephen Pall VK2PS, provided WIA Federal with a very useful submission on special event call signs used in recent years in Australia and around the world.

In regard to the significance of

Australia Day as a "special event" warranting the use of the AX prefix, material from the National Australia Day Council was sought and, as a result, the Department of Immigration. Why the Department of Immigration? All is revealed, shortly.

In December, the WIA sent a two-page submission to the SMA, incorporating the following arguments.

The SMA's Regulatory Assignment and Licensing Instruction (RALI) document, AM2, provides a guideline on the use of the AX prefix as follows: *This prefix is only available for occasions of special national or international significance. . . Occasions warranting the use of the "AX" prefix will be determined by the SMA in consultation with the WIA.*

The submission argued that Australia Day is such an occasion because, firstly, it commemorates the arrival of the "First Fleet" on 26 January 1788, which founded the first British colony on the continent. Secondly, the celebration of Australia Day has been given significant importance and effect from the establishment, and activities, of the National Australia Day Council (NADC) and the eight State and Territory Australia Day Councils (Committee, in Victoria's case).

The National Australia Day Council says: *The National Australia Day Council leads a network of eight State and*

*Territory Australia Day Councils or Committees, and hundreds of local committees organised around Local Government Areas across the country.*

*The National Australia Day Council's charter is a commitment to the development of national pride and identity and recognition of achievement. The network of Australia Day Committees which put together Australia Day celebrations brings out more Australians to organised activities and major events on one day than any other event bar a national election.*

The last statement was particularly highlighted to emphasise the "special national significance" of Australia Day.

The Board of Directors of the National Australia Day Council comprises 14 Australians of diverse backgrounds, headed until late December by Chairman, Phillip Adams, the prominent writer, film-maker and broadcaster. The WIA submission noted the following quote from the Chairman's Report in the NADC's 1996 Annual Report, which further highlighted the scope of Australia Day as being of "special national significance": *About six million people were involved in Australia Day – from concerts, picnics, citizenship ceremonies and sports events to town meetings and discussions and family occasions. The announcement of Australian, Young Australian, Community and Australian Achievers of the Year, as well as awards for achievement in over six hundred communities across Australia, were for many a feature of the day.*

*As well as celebration, Australia Day is also a time of reflection. It is a good time for all of us to think about the place we call "our country" and to consider where we want to go in the future and what we want to be.*

### **ELECTRONIC SURPLUS STORE FOR SALE**

\*Used Signal Generators \* Frequency Counters  
\* Multimeters \* Oscilloscopes  
\* Rectifier Testers \* C.B. Radios  
\* Plus Lots More

#### **ALL AT CHEAP PRICES**

26 CARDIGAN STREET, CARLTON VIC. 3053  
PHONE: (03) 9663 6607 FAX: (03) 9663 5468

In addition, the WIA submission noted that Australia Day citizenship ceremonies have special national significance for migrants who formally take up citizenship on the day. The submission pointed out that Australia's origins are essentially that of a migrant nation, from the First Fleet to the present era. Today, more than one in four residents emigrated here in the 50 years since 1946. Australia Day citizenship ceremonies thus give particular focus to the importance of the day, the submission argued.

While the WIA's submission requested permission for use of the AX prefix over the three days of the Australia Day weekend because principal Australia Day events span the three days, the SMA

granted permission for 26-27 January only, during local time in each State or Territory. While Monday, 27 January was a holiday in most states, the Victorian Government has not decreed it one.

While the WIA anticipates that permission to use the AX prefix on the Australia Day weekend will be an annual event, formal advice had not been received by this issue's deadline.

The submission was researched and written by SMA Liaison Team member, Roger Harrison VK2ZRH, with advice from the other team members, Federal President Neil Penfold VK6NE and David Wardlaw VK3ADW.

Further submissions on the whole field of special event call sign usage are under development.

kHz band is allocated worldwide to the Amateur and Amateur-satellite services. From 6765-7000 kHz, the worldwide allocations are for fixed (primary) and mobile (secondary) services.

**10,100-10,350 kHz.** The Amateur Service requirement for the 10,100-10,350 kHz band is for a new worldwide allocation where the Amateur Service is primary. Internationally, this band is allocated on a primary basis for the fixed service, to the Amateur Service on a secondary basis at 10,100-10,150 kHz, and to the mobile service on a secondary basis at 10,150-10,300 kHz. The 10,100-10,350 kHz band in the United States has two allocations: the 10100-10150 kHz band is allocated exclusively for the Amateur Service and the 10150-10350 band is allocated for the fixed (primary) and mobile (secondary) services. The 10,150-10,300 kHz band is such a large portion of spectrum that the Amateur Service could possibly share this band in order to satisfy another radio service's additional spectrum requirements.

**14,350-14,400 kHz.** In this band, the Amateur Service requirement is for 50 kHz of primary, exclusive worldwide amateur allocation. Worldwide, this band is allocated for the fixed and mobile services.

**18,168-18,318 kHz.** The Amateur Service requirement for expansion of the 18,068-18,168 kHz amateur band by 150 kHz appears feasible into the next higher band. This adjacent higher band is the 18,168-18,780 kHz band that is allocated in the United States and Regions 1, 2, and 3 for the fixed service as primary and for the mobile service on a secondary basis.

**24,740-24,890 kHz.** To satisfy the 150 kHz additional requirement for the 24,890-24,990 kHz amateur band, expansion would have to be into the fixed and mobile allocated band below the amateur band. The band above it is allocated to the standard frequency and time signal service.

**29,700-30,000 kHz.** The amateur service requirement is for re-allocation of the 29,700-30,000 kHz band for the Amateur-satellite service (space-to-Earth). The Republic of South Africa has also proposed to re-allocate this band nationally for this purpose. Presently, this band in the United States is allocated exclusively for non-government land

# US Agency Recommends More Amateur Band Space on HF

The US National Telecommunications and Information Administration (NTIA) has issued a report on spectrum planning options for 3-30 MHz which cites a number of amateur band allocations suited to expansion on a world-wide basis, as well as two new band allocations. The NTIA is a branch of the Department of Commerce responsible for developing telecommunications policy and advising the American President on telecommunications matters.

The report, titled *High Frequency (3-30 MHz) Spectrum Planning Options*, released mid-December, noted the Amateur Service's requirements in regard to HF spectrum, summarised as follows:

**3500-3800 kHz.** The Amateur Service indicated a 300 kHz requirement of a common, worldwide exclusive amateur allocation in the 3500-4000 kHz band. In the United States the 3500-4000 kHz band is allocated for the amateur service; however, in other regions of the world,

the amateur service shares portions of this band with fixed and mobile services. The 3500-3800 kHz band is a good candidate for a common, worldwide exclusive amateur allocation at the 3.5 MHz band.

**4945-4995 kHz.** A new Amateur Service requirement for 50 kHz of shared use around 5000 kHz appears possible at 4945-4995 kHz. This band is allocated to the fixed and mobile services. *[Not suggested for world-wide allocation - VK2ZRH.]*

**6900-7200 kHz.** The amateurs' requirement for a 300 kHz band aligned worldwide at the 6900-7200 kHz band needs to be addressed at US preparations for future WRCs. This requirement is to reduce inter-regional sharing and interference from HF broadcasting in the 7100-7300 kHz band; however, the 7100-7300 kHz band is presently allocated in the United States and in Region 2 to the Amateur Service. In Regions 1 and 3, this band is allocated to the broadcasting service. The 7000-7100

mobile service use at 29,700-29,800 kHz and for the fixed service at the 29,800-29,890 kHz and 29,910-30,000 kHz bands. [In Australia, 29,7000-30,005 kHz is allocated to the fixed and mobile service assigned on a primary basis, with radiolocation secondary, while 29,720-30,000 kHz is allocated to Class Licensed model radio control - VK2ZRH.]

The various requirements were determined from a previous NTIA study carried out in 1995. This latest NTIA report said that the "alignment of the amateur bands at 3.5 and 7 MHz world-wide will require the inclusion of these proposals in US preparations for future WRCs" (World Radio Conferences).

The report also noted that the requested upgraded allocation at 3500-3800 kHz was "a good candidate for a common world-wide exclusive amateur allocation at the 3.5 MHz band." In addition, the report said that the allocation requested at 6900-7200 kHz would serve to "reduce inter-regional sharing and interference from HF broadcasting in the 7100-7300 kHz band."

The WIA's ITU Conference and Study Group Co-ordinator, David Wardlaw VK3ADW, and the SMA Liaison Team are studying the NTIA report. For those with Internet access, a copy can be found at [www.ntia.doc.gov/osmhome/reports/hfspoc/contents.html](http://www.ntia.doc.gov/osmhome/reports/hfspoc/contents.html).

# Another Year's Reprieve for Ch 35 ATV

Amateur television repeater systems on 575-582 MHz around Australia have been granted another year's extension to operate by the Australian Broadcasting Authority (ABA).

The "drop-through", as the ABA refer to it, has been granted for ATV systems at Black Hill in the ACT, Lane Cove, Oakdale and Springwood in NSW, Redbank Plains and Spring Hill in Queensland, Illawarra Hill and O'Halloran Hill in South Australia, Lyndhurst and Olinda in Victoria, and Carine in West Australia.

The Spectrum Management Agency


(SMA) advised the WIA late last year that the ABA had advised the current drop-through period had been extended to 31 December 1997. The WIA asked the SMA about possible extension of the drop-through period at the WIA-SMA Liaison meeting last June.

The 50 centimetre band was formally withdrawn from Amateur use in 1989 (it was previously a "temporary" allocation until required for broadcasting). ATV use of Channel 35 has proved a useful "bridge" between the amateur radio community and the public over recent years.

# VK6RBP HF Beacon Arrives

The five-band HF beacon, which will be the Australian leg of the 18-station International Beacon Project, arrived in Australia on 10 January. Providing it cleared Customs OK, the WIA Western Australian Division hoped to have it on the air in mid-January.

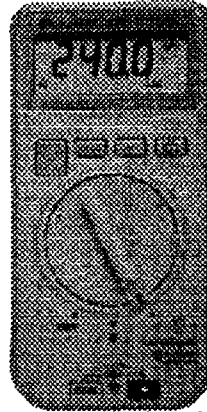
The beacons transmit on five bands in sequence, ten seconds on each band, over a 50-second period. The frequencies are 14.100, 18.110, 21.150, 24.930 and 28.200 MHz. See January *WIA News*, page 4.



**YOUR HOBBY**      **YOUR VOICE**  
 Representing Radio Amateurs - Since 1910

**RECRUIT A MEMBER & THEY COULD WIN!**

**THIS GREAT FLUKE 12B DIGITAL MULTIMETER WORTH \$195**



---

**THERE'S A WINNER EVERY MONTH FOR 1997 12 PRIZES TO BE WON**

This latest hand-held DMM, from the world-leading maker of digital test instruments, has advanced features yet is simple to use. Ideal for tyro & veteran.

**The Fluke 12B measures:**

- ac and dc voltage (with auto-selection)
- resistance & capacitance (.001-1000µ)

**The Fluke 12B features:**

- 4000-count liquid crystal display
- simple rotary dial
- diode and continuity testing
- indicates intermittent opens & shorts
- 2-year warranty

**Fluke 12B prizes generously donated by Philips Test & Measurement.**

Each month's prize is awarded by way of a draw among newly recruited members each successive month and presented to the winner at the earliest opportunity following the draw.

**To sign up a new member, use the back of your AR magazine address leaflet - or clip the coupon, have them fill it out and send it now.**

**SEND TO YOUR DIVISION'S ADDRESS, SHOWN ON PAGE 58.**

✂.....

Please send me a membership application.

NAME .....

ADDRESS .....

..... P/code .....

Call Sign (if any) ..... [AR 1-11/97]

# Rumours of Class Licence for Amateurs Scotched

Persistent rumours over recent months that amateurs were to be shortly transferred from the present Apparatus Licence system and put under a Class Licence by the Spectrum Management Agency have no foundation, according to advice received from the SMA.

A number of amateurs reported being told by staff in their local SMA Area Office that they should not bother paying for a multi-year licence because amateurs would soon be Class licensed. To ascertain the facts, WIA Federal President Neil Penfold VK6NE, contacted the SMA in Canberra.

The facts are: As part of its program of improving spectrum management processes, the SMA is reviewing all non-assigned services, of which there are ten – including the Amateur Service – to see whether sound spectrum management necessitates the issue of individual licences. Non-assigned services do not have an individual frequency assignment allocated by the SMA, but instead share a pre-set spectrum allocation. Apart from the Amateur Service, non-assigned services include some aeronautical services, outside broadcasting networks, maritime and scientific services. Each non-assigned licence type is being individually reviewed.

There is no predisposition to make any particular change to the Amateur Service, the SMA said. The review will incorporate appropriate consultation with the WIA and the Amateur community and will include consideration of the proposals that the WIA will shortly be putting before the Government, they said.

The WIA's position is that, while Class Licensing notionally offers a "fee-free" licence, radio amateurs individually and the Amateur Radio Service in Australia, stand to lose a great many advantages which are currently enjoyed. Class Licences are not issued to individuals. One of the fundamental strengths and

advantages of the Amateur Radio Service is that each amateur operator must be qualified, and is individually licensed by his country's administration. Each amateur and each amateur station is known to the administration. That is the way it is around the world.

Individual licensing is one of the cornerstones of how the Amateur Radio Service gained and maintains its recognition by the ITU and representation at international radiocommunications planning conferences. Without individual licences, the Australian Amateur Radio Service would likely not be recognised by the International Amateur Radio Union and we may lose representation at the international level. The issue and use of amateur call signs would be thrown into question.

From their inception, Class Licences have only been issued covering the use of type-approved equipment meeting prescribed standards. Class Licensing of amateur radio would mean every piece of equipment would have to meet those standards – from microphones to packet radio TNCs. That means antennas, too. Australian amateurs would lose the

ability to construct any item of their own equipment.

Without individual licences accredited by an agency of the Australian Government, the ability to operate your own amateur station in other countries, under reciprocal licensing agreements or through direct application to the administration, would be lost. Your status as an amateur radio operator would not be recognised.

Under Class Licensing the ability to recognise and act against amateur-band pirates would be seriously compromised.

There is very real likelihood that the Amateur Service in Australia would suffer from being identified with Class Licensed operations of low specification such as that on the industrial, scientific and medical equipment (ISM) bands, or the "anything goes" CB service.

*"Without a fundamental and far-reaching rewrite of the definition and operation of Class Licensing as presently defined in the Radiocommunications Act, the Amateur Radio Service in Australia would be disadvantaged and altogether badly served by coming under a Class Licence,"* said WIA Federal President, Neil Penfold VK6NE.

As previously announced in *WIA News*, the WIA is to present its completed submission on Amateur Radio Service licensing to the Minister for Communications and the Arts, Senator Richard Alston, on 12 February.

## Kenya Institutes Novice Licence Grade

The East African country, Kenya, introduced a Novice Licence grade last year, the Kenya Posts and Telecommunications granting licensees access to sub-bands on 80, 40, 15, 10 metres and all bands 2 m and above. Holders of the Kenya Novice Licence are permitted to operate on these bands using the following modes:

**80 m** 3500-3600 kHz CW only; 3600-3700 kHz CW and SSB; **40 m** 7000-7100 kHz CW and SSB; **15 m** 21,090-21,200 kHz CW only; **10 m** 28,100-28,400 kHz CW and SSB; **2 m & above** all modes, as for "Full" Licence holders.

Power limits for Novices are not known. (*IARU Region 1 News*).

ar

## WIA News

### IARU Continues to Grow

Membership of the International Amateur Radio Union continues to grow, with national amateur societies from five countries being admitted to membership during 1996.

The new-member societies were from Mali, Tanzania and Uganda in Africa, Moldova in eastern Europe, between Romania and the Ukraine, and Tajikistan between the western border of the People's Republic of China and the north-eastern border of Afghanistan, north of Pakistan. All are located in ITU Region 1.

There are now 151 separate countries and territories represented in the IARU. Created in Paris, France, the International Amateur Radio Union has been the watchdog and spokesman for the world Amateur Radio community since 1925.

The IARU Constitution organises the Union into three regional organisations that correspond to the three administrative regions of the International Telecommunication Union (ITU). Region 1 covers Europe, Russia, Africa and the Middle East, Region 2 covers the Americas, and Region 3 - Asia, India, Australasia and the western Pacific nations. The WIA is a founder member of the Region 3 IARU organisation. David Wardlaw VK3ADW is the WIA's IARU Liaison Officer. Michael Owen VK3KI is Vice President of the IARU.

**Help stamp out stolen equipment  
- keep a record  
of all your  
equipment serial  
numbers in a  
safe place.**

# RENEW YOUR MEMBERSHIP AND YOU COULD WIN



**This outstanding KENWOOD TM-733A  
dual-band 2m/70cm FM/packet rig worth \$1255**

● 50 watts on 2m ● 35 watts on 70cm  
Simultaneous dual-band VHF-UHF reception  
Data connection for 1200/9600 baud packet radio

**All you have to do is  
renew your Division  
membership when it  
falls due.**

### WHO'S ELIGIBLE?

- members whose renewal falls due between 1/1/97 and 31/12/97
- current members who are on a 3-year membership
- life members
- all membership grades

The prize will be awarded by means of a draw, the result to be published and the prize to be presented to the winner at the first available opportunity early in 1998.

### MORE TM-733A FEATURES

- Switchable 10 W/5 W RF output
- 13.8 Vdc operation
- Large, high-visibility LCD panel
- Dual-channel Rx on VHF & UHF
- Automatic band change
- Multi-scan reception functions
- 70 multi-function memories
- Selectable frequency steps
- Audible frequency identification
- Auto repeater offset on 2m
- Repeater reverse & offset switches
- Tone signalling (DTSS).

TM-733A prize kindly donated by  
Kenwood Electronics Australia P/L,  
PO Box 504, Homebush 2140.  
Ph: (02) 9746 1888. Fax: (02) 9746 1509.



YOUR HOBBY YOUR VOICE

## ■ Propagation

# 144 MHz Meteor Scatter in the Southern Hemisphere

Michael J Farrell, VK2FLR\* gives an in-depth explanation of two metre meteor scatter communication as applicable to Australia.

A major problem for meteor scatter activity on Australian VHF bands is the reliance on meteor shower data published for northern hemisphere operators. Revised meteor data for mid-latitude southern hemisphere stations presents a totally different picture than is obvious from the usual references in the amateur literature from North America and Europe.

Meteor scatter is an under-utilised propagation mode on the Australian VHF scene. The most common DX modes on two metres in this country would be aircraft reflection, tropospheric scatter/bending and ducting, sporadic E and EME, in that order. Two metre meteor scatter is far more accessible to the average two metre station than

moonbounce, which at best is marginal with VK power limits and large multi-Yagi arrays. Even auroral propagation, rarely heard north of the NSW-Victoria border, has produced more two metre contacts than meteor scatter, yet meteor scatter is a mode potentially available all of the time. Furthermore, the Australian amateur population is concentrated in cities which in many cases represent ideal path lengths for meteor scatter contacts: Sydney-Adelaide, Sydney-Hobart, Brisbane-Melbourne, Brisbane-Adelaide, Canberra-Hobart and Canberra-Brisbane.

By comparison, meteor scatter contacts in Europe and North America are more common than sporadic E contacts on two metres, and certainly

more common than EME. Of the 64 pages devoted to two metre activity reports published in DUBUS magazine during 1994, a total of 10 pages was allocated to EME, nine pages to tropo contacts above 700 km, seven pages to sporadic E and nine pages to auroral contacts. Meteor scatter reports took up 29 pages. European activity supports several meteor scatter contests and DXpeditions to rare grid squares are common during major shower periods. In North America, a similar situation applies, with meteor scatter contacts routinely reported in QST since the late 1950s.

Australian meteor scatter activity has a 25 year history. The first reported contacts were on six metres between VK8AU in Tennant Creek and VK8KK in Darwin, VK4RO in Ayr, and VK5ZDR and VK5ZWW in Adelaide in 1970<sup>6,8</sup>. These stations were subsequently joined by VK2ZQJ and VK7ZGJ, all on six metres. By 1973 meteor scatter on six had become a fairly popular sport in the eastern states, with up to six participants in Sydney alone during the major shower periods. Typical paths worked were VK2 and VK3 to VK4, VK5 and VK7, and VK3 to VK4. Attempts were made between VK2 and VK8 and between VK5 and VK6 without success.

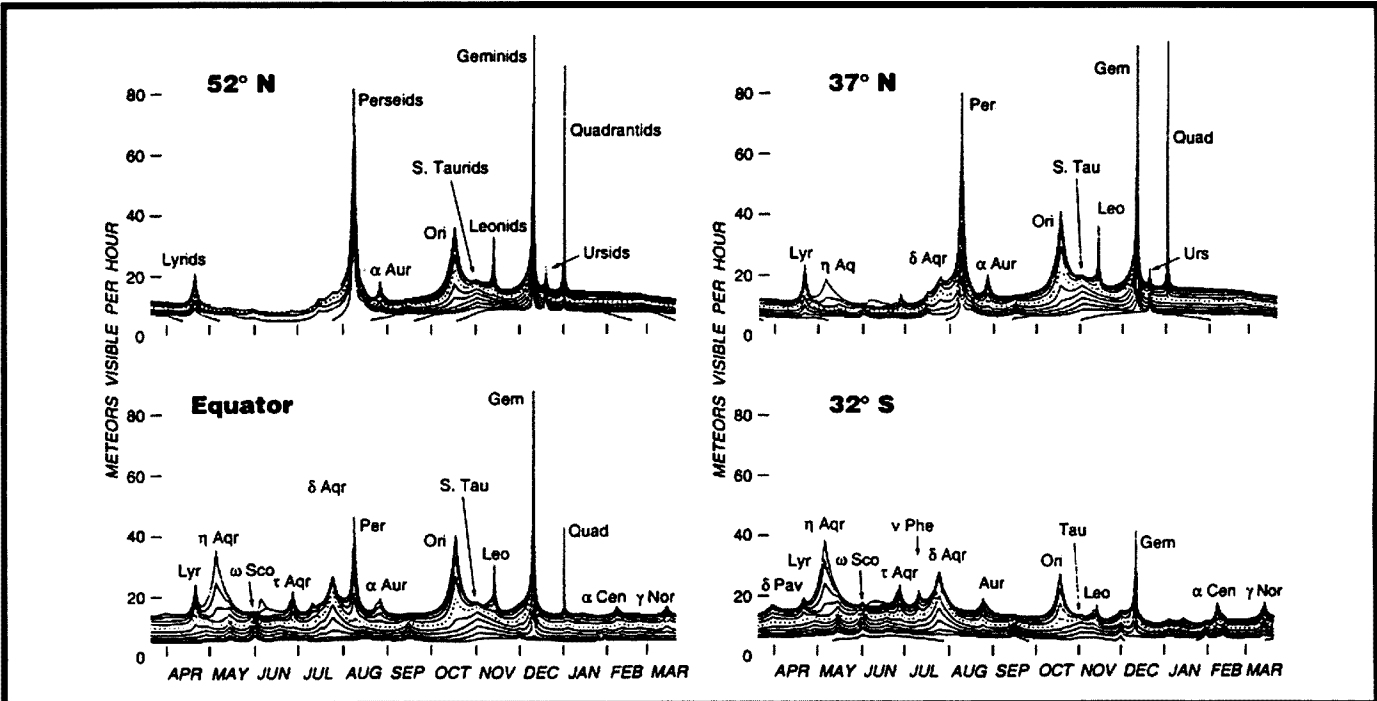


Figure 1 - The meteor year. (Reproduced by permission of Sky Publishing Corporation)

SHOWER	DURATION	MAX	RADIANT		VEL		ZHR			COMMENT
			RA	Dec	km/s	1	2	3		
Quadrantids	Jan 01-05	Jan 03	230	+49	41	110	97	13		not visible in VK
Alpha Centaurids	Jan 28-Feb 21	Feb 01	210	-59	56	*25	16	18		see text
Gamma Normids	Feb 25-Mar 22	Mar 14	249	-51	56	8	13	19		see text
Lyrids	Apr 16-25	Apr 22	271	+34	49	*90	24	20		just visible in VK
Eta Aquarids	Apr 19-May 28	May 03	336	-02	66	50	18	38		good for VK
Piscis Austrinids	Jul 09-Aug 17	Jul 29	341	-30	35	8	18	24		peaks with $\delta$ Aquarids
Delta Aquarids	Jul 08-Aug 19	Jul 29	339	-16	41	20	19	29		good for six, see text
Perseids	Jul 17-Aug 24	Aug 12	46	+58	59	95	80	14		not visible in VK
Alpha Aurigids	Aug 24-Sep 05	Sep 01	84	+42	66	15	20	20		barely visible io VK
Orionids	Oct 02-Nov 27	Oct 22	95	+16	66	25	41	28		fair for VK
Leonids	Nov 14-Nov 21	Nov 18	152	+22	71	*	37	18		try in 1998-99
Phoenicids	Nov 28-dec 09	Dec 06	18	-53	18	100	-	-		a punt; see text
Oeminids	Dec 07-Dec 17	Dec 14	112	+33	35	110	78	42		best for E-W paths
Ursids	Dec 17-Dec 26	Dec 23	217	+75	33	50	23	12		not visible in VK

\* periodic shower produces stated ZHR only in certain years, at other times activity is much lower.  
1 Stated ZHR in Astronomical publications  
2 Observed ZHR at 37°N over 10 years 1981-91  
3 Observed ZHR at 32°S over ten years 1981-91

**Table 1 - Meteor Shower Calendar.**

But the 1970s flurry on six did not produce results on two metres. Attempts were made between Sydney and Adelaide but, as far as is known, no contacts were completed. During 1976 VK7ZGJ was offering two metre schedules without takers. Meteor scatter activity reports appeared occasionally in the VHF notes in *Amateur Radio*<sup>8</sup> until the late 1970s when activity faded with the rise of cycle 21. Presumably the six metre fraternity then had bigger fish to fry. No activity was reported until 1983 when the two metre meteor scatter contacts were made between VK1, VK3 and VK4; however, this coincided with the development of aircraft enhancement modes between Sydney, Melbourne and Brisbane, and between Canberra and Melbourne. Aircraft enhancement has been the "in" DX mode since, and only occasional efforts have been put into meteor scatter. In 1987 VK3UM reported contacts between VK3, northern VK2 and VK4 during the Orionids in the previous year, and advocated the use of 144.350 MHz as a random meteor scatter calling frequency<sup>3</sup>. Since then, occasional contacts have been made between VK3, VK2 and VK4. In 1995, VK2 to VK8 was attempted without success.

There are numerous explanations for the dearth of meteor scatter activity in Australia. Probably the most obvious is that serious VHF activity, with some honourable exceptions, is centred in the

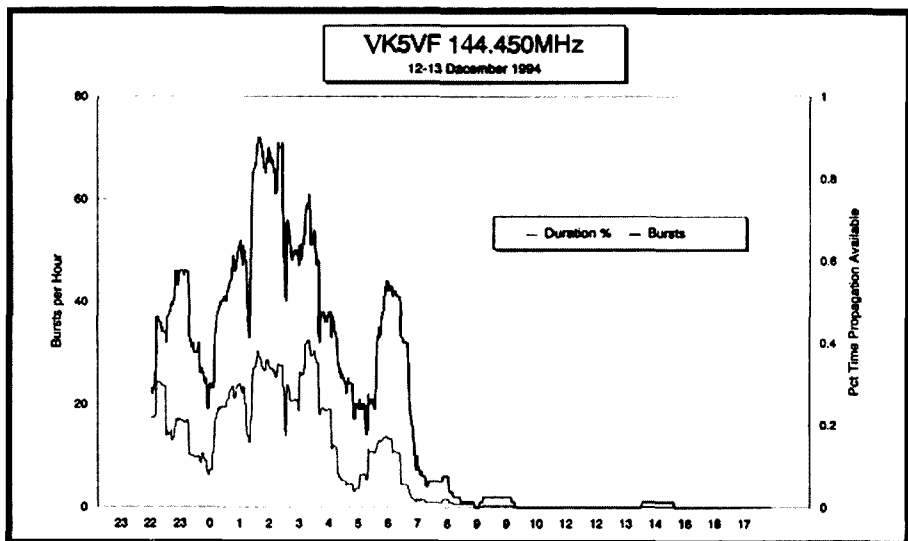
capital cities, and the distances involved are such that two metre contacts are relatively easily achieved during tropo and sporadic E openings in most years. It is simply a matter of waiting around and being on at the time. Thus Sydney works Adelaide on tropo and Es (sporadic E), Tasmania on Es, and Melbourne and Brisbane on tropo/aircraft; Canberra is more or less local anyway. Melbourne works Adelaide and northern Tasmania on tropo, Canberra and Sydney on tropo/aircraft, Brisbane on Es and Albany/Perth on tropo. Sydney and Brisbane get ZL on tropo and Es.

A reasonably well-equipped Sydney station can expect to work VK1, VK3, VK4, VK5 and ZL every year and less

frequently VK7. Alice Springs VK8 is potentially available on Es, given propagation and activity, and VK6 has been worked (once) on tropo. Melbourne is better off in that it can expect VK1, VK2, VK5, VK6 and VK7 on tropo and VK4 and VK8 on Es; in fact, several Melbourne stations need only VK9 to achieve Worked All Call Areas on two metres. Since these DX paths are available without meteor scatter, and the really difficult ones such as VK2-VK6 are too far anyway, the mode has not really been needed, with one exception. This is VK9 Lord Howe Island which would easily support meteor scatter paths to Melbourne, Adelaide, Tasmania and ZL, and tropospheric paths to Brisbane and possibly Sydney. A two metre DXpedition to Lord Howe Island is clearly needed!

Coupled with the availability of other modes is the apparent lack of interest by Australian operators in collecting grid squares on two metres. Grid square collecting is an important incentive in North America and Europe for the use of meteor scatter, as is the ability to work new countries and states. As shown, meteor scatter is not particularly useful for working new states in Australia, while other countries, apart from ZL from the south-east and P29 and JA from VK4 and VK8, are only available on EME.

But another reason that meteor scatter has not been used much on two metres is that it has been tried and found wanting.



**Figure 2**

METEOR SHOWER DATA FOR LATITUDE 35 DEGREES SOUTH

SHOWER	PATH	TIME	OFFSET	COMMENT
<b>Alpha Centaurids</b>	NS	2300-0200	W	The best of several small showers contributing to relatively high background rates at this time of year.
January 28-Feb 21 (February 7)	NW-SE	0700-1000	SW	
	E-W	0000-0900	N	Also applies to 0-Centaurids peaking Feb 1, the 25/hr*
	NE-SW	2200-0400	NE	γ-Normids (Mar 14) and β-Pavonids (Apr 7). January through March is a good period to try random contacts.
56km/s	N-S	0700-1100	E	
<b>Lyrids</b>	NW-SE	0200-0400	SW	The April Lyrids are just worth including in the table.
April 16-25 (April 22)	E-W	0300-0500	S	Only useful for E-W paths in VK as the radiant is well to the north.
90/hr*	NW-SW	0400-0600	NE	
49 km/s				
<b>Pi Puppids</b>	N-S	1200-1500	W	Stated ZHR may be exaggerated. Coincides with Lyrids and definitely worth trying. Another contributor to high background activity rates during April.
April 15-April 28 (April 23)	NW-SE	2000-2300	NE	
	E-W	1200-1400	N	
40/hr*	NE-SW	1200-1500	NW	
18 km/s				
<b>Eta Aquarids</b>	N-S	0230-0530	W	Australia's all round best shower. The high meteor velocity produces trails high up in the E region to produce better results on long-haul paths. This shower has produced complete call signs from VK5VF as received in Sydney.
May 1-6 (May 3)	NW-SE	0330-0630	SW	
	E-W	0600-0900	-	
50/hr	NE-SW	0800-1100	SE	
66 km/s	N-S	0900-1200	E	
<b>Arietids</b>	NW-SE	0730-0930	SW	Never tried. Said to be best for eight days centred on June 7.
May 29-June 19 (June 7)	E-W	0900-1100	S	
60/hr	NE-SW	1000-1200	SE	
<b>Delta Aquarids</b>	N-S	2100-2400	W	Radio rates are higher on six metres and the lower meteor velocity can produce long bursts. On two metres, low velocities produce fewer bursts. An average of 23 bursts/hour was recorded in Sydney from VK7RNH on 144.474MHz at 0300-0700 EAST on 29 July 1995.
July 26-31 (July 29)	NW-SE	2130-0030	SW	
	E-W	0000-0300	S	
20/hr	NE-SW	0230-0530	SE	
43 km/s	N-S	0330-0630	E	
<b>Orionids</b>	N-S	0030-0230	W	The Orionids, like the ε-Aquarids, is associated with Halley's Comet and produced quite good results in the late 1980s. Less efficient for N-S paths.
October 18-23 (October 22)	NW-SE	0200-0400	SW	
	E-W	0300-0600	S	
25/hr	NE-SW	0500-0700	SE	
66 km/s	N-S	0630-0800	E	
<b>Leonids</b>	N-S	0300-0400	W	Produced a 40 second burst long enough to support contacts between VK4, VK3, VK2 and VK1 on 18 November 1995. Should improve over the next few years and could be spectacular in 1998-9.
November 14-20 (November 18)	NW-SE	0400-0600	SW	
	E-W	0500-0700	S	
10/hr*	NE-SW	0630-0930	SE	
71 km/s	N-S	0830-0930	E	
<b>Phoenicids</b>	N-S	1500-1700	W	An intense daylight shower peaking for a few hours. ZL4AAA reports high activity rates from Hobart FM stations. Clearly worth a try, despite low 18 km/s meteor velocity.
December 6	NE-SW	1400-1800	NW	
100/hr	E-W	1500-0100	N	
18 km/s	NW-SE	2200-0200	NE	
	N-S	2300-0100	E	
<b>Geminids</b>	NW-SE	2330-0230	SW	One of the best for two metres in Australia. Because the radiant is well to the north, the Geminids are really only good for east-west paths. Radio rates of up to 70 bursts/hour were observed on VK5VF on 144.450MHz in December 1994 and 1995.
December 10-14 (Dec 12-13)	E-W	0100-0300	S	
100/hr	NE-SW	0200-0400	SE	
35 km/s				

\* ZHR varies from year to year. All times are in local mean time at the midpoint of the path. After Bain W4LTU in reference 1.

**Table 2 - A revised version of Bain's table<sup>1</sup> with all the data adjusted for the southern hemisphere perspective.**

Inspired by reports and articles in *QST* and European publications, many operators have had a go during traditional shower periods; but the results have not been particularly exciting and, in fact, downright disappointing compared with the northern hemisphere experience. The problem here is that meteor showers of legendary fame, such as the Perseids and Quadrantids, are not available in

southern Australia. The radiant of the Perseids, for example, has a declination of +58 degrees, which is below the horizon in Sydney and therefore never visible. Since the Perseids supports two-thirds of all European meteor scatter contacts, we are immediately well behind in terms of shower opportunities. In fact, of the three most popular showers in the northern hemisphere which account for nearly 80% of all contacts,

only one - the Geminids in December - is capable of producing results in the southern Australian states. The others are too far north to be of much use.

If we turn to meteor showers with radiants far enough south to be useful, the pickings are unfortunately slim. The best southerly showers are the eta Aquarids in May, the delta Aquarids in July, the Orionids in October and possibly the Phoenicids in December. Activity rates are only a fraction of the big northern hemisphere showers, leaving us with the only consolation that the background or random activity level in the southern hemisphere tends to be higher than in the northern hemisphere between March and August.

Coupled with this is the more subtle problem that the meteor shower data as published in the classical meteor scatter references<sup>1,4</sup> are a poor guide to shower activity for southern hemisphere operators. Quoted zenith hourly rates mean what they say; hour rates as cited in the literature only apply when the shower radiant is at the zenith, ie overhead for the observer. This means that the cited zenith hourly rate (ZHR) for showers with radiants well to the north of us will produce much lower apparent activity and, since this applies to most of the big showers, VK operators cannot expect to do as well as the North Americans and Europeans. For most showers, and especially the big traditional events, the ZHR for the southern hemisphere is much lower. This is very clear from the observed ZHR data for the two hemispheres as shown in Table 1.

Figure 1 shows the annual visual meteor activity rate throughout the year as observed at four latitudes on the earth's surface over the past ten years. This chart appeared in *Sky & Telescope*<sup>5</sup> last year and was derived from data collected by ten amateur observers, including one in Western Australia, and published in the July 1994 issue of *Astronomy and Astrophysics*. Each plotted line is for a different hour of the night. Rates generally increased from dusk to dawn; the dashed line is at midnight, local mean time. The chart provides stark confirmation that the classical meteor showers of the northern hemisphere experience are much poorer or even non-existent in Australia. The



highest visual counts at 32 degrees south (about Taree NSW) come from the eta Aquarids and Geminids at around 40 per hour, compared with 80-100 per hour from the Perseids, Geminids and Quadrantids in the northern hemisphere. It also seems that the delta Aquarids, the traditional southern hemisphere "major" shower, could be better described as a bump in a period of fairly high background winter activity.

Consistent with the *Sky & Telescope* data, the best two metre meteor scatter opportunities in this part of the world are the eta Aquarids in May, the Orionids in October and the Geminids in December. These three showers have all produced contacts in VK; indeed, returns are good enough to produce results from the lower power two metre beacons. Figures 3 and 4 show plots of meteor returns from the VK5VF beacon on 144.450 MHz as received in Sydney during the 1994 Geminids. The shower peaked for the east-west path at 0200-0300 EAST, producing up to 70 bursts per hour, with many several seconds long. Remember that this is from a 20 watt beacon into an omni-directional antenna; 100 watts into a 10 element Yagi would have an ERP something like 20 dB over the beacon.

Additional meteor scatter opportunities include the delta Aquarids in late July and the alpha Centaurids - gamma Normids in February and March. The delta Aquarids were once quite popular on six metres, but the relatively low meteor velocity makes them less useful for 144 MHz. Still, a burst rate of up to 25 per hour was recorded from the VK7RNH two metre beacon in Sydney during the 1995 shower. The Centaurids and Normids represent the fairly high background meteor rate observed in February and March, when tropo and aircraft circuit operators often notice the effect of random meteors.

Two other showers have potential form. The Phoenicids in December is a very short duration daylight shower with a clearly stated hourly rate of 100. According to ZL4AAA<sup>2</sup>, this shower has produced good returns from Hobart FM stations in ZL1, although I was unable to hear anything from the Phoenicids in 1995. The other shower well worth watching is the Leonids in November, which has produced spectacular results

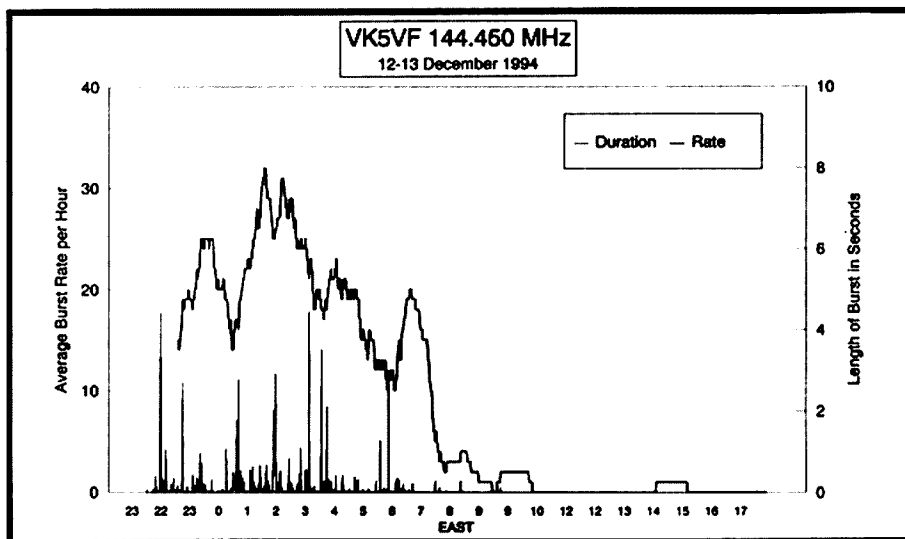


Figure 3

at 33 year intervals. In 1996, visual hourly rates of up to 150,000! were observed in the northern hemisphere, and *QST* reported that the event produced truly amazing conditions on the lower VHF bands<sup>7</sup>. The Leonids are next due to peak in 1999, and activity has already started to increase. On 18 November 1995 east Australian aircraft enhancement circuits on 144 MHz were treated to a 40 second burst from one or more large Leonids meteors that produced contacts between VK4 and VK3, VK2 and VK1.

The classic meteor shower data reference is Bain's table<sup>1</sup> published at least twice in *QST* over the years and reproduced in ARRL VHF handbooks. A revised version of the table (Table 2) is reproduced here with all the data adjusted for the southern hemisphere perspective. Some of the northern hemisphere showers have been omitted because they are not available for mid latitude observers in our parts of the world, but these have been replaced by southern hemisphere showers that offer better value.

### Operating Tips

Two metre meteor scatter contacts are readily available for stations running 100 watts or more to a 13 dB antenna or better. Shower periods give the best results, of course, but random meteors will support contacts when the background rate is relatively high. The most important considerations are frequency readout accuracy and timing.

Potential meteor scatter operators should be able to determine their two metre frequency with an accuracy of better than 500 Hz. A useful check, by the way, is available in any capital city with TV channels 2 and 10. The difference between the two video carrier frequencies is exactly 145 MHz, which


*For All Your Requirements*

AUTHORISED DEALER:

**ICOM**

**KENWOOD**

**AMATEUR ■ COMMERCIAL**  
**MARINE COMMUNICATIONS**

 **Tower**  
Communications

Shop 3, 443 Albany Highway  
Victoria Park, WA 6100  
Telephone (09) 470 1118  
Facsimile (09) 472 3795

can usually be heard as a mixing product in urban locations. Since TV stations maintain accurate frequency control, the 145 MHz beat gives an accurate calibration point.

Timing is even more important as each station will be making timed transmissions for short periods and clocks need to be set accurately. Typical meteor scatter schedules run in one minute sequences where one station transmits for the first and third fifteen second periods and the other station for the second and fourth periods. Thus a Sydney station trying to work Adelaide might transmit from 0-15 seconds and again from 30-45 seconds, while Adelaide transmits at the 15-30 and 45-60 seconds intervals. The short periods are better than, say, one minute periods because there is a much greater chance of catching a long burn that could allow a two-way exchange. But a small error of one or two seconds in the station clocks could lead to the two stations doubling up for four out of 15 seconds, or 27 percent of the time. Timing accuracy is therefore vital.

Antennas should be aimed to maximise meteor returns given the position of the radiant relative to the path. This usually requires beam headings for paths less than 1,500 km to be offset by 7-15 degrees from the great circle bearing. The closer the stations, the greater the offset should be in the direction away from the radiant. About 10 degrees should cover most cases. This is not critical for single Yagi or two stacked Yagi stations as beam widths are generally wide enough to allow for a pointing error of up to 15 degrees anyway. Stations with narrow beamwidths should consult the Bain reference for antenna heading offsets.

Operating mode is usually SSB, although high speed CW is popular in Europe using tape recorders. SSB is a lot more convenient, but try to speak rapidly to maximise the information rate, and avoid phonetics for callsigns. The conventional RS(T) reporting system is not particularly useful for meteor scatter and a recommended system, as used by the Europeans, is set out below. A virtue of this system is that numbers two to five are only used for signal duration and six to nine only for the signal strength. If you

hear a "two" on a short burst, for example, you know that this is definitely not a strength report.

**Recommended MS Reporting System**

Duration	Strength
2 <5s	6 <S3
3 5-20s	7 S4-S5
4 20-120s	8 S6-S7
5 !!!!!!!	9 >S7

A typical exchange might be as follows:

0-15 seconds: VK5LP VK2FLR, VK5LP VK2FLR, VK5LP VK2FLR, etc (from VK2FLR)

15-30 seconds: VK2FLR VK5LP, VK2FLR VK5LP, VK2FLR VK5LP, etc (from VK5LP) and so on until one station copies enough of both callsigns to

identify calling and called stations. He then sends a report:

VK5LP VK2FLR 27 27 27 VK5LP VK2FLR 27 27 27, etc (from VK2FLR)

Since VK5LP is not yet sending a report, VK2FLR assumes that he still needs callsigns so both calls and reports are sent until VK5LP starts sending a report code as well. Once VK2FLR is aware that VK5LP is sending reports, then reports only are sent:

27 27 27 27 27 27 27, etc (from VK2FLR)

As soon as a report is copied, send a "roger" but keep sending your report until you know the other station has got it:

27 roger 27 roger 27 roger 27 roger, etc.

**Meteor Scatter Basics**

The earth is continuously bombarded by dust and small particles swept up in the earth's gravitational field as it orbits the sun. Particles about the size of a grain of sand can be seen burning up in the atmosphere at night as meteors or shooting stars. Larger particles sometimes survive their fiery entry and reach the surface of the earth as meteorites. The rate of entry is highest at around 6 am local time because the observer's position on the earth's surface is then moving in the same direction as the earth's orbit around the sun, hence more meteors are swept up. Conversely, meteor activity is lowest at 6 pm because the velocity of the earth's surface at the position of the observer is now subtracted from the earth's orbital velocity, hence fewer meteors are swept up. Random meteor activity is something like three times as high at dawn as at dusk.

At certain times of the year, the earth passes through dust trails left by comets when meteor activity rises sharply to produce meteor showers for short periods. Shower meteors appear to the observer to originate at a particular point in the sky, called the radiant, specified in astronomical co-ordinates Right Ascension and Declination. Right

Ascension is measured in hours and minutes and represents celestial longitude, while Declination is measured in degrees and minutes and specifies celestial latitude. Declination is stated as a positive or negative number with reference to the celestial equator. Thus the south celestial pole, lying about half way between the Southern Cross and the Small Magellanic Cloud, has a declination of minus 90 degrees. An object lying on the celestial equator has a declination of zero degrees. The familiar constellation Orion (the saucer) has a declination of about plus 5 degrees and is therefore about five degrees north of the celestial equator. The Southern Cross is about minus 70 degrees in declination and therefore is only 20 degrees from the south celestial pole.

To determine whether an object is visible to an observer located at a particular latitude on the earth's surface, declination measured on the celestial sphere can be referred to degrees of elevation above or below the horizon of the observer. An observer in Sydney at a latitude of 34 degrees south, for example, will see the south celestial pole 34 degrees above the southern horizon, but at the same time the north celestial pole will be 34 degrees below the northern horizon. It should be clear that the furthest northerly celestial object visible in Sydney would have a declination of

When you hear a roger from the other station, the contact is complete. During shower periods, long bursts can extend beyond the 15 second periods, so be ready to go back with the appropriate response followed by a quick break to complete the contact or add pleasantries.

## References

- 1 W F Bain W4LTU "VHF Meteor Scatter Propagation" *QST* May 1974  
 2 R B Cooper ZL4AAA "Meteors and VHF" *Break-In* July-September 1994  
 3 D McArthur VK3UM "Two Metre Meteor Scatter" *Amateur Radio* August 1987  
 4 M R Owen W9IP/2 "VHF Meteor Scatter-An Astronomical Perspective" *QST* June 1986

5 M Barlow Pepin (ed) "Observers Page" *Sky & Telescope* June 1995

6 W Watkins VK5ZWW "VHF Meteor Scatter Propagation" *Amateur Radio* August 1971

7 S Harris W1FZJ "November Leonids - Shower of a Lifetime" *QST* January 1967

8 E Jamieson VK5LP (ed) "VHF Notes" *Amateur Radio* April 1967; March, September 1972; September, November 1975; May 1980; December 1983; August 1986; July 1987.

9 G Dawes, P Northfield & K Wallace, *Astronomy 1995, Eastern Australian Edition (Annual)* Quasar Publishing, Strathfield NSW

\*29 Allen Street, Glebe Point NSW 2037

ar

+90 - 34 = +56 degrees. This is why the radiant of the Perseids shower with a declination of +58 degrees is never visible from Sydney.

Right Ascension, the measure of celestial longitude, looks complicated because it is specified in hours, minutes and seconds, but these can easily be converted into degrees. Since a complete circuit along the equator of the celestial sphere is 360 degrees and the earth turns on its axis once every 24 hours, simply divide degrees by hours and minutes. This produces 15 degrees per hour and one quarter of a degree per minute, so an object with a Right Ascension of, say, 11 hours 20 minutes has a celestial longitude of  $(11 \times 15) + (0.25 \times 20) = 170$  degrees. Zero degrees in celestial longitude is at the point on the celestial equator where it crosses the ecliptic, the path followed by the sun along the celestial sphere. When the sun crosses the celestial equator from south to north, it is then the spring equinox in the northern hemisphere and the autumn equinox for us. At that point the sun has zero degrees celestial longitude (or 0 hours 0 minutes 0 seconds in right ascension) and zero degrees in declination or celestial latitude.

Right Ascension tells sidereal time when the particular object is at the zenith for the observer (which is why it is in hours and minutes). To determine

whether the object is visible, the observer must know local sidereal time. Since sidereal time is referred to the apparent rotation of the celestial sphere rather than the sun as is civil time, the sidereal day is about four minutes shorter than the civil day, hence sidereal time must be calculated from astronomical tables. A simple approximation is to apply the formula Greenwich Mean Sidereal Time = 0.06571 days + 1.00274 hours for the number of civil days and hours from the beginning of the sidereal year at midday on March 21, and then adjusting for the difference between the observer's longitude and the Greenwich meridian. Thus 6 am on May 3 in Sydney is 2000 hours on May 2 at Greenwich. Greenwich sidereal time will then be 42 days and 8 hours in civil time after noon on March 21, or 0.06571 x 42 plus 1.00274 x 8, or 10.77 hours GMST. Adding 10 hours gives sidereal time in Sydney as 20.77 hours at 6 am on May 3. Since the radiant of the eta Aquarids is 22 hours 20 minutes, it will then be just 36 minutes or about two degrees from the zenith for a Sydney observer, good for east-west meteor scatter paths.

More accurate estimates can be obtained from astronomical tables as in reference 9 which give Greenwich sidereal time for every day or month of the year; however, the simple method is adequate for this purpose.

ICOM Clearly Ahead



# "VK3LZ calling!"

More sound information from your friends at Icom

IT'S WYONG TIME AGAIN!

Come and see the latest from Icom at the Central Coast Field Day at Wyong on Sunday 23rd February '97. We'll be demonstrating the IC-756, IC-R10, and IC-T7A so come and say hello to myself, Yoshi, Neville and Mick at the Icom stand. Several Icom dealers will also be there including:

Daycom  
 Emtronics  
 Kevin Cavanagh  
 Strictly Ham  
 and Terrace TV

Wyong is always well worth a visit so if you can make it, look out for the Icom team.

ICOM HAVE MOVED.

We now have a new headquarters in Australia to better service our dealers and customers with Icom's continually expanding product range, plus providing general radio technical information and news. We're delighted that the Australian market has shown such confidence in Icom's quality name to allow our recent expansion to take place.

We're now located at:

290-294 Albert Street  
 Brunswick, Victoria 3056  
 Tel: (03) 9387 0666  
 Fax: (03) 9387 0022

"...73"

Contact me at Icom on  
 Freecall 1800 338 915  
 or on the phone or  
 fax numbers above.

ACN 006 092 575

# Equipment Review

## Yaesu FT-10R 2 m Hand Held Transceiver

Reviewed by Ron Fisher VK3OM\*

The first thing that strikes you with the FT-10R is its diminutive size. It is only 57 mm wide by 123 mm high and 26 mm deep and that includes the battery. To put some perspective into that, have a look at the photo that compares it with a somewhat older Yaesu, the FT-208. In appearance, the FT-10R has a family resemblance with the slightly larger FT-51R dualbander reviewed last June. Operating the FT-10R is, like most VHF handhelds, not self evident; however, the instruction manual is very helpful and easy to follow.

One feature that is not obvious from the advertising information is that the entire keyboard is removable and can be replaced with three others. This determines the operating features that the transceiver provides. The version sold by Dick Smith Electronics has an A16D key board provided, which is the second top model. The top version, the A16S, has a digital voice recorder included which is the only feature missing from the A16D. I am not sure if the other keypads are available in Australia or what their cost would be.

The first thing you might want to know is where the battery is. Well, it is, in fact, the back half of the package. A push button at the top back allows the battery to be removed. The Australian version has an FNB-41 battery supplied which has a 600 mAh capacity at 9.6 volts. This gives

a maximum transmitter output power of five watts as standard, unlike most other 2 m handhelds on the market. Naturally, selectable lower power is also available (2.8, 1.0 and 0.1 W).

A very handy belt clip is attached to the rear of the battery pack. Two other

batteries, the FNB-40 which is 6 V at 650 mAh and the FNB-42 which is 9.6 V at 1100 mAh, are available. Also, no battery charger was supplied with our review transceiver which necessitated a few haywire connections when the battery went flat. I am assured that all FT-10R transceivers sold will come with a charger and adaptor to connect to the battery.

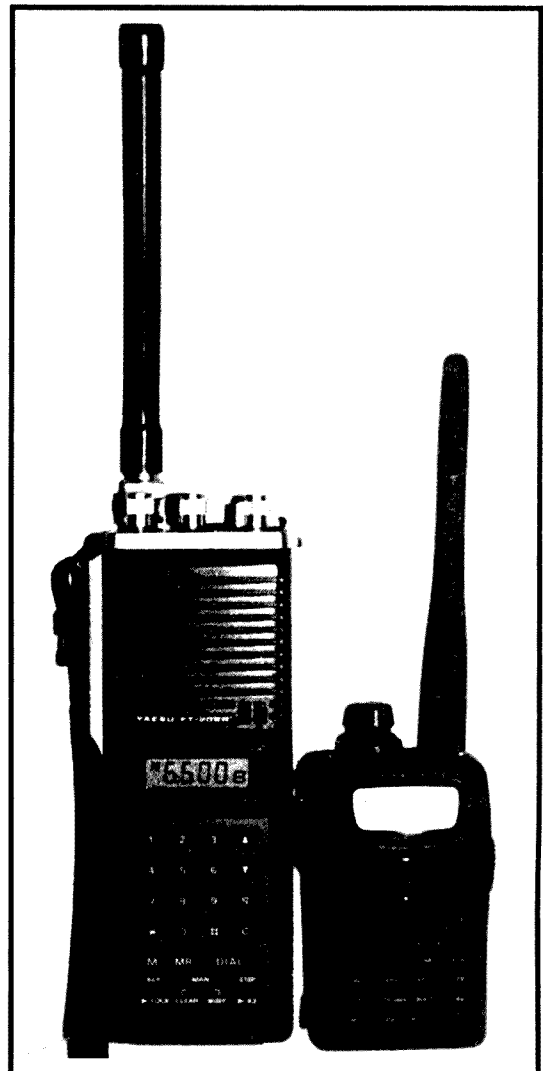
### The FT-10R On Air

If you have been used to a ten year old handheld, you will find some unusual features. The power on/off switch is a small red button at centre left. Its one of those controls that you have to push and hold. It takes half a second for something to happen either for the on or off function.

Next, the push-to-talk button is on the



The reviewer holding the diminutive FT10R in the palm of his hand.



The FT-10R alongside the old FT-208. How things have changed!

top left hand corner which is the ideal position for it. There are two buttons on the side which operate the display illumination and open the squelch for very weak signal reception.

The antenna connector does not have the usual BNC socket but uses the smaller SMA type. If you intend to use an antenna other than the supplied flexible whip, you will need a CN-3 antenna adaptor for use with BNC connectors. There are only two normal rotary controls and these are mounted concentrically on the top of the transceiver.

The larger outer control is the audio gain control and the smaller top knob is a multi-function control. It acts as a tuning control, memory selector and controls 27 other functions such as squelch, transmitter power output and memory labelling, to name a very few. You will be able to spend hours playing with this transceiver without even getting on the air.

All of these functions are clearly displayed on the large (relatively) LCD. The actual size of the LCD is 3.5 cm wide by 1.5 cm high. There are around thirty status indicators built into the display in the normal situation with perhaps double that number when the multi-function control is in use. There is also a ten segment "meter" showing relative received signal strength and transmitter power output.

The tuning control can be set to give a choice of steps. The sizes available are 5, 10, 12.5, 20, 25 and 50 kHz with 1 MHz steps available with the push of a key pad button. In addition to all of this, a frequency can be entered directly via the keypad. If you want 146.700, just push 4,6,7,0,0 on the pad. I would guess that, with 99 memories, most of the time you will use the VFOs and keyboard to tune frequencies that will be entered into the memory, and that most normal operation will be from memory selection.

The frequency coverage of the FT-10R is 144 to 148 MHz on transmit and receive, with an extended receive coverage from 140 to 174 MHz. Unfortunately, the receive coverage does not include the aircraft band.

Naturally, there is an excellent selection of scanning modes either in VFO or memory. In VFO mode, you can



**One half of the FT-10R is transceiver, the other is the battery.**

scan the entire tuning range or you can store upper and lower scanning limits. It is also programmable to resume scanning after five seconds on a signal or to wait until the carrier goes off air.

As with many modern VHF transceivers, the FT-10R has a wide selection of tone signalling functions built-in. However, it seems that these systems are not used to any extent in Australia that I have heard of. Anyhow, if you do use these, they are all available in the FT-10R, so go to it.

With all of this, how does the FT-10R perform on air? In a word or two, very well indeed. The received audio quality is really quite remarkable considering the size of the speaker. The acoustic output is also excellent. On transmit, reports on the audio quality indicated plenty of deviation and good frequency response. There is an input/output socket for an external speaker microphone but it requires a special four contact plug about 3.5 mm in diameter, so my old Yaesu speaker microphone could not be connected without the optional CT-30 microphone adaptor. The matching MH-

34B4B speaker mic is available from Dick Smith Electronics stores as an alternative.

Can you use the FT-10R on packet? Yes, indeed you can, and the instruction book gives a simple circuit to show you just how to do it.

## **The FT-10R – the Bottom Line**

I have always been an enthusiast for Yaesu handhelds. I have two in my collection from which I have had faithful service over many years. While these new models are getting more complicated from an operational point of view, they are still straightforward in their basic features. To add to this, Yaesu instruction books set the standard and are easy to follow and apply.

The FT-10R is priced at \$455 and the matching speaker microphone is \$49.95. Talk to your local Dick Smith Electronics store for more information on this amazing little hand held transceiver.

*\*24 Sugarloaf Road, Beaconsfield Upper VIC 3808*

## ■ Filters

# A Combined Speech LP Filter and CW Filter Using a Single IC Package

Lloyd Butler VK5BR\* describes a simple filter which would work well as the filter in a direct conversion receiver designed for both speech and CW.

## Introduction

Here is a simple circuit which is switchable between a sharp cut-off above 2.5 kHz and a narrow bandpass around 800 Hz. In the low pass (LP) state it can be used on speech as the filter section of a direct conversion receiver. For CW operation, the cut-off frequency is lowered to 800 Hz and another high pass (HP) section with cut-off below 800 Hz is added to form a narrow bandpass around 800 Hz. To use this, the CW Morse beat note is adjusted to the bandpass centre frequency.

## Operation

In the following paragraphs, operation of the circuit is described. If filter terminology used appears unfamiliar, the reader is referred to the opening paragraphs of the writer's previous article (*reference 1*). The article also

discusses a little more about the types of filter employed here.

The circuit makes use of the National Semiconductor switched capacitor LP filter package type MF6, which includes two operational amplifiers with the sixth order Butterworth filter. The filter is also operated from its own internal clock operating at 50 times the cut-off frequency. To achieve the 2.5 kHz and 800 Hz LP cut-off, the clock frequency is switched between 125 kHz and 40 kHz respectively. As a sixth order Butterworth, the switched capacitor filter has an attenuation slope beyond cut-off of 36 dB per octave.

To produce the 800 Hz high pass, one of the operational amplifiers is connected as a second order Chebychev filter. This type filter gives a theoretical attenuation at the first octave of 17 dB, not as great as the LP filter but quite

effective in reducing audio noise or interference below the 800 Hz centre frequency.

Figure 1 illustrates the filter system in block form. For speech, the LP filter is operated on its own. For CW, its cut-off frequency is lowered and its output fed via the HP filter section.

Switched capacitor filters produce spurious output signals if fed with a frequency close to their clock frequency. To guard against any such signal coming from the receiver, the switched capacitor filter is fed via a simple anti-alias filter with a roll-off above 5 kHz.

For circuit detail, refer to Figure 2. The MF6 package operates on a split power rail basis and a centre rail is derived from the single DC supply with resistors R11 and R12. Supply voltage is not critical and the circuit works on any well-filtered single DC supply between eight and 14 volts.

The clock frequency is set by components C3, R4 and R5. Switch SI selects speech or CW and its contacts S1a alter the resistance in the circuit to change the clock frequency and hence the LP cut-off frequency. Components C8, C9, R7, R8, R9 and R10 make up the HP Chebychev active filter in conjunction with one of the MF6 internal operational amplifiers. Switch contacts S1b connect the output either direct from the LP circuit or via the HP circuit.

The non-inverting input of the second operational amplifier is connected internally to centre rail, so this amplifier has had to be used in the inverting mode. Roll-over above 5 kHz for the anti-alias filter is partly done by capacitor C4 in the amplifier feedback circuit and partly by capacitor C1 at the input.

The internal functional block diagram for the MF6 is shown in Figure 3.

## Performance

Measured response of the filter in its two different modes is shown in Figure 4. Other relevant information is: Input Resistance, 2 kohms; Output Resistance, 1 kohm; Voltage Gain, LP -0.5 and BP -1.13; DC Supply Load Current, 5 mA (at 10 V) and 7 mA (at 12 V).

If required, the filter can be used as a stand-alone unit with its input fed from the output of a receiver or transceiver headphones jack. The output of the filter

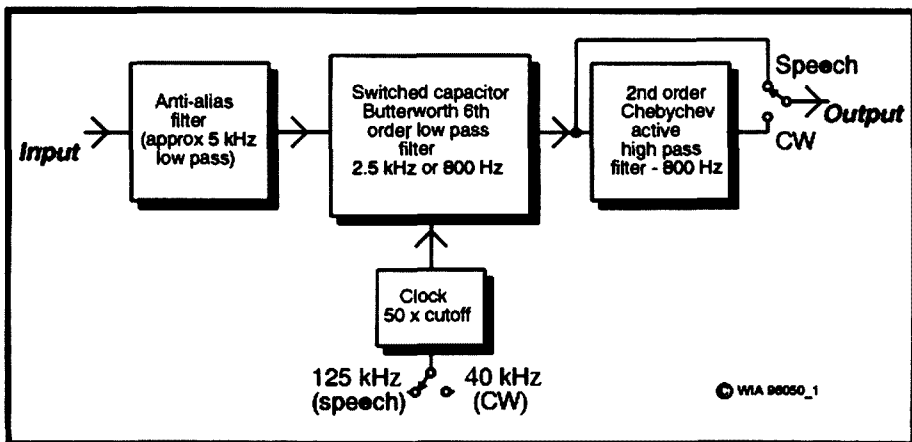
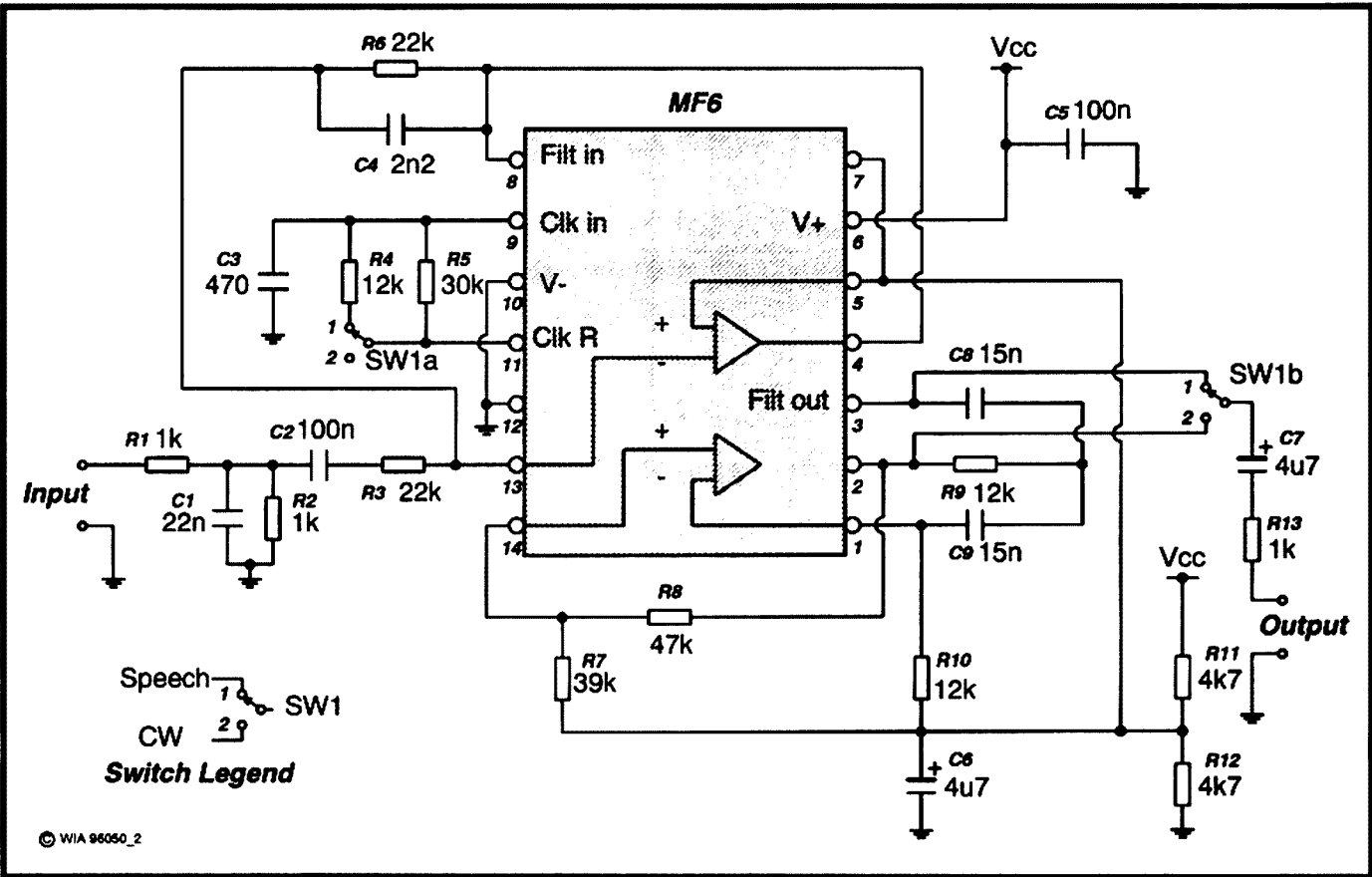


Figure 1 - Block diagram of the combined 2.5 kHz filter for speech and 800 Hz BP filter for CW.



**Figure 2 – Circuit diagram of the combined 2.5 kHz filter for speech and 800 Hz BP filter for CW using one IC package.**

is suitable to operate into high impedance headphones. To operate a loudspeaker, a power amplifier such as the LM380 or LM386 can be added. Of course, the load current of these power amplifiers swings widely with variation in audio level and they require a well regulated power source, preferably isolated from the filter supply.

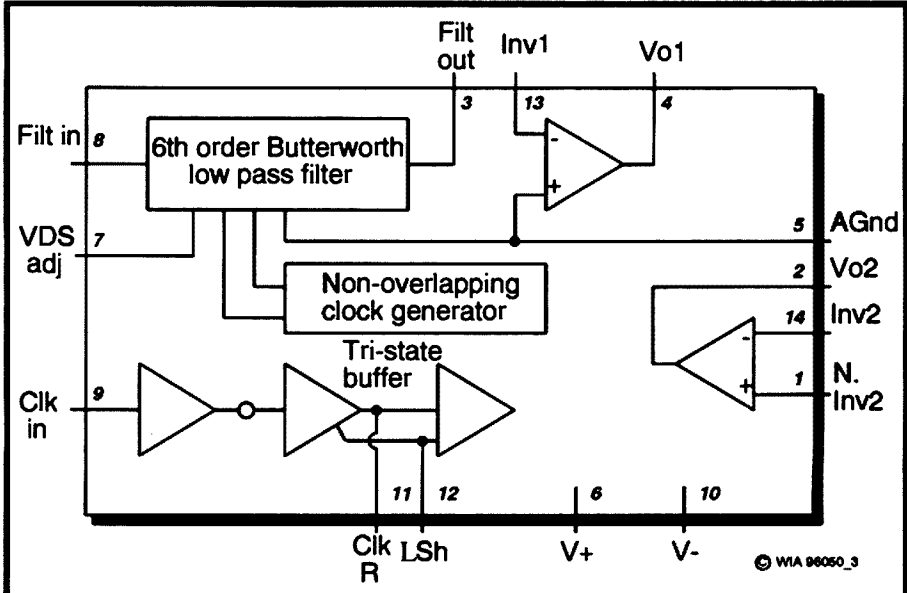
One characteristic of the switched capacitor filter is that there are output components near clock frequency. With the lowest cut-off at 800 Hz, these components are no lower in frequency than around 40 kHz and could easily be electrically filtered out. However, as they are outside the frequency range of the human ear, the ear does the filtering for us.

**Other Uses of the MF6**

What's been described has been a circuit with fixed defined cut-off frequencies. However, the MF6 is very versatile because the LP cut-off can be set to any audio frequency by simply altering the circuit constants controlling

the clock. It was used as a variable filter in a previous article (*reference 1*). In another article (*reference 3*) it was used in conjunction with a CMOS divider IC

package to make a Wideband Variable Audio Frequency Oscillator. If you are interested in the switched capacitor filter, you might have a look at that application.



**Figure 3 – Internal functional block diagram of the MF6 switched capacitor filter.**

# ATN Antennas P/L

ACN 062 557 644

Exported to 46 countries  
on all continents

56 Campbell St  
(PO Box 80),

Birchip VIC 3483

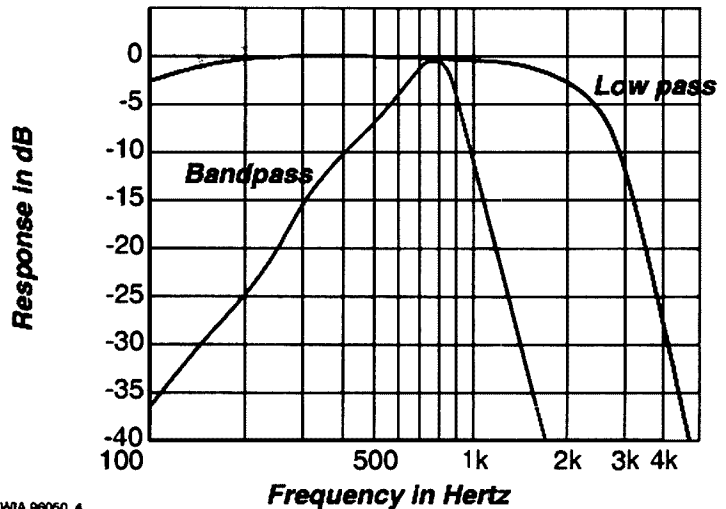
Phone (03) 5492 2224

Fax (03) 5492 2666

- Australian made quality antennas. Log-periodics 7-30 MHz 11 el, 10-30-10, 13-30-6, 13-30-8, 13-30-9, 18-30-7, 20-30-6. 6 models VHF/UHF LP to 50-1300-25. All alum tubing is 6353-T6, 15-25% higher tensile strength than imports. Insulators are Zytel, latest material, and all hardware is stainless steel.
- Monobanders, 40, 20, 15, 10, 6 and 2 m, 70 cm, HF and UHF CB, many models. Single band high gain VHF/UHF TV. Stacking harnesses + couplers, 2, 4, 6 and 8 antennas.
- Aluminium towers to 60 m. Many models incl fixed, tilt-over and Hazer tram where antenna and rotator can be lowered with no climbing.
- Create HD rotators, 5 models.
- Tower accessories, non conducting Kevlar guys and Dacron/polyester halyards, 3 sizes.
- Aluminium pulleys with Stainless Steel hardware.
- B&W continuous frequency coverage wire antennas, 1.8-30 and 3.5-30 MHz, 20/100 W and 1 kW.
- Baluns and power dividers.
- Diamond VSWR/Power meters, 10 models to 1300 MHz.
- 80/40 and 80-10 trap wire antennas.
- Single strand HD copper wire, insulators and accessories.
- Range of power transistors, driver and PA tubes; eg JAN (USA) 6146W, rugged, to replace 6146A, B and S2001, matched pair \$125 incl fragile pack/post.
- Matchall, all band, fully auto, antenna coupler, 1.8-30 MHz, 150 W, matches any wire length (random), \$285 incl p/post.
- Hi-Sierra remote controlled mobile whip, 3.5-30 MHz plus 6 m, \$699 incl air freight Aust-wide.
- 4 Square vertical beams, 20, 40, 80 or 160 m, 8.2 dBd gain, 25 dB F/B, fraction of cost of 40/80 Yagi and tower.

Ask for **FREE** catalogue.

Bankcard, Mastercard and  
Visa acceptable.



© WIA 96050\_4

Figure 4 - Measured filter response showing nominal 2.5 kHz lowpass and 800 Hz bandpass modes.

## Summary

A receiver audio filter has been described which makes use of a single MF6 switched capacitor filter package. It can be selected to operate either as a 2.5 kHz sharp cut-off low-pass filter for speech or a narrow bandpass filter around 800 Hz for keyed tone (as detected in CW mode). It could well be used as the audio filter in a direct conversion receiver where signal selectivity is achieved by the sharp cut-off response of the audio system.

## References

1. Lloyd Butler VK5BR - *An Adjustable Audio Filter System for the Receiver - Amateur Radio, March 1995.*
2. MF6 6th Order Switched Capacitor Butterworth Lowpass Filter, National Semiconductor data sheets.
3. Lloyd Butler VK5BR - *Wideband Variable Frequency Audio Oscillator - Amateur Radio, March 1988.*

\*18 Ottawa Avenue, Panorama SA 5041

ar

## WIA News

### New WIA Members

The WIA bids a warm welcome to the following new members who were entered into the WIA Membership Register during the month of December 1996:

EA2SN  
L21031  
L21032  
L21033  
L21034  
VK2AWR  
VK2CP  
VK2DNO

MR J IZA  
MR R A HOCKEY  
MR B YOUNG  
MR C J THOMPSON  
MR J H KIM  
MR E W RENOUF  
MR J DE CAIRES  
MR P J MARTIN

VK2KAY  
VK2MMM  
VK2TJO  
VK2USB  
VK2ZEJ  
VK3BPU  
VK3CSJ  
VK3EST  
VK3TEH  
VK4AWL  
VK4HBA  
VK5BDH  
VK5TSX  
VK5XTC

MR B J HARWOOD  
MR M RICHMOND  
MR M J HOWELLS  
MR W A MCKEAN  
MR C J NEWTON  
MR A PAYNE  
MR C JEFFREY  
MR D LUSZCZAK  
MR D HUMMEL  
MR R KELLY  
MR A BANNAH  
MR T R TOMLINSON  
MR J W KOPP  
MR A J CAREY



## Antennas

# Random Radiators

with Ron Cook VK3AFW and Ron Fisher VK3OM\*

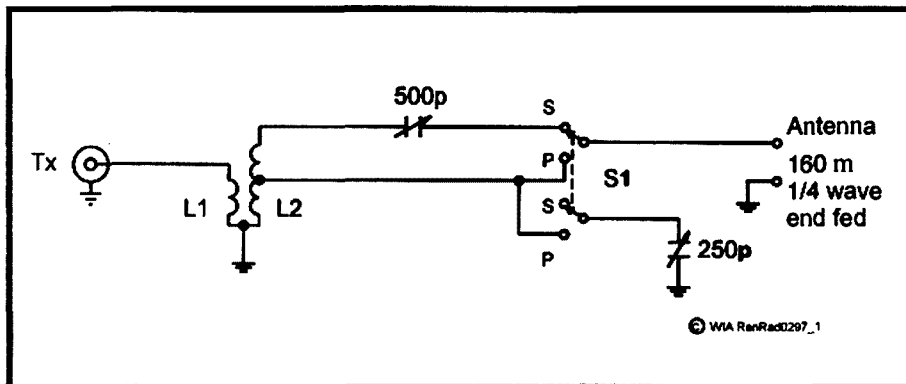


Fig 1 - Simple 160/80 m ATU.

- L1** 6 turns insulated wire on earth end of L2.
- L2** 70 turns #24 SWG enam, 1 inch diameter, centre tapped.
- S1** S = series (160 m)  
P = parallel (80 m)

## More on Simple ATUs

First a note from John, VK3KWA. "Regarding your item "Simple and Effective Two Band ATU" in *Amateur Radio* for March 1996, I found a similar circuit in "Radio Constructor", July 1968. As can be seen from Fig 1, it differs from the one you described in that it is for 160 and 80 metres, and it used two capacitors although, by appropriate switching, a single capacitor could be used.

"The idea of using a tapped coil as in this design could be worth looking at for the 80/40 m design you published, so that the tuner could be used for 30 m and possibly 20 m as well.

"I also found the circuit in Fig 2 (source unknown) for end fed antennas."

Thanks, John.

## Beams in Stormy Weather

Ever wondered which way you should point your beam in stormy weather?

David W6QHS has the answers in an article published in the *VHF EME Report* of February 1996. This is a precis of his article "Pointing Yagis into the Wind".

If your elements are weak, then don't have them broadside to the wind; but if

the boom is weak, then point it into the wind. Better to lose an element than the boom. Generally this will be the best approach, as for typical beams it will result in lower forces on the rotator and mast.

Yagis tend to weathervane along the boom, particularly in gusty conditions. This can put heavy loads on the rotator and mast. If either fails it's probably "goodbye coax" at least!

Sometimes vertical wind gusts are strong enough to damage the boom of a big Yagi, so select a boom a little larger than engineering calculations would suggest are sufficient

The bottom line is, don't overload the mast or rotator. Balance the booms and the elements and leave the antenna pointing into the predominant storm directions when you are away.

## More on Yacht Antennas

Guy VK2BBF writes to say: "Fibre glass yachts are very common - almost the norm. Yachts have keels (except dinghies and trailer-sailors) made of lead or, occasionally, of iron. The keel is held on by very heavy long bolts. The tops of the bolts are accessible in the bilge and form the normal ground for the radio. The keel lead may have direct

electrical contact with the sea but is usually encased in fibreglass. However, it has a large capacitance to the sea, much larger than a plate bolted inside the hull. The keel bolt is connected to the rig or ATU by a copper strap, typically 50 to 75 mm wide and 1 to 2 m in length."

Thanks, Guy, for your contribution.

Another letter was received from Kevin VK3ANY on Mollyhawk II in Cairns. He says: "I have lived aboard a yacht for over two years, cruising the whole east coast of Australia. I thought you might be interested in my experiences. Good results from a yacht are assured if a few simple rules are followed.

"First and foremost, you **MUST** have a steel or aluminium boat. Good results are possible with wooden or plastic boats, but the **BEST** results are only achieved with a steel boat, no ifs, no buts, no maybes. Further, the steel boat should preferably have a steel deck, not a wooden deck as some steel boats have.

"Having sold your wooden or tupperware boat and got your steel boat you will only achieve the desired result with a proper installation. First, the antenna. This should be an insulated backstay. In the normal cruising yacht this will be in the 30 to 50 ft range. Do not be tempted to use a whip aerial. These are suitable for emergency use only if the mast falls over. Use good quality insulators designed for the job, or you will definitely have to use the emergency whip aerial. The insulator will have solid stainless steel terminal fittings to which the backstay is secured. The lead-in should be clamped to the terminal, **NOT** to the backstay itself. The connections must be made waterproof by covering with self-amalgamating tape and then covering with Denso tape. If the lead-in is connected to the backstay, water will find its way down the strands and the lead-in connection will gradually build up resistance due to corrosion.

"Next the ATU. Use an automatic ATU designed specifically for a backstay antenna. The commonly available automatic ATUs sold through marine radio dealers under a number of brands come in two versions, one for backstay aeriels and one for shorter, untuned whip aeriels. A manually tuned ATU is not suitable as, in a typical yacht

installation, it must be mounted remotely from the transceiver.

"Installation of the ATU is important. It must be mounted under the deck immediately beneath the lower end of the backstay. The lead-in from the backstay comes through a deck insulator directly to the ATU. This is the important part. No more than 0.1 to 0.2 of a metre of lead-in wire should be below deck. If the layout of the boat does not allow this, change the layout of your boat! There is no getting away from this. There must be no more than a few inches of lead-in wire below the deck. Remember, we are trying to achieve the best possible results, not merely good results.

"Take a thick copper wire or braid from the earth terminal of the ATU and bond it to the steel deck or deck beam adjacent to the ATU. This should be as short as possible, a few cm maximum. The total length of the lead-in wire and the earth wire should not exceed 0.2 m. You may get away with longer lengths but, if you follow this, you can't go wrong.

"The transceiver can be mounted

anywhere convenient in the boat and connected to the ATU with coax cable. Use heavy cables for the DC supply to the transceiver as it is often mounted some distance from the battery and voltage drops on transmit must be minimised.

"The technique of having an earthing plate inside or outside the hull is nowhere as effective as having a steel hull which provides an almost perfect earth.

"With an installation such as this I have had excellent results on all frequencies from 1.8 to 18 MHz, the upper limit of my transceiver. All the 2 MHz frequencies are covered without problems. I keep daily scheds with Penta Comsat marine station on 4 and 8 MHz and have never failed to get through. Should I call them at a non-sched time I always get answered first call.

"Frequently I have heard boats in the same area, sometimes in the same anchorage, having trouble contacting Penta Comsat and I or another boat have to relay for them. The other boat is invariably timber or fibreglass.

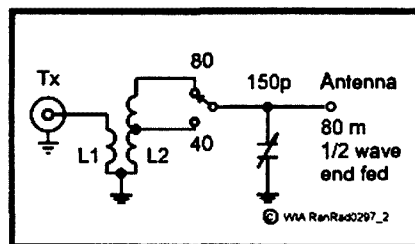


Fig 2 - ATU for 80 m.

**L1** 3 turns thick insulated wire.  
**L2** 26 turns #18 SWG enam, 3.5 inches long on 2.5 inch diameter ribbed coil former.

For 15/20 m

**L1** 2 turns.

**L2** 8 turns #14 SWG enam, 2.5 inches long on 2.5 inch diameter ribbed coil former.

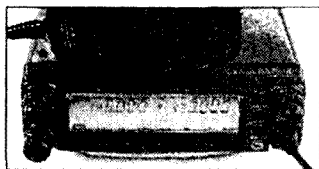
"Although I have emphasised the virtues of steel boats for HF operation, other types of boats can still get good results if the earth plate is as close to the ATU as possible."

Well, that seems to sum it up pretty well, Kevin. Thanks.

73 from him and 73 from me.

\*C/o PO Box 2175, Caulfield Junction, VIC 3161

ar



## Radio and Communications

Incorporating AMATEUR RADIO ACTION and CB ACTION

Published by  
**ACP SYME  
 MAGAZINES,**  
 PO Box 119,  
 Oakleigh,  
 Vic 3166  
 (03) 9567 4200

Here is yet another new Yaesu dual-band transceiver. What makes it different is its amazing receiver, which tunes all the way to 1300MHz! Read our full review this month, and check out loads of other exciting articles at the same time. Don't forget the Editorial, which tells how one country has lost the complete 70cm band. Could we be next?

Of course, February's R&C has loads more for the active amateur. Make sure you check out some of these...

- Review: Diamond WS-1000E. Yes, it's a baby scanner, but even HF enthusiasts should look at this one!
- Construction project: an audio AGC for simple receivers. An opportunity to build something useful.
- The 1997 DXCC list. Here's the latest update to the ever-useful ARRL DXCC listings. With full notes.
- The Avalon Air Show. Here's your chance to catch some rare birds indeed! Full frequencies too...
- Review: Timewave DSP-599zx DSP filter. Why junk a good HF rig? This gadget may be the answer!
- The best IOTA column in Region 3, three DX columns and more... all the best regulars every month!

Don't miss out — **RADIO and COMMUNICATIONS** is great reading for amateurs!  
**Check your local newsagent today!**

(P.S. We also have the biggest collection of radio-oriented Classified adverts in the country. There's lots of them because they work so well. Ask your newsagent to keep a copy for you each month, or ring 1800 25 2515 for subscription details. Hurry — you might miss something!)

---

---

# ALARA

Sally Grattidge VK4SHE\*, ALARA Publicity Officer

---

---

## Our History Goes Global

Christine VK5CTY wrote a piece entitled "Our Mrs Mac" which appeared in *Amateur Radio*, November 1995. This was read in Austria by Wolf Harranth OE1WHC, Curator of the QSL Collection. Wolf contacted Christine seeking information about VK YLs licensed before the war, as he was assisting in the collation of information from around the world for an exhibition, and eventually a book.

As you know, in 1995 ALARA made a huge effort to gather as much information about early YLs as possible, so Christine was able to send a considerable volume of photocopied notes and photographs to

Austria. In reply Wolf wrote, "Thank you very much indeed for all your excellent help! You did a great job, and Australian YLs will now play a prominent role in our exhibition." This thanks goes to everybody who assisted in the History Project by writing their story and sending it to ALARA, as well as those who collected and collated the histories.

## On The Way Up

Mary VK5AMD has just completed a course, and is now qualified as a "Vertical Rescue Training Instructor" for the SES. Mary has been an active SES member in Bordertown SA for several years. From someone who gets hysterical on the third

rung of a ladder, congratulations Mary – don't look down.

## From The Old Country

Diana (Di) Cardell G0RHL is the QSL Bureau Manager for the RNARS (Royal Naval Amateur Radio Society) in the UK, and an avid reader of the ALARA Newsletter. An ALARAMEET magnet now adorns her fridge to remind her of her many VK friends, and she is longing for propagation to improve so that she can make more regular contacts.

Early last year, Di and OM John ran a special event station from the beautiful windmill in their village. The idea came from the British Heritage foundation and included all water and windmills. Windmills are a feature of the Lincolnshire landscape, and the one Di can see from her shack is the only eight-sailed windmill in the country. It is in working order and grinds wheat on Sundays for the tourists.



**ALARAMEET Perth 1996 (l to r) Pam VK3NK, Raija SM0HNV, Christine VK5CTY. Raija has been to several World YL meets and YLRL meets, and travelled from Sweden to Perth to see how it is done in VK land.**



**ALARAMEET PERTH 1996 (l to r) Dot VK2DDB, Eileen ZL1BRX, Judy VK3AGC. Judy broke her wrist only days before she left Victoria for Perth. By the end of the Meet the cast was covered with signatures and now sits on her radio desk reminding her of the friends she made in Perth.**



**ALARAMEET PERTH 1996 (l to r) Win ZL1BBN, Dave ZL1AMN, Fiona XYL of photographer Jeff VK6JKR. Dave is Net Control for the 222 YL DX net.**



**ALARAMEET PERTH 1996 (l to r) Robyn VK4RL, Gwen VK3DYL. Gwen's scarf shows badges from some of over 300 countries she has contacted.**

## More DX

Another DX member who would like to hear more from VK YLs is Anny DF2SL, who may be found listening on the 222 net (Mondays on 14.222 MHz at 0600 UTC – call in from 0545 UTC). Net Controller is Dave ZL1AMN who attended the ALARAmeeet in Perth (see photo).

Carolyn ZL2JP has worked about 40 countries on CW and is having a ball. She and OM Dennis ZL2ME run 60 watts into an inverted vee. Many people said this would give them heaps of trouble, but Carolyn now has about 154 countries in her DXCC tally, which goes to show what can be achieved with simple equipment.

Raija SM0HNV ran in the "Bromma Run" in Sweden a few days before leaving for Perth for the Meet. Her little grandsons ran 400 m and the adults ran 5 km. Raija is also hoping for better conditions soon so that she can make more contacts with her VK friends. She has heard that Ruth IT9ESZ may be in Australia this year.

Barbara KR4SJ lives by Lake Harding, which is backed up water from the Chattahoochee River which separates Georgia and Alabama. When hurricane Opal came through last October it took down 15 trees, four of which landed on their roof, and about 75 feet of sea wall. With no qualified builders available, Barbara and her OM are doing the repairs themselves.

## Travellers

Helene VK7HD, Peter VK7HM, Marlene VK3WQ and Jim VK3DL just happened to be in Adelaide at the same time, and were joined for lunch by Christine VK5CTY, Geoff VK5TY, Jean VK5ZSX, Rod VK5SX, Meg VK5AOV, David VK5OV and Meg's father Reg Reid.

Helene and Peter also visited Jenny VK5ANW, and Meg and David on their way out of Adelaide, and Meg and David were visited by Helene and Jim when they passed through a week or so later.

June VK4SJ and Doug VK4BP spent an evening with Christine and Geoff a couple of weeks earlier before leaving Adelaide to go round the coast and home. They have a marvellous photographic record of their recent overseas trip, during which they met amateurs all around the world and visited both the RSGB and ARRL headquarters. They describe these as "amazing places", but then US has over 500,000 amateurs and UK 70,000, compared to 17,000 in Australia.

\*C/o PO Woodstock, QLD 4816

Tel: 077 788 642

ar

# AMSAT Australia

Bill Magnusson VK3JT\*

## National co-ordinator

Graham Ratcliff VK5AGR

Packet: VK5AGR@VK5WI

E-mail: vk5agr@amsat.org

AMSAT Australia net:

Control station VK5AGR

Bulletin normally commences at 1000 UTC, or 0900 UTC on Sunday evening depending on daylight saving and propagation. Check-ins commence 15 minutes prior to the bulletin.

Frequencies (again depending on propagation conditions):

Primary 7.064 MHz (usually during summer).

Secondary 3.685 MHz (usually during winter).

Frequencies +/- QRM.

AMSAT Australia newsletter and software service

The newsletter is published monthly by Graham VK5AGR. Subscription is \$30 for Australia, \$35 for New Zealand and \$40 for other countries by AIR MAIL. It is payable to AMSAT Australia addressed as follows:

AMSAT Australia

GPO Box 2141

Adelaide SA 5001

## MIR...Frequencies?

I must thank Eric VK2KUR for pointing out that the frequencies listed in the December 1996 column were reversed. I wish that was the end of the story. The frequencies listed were taken from an AMSAT News Service bulletin at the time of writing. By the time they appeared in print, it had been announced by IARU, as Eric correctly noted, that the frequencies were the reverse of those earlier advertised. After preparing this (February) column early due to a family commitment, another announcement has come along stating that they have been reversed AGAIN from 1 Jan 1997!

This latest change appears to have been at the request of the operators on board MIR. The changes have caused a lot of discussion and the problem is not yet resolved. The old frequency of 145.550 MHz used by MIR crews for many years was also contrary to most bandplans and it caused trouble in countries where it was traditionally used for simplex terrestrial comms. The new frequency pair was decided upon at a Region

1 IARU conference and was implemented immediately by the operators on MIR. However, the frequencies violated the Regions 2 and 3 band plans.

Discussions are still continuing in the hope of resolving the problem. There may be no easy solution. The planned International Space Station (ISS) will provide an unsurpassed opportunity for a permanent space platform for amateur radio. It will be essential to get a frequency plan in place before ISS becomes a reality. So, here goes again. To the best of my knowledge at the time of writing, as of 1 January 1997 MIR operations will take place on 145.200 MHz uplink and 145.800 MHz downlink. This apparently applies to packet as well as voice FM (I hope).

## Digisat Woes

The digisats KO-23 and KO-25 have been having problems over the new year period. KO-23's problems have centred around overheating caused by an extended period in which it encountered almost continuous sunshine. The telemetry indicated that the battery was being charged nearly all the time and the temperatures built up to go off scale at over 40 degrees C. One result was that the downlink frequency was varying quite significantly. I estimated that, at one stage in late December, it was -8.5 kHz from nominal. That was the largest frequency change I observed. The next day it was back to normal. Thank goodness for WISP. The program has a feature that allows you to temporarily change the frequencies for the duration of a single pass.

KO-25 suffered a period where the uplink was blocked while new software was loaded and tested. After just a few days, it failed again with no downlink data being transmitted. During this time UO-22 was heavily loaded as it had to cope with all the normal packet gateway traffic as well as the activity that would ordinarily have been taken by KO-23 and KO-25. At the time of writing all three are performing well.

The overheating problem illustrates the difficulty of selecting the most appropriate orbit. The high inclination orbit of KO-23 maximises access time for stations in low to mid latitudes but, at certain times of the year, it results in long periods when the satellite is orbiting in permanent sunshine and sometimes lengthy periods of eclipse. These problems are not so severe for low earth satellites in near polar orbits.

## Now for Some Good News!

After all that gloom and doom let's look at the good news for the month. The UoSAT-12 mission. This is a joint effort by Surrey Satellite Technology and Nanyang Technological University (NTU) in Singapore. It is a "Technology Transfer" project and contains an amateur transponder as well as scientific and research packages. Called "Merlion" it is due for launch into an inclined low earth orbit in mid 1997.

Even though it hasn't been launched, it has already had a significant impact in Singapore. NTU has worked closely with the Singapore Amateur Radio Transmitting Society during the design and construction of the satellite. This has had two important spin-offs. Many NTU staff have been encouraged to take out amateur radio licences and, perhaps even more importantly, the installation of the ground station at NTU has resulted in the relaxation of rules governing use of the VHF and UHF amateur satellite bands in Singapore. External antennas are also now allowed on these frequencies. This is an excellent result. A major break-through for Singapore operators and augers well for the future of amateur radio satellite activity in Singapore.

Merlion will have a 1.6 MHz wide non-inverting "L" band to "S" band analog transponder. Now would be a good time to dust off the 1296 MHz and 2.4 GHz gear. "S" band downlink power is planned to be seven watts into a LHCP quadrifilar helix designed to radiate maximum lobes at 30 degrees to the satellite axis. The axial radiation is about 10 dB down from this and it should result in almost constant signal strength as the satellite goes overhead.

Uplink on "L" band will need to be RHCP. This will be an ideal project for a small ground station tracking antenna system consisting of a LHCP helix or small dish with RHCP feed for downlink and a RHCP helix for uplink.

Let's all wish Merlion a successful launch and commissioning. It will be great to hear our Singapore friends operating on their own OSCAR. Given a reasonably high orbit, there should be plenty of mutual operating windows into VK.

## P3D Report

The satellite continues to pass the various stringent tests that it must undergo to get the OK for launch. The dynamic vibration resonance tests were successful. These tests are conducted to see if there are any critical resonant frequencies which would cause mechanical vibration to become extreme and possibly destructive.

A mechanical vibrator is clamped to the structure and the frequency of vibration

varied to pin-point any dangerous resonances. P3D came in well within NASA specifications. The next critical test is the static load test. This has nothing to do with "static" as in radio noise. The entire assembly including support structures must be subjected to a static (steady) load of nearly five tonnes. This is to simulate the stresses during launch.

## OSCAR Operations Report

(From AMSAT News Service and other sources.)

**MIR:** Frequency problems seem to be resolved, at least in the short term.

**SAFEX:** The 70 cm repeater on MIR is up and running. Downlink on 437.950 MHz and uplink on 435.750 MHz using 141.3 Hz tone access. A note of caution. If you have trouble holding the repeater open it is probably due to the rather severe Doppler shift changes encountered on 70 cm. It is doubly difficult in the case of MIR as it moves so quickly due to its low orbit. I'll devote some space next month to a couple of methods of overcoming this difficulty.

**RS-10:** Operating normally.

**RS-12:** Is giving extremely good downlink signals on 2 metres. In this period of poor propagation on 15 m, the T-mode is providing very easy access to the satellite.

**AO-10:** Good signals. Some QSB and very little activity. The blon/blat was calculated to be about -125/5 a year or so ago. It is quite a while since new kep elements appeared for this satellite but the orbit doesn't shift much and the latest keps should be OK but could be unreliable around perigee. Remember, no sun...no AO-10. Use your tracking program to see if AO-10 is in sunlight and listen to the beacon for signs of FM-ing.

**UO-11:** Good, steady signals have been received from OSCAR-11 on 145.826 MHz. The 2.4 GHz beacon is reported to be down in power output and hence signal level. I haven't fired up my 2.4 GHz gear since moving QTH. Can someone confirm this please?

**RS-15:** Operating normally.

**AO-16:** Operating normally.

**DO-17:** (DOVE) Still having problems with software and hardware. Some time since I had reports of the 2.4 GHz beacon. Once again I'd appreciate a report.

**WO-18:** Is reported as broadcasting telemetry frames every 15 seconds on 435.882 MHz. I've listened and heard nothing.

**LO-19:** Operating normally.

**FO-20:** Operating normally. Strong downlink signal not much activity.

**UO-22:** Operating normally.

**KO-23:** Operating normally.

**KO-25:** Operating normally.

**IO-26:** Operating normally.

**AO-27:** Only switched to amateur frequencies at weekends and then only over Northern hemisphere.

**FO-29:** Operation normal.

**MO-30:** The only report I have to hand is that this satellite suffered damage to the command receiver on launch and that it cannot be commanded and will therefore probably never be put into operation. Does any-one have any other information, either confirming this or to the contrary?

## Preliminary Data for the New RS Satellite

The following information came over on the KO-25 satellite the morning I prepared this column.

**Preliminary data for the new RS satellite, RS16:**

Uplink = 145.915 - 145.948 MHz

Downlink = 29.415 - 29.448 MHz

Beacons = 29.408, 29.451 MHz

Pwr 29 MHz Down = 1.2 W/4 W

Beacon 1 = 435.504 MHz

Beacon 2 = 435.548 MHz

Pwr 435 MHz Beacons - 1.6 W

The Launch will be from the new far-eastern cosmodrome in Svobodny Town. The rocket is "Zeya". H = 500-600 km.

## Next Month

Frequencies in Space...what's the problem? Coping with fast changing Doppler shift.

\*RMB 1627, Milawa VIC 3678  
CompuServe: 100352.3065  
Internet: 100352.3065@compuserve.com  
E-mail: vk3jt@amsat.org

ar

## QSP News

### 1996 Amateur Radio Magazine Awards

After considerable discussion at their January 1997 meeting, the Publications Committee decided to award the Technical Award (for the best technical article(s) for the year) to Drew Diamond VK3XU, three of whose articles were published, all being uniformly excellent.

The Higginbotham Award (for service to amateur radio generally, not necessarily to the magazine) was made to Will McGhie VK6UU whose Repeater Link column has covered a wide range of topics in addition to repeaters.

Congratulations to Drew and Will who will each receive a cheque for \$100.

# Awards

John Kelleher VK3DP - Federal Awards Manager\*

Prospects for the future in DX are beginning to look bright. Not as bright as I would like, however, but good enough to prove that reasonable contacts can be achieved with a little diligence, and co-operation with controllers of established DX Nets. General indications are that the "figures" that we all rely upon for propagation are shaping up just a little better.

Sunspot numbers are beginning to rise, if only gradually, and the A and K indexes are beginning to fall. My estimation is that no really significant change will take place until mid-year 1997.

## The Zone 29 Award

This award is offered by the West Australian Division of the Wireless Institute of Australia to all licensed radio amateurs and SWLs throughout the world.

To qualify for this award, the following conditions must be satisfied:

1. Establishment of two-way communication with any 25 different amateur stations located in CQ Zone 29. Only contacts made after 0800 UTC on 1 January 1952 are considered to be valid.

2. The total of 25 different stations may be obtained by operation on one or more of the authorised amateur bands as applicable at the time of the claimed contact. Cross band contacts will not be accepted.

3. Any type of emission as permitted by the local licensing authorities at the time of the claimed contact(s) may be used. Cross-mode contacts will not be accepted.

4. Minimum acceptable exchange of signal reports shall be: for phone, readability 3 and strength 3; and for CW, readability 3, strength 3 and tone 8.

5. Applications containing multi-band and multi-mode valid contacts will be accepted but the award will be issued with no endorsement(s).

6. Special endorsements will be displayed on the Award Certificate, where applicable, when all valid contacts fulfil the following conditions: (a) single band - multi mode; (b) single band - all phone; (c) single band - all CW; (d) all Phone - multi band; (e) all CW - multi band; and (f) other special endorsements as considered to be outstanding and unique.

7. SWL applications will be accepted and the Award certificate issued, with appropriate endorsements as applicable, when all conditions as listed above are complied with.

8. QSL cards are not required as proof of valid contacts, but the application must show that the log extracts have been examined and verified by two other radio amateurs or the Awards Manager of the applicant's IARU affiliated radio Society. A simple declaration that the applicant has conformed to all

licensing regulations as related to his/her operation is mandatory.

9. Fees for the Award should be in the region of \$AUS4.00 or eight IRCs for overseas stations (I am estimating these fees as my information copy is some years old).

10. Essential information required should include: callsign of station worked/heard; band (MHz) and mode used; date and time (UTC); and RS(T) received and RS(T) given. Standard-form application sheets are available at no cost from the address below, or the applicant may use his/her own as desired.

11. Applications should be addressed to: Awards Manager Zone 29 Award, WIA (VK6 Division), PO Box 10, West Perth WA 6872.

## A Notable Success Story

Subsequent to the publication of RSGB Awards in 1993, I have received a very happy letter from a well known Queensland amateur, Alan Shawsmith VK4SS, in which he states that he has received the WITUZ plaque and WITUZ Supreme Certificate for working all 75 ITU Zones.

Outside the western European area, Alan is the FIRST in the world to claim Supreme WITUZ. He is now in the process of sending off his application for 5BITUZ, as he says, "to put the icing on the cake".

The RSGB HF Awards Manager, Fred Hanscombe, G4BWP whose address is: Sandholm, Bridge End Road Red Lodge, Bury St Edmunds Suffolk IP28 8LQ, United Kingdom, has requested that publicity be given to the handsome list of RSGB Awards which are available world wide. This I will do later this year.

## WIA DXCC

### Phone

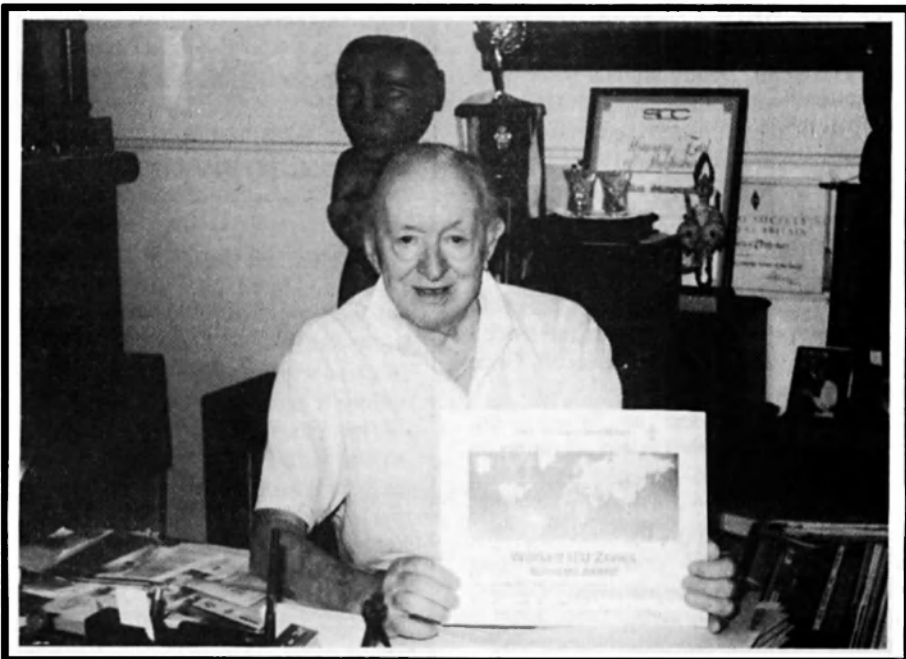
### Honour Roll

Callsign	Countries
VK5MS	328/381
VK5WO	328/360
VK6LK	328/352
VK3QI	328/341
VK4OH	328/334
VK5QW	328/333
VK4LC	327/373
VK2FGI	327/332
VK3DYL	327/332
VK6RU	326/380
VK4KS	326/372
VK6HD	326/350
VK4RF	326/344
VK3AKK	326/337
VK1ZL	326/331
VK5XN	325/345
VK4UA	325/338
VK6NE	322/337
VK5EE	322/327
VK7BC	320/329
VK3AMK	319/337
VK2AVZ	319/325

VK3YJ	318/323
VK3CSR	317/325
VK3OT	315/327
VK2DEJ	315/320
VK4AAR	315/318

### General Listing

VK6AJW	312/317
VK6VS	312/315
VK6PY	307/312
VK5WV	306/325
VK3RF	304/311
VK3WJ	303/308
VK6RO	302/307
VK3JI	298/312
VK4DP	294/305
VK2WU	292/296
VK4BG	287/302
VK3CYL	283/290
VK3DU	282/290
VK5OU	281/286
VK4OD	276/279
VK3VU	272/275
VK3GI	264/267
VK3VQ	259/276
ZS6IR	259/262
VK3DP	256/259
VK4QO	251/255



Al Shawsmith VK4SS with his WITUZ Supreme certificate for working all 75 ITU Zones.

VK4SJ 247/  
 VK2PU 244/247  
 VK6YF 238/241  
 VK4CY 237/238  
 VK2CKW 234/237  
 PS7AB 233/237  
 VK3DS 226/336  
 VK2ETM 226/227  
 VK5IE 219/221  
 VK5BO 218/222  
 VK3CIM 218/221  
 VK3UY 217/217  
 VK6APW 216/217  
 VK3DD 214/217  
 VK4ICU 211/213  
 VK4LV 210/212  
 VK7TS 210/211  
 VK4XJ 204/216  
 VK3DVT 201/203  
 ON6DP 200/202  
 VK4KRP 199/201  
 VK2VFT 198/201  
 VK4DDJ 198/198  
 VK4AU 190/190  
 VK6BQN 186/190  
 VK4BAY 177/179  
 KA1TFU 176/179  
 VK4IL 176/  
 WA1MKS 171/  
 VK2BQS 162/165  
 VK2NO 157/  
 VK4IT 153/154  
 VK4CHB 152/153  
 7J1AAL 149/150  
 VK4ARB 149/150  
 VK4DMP 147/148  
 VK3DNC 141/142  
 VK3DQ 141/  
 VK2SPS 139/141  
 VK6LC 139/140  
 VK2EQ 139/  
 VK6LG 135/135  
 TI2YLL 129/  
 VK4EJ 125/127  
 LU5EWO 125/  
 SM6PRX 122/126  
 VK3TI 122/125  
 VK7WD 115/116  
 VK3BRZ 114/116  
 VK4VIS 113/115  
 VK4NJQ 111/115  
 VK6NV 111/113  
 C2IDJ 109/  
 VK5GZ 108/110  
 VK4LW 105/  
 VK5UO 104/106  
 N4JED 104/105  
 VK3EHP 103/105  
 JN6MIC 103/104  
 VK4BJE 102/104  
 C2INJ 102/  
 JH3OHO 101/103  
 VK2CMV 100/102  
 VK5CJE 100/102  
 VK6APH 100/101

VK3XB 315/349

**General Listing**

VK5WO 307/322  
 VK4RF 306/332  
 VK3KS 301/328  
 VK6RU 275/319  
 VK3JI 267/291  
 VK3AKK 267/272  
 VK3DQ 245/  
 VK4LV 235/242  
 VK7BC 234/243  
 VK3DP 234/237  
 VK2CWS 222/224  
 VK4DA 221/223  
 VK4DP 205/216  
 VK3CIM 202/203  
 VK4OD 192/195  
 VK6PY 191/194  
 VK6MK 188/190  
 VK4ICU 183/  
 VK6HW 179/182  
 VK5GZ 172/174  
 VK4CY 172/  
 VK5BO 159/184  
 VK3DNC 154/157  
 VK5UO 154/155  
 VK4XJ 150/163  
 VK7TS 147/  
 VK4UA 143/155  
 EA6AAK 138/  
 VK7DQ 137/138  
 VK4KS 126/134  
 VK4AAR 125/127  
 VK2TB 123/125  
 VK3AGW 119/120  
 VK4CMY 117/119  
 VK5BWW 110/111  
 VK4DV 109/115  
 OK1FED 109/  
 VK5QJ 107/109  
 VK2FYM 106/108  
 VK8KV 102/103  
 VK2CXC 101/103

**Open**

**Honour Roll**

**Callsign Countries**

VK5WO 328/364  
 VK3QI 328/342  
 VK7BC 328/336  
 VK5QW 328/332  
 VK6RU 326/380  
 VK4KS 326/372  
 VK4RF 326/361  
 VK6HD 326/351  
 VK3AKK 326/337  
 VK4UA 325/340  
 VK3JA 324/371  
 VK3AMK 322/340  
 VK3OT 318/330  
 VK3XB 317/346  
 VK4AAR 315/318

**General Listing**

VK3JI 311/339  
 VK4DP 310/323  
 VK6PY 309/316  
 VK6RO 308/313  
 VK3DP 302/306  
 VK4BG 294/312  
 VK4OD 287/290

VK3CYL 283/290  
 VK4CY 280/283  
 VK3VQ 274/291  
 VK3UY 272/274  
 VK5BO 264/301  
 VK3DQ 262/  
 TF5BW 260/264  
 VK4LV 252/259  
 VK3CIM 252/255  
 VK2ETM 239/240  
 VK5UO 238/241  
 VK4ICU 238/240  
 VK4XJ 233/249

VK7TS 229/230  
 VK2CWS 228/230  
 VK6APW 223/224  
 VK4DA 222/224  
 WA5VGI 216/218  
 VK2VFT 202/205  
 VK6MK 194/196  
 VK3DNC 185/187  
 VK5GZ 182/184  
 VK2BQS 176/179  
 PR7CPK 174/175  
 VK6NV 165/166  
 VK4CHB 160/162

VK2NO 158/  
 VK2CXC 150/152  
 VK6LC 142/144  
 VK2SPS 140/142  
 VK4NJQ 133/139  
 VK4EZ 129/138  
 YB8GH 127/129  
 VK7HV 114/117  
 VK5BWW 111/112

VE7BS 106/107  
 VK3OZ 104/105  
 VK3COR 102/104  
 VK3VB 102/104  
 SM7WF 101/

**RTTY**

**Callsign Countries**

VK3EBP 210/212  
 VK2BQS 115/117

\*4 Brook Crescent, Box Hill South, VIC 3128  
 Phone (03) 9889 8393

ar

**WIA News**

**Intruder Watch Pays Off – Again**

An erstwhile intruder in the exclusive segment of the 40 metre band has been cleared, thanks to the efforts of Col Robertson VK4AKX, of Brisbane. Col had been reporting a broadcast station signal on 7080 kHz over some time. With a little detective work, he identified it as a "spur" from a shortwave broadcast located in Chinese Taipei (Taiwan) which has a transmission on 7105 kHz, in the band segment amateurs share with shortwave broadcasters.

Figuring the station personnel may be unaware of the spurious transmission, Col tried the direct approach and wrote to the station engineer, pointing out his reception of the errant signal on 7080 kHz. Col received friendly cooperation from the station's staff, some adjustments were made in due course and the problem was cleared up. Result, another "intruder" gone. Col remarked to the VK4 International Amateur Radio Union Monitoring Service (Intruder Watch) Co-ordinator, Tom Walker VK4BTW, "If only some of the more persistent poor transmitters were as helpful." (Item courtesy of QTC, monthly newsletter of the WIA Qld Division).

**Big Things Forecast For Next Solar Peak**

A collaboration of 12 scientists from 10 government agencies around the world has found "reasonable consensus" from a survey of forecasts for the size and timing of the next solar peak (Cycle 23) that it will be "a large solar cycle with a smoothed sunspot maximum of 160 . . . (which) will most likely peak in early 2000."

Co-ordinated by the US National Oceanic and Atmospheric Agency (NOAA) Space Environment Centre, with support from the National Aeronautics and Space Agency (NASA) Office of Space Science, the effort was dubbed "The Solar Cycle 23

Project." Those collaborating included scientific representatives from Australia's IPS Radio and Space Services, along with others from Germany, the United Kingdom and the US.

The forecast sunspot maximum is comparable to the last (Cycle 22), which peaked over 1989-90, but not as large as Cycle 19, which peaked in 1957 at a sunspot maximum of almost 200.

The variation in forecasts put the maximum smoothed sunspot count for the peak at 190 and the minimum count at 130, while the range in date of the smoothed cycle peak is from January 1999 at the earliest to June 2001 at the latest.

The Project panel advised that geomagnetic activity during the cycle would be much like that experienced in recent cycles, with average annual levels among the highest in the 128-year record of sunspot observations.

So there's good news and bad news for the peak of Cycle 23. Band conditions will be good to spectacular as a result of the expected high peak, but the HF bands will be "trashed" on occasions by severe geomagnetic storms – which bring enhanced conditions for world-wide 50 MHz DX and auroral propagation for the VHF bands. One man's trash is another's treasure, so to speak.

A host of fascinating information on the next solar cycle is available on the Internet, for those who have access. The Solar Cycle 23 Project panel findings can be found at <http://www.sec.noaa.gov/info/Cycle23.html> or <http://proton.sel.noaa.gov:80/info/Cycle23.html>. Australia's IPS Radio and Space Services' Web site has a paper by Richard Thompson on *The Amplitude of Solar Cycle 23*, at [www.ips.gov.au/papers/richard/outlook\\_23.html](http://www.ips.gov.au/papers/richard/outlook_23.html), and another on *Observed and Predicted Sunspot Numbers, 1986-2006*, at [www.ips.gov.au/papers/ssnpred.html](http://www.ips.gov.au/papers/ssnpred.html).

---

---

## Club Corner

---

---

### "21 TODAY" for FAMPARC in 1997

Yes, 1997 will be a very special year for our club, the Frankston and Mornington Peninsula Amateur Radio Club, as we will be celebrating our 21st birthday.

Our first General meeting took place on Friday, 27 February 1976 and was enthusiastically opened by the then mayor of Frankston, Councillor Geoff Eastwood. The organisers had arranged for this to be held in the Frankston Technical College Staff room. Imagine their delight in seeing it packed to capacity with standing room only. We must have really filled a community need.

The first elected committee included Dennis Johnstone, President; Colin Fisher, Vice President; Earl Russell, Secretary; Mavis Russell, Assistant Secretary; and John Mathews, Treasurer with Robyn Johnstone and Arthur Woodward as Committee members. Arthur was appointed Social Secretary and Chris Edmonds (that well known amateur radio personality) as Publicity Officer. Several of those office bearers are now, unfortunately, silent keys, but we are hoping to have as many founding members and Club supporters as possible at the proposed celebratory functions.

It never ceases to amaze me how patterns evolve in apparently random events. FAMPARC started in a school staff room and, when it finally obtained its own club house, it was in the grounds of another school, St Leonards College, Patterson Lakes Campus. This setting is quite appropriate when you consider the continuing commitment the club has had to amateur radio training.

Our first course was run by Danny VK3NG in our founding year and this tradition has continued, with FAMPARC satisfying student needs from far and wide. 1996 was no exception with the current group doing very well in their examinations thanks to their hard work and the efforts of Peter VK3JPR and Peter VK3TQ (Peters seem particularly attracted to FAMPARC).

Any friends of FAMPARC who would like to take part in our celebration events, planned to start in February with a BBQ get-together, are cordially invited to do so. Details of these will be available on our packet bulletin board, WIA broadcasts, or by contacting Gerard on (03) 9587 0141.

**Keith Forbes VK3ENR**  
FAMPARC Secretary

### Summerland Amateur Radio Club

The 38th Annual General Meeting of the Summerland ARC is set down for Sunday, 9 February 1997 commencing at 2 pm in the clubrooms. All members and others interested are invited to attend.

Annual reports and election of officers will be the order of the day. Some office bearers will not be standing this year, so now is your chance to get involved in the running of your club. Remember, "you get the government you deserve!"

Be there and do your bit to support your club.

Refreshments will be available after the meeting. For more information check out the local BBS on VK2SRC-2, or contact John VK2FFO on 066 274 969 or Bert VK2HIV on 066 242 3239.

**Graeme VK2GJ**  
Publicity Officer

### Radio Amateur Old Timers Club

#### VK6OTN

Early in 1984, the then committee of the RAOTC applied to the Dept of Communications (now Spectrum Management Agency) for the grant of a special club licence with the suffix OTC (Old Timers Club). The DOC replied in June 1984 that the suffix OTC was already allocated and invited us to choose an alternative group.

The club then requested OTN (Old Timers Net). This was granted to the club as a block to cover use in all states VK1 to VK9, based on VK3OTN in Melbourne. And so VK3OTN was born and, on various

occasions, the call prefixes VK1, VK5 and VK6 were used in addition to the regular use of VK30TN.

In August 1996, some members in VK6 applied to the SMA for the allocation of VK6OTN for use in their local RAOTC broadcasts. They were advised that the call could only be approved by Canberra and approval was unlikely.

So, in August, I visited Mr Peter Young, the Area Manager for Victoria, and submitted a series of documents regarding the original licence terms, requesting that they be confirmed. Mr Young agreed to submit this material to Canberra and did so. On 5 December we located some early correspondence between the club and the DOC which provided departmental officers' names and a file number. This information was passed to Mr Young the same day.

Mr Young was then able to ring me on 13 December to advise that, while we could no longer use the OTN suffix in all states on the one licence, the group would be reserved for allocation only to bona fide members of the radio amateurs Old Timers Club based in Melbourne and the call VK6OTN would be licensed to Clem Patchett VK6CW. The new call was used for the first time on Monday, 13 January, with myself as VK30TN exchanging greetings with Clem as VK6OTN on 20 metres.

The club has expressed to Mr Peter Young and Mr Andrew McManus of the SMA, Melbourne our grateful thanks for their interest and assistance in this matter.

### AGM and Luncheon

In Melbourne the usual combined luncheon and annual meeting will be held on Tuesday, 11 March at the Bentleigh Club in Yawla Street Bentleigh at 12.30 for 1 pm. The cost has not yet been determined, but will not be more than \$25. Visitors from other clubs will be welcome but firm bookings must be made with Arthur Evans VK3VQ no later than Friday, 7 March.

Our speaker on the day will be club member Phil Williams VK5NN, who has kindly agreed to come over especially for this meeting. Phil was one of the first to be trained in radar technology with the idea of going to England. Japan's entry into the war meant that he stayed with the RAAF where he served with distinction. As an electrical engineer by profession, Phil is keen to talk about the enormous contribution of the then electrical/electronics industry here in Australia to the war effort. Note the date in your diary now.

Allan Doble VK3AMD

**When you buy something from one  
of our advertisers, tell them you  
read about it in the WIA Amateur  
Radio magazine**

ar



# Contests

Peter Nesbit VK3APN - Federal Contest Coordinator\*

## Contest Calendar February - April 97

Feb 1/2	YU DX Contest	
Feb 8	Asia-Pacific CW Sprint	(Jan 97)
Feb 8/9	PACC CW/SSB DX Contest	(Jan 97)
Feb 8/9	Spanish RITY Contest	(Jan 97)
Feb 15/16	ARRL DX CW Contest	(Jan 97)
Feb 21/23	CQ 160 Metre SSB Contest	(Dec 96)
Feb 22/23	Jock White Field Day (NZART)	
Feb 22/23	RSGB 7 MHz CW Contest	(Jan 97)
Feb 22/23	UBA (Belgium) CW DX Contest	(Dec 96)
Feb 22/23	REF (France) SSB DX Contest	(Jan 97)
Feb 23	High Speed CW Club Contest	(Jan 97)
Mar 1/2	ARRL DX SSB Contest	(Jan 97)
Mar 8/9	Commonwealth Contest	
Mar 14/15	160 m "Have A Go" Activity Period	
Mar 15/16	WIA John Moyle Field Day	
Mar 15/16	Bermuda Contest	
Mar 15/16	BARTG RITY Contest	
Mar 15/16	YL-SSB Contest	
Mar 29/30	CQ WPX SSB Contest	
Apr 5/6	SPDX Contest	
Apr 11/13	JA DX High Band CW	
Apr 12/13	International HF Grid Square Contest	
Apr 12/13	EA DX Contest	
Apr 19	Australian Postcode Contest	
Apr 19/20	SARTG AMTOR Contest	
Apr 19/20	Israel DX Contest	
Apr 26/27	Helvetia DX Contest (Switzerland)	
Apr 26/27	SP RITY Contest	

## 60th Anniversary Commonwealth Contest

8-9 March 1997, Saturday 1200z to Sunday 1200z

The Commonwealth Contest promotes contacts between stations in the Commonwealth and Mandated Territories, and provides a relaxed environment for you to work some choice DX.

All bands from 80-10 m may be used, CW only. Sections are (a) Open; (b) Restricted, operation limited to a 12 hours maximum, with no more than eight hours operation on the Saturday. Off periods must be at least 60 minutes long, and clearly marked in the log. *This year the single band sections have been abolished, and all entries will be classed as multiband.*

Contacts may be made with any station using a Commonwealth prefix, except those within the entrant's own call area. Note that, in this contest, the entire UK counts as ONE call area. Exchange RST + serial number, and score five points per valid QSO plus a bonus of 20 points for each of the first three QSOs with each Commonwealth call area, on each band.

A number of Commonwealth Society HQ stations are expected to be active during the contest, and will send "HQ" after their serial number to identify themselves. Each HQ station counts as an additional call area, and entrants can contact their own HQ station for points and bonuses.

Separate logs and lists of bonuses are required for each band. Send these plus a summary sheet to: RSGB HF Contests Committee, c/o S Knowles



## SP-500

### RF SPEECH PROCESSOR+

GIVE YOUR SSB SIGNAL UP TO 8dB IMPROVEMENT IN READABILITY UNDER WEAK AND NOISY SIGNAL CONDITIONS, JUST LIKE QUADRUPLING YOUR POWER OUTPUT BY USING A BIG AND EXPENSIVE LINEAR AMPLIFIER. TO FIND OUT HOW THE SP-500 ACHIEVES SUCH APPARENTLY REMARKABLE THINGS, GIVE US A CALL.

Other features include • Multi-mode End Transmission Beep (ETB) generator • Processor by-pass switching • Dynamic or Electret mic • LED mode indicators and Multicolour 10 segment LED Bargraph level indicator • 12 volt DC operated.

**PRICE \$295**  
(plus \$15 p&p)

Communication Equipment Co. also makes other radio accessories suited to CB, Amateur and RFOS equipment including the SP-100RF, an RF Speech Processor with the same processing electronics as the SP-500 but supplied as a small PCB for mounting inside the radio. PRICE \$150 + P&P

Ask about CEC's ETB generator PCBs etc.

**ALL CEC PRODUCTS DESIGNED AND MANUFACTURED IN AUSTRALIA.**

**GFS**  
electronics

AVAILABLE FROM:  
17 McKeon Street, Mitcham or  
PO Box 97, Mitcham, Vic. 3132.  
Fax: (03) 9872 4550  
Phone: (03) 9873 3777

The rules shown in the December issue for the JA Low Band Contest held last month somehow got scrambled, and probably caused dreadful confusion to entrants. Ian VK3DID quickly got on the telephone and pointed out my error; however, by then it was too late to get a correction published in the January issue. This is the sort of risk created when contest organisers fail to send a copy of the original rules, which for some reason seems to happen with most Asian contests. Perhaps one of the entrants could request the organisers to add the WIA to their mailing list, when forwarding their log for the event. A copy of the results, when available, would also not go astray.

I was going to talk further about sprint contests this month, but time has absolutely run away so it will have to wait for another day. Many thanks to VK1PJ, VK3DID, VK3ZC, G3PJT, OE4BKU, VE2ZP, ZL1AAS, *Radio Communications*, *CQ*, and *QST*. Until next month, good contesting!

### Jock White National Field Day (NZART)

0300-1200z Sat, 22 Feb and  
1800-0300z Sun, 23 Feb

This contest is open to portable ZL stations, and

also to overseas stations. Both 80 and 40 m can be used, phone and CW. Cross-mode contacts are not permitted. Sections include: CW; phone; mixed mode; 80 m only; "natural" power; QRP max 5 W O/P. Exchange RS(T) plus serial number. ZLs will add their branch number.

This contest is divided into 18 one-hour periods, changing over on the hour. Stations can be contacted once per hourly period, per mode, per band. Note that two consecutive QSOs with the same station are not permitted under the following circumstances, unless five minutes have elapsed: (a) when changing modes but staying on the same band; (b) at the end of one period and the start of the next.

Score 10 points per QSO, and multiply by the total number of branches worked on phone and CW. Multipliers are counted separately on 80 and 40 m, and on phone and CW, ie the same multiplier can be counted up to four times. Separate log sheets are preferred for each period, except where periods contain only a few QSOs, in which case more than one can be on the same page, if they are ruled off.

The summary sheet should show all usual details, plus a summary of the QSOs and multipliers per band and mode. Send logs to: S White ZL2AHC, 19 Rossport Street, Johnsonville, Wellington, New Zealand to arrive by 28 March 1997.

# ET-1000MP



# YAESU FT-1000MP.

## Incredible Performance, Amazing Pricing!

**Dedicated to the memory of JA1MP, the founder of Yaesu Musen, we are proud to announce the release of new pricing on Yaesu's latest high performance HF base transceiver, THE NEW FT-1000MP.**

Based upon the legendary performance of the FT-1000 which, for more than half a decade, has been highly acclaimed by the world's top DXers, Yaesu has created a new 100W HF masterpiece built upon proven RF design and the introduction of a new technology to the Amateur marketplace: Enhanced Digital Signal Processing (EDSP). Teamed up with Direct Digital frequency synthesis, an outstanding receiver section featuring a high intercept front-end and a wide variety of IF filters (including a Collins Mechanical Filter), the FT-1000MP's exclusive EDSP facilities provide an impressive array of IF-based noise-reduction and interference rejection filters for enhanced receiver performance, as well as flexible tailoring of the transmitter for outstanding signal clarity.

The performance of digital processing systems is highly dependent on the quality of software inside the transceiver, and here Yaesu's experience with software design really shines through. Yaesu's IF-based EDSP provides 4 random-noise filtering protocols, audio enhancement with 4 equalisation programs for Tx and 3 for Rx, and an automatic notch filter which identifies and eliminates multiple interfering carriers or heterodynes. Front panel selectable EDSP filter contours (Low, Mid, or High-Cut responses; or Bandpass) aid in QRM rejection, providing improved signal-to-noise ratios and razor sharp selectivity. A comprehensive menu system allows you to easily hear the effect of various EDSP settings, so you can choose the best selection for your operating conditions.

In keeping with the improvements that the EDSP facilities provide, the FT-1000MP also provides new features such as selectable flat response or optimised receiver front-ends, 3 antenna connectors (2 main antennas and an Rx-only socket), selectable tuning steps as small as 0.625Hz, and a Shuttle-jog tuning knob for fast QSY operation. For optimised transmit audio, different SSB IF offsets can be set for both normal and RF speech-processed transmissions, and can be used in conjunction with the Tx EDSP functions. Separate bar-graph S-meters are provided for each receiver, and even a synchronous detection system is used for better AM reception on the Shortwave bands.

Standard features include SSB/CW/AM/FM operation, an in-built AC power supply and Automatic antenna tuner, 13.5V DC socket, dual-mode noise blankers, 500Hz CW and 6kHz AM IF filters, full break-in CW, an in-built electronic keyer with memory, a multi-colour high resolution display, an RS-232 computer interface, and a MH-31B8 hand microphone.

With the new FT-1000MP now available, why not call us for a copy of Yaesu's 12-page colour booklet explaining more about the FT-1000MP's new level of HF performance and design excellence. We're sure you'll soon agree that the world of HF transceivers has just taken a giant leap forward.

Cat D-3400

**2 Year Warranty**

**Save \$500**

**\$3995**

**For further information, orders or the location of your nearest store call:**

**Outside Sydney (local call charge) 1300 366 644**

**Or Fax: (02) 9805 1986**

**DICK SMITH**  
**ELECTRONICS**

B 279B

G3UFY, 77 Bensham Manor Road, Thornton Heath, Surrey, CR7 7AF, UK, postmarked by 7 April 1997.

The Senior Rose Bowl will be awarded to the overall leader, and the Junior Rose Bowl to the runner-up. Certificates of Merit will be awarded to the third-placed entrant overall, to the leading stations in each call area, and to the first three entrants in the restricted section. A Commonwealth Medal will also be awarded to the entrant in either section who, in the opinion of the Committee, has most improved his or her score, or contributed significantly to the contest over the years.

To encourage you to work as many different Commonwealth call areas on as many bands as possible, and to celebrate the 60th Anniversary contest, a special silver or gold 60th Anniversary Certificate, based on the original BERU Certificates awarded in the 1930s, will be awarded to every entrant contacting at least 50 or 60 band-call areas respectively. Entrants should note their claimed band-call area total on the Summary Sheet.

Finally, Bob Whelan's history of BERU "Reflections in a Rosebowl" is available from him for £15 plus postage (QTHR), and includes plenty of tips from leading stations over the years, including unique photographs from the 1930s to the present day.

The following call areas are recognised for the purpose of scoring:

A2, A3, AP, C2, C5, C6, C8/9, CY9, CY0, G/GB/GD/GI/GJ/GM/GU/GW (all one area), H4, J3, J6, J7, J8, P2, S2, S7, T2, T30, T31, T32, T33, TJ, V2, V3, V4, V5, V8, VE1, VE2, VE3, VE4, VE5, VE6, VE7, VE8, VK1, VK2, VK3, VK4, VK5, VK6, VK7, VK8, VK9C, VK9L, VK9M, VK9N, VK9W, VK9X, VK0 (Heard Isl), VK0 (Macquarie Isl), VK0 (Antarctica), VO1, VO2, VP2E, VP2M, VP2V, VP5, VP8 (Falkland Isl), VP8 (S Georgia), VP8 (S Sandwich Isl), VP8 (S Shetland Isl), VP8 (S Orkney Isl), VP8 (Antarctica), VP9, VQ9, VR6, VS6/VR2 (Hong Kong), VU, VU4 (Andaman & Nicobar Isl), VU7, VY1, Y1, Z2, ZB2, ZC4, ZD7, ZD8, ZD9, ZF, ZK1 (N Cook Isl), ZK1 (S Cook Isl), ZK2, ZK3, ZL0 or /ZL (N.Z. reciprocal calls), ZL1, ZL2, ZL3, ZL4, ZL5, ZL7, ZL8, ZL9, ZS1, ZS2, ZS3, ZS4, ZS5, ZS6, ZS8, 3B6/7, 3B8, 3B9, 3DA, 4S, 5B4, 5H, 5N, 5W, 5X, 5Z, 6Y, 7P, 7Q, 8P, 8Q, 8R, 9G, 9H, 9J, 9L, 9M2, 9M6/8, 9M0, 9V, 9Y, GB5CC (RSGB HQ station), various other HQ stations.

If you hear a C9 or a TJ calling BERU, don't be surprised, as Mozambique and Cameroon have been members of the Commonwealth for over a year.

### 160 m "Have A Go" Activity Period

14-15 March, 0800-1400z both days

This yearly activity period is organised by the NZART, and is intended to encourage 160 m contacts between VK and ZL. It is not a contest, and no logs are required. The suggested calling frequency is 1840, followed by QSY. Note that ZLs can operate anywhere within the VK allocation.

### CQ WPX Contest

SSB: 0000z Sat to 2400z Sun, 29-30 March  
CW: 0000z Sat to 2400z Sun, 24-25 May

This contest is sponsored by *CQ Magazine*, and the objective is to contact as many stations worldwide as possible on 1.8-30 MHz (except 10, 18 & 24 MHz). Categories include: single operator (either single or all band), subdivided according to power (unrestricted, low power max 100 W O/P, and QRPp max 5 W O/P); and multioperator (either single or multi-transmitter, all band only). Single operator stations are where one person performs all operating, logging, and spotting functions. The use of DX spotting nets places the station in the multioperator single transmitter category. Multi- multi stations must have all transmitters located within a 500 m diameter circle or within the property limits of the licensee's address, whichever is greater. All antennas must be physically connected by wires to the station transmitters and receivers.

Exchange RS(T) plus a three digit number starting at 001. Continue to four digits if past 1000. Multi-transmitter stations must use separate numbers for each band. Score three points (14-30 MHz) or six points (1.8-7 MHz) for contacts with stations on different WAC continents, and one point (14-30 MHz) or two points (1.8-7 MHz) for contacts with stations within the same WAC boundary. Contacts with stations in the same country are permitted for multiplier credit but have zero point value.

The multiplier is the total number of prefixes worked on all bands (each prefix is counted only once regardless of the number of different bands on which it is worked). A "prefix" is the unique letter/numeral combination forming either the first part of the callsign, or else the normal country identifier for stations using their home callsigns in another DXCC country. For example: N8, W8, AG8, Y22, Y23, HG7, HG73 are all separate prefixes. The prefix for both N8ABC/KH9 and KH9/N8ABC is KH9. KH6XXX operating from Ohio could sign /W8, /N8, /K8, or any other prefix authorised for that district. Portable designators without numbers will be assigned zero after the letter prefix, eg N8ABC/PA becomes N8ABC/PA0. Any calls without numbers will be assigned a zero after the first two letters, eg RAEM becomes RA0EM. Suffixes indicating maritime mobile, mobile, portable, alternate location, and licence class do not count as prefixes (eg /MM, /M, /P, /A, /E, /J). The final score is QSO points x multiplier.

Logs must show times in GMT, with breaks clearly marked. Show prefix multipliers only the first time they are worked. Logs must be checked for duplicates, correct points, and prefix multipliers. Logs must be accompanied by a sorted alphanumeric list of prefix multipliers, and a summary sheet showing call, name, address, category, power, scoring information, and a signed declaration that all contest rules and radio regulations were observed. Logs may also be submitted on 3 1/2" or 5 1/4" DOS disk in ASCII format (.BIN, .RES, .DBF, .WKS also acceptable), providing a sorted multiplier file and a paper summary sheet are included. Send logs postmarked by 9 May (SSB) or 11 July (CW) to: WPX Contest, 76 N Broadway, Hicksville, NY 11801, USA. Indicate SSB or CW on envelope.

A comprehensive range of trophies and plaques is offered, and certificates will be awarded to the highest scoring station in each category, country

and VK call area. To be eligible for awards, single operator stations must show at least 12 hours operation, and multioperator at least 24 hours operation. Single band entries showing points claimed for more than one band will be judged as multiband unless otherwise specified. Where returns justify, 2nd and 3rd place awards will also be made.

### Results of 1996 Canada Day Contest

(call/band/QSOs/mult/score)  
VK4JR \* 20 m 26 8 1616

### 1997 JOHN MOYLE CONTEST

Presented by Phil VK1PJ

Well, once again those who enjoy a weekend in the bush should be planning for this year's John Moyle Field Day. Apart from a minor change to the multioperator section, the rules are the same as last year, including the retention of the six and 24 hour sections.

If anyone wishes to contact me privately to discuss rules, etc, my home phone number is 06 292 3260, and my address is as shown in the Log Submission section below. I wish all entrants good luck, and look forward to seeing you on air during the contest!

#### Overview

1. The aim is to encourage and provide familiarisation with portable operation, and provide training for emergency situations. The rules are therefore designed to encourage field operation.

2. The contest takes place on the 3rd weekend in March each year, and this year (1997) runs from 0100 UTC Saturday to 0059 UTC Sunday, 15-16 March.

3. The contest is open to all VK, ZL and P2 stations. Other stations are welcome to participate, but can only claim points for contacts with VK, ZL and P2 stations.

4. Single operator entries shall consist of one choice from each of the following (eg six hour, portable, phone, VHF/UHF):

- 24 or six hour;
- Portable, Home, or Receive;
- Phone, CW, or Open mode;
- HF, VHF/UHF or All Band.

5. To be eligible in the multioperator section, multioperator entries must be portable, all mode, and consist of one choice from each of the following:

- 24 or six hour;
- HF, VHF/UHF or All Band.

#### Scoring

6. Home stations for all sections shall score:

- Two points per QSO with each portable station;

- One point per QSO with other home stations.
- Portable HF stations shall score two points per QSO.

8. Portable stations shall score the following on 6 m:

- 0-49 km, two points per QSO;
- 50-99 km, 10 points per QSO;
- 100-149 km 20 points per QSO;
- 150-199 km 30 points per QSO;
- 200-499 km 50 points per QSO;
- 500 km and greater, two points per QSO.

9. Portable stations shall score the following on 144 MHz and higher:

- a. 10 to 49 km, two points per QSO;
- b. 50 to 99 km, 10 points per QSO;
- c. 100 to 149 km, 20 points per QSO;
- d. 150 km and greater, 30 points per QSO.

10. For each VHF/UHF QSO where more than two points is claimed, either the latitude and longitude of the station contacted or other satisfactory proof of distance must be supplied.

#### Log Submission

11. Logs must be accompanied by a summary sheet showing: callsign, name, mailing address, section entered, number of contacts, claimed score, location of the station during the contest, and equipment used. For multioperator stations, the callsigns and signatures of all operators should be included. If any VHF/UHF QSOs have been made which qualify for more than two points, the latitude and longitude of the station during the contest must be included.

12. The summary sheet must include the following declaration signed by the operator, or in the case of a multiple operator station, one of the licensed station operators: "I hereby declare that this station was operated in accordance with the rules and spirit of the contest".

13. Logs must be postmarked no later than 25 April 1997, and forwarded to: John Moyle Contest Manager, 33 Willoughby Cres, Gilmore, ACT 2905, Australia. An ASCII text copy on a MS-DOS floppy disc would be most helpful, with the following alternative formats also acceptable: Wordstar, Word, WordPerfect, dBase3 & 4, Lotus 123.

#### Certificates and Trophy

14. At the discretion of the Contest Manager, certificates will be awarded to the winners of each portable section. Note that entrants in a 24 hour section are ineligible for awards in a six hour section.

15. The Australian station with the highest CW score will be awarded the President's Cup, a perpetual trophy held at the Executive Office, and will receive an individually inscribed wall plaque as permanent recognition.

#### Disqualification

16. General WIA contest disqualification criteria, as published in *Amateur Radio* from time to time, applies to entries in this contest. Logs which are illegible or excessively untidy are also liable to be disqualified.

#### Definitions

17. A portable station comprises field equipment operating from a power source independent of any permanent facilities, eg batteries, portable generator, solar power, wind power.

18. All equipment comprising the portable station must be located within an 800 m diameter circle.

19. A single operator station is where one person performs all operating, logging, and spotting functions.

20. A single operator may only use a callsign of which he/she is the official holder. A single operator may not use a callsign belonging to any group, club or organisation for which he/she is a sponsor except as part of a multioperator entry.

21. A multioperator station is where more than

one person operates, checks for duplicates, keeps the log, performs spotting, etc.

22. A multioperator station may use only one callsign during the contest.

23. Multioperator stations may only use one transmitter on a given band at any one time, regardless of the mode in use.

24. Multioperator stations must use a separate log for each band.

25. A station operated by a club, group, or organisation will be considered to be multioperator by default.

26. None of the portable field equipment may be erected on the site earlier than 24 hours before the beginning of the contest.

27. Single operator stations may receive moderate assistance prior to and during the contest, except for operating, logging and spotting. The practice of clubs or groups providing massive logistic support to a single operator is, however, totally against the spirit of the contest. Offenders will be disqualified, and at the discretion of the manager, may be banned from further participation in the contest for a period of up to three years.

28. Phone includes SSB, AM and FM.

29. CW includes CW, RTTY, and packet.

30. It is not expected that any other modes will be used in the contest, but if they are, they shall be classed as CW.

31. All amateur bands may be used except 10, 18 and 24 MHz. VHF/UHF means all amateur bands above 30 MHz.

32. Cross-band, cross-mode and contacts made via repeaters are not permitted for contest credit. However, repeaters may be used to arrange a contact on another frequency where a repeater is not used for the contact.

33. Portable stations may make repeat contacts and claim the appropriate points providing that at least three hours have elapsed since the previous valid contact with that station on the same band and mode.

34. Home stations may not claim points for repeat contacts.

35. Stations must exchange ciphers comprising RS(T) plus a three digit number commencing at 001 and incrementing by one for each contact.

36. Portable stations shall add the letter "P" to their own cipher, eg 59001P.

37. Multioperator stations are to commence each band with 001.

38. Receiving stations must record the ciphers sent by both stations being logged. QSO points will be on the same basis as for Home Stations, unless the receiving station is portable.

39. The practice of commencing operation and later selecting the most profitable operational period within the allocated contest times is not in the spirit of the contest, and shall result in disqualification. The period of operation commences with the first contact on any band or mode, and finishes either six or 24 hours later.

\*PO Box 2175, Caulfield Junction, VIC 3175  
pmesbit@melbpc.org.au



Antenna Sales International

HF - VHF - UHF MOBILE ANTENNA  
HF - VHF - UHF BASE ANTENNA  
CB - MARINE - AIRCRAFT

Monoband to Multiband  
Convert Now, to the all  
New!

PERTH PLUS

HF Mobile antenna

with 80-40-30-20-17-15-12-10-6-2m included

Amateur

Coaxial Cables & Fittings  
HF Spring Bases, Trunk and Gutter Mounts.

Outbacker OBB "Classic"  
Outbacker "Junior plus"

Split Models  
Helical Dipoles  
Long wire Dipoles  
Baluns

\*Free!

With Every Perthplus Purchase.  
1 x AmSoft CD-ROM  
'94 Callsign Database

While our stocks last

Now available from:

MELBOURNE  
Daycom Communications  
Ph 03 6436444

ALICE SPRINGS.  
Farmer Electronics  
Ph 089523388

DARWIN.  
Integrated Technical Services.  
Ph 089-815411

SYDNEY.  
Andrews Communications  
Ph 02 6368060

PERTH.  
Tower Communications  
Ph 4701118

ADELAIDE  
Johnston Electronics  
Ph 08 2871061

PERTH - Model

<http://intercon.com.au/outbacker>

TERLIN AERIALS  
5 Yampi Way  
Willetton W.A. 6155

Ph +61 (09) 3545444  
Fax +61 (09) 3545455

Now  
Free  
Video

Send \$ 5.00 for a 15 minute informational video  
Refundable with every antenna purchase.

# Divisional Notes

## Forward Bias - VK1 Notes

Peter Parker VK1PK

### VK1 Meetings Same Venue, Different Room

The VK1 Division is now holding its general meetings in a different part of the Griffin Centre. Instead of meeting on the top floor, we now meet on the ground floor (Room 1). The new room is nearer Bunda Street, just up from the zebra crossing. The change should be popular with our older members, and others who have trouble climbing the stairs. Another benefit is that, if we hold a junk sale or equipment demonstration, we will no longer have to carry heavy loads up two flights of stairs.

### AGM This Month

This year's Annual General Meeting of the WIA (ACT Division) will take place at 8 pm on Monday, February 24 at the Griffin Centre, Civic. Several committee members will not be re-nominating and volunteers are needed to fill several key positions. If you have thought about becoming involved in the running of the Division, 1997 could be the year for you.

### Division Receives Yagi Donation

Last month you read that Eric VK1EP was the winner of the Chirside Yagi in the Division's raffle. Eric has since informed us that as he already has a HF beam and the Chirside was surplus to his requirements. December's Committee meeting heard that Eric has donated his prize back to the Division, so that it can be used for further fund raising. We thank Eric for his generous gesture. The antenna will be auctioned immediately prior to this month's AGM.

## VK2 Notes

Peter Kloppenburg VK2CPK

Council members witnessed an interesting switch between the respective positions of President and Vice-President at the December meeting of the Divisional Council. Our President, Michael Corbin VK2YC, had decided to take a step back from the actual running of the Division. His recent move to the South Coast near Batemans Bay and his program of property development there, were factors that prevented him from attending various meetings and conferences in Sydney, and be on call for providing advice and support to Divisional staff, Councillors and Members.

Michael steered the ship of WIA state through some very troubled waters over the last three years while gaining trust and cooperation from those members who take an active interest in the well-being of the Division. We thank Michael for using his extensive political management skills, and his time, to make the Division operate effectively and efficiently again. Our new president, Peter Jensen VK2AQJ, will hold the position until the AGM in April '97.

The scheduled Council meeting was not held on the second Friday of December. Because the Division had organised a Christmas party for members on the following Saturday afternoon, it was thought prudent to hold the Council meeting late that morning, thereby mixing business with pleasure for the benefit of members and Councillors alike.

## VK6 Notes

John R Morgan VK6NT

### Notice of Annual General Meeting

It is hereby notified that the Annual General Meeting of the Wireless Institute of Australia (Western Australian Division) Inc will be held on Tuesday, 15 April 1997 following the General Meeting which commences at 8 pm. The meeting will be held in the Board Room, 3rd Floor, CWA House, 1174 Hay Street, West Perth. The agenda will be:

1. Consideration of the Council's annual report
2. Consideration of the financial report
3. Consideration of other reports
4. Election of office-bearers (President, Vice President, and seven other Councillors)
5. Election of two Auditors
6. Appointment of a Patron
7. General business which has been duly notified.

Notices of Motion for the AGM must be received by the Secretary not less than 42 days prior to the meeting (ie by 4 March 1997), and must be signed by at least three members. The Secretary's postal address is: PO Box 10, West Perth WA 6872.

Nominations of candidates for election to Council must be received by the Secretary, in writing, not less than 42 days prior to the meeting (ie by 4 March 1997), with an intimation that the candidate is willing to act. A candidate may submit a statement, not exceeding 200 words, outlining his or her

experience and case for election. Each nomination shall be signed by two members proposing the candidate. Candidates must possess a current amateur licence.

Any financial member who is entitled to vote may appoint a proxy, who must also be a financial member who is entitled to vote, to speak and vote on his or her behalf. Written notice of such proxy must be received by the Secretary prior to the meeting, and be in the following form:

*I (full name), a member of the Institute, hereby appoint (full name), also a member of the Institute, to act for me as my proxy, and in my name to do all things which I myself being present could do at the meeting of the Institute held on 15 April 1997.*

Signed:

Witness:

Date:

### Divisional Meetings

General Meetings are held on the third Tuesday of each month in the Board Room, 3rd Floor, CWA House, 1174 Hay Street, West Perth, commencing at 8 pm. Usually, there is no meeting in December. All interested persons (members and non-members, licensed or listener) are invited to attend, and will be overwhelmed by the free coffee and biscuits.

### WA Repeater Group

As the VK6WIA news broadcast was in recess on the two Sundays following Christmas, the Committee decided to move the WARG Net (VK6RRG) from its usual 1030 time-slot on the VK6RLM repeater (146.750 MHz) to the normally-occupied VK6RAP machine (146.700 MHz), and to activate the links to the "country network" so that listeners outside Perth could listen-in.

At the time of writing, it is too soon to say whether the experiment was successful, but it was clear that many stations on the linked repeaters did not realise that the links are one-way only, since they were designed to relay the VK6WIA broadcasts, and that, therefore, only stations transmitting directly into VK6RAP (146.700 MHz) could take part in the discussions. Your thoughts and opinions are sought.

### If You Have Material ...

Material for inclusion in this column may be sent to VK6NT @ VK6ZSE.#PER.#WA. AUS.OC, or to PO Box 48, Beverley WA 6304, or via telephone on (09) 291-8275.

## "QRM" News from the Tasmanian Division

Robin L Harwood VK7RH

It is with deep regret that we announce the passing of another old-timer, Bill Tanner

VK7TE, who passed away on 10 December. Bill had been active until about 12 months ago but increasing ill health curtailed his activity. He was one of the studio technicians at the ABC Radio 7NT when the studios were next to the Princess Theatre in Brisbane Street, Launceston. He was actively involved with the Deviot Sailing Squadron in recent years. We extend our sympathies to Bill's family and friends. Vale VK7TE.

This month sees each branch conduct their Annual General Meetings. Nominations have closed for positions. There will be a report in the April column with the results.

The Divisional Annual General Meeting will be held on 22 March 1997 at the Activity Centre, Queen's Domain, Hobart. It is scheduled to commence at 1400 hours Eastern Daylight Time. All notices of motion should be in the hand of the Public Officer 28 days prior to that date; that is no later than Friday, 21 March at 1700 hours EDT. Nominations for Divisional Council, as stipulated by the Articles of Association, must be lodged 21 days prior, that is Friday, 28 February at 1700 hours EDT. To be eligible to stand, the proposers and seconders, plus the nominees, must be current financial members of the Tasmanian Division. Nomination forms are available from the Divisional Public Officer.

There are eight vacancies on Divisional Council. If there are more than eight candidates nominating, an election will be needed. All current financial members, with the exception of associate members, will then receive a postal ballot paper which is returnable to the Divisional Postal address or handed in on the day. A reminder that the postal address of the Tasmanian Division is 5 Helen Street, Newstead, TAS 7250.

Meetings for the month of February are: Divisional Council on Saturday, 1 February 10.30 am to be held in the NW Branch (the venue will be announced over the VK7WI broadcast); Southern Branch on Wednesday, 5 February 1997 at the Domain Activity Centre commencing at 2000 EDT; Northwestern Branch on Tuesday, 11 February 1997 at the Penguin High School, Dial Road, to commence at 1945 hours EDT; and the Northern Branch on Wednesday, 12 February 1997 at the Launceston College of TAFE, Alanvale campus, Block "C" to commence at 1930 hours EDT.

Members and friends of the Southern Branch held a barbecue at the Domain Activity Centre on New Year's Day and many New Year's resolutions were shared. Over 30 attended, which was some achievement considering it was right in the middle of a mini-heatwave. Fortunately, a big beach umbrella was provided to give some shade.

The Northern Branch held an informal get-together at Scamander to which all interested amateurs and SWLs were invited. Many stayed over the weekend to sample the wonderful sun-drenched East coast. The Northwestern branch held their regular monthly meeting at the Penguin High School on Tuesday, 14 January.

Repeater Two, VK7RHT, has now been relocated to Guy Fawkes Hill from Mount Wellington. The last transmission from the

old site occurred on Sunday, 12 January and the site closed down after the VK7WI broadcast. It is not known if it will be possible to re-open from Mount Wellington in the future. However, the old site had some serious limitations, mainly due to the large amounts of RF generated at the summit plus the difficulty in maintaining the antennas in winter time. The old site had been operational for 25 years.

ar

---

---

## Education Notes

*Brenda M Edmonds VK3KT\* Federal Education Coordinator*

---

---

Greetings and good wishes for 1997 to all readers.

I had hoped to be able to tell you by now that the new Regulations brochures are in production and that WIA Exam Service will be examining on the revised regulations as from a date in the near future. However, we are not yet quite to that point, although the prospects are improving.

We were told that the brochures will be available "early in the new year" but I do not have any estimated date. It appears that the format will be changed, possibly returning to the style of the old "Amateur Operators Handbook" with all the material in one publication. Those who have tried to help students with the regulations will be pleased if this is done. The separate Technical Licence Specifications (TLSs) have been dropped, being replaced by a Licence Conditions Determination (LCD). This provides all the operating conditions information which was at the start of each TLS, followed by the specific bands, power and emission modes for each grade of licence.

At the time of writing this, the WIA is negotiating the content and format of the Regulations examination syllabus, which is to be included for the first time, and trying to finalise the modifications which we have proposed to the theory syllabuses. The Novice syllabus, in particular, has had to be enlarged to cover the increased privileges which the Novices gained at the revision of the Regulations.

The draft Regulations syllabus, as proposed by the SMA, places a stronger emphasis on operating conditions, and less on operating procedures than is currently the case. It also includes reference to knowledge of parts of the Radiocommunications Act and some ITU Regulations relating to amateur radio. This is in order to align the syllabus with those from other countries. The WIA

will be making every effort to ensure that the difficulty of the examination is not increased by changes to the format, and that the wording of the final version is as simple and clear as possible.

Those involved with examinations will be notified in good time before changes are made to examination procedures or content.

*\*PO Box 445, Blackburn VIC 3130*

ar

## Andrews Communication Systems

(EST. 1976 - ACN 001 968 752)

### NEW

- ★ IC-756 HF+6M, DSP, LCD
- ★ IC-R10 HANDHELD SCANNER
- ★ WS-1000E CUTE SCANNER
- ★ DX-70TH HF+6M 100W.
- ★ DJ-191 SLIM 2M HANDHELD
- ★ DX-1600 HF LINEAR AMP
- ★ AR-7000 DSP, LCD, SCANNER

*Due now or soon*

**PLENTY OF ALINCO RADIOS IN STOCK**

Call us now

**(02) 9636 9060** or (02)  
9688 4301

SHOP 8, 41 BATHURST ST, GREYSTANES,  
N.S.W. 2145. FAX (02) 9688 1995

---

---

# How's DX?

Stephen Pall VK2PS\*

---

---

As the new year starts moving on, there are already plans for new exciting DX activities to assist DXers achieve their ultimate goal, worked all DXCC countries.

There are some unconfirmed rumours that a major North Korean (P5) activity is being prepared before the end of May. There are also plans to activate Clipperton Island; Scarborough Reef should come to life in May this year; and at the end of next year (1998) Bouvet (3Y5) might be active.

If everything goes according to plan, a number of the most sought-after countries will be at our disposal. To work these rare DX countries we need good propagation and good equipment, besides individual skill and help from "Lady Luck".

In the past four weeks since 10 December, the solar flux number was never below 72, so there is hope in that direction. We should be upgrading our operating skills as far as equipment is concerned, and be knowledgeable about all the technical aspects of our transceivers; the misuse of speech processors, the overdrive of gain-controls and the blunders of using split frequencies are the most common mistakes of some DXers. Open microphones, not zero-beating with the frequency in use, asking questions not directed to anyone about the identity of the DX station, using abbreviated or part callsigns, starting up a conversation when a simple exchange of reports would be sufficient, and not asking permission to use a particular frequency, are the signs of the inexperienced DXer. All of us should be prepared to listen long and hard before we join the long queue of the "hopefuls". Last, but not least, the refurbishment and improvement to antenna systems will create wonders for the average 100 W operator.

## Heard Island - VK0IR

As I write these lines on 8 January, the long awaited DXpedition to this remote sub-antarctic island deep in the south of the Indian Ocean, is on its way.

Preliminary information is scratchy, however TO0R was heard and worked from Reunion Island, also TO0R/mm en route to Heard. If everything goes well, they should be active on 12 January or thereabouts.

Here are a few more snippets from the last days of preparation. A new team-member, the 21st, joined the expedition in the middle of December. He is Hans-Rudi Burki HB9BHW, who was introduced by team member Willy HB9AHL. Hans is a keen CW man and his knowledge of some electronics

and that of the new Inmarsat telephone, will be valuable to the team. The two 10 ton containers and the 400 kg of luggage which was sent from Belgium, have safely arrived in good condition. FT5WE confirmed from Crozet that it will be very difficult for the Heard team to operate from that island. Sam FT5WE will board the boat to leave when they pass Crozet. On Reunion the Heard Island crew was staying in bungalows right next to the Ocean. The 21 members of the expedition represent 10 DXCC countries: Spain 1, Switzerland 3, USA 9, Puerto Rico 1, Austria 1, Belgium 2, The Netherlands 1, Russia 1, Australia 1, and Singapore 1.

The DXpedition received official support from the ARRL. The ARRL Colvin Grant Committee has authorised a grant of \$US5000 to the expedition. The Colvin Award is to support amateur radio projects that promote International Goodwill in the field of DX (long distance communication). It is funded by income from W6KG, an endowment established by the late Lloyd Colvin of "Yasme Foundation" fame.

Alan VK4AAR, reading my January notes about Heard Island, reminded me that there were activities from Heard later than 1983. This is quite correct. There were individual activities in 1986 and 1987. However, as far as DXpeditions go, the last ones were in 1983; Frank VK0DA was active for two months during the late 1986 early 1987 (see *Amateur Radio* "How's DX?" August 1995 issue), and Dave VK0HI was also there in December 1987. Incidentally, Alan VK4AAR worked TO0R/mm en-route to Heard Island on CW on 4 January.

## Antarctic Stations

The Antarctic "summer season" is now with us. According to a variety of reports the following stations are active:

\* CE9/CE7JOD - Capitan Arturo Prat - Greenwich Island - South Shetland. Heinz is active every day at 0300 on 14240 MHz. QSL to CE7JOD.

\* CE9SAC - Teniente Luis Carvajal - Adelaide Is. Carlos and Abraham active from 0030 to 0500 around 14.277 MHz. QSL to EA8BGY.

\* CE9OH -Bernardo O'Higgins 2300-0300 - 14.192 MHz.

\* 8J1RL - Ongul Island. Active on CW around 14.019 MHz. QSL to JARL Bureau.

\* KC4USB - USN Marie Bird Surface camp - Mary Bird Land, op Steve. QSL to K4MZU.

\* KC4AAA - USN MARS Amundsen Scott - South Pole. QSL to NC6J.

\* KC4/UA3YH - USN MARS Amundsen-Scott, South Pole. Nicolai active. QSL to RW3XA.

\* KC4AAC - USN MARS Palmer Station, Anvers Isl. Operator Greg WB7CHV.

\* KC4AAD -USAP Siple Dome Station (81° 40' S - 149° 00' W). Operators Wendy and Don. This new base has been set up for three years and is about 500 miles from McMurdo station. Houses 20 personnel.

\* KC4AAF - Upstream Charlie Base. Novice operator Sara.

\* LZ0A - St Kliment Ohridski - Livingston Isl, South Shetland Islands. Dany LZ2UU will be returning to the base around the middle of December. QSL to LZ1KDP.

\* LU1ZV - Army Ejercito Esperanza, Palmer Peninsula. At 0100 around 14.240 MHz.

\* CE9/CE8CMI - Patriot Hills Base, Ellsworth Land. Moncho is active every day at 0300 around 14.270 MHz.

\* HF0POL - Henryk Arctowski - King George Isl. Mark SP3GVX will be active on all bands. QSL to SP3FYM.

\* R1ANT Saam Molodezhnaya - Enderby Land. QSL to UA1MU, Victor Topler, PO Box 38, 192 241 St Petersburg Russia.

\* R1ANZ - Saam Mirny - Guillaume II Coast. QSL to UW1ZC, Valentin Mykitenko, Akademgorodok 2 1, 184340 Loparskaya, Russia.

\* R1ANL - Saam Novolazarevskaya - Princess Astrid Coast.

\* R1ANW -Saam Vostok - Wilkes land. Will be active soon with a novice operator.

\* EM1KA -Akademik Vernadsky Base - Galindez Isl. Roman is very active. QSL to JA2JPA, Takashi Ajiro, 2-14-18 Doubayashi, Shimizu, Shizuoka 424, Japan.

\* VU2AXA - Maitri - Reine Maud Land. QSL to VU2DVC.

\* VU3NHO/P - Maitri - Reine Maud Land.

\* ZS7ANT - Sanae - Princess Martha Coast. QSL to ZS5UND.

\* FT5YP active from Les Petrels CW/SSB.

\* 7S8BBB - Swedish base.

\* OA0MP - Peruvian Antarctic base Machu Picchu on King George Island.

## The Final Word on XY0RR

The DXCC Award Committee of the ARRL published the following press release on 2 December 1996. "In 1991, the DXCC Desk accredited the XY0RR operation that the operators claimed had taken place from Myanmar. That accreditation was based on evidence that the operators had made a legal entry into the country, and possessed



operating permission from the Government of Myanmar.

"Recently obtained information has called this evidence into question. An investigation has disclosed no record in Myanmar of the operators having entered the country on the day and at the place shown in the XYORR documentation. Additional facts have come to light that do not support the claims made in that documentation.

"If the accreditation decision regarding XYORR were to be made today, the operation would not be accredited based on presently available information. However, technical difficulties prevent removal of DXCC credits for this operation. DXCC participants whose credit for Myanmar is based on a contact with XYORR are encouraged to make a replacement contact for their own personal satisfaction."

### **Auckland Islands - ZL9GD**

Early last year, Graham ZL4MV made a short visit to the Auckland Island Group. When replying to my QSL card, he not only sent the much valued ZL9 card but also an interesting letter about his experiences on Enderby Island which is part of the Auckland Islands Group. Here are some of the details from his letter: "On 11 February 1996, after an afternoon sailing on Bluff Harbour, I met the owner/skipper of a large ocean going yacht looking for more crew for a voyage down to the sub-antarctic Auckland Islands. Oh boy, here was a chance for a sailing adventure and to get back to the islands and hopefully try to work some DX to make up in some small way for the disappointments following the fiasco of my 1995 trip when the ARRL ruled that my mini-expedition was invalid due to my unintentional breaking of the rules.

"There was no time to advertise my trip as, two days later, I was at sea calling in at Stewart Island to collect our DOC (Department of Conservation) ranger and then we were sailing to ZL9. This time the wind blew continuously from 20-50 knots, so it was great to get into sheltered anchorage. The Auckland islands are at 50° 5' South, 166° 10' East, away to the South of New Zealand, and are lashed by gales for most of the year.

"On the afternoon of the 17th we arrived at Sandy Bay on Enderby Island at the northern end of the islands group. From December until about April each year, the beach and open ground at Sandy Bay are inhabited by hundreds and hundreds of Hooker sea lions that gather to have their pups and to mate again, a very noisy and busy place indeed.

"The Department of Conservation (DOC) has a base camp on Enderby and another



**Graham ZL9GD on Enderby Island.**

smaller camp site on Adams island, about 30 miles to the South. In the late 1800s cattle, sheep, goats, rabbits and pigs were liberated on the island as a food source for the survivors from the many shipwrecks around these islands, but now all have been culled except a small number of wild pigs.

"The DOC limits the total number of persons allowed to land on the islands to 600 per year and charges \$NZ200 per person for a landing permit. Landing is only allowed on Enderby Island. This may seem severe conditions but they are trying very hard to keep these islands in pristine condition and to keep pollution of any type to an absolute minimum; even the 600 pairs of feet each year has an effect. Most of the people would be from "controlled" tourism and from cruise ships that have visited the island. The day we arrived a Russian cruise ship returning from the Antarctic, the "Ice", called in to take the DOC staff off the island and return them to the New Zealand mainland. Their term of isolation ended for the season.

"With the help of other crew members we ferried my radio equipment, batteries, etc ashore in an inflatable dinghy and landed it through the surf onto the beach and then carried the gear up the hill to a DOC hut where I set it all up, hoisted my inverted Vee antennas and tested the airwaves. My rig was a Kenwood TS180, AT180 tuner and was powered by two car batteries and running about 50 watts. The great thing operating in remote places is the absence of man-made interference and no local QRM.

"On my previous trip I made good use of net controllers and I most sincerely thank all those hams that made themselves available to control nets. This greatly speeds up the number of contacts one can handle in an hour or so. I worked on 20 and 40 metres SSB only. I began calling CQ at 0515 UTC and worked on until the early hours of the morning until my batteries went flat. During the evening I stopped for the occasional break and enjoyed a coffee from the thermos flask.

"Late in the evening I had a most unwelcome visitor in the form of a large female Hooker sea lion. The door of the hut was open and in she came. Lucky for me there was a broom in the hut so I managed to chase her out again with much barking and snarling from the sea lion. I love sea lions, but at a distance.

"Once the batteries were nearing the end, I called the yacht on the handheld and the skipper headed in to take me off the island. I decided it was too risky to try and take the gear off in the dark so I left it all in the hut and, with torch in hand, began to make my way down to the beach to be picked up, only to find sea lions everywhere; so I returned to the hut for the "trusty" broom. I made my way back down to the beach and, with the odd good swing of the broom, I managed to keep a fairly clear path. Leaving the gear until daylight was a good decision, as I got wet to the waist line getting into the dinghy and the sea temperature was at 4° C. Brrrrr... "

Graham was only six days on Enderby island. He operated only three nights from three different sites and managed to work

over 800 DX stations. Being a crew member of the 20 m ketch-rigged yacht "Quintessa", his times and hours of activity were very much limited by the movements of the boat.

His 1995 January/February activity was not allowed by the ARRL because, not knowing the DXCC rules, he operated actually from a boat at anchor at various bays on the island. This time he made sure that his activity was in accordance with the rules by operating with the assistance of two heavy duty batteries on solid ground.

## Yemen - 70

"Zorro" JH1AJT and Franz DJ9ZB were active from Yemen as 701A from 15 to 23 December. It was a demonstration of amateur radio to the Ministry of Communication officials, on SSB only, on a variety of amateur bands. This was the third successful activity from this rare DXCC country. The first one was by 9K2 operators as 701AA, and the second in 1990 by F2VX and F6EXV as 708AA. This latest activity was a success in many ways. It was reported that "Zorro" JH1AJT received an invitation from the Yemen authorities to return at the end of April this year for another operation, possibly including CW and RTTY. The two DXers made a total of 13,140 contacts on the 3.5, 7, 14, 18, 21, 24 and 28 MHz bands. They worked 105+ countries. The equipment used was a TS-50 to an R-5 and dipole antennas. QSL via JH1AJT, Yasuo "Zorro" Miyazawa, PO Box 8, Asahi-Ku, Yokohama, Japan 241.

## Future DX Activity

\* Charles S92SS is back in Sao Tome after a short holiday in the USA. He prefers 17 m CW, and his wife S92YL prefers 20 m SSB DX nets. Both will return to the USA in June 1997. When QSLing, make sure you put "Via Portugal" on the envelope.

\* Gary WA1JBB (ex-C53HG) will be staying in Namibia for the next four years. He is waiting on a V51 callsign.

\* Marcia, XYL of 9G1BJ, will be active for the next two years as 9G1TM, SSB only, mostly on 20-10 metres including WARC bands. QSL via G4XTA.

\* Mark ON4WW is active from Kigali, Rwanda as 9X4WW on 14118 kHz and 1827.5 kHz.

\* Jim KH2D will be active on 160 m for the next few months from 0800 and 1500 UTC on 1828 kHz. QSL via K8NA.

\* Ralf DL2FDK will be active from Thailand as HS0/DL2FDK from 17 January to 17 February on SSB and Pactor, 40 to 10 metres.

\* St Helena ZD7 can be heard on 7003 kHz on CW around 2200 UTC. Operator is Gilbert ZD7BG. QSL direct to Box 157, Island of St Helena.

\* Henry XQ0YQA, on Easter Island, is active on 21 MHz CW at 2100 UTC. QSL direct to Box 4, Easter Island.

\* SurJT1BH is working CW on 10, 15, 20, 40 and 80 metres. QSL to Box 125, Ulan Bator 13, Mongolia.

\* Charles TL8CK is active on 14165 kHz at 2000 UTC. His English is limited. A little knowledge of French will assist towards a successful contact. QSL via F6EWM.

\* Mike VE9AA is organising a DXpedition to St Paul Island, CY9. The date is around the middle of June this year.

\* Joe VE3BW intends to be active from St Kitts as V47CA from 3 to 17 February.

\* Expect some special contacts during February from Namibia. Charlie KY0A (V5/ZS6YG) is organising some activity with W8UVZ. They intend to participate in the ARRL CW contest on 15-16 February.

\* Watch out for the Scarborough Reef expedition early in May. Martii OH2BH is leading a number of operators to that reef.

\* Karl PS7KM and Tino PT7AA will be active from St Peter and St Paul Rock as ZY0SK and ZY0SG for two to three weeks starting around 25 January. Some reports suggest that the prefix will be ZV0. QSL via PT7AA for CW, and to PS7KM for SSB QSOs.

## Interesting QSOs and QSL Information

\* H44TQO - Gunnar - 14165 - SSB - 0931 - Nov (E). QSL via SM4NLL, Hans Ostervall, Hyttingsv 31, S-78134 Borleng, Sweden.

\* J68ER - Bob - 14222 - SSB - 0544 - Nov (E). QSL via W9UI, Robert W Esquire, 8334 Pleasant Plain Road, Brookville, OH 45309, USA.

\* 9M8FC - Chang - 14038 - CW - 1000 - Dec (E). QSL to Joseph Chang, PO Box 2127, 93742 Kuching, Sarawak, East Malaysia.

\* Z32XA - Ozren - 14020 - CW - 0629 - Dec (E). QSL via KM60N Mike T Jakiela, POB 286, Poway, CA 92074, USA.

\* FK5M - Eric - 14260 - SSB - 0436 - Dec (E). QSL via F6AJA Jean Michel Duthilleul, 515 Rue de Petit Hem, Bouvignes, F-59870, Marchiennes, France.  
\* 5X4F - Paul - 14164 - SSB - 0650 - Dec (E). QSL via K3SW James Di Kulp, Signal Hill Farm, 88 Signal Hill Lane, Middletown, VA 22645, USA.

\* 5H3HM - Yuki - 7080 - SSB - 1855 - Dec (M). QSL via JPIFJE via QSL Bureau.

\* 3B8/F5PYJ Claude Leclere, 169 Rue Du Mal Leclerc, F-79000, Niort, France.

\* XT2DP - Dan - 7082 - SSB - 1935 - Dec (M). QSL via WB2YQH Robert E Nadolny, PO Box 73, Springbrook, NY 14140 USA.

\* 5Z1PL - Peter - 7078 - SSB - 1735 - Dec (M). QSL via Peter Lutz, PO Box 1095, Limuru, Kenya, Africa.

\* V63CT - Lee - 14196 - SSB - 0832 - Dec (E). QSL via HL1IWD, via QSL Bureau.

\* A61AN - Naser - 14220 - SSB - 1206 - Dec (E). QSL to Naser Fekri, PO Box 53656, Dubai.

## From Here and There and Everywhere

\* It is with great sadness I report that "Bing" VK2BCH is now a Silent Key. Bing was a well known DXer in the 1980s. He was one of the early DXers who visited Rotuma Island and operated as 3D2XV. He was also active under the callsigns of VK9LB, ZK1XV, 5W1GY, ZK3RVC, A35XV, T20XV and YJ0AXV.

\* The Southern Cross DX Net is operating again at 1100 UTC each day on 14255 kHz. Net controller is Alan VK4AAR.

\* Antoine 3D2AG was on Rotuma for one month preparing for the last year of his university studies. He said that he intends to be more active in the future.

\* Matthew Island, a possible new IOTA Island, was activated by Eric FK8CR and FK8GM for 24 hours on 3 and 4 December under the callsign FK5M. Matthew Island is situated a little south of 22° South Latitude and a little west of 172° East Longitude and is claimed by both France and Vanuatu. There has been a couple of "Flag" raising incidents so far and, at times, different ships have been dispatched from either side to "claim" it. It is an uninhabitable island and is of little use to either country except for the economic zone surrounding it. The French Navy maintains a small amount of provisions there for any shipwrecked person. This was the total activity on this island until 3 December at 2000 UTC when a French DXpedition opened up another page in its history. The trip to the island was by boat and helicopter. The DXpeditioners left the island at 2000 UTC on 4 December. QSL via F6AJA.

\* How to celebrate a birthday? Austin VK5WO made sure it was a special celebration. On that day he was on a 12 hour return flight over Antarctica on a Boeing 747. It was a great experience, one that Austin will remember for a long time.

\* Kerguelen and Crozet islands were very active during 1996, but things have changed. FT5WE, FT5WF and FT5XL all went home at the end of the year, and they will not be replaced with personnel with amateur licences.

\* The Society of New Foundland Radio Amateurs will operate VO500JC special event station during all of 1997 to commemorate the 500th anniversary of John

Cabot's voyage to the new world. The activity will take place from the VO1AA club station. QSL via VO1AA.

\* Competition is the "in" word these days. Old ventures disappear or merge, new ventures become alive. *The DX Bulletin*, for many years edited and published by Chod Harris VP2ML, was taken over by Paul AE4AP and Nancy KB4RGW in August 1996, together with *The DX Reporter* and the *DX Magazine*. In late November 1996, *The DX Bulletin* and *The DX Reporter* merged with a relatively new publication, *The 59(9) DX Report*. Bob WB2YQH will continue to edit and publish *The 59(9)DX Report* from New York State. The *GOLIST*, a well known QSL Managers' list, first changed hands in July 1995 from Jay and Jan O'Brien, W6GO and K6HHD, to Paul and Nancy Smith, AE4AP and KB4RGW. Due to a reorganisation, the new publisher of the *GOLIST* is now John Shelton WB4RRK as from December 1996. It appears that Paul and Nancy will concentrate on producing only the *DX Magazine* in the future. *QRZDX*, which is one of the oldest of the *DX* bulletins, is in its 19th year of publication. It has been edited and published by Carl Smith N4AA since April 1995.

\* Jin JF1IST was active for one week last December from Eritrea as E31FAO. QSL via JH1AJT.

\* According to the Japanese *Five Nine DX Magazine*, Yasu JH1AJT and Jun JH4RHF visited Pyongyang, the capital of the Democratic People's Republic of Korea, from 22 to 26 October. During their visit they met a senior North Korean commissioner, Mr Park Kwang, of the Amateur Radio Association which operates under the umbrella of the National Athletic Committee. There was also some demonstration of modern amateur equipment to the officials. Another rumour, originating from a Spanish source, says that Martii Laine OH2BH, who was attending the Spanish Amateur Society's annual general meeting, was overheard announcing that P5 would be activated before May this year in a "big" operation.

\* Mani VU2JPS has finally received the radio equipment donated by HIDXA. In a fax to Jim VK9NS, dated 26 December 1996, Mani expressed his thanks and gratitude to the members of HIDXA for the donation of a Kenwood TS680S, a Kenpro KR400 antenna rotator for a Cushcraft A43 antenna and a variety of cabling which he received in good condition. It is now up to Mani how often he appears on the bands. The situation with an Andaman prefix of VU4 is still unclear and, of course, the DXCC still has to decide whether they will accept the activity as valid

for the DXCC award. According to Jim, the whole exercise grew to be a very costly project with freight, customs duty, handling, fax and telephone costs, not to mention the value of the equipment itself.

\* YI1RS was heard on 20 m CW. Operator was Amir, PO Box 55072, Baghdad, Iraq.

### QSLs Received

9M8FC (2 w op), 9J2CE (4 w - IN3VZE), C56DX (7 w DL7DF), TT8SP (6 m - N8TV), 3C5Z (1 m - N6ZZ), 5R8F (2 m op).

---

## Novice Notes

Peter Parker VK1PK\*

---

### Operating Portable

#### Introduction

One of the most enjoyable facets of amateur radio is operating portable. You may live in an area plagued with electrical interference, antenna space restrictions or dwell in an "RF hole". In such cases, portable operation allows you to obtain contacts not possible from home.

Or you may be planning a holiday or excursion. While not a substitute for proper RFDS or Marine equipment, amateur radio can add to the enjoyment of the trip, whether you take a VHF hand-held, homebrew QRP rig or full HF station.

Those involved in amateur radio publicity, WICEN, or community service activities will find a properly functioning portable amateur station an asset. Having such a capability also allows you to respond quickly in emergencies.

So there are many reasons to go portable. With the warmer weather upon us, now is a good time to make your amateur station ready for portable operation. An additional incentive is next month's John Moyle Field Day Contest, an event which specifically encourages portable operation.

This article deals with both VHF/UHF and HF portable operation. It also gives a few tips on equipment, power supplies, antennas and operating sites.

#### Equipment

With today's compact transistorised transceivers, almost any hand-held, mobile or home station transceiver can be used portable.

Many operate portable with hand-held VHF or UHF transceivers. While these are fine for limited local operation, one soon finds that short battery life and poor antenna efficiency place a limit on what can be achieved. In addition, many hand-held two metre transceivers have poor receive front-

### Thank You

Many thanks to my fellow amateurs, whose assistance is always very much appreciated. Special thanks to: VK1ZL, VK2XH, VK2YX, VK2JDM, VK2KFU, VK2TJF, VK4AAR, VK5QW, VK5WO, VK8DK, VK9NS, YJ8AA, ZL4MV, ARRL DX Desk, *QRZ DX*, *The 59(9) DX Report*, *The DX News Sheet*, *The 425 DX News* and the *GOLIST* QSL Managers List.

\* PO Box 93, Dural NSW 2158

ar

ends, which make them susceptible to overload from pager transmitters in some areas. Fortunately, as you will read later, many of these disadvantages can be overcome.

Mobile VHF or UHF transceivers are also suitable for portable use, particularly where they have several output power settings to conserve power. Another benefit is that their immunity to pager interference is often superior to that of hand-held equipment. While many older ex-commercial crystal-controlled mobile transceivers exhibit even better immunity, having just a few frequencies available is a severe limitation for hilltop operation. The author has found the 2.5 watt Yaesu FT290R a good performer for portable operation. This particular transceiver also features SSB/CW facilities, permitting extended-range terrestrial and satellite contacts to be had as well as the possibility of later adding a transverter for the HF bands.

There is not a lot of difference between most modern HF rigs for portable operation. However, the standard 100 watt power output is likely to limit transmitting to short periods with anything less than a generator or substantial battery. An alternative is to modify these rigs to low power (QRP) operation. Such modifications are not hard - often you do not even need to remove the lid (Reference 1 is an example).

Another possibility is to purchase the older, lower power, solid state HF transceivers designed specifically for Novice licensees. Examples of such transceivers include the Yaesu FT7 or Kenwood TS-120V. An advertised price of \$300 to \$400 is typical for these sets.

If your scale of operation is such that a full HF station is not warranted, operation on one or two bands can be contemplated. Eighty and forty metres are a good combination for South-Eastern Australia, allowing contacts at

most times. Home construction of suitable equipment is quite feasible for those with previous practical experience.

At this time of the year ten metres comes into its own, with many quality, interstate sporadic-E contacts able to be had. A converted CB will yield good results during such times. However, at this phase of the sunspot cycle, 28 MHz is unpredictable, and one can go for days or weeks without hearing anything. For this reason, portable operators should consider taking equipment for other bands until conditions improve.

### Power

The power source for a portable station can range from a nicad battery pack on a hand-held transceiver to a generator capable of running a full-power HF station. Others use car batteries, sealed lead acid batteries and/or solar panels to power their station.

The power source eventually adopted depends on:-

- \* the period of portable operation;
- \* transceiver current drain; and
- \* size/weight considerations.

Portable operators find that there is a trade-off made between operating period/transmit power output on the one hand, and battery capacity/size/weight on the other.

Your need for transmit power depends on the results desired. In a comparatively

densely populated area, a power output of five watts from a good site should yield results on VHF/UHF, and allow several hours of operation from a relatively compact battery. On 80 metres, a power output of between two and 20 watts on SSB should suffice for most short and medium distance work. Such powers are also practical on 28 MHz when the band opens.

The author considers that the rechargeable, sealed lead-acid battery (or "gel cell") is the most reliable and cost-effective power source for several hours of operation with low to medium transmit powers. As remarked earlier, small nicad battery packs give only a short "talk time". As well, they seem to run out at the most inopportune moment. Much more use from a hand-held transceiver can be obtained by running it from a 12 volt sealed lead acid battery. However, caution should be exercised here. Apart from checking the polarity of connections, one should verify that the hand-held is able to take the full voltage put out by a well-charged battery. If not, a voltage regulator should be constructed to bring the voltage down to that required. Alternatively, batteries complete with in-built regulators are commercially available (Figure 1).

When using larger pieces of equipment, it makes sense to draw up a power budget so

that you know approximately how long your battery will last. Transmitting demands more from the battery than does receiving, with the difference increasing with transmit power. Different activities have differing transmit/receive time ratios. For instance, one-to-one operating is more power intensive than a large net with many on frequency.

To draw up a power budget, you need to know the following:

- \* transmit current consumption;
- \* receive current consumption;
- \* transmit/receive ratio; and
- \* battery capacity (in amp hours).

The first two can be obtained from your transceiver's instruction manual. The battery's capacity should be printed on the battery itself, while you can take a guess for the transmit/receive ratio.

We will use an example here of a Kenwood TS-120V, a popular transceiver for HF portable operation. Its transmit power consumption is 4 amps, while on receive it draws 0.7 A (at 13.8 volts). We assume that we will be listening twice as long as we're transmitting (ie transmit/receive ratio of 1:2). Thus, in an hour one would be transmitting for 20 minutes (0.33 hr) and receiving for 40 minutes (0.67 hr). The object of this exercise is to find the mean power consumption of the station in a given hour of activity. Armed with this information, one could then determine how long a particular battery is likely to last or, conversely, how long one can operate with a battery of a given capacity.

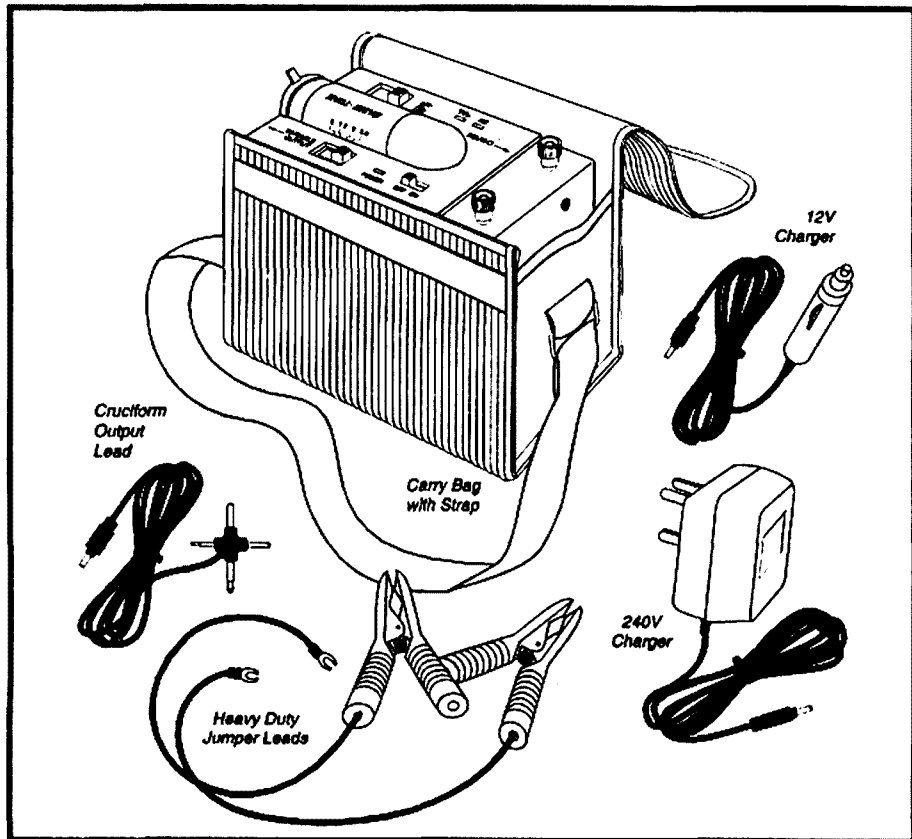
A calculation for the TS-120V would be as follows:

Receive contribution:  $0.7 \text{ A} \times 0.67 \text{ hr} = 0.47 \text{ Ah}$   
 Transmit contribution:  $4.0 \text{ A} \times 0.33 \text{ hr} = 1.32 \text{ Ah}$   
 Total (for 1 hour):  $= 1.79 \text{ Ah}$ .

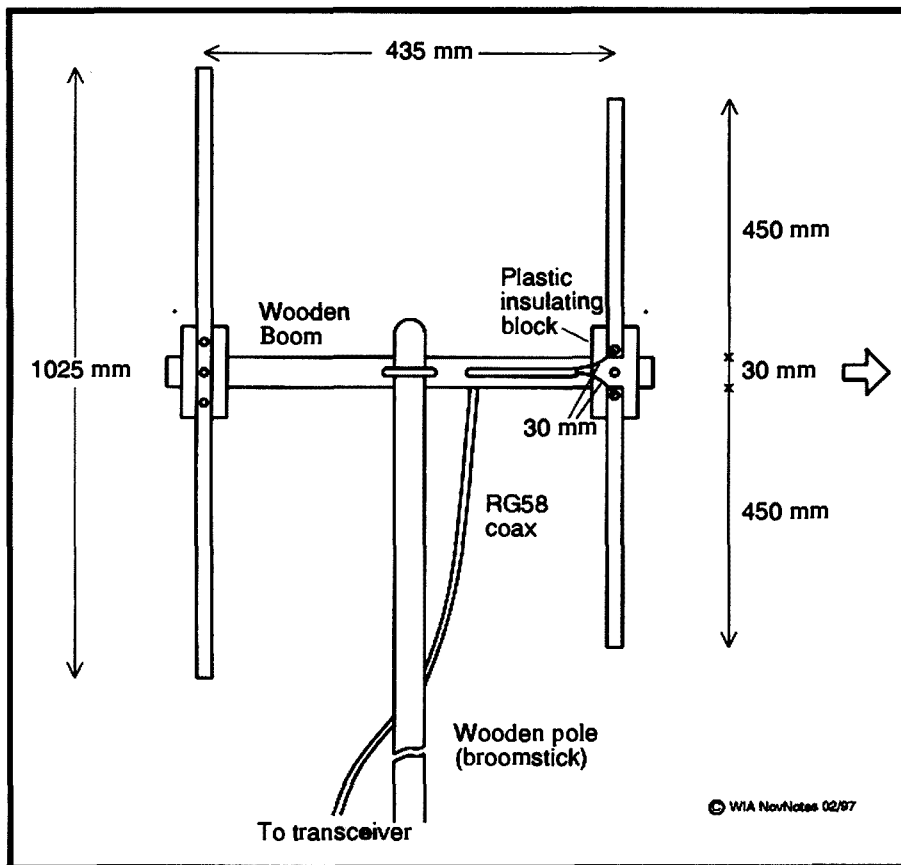
Thus, if we were to operate in this manner for one hour, we would need a total battery capacity of around 2 Ah. With a 6 Ah battery, it should be possible to operate for at least three hours. Empirical tests with a TS-120V and a 6.5 Ah battery showed that ample capacity was available for this period of operating.

The figures above are conservative. This is because the transmit/receive ratio assumed is more typical of active contesting than casual operating, which tends to involve more listening. As well, the SSB and CW modes have lower duty cycles than FM or digital modes, where the transmitter is radiating full power (and thus drawing maximum current) during the entire time the operator is transmitting.

Performing a few calculations like this will reveal why much portable operation takes place with lower transmit powers than is usual from home. Doubling output power will not necessarily improve the quality of



**Figure 1 - A commercially-available rechargeable battery pack and regulator (courtesy Daycom Communications Pty Ltd).**



**Figure 2 - A simple two element Yagi for two metre portable use.**

contacts achieved, but will have a large effect on power requirements and/or the operating time permitted per battery charge.

### Choosing a Site

On not every occasion can one choose the operating site. However, when a choice is possible it should be made with the following factors in mind:

- \* general site amenity (access, shade, freedom from high winds, etc);
- \* distance from power lines (for both safety and interference reasons);
- \* distance from other man-made interference sources;
- \* availability of trees (for supporting HF wire antennas);
- \* altitude (particularly for VHF/UHF operating);
- \* clear paths in desired directions (particularly for VHF/UHF operating); and
- \* distance from pager transmitters (especially for two metre activity).

The relative importance of each of these factors will vary according to the bands used, and the type and distance of contacts desired. Depending on equipment quality, some sites will be unusable for two metre operation because of strong signals from pagers and other transmitters. However, with better equipment, a cavity filter or even horizontal antenna polarisation, the site could prove

useable. As well, other factors can come into play. For instance, if one were experimenting with vertical antennas which rely on a good ground system, an area surrounded by salt water or wetlands might be a good choice.

### Portable Antennas

Like the operating site, the antenna chosen depends on the contacts desired and the type of activity.

Again, the popular VHF and/or UHF hand-held transceivers with their short helical antennas are not ideal. Fortunately, better antennas can be made at home. Perhaps the next step above the standard antenna is a quarter wave whip plugged directly into the rig's antenna socket. Or, a 1/4 or 5/8 wave ground plane can be fabricated from easily available materials - designs frequently appear in the popular amateur handbooks. Still others use J-pole antennas, made either from metal tubing or a length of 300 ohm feedline small enough to be rolled up and carried in a pocket.

Transmit and receive coverage can be further enhanced through the use of a small beam antenna. Gains of 8-10 dB over a dipole are possible with portable Yagi or quad antennas. However, above this level the antenna's boom needs to be lengthened considerably to achieve even a small amount of additional gain. Figure 2 shows a two

element Yagi suitable for two metre portable use. Built on a wooden boom, it makes use of elements from a discarded television antenna. No balun or special matching section is required if the antenna is fed directly with 50 ohm coaxial cable (RG58 suggested for short runs). A wooden mast or tripod can be used to mount the beam. The gain of this antenna would be approximately 4-5 dB above a dipole. Empirical tests have confirmed the Yagi's gain.

Amateurs transmitting from good sites in densely populated areas may find that two or more repeaters are accessible on the one frequency. By concentrating the transmitted signal in one direction, a Yagi or quad allows operation through one repeater without disturbing those listening on other repeaters who would otherwise be hearing one side of the conversation taking place. In such cases, a beam is desirable, not so much because of its gain, but its directivity.

Note that on VHF/UHF, vertical antenna polarisation is favoured for FM and packet radio operation, while horizontal is used by SSB operators. Failure to observe this convention will result in many lost contacts; cross-polarisation losses can be very high. On HF antenna polarisation is much less significant.

On the lower HF bands, most portable operators use simple dipole or inverted-vee antennas. The latter are particularly convenient, as only one central high support is required; the ends can be tied off at only a metre or two above ground. Those using several bands have the choice of multiple dipoles, trapped dipoles, or tuned feeder antennas.

Generally, the antenna should be mounted as high as possible. In most areas it should be possible to find a suitable tree to support an antenna, though there are cases when it would be wise to bring a collapsible mast. Further details on antennas and their construction can be found in the standard handbooks or back issues of *Amateur Radio*.

### Accessories

We have looked at equipment, power supplies and antennas required for portable operation. However, there are a number of other accessories that help make portable operating more enjoyable.

These include:

- \* external speaker-microphone (if using a hand-held transceiver);
- \* RF field strength meter/SWR bridge;
- \* multimeter;
- \* back-up batteries;
- \* logbook/pens;
- \* clock/watch;
- \* VK Callbook (particularly for lists of repeaters, bandplans, addresses); and

\* Personal needs (food, water, insect repellent, shelter, etc).

It may be a good idea to make a checklist of the above items so that none are left behind, particularly if operating some distance from home. Some go further and mount their equipment in cases large enough to carry accessories as well as the transceiver itself. Such an arrangement makes it easy to go portable at short notice.

### Conclusion

This article has provided some pointers on amateur portable operation on the HF/VHF/UHF bands. A good thing about it is that you will probably have most of the

equipment required. As well, a portable station can start off very simple and be gradually added to as time and inclination allows. Don't forget the John Moyle Field Day a little over a month away on March 15/16; the rules are in the *Contests* column in this issue of *Amateur Radio*.

### Reference

1. Buxton, S – Use of IC735 HF Transceiver for QRP Operation – *Amateur Radio*, August 1996, page 24.

\*7/1 Garran Place, Garran ACT 2605  
VK1PK @ VK1KCM.ACT.AUS.OC  
parkerp@pcug.org.au

ar

---

---

## Over to You – Members' Opinions

All letters from members will be considered for publication, but should be less than 300 words. The WIA accepts no responsibility for opinions expressed by correspondents.

---

---

### Lazarus Revisited

I must exclaim that "reports of my death are highly exaggerated!". Your reporting of me as a "silent key" in January *Amateur Radio* has caused me much consternation and exacerbated my ongoing problems with haemorrhoids and flatulence which, in turn, has put me into deeper domestic conflict with the war office (XYL).

I did but compose a small tribute to our late and highly esteemed OldTimer "Trig" Trigwell, which was sent to you by Clem VK6CW. Somehow, you managed to despatch me to those realms where communication is no longer possible using electromagnetic waves but must be carried out by ectoplasm visitations, the use of a ouija board or a Medium.

For years I have suffered the ignominy of having my name firstly used by some singer back in the "sixties" and more recently by Tom Hanks, perhaps in an Oscar award-winning performance in "The Blurbs". Now the final and cruellest cut of all – being named a "Silent Key"!

I ask, sir, nay DEMAND a full retraction of this vile mischief; in pain of non-compliance may an exceedingly high VSWR be visited upon your antenna feeder!

Yours healthily (at the time of writing),

Ray Peterson VK6PW

11 Clive Street  
Bicton WA 6157

*[We most abjectly apologise, Ray. The confusion came about as you have indicated, your callsign being attributed to Trig. We are glad you can see the humour in our inexcusable error. Ed]*

### CW Contacts

May I pass some comments on CW ("to be or not to be"), and my experience to date.

Reaching the age of 72 years, I decided somewhat belatedly to try to join the ranks of amateur radio operators. Being successful in attaining Novice status in April 1996, I decided to try for a full call in late December.

Although able to send and receive at 12 wpm, I find it very hard to achieve a contact on CW (80 metres), although I have no problems with voice.

As Professor Julius Sumner Miller would say, "why is this so"? Is it that the "old hands" do not want new chums to dabble in THEIR mode? If so, CW is destined for a quick and hopefully a painless death.

Bernie Dawson VK2MPN

1 Gobondery Street  
Trundle NSW 2875

### Lost Yachts

World Race Yachts are in the News. We have the press and TV media saying they are in trouble in latitudes far beyond radio communication. What absolute rubbish. If by chance they have no HF radio on board, then they should have been prevented from starting in the race.

Years ago in a similar race I, and other amateurs, worked the yachts approaching Perth and then into Sydney. Likewise, I have kept watch on aeronautical mobile people coming from the USA into Australia, all on a dipole and Kenwood TS-520. No big deal, but they did have positive communication and position reports.

Did anybody work these yachts at all, or did people press buttons which did not work?

For a long time now the so called 11 year cycle and solar flux and other fancy names have been a cop-out for bad communications. Pressing buttons and putting in various filters will not get you a QSO. Leave the filters out,

spin that dial and you will get plenty of contacts.

If possible, upgrade to CW and you will NEVER be without a contact. If you press that key, or use phone on the correct frequency, and use GMT for time, then you will be able to stop using QSB, QRM, and QRN, etc as an excuse.

Expensive transceivers and keyboards and screens to copy CW are not the answer to amateur radio activities. All too often one hears a contact broken off because of the well used "QSB". What the blazes do they expect?. Try working in the tropics or at sea or in the air, and you will see you never had it so good from your comfortable room. If you have one of these new transceivers that make tea and talk to you, learn to use it correctly and don't waste your money.

I hope the yachtsmen are found OK.

G W Lanyon VK2AGL

16 Hilton Avenue  
Roselands NSW 2196

*[It would seem that communications was not the problem. Unstable boats and vicious weather were! The fact that three were successfully rescued shows that the safety systems did work. Ed]*

### More CW Information

The letter from Steve Ireland about CW is wrong on several counts.

1. Most ships do not use CW. The few that do will phase it out by year 2000 when the GMDSS becomes mandatory [*Global Maritime Distress and Safety System. Ed*]. In Australia on 30/6/93 there were 66,290 marine station licences, none of which used CW to communicate. Less than 197 of them would even have had a transmitter capable of CW mode and those ships do not carry a radio Morse key.

2. Regulations aside, no professional seafarer would put to sea with only amateur radio to cover emergency communications.

3. It is irrelevant to amateurs if ships use CW or not, as there is no common frequency to communicate on legally. It is not that long ago that general coverage receivers became common; prior to that amateur gear would not even hear ships.

Is your best reason for CW really to decode a beacon?

Instead of assigning mythical and magical qualities to CW, Mr Ireland should enjoy his bit of the hobby and be happy the rest of us enjoy our bit.

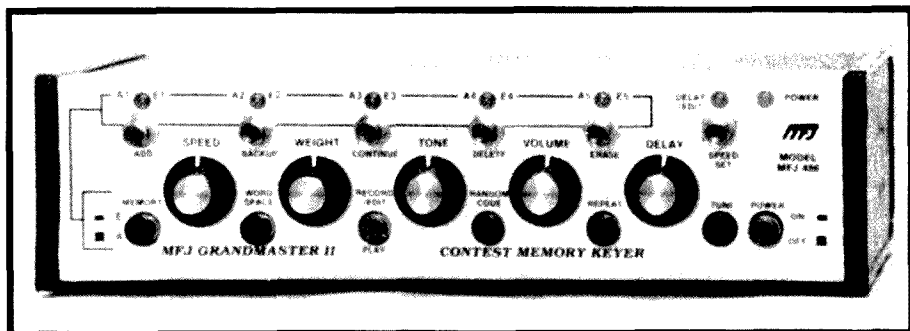
Steve Truscott VK2SPT

158 Regal Way  
Valentine NSW 2280

ar

# Pounding Brass

Stephen P Smith VK2SPS\*



The MFJ-486 Grandmaster Contest Memory Keyer

## Grandmaster Keyer

The number of electronic telegraph aids for operators currently on the market today is quite astounding. Whether it's to assist the operator learn Morse, or to help in his sending ability, or a combination of both, today's operators certainly have the advantage over the operators of yesteryear.

This is particularly true in contest situations where, with the press of a button, the operator can send a pre-programmed message prepared before the event. This relieves the operator of some pressure, especially if he/she is using a pump key or iambic paddle where sending mistakes do crop up after many hours of contesting.

Some operators are quite content to send without the use of electronic telegraph aids, yet others swear by them. I believe the choice is up to the individual. However, sometime during your operating career, you will come across them. So, why not give them a go? You may even like them!

One unit I believe is worth a mention is the MFJ-486 Grandmaster Keyer which is a microprocessor controlled iambic memory keyer. This state of the art unit is not cheap, costing \$409 from Daycom Communications Pty Ltd, but what it offers the operator is truly amazing.

The unit comes with a well written manual with 11 of the pages being approximately A4 size. I would recommend you read the manual several times as it is very easy to miss a particular sequence, especially in the programming steps.

## Rear Panel

The MFJ-486 power requirement for correct operation is a voltage between 12-15 VDC; anything more will damage the unit. A 2.5 mm male plug is required for power input.

A standard 1/4" stereophonic plug, which

plugs into the rear of the unit, is required to use a standard paddle. The unit is also equipped with a headphone jack if private listening is required (a 3.5 mm mono plug). The internal speaker is quieted when the headphones are in operation.

The unit is equipped for grid block and cathode keying. For cathode keyed and solid state transmitters, use the direct keying output. If in doubt try both outputs.

## Front Panel

There are five large black rotary knobs located on the front panel and are for adjustment of speed, weight, tone, volume and delay.

### Speed

This control, in conjunction with the speed set switch, is used to adjust keying speed. There are three settings, depending upon the position of the speed control knob. If the knob is set fully clockwise, and the speed set switch is depressed, the keyer speed is set to 20 wpm (this can be adjusted from four wpm fully anti-clockwise to 20 wpm fully clockwise). If the knob is fully anti-clockwise and the speed set switch is depressed, the keyer speed will be set from 20 wpm to 100 wpm fully clockwise. The third setting is a compromise between the above two settings.

### Weight

This adjustment sets the Dot/Dash ratio from 1.3:1 to 5:1.

### Tone and Volume

The tone knob adjusts the pitch of the CW note. The volume control adjusts the loudness which should be set to a level for easy listening.

### Delay

This control sets the delay time before a message, which is programmed in memory, is repeated; or, in random code, sets the spacing between characters and words.

Underneath the above controls there are six push button controls which, depending on their positions, can have double functions.

## Memory Button

This switch controls which memory bank is used. There are two memory banks with five addresses on each bank. The banks are A and E. The memory locations are numbered from 1 to 5 (more on this later).

## Word Space

This control has two functions. In random code it selects either fixed or random group of characters, and in Record/Edit mode it selects manual or automatic word spacing.

## Power On Off

Turns unit on and off (red button).

## Recording/Editing

This red button provides five settings:

1. A1/E1 Switch – manually adds word spaces in the manual word space mode;
2. A2/E2 Switch – backup one word from the current point;
3. A3/E3 Switch – continue to play the message from the current point;
4. A4/E4 Switch – delete the last word played; and
5. A5/E5 Switch – erase the entire message address from memory.

The A bank is denoted by a red LED on the panel and the E bank by a green LED.

## Recording Messages

To record a message the above buttons are set in a particular order as per instruction manual. When keying in a message, and you hear a long low tone of about two seconds duration, the MFJ-486 doesn't recognise the character being keyed. You may immediately retry the character and the keyer automatically deletes the invalid character.

Once a message has been recorded into memory you can check your message for any errors by hitting the continue button and the message will be played back. When the message reaches the end there will be a delay as set by the delay control before the message repeats itself. After confirming the message is correct, press the dot paddle at the end of the message before it repeats itself. If you make a mistake with the message you can correct the mistake by depressing the backup button.

The backup function will make the editor move backwards one word. You can re-enter the incorrect word and continue with the rest of the message. At any time while the message is playing you may interrupt the message by sending from the key paddles. The message will automatically pause. When the address switch is again pressed the message will finish playing from the point it was paused.

## Random Code Generator

This function has two modes of operation

character sets and messages based on live QSOs, similar to the British RAE examinations. If Morse characters, including punctuation, are to be received, the record/edit button remains out; with the automatic word space button in, groups of five characters are sent; with the button out you receive random group lengths from 1-8 characters. Depending on which mode you are in, you can stop the random code by hitting the dot paddle and restart it by pressing the dash paddle.

The delay knob, as mentioned earlier, can be used to increase the spacing between characters. Messages E1 to E5 remain the same, while messages A1 to A5 will repeat until power is turned off; when turned on again, messages A1 to A5 will have changed.

This has been only a basic outline of the features offered by the MFJ-486 microprocessor memory keyer. Some

difficulties were encountered, especially loading the unit with messages and learning the required sequence of button and knob setting. These problems were overcome by further reading of the manual and with practice.

The MFJ-486 is a top class performer and one that any operator would be proud to own.

### NATO Telegraph Key

In the December Issue of *Amateur Radio*, we looked at the NATO Telegraph Key model 5805-99-591, of which Brian VK2GCE had a few for offer. Unfortunately, his home telephone number was incorrect. The number should have been (02) 9545 2650. Sorry, Brian, for any inconvenience.

Next month, computer programs; can they really help a beginner?

\*PO Box 361, Mona Vale NSW 2103

ar

varicaps to a different type that give the VCO a greater frequency swing, and thus a better chance of locking up reliably. I found that, with the original varicaps, the PLL would lock but the adjustment of L8 was very critical. In this state it would fall out of lock every so often.

Now for the receiver. This proved relatively easy. The crystal frequency remains as per the manual. Rx Xtal =  $(f(\text{carrier}) + 10.7)/2$ . If you are planning to operate around 53.5 MHz +/- 100 kHz, you may run into trouble with a 10.7 MHz IF and may have to look around for the more rare 10.8 MHz IF units.

Add 12 pF across C75 (under PCB), add 12 pF across C76 (under PCB), add 5.6 pF across C71, C72, C73 and C74 (all within the screened enclosures), and add two turns to each crystal netting coil used ie L7, L8, etc.

Whilst discussing the receiver, during the alignment ensure that C75 and C76 are peaked as per the manual by monitoring TP1. I tried this after reading Will VK6UU's recent *Repeater Link* article in *Amateur Radio*, and found better sensitivity than could be achieved by ear!

The PA amplifier: change C26 to 82 pF, add 47 pF across C20 (under PCB), add 47 pF across C22 (under PCB), add 47 pF across C23 (under PCB), add 47 pF across C25 (under PCB), and add 27 pF across C24 (under PCB).

The harmonic filter. At this stage I remembered reading another of Will's *Repeater Link* columns. In the February 1994 issue of *Amateur Radio*, he suggested: add two turns to L1, add one turn to L2, and add two turns to L3.

I applied this to my unit and, not having a proper spectrum analyser in the shack, checked it on the poor man's spectrum analyser and an FM broadcast receiver, along with a calibrated signal generator. I concluded that the second harmonic content was well down. At some stage when I get a

## Repeater Link

Will McGhie VK6UU\*

### Fees

Interesting developments in the increase in repeater licence fees, but I have been asked not to comment at this time. By the time you read this it may be general knowledge. It is difficult writing about this situation due to the delay of about six weeks from when the article is written, until it appears in print. Suffice to say the changes to the cost of licensing repeaters and beacons, if not changed, will see many repeaters and beacons closing down. This has already started to happen in VK6.

### More on E Band to 6 m

I received this description on modifications to the FM828 E band radio to 6 metres from Peter VK2XZP. I have presented modification ideas in the past, and Peter's notes make for an interesting addition, particularly the changes to the varicap diodes. The following is from Peter VK2XZP:

### FM828 E Band Modifications to 6 m

Following a recent exercise converting an FM828 E band remote radio for use on 53.0 MHz packet, I have developed a set of modifications that appear to work. These modifications have only been implemented on one radio at the present time, and have not been fully optimised for the best performance. They are a good starting point, but may require some minor adjustment to get the best results.

I will firstly deal with the exciter. This part proved to be by far the hardest to get going. I have retained the same crystal calculations, as per the service manual: Tx Xtal =  $f(\text{carrier})/8$ .

The modifications are: change C2 to 270 pF, change C3 to 120 pF, and add 27 or 39 pF across the crystal (under the PCB).

These steps would have to be repeated for any other channels implemented: add 12 pF across L4 (under PCB), add 12 pF across L5 (under PCB), add two turns to L6, and add two turns to L8.

Remove both D2 and D4 (varicaps) and substitute a single dual varicap, a BB212, in their place. Add 27 pF from the hot side of L8 to ground (under PCB).

You will note that I have changed the

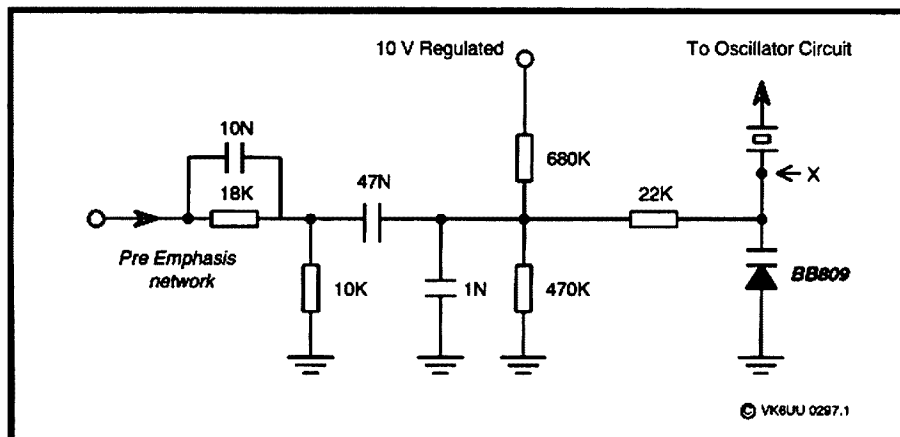


Figure 1 - True FM for the FM828.



chance, I will set the unit up on a proper spectrum analyser at work to view the performance of the harmonic filter and PA.

I hope these notes are of help to you. I must stress that these modifications are not the optimum. I will be interested in hearing from others who have done the same as myself, or have tried my suggestions, and welcome any changes or improvements to my suggestions.

I can be contacted by packet at [vk2x:zp@vk2xbr.nsw.aus.oc](mailto:vk2x:zp@vk2xbr.nsw.aus.oc) and by e-mail at [pmudie@keycorp.com.au](mailto:pmudie@keycorp.com.au)

### True FM of FM828

I have mentioned using direct FM of repeater transmitters for better quality audio, but I had forgotten to reproduce the circuit in *Amateur Radio*. Here it is.

The transmitter reference crystal in the FM828 has to have one side of the crystal isolated from AC ground. At this point (shown as point "X" on the circuit) a varicap is placed between the crystal and ground. Audio is applied through the 22 k isolation resistor, along with about four volts bias. The BB809 was chosen as it has a high capacitance change with respect to voltage change, and I found the diode cheap and easy

to find. Note the bias voltage must be regulated.

Direct FM (also called true FM) does not have inherent pre-emphasis, so this is done by the components, 18 k, 10 nF and 10 k. I have shown the pre-emphasis components on this circuit, but they would be better placed before the amplifier that drives the varicap diode. This is to allow for as much audio voltage as is possible to be applied to the varicap. Crystals have different deviations for the same audio input. Some require a lot of audio to produce the required deviation. The pre-emphasis network as shown reduces

the audio level that can be applied to the varicap. Placing the pre-emphasis network before the audio driving amp allows for greater audio to be applied to the varicap.

The audio amplifier driving the varicap should have a fairly low impedance, as a high impedance source nullifies the low cut of the 10 nF capacitor. An ideal amplifier for this task can be found in the December 1991 edition of *Repeater Link* in *Amateur Radio*.

*\*21 Waterloo Crescent, Lesmurdie 6076*

*Packet: VK6UU @ VK6BBR*

*E-mail: will@vale.faroc.com.au*

ar

**Have you advised the WIA Federal Office of your new callsign? Use the form on the reverse of the Amateur Radio address flysheet.**

## PRESS RELEASE

### MINI-CIRCUITS DESIGNER'S GUIDE

To encourage Radio Amateurs to build and develop their own communications equipment, Mini-Circuits USA are offering, free of charge, their RF/IF Designer's Guide.

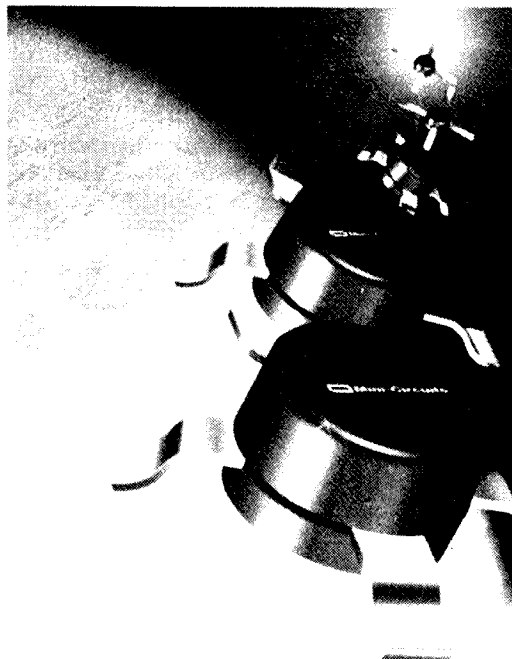
Mini-Circuits manufacture an extensive range of mini-modules, such as RF Amplifiers, Frequency mixers, Power splitters, Filters, Detectors, Attenuators, etc. Circuits are available in various case style packages to suit applications from surface mount to external equipment mounts.

Typical Mixer frequency range from 10kHz to 4.3GHz, making them ideal for engineers interested in LF to SHF work.

If you would like a free copy of RF/IF Designer's Guide, contact Mini-Circuits Australian representatives and stockists.

Clarke & Severn Electronics,  
PO Box 1, Hornsby NSW 2077  
or 02 9482 1944.

## LOW COST ERA AMPLIFIERS PROVIDE LONG TERM RELIABILITY



*Next generation technology and economy are built into Mini-Circuits new series of drop-in and surface mount MMIC amplifiers. The ERA-1 through ERA-5 (and SM versions) are designed to provide generous levels of inexpensive signal gain, and wide dynamic range for applications to 8GHz (usable to 10GHz). And you can count on ERA's reliability for the long-run! At a junction temperature of +185°C, mean time to failure (MTTF) is more than 10 years. A junction temperature of just 5°C less results in an improvement factor of four in MTTF! ERA amplifiers provide the long-term, trouble free operation you can bank on.*

**Mini-Circuits from Clarke & Severn Electronics  
PO Box 1, Hornsby NSW 2077  
Phone: (02) 9482 1944 Fax: (02) 9482 1309**

# Spotlight on SWLing

Robin L Harwood VK7RH\*

The last month of 1996 proved to be a rather tumultuous one for the staff at Radio Canada International. Just before the close of business on Friday, 6 December, the staff were assembled and told that Canada's shortwave service would cease to operate as from 31 March 1997 and that the 123 staff would lose their jobs. This was announced by the parent organisation, the Canadian Broadcasting Corporation, who cited the lack of available funding as the reason. The parent organisation also announced that 10 to 20% of the staff throughout Canada would also lose their jobs.

Naturally the RCI staffers were very depressed, as there had been huge public reaction to the earlier proposed shutdown which resulted in temporary funding being made available by the Federal Government in Ottawa. However, before the huge protest could be mobilised, the Canadian Minister for External Affairs hastily made a statement

in the House of Commons in Ottawa on Thursday, 12 December that funding had been found and that it was not the intention of the Federal Government to close Radio Canada International. It was also claimed that the CBC management had jumped the gun. Funding had been found for another 12 months to keep it going, which relieved those at RCI plus the millions of loyal followers of Canada's shortwave service throughout the world. Not surprisingly, funding for the domestic CBC organisation was not forthcoming so the big reductions in AM/FM and TV programming will go ahead.

Cutbacks seem to be continuing as Radio Vlandeeeren International in Belgium announced that it was axing several language services and also reducing programming, although programming would be continuing in English and Dutch.

Radio Denmark commenced broadcasting a ten minute monthly English program last year but have already dropped it. A commercial Danish station, known as ABC Radio in Copenhagen, which was heard last year broadcasting from Kalingrad in Russia, also ceased on shortwave after a management reshuffle.

The BBC World Service is continuing after funding was guaranteed to keep it going although some economies are to be introduced. The agreement also recognised the autonomy of the BBC World Service, although the funding does come from the Foreign and Commonwealth Office. The "Beeb" has been undergoing some painful restructuring but the Shortwave service has now emerged as an entity on its own while the domestic services are being re-organised, with the various sections being split up and opened up to privatisation.

Programming will now be made outside the BBC and opened up for tender. The first stage of the privatisation has just happened with all of the domestic AM/FM and TV senders being sold to an American concern. According to the London Daily Telegraph on Saturday, 4 January, all the UHF TV, VHF/FM radio and long and medium wave sites, have gone to "The Castle Tower Corporation", a consortium which is based in Houston, Texas. This group apparently already operates 1,200 broadcast sites in the US and Caribbean. They are believed to be paying 210 million pounds for the network of 740 sites.

The World Service sites will remain in the

hands of its management via a buy-out vehicle called "Merlin Communications International". The business is worth roughly 15 million pounds according to the Telegraph. The BBC will invest the proceeds from the sale of the domestic network into its proposed digital services. The proceeds from the World Service sell-off will go to the UK government.

Changes have been made also at our own Radio Australia. On 22 January, programming changes were made across the various ABC radio and television networks including Radio Australia. I believe from promos I have heard over RA that there will be an increasing emphasis on news and current affairs. Reports have also been circulating that programming in Thai, French and Cantonese will cease. Severe budgetary cutbacks were also made to Radio New Zealand's budget.

Port Moresby has actually increased its operating hours to be a 24 hour operation as from 6 January. I am easily hearing it on 4910 kHz as they are running 100 kW on that channel. Arthur Cushen, as quoted on Radio Netherlands, stated that the 24 hour operation was also extended to the various provincial stations, but I cannot confirm if the 90 and 120 metre stations on the so-called tropical bands, have longer hours.

Recently there was a mystery signal on 5719 kHz which generated quite a deal of comment on the various Internet shortwave newsgroups. The signal sounded very similar to an EPIRB, yet this was quickly discounted as it was far too strong and signals were monitored over a very wide area from here in Tasmania to Europe. Most of the speculation was that it was related to the US Navy and may have been transmitting from several sites simultaneously. The characteristics of the signal were very similar to an HF FAX sync pulse but most agreed that it was some form of digital signal and not analogue. Then, on 8 January, the signal characteristics altered and the sync pulses were replaced with digital hash. Sounds as if some kind of HF digital signal delivery system was being tested.

In conclusion, I would like to thank those who sent me e-mail about the numerous numbers signals on HF. I noted that activity did decrease over the Christmas-New Year period from some predictable sites while others continued unabated.

Well that is all for this month. Until next time, the very best of monitoring.

\*5 Helen Street, Newstead TAS 7250  
VK7RH@VK7BBS.LTN.TAS.AUS.OC  
Internet e-mail: robroy@tassie.net.au



**AMATEUR  
TRANSCIVER  
RADIO CENTRE**

BEST LEADING RANGE ON  
DISPLAY OF LATEST  
AMATEUR HF - VHF - UHF  
TRANSCIVERS AT  
COMPETITIVE PRICES

AUTHORISED DEALER FOR

**KENWOOD ALINCO**

**cushcraft**

**ICOM**

WEEKLY SPECIALS THROUGH-  
OUT CHRISTMAS AND NEW YEAR  
EXPAND YOUR COLLECTION

PHONE/FAX  
(02) 9896 2545

141 GILBA ROAD,  
GIRRAWEE, NSW 2145

ar

---

---

# Technical Correspondence

All technical correspondence from members will be considered for publication, but should be less than 300 words.

---

---

## Micropower Transmitter

As always, I enjoy getting *Amateur Radio* and appreciate the work that goes into producing it.

I read Peter Parker's article in November *Amateur Radio* on a "Micropower Two Metre FM Transmitter" with interest.

Whilst I applaud the direction of the article I am uneasy about a few things. In an article intended for newcomers or those with limited knowledge of VHF transmitters, I believe Peter has simplified things too much in the aim to get them busy with their soldering irons.

It seems that the technical oversighting of the circuit diagram/circuitry missed a few points. The audio amplifier cannot work as there is no resistor in the collector lead of

TR1; it draws current but TR2 won't. If the mic gain moving arm goes to the emitter of TR1, TR1 will self destruct. Altering the DC operating conditions of transistors (or valves) in this way easily gets the device out of the linear area of operation, particularly if a largish signal is being handled. It also makes it susceptible to RF interference as I have seen in the past. There are better ways of controlling the audio gain rather than shifting the DC operating conditions.

Getting the crystal on to frequency is a bit awesome requiring up to three adjustments; once again the DC operating conditions of the transistor TR3 are changed. With so many adjustments, many people wouldn't know which to tweak for what result.

It concerns me that the output stage is a quadrupler. Experience with the original IGL transmitters showed that the fifth harmonic was radiated at a noticeable level too, particularly in areas with weak Channel 7 TV reception. Certainly Peter recommended using a bandpass filter, but how many of the builders of such a transmitter will build this filter? I would have to say that the final would have been better to have been a straight-through one or use it as a doubler, with the bandpass filter built onto the board. One problem with designs of this type is not having equipment to test and align them for best performance and no obvious spurious output.

I believe that Peter would have helped prospective builders by having an approximate layout of the board published using Drew Diamond's paddy board method.  
**Rodney Champness VK3UG**  
17 Helms Court  
Benalla VIC 3672

ar

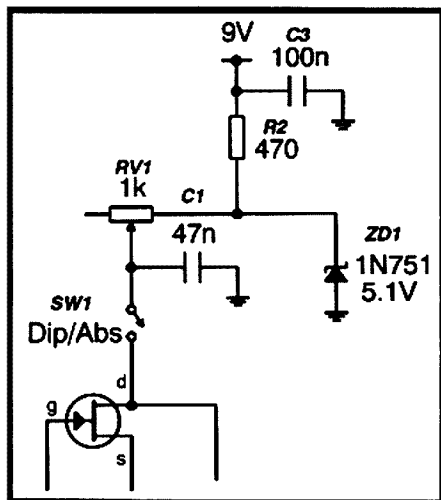
---

---

## Update

### A Dip Meter Using the Lambda Negative Resistance Circuit

This very interesting article appeared on pages 15 - 19 in last month's issue, January 1997. Despite multiple proofing, an error appeared in Figure 4 on page 17. The 5.1 V 1N751 zener diode ZD1 was incorrectly drawn in reversed polarity. The relevant part of the diagram has been redrawn and appears here. Please correct your copy of the January 1997 issue of *Amateur Radio* NOW!



Amended circuit for zener diode ZD1 in the article *A Dip Meter Using the Lambda Negative Resistance Circuit*.

### Silent Keys - January 1997, page 51

As reported by the man himself in the *Over to You* section in this issue of *Amateur Radio*, Ray Peterson VK6PW is NOT a Silent Key despite the accidental listing of him in the *Silent Keys* column last month.

### Well-known Amateur Neville Williams VK2XV, SK

In the WIA News obituary for Neville

Williams on page 5 of last month's *Amateur Radio*, his year of birth was given as 1911. This is incorrect. Neville's birth was actually in 1915.

### Page 1 of January 1997 Issue of *Amateur Radio*

At the top right-hand corner of page 1 last month the issue should be (surprise, surprise!) for January 1997, not 1996!!

ar

---

---

## WIA MORSE PRACTICE TRANSMISSIONS

VK2BWI	Nightly at 2000 local on 3550 kHz
VK2RCW	Continuous on 3699 kHz and 144.950 MHz 5 wpm, 8 wpm, 12 wpm
VK3COD	Nightly (weekdays) at 1030 UTC on 28.340 MHz and 147.425 MHz
VK3RCW	Continuous on 145.650 MHz, 5 wpm, 10 wpm
VK4WIT	Monday at 0930 UTC on 3535 kHz
VK4WCH	Wednesday at 1000 UTC on 3535 kHz
VK4AV	Thursday at 0930 UTC on 3535 kHz
VK4WIS	Sunday at 0930 UTC on 3535 kHz
VK5AWI	Nightly at 2030 local on 3550 kHz
VK5VF	Continuous on 145.650 MHz, 5 wpm to 12 wpm
VK6RCW	Continuous on 147.375 MHz, 3 wpm to 12 wpm

# VHF/UHF - An Expanding World

Eric Jamieson VK5LP\*

## Some News at Last!

I'm not sure whether its due to my appearance with an e-mail address or band conditions have improved (I suspect both) but its great to be at last receiving messages with information for inclusion in these notes. Some editing was necessary this time due to the sheer quantity of information, but don't let that stop you, please keep it coming!

## Beacon Changes

After discussions with **John VK3KWA** of FTAC, the following changes need to be made to update the December 1996 beacon list.

1. Correct VK8AS to VK8RAS, on 50.047.
2. VK3SIX has moved to 50.293 for the summer VK0/ZS tests.
3. VK2RHV 52.325 is definitely on air (reported heard December).
4. VK2RGB 52.425 permanently closed.
5. VK1RCC 144.410 now near Nimmitabel (see paragraph below). Likewise on 432.410 and 1296.410. Change call to VK2RBC.
6. VK3SIX on 144.435 not operating.
7. VK7RMC was replaced by VK7RNW which has now become VK7RAE.
8. Add CW practice beacon VK3RCW 145.650.
9. VK6RPH is on 432.460.
10. Add VK8RAS 432.485.
11. Add VK3RXX 1296.530 Melbourne.
12. VK4RSD 2306.440 should read 2403.440.

## 50 MHz DX Challenge

Keep in mind this "Challenge", details of which were given in the December issue. **Geoff GJ4ICD** hasn't objected, so my idea of receiving your claims by 14 February 1997, for bulk forwarding to Geoff, appears to be satisfactory.

Please supply full details of the claimed contact, plus grid squares to six places; or, if only to four places, the locations (towns) as I have many listed with latitude and longitude; or, if known, the latitude and longitude of the two stations involved in the claim. I can check distance.

The northern hemisphere greatest distance was 8057 km. VK6 to ZL or FK8 would be useful distances. What about VK to South Africa? Perth to Cairns is a long way, and even further to PNG or Fiji!

## Region 1 Bandplan

- 50.020 to 50.080 beacons.
- 50.090 CW centre of activity.
- 50.110 Inter-continental DX calling frequency.
- 50.150 SSB centre of activity.
- 50.185 Crossband centre of activity.
- 50.200 MS centre of activity.

## On the Bands

**Guy Fletcher VK2BBF** advises that: "The Canberra beacon moved some months ago. It is now near Nimmitabel. SSE of Canberra and in QF43, under the care of Rod VK2TWR. It is still on 144.410 MHz, but the call is VK2RBC.

"On 12/12, Gordon VK2ZAB managed a contact with Ray ZL2TAL in New Plymouth at 0200 on two metres. This is believed to be the first

two metre contact this season from Sydney area to New Zealand."

**Ron Cook VK3AFW** advises: "Andrew VK7XR reports good Es on six metres on the evening of 5/12. Skip shortened from VK4 to VK2 at Pt Kembla. Six also opened into Adelaide. The Townsville beacon was copied on two metres, but no one responded to many calls on 144.100!

"At 2153 I worked Trevor VK4AFL 5x9+ on six metres and at 2158 Adrian VK2FZ/4 at 5x9. Adrian was copying the VK7RAE/b and reported that on the two previous days at around 0000 he enjoyed a half hour opening to ZL on two metres!

"On 6/12 (UTC) around 2230 I worked Andrew VK7XR at 5x6/7 on two metres SSB and he reported that again the previous evening the Townsville two metre beacon was heard, but still no response on 144.100! [When this happens phone somebody in Townsville if you want answers ... VK5LP].

"We tried 432 but nothing heard. Andrew had previously worked Rob VK3DEM on 50, 144, 432 and 1296 MHz with signals 5x3 on 1296. Max VK3TMP broke in to announce he had just worked Trevor VK5NC on 1296, 5x7 both ways.

"On the afternoon of 8/12 six metres opened with ZL1, 2, 3 and 4 working VK1, 2, 3, 4, and 7. Stations active from VK3 included John VK3ATQ, Norm VK3DUT and Gavin VK3HY. At about 0800, Andrew VK7XR phoned to say VK pagers were being copied in ZL. At 0847 Arie VK3AMZ worked ZLADK on two metres SSB and shortly after Norm VK3DUT did likewise. Rob VK3DEM reported that Ian VK3SP worked ZL3TIC and ZL2ADT on two metres FM. Ian runs 8 watts!

"On 19/12 Andrew VK7XR worked Des VK3CY on two metres SSB at 5x1 both ways, a path around 600 km.

"On 20/12 Andrew worked Rob VK3DEM on 50, 144, 432 and 1296 MHz, with signals weak on 50 MHz but excellent on 1296. They talked for some two hours on 1296. The VK7RAE two metre beacon was inaudible at this time but the 70 cm beacon was S5.

"I now have a sloping wire dipole at 25 feet on six metres and running an FT690R plus HB 40 W amp, all on loan from Andrew VK7XR. On 21/12 at 1003 hrs I worked John ZL3AAU 5x2 at 1006, Keith ZL3TLG also 5x2, and at 1022 Mike ZL3TIC 5x3/5x5. At 2255 the ZL3SIX beacon was 579. ZL3ADT was worked by Quentin VK3DUQ, Gavin VK3HY and Laurie VK3YDE.

"On 22/12 six metres opened to southern VK4 and northern VK2 with a brief opening to VK5. Skip got down to around 600 km and at one stage there were QSOs every 5 kHz from 50.110 up to and beyond 50.210.

"My log shows: 22/12: 0321 Neville VK2YO 5x7, using a dipole; 0327 Keith VK2AT, also using a dipole; 0354 Austen VK4TN; 0426 Adrian VK2FZ/4; 0437 Steve VK5AIM, signals barely readable at first but up to 5x7 at the end; 0441 Brian VK4RX, another dipole operator! 0447 Gary VK4AR; 0512 David VK2BA; 0525 Keith VK2ZER; 0537 VK4RGG beacon 529 copied up to

0906, with some dropouts; 0604 Peter VK2BIT 5x5 both ways.

"On 24/12 six metres again open to ZL with TV in all day. Also open to VK4. On two metres Norm VK3DUT at his new Lakes Entrance QTH worked ZL3AIC, and at 2347 Rob VK3DEM worked Mike ZL3TIC 5x2.

"Some two metre SSB operators in New Zealand are Steven ZL1TWR, Cliff ZL1MQ, Bob ZL3NE, ZL4AAA, ZL1SL and Mike ZL1IU. Mike's QTH is about 430 m high on the spine of the North Island and north of Auckland. He can see water to the east and west and frequently listens to FM programs out of Sydney. He recently worked Doug VK3UM and others.

"25/12 on 144 MHz: 0016 VK4TZL 5x9. He also worked VK3CAT, VK3DUQ and others. 0027 Tony VK4CH 5x8. Tony also worked VK3UM. VK3CY reported working VK4s ZTL, AFL, OE, CH on two metres between 0000 and 0030.

"26/12: Worked VK2FLR on 144.100 529.

"27/12: 0859 144 MHz Andrew VK7XR, 5x9+30 dB but only 5x3 on 432 MHz. The following morning saw lots of activity on the aircraft enhancement calling frequency of 144.200. VK1BG was heard working VK3s AFW, BDL, UM, ZLS, TBM, GRL, CSJ. VK3UM also worked VK2s ZAB, FWB (near Dubbo). Later that evening VK3CY worked VKSAKK and VK2ZAB on 144 MHz.

"28/12: Worked Adrian VK2FZ/4 on 144 MHz SSB, exchanged contest numbers via meteor, between 6 and 7 am Melbourne time.

"29/12: VK3XLD/P Mt Napier near Hamilton worked on 144 and 432 MHz. David is running about 30 W on both bands and using NBS design Yagis, six elements on two metres and 10 elements on 70 cm. Another portable, Ken VK3DQW, near Nagambie worked on two metres. Ken has about 60 watts out. Both these stations are using an IC202 as the prime mover. While these 1970 rigs are not expensive to buy, given a PA and a GAsFeT preamp, they perform quite well.

"30/12: VK3AFW worked VK1DO and VK1BG via aircraft. VK2ZAB worked Max VK3TMP. Adrian VK2FZ/4 worked Ron VK3AFW on two metres via meteors but neither station copied the complete Ross Hull numbers this time. Adrian also copied VK3CY briefly and commented that he has heard loud bursts from Warren VK3BWT, at Mallacoota.

"Ian VK3ALZ is back on air. The September storms wiped out two arrays and one rotator. He has a 10 element long Quad on two and a Yagi on 432. The 50 and 1296 MHz beams will be put up when a new rotator is found. The 2.4 GHz dish was written off.

"Mike VK3BDL is expected on 1296 as soon as he erects a Yagi. Des VK3CY at Wedderburn 200 km NW of Melbourne, now has a new rig, an IC821H. His signal into Melbourne is 9+ on both 2 and 70.

"Adrian VK2FZ/4, now has 4x70 elements on 1296 MHz. This replaces the previous two loop Yagis. He can now hear Lyle VK2BE, 809 km south every morning on scatter. Signals are usually too weak to exchange info, but the signal can be detected and tuned. When an aircraft is in common view signals are up to S8 for a minute. He needs an aircraft to get any 1296 MHz signal at all from

VK2DVZ, some 550 km away, but it is a reliable path when the aircraft are there.

"I continue to work Andrew VK7XR on two metres CW most weekday mornings. (This seems a bit feeble compared to Adrian's activity). We've had some good phone contacts recently, but no joy on 70 cm this season. Where are all the other VK7s?"

**Ron VK4BRG** by e-mail said: "The following was sent to you by packet but became lost in the system!

"11/11: Six metres: 0035 VK3DQJ plus other VK3s, 1050 VK2FLI near Sydney plus Brisbane area stations. 12/11: 0248 VK5BC, 0444 VK3 area, 0852 VK2BA now living west of Coffs Harbour. 13/12: 2240 VK5BC and VK5RO, 2258 VK2BA.

"14/11: 1120 146.625 Auckland, open well either side of time frame mentioned to and from here to at least VK2 border into ZL, 1137 146.700 repeaters. Noumea repeater on 146.8 worked from area to the north of Brisbane. 2347 6 m VK2XN Narrabri, 2352 6 m VK2AIF near Sydney.

"Six metre openings often provided simultaneous paths over large variations of distance ... also noted were the rather short skip six metre openings. Short skip conditions were also observed on 20 m HF BBS operations.

"28/11: 1159 6 m VK4TZL Hervey Bay, quite short skip for six metres, 2301 144.100 VK4ZHL near Brisbane, 5x2 each way.

"29/11: 0216 144.100 VK4TZL Hervey Bay. He reduced power to 5 W but still S9, 0921 50.130 ZL3NW.

"30/11: 2107 146.800 FK8FL Noumea. Their repeater S9+ (about 1800+ km). 2109 146.800 FK/FSLSP 110 km north of Noumea.

"01/12: 0817 146.800 Noumea repeater S9, no replies, 0827 50.120 VK3CNX Melbourne, 1005 to 2109 Noumea repeater, no replies, 2000 to 2100 two metre repeaters south to VK2 border. VK4R1T beacon Bunya Mountains [New beacon? Details to VK5LP please.]

"05/12: VK4NW 144.100 Bundaberg.

"General comment ... lots of propagation, very little activity! A high has been sitting over the Coral Sea for three days now."

**From Don Graham VK6HK:** "On 14/12 we had a sample of Es DX with VK5 and VK2 on 50 MHz into Perth. Worked VK5RO and VK2YLO between 0028 and 0050.

"I was interested to hear too that there is a move in Region 1 to move the 50.110 calling channel to 50.150. I reckon that is a tremendous idea if only it could be promoted world wide in time for the next solar maximum. [Refer to Region 1 Bandplan item above ... VK5LP.]

"Saw an interesting new 50 MHz antenna system last week in a visit to Bill VK6ACY at Muchea, just north of Perth. Bill has erected an array of four 7 element beams on a 20 metre tower in the "H" frame format. His linear is in a separate building near the base of this mast, with the shack itself about 100 metres away. There is a receive preamp at the mast head too. All with low loss coax. There could be some big signals from Muchea over the summer and beyond! By the way, he has a six element full size 20 metre array on a 30 metre mast, a three element 7 MHz array on a separate 30 metre mast, a four mast phased

vertical for 80 metres, plus a 75 metre mast and 80 metre Yagi approved for erection!"

**Andrew VK7XR** faxed the following: "A large two metre Es and tropo opening occurred on 4/1/97 from 0533 to 1050. The more notable contacts were as follows and most were 5x9.

"Via Es: 0533 VK4KZR, 0542 VK2BRG, 0550 VK4AFL, 0553 VK4JSR, 0556 VK2FZ4, 0557 VK4IC, 0643 VK4WTZ, 0647 VK2DVZ, 0648 VK2XKE, 0651 VK2XPG, 0652 VK2BBF, 0653 VK4ABW/2, 0654 VK4AR, 0701 VK4APG, 0711 VK4UTI, 0720 VK4KGP, 0808 VK2BO, 1006 VK4KOH, 1008 VK4LO, 1028 VK4PU, 1029 VK4ZBH.

"Via tropo: VK2TWR 5x9 144 5x2 432, VK3TMP 5x9 144 5x5 432 4x1 1296, VK3DEM on 50, 144, 432 and 1296 all 5x9, VK3BRZ 5x9 144 and 5x5 432, VK3BWT 50 and 144 5x9, VK3DUT 50 and 144 5x9, VK3XPD 144 and 432 5x1.

"On the same day there were numerous six metre contacts. Also, on 2/1 and 3/1 more than 40

contacts on 50, 144, 432 and 1296 were made across Bass Strait to Melbourne, too many to mention here."

**John VK3ATQ** reports that on 18/12 at 2030 he worked Bob VK7JR on King Island for the first time on six metres. Bob is a white-stick operator and is using a two element Quad made by John. Distance is about 250 km. Both stations were running 100 W SSB. John uses an NBS Yagi at 20 m height and also works Andrew VK7XR, on CW most mornings on 50.120 over a 420 km path.

**Steve Gregory VK3OT** sent in a long list of stations worked and interesting signals heard out-of-band which are pointers to six metre openings, particularly as they relate to eventual long distance F2 contacts. This is valuable information for true DX operators; the signals are there if you look for them! It's unfortunate that space does not allow me to publish more than the representative sample in List 1.

List 1	Time	Frequency	Log entry	Remarks
	21/12:			
	0000	46.172	Video	59+ TV Channel 0 video.
	0015	46.2610	Video	55 TV Tamworth video.
	0030	28.262	VK2RSY/b	559 Sydney.
	0045	52.325	VK2RHV/b	559 Newcastle.
	0100	51.672	Sound	59+ Channel 0 pix locked in.
	0015	40.670/680	Pagers	59+ Northern VK2 hospital.
	0030	49.770	Phone	55 Northern VK2 farmer.
	0030	50.0775	VK4BRG/b	559 Sarina, north Qld.
		50.0575	VK4RGG/b	599 Nerang, Qld.
		50.110	VK2QE	59 CQ call.
		45.240/250	Video	319 Weak ZL video.
		49.830	Carrier	55 Room baby minders.
		28.262	VK2RSY/b	599+ Sydney.
	0100	50.0575/0775	Beacons	539 Both beacons weak.
	0130	50.120	VK2QE	55 VK2QE working VK3 copied.
	0300		Open to VK4 past few hours.	
		50.0575	VK4RGG/b	599+ Nerang, Qld.
		52.345	VK2RHV/b	579 Newcastle, NSW.
		50.160	VK4TZL	59 Working Gippsland.
		52.005	FM Sound	Tamworth Ch 0 stereo.
		52.150	FM Sound	Spurious of Ch 0 Toowoomba.
		52.450	VK2RSY/b	559 Beacon Dural NSW. Es.
		28.261	VK2RSY/b	599 Beacon Dural NSW. Es.
		51.915	FM Sound	Stereo subcarrier WIN TV.
		51.672	FM Sound	Primary Carrier.
		57.2600	Video	
		57.2604	Video	Interstate Ch 1 TV.
		57.2400	Video	
		64.260	Video	
		64.2604	Video	Interstate Ch 2 TV.
	0400	49.7400	FM	559 Illegal cordless phone VK2.
		49.850	FM	Vox Baby room minder 50 mW.
		49.830	FM	Continuous Baby room minder 50 mW.
		50.0575	VK4RGG/b	Nerang, Gold Coast, Qld.
		50.140	SSB	VK2AT working VK3YDE.
		45.2500	Video	Wellington NZ Channel 1 TV.
	2000	28.2300	ZL2MHF/b	559 Mt Climie RE72.
	2100	28.261	VK2RSY/b	599 Sydney.
	2145	45.250+/-	Video	All ZL offsets.
	2215	55.2604	Video	All ZL offsets.
		50.040	ZL3SIX/b	559 RE66.
		62.260	Video	559 NZ TV Channel 3.
	22/12			
	0000	50.110	ZL2/3	59 Working VK4 and VK3.
		50.140	ZL2MQ	59 VK3DUT.

Time	Frequency	Log entry	Remarks	
0100	50.130	ZL2TPY	59 VK4AFL.	
	45.2396	ZLTV	599+	
	45.2500	ZLTV	599+ Wellington.	
	45.2502	ZLTV	599	
	45.2602	ZLTV	599	
	45.2609	ZLTV	599	
	50.750	FM Sound	59+ Comedy Show.	
	51.000	White noise	59+ Nicam stereo sound.	
	55.2412	Video	55 ZLTV.	
	55.2500	Video	55 ZLTV.	
	50.040	ZL3SIX/b	559	
	0230	52.345	VK4ABP/b	519 Longreach, very weak.
		0400	46.2400	TV
	46.172		TV	599+
	Short skip to Mallacoota. Backscatter to VK3 and VK5.			
	49.830	59	Room minders.	
	50.0575	VK4RGG/b	599 Nerang, Qld.	
	52.420	VK2RSY/b	519 Scatter.	
	52.345	VK2RHV/b	559 Direct.	
	52.150	Spurious	59 FM from WIN TV.	
	52.005	Stereo FM	59 Tamworth Video 46.2610.	
	51.915	FM Main	59 Toowoomba Ch 0.	
	51.750/740	FM Main	59 Sound carriers.	
	50.120/170	Lots of interstate Es 59+ all eastern states. Ops observing the no QSO on 50.110 generally.		
0430	50.0570	VK7RAE/b	519 Backscatter.	
	45.740/750/760	New Zealand TV All faded out.		
	52.345	VK4ABP/b	559 Longreach back in.	
	49.7500	Video	319 Es link to afternoon TEP.	
	48.240/25/26	Video	319	
	52.325	VK2RHV/b	559 Newcastle.	
	45.2500	Video	519 Wellington b/s N/E.	
	52.420	VK2RSY/b	559 Sydney, short skip.	
	29.700	Carrier	59+ Unknown location with QSB.	
	28.262	VK2RSY/b	59+ Sydney.	
	30.275	Carrier	59+ Pulse modulation and QSB.	
	52.525	VK2HT	59+ Old FM channel, Newcastle.	
	0440	52.325	VK2RHV/b	59+ Newcastle.
		0521	Video	559 Vladivostok, warbly outlet.
	0530	49.750	Video	xxx Fade down.
0545	TV video all over: 48.2604, 49.7618, 49.7548, 49.7620, 49.7457, 7463, 7474, 7500, 7502, 7504, 7536 and 7544. VK5LP and VK5ZLX also copying video 48.250 59+ into Adelaide. As path shifts S/E E2 offsets building up: 48.2396, 2400, 2402, 2496, 2500, 2502 and 2604 49.7463, 7474, 7477, 7499, 7502, 7547 and 7462.			

Glenn VK4ZTL reports as follows: "15/11: 50.150 0101 VK3DET 5x5, 29.300 0253 JA1FQN 5x9, 146.500 0325 VK4ACC 5x9.  
"17/11: 50.140: 2226 VK3FFW 5x9, 2302 VK3CNX 5x9, 2308 VK5AKK 5x9, 2311 VK5BC 5x9, 2313 VK3EBR 5x9, 2314 VK3AFW 5x5/9, 2339 VK3DUT/p 5x9, 0018 VK3JWZ 5x7, 2323 VK3ACM 5x9.  
"28/11: 144.100 0218 VK4BRG 5x9, 0847 VK4IC 5x9, 50.110 2300 VK4BRG 5x5.  
"8/12: 144.150 0020 VK4KK 5x9, 0032 VK4OE 5x5, 1296.100 0945 VK2FZ/4 5x5/4x1. 11/12: 50.140 2307 VK3DQJ 5x9, 2324 VK2BIT 5x8. 14/12: 50.120 0205 VK5AIM 5x7. 15/12: 144.200 2104 VK4BKM 4x1 Townsville - meteor scatter contact, 1296.150 2252 VK2FZ/4 5x8."  
Log from John VK4FNQ: "23/12: 50 MHz using 1/4 wave vertical while Yagi is repaired: 2350 ZL3NW, 0233 VK8RH 5x7, 0233 VK2KLV 5x5, 0257 VK2BRG 5x6, 0303 VK2TP/m (Wellington NSW) 5x1, 2215 VK2AIF 5x7, 2241

VK2TWR 5x8, 2350 ZL3TCV 5x3. 24/12: 50 MHz: 0012 ZL4TBN 5x9, 0032 VK3JWZ/m 3x1 mobile 40 km south east of Melbourne, 2320 VK4AFL 5/9+.  
"25/12: 144 MHz: 0042 VK4OE 5x9, 0044 VK4AFL 5x2, 0046 VK4AR 3x1, 0110 VK4TZL 5/9+, 0139 VK2DVZ 5x7. 26/12: 50 MHz: 0130 hrd VK8RH 319 (Rex was in and out for an hour but very weak), 0758 ZL3NW 5x9."  
Ron VK4BRG reports on a two metre opening: "25/12: 0011 VK3WRE Traralgon, 0015 VK3HV Morwell running 10 watts, 0121 VK2DVZ Taree. Numerous stations in Sydney area. 0128 VK2BA Dorrigo was heard, most northern station. 0154 VK1VP weak CW signal. Various other paths were worked. Six metres open to southern states."  
**Internet Six News**  
From On-line Six Metre Magazine from Geoff GJ4ICD and others as appropriate.  
6/12: VK6ACY has completed a new array of 4 x 7 element long Yagis, each with a 25 foot boom.

Spacing is 22 foot stacked and bayed. Mast head LNA and 400 watts PEP. Overall height is 80 feet. He is mainly looking across the Indian Ocean to South Africa, but the array is rotatable so he is prepared to consider any sched, in any direction ... e-mail him at vksixacy@wantree.com.au  
12/12: Peter PY5CC said: "Via TEP I heard several USA stations from the west coast, W7 on 50 MHz. I had a good TEP to the northern part of South America and the Caribbean, with the V44K, J3EOC, YV4AB, H10VHF beacons about S1 to S9."  
16/12: 0755: VK7WR, VK7AB, VK7FB/m, VK7GUN. 0840: VK6RPH/b (Perth) VK6RBU/b (Bunbury) and VK8RAS/b (Alice Springs). Perth beacons copied for about an hour but no stations heard. Stations active in Darwin include VK8RH, VK8AH, VK8ZMA, VK8LM and VK8AG ... de Rex VK8RH.  
25/12: VK8 Es Report: 25/12 0000 VK4JH, VK1VP. 0025 VK4FNQ, VK8RAS/b. 0145 P29JFS. Had confirmation from VK8PN that he has heard the YB0ZZ beacon (50.042) so this is now confirmed as a working beacon from YB.  
Info passed on from Kerry ZL2TPY: In about two weeks 5W1AU will be active on Western Samoa. He will run 5W1WS as a beacon on 50.050 and will break it to operate if requested. Fax +685-26711. Number is good. (Country code is 685 in VK but 85 in ZL???) ... de Adam VK3ALM QF22oa.  
The US had winter Es openings during December on 9, 10, 13, 16 (major) and 20.  
**Records on 5.7 GHz**  
Australian amateurs are gradually extending the 5.7 GHz distance. Starting from a modest national record distance of 191 km established in 1991, it was pushed to 237 km on 30/10/96 by Alan Woods VK6ZWZ/p at Cervantes, north of Perth, and Al Edgar VK6ZAY/p at Falcon, south of Mandurah. Both used power levels of about 60 mW.  
Then Alan Devlin VK3XPD/p at Mt Dandenong, near Melbourne, worked David Minchin VK5KK/p at Mt William, western Victoria, over 259 km on 6/11/96. Both were using about six watts.  
On 11/11/96, Neil Sandford VK6BHT/p at Geraldton worked Alan Woods VK6ZWZ/p at Fremantle over a 379 km path for a new record. Both were using about 60 mW.  
The competition between the eastern and western residents of the continent is bound to see this record broken soon! ... de VK6KZ.  
David VK5KK comments: "Looks like the VK6s have pinched our 5.7 GHz National record by working 379 km. Of course they should realise that we will pinch it back soon, just in time for them to pinch it back in the new year!"  
Roger VK5NY reported that: "On 14/12 at 2.30 am local time to 3.15 am, Alan VK2DXE and I tried with little success to work meteor scatter between here and Sydney. The Geminids shower was expected to peak at this time. We both received short bursts of call signs and other bits but no long bursts. A complete contact could not be managed."  
"I have never had much success with meteor showers but I am prepared to give it a try. I often find random tests outside expected peak showers give much the same results. Perhaps we don't

catch the showers at the right time. The odd hours at night don't help much either."

### Other Contacts

John VK3KWA reports: "On 31/12 at 0600 Murray ZL3ADT worked Norm VK3DUT on 144.100. At the time six metres was open and VK2RSY/b on 28 MHz was very strong.

"30/12: VK3XLD/P at Mt Richmond QF01 with 30 W and 10 el on 144 and 10 W and 10 el on 70 cm worked Melbourne and Bairnsdale on both bands. Only VK5 stations heard were VK5VF and VK5RSE. 31/12: VK3DEM worked ZL3ADT S9+20 on 144, also heard ZL3TIC.

"1/1: VK3TMP heard VK6KZ/P on 144 at 0200, and VK8GF at 0230. VK3ACX heard VK6AS at 1210.

"2/1: Around mid evening, VK3AXH heard two VK6 stations talking on two metres. VK6KZ heard VK3XPD working VK3ZQB. At 1205 VK6AS heard briefly here on 144.100. VK5DK worked VK3ACX, VK3XPD and VK3KWA on 144, 432 and 1296, and VK3BRZ on 144 and 432. VK3ACX heard VK6KZ working VK5NC around 1250."

25/12: John VK4KK reported Brisbane stations working VK5 on two metres.

26/12: VK2BOD on six metres worked Eric FK8GM in Noumea at 0627. Signals 5x5. Others to work him were two VK1s and three VK2s.

Steve ZL1TWR reports two metre openings to VK2 on 24/12 and worked VK2ZAB and VK2BBF at 5x9, and on 26/12 between 0115 and 0200 worked VK2BRG, VK2MZ, VK2SC and VK2DVZ to 5x9. Tried 70 cm but no results.

### UK and Europe

Ted Collins G4UPS reports that he compared the number of QSOs during October 1995, when SM7AED was active every morning, with 1996 when he was available only for a few days, and found that 1996 was better than 1995. Total QSOs in October 1995 were 91 (65 CW and 26 SSB), while October 1996, despite SM7AED not available, there were 89 (58 CW and 31 SSB.)

During November, Ted managed to work D, I, G, OE, OH, OZ, SM, SP and S51. Most contacts appeared to be with SP (Poland) stations.

### North America

Emil Pocock W3EP writing in *The World Above 50 MHz* in QST reports that Es openings occurred on October 8, 9, 10, 15, 16, 23, 24, 25, 28, 29, 30 and 31. The real surprise were the openings of 9 and 10 October, during which the E-skip MUF soared through 144 MHz for more than an hour. Two metre contacts reached distances to 1675 km.

### New Zealand

Cliff ZL1MQ in his report lists some interesting contacts. In addition to the many six and two metre ZL to VK contacts, he lists a number on 432 MHz. They all involved ZL3NE on 14/11: at 0731 to VK2FZ/4 559 and at 0750 5x5 SSB, 0802 VK4JSR 5x6, 0848 VK2BRG 5x5, 1107 VK4AFL and 1110 VK4ZQ.

Last November, ZL3NE on two metres worked VK2BRG, VK2FZ/4, VK4APG, VK4IC, VK4JSR, VK4ARN, VK4ZQ and VK4AFL. Anyone try 1296 MHz?

### EME Activity

From Michael Farrell VK2FLR and his score in the ARRL EME contests on 144 MHz.

27/10: 1125 K5GW, 1205 KB8RQ, 1215 K2GAL, 1650 SM5MIX, 1820 SM5FRH, 1845 OE5JFL, 1900 SM5BSZ.

23/11: 0915 VE7BQH, 1037 JL1ZCG, 1057 W5UN, 1724 I2FAK. 24/11: 1059 K7CA, 1657 SM2CEW, 1703 F1FLA, 1826 PA2CHR, 1832 I5JUX.

16 QSOs x 100 x 11 multipliers = 17600 points. "I missed half of the first weekend. I also heard quite a few others, and a number of unidentified stations called me.

"The contest also produced a raft of sched requests which I am working through at the moment. Some of the more interesting were from G4YTL, a two-Yagi station near Oxford and F/G8MBI with a single 6.6 wavelength Yagi with switchable polarisation.

"From published scores and lists of stations worked, it seems I was the only VK station available on 144 for the contest, although I did hear K5GW, one of the biggest stations on at the moment, sending a report to VK2FZ/4. Where are VK3AMZ, VK3AUU and your VK5 mate?

"Speaking of VK2FZ/4, Adrian seems to be workable most of the time from Sydney by the better-sited stations now that he has raised his power to 400 watts.

"I managed a contact with Adrian on 8/10 when conditions were somewhat better. About 35 minutes later I also worked VK4ARN at last, after spending years listening to Gordon working him with consummate ease.

"The weekend aircraft circuits burble on, but with reduced participation from Melbourne, as far as we can tell up here. Bob VK3AJN is a regular, as is Warren VK3BWT at Mallacoota just over the border. Warren was formerly VK2BWT and quite active from Young. Canberra is much quieter now that VK1BG is away."

Chas VK3BRZ reports: "The weekend of 7-8 December was the ZL VHF Field Day, and as it happens we were treated to a great weekend of six metre propagation across the Tasman.

"At 0840 ZL4DK came through loud and clear

calling CQ on 144.100. I immediately replied, but the propagation only lasted 20 seconds or so, and no contact ensued. Minutes later Arie VK3AMZ worked him at 5x7, followed by Norm 3DUT. I missed out yet again! This was a re-run of the experience I had back on 20 January this year, with ZL1TWR. Everyone else worked him but me! It seems I am condemned to always being the proverbial bridesmaid!

"One observation I can make from the admittedly few two metre openings to ZL that I have experienced is that the opening seems to start at the western part of Victoria, moving quickly east. It is very selective, in that whilst I live only 25 km south-west of Arie, I could not hear the faintest sign of the ZLs. By the time the opening reaches eastern Victoria, it lasts long enough for a good number of VK3s to make the contacts. The lesson is that I have to be on the ball early, and hope that the ZLs realize that there is no time for rag-chewing.

"That last point is critically important, as I think that the ZLs have been conditioned over the years, by regular tropo and Es openings to the VK2 coast, some of which last for hours, or days in the case of tropo. We VK3s don't have that luxury."

### Closure

Due to space limitations there has been considerable pruning and re-arrangement of information received for this month. If I have missed anyone please accept my apologies, but the task has been almost overwhelming, having taken many hours of sifting and sorting.

Closing with two thoughts for the month:

1. A wedding is an event, but a marriage is an achievement, and
2. If you think there are no new frontiers, watch a boy ring the front doorbell on his first date.

73 from *The Voice by the Lake*.

\*PO Box 169, Meningie SA 5264

Fax: (085) 751 043

Packet: VK5LP@VK5WI.#ADL.#SA.AUS.OC

E-mail: vk5lp@ozemail.com.au

ar

## Silent Keys

Due to space demands obituaries should be no longer than 200 words.

The WIA regrets to announce the recent passing of:-

MA (Maxwell)	BASTIN	L30253
R V (Ron)	CROSBY	VK2BCH
WC	DWYER	VK2FXD
E L (Eric)	COLYER	VK2JN
S E (Stanley)	BROWN	VK2PQ
I (John)	MORAN	VK3ABQ
P S (Pat)	LANG	VK3ADN
H O	KELLAS	VK3AHK
E G V (Ted)	GABRIEL	VK4YG
A H (Arthur)	JOHNSTON	VK5AAJ
C A (Rev)	REVELL	VK5ACO
W E (Bill)	TANNER	VK7TE
R E	DAVISON	VK9ND

### Ron (Bing) Crosby VK2BCH

I wish to inform you of the recent death of Ron (better known as Bing) Crosby VK2BCH. Ron passed away on 20/12/96, aged 79 years, in Cape Hawke Hospital after a long illness. His funeral was held at St Albans Church in Foster.

Bing was known to many DXers as he made quite a few trips to the Pacific Islands, Fiji, Rotuma, South and North Cook Islands, Samoa, Vanuatu and Lord Howe Island. He was taken ill on his last trip to Rotuma and never properly recovered, spending a lot of time in and out of hospital.

Bing wrote a few stories on some of the trips to the islands which have been published, and were interesting reading.

Ron was an adopted child in the land of his birth, England, and when old enough joined the British Army. He was a Regimental Sergeant Major, saw service in North Africa in the desert in WWII, also in France and Germany, and suffered war injuries. He also served in Asia for the British Army and received an award from the King of Malaysia in person, a rare medal of honour. Ron also served 10 years in the Australian Services, so notched up 35 years in all (an incredible record).

Ron leaves a wife, Susie, who has been a great support, and to her I'm sure all hams will extend their deepest sympathy. We say farewell, Bing, for a job well done.

**Des Hancox VK2AGA**

### **John Moran VK3ABQ**

It is with deep regret that I announce the passing of John Moran VK3ABQ, ex-RAAF, -RAF, on or about Christmas Day 1996 after suffering an apparent collapse at his home in Box Hill South.

John had many friends, and he was always keen to lend a hand to help and promote the cause of the amateur radio hobby. He had been on the broadcast committee of the WIA in the past, was a volunteer health worker at Box Hill Hospital, and a current Boroondara Council "lolly-pop" man at Surrey Hills State School for many years.

John will be sadly missed by all who knew him. We know that his achievements in life will be a hard act to follow. 73 John.

**Geoff Tresize VK3CNX**

### **H O Kellas VK3AHK**

It is with regret that I inform you of the passing of my father VK3AHK (Member 123765) on 1/1 1/1996.

Dad was very proud of his amateur radio hobby. He obtained his first licence in 1946 and maintained it through to the present. We found a collection of QSL cards which we have handed on to another Ham. I am also aware that Dad had sent a larger collection to a collector and had donated some of his early gear to the Moorabbin Club.

On going through his property we found all his call logs from his very first call. Although he had not made a contact since January 1995 he still maintained written contacts with two Hams in the USA, one in South Dakota and the other in Texas.

He was also pleased with his achievements in contacting all 50 States in the USA and having contacted over 100 countries, when that was more difficult prior to the breakup of the eastern European countries.

**John D Kellas**

### **Edmund Gordon Vincent Gabriel VK4YG**

Ted Gabriel was born in December 1919 at Broken Hill. He passed away on 25 November 1996 and was laid to rest in Toowoomba.

The son of a mining engineer, Ted was raised in Zeehan, Tasmania, then moved to Sydney. He studied engineering and developed an interest in aircraft. He obtained his pilot licence in 1939 prior to enlisting in the RAAF. Ted served in Darwin, Butterworth, Sumatra and Java where he was captured by the Japanese and spent time at the infamous Burma Railway.

He participated in many sports as a youth, with fair success, but after the war in 1950, he studied for and passed his examinations for an Amateur Radio Licence, and began operation as VK2AVG. With this callsign, he transmitted far and wide from Northbridge in Sydney, and mobile from the transmitting station which almost filled the boot of his little Austin A40, before moving to WA in 1967. As VK6TG he operated mainly from Port Hedland, and Mt Newman, where he also worked.

After the death of "Tommy", his wife, and his move to Cairns in 1973, he applied for, and was issued with the station callsign he was using at the time of his passing, VK4YG, and became well known and respected throughout the state, especially for his valuable work with the Wireless Institute Civil Emergency Network (WICEN), and was awarded the Distinguished Service Award for his assistance with this body. This award was given by the WIAQ for his receipt and relay of the first radio signals out of Darwin following Cyclone Tracy in 1974, transmitted by a Darwin radio amateur from his car. This relay operation was to continue for some 9 to 10 days, until normal official communications was restored.

Ted was the North Queensland Co-ordinator for WICEN, and wrote many articles on the subject for the national magazine of the Wireless Institute. For this work, he was also awarded the National Medal for Service from the SES.

He was a very active member of the Cairns Amateur Radio Club, where he was available whenever needed for all club activities. He was instrumental in obtaining permission for the club to erect a repeater station at the site of the Bellenden Ker television mast. After his move to Ravenshoe, he also became an active member of the Tablelands Radio Club, where he was greatly respected as a valued experienced member.

He erected his radio masts and constructed a lot of ancillary equipment for use in the house and radio shack, especially after

moving into the house he built at Ravenshoe. The highlight of each day was the daily radio scheds he religiously kept with his old mates, Peter Alexander VK2PA and "Snow" Hodder VK2DV, near, and at Port Macquarie, NSW. Ted passed away whilst talking to Snow during his sched on the morning of 25 November age 76..... ("Snow" thought Ted had had a power failure. He was spot on, really. The only difference was that it was a "personal power failure". Ted would have had a grin at that.)

### **RIP Ted Gabriel**

Vale Ted Gabriel, RAAF pilot, ex-POW and survivor of the infamous prison camps along the Burma Railway, Amateur Radio Operator VK2AVG, VK6TG and VK4YG from 1950-1996, QANTAS Airline pilot, civil construction engineer, willing community service worker (SES and WICEN), social sportsman, unselfish friend to many, and fond family man. At Ted's funeral, the eulogy was read by Fred Tubb, also a survivor of the Burma Railway, and with whom Ted was first captured in Java. He and Ted spent the rest of the war looking out for one another.....

### **Tablelands Radio and Electronics Club**

**Dale McCarthy VK4DMC**  
Secretary

### **W E (Bill) Tanner VK7TE**

It is with regret that I record the passing on 10 December 1996 of Bill Tanner, aged 87 years.

Bill lived all his life in Launceston and was engaged in various avenues of servicing before joining the RAN during WWII, retiring as a CPO. Later he joined the PMG and ABC as a technician. He had one philosophy about fault-finding - everything can be fixed - it just needs getting down to basic theory whether the equipment is ancient or modern, a field in which he excelled.

He was an accomplished musician on several instruments, particularly string bass on which I had the pleasure of joining him many times, and a life member of the Musicians Union, an honour of which he was justly proud.

Bill lived his life to the full in every way. Pre-deceased by his wife, he enjoyed immense pleasure in the company of his many grandchildren. During summer months his sailing interest afforded great pleasure. He will be sadly missed, but well remembered, by all who knew him.

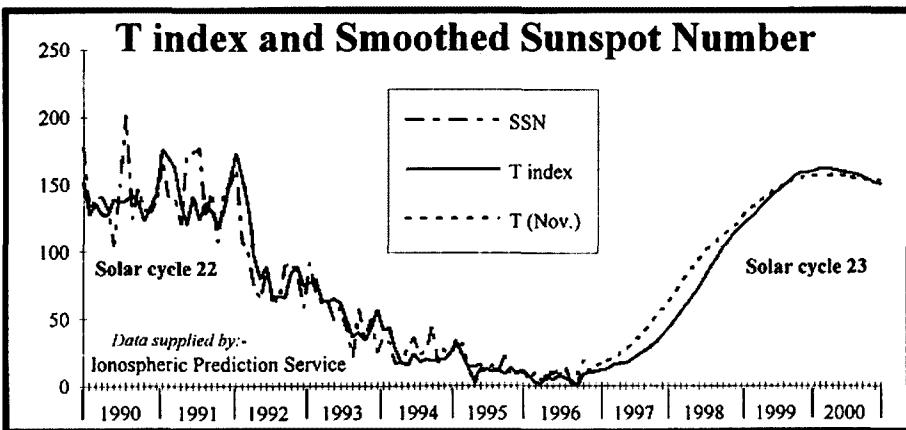
**Ray Kilby VK7RK**

ar



# Ionospheric Update

Evan Jarman VK3ANI\*



## Solar Activity

Solar activity was mostly at very low levels during the last quarter of 1996. The Ionospheric Prediction Service reported that for 37 contiguous days, in September-October, no spots were observed on the sun. In their words: "This sequence is longer than any during recent solar minima – consistent [with] the current minima being "deeper" than those during recent cycles. It is the longest sequence of spotless days for over 50 years."

Activity rose to moderate levels with a class M1 flare at 2044 UTC on 29 November. This was brief with activity returning to very low levels in early December.

The sunspot number in November (18.6) was the highest monthly figure for over a year. The increase was caused by low latitude (old cycle) activity, so cannot be a portent of the new solar cycle. Smoothed sunspot figures continued to decline.

There is a feeling among observers that the minimum between cycles has now passed.

## Ionospheric Activity

Ionospheric maximum useable frequencies have generally been depressed during the last quarter. In the latter half of October this has been by up to 30% particularly in the southern regions of Australia. Conditions improved in late November due to the solar flare.

Conditions in December were enhanced for a few days (17-25 December) up to Christmas. While the enhancement did affect all of Australia, it was particularly pronounced in the northern regions. Around Darwin local night time enhancements of up to 50% were observed.

## Geomagnetic Activity

There were some disturbances during October. The most significant being on 18-19 and 22-23 October. They were related to a pair of coronal holes. On 4 and 10 December there were two mild disturbances, the latter being stronger.

Conditions were unsettled to active during

both disturbances. For the rest of the quarter conditions were quiet to unsettled.

## T index

The Ionospheric Prediction Service revised the T index values in December. The new values have been graphed to allow comparison with previously published data (*Amateur Radio*, November 1996, page 49) which appears as a dotted line on the graph, labelled T (Nov). Solar cycle 23 is now not expected to increase as quickly this year as previously thought. Smoothed sunspot numbers have also been extended to include the last quarter. Any difference between the two indicators is currently so small it is graphically unresolvable.

## Upper Decile

The upper decile was added to the HF predictions for the latter half of last year. It is considered to be an upper limit. Above this line, communication is possible but is anticipated to be for less than a tenth of the time.

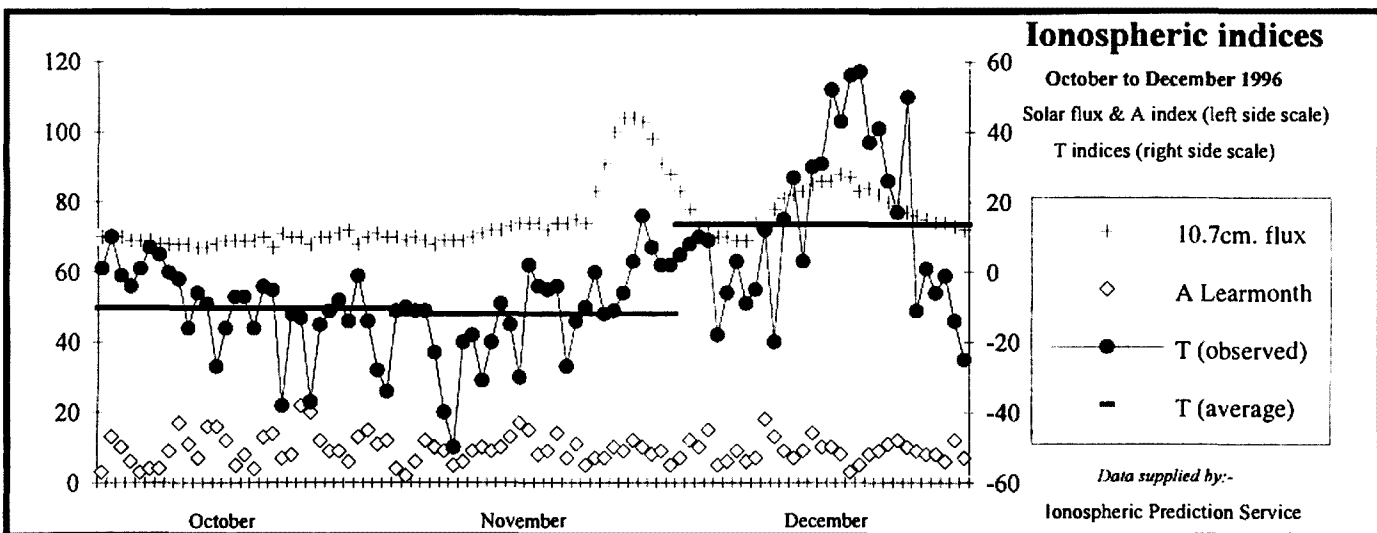
There is a lower decile and it is included in the HF predictions. It has a number of alternative names such as frequency of optimum travail (FoT), or the more common optimum working frequency (OWF).

## Internet

The Ionospheric Prediction Service provides a large amount of information for those with access to the World Wide Web. It includes reports, data and explanatory information for those wanting to know more. This year it is intended to expand services provided and this will include a range of real-time HF predictions. They can be found at <http://ips.gov.au/>

\*C/o PO Box 2175, Caulfield Junction VIC 3161

ar

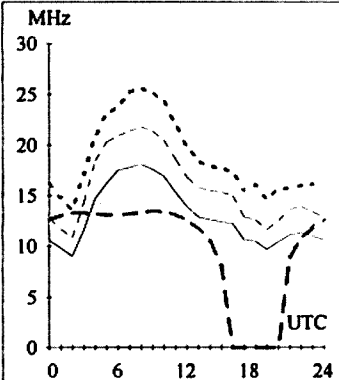
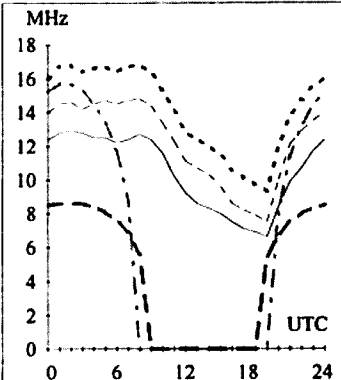


**Adelaide-Auckland** 104  
Second 2F13-19 2E2 Short 3240 km

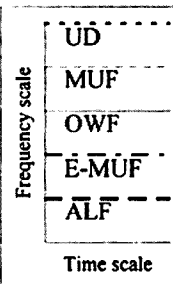
**Brisbane-Harare** 238  
Second 4F2-6 4E0 Short 11988 km

# HF Predictions

*Evan Jarman VK3ANI*



**T Index: 12**



These graphs show the predicted diurnal variation in key frequencies for the nominated circuits. They also indicate a possibility of communication (percentage).

The frequencies identified in the legend are:-

Upper Decile (10%)

Maximum Useable Frequency (50%)

E layer Maximum Useable Frequency

Optimum Working Frequency (90%)

Absorption Limiting Frequency

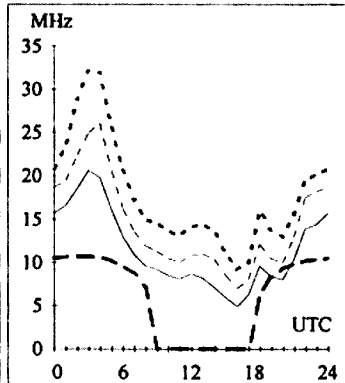
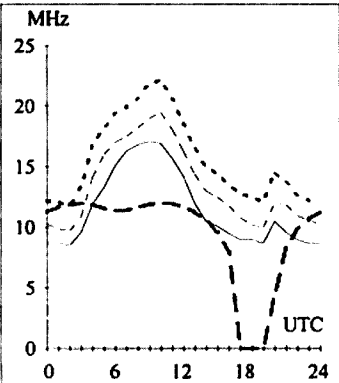
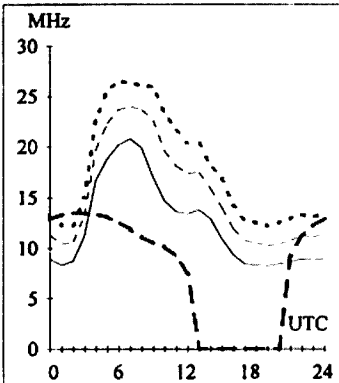
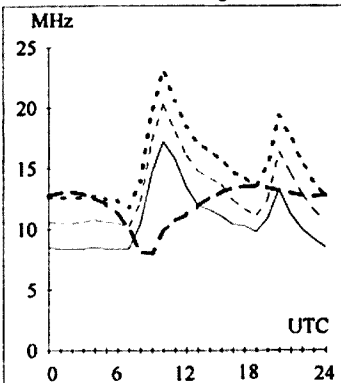
These predictions were made with the Ionospheric Prediction Service Stand Alone Prediction System (ASAPS V3.2. The T index used is shown above the legend. The Australian terminal azimuth, path and propagation mode are also given for each circuit. ar

**Adelaide-London** 132  
First F 0-5 Long 23755 km

**Brisbane-Moscow** 321  
First F 0-5 Short 14072 km

**Canberra-Capetown** 219  
Second 4F4-9 4E0 Short 10777 km

**Darwin-Honolulu** 65  
Second 4F7-13 4E0 Short 8636 km

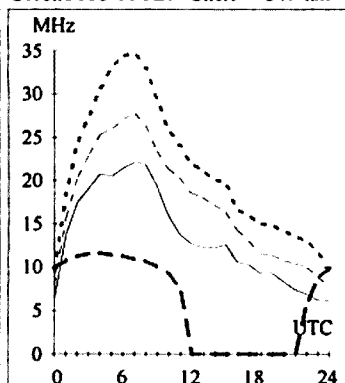
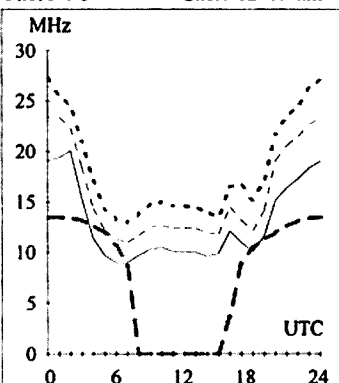
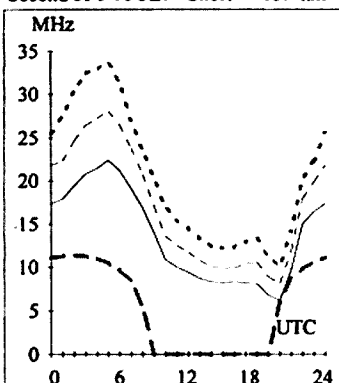
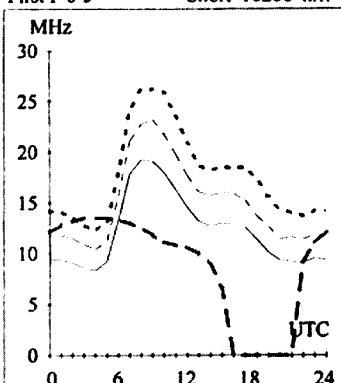


**Adelaide-London** 312  
First F 0-5 Short 16268 km

**Brisbane-Tokyo** 348  
Second 3F6-10 3E0 Short 7159 km

**Canberra-Seattle** 48  
First F 0-5 Short 12709 km

**Darwin-New Delhi** 309  
Second 3F5-11 3E0 Short 7347 km

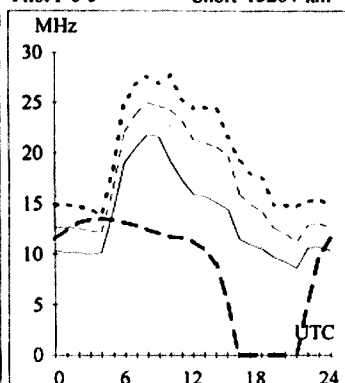
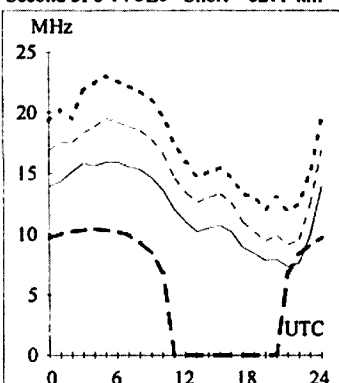
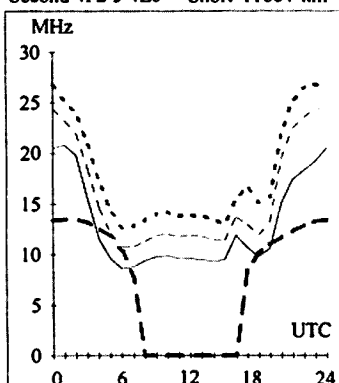
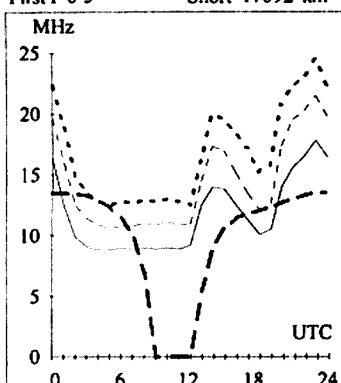


**Adelaide-New York** 67  
First F 0-5 Short 17092 km

**Brisbane-Vancouver** 43  
Second 4F2-5 4E0 Short 11864 km

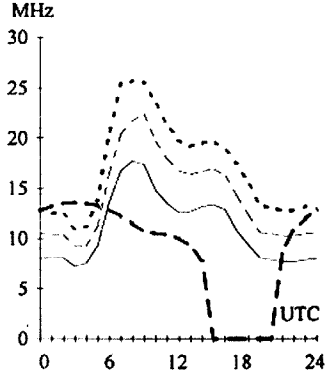
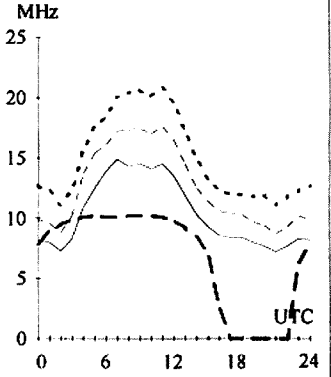
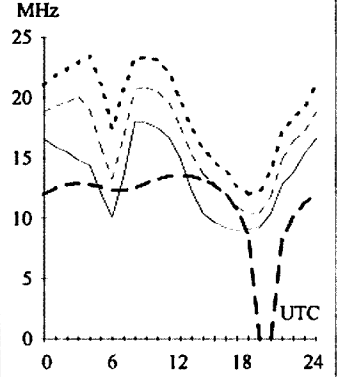
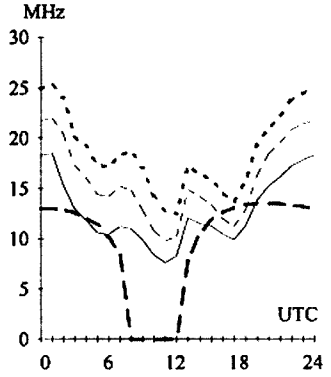
**Canberra-Singapore** 301  
Second 3F8-14 3E0 Short 6211 km

**Darwin-Rome** 311  
First F 0-5 Short 13264 km



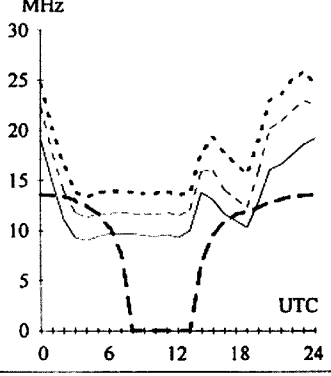
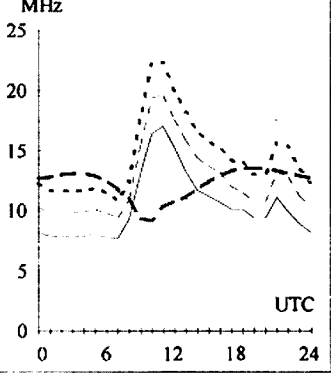
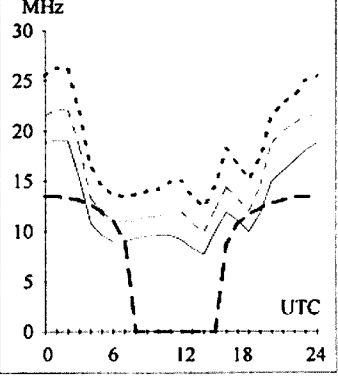
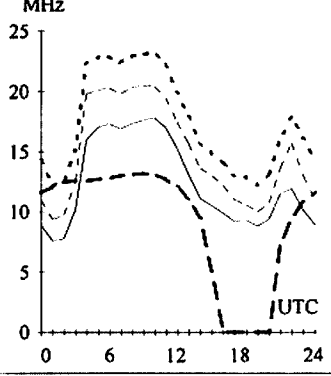
**Hobart-Honduras** 104 **Melbourne-Dakar** 219 **Perth-Johannesburg** 248 **Sydney-Amsterdam** 318

First F 0-5 Short 13930 km First F 0-5 Short 16909 km Second 4F8-14 4E0 Short 8315 km First F 0-5 Short 16639 km



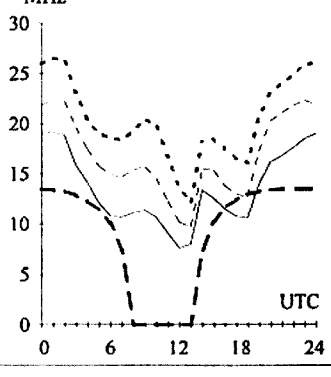
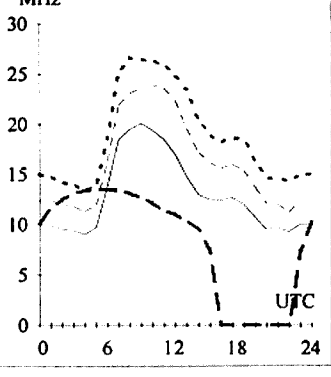
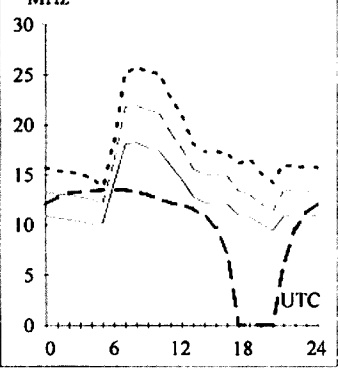
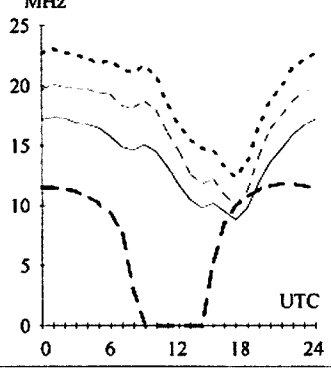
**Hobart-Nairobi** 255 **Melbourne-Los Angeles** 65 **Perth-London** 133 **Sydney-Chicago** 62

Second 4F3-7 4E0 Short 11561 km First F 0-5 Short 12771 km First F 0-5 Long 25544 km First F 0-5 Short 14876 km



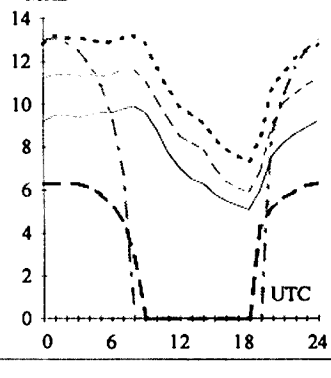
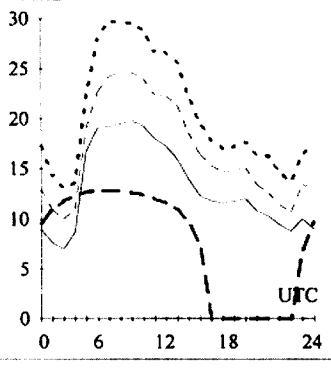
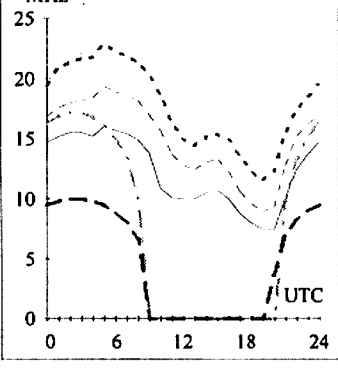
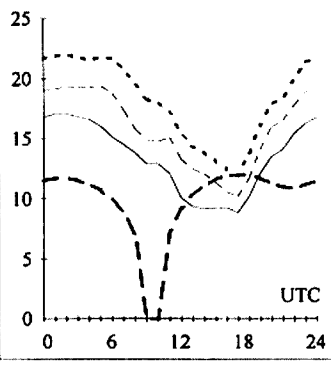
**Hobart-Pitcairn Is** 104 **Melbourne-Madrid** 286 **Perth-London** 313 **Sydney-Mexico City** 83

Second 3F5-8 3E0 Short 7563 km First F 0-5 Short 17308 km First F 0-5 Short 14480 km First F 0-5 Short 12893 km



**Hobart-Santiago** 149 **Melbourne-Vanimo** 354 **Perth-Tel Aviv** 302 **Sydney-Wellington** 119

Second 4F4-6 4E0 Short 10687 km Second 2F9-14 2E0 Short 3927 km Second 4F3-7 4E0 Short 11091 km Second 2F21-28 2E6 Short 2228 km



# HAMADS

## TRADE ADS

### • AMIDON FERROMAGNETIC CORES:

For all RF applications. Send business size SASE for data/price to RJ & US Imports, PO Box 431, Kiama NSW 2533 (no enquiries at office please ... 14 Boanyo Ave Kiama). Agencies at: Geoff Wood Electronics, Sydney; Webb Electronics, Albury; Assoc TV Service, Hobart; Truscotts Electronic World, Melbourne and Mildura; Alpha Tango Products, Perth; Haven Electronics, Nowra; and WIA Equipment Supplies, Adelaide.

• **WEATHER FAX programs** for IBM XT/ATs \*\*\* "RADFAX2" \$35.00, is a high resolution shortwave weatherfax, Morse and RTTY receiving program. Suitable for CGA, EGA, VGA and Hercules cards (state which). Needs SSB HF radio and RADFAX decoder. \*\*\* "SATFAX" \$45.00, is a NOAA, Meteor and GMS weather satellite picture receiving program. Needs EGA or VGA & WEATHER FAX PC card, + 137 MHz Receiver. \*\*\* "MAXISAT" \$75.00 is similar to SATFAX but needs 2 MB of expanded memory (EMS 3.6 or 4.0) and 1024 x 768 SVGA card. All programs are on 5.25" or 3.5" disks (state which) plus documentation, add \$3.00 postage. ONLY from M Delahuntly, 42 Villiers St, New Farm QLD 4005. Ph 07 358 2785.

• **HAM LOG v.3.1** - Acclaimed internationally as the best IBM logging program. Review samples....ARA: "Recommend it to anyone"; The Canadian Amateur: "Beyond this reviewer's ability to do it justice. I cannot find anything to improve on. A breakthrough of computer technology". ARA: "Brilliant". Simple to use with full help, the professional HAM LOG is immensely popular (now in its 5th year), with many useful, superb features. Just \$59 (+ \$5 P & P), with a 90 page manual. Special 5 hour Internet offer. Demos, brochures available. Robin Gandevia VK2VN 02 369 2008 BH fax 02 369 3069.

Internet address rhg@ozemail.com.au.

• **Personalised QSL Cards**, 100 for \$17.50, white or colours. Examples, order forms, send 45 cent stamp to Henry's Publishing, PO Box 6603, Mackay MC, QLD 4741.

## FOR SALE ACT

• **Kenwood TS-120S**, five band HF 100 W txcvr, technical manual, \$450 ONO. Ross Elliott VKIAN 09 581 5696.

## FOR SALE NSW

• **Yaesu FT-901DM** HF txcvr, good condn, manual, YD-148 base mic, plus all leads. **Yaesu FV-901DM** external VFO for the above, mint and boxed, includes manual and leads. **Icom IC-2GAT** h/held, with BP-70 battery, antenna, wall charger, manual, mint condn and boxed. Icom accessories, BC-36 desk top charger, AD-12 external power adaptor, HM-46 s/mic, HS-51 headset, 2 of LC-40 carry cases, all in excellent condn. **MFJ dualbander h/held antenna**, half wave, also **MFJ-1700B** antenna switch, excellent condn. Open to all offers. Consider swapping. Steve VK2SPS QTHR 02 9999 2933.

• Deceased estate **TH6DXX** beam, wind-up tower, HD rotator, indicator unit, coax, guy wires,

complete working order, buyer remove, \$800 ONO. 02 9949 1195 for inspection, or Bill VK2XT 049 591 586.

• **Kenwood TH25-A** 2 m h/held, s/n 907347, with case, charger, manual and box, \$225. **Tono MR-1300E** 2 m amp, 120 W with Rx pre-amp, s/n 75488, \$450. Steve VK2KFJ 02 9975 3933 AH.

• **Yaesu FT-101E**, perf condn, modded for 10 MHz, \$400. **Emtron EAT-300A** ATU, \$180. **Realistic HTX100** 10 m amateur txcvr, new in box, \$240. David VK2COF 02 9498 2622.

• **Avo** and leads, \$75. **Ceramic roller inductor**, \$80. **ATU**, 3 vac capacitors and roller inductor, **ARRL SPC**, \$260. **Palomar Noise Bridge**, \$80. **100 W dummy load**, \$40. Lyons volt stabiliser, 7 kVA, \$150. HP signal generator, 10-420, LP filter NYE, \$30. R McDonald VK2DTR 02 9918 3835.

• **Icom 761 HF** all band/mode txcvr, general coverage receiver, advanced in-built ATU, VOX operation, voice synthesiser option, all advanced functions and controls, set hardly used, s/n 03148, \$2,200 ONO. Mark VK2KFI 042 724 760 or 0412 424 760.

• **AST Premium 286 PC**, ideal for packet, 3.5 and 5.25" FDD, 70 Mb HD, EGA, working with monitor, \$75.00 Brad VK2KQH 02 9906 5855 BH 018 640 377 AH.

• Log periodic antenna, **ATN 13-30-9**, excellent condn, buyer disassemble, \$500 ONO. VK2DER QTHR 02 9687 1477 BH 0412 229 350 AH.

• **Tower galvanised 240 mm triangular 2 section** and centre tube to 50 ft, requires guys, currently horizontal in storage, \$450. Geoff VK2DPE QTHR 047 536 136.

## FOR SALE VIC

• **IC-706**, as new, \$1800. **Nally tower**, dismantled, \$650. **RT80**, suit 2 m packet, \$50. **FM92L**, 70 cm, 25 W o/p, \$250. **Arlec line conditioner**, 500 VA 240 V, \$500. **Amstrad 2286/40** 12 MHz, 40 Mb hard drive, keyboard, mouse, 3.5" floppy, \$100. **CGA monitor**, \$45. **OKI Laserline printer**, 300 DPI, \$250. Harris 2110 fax, Tx OK, Rx print head 95%, \$130. Lee VK3GK, 03 9544 7368, 015 810 101.

• **Kenwood TS-930S** HF txcvr, 160-10 m, auto ATU, narrow SSB filtering, Shure 444 mic, users handbook, workshop manual, immaculate as new condition, little used, \$1445. Bill VK3BR QTHR 03 9584 9512

• **Yaesu FT480R** 2 m all mode, **Mirage linear** with pre-amp, sell or consider swap for Icom 2350 duo-bander or similar with extended receive frequencies. Graeme VK3QS 03 9435 4336.

• **Complete station** includes **TS-520S** txcvr, antenna tuner, two antennas, deluxe mic, coax switch, VSWR meter, connectors plus cable. **Kenwood R1000** receiver, \$600. Stan VK3IS 03 9707 4985.

• **Kenwood TS-520S** complete with crystals for 14.1, 7.2, 3.6 and 1.835 MHz, mic and headphones, instruction manual, s/n 810719. Noel VK3DPB QTHR 03 9306 9231.

• **Icom IC-735**, immac condn, mounting bracket, duplicated operating manual \$950. **FDK Multi 750A** 10 W 2 m all mode, original, operating manual, \$300. Stewart VK3PR 018 513 054.

• **Icom IC-3210A** 2 m 70 cm 25 W, including instruction and service manuals, VGC, \$350. Stewart VK3PR 018 513 054.

• **Yaesu FT-1000**, MD-1 desk mic, SP5 spkr. BPF-1 band pass filter, TCXO-1 temp compensated oscillator, full set of 2.0 kHz, 500 and 250 Hz xtal filters, IRC variable tuning upgrade, 18 months old, less than 20 hours use, absolutely immaculate as new condn in original carton, \$4995 ONO. VK3BR QTHR 03 9584 9512.

• **Icom IC-701** HF txcvr, 160 - 10 m, 100 W, desk mic etc, \$400 ONO. Ron VK3OM QTHR 03 5944 3019.

• **Ameritron ALS600** SS linear amp, 600 W, new, unused, boxed, \$2000. Stan VK3SE 053 322 340 evenings.

• Shack clearance. **Pye Bantam** 6 m h/h with VK3RMS repeater, \$50. **Philips UIIF 747**, mic and cradle, \$30. **Philips UHF828** W1 with mic and cradle, \$50. 2 of Motorola UHF HT220s h/h, unconverted with chargers, \$60 pair. **Motorola UHF HT90** h/h with VK3RCC and 439 MHz simplex, charger, \$85. **Dick Smith SRM5500** VHF marine txcvr, \$80. **AWA RT85**, converted to 6 m, complete and going with 60 ch, \$140. **Philips FM900**, converted to 70 cm with 84 ch, \$140. 2 of **Rangemaster**, converted to 6 m, both with VK3RMS repeater, one with additional 53.5 MHz simplex, \$50 and \$75. Ian VK3AYK 0418 309 050 anytime.

## FOR SALE QLD

• **RF power transistors MRF421**, removed from surplus equipment, 100% checked and guaranteed, factory matched pairs, \$35. Matched quads, \$75. John VK4KK QTHR 07 3269 6647.

• **OSCAR satellite assembly**, two 144-148-8 and two 420-470-14 ATN antennas arranged for either Left Hand or RH circular polarisation, with moulded phasing harness and HD 39 mm fibre glass cross arm. P/N 144-432 44, was \$825 when received 6 months ago from ATN Antennas, original boxes, \$500. Five metre high 900 mm triangular mast, welded and bolted construction designed for rotator, foundation fittings all ready to drop into the holes for erection and pouring, all new, never used, all my load and stress calculations as well as design/detail drawings, \$300. W Yates VK4WYY 07 3285 1061.

• **Desk mic**, 600 ohm balanced output, add a tone control pre-amp to make a fine station mic, several available, \$20 each. Ron VK4BL QTHR.

• 40 of **Scout Tracker 100 W, 8 channel txcvrs**. For further information contact Barry 077 875 770, fax 077 872 916.

• **Brains & Brawn**, HF+6m+2m+70cm, **FT767/FL7000** 1000w, full Tx, auto-tuners, **FEX767-2/6/70** modules, **FAS-1-4R** (new) auto-ant selector, **MD1b8** mic, **FP767P** phone-patch/speaker, **FIF232C** computer iface, all extra filters, service manuals, **Bencher YA-1** LPF. VGC, see/hear on-air, cost over \$10,000, sacrifice the lot \$5,000 ONO (going fishing/mm for a while). Eddie VK4EET 07 3801 3200 AH 07 3403 5703 BH win@tpgi.com.au

• Galvanised tilt-over self-supporting tower, approx 100' high; CDE direction control;

**TH6DXX** antenna, the lot \$1,450. Lin VK4QN QTHR 07 5593 4039.

**FOR SALE SA**

- **Shack clearance** of amateur and CB radio equipment. Send SASE to PO Box 76, Peterborough SA 5422 or phone/fax 086 512 398 for new list. Paul VK5MAP.
- **10 m mast, 6 el antenna** ATN model 13-30-6, tilting, telescopic, mounting base anchor, remote control rotator with connecting cable, all complete and ready to assemble. Reasonable offer. Aldgate SA. A W Bryce VK5FP 08 8370 9924.
- **Icom IC-W21A** 2 m and 70 cm dual band handheld with extended Rx 50 to 1000 MHz, AC charger, cigarette lighter adaptor, antenna, belt clip, with box, s/n 01642, immaculate condn. \$450 ONO. John VK5KBE 014 000 016.
- **Kenwood TS-120S** HF txcvr with manual, \$410. Hank VK5NCA 08 8272 7435.

**FOR SALE TAS**

- **Alpha 87A** linear amplifier, fully automatic tuning, including spare 3C800A7 valves and circuit boards, as new, still under guarantee, \$7000. **Kenwood TL922** linear amplifier, excellent order, \$2500. **Yaesu FT-736** transceiver for 6 m, 2 m and 70 cm, ideal satellite or base station, \$1500. **Tokyo Hy-Power HL160V25** 2 m linear, \$500. Doug VK7AZ, 03 6244 7206.

**WANTED NSW**

- **Automorse and McDonald Pendograph keys**, also any books or manuals, photocopies OK, pay top dollar for good condn keys. Steve VK2SPS (02) 9999 2933 after 6.00 pm.
- **FT221R** 2 m txcvr. Ray VK2FW QTHR 063 653 410.
- Copies of **data sheet(s) for valve type 7360**, will pay any reasonable costs of copying. Pat

VK2ABE PO Box 522, Glen Innes NSW 2370, 067 681 470.

- **GAP Voyager DX; 40 m beam**, Hy-Gain, Cushcraft or KLM; valves 4CX1000A; **Kenwood TS-790A** or **Icom IC-820H**. Tom VK2OE 046 461 024 evenings.
- **Yaesu FRA-7700** active antenna circuit diagram/operation manual photocopy. will pay copy charges and postage. also wanted, ideas on how to minimise extensive QRM to SW receiver from fax machine. Tom VK2ATJ QTHR 02 9349 6683.
- **1296 MHz module for Yaesu FT-736R**. Guy VK2BBF QTHR 047 516 726.

**WANTED VIC**

- 40 m Yagi **402BA, AFA-40, 402-CD** or similar; also triband base station antenna **X6000** or **X7000**. Lee VK3GK 03 9544 7368 or 015 810 101.
- **Kenwood MC60A** or **MC80** 8 pin desk mic. Bob VK3PT 03 5439 6314.
- **Tri-band beam**, 10, 15 and 20 m, in good condn. Ron VK3EXJ QTHR 03 9560 9198.

• New or secondhand **masthead 600 ohm potentiometer for a model 1100m** Emotator antenna rotator. Prepared to buy an old disused rotator complete for spare parts. Peter Cossins VK3BFG QTHR 03 9801 2778 e-mail cossinsp@ozemail.com.au

**WANTED QLD**

- **Owner's manual** (or photocopy) for **Grundig Satellite 3400** Professional Radio Receiver. Russell VK4CCQ, PO Box 264 Ferny Hills QLD 4055; or VK4CCD@VK4YDM; or 07 3351 5798 most evenings.
- Circuit and any information on **Tracker Power Supply 1215**, costs OK. A T Berry VK4BDF QTHR 076 225 474.

- Photocopies of circuit/handbook for **BWD oscilloscope Model 509B**. All expenses refunded. VK4DV QTHR 079 332 646.
- **Horn speakers**, external, long and short, round and rectangular, re-entrant flares, any size, power, condn, with or without drivers, anywhere. Noel VK4CED 07 5496 2222 Fax 07 5496 8002.

**WANTED SA**

- **Six metre beam and linear amp**. Details to Gary VK5DX 08 8370 9196 AH; or 08 8365 3674 BH.
- **Volt meter 0-20 volts**, to fit 65 mm round hole, must be in good condn and good working order. "Somebody must have a spare to sell me!" Paul VK5MAP 086 512 398, phone/fax.
- **FM board and AM filter for Kenwood TS-430S**. Hank VK5NCA 08 8272 7435.

**WANTED WA**

- **Icom IC-970**. Walter VK6BCP QTHR 09 341 2054.
- **Kenwood DG5** digital frequency counter. Rex VK6ARW 099 492 335.

**WANTED TAS**

- **Drake SPR4** comms Rx, reasonable price paid. Martin L70067 QTHR 03 6331 8705.
- **HP 355D attenuators**, require several "faulty" units, complete with knob. Trevor VK7TB, 9 Norfolk St, Perth TAS 7300 or 03 6398 2118.

**MISCELLANEOUS**

- The **WIA QSL Collection** (now Federal) requires QSLs. All types welcome especially rare DX pictorial cards special issue. Please contact Hon Curator Ken Matchett VK3TL, 4 Sunrise Hill Road, Montrose Vic 3765, Tel (03) 9728 5350.

ar

# Hamads

Please use a separate form for For Sale and Wanted items, and be sure to include your name, address and telephone number (including STD code).

- Eight lines per issue free to all WIA members, ninth line for name and address. Commercial rates apply for non-members.
- Deceased estates Hamads will be published in full, even if the ad is not fully radio equipment.
- WIA policy recommends that the serial number of all equipment offered for sale should be included in the Hamad.
- QTHR means the address is correct in the current WIA Call Book.

- Ordinary Hamads from members who are deemed to be in general electronics retail and wholesale distributive trades should be certified as referring only to private articles not being re-sold for merchandising purposes.
- Commercial advertising (Trade Hamads) are pre-payable at \$25.00 for four lines, plus \$2.25 per line (or part thereof), with a minimum charge of \$25.00.
- Copy typed or in block letters, by the deadlines shown on page 1 of each issue of **Amateur Radio**, to:  
Postal: 3 Tamar Court, Mentone VIC 3194  
Fax: (03) 9584 8928  
E-mail: vk3br@c031.aone.net.au

State .....


Please check one box:  For Sale  Wanted  Miscellaneous

**Not for publication:**

Name: \_\_\_\_\_ Call Sign: \_\_\_\_\_ Address: \_\_\_\_\_

# WIA Divisions

The WIA consists of seven autonomous State Divisions. Each member of the WIA is a member of a Division, usually in their residential State or Territory, and each Division looks after amateur radio affairs within its area.

Division	Address	Officers	Call Sign	Weekly News Broadcasts	1997 Fees
VK1	ACT Division GPO Box 600 Canberra ACT 2601	President Philip Rayner Secretary John Woolner Treasurer Bernie Kobier	VK1PJ VK1ZAO VK1KIP	3.570 MHz LSB, 146.950 MHz FM each Sunday evening commencing at 8.00 pm local time. The broadcast text is available on packet, on Internet <a href="http://aus.radio.amateur.misc">aus.radio.amateur.misc</a> newsgroup, and on the VK1 Home Page <a href="http://email.nia.gov.au/~cmakin/wiaact.html">http://email.nia.gov.au/~cmakin/wiaact.html</a>	(F) \$72.00 (G) (S) \$58.00 (X) \$44.00
VK2	NSW Division 109 Wigram St Parramatta NSW (PO Box 1066 Parramatta 2124 Phone 02 9689 2417 Freecall 1800 817 644 Fax 02 9633 1525	President Peter Jensen Secretary Eric Fossey Treasurer Eric Van De Weyer (Office hours Mon-Fri 11.00-14.00 Sat 1000-1300 Mon 1900-2100)	VK2AQJ VK2EFY VK2KUR	From VK2WI 1.845, 3.595, 7.146*, 10.125, 24.950, 28.320, 29.120, 52.120, 52.525, 144.150, 147.000, 438.525, 1281.750 (* morning only) with relays to some of 14.160, 18.120, 21.170, 584.750 ATV sound. Many country regions relay on 2 m or 70 cm repeaters. Sunday 1000 and 1930. Highlights included in VK2AWX Newcastle news, Monday 1930 on 3.593 plus 10 m, 2 m, 70 cm, 23 cm. The broadcast text is available on the Internet newsgroup <a href="http://aus.radio.amateur.misc">aus.radio.amateur.misc</a> , and on packet radio.	(F) \$66.75 (G) (S) \$53.40 (X) \$38.75
VK3	Victorian Division 40G Victory Boulevard Ashburton Vic 3147 Phone 03 9885 9261 Fax 03 9885 9298	President Jim Linton Secretary Bany Wilton Treasurer Rob Halley (Office hours Tue & Thur 0830-1530)	VK3PC VK3XV VK3NC	VK3BWI broadcasts on the 1st Sunday of the month, starts 10.30 am. Primary frequencies 1.840 AM, 3.615 LSB, 7.085 LSB, and FM(R)s 146.700 Mt Dandenong, 147.250 Mt Macedon, 147.225 Mt Baw Baw, and 2 m FM(R)s VK3RMA, VK3RSH and VK3ROW. 70 cm FM(R)s VK3ROU and VK3RGL. Major news under call VK3WI on Victorian packet BBS.	(F) \$75.00 (G) (S) \$61.00 (X) \$47.00
VK4	Queensland Division GPO Box 638 Brisbane QLD 4001 Phone 074 96 4714	President Geoff Sanders Secretary John Stevens Treasurer John Presotto e-mail address: <a href="mailto:wiaq@tmxbrls.mhs.oz.au">wiaq@tmxbrls.mhs.oz.au</a>	VK4KEL VK4AFS VK4WX	1.825 MHz SSB, 3.605 MHz SSB, 7.118 MHz SSB, 14.342 MHz SSB, 28.400 MHz SSB, 29.220 MHz FM, 52.525 MHz FM, 146.700 MHz FM, 147.000 MHz FM, 438.525 MHz (Brisbane only), regional VHF/UHF repeaters at 0900 hrs Sunday. Repeated on 3.605 MHz SSB & 147.000 MHz FM, regional VHF/UHF repeaters at 1930 hrs EAST Monday. Broadcast news in text form on packet under <a href="mailto:WIAQ@VKNET">WIAQ@VKNET</a> .	(F) \$74.00 (G) (S) \$60.00 (X) \$46.00
VK5	South Australian Division 34 West Thebarton Rd Thebarton SA 5031 (GPO Box 1234 Adelaide SA 5001) Phone 08 8352 3428 Fax 08 8264 0463	President Peter Watts Secretary Maurie Hooper Treasurer Charles McEachern  Web: <a href="http://www.vk5wia.ampr.org/">http://www.vk5wia.ampr.org/</a>	VK5ZFW VK5EA VK5KDK	1827 kHz AM, 3.550 MHz LSB, 7.095 AM, 14.175 USB, 28.470 USB, 53.100 FM, 147.000 FM Adelaide, 146.700 FM Mid North, 146.800 FM Mildura, 146.825 FM Barossa Valley, 146.900 FM South East, 146.925 FM Central North, 147.825 FM Gawler, 438.425 FM Barossa Valley, 438.475 FM Adelaide North, ATV Ch 35 579.250 Adelaide. (NT) 3.555 USB, 7.065 USB, 10.125 USB, 146.700 FM, 0900 hrs Sunday 3.585 MHz and 146.675 MHz FM Adelaide, 1930 hrs Monday.	(F) \$75.00 (G) (S) \$61.00 (X) \$47.00
VK6	West Australian Division PO Box 10 West Perth WA 6872 Phone 09 351 8873	President Cliff Bastin Secretary Christine Bastin Treasurer Bruce Hedland-Thomas	VK6LZ VK6ZLZ VK6OO	146.700 FM(R) Perth, at 0930 hrs Sunday, relayed on 1.825, 3.560, 7.075, 14.116, 14.175, 21.185, 29.680 FM, 50.150 and 438.525 MHz. Country relays 3.582, 147.350(R) Busselton and 146.900(R) Mt William (Bunbury). Broadcast repeated on 146.700 at 1900 hrs Sunday, relayed on 1.865, 3.563 and 438.525 MHz; country relays on 146.350 and 146.900 MHz.	(F) \$62.00 (G) (S) \$50.00 (X) \$34.00
VK7	Tasmanian Division 5 Helen Street Newstead TAS 7250 Phone 03 634 42324	President Andrew Dixon Secretary Robin Harwood Treasurer Terry Ives	VK7GL VK7RH VK7ZTI	146.700 MHz FM (VK7RHT) at 0930 hrs Sunday relayed on 147.000 (VK7RAA), 146.725 (VK7RNE), 146.625 (VK7RMD), 3.570, 7.090, 14.130, 52.100, 144.150 (Hobart) Repeated Tues 3.590 at 1930 hrs.	(F) \$74.00 (G) (S) \$60.00 (X) \$46.00
VK8	(Northern Territory is part of the VK5 Division and relays broadcasts from VK5 as shown received on 14 or 28 MHz).			Membership Grades Full (F) Pension (G) Needy (G) Student (S) Non receipt of AR (X)	Three-year membership available to (F) (G) (X) grades at fee x 3 times

Note: All times are local. All frequencies MHz.

## ADVERTISERS' INDEX

Amateur Transceiver Radio _____	44	Terlin Aerials _____	31
Andrews Communication Systems _____	33	Tower Communications _____	11
ATN Antennas _____	18	WIA Recruitment _____	5
Clarke & Severn Electronics _____	43	WIA Membership Retention _____	7
Daycom _____	IFC		
Dick Smith Electronics _____	28, 29, IBC	<b>Trade Hamads</b>	
Electronic Surplus Store _____	3	M Delahuntly _____	54
GFS Electronics _____	27	RJ & US Imports _____	54
ICOM _____	OBC, 13	HAMLOG - VK2VN _____	54
Radio and Communications _____	20	Henry's Publishing _____	54

## TRADE PRACTICES ACT

It is impossible for us to ensure the advertisements submitted for publication comply with the Trade Practices Act 1974. Therefore, advertisers and advertising agents will appreciate the absolute need for themselves to ensure that the provisions of the Act are complied with strictly.

## VICTORIAN CONSUMER AFFAIRS ACT

All advertisers are advised that advertisements containing only a PO Box number as the address cannot be accepted without the addition of the business address of the box-holder or seller of the goods.

# Tough, Compact, Economical

## Yaesu FT-50R 2m/70cm Handheld

For the foremost in top performing, durable, and economical dualband handhelds, there's now only one choice, Yaesu's amazing new FT-50R!

Manufactured to rigid commercial grade standards, the FT-50R provides 2m and 70cm band transceive coverage plus an amazingly wide receiver range (76-200, 300-540, 590-999MHz\*), all in a compact package with water resistant construction that's tough enough to meet the USA MIL-STD-810 rating for shock and vibration resistance, yet is easy to hold and use.

Measuring just 57 x 99 x 30mm (WHD) with the supplied FNB-40 650mA/H Nicad pack, the FT-50R provides 2.0w RF output on the 2m and 70cm bands as standard, and can provide up to 5.0w output when operated from a 12v source (optional Nicad battery or vehicle lead). It also provides 112 memory channels including two Home memories, an Alphanumeric display for channel naming (ie. repeater locations or callsigns) with Omni-glow backlighting, and CTCSS encode for accessing repeaters that require a tone input. Selectable AM/FM receive modes allow for greater flexibility during extended receive operation.

For ease of use, the FT-50R provides super loud speaker output, an Auto Range Transpond System to determine if you are in range of another ARTS equipped transceiver, a Dual-watch system for monitoring sub-band activity, and four Battery saver systems for longer operating times. A selectable LCD voltmeter also allows you to monitor battery performance under load so you can estimate remaining battery life. You can also use the FT-50R with the optional ADMS-1C Windows based PC software/interface to quickly program features or clone programming to other compatible Yaesu radios.

The FT-50R is tough, easy to use, and one of the most economical dualband handhelds you can buy. There's now only one choice, the FT-50R from Yaesu.

(\* Cellular blocked)

D-3655



# \$599

**2 year warranty**



OUR WIDE BAND RECEIVER RANGE IS NOW EVEN WIDER.

ICOM FA-BOJRE



Our wide band receivers give you the world. Starting with our new IC R10, an exciting upgrade of the popular IC-R1 which led the way in handheld receivers. The IC-R10 has a wide frequency coverage of 0.5 MHz to 1300 MHz and is an all mode (FM, WFM, SSB, CW, AM) unit. Features such as a real-time bandscope function, making it easy to find busy frequencies, are firsts for handheld receivers.



IC R9000

Our top of the range IC-R9000 covers 100 kHz - 1999.8 MHz in all modes and features Icom's unique CRT display, intelligent scan functions and an amazing 1000 memory channels, in a unit that delivers superb high frequency stability, even in the GHz range.



IC-R8500

The IC-R8500 is another exciting newcomer with a frequency range of 0.1 to 2000 MHz, excellent frequency stability, and outstanding high receive sensitivity characteristics. With an RS-232C interface allowing direct connection to a PC the new IC-R8500 is truly a state-of-the-art communications receiver.

Our mobile IC-R100 is packed with features and covers the 100kHz - 1800 MHz range in AM, FM, and WFM modes with multi-function scanning and 100 memories with 20 scan edge channels. With the expanded Icom range of communications receivers... the world's radio signals have never sounded so good. Talk to your Icom dealer today for the full technical story.



IC-R100

CALL FREE: 1800 338 915  
290-294 Albert St Brunswick Victoria 3056  
Ph: (03) 9387 0666 Fax: (03) 9387 0022  
A.C.N. 006 092 575

**ICOM**  
Clearly Ahead



# Amateur Radio

March 1997

Volume 65 No 3



*Journal of the Wireless Institute of Australia*



*Full of the latest amateur radio news, information and technical articles including...*

- **Yaesu FT-2500M 2 m 50 W Transceiver Review**
- **The Federal WIA Budget**
- **World Radiosport Team Championship 1996**

**Plus** *lots of other articles, news and special interest columns*

It's here - now, at Daycom!



**IC-756 HF + 6m 100W, auto-ATU, DSP**  
If you missed our Icom Day at the end of November you missed the opportunity to see the all new IC-756. It was pretty hard to see anyway with the crowd always around it!

- All bands 160-6 metres
- 100W output on all bands
- Auto ATU works on all bands
- Dual watch receivers
- Spectrum Scope (just like the IC-781!)
- Dual Pass-Band Tuning
- Adjustable threshold DSP noise reduction
- Audio Peaking Filter
- Automatic Notch filter
- Built-in CW memory keyer
- 100 alphanumeric memories

Some of the reactions: "how much will you give me for my FT-1000 as a trade-in?", "Probably the most innovative radio since the IC781 hit the market!", "This is really a radio for all reasons, easy to use but with all the features a contester or DXer needs."

In stock now, call to secure yours:

## \$3700

IC-2710H Dual Band mobile



The very latest in dual band mobile convenience - removable front panel, remote control microphone & lots of options including PC cloning of radios!

## \$1250



introducing special price.  
**ICOM \$3400**

The **NEW** Icom R-8500 receiver is here now! It covers 100kHz to 2000MHz (no breaks) has 1000 memories and a host of features you wouldn't think possible at just \$3750. Get the full story, call for a brochure or look on the WEB at <http://www.daycom.com.au/>

**MFJ** Performance you can afford!



**MFJ1270C** 1200bps VHF/UHF packet \$249  
**MFJ1276** HF/VHF/UHF packet+PACTOR \$349  
**MFJ1278B** 10 mode multi-mode controller \$599  
**MFJ1278B-DSP** DSP added to MFJ1278B \$759

**MFJ Packet options and accessories**

**MFJ780** DSP add-in card for MFJ1278B \$219  
**MFJ781** External DSP for any TNC \$279

## Kantronics



**KPC-3** 1200bps VHF/UHF packet \$249  
**KPC-9612** 1200/9600bps dual port packet \$459  
**NEW KPC-9612+** coming - run out special \$395!  
**KAM+** Deluxe multi-mode \$669

### MFJ Antenna Tuners

MFJ901B	200W Versatuner	\$149
MFJ910	Mobile antenna matcher	\$45
MFJ921	2 mtr 300W tuner	\$155
MFJ924	70 cm 300W tuner	\$155
MFJ931	Artificial ground tuner	\$169
MFJ941E	300W compact GP tuner	\$230
MFJ945E	300W mobile tuner	\$209
MFJ948	Deluxe 300W (no D/L)	\$270
MFJ949E	Deluxe 300W	\$299
MFJ962C	1.5kW tapped inductor	\$525
MFJ971	200W Portable tuner	\$190
MFJ986	3kW Diff-T roller inductor	\$629



MFJ989C 3kW Deluxe roller inductor \$735

### ARRL 1995 Publications CD-ROM



A whole years QST, QEX and NCJ magazines in a single CD-ROM - how convenient! With power full reader technology the diagrams and photos appear inseparable windows. Fully searchable text. Requires 386 or better with Windows 3.1 or later.

## \$45



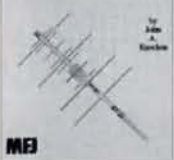
### HAMCALL 1996

Our most popular callbook CD-ROM with Windows, DOS and MAC search engines. Much new information this year including photos of many amateurs!

## \$45

## New books for your library!

### Antennas and Transmission Lines



### Antennas & Transmission Lines

This book of 37 chapters gives you lots of well explained theory, not too much mathematics and lots of practical examples with plenty of 'how-to' added. Great as a handy reference or a useful home study text.

**MFJ3305 \$40**

### Practical Receivers for beginners

Build a DC receiver for 80 & 20, or the "Super-7" for 40, maybe even a simple 50MHz FM receiver, they're all here in this wonderfully practical new book from the RSGB! Great projects, plenty of good practical advice.

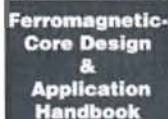
**BR79 \$33**



### Instant Morse the CD-ROM!

Here it is in one easy package - a complete multimedia Morse code teaching package with training software and lots of other info. Requires Windows 3.1 and Sound Blaster compatible sound card.

**BR492 \$99**



### Ferromagnetic Core Design & Application Handbook

This classic book gives you everything you need to know to design with and use ferrite and iron powder cores. From the pen of the master - Doug DeMaw W1FB. A must have reference for every hobbyist or professional.

**MFJ3506 \$40**

## TKIT The NEW Heathkit!



Help reclaim this fascinating band! Six metres is the VHF DX band and even now offers regular overseas contacts with just a little effort. The TT1208 kit is the ideal, low cost way, to get going on 6 metres and find out what only the elite have known for years!

- Requires 3-5W input on 20 metres
- Extremely simple hookup and operation
- Sensitive, low noise 50.54MHz front end
- Fast, silent PIN diode TR switch for QSK & data
- 8W output on 6 metres
- Requires 12-15V DC 3A power supply
- Simple switching between HF and 6 metres
- Rugged steel case

**TT1208 8W 6 metre transverter \$199**



# Amateur Radio Service

A radiocommunication service for the purpose of self-training, intercommunication and technical investigation carried out by amateurs, that is, by duly authorised persons interested in radio technique solely with a personal aim and without pecuniary interest.

## Wireless Institute of Australia

The world's first and oldest National Radio Society  
Founded 1910

Representing the Australian Amateur Radio Service -  
Member of the International Amateur Radio Union  
Registered Federal office of the WIA:  
3/105 Hawthorn Rd, Caulfield North, Vic 3161

All Mail to:

PO Box 2175, Caulfield Junction, VIC 3161  
Telephone: 03 9528 5962 Fax: 03 9523 8191

Business Hours: 9.30 am to 3.00 pm on weekdays

Federal Secretary  
Peter Naish VK2BPN

### FEDERAL OFFICE STAFF

June Fox	Book Keeper
Sue Allan	Membership Secretary
Rita Trebilco VK3NRT	Examinations Officer

### COUNCIL

President	Neil Penfold	VK6NE
VK1 Federal Councillor	Richard Jenkins	VK1RJ
VK2 Federal Councillor	Michael Corbin	VK2YC
VK3 Federal Councillor	Brenda Edmonds	VK3KT
VK4 Federal Councillor	Ross Marren	VK4AMJ
VK5 Federal Councillor	Grant Willis	VK5ZWI
VK6 Federal Councillor	Bruce Hedland-Thomas	VK6OO
VK7 Federal Councillor	Jim Forsyth	VK7FJ

### EXECUTIVE

Peter Naish	VK2BPN
Lance Bickford	VK4ZAZ
Rowland Bruce	VK5OU
Neil Penfold	VK6NE

### FEDERAL CO-ORDINATORS

AMSAT:	Graham Ratcliff	VK5AGR
Awards:	John Kelleher	VK3DP
Contests:	Peter Nesbit	VK3APN
Education:	Brenda Edmonds	VK3KT
EMC and Standards	Roger Harrison	VK2ZRH
FTAC:	John Martin	VK3KWA
Historian:	John Edmonds	VK3AFU
IARU:	David Wardlaw	VK3ADW
Int'l Travel Host Exch:	Ash Nallawalla	VK3CIT
Int'l Beacon Co-ord:	Roger Harrison	VK2ZRH
Intruder Watch:	Gordon Loveday	VK4KAL
ITU Conference and Study Group:	David Wardlaw	VK3ADW
Media:	Roger Harrison	VK2ZRH
QSL Manager (VK9,VK0):	Neil Penfold	VK6NE
Radio Sports:	Wally Watkins	VK4DO
Videotapes:	Bob Godfrey	VK4BOB
WICEN:		

### SMA LIAISON TEAM

Roger Harrison	VK2ZRH
David Wardlaw	VK3ADW
Neil Penfold	VK6NE

# Editor's Comment

## A Torrent of Words

One of the topics most discussed at the last Publications Committee meeting was the trend by most of our columnists to write a little bit more each time. We know that all of our columnists have a devoted band of followers, and the information keeps on pouring in, full of interest to the dedicated readers. But the trouble is that space in the magazine stays fixed, so less and less is available for articles. You told us about a year ago that you all wanted Technical Articles more than any other thing. But there is less and less space for them!

We don't want to upset our enthusiastic columnists by wielding the editorial "blue pencil" (or "red ballpoint"). We would much prefer that they themselves "have a go" at pruning. I'm sure I've said before in these pages that "any fool can say in a thousand words what a genius can say in a hundred". We know you are not fools, nor geniuses in most cases, but perhaps a thousand words might condense to 750? No? 800? Please!!

With this issue, some of you will notice a different fly-sheet carrying your address. The Hamads form has been moved to the fly-sheet so you can send in a Hamad without needing to cut up the back page of *Amateur Radio!* Next month everyone will have the new fly-sheets, when the old ones are all finished, and the Hamads form will no longer be printed inside the magazine.

If you feel motivated to write in and tell us you like or dislike any feature of *Amateur Radio*, please do so! We appreciate feedback, and all suggestions are welcome. For example, we think our uncluttered cover style is better than the "pack 100 items on the cover" appearance of some competing overseas magazines. Do you agree? Tell us, please! How about presentation generally? *Amateur Radio* is YOUR MAGAZINE! Make it the way you want it.

Bill Rice VK3ABP  
Editor

## CONTRIBUTIONS TO AMATEUR RADIO

*Amateur Radio* is a forum for WIA members' amateur radio technical experiments, experiences, opinions and news. Manuscripts with drawings and/or photos are always welcome and will be considered for possible publication. Articles on computer disk or via e-mail are especially welcome. The WIA cannot assume responsibility for loss or damage to any material. A pamphlet, "How to Write for *Amateur Radio*", is available from vk3br Communications Pty Ltd on receipt of a stamped, self addressed envelope.

---

## ■ Federal QSP

# Opening a Door to the Future

---

On 12 February, three of us from the Federal body – David Wardlaw VK3ADW, Roger Harrison VK2ZRH, and myself – took the WIA's submission on amateur licensing to the Minister for Communications and the Arts, Senator Richard Alston.

The Senator gave us a very good hearing, of about 35 minutes. He asked us a lot of questions about amateur radio and learned, as much as could be put across in the limited time, about the broad range of activities amateurs are involved in, the background to our hobby and why we need a licensing system of our own. Through his questions he learned we have bands spread through the radio spectrum and that amateurs are not assigned individual frequencies; of the value amateur radio provides to the community; that it is an international hobby involving self-training; and that amateurs are individually licensed and recognised internationally by the ITU and countries around the world. The question and answer session also covered satellites, communications support for emergencies, call signs and the examination system – Senator Alston did not realise amateurs had to be qualified.

He told his Liaison Officer present at the meeting that the submission was to go to the Department of Communication and the Arts. The Minister's Department will be conducting a review of the Radiocommunications Act and amendments this year.

As the Radiocommunications Amendment Acts had their first readings in Parliament early in December, I contacted the Minister that month to seek a meeting so that the Institute would not miss a timely opportunity to present the case for a better amateur licensing system. The Minister set the date. So, the presentation of the submission was very timely, as confirmed by the Minister's Liaison Officer.

Developing the submission has been a lengthy process. There are those that say it has taken too long. But really, "quick fixes" so often turn out to create more problems than they solve. They leave difficulties for "someone else" to tackle, later. We're trying to get something better for the future. Something that will last. Not something that just suits impatient amateurs now.

The process began with the Federal Council agreeing on a "framework", outlining the issues to be covered and leading to a proposal. This was agreed in mid-1995. Getting this framework required research of what the Federal Council had discussed and established in the past. A first draft was circulated to Federal Councillors in February 1996. From discussions and suggestions coming from that effort, the Exposure Draft was completed which the Federal Council agreed would be sent to

candidates for the March 1996 federal government election. It was also published in *Amateur Radio* and on the Internet.

As a result of that, when Senator Alston became Minister for Communications and the Arts, he invited the WIA to present the final submission once the process of amateur community consultation had been completed. The final draft of the submission was circulated to Divisions in January and I was pleased to see general agreement return from Divisions shortly before we met with the Minister.

We did not expect to "haggle" over details or terms with the Minister. Being able to meet the Minister and establish formal contact, and having the submission sent to the Department of Communications to be considered in the coming review of the Act and amendments, is a considerable achievement of which the Institute can be justifiably proud. When that review comes around, we will have further opportunity to advocate our case.

For now, the door to the future for amateur radio has been opened.

**Neil Penfold VK6NE**  
**WIA Federal President**  
ar

---

## ■ WIA News

*Roger Harrison VK2ZRH, Federal Media Liaison Officer.*

---

# Minister Sends Licensing Submission to Department

The Minister for Communications and the Arts, Senator Richard Alston, has sent the WIA's submission on amateur licensing to his Department, to be considered in a review of the Radiocommunications Act and amendments which will be conducted by the Department this year.

A delegation from the WIA met with the Minister at Parliament House in Canberra on Wednesday, 12 February.

The delegation comprised Federal President Neil Penfold VK6NE, the WIA's representative on the Radiocommunications Consultative Council, David Wardlaw VK3ADW, and the submission's author-editor, Roger Harrison VK2ZRH.

The Minister asked many questions about amateur radio and amateurs' activities. The main thrust of the Institute's submission was outlined,

that the present three licensing systems under the Radiocommunications Act were drafted to suit public and private sector commercial purposes and, for that reason, they do not suit the voluntary, non-pecuniary nature of the Amateur Service and radio amateurs' activities. The basic proposal of creating a separate licensing system under the Act was put forward.

In answering the Minister's questions, the topics covered by the delegation included:

- amateur radio encourages young people to take up an interest in science and technology, leading to careers in science and engineering (presently an important concern of the government); amateur radio involves self-training in radiocommunications and related technologies and techniques;
- amateurs must be qualified through a system of examination;
- amateur radio is an international hobby, recognised by the ITU under international treaties and regulations;
- amateur radio promotes international goodwill and understanding;
- amateur radio provides a regulated, yet self-regulating, outlet for people interested in transmitting, hence providing orderly use of the spectrum where otherwise there might be anarchy with clandestine stations;
- radio amateurs' activities provide value to the community through contributing to the advancement of science, the development of technology and support during community disasters and emergencies;
- that the WIA actively participates in spectrum management processes both locally and internationally, and that the Institute had provided – at our own cost – people to act on behalf of Australia on delegations to international regulatory conferences;

The Minister's Liaison Officer, present during the meeting, later said that the WIA's presentation of the submission was very timely.

The final draft of the submission was completed on 20 January and circulated to all Divisions that week. Following suggestions from some Divisions and discussions with David Wardlaw and Neil Penfold, a small amount of further information was

included and minor amendments made. The Federal Council was to consider publication of the completed submission at the Extraordinary Convention being held over 15-16 February (originally scheduled for 8-9 January, as advised in January *Amateur Radio*, but postponed by the Federal Council in January so that all Federal Councillors could be present).

The 33-page submission of five sections, with 28 pages in four appendixes, includes a four page Executive Summary. This sets out that radio amateurs require:

- individual licences;
- certainty of licence tenure;
- where fees are applicable, an equitable fees framework;
- certain and continuing access to frequency bands throughout the radiofrequency spectrum; and
- continuing participation in spectrum management processes at local, national and international levels.

The Executive Summary also outlines the WIA's arguments that the current three licensing systems have conflicting limitations, restrictions and administrative constraints for the Amateur Service; and that the fees framework for the Apparatus Licence system embodies concepts which are of a commercial, economic nature not applicable to the Amateur Service. All this leads up to the proposal to create a fourth licence type, specifically for radio amateurs which would recognise and provide for the complete flexibility

needed to pursue our activities, within the framework of allocated amateur bands and applicable licence conditions.

The submission specifically asks for recognition of the unique nature and status of the Amateur Service and proposes arrangements which would simplify government administration and reduce amateurs' "engagement" with the authorities through devolvement, citing the existing devolvement of examinations.

The submission argues that it would be open for the government to waive fees in recognition of the value the Amateur Service provides to the community, as has the US government. A copy of the joint resolution of the US Congress and Senate was included in an appendix. The submission also gives recognition to the fact that there is a necessary departmental cost in essential spectrum management and regulatory process, at national and international levels.

Development and presentation of the submission was only the first step in the process. The Minister's office has confirmed that there will be an opportunity to further argue our case and put additional material forward when the Department of Communications and the Arts conducts the review of the Radiocommunications acts and amendments later this year.

The WIA Federal Council is to consider further action in advancing the case for a licensing system for amateurs.

## Government Promotes Year for Youth in Science

The Federal Government announced in January that 1997 has been declared the "Year for Youth in Science". Launched by the Minister for Science and Technology, Peter McGauran, the government will spend \$12 million over the next three years on activities to make young people more aware of science.

The Minister said, "Australia needs

*more scientists, technologists and engineers, not more doctors, lawyers and accountants.*

*"Science and technology is Australia's number one wealth generator and holds the key to improving all of our lives," he said.*

*"We must develop a more positive attitude and a greater understanding in the general community of the role*

science and technology plays in everyday life. Building this recognition will in turn lead to an increased demand for scientists, technologists and engineers, creating more opportunities for young people.

"Australia has a proud history in these fields and governments, the science community and the private sector all have a role to play in

## WIA Says No to Class Licence Devices on 70 cm

When the Spectrum Management Agency wrote to the WIA in December, seeking the Institute's "... views on a proposal to support class licensed operation of low powered devices in the band 433.05-434.79 MHz", the WIA said it did not support the proposal.

The SMA's letter, from the Spectrum Planning Team of the Business Directions Group, said that, "Over the last year, interest in Australia in the 433.05-434.79 MHz band for low powered applications has increased noticeably." The letter went on to explain that the SMA "... has received five business cases for consideration in the last three months, across a broad range of applications, and there are regular inquiries made to our Area Offices.

"The reason for this appears to be a growth in low powered applications sourced from Europe ... and the long standing designation in that Region of the band 433.05-434.79 MHz for industrial, scientific and medical (ISM) applications.

"The various European administrations support the operation of low powered devices on an uncoordinated, licence-exempt basis, in the aforementioned band where amateur services operate. We believe it is appropriate to offer the same uncoordinated, free of licence fee, opportunities in Australia, through our class licensing regime."

The SMA's letter highlighted applications supported under the European arrangements as motor vehicle radio keys, wireless stereo headphones

ensuring this remains the case," McGauran said.

One of the major thrusts of the WIA's licensing submission covers the contribution amateur radio makes in encouraging an interest in science and technology, particularly among young people. The Year for Youth in Science provides an ideal opportunity to promote amateur radio among young people.

and low powered data transmission systems (eg wireless LANs). Radiated power limits specified range from 10 mW for vehicle keys to 500 mW for wireless data systems.

Requests to the SMA had been for devices radiating 25 mW or less, "... which we believe can be supported in this country on an uncoordinated basis," said the SMA. They proposed to allow all types of low powered transmitters to the 25 mW limit, without differentiating between possible applications.

In rejecting the SMA's proposal, the Institute pointed out the problems which had occurred in the UK last year, particularly with motor vehicle radio keys. Radio activated key entry (RAKE) devices, operating on 433.92 MHz, have been a problem in Britain as people had been locked out of their cars because strong UHF transmissions (from amateur, land mobile and military stations) had blocked the radio key (see *WIA News*, January 1997, p 6).

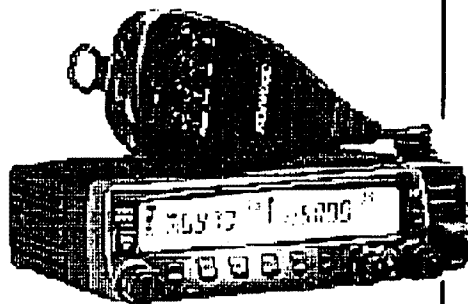
Wireless hi-fi headphones and loudspeaker systems operating on 433 MHz were in the news in Britain in January, with interference being the source of complaint, according to a report in *New Scientist* for 11 January (p 19).

While the European 433 MHz ISM band is used in the major Western European countries, it is not available in Britain, Norway, Finland or Denmark. European manufacturers of wireless headphones, Vivanco, Sennheiser and Philips, had been lobbying Britain's



**YOUR HOBBY** **YOUR VOICE**  
Representing Radio Amateurs - Since 1910

# RENEW YOUR MEMBERSHIP AND YOU COULD WIN



**THIS KENWOOD TM-733A  
2m/70cm FM/packet rig  
worth \$1255**

50 W on 2m 35 W on 70cm  
Switchable 10 W/5 W RF output  
Simultaneous VHF-UHF reception  
Data input for 1200/9600 baud packet  
70 multi-function memories

**All you have to do is renew  
your Division membership  
when it falls due**

**WHO'S ELIGIBLE?** ● members whose renewal falls due between 1/1/97 and 31/12/97 ● current members who are on a 3-year membership ● life members, and ● all membership grades.

**The prize will be awarded by means of a draw, the result to be published and the prize to be presented to the winner at the first available opportunity early in 1998.**

TM-733A prize kindly donated by  
Kenwood Electronics Australia P/L,  
PO Box 504, Homebush 2140.  
Ph: (02) 9746 1888. Fax: (02) 9746 1509.

Department of Trade and Industry unsuccessfully for two years to allow the 433 MHz technology into Britain. Vivanco said they'd "given up on 433 MHz for Britain." It is not known which companies had approached the SMA in Australia.

In Australia, amateurs are a secondary service in the 420-450 MHz band, which is shared with the primary service, radiolocation, and with other fixed and mobile services (also secondary) used by the defence forces.

In replying to the SMA, the WIA pointed out that the 433-435 MHz sector of the 70 cm band was widely used by

voice and packet radio repeater systems, and other amateur operations which would be incompatible with having the proposed devices operating in that band. There was a high likelihood of interference to amateur receiving equipment and interference from amateur transmitters to the proposed low powered devices. In particular, vehicle radio keys employ tuned radio frequency (TRF) receivers which have poor selectivity and are susceptible to blocking and interference from transmitters up to 10 MHz away from the radio key's frequency, as had been experienced in Britain.

## VM4AAA an Authentic Call Sign

The Spectrum Management Agency has advised the WIA that the call sign VM4AAA, often heard on the 14 MHz band, is an authentic call sign, held by a Queensland amateur.

The SMA said that the call sign was awarded to the holder in 1983 by the then Minister for Communications, the Hon. Michael Duffy, "in recognition of extended participation in the Amateur Service."

A proposal at the time to award VM prefixes to amateurs who had been licensed for 50 years or more was not implemented.

Call sign VM4AAA "remains allocated as a special case," the SMA said, and they "will not consider the issue of any further call signs that do not conform to the current amateur call sign template."

## WIA Takes Action on Beacon and Repeater Fees

Following November's change in the method and rate of charging for amateur beacon and repeater licences, resulting in massive increases in the annual licence costs on top of previous increases, the WIA's SMA Liaison Team swung into action, calling for information from all Divisions on beacon and repeater licences in each State and Territory.

While awaiting the information, after consultation with a number of Federal Councillors, the SMA Liaison Team wrote a letter to the SMA requesting

information on the basis behind the Agency's determination of the fees.

The SMA's Radiocommunications Assignment and Licensing Instructions (RALI) AM2 says that "A separate licence is required for each Amateur Repeater station. Such licences only authorise the operation of one pair of frequencies (transmit/receive) except..." and "A separate licence is required for each Amateur beacon station. Each Amateur Beacon licence must only authorise one transmit frequency."

Although the WIA has had

discussions with the SMA about the basis of beacon and repeater licence fee charging since this was introduced in 1995 with the new amateur licence fees regime, the Institute sought information on how this method of charging was determined under the Radiocommunications Act, the Regulations or any SMA Determinations. SMA Liaison Team investigations over 1995-96 had discovered that there was no clear path arising from the legislation or SMA Determinations which arrived at the instruction in RALI AM2. The Team also discovered that it had apparently been applied differently in different states, and even within states.

A reply was received from the SMA in January, which has been referred to the Federal Council meeting to be held over 15-16 February.

The actions of beacon and repeater licensees in forwarding information through the WIA Divisions for the SMA Liaison Team to compile data on the impact of the change to beacon and repeater fees is most appreciated.

ar

### QSP News

#### Nominations for Election of Federal WIA Officebearers

Amateur Radio magazine received a request dated 24 January 1997 from Neil Penfold VK6NE, Federal President of the WIA, asking that the following notice be published:

**To All Members of the Seven Divisions of the Wireless Institute of Australia**

*At the Annual General Meeting of the Wireless Institute of Australia to be held on 3 and 4 May 1997, in accordance with the Articles of Association, the positions of President, Directors, Editor and those of the numerous Federal Coordinators all come up for election.*

*Your consideration of the various positions is sought and, should you wish to nominate a person, please communicate with your Federal Councillor.*



## ■ Equipment Review

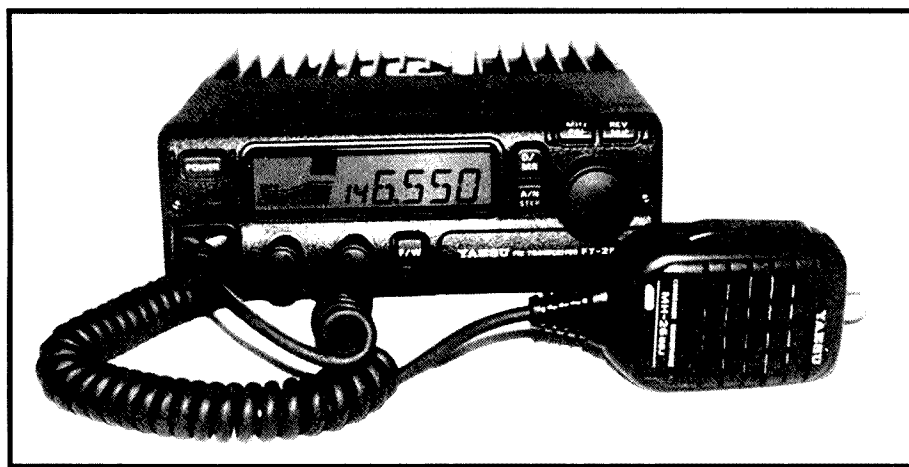
# Yaesu FT-2500M 2 m 50 W Mobile Transceiver

Reviewed by Ron Fisher VK3OM\*

Compared to the earlier FT-2400, the entire front panel has been improved with the tuning control moved higher and increased slightly in size. Unfortunately, though, the modular microphone connector remains which makes it difficult to connect a packet modem. An adaptor lead is available as an option to simplify packet operation. Talking of packet, the FT-2500M is capable of operating with 9600 baud packet but a fairly complicated modification is required. While this is fully described in the excellent manual it would need a fair degree of expertise to carry out. Dick Smith Electronics can undertake the work at minimal cost if requested. Of course, 1200 baud packet operation is available without any modifications.

Features of the FT-2500M include 31 tunable memory channels (isn't it interesting that the tiny FT-10R has over three times this capability), manual or automatic LCD illumination control, and the ability to name any of the memory channels. A CTCSS encoder is included but the decoder is an optional extra.

Originally the FT-2500M was to be supplied with the MH-27 DTMF type microphone but is now supplied with the MH-26G8J. It is this microphone which is pictured with the review transceiver.



Front view of the FT-2500M with the matching MH-26G8J electret microphone.

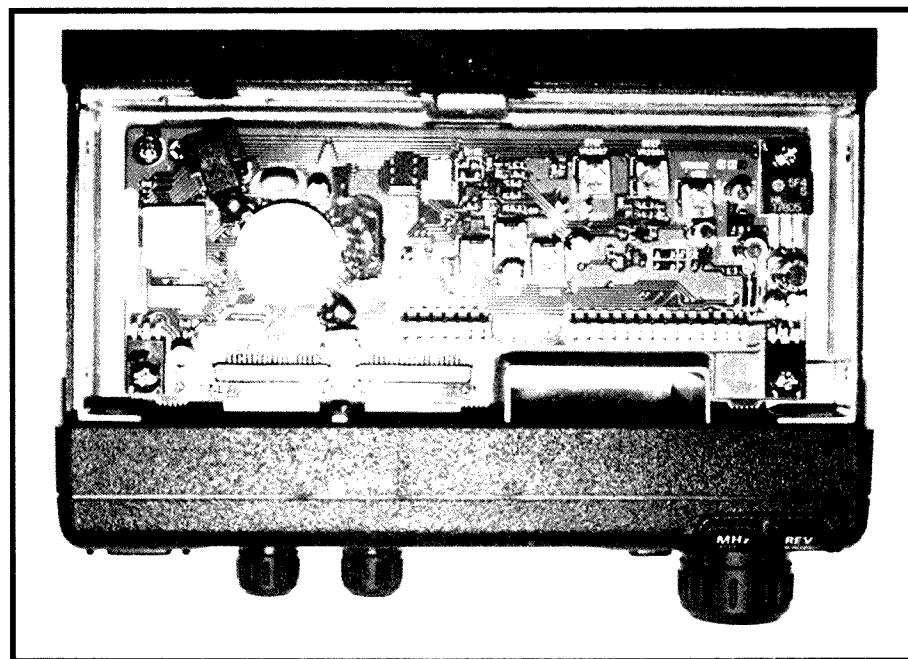
A few years ago I reviewed the predecessor of this transceiver, the FT-2400. This, and the new FT-2500, were designed to meet United States Military Specifications for shock and vibration. The construction is rugged with a one piece die-cast chassis. Maximum transmitter power output is fifty watts with selectable lower power of twenty five and five watts.

Frequency coverage on transmit is 144 to 148 MHz with extended receiver coverage from 140 to 174 MHz. There is no coverage of the AM aircraft band although other Yaesu models of a similar type do include this facility.

The FT-2500M measures 160 mm wide by 50 mm high and 180 mm deep. It weighs in at 1.5 kg which is a shade heavier than some of its contemporaries which, of course, reflects its more rugged construction. The transceiver is supplied with a solid mobile mounting bracket and a generous length of DC connecting cable.

The FT-2500M is designed for simplified operation with a minimum of

controls on the front panel. In fact, five of the controls are hidden behind a drop-down panel which makes for a very clean front panel appearance.



Top inside view of the FT-2500M. Note the pre-set controls for low/mid/high power setting (centre) and the beep level to the upper right.

The small button on the front of the microphone allows switching between VFO and memory operation, which is very handy. The original microphone also had a priority channel select button which is no longer available. Dick Smith Electronics informed me that the new microphone should have better audio quality compared to the earlier model.

### **FT-2500M On Air**

Entering memories in modern transceivers can be an interesting exercise. Buttons held down for slightly different periods of time produce different results. It takes a little time to get used to the system. However, the instruction book is well written and therefore easy to follow.

On-air tests indicated that the new microphone sounded much the same as the earlier one. The transmitted quality sounded rather "spitty" with apparent over-deviation at the high frequency end of the audio spectrum due to a peaky microphone response.

### **FT-2500M On Test**

The first test was to measure the

transmitter output, firstly at 13.8 volts and then at lower voltages to simulate a discharged car battery, and to check at what voltage the set stops transmitting. It is important to know these figures if you are out on an emergency exercise. To answer the last question first, the FT-2500M will continue to put out reasonable power right down to 9 volts. In fact, the output at that voltage is 17 watts.

At 13.8 volts the power output was right on the specified 50 watts and the current drain was 9.5 amps. Mid-power output, specified as 25 watts, was measured at 23 watts with the current drain at 6.5 amps. Low power measured 4.3 watts with 3.2 amps drain.

One of the important parameters with a mobile transceiver is the maximum undistorted receiver audio output. The specification rates this at 3.5 watts at 10% distortion with a four ohm load. My measurements confirmed this figure which was obtained with the volume control full on and with a full saturation signal into the receiver. The internal speaker is mounted in the bottom of the

cabinet which is probably the best compromise for the usual mobile installation. The internal speaker gives reasonable audio quality but, as usual, a good external unit is to be preferred for both mobile and home station use.

Receiver sensitivity is specified at 0.2  $\mu$ V for 12 dB SINAD and again this was confirmed by my measurements. Squelch sensitivity was measured at less than 0.1  $\mu$ V. Overall, the performance of the FT-2500M is first class with the possible exception of transmitted audio quality.

### **FT-2500M - the Bottom line**

At a selling price of \$599, this transceiver represents excellent value, particularly if you need a transceiver that can stand up to a hard life and comes with a two year warranty. If you treat your equipment in a more gentle way you should be rewarded with a lengthy trouble-free life. Thanks to Dick Smith Electronics for the loan of our review transceiver; you should contact them for any further details.

*\*24 Sugarloaf Road, Beaconsfield Upper VIC 3808*

---

# ■ The Federal Budget

*Peter Naish VK2BPN\*, the WIA Federal Secretary, explains the financing of the Federal WIA.*

---

No, you are not about to read a complicated political statement from Canberra regarding how your tax dollar is to be spent! Rather this is an attempt to explain how your WIA Membership Subscription is used to provide you with meaningful benefits.

From time to time there have been descriptions of how WIA Federal is structured. But there has not been a simple account of how it is financed and what it does with the money received. Suffice to say that WIA Federal is operated as a business and obeys the rules laid down by the Australian Securities Commission as they apply to incorporated not-for-profit companies.

The Federal Executive of WIA Federal comprises the Company Directors charged with the responsibility of operating the business enterprise on

behalf of the seven shareholders (the seven State Divisions of the WIA). The key role is accounting for the company's finances and the main tools used are the annual Federal Budget and monthly reports on income and expenditure. The objective of this article is to highlight to you the various areas from which income is derived and how it is then employed to the benefit of Australian radio amateurs.

The principal income comes from the Federal component of members' subscriptions. Other sources are advertising in "AR", payments for sitting licence examinations, sales of the "Call-Book" and interest received from our capital assets deposited in various bank accounts.

The expenditure is much more diverse. The major cost is in the provision of our house journal *Amateur Radio*. Other

areas are the costs of providing the examination service, the collection of subscriptions on behalf of the State Divisions, liaison with the SMA and overseas organisations, and the provision of funding to various activities which include AMSAT, ARDF, amateur radio contests and prizes for *Amateur Radio* articles. In addition there is a cost associated with running the company and providing support for the Federal Council who determine WIA Policy.

One of the major concerns at present is the fall in overall WIA membership. This is having a dramatic impact on the money available for Federal activities. At the same time there has been a drop in advertising revenue and a lower return on our investments due to lower interest rates. These factors have combined to produce a situation where the company

directors will be forced to instigate cost reduction procedures to prevent a rapid reduction in our capital assets and eventual insolvency.

To understand better the expenditure side of the Federal Budget a few words on the various activities and cost control measures are appropriate:

### Amateur Radio Magazine

This seeks to be a high quality publication relevant to the needs of members and reflecting the changing technology of amateur radio. It must remain as such. However, that does not imply that it cannot be produced at a more economical cost. We are fortunate in having both a professional editor and highly talented support team who are able to publish month after month a world-respected journal. Recently we have rationalised our production activities for "AR" and now have a single contractor who is responsible for the type-setting, layout, printing and mailing of the magazine. This change is expected to save money compared with our previous arrangement where several people were involved.

### Examinations

The WIA operates the licence examination service under an arrangement with the SMA. When this was instigated, it was intended that it should be at no cost to the members, ie it would be financially self-supporting. In the early days it returned a surplus to the WIA, but costs have gradually risen and ways are being sought to trim them.

### Liaison

The chief reason for a federated body is the ability for a single united voice to be heard by the licensing and regulatory authorities. Specifically, in Australia the WIA speaks on behalf of all Australian radio amateurs at regular meetings with the SMA in Canberra. Overseas, the WIA is a member of IARU and participates in its regional conferences. The WIA also attends, as part of the

Australian delegation, the various WRCs that have a bearing on amateur frequencies and conditions of licence. Attendance at these conferences and meetings in general tends to be an expensive item. The period 1997 to 2000 is an important era for amateur radio. During these years there will be two WRCs, one in 1997 and the other in 1999. At both, amateur radio issues will be on the agenda including frequency allocations in the HF spectrum and the very sensitive matter of the need to demonstrate Morse code capability for those who wish to operate below 30 MHz. It is vital that the WIA be present with well-prepared material presented by experienced representatives who can ensure that the wishes of Australian radio amateurs are properly heard. Sufficient money has to be budgeted for this.

### The Federal Secretariat

Day to day operation of the Federal company takes place at the Federal Office in Caulfield, Victoria. There we

have a staff who are highly dedicated to the WIA and who ensure that the company operates smoothly. Every opportunity is being taken to minimise the cost of the Secretariat by avoiding unnecessary expenditure. For this, the Directors have the full co-operation of the staff.

For several years, the WIA Federal company has been in the happy position of being able to report an operating surplus at the end of each year. Unfortunately, as a consequence of falling membership the results in recent years have not been so good. In fact a loss was reported for 1995 and a similar situation is likely to occur when the 1996 results are finalised. This situation must not be allowed to continue and the Federal Directors together with the Federal Council are determined to redress the balance. More members would certainly be the best solution but a cost restraint program is also required and appears to be possible.

<b>1997 Membership Subscriptions</b>							
	VK1	VK2	VK3	VK4	VK5	VK6	VK7
	\$	\$	\$	\$	\$	\$	\$
<b>'F' GRADE</b>							
Divisional	23.25	18.00	26.25	28.75	26.25	13.25	25.25
Federal	18.85	18.85	18.85	15.35	18.85	18.85	18.85
<i>Amateur Radio</i>	27.00	27.00	27.00	27.00	27.00	27.00	27.00
IARU Dues	0.90	0.90	0.90	0.90	0.90	0.90	0.90
International	2.00	2.00	2.00	2.00	2.00	2.00	2.00
<b>Total</b>	<b>72.00</b>	<b>66.75</b>	<b>75.00</b>	<b>74.00</b>	<b>75.00</b>	<b>62.00</b>	<b>74.00</b>
<b>'G' GRADE</b>							
Divisional	19.60	17.00	22.60	25.10	22.60	11.60	21.60
Federal	15.30	15.30	15.30	11.80	15.30	15.30	15.30
<i>Amateur Radio</i>	20.60	20.60	20.60	20.60	20.60	20.60	20.60
IARU Dues	0.90	0.90	0.90	0.90	0.90	0.90	0.90
International	1.60	1.60	1.60	1.60	1.60	1.60	1.60
<b>Total</b>	<b>58.00</b>	<b>55.40</b>	<b>61.00</b>	<b>60.00</b>	<b>61.00</b>	<b>50.00</b>	<b>60.00</b>
<b>'X' GRADE</b>							
Divisional	23.25	18.00	26.25	28.75	26.25	13.25	25.25
Federal	17.85	17.85	17.85	14.35	17.85	17.85	17.85
<i>Amateur Radio</i>							
IARU Dues	0.90	0.90	0.90	0.90	0.90	0.90	0.90
International	2.00	2.00	2.00	2.00	2.00	2.00	2.00
<b>Total</b>	<b>44.00</b>	<b>38.75</b>	<b>47.00</b>	<b>46.00</b>	<b>47.00</b>	<b>34.00</b>	<b>46.00</b>

**Have you advised the SMA of your new address?**

## Division Components

Year	VK1 \$	VK2 \$	VK3 \$	VK4 \$	VK5 \$	VK6 \$	VK7 \$
97	23.25	18.00	28.25	28.75	26.25	13.25	25.25
96	23.25	20.00	25.25	25.25	25.25	14.00	22.25
95	23.25	20.00	25.25	25.25	25.25	14.00	22.25
94	18.25	20.25	20.25	18.25	18.25	9.00	17.25
93	18.25	15.00	20.25	18.25	18.25	9.00	15.25
92	18.25	15.00	20.15	18.25	18.25	9.00	15.25
91	15.75	15.00	19.00	17.50	17.50	9.00	15.00
90	16.00	10.00	16.00	16.00	16.00	7.00	13.00
89	11.00	8.50	17.00	12.00	11.00	9.00	9.00

## Federal Components

Year	AR \$	Intern'l \$	IARU \$	Office \$	Total \$
97	27.00	2.00	0.90	18.85	48.75**
96	27.00	2.00	0.75	17.00	46.75
95	27.00	2.00	0.75	17.00	46.75
94	32.00	2.00	0.75	17.00	51.75
93	31.00	2.00	0.75	17.00	50.75
92	31.00	2.00	0.75	17.00	50.75
91	31.00	2.00	0.75	16.25	50.00
90	30.00	2.00	0.75	16.25	49.00
89	19.14		0.75	13.11	33.00
88	16.25		0.75	13.00	30.00
87	14.20		0.75	12.33	27.00
86	11.76		0.47	12.27	24.00
85	11.76		0.47	12.27	24.50
84	12.05		0.45	10.50	23.00

\*\*VK4 pay \$45.25 Federal component

\*C/o PO Box 2175, Caulfield Junction VIC 3161

ar

Olympics of Amateur Radio.

My story begins in late 1995 when I received a letter from Martin VK5GN asking if I would be interested in participating in the WRTC-96 with him. In previous years Martin had won quite a few SSB contests – my forte had been CW contests, telegraphy being my preference for communications.

WRTC? I had read something about this back in 1990 so it was a review of old ARs, QSTs, RadComs and CQ magazines to learn the background. The 1990 event had been held in Seattle, Washington State. Twenty teams had competed during the IARU contest (July). For this event every contest station was given an ICOM 765 or 735 and each had similar antennas with similar locations to make it a level playing field. It was a great success, supported by major world electronic companies as well as other industries. Even the Governor of the State showed extreme interest and attended the final presentation.

## San Francisco

WRTC-96 was planned to be the event of all events and it lived up to its predictions. The host organisation was the Northern California Contest Club and the venue set for the San Francisco bay area (better known as Silicon Valley). As a point of interest, in this quite small area there are said to be over 6,000 licensed amateurs. The date was again during the IARU Contest in July, only this time it was planned as an 18 hour marathon with the FCC issuing special 1x1 calls for the occasion.

The selection of the teams was not necessarily by the country of origin because, as in Australia, we do not have a Contest Club as such. In most cases the selection of the teams was by the International WRTC Committee who, over the previous years, had noted world and national winners. To be invited to represent Australia in this prestige event was really an honour and I rate it as the highest recognition of my 50 years as a Radio Amateur.

I thought there would be a lot of time between January and July to prepare myself for this test, but time just seemed to fly by. The Internet became the main method of communication during this

## ■ Operating

# World Radiosport Team Championship 1996

*David Pilley VK2AYD\* recounts his experiences in one of the biggest contests ever.*

Over the past few months many amateurs have asked "What was the WRTC-96 and what was it like to participate in?" This is my story.

The WRTC-96 was perhaps the biggest contest event in the history of amateur radio. It brought together many

of the best contest operators in the world. 52 two-man teams from over 30 countries were put head-to-head to compete for the title of Champion of Champions. Over 250 people from as many countries were also involved in the organisation. It could be said to be the

time and a reflector had been set up in Japan so that news up-dates could be given and received just about instantaneously.

I was advised that the meeting point was to be Motel 6 at Belmont, just south of San Francisco airport. Accommodation for the five days would be provided by the sponsors free, but we had to find our own air fare, transportation, etc. One of the rules was that we had to provide our own equipment, which had to be to a specific standard, eg 100 watts maximum, no special DSP filters, etc. The antennas (a triband beam at 15 metres and a 40 metre dipole would be provided).

We were also encouraged to bring our own computers for logging and our favourite keyers. Voice keyers were not allowed. So I set about writing to the various Australian suppliers to see if they would like to loan us equipment. No interest. Some did not even have the politeness to respond. To test the waters I even wrote to the Olympic committee and the Minister of Sports and

Recreation to see if they would like to provide something that we could use to identify ourselves as Australia. They did at least respond but were unable to assist. But what the heck, we were going in any case! How could we miss this great moment in amateur radio?

Martin and I had never met so we decided to get together in May for the CQ WW WPX Contest at his home just north of Adelaide. At least we would determine our compatibility! I flew over to Adelaide and soon realised why he did so well in the contest with his antenna farm. We had quite a few other things in common, so we got on well. I am not aware of the results of this contest at the time of writing.

As the day drew closer, we gathered together the bits and pieces needed. Keyers, phones, etc. I had starting running a daily sked with FOC friends in the Bay area and already we had the promise of the use of a new Ten-Tec Omni VI and an FT-1000, so we were OK for rigs. Martin had organised a lap-top and we were ready to go.

About a month before departure day I received a request that I attend the Microwave Convention at San Francisco, three weeks before the WRTC. That certainly was very convenient and it gave me time to meet a few friends before arriving in Belmont.

I arrived at Motel 6 on Tuesday afternoon, complete with a new Omni VI and the FT-1000. The rules were that we could have two rigs. One nominated as the main rig and the other for listening and stand-by should the other fail. The foyer of the motel was like the United Nations. Italian, French, Russian, every language seemed to be spoken. The motel was quite large, and was in the shape of a triangle with a big pool in the centre. This became the meeting and partying centre for the rest of the week.

Next morning, Wednesday, Martin arrived complete with a good Aussie head-cold and all the bits and pieces needed for the contest. Over the past few months the WRTC Committee, under the guidance of Bruce AA6KX and Bob W6RJ, had seconded 52 existing stations

## PRESS RELEASE

### MINI-CIRCUITS DESIGNER'S GUIDE

To encourage Radio Amateurs to build and develop their own communications equipment, Mini-Circuits USA are offering, free of charge, their RF/IF Designer's Guide.

Mini-Circuits manufacture an extensive range of mini-modules, such as RF Amplifiers, Frequency mixers, Power splitters, Filters, Detectors, Attenuators, etc. Circuits are available in various case style packages to suit applications from surface mount to external equipment mounts.

Typical Mixer frequency range from 10kHz to 4.3GHz, making them ideal for engineers interested in LF to SHF work.

If you would like a free copy of RF/IF Designer's Guide, contact Mini-Circuits Australian representatives and stockists.

Clarke & Severn Electronics,  
PO Box 1, Hornsby NSW 2077  
or 02 9482 1944.

## LOW COST ERA AMPLIFIERS PROVIDE LONG TERM RELIABILITY



*Next generation technology and economy are built into Mini-Circuits new series of drop-in and surface mount MMIC amplifiers. The ERA-1 through ERA-5 (and SM versions) are designed to provide generous levels of inexpensive signal gain, and wide dynamic range for applications to 8GHz (usable to 10GHz). And you can count on ERA's reliability for the long-run! At a junction temperature of +185°C, mean time to failure (MTTF) is more than 10 years. A junction temperature of just 5°C less results in an improvement factor of four in MTTF! ERA amplifiers provide the long-term, trouble free operation you can bank on.*

**Mini-Circuits from Clarke & Severn Electronics**  
**PO Box 1, Hornsby NSW 2077**  
**Phone: (02) 9482 1944 Fax: (02) 9482 1309**

in the Bay area to be the host stations for us to compete from. Which station we would be operating from would not be determined until the Friday prior to the contest.

## Registration

That morning we all met for registration. Lots and lots of hand-shaking with amateurs we had often competed with and now met in person. Each person was given a special WRTC-96 embossed Tee-shirt. Competitors were White, Judges and Committee were Blue, Referees were Red. Everyone could easily be recognised as to their involvement. Yes, for 52 stations they needed 52 referees (to keep us honest).

In the afternoon we were all taken to Coyote Point Park where Icom had organised an excellent picnic. The evening was a "pool" event! For those that did not hold a US call, special dispensation was given by the FCC and those that wanted to sit the US exams were given the opportunity. All the Russians turned into AC6s! I already had a US call, N3AFU, so no problems.

Thursday we were given the option of a tour of San Francisco, organised by *CQ Magazine* and Cushcraft, or a tour of Silicon Valley organised by ARRL/TGV. Martin and I chose the latter which took us on a tour of Force 12, the antenna manufacturer, to HRO (Ham Radio Outlet) and Fry's computer superstore where quite a few dollars exchanged hands. Martin also acquired a set of band-pass filters which were more than useful during the contest to aid listening on the second receiver. In the afternoon we were transported in three buses to a dinner sponsored by Shell Oil at historic Martinez. It was about an hour's drive north which was an interesting peak-hour experience. Martin's head cold was beginning to peak and I had signs of it coming on.....!

Friday and you could feel the tension. At 10 am the competitors, judges and referees all met for the final briefing by K3EST, N6AA and K4VX, and to learn who our host station would be. As Australia is near the top of the alphabetical list we had an early draw. We drew the station of Fred Streib W6NA at Palo Alto and our referee was RU1AA. An envelope giving our 1x1

call was given to RU1AA. This would be opened an hour before our start.

Back to our room to pack and check over our equipment. Had we missed anything? Too bad now. As Martin and I had no transport, Bruce AA6KX kindly offered to ferry us to our operating QTH which was set in a lovely residential part of Palo Alto.

Fred and his wife Rosemary were wonderful hosts and really made us feel at home. We were surprised to find Fred already had two full Ten-Tec stations installed and it seemed such a shame to have to remove his Omni VI and replace it with ours, but those were the rules. Above the house at 13 metres was a HB9CV triband beam, and a 40 metre dipole had been installed by W6RGG. The FT-1000 was set aside for just listening.

A VCR was installed to record all events and a dual phone outlet was provided so that the referee could monitor the operator. I had the good fortune to spend a week with WJ6O prior to the event so was already quite familiar with the Omni VI. This transceiver is dedicated to amateur radio and only covers amateur bands. It is possibly the easiest radio I have had to operate. The features were built-in, whereas with the

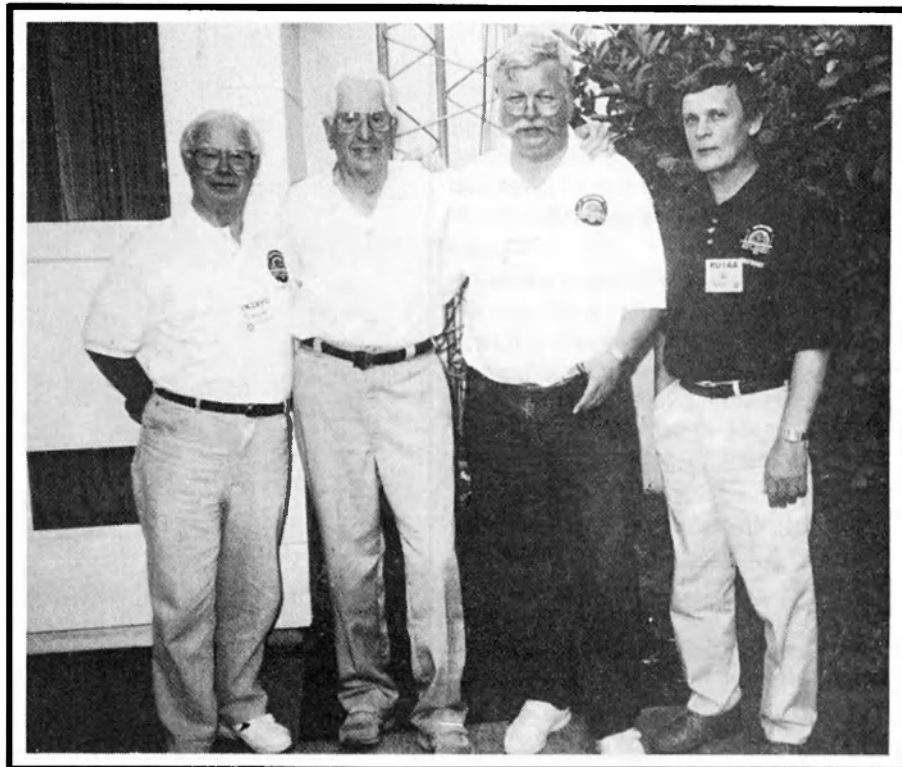
FT-1000 you had to fiddle knobs to optimise it!

That evening we were well fed and ready for the 5 am start the next morning. As Martin was more familiar with the "TR" logging program (I use "CT" at home), we decided to adopt this. I got some practice with the program before making an early night.

Saturday, 4 am (yes, there is such a time!) we woke, showered and prepared for the big moment. The call would be W6Z. The WRTC contest was to be part of the IARU CW/SSB contest which starts at 5 am local time. We would enter the IARU contest at 5 am and leave it at 11 pm. To provide incentives to work WRTC stations, the committee had arranged various trophies and most of the Silicon Valley gang were eager to see who would be the first to qualify. Here was a contest within a contest within a contest!

## Nice Clear Spot?

As HF (14 MHz up) was still pretty dead at this time of day, we decided to open up on 7 MHz with CW. 80 metres was not going to be used by the WRTC for the marathon. I listened around the band. Lots of signals tuning, some in QSO. I found a nice clear spot and



From l to r, VK2AYD, W6NA, VK5GN, RU1AA.

decided that would be it. Lock onto a frequency and save the S & P (search and pounce) for later. We set our computer clock and waited. 5 am and I pressed the auto CQ button – so did half of Silicon Valley! They all seemed to be on the same frequency that was once clear and now reading 20 dB over S9 and totally unintelligible.

I quickly searched for another frequency, found one, and started to run stations, but kept coming unstuck with the TR program, hitting the wrong keys. Finger trouble at this time was not good and I was getting mad with myself. It took me over half an hour to really settle in and I think a lot of it was nerves, knowing I had to be up in the 100 QSOs/hr to be competitive.

I quickened the pace and exchanges to get over this magic number. After a couple of hours I was ready to pass the baton to Martin and let him raise the level on SSB when suddenly the TV cameras and reporters arrived. I quickly vacated the hot seat and Martin took over. For those of you that know Martin you can imagine his profile with the hands free mic and headset on. The camera man thought the same and some interesting footage was made which we were able to view on closed circuit at the presentation banquet.

Martin soon had the rate up over 150 and we settled down for 18 hours of competition. RU1AA, our referee, was also a keen CW operator so I couldn't make errors without notice! His command of English was not so good so when Martin was on, it was left to the recorder! We worked throughout the day in two hour shifts and when not operating we endeavoured to listen on the other receiver; however, in spite of having excellent band-pass filters fitted, it was nearly impossible. Our hosts, Fred and Rosemary, laid on a magnificent luncheon in their garden but, with all the excitement, it was not really a good time to sit and relax.

**Remember to leave  
a three second  
break between  
overs when using a  
repeater**

At about 9 pm that evening we were around 1800 QSO's but we had very few multipliers so we reverted to S & P for the last two hours. That probably was a bad move, but it was our decision. Some local knowledge would have been useful as I'm sure at times I had the beam in the wrong direction. But all this is thoughts after the event.

I don't remember what the break down of QSOs were per band. In those 18 hours, after deletions and corrections by the judges, we were accredited 1822 stations. At the stroke of 11 pm our station closed and our computer log was removed and transported to the judges who spent all night analysing the logs and making changes as necessary. Martin and I returned to the motel with our equipment and slept through what was left of the night.

### Day of Reckoning

Sunday and the day of reckoning! Everyone was around the pool. The Slovenians were offering strange drinks and Rusty W6OAT had organised endless pizzas. Lots of talk on QRM, QRN, who stole my frequency, etc, but all in a good spirit. That evening we were all invited to a banquet at Stanford University for the prize giving.

The winners were KR0Y and K1TO who had 2457 QSOs to their credit. The gold medal was presented to them by the President of the ARRL, KB6ZV. It was a magnificent evening with what seemed like thousands of people there. I wished I had an Australian flag to fly as some of the other competitors were displaying theirs. It was a great moment in my life. We didn't win gold, but I did come home with gold – I went gold-panning in the Sierra mountains with WJ6O!

On Monday, Yaesu invited us all to a tour of the Napa Valley via the San Francisco ferry. The wineries at Mondavi were our first stop and then to Sattui Winery for a gourmet lunch and a long drive back by road. That evening the pool area was once again full of DX and lots of grog!

So ended WRTC-96. Where will it be held next? They suggested Australia in the year 2000 to coincide with the Olympic games. My suggestion was that each team had an out-back pedal power rig, one operator to pedal and one to work

the rig! This soon changed their minds! Whoever picks up the gauntlet for the next WRTC will have a hard act to follow, and whoever represents the Australia Team I can assure will have a memory that will never erase. WRTC-96 was the first time Australia had been invited. Let's make sure it's not the last.

I would like to thank the organisers, especially those behind the scenes who provided transport on time, organised our days and ensured no one would have an unhappy moment. To WJ6O who offered the loan of his brand new Omni VI, K6TS who loaned his FT-1000 (what trust!), our host station W6NA and to W6DU who looked after me whilst I recovered from the dreaded lurgy after the event. Isn't Amateur Radio a great fraternity? I'd also like to thank friends at Charter Freightlines and Clarke Electronics, Sydney, who gave me support and encouragement to take up the challenge.

*\*41 Cain Close, Wauchope NSW 2446*

ar

## Andrews Communication Systems

(EST. 1976 - ACN 001 968 752)

**WE WILL NOT BE UNDERSOLD  
ON ALINCO RADIOS**

- ★ IC-756 HF+6M, DSP, LCD
- ★ IC-R10 HAND HELD SCANNER
- ★ WS-1000E CUTE SCANNER
- ★ DX-70TH HF+6M 100W
- ★ MFJ TUNERS AND CONTROLLERS
- ★ DX-16000 HF LINEAR AMP.
- ★ AR-7000 DSP, LCD, SCANNER

**3 YEAR WARRANTY ON  
OUR ALINCO RADIOS**

Call us now

**(02) 9636 9060** or (02) 9688 4301

SHOP 8, 41 BATHURST ST, GREYSTANES,  
N.S.W. 2145. FAX (02) 9688 1995

# Technical Abstracts

Gil Sones VK3AU1\*

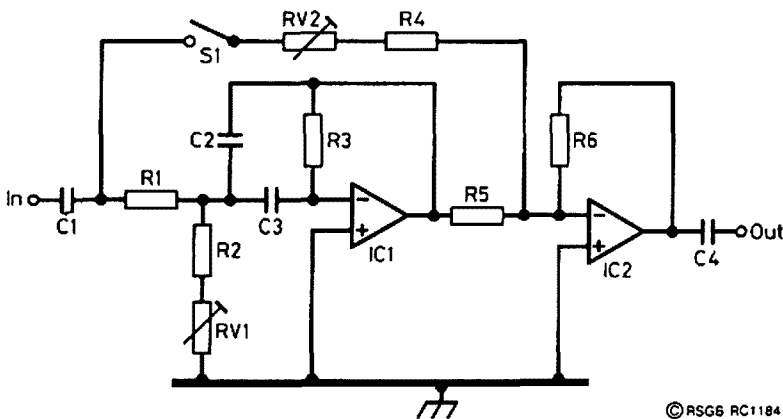


Fig 1 - CW Zero Beat Tuning Aid.

## CW Zero Beat Tuning Aid

With modern transceivers the received beat note must be matched to the CW offset if the transmitted signal is to be on the same frequency as the signal being received. The sidetone is usually at the correct pitch but comparison may be difficult. In the *Eurotek* column of *Rad Com* for October 1996, Erwin David presented a tuning aid originally published in the April issue of *CQDL* by Hans Cordes DJ4AZ. This aid was based on an idea from VE3EDR published in an ARRL publication.

The aid is a notch filter on the correct beat note frequency for the transceiver CW offset. The signal is tuned so as to be in the notch and then the notch filter is switched to peak the signal, or could be switched out of circuit.

The circuit of the filter aid is shown in Fig 1. With S1 closed the filtered audio and the unfiltered audio are added in the summing amp IC2. The two inputs are out of phase and cancel, and the circuit functions as a notch. Open S1 and the circuit acts as a peaking filter. If the filter were bypassed by additional switching, a wider bandwidth position could be provided as well.

The tuning range is approximately 500 to 1000 Hz which should suit most transceivers. The op amps are not critical and 741 types would be suitable. The parts list is given in Table 1. RV1 is the notch tuning and RV2 sets the notch depth.

### Table 1 - Parts List

Resistors 5%	
R1	68 k
R2	1k8
R3	180 k
R4, 5, 6	10 k
RV1, 2	5 k 10 turn
Capacitors	
C1, 4	1 $\mu$ F non polarised
C2, 3	10 nF 5%
Op Amps	
IC1, 2	741 or similar

## Two Metre Field Strength Meter

A field strength meter which reads linearly between one volt per metre and a full scale of five volts per metre appeared in the *Eurotek* column of *RadCom* for

November 1996. Erwin David G4LQI reported on the design of Anjo Eenhom PA0ZR which was originally presented in *Electron* for August 1996. In the Netherlands amateurs are responsible for RFI to consumer products where a certain field strength is exceeded by the amateur transmission. This is currently one volt per metre which is to be lifted to three volts per metre. Hence the need for a field strength meter.

The design presented in Fig 2 is calibrated per definition without comparison to a standard instrument. It is intended for use in the 144 to 148 MHz band. Careful construction is needed. The dipole was made out of 6 mm diameter tubing and the components were mounted on a small insulating board. The dipole and the component board were then fitted with a wooden handle at right angles to the dipole.

The diode is a Schottky type with a voltage drop of 0.4 volt which will allow a reasonably linear scale from 1 to 5 V/m. The meter is 100 microamps full scale and the required multiplier is 60 kilohms which is split into two resistors of 30 kilohms. The resistors may have to be made up to value and allowance made for the meter resistance.

At one volt per metre the voltage delivered by the unterminated folded dipole is 1.3 volts. With a Schottky diode this will give a reasonably linear scale from one volt per metre to a full scale of five volts per metre. The calibration can be at DC for the meter.

This can be a useful field strength meter to provide a quick check, and an

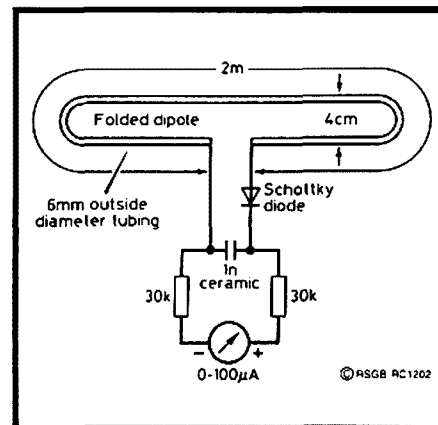


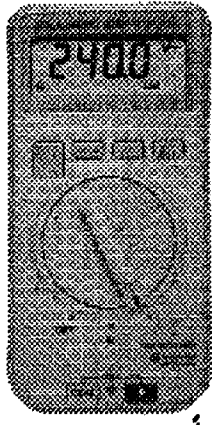
Fig 2 - 145 MHz Field Strength Meter.





**YOUR HOBBY** **YOUR VOICE**  
 Representing Radio Amateurs - Since 1910

**RECRUIT A MEMBER & THEY COULD WIN!**  
**THIS GREAT FLUKE 12B DIGITAL MULTIMETER WORTH \$195**



**THERE'S A WINNER EVERY MONTH FOR 1997 12 PRIZES TO BE WON**

This latest hand-held DMM, from the world-leading maker of digital test instruments, has advanced features yet is simple to use. Ideal for tyro & veteran.

**The Fluke 12B measures:**

- ac and dc voltage (with auto-selection)
- resistance & capacitance (.001-1000µ)

**The Fluke 12B features:**

- 4000-count liquid crystal display
  - simple rotary dial
  - diode and continuity testing
- indicates intermittent opens & shorts
  - 2-year warranty

**Fluke 12B prizes generously donated by Philips Test & Measurement.**

Each month's prize is awarded by way of a draw among newly recruited members each successive month and presented to the winner at the earliest opportunity following the draw.

**To sign up a new member, use the back of your AR magazine address leaflet - or clip the coupon, have them fill it out and send it now.**

**SEND TO YOUR DIVISION'S ADDRESS, SHOWN ON PAGE 56.**

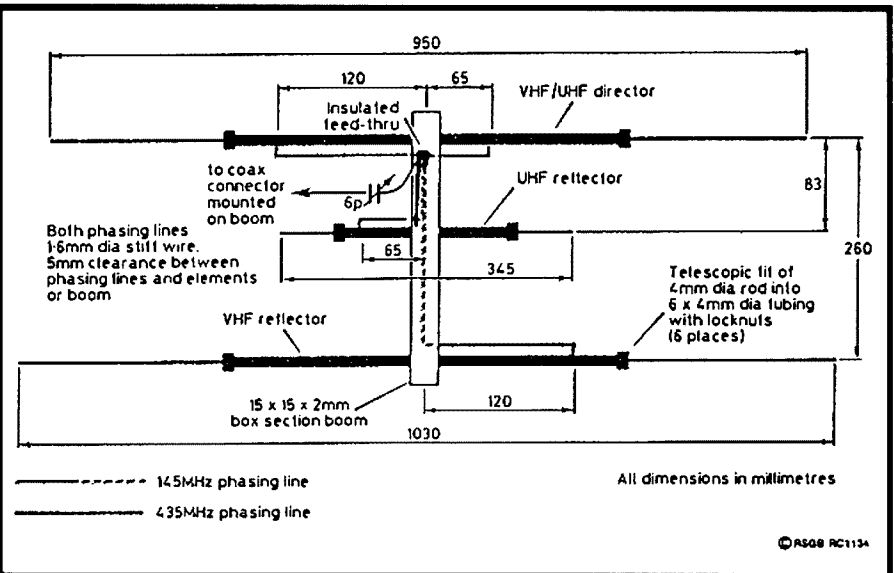
✂ Please send me a membership application.

NAME .....

ADDRESS .....

..... P/code .....

Call Sign (if any) ..... [AR 1-11/97]



**Fig 3 - Dual band HB9CV Beam.**

important instrument when faced with an RFI immunity level problem.

**Dual Band HB9CV Beam**

The HB9CV antenna is a variant derived from the ZL Special which is popular in Europe and elsewhere. It is used in some ARDF foxhunt equipment. A dual band model for two metres and 70 centimetres appeared in the *Eurotek* column of Erwin David G4LQI in *RadCom* for September 1996. The design was originally published by

Walter Gloger DL3AC in *CQ-DL* November 1995. A Dutch company, EPS Antennas of PA3EPS, has a commercial model available.

The two feed systems are connected together to give a common feed. The director functions on both bands, and separate reflectors and phasing lines are used. The aerial is shown in Fig 3. The gain claimed is modest but it is a very compact dual band beam.

\*C/o PO Box 2175, Caulfield Junction VIC 3161 ar

**WIA News**

**Big Things Planned for NZ Conference**

The New Zealand Association of Radio Transmitters (NZART), the WIA's counterpart in that country, is holding its annual Conference, imaginatively dubbed "Conference '97", in Hamilton on the North Island over the weekend of 30 May to 2 June. This is the Queen's Birthday holiday weekend in New Zealand.

Apart from the NZART's annual general meeting, there will be show-and-tell sessions on Amateur Radio Direction Finding (ARDF), amateur satellites, data modes, homebrew radio, slow scan television, and more.

A special event station, ZL6HAM, will be on the air during the conference.

A delegation of two people from the WIA Federal Council, including Federal President Neil Penfold VK6NE, will attend the NZART Conference this year. Each society sends a delegation to the other's annual general meeting in alternate years.

**World Amateur Numbers Climb**

The International Amateur Radio Union (IARU) reports that there are presently nearly three million licensed amateur stations world-wide and that the rate is increasing annually at 7%.

The IARU estimates that, at this rate, there will be some four million amateur stations by the end of the 20th century.

## Humanitarian Award for Two Amateurs

A British and an American amateur have been jointly awarded the American Radio Relay League's International Humanitarian Award for 1996. They are Ken Kirk-Bayley GJOKKB and Robert C Smithwick W6JZU, the co-founders of MediShare International.

The *ARRL Letter Online* for 24 January 1997 said that the Award is given to Amateur Radio operators who have used their skills to benefit others and have worked to promote international goodwill.

MediShare International provides medical supplies, instruments, equipment, and trained health professional volunteers to work in clinics and hospitals in Third-World countries. Smithwick's outstanding achievement began in 1989 when he overheard a ham in Rwanda tell another on the Island of Jersey that his small local hospital needed a part to fix the only steriliser in its operating room. Smithwick, a retired dentist, broke in on the QSO and said he could help by using his connections with another service-oriented organisation, the Medical Amateur Radio Council (MARCO), founded in 1965, the *ARRL Letter* reported.

*"Thanks to the quick efforts of Smithwick, the Jersey radio amateur (Kirk-Bayley), and another from the US who volunteered to make the steriliser part, the Rwandan hospital got what it needed and MediShare International was born. It's now a MARCO program.*

*"Over the years, MediShare International has accepted hundreds of thousands of dollars worth of medical-dental equipment, and medical supplies, which in turn was repaired, refurbished as required, converted for use in the country of destination, and shipped to hospitals and clinics in Third World countries. MediShare paid much of the costs of repair and transportation from donations of MARCO members.*

*"Among other projects, organisation volunteers are now working to staff a new surgery, obstetric and paediatric wing at a Kenya hospital. Soon, MediShare International hopes to begin bringing people to the US to teach them medical-equipment repair skills they can use in their own countries. Smithwick lives in Los Altos Hills, California. He's been a ham for more than 50 years."*

ar

## ■ CD-ROM Review

# QST, NCJ and QEX on CD-ROM

*Publisher: The American Radio League, Inc.*

*Reviewed by: Evan Jarman VK3ANI*

Personal computer systems are now used in the production of most magazines – *Amateur Radio* is no exception. Apart from the ease of production, having magazine material stored on computer makes it very easy to search or manipulate the information by getting the computer to do most of the hard or mundane work involved.

The ARRL have now released all their magazines published in 1995 in a computer

literate form, the CD-ROM. The text for every article is included as are the pictures and the diagrams. Software files referred to in articles are included. Even the advertisements are there, indexed on vendor and product too.

All articles are indexed to allow for logical searching using title, author, call sign, etc but, when looking for something unique, this system excels.

The searching facilities included on the CD-ROM are equal to any, with displays of the number of times each publication has the desired "key". Once found the item can be accessed at the click of a mouse. The search "key" can be a few letters to a block of text. Bookmarks can be inserted for those items frequently wanted for a variety of subjects. Everything can be done via mouse or keyboard from the Windows desktop.

I have held on to the disk for a few months to road test the system as required. Whenever there was a need to



check for previously published material, it could be found within seconds. Invariably the software found what I was looking for embedded in the most unlikely spot, places you never dream of looking. It certainly beats searching through 36 magazines.

As a medium for storing magazines this is ideal. The entire year's output for the three magazines on one disk with space to spare and it's cheaper than subscribing to one. The items most wanted can be printed for those who need a paper copy to work from.

The disk is complete. It comes with all the driving software but needs Windows 3.1 or later as the operating system. This CD-ROM requires an IBM/C personal computer with at least 4 Mbyte of RAM, CD-ROM drive (double speed or better), VGA display and 10 Mbyte of spare hard disk space running Windows 3.1 or better. It prefers a 486 with 8 Mbytes and 800 by 600, 256 colour graphics.

---

# A Case for Using Morse Code for Emergency Services

*Kris Gerhardt VK4CPG\* has put together some interesting thoughts in favour of Morse code "when all else fails".*

---

## Introduction

When comparing digital communication modes from CW to Clover-II the main disadvantage mentioned for CW is that the typical data transfer speed on HF is very low (max 50 bd = 60 wpm), whereas Clover-II runs up to 750 bd. The other disadvantage is that it has no error correction and thus has a poor noise and interference tolerance (ref 1). The latter may be true for computerised digital decoding techniques, but is grossly underrated in situations with human "decoders". CW has proven its worth in many cases such as the first intercontinental radio contacts, emergency situations, moon bounce and meteor scatter communication where other methods would have failed. It is therefore worth a second look before it lands in the dust bin.

## General Principles of Digital Techniques

Basically, digitising of information (data, speech, music, etc) is nothing more than creating and detecting the presence or absence of some discernible physical condition such as light, magnetism, current or voltage. In other cases, two conditions such as certain voltage or frequency ranges are defined as "high" or "low" (or 1 and 0) and exist next to undefined conditions. Although these high/low/nothing conditions are actually three levels, only two are normally used. After a starting signal the information is sampled to see whether at a certain time the level is "low" or "high". This can be in blocks of five (Baudot) or seven (ASCII) time units, with or without additional error correction bits. These systems need a fixed "clock-speed" because all sampling must be synchronised.

## Morse Code is Different

Samuel Morse based his telegraphy code on character distribution. The most frequent letters occurring in English text were given the simplest code, starting with the letter E. This makes Morse code more efficient than ASCII and Baudot, where every character is equally long. Another, more important difference is that Morse code can be used in many situations, by simply switching something on or off. A Morse code character is essentially determined only by a sequence of three states (long, short, silence).

Although the duration of these events is formally defined, the character will be readable as long as a dot differs in length from a dash and the spacing between characters is roughly some silence and between words is more silence. This means that timing is not very important. This is contrary to other digital methods which use a series of highs and lows at certain times. This is important, as Morse code operators never send manually in the same way. Each operator has a typical "fist" or "signature" which may deviate considerably from "model code" and may also vary his/her sending speed during a transmission.

Because of its low speed, Morse code can use on/off switching (with some processing to avoid "key-clicks") and, having a small bandwidth, it is therefore very efficient for low S/N ratios. Generally, systems with on/off switching of a signal are more noise resistant than systems with two signals that differ in some characteristic. Differences in frequency (FSK) are more difficult to detect but are easier to process at high speeds.

Morse code based on frequency shift keying, as done in other digital modes,

has never given the same results, unless the space frequency is tuned zero beat (no audible tone). In that case the bandwidth is, however, much greater than the typical <200 Hz for shaped on/off Morse signals and the duty cycle for the transmitter is 100%.

## Morse Code is Not for Machines

Machines to decode Morse require well-defined differences in duration between dots and dashes, characters and words. That timing is often not precise. As Morse code has no built-in error correction, noise received within a time frame is considered as a signal and decoded. Even with sharp filters, noise blocking and signal processing, CW is unreliable when received by machines in the presence of noise. The conclusion is that CW computers can only be used to receive CW up to, say, 50 wpm in cases where the sender uses timed electronic or mechanical keys at a fixed speed in a relatively noise-free path. They are, of course, ideal senders of code.

## The Importance of the Human Factor

Humans cannot decode ASCII, Baudot or any of the packet modes. On the other hand, a tone between 600 and 1200 Hz can be recognised by the human ear and brain in an incredibly noisy environment. A signal to noise ratio of 0 dB is totally adequate to decode Morse signals. Even near deaf people can still communicate through Morse. Also, people in countries with different languages can communicate effectively in Morse, as pronunciation of words is not relevant.

Although it is not encouraged that telegraphists "journalise", everyone knows that plain text is easier to understand than unrelated characters. The human brain processes signals by taking its history and logic also in consideration and needs only partial information to make an intelligent guess about a word or a sentence. This means that the error correction in Morse code is performed by the human brain. Only in cases where random characters are transmitted, words may have to be sent twice as a method of "forward error correction". Together with break-in

keying, this forms a practically error free transmission mode.

The other advantage of receiving Morse "language" by human operators is the insensitivity to the strength, timing and character of the signal. Highly irregular code can still be received with reasonable accuracy. Also, receiving Morse code in a mixture of other signals, Morse or not, remains possible. Here again it is shown that the human hearing is a superior device. Not only is it difficult to overload, but it can also identify small differences in regularities and frequencies in an environment of many other signals. A trained operator can pick up a weak signal sent by a miserable operator out of three or four others, while still reading another at the same time. This is hardly possible with any other mode.

The conclusion is that Morse code, when interpreted by a human operator, is far superior to other digital techniques in situations of simple equipment, low signal-to-noise ratios and the transmission of plain language or well-codified messages. It compares in that respect with listening to several people talking at the same time. As long as the conversation is not too difficult, the built-in redundancy in the language makes it possible to understand several people. The same is possible with Morse code.

## Emergency Situations

In emergencies we are interested in an all-purpose communication code that is still useable when mobile telephone and radio transmitter towers may have fallen over, optical fibre cables are broken, telephone exchanges gone, radio stations flooded and no power is available other than 12 V from car batteries. We only

need to see the photos of areas visited by earthquakes or cyclones to get an impression of the chaos that exists in these situations.

It is unlikely that computers and complicated gear will survive in these circumstances. On the contrary, an elementary on/off signal source (even a smoke signal) is always available or can be improvised for communication in practically all cases. Ultimately, we can talk to all living beings as soon as we know that they are sensitive to some condition that can be changed fairly rapidly. To give some examples: changing between two acidity levels (pH), light (frequency or level), sound (levels or frequency), pressure, speed, etc all can convey messages in Morse.

Radio amateurs, throughout the years, have been involved in disaster communication, experiments with unusual wireless channels and social activities (which might include exchanges with aliens). It is therefore logical that they should be proficient at the base level in Morse code, the simplest, most efficient and versatile digital communication technique for emergency situations.

Not many other people are now being trained in Morse code. Ship's telegraphists and some military personnel are about the only ones who handle Morse code signals professionally and can take front line responsibility for communication when all other means fail.

So, amateurs trained in Morse code will be required. Their assistance would also involve the use of simple, robust receivers and transmitters, that work with improvised antennas, are powered

exclusively by batteries and can easily be repaired by the operator in case of damage. Preferably these should be crystal controlled, operating on a specific emergency channel provided for in the Band Plans.

## Plan for the Future

It is unnecessary to insist on two-way CW for amateur emergency communication. It is far more logical to use any mode that is the most appropriate in the given situation. Even in very bad emergencies there are still places to be found where base stations with a very strong transmitter can be set up to receive CW messages from the disaster area and send information back in voice. Communication with Morse code one way and voice the other way can be maintained for a long time and would be useful, if two-way voice or digital communication is not possible.

In that case it is not necessary for everyone to be able to read 20 wpm CW, but it would help when many could send at that speed. The WIA could plead for the inclusion of protected emergency channels in the band plans and organise QRP-CW/fixed-SSB field day contests. The (really) portable stations would be required to send CW but receive SSB or FM from fixed stations to simulate emergency situations. All amateurs capable of sending Morse code, but who cannot receive it, can thus participate in these activities.

Another way of stimulation is to include technical topics for QRP CW stations in our magazine, although there is a special QRP-CW club. A third way is to extend the pool of potential CW operators by organising local CW courses in tone-modulated AM on the Citizens Band. Not only will this bridge the psychological gap between CBers and "regular HAMS" but it will also help a number of people to get a cheap radio to receive CW and learn the code in the comfort of their own place. It sounds revolutionary but is in fact only a community service within the allowed CB radio service.

### Reference

1. *The ARRL Handbook for Radio Amateurs 1995 Chapter 12*

\*PO Box 196, Hervey Bay QLD 4655

ar

## WIA News

### Record Membership for ARRL

The American Radio Relay League (ARRL) reported record membership numbers for 1996, with a grand total of 175,023 at the end of the year. This was up 2.1% on 1995 membership numbers, according to the *ARRL Letter Online* for 10 January 1997.

The 175,000-plus membership is the highest in the League's 83-year history. Licensed amateurs in the USA number more than 650,000.

The 1995 League membership showed a decline of 0.6% compared with 1994 numbers. The ARRL conducted membership drives in 1996. A mailed promotion in November 1996 netted 1461 more members.

ARRL executive vice president David Sumner K1ZZ said the record membership numbers were, "not bad for the worst business year for Amateur Radio in recent memory."

ar

## ■ Book Review

# Practical Receivers for Beginners

*Publisher: Radio Society of Great Britain*

*Author: John Case GW4HWR*

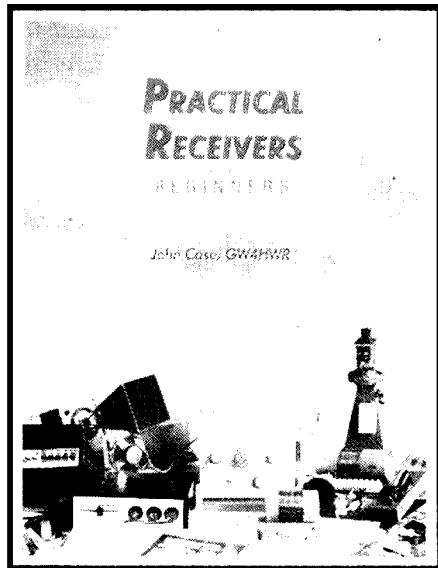
*Reviewed by: Evan Jarman VK3ANI*

While most amateurs favour equipment with "bells and whistles", there is a unique satisfaction in operating even simple homebrew.

The RSGB recently published this book which is a companion for "Practical Transmitters for Novices" by the same author.

It describes some of the author's designs for receivers that cover bands from broadcast to microwave. Most of the designs are extremely simple. The 10 GHz receiver that uses a LM386 and a diode will not set world records, but it does give a feel for the "plumbing" involved.

While the majority of the designs published are a bit more than weekend work, they are not too involved. The FM receiver for 6 m, and the direct conversion receiver for 80 and 20 m, are the most complicated designs published. The diagrams are the usually exceptional standard that Derek Cole has made synonymous with the RSGB. There is enough detail to make construction easy for most. Nearly all the construction is based on a PCB which makes building very easy. An appendix that gives PCB construction details makes you wonder why the demise of homebrew seems to parallel the rise of the PCB.



The book does also provide a little of the theory of radio as a help to the equipment design.

Most of the equipment described in this book does not operate on Australian Novice bands. This will limit its appeal to those who are primarily tinkerers.

The review copy came direct from the RSGB, publishers of the book. Copies should be obtainable from the usual suppliers of RSGB publications. ar

## WIA News

### Britain Reduces Amateur Exam Fees

The British communications regulatory authority, the Radio-communications Agency, announced in late January that examination fees for candidates for the Radio Amateurs Examination would be reduced and the present two exam papers amalgamated into one, from May 1998.

Candidates presently pay 19 pounds 40 pence (around \$AUS40) per paper, about \$AUS80 all up.

The present two papers are to be amalgamated into a single paper of 80 questions next year and the cost for sitting the examination will be 26 pounds, which is more than \$AUS50.

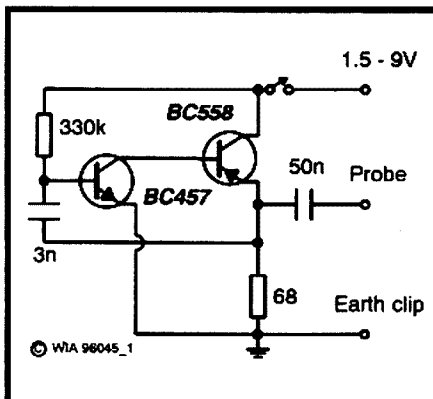
The approval fee for British examination centres, presently a one-off fee of 250 pounds (around \$AUS500), will drop to 100 pounds (around \$AUS200).

The changes came about following representation from the Radio Society of Great Britain (RSGB).

## ■ Test Equipment

# A Simple Signal Injector

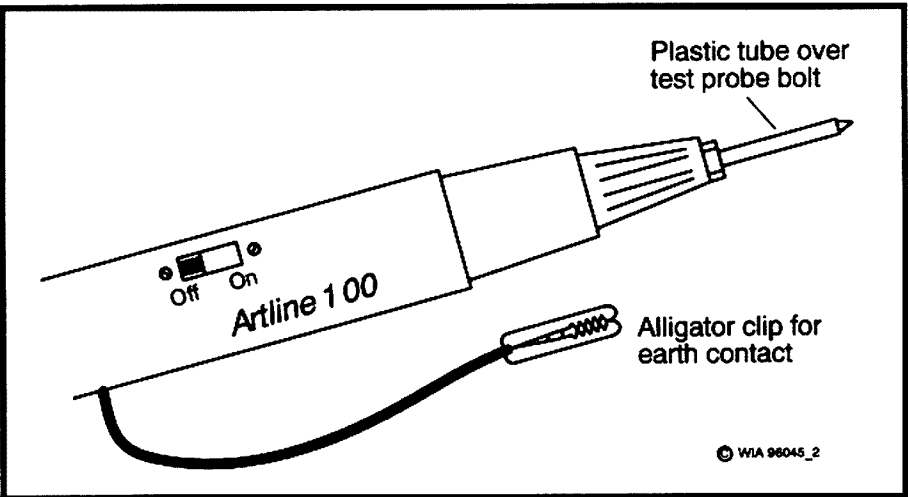
*Graeme Wilson VK6BSL\* describes a very useful piece of test equipment which can be built in a couple of hours.*



**Fig 1 - Circuit diagram of the simple signal injector.**

Here is a simple weekend project. This simple signal injector is based on a circuit which is a multi-vibrator rich in harmonics. Its fundamental operating frequency is about 1 kHz and, at 9 volts, the output is about 200 mV.

Any general purpose small signal NPN or PNP transistors can be used. Choose transistors which have similar gain characteristics. Looking at the output on a CRO, the trace looked like a number of needle-like pulses occurring every millisecond. The output could be detected up to around 50 MHz using the receiver on AM; levels were much lower



**Fig 2 - The simple signal injector in a modified Artline 100 felt tip marker pen (see text).**

using either sideband, and it was not detectable using FM. *(I built one to try it out, and it works. Tech Ed)*

I found that an Artline 100 felt tip marker pen made an ideal casing for the circuit board and AA battery cell. Drill a 3.2 mm hole in the plastic screw top and fit a 50 mm long 3 mm brass bolt and nut. Sharpen the end of the bolt to a point for the probe and fit a small piece of heat-shrink tubing over the probe to insulate all but the tip. Fit a small slider switch to the casing to turn the power on and off. The method of fitting and connecting the battery is left to the constructor.

To use this handy tester, it is recommended that you start at the output stage of the receiver and work towards the antenna. If the signal is heard, move the probe to the base of the transistor in the preceding stage. Continue moving forward towards the antenna until the signal cannot be heard. When this happens you have located the faulty stage. As you move towards the antenna the signal should be louder if each stage is amplifying the signal.

*\*26 Dollis Way, Kingsley WA 6026*

**ar**

test equipment. There are now many suitable test instruments available and the book shows you how to carry out measurements using instruments available from dealers and which may also be found at hamfests.

As well as standard test equipment, the book shows you how to build your own items of test equipment. These range from simple items to more complex items of equipment. The use of test equipment is also discussed in a most practical manner.

Of interest is the setting up of your own backyard antenna range using a PC to act both as a data logger and plotter. With a little ingenuity, a very useful test range can be built from simple building blocks of equipment.

There are listings for design programs for use with a PC which would be handy if you can't find them on a CD, disc or BBS, etc.

A chapter on the NEC based modelling programs is of interest. The strengths and weaknesses of these programs are discussed. Together with empirical data from the simple measurements described in the book, these modelling programs can assist in understanding and optimising antenna performance.

All in all, a very interesting and worthwhile book for the experimenter's library. The review copy came direct from the RSGB, publishers of the book. Copies should be obtainable from the usual suppliers of RSGB publications.

**ar**

# ■ Book Review

## The Antenna Experimenter's Guide (second edition)

**Publisher:** The Radio Society Of Great Britain

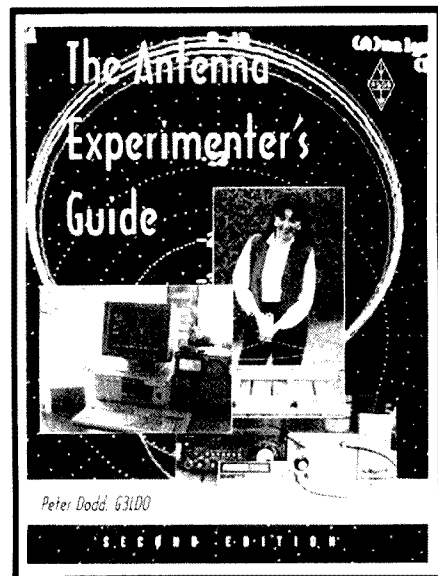
**Author:** Peter Dodd G3LDO

**Reviewed by:** Gil Sones VK3AUI

This book is for the antenna experimenter. The building, testing and optimising of antennas is covered in a very practical manner. There are, of course, some very interesting designs described, but the emphasis is on the design, testing and optimisation of

antenna designs. The book goes beyond just matching the antenna to the feedline and describes how to measure antenna performance and optimise a design.

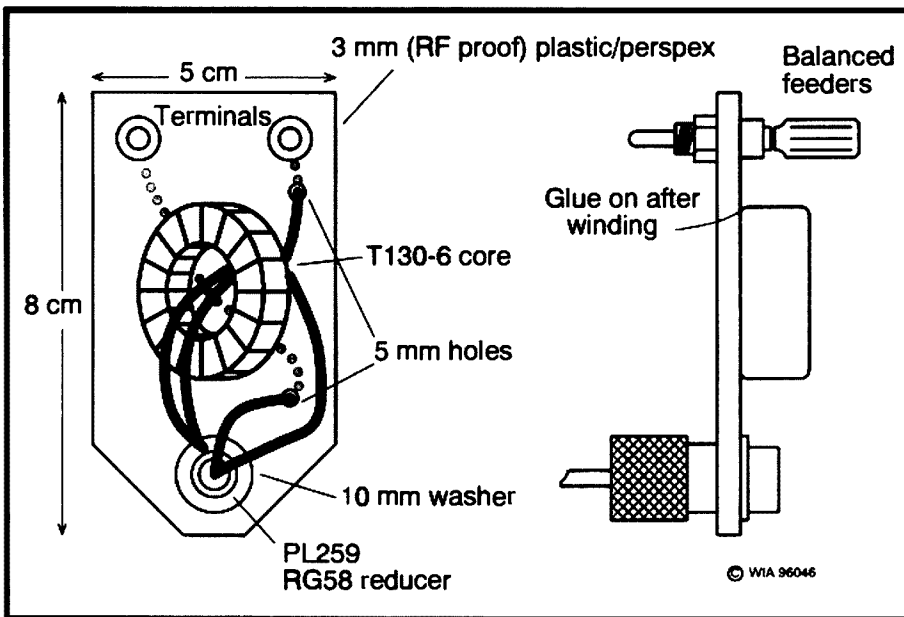
The measurement of antenna characteristics is covered using both standard test equipment and home-built



## ■ Antennas

# Balanced Feeder Balun Adaptor

*Graeme Wilson VK6BSL\* explains how he constructed an adaptor to enable his unbalanced ATU to work with balanced feeders.*



Construction details of the balanced feeder balun adaptor.

I needed to use my unbalanced Antenna Tuning Unit with an antenna which used balanced tuned feeders. I found that the neatest and most convenient way to do this was to construct a balanced to unbalanced adaptor which could be fitted on the back of the tuner using a PL259 connector.

The adaptor uses a 4:1 balun mounted on a perspex plate measuring 8 cm by 5 cm. The balun was made by winding 12 bifilar turns of 16 AWG wire on a T130-6 yellow core, connecting the finish of winding one to the start of winding two, and grounding this junction to the body of the PL259 connector. I then connected the start of winding one to one of the balanced inputs, connected the finish of winding two to the other balanced input terminal and, from this terminal, connected a wire to the centre pin of the PL259 connector.

I then glued the balun to the perspex plate (if you use a mounting screw it should be nylon).

Fitting this adaptor to your ATU is easy. Simply screw the PL259 to the antenna connector, then connect the twin feed line to the two terminals.

\*26 Dollis Way, Kingsley WA 6026

ar

## ■ Antennas

# The Z Match and Its Matching Load Range—An Inherent Drop-out with Certain Capacitive Loads

*Lloyd Butler VK5BR\* and Graham Thornton VK3IY\*\* publish the results of their joint study on the ubiquitous Z Match*

### Introduction

We draw the attention of Z match users to a drop-out region in the load range of that tuner which was not noticed in earlier tests. We explain the reason why

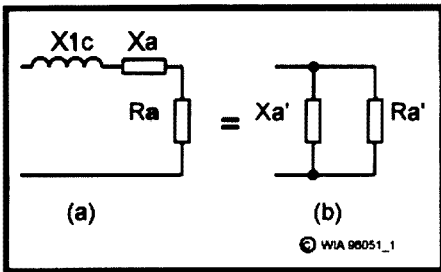
there is such a region and discuss some ideas on how to deal with the problem.

### Background Theory

The Z match tuner can be resolved as a simple L network of series capacity and

shunt inductance combined with an output coupling circuit. For fundamental reasons, an L network of this type cannot match a resistance component loaded in parallel across its output that is lower in value than the desired reflected load (usually 50 ohms). In practice, this lowest value is even further increased because of limits in the adjustable range of the series capacitor. However, if the load resistance is applied to the output via a series reactance, the load resistance (now the series resistance component) is reflected across the L network output as a higher parallel value. Provided there is some series reactance, the L network can therefore match values of series resistance in the load lower than the nominal minimum value. The Z match output circuit makes use of this property.

To further illustrate the effect in the Z match, refer to the circuit figure 1 (a) and its equivalent 1 (b). The impedance components  $R_a$  and  $X_a$ , reflected via the



**Figure 1 – Reflected components across L match.**

**$X_{Lc}$  = Inductive reactance reflected from under-coupled coil**

**$X_a$  = Series reactance reflected from antenna via coil**

**$R_a$  = Series resistance reflected from antenna via coil**

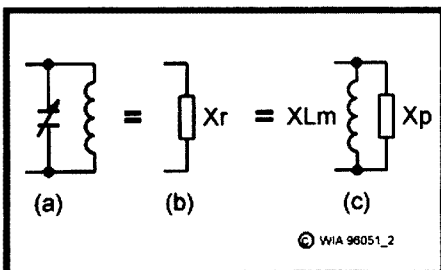
**$X_{a'}$  &  $R_{a'}$  are the equivalent parallel components.**

**If  $(X_{Lc} + X_a)$  is finite, then  $R_{a'}$  is greater than  $R_a$ .**

**If  $(X_{Lc} + X_a) = 0$ , then  $R_{a'} = R_a$  and  $X_{a'}$  is infinite.**

coil from the antenna, are shown in series with an inductive component  $X_{Lc}$ , reflected from the under-coupled coil itself. The series circuit can be considered as a parallel equivalent with parallel components  $R_{a'}$  and  $X_{a'}$ . Provided  $(X_{Lc} + X_a)$  is a finite value, then the equivalent shunt resistance  $R_{a'}$  is higher than  $R_a$  and the higher the series reactance then the higher  $R_{a'}$  becomes. For resistive loads, the under-coupled output coil reflects series reactance component  $X_{Lc}$  on its own. When there is inductive reactance coupled in from the antenna,  $R_{a'}$  is further increased and the ability of the L network to match low resistance loads is further enhanced.

Before proceeding further into the main point of our discussion, we will



**Figure 2 – Shunt tuning equivalent.**

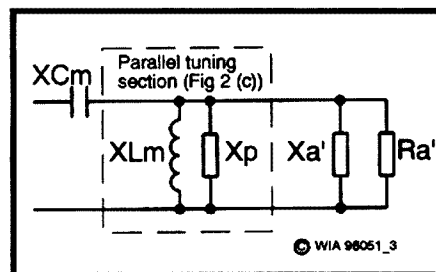
**(a) Tuning capacitor and primary coil in parallel, equals**

**(b) Resultant shunt reactance (one component), equals**

**(c)  $X_r$  split into two components (refer Fig 3).**

clarify what happens to shunt component  $X_{a'}$  connected across our L match network. First look at Figure 2. In 2 (a), we have our Z match coil primary winding with a tuning capacitor connected across it. Combining these two elements we have a single reactance 2 (b) which can be set over quite a wide range by adjusting the tuning capacitor. Let's split this into two imaginary reactances in parallel which we will call  $X_{Lm}$  and  $X_p$  (refer 2 (c)).

Now to Figure 3, which depicts the L match loaded with the equivalent parallel components previously discussed. Series component  $X_{Cm}$  (our series tuning capacitor in the Z match) and shunt component  $X_{Lm}$  are the values necessary in the L match circuit to match reflected shunt resistance  $R_{a'}$ . Component  $X_p$  is equal in value but opposite in sign to reflected shunt reactance  $X_{a'}$  and so  $X_{a'}$  is cancelled out.



**Figure 3 – L match with parallel equivalent load.**

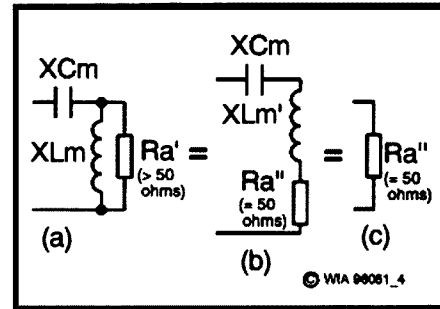
**$X_{Cm}$  = Series capacitive reactance of L match**

**$X_{Lm}$  = Shunt inductive reactance of L match**

**$X_{a'} = -X_p$ .**

**Note:  $X_{Cm}$  and  $X_{Lm}$  have values necessary to transform  $R_{a'}$  to a resistance of 50 ohms as seen at the network input.**

Having eliminated  $X_p$  and  $X_{a'}$ , we now have the diagram Figure 4 (a) with parallel components  $X_{Lm}$  and  $R_{a'}$  in series with  $X_{Cm}$ . Making another conversion of the parallel components to series form as shown in 4 (b), we get inductive reactance  $X_{Lm'}$  and resistance  $R_{a''}$  both now in series with  $X_{Cm}$ . We now see a series resonant circuit. The series reactance  $X_{Cm}$  is equal but opposite in sign to reactance  $X_{Lm'}$  leaving just resistive component  $R_{a''}$  (Figure 4 (c)) which is 50 ohms and the correct load for our transmitter.



**Figure 4 – L match section – conversion of shunt to series form.**

**$R_{a'}$  = Parallel resistive load of L match section (greater than 50 ohms)**

**$X_{Lm}$  = Shunt inductive reactance of L match (to make  $R_{a''} = 50$  ohms)**

**$R_{a''}$  = Equivalent series resistance (equal to 50 ohms)**

**$X_{Lm'}$  = Equivalent series inductance**

**$X_{Cm}$  = Series capacitive reactance of L match**

**$X_{Cm} = -X_{Lm'}$**

## The Problem

Our problem area occurs for certain capacitive loads. Referring again to Figure 1, if the reflected reactance  $X_a$  is capacitive and it is small compared with the inductive reactance  $X_{Lc}$  reflected by the coil, or if it is much larger, then there is unlikely to be a problem. However, if this capacitive reactance is of such a value as to cancel or near cancel the inductive reactance, then the property which causes the circuit to reflect the series resistance component as a higher parallel value is nullified or reduced. Hence, for a given frequency, there is a range in the value of capacitive reactance referred to the Z match input for which very low load resistance values in series cannot be matched.

The existence of this characteristic was fairly recently observed by Graham VK3IY when he did some theoretical analysis on the operation of the coil. Subsequent tests carried out on an *AR Single Coil Z Match* by Lloyd VK5BR clearly confirmed his observation.

Tests on the sample *AR Single coil Z Match* unit revealed a critical capacitive reactance range when combined with resistance below a critical resistance value. The range in values (including those in the unit modified to switch in 1.8 MHz) are shown in Table 1. The



resistance given is the minimum value when the capacitive reactance is in the middle of the range shown and can be considered as the worst case value. For 3.5 to 28 MHz, the values apply to a maximum tunable series capacitance in the Z match network of 350 pF. For 1.8 MHz, the value applies to a maximum tunable series capacitance of 1000 pF.

**Table 1**

Frequency Band MHz	Xc ohms	Ra ohms
1.8	16 to 32	below 16
3.5	25 to 50	“ 30
7	55 to 100	“ 80
14	80 to 180	“ 80
21	170 to 300	“ 80
28	250 to 500	“ 75

Hopefully, most *AR Single Coil Z Match* users will not have an antenna which reflects a low resistance combined with a capacitive reactance within this critical range. However, we do know of one G5RV antenna which measured an impedance on 7 MHz of 40-j100 ohms, right in the “no-go” region of the *AR Single Coil Z Match* and, hence, there was a matching difficulty using that unit. Perhaps not all G5RV installations will reflect a similar load impedance on 7 MHz but it is worth keeping in mind if one has a G5RV. Also, if a different Z match with different secondary inductance is used then the critical range of capacitance will be different and might not coincide with the antenna capacitance.

## How to Fix It

Faced with the problem discussed, it can be dealt with by simply shifting the load reactance along a bit so that the no-go region is out of the antenna load range being used. There are several ways in which this can be done.

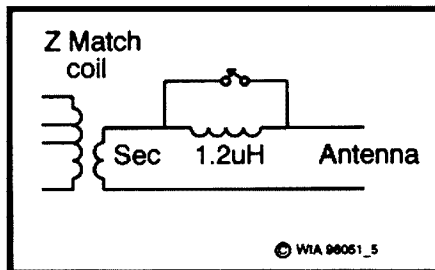
(1) A capacitor can be placed in series with the antenna load, selected so that its capacitive reactance roughly doubles the reactance in the load circuit. The disadvantage with this method is that a different value of capacitor must be switched in for each frequency band.

(2) An inductor can be switched in series with the antenna load and, if suitably selected, the single inductor can

be used on all bands (refer figure 5). An experimental air wound inductor of around 1.2  $\mu\text{H}$  has been constructed. This consisted of nine turns of 14 B&S enamel wire wound at a diameter of 24 mm and spaced to a length of 27 mm. This worked extremely well, shifting the no-go region out of the nominated critical range on all bands.

(3) The coil secondary winding can be switched to reduce the number of secondary turns and, hence, alter the secondary inductance (refer figure 6). The secondary of the *AR Single Coil Z Match* has four turns and switching in a tap at three turns reduces the secondary inductance to a little over half the previous value, which is just enough to move the no-go region sufficiently on all bands except 1.8 MHz.

Which method do we use? Well, the series inductor gives the more positive no-go region shift and you only need one inductor for all bands. However, the coil tap idea saves making the inductor – so take your pick!

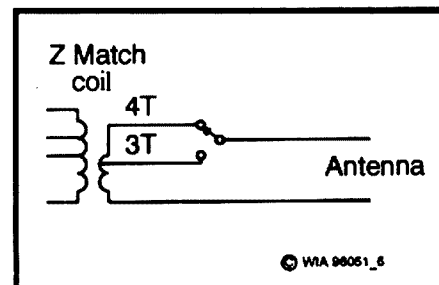


**Figure 5 - Modification to allow shifting of load reactance to avoid no-go region - series inductor method.**

Whilst our discussion has tended to be written around the single coil Z match, the same no-go region can be experienced in one or the other outputs of the two coil Z match. In the latter unit we have two coils of different secondary inductance and, for certain frequency and load conditions, it is possible to get a match using either coil output. As the coils are different, reflected reactances into the primaries are different and if this overlap occurs in the low resistance region, the no-go region can be dodged by changing from one coil output to the other.

On the *Compact Coil or Rononymous Two Coil Z Match*, recent tests have

showed that this overlap matching condition can be achieved on the 7 MHz and 14 MHz bands. In the initial design, low resistance loads can only be matched on the 3.5 MHz band using output from coil B and, hence, at 3.5 MHz this dodge is not available. However, in an article in September 1995 issue of *Amateur Radio*, we pointed out that if the secondary of coil A was reduced from its seven turns to four turns, then low resistance loads at 3.5 MHz could be operated using coil A output with subsequent improvement in efficiency. By adding this modification, the overlap condition for low resistance loads is also extended to 3.5 MHz and the dodge becomes available on this band.



**Figure 6 - Modification to allow shifting of load reactance to avoid no-go region - secondary coil tap method.**

At 21 MHz and 28 MHz, matching of low resistance loads is only available using coil B and, hence, other correction methods, such as switching in the series inductor, might need to be applied. The secondary inductances in the two coil unit are higher than in the single coil unit but a satisfactory shift in the no-go region was still achieved using the previously described 1.2  $\mu\text{H}$  series inductor.

If the two coil Z match is only used on the lower HF bands then perhaps the only modification necessary is to reduce the number of secondary turns for coil A as discussed. An RSGB model version of the two coil Z match has not been available for no-go region experimentation but similar results to those obtained using the compact coil version are anticipated.

## Conclusion

The Z match is well known for its ability to match a wide range of load impedance conditions over the HF spectrum. However, we have described one particular load condition which, if

experienced, might require some extra attention.

Our discussion has concentrated on the *AR Single Coil Z Match* and *Compact Coil or Rononymous Two Coil Z Match*, both of which have received prominence in past issues of *Amateur Radio*. In the single coil Z match, we have described how this no-go load condition can be avoided by switching in an additional component or switching an output coil tap. For the two coil Z match, we have discussed how the need for these further components is avoided in the 3.5 to 14 MHz range.

## References

1. *Random Radiators (VK3AFW & VK3OM) Rononymous Z Match*, *Amateur Radio* March 1990.

2. *Lloyd Butler VK5BR – Tests on the Compact Coil Z Match*, *Amateur Radio*, December 1990.

3. *Random Radiators (VK3AFW & VK3OM) – AR Single Coil Z Match* *Amateur Radio*, February 1993.

4. *Lloyd Butler VK5BR – AR Single Coil Z Match* – *Amateur Radio*, April & May 1993.

5. *Lloyd Butler VK5BR – Efficiency of the Z Match* – *Amateur Radio*, September 1995.

6. *Graham Thornton VK3IY – An L of a Network* – *Amateur Radio* March, April & May 1995.

7. *Graham Thornton VK3IY – Technical Correspondence – The choice of ATUs: L, Z, or T*. *Amateur Radio* August 1995.

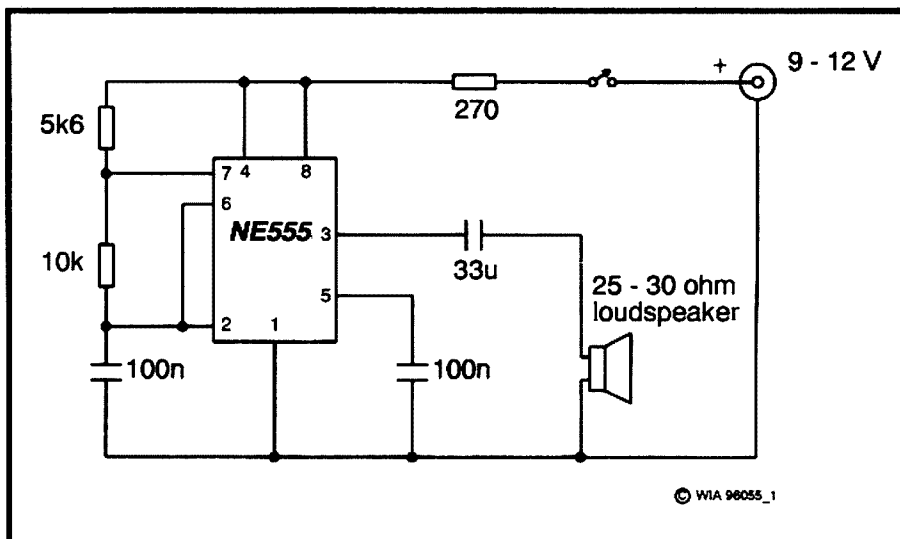
\*18 Ottawa Avenue, Panorama SA 5041

\*\*17 Britannia Creek Road, Wesburn VIC 3799

ar

# ■ Morse Oscillator MorseMouse

*Peter Parker VK1PK\* has built a novel Morse practice oscillator.*



**Figure 1 – MorseMouse schematic.**

The Morse practice oscillator presented here is of standard design. What is unique is the packaging of the project. Instead of the conventional plastic case a discarded computer mouse houses the device. Apart from being a conversation piece for the shack, the enclosure is eminently practical as the mouse buttons can act as a built-in key. The circuit is shown in Figure 1.

All parts for the project are readily available. The mouse in which the project is to be mounted should be bought first. A used mouse may be found at computer markets and trash and treasure sales for a few dollars. The most important thing to look for is a reliable switch mechanism. A mouse large enough to enclose the circuitry and speaker should be selected.

MorseMouse can be as simple or as elaborate as you want. While the prototype is very basic, features such as a volume control, variable tone, internal battery, and socket for an external key and/or transmitter could be added.

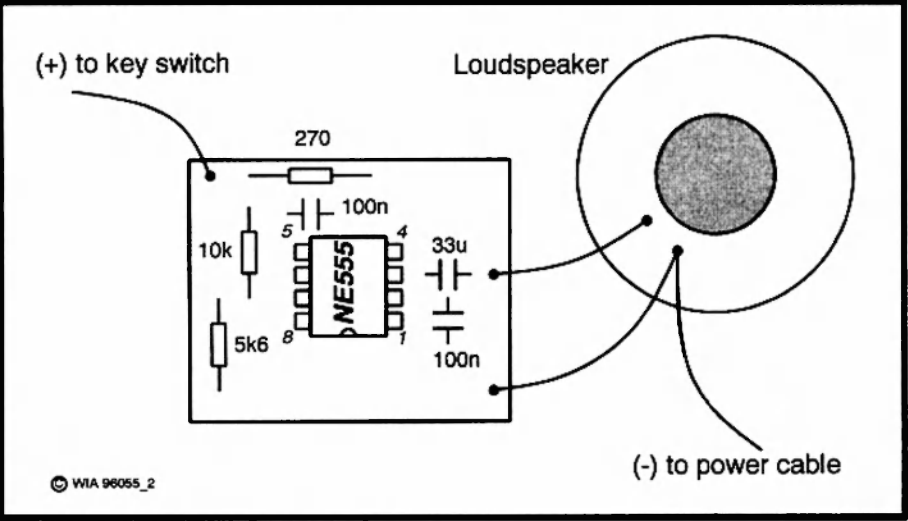
After a mouse has been bought it must be stripped. First remove the ball from the bottom of the mouse. Then open the mouse by unscrewing the screws that

hold the top and bottom of the case together. The printed circuit board inside the mouse should now be unscrewed from the base of the mouse. This is so that all components on the board except the two switches can be unsoldered. Do not damage the board itself. It carries the mouse switches and is needed to support the small piece of matrix board on which components are mounted. Please note that another brand of mouse may be built differently. So the exact procedure outlined here may not be applicable for your unit.

Check the operation of the mouse switches with a multimeter or continuity tester. When pressed, a closed circuit should be indicated. While not essential, the two switches could be wired in parallel to allow Morse to be sent with either button.

The existing mouse cable becomes a power lead for connection to an external 9 – 12 volt supply or battery. One lead should be deemed positive. This should be soldered to one side of the switch on the underside of the printed circuit board. An 8 – 10 cm length of hook-up wire is soldered to the other, normally open, switch contact. The other end of this lead

**Sign up a new  
WIA member  
today –  
we need the  
numbers to  
protect our  
frequencies  
and privileges**



**Figure 2 - Component layout.**

connects to the free end of the 270 ohm resistor on the matrix board.

All components are mounted on a small piece of unclad matrix board. If there is enough space inside the mouse a socket is recommended for the 555 IC. Contrary to standard construction techniques, the IC or IC socket is mounted first near the centre of the matrix board. This is so that other components can be mounted around the IC without undue crowding.

Figure 2 gives a suggested mounting arrangement for the components. Note that all components are mounted above the board and that their leads are passed

through the holes and soldered underneath.

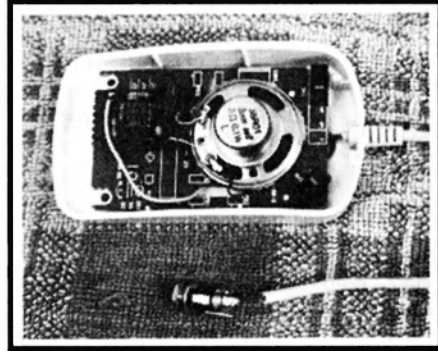
Although few parts are used, the first-time constructor will need to take extra care due to the small size of the circuit board. Particularly important are the connections underneath the matrix board. Crossing wires should be insulated from one another by slipping a piece of spaghetti tubing over one of the leads. An offcut of insulation from a piece of medium gauge insulated wire is an acceptable substitute.

It is wise to test the board for correct operation before mounting it inside the mouse. Simply connect the speaker and

apply 9-12 volts of power. A steady tone from the speaker should be audible. If not, disconnect the power and check the power polarity and the orientation of the IC in its socket. If this fails, then check your wiring against the schematic diagram.

Once satisfied that the oscillator is working, both the board and the speaker can be mounted inside the mouse case. The speaker is installed face down so that its cone is over the hole in the base of the mouse formerly occupied by the ball. A few dabs of strong glue around the rim of the speaker will bond it to the printed circuit board. As the two leads between the speaker and the matrix board are short and rigid there is no real need to glue the matrix board to the main board. However, should you wish to do so, apply the glue sparingly so the matrix board can be removed should servicing ever be required.

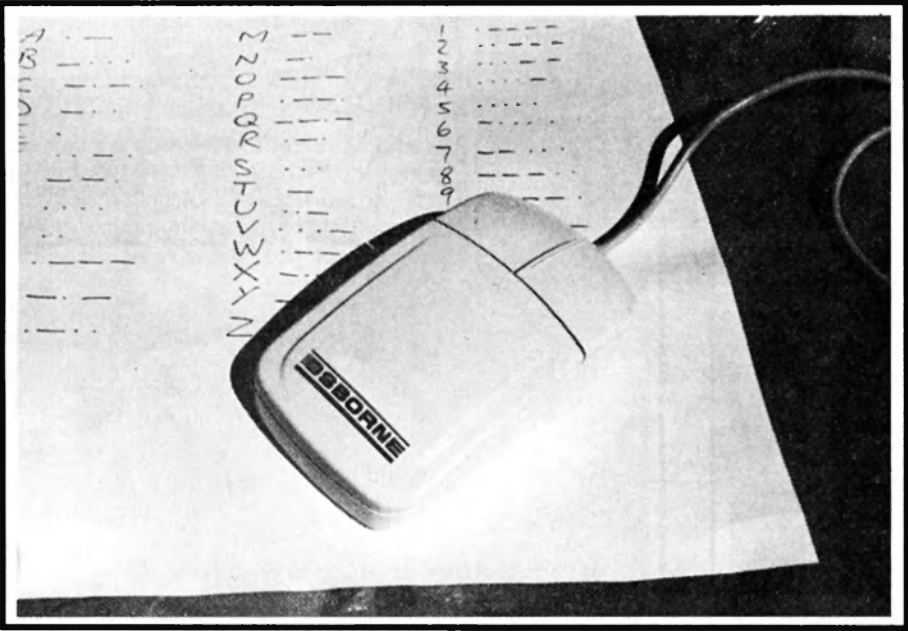
MorseMouse is presented as a fun project to which many modifications can be made. The experimentally minded



**Inside MorseMouse**

could use the MorseMouse circuit as the basis of a continuity tester or simple audio signal generator. Apart from the basic oscillator, a mouse could house other projects such as an iambic keyer or a small QRP transmitter. It should not be too difficult to make a pair of them linked by telephone cable to form a telegraph system for learning Morse Code and/or practising CW operating procedure off-air. Or you could simply use the mouse as a rugged and lightweight emergency Morse key particularly if operating portable. The possibilities are almost endless.

\*7/1 Garran Place, Garran ACT 2605



**MorseMouse**

# Antennas

## An Antenna Problem Solved

*Keith McLeod VK5MT\* and his XYL VK5BMT used an unusual solution to the problem of fixing their beam antenna without having to dismantle it from the tower.*

The HF beam was becoming a major problem. Not only was the reflector element of the TH4 very loose and constantly being tipped one way or the other when the galahs came visiting, but the resulting movement was such that the element was actually spinning off the boom.

What to do had been the question for quite a while. How could it be fixed without complete dismantling of the antenna systems on the tower?

Investigations revealed that to reach the required height of 50 ft (12.5 m), it was impossible to use a small cherry picker which could only reach 40 ft. The larger cherry picker needed was too big to bring into the backyard.

INSTANT SCAFFOLDING provided the answer. It took four men 1 1/4 hours to erect the structure and only two hours

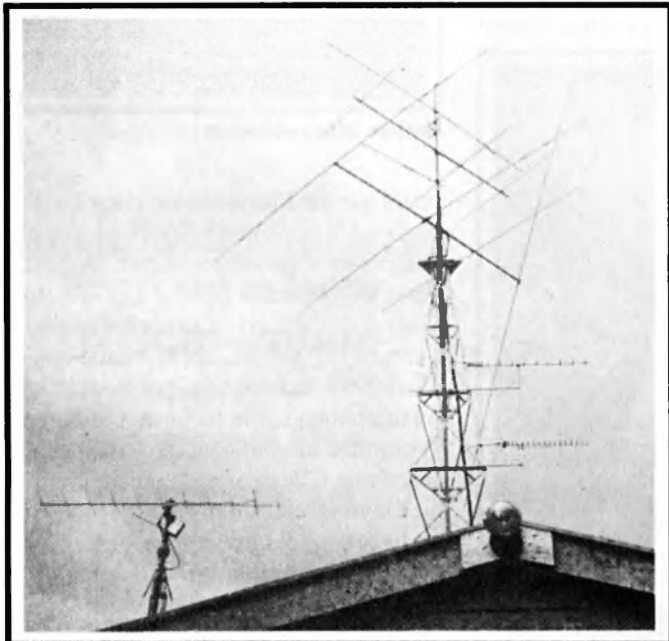
later to dismantle it. It was attached to the tower in four places and felt very secure.

Using the scaffolding, replacing the clamp/insulator was almost a pleasure.

*\*1 Hawkins Avenue, Flinders Park SA 5025*

ar

**Keith VK5MT and Peter VK5ZPS carrying out the repairs with ease.**



**The reflector element of the TH4 was almost vertical.**



**The instant scaffolding being erected.**

---

---

# ALARA

Sally Grattidge VK4SHE\*, ALARA Publicity Officer

---

---

## ALARA 16th Contest, 9 November 1996

Marilyn Syme VK3DMS, ALARA Contest Manager

Bev VK4NBC	391	Top score overall, Top VK member, Top VK YL CW, Top VK Novice, Top VK4 member – Florence McKenzie Trophy
Aola ZL1ALE	266	Top DX member, Top phone, Top New Zealand member
Alan VK8AV	263	Top VK OM
Bev VK6DE	261	Top VK6 member
Aimee FK8FA	239	Top Pacific Islands member
Dave ZL1AMN	237	Top New Zealand OM
Mavis VK3KS	213	Top VK3 member
Christine VK5CTY	207	Top VK5 member
Gwen VK3DYL	206	Check log
Celia ZL1ALK	203	
Poppy VK6YF	200	
Pat VK3OZ	185	
Ivor VK3XB	169	
Marilyn VK3DMS	103	Check log
Sally VK4SHE	102	
Alma ZL1WA	101	Check log
Dot VK2DDB	98	Top VK2 member
Harvey VK3AHU	95	
VK5GGA	85	Top Club station (SA Girl Guides Assoc.)
Margaret VK4AOE	83	Check log
Dawn ZL2AGX	77	Check log
Kim VK3CYL	75	Check log
Elva ZLIBIZ	62	
Bron VK3DYF	47	
Helene VK7HD	41	Top VK7 member
Len VK3ALD	33	
Barbara VK4GTX	15	Top SWL

A total of 27 logs (including 6 check logs) was received, made up of 15 VK ALARA members, six DX ALARA members, four VK OMs, one DX OM, and one Club station.

Another Contest has been and gone, with mixed results. Firstly our warmest congratulations to Bev VK4NBC, who put in a great effort, gaining 168 points on CW to qualify for the Florence McKenzie Trophy. Bev also earned the Top Score VKYL trophy as well as various other categories!

With conditions again not very good, Bev's effort was wonderful. Many of the other scores were also remarkably high considering the effort it took to find a contact during the day. Even on 80 m in the evening the noise was bad enough to scare off all but the most dedicated. I know my ears were ringing when I closed down! Having said that, there were remarks made from those taking part that it was better than last year!

Once again we must congratulate the Girl Guides in South Australia who enjoyed their second contest just as much as their first, and our friend Alan VK8AV who has again taken Top OM. We appreciate your participation

Alan. Special mention must be made of our top VK3 member this year, Mavis VK3KS, who worked the Contest on 39 ft of wire just

above the roof tiles (and hoped her neighbour's phone wouldn't ring!) A welcome back to Australia for Barbara VK4GTX, who was only able to listen this time, having not unpacked the power supply. Of course the ALARAMEET in Perth gave an impetus to the ZL girls, with Aola ZL1ALE taking out the top DX score.

Despite the battle for contacts, everyone enjoyed the contest. It is a great way to catch up with many of ALARA's members. Thank you each one who took part; let's hope that the cycle starts to turn around just a bit by next November. See you all next 8 November for the 17th Contest!

### Welcome New Members

Kath VK4KU joined in January. Elfy N6DOC joined in October last year, sponsored by Joy AK4AT. Pat ZL1LD joined in December last year, sponsored by Peggy VK6NKU

### AGM

Don't forget the AGM in May. Nomination forms for the committee are in the January newsletter, so do give serious thought to taking one of the positions; no experience is necessary, and you will be given heaps of help, so don't be shy.

### Thelma Souper Memorial Contest 1997

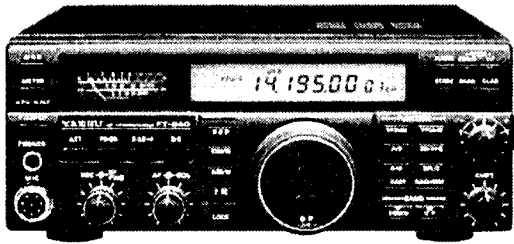
This contest will be held on Saturday, 5 April and Sunday, 6 April from 0700 to 1000 UTC each evening. All contacts to be on 80 m. Phone and/or CW may be used. YLs contact YLs and OMs. OMs contact YLs only. One contact with each station permitted in each half hour period. Call "CQ WARO CONTEST", exchange report, serial number



Aimee FK8FA (left) and Aola ZL1ALE at ALARAMEET Perth 1996.

# DICK SMITH ELECTRONICS

## Affordable Radio Communications



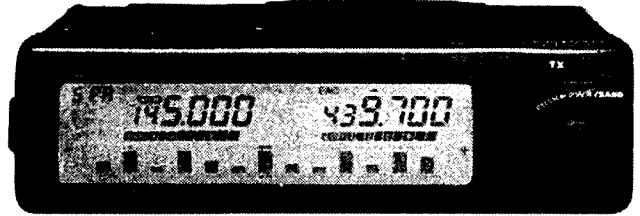
### FT-840 Economical HF Mobile Transceiver

**SAVE \$100**

A serious HF transceiver that won't break the bank and doesn't compromise performance at home like many current micro-rigs. The Yaesu FT-840 gives you full 160m-10m Amateur band coverage with 100W PEP output on SSB/CW/AM, continuous receiver coverage (100kHz-30MHz), 100 memory channels, a large back-lit LCD screen, an effective noise blanker, and an uncluttered front panel. The FT-840 is simple to use, with useful features like an SSB speech processor for added audio punch, IF Shift to fight interference, and Direct Digital Synthesis oscillators for cleaner transmit and improved receiver performance. Includes DC power lead and hand microphone...just connect your power supply and antenna and start having fun.

Cat D-3275

**2 YEAR WARRANTY \$1395**



### FT-850 Deluxe 2m/70cm

The Yaesu FT-850 2m/70cm mobile FM transceiver introduces the advantages of a large removable Omni-Glow display with all major controls on an easy to use hand microphone, and MIL-STD 810C ruggedness.

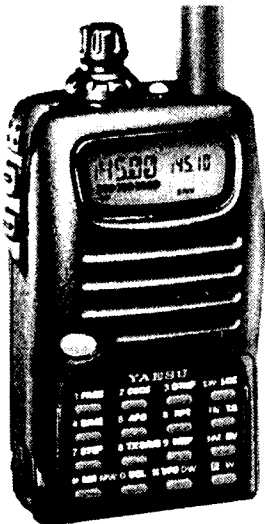
Three dual-band receive configurations (VHF+VHF, UHF+UHF, VHF+UHF) allow cross-band full-duplex as well as standard single band operation. A unique Spectra-Analyzer with selectable channel and indicator widths shows station activity and relative signal strengths. Simple menu programming with alphanumeric labelling also covers most transceiver functions. Other features include 110 memory channels, inbuilt CTCSS encoder, a 1200/9600 baud packet socket, battery voltage readout, DTMF paging and extensive scanning facilities. Supplied with MH-39 hand mic, DC power lead and instruction manual. Cat D-3318

Frequency Range: Tx 144-148, 430-450MHz  
Rx 110-174, 300-500MHz  
2m - 50, 10, 5W  
70cm - 35, 10, 5W

RF Output:

**\$999**

**2 YEAR WARRANTY**



### FT-10R 5 Watt 2m Hand-Held

A compact 2m hand-held with a unique clam shell design and rear-mounted NiCad battery pack that provides 5W RF output as standard through the use of a MOSFET power amplifier and extensive component miniaturisation. Built to a tough MIL-STD 810 rating for shock and vibration resistance, the FT-10R also uses gasket seals for improved weatherproofing.

Features:

- Tx 144-148MHz, Rx 140-174MHz
- RF Output: 5.0, 2.8, 1.0, 0.1W
- Dual watch facility
- Large Omni-Glow backlit display
- High efficiency speaker for super loud audio
- CTCSS encode/decode
- Auto battery save, Tx save & auto power off for longer operating times
- 12V DC socket for charging and power
- Keypad frequency entry
- 99 memories
- Digital code squelch

Size: Just 62 x 100 x 42mm (WHD)

Comes with FNB-41 9.6V 600mA/H NiCad, A16D version keypad, belt-clip and AC charger.

Cat D-3650

**SAVE \$56**

**2 YEAR WARRANTY**

**\$399**



*Offers expire 30/3/97*

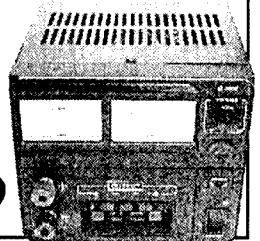
### 3-15V 25A Heavy Duty Power Supply

Ideal for service organisations and demanding enthusiasts! It provides DC output from 3-15V with current up to 25 amps at 15V (lower current at lower voltages), front panel metering, high current banana-style plus low-current output connections. An internal heatsink and thermally-switched fan provide cooling without protrusions in the compact metal case. Specially modified for reliable long-term operation, it uses a rugged 50 amp bridge rectifier and trifilar transformer plus extensive overload protection through dissipation limiting circuitry for the pass transistors, a 30 amp instantaneous current limit, AC mains circuit breaker, transformer thermal fuse and fused auxiliary secondary winding.

Cat D-3800

**SAVE \$50**

**Great Value! \$249**



# Yaesu FT-1000MP

## Incredible Performance, Amazing Price!



Now's your chance to pick up Yaesu's latest high performance HF base transceiver, the new FT-1000MP, at a great new price. You'll be amazed at its incredible performance, but if you need convincing, just read what the experts have to say.

#### On Operation:

"I would classify the transceiver as 'user friendly' compared to some other modern transceivers I have operated." - CQ  
"..... we found it to be a proficient performer." - QST  
".....In term of ergonomics my preference is marginally for the Yaesu.....The second receiver is certainly better implemented....."  
- Radio Comms (UK)

#### On Documentation:

"In general, Yaesu's manuals are the epitome of clear, concise, and complete documentation, and the FT-1000MP's 104 page Operating Manual is no exception." - QST

#### On The Receiver:

"Its receiver is a real beauty ... its very clean and the audio is very clear and punchy ...." - Radio & Communications  
"Measurement of second order intermodulation ... showed an average result for the IC-775DSP but the FT-1000MP was some 10dB better than any other radio measured." - Radio Comms (UK)  
"The receiver is quiet and good at its job, and Yaesu's EDSP is icing on the cake." - QST  
"Certainly, this receiver is designed to withstand the onslaught of very strong signals...." - CQ

#### On The Transmitter:

"CW operators will be impressed with the FT-1000MP keyer." - CQ  
"The transmitter is good as well, with a lightning fast automatic tuner built in as standard." - Radio & Communications  
"The FT-1000MP has excellent spectral purity of the output signal." - CQ

#### Digital Signal Processing:

"The EDSP filter operates smoothly and effectively in all of its modes." - CQ  
"Having the DSP built-in means it works as well as possible - and is clearly better than most after-market add-ons." -Radio & Communications  
"The double-whammy of crystal and mechanical filters plus DSP in the FT-1000MP is a killer combination." - QST

#### Conclusions:

"... I am unable to report finding even a picky fault with the FT-1000MP." - CQ  
"So does the inbuilt DSP say 'buy me'? In this humble scribes opinion, you bet!" - Radio & Communications  
"The FT-1000MP offers performance and flexibility in a quality radio." - QST

Interested in more information? Why not call us for a copy of Yaesu's 12 page colour booklet, 46 page Technical Overview, or for copies of various magazine reviews. We're sure you'll soon agree that the world of HF transceivers has just taken a giant leap forward.

QST - ARRL QST (USA) Magazine review April 1996  
CQ - CQ (USA) Magazine review April 1996  
Radio Comms - Radio Communications (UK) review  
January 1996  
Radio & Communications - Radio & Communications (Aust)  
review July 1996

Cat D-3400

**\$3995**  
2 YEAR WARRANTY



For further information, orders or the location of your nearest store call:  
Ph: 1300 366 644 (local call charge)  
Or Fax: (02) 9805 1986

**DICK SMITH**  
ELECTRONICS



**Helene VK7HD (left) and Celja ZL1ALK at ALARAmeeet Perth 1996. Helena came to Perth via Queensland and the Northern Territory, returning to Tasmania via South Australia and Victoria.**

(commencing 001) and name. To qualify as a multiplier, WARO MEMBER stations must have contacts with at least 20 different stations.

A bonus station using the WARO callsign ZL2YL will be in operation for random periods and will count as a multiplier once on each night of the contest, if worked. Club stations may be operated by multiples of YLs providing that they are WARO members and have licences applicable to the band being operated.

If a club station worked in this way sends in a log with a declaration stating that its operators are both fully licensed as well as being WARO members, they will be considered both as a legitimate contact and ONE multiplier. All radio regulations must be observed.

**Scoring:** To qualify:-  
 a. Enter date at beginning of each evening.  
 b. Each log entry must contain time of contact, callsign of station worked, cypher sent, cypher received and name of the operator contacted. Score one point for each contact, multiplied by the number of WARO members and bonus station if worked.

**Prevent pirates  
 - make sure  
 you sell your  
 transmitter to  
 a licensed  
 amateur**

Logs to have each contact claimed as a multiplier underlined. Include a separate summary sheet showing:

- a. Your callsign, name and address;
- b. The number of contacts;
- c. The number of WARO members worked;
- d. Your score; and

## Awards

*John Kelleher VK3DP - Federal Awards Manager\**

It has been requested that I clarify the situation regarding the submission of additions and alterations to DXCC listings.

Normal copy for publication must be in the hands of those responsible at least one clear month before appearing in our magazine, *Amateur Radio*. So, to complete the necessary processing of DXCC additions and alterations, I must have that information in my hands at least six weeks before publication date. For the February listings, around Christmas, and for the August listings, about the same time as mid-year stocktaking sales.

My apologies to VK4SJ (SSB 256) and VK2DEJ (SSB 317/322) who were not included in the February listings, due to late receipt of upgrade information. Incidentally, why do I only have one VK1 in my DXCC register?

Information on Awards this month comes from Canada, Pakistan, Japan, the Royal Flying Doctor Service, and the "Twenty Eight" chapter of the Ten-Ten International Net Inc.

### The Stampede City Award

Sponsored by The Calgary Amateur Radio

e. A declaration that all radio regulations have been observed.

Logs which do not comply with all the above requirements will be disqualified.

**Logs:** To reach the contest manager, Chris Armstrong ZLIBQW, PO Box 209, Kawerau 3083 New Zealand no later than 6 May 1997. No logs will be returned and no correspondence will be entered into. Contacts made during this contest may count towards the NZ WARO Century Award.

**Awards:** The highest scoring WARO member and OM operator will each be awarded a trophy to be held for one year. Certificates will be awarded to the first three WARO members, the first three OM operators, and the highest scoring VK/YL operator.

### NZ ARDF

Easter (28-31 March) sees the First NZ Radio Orienteering Championships take place in Christchurch. ALARA sends greetings to all competitors and organisers, wishing them a successful and enjoyable competition.

*\*C/o PO Woodstock, QLD 4816  
 Tel: 077 788 642*

*Packet: VK4SHE@VK4RAT.#NQ.QLD.AUS.OC  
 Internet e-mail: rgrattid@ozemail.com.au*

**ar**

Association. Obtain 10 points by contacting Calgary amateurs on any band, any mode from 1 January 1962. Log information ONLY is required. VE6 stations can qualify by operations from outside Alberta. The award is also available to Short Wave Listeners.

Stations VE6AO, VE6NQ (Club Stations), and Life Members VE6AP, AUZ, GQ, JI, MX, RH, RQ, SA, VK, VO, VE7DE, and VE7OK each count two points. Other Calgary stations count one point each. Send log information to: Award Manager, Stampede City Award, Calgary Amateur Radio Association, PO Box 592, Station "M", Calgary, AB T2P 2J2, Canada.

The fee for the Award is \$CDN3.00 for Canadian Amateurs and \$US3.00 for other stations.

### Pakistan's Golden Jubilee Award

The Pakistan Amateur Radio Society will be celebrating the 50th Anniversary of Pakistan and shall issue special Golden Jubilee Awards to commemorate this anniversary in 1997. The independence day



of Pakistan is 14 August 1997. The following rules apply for the Award.

\* Contact a minimum of five Pakistani Stations on any mode, ie CW/SSB/AMTOR/Packet, etc on any HF band from 1 July to 30 September 1997.

\* A certified copy of your log book/sheet (certified by any two radio amateurs), with a fee of five IRCs to cover postage, should be sent to: The Award Manager, PARS, PO Box 65, Lahore 54000, Pakistan to arrive no later than 31 December 1997.

Pakistani Stations will be using special callsign AP50 during the award period. A special Golden Jubilee Shield will be awarded to the one station who achieves the maximum number of contacts on any mode on any band. All other foreign stations contacting a minimum of five Pakistani stations will be awarded Golden Jubilee Award certificates.

### JARL 70th Anniversary Awards

The Japan Amateur Radio League (JARL) was established in 1926 by a group of 37 radio communication enthusiasts. In those days there was an ardent and earnest desire to promote and to develop the utilisation of radio wave technology in Japan which resulted in those amateurs forming a national radio organisation, the present JARL.

Thanks to their continued efforts, amateur radio developed slowly but surely until currently the number of amateur radio stations in Japan is about 1,370,000, which can be regarded as being almost half of the total amateur stations in the world!

To commemorate the 70th Anniversary, the following Awards are available:

J Award – Contact at least seven Japanese prefixes.

A Award – Contact seven different countries (not JA/JD)

R Award – Contact at least seven JARL commemorative stations.

L Award – Contact at least seven Japanese stations in different grid squares (first four characters).

70 Award – Contact 70 stations on ONE band or mode. In the case of 2400 MHz or above, the number of stations are: 2400MHz, 35; 5600 MHz, 10; 10 GHz, 7; 24 GHz, 2.

All contacts must be made between 1 June 1996 and 31 May 1997. Applications will be accepted until 31 December 1997. These awards are also available to SWLs. Please send a log entry (GCR not needed) and six IRCs to: JARL Award Desk, 14-5, Sugamo 1-chome, Toshima-ku, Tokyo 170-73, Japan.

### The Royal Flying Doctor Service Award

This Award seeks to recognise the great work being done by the Australian Flying Doctor Service, and to acknowledge the assistance given, especially in its formative years, by amateur radio operators. Even today, many radio amateurs are involved in its operation.

For the Rev John Flynn, the establishment of the service, in 1928, was the fulfilment of a dream to spread a "Mantle of Safety" over the people of the vast inland of Australia, combining the use of aviation, medicine and radio. Flynn always maintained that the effectiveness of the service was 75% due to radio. Today too, the people of the inland areas of our vast continent rely to a large extent on radio to communicate with each other, and the "School of the Air" helps bring education to the children in these isolated areas.

Radio amateurs too, rely on radio to communicate with each other, not only in

Australia, but around the world. The "Twenty Eight" Chapter of 10-10 International offers this award to any radio amateur or SWL in the world (although offered by this chapter of 10-10, it is not a 10-10 activity).

Requirements are:

1. The award will be available annually, a new certificate being introduced each year.

2. Originally for contacts on the 10 m/28 MHz band, contacts can now take place on ANY BAND, ANY MODE, within the limitations of the licence held by the applicant.

3. Using as many letters as you wish from the prefix/suffix of station Call Signs worked/heard from anywhere in the world, make up the words ROYAL FLYING DOCTOR SERVICE. Each callsign can be used once only each year, but can of course be used in successive years. If you work/hear a VK station whose operator works for or relies on the RFDS for normal contact with the world, this can count as an "instant qualifier" for the award. All VK6 stations may also be claimed as instant qualifiers no matter what band or mode.

4. List all contacts, including date, band and mode, station worked/heard, location, and letters used. SWLs list (and can use) both stations heard.

5. Cost of Certificates are \$AUS5.00 in VK, or \$US equivalent for DX stations. Of this, \$AUS1.00, or enough for return Air Mail postage ONLY will be taken, and the remainder will be sent to RFDS on your behalf. If you wish to donate more to RFDS, postage ONLY will be taken. For amounts of more than \$5.00, a receipt will be issued ON REQUEST; please mark your application accordingly.

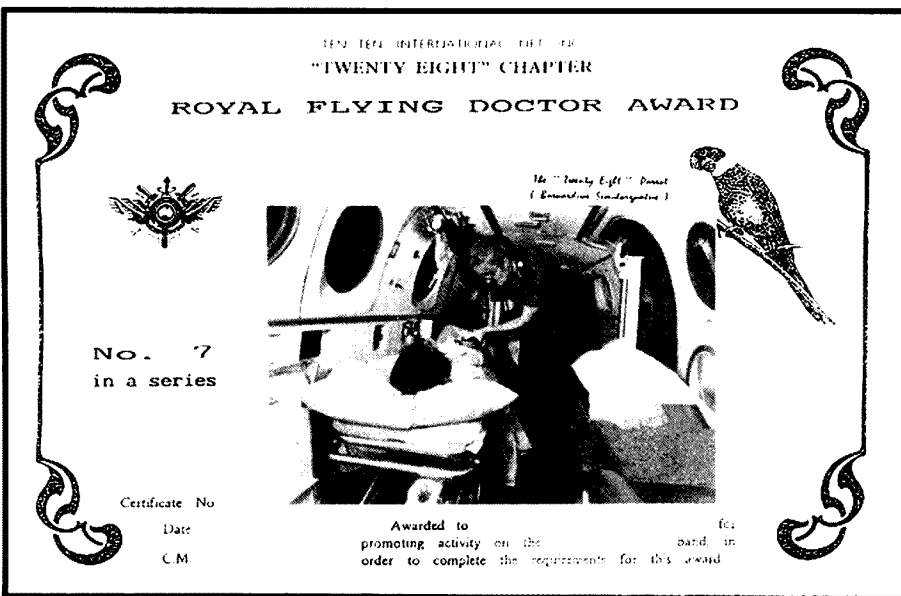
6. Please post applications to: Dave Handscomb VK6ATE, PO Box 39, Quinn's Rocks, WA 6030, Australia.

### The "Six-Twenty Eights" Award

In late 1986, a number of 10-10ers in Perth got together to form a new Chapter, the first in Western Australia. To be known as the Twenty Eight Chapter, it was officially recognised in January 1987. The Chapter has continued to thrive, and January 1997 celebrates its 10th birthday. In looking around for a way to mark this great event, it was realised that 1997 is also 168 years after European settlement in Western Australia. 168 just happens to be 6 x 28. Consequently, the Chapter members have decided to issue a special award, to be available to 10-10ers and other users of the 28 MHz band. The award will also be available to SWLs.

Rules are:

1. All contacts/heard must be made on the 10 m/28 MHz band.



## STAMPEDE CITY CERTIFICATE

THIS IS TO CERTIFY THAT

J T KELLEHER VK3DP

Has established Two-way Radio Communication with ten radio amateurs in Calgary, Alberta, Canada. In recognition of this achievement we take pleasure in granting this certificate.

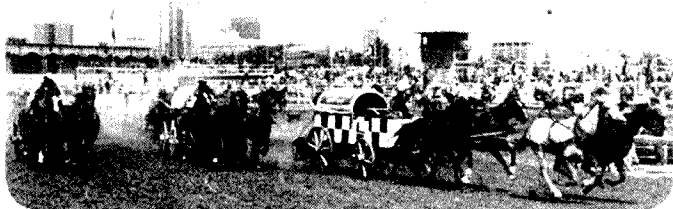


### CALGARY EXHIBITION & STAMPEDE

President  
Calgary Amateur Radio Assoc.

GREATEST OUTDOOR SHOW ON EARTH

General Manager  
Calgary Exhibition & Stampede



the event a success. Keep listening to the VK1WI Broadcast for more details.

### VK1 Amateur Radio Classes

This year's amateur licence classes started last month. Being held each Wednesday at the Narrabundah Residents Hall, Morse classes begin at 7.30 pm while the theory course starts at 8 pm. If you require further information on these classes or amateur radio, please call Jeff Archie VKIJE on 294 1688 (H) or 293 3166 (W).

### New Sound for VK1WI Broadcast

By the time you read this, VKI should have a new Broadcast and Publicity Officer. After nearly two years of producing the broadcast, I have decided to stand aside and let someone else try their hand at the job. I also did not seek re-election to the committee at last month's AGM. The change means that next month's *Forward Bias* will be the last written by me.

I have enjoyed my two years as Broadcast and Publicity Officer for the VKI Division. In that period I have seen the news service expand and embrace technologies such as packet radio and the Internet. Co-operation with other Divisions increased. Listenership steadily rose. We became South-East Australia's most successful amateur radio news service with listeners and readers in all states.

Of course, none of this progress would have been possible without the support extended to me by two successive VKI Committees, colleagues in other states, and contributors around Australia. Our HF relay stations have often stepped in to assist at short notice, as have members of the committee. I would especially like to thank our listeners, close to 100 of whom have called back on two metres alone, for their unstinting loyalty. Without this, we would have no broadcast at all.

### News Contributions Needed Now

I would urge all of you to support my successor, whoever he or she may be. The best way to do this is to contribute items to the broadcast. Maybe you've worked some rare DX, read about an interesting antenna, built a project, or tried an exotic mode. If so, you can be sure that VK1WI listeners would like to hear your story. One of the best ways of contributing broadcast items is via packet radio, and to make things even easier, VK1WI now has its own packet address for news contributions.

Send material (as a personal message) to BCAST @ VKIBBS

Messages will be automatically forwarded to the Broadcast Officer if he/she has packet

2. Any mode (CW, SSB, FM, etc) is acceptable.

3(a). Stations in VK, ZL and P29 make two-way contact with 28 stations from at least six of the 10 VK call areas, of which VK6 MUST BE one, with at least six VK6s being members of the "Twenty Eight" Chapter of 10-10.

3(b). DX stations are required to make two-way contacts with 10 stations from at least six of the 10 VK call areas, of which VK6 MUST BE one, with at least one VK6 to be a member of the Twenty Eight Chapter.

4. The "Six-Twenty Eights" Award will be available for ten months, from 0001z 1 January 1997 to 2359z 31 October 1997.

5. Logs of stations contacted/heard, together with your Award application, should be forwarded to: Dave Hanscomb VK6ATE,

Certificate Manager "6x28" Award, PO Box 39, Quinn's Rocks, WA 6030, Australia.

6. The fees for the Award will be \$AUS5.00 for VK stations and \$US5.00 or equivalent for all other stations. This cost includes Airmail Postage.

The Chapter holds Nets every SUNDAY at 0210z and at 0830z on 28.560 MHz +/- QRM. Members also operate on the band at any time, any frequency. Chapter Members include Brian VK6NKB, Dave VK6ATE, Rob VK6RG, Mark VK6AR, Neil VK6NGN, Peter VK6HU, Syd VK6SMH, Doug VK6ASM, Tony VK6PP, Geoff VK6ZY, NCRG VK6ANC and others.

\*4 Brook Crescent, Box Hill South, VIC 3128

Phone (03) 9889 8393

ar

## Divisional Notes

### Forward Bias - VK1 Notes

Peter Parker VK1PK

#### Amateur Radio Comes Alive

Thousands of people will get to see amateur radio at a public display planned for later this month. November's Committee meeting gave the go ahead for the Division to establish an amateur station and information booth in front of Old Parliament House on Canberra Day.

The annual "ACT Alive" event is a chance for community groups to publicise their

activities. The committee of the VK1 Division thought the opportunity too good to pass up. Being held on March 17, the Division has decided to establish an amateur radio station on the lawns of the Old Parliament House. Other attractions on the day include music, dance, street theatre, and carnival rides.

The deadline for applications was 29 November, 1996. The Division has already advised the organising committee that it will be establishing a stall. Operators and volunteers will of course be required to make

radio, or to another committee member if he/she does not. The new address, which came into effect three months ago, has the advantage of maintaining continuity, even during times when there is a change of Broadcast Officer.

### VK2 Notes

*Peter Kloppenburg VK2CPK*

The date for the 1997 Annual General Meeting (AGM) has been set for Saturday, 19 April. Closing days for Motions on Notice and Nominations for Council is Saturday, 8 March. The returning officer is Peter VK2EMU. You can call him on 02 9584 3236 at home.

Radio amateurs in far away places can now listen in on the 20 metre band to the weekly VK2WI Sunday broadcast. Until further notice transmissions will be on a frequency of 14.170 MHz.

In addition, the Dural team is investigating the possibility of transmitting the broadcast on the Travellers' Net frequency of 14.116 MHz.

Council discussed a possible date for the next Conference of Clubs. It was decided to hold the next conference on the date of the AGM. For further details contact the Parramatta office on 02 9689 2417.

### "QRN" News from the Tasmanian Division

*Robin L Harwood VK7RH*

The Annual General Meeting of the Tasmanian Division will be held on Saturday, 22 March at the Domain Activity Centre. It is scheduled to commence at 1400 hours EDT. As I am compiling this in early February, I am unable to include an agenda, but this will be given over VK7WI in the weeks preceding the meeting. There will be some Notices of Motion tabled by the Hon Solicitor to amend the Articles of Association, and these will also be broadcast over VK7WI.

Some Councillors have not re-nominated and we would like to thank them for their contribution to Divisional Council.

Branch AGMs were conducted last month and there will be a report in the April issue on

their outcome. Details of the Divisional AGM will be in the May issue.

On Saturday, 1 February the Divisional Council met at the home of Ron Churcher VK7RN at Kelcey's Tier. This was the final meeting of Council before the March AGM and there were a few matters to tie up before then. Some of the issues addressed were Call Books, public liability insurance, repeaters and the VK7WI broadcast. An offer for a web site from a Tasmanian server was tabled but this was to be investigated further as there is a possibility a Federal site could also become available.

On Sunday, 12 January the Mount Wellington site for Repeater 6700 closed down after the VK7WI broadcast. Just six hours later the repeater was up and running from its new location at Guy Fawkes' Hill, which is close to Mount Rumney on the eastern shore. Although not as high as Wellington, it has provided fairly good coverage and many operators are once again able to access 6700. We now realise the extent to which the former site was de-sensitised by the huge levels of RF at the top of the mountain.

Incidentally, the pictures of the former ABC tower coming down at the end of January went around the world and it came down exactly in the spot predicted.

The Northern Branch had a social get-together at Scamander, on the east coast, on 11 January. Over 30 attended and this was a valuable opportunity for members who normally are not able to come to the monthly meetings in Launceston. Your scribe did not wear a hat and consequently paid the price, suffering from sunburn for a few days. Our thanks to VK7KPG and VK7MCG for making their QTH available. The consensus is that it will be an annual event.

Meetings for this month are: the Southern Branch on Wednesday, 5 March 1997 at the Domain Activity Centre at 2000 EDT; the Northwestern and Northern Branches will probably be having a combined meeting at Deloraine on 11 March, but this will be confirmed over VK7WI; and the Northwest is also planning a picnic on Saturday, 1 March at Legion Park, Ulverstone and all amateurs are welcome. ar

**Sign up a new WIA member  
today - use the form on the  
reverse of the Amateur Radio  
address fliersheet**

ICOM *Clearly Ahead*



**"VK3LZ  
calling!"**

More sound information from your  
friends at Icom.

**EVERYONE'S TALKING ABOUT  
OUR NEW ALL MODE,  
HAND-HELD UNIT**

The first shipments of Icom's new  
IC-R10 all mode, hand-held receiver  
are now in the field and causing  
overwhelming demand.

We have tripled our output requirement  
from our factory and are supplying our  
Dealers as fast as possible. As they always  
say, the best form of  
advertising is word-of-mouth!  
Be sure to see your nearest Icom Dealer  
and reserve one for yourself today!

**OUR NEW FLAGSHIP  
HAS LANDED!**

Icom's new flagship transceiver, the  
IC-756, has also hit the market and is  
receiving extraordinary praise from  
all who have seen and used it.  
All modesty aside, with its high level of  
features and quality it is undoubtedly the  
No.1 unit available. Ask your Icom  
Dealer for a demo now, we feel sure you'll  
agree the IC-756 is one impressive unit!

**"...73"**

FreeCall 1800 338 915

290 -294 Albert Street  
Brunswick, Victoria 3056  
Tel : (03) 9387 0666  
Fax : (03) 9387 0022

ACN 006 092 575

# AMSAT Australia

Bill Magnusson VK3JT\*

**National co-ordinator**  
Graham Flatcliff VK5AGR  
Packet: VK5AGR@VK5WI  
E-mail: vk5agr@amsat.org

**AMSAT Australia net:**  
Control station VK5AGR

Bulletin normally commences at 1000 UTC, or 0900 UTC on Sunday evening depending on daylight saving and propagation. Check-ins commence 15 minutes prior to the bulletin.

Frequencies (again depending on propagation conditions):

Primary 7.064 MHz (usually during summer)...

Secondary 3.685 MHz (usually during winter).

Frequencies +/- QRM.

**AMSAT Australia newsletter and software service**

The newsletter is published monthly by Graham VK5AGR. Subscription is \$30 for Australia, \$35 for New Zealand and \$40 for other countries by AIR MAIL. It is payable to AMSAT Australia addressed as follows:

AMSAT Australia  
GPO Box 2141  
Adelaide SA 5001

**Keplerian Elements**

Current keps are available from the Internet by accessing the AMSAT FTP site, <ftp.amsat.org> and following the sub-directories to "KEPS".

## New Satellite in the RS Series

It is reported that a new RS satellite is due for launch early in 1997. Some preliminary data has been doing the rounds. It will be known as RS-16 and will be launched into a 500-600 km orbit:

UPLINK = 145.915 - 145.948 MHz

DOWNLINK = 29.415 - 29.448 MHz

BEACONS = 29.408, 29.451 MHz

PWR 29 MHz DOWN = 1.2 W/4 W

BEACON 1 = 435.504 MHz

BEACON 2 = 435.548 MHz

PWR 435 MHz BEACONS - 1.6 W

## Rumour Department

There are rumours circulating that we may soon see more "Iskra" type satellites ejected into quite temporary orbits from MIR. These are usually small packages almost literally pushed out of the airlock of MIR by hand. They generally have a life of about 100 days. Stay tuned for more news.

## Mars Global Explorer Signals Heard

Richard G3RWL reports copying the Mars Global Surveyor on 70 cm using an Icom IC-471 (with a "souped up" front end), an MFJ DSP audio filter, a 12 element circularly polarised Yagi, a preamp, and a pair of ears well trained in CW. Richard admits that the noise reduction functions of the DSP filter were probably responsible for his reception of the weak signal from the Mars probe. This reception report is a bit unique, however, in that the signal was actually copied by ear and not by computer, as were many other reports. I have not received any reports from VK of signals heard.

## Heard Island DXpedition Uses Digisats

At the time of writing, a DXpedition to Heard Island is in progress. Operators using the call VK0IR have been using amateur packet satellites to transmit current log data from one of the most remote locations on earth. Logs are uploaded from VK0IR, downloaded by ON1AIG, and transmitted from Belgium via the Internet to waiting hams around the world. Logs transmitted so far include nearly 20,000 call signs of stations which have worked the expedition. Many log files could be seen daily on the birds. A very interesting exercise for those involved and a good demonstration of the ability of the digisats to exchange heaps of data over vast distances.

## SimSat Project Set to Fly in USA

The Simulated Satellite (SimSat) project is a new educational venture that allows students to fly experiments to altitudes of 60,000 feet and beyond. A SimSat "spacecraft" uses a small high-altitude weather balloon accompanied by one or more experiments. The experiments are designed and built by participating students and their mentors. The payload is tracked by groups of students and radio amateur enthusiasts as the balloon is carried by upper-level winds.

The project simulates many of the

practices and remote observing challenges inherent in working with satellites, and offers a unique hands-on experience for students. The growing SimSat volunteer group in the Washington, DC area is comprised of AMSAT members, teachers, NASA Goddard Space Flight Centre workers, community business persons, sponsors, parents, radio amateurs and others.

## Selecting Frequencies for Amateur Radio in Space

The recent problem with regard to MIR frequencies is an indication of just how much thought and negotiation must go into selecting working frequencies for amateur radio satellites and space operations. With the International Space Station set to become a reality in the near future, those involved in frequency selection and band planning will need to display extraordinary skill and patience.

Most satellite operation is done on the VHF and UHF bands. In nearly every country these bands are very busy and there is pressure on the small amateur radio band segments. Whilst there is a certain amount of similarity the amateur segments are by no means the same in all countries. In some countries amateurs and commercial interests share some segments within the VHF and UHF bands. The amateur service is usually secondary to the commercial service in these cases.

Within the amateur radio bands there are many differing bandplans around the world and, if that isn't bad enough, "gentlemen's agreements" have grown up over the years as have club and group nets and the like. Because of the propagation properties of VHF and UHF transmissions, most of these differences do not pose much of a problem in day to day operation. Satellites are a different proposition, however. Every frequency, whether uplink or downlink, whether beacon or transponder, must be carefully considered in the light of the above restrictions.

The amateur radio world is divided up, for administrative purposes, into three regions. Efforts are made to harmonise bandplans within the regions. Agreement has to be reached with all regions before frequencies can be assigned to an amateur radio satellite. There have been instances in the past where clashes have occurred and there will probably be anomalies in the future. In many cases there is no easy answer to frequency selection. Spare a thought for those brave souls who unselfishly put their hands up to take on the job of co-ordinating frequencies in the amateur radio satellite service.

\*RMB 1627, Milawa VIC 3678

E-mail: vk3jt@amsat.org

ar

# Contests

Peter Nesbit VK3APN - Federal Contest Coordinator\*

## Contest Calendar March - May 1997

Mar	1/2	ARRL DX SSB Contest	(Jan 97)
Mar	8/9	Commonwealth Contest	(Feb 97)
Mar	14/15	160 m "Have A Go" Activity Period	(Feb 97)
Mar	15/16	WIA John Moyle Field Day	(Feb 97)
Mar	15/16	Bermuda Contest	
Mar	15/16	BARTG RTTY Contest	
Mar	15/16	YL-ISSB Contest	
Mar	29/30	CQ WPX SSB Contest	(Feb 97)
Apr	5/6	SP DX Contest	
Apr	11/13	JA DX High Band CW	
Apr	12/13	International HF Grid Square Contest	
Apr	12/13	"King of Spain" DX Contest	
Apr	19	Australian Postcode Contest	
Apr	19/20	SARTG AMTOR Contest	
Apr	19/20	Israel DX Contest	
Apr	26/27	Helvetia DX Contest (Switzerland)	
Apr	26/27	SP RTTY Contest	
May	3/4	ARI DX Contest (CW/SSB/RTTY)	
May	10/11	Sangster Shield Contest	
May	10/11	CQ Mir DX Contest	
May	24/25	CQ WPX CW Contest	(Feb 97)

Last November I published a letter from Peter Parker VK1PK analysing the main categories of contest operation, and suggesting that a rule sometimes used in sprint contests (ie having to QSY after a certain number of contacts on the same frequency), might have more general application in other contests.

In response to Peter's comments, several readers contacted me to put their views, including Jim Muller VK1FF/WB2FFY who sent a detailed and informative e-mail message. Jim's views echo those of the other respondents: "I'd like to make a few comments on the letter you printed from Peter Parker VK1PK. Whilst I respect Peter's point of view, I have to say that I don't think his proposal would have a desirable result, and that it would probably cause overall contest activity to drop.

"I consider myself a "hard core contester" and DXer and, like many others, identify with both groups one and two in that:

- I operate in 10-13 contests per year, making over 100 QSOs more than half the time;

- I usually operate as much of the contest period as possible;

- I arrange my vacation and family activities around the BIG contest weekends; and

- I ALWAYS send in a log.

"But, also:

- I spend 60-70% of my operating time searching and pouncing (S&P) (Peter's group two), rather than remaining on a particular frequency for several hours (Peter's group one); although there are times when I have been fortunate to run pile-ups on a particular frequency for a couple of hours;

- I often spend a fair amount of time calling a station if it's a new one for an award, such as DXCC (for example, I called D44 in zone 35 during the CQ WW CW contest for over one hour, PY0 for 30 minutes, and A45 for 15 minutes); and

- My station is definitely modest, with a TS-520 (100 W) into 40 and 80 m dipoles only 12 m high.

"In most contests I alternate between running small pile-ups, and periods of S&P. Understanding propagation and the station's capability makes it easy to switch between the two roles. Even in "local" contests like the RD, I find myself holding a frequency for a period of time, and then switching to S&P. So I disagree with Peter's points that:

- "many group two stations never exchange numbers with other group two", because almost anyone can run a frequency if they really want to; and

- "Group two and three contesters have much less opportunity to make calls and work each other, especially in the middle, most-used portions of the band".

"Admittedly it is often difficult for little pistols to call CQ in the middle (or on the CW bands on the low end) of the band. But who says you have to operate there to make lots of contacts. I'm often quite successful operating above the main show around 7.045 - 7.050 during openings to the US. In fact, I operated the entire ARRL DX CW contest last year exclusively above 7.045, and made over 400 QSOs with my 100 W and dipole.

"I agree, as you mention in your comments, that there have been times when I've missed multipliers or QSOs because a group two station was supposedly only calling group one stations. I also try every trick in the book to snag those stations, and sometimes it works .... even if it's on a group one's frequency and they have to stand by!

"There is no doubt that the key to the success of a contest is the activity of the casual operators. In addition to the definitions given by Peter, these can include medium and high power stations, who are looking for new DX contacts for awards, or just personal satisfaction. For example, several VK1s operated in the CQ WW SSB contest last October, but only one was going to send in a log. The others weren't in it for the contest - they were there to WORK NEW COUNTRIES, which they did! It was only after talking with them several times, and offering to help with the scoring, that a couple eventually submitted logs. But there were still a couple who really didn't want to be bothered submitting a log. They got out of the contest exactly what they wanted - which was to work a bit of DX and get some new ones, ie "group two to group one QSOs".

"In Peter's summary he suggests a five QSO QSY rule, when, in fact, contests like this already exist. Whilst I've won a couple of sprints of this format, I didn't enjoy them as much. In fact, I often found it harder to work new ones, because they were constantly QSYing! Contests like this appeal mainly to the "hard core" contesters. I seriously doubt we'd see a meaningful increase in group two to group two QSOs, in fact I think the opposite would happen, with less participation and fewer QSOs.

"I also think a five QSO QSY rule would be difficult in practice. Most contests with the QSY rule require the station calling CQ to move immediately after the first QSO. This makes it easy to determine who stays and who moves, without having to determine whether it was their 1st, 2nd, 3rd, 4th, or 5th QSO.

"Contesting, or even operating in general, appeals to people for many reasons. I like winning, but the main thing I enjoy about contesting is the opportunity to send and receive high speed Morse and accurately work many stations as quickly as possible.





---

---

# How's DX?

Stephen Pall VK2PS\*

---

---

As I write these lines, the Heard Island DXpedition is on its way back to Reunion Island, after one of the most successful expeditions ever undertaken by a major group of amateur radio operators.

The idea of activating Heard Island again, after the success of the 1983 activities, germinated on or after the Peter I Island activity.

After the unfortunate first attempt in late 1995, which culminated in a considerable loss of money due to the "Australian boat experience" and loss of reputation among some of the DX fraternity, the proof of the pudding was in the eating. In this case, the number of QSOs completed in 13 days of activity, a staggering total of 80,673 contacts on 10 amateur bands.

There were many sceptics and many doubters. There were questions raised about the organisational ability of the group, about the capacity for finance, and the bad timing with propagation at the bottom of the solar cycle. The average DXer was not convinced about the viability of the project.

Public opinion started to change after the announcement that the transportation problem was solved by securing the French Antarctic Research vessel, the "Marion Dufresne" to carry the group of amateurs to Heard Island and back. The budget of the project was a staggering \$US320,000. A lot of money for carrying 21 people to a remote island and back just for the "fun" of operating amateur radio. The charter of the vessel was around the \$US200,000 mark. The team members contributed \$US10,000 each, a total of \$US232,000. The rest came as donations from DX Foundations, private, and corporate sources. Besides the ARRL Colvin Grant of \$5000 (mentioned in our February issue) the Northern California DX Foundation contributed \$20,000 and two individual amateurs, W6OTC and JH1AJT donated \$10,000 each.

The tales and lamentations of each individual VK and ZL amateur will be heard for many months to come. Many VKs and ZLs were not able to work VK0IR because of propagation, QRM, because of "perceived" neglect of our area and because of lack of instant information about the 24 hours forecast of planned activities from the island.

There is no doubt that VK-ZL amateurs had some disadvantage. Propagation was not the best for days, especially on the low bands. Good propagation to Europe and to the East Coast of the United States and to Japan,

tended to decide each day's activity on the island.

We should not forget that one of the primary goals of the DXpedition was to get as many as possible different stations in the log. As at Wednesday, 22 January, VK0IR had 20,407 different calls in the log for 55,000 QSOs.

A further disadvantage, in my opinion, and this was self-inflicted, was the fact that the number of VK-ZL DXers who have good and speedy DX packet facilities and/or Internet connections is very limited. Whilst the real activity was on amateur bands – "in the ether", to use old-timer jargon – the main organisational and back-up facility was on local and international telephone lines via computers and the Internet, which cost money to the unprivileged.

The Pilot Program system of ON4UN, N1DG, W0EK, K0EU, W4WW, W2IJ (responsible for the Pacific) and JH1ROJ, published at least one, very often two or three, Pilot Program Bulletins each day, about conditions, number of QSOs, antennas, beacons, 80 and 160 metre planned activities, propagation predictions, possible times and frequencies of activities (including frequency changes, of which there were at least three), on a variety of seven Internet e-mail addresses in addition to the DX packet network system which was not as "speedy" as the "real time" Internet.

How many of us ordinary VK DXers had this Internet facility, either directly or indirectly? I think, not many. How many were in the "know" about tomorrow's plans of activity on the Island? A few. The overall results speak for themselves.

I personally had no access to such facilities, so I relied (as many thousands did) on the "gossip news" on the band, on my chasing instincts, and so called "skills". Yesterday, well after the closure of VK0IR, I had the fortunate opportunity to become the owner of a hard copy of the 94 messages sent over the Internet by the Pilot Program between 26 December and 1 February, contained on approximately 200 pages of print. Here are some titbits from this massive information pile in chronological order.

## Heard Island VK0IR

**30 December** The DX Group using the callsign TOOR on Reunion Island, becomes active, mainly on CW and 160 metres. The ship "Marion Dufresne" arrives. Captain and crew extremely cooperative.

**1 January** Due to a strike in France, the

departure of the ship has been delayed. The crew of the vessel goes on strike from 1500 hours on 3 January to 1500 hours on 5 January in sympathy with a general strike in France which is connected with marine transport. Meeting of the leaders of the DX Group with TAAF coordinator (Terres Australes et Antarctiques Francaises). Schedule is revised. Depart Reunion on 5 January, no stopover at Crozet, to land on Heard on 11 or 12 January as originally planned.

**2 January** VK2DJM and RA3AUU, the last of the operators, arrive at Reunion Island.

**3 January** Last checking and reloading of the containers. Total weight of the cargo of the expedition estimated at 25.6 tons.

**5 January** TOOR went QRT with 411 QSOs and 50 countries worked on 160 metres. The "Marion Dufresne" left at 1600 UTC for Heard Island.

**9 January** At 1600 UTC on Thursday the boat was 1350 km (850 nautical miles) from Heard Island.

**11 January** Fax from the boat: "We are a few hours away from Heard Island. Wind, NW 23 knots; Temp. +9°C; low clouds, visibility four miles, sea relatively calm."

**12 January** Landing started at 22.30 UTC (0330 local time) on Saturday night UTC, Sunday morning local time. All operators and equipment were put ashore by helicopter. It took five hours and 51 helicopter flights to move everything. No damage sustained. The beacon was put on air at 1130 UTC. Camp was established.

**13 January** All preparatory work finished, three operating tents already equipped. Beacon is operating. All generators are up and running. The village (the sleeping quarters) is located 70 m from the sea shore, the CW and SSB tents are separated by nearly 700 metres.

**14 January** VK0IR started operating at 0654 UTC. Problems with the PACSAT station, RF from six working stations burns out the preamp of the receiver. Great signals on 160 metres from Europe and east coast of USA, 150 reception reports were received on the beacons' activity. Pilot Stations Chief, ON4UN, reports that they had received 3500 messages on Internet since 25 December, all related to this DXpedition.

**15 January** Simultaneous CW and SSB operation on same band. PACSAT still not working. Propagation reports in the main tent are based on predictions, observed openings (beacon plus feedback from pilots' own logs). Japanese report hearing VK0IR around 2100 UTC on 160 m and not at 2200 UTC as predicted. Satellite openings on AO-10. The most difficult paths are to the US west coast and South America.



**16 January** Radio Austria International covers the expedition activities by satellite phone interviews on 18 and 19 January to all target areas world wide. PACSAT is still under repair. After 48 hours operating, 12,000 QSOs in the log (VK/ZLCW 89, SSB 149). It is very difficult to work South America. The 40 m SSB frequency has been changed to 7047.5 because of QRM. The shower is now up with a maximum of one litre of hot water each per day to shower. Heard Island is like a "black and white movie". Black from volcanic ashes, white from snow.

**17 January** A total of 305 QSOs with VK/ZL (CW 107, SSB 191, RTTY 7). Peak report from North America on 160 m (579). The only comment about any VK activity in these Pilot programs was that Dave VK2DJM has proven to be a superior "site engineer", making sure that all is kept up well. So far there has been no major storm. Many difficulties with European pile-up. There is no discipline at all. The fibre glass section of the 80 m SSB antenna broke; they are trying to repair it.

**19 January** Over 37,000 QSOs have been made. Daily detailed weather received from the ship. Peter ON6TT, who is responsible for radio operations, makes use of the information sent to the Pilots, which is

processed and forwarded to the island to help in planning the next day's operation. INMARSAT proves to be unreliable for the data-link, but the radio amateur satellites KO-23 and KO-25 are excellent.

**20 January** At the request of the JA stations, VK0IR will be transmitting now on 1.822 MHz. USA "WWW" Internet site was visited by 27,372 visitors, and the European server by 9,809 visitors. Weather 0°C, windchill -14°C, wind 70 km/h. Hail and snow storm. After six days of operation, VK0IR had 17,240 QSOs with Europe, proving wrong the sceptics who said there would be no propagation on that path. PACSAT is up and running again, the logs are travelling via the satellites. Europeans are working the island with 100 watts and simple antennas. Peter announced that they would pay more attention to Japan on the bands. The island is active on 21, 24 and 28 MHz. Europe is elated.

**21 January** So far 50,017 QSOs. The 80 kph winds blew the 80 metre SSB antenna down again. The 80 m CW frequency was moved to 3504.5 and the SSB frequency to 3798 kHz. 160 m is now using 1.822 kHz. 40 m could be found on 7047.5, 7052.5, 7057.5 or on 7065 kHz. 40 m CW on 7007 or 7022 kHz.

**22 January** Peter said: Tomorrow will be

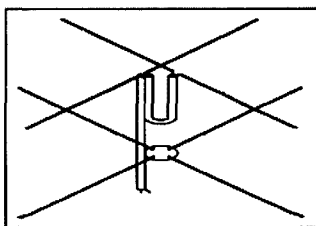
JA and EU day.

**23 January** So far 60,189 QSOs.

**25 January** 71,184 QSOs with 24,871 different stations.

**26 January** Rough weather, winds 90 km/h, windchill -14°C. They started to take down some antennas. The ship will arrive to pick them up on 28 January. Bob KK6EK writes: "There are 24 antennas. 12 of which are grouped into four square vertical arrays for 40, 80, and 160 m. We have a small tractor and wagon to drive heavy loads around. We run seven Honda generators continuously, providing more than 30 kW of power. An electronic camera captures still photos that are uploaded and posted on the WEB pages.

**27 January** Final statistics: Total QSOs logged, 80,673 (CW 45,536, SSB 33,081, RTTY 2056). Total per band: Satellite 634, 10 m 228, 12 m 748, 15 m 9,818, 17 m 9,691, 20 m 30,351, 30 m 7,111, 40 m 15,558, 80 m 5,293, 160 m 1,241. Total Japanese contacts, 14,941. Total European, 35,846. Eastern North America, 14,532. Central North America, 5,837. Western North America, 4,157. Other parts of the world, 4,647 contacts. Australian and New Zealand contacts (together): CW 253, SSB 447, RTTY 13; a total of 713. Satellite 5, 10 m 4, 12 m 2, 15 m 38, 17 m 61, 20 m 465, 30 m 32, 40 m 44, 80 m 57, 160 m 6.



## Radio and Communications

INCORPORATING AMATEUR RADIO ACTION and CB ACTION

Published by  
**ACP SYME  
MAGAZINES,**  
PO Box 119,  
Oakleigh,  
Vic 3166  
(03) 9567 4200

Any idea what cigarette smoke can do to the inside of your expensive transceivers? You'd better read this month's memoirs of a retired radio technician to discover the gruesome facts. Meanwhile, we present a construction project which could keep you busy for ages. What is it? Take a look at the picture above and see if you can guess...

The March issue of R&C could keep the active amateur amused forever. Here's a couple of clues...

- Tools — which ones do you really need, and which ones should you give a miss at the store?
- Gone Tropo: our regular VHF/UHF column looks at DX hogs. Are you spoiling the fun for others?
- The latest IARU list. How are international call signs allocated? Here's the full list of what's what.
- New Family Radio Service — could CB get the chop altogether with this new UHF radio service?
- SSTV — the final episode. Rai Taylor, VK7VV shares a full four pages of accumulated SSTV knowledge.
- The best IOTA column in Region 3, mods, DX columns and more... all the best regulars every month!

Don't miss out — **RADIO and COMMUNICATIONS** is great reading for amateurs!  
**Check your local newsagent today!**

(PS. We also have the biggest collection of radio-oriented Classified adverts in the country. There's lots of them because they work so well. Ask your newsagent to keep a copy for you each month, or ring 1800 25 2515 for subscription details. Hurry — you might miss something!)

**29 January** Last QSO took place on Monday, 27 January at 1155 UTC between VK0IR and ON4UN, the Chief "Pilot Station". The last people and the last cargo were successfully taken off the island at 0328 UTC on 29 January. A total of 49 helicopter flights were made. According to ON4UN, well over 5000 messages were handled on Internet plus the messages of the individual Pilots, plus DX-clusters and packet radio BBS systems.

**1 February** Because of extremely rough weather, there will be no stopover on Kerguelen. The ship will proceed directly to Reunion. The voyage between Heard and Kerguelen has been very, very rough, with 30 foot high seas and everybody sea-sick.

This is what happened in the DX World in the first month of 1997, the year of a DXpedition of a life time.

### Future DX Activity

\* Bill KM1E will be active as C6AGN from the Bahamas until the end of May. QSL via KA1DIG.

\* PZ5DX will activate Suriname from mid-March to early April. QSL via K3BYV.

\* Steve VE8RCS is operating on Ellesmere Island, from Alert NWT, the northernmost permanent settlement in the world.

\* Hugolin XT2HB is a newly licensed amateur and has been active on 14,225 kHz around 1730 UTC on weekdays and at 0730 UTC on weekends. QSL via Dep.O1.BP 6397, Ouagadougou, Burkina Faso, Africa.

\* Bob 4S7RPG has been heard operating on 1826.5 and listening on 1837 kHz, at his sunset around 1230 UTC for North America. QSL to G3REP, his home call.

\* Dick N4ISV is operating CW/SSB, 80-15 m as 9M2RY. QSL via N4JR.

\* St Marten Island will be very active in February and early March. Four American hams, ND5S, KF5LG, W8EB, and KB8ZXO will be operating as PJ8/home-call. QSL via each individual home call.

\* The PJ8A callsign will be used during the ARRL DX Phone Contest on 1 and 2 March. QSL via W9NIP.

\* Enrique EA5AD will use the callsign 7X0AD during the year whilst he is in Algeria. QSL via EA4URE.

\* Gary, who is with the Voice of America, will be active from Sao Tome as S92AT for a number of years.

\* Try to work Rolf XV7SW on 160 metres. His transmitting frequency is 1.827, but he is listening "down" on 1.824 MHz. QSL via R T Salme, Embassy of Sweden, Box 9, Hanoi, Vietnam.

\* Hans DL8NBE and Rolf HB9DIF will be active in March from the Maldives as 8Q7BE (SSB/RTTY) and as 8Q7BV (CW)

on all bands. QSL to home calls via the bureau only.

\* Gerard F2JD (ex 5R8EN) hopes to be on the air from Panama in the near future.

\* Bent OZ2BJC will be on 14,320-14,330 kHz as PZ5CJ each day around 1100 UTC for a sked with his twin brother OZ2CLJ.

\* Maurizio 5R8FH is a lay missionary in south central Malagasy, and can be heard on 20 and 15 m with 80 W and a three element Yagi. QSL via IIPIN.

\* Ahmed SU3AM is often operating from the new club station SU0ERA. QSL via SU1ER.

\* Tukang Besi Island will be activated in March, reports Tjok YBORX. The callsign will be 8B8WI.

### Interesting QSOs and QSL Information

\* AP2LN - Amin - 21,276 - SSB - 1130 - Dec (E). QSL via Muhammad Amin, House 424, B Block, Nizamabad, Faisalabad, Pakistan.

\* A92FZ - Bob - 14,263 - SSB - 0628 - Dec (E). QSL via W3HCW, Carl F McDaniel, 2116 Reed St, Williamsport, PA 17701, USA.

\* 9U5DX - Gene - 14,164 - SSB - Dec (E). QSL via F2VX, Gerard Debelle, 4 Le Haut d'Yvrac, F-33370, Tresses, France.

\* A71CW - Chris - 14,035 - CW - 1219 - Dec (E). QSL via Krysztof Darbowski, PO Box 22101, Doha, Qatar.

\* 4L1BW - Serge - 14,192 - SSB - 1235 - Dec (E). QSL via N3CBW, Herbert B Mutter, 13805 Town Line Road, Silver Spring, MD 20906, USA.

\* 4L5O - Omar - 14,192 - SSB - 1237 - Dec (E). QSL via TA7A Sedat Melek, PO Box 71, TR 61000, Trabzon, Turkey.

\* ZK1DI - 14,195 - SSB - 0513 - Jan (E). QSL via DK1RV, Hans-Georg Goebel, Konigsberger Str II, D-57250, Netphen, Germany.

\* KH0TCN - Victor - 14,164 - SSB - 0523 - Jan (E). QSL via Victor M Tesone, Box 464, San Andres, Colombia.

\* P40WA - John - 7,009 - CW - 0944 - Jan (E). QSL via K9UWA John C Collier, 1624 Carroll Rd, Fort Wayne, IN 48825, USA.

\* ZP0V - 14,255 - SSB - 1021 - Jan (E). QSL via ZP5WYV Yoe Zambon, POB 512, Asuncion, Paraguay.

\* DL0ITU - Werner - 14,011 - CW - 1127 - Jan (E). QSL via Sonder-station DARC, Sternwartenweg 23, D-24105, Kiel, Germany.

\* 3DA0AC - Horace - 14,164 - SSB - 0604 - Jan (E). QSL via Horace A Long, POB 107, Mbabane, Swaziland, Africa.

### From Here There and Everywhere

\* It was reported in *QRZ DX* that Andy IK4WMG said the DXCC has rejected the card for the T31/T3ODP activity, because of lack of documentation.

\* Referring to my previous comment on the fate of the *DX Magazine*, it has now been revealed that the magazine will be published in the future by Carl Smith N4AA, the current publisher of *QRZ DX*. The March/April issue 1997 will be the first by the new publisher.

\* The following was reported recently by *Caribbean Magazine*: "The residents of Nevis Island will vote later this year to secede from the Union with St Kitts. If the result is positive, then they will become the smallest island nation in the Caribbean." A new DXCC country?

\* ZS8IR still has broken 160 m antenna problems. The storm that caused the first damage to the Battle Creek Special had winds in excess of 186 km per hour.

\* If you worked EP2DA from 1967 to 1971 and never got a card for that operation, try your luck with KD2DY Don Alexander, 330 Appalachian Drive, Boone, NC 28607, USA, with the usual reply envelope and return postage. Don still has parts of the log of that operation.

\* Reported by Jean F6AJA that he received the logs for the FK5M expedition. QSLs will be ready in February.

\* Tony WA4JQS, the leader of the South Sandwich Island Antarctic DX Group, reported that the paperwork for the 1997/98 operation is proceeding very well. Permission had been received for a December 1997 landing date. However, the possible establishment of a CCAMLR (Convention of the Conservation of Antarctic Marine Living Resources) ecosystem monitoring program to be set up on the island, to take effect in October 1997, could cause some complications before the projected landing time. For this reason, the whole activity has been postponed for another year and the group has re-applied for a 1998 season landing date. There were also many requests from JA operators who hoped that the opening of the 28 MHz band to Japan will be better. This was also a big factor in the new date request. This reminded me of my wise grandmother who said something about the pig or who played the tune. We are talking about a 1998 Bouvet Island DXpedition.

\* Steve PA3GBQ will be in Ghana during February and early March, using the callsign 9G5BQ. He will try to be more active on the low bands. QSL via home call.

\* Advance notice. PB0ALB will be active in Sarawak from 19 April to 6 June as 9M8CC.

\* Do you need Sable Island, CY0, as a DXCC country? If yes, the news is not good. Val VE1AL reports that the Canadian Government has announced it plans to close the weather station on Sable Island unless private interests, who use the services, are willing to pay for it. The other possibility is that the station there will be automated. It appears that future accessibility to Sable Island by amateur radio operators could be in severe jeopardy. Sable Island has special designation as an "environmentally protected area" and government permission for "visitors" would likely be scrutinised more closely. If there will be no more permanent residents on the island, light planes might be banned from landing, for safety reasons, on the sandy beach. Approaching Sable Island by sea is extremely dangerous, as it is known as the "graveyard of the Atlantic" and this leaves only the very expensive helicopter service for transport.

\* T3Z2 has been active. The correct QSL information is via N7YL and not via W7.

\* The new address of the SRR, The Soyuz Radiolyubitelej Rossii, the Russian Radio Association, which is the member of the International Amateur Radio Union, is: Soyuz Radiolyubitelej Rossii, PO Box 59, Moscow, 105122, Russia.

\* When you live on an island paradise, where do you go for a holiday? To another island nearby and take amateur radio and a long wire with you. This is exactly what Meralda VR6MW, Betty VR6YL, Jay VR6JC, Michael VR6AZ, Paul VR6PL, Dave VR6DB and a number of Pitcairn Islanders did in the second part of January. A total of 26 people, 10 in one of the aluminium launches and 16 in the other boat, sailed to Oeno Island, which lies 26 miles NW of Pitcairn. They took a generator with them for evening light and radio, and drinking water. They camped in tents. Incidentally, the Pitcairn Island population has reached an all-time low. There are now only 36 residents on the island.

\* A little while ago I had a CW contact with Bangladesh, with Ray S21 YR. I soon found

out that Ray is actually G3WZ who, after visiting Bangladesh, came over to Sydney for a short visit. We arranged a quick "eyeball" QSO. Ray is a seasoned traveller and previously operated from Barbados as 8P9AQ, from Fiji as 3D2WZ and now from Bangladesh. Whilst the latest International Callbook shows only six callsigns, two locals and four visiting hams with the S21 prefix, there are about 12 active local hams on the bands, according to Ray. Interesting snippets from our discussion. Mains power is 240 V, but distribution has its "hiccups". Therefore, a mains power surge resistor filter is advisable, as some parts of Dhaka might have only two hours of power in a day. "In general," says Ray, "the granting of licences in Barbados and Suva was only a matter of slowness of officialdom and licences were granted for one year. In Bangladesh, at present, the slowness is similar, but the cost is greater, and for a first visit may only be for a week. There could be also some difficulty in bringing in, and taking out, your own personal amateur equipment."

\* Who else was active in the past from Heard Island? Colin VK2BCC was on Heard Island between 1 October 1985 and 25 November 1985 as VI0CC, and active on CW and SSB, according to CT1BOH who worked him.

\* *The Sydney Morning Herald*, 16 January edition, carried an article entitled "Big Ben may have erupted – you heard it here first". The article referred to a massive plume above Heard Island which was observed on satellite images at the Australian Davis base, Antarctica. The possibility of a volcanic eruption by Australia's only active volcano, was canvassed by Professor Pat Quilty who is the Australian Antarctic Division's geologist and chief scientist. The SMH said: "Professor Quilty has sent a fax to the crew of a French vessel, the "Marion Dufresne", to inform them about the possibility that Big Ben has erupted or is erupting. The ship dropped a team of radio operators on the island last Sunday. They are scheduled to be collected on January 28." A little further in the article was: "On 28 January an Australian

Antarctic Division ship leaves Australia for a nine week voyage, which will spend three days from 19 March on Heard Island. Weather and time permitting, Professor Quilty is hoping to fly over the summit and the crater to investigate the eruption".

\* I have to close this column today with some sad news. Ray VK4DX, formerly VK2BKD, recently lost everything in a fire – his house, its contents and all his amateur equipment. He escaped just with the clothes he was wearing. The news travelled fast and he was inundated with sympathy messages. He wants to thank all his friends who contacted him and indicated that within six weeks or so he will be active again from some beach as mobile or as portable.

## Thank You

Many thanks to my supporters who regularly supply me with news and information which makes this column possible. Special thanks to VK2XH, VK2YX, VK2DJM, VK2KFU, VK2TJF, VK9NS, VR6YL, S21YR, the Sydney Morning Herald, ARRL DX Desk, QRZ DX, The 59(9) DX Report, The DX News Sheet, The 425 DX News and the GOLIST QSL managers list.

\*PO Box 93, Dural NSW 2158

ar

## COM-AN-TENA

(formerly A. J & J Coman Antennas)

6M std 6 ele 40 mm boom	\$216
2M co/linear 2 5/8 7dbd	\$ 97
12 ele 2M broad B/width	\$135
6M 4 ele delta loop	\$221
6M 5/8 vertical – radial	\$157
6 ele 6 M N.B.S. 50 mm Boom	\$310
Duo 10-15 M	\$305
3 ele 15 M	\$214
3 ele 20 M	\$351
20 m log-yag array 11.5 dbd	\$765
M B Vert NO TRAPS 10-80 M	\$275
Tri band beam HB 35 C 5 ele	\$690
40 M linear loaded 2 ele	\$536
13-30 M logperiodic 9 ele	
all stainless/steel fittings	\$891
70 cm beam 33 ele 19.9 Db	\$228
23 cm slot fed 36 ele brass cons	
s/solder-assembled, 18 dbd	\$170
80 m top load/cap/hat vert.	\$260
Tri band 6 ele 6M boom	\$860
2 m 144.100 2.2 wavelength boom	\$145

**When no answer on factory phone  
call on mobile 0419 542 437**

**Call ANDY COMAN VK3WH,  
LOT 6 WEBSTERS ROAD,  
CLARKFIELD 3429  
PHONE (03) 5428 5134**

## WIA News

### New WIA Members

The WIA bids a warm welcome to the following new members who were entered into the WIA Membership Register during the month of January 1997.

VK2VZQ	MR M F RAMSAY
L40376	MR R MCLEAN
L40377	MR P FAGG
VK4YJN	MR T HOUWELING
L40378	MR G FINDLAY
VK6BSS	MR B S SMITH
VK6IP	MR K KHUEN-KRYK

---

---

## Over to You – Members’ Opinions

---

---

All letters from members will be considered for publication, but should be less than 300 words. The WIA accepts no responsibility for opinions expressed by correspondents.

---

---

### Professional Communicators

I have followed with concern, over the last few years, the generally futile and flimsy arguments for CW versus no CW. The exchanges in Oct '96 and Jan '97 have finally disturbed me into a reply.

VK6VZ's comments in Jan '97 lacked logic in the following areas:

1. *"The dangers in letting loose people who have no knowledge of CW on to frequency allocations where this is still a used mode....."*

Commercial users utilise a number of modes in shared bands. Not all of these modes are de-codable by amateur transceivers. Is it dangerous to let amateurs on such bands? Obviously the SMA doesn't think so, or we would have lost our privileges in these bands long ago.

2. *"Causing interference to a commercial or government user....."*

All amateurs should avoid causing interference to all users. All amateurs should stay clear of all signals, even amateur, so as not to interfere. If a transmission began over an amateur QSO in progress on a shared band and the amateurs did not understand the transmission, they should feel obliged to move, in case they were interfering with the primary user of the band.

3. *"After fighting bushfires, CW should be a breeze...."*

I spent the best part of 10 years getting from 2 to 3.5 WPM, until it finally clicked and I got to 7 WPM in a month. This year I intend to get the Morse for a full call. Conversely, I read the ARRL Handbook like a novel and got my limited call in a month. The ability to do some things has absolutely no bearing on one's ability to do other things.

The following are my additions to the CW or not CW debate, as the above stream of articles are just a few in a much larger debate. Essentially, I believe we have lost the plot.

As I understand it, way back when licensing began, an operator had to prove that he/she was proficient. This involved:

- The regulations relevant to the licence.
- The theory of building a station – there being no black box rigs available.
- Communicating – the only available mode being CW.

Thus, an operator proved that he/she could assemble a station and communicate with it, complying with relevant regulations.

Essentially, these still apply today.

Operators should show proficiency in:

- Regulations. This should not include the Q code as this is only intended for use by one mode. QTH and QSO are possible exceptions.

- The theory of building a station. This implies an amateur licence is a type of experimental licence.

- Communicating in one or more of the agreed standard modes for amateur communications.

I believe that most other arguments are really not part of the debate, especially whether:

- "The Code" is easy or hard.
- Historically, CW was a requirement.
- It is still in use as a mode of communication.

Most importantly, these days CW is not the prime mode and should not hold mystical significance. It is most useful in many instances, but these are not the realm of the majority of amateurs. The number of full calls who have not used CW in years is testimony of this.

I'm sure these comments will stir up another hornet's nest. However, let's be courteous and state plausible arguments, instead of denigrating each other. Above all, amateur radio should cross all boundaries by viewing us all as equal and worthwhile people.

**Greg Short VK6JCK**

**5 Glenn Place**

**Duncraig 6023**

[gshort@faroc.com.au](mailto:gshort@faroc.com.au)

### Computer QRM

Each year as Christmas approaches I get a little edgy. Why? Computers! Someone nearby always seems to buy a newer, faster, dirtier model for Christmas. As a very keen VHF/UHF operator engaged in weak-signal work, EMI from computers is anathema, and it seems that each year they get worse, in spite of impending EMC/EMI legislation.

A few days before last Christmas, I switched on my 2 m and 70 cm gear only to be greeted with broadband hash and birdies at strength nine across the bottom end of each band. The signal peaked North-East of me. I found the offending machine, over 100 metres away. It was a new acquisition, and I told the owners of the problem. Needless to say, they were helpless. I took the details of the computer and vendor, telephoned the latter and spoke to the "engineer".

I informed him of the problem, and asked

his intentions. The answer was short but not sweet – nothing! "We are not in a position to do anything about it" was the reply, which I took to mean they got the money, now beat it!

I next telephoned the Spectrum Management Agency (SMA), and asked if they were going to do some spectrum management but, predictably, the answer was no – they just collect money. In fact, despite all the brouhaha about EMC/EMI legislation, it appears that it does not take effect until 1 January 1999! I asked who will enforce it, and the reply was that the industry is expected to be largely self-regulating (flying pigs, anyone?).

Then, I thought, Market forces! If a vendor of quality, EMC-compliant products (not just computers) loses sales to a cowboy enterprise, they will surely be peeved! They might even take action. The consumer, too, has the right to be informed as to which products are susceptible to EMI, or might cause interference, as this may affect their buying decision. But who is going to do the informing? Why not the WIA?

I suggest that the WIA commence an on-going register of products which are either susceptible to EMI or are the cause of it. The register should include the type of product (TV, video recorder, computer, etc), its brand, the supplier, and whether the supplier is helpful. The register should be published regularly in *Amateur Radio*, and radio amateurs should circulate it widely. Perhaps the WIA EMC coordinator could start a campaign to inform the public, and advise them to purchase only products which comply with relevant standards.

I'll start the ball rolling with the first entry. The computer I referred to above is a Pentium 166 of unknown brand, sold by SOUTH PACIFIC COMPUTER SERVICES in Melbourne.

This is a grave matter indeed. Sooner or later, virtually every ham operator will experience an EMC problem, whether it be TVI or the loss of one or more bands through interference. The authorities are not going to help. We have to help ourselves. Think of the thousands of dollars of equipment in a ham shack which can be rendered useless in an instant by a rogue computer.

I urge the WIA to take this matter seriously. I would be pleased to offer my assistance if this is necessary.

**Chas Gnaccarini VK3BRZ**

**66 Smeaton Close**

**Lara VIC 3212**

### From the Coal Face

"Amateur radio is dying" I hear some of the fraternity bemoan. From a theory instructor's vantage point, I'm reluctantly inclined to agree.

Until about 1990, the excuses tried on me by prospective theory students were that Morse Code was out-of-date-stuff and that new technologies were taking its place etc, etc.

Way back in the late 1960s we gave in to these "complainers" and introduced a Novice Class licence with CW at 5 wpm and simple theory. That, we figured, would keep our numbers up and coming; and indeed it did, until the Internet appeared!

The computer began to kill off interest in ham radio, even though all our modern transceivers are dependent upon this new technology! But, at what cost?

Ask any youngster which he prefers - ham radio or the Internet? The most likely reply is an innocent, "What's ham radio?"

Surf the Net with no examinations or licence required; just enough of that folding stuff and the world is yours. No need to know what's in the box or how it really works, but only how to operate it!

It seems that we are encouraging a generation of operators rather than potential technicians; basic theories are now becoming the property of the minority. And it's not just the youngsters!

"Where's Joe Blow these days?" we ask a club member, to be informed that Joe doesn't come to the club much these days since he got himself a computer.

Visitors to most radio clubs are now being bombarded with computer jargon and

accessing information is the goal! Less and less discussion on circuitry, building of transmitters, etc. We are told that it is impractical to build much of the project when you can buy a "chip" instead. We ignore basics, so much of the technologies are being forgotten. In the commercial world, these and other technologies are being lost for financial and other curious reasons which can't be discussed here.

If we earnestly want to preserve Ham Radio, we must promote it!!

Here are some possible remedies? Hams are a conservative lot, it's said, and I believe it. So, let's be bold. I suggest dropping the Novice Class licence! Now, that will upset a few readers, but there's more! How about an AOCPL licence with 2 classes? No code for the lower level licence and full privileges on ALL bands excepting 20, 30 and 40 metres. Morse at 10 wpm for these "Blue-Chip" bands!

These are only ideas, but at least it's a start! We must encourage the use of our bands which are being eyed by the commercials AND increase our numbers.

I hear some say we should drop CW altogether. If that happens, many will be sad. I believe that CW is a worthwhile skill and a character builder, both needed by our present society.

Max Morris VK3GMM  
PO Box 222  
Rye VIC 3941



HF - VHF - UHF MOBILE ANTENNA  
HF - VHF - UHF BASE ANTENNA  
CB - MARINE - AIRCRAFT

**Monoband to Multiband  
Convert Now, to the all  
New!**  
**PERTH PLUS**  
HF Mobile antenna  
with 80-40-30-20-17-15-12-10-6-2m included

Also in Stock  
Coaxial Cables & fittings  
HF Spring Bases, Trunk and Gutter Mounts.

Outbacker OB8 "Classic"  
Outbacker "Junior plus"

Split Models  
Helical Dipoles  
Long wire Dipoles  
Baluns

**\* Free!**

With Every Perthplus Purchase.  
1 x AmSoft CD-ROM  
'94 Callsign Database

While current stocks last

Now available from .

MELBOURNE  
Daycom Communications  
Ph 03 6436444

ALICE SPRINGS.  
Farmer Electronics  
Ph 089522388

DARWIN.  
Integrated Technical Services.  
Ph 089-815411

SYDNEY.  
Andrews Communications  
Ph 02 6369060

PERTH.  
Tower Communications  
Ph 4701118

ADELAIDE  
Johnston Electronics  
Ph 08 2871061

PERTH - Model

<http://intercon.com.au/outbacker>

TERLIN AERIALS  
5 Yampi Way  
Willletton W.A. 6155  
Ph +61 (09) 3545444  
Fax +61 (09) 3545455



Send \$ 5.00 for a 15 minute informational video  
Refundable with every antenna purchase.

## Pounding Brass

Stephen P Smith VK2SPS\*

In previous columns we have looked at various methods to learn and become proficient in the use of Morse code. Some of the methods discussed were the use of audio cassettes and on-air transmissions run by the various volunteer groups.

Another method that is highly commended is the humble PC (Personal Computer). Most amateurs today have some form of PC, whether it's for packet transmission or downloading files from the Internet. An amateur radio operator can also learn Morse code and become quite proficient in its use by using the PC.

One of the advantages in using a PC is that you can set the speed of transmission from as low as one wpm up to 100 wpm (depending upon the program chosen) by the push of a button, whereas the use of cassettes can be quite costly when you consider you have to purchase a higher speed once the previous cassette has been learned. Also, you can use an air transmission and these are excellent to a point, as most transmissions are set to certain speeds depending upon the operator's

ability. Once learned the operator has two options to increase speed; get an operator to send at a higher speed or purchase a good Morse program and use a PC. The latter seems preferable.

In coming issues we will look at two programs which are excellent in quality and cost. "Instant Morse from the RSGB", and "The Mill" by J S Farriar which teaches both International and American Morse.

However, in this issue we will look at the "GGTE Morse Tutor - Advanced Edition". This comes with a 3.5" disc and a 16 page booklet which is well written and very easy to follow. System requirements are an IBM PC or compatible with approximately 235 kbytes of free memory.

Prior to installing the Morse Tutor Advanced Edition, you have to create a directory on your hard drive (they advise a directory named "MTA"). Once the directory is created it's a straight forward process to load the program by following the instructions.

Let's now look at the program and examine

some of the many features offered. When the program is first initiated, Morse Tutor is displayed in yellow on a blue screen as the standard default setting. To continue you hit any key which takes you to the "Selection Menu" where the following modules are displayed: Morse Tutor; Computer Generated Random QSOs; Direct Keyboard Creation of QSO; Text File input of QSO; Select Colours; Recalibrate; and Exit to DOS.

To initiate a chosen module you press the key corresponding to the first letter of the desired choice. For example, to select Morse Tutor, the first module, you type "M" and hit Enter; this initiates the program and displays the Parameter Settings which are broken down into four groups, being:

Tone frequency is set to..... 800 Hz  
Morse code word speed is set to..... 30  
Morse Code character speed is set to..... 30  
Character display while sending is set to..... on

To initiate a module you again press the key corresponding to the first letter as mentioned above.

Tone frequency sets the note of the transmitted CW signal to the speaker outputs. The Americans use 700 Hz for practice sessions, but in Australia 800–825 Hz seems to be the standard (although this varies with individuals).

If you select either Morse code word speed or Morse code character speed, two options are displayed: Standard Mode; and Farnsworth Mode. In standard mode the dit is assigned one time unit, the dah three time units, the space between elements is one time unit, the space between characters is three time units, and between words is seven time units. This uniform allocation results in equal word speed and character speed and is the international standard for Morse code.

In Farnsworth the dits and dahs are shorter and the intervals between characters, and between words, are longer than with the standard mode. You can argue both methods, but Farnsworth is the way to go for me. Just follow the screen instructions, whether you chose Standard or Farnsworth; if you are unsure, try one method for a while then the other.

The last module in this group is Character display. This displays the characters on the screen as the code is being transmitted, although you can inhibit the display and just listen to the sounds.

Once the parameters are set press Enter, and you will move to another screen Menu which shows lessons ranging from lesson O through to lesson 12:

LESSON O Timing tests (sends Paris for two minutes)

LESSON I A N S O

LESSON 2 E T I M  
LESSON 3–7 Remainder of the alphabet  
LESSON 8–9 Numbers 1 through to O  
LESSON 10 Period, Comma, Question Mark and Slant Bar.  
LESSON 11 AR SK BT and KN  
LESSON 12 Random QSOs.

Lets look at LESSON 1 as an example.

LESSON 1 Introduction: In this lesson you will be introduced to your first four letters, A, N, S and O. Each lesson is divided into several parts: New letters; Current characters sent randomly; and Words sent randomly.

New Letters: Each character will be displayed on the screen while it is sent five times in code working through letters A to O as above.

Current Characters Sent Randomly: Each character is sent in random order in groups of five until you stop the Morse transmission.

Words Sent Randomly: Words are sent with letters learned until you stop the Morse transmission by hitting any key.

All lessons follow this format. Once finished you are returned to the main menu again. Follow any on-screen instructions.

#### Computer Generated Random QSOs

Once selected from the selection menu this module will run for approximately 10 minutes (a shorter duration can be selected). When you press the Enter key, the QSO will start at the speed set previously and displayed on the screen. You can pause the program anytime by pressing any key or "X" to exit. If you decide to exit you will be faced with the options of seeing the remainder of the QSO or the QSO score board. The score board displays how many times a particular letter, number or punctuation mark was used during the transmission. Again follow any on-screen instructions.

#### Direct Keyboard Creation of QSO

This module is extremely useful for operators having difficulties learning certain characters or punctuation, or you can type in a complete QSO and have this transmitted back to you to get receiving practice. Once keyed in, follow the on-screen instructions. From the QSO option menu press "T" for "transmit" QSO and off it runs.

#### Text File Input of QSO

This module allows you to input a text file created with Morse Tutor, a word processor, or an editor, and saved as an unformatted ASCII text file.

#### Select Colours

This module allows you to change the default colours by selecting a range of colours, 16 in all, for both background and foreground.

#### Recalibrate

This is done when the disk is loaded on to the hard drive. For higher accuracy you can re-calibrate by following on screen instructions; this only takes a few minutes and alters the timing of Morse Tutor – Advanced Edition on your computer.

#### Exit to DOS

Self explanatory.

A lot of time and effort has gone into the design of this program. Whether you are a beginner or an advanced operator, I'm sure you will find it extremely helpful in your Morse studies.

Two versions are available, Morse Tutor and Morse Tutor – Advanced. Further enquires can be made to Daycom Communications Pty Ltd in Melbourne

Next month we will look at the RSGB Instant Morse program on CD-ROM.

*\*PO Box 361, Mona Vale NSW 2103*

ar

---

## Repeater Link

*Will McGhie VK6UU\**

---

### CAD Feedback

A couple of dozen requests for copies of the CAD drawing program, Draft Choice, has been encouraging. There is interest in computer drawing for amateur radio from those who contacted me. If you would like a copy of Draft Choice version 2, then please contact me and I will supply. Also included with the Shareware program I will add some sample circuit drawings.

### January Photo

I enjoyed the photo on the front cover of *Amateur Radio* for January showing the snow covered site of VK2RMS. I have always wanted to look after a repeater on a

hill covered in snow, but we just don't get snow in VK6 to any degree. The odd day in the Stirling Ranges some of the mountains get a light cover but nothing like Victoria and New South Wales. I wonder if the site owners could write up a detailed story on the repeater installation?

### Regulations

What happened to the deregulation of the amateur service, particularly repeater regulations? The more I see of the regulations applied to voice repeaters the more "why bother" I feel. It is just too hard. The fundamental point is missed. How can you have experimentation if the regulations limit experimentation. Until this point is

## AMSA Promoting Global Maritime Distress and Safety Systems

The Australian Maritime Safety Authority (AMSA) has begun promoting the use of Global Maritime Distress and Safety System technologies by recreational boaters. GMDSS, as it is known, is the "state of the art" maritime distress and safety communications system introduced in 1992 that has completely transformed maritime radio communications.

It employs modern radio communications technologies, such as satellite and digital communications, which provide prompt distress alerting and safety communications across vast ocean areas.

Designed to automate the initial radio distress alerting function, GMDSS also removes the requirement for ship and shore radio operators to personally maintain listening watches on distress frequencies.

The GMDSS will become compulsory for all ocean going merchant vessels of 300 tonnes and over from 1 February 1999 but, according to AMSA, the system is suitable for all classes of vessel.

"It is also suitable for small craft," says the Authority's Senior Marine Radio Surveyor, Glenn Dunstan, "hence our wanting to increase the use of the 8, 12 and 16 MHz radio-telephony distress channels by non-GDSS vessels, and educate the recreational boating community on the benefits of the system."

Mr Dunstan said the AMSA is particularly keen to encourage the use of Digital Selective Calling or DSC. "DSC is a paging system that issues data signals to automate the transmission of distress or safety alerts via MF, HF or VHF marine radio," he said. "The DSC message indicates the identity of the calling station and the purpose of the call and is used as a means of establishing *initial contact* between stations. There is a dedicated DSC distress and safety channel in the MF in each of the HF marine radio bands."

Two information leaflets have been produced as part of AMSA's promotional campaign, each dealing specifically with the issues identified above. Further information is available from Glen Dunstan, AMSA, 06 279 5871

understood by all, repeater development is tied to what the regulators think, in a narrow perspective. You can't have finely detailed regulations and expect creativity to flourish. We need broad clever regulations, not the immense detail we now have. It seems the solution to too many regulations is to add a few more to get around the regulations. That's my opinion for what it is worth.

### Latch

If your repeater uses some form of remote control, then it is almost certain that there will be a latch circuit somewhere in the control. A latch stores a command. When you send a DTMF command to a repeater, the signal you send is there only for as long as you transmit the signal. Without a latch, the command reverts back to its original state.

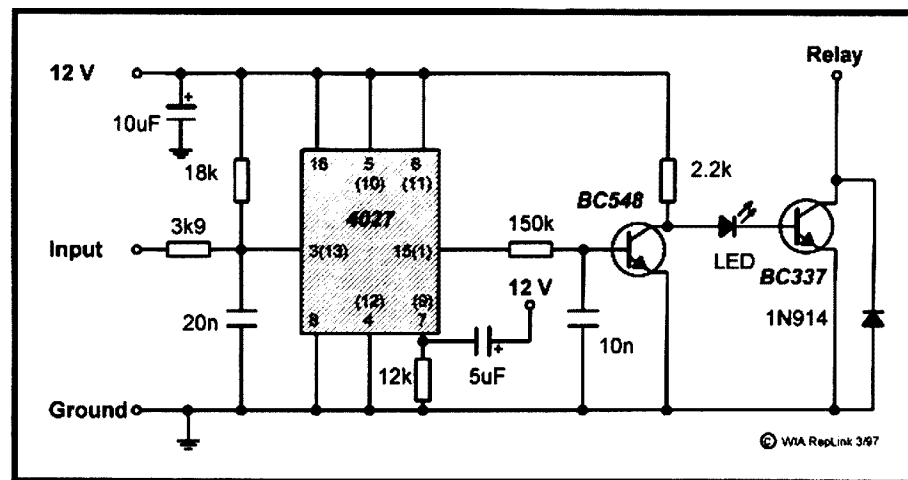
The latch is a divide-by-two circuit. The DTMF command goes from off to on to off to on. This is two cycles or pulses. However, the

reset the latch to off, making pin seven go high does just that.

Note the LED that feeds the BC337. On switch-on the LED should be off. If the input is then earthed for a short time, such as a DTMF command, the LED will light and stay on once the input goes high again: The collector of the BC337 goes to ground, and this can be used to turn on a relay, hence the inclusion of the diode. The BC337 will switch over half an amp if required.

I included the 3.9 k resistor and the 20 nF capacitor to prevent contact bounce. Most CMOS chips are very fast and any signals on their inputs that are not true on-off, but contain a "dirty" pulse, will toggle the chip more than once. You get what appears to be random toggling. It is really the chip toggling several times for each "dirty" pulse.

Also note the 150 k resistor and the 10 nF capacitor. I found that, when a relay was



**A latch circuit, using a 4027 IC, which is suitable for a repeater.**

latch has gone from off to on to off. This is one cycle. The latch holds the command once the command has been removed.

### 4027

There are many uses for latches in repeaters so I have produced this basic latch circuit using the 4027. This IC contains two latches in one 16 pin chip. I always have trouble converting the raw data as supplied in the IC handbooks to a working circuit. So many options, when all I want is a simple latch. The results of my efforts are to be found in the accompanying circuit. One most important requirement is that the latch defaults to the same state every time the power is turned off and on again. If you have a power failure at the repeater site, you want to be sure that, on restoration of power, the repeater's control circuit defaults to a known condition. This is done by the 5 µF capacitor holding pin seven high on switch-on for a short length of time. Also, if you require to

attached to the collector of the BC337, the circuit did not operate reliably. Remove the relay and it worked fine. I have no idea why the relay caused this. I tried a capacitor across the relay to reduce spikes, and greater filtering across the 12 volt feed. Nothing worked until I added the 150 k and the 10 n. These components fixed the problem.

The figures in brackets are the pin connections for the other toggle circuit contained on the 4027. This latch is part of a DTMF remote control circuit that I intend reproducing at a latter date. The circuit is not micro controlled and is easy to construct using standard ICs. Included in the circuit is a three digit number code to do a given function, and a modification of the latch shown here. Hope the circuit is of use.

\*21 Waterloo Crescent, Lesmurdie 6076

Packer: VK6UUU @ VK6BBR

E-mail: will@vale.faroc.com.au

ar

# Spotlight on SWLing

Robin L Harwood VK7RH\*

As you all know by now, the Mansfield Report on the future direction of the ABC strongly recommended that the external services, that is Radio Australia and TV Australia, be scrapped and the funds saved by the axing of these services be ploughed back into the domestic services. Naturally, a predictable outcry has arisen, particularly from the Asian-Pacific regions which heavily rely on news services from Radio Australia and also from the many thousands of loyal listeners scattered worldwide. Whilst this is to be expected, it is worth noting that there has not been much comment over the possible axing of TV Australia. I believe that the ABC have been trying to find a private buyer to take it over. Although some politicians seem to feel that the future of the external services is down the satellite television highway, I strongly disagree, as there are other competing products and servers with far more appeal than the fare dished out by TV Australia.

I personally think that it is extremely short-sighted to close down Radio Australia as it demonstrably has a huge impact in the Asia-Pacific regions and has been under-utilised for a number of years.

When a management decision was made to discontinue broadcasting to Africa, Europe and North America, Australia lost a valuable audience which relied on an independent voice to bring current news and information of Australia and the Pacific rim.

Another criticism I have of Radio Australia is that the choice of programming often is clearly inappropriate for the audience. Although news and current affairs dominate the output, often it is programming from Radio National that was used as a fill-in. Radio National's output is varied but I would have thought that programming should have more information for those overseas wanting to find out more about Australia rather than the views of some obscure left-wing academic in a university think-tank on a topic that has no relevance to Australia.

In my opinion, RA's programming has progressively gone downhill and lost that personal touch that it once enjoyed with personalities such as Keith Glover. The disappearance of the intimacy in broadcasting is apparent in the current ABC domestic structure also, with many familiar voices disappearing to be replaced with networked programming, often from Sydney.

Listening to shortwave these days is not as

pleasurable as when one could tune to hear the famous Eddie Startz from Hilversum every Sunday with the "Happy Station", or Earle Fisher from Radio Canada International, Keith Glover from Melbourne, or even the two Bobs From Berne with the Shortwave Merry-go-Round. Thank goodness we still have Jonathan Marks on Radio Netherlands and Rudi Hill on Radio New Zealand International on-air.

Also Kim Elliot's "Communications World" on the VOA is a must. Kim's effervescent humour certainly shines through, contributing to a very interesting program. Talking of voices that have disappeared off the bands, it was pointed out to me how popular Vasily Stroganov was on Radio Moscow with his pop music programming compared to reams of Marxist rhetoric. It certainly was a breath of fresh air and was a portent of what was to come with the disappearance of the USSR. Last heard, Vasily was running a commercial FM station in Moscow.

Radio Moscow has undergone a name change and has been considerably downsized, yet the programming is still rather rigid even though all of the Marxist stuff has gone. It was so easily heard 24 hours a day just ten years ago, but now it is darned difficult to find. Joe Adamov is still there but how he has changed since the fall of Communism. Ten years ago he was singing the praises of Lenin, now he doesn't have a kind word for the former regime.

For those who are interested in keeping up with the latest DXing news, an electronic based news service is up and running here in Australia. Known as the "Electronic DX

Press" it is the brainchild of Bob Padula, a well-known DXer in Melbourne. As the name suggests, it is for the speedy interchange of the latest DX happenings via the Internet. To continue receiving this, subscribers are required to forward news for inclusion, similar to other lists. Also hard copy of this service is available but for a subscription. For details and additional information, visit website <http://www.wp.com/edxp> or write to Bob Padula, 404 Mont Albert Road, Box Hill VIC 3127. This column will be including the "EDXP" as one of the news sources. Any information from here will have (EDXP) after it to indicate as its source.

A recent Australian development has been the WINRADIO, a communications radio that is designed to fit on a PC card and operate under a Windows platform. Frequency coverage is reportedly from 500 kHz to 1.3 GHz without any gaps. Although the focus seems to be VHF/UHF/SHF, it is claimed to also work on shortwave with the addition of an external antenna and preselector. The amount of birdies and other hash emanating from my Pentium to my existing receiving setup makes me curious to its performance so naturally I am interested to hear comments from those who have used the system. Incidentally, if you are interested in finding out further details you can visit their website at <http://www.winradio.net.au> or write to Rosetta Laboratories, 222 St Kilda Road, St Kilda VIC 3182.

That's all for this month. Don't forget you can contact me on the Internet at [robroy@tassie.net.au](mailto:robroy@tassie.net.au) or to the "snail mail" address at the end of this column.

\*5 Helen Street, Newstead TAS 7250  
VK7RH@VK7BBS LTN.TAS.AUS.OZ  
Internet e-mail: [robroy@tassie.net.au](mailto:robroy@tassie.net.au)

ar

<b>WIA MORSE PRACTICE TRANSMISSIONS</b>	
VK2BW1	Nightly at 2000 local on 3550 kHz
VK2RCW	Continuous on 3699 kHz and 144.950 MHz 5 wpm, 8 wpm, 12 wpm
VK3COD	Nightly (weekdays) at 1030 UTC on 28.340 MHz and 147.425 MHz
VK3RCW	Continuous on 145.650 MHz, 5 wpm, 10 wpm
VK4WIT	Monday at 0930 UTC on 3535 kHz
VK4WCH	Wednesday at 1000 UTC on 3535 kHz
VK4AV	Thursday at 0930 UTC on 3535 kHz
VK4WIS	Sunday at 0930 UTC on 3535 kHz
VK5AW1	Nightly at 2030 local on 3550 kHz
VK5VF	Continuous on 145.650 MHz, 5 wpm to 12 wpm
VK6RCW	Continuous on 147.375 MHz, 3 wpm to 12 wpm



---

---

# Technical Correspondence

All technical correspondence from members will be considered for publication, but should be less than 300 words.

---

---

## More About A Micropower Two Metre FM Transmitter

In last month's *Amateur Radio*, Rodney Champness VK3UG made several comments regarding the Micropower Two Metre FM Transmitter that appeared in November's magazine. I will respond to these in order.

1. The audio amplifier cannot work as there is no resistor in the collector lead of TR1; it draws current but TR2 won't.

Agreed. Reference to the prototype unit and the original circuit shows a 2.2 k resistor between the collector/base junction of the first and second transistors and the positive rail. This resistor was omitted from the published diagram. Readers should correct the circuit accordingly.

2. If the mic gain moving arm goes to the emitter of TR1, TR1 will self destruct. Altering the DC operating conditions of transistors (or valves) in this way easily gets the device out of the linear area of operation, particularly if a largish signal is being handled.

Agreed. Examining the prototype unit and the original circuit reveals that the wiper is connected not directly to earth (as shown in the published circuit), but through a 47  $\mu$ F tantalum or electrolytic capacitor. Readers should again amend the published circuit.

3. Getting the crystal on to frequency is a bit awesome requiring up to three adjustments; once again the DC operating conditions of the transistor TR3 are changed. With so many adjustments, many people wouldn't know which to tweak for what result.

Attempting to skim on the number of adjustable components has problems of its own. Building such a design may lead to excessive troubleshooting time if the constructor (eventually) finds that fixed component values need to be changed. Several designs were tried for this transmitter, some with fewer adjustable components than the circuit described. They didn't work as well, and took longer to adjust. I decided that a reliable, well-known circuit that did not use esoteric parts (like varicap diodes) was the best choice, even if it did require one or two extra adjustments.

4. Certainly Peter recommended using a bandpass filter, but how many of the builders of such a transmitter will build this filter?

One can do no more than recommend that they do. The article makes the need for this clear in the fifth paragraph.

5. I believe that Peter would have helped prospective builders by having an approximate layout of the board published using Drew Diamond's paddy board method.

Agreed. Previous experience with providing component layout diagrams has been that they are always the very first part of the submitted article to be left out when space is short. A change to this policy will only come about when there is evidence that the general membership would agree to some columns being curtailed to make room for longer technical articles. The extra time to redraft the extra diagrams (should this be needed) is another factor that would need to be taken into account.

Rodney's comments about the article being over-simplified are probably valid. Nothing less than a small book would be required to do the topic justice. However, for the reasons outlined above, it is unlikely that articles significantly more detailed than that submitted would be able to be published, given the need for the magazine to appeal to a diverse readership. An alternative could be for the WIA to publish its own technical handbook. However, apart from the successful WIA Book of the early 1980s, the idea, though discussed at various times, has never come to fruition. The Internet may be another solution.

In closing, I thank Rodney for his comments. The first two, which drew

attention to errors in the published circuit, have been particularly useful.

Peter Parker VK1PK

7/1 Garran Place, Garran, ACT, 2605  
parkerp@pcug.org.au

## Improvised Antenna

After reading the excellent treatise on hybrid antennas and radiation patterns in January *Amateur Radio*, I resolved to try a quarter-wave long-wire for 40 metres. I used 33 ft of light insulated hook-up wire going from the ATU across the top of the shack door, down a hallway, across a bedroom door, then supported by a lamp shade and tied with a piece of string (no insulator) to a venetian blind.

The house is timber and tile (uninsulated). The station consisted of a KW 107 Supermatch ATU, a Kenwood TS-520S transceiver, and a good earth.

Considering the configuration, in comparison to a well balanced 40 metre dipole at an average height of 30 feet, the results were quite pleasing, being only approximately two S points down on the Coral Coast Group all round; also worked VK5BK, ZL1UE and ZL4TV.

The quarter-wave length can be calculated easily and tried for other HF bands. It could be the answer to the small block. Possibly in the ceiling where applicable, or portable from caravans, motels, flats, etc. And it's cheap; the hook-up wire plus banana plugs, came to only \$4.00!

Les Daniels VK2AXZ

9 Highfield Terrace, Cardiff Heights NSW 2285

ar

---

---

## Silent Keys

*Due to space demands obituaries should be no longer than 200 words.*

---

---

The WIA regrets to announce the recent passing of:-

W K	SCOTT	L20870
J H	PANIZZA	L60341
F A H (Fred)	FREEMAN	VK3ALG
L H (Lionel)	DECKER	VK3EOH
R E (Rob)	GUNNOURIE	VK5FI

### Rob Gunnourie VK5FI

Rob died suddenly on 20 January at age 73. He spent his early life in Longreach Queensland where he became interested in radio while still at school in the 1930s.

He enlisted in the RAAF during the Second World War in 1941, spending many hours learning radio theory by moonlight whilst on guard duty. He served his country in

England as a wireless operator/air gunner for two years.

On his return from active service he settled in Victoria and was employed at the broadcast station 3NE at Wangaratta and then at 2TM at Tamworth. On the introduction of television he was involved in site surveying for the proposed BTQ7 television station in Brisbane. His involvement was as the technical officer in charge of radio frequency coverage measurements and related problems.

He moved to Woomera in 1964 to work at the NASA tracking station until he became an employee of the Dept of Supply, also at Woomera, involved in communications and missile tracking. He then transferred down to

Adelaide and joined the Jindalee Over-the-Horizon Radar team until his retirement.

Rob had a strong interest in caravanning which he pursued often whilst retired, making many trips throughout Australia. He had a deep interest in computing and amateur radio, holding the call-signs of VK2AQQ, VK4OG and VK5FI and was always an active member of the local radio club. He served on the committee of both the WIA and the North East Radio Club.

I am sure Rob will be missed by all his friends as he was a very obliging and friendly person. Deepest condolences to his wife June and family.

**Rick Grivell VK5GV**

### **Frederick Alexander Freeman VK3ALG**

Fred Freeman was one of the founding members of the Geelong Amateur Radio Club in 1948 and his interest continued for nearly 49 years. At the first meeting of the club, Fred was appointed Publicity officer and it was in this position that he became the voice of the GARC through his weekly notes in the *Geelong Advertiser*.

After our meetings he would call at the Advertiser office before going home by tram to Chilwell or, as Fred would insist after a move further south, to Marnock Vale and his world of wool spinning and weaving by the Barwon River.

Fred continued to support the club and amateur radio, becoming an active home constructor of radio transmitters and receivers using many of the bits of war surplus material that were about at the time. He was enthusiastic in transmitter hunting and the weekend picnics that usually followed. He was the eyes and ears of anyone who had a motor car with a spare seat either inside or out, as his own notes will tell.

Remembering Fred, I am reminded of Sir Reg Ansett who said persistence was the key to his success. But persistence was not Fred. "Consistence" is a more suitable word and it was well earned. Fred became our QSL manager, a job that involved many hours of sorting and distributing "post cards" to hams around the world and thousands would have received their card with the stamp on the back, "VK3ALG QSL SERVICE". And it is the word "service" that also fits well when we think of Fred.

So, in those words "consistent service" we can sum up Fred's years with ham radio and add to that the memory of his company at club meetings and the Wednesday afternoon "coffee club" at the GARC. He will be leaving a gap that will take time to fill.

In memory of Fred,  
**Dick Heighway VK3ABK**

ar

---

---

## **VHF/UHF – An Expanding World**

---

---

Eric Jamieson VK5LP\*

All times are UTC.

### **General news**

David VK3AUU sent me a letter some time ago which, for various reasons, was put aside. I have apologised to David and now bring you information regarding his receiving equipment and thoughts on Aircraft Enhancement of signals.

David lives at Drouin South, away from the city noise sources, which is a decided bonus. He says that: "The antenna consists of 4 x 19 element DL6WU Yagis stacked 4.05 metres high and 4.5 metres wide at a centre height of 10 metres. Measured gain is 21 dBd. The phasing harness goes to the antenna change-over relay and GaAsFET pre-amplifier. The feedline to the main receiver is about 40 metres resulting in a 10 dB increase in receiver noise when the pre-amp is connected.

"The rig uses a Yaesu FTV700 transverter to a FT757 transceiver. Audio output goes to an Autek QF1A active filter which has a bandwidth of about 1000 Hz. The signal strength is monitored on a Wandel & Goltermann SPM-6 receiver at the FT757 455 KHz IF with the AGC disabled. The SPM-6 has an effective noise bandwidth of 1.7 KHz and the meter has a full scale reading of 20 dB, but a 110 dB attenuator can be used to measure greater signal variations.

"S readings which are equal to signal plus noise, are given as follows with reference to the residual noise. S1 is 1 dB (ie signal is about 6 dB below noise level). S2 is 3 dB, equal to noise level. S3 is 7 dB, S4 is 12 dB, S5 is 18 dB. Signals generally don't become stronger. What is interesting to note is that with this receiver bandwidth, on sideband it is possible to recognise a familiar voice at 1 dB and easily copy a callsign and report at 2 dB. This is much better than I ever would have expected from previous literature.

"Stations worked recently include VKs 1DO, 1ZQR, 1ACA, 1VP, 1BG, 1BUC, 2ZAB, 2BIT, 2XKE, 2BBF, 2BWT, 2TWR, 2FLR and 2KYP.

### **50 MHz Band Plan**

**Your comments are needed – please refer to the FTAC Notes elsewhere in this issue and make your response as soon as practicable!**

"You don't need all this high gain gear to work aircraft enhancement if you are in the right place at the right time. I have worked VK3CY in Maryborough, Victoria, from the caravan park in Canberra using SSB and 80 watts to an omni-directional mobile antenna."

Mike Farrell VK2FLR reports: "By way of an update on the EME front, I was able to clear most of the sked requests out of Europe after the ARRL EME contest during December. Conditions were consistently good, with my own echoes detectable most of the time and often quite loud. As I have commented before, the slower Faraday rotation during periods of low solar activity can create conditions where I can be locked out of particular paths for a long time. It was nice to be locked in for a change.

"Between 7 and 31 December I have worked on sked DC7UT, F/G8MBI, 9HICD, EA2LU, G4YTL, DL2RSX and DL1HYZ, plus GM4JJJ on random. Both 9HICD and G4YTL are only two Yagi stations, and F/G8MBI runs only a single 6.6 wavelength Yagi with switchable polarisation. With the exceptions of EA2LU and DL1HYZ, all others are four Yagi stations running under one kilowatt. The contact with F/G8MBI gave him WAC on two metres EME with a single Yagi – a very creditable effort, and one which underscores the usefulness of switchable polarisation on 144 EME.

"Rod Graham VK2BQJ is now on 144 and 432 SSB. He is all-mode receive and FM transmit on 1296 to a small Yagi. A two metre dish is under construction. Rod also has a K1FO 22 el on 70 cm and a DL6WU 13 el on two, plus a dipole on six. A ring of 2C39s is under way for 23 cm. I think we can consider him well and truly back on again." [Good to have my old sparring partner back on the bands... VK5LP.]

David VK5KK reports an update of two metres and above contacts between Christmas and New Year.

"25/12: 144 MHz Es to VK2 and VK4. 0018 VK2BA, followed by VK4OE, VK4AFL, VK2FZ/4, VK4KZR and VK4KK. Last signals at 0115. Other VK5s heard working VK2/4 included VK5PO, VK5KCX and VK5NC.

"30/12 to 2/1/97: Band open to Albany/Esperance with VK6AS and VK6KZ/p on 144, poor signals on 432 MHz. Band has been open for two days out of seven since the beginning of November, but nothing special so far.

"1/1/97: 0705 worked VK5AKM on 10368.1 MHz (SSB) home station to VK5KK home station. Distance 31 km, signals 55 both ways with lots of trees in the way! VK5AKM's equipment: Qualcomm Transverter running 200 mW into a 600 mm dish, rotatable at 14 m. VK5KK using DB6NT, one watt into a 600 mm dish about 6 m up. Now five VK5s on narrow-band 10 GHz!"

Ron VK3AFW reports: "On 3/1 Max VK3TMP worked Bill VK6AS and Wally VK6KZ, on two metres after 11.20 pm (1220 UTC). VK3ACX and VK3ZQB also worked Bill. Andrew VK3KAQ/p heard working Wally on 432.

"My log shows the following: 5/1: 2111 144 VK7XR and 2153 VK2ZAB. 6/1: 0505 144 Rob VK3DEM worked Bob ZL3TY at Greymouth on the west coast. Bob was 5x2/3, Rob received 5x9+20. Rob now has had more two metre Es openings to ZL than VK4 this season! 1900-2000, two metre meteor scatter, exchanged reports with VK2FZ/4, but no contest number exchange completed - my last two digits not copied."

An e-mail from Steve VK2KFJ reports: "Our club, the Manly Warringah Radio Society, have a six metre voice repeater, VK2RMB on 53.675 o/p and 52.675 i/p which has been operating for three years now, but was off-air over summer due to a faulty antenna. It is now operational using two J-poles, vertically polarised, no cavities and 25 watts output. Also, the analog interface is being finalised and this will allow access to the six metre repeater from both our two metre and 70 cm repeaters.

"The club is also planning a ten metre FM simplex gateway to be connected with our existing three repeaters, to make things interesting. This will help to put some activity on to the FM portion of six metres and hopefully attract more DX opportunities. As for a six metre gateway, we would probably run a six metre FM simplex gateway, from a private residence and then cross-band feed it into the club's 70 cm repeater; this is really only speculation and depends what answer FTAC give me.

"I haven't been on six metre SSB for years, but like to keep up on what's happening. My radio activity is confined to mobile use (2 m/70 cm FM) nowadays, hence my interest in trying six metres and ten metres FM into our club repeater, the same goes for many of our club members.

"VK2RWI 53.850 is still listed as operational but is not. It made a brief operational stint for a month a few years ago, but never returned due to technical and political problems, a shame!

"Despite reports to the contrary, the

Newcastle repeater VK2RSN on 53.625/52.625 is operational and working well when I recently checked it. It has a very distinctive tail made up of a short sequence of musical tones. The repeater operates from Mt Sugarloaf, along with three other two metre and one 70 cm repeater, but none of these are interlinked."

## New Zealand

Cliff ZL1MQ sent a comprehensive listing of 50 MHz contacts between ZL and VK, comprising 4 to VK1, 29 VK2, 28 VK3, 36 VK4, 14 VK5, 1 VK6, 2 VK7, and 2 FK8. These were contacts made between 10/12 and 4/1. There were many others.

There were 55 two metre contacts in the same period. The majority were made between 0200 and 0600, but some were later, others around 2300 to 0000. In the following list multiple contacts with the same station on the same day have been omitted.

10/12: VK2FZ/4 and VK2BRG to ZL3NE; 12/12: VK2FZ/4 to ZL1AKJ, ZL3NE and ZL1TWR, VK4KK to ZL3NE; 24/12: VK2BBF to ZL3NE, VK2ZAB to ZL1TWR; 26/12: VK2BHE to ZL3NE, VK2BRG to ZL3NE and ZL1TWR, VK2DVZ to ZL3NE, VK2MZ to ZL1TWR, VK2TVZ to ZL1TWR, VK2ZC to ZL1TWR.

03/01: VK2BBF to ZL3TIC, VK2DVZ to ZL3AIC, ZL3AR, ZL3TCU, ZL3TIB, ZL3TIC and ZL3TJZ, VK2ZAB to ZL3TIB, ZL3ADT, ZL3AR, ZL3NW, ZL3TCU, ZL3TIC and ZL3TJZ, VK3BWT to ZL1TWR.

04/01: VK2BBF to ZL3NE, VK2BVZ to ZL3NE and ZL1TWR, VK2DXE to ZL3NE and ZL1TWR, VK2KBT to ZL1TWR, VK2XBE to ZL3NE, VK2XKE to ZL3NE and ZL1TWR, VK2YUS to ZL3NE and ZL1TWR, VK2ZAB to ZL3NE and ZL1TWR, VK4ABT/2 to ZL3NE, VK4ABW/2 to ZL1TWR.

## Overseas

Emil Pocock W3EP in QST's The World Above 50 MHz reports: "The usual fare of December propagation included a productive Geminids meteor shower and at least 16 days with sporadic E somewhere across the country, with the MUF above 88 MHz on 15/12. VE7SKA (CN88) and VE6MK (DO33) reported an aurora session on December 10 after 0200, but only Canadian stations seemed to be in on this one. The geomagnetic disturbance may have triggered an unusual 6-metre transequatorial session the following afternoon, which allowed several Arizona stations to work Brazil.

"John Butrovich, W5UWB (EL17), reported a great mid-winter tropo opening on December 28 after 0000. From the Texas gulf

coast, John worked northward on 144 MHz as far as KB9IEC (EM69), for his best DX of the evening of about 1600 km."

Ted Collins G4UPS reports maintaining his daily contacts with G3CCH and SM7AED or SM7FJE. He regrets no others have attempted similar experiments, particularly when there are so many countries and paths in Europe which could be exploited.

Ted's additional December overseas contacts were limited to OI3MF, OZ2LD, IK0FTA, and beacons GB3BUX, GB3LER, GB3MCB, GB3NHQ, GB3RMK, HV3SJ and OZ6VHF.

Steve VK3OT advises that on 16/1/97 at 0405 he worked Kazu JA3JTG at 539, a TEP contact not normally expected at this time of the year. However, he had earlier told me (VK5LP) that he expected to do so on that day!

What is interesting is that previously he also worked JA3JTG on 16/1/96 at 0535 which was one year, one day and one and a half hours prior to this contact. Subtracting one day for 1996 being a leap year and we see the contacts exactly one year apart!

By e-mail, Hatsuo JA1VOK sent a congratulatory message to Steve regarding the above contact, acknowledging that at this



**AMATEUR  
TRANSCEIVER  
RADIO CENTRE**

ALL YOUR AMATEUR TRANSCEIVER REQUIREMENTS.  
LEADING SUPPLY OF HF/VHF/UHF BASE - MOBILE - H/HELDS AT COMPETITIVE PRICES

**ALINCO** COMPLETE LEADING RANGE OF ALINCO TRANSCEIVERS & ACCESSORIES - AUTHORISED DEALER



AUTHORISED DEALER



AUTHORISED DEALER



No. 1 AMATEUR QUALITY ANTENNAS  
AUTHORISED DEALER

**CALL FOR YOUR LATEST FREQUENCY FAVOURITE  
EXPAND YOUR COLLECTION**

PHONE/FAX  
(02) 9896 2545

141 GILBA ROAD,  
GIRRAWEE, NSW 2145

part of the solar cycle such contacts generally are rare.

## New records

**John VK3KWA** advises that he has processed the following new record claims.

3.4 GHz: VK3XPD/3 to VK5KK/3 06/11/96 248.1 km. New VK3 record. (VK3XPD: Mt Dandenong, DB6NT transverter, 4 W to 600 mm dish. VK5KK: Mt William, KK7B transverter, 4 W to 600 mm dish.)

3.4 GHz: VK3XPD/3 to VK5NC/5 18/01/97 501.5 km. New VK3 state record. (VK3XPD: DB6NT transverter, 5 W GaSFet PA, 600 mm dish, FT290 IF. VK5NC: DB6NT transverter, 5 W GaSFet PA, 600 mm dish, IC202 IF.)

5.7 GHz: VK6ZAY/6 to VK6ZWZ/6 20/10/96 236.0 km. New VK6 record, and also national record from 20/10/96 to 06/11/96. (VK6ZAY: Falcon, IC202, homebrew transverter, 23" dish with horn feed. VK6ZWZ: Cervantes, 600 mW to 23" dish, penny feed.)

5.7 GHz: VK3XPD/3 to VK5KK/3 06/11/96 248.1 km. New VK3 record, and current national record. (VK3XPD: Mt Dandenong, DB6NT transverter, 2 W to 600 mm dish. VK5KK: Mt William, IC202, DB6NT, 8 W to 600 mm dish.)

5.7 GHz: VK3XPD/3 to VK5NC/5 18/01/97 501.5 km. New VK3, VK5 and new national record. (VK3XPD: DB6NT transverter, 3 W IMFET PA, 600 mm dish. VK5NC: DB6NT transverter, 5 W IMFET PA, 600 mm dish.)

5.7 GHz: VK5NC/5 to VK5KK/3 06/11/96 187.7 km. New VK5 state record.

24 GHz: VK2AXA/2 to VK3XPD/3 26/10/96 8.6 km. First VK2 state record for this band. (VK2AXA: Eastern Hill Lookout, Albury, WBFM, Gunnplexer. VK3XPD: Hume Weir Caravan Park, WBFM, 40 mW Gunn, 400 mm dish.)

24 GHz: VK3XPD/3 to VK5KK/3 08/11/96 71.0 km. New VK3 state record. (VK3XPD: Mt Bolangum. Equipment as above. VK5KK: Mt William. Equipment same as VK3XPD.)

**Glenn VK4ZTL** by fax reports that he had been quite active since the Ross Hull Contest began, but often runs out of people to work!

21/12: VK3DUQ and VK7XR; 22/12: VK7GUN; 23/12: ZL3NW and ZL4LV; 24/12: VK2EU and VK7GK; 25/12: Good two metre opening between 2358 and 0032, VK5NC, VK3AFW, VK3XPD, VK3DUQ, VK3CAT, VK3CY, VK3UM, VK3CMN and VK3AMZ, all 5x9 each way. On six metres VK3OT.

29/12: 0500-0600 VK2ZZY, VK2BHO, VK3HY, VK3AZY, VK3YDE, VK3CNX, VK3BDL and VK3KMN.

2/1: 0231-0636 on six metres: VK1MJ; VK2s ZVF, DN, ZAB, GJC, AKF, APG, BZE; VK3s AZY, ZCW, OW, YDE, TMP, KAY, AKL, BWT, ATN/p, AKK, MC, WRE, CEB, TNW, DUQ; VK4WDM (Townsville); VK5s AKK, NA, AYD, PO, ZTY; VK7LZ. Glenn commented this was a good day considering it was a quiet afternoon!

4/1: VK7XR on two metres. Also worked Gordon VK2ZAB on two metres aircraft enhancement after many attempts. Distance 934 km. Glenn worked Gordon again on 8/1 at 2051 and again on 15/1 at 2050. All signals 5x1 each way. Note closeness of time.

12/1: Worked Doug VK4OE/p at Stanthorpe during Field Day Contest on 1296 MHz for best ever distance of 391 km, using a Downeast Microwave Transverter Kit with 15 watts to a 45 element loop Yagi.

## Beacons

**Geoff GJ4ICD** said by e-mail that: *"The YB0ZZ beacon prepared by Rex VK8RH, was installed on 50.042 at Jakarta repeater site in O133 with a ground-plane 20 m during December, according to YC0UVO. The beacon keeper is Budi YB0HD and he can be called on 50.110."*

*"The 5W1WS beacon prepared by ZL2TPY is expected to be installed on 50.050 in AH46 with 10 W and 5 el by Phil 5W1AU late January. Kerry hand-passed the beacon set to Phil last month....de JA1VOK"*

*"16/1/97: For information, the Darwin six metre group have developed a five watt beacon/keyer combo designed for remote and solar applications. We hope to deploy this to P29 and several others around the top of Australia. There is also a 50 watt PA option for the unit....Rex VK8RH."*

*"14/1/97: The VK3SIX beacon is restored and running 15 watts and beaming north. Frequency is back to WIA FTAC assigned 50.053....de VK3OT"*

## Internet Six News

Courtesy **Geoff GJ4ICD** and *Internet Six News*. 1/1: 1030 VK6HK 41 Perth working VK3AMZ, 1031 VK6KAT 41 Perth, 1035 VK6KRC 55 Perth OF78 2750 km. At last! A long awaited VK6 opening. Only open for 15 minutes. ... de Adam VK3ALM.

5/1: 0223 ZL3TIC to VK6BE, VK6APZ 50.120, VK6RPH/b also in at 0142.

6/1: Long opening to ZL – 0800 ZL2MQ 58 RF80, 0804 ZL2IA 58 RF80, 0809 ZL2TPY 59+ RF70, 1054 VK5ZBK 59 backscatter from east, 1530 ZL3SIX/b 529. **Steve VK3OT** reports that the ZL path was open from 0700 at least until 1200 station close. It was still open at 1930 with 45.250 NZTV Wellington. The MUF rose to 67 MHz last evening and two metre contacts occurred again. Stations in VK and ZL have been

reporting up to five hours of sustained propagation on 144 MHz between VK7 and VK4, and two hours between ZL and VK3/VK7. The VK6APZ to ZL3TIC QSO between PF06 and RE66 lasted for several minutes and was calculated at 4850 km.

7/1: 1130 ZL4TBN calling CQ VK6, Perth – Melbourne opening on two metres at this time, 1145 ZL3SIX/b 519, ZL Ch 1 45.240/250/260 video, ZL Ch 2 55.250 video, 1214 ZL4TBN, 1219 ZL3AAU. ... de VK3ALM.

12/1: **Steve VK3OT** reported: 0005 worked ZL3TY 53 both ways. 0100 50.130 VK6KDX, VK6ACY into VK1, 0214 50.306 VK6RBU/b Bunbury, 50.110 VK6RO VK6AO, plus VK1, VK2, VK3 and VK5 into Perth, 50.130 VK1RX back. 50.220 VK6ACY 25 W to 4x7 el Yagis FB signal, 0230 50.175 VK6HK, 0250 50.066 VK6RPH/b Perth 559, 50.306 VK6RBU/b Bunbury 319, 50.110 VK6KRC CQ call 55, 50.306/b VK6RBU up to 559, 50.066 VK6RPH/b down to 339. Best VK6 opening for this year.

13/1: Massive Es in USA! The USA saw nearly eight hours of Es yesterday, contacts were made with Mexico and most of the USA.

15/1: VK3OT TEP/Es Report: 0300 49.750 warbly Vladivostok – significant in JA path, 0316 50.009 JA2IGY/b into VK3 from PM84jk, 0349 50.111 JA3JTG CQ call on CW, 0353 JA5CMO CQ, 0405 50.110 JA3JTG Kazu in PM75pc worked 539/559, 0418 50.111 JF2HEV called but could not make two way.

20/1: A major Es opening in Europe to OK, OE, DL, GM, SM, LA, HB9, HB0, SP, OZ, I, F, EA, CT, etc. 18 countries were logged. In the morning there were three hours of Es and later in the day another four hours. The MUF went over 90 MHz!

24/1: ZL news de ZL3TY: 2221 FK8FU, 2255 ZL3NW backscatter, 2308 VK4TZL, 2325 VK4SIX, 2345 VK2QE. 25/1: 0314 VK2YO, 0455 VK6APZ, 0545 VK1RX, 0551 VK5PW, 0554 VK5RO, 0604 VK7GUN, 0615 VK3DEM, 0630 VK7XR, 0802 VK4KK, 0902 VK7DC, 0955 VK2BHO.

**Mike ZL3TIC** reports: *"25/1: The band was open all day, lots of backscatter, heard ZL3TY, ZL4LV, ZL4TBN and ZL4TPY. The day opening peaked about 2 pm local, also at noon American Samoa TV (55.2495, 59.7495 NTSC was 5/9+), but where are the 5W1s, 3D2s, etc. The second peak was about 7 pm when we had VK1, 2, 3, 4, 5 and VK6APZ in also. Two metres opened with pagers up to 59+ but did not work anyone, the broadcast band was wide open to VK7 region."*

"25/1: from Dave ZLATBN: 0400 VK2FZ/p4, 0512 VK3DEM 59+, 0515 VK3DUT 59+, 0856 VK7DC 53-4. 25/1 from Frank Z2AGI: 0519 VK4JH 50.135, 23/1: 0937 VK5BC 50.110 CW, 15/1: 2319 VK2DN 50.105 CW, 15/1: 0950 VK5BC 50.110 CW"

**Richard VK2ARS** sent information regarding the activities of the VK2 VHF/UHF Group. I cannot include that information this month, but will do so in due course. He also included the following as contacts made on the bands two metres and above for the month from 22/12. All contacts are on 144 MHz unless otherwise noted.

22/12: 0200 VK2ZAB ZL1IU 57 57, 0542 VK2ZAB ZL1IU 53 52.

24/12: 0115 VK2BBF ZL1IU 55, 0413 VK2BBF ZL1IU 55, 0414 VK2ZAB ZL1IU 57 59, 0443 VK2BBF ZL3NE 56, 0444 VK2BBF ZL1TWR 57, 0447 VK2ZAB ZL1TWR 57 57, 0448 VK2ZAB ZL3NE 57 59.

26/12: 0115 VK2ZAB ZL1IU 57 59.

27/12: 0239 VK2ZAB ZL2TPY 56 58, 0420 (23 cm) VK2FLR VK2ZAC 53 53, 1855 VK2FLR VK2ADY 55 59 Cessnock, 1915 VK2FLR VK1DO 55 55, 1920 VK2FLR VK2ZRE 55 55 Adaminaby, 19:42 VK2FLR VK3AFW 51 529 Melbourne (CW), 19:47 VK2FLR VK2TWR 53 53, 2000 VK2FLR VK1BG 57 59.

28/12: 0445 VK2FLR VK2DVZ 52 51 Taree (back of beam), 1919 VK2FLR VK1BG 54 56, 1940 VK2FLR VK2ZRE 52 53, 2025 (23 cm) VK2FLR VK2ZAB 57 53.

29/12: 1907 144.088 (EME) VK2FLR G4YTL O O 2 Yagis, 1938 144.067 VK2FLR DL2RSX O O 8 x 5 el Yagis, 2007 144.088 VK2FLR DL1HYZ O O 8 Yagis, 2020 VK2FLR VK1BUC/2 53 55 Batemans Bay, 2030 VK2FLR VK2AAS/2 55 57, 2152 (23 cm) VK2FLR VK2ZAB 57 56.

30/12: 2050 144.054 VK2FLR 9H1CD O O 2 Yagis, 2138 144.054 VK2FLR GM4JJJ O O 4 Yagis.

1/1: 1900 (23 cm) VK2FLR VK2ZAB 58 58.

3/1: 0157 VK2ZAB ZL3AR 53 57 Es, 0200 VK2ZAB ZL3TIC 56 58 Es, 0208 VK2ZAB ZL3TIB 54 5? Es, 0219 VK2ZAB ZL3AIC 52 55 Es, 0225 VK2BBF ZL3TJV 51, 0235 VK2ZAB ZL3NW 51 53 Es, 0237 VK2ZAB ZL3TCU 53 52 Es, 0242 VK2ZAB ZL3TJZ 52 54 Es, 0245 VK2ZAB ZL3TLG 55 56 Es, 0248 VK2ZAB ZL3TJV 53 51 Es, 0336 VK2BBF ZL3ADT 51, 0340 VK2ZAB ZL3ADT 53 54 Es, 0406 VK2BBF ZL3AIC 51, 0408 VK2BBF ZL3TIC 41, 2053 VK2ZAB VK4TZL 31 41 Tropo-scatter, 2155 (23 cm) VK2FLR VK2ZRU 59 59, 2130 (70 cm) VK2FLR VK2BQJ 57.

4/1: 0412 VK2ZAB ZL1IU 53 53 Es, 0413 VK2BBF ZL1TWR 57, 0413 VK2ZAB ZL1TWR 54 57 Es, 0421 VK2ZAB ZL3NE 57 59 Es, 0426 VK2BBF ZL3NE 55, 0652 VK2BBF VK7XR 59, 1910 VK2FLR VK2FZ/4 41 51 80 km N of Brisbane, 1945 VK2FLR VK3AMH 53 55 Nagambie, 1610 VK2FLR VK3BWT 53 56, 2032 VK2ZAB VK4TZL 54 54 tropo inversion.

5/1: 1845 VK2FLR VK2FZ/4 53 52, 2155 VK2ZAB VK3AFW 51 52 aircraft reflection.

6/1: 0021 (70 cm) VK2ZAB VK3TMP 51 51 aircraft reflection.

7/1: 2050 VK2ZAB VK4TZL 51 51 aircraft reflection.

11/1: 0057 (23 cm) VK2ZAB VK2EMA 51 51 aircraft assisted/tropo, 1450 VK2FLR VK1ACA/p1 57 59 Mt Ginini, 1450 (70 cm) VK2FLR VK1ACA/p2 53 529.

12/1: 0017 144.07 VK2FLR VE3AX O O 4 Yagis, 0141 VK2BBF VK5PO 59, 0142 VK2BBF VK5RO 59, 0144 VK2BBF VK5AKK 59, 0148 VK2BBF VK5ZLX 55, 2335 VK2FLR VK5PO 59 59 Es, 2338 VK2FLR VK5ABI/p5 53 59 Es, 2343 VK2FLR VK5RO 59 59 Es, 2345 VK2FLR VK5AKK 57 59 Es, 2347 VK2FLR VK5ZLX 57 55 Es, 2335 VK2FLR VK2EU/p2 42 44 Captain Flat QF44.

19/1: 2115 (70 cm) VK2ZAB VK4AFL 51 51 tropo inversion.

20/1: 2248 VK2ZAB ZL2TAL 53 55 tropo ducting, 2305 VK2ZAB ZL2VAL 53 55 tropo ducting, 2316 VK2ZAB ZL1SL 54 56 tropo ducting, 2338 VK2ZAB ZL1RS 58 59 tropo ducting.

#### **Closure**

There has been a great deal of information received again this month, which is appreciated. However, similar information is sometimes received from more than one source, so I need to be

alert to prevent doubling of news.

March and April cover the equinox, so be aware that TEP may be more common during those two months.

Closing with two thoughts for the month:  
1. A generation ago most men who finished a day's work needed rest; now they need exercise, and

2. The kindness planned for tomorrow doesn't count today.

*73 from The Voice by the Lake.*

\*PO Box 169, Meningie SA 5264

Fax: 08 8575 1043

Packet: VK5LP@VK5WI.#ADL.#SA:AUS.OC

E-mail: vk5lp@ozemail.com.au

ar

## **Dx Stop Press**

**New IOTA Island - St Peter Island**

A group of four South Australian amateurs, under the leadership of Mal VK6LC, will activate this new island from 28 - 31 March 1997 on the usual IOTA frequencies. The callsign will be VK5ISL.

**Steve Pall VK2PS**

**THIS SPACE  
COULD BE EARNING  
YOU MONEY!**

**ADVERTISING  
RATES AVAILABLE  
FROM**

**UNION  
PUBLICITY  
SERVICE  
PTY LTD**

**PO BOX 282,  
TOONGABBIE NSW  
2146**

**TELEPHONE:  
1800 654 181**

### **ELECTRONIC SURPLUS STORE FOR SALE**

\*Used Signal Generators \* Frequency Counters  
\* Multimeters \* Oscilloscopes  
\* Rectifier Testers \* C.B. Radios  
\* Plus Lots More

#### **ALL AT CHEAP PRICES**

26 CARDIGAN STREET, CARLTON VIC. 3053  
PHONE: (03) 9663 6607 FAX: (03) 9663 5468

**Adelaide-Capetown 226**

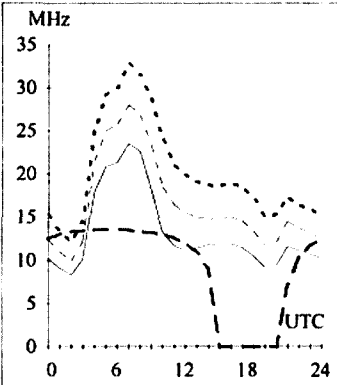
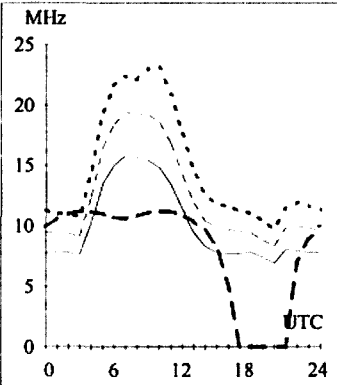
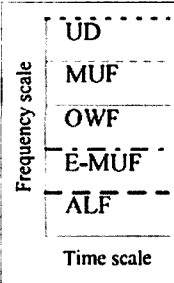
Second 4F5-9 4E0 Short 10154 km

**Brisbane-Cairo 288**

First F 0-5 Short 14391 km

# HF Predictions

Evan Jarman VK3ANI

**T Index: 13**

These graphs show the predicted diurnal variation in key frequencies for the nominated circuits. They also indicate a possibility of communication (percentage).

The frequencies identified in the legend are:-  
Upper Decile (10%)

Maximum Useable Frequency (50%)

E layer Maximum Useable Frequency

Optimum Working Frequency (90%)

Absorption Limiting Frequency

These predictions were made with the Ionospheric Prediction Service Stand Alone Prediction System (ASAPS V3.2. The T index used is shown above the legend. The Australian terminal azimuth, path and propagation mode are also given for each circuit. ar

**Adelaide-Honolulu 57**

Second 4F6-11 4E0 Short 9160 km

**Brisbane-London 147**

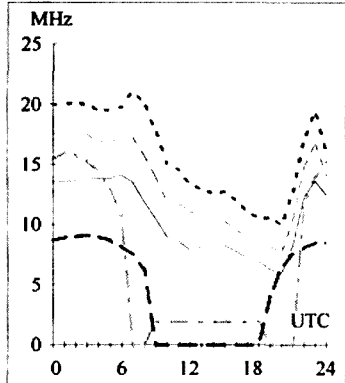
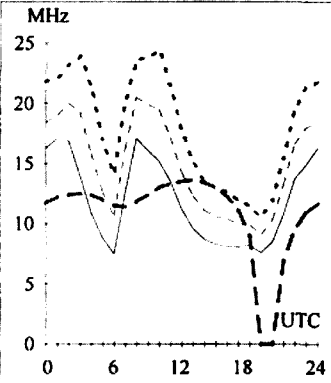
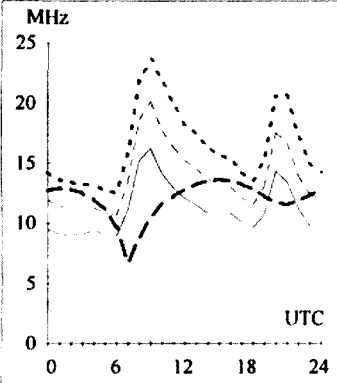
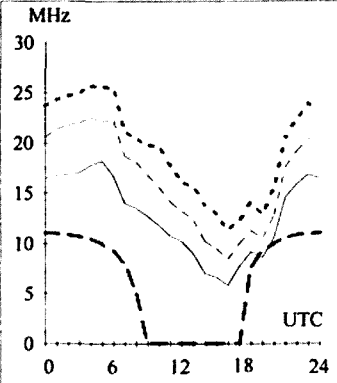
First F 0-5 Long 23498 km

**Canberra-Dakar 214**

First F 0-5 Short 17361 km

**Darwin-Auckland 130**

Second 3F12-15 3E2 Short 5135 km

**Adelaide-Singapore 138**

Second 3F11-15 3E1 Short 5414 km

**Brisbane-London 327**

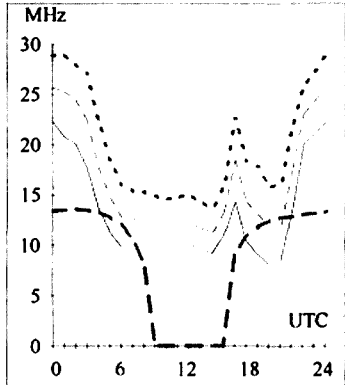
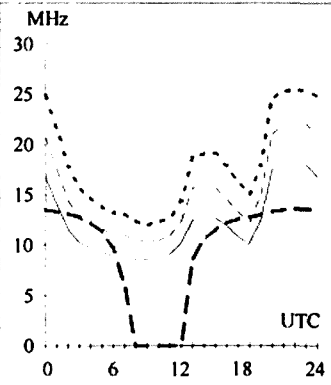
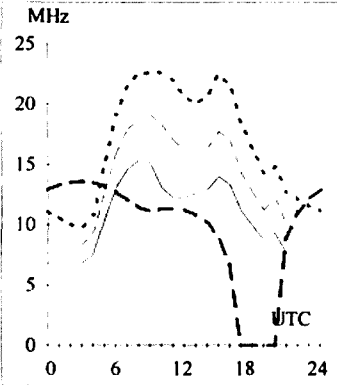
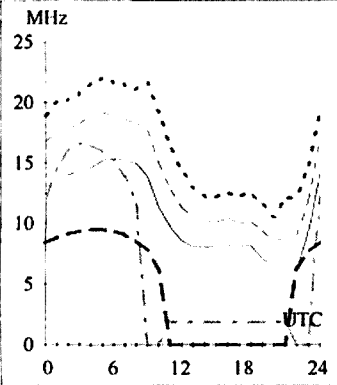
First F 0-5 Short 16526 km

**Canberra-New York 68**

First F 0-5 Short 16218 km

**Darwin-Los Angeles 58**

First F 0-5 Short 12693 km

**Adelaide-Tokyo 1**

Second 3F4-8 3E0 Short 7855 km

**Brisbane-Seattle 44**

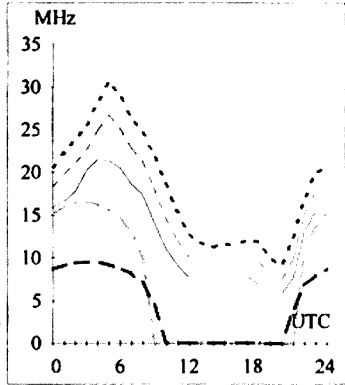
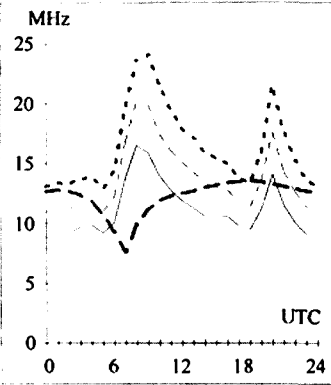
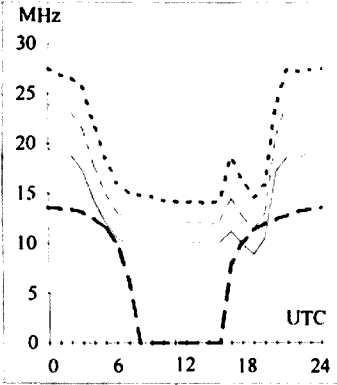
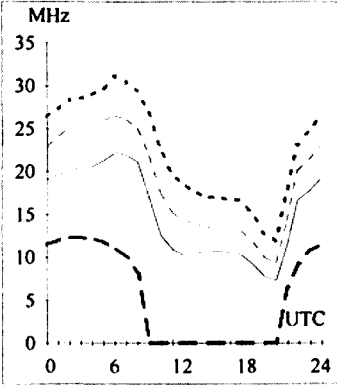
Second 4F2-5 4E0 Short 11845 km

**Canberra-Rome 115**

First F 0-5 Long 23807 km

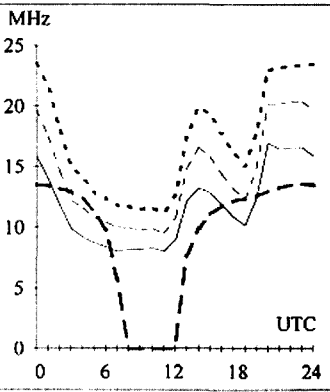
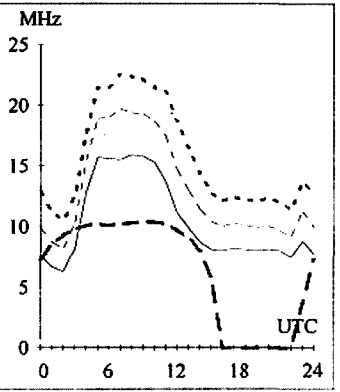
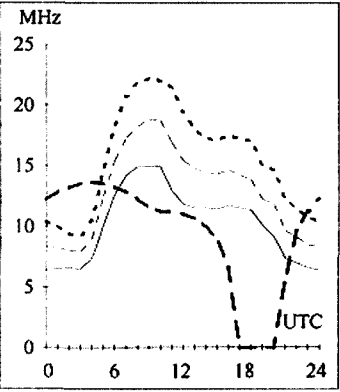
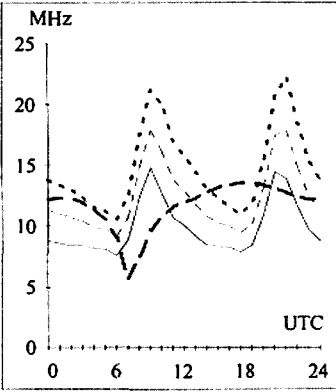
**Darwin-Tokyo 10**

Second 3F10-16 3E1 Short 5437 km



**Hobart-London** 123 **Melbourne-Glasgow** 321 **Perth-Harare** 257 **Sydney-Ottawa** 58

First F 0-5 Long 22619 km First F 0-5 Short 16973 km Second 4F8-11 4E0 Short 8496 km First F 0-5 Short 15864 km

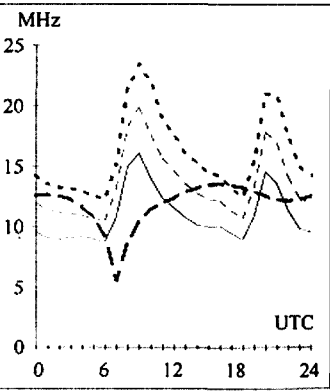
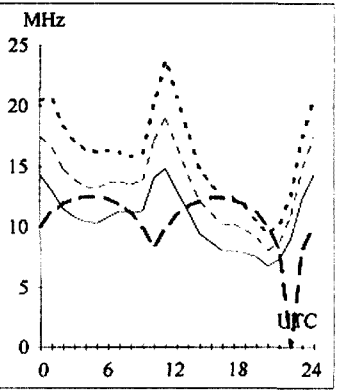
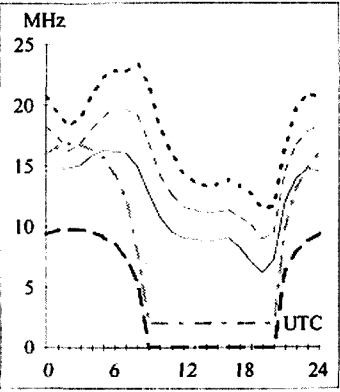
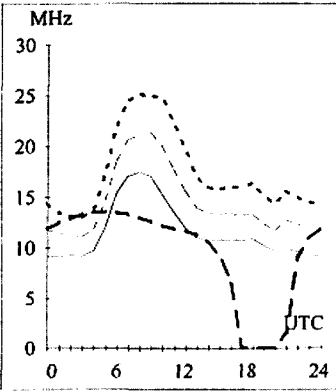


**Hobart-London** 303 **Melbourne-Guam** 0

Second 3F10-15 3E1 Short 5703 km

**Perth-Montevideo** 187 **Sydney-Paris** 132

First F 0-5 Short 17404 km First F 0-5 Long 23067 km

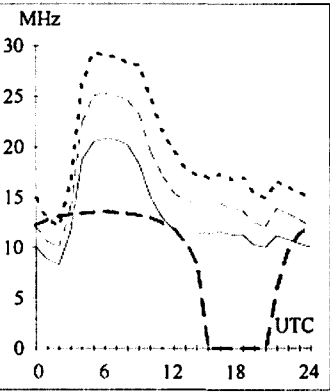
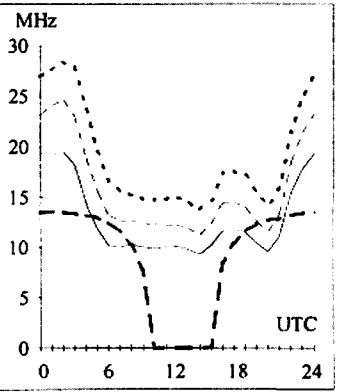
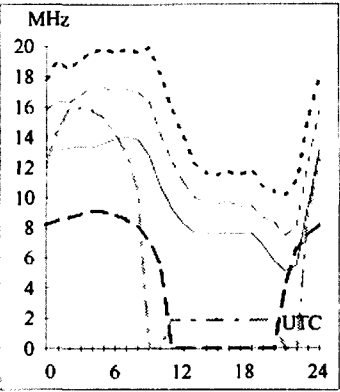
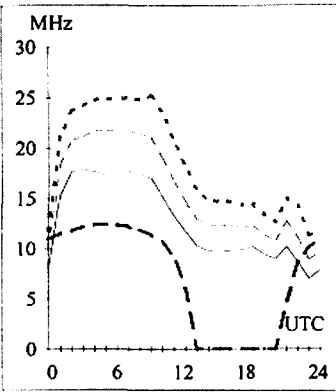


**Hobart-New Delhi** 304 **Melbourne-Jakarta** 303

Second 4F4-8 4E0 Short 10687 km Second 3F11-15 3E2 Short 5214 km

**Perth-San Francisco** 66 **Sydney-Tel Aviv** 287

First F 0-5 Short 14743 km First F 0-5 Short 14173 km

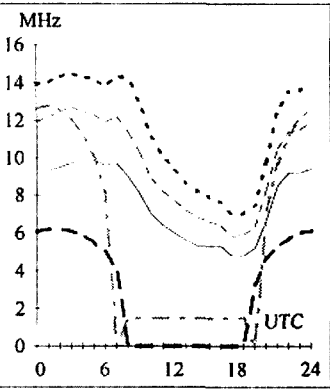
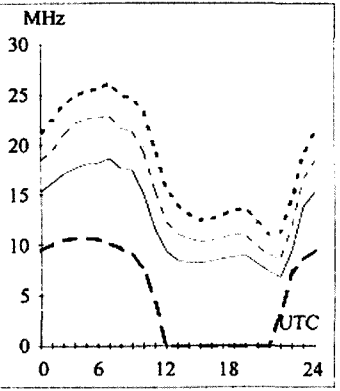
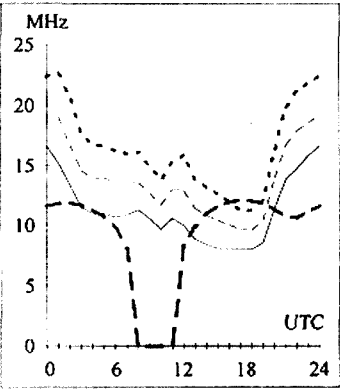
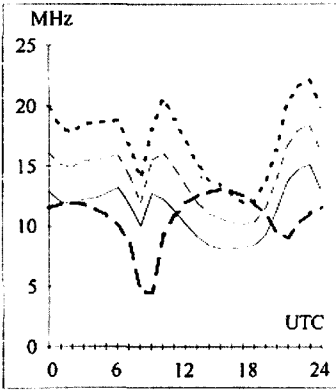


**Hobart-Rio de Janeiro** 169 **Melbourne-Santiago** 150

First F 0-5 Short 12619 km Second 4F3-4 4E0 Short 11272 km

**Perth-Sapporo** 19 **Sydney-Wellington** 119

Second 4F7-12 4E0 Short 8733 km Second 2F21-26 2E6 Short 2229 km



# HAMADS

## TRADE ADS

### • AMIDON FERROMAGNETIC CORES:

For all RF applications. Send business size SASE for data/price to RJ & US Imports, PO Box 431, Kiama NSW 2533 (no enquiries at office please ... 14 Boanyo Ave Kiama). Agencies at: Geoff Wood Electronics, Sydney; Webb Electronics, Albany; Assoc TV Service, Hobart; Truscotts Electronic World, Melbourne and Mildura; Alpha Tango Products, Perth; Haven Electronics, Nowra; and WIA Equipment Supplies, Adelaide.

• **WEATHER FAX** programs for IBM XT/ATs \*\*\* "RADFAX2" \$35.00, is a high resolution shortwave weatherfax, Morse and RTTY receiving program. Suitable for CGA, EGA, VGA and Hercules cards (state which). Needs SSB HF radio and RADFAX decoder. \*\*\* "SATFAX" \$45.00, is a NOAA, Meteor and GMS weather satellite picture receiving program. Needs EGA or VGA & WEATHER FAX PC card, + 137 MHz Receiver. \*\*\* "MAXISAT" \$75.00 is similar to SATFAX but needs 2 MB of expanded memory (EMS 3.6 or 4.0) and 1024 x 768 SVGA card. All programs are on 5.25" or 3.5" disks (state which) plus documentation, add \$3.00 postage. ONLY from M Delahuntly, 42 Villiers St, New Farm QLD 4005. Ph 07 358 2785.

• **HAM LOG v.3.1** - Acclaimed internationally as the best IBM logging program. Review samples....AR: "Recommend it to anyone"; The Canadian Amateur: "Beyond this reviewer's ability to do it justice. I cannot find anything to improve on. A breakthrough of computer technology". ARA: "Brilliant". Simple to use with full help, the professional HAM LOG is immensely popular (now in its 5th year), with many useful, superb features. Just \$59 (+ \$5 P & P), with a 90 page manual. Special 5 hour Internet offer. Demos, brochures available. Robin Gandevia VK2VN 02 369 2008 BH fax 02 369 3069.

Internet address rhg@ozemail.com.au.

• **Personalised QSL Cards**. 100 for \$17.50, white or colours. Examples, order forms, send 45 cent stamp to Henry's Publishing, PO Box 6603, Mackay MC, QLD 4741.

## FOR SALE NSW

• **Telegraph key**, NATO type (see AR Dec 1996) in original 1991 packing, this is a "Rolls Royce" key, \$100 plus P&P. Brian VK2GCE, QTHR, 029 545 2650.

• **MFJ1278B** packet TNC, \$330. Yaesu FL2100B HF amplifier, \$550. Icom IC-706 HF/VHF txcvr with accessories, \$1700. Ernest VK2BED, 02 9771 2561.

• Three el **TET HB33SP** tribander, **KR400RC** rotator with controller, \$450. Two section galv pipe mast with hand winch, approx 40 ft, \$100. Alf VK2API, 044 715 772.

• **Yaesu FT1**, VGC (put me on the Honour Roll), \$950. **Yaesu FT-726R** 2 m/70 cm, **100 ft 9913**, **13B2 Cushcraft antenna**, \$1450. **Boy VK2DTH**, 076 763 153.

• **Yaesu FT-101B**, s/n 4J313365, excellent condn, new finals, \$380. **Yaesu FT-101E**, s/n 8L370013, 110 V and 240 V, good order, \$420. **Yaesu FT-757GXII**, as new, original carton and manual, \$880. **Bob VK2GZ**, QTHR, 044 711 895.

• **Yaesu FT-901D** txcvr, **YM34** desk mic, manual, \$550. **FV-901** scanning VFO with memories, \$250. **FT-209RH** 2 m txcvr, never used, PA3 car adaptor, P/S charger, MH-12 spkr/mic, \$400. **Hi-Mound MK701** key, unused, \$100. **Tokyo Hy- power HC2500** 2.5 kW ATU, \$400. **Palomar TX200** 3-30 MHz linear amplifier, \$200. All good condn. **Peter VK2DBI**, QTHR, 063 675 095.

• **Pair 572B/160TL valves**, HF Tx, made in USA by Centron, suit FL2100B/FL2100Z 1000W HF amp, \$300 pair. **VK2EZQ**, 019 460 437, leave message or talk between 1900 and 2000 hrs Sydney time.

• **Vintage**: Inter-services Radar Manual (1950) Ed; Radiotron Designer's Handbook (1952); Radiotron amateur receiver mounted in steel 6 ft rack; ITT Reference Data for Radio Engineers (1968); Standard Handbook for Electrical Engineers (7th Ed). **TH6DXX** ant; two 32 ft lattice masts (one with pipe extension and rotator); five band **Hustler vertical ant**; **Novice band vertical ant**; brand new pair tubes (CV2245) still in cartons; 6 ft steel PMG-type equipment rack; **Datong FL2** filter to reduce QRM (for CW and SSB). Offers and info, Gordon VK2DGS, 02 9924 2052.

• **Yaesu FT-101ZD**, with mic and service manual, VGC. new finals, s/n 120956, \$500. **VK2UJ**, QTHR, 068 653 213.

## FOR SALE VIC

• **Kenwood TS-711A** all mode VHF txcvr with instruction manual and mic, EC, \$1100. Steven VK3CIM, QTHR, 03 9547 5894.

• **Kenwood TR-751A** 2 m all mode, s/n 7050460, with operators manual, EC \$500. **Pakratt PK-232** multi-mode data controller HF/VHF, s/n 14261, not MBX, with operators manual, EC, \$300. **Morse key Hi-Mound HK708**, EC, \$35. **VK3CAY**, QTHR, 03 9398 2714.

• **Icom 2SAT** 2 m hand held with Icom car cig lighter plug-in attachment and 110 volt charger, \$350 ONO. Russ White VK3MWR, PO Box 96 Beaconsfield VIC, 03 9796 2601.

• **Icom IC-775 DSP** c/w all optional filters, 12 months old, \$5,250. **Icom W31A** H/T, never used, 4 months old, \$650. **Cushcraft R7** 8 band trap vertical, \$650. 45 ft **Nally windup/tilt tower**, c/w KLM 7.2/10-30-7 log periodic ant and Hy-Gain heavy duty rotator with 110 volt transformer, buyer to dismantle, \$2,300. **Kantronics Kam Plus TNC** c/w Hostmaster 11+ software, \$500. **Bencher** Gold iambic paddle, \$180. **Bencher Chrome** straight key, \$125. **Magellan 2000** hand held GPS, new in box, \$300. Approx 200 kg 12 gauge hard drawn copper wire, insulated, \$500. **Seiko world clock**, analogue, \$20. All items in

first class condn, most less than 12 months old, genuine sale due to other interests, Geoff VK3FES, QTHR, 0419 531 157 (licensed hams only for Tx equipment).

• **Radio Amateur Callbook**, 1996 Summer edition on CD-ROM, \$30. **Damien VK3RX**, 03 5427 3121.

• Estate late **VK3CX**. **Yaesu FL-2100B** linear, some spare tubes, \$500. **Yaesu FC-102** ATU, \$200. **Butternut** multi-band vertical antenna, \$175. **Oskor Block HF SWR** meter, also UHF unit, \$60 each. **Kenwood TM-231** 2 m txcvr, \$450. Lifetime collection of components and accessories, send SAE for list or name wanted items. **Bill VK3ABP**, QTHR, 03 9398 2549.

• **Icom IC-575A** 6/10 m SSB/CW/FM/AM txcvr, AC/DC, DDS, PBT, 100 mems, current model, ideal for Limiteds to operate 10 and 6 metres, c/w original packaging, manuals and accessories, \$1200. **Adam VK3ALM**, QTHR, 015 362 799 or 03 9794 7873.

## FOR SALE QLD

• **Yaesu FT-101E**, new 6JS6C tubes, s/n 6N240563, incl digital display **Yaesu YC-601E**, s/n 84030483; **Shure h/h mic**; the lot \$650. **Henry VK4CQH**, QTHR, 070 921 994.

• **Kenwood AT-230** antenna tuner, \$230 ONO. **Outbacker Jr** antenna, 1.2 m long, \$200. **AV-5 5-band** vertical antenna, \$200. 8 band **antenna radial kit**, \$100. **RS2100** RTTY 'scope, \$100 ONO. **Dick Smith W502** SWR/Pwr meter, 1.6 - 80 MHz, \$175. **R Ettinger VK4DIC**, QTHR, 07 3264 1655.

• **Kenwood TS-850S**, CW filters and auto ATU, VGC, \$2,800. **Ron VK4CRO**, QTHR, 07 3390 7762.

• **Icom IC-551** or **IC-551D optional modules**: FM module, \$50; pass-band tune module, \$50. Unmodified and in excellent working order. **John VK4KK**, QTHR, 07 3269 6647.

• **Desk Mike**, 600 balanced output, add a tone control pre-amp to make a fine station mic, several available, \$20.00 each. **Ron VK4BL**, QTHR, e-mail rbrowp@tpgi.com.au.

## FOR SALE SA

• **Yaesu FRG-100** comm receiver, includes CW filter and FM board, DC supply, s/n 3H090015, \$700. **Yaesu FT-200** HF txcvr, with PSU, s/n 11321301, \$170. **Clipsal Morse key**, old type, \$60. **VK5KCX**, 085 224 528.

• **Panasonic Professional Super VHS video equipment**: WJMX12 production mixer, \$2000; WVF70E camera with dockable AG7450 recorder with battery pack and charger, \$6000; NV-FS1 video cassette recorder, \$500. All as new with cables. Would suit weddings or any small to medium video production work. **Kenwood TS-820**, \$400. 3.5 HD floppy disks, unopened boxes of 10, no brand, surplus stock, \$3.00 each. **Ian VK5IS**, 08 8636 2274 (work), 08 8636 2465 (home).



**FOR SALE WA**

• Shack clearance due to ill health. VK6AAS has for sale **Yaesu FT-101ZD**; **Yaesu FC-901** antenna coupler and tuner; **6 m triangular mast section** with winch up pipe section for further 5 m; **mobile 5 band HF antenna**; **3 band rotatable dipole**; **5 band wire dipole**; **antenna rotator**. Prefer to sell as one lot for \$1000. Contact Peter VK6APS on 096 521 326 all hours.

**WANTED NSW**

• **Command receiver parts** for restoration: tuning condenser (3 gang); aerial terminal; 3 IF transformers 2830 kHz; 3 IF transformers 239 kHz; 3 IF transformers 705 kHz; RF coil set 1.5-3.0 MHz; BFO coil box 705 kHz; dial 0.5-1.5 MHz; dial 1.5-3.0 MHz; dynamotor DY2; dynamotor shock mounts; Bowden cable; 2, 7 and 8 pin female connectors; rack; or any junk set of parts - 0.5-1.5, 1.5-3.0, 100-156 MHz preferred. Ray Robinson VK2ZON, 7 Roland Ave, Wahroonga, 02 9489 8561.

**WANTED VIC**

• **40 channel selector switch** (dual gang) for early model Cybernet (02A) chassis CBs. Ben VK3KBC, 03 9536 87460.

**WANTED QLD**

• **Transmitting tubes** type 4CX250B/4CX250R series. Good prices paid for good tubes. John VK4KK, QTHR, 07 3269 6647.

**WANTED SA**

• **3-500Z tubes**, \$350 offered for unused pair, postage and insurance paid extra. Kevin VK5BCB, 08 8725 9248, fax 08 8726 6350.

**MISCELLANEOUS**

• **THE WIA QSL Collection** (now Federal) requires QSLs. All types welcome especially rare DX pictorial cards special issue. Please contact Hon Curator Ken Matchett VK3TL, 4 Sunrise Hill Road, Montrose Vic 3765, Tel 03 9728 5350.

**Are you reading someone else's Amateur Radio? Call 03 9528 5962 to find out how to get it every month!**

**VK QSL BUREAUX**

The official list of VK QSL Bureaux. All are Inwards and Outwards unless otherwise stated.

- |         |   |
|---------|---|
| VK1     | GPO Box 600 CANBERRA ACT 2601           |
| VK2     | PO Box 73 TERALBA NSW 2284              |
| VK3     | Box 757G, GPO MELBOURNE VIC 3001        |
|         | 40G Victory Blvd ASHBURTON VIC 3147     |
| VK4     | GPO Box 638 BRISBANE QLD 4001           |
| VK5     | PO Box 10092 Gouger St ADELAIDE SA 5001 |
| VK6     | GPO Box F319 PERTH WA 6001              |
| VK7     | GPO Box 371D HOBART TAS 7001            |
| VK8     | C/o H G Andersson VK8HA                 |
|         | Box 619 HUMPTY DOO NT 0836              |
|         | C/o Neil Penfold VK6NE                  |
|         | 2 Moss Court KINGSLEY WA 6026           |
| VK9/VK0 |   |

**Hamads**

- Please use a separate form for For Sale and Wanted items, and be sure to include your name, address and telephone number (including STD code).
- Eight lines per issue free to all WIA members, ninth line for name and address. Commercial rates apply for non-members.
- Deceased estates Hamads will be published in full, even if the ad is not fully radio equipment.
- WIA policy recommends that the serial number of all equipment offered for sale should be included in the Hamad.
- QTHR means the address is correct in the current WIA Call Book.

- Ordinary Hamads from members who are deemed to be in general electronics retail and wholesale distributive trades should be certified as referring only to private articles not being re-sold for merchandising purposes.
- Commercial advertising (Trade Hamads) are pre-payable at \$25.00 for four lines, plus \$2.25 per line (or part thereof), with a minimum charge of \$25.00.
- Copy typed or in block letters, by the deadlines shown on page 1 of each issue of *Amateur Radio*, to:  
 Postal: 3 Tamar Court, Mentone VIC 3194  
 Fax: (03) 9584 8928  
 E-mail: vk3br@c031.aone.net.au

State .....


Please check one box:  For Sale  Wanted  Miscellaneous

**Not for publication:**

Name: \_\_\_\_\_ Call Sign: \_\_\_\_\_ Address: \_\_\_\_\_

# WIA Divisions

The WIA consists of seven autonomous State Divisions. Each member of the WIA is a member of a Division, usually in their residential State or Territory, and each Division looks after amateur radio affairs within its area.

Division	Address	Officers	Call Sign	Weekly News Broadcasts	1997 Fees
VK1	ACT Division GPO Box 600 Canberra ACT 2601	President Philip Rayner Secretary John Woolner Treasurer Bernie Kobler	VK1PJ VK1ZAO VK1KIP	3.570 MHz LSB, 146.950 MHz FM each Sunday evening commencing at 8.00 pm local time. The broadcast text is available on packet, on Internet <a href="http://aus.radio.amateur.misc">aus.radio.amateur.misc</a> newsgroup, and on the VK1 Home Page <a href="http://email.nla.gov.au/~cmakin/wiaact.html">http://email.nla.gov.au/~cmakin/wiaact.html</a>	(F) \$72.00 (G) (S) \$58.00 (X) \$44.00
VK2	NSW Division 109 Wigram St Parramatta NSW (PO Box 1066 Parramatta 2124 Phone 02 9689 2417 FreeCall 1800 817 644 Fax 02 9633 1525	President Peter Jensen Secretary Eric Fossey Treasurer Eric Van De Weyer (Office hours Mon-Fri 11.00-14.00 Sat 1000-1300 Mon 1900-2100)  Web: <a href="http://marconi.mpce.mq.edu.au/wia">http://marconi.mpce.mq.edu.au/wia</a> e-mail address: <a href="mailto:wiansw@sydney.dialix.oz.au">wiansw@sydney.dialix.oz.au</a> Packet BBS: VK2WI on 144.850 MHz	VK2AQJ VK2EFY VK2KUR	From VK2WI 1.845, 3.595, 7.146*, 10.125, 24.950, 28.320, 29.120, 52.120, 52.525, 144.150, 147.000, 438.525, 1281.750 (* morning only) with relays to some of 14.160, 18.120, 21.170, 584.750 ATV sound. Many country regions relay on 2 m or 70 cm repeaters. Sunday 1000 and 1930. Highlights included in VK2AWX Newcastle news, Monday 1930 on 3.593 plus 10 m, 2 m, 70 cm, 23 cm. The broadcast text is available on the internet newsgroup <a href="http://aus.radio.amateur.misc">aus.radio.amateur.misc</a> , and on packet radio.	(F) \$66.75 (G) (S) \$53.40 (X) \$38.75
VK3	Victorian Division 40G Victory Boulevard Ashburton Vic 3147 Phone 03 9885 9261 Fax 03 9885 9298	President Jim Linton Secretary Barry Wilton Treasurer Rob Halley (Office hours Tue & Thur 0830-1530)	VK3PC VK3XV VK3NC	VK3BWI broadcasts on the 1st Sunday of the month, starts 10.30 am. Primary frequencies 1.840 AM, 3.615 LSB, 7.085 LSB, and FM(R)s 146.700 Mt Dandenong, 147.250 Mt Macedon, 147.225 Mt Baw Baw, and 2 m FM(R)s VK3RMA, VK3RSH and VK3ROW. 70 cm FM(R)s VK3ROU and VK3RGL. Major news under call VK3WI on Victorian packet BBS.	(F) \$75.00 (G) (S) \$61.00 (X) \$47.00
VK4	Queensland Division GPO Box 638 Brisbane QLD 4001 Phone 074 96 4714	President Geoff Sanders Secretary John Stevens Treasurer John Presotto e-mail address: <a href="mailto:wiaq@tmxbris.mhs.oz.au">wiaq@tmxbris.mhs.oz.au</a>	VK4KEL VK4AFS VK4WX	1.825 MHz SSB, 3.605 MHz SSB, 7.118 MHz SSB, 14.342 MHz SSB, 28.400 MHz SSB, 29.220 MHz FM, 52.525 MHz FM, 146.700 MHz FM, 147.000 MHz FM, 438.525 MHz (Brisbane only), regional VHF/UHF repeaters at 0900 hrs Sunday. Repeated on 3.605 MHz SSB & 147.000 MHz FM, regional VHF/UHF repeaters at 1930 hrs EAST Monday. Broadcast news in text form on packet under WIAQ@VKNET.	(F) \$74.00 (G) (S) \$60.00 (X) \$46.00
VK5	South Australian Division 34 West Thebarton Rd Thebarton SA 5031 (GPO Box 1234 Adelaide SA 5001) Phone 08 8352 3428 Fax 08 8264 0463	President Peter Watts Secretary Maurie Hooper Treasurer Charles McEachern  Web: <a href="http://www.vk5wia.ampr.org/">http://www.vk5wia.ampr.org/</a>	VK5ZFW VK5EA VK5KDK	1827 kHz AM, 3.550 MHz LSB, 7.095 AM, 14.175 USB, 28.470 USB, 53.100 FM, 147.000 FM Adelaide, 146.700 FM Mid North, 146.800 FM Mildura, 146.825 FM Barossa Valley, 146.900 FM South East, 146.925 FM Central North, 147.825 FM Gawler, 438.425 FM Barossa Valley, 438.475 FM Adelaide North, ATV Ch 35 579.250 Adelaide. (NT) 3.555 USB, 7.065 USB, 10.125 USB, 146.700 FM, 0900 hrs Sunday. 3.585 MHz and 146.675 MHz FM Adelaide, 1930 hrs Monday.	(F) \$75.00 (G) (S) \$61.00 (X) \$47.00
VK6	West Australian Division PO Box 10 West Perth WA 6872 Phone 09 351 8873	President Cliff Bastin Secretary Christine Bastin Treasurer Bruce Hedland-Thomas	VK6LZ VK6ZLZ VK600	146.700 FM(R) Perth, at 0930 hrs Sunday, relayed on 1.825, 3.560, 7.075, 14.116, 14.175, 21.185, 29.680 FM, 50.150 and 438.525 MHz. Country relays 3.582, 147.350(R) Busselton and 146.900(R) Mt William (Bunbury). Broadcast repeated on 146.700 at 1900 hrs Sunday, relayed on 1.865, 3.563 and 438.525 MHz; country relays on 146.350 and 146.900 MHz.	(F) \$62.00 (G) (S) \$50.00 (X) \$34.00
VK7	Tasmanian Division 5 Helen Street Newstead TAS 7250 Phone 03 634 42324	President Andrew Dixon Secretary Robin Harwood Treasurer Terry Ives	VK7GL VK7RH VK7ZTI	146.700 MHz FM (VK7RHT) at 0930 hrs Sunday relayed on 147.000 (VK7RAA), 146.725 (VK7RNE), 146.625 (VK7RMD), 3.570, 7.090, 14.130, 52.100, 144.150 (Hobart) Repeated Tues 3.590 at 1930 hrs.	(F) \$74.00 (G) (S) \$60.00 (X) \$46.00
VK8	(Northern Territory is part of the VK5 Division and relays broadcasts from VK5 as shown received on 14 or 28 MHz).			Membership Grades Full (F) Pension (G) Needy (G) Student (S) Non receipt of AR (X)	Three-year membership available to (F) (G) (X) grades at fee x 3 times

Note: All times are local. All frequencies MHz.

## ADVERTISERS' INDEX

Amateur Transceiver Radio _____	49	Terlin Aerials _____	43
Andrews Communication Systems _____	13	WIA Recruitment _____	15
Clarke & Severn Electronics _____	11	WIA Membership Retention _____	5
Com-an-tena _____	41	<b>Trade Hamads</b>	
Daycom _____	IFC	M Delahunty _____	54
Dick Smith Electronics _____	28, 29, IBC	RJ & US Imports _____	54
Electronic Surplus Store _____	51	HAMLOG - VK2VN _____	54
ICOM _____	OBC, 33	Henry's Publishing _____	54
Radio and Communications _____	39		

## TRADE PRACTICES ACT

It is impossible for us to ensure the advertisements submitted for publication comply with the Trade Practices Act 1974. Therefore, advertisers and advertising agents will appreciate the absolute need for themselves to ensure that the provisions of the Act are complied with strictly.

## VICTORIAN CONSUMER AFFAIRS ACT

All advertisers are advised that advertisements containing only a PO Box number as the address cannot be accepted without the addition of the business address of the box-holder or seller of the goods.



# FT-900 Deluxe HF Mobile

The Yaesu FT-900 is a revolutionary new 100W HF transceiver that answers the need for a truly practical mobile radio, but without the performance compromises of most micro-sized rigs when used in base station installations.

For convenient mobile operation, a lightweight front sub-panel with access to commonly used controls can be easily mounted away from the transceiver's body using an optional mounting kit. The large "Omni-Glow" backlit LCD screen provides high visibility over a wide range of viewing angles, while the voice and data between the sub-panel and the transceiver are digital to minimise RF feedback or noise pick-up problems. A tough diecast top panel/heatsink and duct-flow cooling systems allows extended transmission periods, while still allowing the optional ATU-2 auto antenna tuner to be mounted inside the transceiver.

In base station uses, the FT-900's performance really shines through. Its superb front-end uses extensive bandpass filters, selectable dual FET pre-amp, and a quad-FET

mixer to minimise overloads, while a Collins SSB mechanical filter provides the excellent skirt selectivity required for the crowded bands we'll see again as the solar cycle improves. For pure local signals and ease of tuning, two Direct Digital Synthesisers and a magnetic rotary encoder provide selectable 2.5, 5, or 10Hz tuning steps, while a 10 button keypad provides direct frequency or band entry. Interference fighting facilities include IF Shift, IF Notch, and an effective Noise blander.

Other features include SSB/CW/AM/FM operation, 100 memory channels, 2 VFOs per band, SSB Speech processor with IF shift for audio tailoring, VOX, electronic CW keyer, CTCSS tones for 29MHz FM, and a general coverage receiver (100kHz to 30MHz).

The FT-900 is only 238 x 93 x 253mm (WHD), weighs just 5.5kg, and is supplied with a hand microphone, DC power cable, and detailed Instructions.

Cat D-3280



# \$1795

**2 YEAR WARRANTY**

For further information, orders or the location of your nearest store call:  
**1300 366 644** (Local Call Charge)  
**Or Fax: (02) 805 1986**



B 2414

OUR WIDE BAND RECEIVER RANGE IS NOW EVEN WIDER.

ICOM FA-BOIRE



**O**ur wide band receivers give you the world. Starting with our new IC-R10, an exciting upgrade of the popular IC-R1 which led the way in handheld receivers. The IC-R10 has a wide frequency coverage of 0.5 MHz to 1300 MHz and is an all mode (FM, WFM, SSB, CW, AM) unit. Features such as a real-time bandscope function, making it easy to find busy frequencies, are firsts for handheld receivers.



IC-R9000

Our top of the range IC-R9000 covers 100 kHz - 1999.8 MHz in all modes



IC-R8500

and features Icom's unique CRT display, intelligent scan functions and an amazing 1000 memory channels, in a unit that delivers superb high frequency stability, even in the GHz range.

The IC-R8500 is another exciting newcomer with a frequency range of 0.1 to 2000 MHz, excellent frequency stability, and outstanding high receive sensitivity characteristics. With an RS-232C interface allowing direct connection to a PC the new IC-R8500 is truly a state-of-the-art communications receiver.



IC-R100

**O**ur mobile IC-R100 is packed with features and covers the 100kHz - 1800 MHz range in AM, FM, and WFM modes with multi-function scanning and 100 memories with 20 scan edge channels. With the expanded Icom range of communications receivers... the world's radio signals have never sounded so good. Talk to your Icom dealer today for the full technical story.

CALL FREE: 1800 338 915  
290-294 Albert St Brunswick Victoria 3056  
Ph: (03) 9387 0666 Fax: (03) 9387 0022  
A.C.N. 006 092 575

**ICOM**  
Clearly Ahead

# Amateur Radio

April 1997

Volume 65 No 4



*Journal of the Wireless Institute of Australia*



*Full of the latest amateur radio news, information and technical articles including...*

- The Heard Island Experience - VK2PS with VK2DJM
- Future of the Amateur Service - A Discussion Paper
- The DB 80 - An 80 m SSB/CW QRP Transceiver

**Plus** *lots of other articles, news and special interest columns*



## IC-756 HF + 6m 100W, auto-ATU, DSP

If you missed our Icom Day at the end of November you missed the opportunity to see the all new IC-756. It was pretty hard to see anyway with the crowd always around it!

- All bands 160-6 metres
- 100W output on all bands
- Auto ATU works on all bands
- Dual watch receivers
- Spectrum Scope (just like the IC-781!)
- Dual Pass-Band Tuning
- Adjustable threshold DSP noise reduction
- Audio Peaking Filter
- Automatic Notch filter
- Built-in CW memory keyer
- 100 alphanumeric memories

Some of the reactions; "how much will you give me for my FT-1000 as a trade-in?", "Probably the most innovative radio since the IC781 hit the market!", "This is really a radio for all reasons, easy to use but with all the features a contestor or DXer needs."

In stock now, call to secure yours:

# \$3700

## R8500 HF/VHF/UHF receiver



The **NEW** Icom R-8500 receiver is here now! It covers 100kHz to 2000MHz (no breaks) has 1000 memories and a host of features you wouldn't think possible at just \$3750. Get the full story, call for a brochure or look on the WEB at <http://www.daycom.com.au/>

introductory special price: **\$3400**

## MFJ Antenna Tuners

MFJ901B	200W Versatuner	\$149
MFJ910	Mobile antenna matcher	\$45
MFJ921	2 mtr 300W tuner	\$155
MFJ924	70 cm 300W tuner	\$155
MFJ931	Artificial ground tuner	\$169
MFJ941E	300W compact GP tuner	\$230
MFJ945E	300W mobile tuner	\$209
MFJ948	Deluxe 300W (no D/L)	\$270
MFJ949E	Deluxe 300W	\$299
MFJ962C	1.5kW tapped inductor	\$525
MFJ969	300W Roller inductor <b>NEW</b>	\$360
MFJ971	200W Portable tuner	\$190



MFJ986	3kW Diff-T roller inductor	\$629
MFJ989C	3kW Deluxe roller inductor	\$735

## ARRL 1995 Publications CD-ROM



A whole years QST, QEX and NCJ magazines in a single CD-ROM - how convenient! With powerful reader technology the diagrams and photos appear inseparable windows. Fully searchable text. Requires 386 or better with Windows 3.1 or later.

# \$45



## HAMCALL 1996

Our most popular callbook CD-ROM with Windows, DOS and MAC search engines. Much new information this year including photos of many amateurs!

# \$25

# hy-gain

## HyGain DX77

### Advanced Vertical Window

- 7 Band Vertical
- 10-12-15-17-20-30-40 metres
- No ground radials required
- Tilt mount
- Height: 29 feet
- Power: 1.5kW
- Industrial grade construction
- Bandwidth (<2:1 SWR)
  - 10 metres 1.7MHz
  - 12 metres 100kHz
  - 15 metres 500kHz
  - 17 metres 100kHz
  - 20 metres 250kHz
  - 30 metres 100kHz
  - 40 metres 150kHz



Daycom and HyGain introduce the DX77 Advanced vertical Window with features surpassing any HF vertical on the market. The superior mechanical design, high power capability and 55% greater bandwidth than competitive verticals on 20 and 40 metres make it an exceptional value for a high performance system.

The unique design of this vertical antenna provides a no compromise performance without the need for ground radial wires. It puts the world at your fingertips on the HF ham bands, 10 through 40 metres, including the WARC bands! Capable of handling 750W average or 1500W PEP the HyGain DX77 won't balk at the output of your linear! Automatic band-switching and low angle of radiation allow for enhanced DX performance.

in stock now at

# \$875

# OPTOELECTRONICS XPLORER Test Receiver

## All the information, in one hand!

In one convenient handful the amazing new Optoelectronics XPLORER Test Receiver not only finds signals for you, but it will tell you frequency and deviation as well as decoding sub-audible and DTMF tones. Sweeping the range 30 to 2000MHz in less than 1 second the Xplorer will lock on to any signal in the nearfield and demodulate the FM audio for monitoring. You also see frequency on the LCD display along with other information about the signal.

- Frequency range: 30MHz - 2GHz
- FM Deviation range: 100kHz
- Audio frequency response: 50 - 3000Hz
- Auto sweep time: <1 second 30-2000MHz
- Internal speaker, headphone jack, tape control jack, serial interface connector, rotary encoder & flexible push button panel.
- Easy to read LCD display with EL backlighting
- Internal 7.2V 850mAh NiCd battery
- Rapid charging (<1hr) with intelligent charging controller
- NMEA-01283 interface for GPS receiver

**XPLORER Test Receiver \$1700**



# TOKIT The NEW Heathkit!



Help reclaim this fascinating band! Six metres is the VHF DX band and even now offers regular overseas contacts with just a little effort. The TT1208 kit is the ideal, low cost way, to get going on 6 metres and find out what only the elite have known for years!

- Requires 3-5W input on 20 metres
- Extremely simple hookup and operation
- Sensitive, low noise 50-54MHz front end
- Fast, silent PIN diode TR switch for QSK & data
- 8W output on 6 metres
- Requires 12-15V DC 3A power supply
- Simple switching between HF and 6 metres
- Rugged steel case

**TT1208 8W 6 metre transverter \$199**

# Amateur Radio



## Journal of the Wireless Institute of Australia

Vol 65 No 4

ISSN 0002-6859

April 1997

Amateur Radio is published by the Wireless Institute of Australia, ACN 004 920 745 as its Official Journal, on the last Friday of each month.

### Editorial

#### Editor

Bill Rice VK3ABP\*

**Production Manager**

Bill Roper VK3BR

**Senior Technical Editor**

Peter Gibson VK3AZL\*

**Technical Editors**

Evan Jarman VK3ANI\*

Gil Sones VK3AUI\*

Don Graham VK6HK

**Contributing Editor**

Ron Fisher VK3OM\*

**WIA News Editor**

Roger Harrison VK2ZRH

**Proof Readers**

Allan Doble VK3AMD

Jim Payne VK3AZT

Graham Thornton VK3IY

John Tutton VK3ZC

\*Publications Committee member

### Production

**Administration, Advertising, Drafting,**

**Production**

vk3br Communications Pty Ltd

3 Tamar Court, Mentone VIC 3194

**Typesetting and Printing**

Industrial Printing and Publishing Pty Ltd

122 Dover Street, Richmond, VIC 3121.

**Mail Distribution**

Mail Management Australia Pty Ltd

6 Garden Boulevard, Dirrigley VIC 3172

**New Advertising**

Eyvonne & Keith Tootell

Union Publicity Service Pty Ltd

PO Box 282, Toongabbie NSW 2146

Telephone: 1800 654 181 - 02 9831 1299

Fax: 02 9831 6161

**Amateur Radio Correspondence**

All contributions, correspondence, Hamads

and queries concerning the content of

Amateur Radio should be sent to:

Amateur Radio

vk3br Communications Pty Ltd

3 Tamar Court, Mentone VIC 3194

E-mail: vk3br@c031.aone.net.au

Phone and Fax: 03 9584 8928

Mobile: 0418 534 168

**Business Hours:** 9.30 am to 3.00 pm weekdays

**Amateur Radio Delivery**

All correspondence and queries

concerning the delivery of

Amateur Radio should be sent to:

Amateur Radio

WIA Federal Office

PO Box 2175

Caulfield Junction VIC 3161

**Registered Office:**

3/105 Hawthorn Road

Caulfield North VIC 3161

Telephone: 03 9528 5962

Fax: 03 9523 8191

**Business Hours:** 9.30 am to 3.00 pm weekdays

**Editorial and Hamads Deadlines**

May 07/04/97

June 12/05/97

July 09/06/97

**Receipt of Amateur Radio by Mail**

The issue will be delivered to Australia Post on Tuesday, 29 April 1997 for mailing to members.

If this magazine is not received by the 15th of the month of issue, and you are a financial member of the WIA, please check with the Post Office before contacting the registered office of the WIA. ©

© Wireless Institute of Australia 1997

### CONTENTS

#### Technical

The DB 80, an 80 m SSB/CW QRP Transceiver \_\_\_\_\_ 14

*Dr T C Choy VK3CCA*

**Technical Abstracts**

Two Metre Mobile Comparison \_\_\_\_\_ 19

Probe Housing \_\_\_\_\_ 19

Travelling Wave Loaded Monopoles \_\_\_\_\_ 20

The Dipper Transformer \_\_\_\_\_ 21

*Gil Sones VK3AUI*

#### General

The Heard Island Experience \_\_\_\_\_ 7

*Stephen Pall VK2PS*

**WIA Federal Discussion Paper**

Response to the IARU Future of the Amateur Service Committee \_\_\_\_\_ 11

*Grant Willis VK5ZWI and David Wardlaw VK3ADW.*

SEANET is a Success in Chennai \_\_\_\_\_ 23

*Thomas E King VK2ATJ*

Visit by LZ1AF \_\_\_\_\_ 25

*Ernest Sloman VK2BUE*

#### Columns

Advertisers' Index \_\_\_\_\_ 56

ALARA \_\_\_\_\_ 26

AMSAT Australia \_\_\_\_\_ 27

Awards \_\_\_\_\_ 31

Club Corner \_\_\_\_\_ 32

Contests \_\_\_\_\_ 33

**Divisional Notes**

VK1 Notes \_\_\_\_\_ 36

VK2 Notes \_\_\_\_\_ 36

VK7 Notes \_\_\_\_\_ 37

Editor's Comment \_\_\_\_\_ 2

Education Notes \_\_\_\_\_ 41

Hamads \_\_\_\_\_ 54

HF Predictions \_\_\_\_\_ 52

How's DX? \_\_\_\_\_ 38

Morse Practice Transmissions \_\_\_\_\_ 47

Novice Notes \_\_\_\_\_ 42

Over To You \_\_\_\_\_ 41

Pounding Brass \_\_\_\_\_ 44

QSLs from the WIA Collection \_\_\_\_\_ 45

QSP News \_\_\_\_\_ 13, 40

Repeater Link \_\_\_\_\_ 46

Silent Keys \_\_\_\_\_ 51

Spotlight on SWLing \_\_\_\_\_ 48

Update \_\_\_\_\_ 48

VHF/UHF - An Expanding World \_\_\_\_\_ 49

VK QSL Bureaux \_\_\_\_\_ 55

WIA News \_\_\_\_\_ 3, 22, 26, 30

WIA - Divisional Directory \_\_\_\_\_ 56

WIA - Federal Directory \_\_\_\_\_ 2

#### Cover

The Heard Island DXpedition VK0IR accommodation huts with the flagpole and beacon in the foreground, and the majestic beauty of "Big Ben" thrusting above the clouds in the background (see Stephen Pall's article on page 7).

#### BACK ISSUES

Available, only until stocks are exhausted, at \$4.00 each (including postage within Australia) to members.

#### PHOTOSTAT COPIES

When back issues are no longer available, photocopies of articles are available to members at \$2.50 each (plus \$2.00 for each additional issue in which the article appears).

The opinions expressed in this publication do not necessarily reflect the official view of the WIA, and the WIA cannot be held responsible for incorrect information published.

# Amateur Radio Service

A radiocommunication service for the purpose of self-training, intercommunication and technical investigation carried out by amateurs, that is, by duly authorised persons interested in radio technique solely with a personal aim and without pecuniary interest.

## Wireless Institute of Australia

The world's first and oldest National Radio Society  
Founded 1910

Representing the Australian Amateur Radio Service -  
Member of the International Amateur Radio Union

Registered Federal office of the WIA:

3/105 Hawthorn Rd, Caulfield North, Vic 3161

All Mail to:

PO Box 2175, Caulfield Junction, VIC 3161

Telephone: 03 9528 5962 Fax: 03 9523 8191

Business Hours: 9.30 am to 3.00 pm on weekdays

Federal Secretary  
Peter Naish VK2BPN

### FEDERAL OFFICE STAFF

June Fox	Book Keeper
Sue Allan	Membership Secretary
Rita Trebilco VK3NRT	Examinations Officer

### COUNCIL

President	Neil Penfold	VK6NE
VK1 Federal Councillor	Richard Jenkins	VK1RJ
VK2 Federal Councillor	Michael Corbin	VK2YC
VK3 Federal Councillor	Brenda Edmonds	VK3KT
VK4 Federal Councillor	Ross Marren	VK4AMJ
VK5 Federal Councillor	Grant Willis	VK5ZWI
VK6 Federal Councillor	Bruce Hedland-Thomas	VK6OO
VK7 Federal Councillor	Jim Forsyth	VK7FJ

### EXECUTIVE

Peter Naish	VK2BPN
Lance Bickford	VK4ZAZ
Rowland Bruce	VK5OU
Neil Penfold	VK6NE

### FEDERAL CO-ORDINATORS

AMSAT:	Graham Ratcliff	VK5AGR
Awards:	John Kelleher	VK3DP
Contests:	Peter Nesbit	VK3APN
Education:	Brenda Edmonds	VK3KT
EMC and Standards	Roger Harrison	VK2ZRH
FTAC:	John Martin	VK3KWA
Historian:	John Edmonds	VK3AFU
IARU:	David Wardlaw	VK3ADW
Int'l Travel Host Exch:	Ash Nallawalla	VK3CIT
Int'l Beacon Co-ord:	Roger Harrison	VK2ZRH
Intruder Watch:	Gordon Loveday	VK4KAL
ITU Conference and Study Group:	David Wardlaw	VK3ADW
Media:	Roger Harrison	VK2ZRH
QSL Manager (VK9,VK0):	Neil Penfold	VK6NE
Radio Sports:	Wally Watkins	VK4DO
Videotapes:	Bob Godfrey	VK4BOB
WICEN:		

### SMA LIAISON TEAM

Roger Harrison	VK2ZRH
David Wardlaw	VK3ADW
Neil Penfold	VK6NE

# Editor's Comment

## Supply and Demand

Many of you will have seen over the last few months that Jim VK3CX had become a Silent Key, that he was my brother-in-law, and that I had advertised some of his equipment in the March *Hamads*. Surprisingly (to most of you), this was the first time I had ever sent in a Hamad! The reason for this is that for most of my near 50 years on the air, I have been using exclusively home-brew equipment and, by the time I had declared it obsolete, no one else would have wanted it anyway!

But with Jim's mostly commercial collection of ham gear, it was a different story. I was most impressed by the response to the Hamad. Even before my own copy of *Amateur Radio* had arrived in the mailbox, the first phone call had come in. A country member was interested in the FL-2100B linear amplifier.

Over the next two days there were three more enquiries for the 2100B and/or spare 572B tubes for it! First come, first served, seemed the only way to go, so apologies to those who missed out.

Fortunately, most inquirers differed from each other as to what item(s) they wanted, so about seven others were, or will be, satisfied. Of course there may still be more enquiries to come, but I would think the initial rush is over.

So I have now learned first-hand how effective a Hamad can be. And they are free (to members of the WIA, provided the ad is no more than eight lines).

The other point which impressed me was how popular an item is the 2100B. This is no doubt because it is the cheapest commercial unit capable of producing our maximum legal output of 400 W PEP. Of course it uses obsolescent valve technology, but a solid-state equivalent would cost far more. It is interesting to note that supplies of the valves used in the 2100B are still available (although with difficulty and at substantial prices). The effects of demand on supply are unavoidable it seems!

Bill Rice VK3ABP  
Editor

### CONTRIBUTIONS TO AMATEUR RADIO

*Amateur Radio* is a forum for WIA members' amateur radio technical experiments, experiences, opinions and news. Manuscripts with drawings and/or photos are always welcome and will be considered for possible publication. Articles on computer disk or via e-mail are especially welcome. The WIA cannot assume responsibility for loss or damage to any material. A pamphlet, "How to Write for *Amateur Radio*", is available from vk3br Communications Pty Ltd on receipt of a stamped, self addressed envelope.



---

## ■ WIA News

Roger Harrison VK2ZRH, Federal Media Liaison Officer

---

# Special Call Signs Available for ITU Day

The Spectrum Management Agency has granted the use of AX\*ITU for stations operating to celebrate the ITU's annual World Telecommunication Day, which is on 17 May. This year, it's a Saturday. Operation is to be sponsored by Divisions who wish to do so, over the period 0001 to 2359 hours local time.

Permission for operation of AX\*ITU stations this year came from the SMA following a request to them from the NSW Division Special Projects Officer, Stephen Pall VK2PS, for use of the call sign AX2ITU and was granted as a consequence of a submission from the WIA-SMA Liaison Team sent to the SMA last December.

There has been a long-standing tradition in Australia of celebrating the annual World Telecommunication Day by operating stations using an AX\*ITU call sign. Under previous communications administrations, use of the call signs was permitted without the need for special application by each Division. However, this rule changed in 1995, resulting in some confusion surrounding permission for its use in 1996.

The WIA-SMA Liaison Team's submission to the SMA last December, which concentrated on the general principles for use of the AX and VI prefixes and special call signs involving these prefixes, put the WIA's views on:

- events justifying general use of the AX or VI prefixes by all Australian amateurs,
- events justifying the use of the AX or VI prefixes by specific, nominated stations,
- events justifying the use of specific AXnaaa or VInaaa call signs (n = geographic numerator, a = any alpha character), and
- events justifying the use of the AX or VI prefix in conjunction with a

numerator and/or suffix outside the call sign templates.

The submission advanced the WIA's view that there are a number of well-recognised events or occasions for which there exists a demand for the use of special-event call signs, noting that some of these are cyclic in nature (Australia Day and national centenaries, for example), while others are one-off events (the Sydney Olympics, for example).

As a result of the December submission, the use of AX on Australia Day this year was granted for all Australian amateurs. The submission also specifically noted that State Divisions of the WIA have, in the past, applied to use AX\*ITU to mark the annual celebration of World Telecommunication Day. Stephen Pall's letter, sent in February, triggered the granting of this year's use of AX\*ITU call signs in those states wishing to activate a station.

## WIA Seeks Support for Licensing Submission from Parliamentarians

Following a decision at the Extraordinary Federal Convention of the WIA held over 15-16 February, the Institute began a program of sending copies of the submission on Amateur licensing to selected parliamentarians.

The member for Braddon, in Tasmania, Chris Miles, requested a copy of the completed submission following discussions of the draft with a Tasmanian Division Councillor.

Members of both the House of Representatives and the Senate have been chosen to receive copies. A covering letter explaining amateur radio and outlining the purpose and the major points of the submission has been sent with each copy.

The WIA Federal Council has passed a motion "that the principles espoused in the submission to the Minister on licensing be adopted by the Federal Council". In later discussions, the Federal Council also expressed the view that this is not the time for parliamentarians to receive a barrage of letters and phone calls from radio amateurs, similar to what happened in 1995 following the proposed hike in fees then.

In its submission, the WIA asked that it be permitted to determine the allocation of special-event call signs under a Memorandum of Agreement with the SMA, as follows:

(i) use of the AX and VI prefixes in lieu of the standard VK prefix, with the WIA providing the SMA with advance notice of events and AX/VI prefix usage,

(ii) coordinating and recommending applications for specific AXnaaa and VInaaa call signs to be licensed by the SMA, and

(iii) coordinating and recommending applications for AX- and VI-prefix call signs to be licensed by the SMA where the numerator and/or suffix are outside the call sign templates.

*"This proposed system would work in a similar manner to the existing system of WIA coordination of beacon and repeater licence applications, except that it would be done on a nationwide basis, through WIA Federal,"* the submission proposed. *"This system would greatly simplify the administration of special event call signs and reduce the involvement of SMA staff."*

The WIA hopes to be able to get a resolution on this issue at the earliest opportunity. In the meantime, support your Division's operation of AX\*ITU.

# Executive Summary

The WIA Federal Council, at the convention of 15-16 February, directed that the Executive Summary of the completed licensing submission be published in *Amateur Radio*, rather than the full document. For members wanting to read the complete submission, each Division has a master copy and will be able to supply a photocopy on request. The WIA plans to have the licensing submission available on the Internet in due course.

## Executive Summary

The Wireless Institute of Australia, the peak body representing the interests of Australian radio amateurs, seeks amendments to the Radiocommunications Act to provide a more appropriate licensing system for the Amateur Radio Service in Australia.

The submission seeks government recognition of the value of the Amateur Radio Service to the community. It argues a case that the present licensing systems are unsuited to the purpose, role and activities of the Amateur Radio Service in fundamental ways, although radio amateurs are presently licensed under the Apparatus Licence system.

The International Telecommunications Union defines the **Amateur Service** as: "A radiocommunication service for the purpose of self-training, intercommunication and technical investigations carried out by amateurs, that is, by duly authorized persons interested in radio technique solely with a personal aim and without pecuniary interest."

The submission sets out that Australian radio amateurs require:

- individual licences,
- certainty of licence tenure,
- where fees are applicable, an equitable fees framework,
- certain and continuing access to frequency bands throughout the radiofrequency spectrum, and
- continuing participation in spectrum management processes at local, national and international levels.

Radio amateurs *operate* radiocommunications *stations* comprising equipment which may:

- be designed and constructed by themselves;

- be assembled from units of commercially manufactured equipment originally designed for civilian, government or military applications, and adapted or modified for amateur radio pursuits;

- be assembled from commercially manufactured equipment designed for the world amateur radio market; or

- comprise a variety of combinations and permutations of the above.

They operate their stations on frequency bands, allocated under the *Australian Radiofrequency Spectrum Plan*, ranging from the medium frequencies (MF) through to the microwave extra high frequencies (EHF).

Amateurs operate within the specified limits of these bands and are only constrained in technical operation by the applicable licence conditions covering specified bands, transmission modes, bandwidths and powers, etc.

Radio amateurs have total flexibility to change their equipment, transmission modes, location and antennas, provided they comply with the core technical conditions of their licence, and any coordination requirements. This flexibility is essential to maintaining technical experimentation as one of the core activities and attractions of amateur radio. Among all the defined radiocommunications services, amateur radio operation is *unique*.

Radio amateurs have always been licensed as technically qualified

*individuals* and, by the very nature of their activities, require individual licences.

In relation to the purpose, role and activities of radio amateurs, the current three licensing systems have conflicting limitations, restrictions and administrative constraints.

(a) The **Apparatus Licence** system, being intended for business operations of the private and public sectors, focuses on equipment and its application. This licence system has clearly been distorted to accommodate the Amateur Service.

(b) The **Class Licence** system with its focus on type-approved equipment which has to meet prescribed specifications, and the fact that these licences are not issued to individuals, would have to be fundamentally redefined to accommodate the requirements, activities and practices of the Amateur Service. To do so would only distort this licence system to accommodate the Amateur Service, creating an unsatisfactory situation as has occurred under the Apparatus Licence system.

(c) The main goal of the **Spectrum Licence** system, to allow commercial market mechanisms to play a role in allocating spectrum between users, is in direct conflict with the requirements, activities and practices of the Amateur Service.

The fees framework of the Apparatus Licence system embodies the concept of "spectrum denial" and employs a Spectrum Access Tax formula that values scarcity and demand, and acts as "a rationing device." These are all precepts which are of a commercial, economic nature and not applicable to the Amateur Service which is a voluntary, non-pecuniary service.

Because radio amateurs operate in defined frequency bands, shared with other radio amateurs (and in some instances, other services), and have the flexibility to, at will, use transmissions of differing bandwidth, transmit on different frequencies within their assigned bands, and to change their location, it is a practical impossibility to apply the Apparatus Licensing system's Spectrum Access Tax formula to amateur operations.

The Amateur Radio Service in

**Help stamp out  
stolen equipment  
- keep a record  
of all your  
equipment serial  
numbers in a  
safe place.**

Australia would be better served by a licence fee regime that was truly transparent, equitable for all licensees and reflected the value to the community of the Amateur Service.

**The WIA proposes the creation of a fourth licence type under the Radiocommunications Act, to be called the Amateur Radio Licence.**

This would provide:

- a once-only issue of a licence for life to a person meeting the requirements of an Amateur Operator's Certificate of Proficiency; or, alternatively,
- a five-year licence duration, with renewal, to a person meeting the same requirements.

The proposed licence meets the definition of the Amateur Service which requires that radio amateurs be licensed as individuals, and that radio amateurs' pursuits are of a non-pecuniary nature involving self-training, intercommunication and technical investigations.

Additionally, the proposed licence would recognise and provide for the complete flexibility amateur radio operators have in pursuing their activities, within the framework of the allocated amateur frequency bands and applicable licence conditions determined under the *Radiocommunications Act*. The present seven licence sub-types would be retained.

Amending the Radiocommunications Act to create this proposed licence would also serve to recognise the value of the Amateur Service to the community, and the value it returns to the nation. The submission demonstrates how the Amateur Service:

- creates within the community a pool of technically knowledgeable people trained in communications operations,
- motivates young people to take up scientific or technological careers,
- contributes to the advancement of scientific knowledge,
- contributes to the development of technology and the communications infrastructure,
- enhances international understanding and goodwill, and
- provides communications support during emergencies and for community activities.

The cost of public administration of the Amateur Service in Australia has previously been reduced through devolvement of the amateur licence examination system to the WIA. The principle of devolvement of administrative routines could also be applied to the issuing of, for example, Certificates of Proficiency and call signs, reducing individual amateur radio operators' engagement with the SMA, thus achieving further savings in administrative burden and cost. The WIA proposes options for such devolvement.

It would be open to the Government to waive fees for the proposed **Amateur Radio Licence**, as it has done with other voluntary-based community services which use radiocommunications (eg Surf Life Saving), and as the American Government has done in recognition of the value to the community of the Amateur Service.

However, it is recognised that there is some necessary "engagement" between the amateur radio community and the SMA, in terms of the SMA meeting its obligations under the ITU Radio Regulations treaties and the Radiocommunications Act.

In the event a licence fee is retained, the WIA proposes that it be made up of two components: a *Spectrum Management* component, and an *Administrative Charge*, akin to the two like-named components of the Apparatus Licence fee.

This fee framework does not include a *Spectrum Access Tax* component, for all sub-types of Amateur licence, in recognition of the value of amateur radio to the community, and the value amateur radio operators and their activities return to the community.

The nett cost in loss of revenue would amount to less than \$200,000 annually in 1997 terms.

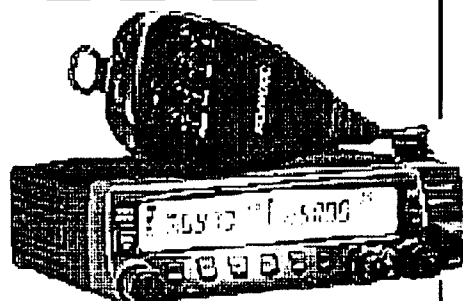
The *Spectrum Management* charge is proposed to be retained at the present level of \$3 as it is clear that the SMA has determined that this satisfies their administrative requirements in respect to the Amateur Service.

The *Administrative Charge* would be reduced by reducing amateur radio operators' engagement with the SMA, as proposed, through devolvement of certain administrative routines.



**YOUR HOBBY** **YOUR VOICE**  
Representing Radio Amateurs - Since 1910

# RENEW YOUR MEMBERSHIP AND YOU COULD WIN



## THIS KENWOOD TM-733A 2m/70cm FM/packet rig worth \$1255

50 W on 2m 35 W on 70cm  
Switchable 10 W/5 W RF output  
Simultaneous VHF-UHF reception  
Data input for 1200/9600 baud packet  
70 multi-function memories

**All you have to do is renew  
your Division membership  
when it falls due**

**WHO'S ELIGIBLE?** • members whose renewal falls due between 1/1/97 and 31/12/97 • current members who are on a 3-year membership • life members, and • all membership grades.

**The prize will be awarded by means of a draw, the result to be published and the prize to be presented to the winner at the first available opportunity early in 1998.**

TM-733A prize kindly donated by  
Kenwood Electronics Australia P/L,  
PO Box 504, Homebush 2140.  
Ph: (02) 9746 1888. Fax: (02) 9746 1509.

# World Telecommunication Day, 17 May

On 17 May each year, the International Telecommunications Union (ITU) commemorates its founding in Paris 132 years ago. This year, the theme of the event is Telecommunications and Humanitarian Affairs.

The ITU said this year, the event "will focus on the vital and growing link between telecommunications and the emergency relief operations which follow natural and man-made disasters, such as cyclones, earthquakes, or wars.

"The many different aid agencies working around the world have long relied heavily on telecommunications, both to keep in contact with disaster-struck areas, and to coordinate their own activities. Radiocommunications, in

particular, is a mainstay of many emergency relief operations, because of its high level of reliability, the portability of equipment and its high disaster-survival capability.

"Today, as well as tried and tested communications systems such as radio, developments in technology have yielded other alternatives which can benefit disaster victims and field workers alike in coping with the aftermath of a catastrophe."

The ITU said among these new technologies were mobile telephony and

satellite communications using low and medium Earth-orbit (LEO and MEO) satellites.

"In order to enable the benefits of these new technologies to be available as widely as possible, the ITU is working with other international organisations, notably the United Nations Department of Humanitarian Affairs, to create a new Convention covering the international use of emergency telecommunications. This Convention, which has already been accepted by the ITU Council, is now expected to be adopted at an international conference later this year," the ITU said.

In welcoming the theme of this year's event, the ITU's Secretary-General, Dr Pekka Tarjanne, said it was very important both in recognising the achievements of the past, and in looking towards those of the future.

## Wilkinson Award for Two Victorian Amateurs

The WIA Federal Council has awarded the 1997 Wilkinson Award to Neil Trainor VK3IJ and Bill Magnusson VK3JT for their contribution to WIA education and examination activities.

The award was decided at the WIA Federal Extraordinary Convention held over 15-16 February. Congratulations to Neil VK3IJ and Bill VK3JT.

The Award is for special achievement in any facet of amateur radio. It is named in memory of Ron Wilkinson VK3AKC who, through dedicated determination, set a number of VHF/UHF records over the post-WW2 decades, including work on 1296 MHz moonbounce.

## First Winner for Recruitment Prize

The first of the Fluke 12B digital multimeter prizes for new members, who joined in the month of January this year, went to M F Ramsay VK2VZQ, of Bellambi NSW, who joined the NSW Division.

Mr Ramsay was chosen from a field of nine possible candidates, drawn by WIA Federal Secretary, Peter Naish VK2BPN, at the WIA Federal Extraordinary Convention held over 15-16 February. Mr Ramsay was the only NSW candidate, there being six from Queensland and two from Western Australia in the draw.

Each month throughout 1997, a Fluke 12B digital multimeter will be given away to a lucky winner who joined a WIA Division in the previous month. The Fluke multimeter prizes have been generously donated by Philips Test and Measurement. See the recruitment advertisement in this issue for more details.

### Andrews Communication Systems

(EST. 1976 - ACN 001 968 752)

**WE WILL NOT BE UNDERSOLD  
ON ALINCO RADIOS**

- ★ IC-756 HF+6M, DSP, LCD
- ★ IC-R10 HAND HELD SCANNER
- ★ WS-1000E CUTE SCANNER
- ★ DX-70TH HF+6M 100W
- ★ MFJ TUNERS AND CONTROLLERS
- ★ DX-1600 HF LINEAR AMP.
- ★ AR-7000 DSP. LCD. SCANNER

**3 YEAR WARRANTY ON  
OUR ALINCO RADIOS**

Call us now

**(02) 9636 9060** or (02)  
9688 4301

SHOP 8, 41 BATHURST ST, GREYSTANES,  
N.S.W. 2145. FAX (02) 9688 1995

## ■ DXpedition

# The Heard Island Experience

Stephen Pall VK2PS\* talks to David VK2DJM about his part in the historic Heard Island DXpedition.

"I raised my finances myself, which were substantial. The participation fee was \$US10,000, plus return fares to Reunion, plus incidental expenses, arctic clothing, cameras and films, etc."

"You had no sponsors at all?"

"No, I had sponsors, but not many. About four VK/ZL individuals donated money, the VK2 WIA Division contributed \$150, and about seven amateur radio clubs supported me with some funds. A few commercial firms also assisted the group. Colgate-Palmolive donated personal hygiene articles for the whole team. Australian Geographic Magazine promised to buy some of my photos. Sphere Communications Pty Ltd of Kingsford NSW provided the team with a complete weather station, designed and manufactured in Australia, which proved to be very useful during our stay on the island. This weather station electronically records the speed of wind, the direction of wind, indoor-outdoor temperature, windchill effect, rainfall and barometric pressure. The device is called Ultimeter 2000.

"I also tried to raise money by starting my philatelic envelope project. Other members of the expedition had similar ideas, so it became a common money raising project for the whole DXpedition."

"I understand each amateur, besides being a duty operator, had a special task allocated to him. What was yours?"

"My task was disaster management. I was responsible for the physical safety of antennas, equipment and personnel. In the case of an accident it was my role to have an emergency disaster plan put into operation," says David.

David is well qualified for that particular job. He is actively involved in the State (NSW) Emergency Service. He was directly involved in the 1986 major floods and storms in the Sydney region, in the Newcastle earthquake emergency, in the violent windstorms in the Kuringai area, and in the ravaging bushfires in Sydney in 1994. His six years of army reserve training, connected with operational and strategic communication systems, gave him a good background to his amateur activities. Now that he has been injected with the "DX virus" his next plan is to upgrade his Morse skills to



David VK2DJM with family teddy bears.

David and I are looking at hundreds of photographs. Snow capped peaks, pebble beaches, black volcanic sand, glaciers, birds, accommodation shelters, elephant seals, penguins, bearded radio amateurs, antennas and radios.

One of the pictures shows a bearded radio amateur and three teddy bears sitting on an operating table next to an FT-1000. The teddy bears belong to the amateur's children, Alexis (5) and Renee (2).

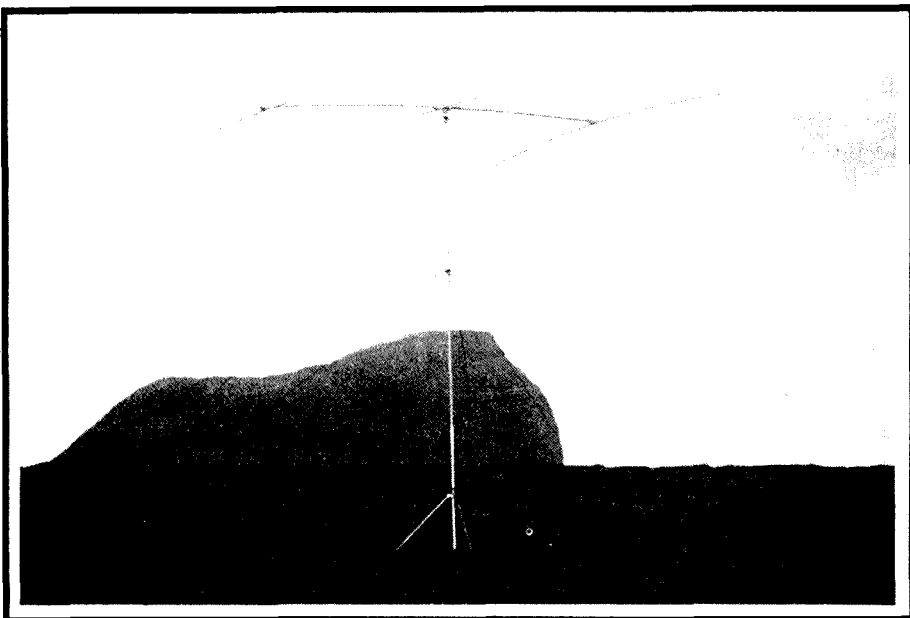
Their father promised to take the teddy bears on a long long journey and bring them back when he returned. These teddy bears have special names. The biggest teddy is named Campbell, honouring the first Australian radio amateur who activated Heard Island in 1947, Allan Campbell-Drury. The second teddy's name is Adele, named after the millions of penguins inhabiting the Antarctic. The third bear is Bee-Bee,

named after Big Ben, the island's 2745 m high, active snow-capped volcano.

"What made you go to the island and how did you find out about the expedition?" was my opening question to David.

"I heard some news about a 1995 failed attempt to go there. Later, magazine articles and amateur radio news-broadcasts triggered my memory. The Internet web site gave me quite a lot of information about the proposed expedition. It seemed to me to be an exciting task to go to an unusual Australian Territory," replied David VK2DJM, the only Australian amateur who was part of the twenty man expedition. Carlos NP4IW, the twenty first member had to withdraw at the last moment.

"How did you manage to get there. It is so far away and it is quite a costly undertaking?" comes the next question.



**One of the mono-band antennas with "Rogers Head" in the background.**

obtain a full licence. David is currently employed by GEC Electronics as operations and quality assurance manager. He is married to Kathy and his two daughters adore him.

"How was the journey on the ship?" comes my next question.

David is looking around on his cluttered desk. He picks up the photo of the ship and shows it to me. "The French polar ship, the "Marion Dufresne" is a very up-to-date and modern ship, specially designed and manufactured for Antarctic work. It took me 22 hours to fly from Sydney, via Melbourne and Mauritius, to Reunion and six and a half days by ship to arrive at Heard Island.

"We had other passengers on board too. Some relieving French teams for other sub-Antarctic French bases. Professor Harold Heathwell, a scientist specialising in micro-organisms, who took part in one of the 1983 DXpeditions, was there as a passenger. He gave valuable background briefing about what we could expect on the island.

"There were daily training seminars for the DXpeditioners. In addition to the seminars, all the equipment was unpacked, checked, and repacked into manageable sizes for helicopter transport at the landings. The weather was excellent going to the island, but very stormy coming back. Many of the DXpeditioners were seasick. I had the

good fortune not to be affected by the movements of the ship," says David with a smile.

"And the landing?"

"The excitement of the DXpeditioners was very high but finally we arrived at the island of our dreams which was to be our home for the next 20 days. We were stunned by the harshness and the beauty of the island, with the sight of the glaciers, with the snow capped peak of Big Ben, with the black volcanic sand and with the view of the ramshackle ruins of the former ANARE station.

"It took 52 flights for the specialist French "Lama" helicopter to land all of us, plus the 34 tons of equipment, in Atlas Cove. The helicopter's capacity is one pilot and four passengers, or one pilot and 800 kg of freight. The French were very helpful and cooperative all the time. It took us a total of 58 hours to construct our camp and be fully operational. The ship was anchored offshore at a distance of about three kilometres, and did not sail until it was considered that the expedition was safe and consolidated on the island."

"Did you operate much?"

David's eyebrows turn into a question mark. "Quite a bit, actually," comes the soft reply. "All the expeditioners were scheduled into a minimum of three-hourly operational shifts at least twice in 24 hours. This meant at least six hours or more before a microphone, or with the

key for the CW operators. The rest of the time was spent with other allocated jobs, like kitchen duty.

"Being responsible for the physical safety of the "village", every day I inspected every shelter, every mast or other equipment, every anchorage point and the guying ropes of every mast. We had winds sometimes up to 130 km/h so it was vital that our equipment was in good shape. Sometimes we had sunshine, but we had snow, hail, sleet and small hail pellets which flew horizontally against anything with incredible speed.

"The weather pattern was very changeable, even for very short distances. One could leave the shelters in calm weather to walk the distance of 700 metres to the operational tent, only to arrive in a rainstorm. We had three radio tents, one for CW, one for SSB, and the third one for RTTY and the centralised computer equipment. The distance between the CW and SSB tents was such, that it enabled simultaneous operation by both modes on the same band.

"Sitting on the receiving end of a pile-up was an awesome experience for me. It required steel nerves and absolute concentration. The band, not counting the pile-up, was remarkably quiet. No QRM, and no QRN, except for some very violent atmospheric crashes on 160 and sometimes on 80 metres. It was also nice to hear the excited voices and the many thank you comments when contact was made with other parts of the world."

I then asked David the controversial question which is still a sore point with some VK and ZL amateurs. "In what way did the use of modern technology influence the outcome of the expedition?"

"An elaborate computer network was used for logging the contacts. This simplified and centralised the logs for easy transfer to other systems, which enabled the individual with Internet access to check whether he was in the log. Messages to and from the island were relayed via PACSAT to the pilot centre in Belgium, from where they were distributed on the packet and Internet systems.

"Interestingly, one of the pin diodes of the PACSAT equipment developed a

fault and became hot and unstable. The "box", when not in use, was wrapped in a plastic bag and placed outside the tent in the cold. Within a short time it recovered completely. The information on the Internet was used by many non-amateurs, schools, students and individuals. It created an enormous interest."

Our formal interview with David was interrupted at this stage by mutual consent. A lengthy discussion and exchange of views followed, including discussing the poor participation rate of the VK/ZL amateurs. A total of only 713 QSOs out of nearly 25,000 amateurs in both countries; or, on average, one contact for every 35 amateurs. There were many multiple contacts on different bands and modes so the 713 figure might go down as low as 600 individual amateurs.

Not entirely agreeing with each other, we came up with the following hypothetical answers:

a. The VK/ZL amateur fraternity was not prepared for the intensive non-amateur technological backup which heavily influenced the 24 hour activity-planning by the Heard Island personnel.

b. With reference to the role played by the packet and Internet systems, the packet system is amateur operated, is free and, in Australia, quite slow and sometimes plagued by hiccups. Quite often it took up to seven days for the DX news to reach the individual packet user. In contrast, the Internet is virtually instant, but is accessed only by very few users among Australian amateurs. Some limited access is available to the Internet via employers (do they know about it?) and educational institutions, but most of the amateurs with this access are not DXers, or even users of the HF bands, so the opportunity of news dissemination was not explored nor used.

c. To our knowledge there is no active packet and/or other type of DX Cluster anywhere in Australia (if there is, let's hear from them!).

d. The decision as to what bands and modes would be used the next day, and to what direction or into which countries, was made 24 hours beforehand on Heard Island, and was immediately advised to the Belgian Pilot Centre. The decision was made by Peter ON6TT and was



**The VK0IR team. (l to r - standing) Bob N6EK, Hans HB9BHW, Arno OE9AMJ, Bob K4VEE, Ralph KOIR, Bob KK6EK, Peter ON6TT, AI W3VN, Mike N6MZ, Wes W8FMG, Michael E8AFJ, James 9V1YC and Willy HB9AHL. (l to r - sitting) Harry RA3AUU, Kurt HB9AFI, David VK2JDM, Ghis ON5NT, Arie PA3DUU, Glenn W0GJ and Mike KOAJ.**

based on personal experiences, on beacon observation reports, and analysis of the previous days logs. It was also based on some computer propagation modelling and, in large part, on the feedback coming from the pilot stations. There was one pilot in Japan, one in Europe and five in the United States. One of the US pilots also had the duty to act as a monitor for the Pacific region. These pilots were accessible via the Internet and packet, but the Internet was the preferred mode. There was no pilot station in the VK/ZL area. Why? Because, according to David, nobody volunteered to become a pilot despite David's urging and calls for the support of a VK/ZL pilot. Nobody came forward. Did the "I'm all right, Jack" syndrome raise its ugly head among our DXers, or did we really not have the access capability to the Internet? Did any feedback come back via the pilots from Australia to Heard Island? We do not know. Not yet! I am now trying to find out the answer to this question from appropriate sources, so please be patient. It is possible that there was no feedback or minimal feedback from Australia and the decision-makers assumed that there was no propagation and that we could not hear them. But we, on this end of the "wet string", did hear them, sometimes quite loud on 80 metres, but the island was working JAs and Europeans.

e. There is a slight possibility that

some of the island operators were carried away with their individual success, and just forgot the big bulk of VKs and ZLs.

f. Propagation favoured more the south-north direction but not so much the west-east direction.

g. Directional antennas were used by the expedition into specific target areas.

h. There were no press, radio or television news reports in the Australian media about the expedition. Only once, in a news item in the *Sydney Morning Herald*, which reported a possible eruption of Big Ben on Heard Island, was mention made (two lines) about amateurs being on the island. Whose fault is this? Or was it a fault? We do not know! Was this amateur activity also ignored by the European, Japanese and North American media? We do not know!

In my personal opinion a golden opportunity has been missed by all of us for not presenting the amateur fraternity as a serious, science-oriented body, which will go to great lengths and expenses to explore new communication methods and propagation patterns by pushing the horizons of communication science to its most distant limits.

After a frustrated one hour discussion, David and I resumed the interview.

*"How can you describe the every day life on the island during these three weeks?"*

*"There were five people on radios, five people were sleeping, a number of*

the off-duty operators undertook some hikes around and outside the campsite (as a rule, for safety reasons, three people had to cluster into a hiking group), others attended to every day chores, cooking, housekeeping, cleaning, and there were some constantly attending the satellite equipment.

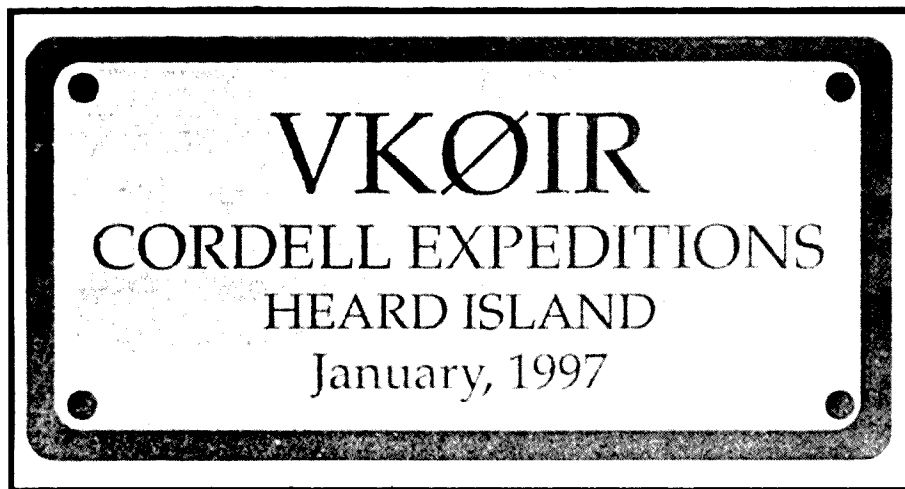
"We had plenty of food. We had at least one hot meal a day. There was a variety of tinned meat, rice, vegetables, stew, hot soup. Breakfast was self serve and included cereals, milk, bread, plenty of orange juice, chocolate and fruit. During the day we had all sorts of snacks. We carried four tons of food for the three weeks. We had plenty of drinking water in huge plastic tanks. We had a perfectly working prefabricated toilet, with bowl, urinal, hand basin and a mirror on the wall.

"The type of clothing and its use was an individual decision. We slept in sleeping bags on some sort of underlay mattress. We were prepared for any medical emergency. The only casualty was at the beginning of our stay on the island, a dislocated shoulder. We had three highly respected medical specialist doctors among our DXers and they were prepared for any emergency. The weather changed very quickly, from clear sunshine to stormy conditions. We had heavy snow fall for two days, but plenty of sleet and hail on other days.

"Big Ben, the active volcano, was at a distance of nine kilometres and the base of the mountain was three kilometres to the top. The volcano constantly vented steam from one or two fissures on the south-westerly slope of the mountain. We had two and a half sunny days when the mountain was totally visible in its majestic beauty. It was an unforgettable sight!

"Despite the bad weather we never lost an antenna mast, except the 80 metre vertical which broke due to wind pressure on the very first attempt. We had some bent antennas and we lost some aluminium elements. Wildlife was in abundance."

David stops his story and reaches into the pile of photos. Elephant seals, huge colonies of penguins, seals, skua birds, albatrosses, a handle of an old spade almost totally covered by moss, are shown in the photo prints.



**Fig 1. The plaque fixed permanently near the old ANARE huts as a memento of the January 1997 VKØIR activity.**

"Well, to say it in one sentence. Life on the island was very busy, but totally lacked any real normality compared to our usual daily life." A long pause. David is in deep thought as he remembers the past weeks.

"We left nothing behind," starts David again. "We reduced the whole camp into bits and pieces within hours and took it back to the ship by helicopter. Only two mementos were left behind. One was a VKØIR coffee mug, left in one of the ANARE emergency huts, which are still in reasonable condition. The other was a small plaque bolted into a rock face (see Fig 1).

"The indentations, made by our shelters and our boots on the sand and on the land, disappeared within hours; wind and sand movement took care of that. Heard Island returned to its tranquillity as the very distant outpost of our land. The Heard island DXpedition was moving out."

*"Everything must come to an end. How was the journey back from the island?"*

David looks at me, with a glimmer in his eye. "Everybody was very happy to be going home. It was great to see the ship emerging from the mist on the horizon. It was a fantastic feeling to see the helicopter flying towards us. The first hot shower on the ship was fantastic; some of us went back to have a hot shower for the second time. For the next few days everybody was fast asleep. Only a few attended meal times. It was total relaxation.

"Little did we know what was ahead of us. Before reaching Kerguelen, we had very heavy weather. Twenty metre swells, 60 to 70 knot winds, and a DXpedition of sea-sick radio amateurs. Fortunately, I was not affected. I was on the bridge admiring and experiencing nature at its wildest. Waves many stories high swamped the bow of the ship and the upper deck. In the dining room everything was topsy-turvy, chairs became mobile, cups, glasses and bottles were sliding on tables.

"We had a short stopover on Kerguelen. Some ship's personnel disembarked, others boarded, but there was no radio activity as such. Although there was an exception. Ten individual contacts were made with a South African amateur, who will wonder for a long time why he had 10 contacts with 10 different operators with the same callsign from Kerguelen island. The expeditioners used one of the official transmitters on the island for these short QSOs," said David, concluding the interview.

Within 24 hours of arrival back on Reunion, there were no more DXpeditioners left there. All returned to their countries in the knowledge that they have done a magnificent job and that the name of Heard Island will now appear at the bottom of the list of the "most wanted" countries in the DXCC world.

*\*PO Box 93, Dural NSW 2158*

*© This article is the intellectual property of Stephen Pall VK2PS and is copyright. No part or the whole may be reproduced in any form without the author's written permission.*

**ar**



## ■ Administration

# WIA Federal

# Discussion Paper

## Response to the IARU Future of the Amateur Service Committee

Prepared by Grant Willis VK5ZWI and David Wardlaw VK3ADW

### 1.0 Introduction

At the International Telecommunications Union (ITU) World Radio Conference to be held in 1999, the international regulations governing and defining the nature of the Amateur Radio and Amateur Satellite services are due to be reviewed. In response to this, the International Amateur Radio Union (IARU) set up the Future of the Amateur Service Committee (FASC) to look at the regulations with the aim of proposing changes that are representative of what the global Amateur Service wants today.

A major forum for the WIA to have an input to the IARU work on this issue arises in September this year at the IARU Region 3 conference in Beijing. A sub-committee within the WIA Federal body has been looking at the FASC papers and has prepared the following discussion paper for members to consider. Member feedback can be sent to the WIA IARU Liaison officer, David Wardlaw VK3ADW, PO Box 2175, Caulfield Junction, VIC 3161, and should reach David no later than 30 April. This will allow the WIA time to prepare a final paper for presentation in Beijing.

### 2.0 WIA Position on FASC Papers – Reviewing the Amateur Regulations

The WIA sub-committee considered each of the ITU regulations and how they impact on Amateur Radio today and in the future.

#### 2.1 The ITU definition of the Amateur Service

*S1.56 Amateur Service: A radio-communication service for the purpose of self training, intercommunication and*

*technical investigations carried out by amateurs, that is, by duly authorised persons interested in radio technique solely with a personal aim and without pecuniary interest.*

Generally, the WIA sub-committee felt that the definition of the Amateur Service was quite appropriate. Discussions with Federal Council raised the possibility of changing the words “self training” to “continuous self training”, to recognise that amateur operators are learning all the time, especially considering that the amateur service does have an experimental nature both in hardware and in operating techniques. What do members think? Is this something that should be pursued?

#### 2.2 The Banned Countries List

*S25.1 (1) Radiocommunications between amateur stations of different countries shall be forbidden if the administration of one of the countries concerned has notified that it objects to such radiocommunications.*

The WIA sub-committee proposed that this clause should be modified or even deleted. This regulation has negative impacts on the amateur service's ability to handle natural disaster traffic in the case where communications are required to or via a banned country. The notification requirements were also a concern, as the process to notify the amateur service may not work effectively in all countries. This could result in international stations contacting a banned country unknowingly, thus breaking the law in both countries as a result of the ITU treaty, a situation which does not seem fair where the notification process breaks down.

The WIA sub-committee considered the following:

1. This regulation could be dropped from the ITU regulations, leaving it to the individual administrations to prohibit their own citizens from communicating with other countries.

2. Modify the wording along the lines of “countries have the right to limit international communications except as needed for disaster communications”, a statement which is already supported by the ITU through resolution 640 which indicates support for the amateur service performing disaster communications duties. This supports the role of the amateur service in disasters, while not addressing the notification issue.

Which approach would members prefer the WIA take?

#### 2.3 Plain Language Communications

*S25.2 (2) (1) When transmissions between amateur stations of different countries are permitted, they shall be made in plain language and shall be limited to messages of a technical nature relating to tests and to remarks of a personal character for which, by reason of their unimportance, recourse to the public telecommunications service is not justified*

It was considered that the natural meaning of the words “plain language” doesn't cover any form of communications other than by voice, CW or other internationally recognised code. The modern interpretation of this has been to prevent Amateur Operators from using encryption, which is important in the detection of pirate stations operating in the amateur bands and policing the content of amateur transmissions, from an administration's point of view.

Use of the words “not obscuring meaning” was considered as a way of covering the encryption argument but this appeared to have other implications. For example, if someone chose to say “in plain language” the statement “Station 1 Code 4” then the meaning could well be obscured.

The final suggestion was that the regulation could be re-worded as “an Amateur Station is not permitted to transmit a signal that cannot be decoded

and understood by a third party". An exception that should be considered would be the use of "telecommand" applications for the Amateur Satellite Service, which by their nature require encryption to ensure spacecraft integrity during command activities, a point which was raised by AMSAT.

Member feedback on the WIA's recommendation is sought.

## 2.4 Third Party Traffic in the Amateur Service

*S25.3 (2) It is absolutely forbidden for amateur stations to be used for transmitting international communications on behalf of third parties.*

*S25.4 (3) The proceeding provisions may be modified by special arrangements between the administrations of the countries concerned.*

The third party international regulations have been twisted the most over the last few years, in particular with the advent of the global amateur packet radio network. The natural meaning of "third party" means that the passing of traffic from one amateur to another via a third amateur should be banned with the exception outlined in S25.4. This is quite clearly unacceptable in today's amateur radio service.

Dealing with the problem is complicated as it covers so many aspects of the hobby. For example:

(1) Amateurs passing traffic from Amateurs to Amateurs via Amateurs (eg Packet Radio);

(2) Amateurs allowing non-amateurs to speak over their stations (eg JOTA);

(3) Amateurs passing messages on behalf of non-amateurs (eg the USA Traffic Nets); and

(4) Amateurs passing National and International disaster communications (eg WICEN).

One proposal was that the third party regulations should be dropped and that regulation of third party traffic be undertaken at a national level rather than an international one. This raises further concerns:

(1) Not having the international regulation may hinder the ability to control undesirable types of traffic on amateur radio (although the traffic content restrictions and encryption

aspects elsewhere in the regulations should cover this);

(2) The international authorities may feel that their ability to regulate is being eroded; and

(3) There may be a fear in some countries that removing this regulation may affect the revenue for their local telecommunications carrier

Not all of these issues directly affect amateurs, but will potentially be considerations by administrations when they consider this issue.

A minimum consideration would be to modify the regulation to allow activities such as disaster communications, packet radio, JOTA, NTS and others to continue and develop in the future.

Suggestions from members are welcome.

## 2.5 Morse Code Treaty Requirement

*S25.5 (3) (1) Any person seeking a licence to operate the apparatus of an amateur station shall prove that he is able to send correctly by hand and to receive correctly by ear, texts in Morse code signals. The administrations concerned may, however, waive this requirement in the case of stations making use exclusively of frequencies above 30 MHz.*

The Morse code issue is always a contentious one. However, in the context of the international amateur radio regulations, there are some issues to be considered which have not been raised in much of the public debate.

Is the Morse code treaty requirement going to hinder the development of the Amateur Radio Service in developing countries where Morse code testing proficiency may not be available these days? In some countries, this may be a major barrier to increasing the number of Amateur Operators. It should be a goal of every amateur society in the world to increase the number of Amateur Radio Operators globally.

Within the Amateur Radio Service, current Morse code testing is not uniform across the world. The ITU Amateur Regulations do not set down a uniform standard for Morse code testing. This does generate problems for reciprocal licensing and complicates

moves towards an international amateur licence.

Looking to the future, a review of the Amateur Regulations by the ITU may not occur again for 30-40 years (the last one was in the 1950s). It concerned the WIA sub-committee that retaining Morse code as a treaty requirement could hinder the future development of amateur radio. The suggestion was that we should be seeking to achieve some flexibility so that the issue of Morse code testing could be reviewed in perhaps 10-20 years or even less, without having to wait until the issue can again be placed on the ITU World Radio Conference agenda.

Considering the future, and the likely ITU time scales, the WIA sub-committee recommends that Morse code proficiency be dropped as a treaty requirement, but be retained by national administrations. There are potential problems with this approach, one of which is reciprocal licensing.

Another solution considered was to have Morse code, as well as the other technical qualifications required to be an amateur operator, grouped into an ITU-R recommendation which is incorporated by reference into the ITU radio regulations. This approach was first introduced at World Radio Conference '95. An ITU-R recommendation is more readily able to be amended, between WRCs if required, and allows Morse code to be retained currently at the ITU level but be reviewed in a time frame that can be set more easily by the amateur service in the future.

In Australia, it is recognised by the WIA that, presently, a majority of members still wish to retain Morse code testing. The WIA is not currently seeking to remove this requirement in Australia. However, on the international scene, there is merit in the amateur service being able to control the timing of the next review of the Morse code requirement. Either approach achieves the goal of being able to review the Morse code requirement in a time frame to suit the amateur service, rather than one to suit the ITU.

Which proposal would the membership prefer the WIA to follow?

## 2.6 Operator Technical Qualifications

S25.6 (2) Administrations shall take measures as they judge necessary to verify the operational and technical qualifications of any person wishing to operate the apparatus of an amateur station.

The WIA sub-committee considered the need for these qualifications a fundamental aspect of the amateur service, as they define the unique self training and education aspects of amateur radio. The present problem is that individual administrations are left to decide what topics amateur operators should be examined on. The IARU suggestion is that the broad topics that amateur operators need training on could be covered in a document incorporated by reference into the ITU regulations.

Re-arranging the statement requiring amateur operators to be qualified could assist in providing for an international amateur licence. There have been some moves by IARU to look at ways of achieving this, and the WIA sub-committee recommends that any moves to establish an international amateur licence should be encouraged.

## 3.0 Conclusion

The issues presented here are open for input by members. If you have any points you would like to communicate to the IARU Liaison officer and the WIA sub-committee, write to the WIA at **PO Box 2175, Caulfield Junction, VIC 3161**, or fax us on **(03) 9523 8191**. E-Mail is also acceptable to [gwillis@dove.net.au](mailto:gwillis@dove.net.au). Please ensure that your responses reach us no later than 30 April 1997.

ar

## QSP News

### WRTC-2000

Since the outstanding success of the WRTC-96 (World Radiosport Team Championship) held at Silicon Valley, North California in July 1996, there has been speculation where the next event will be. It would have been appropriate to hold it in Australia during the Olympics, but the facilities (52 compatible stations) are not readily available.

On 13 February the Slovenia Contest Club at Ljubljana, Slovenia, announced that, following approval from the WRTC Committee, they will host WRTC-2000. Tine S50A, Robert S53R, Franc S59AA and Leon S59A are in the process of defining the basic criteria for the selection of competitors and other organisational preparations.

The selection of competitors for the WRTC-96 was by the World Committee and was based upon the results of the world contests over the years prior to 1996. In 1996 Martin VK5GN and David VK2AYD represented Australia.

WRTC-2000 will continue to carry the WRTC into the 21st Century. It will

be a mile-stone event in amateur radio contesting. Let's make sure Australia is again represented.

*(News item from David Pilley VK2AYD)*

### ICARE '97 Conference

ICARE (International Council for Amateur Radio in Education) will hold its third annual Conference in Durban, South Africa from 9 - 12 July 1997.

I quote from the information received: "ICARE '97 provides a forum for teachers to share amateur radio projects which have been successful in the educational environment. It provides ideas for those who have not yet taken amateur radio into school. It helps set up a framework for links with schools and teachers not only over the airwaves but also via the Internet and the magazine AMRED".

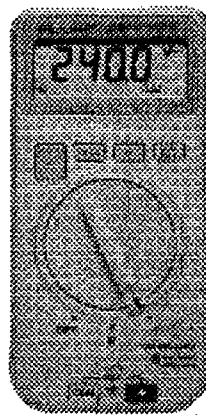
Conference proceedings are published and circulated to Country Co-ordinators. For further information, contact Brenda VK3KT.

*(News item from Brenda Edmonds VK3KT)*



**YOUR HOBBY** **YOUR VOICE**  
Representing Radio Amateurs - Since 1910

**RECRUIT  
A MEMBER &  
THEY COULD  
WIN!  
THIS GREAT  
FLUKE 12B  
DIGITAL  
MULTIMETER  
WORTH \$195**



**THERE'S A WINNER  
EVERY MONTH FOR 1997  
12 PRIZES TO BE WON**

This latest hand-held DMM, from the world-leading maker of digital test instruments, has advanced features yet is simple to use. Ideal for tyro & veteran.

#### The Fluke 12B measures:

- ac and dc voltage (with auto-selection)
- resistance & capacitance (.001-1000μ)

#### The Fluke 12B features:

- 4000-count liquid crystal display
- simple rotary dial
- diode and continuity testing
- indicates intermittent opens & shorts
- 2-year warranty

**Fluke 12B prizes generously donated by Philips Test & Measurement.**

Each month's prize is awarded by way of a draw among newly recruited members each successive month and presented to the winner at the earliest opportunity following the draw.

**To sign up a new member, use the back of your AR magazine address leaflet - or clip the coupon, have them fill it out and send it now.**

**SEND TO YOUR DIVISION'S ADDRESS, SHOWN ON PAGE 56.**

✂-----  
Please send me a membership application.

NAME .....

ADDRESS .....

..... P/code .....

Call Sign (if any) ..... [AR 1-11/97]

# ■ QRP Transceivers

## The DB 80, an 80 m SSB/CW QRP Transceiver

*Dr T C Choy VK3CCA\* shows that experimentation and home construction are still alive in amateur radio.*

### Introduction

What do you get when you cross an American Breed with an Australian Diamond? The answer is the Diamond Breed, a new QRP transceiver which I have built based on the earlier works of these authors and hence the name DB 80 (see Refs 1 & 2).

I was in the middle of constructing the Breed CW QRP transceiver when Drew's article appeared and so fate fell upon me to bring the two together. Gary's original article was an excellent account of his experience with the Motorola MC3362 chip, which was originally designed for mobile phones and other narrow band FM receivers. The resultant receiver based around this chip was excellent for its simplicity. The VFO, in particular, was a joy using only one coil and capacitor with excellent stability as compared to the need for a separate diecast-boxed FET based VFO of Drew's.

With an extra LM324 quad op amp and the MC3340 gain control chip,

Gary's receiver provides better audio bandpass filtering with an audio derived AGC system which improves the receiver's overall performance as well as providing the bonus of an S meter readout. However, Gary's transmitter was not easily adaptable for SSB work. I found the use of the LM6321, 2N3866 and MRF475 combination overly expensive. Having read Drew's article I decided to redesign this part, replacing the expensive LM6321 with an MPF102 FET + 2N2222 combination soldered dead-bug style around the pins on the original PC Board. I replaced the 2N3866 with a 2N3053 and the MRF475 with the IRF511 MOSFET. These combinations brought my project within the XYL's permitted recreational budget.

To bring the system to 80 m, I had to redesign the receiver front-end filter and the post-mixer filter on the transmitter. I wrote a Pascal program to do this several years ago when I needed to prove to myself that I can still cut it, ie to program and debug.

For SSB I used the original VK3XU modulator circuit with the exception that the BFO now comes from pin 2, a buffered BFO output from the MC3362 chip unused in Gary's circuit. A little more switching, plus a separate crystal oscillator, brought the development of this system to its completion. The latter was an extravagance as I found off-balancing the NE602 which Drew used in his circuit a little inconvenient. I like to match the sidetone oscillator in the transmitter circuit with my transmitted signal.

I am sure readers will have no difficulty building this transceiver. In fact, nice circuit board lay-outs already exist in the *ARRL Handbook*, although I constructed my modulator board using a piece of veroboard.

### Receiver Board

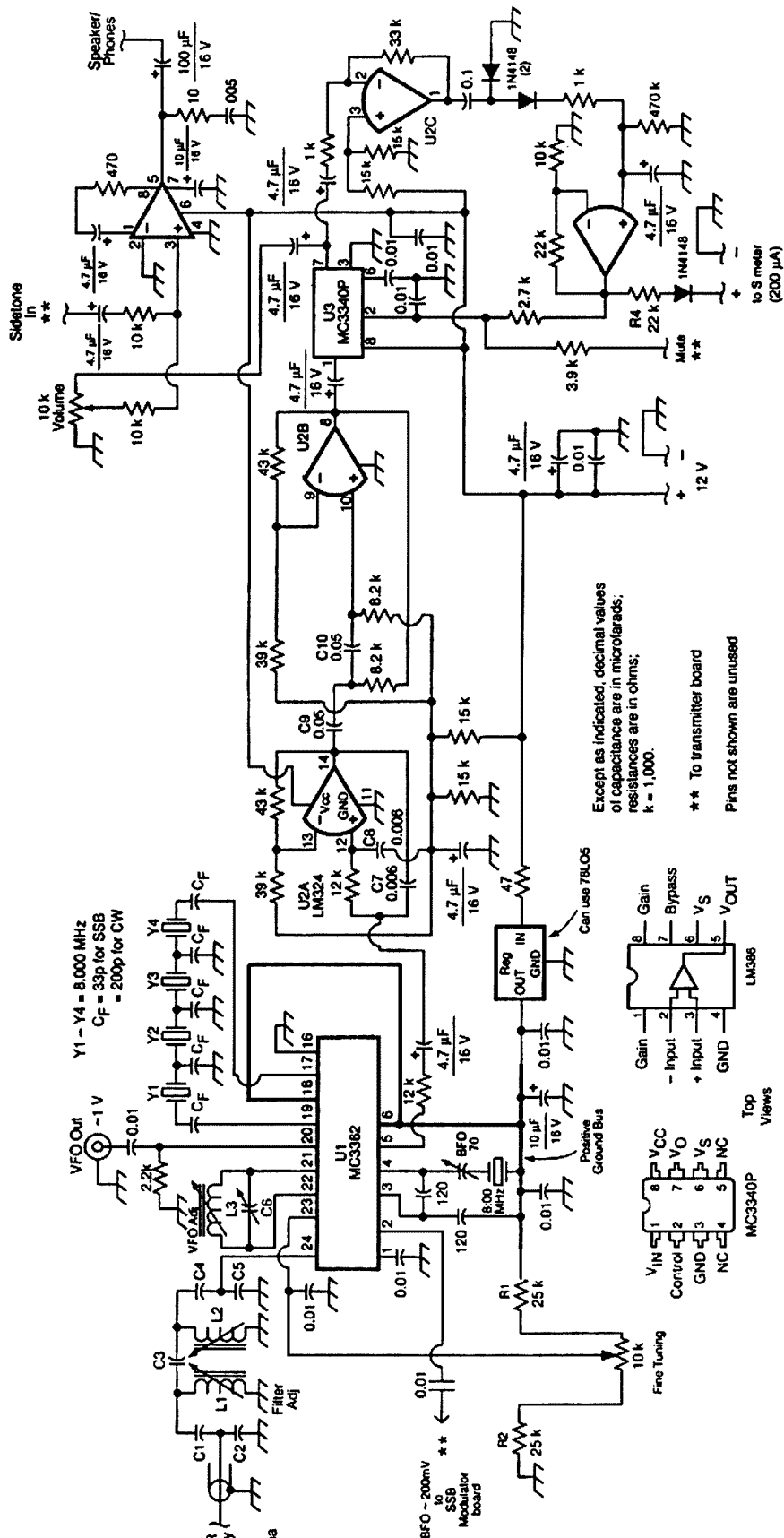
Figure 1 is the circuit diagram of the re-designed 80 m receiver. The main changes are the front end filter, crystal and audio filter inductor and capacitor values. The main tuning capacitor is an air spaced 140 pF variable capacitor in parallel with a 1100 pF polystyrene. I used the MC3362 varactor diode as fine tuning. Readers might like to wire in a more sophisticated RIT system with relay or diode switching. I found my circuit simple enough to use and leave it to the big boys with their expensive sets to RIT tune into me if I am slightly off frequency.

Two extra pin connections were made to the board, one to pin 2 (the BFO output on the MC3362 chip for the transmitter) and another to pin 7 of the LM386 chip to provide extra muting (see later). Construction of this board is straightforward but readers should know of two caveats that caused me some aggravation. The capacitor on pin 1 of UI should be checked for quality before soldering. My first prototype drew 100 ma of current and overheated the chip on completion due to this faulty capacitor. You can see my frustration in diagnosing this fault.

The ARRL's circuit board in the 1992 edition contained certain errors that required correction. Pin 11 on the LM324 was left ungrounded. Pins 6 & 7 of the MC3340 and LM386 chips were incorrectly wired. These errors led to a 10 dB loss in gain in my prototype board.



**VK3CCA with second operator Tiger. Immediately to his left on the desk top are the DB 80, Morse key and ATU.**



W<sub>A</sub> = 15 k to 25 k (depends on meter resistance) (200 μA)

Except as indicated, decimal values of capacitance are in microfarads; resistances are in ohms; k = 1,000.

\*\* To transmitter board  
Pins not shown are unused

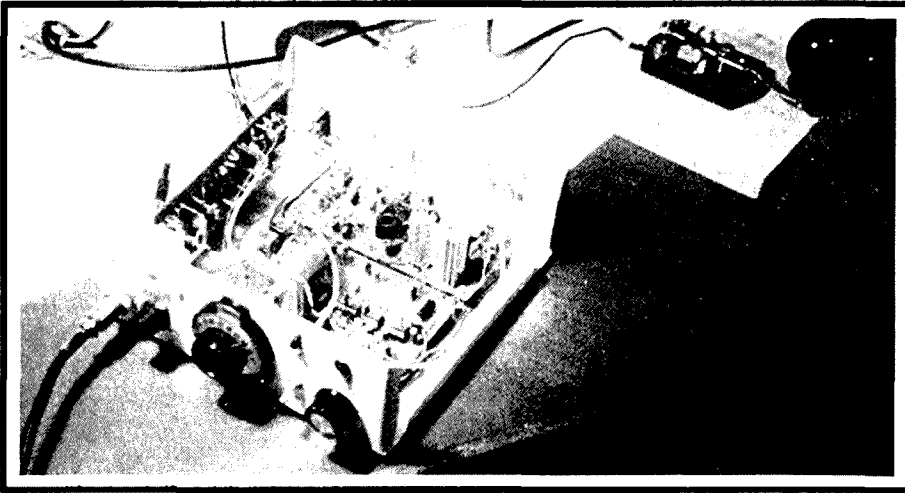
**Main Tuning**

- L<sub>1</sub> & L<sub>2</sub> = 5.5 μH (25 turns 24 swg on Amidon L-43-2 former)
- L<sub>3</sub> = 1.4 μH (12 turns 22 swg on Amidon L-43-2 former)
- C<sub>1</sub> = 390 pF, C<sub>2</sub> = 2200 pF, C<sub>3</sub> = 18 pF, C<sub>4</sub> = 470 pF, C<sub>5</sub> = 1300 pF, C<sub>6</sub> = 1100 pF polystyrene in parallel with 140 pF Varicap

For 80 m band (3.5 to 3.7 MHz)

# 80 metres SSB/CW QRP Receiver (Schematic)

Fig 1 - Receiver circuit using the MC3362, LM324, MC3340 and LM386 chips.



**The DB 80 with the cover off showing the placement of the three boards. Note the space left for a linear and/or frequency counter.**

The 78L06 chip is now rather hard to get but I found no loss in performance replacing this with a 78L05.

The most expensive part is the slow-motion tuning mechanism for the main tuning capacitor. I could find no cheaper alternative and had to pay \$23 at DSE. A plastic coupler is essential as hand capacity makes tuning impossible. I solved this when I found an old plastic rotary switch which, when dismantled, contained all the parts needed for a coupler. No doubt readers will have other solutions for this mechanical system.

The VFO and front-end filter coil formers were purchased from Stewart Electronics. They are, unfortunately, rather expensive with the set of five coils, including two more for the transmitter board, costing almost \$20. I am sure readers who have old transistor radio coil formers or the DSE R5040 coil set would like to experiment with these alternatives.

The receiver is very sensitive on this band, especially if your comrades on air are mostly not QRP. I had an S9+20 report from a VK2 station one night with a 20 dB attenuator wired in! The -123 dBm MDS quoted by Gary must be very conservative even on 20 m.

### Transmitter Board

I redesigned Gary's transmitter circuit (see Figure 2), removing the crystal oscillator parts to U1 and took a pin out via a capacitor from pin 6. The SSB modulator or CW oscillator signals now come to U1 via this pin.

The LM6321, as mentioned, was

replaced by a FET buffered with a 2N2222 IF amp. The driver is now the 2N3053 driving the IRF511 MOSFET power amp. This was biased as a Class AB amplifier for linear operation. This combination saved me dollars and dollars. The 2N3053 cost \$1.25 from DSE and the IRF511s about \$3.50 from Tandy. I later bought a whole bunch from SIM LIM's in Singapore for \$1 each! The original MRF475, 2N3866 plus LM6321 combination would have exceeded the budget for the whole project three times over! In particular, the latter video chip could only be purchased from Farnells at \$7 each if ordered in bulk. The keying power transistor TIP110 can be any NPN type capable of switching about 1A.

I have detected no bugs while constructing the transmitter board, which worked like a charm the first time. I do recommend keeping the oscillator components to U1 in initially and then removing them when the Tx board has been debugged and checked. The only minor problem on SSB was with RF feedback. This was more a function of the simple case I used. With a poorly matched antenna the muting circuit on the MC3340 is insufficient to mute the modulated voice coming back from the audio amp. Unless you love to hear yourself speaking, my recommendation is to work into a properly matched antenna with low SWR or to mute the LM386 completely by connecting pin 7 to the mute line. This problem is not so annoying on CW as the sidetone oscillator already makes a lot of noise.

### Modulator Board

This is directly borrowed from Drew's circuit (see Fig 2). The 741 op amp mic gain amplifier is standard. Note that I removed the 560 ohm resistor, although you may have to leave in if you have a low impedance microphone. The only way to adjust the 100 k mic gain resistor is on air. I recommend using a ten turn trimmer pot. I backed off the gain during early on-air tests when there were reports of over-modulation. More precise adjustments can be made if you have a two-tone oscillator and scope.

The NE602 circuit in the first mixer is a lot simpler than Drew's when I removed all the de-balancing and switching circuitry. The BFO from the receiver board goes directly to pin 6. I use a separate FET oscillator with a pair of diode switches for SSB and CW. A Cohn filter set is used in the modulator board which is a duplicate of the one on the receiver.

### Construction Hints

Both the receiver and transmitter boards are wired on the original PC boards from the *ARRL Handbook*. Everyone has his favourite technique of homebrewing PC boards. The one I opt for is John Grebenkemper KI6WX's technique [Ref 3] of producing a negative on transparency and then ironing it on and SLOWLY peeling the pattern off. Fortunately, my XYL is too busy pursuing other interests to know what I am up to with her iron.

The order of construction should be the receiver board, the transmitter and then the modulator board. I developed the latter on a veroboard. The metal case of about 20 x 20 cm was also home-made from a piece of aluminium. I left enough space for a 30 W linear later on as I intend taking this rig on my travels. Unfortunately, as you can see from the photograph, I did not leave enough room on the front panel for a digital frequency readout, so those with such an intention should leave some more space for it. One of the unfortunate facts of life is the different ways microphones are wired. You will need to determine that for yourself and keep to the same microphone for this rig. I have four rigs and no two microphones are interchangeable (manufacturers please note)!

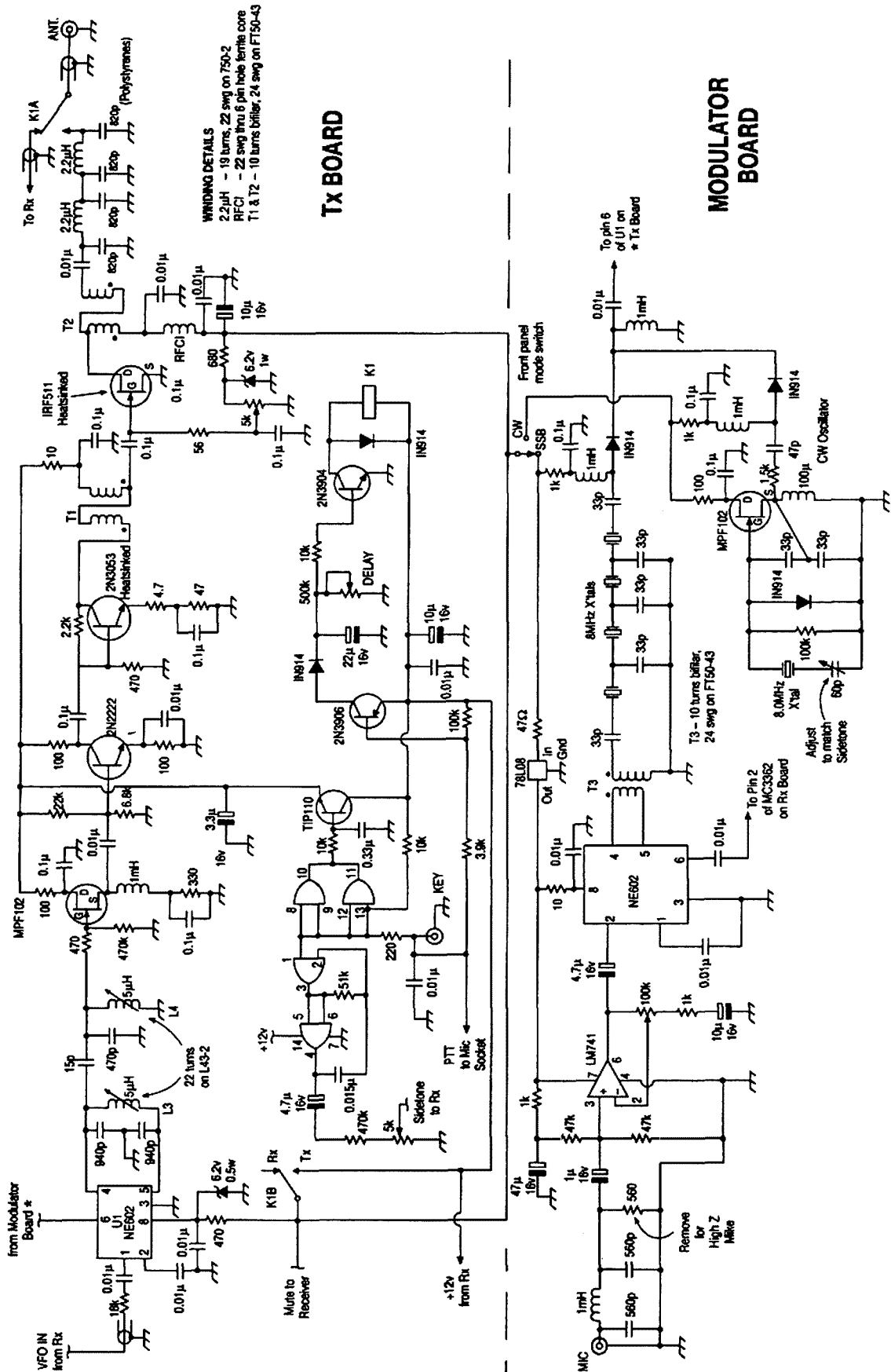


Fig 2 - Transmitter and modulator boards.

The various inductors and chokes were purchased several years ago when Jaycar had them in a mixed pack of 50 for \$5. Unfortunately, they no longer stock them so hamfests are about the only place if you want to cut cost.

The 140 pF variable capacitor is still commonly available through hamfests and I am sure most people will have these.

Not only should the various boards be built in stages, I recommend the transmitter, in particular, be tested from the post-mixer filter onwards, a stage at a time. Eventually, when you have burnt a 1 W resistor dummy load on the output during transmit and checked that the waveform is nice and clean, you can say bravo, QED, Eureka or whatever your nearest dialect equivalent is. The appropriate phasing on the balun transformers at the driver and RF power amp need some care unless you don't mind burning up a few of the RF transistors for self-education! Refer to Drew's original article [Ref 2] for more detailed drawings.

## Alignment

You will need a frequency counter or separate station receiver. The IF is 8 MHz and the VFO tunes from 4.5 to 4.3 MHz, so the transceiver covers the whole 3.5 to 3.7 MHz of the Australian 80 m band. Overseas readers should have no problem broadening the filters for their wider 80 m coverage, eg for the UK, 3.5 to 3.8 MHz. I do not recommend attempting to cover the whole of the US allocation, 3.5 to 4 MHz, with this transceiver as the band is too wide for the filter design here. There is some slight loss in power of about 10% at the lower end of the band, mainly due to a mismatch between my modified LM3261 circuit and the post-mixer filter in Fig 2. The cure would involve complications that are not worthwhile.

Make sure you adjust the BFO trimmer capacitor on the receiver board to the USB of the Cohn filter. This circuit differs from Drew's because of the lower VFO frequency. On-air adjustment is the simplest way. Tune to a QSO on the band and adjust the BFO trimmer capacitor for best clarity. I found a frequency counter and scope useful, although I have for

years lived with merely a home-made diode probe and digital multimeter.

The most tedious part is calibrating the S meter. I have a 200 microamp meter (internal resistance about 600 ohms), bought from Jaycar, and found the 22 k resistor correct for a 50 microvolt S9 input, using a homemade attenuator. Incidentally, if you intend to do this calibration, an oscillator like that on the modulator board with a colour burst crystal on 3.579545 MHz with a 100 dB step attenuator form the appropriate tools.

Having done it once, I guess readers need not repeat the task and simply use the value recommended.

On the Tx board the only major adjustment is the 100 mA bias current for the IRF511. The sidetone level and QSK delay are all a matter of personal taste. On-air the rig is a joy to use in spite of just 4 W QRP and the reports received have been very positive. I have worked VK1, VK2, VK5, VK7s and two reports from VK6 during the first week of operation. This was way beyond my expectations.

As I calibrated the mid-scale mark 50 on the slow motion dial for 3.6 MHz, there were some non-linearities on the scale at the edge of the band. Remember the square root law. In fact, some care has to be exercised at the band edges. I suggest marking these on the scale to prevent out-of-band operation. One way is to re-calibrate the scale but, in the longer term, I plan to squeeze in a frequency counter.

A 30 W linear is definitely needed when propagation conditions are not optimum. I am sure there are plenty of other possible improvements, including a dual band rig with a 9 MHz IF, as well as the possibility of a digital VFO with a phase-locked loop.

This rig is an ideal club project and a good introduction for someone wanting to master SSB principles.

## Acknowledgments

I wish to thank VK1TX for on-air assistance (he was my first interstate QSO when this rig was fired up) as well as VK2IET, VK3OK, VK1PK, VK5KKT, VK7AAQ and, in particular, VK6KVU and VK6MJF for their patience and their signal reports. Although I work at the Department of

Physics at Monash University, I wish to state that no resources of the university, neither parts, manpower nor workshop facilities were ever involved in this project. All parts were purchased at my own cost and construction done on my own time during weekends in my home garage workshop. It is, therefore, a "fair dinkum" homebrew which I strongly encourage any VK amateur to improve or reproduce.

The circuit Fig 1 is a modified version of the ARRL circuit in Ref 1. The circuit of Fig 2 is based on the ARRL circuit of Ref 1 and the Drew Diamond circuit of Ref 2.

## Parts list (Main items)

### Semiconductors

MC3362, LM324, MC3340, LM386, 2 x 78L06, 2 x NE602, CD4001, 2 x MPF102, 2N2222A, 2N3053, IRF511, TIP110, 2N3904, 2N3906, 741, 2 x 6.2 V Zeners and some 1N914 diodes.

### Crystals

10 x 8 MHz computer crystals.

### Inductors

5 x L-43-2 Amidon coil formers plus can and slugs, 2 x T50-2 toroids, 3 x FT50-43 toroids, a six hole ferrite core, assorted RF chokes and 1 DPDT PC board mounting relay.

### Miscellaneous

200 microamp S meter, heatsinks, slow motion drive mechanism, switches, pots, copper wires, etc.

### Sources

Jaycar, Dick Smith, Stewart Electronics and Rod Irving. Some parts are also available from the CW Operators Club through mail order.

### References

*Reference 1. A Portable QRP CW Transceiver by Gary Breed K9AY in QST, Dec 1990 and Jan 1991, also reprinted in the ARRL Handbook, 1992 edition and later editions.*

*Reference 2. TCF Sideband/CW Transceiver for 80 metres by Drew Diamond VK3XU in Amateur Radio Oct 1993.*

*Reference 3. Ironing out your own printed-circuit boards by John Grebenkemper K16WX, QST, July 1993*

\*7 Rees Street, Burwood, VIC 3168  
Internet address: tuck@sci.monash.edu.au

ar



# ■ Technical Technical Abstracts

Gil Sones VK3AUI\*

## Two Metre Mobile Comparison

A comparative review of two metre mobiles appeared in *QST* for November 1996. The review was conducted by *QST* Senior Assistant Technical Editor, Rick Lindquist KX4V. A panel of reviewers assessed the performance of the radios.

A previous comparative review from November 1995 *QST* was summarised in *Amateur Radio* for April 1996. The comparison of 9600 baud packet-ready radios in *QST* for May 1995 was given in *Amateur Radio* for October 1995 and this is also interesting reading. In this review only two radios were tested for 9600 baud performance. The radios tested for packet were those which had a data jack or connection. Neither had a specification for packet performance.

The Bit Error Rate (BER) information is of interest to anyone contemplating 9600 baud packet. In general, 9600 baud operation is considerably more difficult than the usual 1200 baud VHF/UHF operation. This is reflected in the results obtained in the BER tests.

The results obtained are contained in Table 1. The BER may be unfamiliar to readers. The BER is a measure of the performance of a digital communication circuit. It is simply a measure of the number of bits which are sent through the system incorrectly. A packet contains around 1000 bits so that if the BER is around one per 1000 or  $1 \times 10^{-3}$ , the system will be just about unusable. If the BER is 100 times better at one error per 100,000 bits or  $1 \times 10^{-5}$ , then the system will be much better and you may not notice the losses. The figures are shown in Table 1.

The sensitivity of the receivers is given in dBm and the impedance is 50Ω. This is used in preference to the input voltage in microvolts and is quoted for 12 dB SINAD. This allows a more meaningful comparison once you have

adjusted to the nomenclature. It also gives a better idea of how big a signal you will need to get good packet performance.

The transmit-to-receive turn-around time is of interest for packet operation.

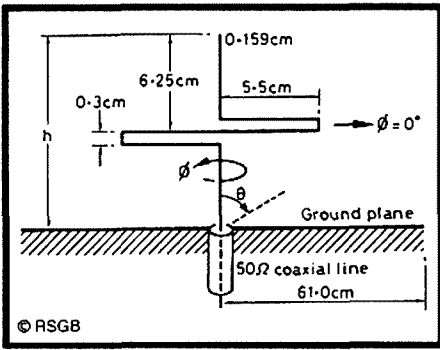
Table 1

Radio	IC2000H Icom	TM261A Kenwood	FT3000M Yaesu	DR150T Alinco	T-kit 1220 Ten-Tec
Sensitivity dBm for 12 dB SINAD	146 MHz -122.5	-123.5	-123.0	-123.5	-121.0
Two Tone 3rd Order IMD	146 MHz 69	74	70	61	61
Dynamic Range dB	20 kHz Offset				
	440 MHz		60	49	
Adj Channel Rejection dB	146 MHz 97	91	101	86	90
	10 MHz Offset				
IF Rejection dB	440 MHz 69				
	146 MHz 69	71	79	61	61
Image Rejection dB	20 kHz Offset				
	440 MHz 66	49			
Tx Out Power Watts	109	96			
	63	>120	(VHF) 81	(VHF) 67	76
Tx/Rx Turnaround Time m/S Data Mode			(VHF) 85	(VHF) 94	64
			(VHF)	(VHF)	
Rx BER 9600 Baud at 12 dB SINAD			1.8x10 <sup>-3</sup>	2.7x10 <sup>-4</sup>	
Rx BER 9600 Baud at 16 dB SINAD			1.1x10 <sup>-4</sup>	<1.0x10 <sup>-5</sup>	
Rx BER 9600 Baud at -50 dBm			2.3x10 <sup>-5</sup>	<1.0x10 <sup>-5</sup>	
Tx BER 9600 Baud at 12 dB SINAD (Rx Sig)			6.6x10 <sup>-3</sup>	6.5x10 <sup>-3</sup>	
Tx BER 9600 Baud at 12 dB SINAD + 30 dB (Rx Sig)			4.7x10 <sup>-4</sup>	1.6x10 <sup>-3</sup>	
Tx Current Amps	10	8.7	10.5	9.3	4.9
Rx Current Amps	<0.5	0.67	0.4	0.5	0.33

However, the prime thing is to be receiving or transmitting intelligible packets which is different to having full audio or RF. The figure given, however, does give an indication.

## Probe Housing

Max VK2ARZ sent details and a sample of a neat probe housing made from a container originally made to contain Blood Glucose Test Strips. The container is the one used by Boehringer Mannheim to package their Blood Glucose testing strips. It is an aluminium tube approximately 9 cm long and 3 cm in diameter and has a plastic lid.



**Fig 1 - Monopole loaded with modified folded dipole.**

Max built a signal injector into one of these, using a circuit from the ARRL Handbook. Max also suggested the use of these tubes to house an RF diode detector probe. The housing is very neat and these containers are fairly readily available. Many diabetics use the strips. There are other similar containers used for other medications. I have seen these containers used as canisters for 120 roll film.

The containers have a desiccant in the lid. This was at one time in a self contained snap-in module, but it is now built into the lid. You should exercise care in removing this and disposing of the desiccant.

The label is attached to these containers with a reasonably tenacious glue. You should peel off as much as you

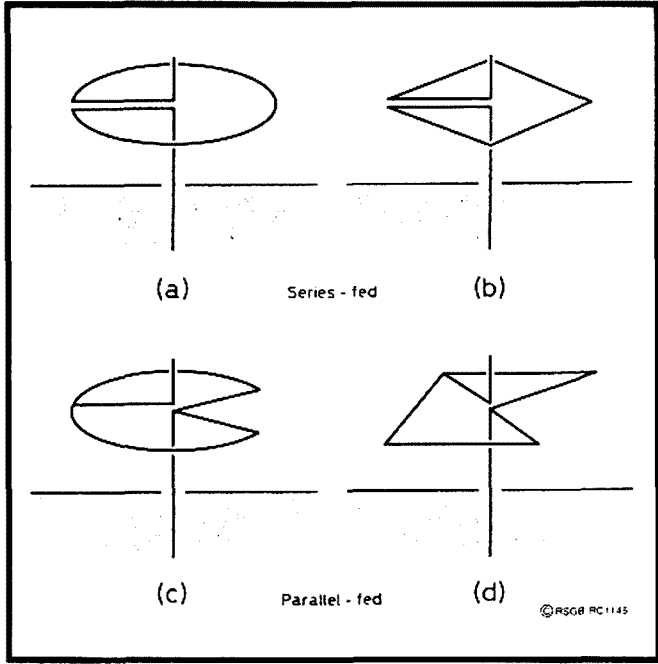
can, then will need to use a solvent to remove the rest of the label and the remnants of the glue. There are a number of solvents which will work. Eucalyptus oil is effective and is less offensive than some others.

Recently these containers have been made of plastic. The dimensions are the same and this change should not pose too great a problem to amateur reuse.

**Travelling Wave Loaded Monopoles**

Travelling wave antennas, or that part of the antenna where a travelling wave exists, have a substantially constant current and voltage along their length. This is often achieved using resistive loading as in a terminated rhombic or a terminated long wire. The result of resistive loading is some dissipation in the resistive element.

Dr Edward E Altshuler has described a series of monopoles where the resistive loading has been replaced with either a modified folded dipole, loop elements, or a pair of folded dipoles. These were described originally in a number of articles in the *IEEE Trans Ant & Prop* July 1961, July 1993, June 1996, and August 1996. The information appeared in a form for radio amateurs in the RSGB monthly magazine *RadCom* in Pat Hawker's *Technical Topics* columns in January 1994, October 1996, and December 1996.



**Fig 2 - Monopoles loaded with circular or square loops, series or parallel fed.**

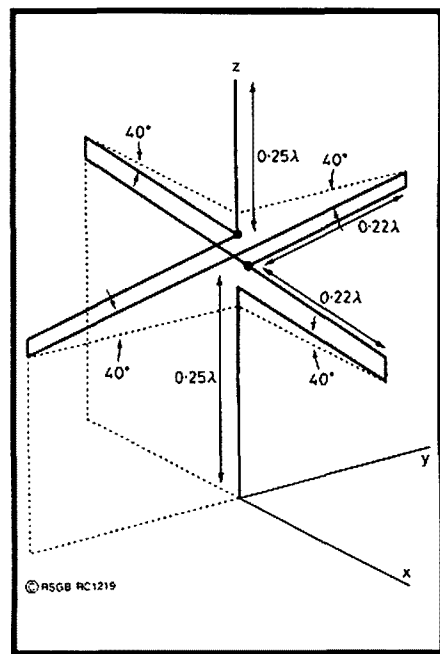
The first monopole antenna loaded with a modified folded dipole is shown in Fig 1. The lower segment of the antenna has a travelling wave current distribution and can be of any length. The antenna dimensions are for 1.2 GHz. There will be a mixture of both horizontal and vertical radiation. If a 240 ohm resistor was used in place of the folded dipole the bandwidth would be greater and there would be no horizontal component. However, the benefit of the horizon-

tal component of the radiation would be lost.

Further work involved the use of loop elements as the loading element. The use of a one wavelength loop provided circular polarisation over a 1.4 to 2.0 GHz bandwidth for a 1.6 GHz design. Both series and parallel fed loops were tried as the loading element. Optimum results were obtained with the loop element about 0.25 wavelength above the ground plane. The loop loaded monopoles are shown in Fig 2. These antennas were intended for use with satellite systems such as Iridium and GPS. Iridium is a system of low earth orbit satellites for a phone system.

The latest design uses two crossed folded dipoles as the loading element. This is shown in Fig 3. It is claimed to provide hemispherical coverage with circular polarisation. The folded elements are tilted up and down by 40 degrees to produce the circularly polarised wave. This is shown by the dotted lines in Fig 3. This design is covered by US Patent No 5,289,198 of 22 February 1994.

This is an unusual series of antennas which would be very interesting to experiment with. At 1.2 GHz the builders of repeaters in the UK found that the signal received by a mobile became of mixed polarisation due to the many reflections in some areas. Maybe one of



**Fig 3 - Double folded monopole.**

# ATN Antennas P/L

ACN 062 557 644

Exported to 46 countries  
on all continents

56 Campbell St  
(PO Box 80),

Birchip VIC 3483

Phone (03) 5492 2224

Fax (03) 5492 2666

- Australian made quality antennas. Log-periodics 7-30 MHz 11 el, 10-30-10, 13-30-6, 13-30-8, 13-30-9, 18-30-7, 20-30-6.6 models VHF/UHF LP to 50-1300-25. All alum tubing is 6353-T6, 15-25% higher tensile strength than imports. Insulators are Zytel, latest material, and all hardware is stainless steel.
- Monobanders, 40, 20, 15, 10, 6 and 2 m, 70 cm, HF and UHF CB, many models. Single band high gain VHF/UHF TV. Stacking harnesses + couplers, 2, 4, 6 and 8 antennas.
- Aluminium towers to 60 m. Many models incl fixed, tilt-over and Hazer tram where antenna and rotator can be lowered with no climbing.
- Create HD rotators, 5 models.
- Tower accessories, non conducting Kevlar guys and Dacron/polyester halyards, 3 sizes.
- Aluminium pulleys with Stainless Steel hardware.
- B&W continuous frequency coverage wire antennas, 1.8-30 and 3.5-30 MHz, 20/100 W and 1 kW.
- Baluns and power dividers.
- Diamond VSWR/Power meters, 10 models to 1300 MHz.
- 80/40 and 80-10 trap wire antennas.
- Single strand HD copper wire, insulators and accessories.
- Range of power transistors, driver and PA tubes; eg JAN (USA) 6146W, rugged, to replace 6146A, B and S2001, matched pair \$125 incl fragile pack/post.
- Matchall, all band, fully auto, antenna coupler, 1.8-30 MHz, 150 W, matches any wire length (random), \$285 incl p/post.
- Hi-Sierra remote controlled mobile whip, 3.5-30 MHz plus 6 m, \$699 incl air freight Aust-wide.
- 4 Square vertical beams, 20, 40, 80 or 160 m, 8.2 dBd gain, 25 dB F/B, fraction of cost of 40/80 Yagi and tower.

Ask for **FREE** catalogue.

Bankcard, Mastercard and Visa acceptable.

resonance of the circuit it is coupled to. It would be useful to be able to eliminate this jump and so have a more accurate dip at resonance.

A means of achieving this, by separating the oscillator from the circuitry providing the dip, was given in an article in *RadCom* for December 1996. The article was titled "The Dipper Transformer" and the author was P Buchan G3INR. The basic circuit of the Dipper Transformer is shown in Fig 4(a). At resonance the circuit under test accepts a small amount of RF energy which results in a reduction of the output of the detector. This is a dip as in the normal GDO. The oscillator can be well isolated from the circuit so that the frequency pulling does not occur.

A practical circuit is shown in Fig 4(b) which uses a low power transmitter of up to 10 watts as the RF source. The dipper transformer is connected across the dummy load. At resonance the meter reading will dip as a small amount of energy is absorbed by the resonant circuit. This is a simple circuit but it is limited to use within an amateur band. The claimed accuracy is 2 to 3 kHz at frequencies inferred to be close to the 80 metre band. The only frequency mentioned in the article was 4 MHz.

By using a more sensitive detector it is possible to drive the Dipper Transformer with 200 to 500 mV of RF. This makes

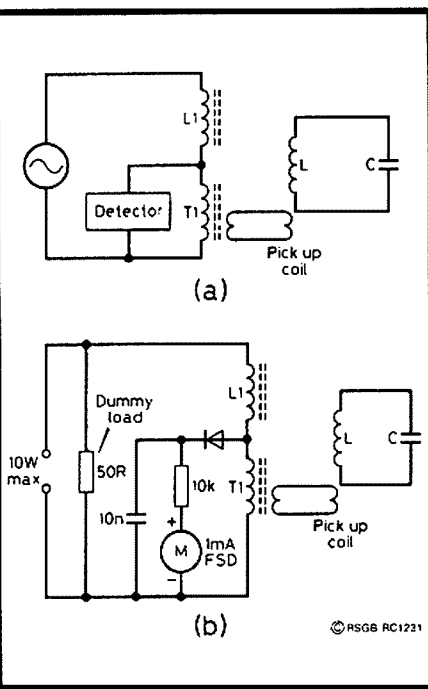


Fig 4 (a) - Basic circuit of The Dipper Transformer.

(b) - Circuit suitable for use with a transmitter as the RF Source.

these designs would give good results in this situation.

## The Dipper Transformer

The Dip Oscillator (or GDO) is a very useful instrument. However, it does have a problem due to pulling of the oscillator as the GDO is tuned through the

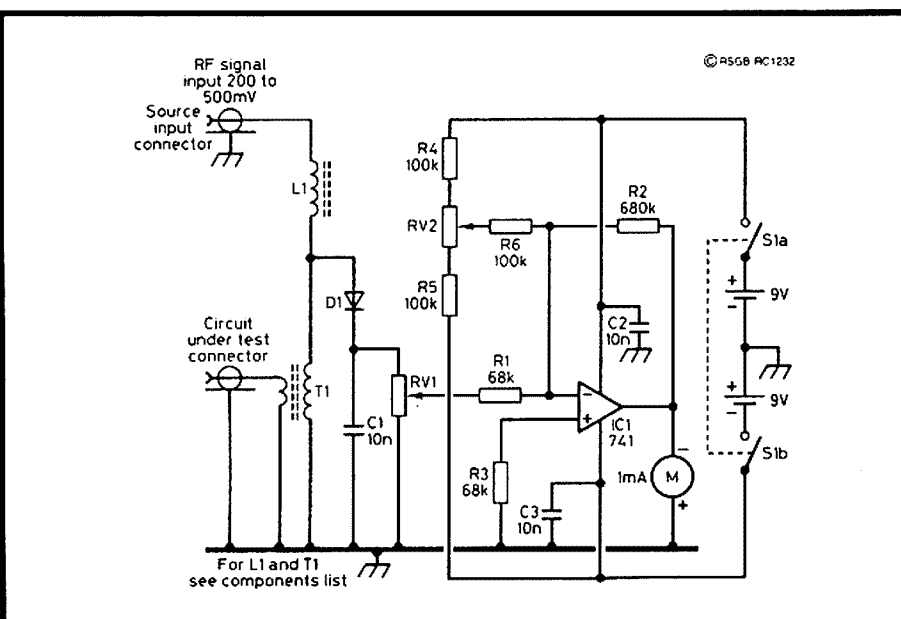


Fig 5 - Dipper Transformer for use with a signal generator source, using an Op Amp as a DC Amplifier in the detector circuit.

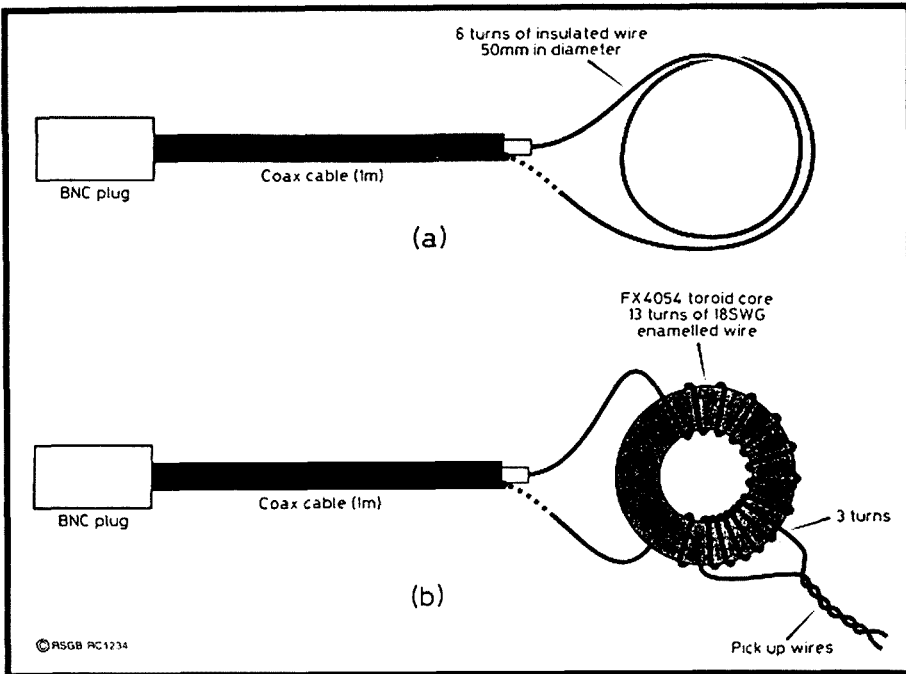
## "Single Fee per Site" Policy for Beacons and Repeaters

Following Federal Council discussion of the beacon and repeater fees issue at the Extraordinary Convention of 15-16 February, it was agreed that the WIA should seek to have beacon and repeater fees charged on the basis of a single fee per site, regardless of how many individual transmitters were in operation at a site.

This was considered to be the fairest and most equitable basis on which amateur beacon and repeater fees should be levied, as unattended beacons and repeaters were, after all, amateur stations and as individual amateurs could operate on any number of frequencies at any time, there was no sound reason why amateur band beacons and repeaters should be charged a licence fee per transmitter frequency where individual amateurs paid a single licence fee.

The Council noted that many sites with a multiplicity of beacon transmitters or repeater systems were issued with one call sign but charged a separate licence fee for each transmitter, even though the systems may have been in place for decades. The Federal Council felt that the licensing situation for beacons and repeaters had developed such that the financial burden of the licence fees was creating an impediment to further development and experimentation, and was discouraging the maintenance of existing systems and sites.

The WIA's view that there should be a single licence fee per site for amateur beacons and repeaters regardless of how many individual transmitters are in operation, was subsequently conveyed to the Spectrum Management Agency through the WIA-SMA Liaison Team. It is hoped that the issue may be resolved in the near future.



**Fig 6 - Test Probes for use with The Dipper Transformer.**

possible the use of a signal generator as the RF source and a wider frequency coverage. A suitable circuit is shown in Fig 5 using a 741 series Op Amp as a DC

amplifier to drive the meter. A single supply Op Amp, such as the LM324, could be used with some circuit adjustments.

The detector diode is a Schottky type BAT85. Other similar types could be substituted. The forward voltage should be small and the reverse rating adequate for the RF drive voltage. The BAT85 was quoted as obtainable from Electromail whose part No was 300 978. They may be available locally from RS Components or Farnell.

The inductors were wound on FX4054 toroids obtained in the UK from Maplin (Maplin Part No JR84F-32). T1 had a primary of 12 turns of 24 - 26 SWG enamelled copper wire spaced around the toroid. The secondary was five turns of thin plastic-coated wire wound around the earthy end. L1 was also 12 turns as for the T1 primary. Substitute toroids could be used. They should be in the region of 13 mm outside diameter and suitable for use at the frequency of interest.

Suitable test leads are shown in Fig 6. The one in Fig 6(a) using a small coupling loop is used to couple to tuned circuits. The other in Fig 6(b) can be used to couple to an antenna feed point or into a toroidal circuit.

*\*Clo PO Box 2175, Caulfield Junction VIC 3161*

ar



## AMATEUR TRANSCEIVER RADIO CENTRE

ALL YOUR AMATEUR TRANSCEIVER REQUIREMENTS.  
LEADING SUPPLY OF HF/VHF/UHF BASE - MOBILE - H/HELDS AT COMPETITIVE PRICES

**ALINCO** COMPLETE LEADING RANGE OF ALINCO TRANSCEIVERS & ACCESSORIES - AUTHORISED DEALER

**ICOM** AUTHORISED DEALER

**KENWOOD** AUTHORISED DEALER

**Cushcraft**

No. 1 AMATEUR QUALITY ANTENNAS  
AUTHORISED DEALER

CALL FOR YOUR LATEST FREQUENCY FAVOURITE  
EXPAND YOUR COLLECTION

PHONE/FAX  
(02) 9896 2545

141 GILBA ROAD,  
GIRRAWEE, NSW 2145

## ■ Events

# SEANET is a Success in Chennai

*Thomas E King VK2ATJ\* tells all about the latest SEANET.*

More than 200 licensed amateur radio operators, shortwave listeners and wireless enthusiasts from throughout India, plus many other Asian countries and Australia and New Zealand attended the 24th SEANET Convention in Chennai – the former Madras – in late November 1996.

The amateur radio movement is nearly 75 years old in India where there are about 13,000 government-licensed operators. Numerous amateur radio conventions and seminars have been organised over the years but this was the first time an international amateur radio convention had ever been co-ordinated anywhere in India.

Effectively and efficiently organised by the Madras Amateur Radio Society, the three day social and educational event was designated as the Rajiv Gandhi Memorial SEANET in tribute to India's late Prime Minister, Rajiv Gandhi, who was active as VU2RG, long before his rise in politics and throughout his government career.

In fact, even a few hours before his

assassination on 21 May 1991 he was in contact with other amateurs, recalled Mrs Sonia Gandhi, Chairperson, Rajiv Gandhi Foundation and herself licensed as VU2SON.

Mrs Gandhi, as Chief Guest, presided over the SEANET '96 valedictory function speaking on the valuable role that amateur radio and the nearly three million operators worldwide play in providing communications in the time of need.

Even fully developed countries rely upon amateur radio operators when other methods of communication fail, she noted. In her role with the organisation, Mrs Gandhi carries on the promotion of amateur radio in India as just one of many duties. A series of Rajiv Gandhi Foundation Amateur Radio Awards is presented every year while, throughout the year, the foundation is instrumental in helping radio clubs in their training efforts, popularising amateur radio and organising demonstrations and conferences.

The Valedictory Function was the concluding event of the SEANET

Conference; the inauguration of the conference by Mr M K Stalin, the Mayor of Chennai, was the first.

Though Mr Stalin was the chief guest, the delegates, at least those from India, were more in awe of a screen idol who also participated in the inauguration.

Kamal Hassan is a well known film star of South India but it was as licensed amateur radio operator VU2HAS that he inaugurated VU96SEA, the SEANET '96 special event station, making the convention's first radio contact with an amateur station in Thailand.

Specially printed SEANET '96 QSL cards were sent to all stations contacted. As well, they were distributed as souvenirs to those attending the convention staged in the suburban Savera Hotel.

In his SEANET '96 keynote address, Mr N Ravi VU2NRV, Editor, the Hindu, outlined the "Social and Scientific Aspects Beyond the Hobby of Amateur Radio".

The apprehension about the threat to national security, as voiced by some Indian government officials who had no real knowledge about the numerous positive aspects of amateur radio, was totally unfounded, said Mr Ravi.

Compared with modern methods, he noted, amateur radio transmissions which are on internationally assigned bands could not be the preferred mode for the communication of secret messages.

Yet, in countries like India, hobby radio enthusiasts still had to go through unnecessary procedures like police verification and a security clearance to get a licence.

This, plus the slow issue of licences by government authorities, discouraged the hobby. Mr Ravi requested the Mayor of Chennai to set up radio clubs in Corporation of Chennai high schools and consider providing meeting space for radio clubs to train more operators.

Dr S Suresh VU2FSS, President, Madras Amateur Radio Society, welcomed the SEANET '96 gathering. Dr M Gajapathy Rao VU2GJR, Organising Chairman, SEANET '96, proposed the vote of thanks to delegates who later watched a cultural dance presentation and the following day visited historic Mahabalipuram, south of Chennai.



**Noted South India film star, Kamal Hassan VU2NAS, opened the special event SEANET '96 amateur radio station. (Photo by Tom King)**



Lighting the traditional lamp to inaugurate SEANET '96 was the Mayor of Chennai, Mr M K Stalin. (Photo by Tom King)

Formed in 1964, the SEANET is an informal gathering of amateur radio operators, most of whom are located in Southeast Asia. All amateurs are welcome, however, and operators from Japan, Korea and other North Asian nations plus Australia and New Zealand and even Africa and Europe regularly make contact with the network.

SEANET is not a club or a society requiring membership or the payment of dues. Rather its main purpose is to serve as a "meeting place" on the shortwave bands for active amateurs in the region. Whenever needed, the net can provide emergency communication throughout this heavily populated region of the world. Over the years emergency communications have been coordinated for a multitude of natural disasters as well as the delivery of medical supplies.

The SEANET conventions date to December 1971 when about 30 amateurs met in Penang, Malaysia and decided that an annual get-together should be organised in the Southeast Asian region.

Since then the SEANET has been organised several times each in Thailand, Singapore, the Philippines, Malaysia and Indonesia. In 1992, the 20th annual SEANET Convention was held in Darwin, Australia, the first time it had been organised outside the Southeast Asian region.

In 1993 it was Bangladesh's turn to be host for the first time and, in 1996, India's first time with the (yet-to-be-

renamed) Madras Amateur Radio Society successfully organising the 24th SEANET in Chennai.

*"SEANET in Madras, rather Chennai, will be a difficult act to follow but we will do our best",* said Barrie Burns VK8DI, as he made a comprehensive presentation about the facilities and functions scheduled for amateurs attending the SEANET 1997 Convention in Darwin.

Being organised by the Darwin

Amateur Radio Club, SEANET '97 – the 25th convention of the Southeast Asia Network – is set for Friday, 14 November to Sunday, 16 November 1997.

The planned program is:

Friday, 14 November: Convention Registration; Independent time for explorations of Darwin and eyeball QSOs; Tea "Aussie BBQ Territory Style"; and SEANET call at 1200z.

Saturday, 15 November: Convention Photograph; Tour of Darwin; Lunch at the Parap Markets; Grand Convention Dinner and Entertainment; Group Presentations and SEANET Contest Awards; and SEANET call at 1200z.

Sunday, 16 November: Technical Sessions (3); and Plenary Session.

The venue for SEANET '97 will be the Mirambeena, a 125 room holiday resort located in the centre of Darwin.

Further information and registration forms are available from:

Bill Murphy VK8ZWM, e-mail: [wmurphy@scondwn1.telecom.com.au](mailto:wmurphy@scondwn1.telecom.com.au), packet: [VK8ZWM@VK8DA](mailto:VK8ZWM@VK8DA), phone: (08) 8983 2456; or Frank Turnham VK8FT, e-mail: [turnham@ozemail.com.au](mailto:turnham@ozemail.com.au), packet: [VK8FT@VK8DA](mailto:VK8FT@VK8DA), phone: (08) 8983 2954.

Additionally, amateurs can check into the SEANET which meets nightly on 14.320 MHz at 1200z.

\*PO Box 140, Kensington NSW 2033

ar



Thomas E King VK2ATJ, one of the amateurs to travel the farthest distance to get to SEANET '96, meets with K G Girimaji VU2GX, one of the oldest amateurs in India. (Photo by Tom King)

## ■ People

# Visit by LZ1AF

*Ernest Sloman VK2BUE\* enjoys meeting an overseas amateur radio contact.*



**68 galahs perched on VK2BUE's 21 MHz Yagi beam elements (a frequent occurrence), which alters the horizontal into an "inverted vee".**

On Monday, 13 May 1996, Dimiter Petrov LZ1AF arrived at Tenterfield NSW to visit me, Ernie Sloman VK2BUE (ex ZB1AI, VK3DGQ).

We have been corresponding regularly since our first QSO in 1994 on 21 MHz before the low sunspot count caused the MUF to fall below that frequency. Dimiter arrived in Brisbane to stay with his daughter, who is now a naturalised Australian. Subsequently he came to stay overnight with us.

He brought me a present of a "backward" clock, suitably inscribed "LZ1AF to VK2BUE" and, with a smile, said, "Look at this clock and grow younger". At my age I can appreciate that! I am an old-timer aged 83. I have been a CW operator since 1930 in the Royal Navy and, in 1933, started flying as a telegraphist/air gunner. Operating CW in an open-cockpit aircraft is quite an experience. However, 60 years later, I have become a "troglodyte".

Dimiter gave my XYL a beautifully crafted wooden container holding a phial of essence of tartar of roses and, for the

two of us, a cassette of Boris Christoff and a Bulgarian choir singing Bulgarian and Russian chants.

I gave him a large and comprehensive dictionary of Australian and aboriginal names and words with details of their origin and meanings. There was a reason for that. Once, during correspondence with Dimiter, I sent him a photograph of 68 galahs perched on my 21 MHz Yagi beam elements (a frequent occurrence), which altered the horizontal into an "inverted vee".

He could not find the word "galah" in any of his reference books. You can be sure he knows both meanings now! I also gave him a cassette of Mahler's second symphony (the Resurrection Symphony), which he enjoyed very much indeed.

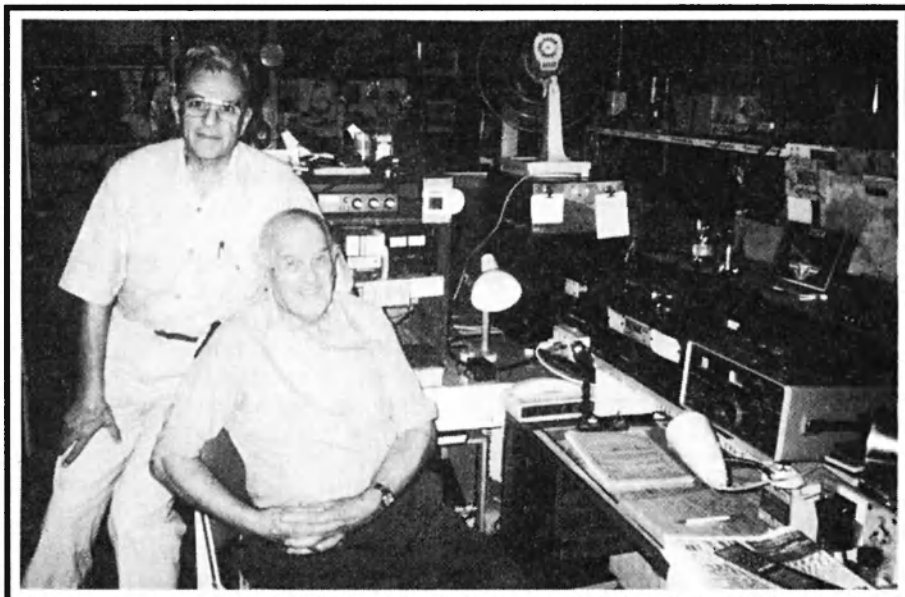
Dimiter is the DX Editor of Radio Bulgaria (since 1957), and has been on the air as LZ1AF since 1950. He taught himself to speak English, and I must say he made a very good job of it.

We really enjoyed meeting Dimiter, a charming and educated gentleman who told us so many things about his country. We also found that we had so many things in common to share. A very rewarding experience.

Viva CW and amateur radio!

*\*169 High Street, Tenterfield NSW 2372*

ar



**Ernie VK2BUE (seated) with Dimiter LZ1AF in Ernie's very well equipped radio shack.**

# ALARA

Sally Grattidge VK4SHE\*, ALARA Publicity Officer

## YLs in Orbit

from Irving ZLIMO, WARO Newsletter

This may be last year's news, but it is still interesting to know about the select few YLs who have experienced life "off the planet".

In March 1996, Shuttle Atlantis (STS-76) was launched with two YLs on board. Linda Goodwin N5RAX and Shannon Lucid, both Mission Specialists accompanied three other hams, Kevin Chilton KC5TEU (Mission Commander), Richard Searfoss KC5KCM (Pilot) and Ronald Sega KC5ETH (Mission Specialist). The aim of the mission was a MIR docking, and research activities. SAREX activities were limited due to work schedules.

Linda sat her Technician's licence in 1990 for the STS-37 mission, has since upgraded to Technician Plus, and married fellow astronaut Steve Nagel N5RAW making them the first married astronaut ham couple (what some people do for publicity!). Linda also used SAREX on her second mission STS-59.

Shannon and her husband are also planning to take their Technician test. She used the MIR callsign ROMIR while in space and made many North American contacts using the 145.550 simplex frequency. Shannon is the first woman to make five flights and at 53 is the oldest woman to fly in space.

Of the 1978 group of women astronauts selected by NASA, Shannon and Rhea Seddon remain active, and Anna Fisher recently returned to active status after several years leave-of-absence. Shannon remained on MIR for about four months with the EO-21 crew, and returned on the Shuttle link-up in August.

Other licensed YL astronauts are Kathryn Sullivan N5YYV, Ellen Ochoa KB5TZZ and Ellen Baker KB5SIX.

## Svalbard

from Kirsti VK9NL, Norfolk Island

The next International YL Meet (August 1998) will be in Svalbard and, as this is only a rather strange sounding name to most of us, it was interesting to hear Kirsti's first hand account of a visit there in 1995 when she

operated while on a snow scooter expedition in the area.

At Frithjovshavn she set up her NO/PRC 111 Military HF rig and dipole and was on the air when a polar bear was spotted about 20 metres away. As a female student had been killed by a bear the week before, Kirsti was understandably nervous and the four-legged QRM brought her transmission to a close for the day.

Kirsti assures us there is no danger in trekking in the wilds if properly equipped. She works in military communications, belongs to a pistol club and owns a 0.357 Magnum. Longyearbyen, a town of 2000 people with shops, hotels, schools and churches, where the YL Meet will take place, is quite safe.

Kirsti's latest trip was to Vietnam. She always tries to get on the air from countries she visits and has operated from Dubai, China and South Africa. "I especially like taking equipment with me out in the wilds and making it work. That is what I call real DXpeditioning," she says.

## Going Dutch

The new Chairman and Editor of the Dutch YL Committee is Ada PA3FSD from Leewarden in the northern part of Holland. Ada wants to know what YLs are doing in other parts of the world and would love to hear from VK YLs. Her address is A C Holtrop-de Vries PA3FSD, Brouwerstraat 25, 8932 L V Leewarden, The Netherlands.

There is also a new address for the Midwinter Contest: Chantal Koekoek PA3GQG, Olmenplein 3, 6463 EV Kerkrade, The Netherlands.

## Priceless Pearl

Pearl ZL2QY, Patron of WARO, is no longer able to take part in contests and nets, as she is now totally blind and has hearing problems. She thanks ALARA members for the years of friendship she has enjoyed, wants them to know they are not forgotten, and the reason for her silence on the air.

Pearl is still able to keep a daily sked with some close friends, with the help of more friends who keep her rig operational and on the right frequency for her. Pearl is a very determined lady who has remained active for many years with failing eyesight, and the members of ALARA wish her well. Pearl is sponsored by Mavis VK3KS.

## Showing the Flag

Dot VK2DDB was involved in the Hornsby and District Radio Club's "Introduction to Amateur Radio" night in January. The club put on a night for the public to see what amateur radio is all about, with HF, two metres, packet, WICEN, ATV, home brew, ancient equipment and, of course, the ALARA table manned by Dot. Apart from showing the visitors that ham radio is not just for OMs, she provided six dozen blueberry muffins and four dozen little iced cakes. Only eight muffins remained at the end of the night, so either the event was well attended or those who were there were rather hungry.

\*C/o PO Woodstock, QLD 4816  
Tel: 077 788 642

Packet: VK4SHE@VK4RAT.#NQ.QLD.AUS.OC  
Internet e-mail: rgrattid@ozemail.com.au

ar

## WIA News

### 1999 Region 3 ARDF Championships

WIA ARDF Coordinator, Wally Watkins VK4DO, advises that the 1999 Amateur Radio Direction Finding Championships will be held in South Korea, possibly in the month of September.

ARDF is a combination of hidden transmitter hunt and orienteering, with a history dating back 60 years. Wally's aim is to field a full team of 12 competitors who will represent Australia on behalf of the WIA.

There are four competitor categories: Junior, Senior, Women and Old-Timers.

Anyone interested in being part of the team, whether holding an amateur licence or not, should contact Wally.

Estimated cost for the trip would be around \$AUS2,500 per person. Wally advises that there may be limited assistance for juniors. An amateur radio club may be interested in raising money to support a member who shows an interest in taking part. Selection of team members will take place in the middle of next year, so you should indicate your interest now. If there are more than 12 nominations, a selection trial will be necessary.

Copies of the rules for competitors are available on request. For interest, a 25-minute video of the championships held at Townsville in July last year is available for \$10, post paid. Contact Wally Watkins VK4DO, PO Box 432, Proserpine 4800.

**Support the  
advertisers who  
support Amateur  
Radio magazine**



# AMSAT Australia

Bill Magnusson VK3JT\*

## National co ordinator

Graham Ratcliff VK5AGR

Packet: VK5AGR@VK5WI

## AMSAT Australia net:

Control station VK5AGR

Bulletin normally commences at 1000 UTC, or 0900 UTC on Sunday evening depending on daylight saving and propagation. Check-ins commence 15 minutes prior to the bulletin.

Frequencies (again depending on propagation conditions):

Primary 7.064 MHz (usually during summer).

Secondary 3.685 MHz (usually during winter).

Frequencies +/- QRM.

## AMSAT Australia newsletter and software service

The newsletter is published monthly by Graham VK5AGR. Subscription is \$30 for Australia, \$35 for New Zealand and \$40 for other countries by AIR MAIL. It is payable to AMSAT Australia addressed as follows:

AMSAT Australia

GPO Box 2141

Adelaide SA 5001

## Keplerian Elements

Current keps are available from the Internet by accessing the AMSAT FTP site, [ftp.amsat.org](ftp://ftp.amsat.org) and following the sub-directories to "KEPS".

## More on the Reception of Mars Global Explorer Signals

An excellent article on this subject appeared in Vol 20, No 1 of the *AMSAT Journal*. It was an account by Darrel Emerson AA7FV of his efforts to receive the weak and elusive signals from the Mars Global Surveyor. He sub-titled his story, "How to Use MilliHertz Bandwidths with a Drifting Receiver". The article makes challenging yet fascinating reading.

As an electronic hobbyist whose calculus is more than a little rusty, I appreciated his complete, easy to follow style in writing up the account. The outstanding impression one is left with after reading the article is just how futile it would be to try to hear the signal using even a well equipped amateur station.

Darrel outlined his first experimental setup and the techniques used to achieve frequency stability such that the required "fractional Hertz" bandwidths can be achieved using digital signal processing (DSP). He went on

to describe the computer program written to analyse the data collected by using a soundblaster card in his computer to sample the receiver output at 5000 8-bit samples per second for a period of 105 seconds.

His summary contained a discussion of the possibility of refining the technique to try receiving the signal from the Surveyor when it achieves a Mars orbit. The reference section at the end of the article contains some valuable sources of information for anyone contemplating this kind of work in the future.

The remarkable thing is that the antenna Darrel used is typical of many found in amateur satellite stations, a 15x15 CP Yagi. The real work was done in refining the reference oscillator stability and in developing the software necessary to process the data. Well done Darrel! This work must be close to the frontier of amateur radio operation.

## MIR Operating Frequencies Still in Dispute

Oh, dear! It seems that the frequency pair chosen for MIR at the Region 1 conference is still causing concern. As far as I know, no change is imminent but it is almost certain that a change will have to take place eventually. There does not seem to be any problem in our part of the world but in Region 2, particularly, it has caused serious interference.

A number of "movers and shakers" have expressed surprise that the Region 1 decision was implemented without first referring to the wider IARU committee. Let's hope that cool heads prevail on this one and it is resolved in the run-up to the International Space Station frequency determinations.

## Millennium Satellite

This is an interesting one. Sort of a "Clayton's" OSCAR. A bit like UO-11 in that it is designed with the education community in mind. It is still in the early planning stages and it's uncertain whether it will have a downlink in the amateur radio bands.

Whereas UO-11 was an experimental satellite with some schools participation, the Millennium satellite will be totally devoted to school science experiments. Schools in UK have already been invited to design an experiment to be carried into space by this satellite. It will feature live colour images of earth, on-board instruments for school science observation and will be linked to the Internet. A World-Wide-Web site is already in operation ([www.mscl.org.uk](http://www.mscl.org.uk)) and through

this you can register interest in any of the levels of activity.

Although the Millennium satellite is primarily set up to support UK education establishments (and these will have first priority), one can safely assume it will fly over VK. It will be interesting to see if any local schools take up the challenge.

Small, simple receiving and decoding apparatus will be available to schools commercially along with technical support and educational materials. It is planned to launch Millennium in late 1998 with the schools equipment being available around the same time. Commissioning will be complete and it will be in full use by April 1999.

## Kepelements...Ever Wondered How They are Done?

Clive Wallis G3CWV writes a most interesting column in AMSAT-UK's *OSCAR News* each month. It's directed to those readers who are not licensed amateur radio operators but have an interest in amateur radio satellites. It's good reading.

In issue No 123 he devoted space to an explanation of just how the "kepelements" we rely on so much are produced. It's worth a summary here. The information originally came from Ken Erandes N2WWD (see the AO-10 keps par below).

Ken served as an orbit analyst instructor and, as a contractor, has designed software currently in use at NORAD. They have a network of more than 20 radar sites around the world as well as a network of optical sites. The radar sites provide positional and Doppler data with a time tag (epoch time) and the optical sites provide angles, right ascension and declination and a time tag.

Whereas important active payloads may be tracked many times a day, stable objects (like OSCARs) and debris are sometimes only tracked every couple of days. The updates are processed at NORAD where the kepelements are computed by correction of the earlier data. High priority objects are corrected manually by orbit analysts.

## Fresh Keplerian Elements for AO-10

Users will be aware that there has not been an official update to the keps for AO-10 for quite some time. Many reports are to hand that the satellite is not easy to track using the old kepelements, particularly near perigee. Stacy (W4SM) and Ken (N2WWD) have brought an old Keplerian data set up to date. This data set should be good for tracking AO-10 over the next several months.

OZIMY was in a position to test the set against the actual times of the satellite

# DICK SMITH ELECTRONICS

## Great Savings On Communications



### FT-10R 5 Watt 2m Hand-Held

A compact 2m hand-held with a unique clam shell design and rear-mounted NiCad battery pack that provides 5W RF output as standard through the use of a MOSFET power amplifier and extensive component miniaturisation. Built to a tough MIL-STD 810 rating for shock and vibration resistance, the FT-10R also uses gasket seals for improved weatherproofing.

#### Features:

- Tx 144-148MHz, Rx 140-174MHz
- RF Output: 5.0, 2.8, 1.0, 0.1W
- Dual watch facility
- Large Omni-Glow backlit display
- High efficiency speaker for super loud audio
- CTCSS encode/decode
- Auto battery save, Tx save & auto power off for longer operating times
- 12V DC socket for charging and power
- Keypad frequency entry
- 99 memories
- Digital code squelch

Size: Just 62 x 100 x 42mm (WHD)

Comes with FNB-41 9.6V 600mA/H NiCad, A16D version keypad, belt-clip and AC charger.

Cat D-3650

**SAVE \$56**

**2 YEAR WARRANTY**

**\$399**



### 3-15V 25A Heavy Duty Power Supply

Like no other - packed with features & affordable! This benchtop power supply is ideal for service organisations and enthusiasts needing a low-noise regulated DC power source. DC output is from 3-15V while current is up to 25 amps at 15V (lower current at lower voltages). With front panel metering, high current banana-style & low-current output connections for extra flexibility. Internal heatsink & thermally-switched fan provides cooling without protrusions in the metal case (which is just 320 x 150 x 145mm). Specially modified for more reliable long-term operation, it uses a rugged 50 amp bridge rectifier & trifilar transformer. Also includes extensive overload protection through dissipation limiting circuitry for the pass transistors, a 30 amp instantaneous current limit, AC mains circuit breaker, a transformer thermal fuse & fused auxiliary secondary winding.

Cat D-3800

**SAVE \$50**

**Great Value! \$249**



### FT-990 All-Mode Base Transceiver

We're overstocked on ex-demo transceivers, so take advantage of this opportunity to save on an excellent HF base-station rig! The FT-990 offers many of the features of the legendary FT-1000, only in a more compact and economical base station package. Together with clear front-panel layout & labelling, its large back-lit meter and uncluttered digital display allows for easy operation.

The receiver uses a wide dynamic range front end circuit and two DDSs to provide a very low noise level and excellent sensitivity over the 100kHz to 30MHz range. Transmitter output to 100W on all HF Amateur bands (SSB, CW, FM) with high duty cycle transmissions allowed. The internal auto antenna tuner and an in-built power supply are standard features, while the customizable RF speech processor and switched capacitance audio filtering facilities are unique to the FT-990. Other features include IF Shift and IF Notch filters, IF bandwidth selection, 90 memories and one-touch band selection.

Cat D-3260

**Ex-Demo**

**Only \$2750**



**2 YEAR WARRANTY**



## FT-840 Economical HF Mobile Transceiver

A serious HF transceiver that won't break the bank and doesn't compromise performance at home like many current micro-rigs. The Yaesu FT-840 gives you full 160m-10m Amateur band coverage with 100W PEP output on SSB/CW/AM, continuous receiver coverage (100kHz-30MHz), 100 memory channels, a large back-lit LCD screen, an effective noise blanker, and an uncluttered front panel. The FT-840 is simple to use, with useful features like an SSB speech processor for added audio punch, IF Shift to fight interference, and Direct Digital Synthesis oscillators for cleaner transmit and improved receiver performance. Includes DC power lead and hand microphone... just connect your power supply and antenna and start having fun. Cat D-3275

2 YEAR WARRANTY



**\$1395**

**SAVE \$100**



## FT-900 Deluxe HF Mobile Transceiver

The Yaesu FT-900 is a revolutionary new 100W HF transceiver that answers the need for a truly practical mobile radio, but without the performance compromises of most micro-sized rigs when used in base station installations. For convenient mobile operation, a lightweight front sub-panel with access to commonly used controls can be easily mounted away from the transceiver's body using an optional mounting kit. The large "Omni-Glow" backlit LCD screen provides high visibility over a wide range of viewing angles, while the voice and data between the sub-panel and the transceiver are digital to minimise RF feedback or noise pick-up problems. A tough diecast top panel/heatsink and duct-flow cooling systems allows extended transmission periods, while still allowing the optional ATU-2 auto antenna tuner to be mounted inside the transceiver. Cat D-3280

**BONUS**  
Half-price ATU-2 auto antenna tuner when purchased with your FT-900. SAVE \$249

**\$1995**

2 YEAR WARRANTY

## Yaesu FT-736R VHF/UHF Base Station Transceiver

Whether your interest is in talking through your local repeater, operating SSB DX, or talking to the world via satellite, this high-performance multimode base station transceiver can do it all! In its standard form, the FT-736R provides 25W output on the 2m (144-148MHz) & 70cm (430-450MHz) bands in SSB, CW, and FM modes. Can be expanded to cover the 6m (50-54MHz) & 23cm (1240-1300MHz) bands by installing optional modules.

### Features:

- Digital control with keypad or VFO frequency entry.
- Efficient switch-mode AC power supply.
- 100 general-purpose memories.
- 10 full-duplex crossband memories, 2 independent VFOs per band.
- 2 full-duplex VFOs - transmit & receive frequencies (and modes) can be tuned independently or synchronously for satellite operation.
- Adjustable IF Notch and IF Shift filters.
- Noise blanker, 3-speed selectable AGC.
- High-stability (+/-1ppm) PLL reference oscillators.
- Speech processor and VOX for SSB.
- VFO or selectable channel steps on FM.
- Digital input connection for packet TNCs.

Cat D-2920

**\$2295**

**SAVE \$200**



### Specifications:

Modes: LSB/USB (J3E), CW (A1A), FM (F2D, F3E)  
 Receiver: 50, 144MHz: Dual Conversion  
 Other Bands, Triple Conversion  
 Sensitivity SSB/CW better than 0.2uV for 12dB S+N/N  
 FM: better than 0.35uV for 12dB SINAD  
 Dimensions: 368 x 129 x 286mm (WHD)

2 YEAR WARRANTY

D-2921 6m module **\$499**  
 D-2922 23cm module **\$899**

Offers expire 30/4/97

**DICK SMITH**  
**ELECTRONICS**

For further information, orders or the location of your nearest store call:

Ph: 1300 366 644 (local call charge)  
 Or Fax: (02) 9805 1986

B 2876

entering perigee eclipse. He reports that this set gives predictions of the perigee eclipse times accurate to less than 1 minute.

### AO-10

1 14129U 83058B 97054.50000000  
 .00000010 00000-0 57107-5 0 5005  
 2 14129 25.8792 163.0281 6052907 93.3854  
 313.1701 2.05882272103000

### RS-16 Successfully Launched

The latest satellite in the Russian RS series was launched on 04-MAR-97 from the new space base Svobodny. Several reports of its reception are to hand. The CW beacon on 29.408 MHz is loud and clear. At the time of writing the transponders are not yet turned on.

In case you missed last month's column, here are the relevant frequencies.

UPLINK = 145.915 - 145.948 MHz  
 DOWNLINK = 29.415 - 29.448 MHz  
 BEACONS = 29.408, 29.451 MHz  
 PWR 29 MHz DOWN = 1.2 W/4 W  
 BEACON 1 = 435.504 MHz  
 BEACON 2 = 435.548 MHz  
 PWR 435 MHz BEACONS - 1.6 W

Next month, Phase 5! .... what on earth is that?

\*RMB 1627, Milawa VIC 3678  
 E-mail: vk3jt@amsat.org

ar

## WIA News

### New WIA Members

The WIA bids a warm welcome to the following new members who were entered into the WIA Membership Register during the month of February 1997:

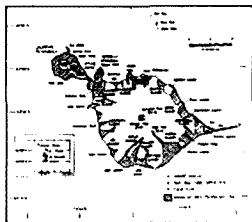
L30946	MR K HUBBARD
VK2ABR	MR M FRAZER
VK2ATW	MR G K EDWARDS
VK2BET	MR E J TRIMINGHAM
VK2BJC	MR B J CONNOLLY
VK2BOJ	MR J W OSWALD
VK2HAQ	MR A CUMMING
VK2IBL	MR B LUZAIC
VK2KS	MR W F TAM-GRANGE
VK2LMA	MR E M HUHTA
VK2MIA	MR D NELSON
VK2MPQ	MR G J FAULKNER
VK2ON	MR A J LYNCH
VK2ZDK	MR R E SMALLACOMBE
VK3HFM	MR F J MESSEMAKER
VK3TBM	MR B J MILLER
VK3TXA	MR C GOETZE
VK6NO	MR E J VALLAS
VK7ZPB	MR P BLUNDSTONE

### Some Wireless Audio Products Will Not be on 70 cm

Philips Consumer Electronics will shortly release in Australia a range of "wireless" audio products, including wireless loudspeakers and other audio peripherals, which will employ low power transmissions on 927 MHz. (See WIA News, page 5, March 1997 *Amateur Radio*).

The transmissions will be wideband FM to provide what Philips claim to be "digital quality" sound, with a 95 dB signal-to-noise ratio. To avoid interference between adjacently located units, there is a choice of seven channels available. Transmission power levels are in the lower milliwatt range, as these wireless audio products are only intended for applications in and around the home.

Low power wireless devices such as these are covered by a Class Licence for use on the 915-928 MHz band, which is shared with other low power wireless applications.



# Radio and Communications

INCORPORATING AMATEUR RADIO ACTION AND CB ACTION

Published by  
**ACP SYME MAGAZINES,**  
 PO Box 119,  
 Oakleigh,  
 Vic 3166  
 (03) 9567 4200

That little spot at the top left is Heard Island, a cold and damp (and windy) island just off Antarctica. A hardy VK joined this year's DXpedition to Heard, and we have his story this month. We also report on Kenwood's latest HF box, the TS-570D...



*April's R&C is jam-packed with amateur radio stories. How do these grab you...*

- **The Beverage Antenna.** Got a spare kilometre or two of back yard? If so, we have your antenna!
- **50 Years of 50 Megs.** The whole incredible story, narrated by Steve Gregory, VK3OT (6M DXCC)
- **Review: Kenwood TS-570D.** Affordable HF meets inbuilt DSP. Does it help? VK3ND says yes.
- **Build your own desk microphone.** Hank Pruncken, VK5NCA, did, and it works a treat...
- **Modifications.** If you have an Icom IC-737/A or a Yaesu FT-50R or FT-51R you must read this!
- **The best IOTA column in Region 3, three DX columns and more... all the best regulars every month!**

Don't miss out — **RADIO and COMMUNICATIONS** is great reading for amateurs!  
**Check your local newsagent today!**

(PS. We also have the biggest collection of radio-oriented Classified adverts in the country. There's lots of them because they work so well. Ask your newsagent to keep a copy for you each month, or ring 1800 25 2515 for subscription details. Hurry — you might miss something!)

---

---

# Awards

John Kelleher VK3DP - Federal Awards Manager\*

---

---

I have received an update on the Zone 29 Award from Christine VK6ZLZ. I was very pleased to receive this information, because it shows that some sections of the WIA are heeding my pleading for relevant details on local and overseas awards for publication in this, your magazine. The one amendment to the abovementioned award was the fee of \$AUS2.00, or five IRCs for overseas stations. Thank you Christine.

This causes me to wonder why I still have only one VKI in my DXCC listings. It also brings to mind that the VKI Division sponsors The VKI Award, or has that award become defunct?

What of the Tasmanian Awards? Are they still in vogue? Daily I hear amateurs looking for local awards and, being frustrated, then looking to NZ and USA counties awards. With conditions the way they are, that procedure can be just as frustrating.

A question was put to me on the ANZA Net (14164 kHz daily) in regard to the ARRL DXCC. Is there a checkpoint in Australia for this Award? The answer is NO. It may be important to know that our own WIA DXCC is run on parallel lines to that controlled by the ARRL and, in my humble opinion, bears equal prestige, an opinion shared by over 400 others, whether WIA members or not. Fees for the local version are \$US5.00 for all others, and FREE to WIA members, which is a fraction of the cost associated with the other version.

A previous issue of this magazine showed a proud Alan Shawsmith VK4SS displaying his WITUZ plaque for working all 75 ITU Zones. I have had phone calls asking for clarification of the actual ITU Zones. Here it is.

## Zone

1. KL7
2. VE6, VE7, VE8 (South of 80° N and west of 110° W), VY1.
3. VE5, VE3/4/8 (South of 80° N and between 90° and 110° W).
4. VE2/3/4/8 (South of 80° N and between 70° and 90° W including all Baffin Island).
5. OX (South of 80° N).
6. W6m W7 (excluding Wyoming and Montana east of 110° W)
7. W5 (excluding Mississippi), W7 (Wyoming and Montana east of 110° W), W0.
8. W1, W2, W3, W4, W5 (Mississippi only), W8, W9, 4U (New York).
9. CY9, CY0, FP, VE1, VE2 (east of 70° W), VO1, VO2, VY2.
10. FO8 (Clipperton), XE, XE4.

11. C6, CO, FG, FM, FS, HH, HI, HK0 (San Andres), HP, HR, J3, J6, J7, J8, KG4, KP1, KP2, KP4, KP5, P4, PJ (Neth Antilles), PJ (Saint Maarten), TG, TI, V2, V3, V4, VP2 (Anguilla), VP2 (Brit Virgin Is), VP2M, VP5, VP9, YN, YS, YV0, ZF, 6Y, 8P, 9Y.

12. CP, FY, HC, HC8, HK, HK0 (Malpelo), OA, PY (west of 60° W), PZ, TI9, YV, 8R.

13. PY (north of 16.5° S and east of 60° W), PY0 (Fernando de Noronha), PY0, (St Peter & Paul).

14. CE (north of 40° S), CE0 (Juan Fernandez), CE0 (San Felix), CX, LU (north of 40 S), ZP.

15. PY (south of 16.5° S), PY0 (Trinidad).

16. CE (south of 40° S), LU (south of 40° S), VP8 (Falklands).

17. TF.

18. JW (south of 80° N), JX, LA, OH, OH0, OJ0, OY, OZ, SM.

19. RIM (MV Island), UA1 (between 60° and 80° N and west of 50° E), UA9 (between 60° and 80° N and west of 50° E).

20. RIF (FJL south of 80° N), UA1 (between 60° and 80° N and east of 50° E), UA9 (between 60° and 80° N and between 50° and 75° E).

21. UA9/0 (between 60° and 80° N and between 75° and 90° E).

22. UA0 (between 60° and 80° N and between 90° and 110° E).

23. UA0 (between 60° and 80° N and between 110° and 135° E).

24. UA0 (between 60° and 80° N and between 135° and 155° E).

25. UA0 (between 60° and 80° N and between 155° and 170° E).

26. UA0 (between 60° and 80° N and east of 170° E).

27. C3, EI, F, G, GD, GI, GJ, GM, GU, GW, LX, ON, PA, 3A.

28. DL, HA, HB, HB0, HV, I (excluding IG9 and IH9), IS, LZ, OE, OK, OM, S5, SP, SV, SV/A, SV5, SV9, T7, T9, TK, YO, YU, Z3, ZA, 1A0 (SMOM), 4U (Geneva), 9A, 9H.

29. EK (Armenia), ER (Moldova), ES (Estonia), EU (Belarus), LY (Lithuania), UA1 (south of 60° N), UA2, UA3, UA4 (west of 50° E), UA6, UN (Kazakhstan west of 50° E), UR (Ukraine), YL (Latvia), 4J (Azerbaijan), 4L (Georgia).

**Prevent pirates - make  
sure you sell your  
transmitter to a  
licensed amateur**

30. EX (Kyrgyzstan west of 75° E), EY (Tajikistan), EZ (Turkmenistan), UA4 (east of 50° E), UA9 (south of 60° N and west of 75° E), UK (Uzbekistan), UN (Kazakhstan between 50° and 75° E).

31. EX (Kyrgyzstan east of 75° E), UA9/0 (south of 60° N and between 75° and 90° E), UN (Kazakhstan east of 75° E).

32. JT (west of 110° E), UA0 (south of 60° N and between 90° and 110° E).

33. BY (north of 44° N), JT (east of 110° E), UA0 (south of 60° N and between 110° and 135° E).

34. UA0 (south of 60° N and between 135° and 155° E including Primor'ye and Sakhalin, but excluding the Kuriles).

35. UA0 (south of 60° N and between 155° and 170° E including the Kuriles Islands).

36. CT3, CU, EA8.

37. CN, CT, EA, EA6, EA9, IG9, IH9, SO, ZB, 3V, 7X.

38. SU, 5A.

39. A4, A6, A7, A9, HZ, JY, OD, TA, YI, YK, ZC4, 4W/70, 4X, 5B, 9K.

40. EP, YA.

41. A5, AP, S2, VQ9, VU (India), VU (Laccadives), 4S, 8Q.

42. BY (west of 90° E), 9N.

43. BY (between 90° and 110° E, excluding Hainan).

44. BV, BY (south of 44° N and east of 110° E, including Hainan), HL, VS6/VR2, XX9.

45. JA, JD1 (Ogasawara).

46. C5, D4, EL, J5, TU, TY, TZ, XT, 3X, 5N, 5T, 5U, 5V, 6W, 9G, 9L.

47. S9, TJ, TL, TT, 3C.

48. ET, J2, ST, ST0, T5, 5X, 5Z.

49. HS, VU (Andamans), XU, XV, XW, XZ.

50. DU, 1S (Spratly).

51. H4, P2, YB8/9 (east of 130° E).

52. D2, TN, TR, 3C0, 9Q, 9U, 9X.

53. C9, D6, FH, FR (Reunion), FR/G, FR/JE, FR/T, S7, Z2, 3B6, 3B7, 3B8, 3B9, 5H, 5R, 7Q, 9J.

54. V8, VK9X, VK9Y, YB1-7, YB8/9 (west of 130° E), 9M2, 9M6/8, 9V.

55. VK4, VK8, VK9 (Willis).

56. FK, VK9 (Mellish Reef), YJ, 3D2 (Fiji), 3D2 (Conway Reef), 3D2 (Rotuma).

57. A2, V5, ZS, ZS8, 3DA, 7P.

58. VK6.

59. VK1, VK2, VK3, VK5, VK7.

60. VK9 (Lord Howe), VK9 (Norfolk), VK0 (Macquarie), ZL, ZL7, ZL8, ZL9.

61. KH1, KH3, KH4, KH5 (Palmyra but not Jarvis), KH5 (Kingman Reef), KH6, KH7, T32 (Northern Line Is only).

62. A3, FW, KH5 (Jarvis), KH8, T31, ZK1 (North Cooks), ZK2, ZK3, 5W.

63. CE0 (Easter Is), FO, T32, VR6, ZK1 (South Cooks).

64. KC6, KH2, KH0, V6 (west of 150° E).

65. C2, KH9, T2, T30, T33, V6 (east of 150° E), V7.

66. ZD7, ZD8, ZD9.

ICOM Clearly Ahead



**"VK3LZ  
calling!"**

More sound information from your  
friends at Icom.

**ENTHUSIASTS  
BRAVE THE WEATHER  
AT WYONG CONVENTION.**

Another successful convention, despite  
the oppressive weather conditions.  
It just goes to show radio enthusiasts  
are hardy souls!  
Many thanks to our hard working  
participating dealers.  
Lots of interest was shown in Icom's  
ever-expanding range, especially the  
exciting newcomers the IC-756  
and IC-R10.

**IC-706 MK II HAS ARRIVED!**

All the rumours can now be put to rest.  
Icom's new IC-706 MK II has replaced  
the very popular IC-706 with a wide  
range of enhanced features.  
Check it out at your nearest  
authorised Icom Dealer today.  
You'll find it's a tremendous performer.

**"...73"**

**Call me at Icom on  
free call 1800 338 915  
ph: (03) 9387 0666  
fax: (03) 9387 0022**

ACN 006 092 575

L. L. BROWN ADVERTISING

67. Antarctica (north of 80° S and between 20° W and 40° E), 3Y (Bouvet).
68. FT (Amsterdam), FT (Crozet), FT (Kerguelen), VK0 (Heard).
69. Antarctica (north of 80° S and between 40° and 100° E).
70. Antarctica (north of 80° S and between 100° and 160° E).
71. Antarctica (north of 80° S and between 160° E and 140° W).
72. Antarctica (north of 80° S and between 140° and 80° W), 3Y1 (Peter I Is).
73. Antarctica (north of 80° S and between 80° and 20° W), VP8 (South Georgia), VP8 (South Orkneys), VP8 (South Sandwich), VP8 (South Shetlands).
74. Antarctica (between 80° and 90° S South Pole).
75. JW (north of 80° N), OX (north of 80° N), R1F (FJL north of 80° N), UA0 (Severnaya Zemlya north of 80° N), VE8 (north of 80° N).
90. JD1 Minami Toroshima.

This award may be claimed by any

licensed radio amateur who is eligible under the General Rules, and who can produce evidence of having contacted, since 15 November 1945, land based amateur radio stations in at least 70 of the 75 broadcasting zones as defined by the International Telecommunications Union (ITU).

The certificate holder may claim, on payment of a contributory charge, a handsome plaque with a plate detailing name, callsign, date, and number of the award. Additionally, an amateur providing evidence of having contacted all 75 ITU zones may claim the Supreme Plaque in recognition of the magnitude of his/her achievement, again on payment of a contributory charge.

Claims should be sent to: RSGB HF Awards Manager, Fred Hanscombe G4BWP, Sandholm, Bridge End Road, Red Lodge, Bury St Edmunds, Suffolk IP28 8LQ, United Kingdom.

\*4 Brook Crescent, Box Hill South, VIC 3128  
Phone (03) 9889 8393

ar

## Club Corner

### Radio Amateur Old Timers Club

The annual meeting and luncheon of the Radio Amateur Old Timers Club of Australia was held on Tuesday, 11 March at the Bentleigh Club.

Your committee was re-elected, with the exception of John Tutton VK3ZC who did not offer for re-election. John had served on the committee of the club since its inception and, for many years, organised our annual series of QSO parties. Club members owe a debt of thanks to John for his many years of service. Milton Crompton VK3MN was elected to fill the vacancy and will take office on 31 July.

The guest speaker was Phil Williams VK5NN who travelled over from Victor Harbour for the occasion. Phil was one of the first group to be trained in the top secret techniques of radar with the aim of going to England and operating there. Japan's entry into WWII changed that plan and Phil started operations in Western Australia.

At the end of the war, with the rank of Flight Lieutenant, Phil was in charge of radar operations in eastern New Guinea. Returning to duty as an electrical engineer with the South Australian Electricity Trust, Phil spent some time in England studying the use of atomic energy for power generation. For some years after the war, Phil spent some time each year at RAAF Headquarters in Melbourne as a valued member of the RAAF Reserve. He also spent a lot of time as an

office-bearer with the WIA at both federal and state levels, and was a regular contributor of articles about SSB operation in *Amateur Radio*.

The theme of Phil's talk was the development of radar and the enormous contribution of Australian industry to the war effort.

A suitable vote of thanks to Phil was moved by Bill Rice VK3ABP who knew him when they were both studying at Adelaide University after the war.

We were pleased to have with us as a guest Mrs Jean Hillier (nee Maney), the author of the recently published book "No Medals in This Unit". Jean was one of the first women to enlist in the Australian Army Signals in 1942 and be a top secret Kana Code operator like the "Eavesdroppers" of the RAAF Wireless Units.

Her book, available from Daycom Communications Pty Ltd at \$15 plus packing and postage, tells the personal stories of Jean and a number of other women who served in this operation.

Jean was delighted to meet so many people who had been involved in the production and use of the AR7 receiver.

Ken Matchett VK3TL, the curator of the amazing WIA Federal QSL Collection, had on display a series of folders containing what must surely be a unique collection of QSL cards from every known DX country both past and present.

# Contests

Peter Nesbit VK3APN - Federal Contest Coordinator\*

## Contest Calendar April - June 1997

Apr 5/6	SP DX Contest (CW & SSB)	(Mar 97)
Apr 11/13	JA DX High Band CW	(Mar 97)
Apr 12/13	International HF Grid Square Contest	(Mar 97)
Apr 12/13	"King of Spain" DX Contest	
Apr 19	Australian Postcode Contest	(Mar 97)
Apr 19/20	SARTG AMTOR Contest	
Apr 19/20	Israel DX Contest	(Mar 97)
Apr 26/27	Helvetia DX Contest (Switzerland)	(Mar 97)
Apr 26/27	SP RTTY Contest	
May 3/4	ARI DX Contest (CW/SSB/RTTY)	
May 10/11	CQ-M DX Contest	
May 17/18	Sangster Shield Contest	
May 24/25	CQ WPX CW Contest	(Feb 97)
Jun 1	Portugal Day Contest (SSB)	
Jun 7/8	IARU Region 1 Field Day (CW)	
Jun 14	QRP Day Contest (CW)	
Jun 14	Asia-Pacific CW Sprint	(Jan 97)
Jun 14/15	ANARTS RTTY Contest	
Jun 14/15	South America WW Contest (CW)	
Jun 21/22	VK Novice Contest	
Jun 21/22	All Asia CW DX Contest	
Jun 28/29	ARRL Field Day	

Despite starting out relaxed and well organised, last weekend finished up in total chaos. I had intended to make a full-on effort for the 60th Anniversary Commonwealth Contest (BERU) and, as part of the preparations, had disassembled the station a week or so earlier to tidy up the mains wiring and shield the operating desk. The reason for this was to eliminate RF from the computer on 80 m, which had been a nuisance for some years, restricting me to manual logging on that band. With visions of hundreds of G and VEs waiting to be worked on 80 m (well, we all like to dream), I was determined to fix the problem before the beloved "BERU" arrived.

My yearly enthusiasm for installing some new antennas had also predictably rolled around, so there I was on Friday night with the station still in bits, convinced I'd be able to get it all back together and have time left over for the "ten thousand times up and down the ladder ritual" which seems to accompany the installation of every new antenna.

Saturday morning arrived, and without warning something snapped in my brain. I'd heard about all I could take regarding the Melbourne Grand Prix, so I grabbed the XYL and said "we're going". All thoughts of getting the station back together were pushed into the background, because (as I kept telling myself) "there's always tonight before it starts", and "I'll do the antennas tomorrow". Ha ha, silly me!

A couple of hours after returning home,

my brain was still in orbit from the excitement of the day (I recommend that anyone planning to enter a contest stays well clear of international motor races beforehand). Finally, fifteen minutes before the start of the contest, I managed to steer myself into the shack to survey the scene. Slowly swinging my gaze from left to right, I took in the metal filings and drill shavings strewn across the desk, the mains wires and master switch yet to be connected, and the various bits of equipment scattered around the room and in the spare bedroom. "Guess what?" I said to the XYL, "I'm having an early night."

Throughout the night I was tormented by dreams of all those Gs and VUs calling "CQ BERU", and at 5 am leapt out of bed to join the fray. "I'll just throw a few wires together, shouldn't take more than five minutes", or so I thought. Upon entering the shack, my blood froze as I surveyed the scene, which looked even worse than the previous evening. I quietly slunk back to bed, consoling myself with the thought that I should be able to work most of the Gs on long path, and there probably weren't any VUs active this year anyway (gee, doesn't this guy ever learn?)

Sunday went all too quickly, with the station finally back together at 8 pm. As I listened around, I noticed several VKs sporting numbers close to four hundred (which is very good for the BERU), and many good signals from VE on 40 and 80.

Once again, I had started a contest "slightly late", and missed heaps in the process. There's not much that one can do in the final three hours, but at least I could now use CT on 80, not that it was needed!

For once there's no moral to the story. I might have missed most of the action, but at least the shack is finally RF-free and, unexpectedly, the level of mains noise on receive seems to be lower. And, of course, I'm prepared a whole year in advance for next year's BERU! Now, how many people can claim to be as well prepared as that?

For information and assistance this month, many thanks to VK3KWA, I2UIY, OE4BKU, and ZL1AAS. Until next month, good contesting!

73, Peter VK3APN

## ARI International DX Contest CW/SSB/RTTY

2000z Sat to 2000z Sun, 3/4 May

This contest occurs each year on the first full weekend of May. Anyone can work anyone else, and categories are single operator CW, SSB, RTTY or mixed; multi-operator single transmitter mixed; and SWL mixed. Bands are 160-10 m (no WARC). The same station can be worked on the same band once each on CW, SSB, and RTTY, but the multiplier can be claimed only once for that band. Once a band or mode has been used, 10 minutes must elapse before it can be changed. Send RS(T) + serial number. Italian stations will send RS(T) + province.

Score 10 points per Italian QSO, three points per QSO with stations in another continent, one point per QSO with stations in own continent, and zero points per QSO with stations in own country. Final score equals total points from all bands times total multipliers from all bands.

Multipliers are the sum of Italian provinces (max 103) and countries (excluding I and IS0) on each band. Province codes include: 11: AL AT BI CN GE IM NO SP SV TO VB VC; IX1: AO; 12: BG BS CO CR LE LO MI MN PV SO VA; 13: BL PD RO TV VE VR VI; IN3: BZ TN; IV3: GO PN TS UD; 14: BO FE FO MO PR PC RA RE; 15: AR FI GR LI LU MS PI PT SI; 16: AN APAQ CH MC PS PE TE; 17: BA BR FG LE MT TA; 18: AV BN CB CE CZ CS IS KR NA PZ RC SA VV; IT9: CL CT EN ME PA RG SR TP AG; 10: FR LT PG RI ROMA/RM TR VT; IS0: CA NU SS OR.

Use a separate log for each band, and a check log (ie sorted callsign list) for 100+ QSOs on any band. Send log within 30 days to: ARI Contest Manager I2UIY, PO Box 14, 27043 Broni (PV), Italy. Logs on disk are welcome, and an MS-DOS logging program is available from the contest manager for \$US5.00 (to cover disk/postage).

## CQ-M Contest (CW, Phone, Mixed)

2100z Sat to 2100z Sun, 10/11 May

Sponsored by the Krenkel Central Radio Club, this contest runs on the second full weekend of May each year. Categories are single operator, single and all band; multi-operator single transmitter; 20 m SSTV; SWL. Bands are 160-10 m. No cross-mode QSOs please. Call "CQ-M", and exchange RS(T) (or RSV on SSTV) plus serial number. Score one point per QSO with own country, two points with a different country in the same continent, and three points with other continents (continents as for WAC). The final score equals total points times total number of countries from each band. Countries are according to the R-150-C list, which is similar to the ARRL DXCC list except for former USSR countries. Serious competitors should review the R-150-C list. Awards apply, and there are achievement awards for stations making 200+ QSOs. Mail logs by 1 July to: Krenkel Central Radio Club, CQ-M Contest Committee, Box 88, Moscow, Russia.

## Sangster Shield

0800-1100z Sat and 0800z-1100z Sun, 17/18 May

This unusual contest emphasises low power operation. The object is to work as many ZLs on 80 m CW as possible. QSOs can be repeated once per 1/2 hour period, ie 0800-0830, 0830-0900, etc. At least five minutes must elapse between repeat QSOs with the same station, or else another station must be worked in between. Send RST plus power output; ZLs will send their RST/branch/power. Non-ZLs using up to 5 W score 10 points per QSO with a ZL, if the ZL worked is using up to 5 W; or five points per ZL using over 5 W. Non-ZLs using more than 5 W score five points per QSO with a ZL using up to 5 W. QSOs between stations where both use more than 5 W are invalid for the contest. Final score equals total points times number of ZL branches worked. Send logs to reach: Contest Manager ZL3KR, 4

Exton Street, Christchurch 8005, NZ by 13 June. Certificates will be awarded to the highest scoring non-ZLs in their respective call areas.

## Results of 1996/97 Ross Hull Memorial VHF-UHF Contest

Presented by John VK3KWA

Congratulations to Adrian Pollock VK2FZ/4, who has won again with an enormous score of over 19,000 points. Second place goes to Gordon McDonald VK2ZAB with over 15,000 points, and third to Rob Ashlin VK3DEM.

In band-by-band scoring, Adrian scored equal top on 6 m with Phil Helbig VK5AKK. Glenn McNeil VK4TZL and Rob Ashlin VK3DEM came close behind. On 2 m, the top score went to Gordon VK2ZAB, followed by Phil VK5AKK and Adrian VK2FZ/4. On 70 cm, the top scores went to Adrian and Gordon.

The highest score achieved on any band was 7470 points scored by Adrian on 1296 MHz. It was also good to see two entries for 2.4 GHz and one for 10 GHz.

Congratulations to Adrian for his second consecutive win this year. Competition should be fierce again next year and, with some major changes to the rules (see below), it will be hard to predict who will come out on top.

## Some Notable Contacts

In spite of the very high scores made by the top stations, some notable contacts were made by entrants who described their stations as modest. It proves again that big beams and linears can come in very handy, but it is still possible to do well without them.

6 m: Many logs, including most VK call areas and large numbers of ZLs.

2 m: VK2FZ/4 worked VK3AFW via meteor scatter. VK5AKK made a large number of VK2 and VK6 contacts. VK3DEM worked seven VK call areas and ZL3. VK3ZLS worked six call areas using only 30 watts. VK7XR made 17 VK4 contacts and 11 VK2 contacts. VK2BBF worked six VK call areas and made 16 ZL contacts. VK2DVZ made 13 ZL contacts.

70 cm: VK3DEM worked six call areas and VK3CY worked five. VK5AKK made 18 VK6 contacts.

23 cm: VK2ZAB worked VK2FZ/4 every day, and also ZL1AVZ for a new VK2 distance record of 2305.1 km. VK3DEM worked five call areas.

## Activity

Activity was much lower than last year, despite better propagation. Most contest activity was between a small number of "top" stations, who built up high scores mainly by working each other. People with more modest stations, including some with quite good ones, were not in demand for contest points, and this led to the lowest level of activity for some years.

The reason is that under the "best 100" scoring, a top station does not need to work anyone locally or even at medium distances. Gordon VK2ZAB pointed out that his average two metre distance was 1200 km, and he was even able to eliminate some eight point contacts from his log. Adrian VK2FZ/4 made an enormous score by repeatedly working the same interstate stations, which he found became quite boring.

It seems that the "best 100" should be dropped if there is to be a revival of activity. There is also a general consensus that there should be a limit on the number of repeat contacts with the same station, and that (as Guy VK2BBF put it) "entrants should be forced to work a larger number of different stations".

## Other Comments

There were some complaints that the contest is too long because it is necessary to live in the shack for a month in order to get the best possible score. Ross VK2DVZ suggested cutting it back to two weeks, or else running it over five weekends.

The first attempt to fix the problem was the "best seven days" scoring, and the second was the current "best 100" system. Both of these systems made it unnecessary to live in the shack for the full contest period, but neither has worked because most serious entrants are still doing it.

But what about shortening the contest? This was tried in 1988. The contest ran for just two weeks, and it was over before most people realised that it was on. Many amateurs were unable to join in because they did not happen to be free during those two weeks, and the best propagation occurred before and after the contest. It was a fizzer. And there were still complaints about having to live in the shack for a fortnight! The same thing would probably happen again if it were shortened, and even more so if it ran only on weekends.

Ever since 1950, except for one year, the contest has usually run for four weeks, and sometimes as many as seven. I feel that a reasonable duration is a very important part of the basic purpose of the contest, which is to get more stations on the air for as much of the DX season as possible. But how to prevent people from spending every waking hour in

## U-CAN-DO computer animated

"Electronics" educational videos: 19 titles

- AM radio theory
- FM Radio part I
- DC circuits
- FM Radio part II
- AC circuits

Send reply paid envelope for full list  
Cost \$80 each plus \$20 handling & postage  
Mail order from Rudkin Trading®  
PO Box 373, Unley SA 5061, Australia  
Fax 08 8373 4496



the shack? I do not think I can, even if the contest only ran for one week. All I can do is make it unnecessary.

The 6 metre scoring cap also came in for criticism. It is part of a policy to try to keep the scoring potential of all bands as equal as possible, and to prevent the contest from being won on the strength of bonanza points from sporadic E openings. But under the present rules, 6 m has much less scoring potential than the higher bands. This needs to be changed. Other entrants suggested the opposite: drop 6 m altogether. There is no pleasing everyone in this case!

### Next Year

It seems clear to me that we need new rules which aim for the greatest possible participation, and require many more contacts to be made. There should also be a new approach to the 6 m dilemma. I suggest several changes.

The first is to drop the "best 100" scoring and have no limit on the number of scoring contacts that can be made. To prevent the need to work everything that moves, this could be combined with a moderate minimum contact distance.

The second is to return to the "best 7 days" scoring. This would limit the number of repeat scoring contacts to seven, and make it necessary to work many more different stations. It also means that entrants would not need to spend every day in the shack.

The third is a suggestion made by John VK3BQS, which is to drop the 6 m scoring cap, and to adopt a new rule to prevent any one band from contributing the lion's share of the total score. John suggests that all bands should be scored on the same basis, but that anyone entering a multiband log should be allowed to derive no more than 50 per cent of their total score from any one band. This should encourage more multiband activity, because every station worked on an entrant's best band would have to be balanced by a contact made on another band.

As usual, I would very much appreciate comments on these proposals. No decision has yet been made, although I feel that the above ideas would make the contest much more attractive. If you have any other ideas, please let me know. Comments please!

**Have you  
advised the  
SMA of your  
new address?**

### 1996/97 Ross Hull Contest Results

Call	Name	50MHz	144MHz	432MHz	1.2GHz	2.4GHz	3.4GHz	10GHz	TOTAL
VK2FZ/4	A Pollock	1200	3984	5719	7470	858	-	-	19231
VK2ZAB	G McDonald	339	5004	5334	4570	-	-	-	15247
VK3DEM	R Ashlin	1190	3084	3025	2910	832	-	928	11969
VK2DVZ	R Barlin	-	3508	3129	4140	-	-	-	10777
VK5AKK	P Helbig	1200	4048	3689	170	-	-	-	9107
VK3TMP	M Pickering	211	3164	3003	1790	-	-	-	8168
VK7XR	A Hay	967	3064	2233	1300	-	-	-	7564
VK3CY	D Clarke	-	3232	3668	-	-	-	-	6900
VK4TZL	G McNeil	1195	1700	1090	-	-	-	-	3985
VK3AFW	R Cook	176	1822	1344	-	-	-	-	3342
VK2BBF	G Fletcher	-	3152	-	-	-	-	-	3152
VK4KZR	R Preston	-	800	238	980	-	-	-	2018
VK3ZLS	L Sim	-	1780	-	-	-	-	-	1780
VK4IC	B Gibbs	294	876	-	-	-	-	-	1170
VK3AJE	B Gardiner	-	32	21	-	-	-	-	53

### Ross Hull Contest

#### List of Winners (1950-97):

1950-51 VK5QR	1965-66 VK3ZDM	1981-82 VK6KZ
1951-52 VK5BC	1966-67 VK5HP	1982-83 VK6KZ
1952-53 VK4KK	1967-68 VK3ZER	1983-84 VK6KZ
1953-54 VK6BO	1968-69 VK5ZKR	1984-85 VK3ZBJ
1954-55 VK4NG	1969-70 VK3ZER	1985-86 VK3ZBJ
1955-56 VK3GM	1970-71 VK4ZFB	1986-87 VK3ZBJ
1956-57 VK3ALZ	1971-72 VK5SU	1987-88 VK5NC
1957-58 VK3ALZ	1972-73 VK5SU	1988-89 VK5NC
1958-59 VK3ALZ	1973-74 VK5SU	1989-90 VK3XRS
1959-60 VK4ZAX	1974-75 VK5SU	1990-91 VK3XRS
1960-61 VK3ARZ	1975-76 VK5SU	1991-92 VK3XRS
1961-62 VK5ZDR	1976-77 VK4DO	1992-93 VK3XRS
1962-63 VK4ZAX	1977-78 VK3OT	1993-94 VK3XRS
1963-64 VK5ZDR	1978-79 VK4DO	1994-95 VK3XRS
1964-65 VK3ZER	1979-80 VK3ATN	1995-96 VK2FZ/4
	1980-81 VK6KZ	1996-97 VK2FZ/4

### VK and ZL RESULTS of 1997 VK/ZL/OCEANIA DX CONTEST

*Presented by John Litten ZL1AAS, NZART Contest Manager*

Here are the VK and ZL results of the 1997 Contest. It has been my custom to get them out as soon as possible; however, because the overseas logs are still arriving, it will be a month or two before the complete results can be published.

Phone entries are up slightly this year, but look at the CW section. Who said CW is dead? Just look at the 40 metre scores in particular!

#### Phone, Single Operator:

	80m	40m	20m	15m	10m	Score
VK1NTW				60358		60358
VK2APK		200340				200340
VK2PS	2684					2684
VK2VM		4640	2028	114444		212160
VK2XT	60	5220	10710	215940	3	457758
VK4BAY		1105	270	26350	612	58000
VK4EET		10140	1800			29820
VK4LAA	10					10
VK4MZ	1440	193550	35074	113920	5832	1252728
VK5AI		245	441	114444		212160
VK8AV			6204	36720	240	87248
VK8DK		550	156			1496
ZL1AIZ	64350	30030	1024	512		270111
ZL1ANJ		22265	88	84900		206298
ZL2AMI		40040		336		97482
ZL2AWH	480	2090	4650	2184		39445
ZL3TX	3800	100	1380			14363
ZL4AV	40	405	1054	8		4532

**Phone, Multi-operator:**

VK4EMM 1000 41625 11475 306740 7560 1015105

Phone, Check Logs: VK5OE, VI75RAAF, ZL3GQ

**CW:**

VK2AIC	40	200	525	180	4500
VK2APK	25850	875670	22302	9328	864 2072283
VK2AYD	52510	602880	17368	7154	585 1734486
VK2BQQ		240625			240625
VK2DID	100	3960	169	180	11904
VK2KM	40	987480	15200	18460	2112 1872351
VK2PS	280	97745			1584 139973
VK2VM	83070				83070
VK3APN	1800	342990			385670
VK4EMM	93790	1469590	12150	25872	10032 3906396
VK4ICU		500	2052	3960	3393 37074
VK4TT			39878		39878
VK4XA				18639	18639
VK5AGX			1120		1120
VK5AI	120	8085	3216		29568
VK5GN	34170	71440	11776	7700	1020 544004
VK6IV		12375			12375
VK8AV	72000	333900	43254	57980	8364 2233660
VI75RAAF	10	33945	9086	9794	1311 189612
ZL1AIH	2040	21390			38110
ZL1AIZ	158110	181700	1960	1914	937980
ZL1HV	320	28810	7632		88088
ZL2AGY		1348950			1348950
ZL2AWH	240	2280	210	144	9585
ZL2CD		193590			193590
ZL2REX	90	47150	1998		80398
ZL3GQ	112500	1419795	37026	8816	3709228
ZL4OK	13440	91060	525	4872	3 277278
ZL4OL	29140	142975	110	8	328320

Check Logs: VK3KS, VK3XB, ZL1ALZ, ZL2VS, ZL4GU

\*PO Box 2175, Caulfield Junction, VIC 3175  
pnesbit@melhpc.org.au

ar

the Division to promote all aspects of amateur radio and for us to introduce more club-type activities. He also sought the views of members on obtaining premises for Divisional activities.

**Closure**

This will be my final *Forward Bias* column. I would like to thank my readers and the Publications Committee for their support over the last two years. My association with *Amateur Radio* will continue through the *Novice Notes* column.

**VK2 Notes***Peter Kloppenburg VK2CPK*

It was pleasing for VK2 Council to note that membership increased by 101 members between February 1996 and February 1997. This increase came about despite the bad propagation conditions that prevail during the low sun spot minimum. But it is precisely because of this that the amateur community feels the need for up-to-date information about possible openings on HF and VHF and the various propagation modes that can be used. All of this, such as predictions and anecdotal writings, are regularly published in this journal.

Council believes that the journal and its contents make a very significant contribution to the enjoyment of the hobby of amateur radio by publishing details and data of on-air activity.

Council received a report from Ken Westerman VK2AGW, Affiliated Clubs Officer, about the operation of the Affiliated Clubs Net. Ken has decided to temporarily discontinue the net until further notice. He commented that participation and attendance had been poor and therefore the net was not fulfilling a useful purpose. Council has decided to reinstate the net at 7.30 pm on a day other than Sunday. The matter of selecting a suitable day will be placed on the agenda of the next Conference of Clubs (CoC).

Council has decided not to hold the CoC on the day following the Annual General Meeting (AGM). Instead, the CoC will be held on Saturday, 10 May, 1997.

The position of Trash and Treasure coordinator has been taken over by the Secretary until the next AGM. This decision was taken by Council because of the possible conflict of interest by Councillor Kloppenburg, who is in the business of trading in electronic instrumentation while at the same time holding the portfolio of Trash and Treasure coordinator on Council.

During the February Council meeting, Peter Jensen VK2AQJ, President, issued draft copies of the Memorandum of

**Divisional Notes****Forward Bias - VK1 Notes***Peter Parker VK1PK***Ginini Thieves Let Off!**

VK1 amateurs have failed in their bid to win compensation from those responsible for the theft of repeater equipment from Mount Ginini. *Forward Bias* readers will recall that one adult and one juvenile were found guilty of the theft last year. Because of the severity of the crime, the matter was referred to the Supreme Court for sentencing.

Handing down his decision on Tuesday, 18 February, His Honour Justice Terrance Higgins gave both offenders 104 hours each of community service work as punishment. The prosecution's bid for compensation was refused.

**AGM Results**

The VK1 Division has a new committee following the Annual General Meeting held

on Monday, 23 February. Most key positions were filled but a ballot was not required due to insufficient nominations. The Committee comprises: President, Hugh Blemings VK1YYZ; Vice President, Gilbert Hughes VK1GH; Vice President, Simon Trotter VK1AUS; Secretary, John Woolner VK1IET; Treasurer, Les Davey VK1LD; Federal Councillor, Richard Jenkins VK1RJ; Committee member, Jim Muller VK1FF.

The position of Broadcast Officer was not filled, meaning that the future of the VK1WI weekly broadcast is in doubt at the time of writing. In addition, the committee is under strength, with several committee member positions still vacant.

February's meeting was a drawn-out affair, running for over two hours. Early on it looked as if we were not even going to reach a quorum, though one or two late comers saved the day. The incoming president, Hugh Blemings VK1YYZ, spoke of the need for



Seen at the Radio Vet's Xmas party at Radio House on 19 December 1996: (l to r - back row) Ray VK2DRC, Pierce VK2APQ, Ray VK2BBI, Franklyn VK2DYP, Basil VK2EQY, Bill VK2EXX, George VK2BGU, John VK2MJS. (l to r - middle row) Rick VK2PH, John VK2WRT, Mike VK2YC, Ivan VK2ARI, Tim VK2ZTM. (l to r - front row) John VK2HJM, Max VK2AFE.

Association (M&As). The Policy and Strategy subcommittee, of which he is Chairman, has spent considerable time re-writing the M&As, also known as the Constitution. This document was first written in about 1910, when amateur radio was beginning to be thought of as a hobby. Things have changed considerably since then, and the M&As need an update to make them relevant to the present Institute's operations and the members' requirements.

Council has allocated the portfolio of "Deceased Estates Officer" to Peter Jensen VK2AQJ, who happens to be the President as well.

Council is worried about the large number of books out on loan and overdue. A total of 200 books are unaccounted for. If anyone has a WIA library book on his shelf which is overdue, please return it as soon as possible.

Due to problems with finding suitable volunteers to run the office on Monday evenings, Council has decided to cancel office hours for that evening.

### "QRM" News from the Tasmanian Division

Robin L Harwood VK7RH

Elections were held in February for the office bearers in the three Branches in the State. There were very few changes noted in the South and the Northwest. However, in the North some new faces have come forward. In

the South, Andrew Dixon VK7GL was re-elected as President with John Bates VK7RT being Secretary and Mike Jenner VK7FB re-elected as Treasurer. In the Northwest, David Spicer was re-elected as President with Ron Churcher VK7RN as Secretary. A new Treasurer was elected, Terry Ives VK7ZTI. In the North, Geoff Wells VK7ZOO was elected as President with Allen Burke VK7AN as Vice-President. Robin Harwood VK7RH is Secretary and Tim Holloway VK7TIM was elected as Treasurer.

In the South and the North new faces were elected to be the Branch WICEN Officer, being VK7JGD and VK7BE respectively, whilst the Northwest is currently vacant.

12 nominations were received for Divisional Council and the results of this will be given in next month's column, along with details of the Annual General Meeting. Two Councillors from 1996 did not re-nominate and we would like to thank Joe Gelston VK7JG and Terry Ives for their contribution to Divisional Council.

The North and Northwestern Branches held a combined meeting in Deloraine on 12 March. A good time was enjoyed by all attending, especially the supper put on by our Deloraine hosts. Our thanks go to Frank Clark VK7CK, Bruce Cameron VK7GC and Bill Carter VK7AK for organising this annual get-together.



Antenna Sales International  
 HF - VHF - UHF MOBILE ANTENNA  
 HF - VHF - UHF BASE ANTENNA  
 CB - MARINE - AIRCRAFT

Monoband to Multiband  
 Convert Now, to the all  
 New!  
**PERTH PLUS**  
 HF Mobile antenna  
 with 80-40-30-20-17-15-12-10-6-2m Included

Also in Stock

Coaxial Cables & fittings  
 1/8" Spring Bases, Trunk and Gutter Mounts

Outbacker OBB "Classic"  
 Outbacker "Junior plus"

Split Models  
 Helical Dipoles  
 Long wire Dipoles  
 Baluns

**\* Free!**

With Every Perthplus Purchase.  
 1 x AmSoft CD-ROM  
 '94 Callsign Database

While currency stocks last

Now available from :

MELBOURNE  
 Daycom Communications  
 Ph 03 5436444

ALICE SPRINGS.  
 Farmer Electronics  
 Ph 089522388

DARWIN.  
 Integrated Technical Services.  
 Ph 089-816411

SYDNEY.  
 Andrews Communications  
 Ph 02 6369060

PERTH.  
 Tower Communications  
 Ph 4701118

ADELAIDE  
 Johnston Electronics  
 Ph 08 2871061

PERTH - Model

<http://intercon.com.au/outbacker>

TERLIN AERIALS Ph +61 (09) 3545444  
 5 Yampi Way Fax +61 (09) 3545455  
 Willetton W.A. 6155



Send \$ 5.00 for a 15 minute informational video  
 Refundable with every antenna purchase.

ar

---

---

# How's DX?

Stephen Pall VK2PS\*

---

---

Who said that Morse code is a dying art of communication and should be abandoned by the amateur service? The statistics of the Heard Island DXpedition show a different picture. I note the following about the mode used for QSOs: Japan, CW 8,991, SSB 5,473; Europe, CW 21,358, SSB 13,756; Eastern North America, CW 7,555, SSB 6,601; Central North America, CW 3,050, SSB 2,537; Western North America, CW 2,367, SSB 1,668; rest of the world, CW 1,962, SSB 2,599.

What about Australia and New Zealand? You guessed it! The VK/ZL group was the only one where the SSB mode was in the majority: SSB 447, CW 253, RTTY 13. Does this kind of statistic tell us anything?

To me, and I am not an expert in analysing statistics, the above figures show the following:

1. the practice of using Morse code, being the original digital mode in CW, is not dead in the rest of the world;
2. one hundred watts of CW power appears to be more useful than, say, 200 watts of SSB power;
3. when propagation is not ideal, a CW signal goes further than an SSB signal; and
4. in a pile-up, a CW signal can be more easily detected than an SSB signal.

Anecdotal evidence suggests that Morse code is still very useful, especially in emergency situations. A few weeks ago it was reported in broadcast news that an inter-island trading ship sank in the Cook Island waters, due to an engine fire. The twenty five occupants of the 250 tonne ship were forced into life rafts and a dinghy, and were drifting. The pilot of a passing commercial airliner spotted the survivors and used the plane's landing lights to indicate to them in Morse code that help was on its way. They were all rescued.

Changing the subject to propagation, there is no doubt that we have passed the minimum point of Cycle 22. Good occasional openings on 20 metres, coupled with marginal activity on 15 and 10 metres, indicates that we are now in Cycle 23. Talking to Dr Richard Thompson from IPS Radio and Space Services the other day, he confirmed that we have passed the minimum of the past cycle. However, scientists all over the world are not yet certain of the exact date of the minimum. Mathematical formulae used in calculating the date refer to smoothed average sunspot numbers; therefore, it takes a long time

before all the scientific data is available to calculate the exact date.

In the opinion of Dr Thompson, we reached the minimum in the latter part of 1996 when the sunspot number was a very low 8.2. Other scientists are of the opinion that the minimum was in mid-October 1996. It appears that the final answer will be given in approximately six months time.

At present we have a good mixture of old and new spot numbers on the sun. The month of February looks like being the watershed for the new cycle. There is a good possibility that the number of sunspots in the new cycle will be more than the spots in the old cycle.

Dr Thompson predicts that the "T index" will rise to about 40 by the end of the year and we will reach the peak of Cycle 23 early in the year 2000, only three years away.

## Kerguelen Island - TXOK

The expeditioners on their way back from Heard Island VK0IR planned to have a 24 hour, or at least an overnight, activity from Kerguelen. They packed one huge crate with two complete stations in preparation for the event.

However, as they approached Kerguelen a storm caught up with them which decreased their chances of operating. The French Antarctic co-ordinator said that, because of a depression heading towards Kerguelen, the crate could not be off-loaded and the expeditioners were allowed only two hours on shore. On setting foot on the island they

discovered that their TXOK licence had been changed to FT5XM. But they managed, somehow, to get "on the air", at least symbolically. Half of the team made a one-each single QSO with the assistance of the commercial station used in the Post Office. All contacts were made with the same station, ZS6SOA.

## Heard Island VK0IR

The final statistics from Heard Island indicate that the total contacts on CW (45,536) far outweighed the total number of SSB contacts (33,081).

The QSL route for the expedition is: INDEXA, C/o John Parrott W4FRU, PO Box 5127, Suffolk, VA 23435 USA, with the usual reply envelope and return postage (and a donation if you so wish). No QSL requests by e-mail please.

The cards will be mailed out in the order received and mailing will begin as soon as the logs and cards are received. Please send all Heard Island QSL cards in one envelope, all Reunion QSL cards in another envelope, and all QSL cards for the maritime mobile operation in a third envelope, otherwise delay will occur.

John has plenty of local help with this activity. Incidentally, the name INDEXA, mentioned at the heading of the QSL address, stands for **The International DX Association Inc**, PO Box 607, Rock Hill, SC 29731, USA. It is a non-profit organisation for the enhancement of amateur radio and is an active supporter of many DXpeditions.

## Huang Yan Dao - BS7H

The Chinese Radio Sports Association (CRSA) has announced plans for the third DXpedition to Huang Yan Dao, also known



Mike KOAJ busy with the key on Heard Island.



**Remains of the old ANARE station on Heard Island.**

as Scarborough Reef. A multi-national team, led by BZ1OK and JA1BK, will sail from Guangzhou (Canton) on 28 April and is expected to commence a one-week operation on Wednesday, 30 April.

The primary goal of the expedition is to provide at least one QSO with as many individual DXers as possible. A secondary goal will be to provide contacts on additional bands and modes, including 160 to 6 metres, CW, SSB, satellite and RTTY with four stations on the air.

Operators will be BZ1OK, JA1BK, JA1RJU, N7NG, W6EU, W6RGG and maybe others. The QSL manager is JA1BK. There will be an "operational support network" consisting of several stations through the world which will be in constant communication with the operating team (*shades of the Heard Island "pilot" system? VK2PS*). The DXpedition enjoys strong support from the PRC government.

### **Pratas Island - BV9**

Joe BV/N0IAT in Taiwan, ROC, reported that he had a long discussion with several Taiwanese hams during the Chinese Lunar New Year holiday and was told that the application for the upcoming DXpedition to Pratas Island, one of the newest DXCC countries, was rejected. Citing military preparedness, the officials rejected the application. Pratas is one of the Republic of China strongholds and it is primarily an island of military installations and not for civilian use.

### **Bouvet Island - 3Y**

The South Sandwich Island Arctic DX Group reported that the 1997/98 expedition will depart Capetown in January 1998 on the

67 metre long vessel "Afrique du Sud", and will commence activity for 12 days starting 5 February 1998. Tony WA4JQS and Barry ZS1FJ are planning the expedition which will cost \$US100,000.

In the meantime it was reported that Kaare LA2GV was active for three hours during the morning of 22 February as 3Y2GV on 18,090 kHz working Europe. Kaare (who was a member of the first Peter 1 DXpedition) was travelling on a Norwegian Antarctic Ship and was unable to give any advance warning of his activity.

### **Groote Eylandt - VK8NGE**

Stuart VK8NSB is returning to his old hunting ground of Groote Eylandt island (OC-141) and will be active as VK8NGE from 21 March to 6 April on 80, 15 and 10 metres CW and/or SSB. The island lies in the Gulf of Carpentaria (13° 58' S and 136° 38' E). QSL via Bill Horner VK4FW.

### **St Peter Island - VK5ISL**

St Peter Island is located at 32° 19' S and 133° 34' E, off the mainland of South Australia, approximately 14 km from the township of Ceduna. The island forms part of the Nuyts Archipelago in the Great Australian Bight.

Malcolm VK6LC, the well known IOTA DXpeditioner, had been asked by Tony VK5WC, Neville VK5WG, Terry VK5LED and Paul VK5MAP to organise, manage and train the group by practical experience for future IOTA DXpeditions. They landed on St Peter on 27 March and departed on 1 April.

Government landing and transmitting licence was obtained and the DXpedition registered with the RSGB and the IOTA

Committee as a new reference number in their program. The operating frequencies were 3605 for VK/ZL, 3798 for others, 7045 (NA 7178 listening), 14260 and 21260 kHz. Two stations were used. A variety of wire and multiband antennas were at hand in addition to the Australian ATN 4 Square vertical array antennas for the 40 and 20 m bands.

Special support was given by the IOTA Convention in 1996 and by the members of the Diamond DX Club of Italy. QSL direct with return postage and envelope to: Gjanni Vareto 11HYW, PO Box 1, 10060 Pancalieri, Italy.

### **International Marconi Day - VK2IMD**

This is now, if my mathematics are correct, the tenth year that amateur radio operators have activated special call signs or special suffixes to celebrate the birthday of Marconi which is 25 April. VK2IMD will be on the air for 24 hours on 19 April, with some 58 other amateur radio stations all around the world, to celebrate the event. The activity will start at 0001 UTC on 19 April on all bands, SSB, CW, FM and packet. QSL, with return envelope and postage, to WAHRA (Wahroonga Amateur Historical Radio Association), PO Box 600, Wahroonga NSW 2076.

### **Future DX Activity**

\* Mark 9X4WW is now active from Rwanda until August 1997. He is allowed to operate only on the allocated frequency of 14118 kHz. QSL via ON5NT.

\* Tom VK0TS from Macquarie Island showed up a few times on 40 metres during February and March having QSOs mainly with his VK1 friends. He expects to be more active from April onwards. QSL via VK1AUS, S N Trotter, PO Box 2063, Kambah Village, ACT 2902.

\* Ron ZLIAMO intends to go to Banaba Island T33 in April 1997.

\* Chris A71CW, who made over 100,000 contacts from Qatar, will move now to Oman, A4. No call sign has yet been allocated.

\* Dominique F5RYC will be active in the near future as J28YC from Djibuti. QSL via F6EJI.

\* C6A/DL3ABL and C6A/DL6MHW will be looking for contacts from the Bahamas on CW/SSB on all HF bands. QSL via DL3ABL.

\* Harold DF2WO will operate from Burkina Faso, from 28 March to 14 April, as XT2AW, CW/SSB on all bands. QSL to home call.

\* Contrary to rumours, there will be no activity from Aves Island YV0 this year.

\* Mario HB9BRM is now in Sri Lanka and is using the call sign 4S7BRG.

\* Frank 9Q5PA is an employee of the American Embassy and will be in Zaire for the next 15 months. QSL to Frank Patris, C/o America Embassy, Kinshasa, Unit 31550, APO 09828, USA.

\* Eric FT5ZG has been active on Amsterdam Island since 13 January. CW only on 40 metres at 1730 UTC. QSL via F5RQQ.

\* 9U5CW and 9U5DX will use the special call 9U5T for all the major contests in 1997. QSL via F2VX. Please enclose a large envelope.

\* Gerard F2JD, has been issued with a Panamanian callsign, HP1XBI. He is active from 40 to 15 metres, including the WARC bands. QSL via F6AJA.

\* JG8NQJ/JD1 will be on the Island of Minami-Torishima until 23 April. He operates on 40 to 10 metres. QSL via Susumu Sanada JA8CJY, 5-4 Shin-Ei, Toyohira, Sapporo 004, Japan.

\* XU2FB is Bob KE2FB in Cambodia. He works at the US Embassy in Phnom Penh. QSL via N4JR.

\* Sam V63KU is active almost daily between 14175 and 14200 kHz. QSL via JA6NL, or via the bureau, or to Box 1679, Truk Lagoon, Micronesia.

\* Rich KF8UM will take part from the US Virgin Islands in the CQ WPX SSB contest on 26 March to 12 April, and outside the contest, with the call KP2/KF8UM. QSL direct (new address) to Richmond Blake, Rt 3, Box 234-A, Bridgeport, WV 26330, USA.

\* Stromboli Island (EU-O17) will be activated by IT9TZZ and IT9NGN from 30 May to 6 June.

\* Lubang Island (OC-126) will be on the air with the help of DU1IXY, DU3NHK, DU3BAA and JH0HZE/DU1 from 13 April to 20 April.

### Interesting QSOs and QSL Information

\* VK0TS - Tom - 7070 - 1153 - Jan (E). QSL via VK1AUS - S N Trotter, PO Box 2063, Kambah Village, ACT 2902.

\* HK3AO - Luis - 14164 - SSB - 0612 - Jan (E). QSL to Luis Eduardo Caicedos, PO Box 54, Bogota, Colombia, South America.

\* VK9XZ/P Cocos Keeling - Bill - 14260 - SSB - 0650 - Jan (E). QSL via Bill Billington VK6UE, 30 Bindaree Tce, Kingsley, WA 6026.

\* ET3BN - Peter - 14025 - CW - 0601 - Feb (E). QSL to Dr Peter Haferkorn, PO Box 150194, Addis Ababa, Ethiopia, Africa.

\* H44FN - Hari - 7011 - CW - 0652 - Feb (E). QSL via Bela Mihaly HA8FW, Csongradi Sgt 122/A, 4/9, H-6724, Szeged, Hungary.

\* S21XX - 14025 - CW - 1044 - Feb (E). QSL via Hannes Schmidt DL3NEO, Hans Sachs Str 24, D-91207, Lauf, Germany.

\* CP6ND - Arturo - SSB - 14195 - 0636 - Feb (E). QSL to Luis Arturo Resales King, PO Box 504, Santa Cruz, Bolivia, South America.

\* ZL7ZB - Lothar - 14197 - SSB - 0556 - Feb (E). QSL via Lothar Grotehusmann DJ4ZB, Quakerstr 35, D-13403, Berlin, Germany.

\* 9U5CW - Alfredo - 14021 - CW - 0642 - Feb (E). QSL via Gerard Debelle F2VX, 4 Le Haut d'Yrac, F-33370, Tresses, France.

\* XX9AU - Cheang - 14180 - SSB - 1010 - Feb (E). QSL to PO Box 6018, Macau, Asia.

\* P29VXX - Falk - 14195 - SSB - 1017 - Feb (E). QSL via Juergen Maerz DL7UFN, Glambecker Ring 7, D-12679, Berlin-Marzahn.

\* 4L5A - 14160 - SSB - 0518 - Feb (E). QSL via Mario Gava IK3HHX, Via S Lorenzo 29, I-31010, Mareno, Piave, Italy.

### From Here and There and Everywhere

\* Rudi, a well-known German DXer, decided to manage his own QSLing. He has moved lately. His new address is Rudolf Klos DK7PE, In Kirschgarten 17, 55263 Wackernheim, Germany.

\* HG5HRJ is a special event station, operational during 1997, celebrating the 150th anniversary of the Hungarian

Railways. QSL manager is HA5BSW.

\* In my column in the February 1997 issue, I mentioned a new Antarctic Base with the callsign KC4AAD. The comment was made that this is a new base and has been set up for three years. The background about this station came a few weeks later in a short newspaper article. There is now a new automated astronomical site testing laboratory, a joint Australian-United States project in Antarctica, which will operate for two years measuring the brightness of the polar sky to confirm that Antarctica is the best place on Earth to study the stars. If the observation goes smoothly, the Observatory (AASTO) will be redeployed in 1999 to "Dome C" about 2000 kilometres from the South Pole and one of the coldest of the high spots (2385 metres above sea level) in Antarctica.

\* Alan VK8AV is one of the few VK DXers who have contacted Heard Island nine times, on seven bands, on CW and SSB, among them the much coveted 160 m band.

\* Toly 3W5RS is QSLing via Box 303, Vung Tau, Vietnam.

\* The Oceania DX Group was active from 15 to 22 March 1997 with the interesting special call of VI21DS. They were active on behalf of the Down Syndrome Association of Queensland Inc, a charity organisation raising money by issuing a special award at the cost of \$US5.00 or 10 IRCs. The "21" in the callsign is very significant as it is this chromosome which is often the cause of the disability. Award Manager is the ODXG, PO Box 929, Gympie, QLD 4570.

\* Lothar DJ4ZB was active as ZL7ZB from the Hotel Chatham on Chatham Island with a 20 m sloper antenna from 12 February until 14 March.

\* The three operators of S21XX made 925 QSOs on 160 m, 2,550 on 80 m, and 2,900 on 40 m. Total number of contacts was 12,234.

\* LM1SKI, was a special event station in Trondheim, Norway during the Nordic Ski World Championships from 20 February to 2 March. This was the first time that Norway used the LM prefix for the amateur service. QSL via LA1K.

\* It has been reported that there is a very severe "interference" problem with the Armenian mail system.

\* 3Z2GD, a special Polish call, celebrated the 1000th anniversary of the City of Gdansk. QSL via SP2FOV.

\* VI3GP was active again as a special event station early in March celebrating the Melbourne Grand Prix. QSL via VK3ER.

\* Kuwait celebrated its National Liberation Day on 25 and 26 February. 9K2RA/NLD and Abdul 9K2GS/NLD were active. Abdul's card goes via WB6JMS.

## QSP News

### Special Event Station GB70GBH

Dr Ken Jones G3RRN of Lincoln, England has arranged for the above special event call sign to commemorate the 70th anniversary of the inauguration of the Lincolnshire - Australia Beam Wireless Service on 8 April 1927.

A team of local amateurs will operate a

station with the call sign GB70GBH from the original transmitting site at Tetney, near Grimsby, Lincolnshire on Saturday 5 and Sunday 6 April, and on 8 April. The intention is to erect a rhombic antenna, and they will be looking for contacts with VK and ZL on 14 MHz and 10.1 MHz.

(News item from Alan Cook VK3AUC)

---

---

## Education Notes

Brenda M Edmonds VK3KT\* Federal Education Coordinator

---

---

\* It was reported from Sweden that the Swedish authorities are lowering the CW requirement of the amateur test from 12 to 5 wpm. It used to be 16 wpm until just a few years ago.

\* This year the UK short contest callsign will have the number 7 for 1997. Examples: GM7X Scotland, G7A England, GU7D Guernsey, MM7Z Scotland and MI7S Northern Ireland. Do not forget the new prefixes: GM=GM and MM, GW=GW and MW, GI=GI and MI, etc.

\* The Brazil net is active on 14240 kHz on Monday to Friday at around 0900 UTC, and Sundays on 14222 kHz at 1800 UTC.

\* R1ANL at Novolazarevskaya Base, Antarctica should be active by now. Licence was issued on 1 January and is valid for 12 months.

\* After the successful 7O1A activity in Yemen, the Yemeni Ministry of Communication gave permission to Franz DJ9ZB to return to the country in the northern spring to operate in all modes. INDEXA has shipped the equipment and beams for 10 to 40 metres, including WARC antennas, for the 1997 operation. The equipment used in the December 1996 activity was donated to the Yemeni MOC.

\* John PA3CXC has moved from Southern Sudan (ST0) for six months to Rwanda (9X5).

\* GB100LP and GB100FI will be active on all modes on all bands from 10 to 16 May to celebrate the 100th anniversary of Marconi making the first ever QSO across water. QSL via GW0ANA.

\* The correct QSL address of R1ANT (change of operator in October to Yuri) is UA1GO, PO Box 600, St Petersburg 198206, Russia.

\* The QSL route for T20AA is now KD4XN.

### QSLs Received

3DA0DX (3 m ZS6BRZ); LY5A (3 m - LY2ZZ); 5U7Y (3 m - JG3UPM); ZF0F (3 m - PY5EG); FT5XL (4 m F5NZO); VK8TI (30 m GARG, Box 1153, Nhulunbuy).

### Thank You

Many thanks to all those who supply me with news and other information. Special thanks to VK2XH, VK2KFU, VK2JDM, VK2TJF, VK4FW, VK6LC, VK6VS, VK8NSB, WIA, L40370, HA5BSW, ARRL, *The Sydney Morning Herald*, ODXG, INDEXA, IFS Radio and Space Services, Dr R Thompson, *QRZ DX*, *The DX News Sheet*, *The 59(9) DX Report*, *The 425 DX News*, and the *GOLIST QSL Managers list*.

\*PO Box 93, Dural NSW 2158

ar

I have recently looked at the statistics relating to examinations run by WIA Exam Service, and been shocked to find how the demand for examinations has dropped over the last few years.

In 1992, the first year for which the WIA was the only supplier, there were well over 2000 candidates and nearly 500 events. In 1995, although there were still over 400 events, there were less than 1200 candidates. The trend has continued into 1996. Admittedly, in some areas the pass rates have increased slightly which may mean that there are fewer repeat candidates. But that does not affect the conclusion that we are attracting new recruits at an ever-decreasing rate.

It is time to have a good hard look at where we expect to be in the next century. Will amateur radio as a hobby be around into the next century? Will the WIA make it to its centenary?

Certainly, as our numbers diminish, our voice in both national and international spheres carries far less weight. In many other countries amateur radio is growing in both numbers and influence. What can we do to preserve our privileges for the next generation?

A profile of the amateur population shows that the average age is increasing. Most of our new recruits are of middle age or older. These newcomers bring a wealth of general experience to the hobby. Many play a valuable part in the management of clubs or

Divisions. But for continued survival we need to recruit from the younger groups.

I have written previously about ICARE, the International Council for Amateur Radio in Education which was formed in 1995 to encourage the use of amateur radio in schools and Universities throughout the world. I have just received the information about ICARE's third annual conference to be held in July 1997. This year it is to be held in Durban, South Africa, "to encourage attendance by licensed teachers in the southern hemisphere".

Although it is unlikely that I will be able to attend, I have the details if anyone else is interested, and I would be very pleased to be able to submit a report on the activities within schools and universities in Australia. I appeal for information from any readers who are using radio in these situations.

If European, American and African schools have shown an active interest in amateur radio, why is it so hard to encourage Australian schools to see the potential value of this hobby?

I can provide some help with publicity materials, but would welcome ideas on how to reach educational establishments and teachers. This may be one way to increase our recruiting of younger members, and we need to explore all possibilities.

\*PO Box 445, Blackburn VIC 3130

ar

---

---

## Over to You - Members' Opinions

All letters from members will be considered for publication, but should be less than 300 words. The WIA accepts no responsibility for opinions expressed by correspondents.

---

---

### Admission of Guilt?

On a recent morning, in the phone portion of the 7 MHz band, I heard a well-known VK3 amateur.

He was working a European station and, when asked by the other party what antenna he was using and what power, replied that his antenna was an inverted Vee and that he was using 500 watts. Perhaps I have misread the regulations in thinking that the VK legal limit is 400 watts PEP. As inverted Vee antennas

are not usually regarded as gain antennas, I do not imagine that he was referring to ERP.

I am quite sure that there are other VK amateurs who use powers in excess of the legal limit, but I doubt that very many of them would be so imprudent as to admit it on air!

Len Heal VK4BQL  
91 Goman Street  
Sunnybank Hills  
QLD 4109

ar

# Novice Notes

Peter Parker VK1PK\*

## Simple Test Equipment to Build

This month we plug in our soldering irons and put together some pieces of basic test equipment. Though inexpensive, the projects described will prove useful in the radio shack. Any one of them can be assembled in an afternoon. They are described in order of complexity, so that the reader can find a project suitable for their expertise. Extensive constructional information is not provided; refer to April 1996 *Novice Notes* for advice on obtaining components, construction techniques and sources of information.

## Field Strength Meter

A field strength meter is perhaps the simplest piece of RF test equipment that can be built. Used for checking transmitters, antenna experimentation, and testing RF oscillators, field strength meters provide an indication of the presence of RF energy. They are not frequency sensitive and are useful where indication of a change in level is more important than the actual strength of the signal indicated.

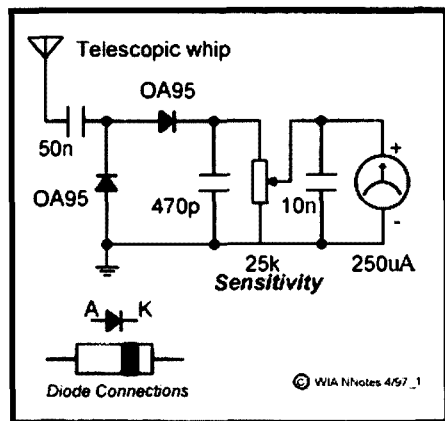


Fig 1 - Schematic diagram of a field strength meter.

Figure 1 shows a schematic of an RF field strength meter. Like a crystal set, it requires no power source. However, unlike a crystal set, the meter has no tuned circuit. It responds to signals of any frequency.

The meter works by converting any RF signal present at the antenna to a DC voltage. This voltage drives a meter movement to give an indication of relative RF. The meter includes a control to reduce its sensitivity where required.

Because it uses few parts, a printed circuit board is not necessary; components can simply be soldered to one another. However, a box is desirable for operating convenience.

The case and aerial from a discarded toy walkie-talkie were used in the prototype, although any small plastic case will suffice. The meter movement need not be large; we are only detecting the presence of RF, and not making precise measurements. A meter from an old radio or tape recorder should work fine.

The diodes can be any germanium type; the actual part number is not important. Germanium diodes can be recognised by their 6 mm-long clear glass case with two coloured bands towards the cathode end. None of the component values shown is critical; a 50 percent variation would have little effect on circuit operation.

To test the operation of the meter, a transmitter is required to provide a source of RF. Placing the field strength meter's extended antenna near a handheld VHF rig should produce an indication on the meter, assuming that the sensitivity control has been set to maximum. No indication means that the meter is not working.

Common construction errors include connecting the diodes or the meter incorrectly and using silicon diodes in place of the germanium diodes specified. In this case, the meter will still work, but with reduced sensitivity. The earth wire is optional; when working with low-powered oscillators, it is useful to clip it to ground (of the circuit under test) to ensure a better indication on the meter.

Those without a transmitter can use an RF signal generator or crystal oscillator (such as that described later) for testing purposes. In this case, place the meter's antenna directly on the output terminal to verify operation. However, only attempt this with transistorised circuitry; component ratings and safety considerations make the meter

described here unsuitable for poking around valve equipment.

The field strength meter is a useful instrument in its own right, but it can be made more versatile. Modifications include adding an amplifier (for greater sensitivity), including a tuned circuit (so it only detects signals in a particular band), or converting it into an RF wattmeter and dummy load. Circuits for such instruments are found in the standard handbooks.

## Crystal Checker

Figure 2 shows the circuit of a simple crystal checker. It switches on a light emitting diode (LED) if the crystal is working.

The crystal under test is placed in an oscillator circuit. If it is working, an RF voltage will be present at the collector. This is rectified (converted to DC) and made to drive a transistor switch. Applying current to the base causes current to be drawn through the collector, thus lighting the LED.

If an indication of frequency is required, simply use a general coverage receiver to locate the crystal oscillator's output. Note, however, that when testing overtone crystals (mostly those above 20 MHz), the output will be on the crystal's fundamental frequency, and not the frequency marked on the crystal's case. Fundamental frequencies are approximately one-third, one-fifth or one-seventh the overtone frequency, depending on the cut of the crystal.

The circuit may be built on a small piece of matrix board and housed in a plastic box. Alternatively, a case made from scrap printed circuit board material may be used. Either a selection of crystal sockets or two leads with crocodile clips will make it easier to test many crystals quickly. The RF choke is ten turns of very thin insulated wire (such as from receiver IF transformers) passed through a cylindrical ferrite bead. Its value does not seem to be particularly critical, and a commercially-available choke could probably be substituted.

The circuit can be tested by connecting a

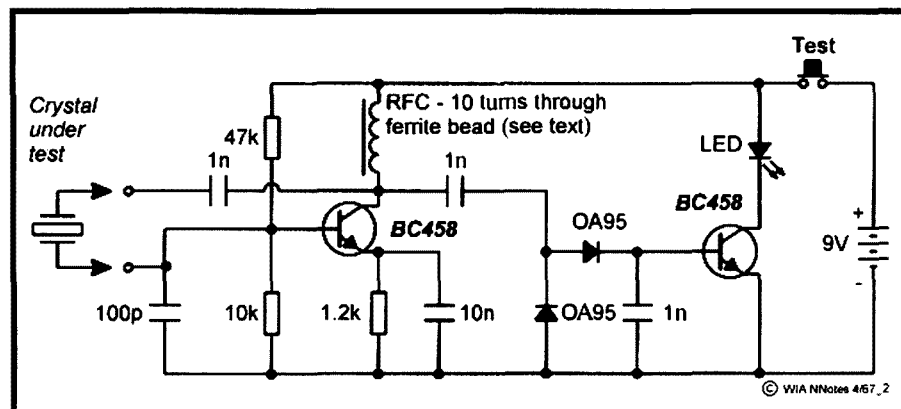


Fig 2 - Schematic diagram of a crystal checker.



crystal known to work, and checking for any indication on the LED. A shortwave transistor radio tuned near the crystal's fundamental frequency can be used to verify the oscillator stage's operation. Note, however, that this circuit may be unreliable for crystals under 3 MHz, and some experimentation with oscillator component values may be required.

The crystal checker also tests ceramic resonators. Other applications include use as a marker generator for homebrew HF receivers (use a 3.58 MHz crystal) and as a test oscillator for aligning equipment.

### Capacitance Meter

This project is more complex than the others described earlier. However, when finished, you will have an instrument capable of measuring all but the largest capacitors used in radio circuits. Unlike variable resistors, most variable capacitors are not marked with their values. As well, the markings of capacitors from salvaged equipment often rub off. By being able to measure these unmarked components, this project will prove useful to the constructor, vintage radio enthusiast or antenna experimenter.

The common 555 timer IC forms the heart of the circuit (Figure 3). Its function is to charge the unknown capacitor (Cx) to a fixed voltage. The capacitor is then discharged into the meter circuit. The meter measures the current being drawn through the 47 ohm resistor. The 555 repeats the process several times a second, so that the meter needle remains steady.

The deflection on the meter is directly proportional to the value of the unknown

## Novice Plus

### Helping you get more from amateur radio

#### Soldering without an iron

• Did you know that antenna wires should be soldered (not just twisted) to ensure a good connection?

There is a way to solder two pieces of wire together outside without a soldering iron. After making sure that the conductors are clean, twist the wires together. Then wind a piece of solder around the connection and wrap a piece of aluminium foil around the joint. Hold a candle or match under the foil. The solder should melt, properly connecting the wires. Perform this operation with care to prevent being splattered with molten solder. After allowing time for the joint to cool, unwrap the foil and inspect the connection.

#### Using small drills in standard chucks

• Those who only occasionally etch their own printed circuit boards may not be able to justify the purchase of a special drill for use in PC board work. However, some standard drill chucks do not adjust right down to take the 1 mm diameter drill bits used.

To cure this, wrap a piece of thin solder around the end of the drill bit that fits into the chuck. Then tighten the chuck to properly grip the bit. This method can also be used to make use of snapped drill bits.

capacitor. This means that the scale is linear, like the voltage and current ranges on an analogue multimeter.

The meter has five ranges, from 100 pF to 1  $\mu$ F (1000 n), selected by a five-position two-pole switch. In addition, there is a x10 switch for measuring higher values and a divide-by-two facility to allow a better indication on the meter where the capacitor being measured is just above the top value in each range.

Component values are critical. For best accuracy, it is desirable that the nine resistors wired to the range switch have a 2% tolerance. If OA47 diodes are not available, try OA91 or OA95 germanium diodes instead.

Construct the meter in a plastic box; one

that is about the size of your multimeter, but deeper, is ideal. The meter movement should be as large as your budget allows; you will be using it to indicate exact values. A round 70 mm-diameter movement salvaged from a piece of electronic equipment was used in the prototype. The meter you buy will have a scale of 0 to 50 microamps. This scale needs to be converted to read 0 to 100 (ie 20, 40, 60, 80, 100 instead of 10, 20, 30, 40, 50). Use of white correction fluid or small pieces of paper will help here.

The components can be mounted on a piece of matrix board or printed circuit board. Use a socket for the IC should replacement ever be needed. Keep wires short to minimise stray capacitance; stray capacitance reduces accuracy.

Calibrating the completed meter can be done in conjunction with a ready-built capacitance meter. Failing this, a selection of capacitors of known value, as measured on a laboratory meter, could be used. If neither of these options are available, simply buy several capacitors of the same value and use the one which is nearest the average as your standard reference. Use several standards to verify accuracy on all ranges.

To calibrate, disable both the x10 and divide-by-two functions (ie both switches open). Then connect one of your reference capacitors and switch to an appropriate range. Vary the setting of the 47 k trimpot until the meter is reading the exact value of the capacitor. Then switch in the divide-by-two function. This should change the reading on the meter. Adjust the 10 k trimpot so that the needle shows exactly twice the original reading. For example, if you used a 10 nF reference, and the meter read 10 on the 100 nF range, it should now read 20. Now switch out the divide-by-two function.

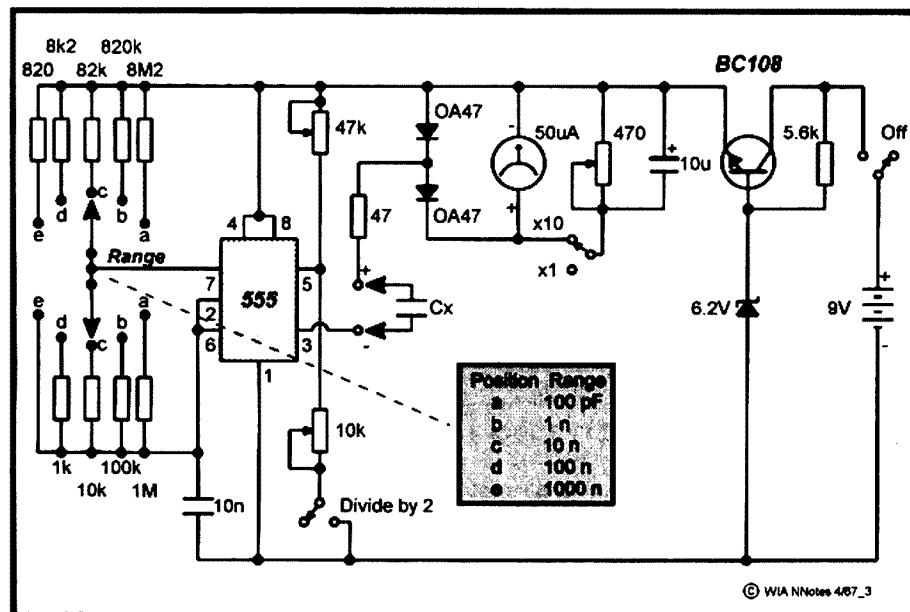


Fig 3 - Schematic diagram of a capacitance meter.

If you are not doing so already, change to a reference with a value equal to one of the ranges (eg 1 nF, 10 nF, 100 nF etc). Switch to the range equal to that value (ie the meter reads full-scale (100) when that capacitor is being measured. Switching in the x10 function should cause the meter indication to drop significantly. Adjust the 470 ohm trimpot so that the meter reads 10. Move down one range (eg from 10 nF to 1 nF). The meter should read 100 again. If it does not, vary the 470 ohm trimpot until it does. That

completes the calibration of the capacitance meter. Now try measuring other components to confirm that the measurements are reasonable. With care, an accuracy of five percent or better should be possible on most ranges.

#### REFERENCE

*Hawker, P Amateur Radio Techniques, Seventh Edition, RSGB, 1980.*

\*7/1 Garran Place, Garran ACT 2605  
VK1PK @ VK1KCM.ACT.AUS.OZ  
parkerp@pcug.org.au

flags, the Union Jack and the American Stars and Stripes. Depending upon which one you initiate, you will be introduced to the Morse scene of that particular country. Clicking on to the Union Jack brings you to the Main Menu of Instant Morse.

Within this menu we have a number of sub-menu headings, **Morse History**, **Learn Morse**, **After Instant Morse**, and **About the Morse Test**. Each of these sub-menu headings is further sub-divided, depending upon which one you chose.

Lets take **Morse History**. When initiated, you are introduced to a screen full of Morse related pictures, seven in all, covering: **History of Signalling**, **Samuel Morse**, **Original Idea**, **Changes and Progress**, **Amateur Interest**, **War**, and **Today's Usage**. Each subject gives a short history relating to that period of time. Some of the subjects are accompanied by sound (if you have speakers fitted to your PC). To get back to the Main Menu you click on End.

This time we will initiate **Learn Morse** from the Main Menu. Here we are introduced to two sub-groups, **Morse Fundamentals**, and **Learn Morse**. **Morse Fundamentals** is further sub-divided to cover **Spacing**, **Dot/Dash Ratio**, and **Dits and Dahs**. A full explanation is given of each of these by clicking on the appropriate group.

When initiated, **Learn Morse** displays three boxes which are **Learn Letters**, **Learn Numbers** and **Miscellaneous**. Taking **Learn Letters** as an example, a click on this box brings up a clear screen with two new boxes, one to return you to the Main Menu and the other to start the process. Click on **Learn** and off we go.

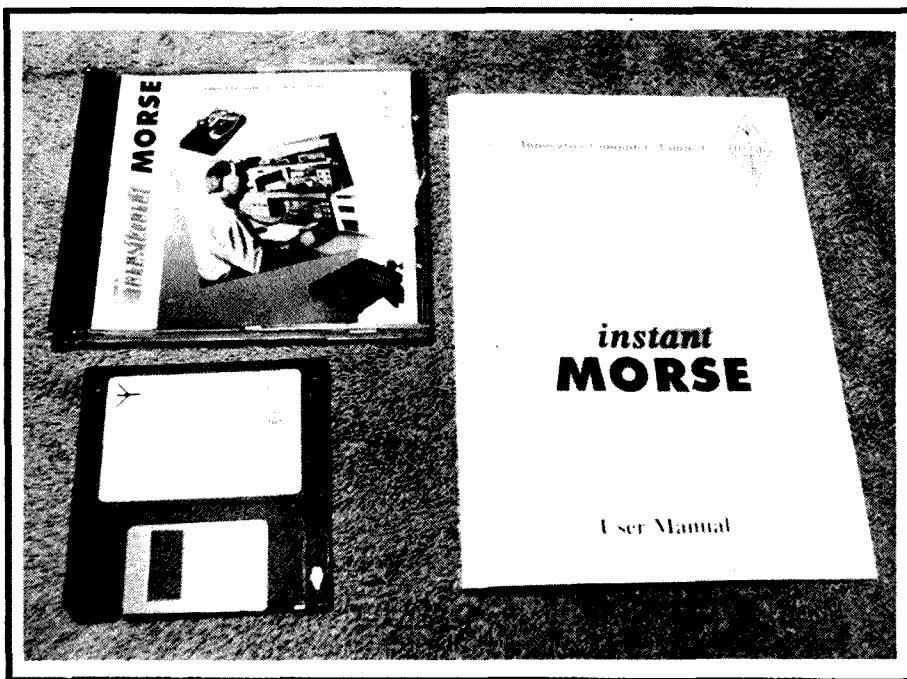
The letters are presented to you one at a time in random order. The screen only displays three letters and each letter is initiated one at a time by clicking on the **Learn** box. Take the letter "D" as an example. When the letter is displayed a short message about that letter is played through your speakers followed by the Morse sound for that letter, which is only sent once. When the Morse sound has finished you click on the **Learn** box and the process is repeated for two other random letters.

At the completion of these three letters, a new box is displayed, this being **Quiz Me**. By clicking on this box, the three previous letters learned are repeated but with no sound this time. You use your mouse to click on the dit or dah box by putting in the correct dit or dah for that letter. This will determine if you move on to the next letter to learn. It is quite an interesting exercise.

**Learn Numbers** and **Miscellaneous** follow similar guide lines. You can return to the Main Menu by clicking on return.

## Pounding Brass

Stephen P Smith VK2SPS\*



The Radio Society of Great Britain has just recently released a new Morse teaching program, which is available on CD-ROM, entitled "Instant Morse".

A few weeks ago, Daycom Communications Pty Ltd in Melbourne released the above program. It is currently selling for \$99.00, which is pretty good value when you consider the amount of information contained on the disk. The program consists of a six page manual containing a basic introduction to Instant Morse, installation procedure, trouble shooting guide, CD-ROM disk and a 3.5 inch backup disk along with registration material.

System Requirements are: 80386 IBM or compatible PC, Windows 3.1 or later, 4 MB RAM, 256 Colour VGA monitor, Sound

Blaster or compatible sound card, mouse, and CD-ROM drive.

The loading process took me about 10 minutes, following the on-screen instructions. Once loaded you are presented with a number of icons under the main heading of Instant Morse. The icons are: Support, Instant Morse, Academy, CW Tutor, MSE Tutor, and Super Morse. The last four programs are shareware.

Due to the amount of information contained I will concentrate mainly on the **Instant Morse** icon and review the others at a later date. When the **Instant Morse** icon is initiated, you are confronted by a full screen of Samuel F B Morse, along with a short introductory message. About a third of the way down the screen you will also see two

Looking at *After Instant Morse* from the Main Menu again, this is further sub-divided into three groups: **Consolidation, Practice, and Technicalities.**

Practice covers such things as personal tuition over the air services (similar to our WIA Morse broadcasts), bundled software and Electronic Tutors.

I found **Technicalities** to be very interesting as pictures tell a thousand words. It is broken into two sub-groups, being: **How to Operate a Morse Key**, and **Correcting Errors.**

**How to Operate a Morse Key** is broken down into the following categories:

- Stance:**
1. That's the way to do it
  2. Leaning too far forward
  3. Elbow too high
  4. Seat too low
  5. Seat too high
- Using the Key:**
1. Gently does it
  2. Vice-like grip
  3. The mobile key
  4. Tension too high
  5. Gap too wide
  6. The slapper

For example, clicking on **Seat too High** under the **Stance** heading, will display an operator about 1/3 the size of the screen incorrectly operating a pump key due to his seat being incorrectly positioned in relation to the key and table. Many of the other sub-groups under the **Stance** and **Using the Key** headings also use sound and motion (multimedia) in the manipulation of the key; quite fascinating to watch.

The last group under menu is **The Morse Test.** Like the others, it is further sub-divided into the following groups:

1. What you need to know
2. How to apply for the test
3. Where to take the test

These sub-groups cover the British examination system.

I have only covered a small portion of the program, and haven't looked at the American side, nor the four Shareware programs. As I mentioned earlier, I will report my findings on these at a later date. In any case, I can highly recommend this **Instant Morse** program to anyone interested in Morse code. Whether you are a beginner or an advanced operator, there is something there for everyone.

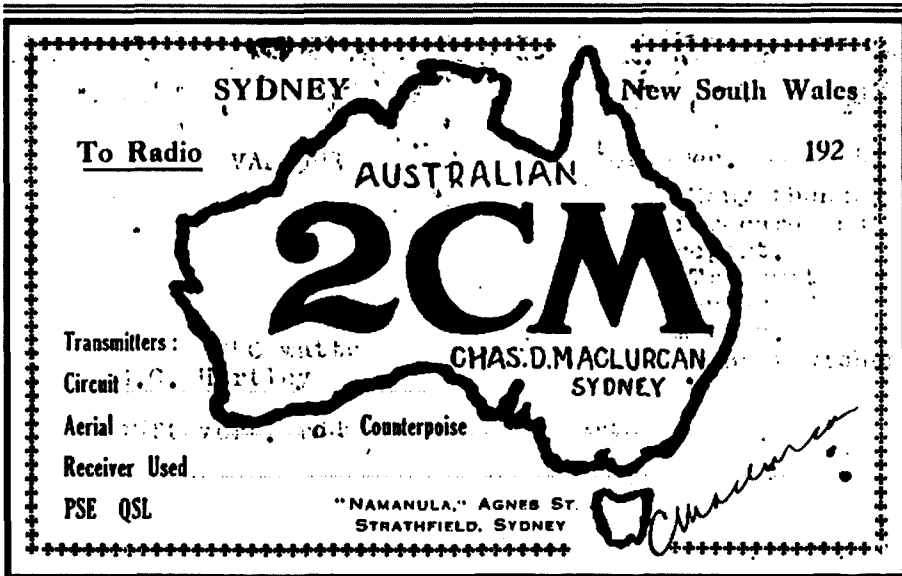
Well done RSGB for an outstanding program.

Next month, **Operating Protocol, Sitting for an Examination, and where to buy a good Morse key.**

PO Box 361, Mona Vale NSW 2103  
ar

## QSLs from the WIA Collection

Ken Matchett VK3TL \* Honorary Curator WIA QSL Collection



### 2CM

This QSL, dated 10 December 1925, is from Chas D Maclurcan, one of Australia's greatest wireless pioneers. Becoming interested in radio a few years before World War I, he became well-known to thousands of radio amateurs and listeners as a broadcaster of both speech and music on Sunday evenings. On this QSL he has typed "Many

thanks for your card and report. Transmit Sundays 36 metres". He also gives further details: "250 watts transmitter, S C Hartley. Aerial: 35 ft. vert rod. Counterpoise: Earth".

An interesting account of the life of this famous radio experimentalist can be found in the *Electronics Australia* 1994 publication, *Australia's Radio Pioneers* by Neville Williams.

### JU830C/4

Operating from the Gobi desert in Mongolia, the Mongolian Radio Sports Federation promoted a special operation from 3 July to 6 July 1992 in celebration of the 80th birthday of Chinghis Khan. It was this leader who welded together many of the

Mongol tribes into a powerful fighting force which, under him, invaded China and penetrated as far west as the Caucasus. The title "Chinghis" (Genghis) Khan may be translated as "Universal Leader".

ANTIGUA ISLAND  
West Indies

**V2A**

St. John's Cathedral  
as viewed from Newgate St.

distinguishing letter eg VP2A (Antigua), VP2K (St Kitts).

On 1 November 1981 the VP2A call was replaced by V2, following the country's independence after nearly 350 years of colonial rule.

### Thanks

The WIA (Federal) would like to thank the following for their kind donation of QSLs to the National Collection: Alf VK3CAG, Bill VK2WS, and Dexter W4KM. Also the family and friends of the following SKs: Bill Thompson VK2AHT (courtesy of Bill VK2XT), and Harry Caldecott VK2DA.

### Writing an Historical Article for Amateur Radio

If you are writing an article for this periodical which deals with amateur radio stations and operators of the past, perhaps your article can be enhanced by the inclusion of a photograph showing the station's QSL card. The National QSL collection (administered by the Federal Office) would probably be able to assist. Please contact the Hon Curator, Ken Matchett VK3TL, by phoning (03) 9728-5350.

\*4 Sunrise Hill Road, Montrose VIC 3765  
Tel (03) 9728 5350

ar

### V2A

Last year we featured a QSL card with no fewer than nine letters and numbers. The QSL featured here from Antigua is in bold contrast. It was sent on the occasion of the 1985 CQ Worldwide CW contest, the operation being sponsored by the Southwest Ohio DX Association.

The single letter call-sign suffix is still fairly uncommon, those in Australia being held by special experimental (amateur) stations, although world-wide it has been used for special occasions. Before World War 2, several islands of the Caribbean shared the VP2 (Windward Islands) prefix but post-war DX-lists differentiated these with a

## Repeater Link

Will McGhie VK6UU\*

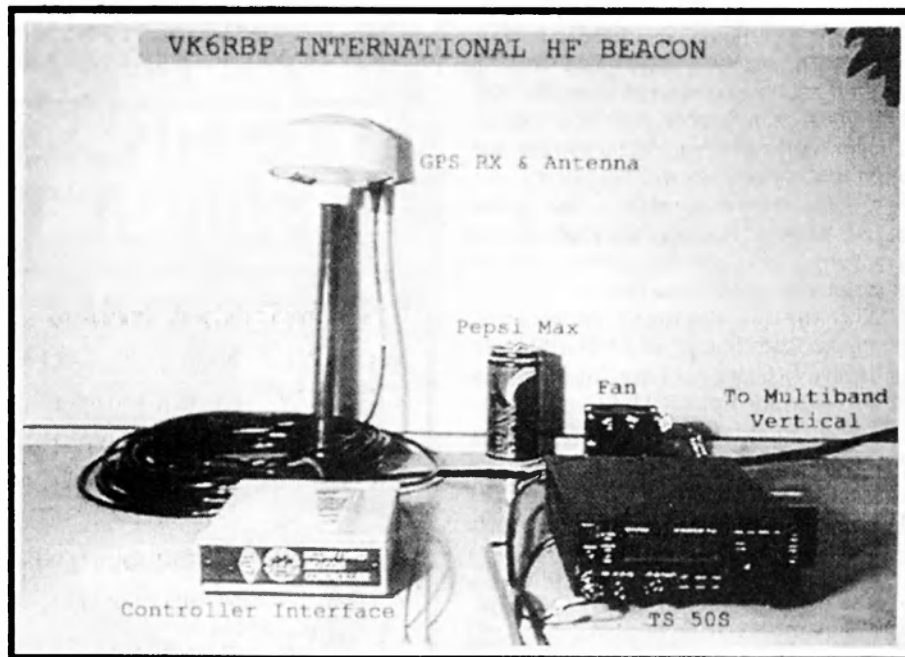
### International HF Beacon

What is an article about the International HF Beacon to do with voice repeaters, I hear you say? Well, not a lot, but the beacon is to be installed at one of our repeater sites close to Perth and its technical nature, I hope, will make for interesting reading.

### Photo

Firstly, the accompanying photo. I have not seen the final result as printed in *Amateur Radio*, but the quality, at best, will only be fair. The reason for this is due to the process of how the photo was produced. The beacon equipment turned up at my place and I used my domestic video camera and a video capture device (Snappy) to capture a picture on the computer. The picture was optimised and captioned. What you can do with pictures on a computer is truly amazing, but there is a limit. If the original picture has limitations, then the final result will also have some limitations.

The resulting digitised picture was then sent to *Amateur Radio* via the Internet for comment. Was it suitable for publication? The picture was printed out on a laser printer



and the result sent to the printers for photographing in order to place in our magazine. Quite a long process and the answer was yes, it was suitable for publication, albeit only fair in quality. What you see is the result. An interesting process and worth the experiment.

### The Beacon Project

Over two years ago, WIA Federal was contacted to find out if it could find a site for an International HF Beacon. The preferred site was Perth, Western Australia, to provide the best interlinking global coverage. The VK6 Division of the WIA agreed to accept

the beacon and manage it. The management, in fact, went to the local repeater club, WARG, as they have a suitable site for the beacon at Roleystone, 25 kilometres south-east of Perth.

The site has a large guyed 80 metre mast, but it was decided not to place the HF multiband vertical antenna, a Cushcraft R5, on the mast. Omni-directional radiation from mounting the antenna on this mast would not be possible, and 100 watt CW so close to the on-site buildings could cause a problem. A small, 10 metre mast, some 80 metres from the main mast, is to be installed and the R5 placed on top of this mast. The coax run from the repeater building to the small mast is RG333/U. This 1" (2.5 cm) diameter coax is almost lossless at HF.

### On Test

The beacon arrived and was unpacked. There is not much to the beacon, despite its capabilities. Setting up the beacon was easy. All leads are labelled; I just connected it all up and ran the TS-50S transmitter into a dummy load. As the photo shows there are three units plus the antenna. The units are the GPS receiver, interface unit and the TS-50S. I placed the GPS antenna/receiver outside and applied power to all three units.

An LED on front of the interface unit flashes on for one second and then off for three seconds. This indicates all is working with the GPS receiver, and the GPS receiver is looking for enough satellites to find its position and accurate time reference. The position information is not needed, only the accurate time reference. It took about 10 minutes for the front panel LED to flash one second on, one second off. This indicated that enough GPS satellites had been received for an accurate time reference. The interface unit now knows the exact time and waits for its time slot to key up the beacon.

When the time slot for VK6RBP comes along, the TS-50S is keyed on 14.100 MHz and sends VK6RBP in Morse, followed by a carrier switching from 100 watts to 10 watts to 1 watt to 0.1 watt. The beacon then immediately switches to the next higher band, 18.110 MHz, followed by 21.150 MHz, 24.930 MHz, and finishing on 28.200 MHz.

The complete process of transmitting takes 50 seconds. The remainder of the time, two minutes 20 seconds, the beacon is silent. If you only look at, say, the 20 metre beacon, it transmits every three minutes for 10 seconds. A bit complicated but simple from the users' point of view.

### Interleaved

What is really clever is the way the beacons interleave. If you listen on any of the beacon frequencies when all beacons are running, there is always a beacon on-air from

somewhere in the world. As long as you know the time schedule, and hear a beacon, you know propagation is open to that part of the world; or you can read the Morse for the beacon's location.

### Home Page

The Northern California DX Foundation, who paid for the HF beacon, have a home page with more detailed information. It can be found at <http://www.ncdxf.org/beacon.htm> Also have a look at the VK6 home page with information about the Australian beacon at <http://www.faroc.com.au/~vk6wia/hf-bcn.htm>

### Cost

The entire beacon, including the antenna, was supplied on loan at no cost to the WIA. However, there was a customs import duty of \$436 and an SMA licence cost of \$250. All efforts to have the import duty waived failed, as did argument with the SMA over the \$250 licence charge. Due to the changes in the way beacons and voice repeaters are charged at \$50 per frequency per year, the HF beacon operating on five frequencies results in a total licence cost of five times \$50. These costs have been paid by the Federal WIA.

### Callsign

VK6RBP (Radio Beacon Perth) was not the first choice, VK6B was. However, this callsign was already issued. Other ideas simply showed the rigid nature of callsign licensing in Australia. In the end, only an R call could be issued.

### On Air

By the time you read this, the beacon should be on-air. However, at the time of writing, there has been a delay with the site

owners wanting their legal people to have a look at the proposal. We have been told verbally there are no problems but I guess lawyers have to do something.

### Repeater Beacon Fees

I was at the last Federal WIA conference, held in Sydney during February, and the fees issue was discussed. Much of what was discussed is not for publication but there is progress. The following WIA News release was prepared on the packet network. It is not the entire release but is the important bit:

*"The WIA has had discussions with the SMA about the basis of beacon and repeater licence fee charging since this was introduced in 1995 with the new amateur licence fees regime. The Institute sought information on how this method of charging was determined under the Radiocommunications Act, the Regulations or any SMA Determinations. SMA Liaison Team investigations over 1995-96 had discovered that there was no clear path arising from the legislation or SMA Determinations which arrived at the instruction in RAL1 AM2. The Team also discovered that it had apparently been applied differently in different states, and even within states."*

There are several anomalies in the licensing system, to say the least. Different regulations exist between voice repeater licensing and digital repeater licensing, and these various regulations are applied differently between states. I've said it before and I say it again, a real mess!

*\*21 Waterloo Crescent, Lesmurdie 6076  
Packet: VK6UU @ VK6BBR  
E-mail: will@vale.faroc.com.au*

ar

## WIA MORSE PRACTICE TRANSMISSIONS

VK2BWI	Nightly at 2000 local on 3550 kHz
VK2RCW	Continuous on 3699 kHz and 144.950 MHz 5 wpm, 8 wpm, 12 wpm
VK3COD	Nightly (weekdays) at 1030 UTC on 28.340 MHz and 147.425 MHz
VK3RCW	Continuous on 145.650 MHz, 5 wpm, 10 wpm
VK4WIT	Monday at 0930 UTC on 3535 kHz
VK4WCH	Wednesday at 1000 UTC on 3535 kHz
VK4AV	Thursday at 0930 UTC on 3535 kHz
VK4WIS	Sunday at 0930 UTC on 3535 kHz
VK5AWI	Nightly at 2030 local on 3550 kHz
VK5VF	Continuous on 145.650 MHz, 5 wpm to 12 wpm
VK6RCW	Continuous on 147.375 MHz, 3 wpm to 12 wpm

# Spotlight on SWLing

Robin L Harwood VK7RH\*

Recently, whilst tuning across 31 metres, I heard Radio Thailand broadcasting in English. As it is many years since I have heard this station, I was pleasantly surprised at the quality and strength of the signal as it formerly was weak and easily buried in the QRM. Presumably it is now using the shared facilities of either the VOA or the BBC, both of which have constructed relay bases in different areas of Thailand. Listen for yourself to HSK9 from Bangkok on 9830 kHz at 1230 to 1259 UTC.

The "Voice of Free China" has been around for decades as well and is based in Taipei, Taiwan. This station has been well heard here, especially on 7130 kHz, and it was one of the first stations who confirmed my reception report when I commenced shortwave listening. The best reception in this area is on 9610 kHz; and is in English between 1200 and 1300 hours UTC.

Although the signal level is good, I find that the presentation and pronunciation is poor. It has been reported that some re-organisation of the external broadcasting structure on Taiwan has taken place with several separate entities being merged into a single organisation. For example, the various networks who mainly broadcast to the Chinese mainland have been merged with the external broadcasting service. It is too early to say what, if any, changes will be made to the programming. The VOFC also is relayed over the American religious broadcaster WYFR in Florida as part of a reciprocal arrangement. WYFR, otherwise known as "Family Radio", is relayed via Taiwan in Chinese and English.

I recently obtained the Klingenfuss Super Frequency List on CD-ROM and have been using it both on broadcasting and utility stations. I have found it very handy to use instead of diving into the World Radio TV Handbook or my Utility Guides. However, it is only as good as the current schedule and no guide, whether electronic or hard copy, can be expected to be 100% accurate. Yet, with the CD-ROM, you can extract information and paste it to your hard disk. There you can edit it, adding updated information on your HDD. You cannot, of course, modify the CD-ROM.

Apparently the CD-ROM complements the Klingenfuss Hard Copy guides, which I did not order. I would rate the Super Frequency List as good. If you are interested in obtaining this I would recommend that you contact the Australian agent, Bob Padula, 404

Mont Albert Road, Surrey Hills, VIC 3127. I am informed that an updated Klingenfuss schedule will be available next month. For more details I recommend that you contact him. Incidentally, my CD-ROM came from Grove Publications in the USA. The price is around \$57 Australian; this will vary with exchange rates.

The future of Radio Australia is still unclear. A Senate Select committee is now reviewing the future of Radio Australia and Television Australia. Media reports say that the committee is hoping to finalise their report by mid-May. Broadcasts from RA are continuing.

Albania is currently in the news following the internal political crisis brought on by the collapse of the domestic economy. I have had requests for Tirana's current frequencies but it is a while since I have heard them. Before the fall of the hardline communist regime led by Enver Hoxha, Radio Tirana was easily heard as it flagrantly operated within our exclusive amateur allocations. For example, they were on 7080 kHz in English in our late afternoons with their hardline Marxist-Leninist stance. They also were on 14320

kHz at 0500 and 1300 broadcasting to China. Apparently the Chinese constructed a shortwave and medium wave site to relay Radio Peking (as it then was called) to Europe. I recollect easily hearing the medium wave signal whilst in Europe in 1979 on a small National pocket transistor. Programming was identical to that on shortwave. The female English announcer was notable in having an Australian accent.

From the CD-ROM, Tirana is currently listed on a variety of frequencies. It is on 5895 kHz between 1200 and 1915. Interestingly, it is shared between Trans World Radio, the US evangelical broadcaster, and Radio Tirana. TWR apparently operates the megawatt MW station in the evening hours and it is heard throughout Europe. The Albanian Radio domestic network is relayed over 6100 kHz between 0300 and 2200 UTC and may be audible here.

Another channel worth keeping an ear to is 7385 kHz where Radio Tirana is transmitted in various European languages from 0600z. No frequencies above 9.7 MHz are listed and it does not broadcast outside of Europe except to North America. However, I have noted some comments in the newsgroups stating Tirana is not being heard there.

\*5 Helen Street, Newstead TAS 7250  
VK7RH@VK7BBS.LTN.TAS.AUS.OC  
Internet e-mail: rbruy@tassie.net.au

ar

## Update

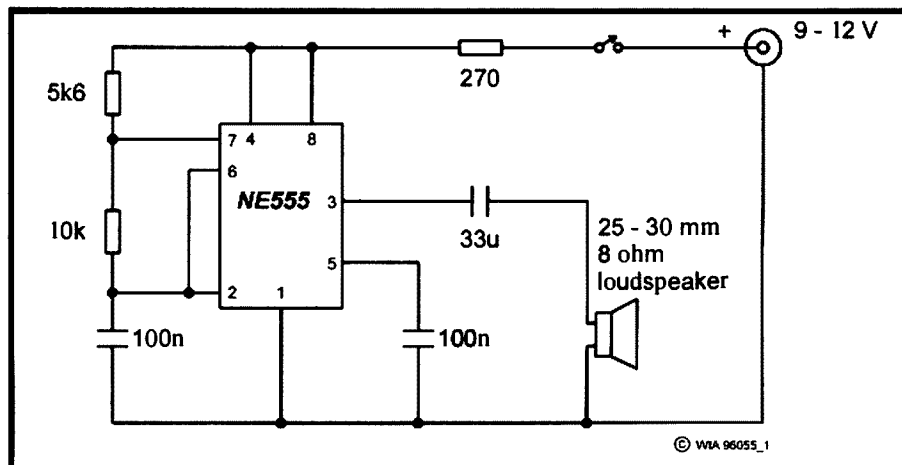
### MorseMouse

The gremlins have been at work again. Figure 1 of Peter Parker VK1PK's interesting little article, which appeared on page 24 of last month's issue of *Amateur Radio*, would have us believe that a special 25-30 ohm loudspeaker was needed. Not so! As the accompanying revised Fig 1 shows, the

caption to the speaker should have read "25-30 mm 8 ohm loudspeaker".

It might be a good idea to correct your copy of the March 1997 issue of *Amateur Radio* now. And why not build a MorseMouse. You could have a lot of fun.

ar



Revised Fig 1 - MorseMouse schematic.

---

---

# VHF/UHF – An Expanding World

Eric Jamieson VK5LP\*

---

---

All times are UTC.

## Something different

Mark Nicholls VK4RMN sent a fax regarding interesting propagation experienced at 2000 feet on 20 February. Mark is based at Roma in south west Queensland with the Flying Surgeon Service, provided by the Queensland Department of Health to outback Queensland. This is a separate service to that other most worthy institution, the Royal Flying Doctor Service.

Leaving Roma at 2110 and at a height of 2,000 feet ASL (aircraft use imperial measurements), Mark began to receive transmissions on the VHF AM frequency of 126.0 MHz from the Riverina area of southern NSW, with those aircraft being on descent through 5,000 down to 3,000 feet. Signals were judged at 5x9 as the King Radio in the Cessna 421B does not boast an S meter. Copy was available for about thirty minutes until Mark was in the Carnarvon Gorge area at 10,000 feet when signals began to fade out.

Mark said: "I would liked to have called the respective aeroplanes but local traffic on 126 MHz was too busy, so it would not have been the thing to do!"

The distance from Narrandera to Roma is 503 nautical miles or 931.6 km. Nominal power output of aircraft radio is about 15 to 20 watts. The area frequency for the Riverina is also 126 MHz and no relay stations were involved, so it was a direct path.

At home, Mark uses a Yaesu 480-R with an 80 watt linear amplifier to a 13 element ATN Yagi, horizontally polarised. He listens on VHF whenever he can, but says: "We are a long way from anywhere!" Thanks Mark.

## New Zealand

Cliff Betson ZL1MQ summarises the summer DX season as follows: "50 MHz: About 240 contacts to VK all districts except VK8. Double hop contacts on 4/1 with ZL1AKW, ZL1TMF and ZL2WNB to VK6BE, ZL3AAU and ZL3KG to VK6OTZ, VK6YU and VK6AGY. The three stations which worked VK6BE went portable on 4/1 and worked VK1 to 7 inclusive using 60 watts – good coverage for one day.

"Frank ZL2AGI reported 21 VK stations with openings on ten days during January to VK1RX, VK2 to 5 and VK7XR. Others involved were ZL3AAU, ZL3TIC, ZL3TY and ZL4TBN.

"144 MHz: More than 100 contacts to VK2, 3 and 4. ZLs involved were 1TWR, 1AVZ, 1AKW, 1IU, 1UWQ, 1SL, 1WTT,

2TAL, 3TY, 3NE, 3BWT, 3AR, 3NW, 3AIC, 3TIC, 3TCU, 3TJZ, 3TIB and 3DUT

"432 MHz: Eleven VK contacts reported. 14/11: ZL3NE to VK2BRG, VK2FZ4, VK4JSR, VK4AFL and VK4ZQ. 21/12: ZL1TWR to VK2ZAB, ZL1AVZ to VK4ABW/2, VK2BE and VK2ZAB. 22/12: ZL1TWR to VK2ZAB.

"1296 MHz: 22/12: Brian ZL1AVZ to VK2ZAB (S9+ in Auckland) and VK2BE. Distance in excess of 2000 km."

## Grid Squares Worked from Europe

VK3OT and VK5LP have been preparing a list of the total contacts made from Australia on six metres to the UK and Europe during Cycle 22. It has become a very interesting exercise and it appears at this stage that more than 2000 contacts were made between 1988 and 1992.

The majority of contacts were made from the north-western area of VK6 (VK6PA and VK6JQ), and Alice Springs (VK8ZLX). On the eastern side of the continent, VK3OT scored as well as anyone. Many contacts were made from VK2 and VK4 and, on a few occasions, from VK5; we lack much of this information, also that from the remainder of VK6.

To gain an overview of how the contacts unfolded, anyone who made contact with the UK and Europe is invited to submit their entries from log books, giving the time in UTC, date, your callsign and grid square, station worked and grid square if known, preferably in that order please. Grid squares to four places are acceptable. If you made only one contact we would be happy to include it.

The method of release of the final results has not yet been determined, as they are primarily designed for research purposes into propagation and spread of contacts. Anyone genuinely interested will eventually be able to obtain a copy. Please send your entries to me (VK5LP), no later than 30 April 1997. You may e-mail, packet, fax or post them to me – see details at end of this column for addresses. A contact phone number could be helpful.

## 50 MHz Country Listing

World Top 20. Updated 7/10/96: JA4MBM 158/157, GJ4ICD 157/157, PA0HIP 157/156, SV1DH 151/151, JA1BK 151/151, PY5CC 151/150, G3WOS 150/150, PA3BFM 149/145, G4CCZ 147/147, G4IGO 145/143, ON4KST

141/137, G4UPS 141/140, JE1BMJ 140/140, ON4ANT 140/137, SV1EN 138/138, SM7FJE 138/137, SM7AED 138/135, VE1YX 136/136, G0JHC 136/135, JA1VOK 135/135.

Geoff GJ4ICD in Internet Six News reports that last January, after 13 years, Chris GM3WOJ received the first 50 MHz DXCC (No 219) for Scotland. Best DX was KG6DX, although his signals were heard in VK7. Chris achieved his DXCC from IO77ws in the north of Scotland which is a long way from eastern VK!

## NSW VHF/UHF DX Group

From Richard VK2ARS: "Charter of the NSW VHF/UHF DX Group (note it's not a club but a group of people with similar interests who get together) is to promote long distance communication without the use of earth-based repeaters. We agree that there is a need for repeaters but not for home-base to home-base use.

"Regular schedules for communications using FM 146.550 occur on Sunday mornings at 11.00 am local. Tuesday activity nights on two metres SSB. Thursday activity nights on 70 cm SSB.

"Since we started the number of active stations in Sydney and NSW has increased by 100% so the chances of a reply when calling CQ has improved remarkably.

"Last year we had some interesting chats and projects, and the following are proposed for this year: All activities to continue with a possible activity night for 23 cm, and 10 GHz towards the end of this year or early next year. Presentation at Wyong of what is required for long distance communications on two metres by Gordon VK2ZAB. Talks: Propagation via aircraft enhancement. Test equipment building and how to use it. Where do you find those illusive parts for that special project? Home made filters and cavity AM17 (ex CAA 2 x 4CX250 amplifier), overview and modifying it for amateur two metre operation."

## General Activities

From Rob VK3DEM – The Demon from Bairnsdale QF32te – reports on summer contacts of interest, including more than 20 contacts to VK7 on 144, 432 and 1296:

7/12: 0500 – 2358 50 MHz ZL2TPY, ZL3s TIC, TIB, TY, NW, ADI, ZL4s DK, TBN, LV, all in the ZL VHF Contest, most signals to 5x9.

23/12: ZL3TIC 144 MHz. 27/12: 0708 VK2TWR/p and VK2VZ/p Bald Hill QF43gs on 1296 MHz.

28/12: 0025 VK7XR 144 5x9, 432 5x9, 1296 5x3, 50 5x3; 0301 VK7KAP 1296, 432 and 144 all 5x9; 0455 144 VK2BBF 5x2, VK2ZAB 5x2; 2113 VK2FWB 5x3,

VK1BG 5x2; 2154 432 VK1VP 5x3.  
4/1: 1008 VK4TN 5x9; 1045-1052  
VK2FZ/4, VK4s APG, AFL, JSR, DH, LO,  
ZBH – all on 144 Es.  
6/1: 144 ZL3TY 5x2.  
7/1: 2020 144 VK5NC 5x5, 2057 VK5AKK  
144 5x2, 432 5x1; 2145 432 VK5NY 5x2.  
8/1: 0150-0415 50 ZL4TBN, ZL3TLG,  
VK6KAT, VK6KZ, VK6APZ 5x5-9; 0120  
VK3TMP 5x5, VK3XPD 5x3, both on 1296.  
15/1: 2121 144 VK5AKK 5x2; 2340 144  
VK6KDC (OF85bs) 5x2 2852 km.  
16/1: 0007 144 VK6KDC 523, 0010 432  
VK6KDC 5x2 (very happy with that one!),  
2150 144 VK6WG 5x2.  
17/1: 2019 1296 VK5NC 5x3 600+ km.

Andrew **VK7XR** reports good tropo  
openings across Bass Strait. Most mornings  
signals are 5x1 to 5x2, but the following list  
indicates the enhancement mentioned.

05/2: 2100 VK3AFW 5x9 144 and 5x5 on  
432. VK3ATQ 5x8 50.

12/2: 2115 VK3AFW 5x5 144.

13/2: 2029 VK3ATQ 5x2 50, 2039 VK3YY  
5x2 50, 2112 VK3AFW 5x2 144.

16/2: 2017 VK5NC 5x1 144, 2033 VK3ATQ  
5x2 50, 2111 VK3AFW 5x2 144.

17/2: 2017 VK3YY 5x4 50, 2018 VK3ATQ  
5x4 50, 2025 VK3BQS 5x7 50, 2108  
VK3DEM 5x9 144, 2109 VK3TMP 5x9 144,  
2113 VK3DEM 5x9 1296, 2118 VK3AFW  
5x2 144, 2121 VK3TMP 5x1 432.

18/2: 0822 VK3ZLS 144 5x9, 0836  
VK3BWT 144 5x9, 0928 VK3TMP 144 5x9,  
0930 VK3TMP 432 5x7, 0933 VK3TMP  
1296 5x7, 0952 VK3BRZ 144 5x9, 0955  
VK3BRZ 432 5x9, 1035 VK3RQ 144 5x7,  
1057 VK3XQD 144 5x9, 1107 VK3DUQ  
144 5x9, 1117 VK3KLO 144 5x5, 1121  
VK3KLO 432 5x2, 2019 VK3RGL 2 m  
beacon 5x9, 2020 VK2RBC 2 m beacon 5x2,  
2021 VK5RMG 2 m beacon 5x4, 2022  
VK3RTG 2 m BEACON 5x1, 2023  
VK3RMB 70 cm beacon 5x3, 2031  
VK3ATQ 50 5x2, 2112 VK3AFW 144 5x6,  
2118 VK3AFW 432 5x3, 2150 VK3TMP  
144 5x9, 2200 VK3BWT 144 5x9.

David **VK3AUU** reports on a trip to the  
Blue Mountains in NSW during January and  
on the way visited VK2TWR, VK1VP,  
VK2BBF, VK3AJN and VK3UM. His  
mobile rig was on 144 MHz SSB running 50  
watts to a M2 halo.

From Lakes Entrance, David worked  
VK7XR, VK2TWR and VK3BIT at  
Mallacoota. From Goulburn VK2BBF and  
VK2ZAB, and from Katoomba in the Blue  
Mountains, apart from most of the active  
Sydney stations, he worked VK1BG.

On to Lithgow, from the highest point he  
worked VK2DVZ at Taree (280 km) and  
VK1VP. To Bathurst VK2TWR/p (300 km)  
and from Orange VK2EMA at Tottenham

220 km. At Corowa he worked VK3AJN and  
VK3CY at Wedderburn. Choosing high  
elevations helped all contacts. David  
included a map showing the direction of the  
contacts, but lack of space prevents me from  
publishing it. Thanks for the news David.

John **VK3ATQ** advises that on each  
week-day morning from 2000 to 2045 (7.00  
to 7.45 local) schedules on 50.120 MHz now  
have operators in VK1, 2, 3 and 7 on a regular  
basis, with a total of 20 different callsigns  
being heard at various times. VK7 is well  
represented by Andrew VK7XR, Joe  
VK7JG, Brenton VK7JB on Tasmania and  
Bob VK7JR on King Island. Graham  
VK7ZO in Hobart has expressed interest in  
joining the group.

Eddie VK1VP is active from Canberra  
most mornings. Glen VK3YY appears from  
time to time depending on work  
commitments. John VK3BQS is the  
mainstay of the net in Gippsland.

### TV Channels

A message from John **VK3KWA** said that  
Andrew VK7XR had advised that Channel  
5A at Wynyard is finally in the phasing out  
stage and is now running on reduced power.

Steve **Gregory VK3OT** reports the only  
remaining Channel 0 transmitters are as  
follows:

46.172 Hi power Toowoomba Qld  
46.240 Hi power Wagga NSW  
46.240+ Low power Cooma NSW  
46.240- Low power Narooma NSW  
46.260+ Med power Tamworth NSW

### VHF-UHF e-mail Reflector for VK

Guy **Fletcher VK2BBF** asks that the  
following be made known. The VK e-mail  
reflector is now running. It is an open list so  
anyone can subscribe and then post messages  
out to the group.

To subscribe, send e-mail to [majordomo@marconi.mpce.mq.edu.au](mailto:majordomo@marconi.mpce.mq.edu.au) and leave Subject  
blank, and include in the body of the text  
*subscribe vk-vhf* and no other text.

To unsubscribe, do the same with  
*unsubscribe*. To obtain help and a list of  
commands, put *help* in the body. To find out  
who is on the list, put *who vk-vhf* in the body.

To post a message to all subscribers, e-  
mail [vk-vhf@marconi.mpce.mq.edu.au](mailto:vk-vhf@marconi.mpce.mq.edu.au) and  
use the Subject line and Text body as you like.  
The originator does not appear to receive a  
copy of the message!

### UK Six Metre Group

At the 16/2/1997 AGM of the UK Six  
Metre Group (UKSMG), Adam VK3ALM  
was appointed the UKSMG's VK Country  
Manager.

Adam reports: "*The UKSMG was formed*

*in 1982 with the primary aim of encouraging  
an interest in the 50 MHz band by amateurs.  
The UKSMG maintains a fund to provide  
beacons in various parts of the world. Over  
the last few years the group has also supplied  
many pieces of equipment to encourage and  
help six metre enthusiasts activate new  
countries.*

*"The ambition of the UKSMG, through the  
medium of its 52 page quarterly magazine  
"Six News", is to provide the best  
information available on all aspects of the  
band, including DX news and reports,  
beacon lists, propagation reports, six metre  
equipment reviews, QSL addresses,  
DXpedition news and technical articles.  
Articles for publication in "Six News" are  
welcome.*

*"By joining the UKSMG for \$AUS40, VK  
members receive "Six News" by airmail.  
More than 800 members in 50 countries  
support the group, and help to maintain the  
Internet World Wide Web site maintained by  
Chris G3WOS, the current UKSMG  
Chairman.*

*"If you would like further information and  
a copy of the application form, then send a  
DL sized stamped self-addressed envelope  
to: Adam Maurer, VK Country Manager, 1  
Jeffrey Street, Dandenong North, VIC 3175.  
E-mail address is adam@rint.com.au"*

### Microwaves

On 14/1/97 at 2330, Bob **G3GNR**  
contacted SM6ESG in JO67cc on 10.3681  
GHz, the distance 1275 km. This is believed  
to be a new UK 10 GHz tropo record. The UK  
24 GHz record is now 391 km.

An update from **Wal VK6KZ** advises: "*I  
have been unsuccessful in bridging the Bight  
again on 10 GHz despite two expeditions to  
the south coast. The first trip was from 31/12  
to 3/1 when contacts were limited to 144 and  
432 MHz to Adelaide, Mt Gambier and  
Melbourne, with nothing heard on 10 GHz in  
tests with Trevor VK5NC and David VK5KK.  
The most distant DX was Andrew VK3KAQ/p  
near Ross Hill east of Melbourne.*

*"The second trip was between 31/1 and  
4/2 when I had a number of long distance  
contacts across the Bight on 144, 432 and  
1296 MHz. Attempts were unsuccessful with  
David VK5KK, Trevor VK5NC, and Russell  
VK3ZQB on 5.7 and 10 GHz, and on 10 GHz  
with Roger VK5NY.*

*"Clearly the MUF didn't rise high enough  
for 5.7 and 10 GHz. I also looked for the  
Adelaide 2.4 GHz beacon without success.*

*"My view is that the high pressure cells at  
the time lacked a high enough central  
pressure and/or were too far south in latitude  
with the path being tangential rather than  
across the centre of the high as with the  
contact on 10 GHz in 1995.*



"Highlight of the second trip was being able to help Wally VK6WG get his 10 GHz gear fully operational. As a consequence, I was able to work two new grid squares from Torbay. The first was by turning an impossible 25 km path from Wally's QTH to mine at Torbay into one of 86 km. Wally lives on the slopes of Mt Melville which shaded the direct signals. We both pointed at the Porongorup Ranges to the north of Albany and had a good SSB path. Later, Wally moved to a new grid square near the Albany airport with paralytic signals over a direct line-of-sight path of about 35 km.

"The main interest has been 5.7 GHz with contacts between Neil VK6BHT/p Geraldton and Alan VK6ZWZ/p taking the distance record of 501 km from Alan VK3XPD/p Mt Dandenong and Trevor VK5NC/p Robe, to 544 km when Alan drove to Busselton the day after I worked Neil over 379 km from Fremantle.

"On 16/2 at 0930 UTC, Neil Sandford VK6BHT/p at Port Gregory, about 60 km north of his QTH, and Alan Woods VK6ZWZ/p at Busselton, about 230 km by road from his QTH, worked each other on SSB over the 614 km path. Over the half hour contact signals showed QSB but peaked at 5x9. This will be a hard path to beat until the Bight is bridged!

"The likelihood of a path was indicated by good reception in Perth of the WA VHF Group 1296 MHz beacon at Busselton and the existence of a trough up and down the west coast."

## Overseas

Geoff GJ4ICD reports: "Apart from the VK5LP entry for a contact to ZL2UJG at 3332 km, on 6/1 VK6APZ PF06 worked ZL3TIC RE66 at a distance of 4850 km. So it looks like he/they win the Southern Hemisphere 50 MHz DX Challenge Trophy.

"Also January 20 - what a day to remember for propagation in the winter! Europe had noted all the openings in the US and at last it was our turn. The Xray flux showed high levels on 19/1 and 20/1 and, as mentioned before, this may be one of the causes of Es. At 1800 the reported MUF in Germany was 88 MHz, with 50 MHz sounding like 20 metres!

"Most countries in Europe caught the openings including HB0LL; I logged LA, SM, OH, SP, DL, OK, OE, HB9, HB0, GM, EA, CT, I, and PA0; some very short skip was noticed with stations in Germany being S9+."

Ted G4UPS made the following comments for another view regarding the above mentioned Es opening on 20 January: "A date for the record books. Weather pattern over the UK and parts of Europe was high

pressure, but quite mild here in the SW of UK. First indications of an opening came with the SK5/LA7 beacons on 28 MHz, then the SK3SIX/b on six metres at 0951 and ES0SIX/b at 0956.

"First amateur signals SM1BSA 449 at 0959 working DJ2RE, followed by a big opening to SM/OZ/DL/OH/ES and OH1SIX/b. Band closed at 1340 to re-open at 1608 with Russian inband-TV. At 1623 SR6SIX/b plus quite a few SP stations, then many SM/OZ/YL/SP/ES/DL/OE/S5/HB9/HB0/IYU and EH. After 1830 most activity came from Italy until fading out at 1915.

"It is not common to have such a widespread intense opening in January. Since 1/1 my country count is 18 with 58 different grid squares, the highest I can remember for January."

Emil W3EP in March QST's *The World* above 50 MHz reports on the annual Danish Microwave Activity Week, June 15-21, 1996, which attracted 27 operators from four countries, including guests from Germany, France and the Netherlands. The typical Danish spring weather did not help propagation, yet some impressive contacts were made. Activity started on 10 GHz and went up from there! Steen Gruby, OZ9ZI, provided these highlights: "Participants made several contacts on 10 GHz over 300 km, including OZ6TX to LA/DCD8DA at 385 km. The best on 24 and 47 GHz were also made with Norway on one end of the path. SM/OZ1JLA (with OZ1FPN) found LA/DCD8DA (with OZ9ZI) over a 253 km path on 24 GHz. OZ1JLA was running just 60

mW and a 48 cm dish; DCD8DA had 265 mW On 47 GHz, a new Danish DX record was set with the 162 km contact between OZ/DB6NT and LA/OZ9ZI (with DCD8DA). Incredibly, OZ9ZI was generating just 100 microwatts into a 25 cm dish! On 76 GHz, the longest contact was 83 km, between OZ1UM and OZ/F10IH. Both stations ran less than 3 mW into 25 cm dishes."

The above is included for VK microwave enthusiasts to indicate what they are up against as they move higher in frequency!

David VK5KK reports that the microwave (1296 and above) VK5 beacons are having directional antennas progressively added to achieve 100 watts ERP to the SE and/or west direction to make them more useful as DX beacons over 500 km. The first will be the 1296 MHz beacon with two 15 element DL6WUs (13 dBd gain), one at 265 degrees, the other at 140 degrees. At the moment the 1296 MHz beacon has 5 dB gain to the west.

## Closure

Closing with two thoughts for the month:

1. The difference between a prejudice and a conviction is that you can explain a conviction without getting mad, and
2. Don't meet trouble halfway. It is quite capable of making the entire journey.

73 from *The Voice by the Lake*

\*PO Box 169, Meningie SA 5264

Fax: 08 8575 1043

Packet: VK5LP@VK5WI.#ADL.#SA.AUS.OZ

E-mail: vk5lp@ozemail.com.au

ar

## Silent Keys

Due to space demands obituaries should be no longer than 200 words.

The WIA regrets to announce the recent passing of:-

KB (Kenneth)	BROWN	VK2AJJ
JF (John)	SMITH	VK2LSH
NH (Norm)	TOWNLEY	VK3ANT
CD (Charles)	SELL	VK6NSL

### John "Swampy" Smith VK2LSH

1965 - 1997

Our friend John, or "Swampy" as many knew him, died on Tuesday, 25 February 1997 at 8.30 am. At this time we lost a radio colleague, a lovely bloke, and most importantly, a dear friend. It came as a complete shock to all who knew him.

John could be described as one of the most dedicated DXers in VK. On 15 m and 10 m, John could be heard fading away with the QSB after a hard evening of chasing

Europeans. He slept in the shack, giving him the best chance of hearing it come back. He was the first one on and the last one off. There were many times when I heard John calling "nothing" with his well known CQ call, until "nothing" turned into "something".

For any of you out there who dealt with John with regard to Kenwood radios and HF antenna equipment, you were all wrong. "Swampy" was always right.

We will miss "Swampy" for the laughs, the overdriven modulation, and the "off frequency transmissions". This week, the radio is much quieter and we have lost a dear friend.

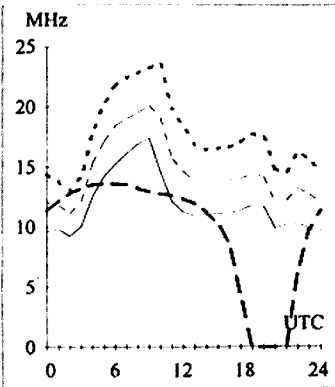
Ave Swampy.

Aaron VK2ON ex VK2NAL, Steve VK2MSD, and many CBers and friends in Hunter Region NSW

ar

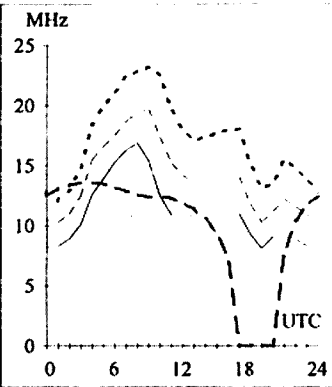
**Adelaide-Amsterdam 313**

First F 0-5 Short 15909 km



**Brisbane-Berlin 321**

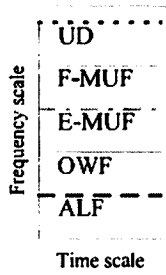
First F 0-5 Short 15678 km



# HF Predictions

*Evan Jarman VK3ANI*

**T Index: 15**



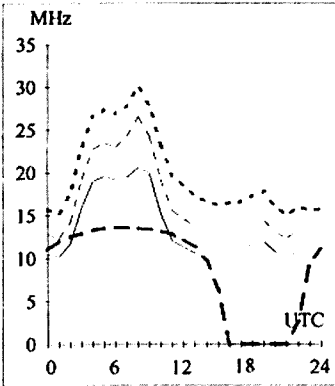
These graphs show the predicted diurnal variation of key frequencies for the nominated circuits. This also indicates a possibility of communication (percentage).

The frequencies, identified in the legend, are:-  
 Upper Decile (F-layer, 10%)  
 F-layer Maximum Useable Frequency (50%)  
 E-layer Maximum Useable Frequency  
 Optimum Working Frequency (F-layer, 90%)  
 Absorption Limiting Frequency

The predictions were made with the Ionospheric Prediction Service program, ASAPS V3.2. The T index used is shown above the legend. The Australian terminal azimuth, path and propagation mode are also given for each circuit.

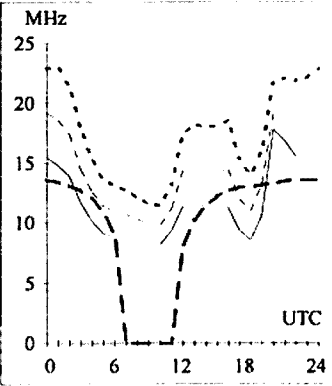
**Adelaide-Ankara 299**

First F 0-5 Short 13628 km



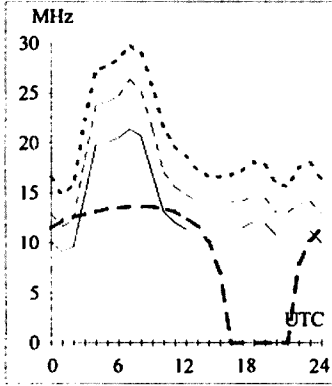
**Brisbane-Boston 56**

First F 0-5 Short 15722 km



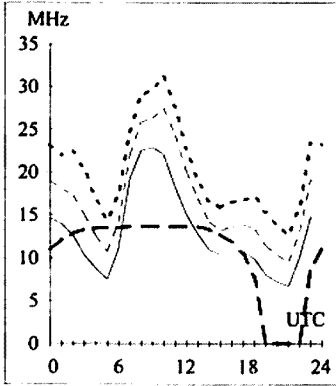
**Canberra-Cairo 283**

First F 0-5 Short 14265 km



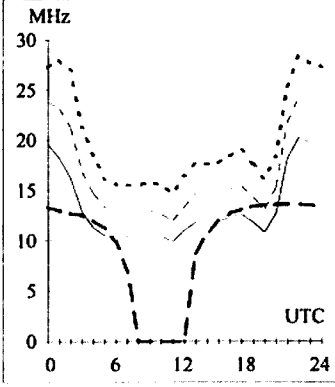
**Darwin-Dakar 278**

First F 0-5 Short 16578 km



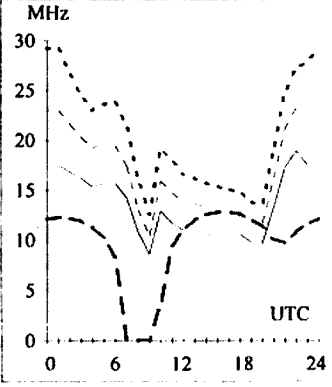
**Adelaide-Atlanta 79**

First F 0-5 Short 16091 km



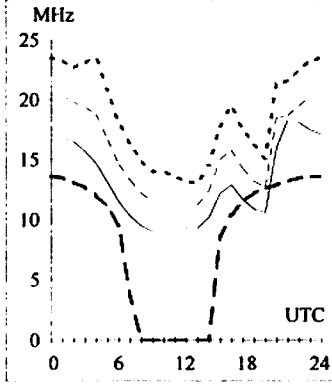
**Brisbane-Brasilia 152**

First F 0-5 Short 14700 km



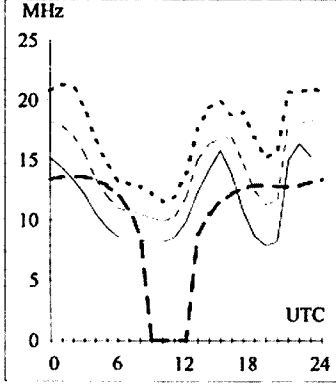
**Canberra-Calgary 46**

First F 0-5 Short 13409 km



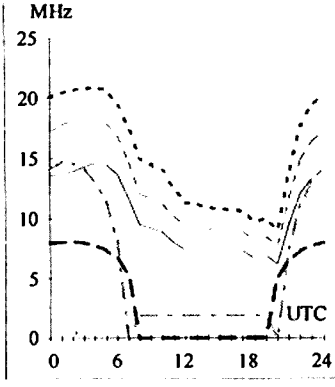
**Darwin-Dayton 42**

First F 0-5 Short 15430 km



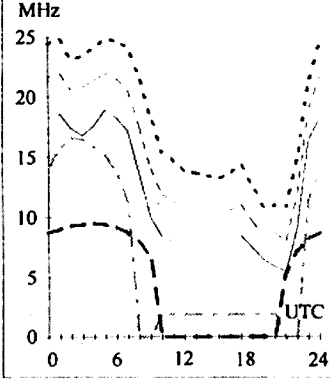
**Adelaide-Auckland 104**

Second 2F13-15 2E2 Short 3240 km



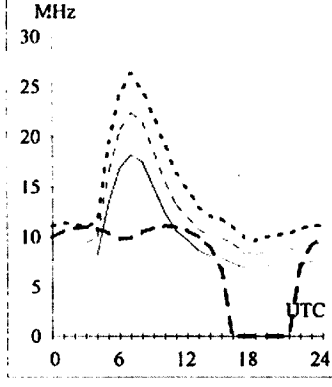
**Brisbane-Brunei 305**

Second 3F10-15 3E1 Short 5441 km



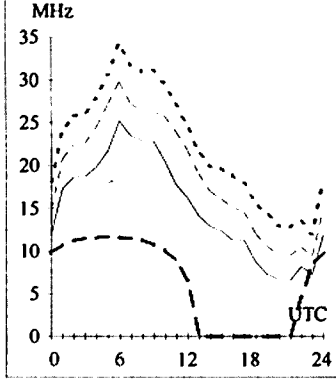
**Canberra-Capetown 219**

Second 4F4-5 4E0 Short 10778 km



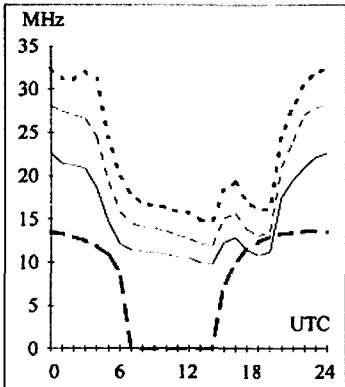
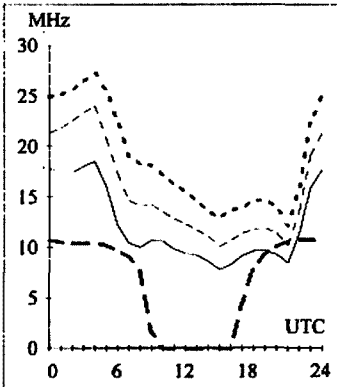
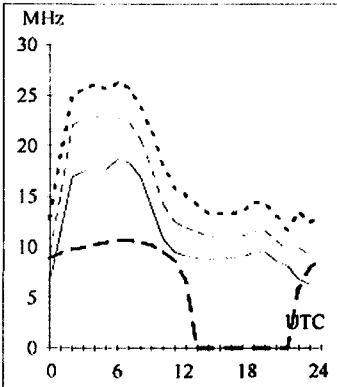
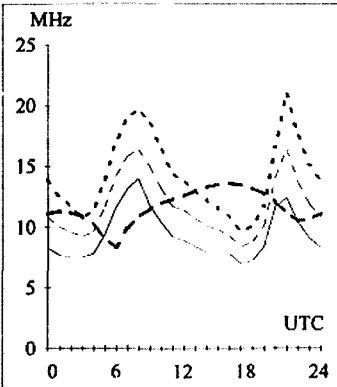
**Darwin-Delhi 309**

Second 3F5-11 3E0 Short 7347 km



**Hobart-Helsinki** 137 **Melbourne-Maldives** 284 **Perth-Papeete** 107 **Sydney-San Francisco** 56

First F 0-5 Long 24262 km Second 4F7-10 4E0 Short 8663 km Second 4F6-7 4E0 Short 9398 km Second 4F2-4 4E0 Short 11952 km

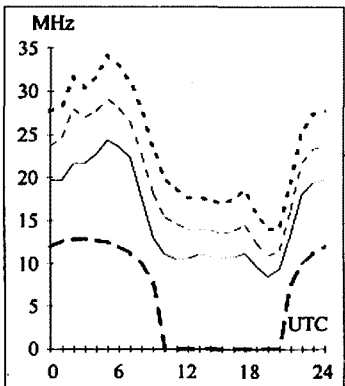
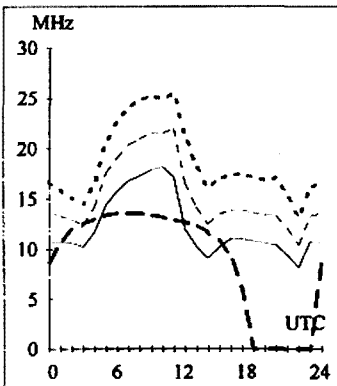
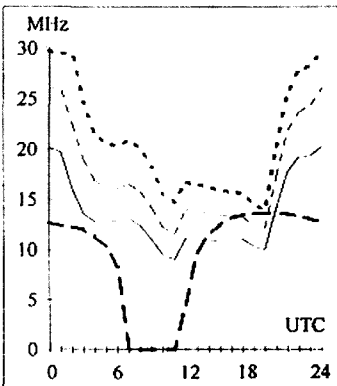
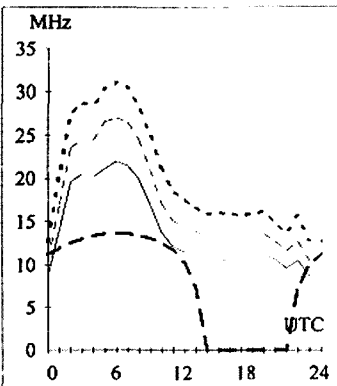


**Hobart-Herat** 299  
First F 0-5 Short 12172 km

**Melbourne-Miami** 94  
First F 0-5 Short 15584 km

**Perth-Paris** 310  
First F 0-5 Short 14281 km

**Sydney-Seoul** 340  
First 3F3-7 3E0 Short 8325 km

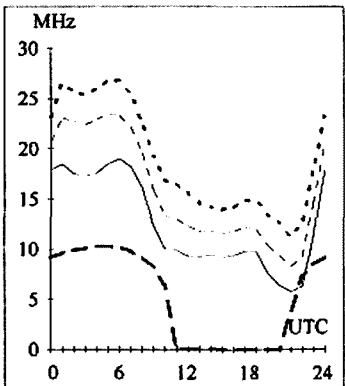
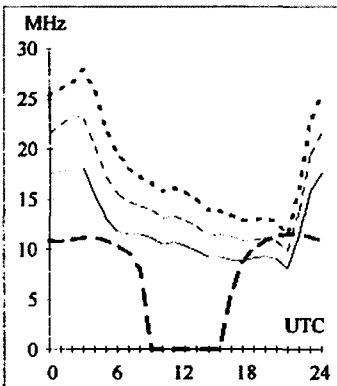
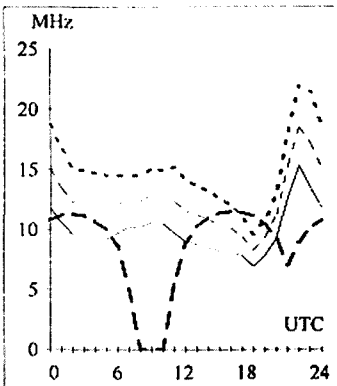
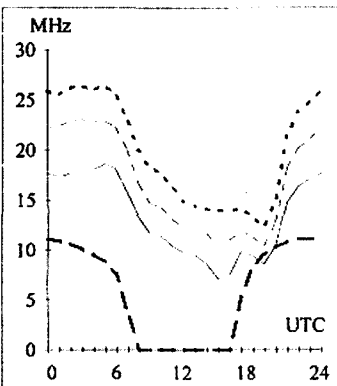


**Hobart-Honolulu** 50  
Second 4F7-10 4E0 Short 9071 km

**Melbourne-Montevideo** 162  
Second 4F2-3 4E0 Short 11639 km

**Perth-Pitcairn Is** 124  
Second 4F4-5 4E0 Short 10573 km

**Sydney-Singapore** 298  
Second 3F8-11 3E0 Short 6295 km

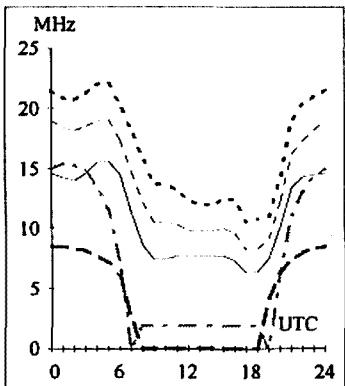
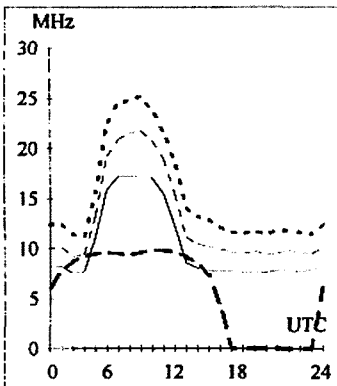
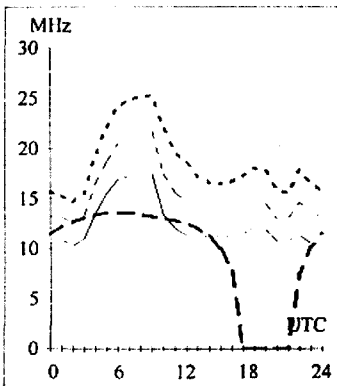
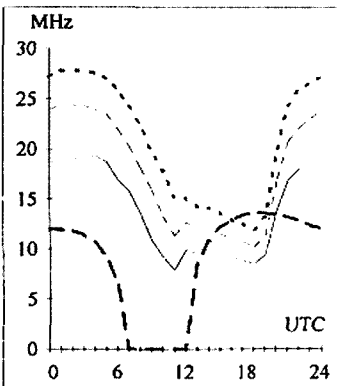


**Hobart-Honduras** 104  
First F 0-5 Short 13928 km

**Melbourne-Munich** 302  
First F 0-5 Short 16119 km

**Perth-Pretoria** 249  
Second 4F8-10 4E0 Short 8327 km

**Sydney-Suva** 64  
Second 2F13-15 2E2 Short 3221 km



# HAMADS

- Hamads may be submitted on the form on the reverse side of the *Amateur Radio* address flysheet. Please use your latest flysheet where possible.
- Please submit separate forms for For Sale and Wanted items, and be sure to include your name, address and telephone number (including STD code) if you do not use the form on the back of the *Amateur Radio* address flysheet.
- Eight lines (forty words) per issue free to all WIA members, ninth and tenth lines for name and address. Commercial rates apply for non-members.
- Deceased estates Hamads will be published in full, even if the ad is not fully radio equipment.
- WIA policy recommends that the serial number of all equipment offered for sale should be included in the Hamad.
- QTHR means the address is correct in the current WIA Call Book.
- Ordinary Hamads from members who are deemed to be in general electronics retail and wholesale distributive trades should be certified as referring only to private articles not being re-sold for merchandising purposes.
- Commercial advertising (Trade Hamads) are pre-payable at \$25.00 for four lines (twenty words), plus \$2.25 per line (or part thereof), with a minimum charge of \$25.00.
- Copy should be typed or in block letters, and be received by the deadlines shown on page 1 of each issue of *Amateur Radio*, at:

Postal: 3 Tamar Court, Mentone VIC 3194

Fax: (03) 9584 8928

E-mail: vk3br@c031.aone.net.au

## TRADE ADS

• **AMIDON FERROMAGNETIC CORES:** For all RF applications. Send business size SASE for data/price to RJ & US Imports, PO Box 431, Kiama NSW 2533 (no enquiries at office please ... 14 Boanyo Ave Kiama). Agencies at: Geoff Wood Electronics, Sydney; Webb Electronics, Albury; Assoc TV Service, Hobart; Truscotts Electronic World, Melbourne and Mildura; Alpha Tango Products, Perth; Haven Electronics, Nowra; and WIA Equipment Supplies, Adelaide.

• **WEATHER FAX programs** for IBM XT/ATs \*\*\* "RADFAX2" \$35.00, is a high resolution shortwave weatherfax, Morse and RTTY receiving program. Suitable for CGA, EGA, VGA and Hercules cards (state which). Needs SSB HF radio and RADFAX decoder. \*\*\* "SATFAX" \$45.00, is a NOAA, Meteor and GMS weather satellite picture receiving program. Needs EGA or VGA & WEATHER FAX PC card, + 137 MHz Receiver. \*\*\* "MAXISAT" \$75.00 is similar to SATFAX but needs 2 MB of expanded memory (EMS 3.6 or 4.0) and 1024 x 768 SVGA card. All programs are on 5.25" or 3.5" disks (state which) plus documentation, add \$3.00 postage. ONLY from M Delahuntly, 42 Villiers St, New Farm QLD 4005. Ph 07 358 2785.

• **HAM LOG v.3.1** - Acclaimed internationally as the best IBM logging

program. Review samples....AR: "Recommend it to anyone"; The Canadian Amateur: "Beyond this reviewer's ability to do it justice. I cannot find anything to improve on. A breakthrough of computer technology". ARA: "Brilliant". Simple to use with full help, the professional HAM LOG is immensely popular (now in its 5th year), with many useful, superb features. Just \$59 (+ \$5 P & P), with a 90 page manual. Special 5 hour Internet offer. Demos, brochures available. Robin Gandevia VK2VN 02 369 2008 BH fax 02 369 3069.

Internet address rhg@ozemail.com.au.

• **Personalised QSL Cards.** 100 for \$17.50, white or colours. Examples, order forms, send 45 cent stamp to Henry's Publishing, PO Box 6603, Mackay MC, QLD 4741.

## FOR SALE ACT

• **Yaesu FT200**, s/n 320054, and PSU, not working but fixable. **Hallicrafters S58** receiver, 538 kHz to 34 MHz, s/n 183784. **Heathkit HW32**, s/n 5426780R, SSB txcvr and PSU. Manual for each. Claude VK1CS, QTHR, 06 241 2686.

## FOR SALE NSW

• **Icom IC-735 HF** all band s/state txcvr, 100 W, gen coverage rcvr, all mode, manual, original carton plus hand mike, as new, \$1200

ONO. **Werner Wolf** multiband tuned vertical antenna, 8 m, VGC, \$200, ONO. **MFJ Versa HF Tuner II Model MFJ949** with X-needle, 50ohm dummy load, switched inductor, 300W, 160-10 m, as new, original packing, \$200, ONO. **Icom SM-8** desk mike with optional cord, as new, \$100, ONO. **Homebrew 13.8 V 20 A regulated power supply**, fully metered, O/V and O/C protection, inbuilt forced cooling, peaks 25 amp, \$90, ONO. Transmitting equipment sold to licensed amateurs only. John VK2GMR, 066 461 460.

• **Kenwood TS-520S HF txcvr**, **SP-520S** spkr, mic, manual, mint condn, cartons, \$390. **DG5 Digital Display**, manual, mint condn, \$125. Geoff VK2FY, QTHR, 02 9600 7352.

• **Kenwood TS-711 2 m** all mode txcvr, s/n 8050176, 25 W, voice synthesiser, inbuilt PSU, excellent unit, VGC in original carton, complete, \$1200. **Kenwood PS-50 20 A PSU**, s/n 8010444, VGC, original carton, complete, \$300. Peter VK2APP, QTHR, 063 826 086.

• **Kenwood TS-811B 70 cm** all mode txcvr, as new condn, \$1 100. **Kenwood TS-700SP 2 m** all mode txcvr, digital read-out, built in PSU, as new condn, \$650. A Walsh VK2TBW, 048 612 092 fax 048 611 536 anytime.

• **PK232 TNC**, all mode, VGC, manuals, leads, \$350 ONO. **Elite Line TX5500** amplifier, VGC, 180 W PEP, \$250 ONO. **Laptop computer**, dual 3 1/2 inch drives, great portable packet station, \$150 ONO. Paul VK2HV, 049 335 995.

• **US and International Call Books**, 1996, in mint condn, \$80 incl postage. Steve VK2PS, QTHR, 02 9654 1809.

## FOR SALE VIC

• **Yaesu FP-757HD PSU**, 20 A, EC, \$320. Kevin VK3CKL, QTHR, 03 9792 9503.

• **VK3EOH Deceased Estate**, **Kenwood TS-440S**, HF txcvr with ATU; **Kenwood PS-50 PSU**; **Kenwood TR-751A** all mode txcvr; **Kenwood SW100**; **EP200 SWR** and power meter; extras and antenna; \$2000. Mrs I Decker, 03 9749 9878.

• **Kenwood TS-520S HF txcvr**, s/n 811317, circuit and operating manual, overhauled including new driver and finals, \$300. Lindsay VK3IQ, 03 5672 2563.

• **Kenwood TS-820S HF txcvr**, s/n 740961, digital frequency display, excellent condn, recently checked by Kenwood in Sydney, original carton, manual, mic, extrn spkr; also matching cabinet **DSIA DC** converter for mobile operation (unused), in carton. \$650 the lot. Gordon VK3ABI, QTHR, 03 5289 1812.

• **G2DAF linear amp**, home brew with two

813s, new valves, good quality parts and separate h/brew PSU, requires some work to complete, \$250 ONO. Castlemaine area, Bob VK3PT, 03 5439 6314.

- **Kenwood MA-5**, HF mobile 5 band antenna, \$180. **Kenwood AT-130** antenna tuner, as new, \$150. **Kenwood TR-7850** 2 m FM txcvr, 50 watts, \$350. **Kenwood TS-120S** HF txcvr, as new, \$470. All in excellent condn, used only as stand-by equipment. **ATN 7 el log periodic**, \$580 ONO. **VK3CYL**, QTHR, 03 9801 2792.

- **Toshiba T3200SX 386 laptop computer**, mono screen, 40 Mb HDD, 1.44 FDD, usual comm and printer ports, carry case, plus a new packet modem and all appropriate software, a bargain at \$350 ONO. **Compaq 286 portable computer** in carry case, mono plasma screen, 40 Mb HDD, 1.44 FDD, plus a new packet modem and all appropriate software, \$250 ONO. **Harold VK3AFQ**, QTHR, 03 9596 2414 anytime.

- **TS-430S**, FM board, wide AM filter, mobile bracket, \$920. **FT-101ZD Mk 2**, \$650. **FC-901** tuner, \$250. **FV-101DM** digital ext VFO, \$175. **Philips 926 99** ch 70 cm FM, \$220. **Nicads** size D 1.2 V/4 Ah, \$6 each. **FM900** selcall, \$40. **Antennas BNC/TNC**, suit hand holds, new, VHF/UHF \$15 ea. **Marconi MI2955**, \$7000. **RT80**, suit 2 m packet, \$45. **Epson LX-800**, \$100. **Amstrad 286 PC**, \$90. **Acoustic hood**, \$50. **Lee VK3GK**, 03 9544 7368, 015 810 101.

- **Kenwood MC60A** base mike, \$80. **Revex ant switch** (DSE D5208), \$35. Both as new condn. **Yaesu FC-102 ATU**, fair condn, \$100. **Damien VK3RX**, 03 5427 3121.

### FOR SALE QLD

- **Electronics books**, 1928 to present. 45 cent stamp for catalogue. Some parts also. **P Hadgraft VK4APD**, QTHR, 07 3397 3751.

- **DC RF interference filter**, 2 x 100 amps @ 24 VDC, suit wall mounting on shielded room, \$190. **Mains RF interference filter**, 2 x 20 amps @ 240 VAC, suit wall mounting on shielded room, \$190. **Notch filter**, K&L Dual, tunable 50 to 75 MHz, two separate calibrated vernier dials, \$210. **Gary VK4AR**, QTHR, 07 3353 1695.

### FOR SALE SA

- **Icom IC-W21A** 2 m/70 cm dual band handheld, with Rx 50 to 1000 MHz, AC charger, cigarette lighter adaptor, antenna, belt clip, as new in box, s/n 01642, immaculate condn, \$450. **John VK5KBE**, QTHR, 014 000 016.

- **Akai GX4000D** stereo tape deck, as new, 4 track, 2 mic inputs, glass crystal FF heads, 2 speed rec, 2140 mins, freq response 30 to 24,000 Hz, many exclusive features, blank tapes available also with top band music, ideal dancing, monitored with 2 VU meters, breath-taking fidelity, \$475. Bargain, will sell for \$190. **A E Shepard VK5DC**, QTHR, 08 431 4194

### FOR SALE WA

- **Shack clearance** due to ill health, **VK6AAS** needs to sell **Yaesu FT101ZD** with desk mic; **FC-901** antenna coupler; **40 ft winch-up mast**; **rotator and controller**; **5 band wire dipole**. Contact **Peter VK6APS**, QTHR, 09 652 1326.

### WANTED NSW

- **Crystal microphone or crystal microphone insert(s)**. **VK2BJU**, QTHR, 02 9673 4305.

- **Icom IC-735** with operating manual, must be in good condn. Also, **service manual for Kenwood TS-900**, all costs gladly refunded. **Stan VK2BRZ**, QTHR, 044 417 061.

- **Automorse, McDonald Pendograph and Australian Buzzer semi-autos** required; also any service manuals for the above keys. **Photocopies OK**. Pay top dollar for good condn keys. **Steve VK2SPS**, 02 9999 2933 after 6.00 pm.

- **Tono 7000E Morse/RTTY computer**. **Scotty VK2KE**, 060 218 897.

### WANTED VIC

- **Band-change switch (ceramic) for Yaesu FL-2500** linear, bank B rear, or complete. **Kevin VK3CKL**, QTHR, 03 9792 9503.

- **Copy of circuit or handbook for AWA**

receiver type **CR-6B**. Will pay all costs. **Morris VK3DOC**, 03 9824 8988.

- **Valves 8122**. **Stan VK3SE**, 03 5332 2340.

### WANTED WA

- **IC-970, IC-781**, only good condn. **Walter VK6BCP**, QTHR, 09 341 2054 or fax 09 341 1230.

- **Icom IC2KL linear**, faulty unit also considered. **Phil VK6APH**, QTHR, 09 245 2973.

### WANTED TAS

- **Attenuators HP models 355C, 355D**. Require several units of each, any condn. **Trevor Briggs VK7TB**, 03 6398 2118 after 6.00 pm, or mail info to 9 Norfolk St, Perth, TAS 7300.

- **Patrolman 50 and Selena B206; GE Super Radio 1; GE Super Radio 2**. **Martin L70067**, QTHR, 03 6331 8705.

### MISCELLANEOUS

- **THE WIA QSL Collection** (now Federal) requires QSLs. All types welcome especially rare DX pictorial cards special issue. Please contact Hon Curator **Ken Matchett VK3TL**, 4 Sunrise Hill Road, Montrose Vic 3765, Tel 03 9728 5350.

ar

## VK QSL BUREAUX

The official list of VK QSL Bureaux. All are Inwards and Outwards unless otherwise stated.

VK1	GPO Box 600 CANBERRA ACT 2601
VK2	PO Box 73 TERALBA NSW 2284
VK3	Inwards Box 757G, GPO MELBOURNE VIC 3001
	Outwards 40G Victory Blvd ASHBURTON VIC 3147
VK4	GPO Box 638 BRISBANE QLD 4001
VK5	PO Box 10092 Gouger St ADELAIDE SA 5001
VK6	GPO Box F319 PERTH WA 6001
VK7	GPO Box 371D HOBART TAS 7001
VK8	C/o H G Andersson VK8HA
	Box 619 HUMPTY DOO NT 0836
VK9/VK0	C/o Neil Penfold VK6NE
	2 Moss Court KINGSLEY WA 6026

**Copies of Amateur Radio articles. Photocopies of any article published in a back issue of Amateur Radio are available to members at \$2.50 each (plus \$2.00 for each additional issue in which the article appears)**

# WIA Divisions

The WIA consists of seven autonomous State Divisions. Each member of the WIA is a member of a Division, usually in their residential State or Territory, and each Division looks after amateur radio affairs within its area.

Division Address	Officers	Weekly News Broadcasts	1997 Fees
<b>VK1</b> ACT Division GPO Box 600 Canberra ACT 2601	<b>President</b> Hugh Blemings <b>Secretary</b> John Woolner <b>Treasurer</b> Les Davey	<b>VK1YYZ</b> 3.570 MHz LSB, 146.950 MHz FM each Sunday evening commencing at 8.00 pm local time. The broadcast text is available on packet, on Internet <a href="http://www.aus.radio.amateur.misc">aus.radio.amateur.misc</a> newsgroup, and on the VK1 Home Page <a href="http://email.nla.gov.au/~cmakin/wiaact.html">http://email.nla.gov.au/~cmakin/wiaact.html</a> <b>VK1IET</b> From VK2WI 1.845, 3.595, 7.146*, 10.125, 24.950, 28.320, 29.120, 52.120, 52.525, 144.150, 147.000, 438.525, 1281.750 (* morning only) with relays to some of 14.160, 18.120, 21.170, 584.750 ATV sound. Many country regions relay on 2 m or 70 cm repeaters. Sunday 1000 and 1930. Highlights included in VK2AWX Newcastle news, Monday 1930 on 3.593 plus 10 m, 2 m, 70 cm, 23 cm. The broadcast text is available on the Internet newsgroup <a href="http://www.aus.radio.amateur.misc">aus.radio.amateur.misc</a> , and on packet radio. <b>Vk1LD</b>	(F) \$72.00 (G) (S) \$56.00 (X) \$44.00
<b>VK2</b> NSW Division 109 Wigram St Parramatta NSW (PO Box 1066 Parramatta 2124 Phone 02 9689 2417 Freecall 1800 817 644 Fax 02 9633 1525	<b>President</b> Peter Jensen <b>Secretary</b> Eric Fossey <b>Treasurer</b> Eric Van De Weyer (Office hours Mon-Fri 11.00-14.00 Sat 1000-1300 Mon 1900-2100) Web: <a href="http://marconi.mpcpe.mq.edu.au/wia">http://marconi.mpcpe.mq.edu.au/wia</a> e-mail address: <a href="mailto:wiansw@sydney.dialix.oz.au">wiansw@sydney.dialix.oz.au</a> Packet BBS: VK2WI on 144.850 MHz	<b>VK2AQJ</b> <b>VK2EFY</b> <b>VK2KUR</b>	(F) \$66.75 (G) (S) \$53.40 (X) \$38.75
<b>VK3</b> Victorian Division 40G Victory Boulevard Ashburton Vic 3147 Phone 03 9885 9261 Fax 03 9885 9298	<b>President</b> Jim Linton <b>Secretary</b> Barry Wilton <b>Treasurer</b> Rob Halley (Office hours Tue & Thur 0830-1530)	<b>VK3PC</b> <b>VK3XV</b> <b>VK3NC</b>	VK3BWI broadcasts on the 1st Sunday of the month, starts 10.30 am. Primary frequencies 1.840 AM, 3.615 LSB, 7.085 LSB, and FM(R)s 146.700 Mt Dandenong, 147.250 Mt Macedon, 147.225 Mt Baw Baw, and 2 m FM(R)s VK3RMA, VK3RSH and VK3ROW. 70 cm FM(R)s VK3ROU and VK3RGL. Major news under call VK3WI on Victorian packet BBS. (F) \$75.00 (G) (S) \$61.00 (X) \$47.00
<b>VK4</b> Queensland Division 40G Wigram St Brisbane QLD 4001 Phone 074 96 4714	<b>President</b> Geoff Sanders <b>Secretary</b> John Stevens <b>Treasurer</b> John Presotto e-mail address: <a href="mailto:wiaq@tmxbris.mhs.oz.au">wiaq@tmxbris.mhs.oz.au</a>	<b>VK4KEL</b> <b>VK4AFS</b> <b>VK4WX</b>	1.825 MHz SSB, 3.605 MHz SSB, 7.118 MHz SSB, 14.342 MHz SSB, 28.400 MHz SSB, 29.220 MHz FM, 52.525 MHz FM, 146.700 MHz FM, 147.000 MHz FM, 438.525 MHz (Brisbane only), regional VHF/UHF repeaters at 0900 hrs Sunday. Repeated on 3.605 MHz SSB & 147.000 MHz FM, regional VHF/UHF repeaters at 1930 hrs EAST Monday. Broadcast news in text form on packet under WIAQ@VKNET. (F) \$74.00 (G) (S) \$60.00 (X) \$46.00
<b>VK5</b> South Australian Division 34 West Thebarton Rd Thebarton SA 5031 (GPO Box 1234 Adelaide SA 5001) Phone 08 8352 3428 Fax 08 8264 0463	<b>President</b> Peter Watts <b>Secretary</b> Maurie Hooper <b>Treasurer</b> Charles McEachem Web: <a href="http://www.vk5wia.ampr.org/">http://www.vk5wia.ampr.org/</a>	<b>VK5ZFW</b> <b>VK5EA</b> <b>VK5KDK</b>	1827 kHz AM, 3.550 MHz LSB, 7.095 AM, 14.175 USB, 28.470 USB, 53.100 FM, 147.000 FM Adelaide, 146.700 FM Mid North, 146.800 FM MILDURA, 146.825 FM Barossa Valley, 146.900 FM South East, 146.925 FM Central North, 147.825 FM Gawler, 438.425 FM Barossa Valley, 438.475 FM Adelaide North, ATV Ch 35 579.250 Adelaide. (NT) 3.555 USB, 7.065 USB, 10.125 USB, 146.700 FM, 0900 hrs Sunday. 3.585 MHz and 146.675 MHz FM Adelaide, 1930 hrs Monday. (F) \$75.00 (G) (S) \$61.00 (X) \$47.00
<b>VK6</b> West Australian Division PO Box 10 West Perth WA 6872 Phone 09 351 8873	<b>President</b> Cliff Bastin <b>Secretary</b> Christine Bastin <b>Treasurer</b> Bruce Hedland-Thomas	<b>VK6LZ</b> <b>VK6ZLZ</b> <b>VK6OO</b>	146.700 FM(R) Perth, at 0930 hrs Sunday, relayed on 1.825, 3.560, 7.075, 14.116, 14.175, 21.185, 29.680 FM, 50.150 and 438.525 MHz. Country relays 3.582, 147.350(R) Busseton and 146.900(R) Mt William (Bunbury). Broadcast repeated on 146.700 at 1900 hrs Sunday, relayed on 1.865, 3.563 and 438.525 MHz; country relays on 146.350 and 146.900 MHz. (F) \$62.00 (G) (S) \$50.00 (X) \$34.00
<b>VK7</b> Tasmanian Division 5 Helen Street Newstead TAS 7250 Phone 03 634 42324	<b>President</b> Andrew Dixon <b>Secretary</b> Robin Harwood <b>Treasurer</b> Terry Ives	<b>VK7GL</b> <b>VK7RH</b> <b>VK7ZTI</b>	146.700 MHz FM (VK7RHT) at 0930 hrs Sunday relayed on 147.000 (VK7RAA), 146.725 (VK7RNE), 146.625 (VK7RMD), 3.570, 7.090, 14.130, 52.100, 144.150 (Hobart) Repeated Tues 3.590 at 1930 hrs. (F) \$74.00 (G) (S) \$60.00 (X) \$46.00
<b>VK8</b> (Northern Territory is part of the VK5 Division and relays broadcasts from VK5 as shown received on 14 or 28 MHz).			<b>Membership Grades</b> Full (F) Pension (G) Needy (G) Student (S) Non receipt of AR (X) Three-year membership available to (F) (G) (X) grades at fee x 3 times

Note: All times are local. All frequencies MHz.

## ADVERTISERS' INDEX

Amateur Transceiver Radio _____	22	U-CAN-DO Electronics Videos _____	34
Andrews Communication Systems _____	6	WIA Recruitment _____	13
ATN Antennas _____	21	WIA Membership Retention _____	5
Daycom _____	IFC	Trade Hamads _____	
Dick Smith Electronics _____	28, 29, IBC	M Delahunty _____	54
ICOM _____	OBC, 32	RJ & US Imports _____	54
Radio and Communications _____	30	HAMLOG - VK2VN _____	54
Terlin Aerials _____	37	Henry's Publishing _____	54

### TRADE PRACTICES ACT

It is impossible for us to ensure the advertisements submitted for publication comply with the Trade Practices Act 1974. Therefore, advertisers and advertising agents will appreciate the absolute need for themselves to ensure that the provisions of the Act are complied with strictly.

### VICTORIAN CONSUMER AFFAIRS ACT

All advertisers are advised that advertisements containing only a PO Box number as the address cannot be accepted without the addition of the business address of the box-holder or seller of the goods.

# Yaesu FT-1000MP

## Incredible Performance, Amazing Price!



Now's your chance to pick up Yaesu's latest high performance HF base transceiver, the new FT-1000MP, at a great new price. You'll be amazed at its incredible performance, but if you need convincing, just read what the experts have to say.

### On Operation:

"I would classify the transceiver as 'user friendly' compared to some other modern transceivers I have operated." - CQ  
 "..... we found it to be a proficient performer." - QST  
 ".....In term of ergonomics my preference is marginally for the Yaesu.....The second receiver is certainly better implemented....."  
 - Radio Comms (UK)

### On Documentation:

"In general, Yaesu's manuals are the epitome of clear, concise, and complete documentation, and the FT-1000MP's 104 page Operating Manual is no exception." - QST

### On The Receiver:

"Its receiver is a real beauty ... its very clean and the audio is very clear and punchy ...." - Radio & Communications  
 "Measurement of second order intermodulation ... showed an average result for the IC-775DSP but the FT-1000MP was some 10dB better than any other radio measured." - Radio Comms (UK)  
 "The receiver is quiet and good at its job, and Yaesu's EDSP is icing on the cake." - QST  
 "Certainly, this receiver is designed to withstand the onslaught of very strong signals...." - CQ

### On The Transmitter:

"CW operators will be impressed with the FT-1000MP keyer." - CQ  
 "The transmitter is good as well, with a lightning fast automatic tuner built in as standard." - Radio & Communications  
 "The FT-1000MP has excellent spectral purity of the output signal." - CQ

### Digital Signal Processing:

"The EDSP filter operates smoothly and effectively in all of its modes." - CQ  
 "Having the DSP built-in means it works as well as possible - and is clearly better than most after-market add-ons." - Radio & Communications  
 "The double-whammy of crystal and mechanical filters plus DSP in the FT-1000MP is a killer combination." - QST

### Conclusions:

"... I am unable to report finding even a picky fault with the FT-1000MP." - CQ  
 "So does the inbuilt DSP say 'buy me'? In this humble scribes opinion, you bet!" - Radio & Communications  
 "The FT-1000MP offers performance and flexibility in a quality radio." - QST

Interested in more information? Why not call us for a copy of Yaesu's 12 page colour booklet, 46 page Technical Overview, or for copies of various magazine reviews. We're sure you'll soon agree that the world of HF transceivers has just taken a giant leap forward.

QST - ARRL QST (USA) Magazine review April 1996

CQ - CQ (USA) Magazine review April 1996

Radio Comms - Radio Communications (UK) review

January 1996

Radio & Communications - Radio & Communications (Aust) review July 1996

Cat D-3400

**\$3995**  
2 YEAR WARRANTY



For further information, orders or the location of your nearest store call:

Ph: 1300 366 644 (local call charge)

Or Fax: (02) 9805 1986



# WITH OUR RANGE, WE'RE TALKING SERIOUS PERFORMANCE TO SUIT EVERY POCKET.

**Just arrived!**  
**IC-706MKII**  
With improved VHF band  
RF stage, boosted output  
power and more.



For years now, the Icom range has delivered truly professional features and performance to the ever changing world of amateur radio.

Take the IC-706...this unit is a world first combining the compactness of a mobile rig with the features of a top class base station...all at a very affordable price. It covers HF plus the six and two metre bands, all modes, to offer the serious enthusiast the power and functions to compete with the big rigs.

And if you are looking for absolute top-of-the-line performance and features, check out the IC-775 DSP. From its amazing digitally processed signal to a superb array of features, this is a radio that is hard to better in any class.

Icom radios give you a remarkably wide choice...but whatever your budget, you can be sure the rig you buy will be precision built with the quality and innovation that keeps Icom clearly ahead.



IC-775DSP

For more information see your nearest Icom Dealer, or call free on 1800 338 915, or write to: Icom Australia Pty. Ltd. 7 Duke St. Windsor VIC 3181 Ph (03) 9529 7582 Fax (03) 9529 8485

  
**ICOM**  
Clearly Ahead

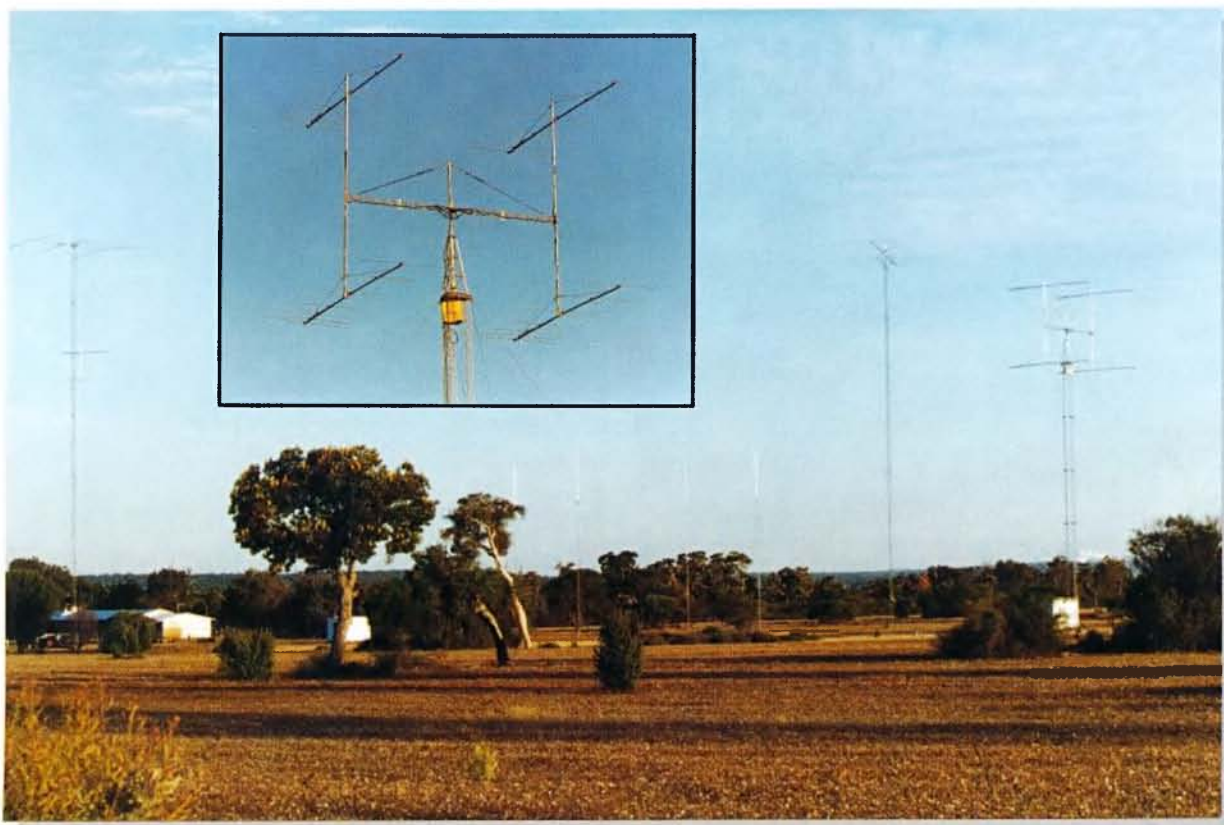


# Amateur Radio

May 1997  
Volume 65 No 5



*Journal of the Wireless Institute of Australia*



*Full of the latest amateur radio news, information and technical articles including...*

- “Nano-L” Inductance Bridge for Small Coils
- Conversion of Philips FM92 E to Six Metres
- Review of the Icom IC-756 HF Transceiver

**Plus** *lots of other articles, news and special interest columns*

# Australia's AMATEUR RADIO SUPERSTORE!

# DAYCOM



## IC-756 HF + 6m 100W, auto-ATU, DSP

If you missed our Icom Day at the end of November you missed the opportunity to see the all new IC-756. It was pretty hard to see anyway with the crowd always around it!

- All bands 160-6 metres
- 100W output on all bands
- Auto ATU works on all bands
- Dual watch receivers
- Spectrum Scope (just like the IC-781!)
- Dual Pass-Band Tuning
- Adjustable threshold DSP noise reduction
- Audio Peaking Filter
- Automatic Notch filter
- Built-in CW memory keyer
- 100 alphanumeric memories

Some of the reactions; "how much will you give me for my FT-1000 as a trade-in?", "Probably the most innovative radio since the IC781 hit the market!", "This is really a radio for all reasons, easy to use but with all the features a contestor or DXer needs."

In stock now, call to secure yours:

## \$3700

## R8500 HF/VHF/UHF receiver



The **NEW** Icom R-8500 receiver is here now! It covers 100kHz to 2000MHz (no breaks) has 1000 memories and a host of features you wouldn't think possible at just \$3750. Get the full story, call for a brochure or look on the WEB at <http://www.daycom.com.au/>

introductory special price: **\$3400**

## MFJ Antenna Tuners

MFJ901B	200W Versatuner	\$149
MFJ910	Mobile antenna matcher	\$45
MFJ921	2 mtr 300W tuner	\$155
MFJ924	70 cm 300W tuner	\$155
MFJ931	Artificial ground tuner	\$169
MFJ941E	300W compact GP tuner	\$230
MFJ945E	300W mobile tuner	\$209
MFJ948	Deluxe 300W (no D/L)	\$270
MFJ949E	Deluxe 300W	\$299
MFJ962C	1.5kW tapped inductor	\$525
MFJ969	300W Roller inductor <b>NEW</b>	\$360
MFJ971	200W Portable tuner	\$190



MFJ986	3kW Diff-T roller inductor	\$629
MFJ989C	3kW Deluxe roller inductor	\$735

## ARRL 1995 Publications CD-ROM



A whole years QST, QEX and NCJ magazines in a single CD-ROM - how convenient! With powerful reader technology the diagrams and photos appear in separate windows. Fully searchable text. Requires 386 or better with Windows 3.1 or later.

## \$45



## HAMCALL 1996

Our most popular callbook CD-ROM with Windows, DOS and MAC search engines. Much new information this year including photos of many amateurs!

## \$25

# hy-gain

## HyGain DX77

### Advanced Vertical Windom

- 7 Band Vertical
- 10-12-15-17-20-30-40 metres
- No ground radials required
- Tilt mount
- Height: 29 feet
- Power: 1.5kW
- Industrial grade construction
- Bandwidth (<2:1 SWR)
  - 10 metres 1.7MHz
  - 12 metres 100kHz
  - 15 metres 500kHz
  - 17 metres 100kHz
  - 20 metres 250kHz
  - 30 metres 100kHz
  - 40 metres 150kHz



Daycom and HyGain introduce the DX77 Advanced vertical Windom with features surpassing any HF vertical on the market. The superior mechanical design, high power capability and 55% greater bandwidth than competitive verticals on 20 and 40 metres make it an exceptional value for a high performance system.

The unique design of this vertical antenna provides a no compromise performance without the need for ground radial wires. It puts the world at your fingertips on the HF ham bands, 10 through 40 metres, including the WARC bands! Capable of handling 750W average or 1500W PEP the HyGain DX77 won't balk at the output of your line! Automatic band-switching and low angle of radiation allow for enhanced DX performance.

in stock now at

## \$875

# OPTOELECTRONICS XPLORER Test Receiver

All the information, in one hand!

In one convenient handful the amazing new Optoelectronics XPLORER Test Receiver not only finds signals for you, but it will tell you frequency and deviation as well as decoding sub-audible and DTMF tones. Sweeping the range 30 to 2000MHz in less than 1 second the Xplorer will lock on to any signal in the nearfield and demodulate the FM audio for monitoring. You also see frequency on the LCD display along with other information about the signal.

- Frequency range: 30MHz - 2GHz
- FM Deviation range: 100kHz
- Audio frequency response: 50 - 3000Hz
- Auto sweep time: <1 second 30-2000MHz
- Internal speaker, headphone jack, tape control jack, serial interface connector, rotary encoder & flexible push button panel.
- Easy to read LCD display with EL backlighting
- Internal 7.2V 850mAh NiCd battery
- Rapid charging (<1hr) with intelligent charging controller
- NMEA-01283 interface for GPS receiver

XPLORER Test Receiver **\$1700**

# TKIT The NEW Heathkit!



Help reclaim this fascinating band! Six metres is the VHF DX band and even now offers regular overseas contacts with just a little effort. The TT1208 kit is the ideal, low cost way, to get going on 6 metres and find out what only the elite have known for years!

- Requires 3-5W input on 20 metres
- Extremely simple hookup and operation
- Sensitive, low noise 50-54MHz front end
- Fast, silent PIN diode TR switch for QSK & data
- 8W output on 6 metres
- Requires 12-15V DC 3A power supply
- Simple switching between HF and 6 metres
- Rugged steel case

TT1208 8W 6 metre transverter **\$199**



**DAYCOM Communications Pty. Ltd.**  
44 Stafford Street, Huntingdale 3166

Bankcard, MasterCard  
& Visa all welcome

Phone (03)9543-6444  
FAX (03)9543-7238

# Amateur Radio



## Journal of the Wireless Institute of Australia

Vol 65 No 5

ISSN 0002-6859

May 1997

Amateur Radio is published by the Wireless Institute of Australia, ACN 004 920 745 as its Official Journal, on the last Friday of each month.

### Editorial

#### Editor

Bill Rice VK3ABP\*

#### Production Manager

Bill Roper VK3BR

#### Senior Technical Editor

Peter Gibson VK3AZL\*

#### Technical Editors

Evan Jarman VK3ANI\*

Gil Sones VK3AUI\*

Don Graham VK6HK

#### Contributing Editor

Ron Fisher VK3OM\*

#### WIA News Editor

Roger Harrison VK2ZRH

#### Proof Readers

Allan Doble VK3AMD

Jim Payne VK3AZT

Graham Thornton VK3IY

John Tutton VK3ZC

\*Publications Committee member

### Production

#### Administration, Advertising, Drafting, Production

vk3br Communications Pty Ltd

3 Tamar Court, Mentone VIC 3194

#### Typesetting and Printing

Industrial Printing and Publishing Pty Ltd

122 Dover Street, Richmond, VIC 3121.

#### Mail Distribution

Mail Management Australia Pty Ltd

6 Garden Boulevard, Dingley VIC 3172

### New Advertising

Eyvonne & Keith Tootell

Union Publicity Service Pty Ltd

PO Box 282, Toongabbie NSW 2146

Telephone: 1800 654 181 - 02 9831 1299

Fax: 02 9831 6161

### Amateur Radio Correspondence

All contributions, correspondence, Hamads and queries concerning the content of Amateur Radio should be sent to:

#### Amateur Radio

vk3br Communications Pty Ltd

3 Tamar Court, Mentone VIC 3194

E-mail: vk3br@c031.aone.net.au

Phone and Fax: 03 9584 8928

Mobile: 0418 534 168

Business Hours: 9.30 am to 3.00 pm weekdays

### Amateur Radio Delivery

All correspondence and queries concerning the delivery of Amateur Radio should be sent to:

#### Amateur Radio

WIA Federal Office

PO Box 2175

Caulfield Junction VIC 3161

#### Registered Office:

3/105 Hawthorn Road

Caulfield North VIC 3161

Telephone: 03 9528 5962

Fax: 03 9523 8191

Business Hours: 9.30 am to 3.00 pm weekdays

### Editorial and Hamads Deadlines

June 12/05/97

July 09/06/97

August 07/07/97

### Receipt of Amateur Radio by Mail

The June issue will be delivered to Australia Post on Tuesday, 3 June 1997 for mailing to members.

If this magazine is not received by the 15th of the month of issue, and you are a financial member of the WIA, please check with the Post Office before contacting the registered office of the WIA. ©

© Wireless Institute of Australia 1997

### CONTENTS

#### Technical

"Nano-L" Inductance Bridge for Small Coils _____	6
<i>Drew Diamond VK3XU</i>	
Conversion of Philips FM92 E Band to Six Metres _____	9
<i>Northern Corridor Radio Group Inc VK6ANC</i>	
Equipment Review - The Icom IC-756 All Mode HF & 6 Metres Transceiver _____	13
<i>Ron Fisher VK3OM</i>	
Technical Abstracts _____	17
<i>Gil Sones VK3AUI</i>	
Random Radiators _____	20
<i>Ron Cook VK3AFW and Ron Fisher VK3OM</i>	
Power Supply Protection _____	26
<i>John Bedwell VK3EHZ</i>	
Equipment Review - Revex W570 1.6 to 1300 MHz SWR/Power Meter _____	27
<i>Ron Fisher VK3OM</i>	

#### General

Ham Camp in the Flinders Ranges _____	22
<i>Paul Meier VK5MAP</i>	
Wanted: 100 Members to Replace the Dead! _____	23
<i>Peter Parker VK1PK</i>	
Book Review - The Novice Operators Theory Handbook _____	25
<i>Evan Jarman VK3ANI</i>	
Book Review - 1997 RSGB IOTA Directory and Yearbook _____	26
<i>Ron Fisher VK3OM</i>	
Reg Busch VK3LS _____	27
<i>Allen Crewther VK3SM</i>	

#### Columns

Advertisers' Index _____	56	Intruder Watch _____	43
ALARA _____	33	Ionospheric Update _____	50
AMSAT Australia _____	31	Morse Practice Transmissions _____	23
An Amateur and His Station _____	55	Over To You _____	43
Awards _____	34	Pounding Brass _____	45
Club Corner _____	35	Repeater Link _____	46
Contests _____	35	Silent Keys _____	51
Divisional Notes		Spotlight on SWLing _____	47
VK3 Notes _____	38	Update _____	45
VK7 Notes _____	38	VHF/UHF - An Expanding World _____	48
Editor's Comment _____	2	VK QSL Bureaux _____	25
Hamads _____	54	WIA News _____	3, 19, 33, 35
HF Predictions _____	52	WIA - Divisional Directory _____	56
How's DX? _____	39	WIA - Federal Directory _____	2

#### Cover

**Bill Hosie VK6ACY** really does have an antenna "farm". From left to right, a 40 m three element Yagi at 43 m above ground; an 80 m four square array consisting of four quarter wave verticals, each with 48 quarter wave ground radials; a six element 20 m Yagi at 43 m high; and a four by seven element stack for 6 m at 80 feet high. Inset is a close-up of the impressive 6 m array. (Photos by Bill VK6ACY)

### BACK ISSUES

Available, only until stocks are exhausted, at \$4.00 each (including postage within Australia) to members.

### PHOTOSTAT COPIES

When back issues are no longer available, photocopies of articles are available to members at \$2.50 each (plus \$2.00 for each additional issue in which the article appears).

The opinions expressed in this publication do not necessarily reflect the official view of the WIA, and the WIA cannot be held responsible for incorrect information published.

# Amateur Radio Service

A radiocommunication service for the purpose of self-training, intercommunication and technical investigation carried out by amateurs, that is, by duly authorised persons interested in radio technique solely with a personal aim and without pecuniary interest.

## Wireless Institute of Australia

The world's first and oldest National Radio Society  
Founded 1910

Representing the Australian Amateur Radio Service -  
Member of the International Amateur Radio Union  
Registered Federal office of the WIA:  
3/105 Hawthorn Rd, Caulfield North, Vic 3161

All Mail to:

PO Box 2175, Caulfield Junction, VIC 3161  
Telephone: 03 9528 5962 Fax: 03 9523 8191

Business Hours: 9.30 am to 3.00 pm on weekdays

Federal Secretary  
Peter Naish VK2BPN

### FEDERAL OFFICE STAFF

June Fox	Book Keeper
Sue Allan	Membership Secretary
Rita Trebilco VK3NRT	Examinations Officer

### COUNCIL

President	Neil Penfold	VK6NE
VK1 Federal Councillor	Richard Jenkins	VK1RJ
VK2 Federal Councillor	Michael Corbin	VK2YC
VK3 Federal Councillor	Brenda Edmonds	VK3KT
VK4 Federal Councillor	Ross Marren	VK4AMJ
VK5 Federal Councillor	Grant Willis	VK5ZWI
VK6 Federal Councillor	Bruce Hedland-Thomas	VK6OO
VK7 Federal Councillor	Jim Forsyth	VK7FJ

### EXECUTIVE

Peter Naish	VK2BPN
Lance Bickford	VK4ZAZ
Rowland Bruce	VK5OU
Neil Penfold	VK6NE

### FEDERAL CO-ORDINATORS

AMSAT:	Graham Ratcliff	VK5AGR
Awards:	John Kelleher	VK3DP
Contests:	Peter Nesbit	VK3APN
Education:	Brenda Edmonds	VK3KT
EMC and Standards	Roger Harrison	VK2ZRH
FTAC:	John Martin	VK3KWA
Historian:	John Edmonds	VK3AFU
IARU:	David Wardlaw	VK3ADW
Int'l Travel Host Exch:	Ash Nallawalla	VK3CIT
Int'l Beacon Co-ord:	Roger Harrison	VK2ZRH
Intruder Watch:	Gordon Loveday	VK4KAL
ITU Conference and Study Group:	David Wardlaw	VK3ADW
Media:	Roger Harrison	VK2ZRH
QSL Manager (VK9, VK0):	Neil Penfold	VK6NE
Radio Sports:	Wally Watkins	VK4DO
Videotapes:	Bob Godfrey	VK4BOB
WICEN:		

### SMA LIAISON TEAM

Roger Harrison	VK2ZRH
David Wardlaw	VK3ADW
Neil Penfold	VK6NE

# Editor's Comment

## The Convention

Every year in May, the WIA holds its Federal Convention. This is the meeting, attended by all the Federal Councillors (at least one from each Division), at which the office-bearers are selected for the next 12 months. Office-bearers are people such as the President, the Directors and all the Federal Co-ordinators, including the Editor.

This year the Convention is to be on the weekend of 3 and 4 May, so by the time you read this it will probably be over. Whether any appointments are changed will have been decided by the votes of the seven Divisions, one vote from each Division, even though a Division may be represented by one or two Alternate Councillors and/or observers, as well as the regular Councillor.

In their turn each of these Councillors has been elected by his/her Divisional Council to act as their Division's Federal representative. And, in their turn, the Divisional Councillors have been elected by you, the members of the Divisions. So there is a certain amount of democracy in the system, although some may think there is scope for improvement.

Until 1988 there was only one Federal Convention each year, and it met usually in Melbourne. But, in 1988, the Executive (as it was then designated) was expanded to include several members from other states, in addition to the Federal Councillors from each state. The function of Executive being to provide continuous management control necessitated that it should meet, as a rule, monthly. This involved additional costs in bringing interstate members to Melbourne, so a compromise was struck that Council and Executive meet quarterly at three Extraordinary Federal Conventions as well as the May Federal Convention.

More recently, to reduce costs, the relatively large Executive was disbanded and, after a period in which Council and Executive functions were combined, further change introduced the four-person Executive we now have. As you see, the system by which the Federal WIA is managed has undergone considerable change over the years, and even now only a super-optimist would describe it as perfect!

But through all these changes, the annual Federal Convention still survives. Long may it continue to keep amateur radio alive in Australia!

Bill Rice VK3ABP  
Editor

### CONTRIBUTIONS TO AMATEUR RADIO

*Amateur Radio* is a forum for WIA members' amateur radio technical experiments, experiences, opinions and news. Manuscripts with drawings and/or photos are always welcome and will be considered for possible publication. Articles on computer disk or via e-mail are especially welcome. The WIA cannot assume responsibility for loss or damage to any material. A pamphlet, "How to Write for *Amateur Radio*", is available from vk3br Communications Pty Ltd on receipt of a stamped, self addressed envelope.

## ■ WIA News

Roger Harrison VK2ZRH, Federal Media Liaison Officer

# Public Comment on Update Proposal for Short Range Class Licence Applications Sought by SMA

At the end of March, the Spectrum Management Agency (SMA) issued a release seeking public comment on a proposal to update the current Class Licence for Low Interference Potential Devices.

The SMA cited growing community demand for these radio devices for short range applications. The SMA said, "The proposed updates to the class licence are intended to support greater opportunities for electronic article surveillance devices, underground communication systems, electronic tolling systems, alarm transmitters, radio-determination transmitters, and various devices operating in the frequency ranges 0 to 9 kHz and 433.05 to 434.79 MHz."

The SMA offered a package of information, including a background paper explaining the nature of the updates. The WIA's SMA Liaison Team requested copies in early April. The closing date for comment was 2 May 1997.

As its chairman, Federal President Neil Penfold asked the WIA SMA Liaison Team to draft a response, working in conjunction with Federal Technical Advisory Committee (FeTAC) chairman John Martin VK3KWA. The draft was to draw on the material previously sent to the SMA earlier this year in response to a query regarding the subject of low power devices sharing the 433.05-434.79 MHz

segment of the 70 cm amateur band (see *WIA News*, page 5 in the March issue).

Apart from possible interference to these devices from amateur transmission, there is potential for interference from the devices to individual amateur stations, as well as repeater systems which operate in the 433-434.8 MHz segment of the 70 cm band.

Problems were experienced in the UK last year with radio activated key entry (RAKE) devices for motor vehicles which operated on 433.92 MHz. People had been locked out of their cars because strong UHF transmissions from amateur, land mobile and military stations had blocked the radio keys, which employ simple tuned radio frequency (TRF) receivers (see *WIA News*, January 1997, p 6). Also, in January this year, interference complaints regarding "wireless" hi-fi headphones and loudspeaker systems operating on 433 MHz were in the news in Britain.

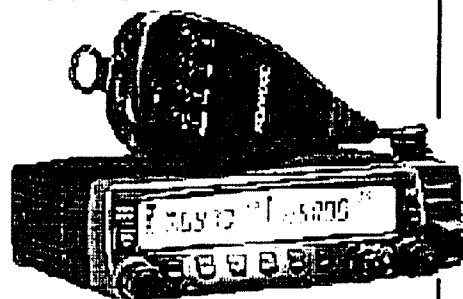
Amateurs are a secondary service in the 420-450 MHz band, sharing it with radio-location systems and the military.

**Support the  
advertisers  
who support  
Amateur Radio  
magazine**



YOUR HOBBY YOUR VOICE  
Representing Radio Amateurs - Since 1910

# RENEW YOUR MEMBERSHIP AND YOU COULD WIN



**THIS KENWOOD TM-733A  
2m/70cm FM/packet rig  
worth \$1255**

50 W on 2m 35 W on 70cm  
Switchable 10 W/5 W RF output  
Simultaneous VHF-UHF reception  
Data Input for 1200/9600 baud packet  
70 multi-function memories

**All you have to do is renew  
your Division membership  
when it falls due**

**WHO'S ELIGIBLE? ● members  
whose renewal falls due between  
1/1/97 and 31/12/97 ● current  
members who are on a 3-year  
membership ● life members, and  
● all membership grades.**

The prize will be awarded by means of a draw, the result to be published and the prize to be presented to the winner at the first available opportunity early in 1998.

TM-733A prize kindly donated by  
Kenwood Electronics Australia P/L,  
PO Box 504, Homebush 2140.  
Ph: (02) 9746 1888. Fax: (02) 9746 1509.

# Australia's First Spectrum Auction Raises \$1m

Two 4 MHz blocks of spectrum at 500 MHz went up for auction in February, closing in late March with a total of \$1.03 million in bids for spectrum licences being received by the Spectrum Management Agency (SMA). This is the first time fully trade-able spectrum licences have been allocated in Australia.

The two bands are at 501-505 MHz and 511-515 MHz. For the licence auction they were divided into a range of bandwidths, from 12.5 kHz to 1 MHz, both bands being available for licensing in 17 geographical areas across Australia. Some 900 separate licence "lots" were put up for auction. Successful bidders will receive a 15-year spectrum licence. Licensees are able to determine the use of the spectrum within their allocated band or bands, and geographical regions, set by the core conditions of the spectrum licence. Licensees will be able to trade the licences, as well as sub-let channels or bands in any or all geographical areas covered by the spectrum licence.

A rating unit scheme yielded data on lot prices obtained in the auction process, which employed a "simultaneous ascending auction" system, with

multiple rounds of bids progressing until there were no further bids on the lots offered. The average price per lot for all markets was 76 cents, with Northern Queensland regions attracting the most market interest and the highest bids. Lots in the Townsville region rated an average price of \$7.14 per lot unit, with Mackay coming in at \$3.77, followed by Darwin at \$3.12 and Adelaide at \$2.53, according to the SMA. Sydney lots achieved average prices per lot rating unit of 56 cents, and Melbourne somewhat behind at 45 cents.

The biggest bidder was the newly-

formed private mobile radiocommunications specialist company, Simoco Pacific (based out of Melbourne), part of the British-headquartered multinational Simoco group, formed from the old Philips Private Mobile Telecommunications division last year.

Meanwhile, in the United States, the two top bidders in the Federal Communications Commission's auctions of wireless mobile phone licences, which raised a total of \$US10.2 billion, have asked for easier payment terms.

NextWave Telecom, who bid a total of \$US4.7 billion, and Pocket Communications, whose bids added up to \$US1.4 billion, for a series of UHF-band licences, have asked for leniency from the regulators on the terms of payment. Effectively, their bids have become loans from the government. "What next, spectrum lay-bys?", asked one industry commentator.

## The Licensing Submission: What Next?

When the WIA's submission on amateur licensing was presented to the Minister for Communications and the Arts, Senator Richard Alston, in February, the Minister referred it to his department to be considered in a review of the Radiocommunications Act and amendments.

The WIA has learned from the Minister's office that that review will definitely be conducted this year. The Department are still settling the terms of reference for the review, the WIA was told, and the Radiocommunications Consultative Council (RCC) will be notified in due course.

The WIA is represented on the (RCC) by David Wardlaw VK3ADW.

The Radiocommunications Amendment Act passed through the Senate along with the series of Telecommunications Act amendments and related other bills during parliamentary sittings between 17 and 24 March.

## Changes at the SMA

The Spectrum Manager, Christine Goode, has departed the Spectrum Management Agency to take up a position with the Commonwealth Superannuation Board. Senior SMA officer, Roger Smith is the acting Spectrum Manager.

The change came in preparation for the establishment of the Australian Communications Authority, which has been created by an act of Parliament and will commence operation from 1 July 1997. It will succeed and take over the combined roles of the Spectrum Management Agency and the telecommunications regulator, Austel.

The head of Austel, Neil Tuckwell, has moved to the Australian Competition and Consumer Commission (ACCC), working under contract as a consultant.

### Late SMA News

The WIA has been notified by the SMA that the Radiocommunications Licence Conditions (Amateur Licence) have been gazetted.

All WIA divisions have a copy and it is available from all SMA offices and also on their Internet home page [www.sma.gov.au](http://www.sma.gov.au)

It is expected that, in the near future, all Regulations Examinations will be based on this document.

Further information next month.

# February's Recruitment Prize Winner

Mr J W Oswald VK2BOJ, a member of the NSW Division, is the lucky winner of the second Fluke 12B digital multimeter, the prize in the WIA's 1997 recruitment campaign. Mr Oswald's name was drawn from a field of 22 members who joined a Division in February.

Each month throughout 1997, a Fluke 12B digital multimeter, worth \$195, will be given away to a lucky winner who joined a WIA Division in the previous month. The Fluke multimeter prizes have been generously donated by Philips Test & Measurement.

The Fluke 12B measures ac and dc voltage (with auto-selection above 4.5 V), and resistance and capacitance from 1000 pF to 1000 µF. The instrument features a simple rotary dial, a 4000-count liquid crystal display, and diode

and continuity testing. Its "continuity capture" feature indicates intermittent open and short circuits. It comes with test leads and a two-year warranty. Fluke is the world's pre-eminent manufacturer of digital test instruments and the Model 12B is from their recently-released range of hand-held instruments.

Every newcomer to electronics and amateur radio needs a good multimeter, and every seasoned enthusiast could always do with another one!

Membership recruitment advertisements appear in each issue of *Amateur Radio* magazine, and in *Radio and Communications* magazine.

Membership recruitment and renewal advertisements are now appearing on WIA Divisions' World Wide Web pages on the Internet.

# International Forum on Digital Communications

Interested in digital radio communications? The 1997 American Radio Relay League and Tucson Amateur packet Radio Digital Communications Conference will be held over 10-12 October, in Baltimore, Maryland in the USA. The conference venue will be located minutes from the BWI airport, between Washington DC and Baltimore, according to the ARRL.

The Digital Communications Conference is an international forum for radio amateurs interested in digital communications, networking and related technologies. Coverage includes HF/VHF/UHF digi-modes, APRS,

spread spectrum, DSP and other modes. The forum is a place to meet other amateurs with like interests, publish your work and present new ideas and techniques for discussion.

Two \$US500 conference travel awards are offered for papers from students. Student papers have to be with the organisers by 30 June. Deadline for general conference papers is 22 August.

Full details can be found on the Web at [www.arrl.org/announce/dcc97.html](http://www.arrl.org/announce/dcc97.html), or [tapr.or/dcc](http://tapr.or/dcc). Or, write to: Tucson Amateur Packet Radio Corp, 8987-309 E Tanque Verde Rd #337, Tucson, Arizona 85749-9399 USA.

IOOM *Clearly Ahead*



## "VK3LZ calling!"

More sound information from your friends at Icom.

**MORE CONVENTIONS  
COMING UP!**

Three important dates to remember are:

**BARCFEST (BRISBANE)  
SATURDAY MAY 3RD**

**MOORABIN HAMFEST (VIC)  
SATURDAY 10TH MAY**

**MT. GAMBIER (S.A.)  
SATURDAY JUNE 7TH &  
SUNDAY JUNE 8TH**

Whether you're a seasoned campaigner or a newcomer to the fascinating world of amateur radio, these conventions are a great opportunity to obtain advice, information and of course a bargain or two.

Come and join your friends from Icom and many of our leading dealers and check out our extensive range of equipment. You'll be able to have a close look at our flagship IC-756 and the exciting new IC-706 MKII. We'll also make sure there'll be some very good specials to make your trip worthwhile. We look forward to seeing you there!

## "...73"

**FreeCall 1800 338 915**

**290 -294 Albert Street  
Brunswick, Victoria 3056  
Tel : (03) 9387 0666  
Fax : (03) 9387 0022**

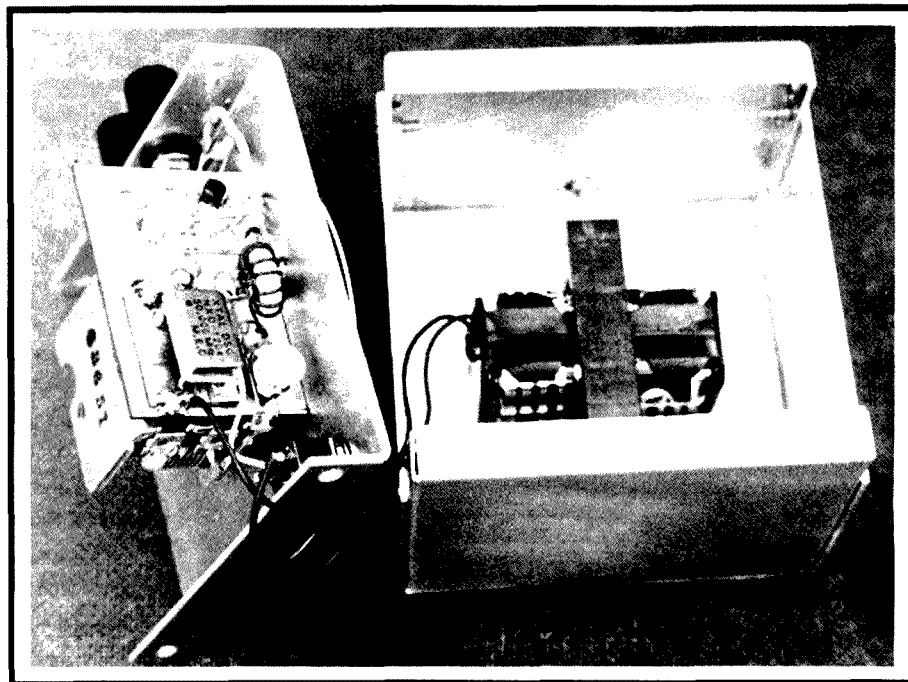
ACN 006 092 575

L.I. BROWN-SMITHSONIAN

## ■ Test Equipment

# “Nano-L” Inductance Bridge for Small Coils

*Drew Diamond VK3XU\* tells us how to build a very useful piece of test equipment.*



**Inside view of the Nano-L Inductance Bridge.**

Some experimenters may have trouble in measuring small values of inductance, even when employing a suitable dipper and the “resonance dip” method. Indeed, more than a few of the fancy “laboratory” bridges will not go much below 5 mH. Recent VHF work involving coils and loops of only a few hundred nH caused me to think about a simple, handy little meter for measuring inductors below 500 nH (or 0.5 mH, the lower calibrated limit of my “Little-L”). Here is one simple approach to the problem. The measuring range is from less than 50 nH to 500 nH (0.05 mH to 0.5 mH), which should cover most tank and filter coil requirements encountered by workers in the VHF field.

### Circuit

A standard 50 MHz computer crystal oscillator clock module generates our

test signal. 50 MHz was chosen for several reasons; it is a stock frequency, the price is reasonable, the coil under test is “excited” by an appropriate frequency (and therefore gives a better idea as to its “Q-ness”), and the signal makes a handy frequency calibration source/band edge marker for six metre work (more later).

To avoid measurement errors, a 50 MHz tank at L1 removes harmonic energy from the TTL output, and thus supplies a near sinusoidal signal to the unknown terminals at LX. When the coil under test is resonated by the variable capacitor, the voltage at the “hot” terminal will be at a maximum, sufficient to cause the germanium diodes to conduct. A small proportional detected DC will be injected into the base of the 2N3904, turning the transistor on, thus causing the LED to glow. After careful

peaking of the variable capacitor, the value may be read from the calibrated dial. About 25 mA is drawn from the 6 V supply comprised of 4 x 1.5 V penlight cells.

### Construction

As some items are best left “un-metricated”, I offer apologies in advance for mixing metric and Imperial measurements in what follows. To reduce unwanted stray capacitance (which would reduce the measuring range, and cause errors), some of the wiring is “direct”. The clock module, filter tank and detector components are accommodated upon a plain circuit board using paddyboard construction. A suggested layout is shown, although component placement is not especially critical, provided that all RF carrying leads are as short as reasonably practicable.

The 210 pF (max) variable capacitor used is one section of a locally-made dual gang 8 to 95 pF/8 to 210 pF unit, available from at least one supplier, although any gang of about 200 or 400 pF maximum C, and 8 or 10 pF minimum, will do. Wiring lead lengths are reduced by using tag 1 and tag 2 of the capacitor as shown in the drawings.

The instrument should be housed in an aluminium or die-cast box. That shown is home-made, but is similar to the Horwood 34/4/DS measuring 100 x 100 x 75 mm. If the 95/210 pF capacitor is used (see Parts), the calibrated dial scale shown should give quite reasonable accuracy (more on calibration later).

Operationally, the LED forms the “cursor”, or pointer, by aligning it with the calibrated scale. The variable capacitor is mounted so that its spindle is centred in the panel. Make sure that the three 4 BA CSK fixing screws do not foul the plates. Use spacers (or washers) on the screws, between capacitor and panel, and/or cut the screws to length if necessary.

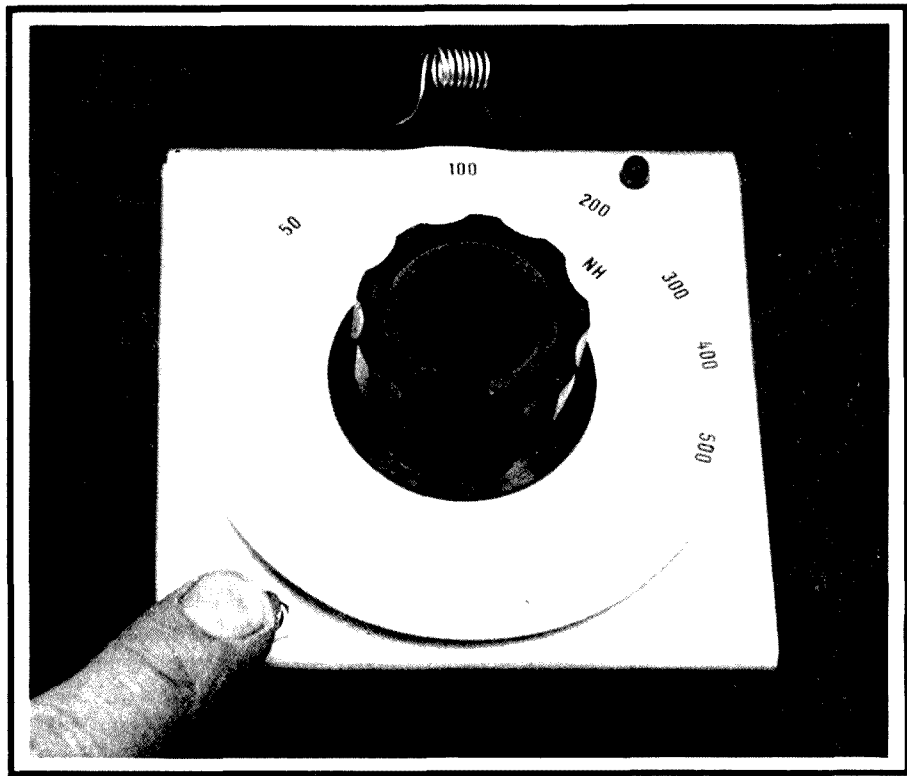
Here’s a dodge for easier marking-out for the capacitor mounting holes. Drill a 1/4” hole in the exact centre of the panel for the capacitor spindle. Obtain three off-cuts from 4 BA steel screws, about 15 mm length (perhaps from your three mounting screws). Fix these in the chuck of your drill, lathe fashion. Form a



conical point on the cut end of each screw by applying a file to the rotating work-piece. Insert these three stud screws into the front capacitor mounting holes, points facing out. Now insert the capacitor spindle squarely through the 0.25" hole from inside the box so that the side of the capacitor faces the spot where the LX terminal set shall be. Apply a firm pressure to the studs, thus accurately marking where the mounting holes are required.

The crystal module is soldered to a small substrate board which, in turn, is soldered or glued to the main board. A small four-square substrate accommodates the detector components. Winding details for the tank coil L1 are shown on the circuit. Use an Amidon T50-6 (yellow) core for L1. The tank trimming capacitor may be an ordinary Philips 22 pF (green). When mounting the trim cap on to the board, observe that the tag which connects to the screwdriver slot is the one soldered to the circuit board foil. Preset to about half capacitance.

The dial shown was made from sheet aluminium, about 1.3 mm thickness, and about 100 mm diameter. Scribe the 50 mm radius with a compass. Cut out slightly oversize with a rod saw (Abrafite

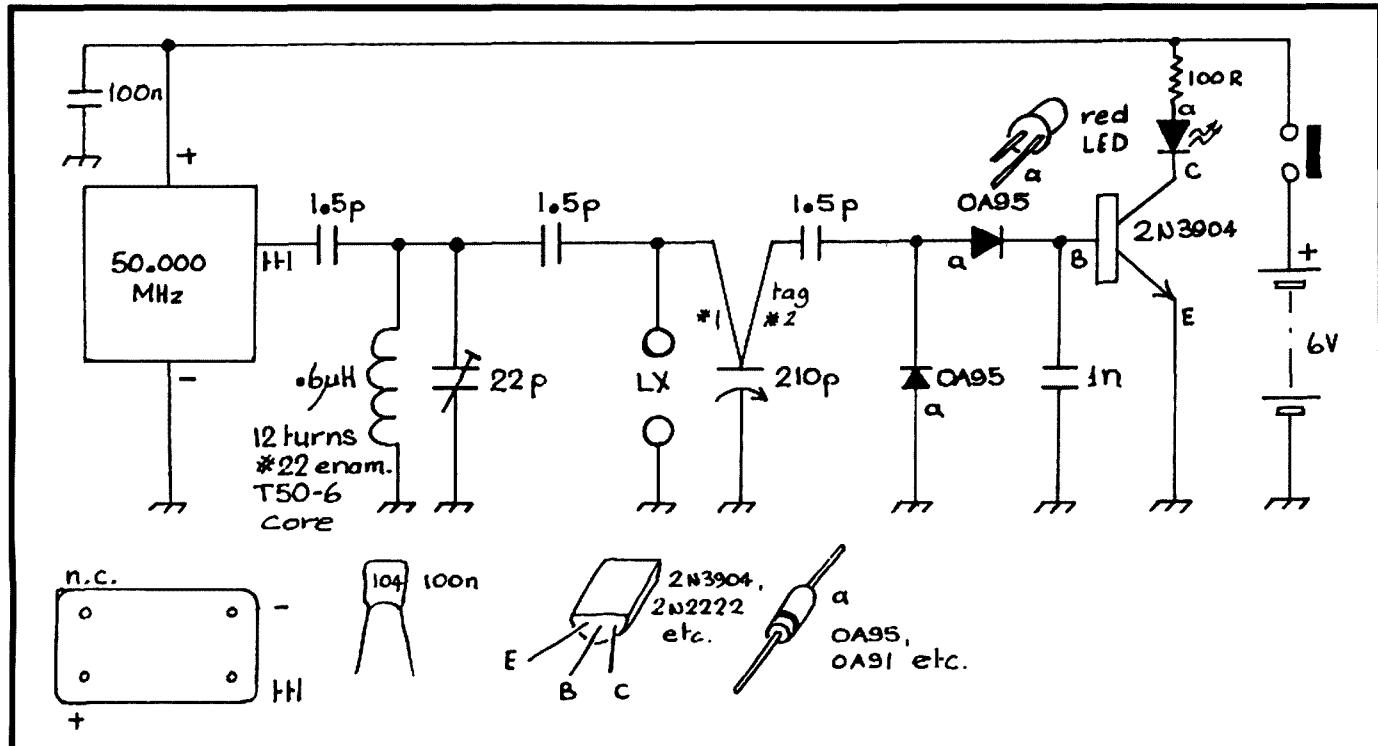


**The dial assembly.**

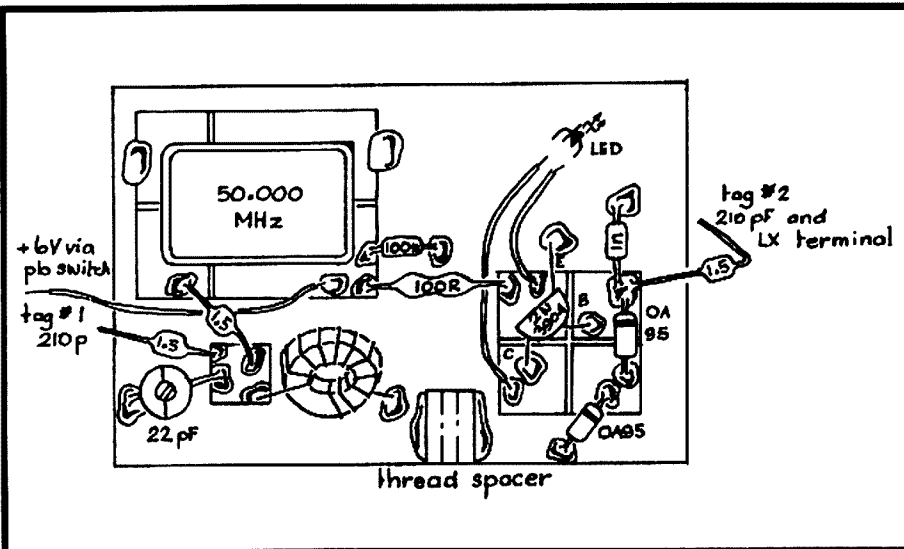
[TM]). Drill a 1/4" hole in the centre. Fit a 1/4" bolt and nut through the hole. If you have access to a lathe, fix the assembly in a three-jaw and turn to 100 mm od. Otherwise, fix the assembly in

the chuck of a power drill which is mounted in your bench vice, and apply a file to the rotating outer edge of the disc.

Carefully work to a smooth finish. Find a suitable knob, and drill three



**Fig 1 - Circuit diagram of the Nano-L Inductance Bridge.**



**Fig 2 - Component layout on the circuit board.**

equally spaced (120 degrees apart) holes in the rear to correspond with three holes in the disc. Use CSK screws to join these parts. Before assembly, paint the disc with white undercoat, ready to receive your calibrations.

**Calibration and Operation**

Shown is a set of test coils for calibrating the dial. The 50, 100, 200 and 300 nH coils are made from #18 B&S (1 mm) tinned or enamelled copper wire, wound upon the shank of a 6.5 mm

(0.25") drill, spaced about one wire diameter between turns. Or, preferably, you can use an ordinary 5/16" Wh 18 tpi bolt. Wind the turns on, then unscrew the bolt from the coil. The 400 and 500 nH coils were wound upon the shank a 13 mm (0.5") drill, one wire diameter between turns, but this time, to avoid shorted turns, use #18 B&S enamelled wire.

Start by fixing the 300 nH coil in the LX terminals. Move the dial around the half capacitance point so that the LED glows. Peak the 22 pF trim cap across L1

for maximum glow. Now mark the dial for the remaining calibration points using the appropriate coil, peaking the LED glow for each one.

The 50 MHz clock makes a handy 6 m band edge identifier and signal source for receiver work. By switching the device on, with a test coil (or hairpin loop - about 200 mm) resonated, signal strength is controllable by simply placing the bridge some distance from the antenna - ideal for "equivalent" sub-microvolt tests where no calibrated generator is available. Similarly, it is also useful as a remote signal source in checking antenna characteristics.

**Parts**

The 95/210 pF variable capacitor is available (at the time of writing) from Truscotts Electronic World, (03) 9 723 3860. My 50 MHz crystal module was purchased from Rod Irving Electronics. See Hamads for Amidon suppliers. The remaining components should be available from the mainstream electronic parts suppliers. Drop me a line, at the address below, if you have trouble in locating any of the parts, or in making your model work satisfactorily (SASE please).

**References and Further Reading**

1. *Easy to Build Inductance Meter - Marriner, W6XM, Ham Radio (USA) Apr '82.*
2. *"Little-L" Inductance Bridge for RF Coils - Diamond, Amateur Radio Nov '92.*
3. *VHF-UHF Manual - Jessop, RSGB.*
4. *Test Equipment For the Radio Amateur - Smith, RSGB.*

\*45 Gutters Road, Wonga Park VIC 3115  
at

**TEST AND CALIBRATION COILS**

**50 nH:** 2 turns #18 B&S (1 mm) tinned or enamel Cu wire, spaced 1 mm between turns, 6.5 mm id.

**100 nH:** 4 turns #18 B&S tinned or enamel Cu wire, spaced 1 mm between turns, 6.5 mm id.

**200 nH:** 7 turns #18 B&S tinned or enamel Cu wire, spaced 1 mm between turns, 6.5 mm id.

**300 nH:** 10 turns # 18 B&S tinned or enamel Cu wire spaced 1 mm between turns, 6.5 mm id.

**400 nH:** 6 turns # 18 B&S enamel Cu wire, spaced 1 mm between turns, 13 mm id.

**500 nH:** 7 turns # 18 B&S enamel Cu wire, spaced 1 mm between turns, 13 mm id.

**For 50 - 300 nH; use a 5/16" Wh 18 tpi. bolt as a winding guide.**

**Help stamp out  
stolen equipment  
- keep a record  
of all your  
equipment serial  
numbers in a  
safe place.**

# ■ Transceiver Modifications

## Conversion of Philips FM92 E Band to Six Metres

*Sponsored by Northern Corridor Radio Group Inc VK6ANC\*. We acknowledge VK6ZTJ Trevor Sorensen of Tambellup for his work on the original prototype and Phil Jamieson VK6ZPP for support.*

### Disclaimer

The authors and the NCRG Inc have taken all care in the preparation of this article. They do NOT accept liability howsoever caused by any person or group of people who, having attempted this project, are unable to successfully complete it through any cause. This project is presented in good faith and all assistance will be rendered to written or faxed queries in an attempt to assist those who may require help.

### Introduction

Firstly, this has turned out to be a challenging project that can be achieved cheaply. Philips FM92 sets have been around for about 15 years and have proved reliable in commercial service. Although they range right up to UHF, this conversion is only meant for the E band (Original frequency around 70 MHz) sets. It covers both local and remote mounted sets in both IF versions (10.7 & 21.4, Mark 1 & 2).

Whilst the conversion means having to undertake major surgery, some of the finer mods have not been done due to limited test facilities. Your constructive input and suggestions are most welcome. This project will take around 12 hours to complete. Patience and gentle handling is required. Depending upon options within your set, scanning of two blocks of 10 frequencies each, CTCSS, Selcall and tone burst can be programmed into the EPROM. The frequency range is 52.025 to 53.975 MHz at 25 kHz spacing with adjustable power levels up to 30 watts. Sensitivity is 0.3 to 0.4  $\mu\text{v}$  at either end of the band.

### What's Needed to Complete This Project

1. A fine tip VERY "Hot" soldering iron. We used a mini Scope iron. It needs to be able to supply adequate heat to allow penetration through the circuit boards because, if desoldering is prolonged, horrendous damage to tracks and substrates will take hours to repair (if you can) and raise your blood pressure unacceptably.
2. A good solder sucker is recommended – a Scope SR27 was used with good results.
3. A multi-meter, digital or analogue.
4. A six metre signal source capable of 52.5 to 53.00 MHz with a variable output level down to -100 dBm will ensure the best setting of the receiver's "front end".
5. A frequency counter (optional).
6. A dummy load rated at 30 watts continuous.
7. A VSWR/Power meter rated to 30 watts.
8. A tuning tool set, with a ceramic tip if possible which comes in handy for VCO tuning due to lack of inductance producing properties.
9. Lack of aggression and distractions. VERY IMPORTANT and strongly recommended!
10. Components, winding wire, nail varnish (colour unimportant) and the usual hand tools that most amateurs have in the shack.

### How To Do It

Firstly, ensure that your FM92 works; connect it up and see that it transmits and receives. If you are offered two sets,

make sure that they are identical models. Confirm the IFs and if they are Mark 1 or 2. Sets can be had for as little as \$20 each. Look to Government utilities, bush fire boards, councils and the rural commercial business scene as possibilities. (NCRG Inc may also be able to help you – please fax us for current stock or details).

Remove both covers, and locate and remove the 2764 EPROM from beneath the large metal shield on the front left hand corner of the CPU board. The shield is held in place by four screws. Send the EPROM to NCRG Inc for programming, and be sure to nominate the radio type, local or remote, and type of IF filter (21f15c = 21.4 MHz or 10f15c = 10.7 MHz). If you have CTCSS/Selcall/tone burst fitted, then nominate the frequencies which require these features. We will program an EPROM for 62 channels total and any combination of channel mix in two blocks of 10 channels each for scans. This covers the entire FM simplex and repeater portions of the six metre band! A printed sheet will be supplied to illustrate the programmed sequence. Program cost is \$10 plus return postage (\$20 total if we supply and program the EPROM).

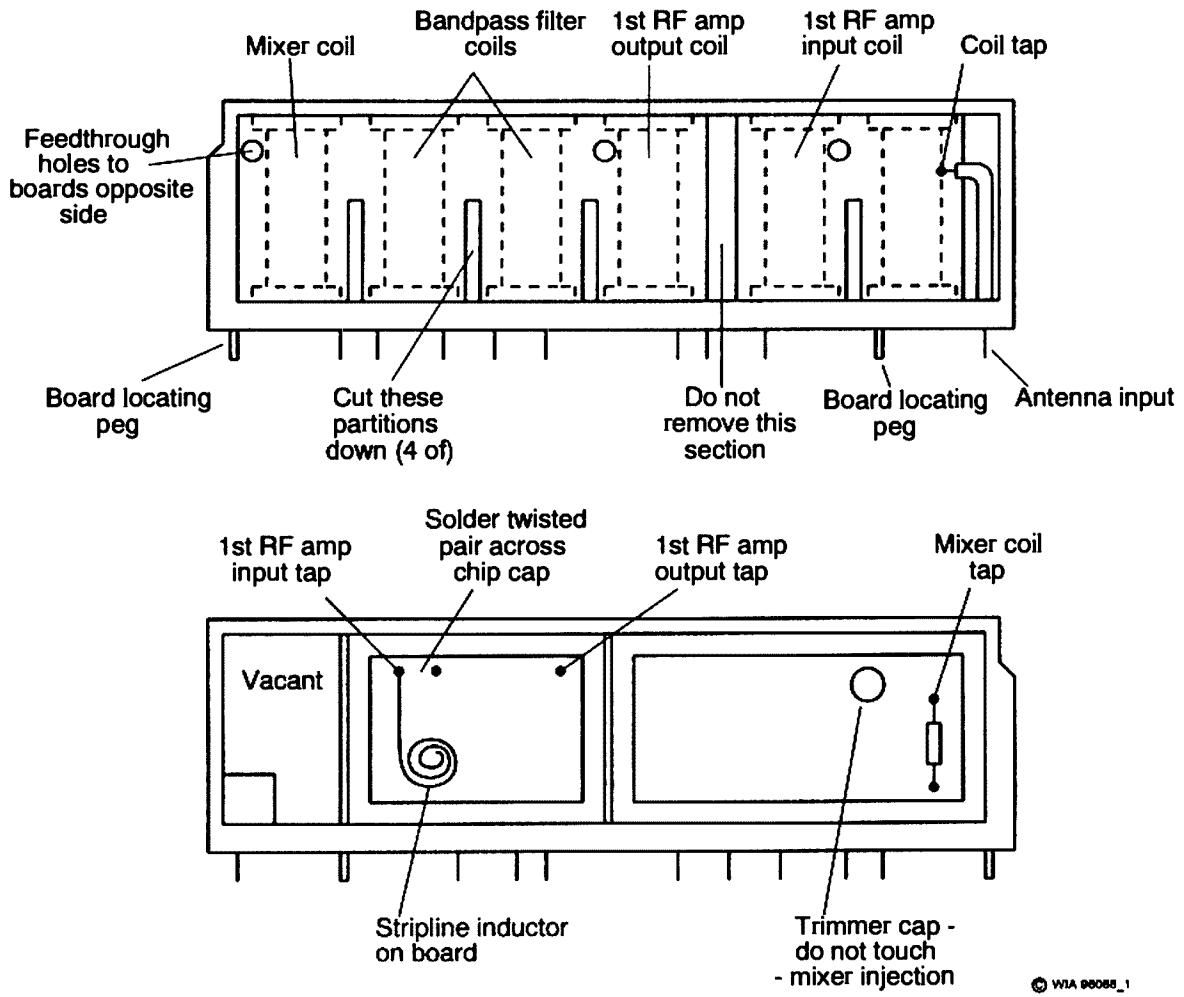
### NOTE

*NCRG Inc has obtained written permission from Philips to modify the FM92s and provide the eproms for this project. YOU MUST ensure that the exterior of the radio is marked to reflect the modified status of these sets should they ever find their way to non amateur usage or ownership. This protects US and YOU against prosecution!!!*

Carefully remove the screws holding down the VCO block and front end receiver modules. Desolder the pins. The VCO is at the front left hand corner of the receiver board and the front end block is toward the middle at the front; you can't miss them! Remove the side shields from both modules (VCO has one cover – the front end has two). Care is required; they should just pop off with careful leverage.

### Front End Module

Desolder the coil taps on the circuit board (opposite sides of coil) and ground connections from the module top. DO NOT remove the board from the module block. Move all slugs to the coil centres.



**Figure 1(a) - Receiver front end - mixer module. Drawings not to scale. Re-sleeve all tap tails with existing tubing to prevent shorting to earth.**

Remove the coils by gently levering them out with a small flat-blade screwdriver. Place them IN ORDER of removal on the bench. GENTLY lever off the end stopper of each coil former noting the exact position of the tap to the earthed end of the coil AND the number of turns before the earthed end. Rewind the coils as per the chart with the SAME size wire and in the SAME direction as they were originally wound (BUT with the additional turns added as shown).

An easy way to wind the coils is to move the slug half way out and refit the end. Hold the coil with long nose pliers between the slug and the top edge of the square end. Wind the earth tail and tap, then move as evenly as possible over the bobbin space for the remaining 50 - 52 turns. It takes practice, BE patient and have a break between coils. You will notice that two coils have NO tap, these

are the band pass filters. Ensure that EACH coil is wound in the SAME direction to avoid insensitivity or receiver malfunction.

Cut the vertical shields from within the block to 2 mm from bottom. If this is not done then the mutual coupling interaction between the coils will be half shielded causing receiver insensitivity. Ensure ALL edges are cleaned off. You can use side cutters to remove the bulk of the shields and a small engraver, if available, to "grind" to a smooth finish. DO NOT remove the thick divider toward the end of the block.

Rewind coils as per Table 1 if L122 and L114 are wound together with a common tap. If these are separate coils, then the following measurements apply: L122 - 3 1/2 turns, L114 - 6 1/2 turns.

A general observation is that all coils have 25 - 30% more turns than originally

manufactured by Philips (ONLY for the majority of the coil, the tap to ground remains the SAME)

Refit the coils and solder the taps and earth tails back in place. Cut two 30 mm lengths of 0.125 mm winding wire and twist them together, open at both ends. Twist and tin one end, then solder this across the input chip capacitor at the tap point of the first RF amp input coil. This is done to raise the input capacitance by only a few picofarad due to the much lower input frequency. Changing the chip cap is not worth the trouble!

Wind the twisted pair in a small circle and coat the open ends with nail varnish to prevent shorting. Push it down into the corner of the board below the level of the shield. Refit the shields by soldering them on. A useful tip is that we used a standard Scope iron with a chisel point. Fit the module back into the radio.

**Table 1**

Coil	Turns	Wire Size
L101	3.5	0.63
L103	3.5	mm
L104	3.5	0.63
L105	1.0	mm
L106		1.00
L108	10.5	mm
L109	3.5	
L110	1.5	
L114	2.5	1.00
L115	1.5	mm
L116	3.5	
L117		
L118	6.5	
L119	6.5	
L120	5.5	1.00
L121	5.5	mm
L122	5.0	0.63
		mm

A low pass filter must be fitted between the VCO buffer and the pre-driver for the PA. The existing buffer filter cannot be altered; it was designed to work above 130 MHz and is useless for our second harmonic suppression at 52–54 MHz. The components are mounted directly on the unused circuit pads thoughtfully provided between the buffer filter and the receiver block! We decided to use a design from the ARRL handbook.

### Buffer Output Filter

Filter No 26 (see Fig 1(b))

FCO = 52 MHz,  $F_{3dB} = 57.5$  MHz,  $F_{AS} = 90.1$  MHz,  $F_2 = 145.0$  MHz,  $F_4 = 94.0$  MHz,  $A_{sdh} = 49$  dB.

C1 = 56 pF, C2 = 6 pF, C3 = 100 pF, C4 = 17 pF, C5 = 47 pF

L2 = 0.201  $\mu$ H, L4 = 0.168  $\mu$ H

L2 = 7 turns of 6 mm diameter, 6.5 mm long, using 24g (0.5 mm) wire.

L4 = 6 turns of 6 mm diameter, 5.5 mm long, using 24g (0.5 mm) wire.

Both should be spaced at one wire thickness. Use ground capacitors to support coils.

### VCO

To remove the VCO board from the block, use your standard Scope iron by heating the case whilst gently prying the board downwards. Remove both offset and main tuning coils CAREFULLY. These are glued to the board; use long nose pliers, grip the coil and gently rock

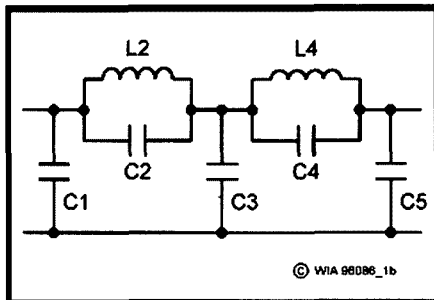


Figure 1(b) – Buffer output filter.

until it lets go. Cut the end off, wind your coil and secure with nail varnish.

If you break the former during removal, salvage another from another old set and use it. Remember to exchange the slugs between the damaged former and your “new” one. If you can’t find another set, and you purchased a second radio, now’s the time to get one from it for this job! Resolder the block back into the case prior to refit into the radio.

A useful tip. A used 9 volt transistor battery firmly held in a vice with the board resting on it and the case on top prior to applying heat, usually works. You are only soldering this board back into the unit on a couple of raised pillars inside the module. Careful application of heat and pressure on the case to reflow

the solder usually works. Of ALL the faults that occur in FM92s, this one is the hardest to fix as it causes microphonic resonance because the board “floats” within the case causing frequency variation. After cooling, carefully inspect the solder bond within the module. Redo it if you’re not satisfied. Refit the VCO and grin BROADLY – you’re getting there!!

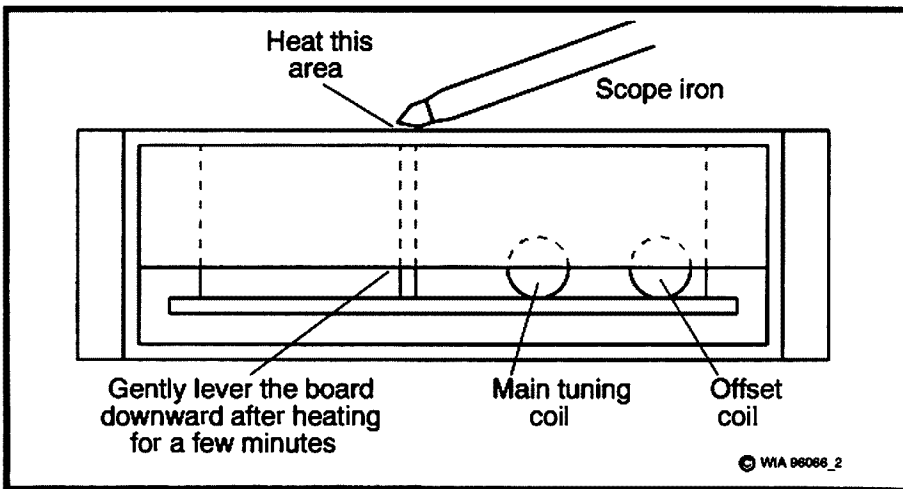
### Power Amplifier (PA) Stage

Unsolder the wiring from the posts, unsolder the co-axes on the board and remove the PA final transistor locknut on the underside. Remove the board fixing screws and then gently remove the board. Desolder and remove the inductor coils. Wind the new coils around twist drill shanks of the same internal coil diameter and space the turns evenly to fit into the same space that they previously occupied. Ensure that all coils are wound in the SAME DIRECTION as the previous units.

Desolder and remove the various capacitors, and substitute capacitors as per Table 2. Note that C122, C123 and C128 are added in parallel with the existing capacitors; and that C127 and

Table 2

Capacitor	Original Value	Fit for 6 m	Preferred value
C101	220 pF	270 pF	270 pF
C102	68 pF	82 pF	82 pF
C107	100 pF	120 pF	120 pF
C108	82 pF	100 pF	100 pF
C111	68 pF	82 pF	82 pF
C112	82 pF	120 pF	120 pF
C117	47 pF	56 pF	56 pF
C118	180 pF	220 pF	220 pF
C119	68 pF	82 pF	82 pF
C120	5.6 pF	leave as is	
C122	330 pF	add 82 pF	82 pF
C123	330 pF	add 82 pF	82 pF
C126	47 pF	56 pF	56 pF
C127	270 pF	add 68 pF beneath	68 pF
C128	250 pF	add 68 pF	68 pF
C130	27 pF	33 pF	33 pF
C135	39 pF	47 pF	47 pF
C136	39 pF	47 pF	47 pF
C139	27 pF	33 pF	33 pF
C140	47 pF	56 pF	56 pF
C141	15 pF	18 pF	18 pF
C142	47 pF	56 pF	56 pF
C143	27 pF	33 pF	33 pF
C144	470 pF	add 120 pF beneath	120 pF



**Figure 2 - VCO underside view. Place the VCO block on a stable surface and remember it gets very hot! To replace the board, place it in the same position but use a spacer under the board to keep it firmly against the posts. Re-heat at the same point and observe the solder melt. Do not overheat the block as it will damage the board!**

C144 are added in parallel beneath the board. Lay the capacitors flat. Some of the removed capacitors can be re-used if desired. Refit the new/relocated capacitors as close to the board as possible and cut off any excess lead length flush with the board. **ALSO NOTE** there is only a few millimetres clearance on the underside of the board but, with careful placement, some of the flat style capacitors can be mounted here.

Once again, this is a fairly tedious job, so go carefully, check each component prior to fitting and have a break if the stress level freaks you out! Refit the PA board and don't forget the locknut.

### Easy Stuff

Remove the 50 k deviation pot and replace with a 100 k. The prototype lacked deviation adjustment and for those who know the circuit, this

increases the loop gain of the exciter. Refit the programmed EPROM to the set and refit the shield.

### Tune Up

Connect the speaker, microphone and DC lead, then switch on. Listen to the receiver audio. It should be making intermittent rasping sounds which means that the VCO is out of lock. Move in the Main VCO tuning slug until the rasping sound changes to a normal open-mute noise. Set the mute with the mute control. Connect your multimeter to the test point post at the rear of the VCO, noting that this is **POSITIVE** volts, and the chassis is negative.

Set the multimeter to the 12 volt range, select your **HIGHEST RECEIVE** frequency and move the **MAIN** tuning slug to see **NO MORE** than 12 volts on the meter. Now connect a power meter

and dummy load to the output. Select the **HIGHEST TRANSMIT** frequency, activate **PTT** and move the **OFFSET** slug to achieve **NO** more than 12 volts at the test point. You should now see some output on your meter. Locate the power trim pot on the PA stage and adjust it for maximum output. **NO** more than 25 watts is available without risk of the final transistor going to "Silicon Heaven" (expensive mistake at \$40 plus the stress of tax and finding a supplier!).

Do not exceed 4.5 amps total consumption from the supply. Adjust the **OUTPUT** trim capacitor and power pot to optimise output and minimise total DC supply current. Now manually scan through the channels whilst noting that the multimeter **NEVER** exceeds 12 volts; optimise both the Main and Offset coil slugs to achieve this state.

### Receiver Tuning

Set the signal generator to 53.00 MHz. Move all the slugs in the receiver block to mid point. Connect your multimeter to point "S" (test point 201, in line with the VCO block and next to the 9 pin IC). There should be two to eight volts DC on this point. Open the mute, and move slugs until a tone is heard. Monitor the voltmeter and adjust the slugs until maximum voltage is obtained. Peak each coil for maximum voltage on the meter. Reduce the signal input (or find a weak signal) and retune for maximum reading.

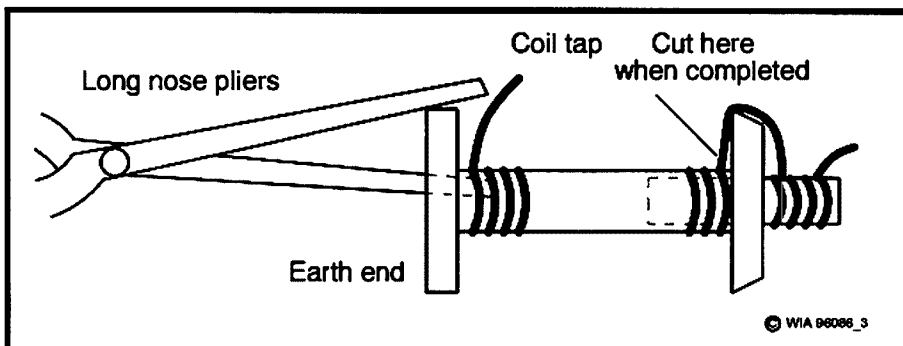
### Output Harmonics

A word of caution. Although the output filter meets minimum rejection standards, it has been found that ground or shot noise from the VCO can cause grief on Channel 2 TV receivers. If this is a problem, check your own TV first and then carry out **ALL** the requirements of the regulations to minimise or eliminate TVI. If anyone wishes to do some additional experimenting with filters and wants to pass their experience back to us, then we will endeavour to produce regular updates with your contributions acknowledged.

Well, that's about it! You now have a good, portable synthesised radio working on six FM for under \$100 and your knowledge **AND** patience have been increased immeasurably!

\*PO Box 244, North Beach WA 6020  
Fax (09) 409 1203

ar

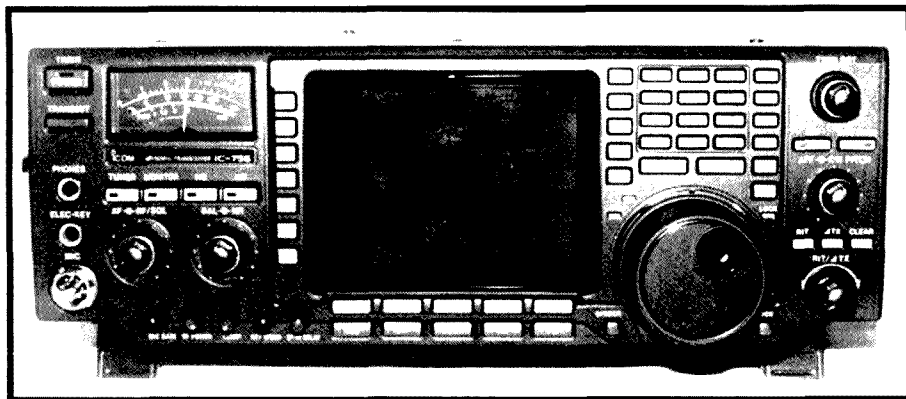


**Figure 3 - Hold the coil former as shown, at the square end, with the slug half-way out the other end. Wrap the end of the coil around the slug as shown to hold the end of the coil in place while the varnish is applied then dried. Clip off the wire as close to the end of the former as possible.**

## ■ Equipment Review

# The Icom IC-756 All Mode HF & Six Metres Transceiver

Reviewed by Ron Fisher VK3OM\*



Icom IC-756 transceiver.

As the Icom advertisements say, "For the Ham who's always wanted an IC-781". You remember the IC-781, of course. It was the big Icom with the CRT display in the middle of the front panel. It also had a BIG price tag to go with it. I believe that it is, in fact, still available at around \$15,000 (on special order only). Stand back a few metres and you might almost mistake the new IC-756 for a 781. However, at a retail price of \$3,700, you will certainly find the IC-756 more affordable.

This price tag puts the new Icom into direct competition with a wide range of transceivers from the other two manufacturers of the big three. But perhaps the main one it will compete against is the Yaesu FT-1000MP at just \$250 more, which includes a built-in AC power supply but not the six metre coverage of the IC-756.

### Features and Facilities

The IC-756 incorporates just about everything you would expect to find in a top-line transceiver. The one exception is a built-in AC power supply. There is no provision at all for a self-contained power supply and just no room to fit it in

with the existing physical design. The transceiver requires a standard 13.8 volt 20 amp power source which is connected via a standard 6 pin DC plug.

The IC-756 transmits and receives all modes. These are SSB, CW, AM, FM and RTTY. The frequency coverage on receive is 30 kHz to 60 MHz continuous, with transmissions restricted to the various amateur bands. Tuning is in either one Hz or ten Hz steps, selectable in one, five, nine or ten kHz segments. Each amateur band has direct access with a dedicated button. In addition, you can enter any frequency directly from the keyboard.

The IC-756 has a Dual Watch feature which allows the reception of two different frequencies within any one amateur band. There is only one tuning control but this can be assigned to either receiver. Without doubt the most dominant feature is the display. I will look later at the extraordinary range of facilities that it has, but firstly a description of the display itself.

It is an LCD, but uses a dot matrix system to build up the information. It measures 110 mm wide and 83 mm high

and looks quite different to the LCDs we have become used to in amateur equipment. In fact, it looks very similar to the display on my dedicated word processor.

The background colour is a silvery white with purple characters. Both the brightness and contrast are adjustable via the menu system. After initial switch-on, the display takes a few minutes to come up to normal brightness. Back to the display later and on with the numerous features of this exceptional transceiver.

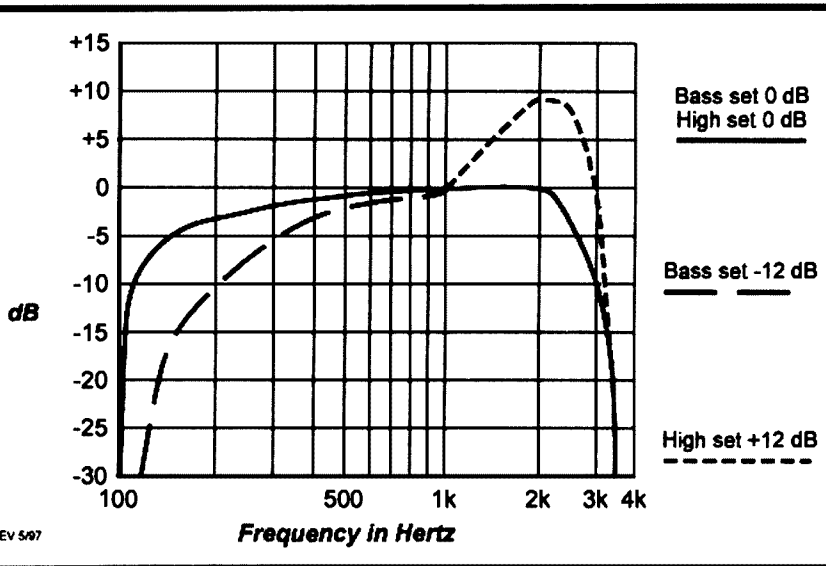
When you think of new HF transceivers these days, you naturally expect some form of digital signal processing. The IC-756 has both transmit and receive DSP. On receive there is adjustable noise reduction, an automatic notch filter for use on SSB, and an audio peak filter for CW operators.

Transmitted SSB audio has very comprehensive low and high response tailoring. Both ends are adjustable +/- 12 dB to produce almost any required sound. The DSP operates, as usual, at a very low frequency IF of 15.625 kHz. There are twin pass-band-tuning controls which allow the operator to adjust both sides of the selectivity curve independently.

One of the important features of the 756 is the solid construction. The transceiver is built into a specially designed diecast frame. It is divided into compartments to both improve the shielding and the rigidity of the whole assembly. The construction is reflected in the weight, which is a solid 10.5 kg. The overall size is slightly larger than the average transceiver in the class, being 340 mm wide, 111 mm high and 285 mm deep.

The front feet are a new design. They flip down to raise the front panel for improved viewing, or flip up if you prefer the fiat look. Quite a neat idea.

Again, as expected in mid-priced transceivers, there is a built-in automatic antenna tuner. This is fast acting and has a built-in memory which re-tunes the ATU every 100 kHz after the tuner has been used on a particular band. There are two antenna connectors which can be assigned to any particular band, a very handy feature.



**Figure 1 - The Icom IC-756 transmit audio response at 14.2 MHz, no compression, power output 10 watts at 1 kHz reference.**

## On The Air

To keep everything in the family, I used my old Icom PS-15 power supply to put the IC-756 on the air. No instruction book was available when I first borrowed the transceiver so I had to "fly" it by intuition. However, having had some experience using the IC-706, it proved to be very easy to operate, although I had to wait for a minute or so for the display to come up to normal intensity.

The tuning control is extremely smooth in its action and, with the tuning rate set for one Hz steps, you get 500 Hz per knob revolution. Set the TS button for 10 Hz steps and the tuning rate increases to 5 kHz per knob revolution. For general tuning around you will find the 10 Hz steps ideal but, for sorting out weak signals on a crowded band, the one Hz steps are superb.

Received audio quality on the internal speaker was good, and excellent on my normal external speaker. The same applied to AM reception, except that, with a good external speaker, the quality was the best-ever I have heard from an amateur transceiver.

One of the nice features on the IC-756 is the RF gain/squelch control. Via the menu system it is possible to set this control as an RF gain only, squelch control only, or a combination of both. How, you may ask, can this be done? Simply by using half the travel of the potentiometer for each function. Very neat!

Reports on the transmitted SSB signal were not as encouraging as I expected they might be. As usual, I tried it out on the Travellers Net co-ordinators and got a rather lukewarm response. I used both an Icom handheld microphone and an SM6 desk microphone. In general, the desk microphone was preferred. I finally listened to the transceiver operating from another amateur's shack so I could make a decision myself. My opinion is that it sounds flat and somewhat lifeless. Sure, you can increase both the high and low end of the audio band-pass but this didn't have the effect that I thought it should. The audio was certainly improved with the processor in use but it still didn't have the bite I thought it should have. Maybe the IC-756 is designed to use a microphone with different charac-

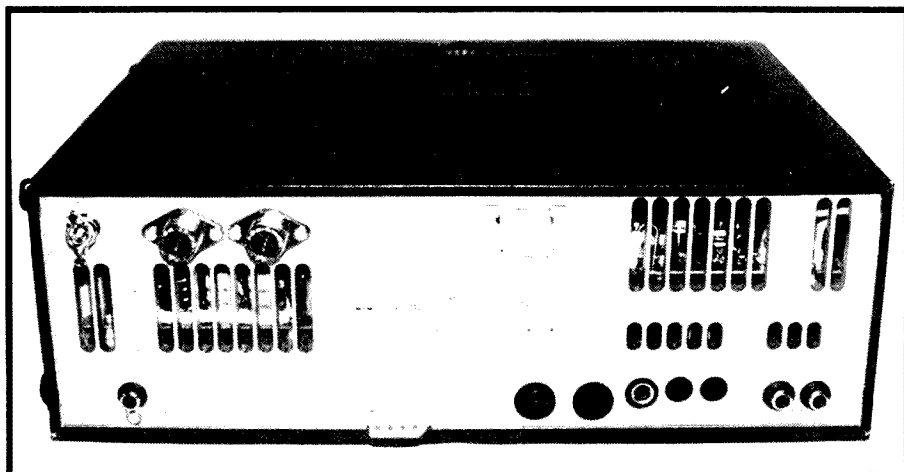
eristics to the two that I have. Perhaps one day I might get the chance to try the new SM-20.

The transmitter cooling was very effective. The large fan is mounted a short distance behind the front panel (see photo) and comes on as soon as the transmitter is keyed. It is very quiet in operation.

The meter is clearly illuminated and reads ALC, SWR and power output while in transmit and, of course, S units when receiving. I noted that the power output readings were spot-on. There is, unfortunately, no metering for compression when the speech processor is used. The illumination is adjustable via the menu system.

The amount of information contained in the display is quite amazing. Let's run through a few of them. Take a look at the close-up photo of the display. The top line shows the status of the filters selected for the mode in use for both the 9 MHz and 455 kHz IFs. Next in line is a graphical representation of the twin band-pass filters. Last is a 24 hour clock which can be programmed to switch the transceiver on and off. Down the left hand side is the status of the seven buttons to the left of the display. The top half of the main display area contains the VFO, mode and memory information.

The bottom half is possibly the most interesting section. It switches between several different setting modes but the best one of them all is the "Spectrum Scope". This gives a graphical picture of what is going on over a range of frequencies either side from the centre or tuned frequency. This display can be set



**The uncluttered rear panel of the IC-756.**



to three different band widths, +/- 12.5, 25 and 50 kHz.

The vertical grid equates to signal strength with each segment equal to 10 dB. It certainly works better than the band scope on my old SM-220.

Other options in this part of the display include memory channel information, which can include frequency and an alphanumeric tag, filter information, selection and level setting for the transmit audio frequency response, monitor and beep level, and display illumination.

The CW operator hasn't been forgotten either. The transceiver has a built-in memory electronic keyer with fully adjustable keying speed and keying weight. Also, the ratio of dot-space-dash can be set to the operator's preference. Again, all the information is displayed on the screen to set these parameters. There is also a range of optional CW filters, although I found that the twin band-pass tuning controls could sharpen the selectivity to the point that would satisfy most casual CW operators.

Finally, a few comments on the operation of the DSP filtering. This has two functions, noise reduction and an automatic notch filter. The notch filter works like magic. Of course, you can only use it on SSB. If you try it on CW it might notch out the signal you want to listen to.

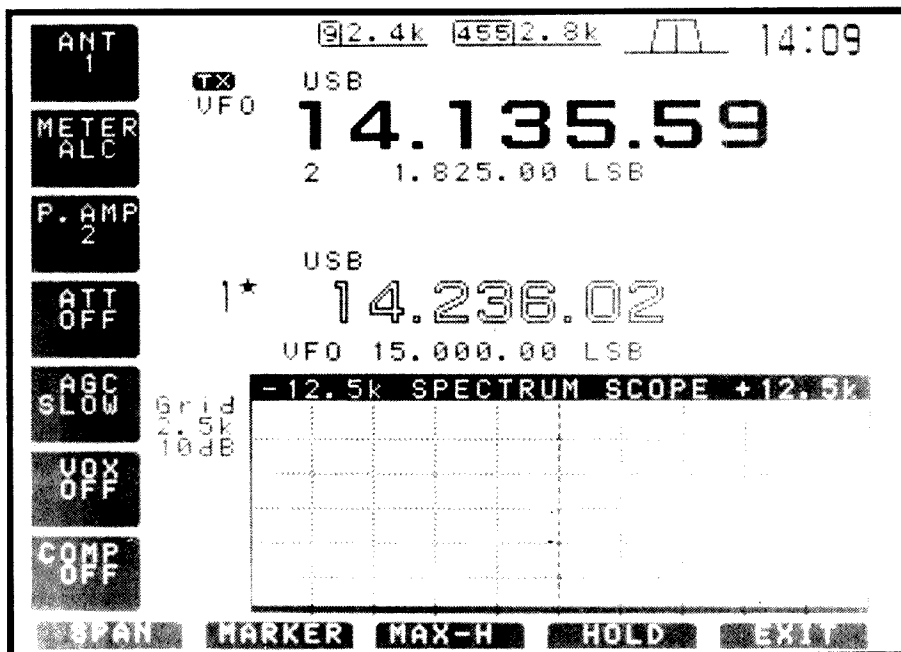
The noise reduction facility has an adjustable threshold and seems to work fairly well, although I found in many cases that the noise blanker was superior. However, at times the two together produced better results.

## On Test

As usual the first test was for transmit power output and DC current drain.

Band (MHz)	Power Output	Current
1.8	110 W	16 A
3.5	105 W	17 A
7.0	105 W	16 A
10.1	105 W	16 A
14.2	100 W	17.5 A
18.1	100 W	17 A
21.1	100 W	18 A
24.5	100 W	15 A
28.5	95 W	17 A
51.5	100 W	21 A

The above power output was measured in the CW mode with 13.8



The large LCD display set to the Spectrum Scope mode.

volts applied to the transceiver. PEP output when using SSB was exactly the same as the CW output when checked on an oscilloscope. FM power on 29.5 and 52 MHz was the same as the CW output power on those bands. With the RF power control at minimum, the average power on all modes was about 2.5 watts with the current drain at 6 amps.

Next on the list was to estimate the transmitter intermodulation distortion. My tests showed this to be -27 dB compared to 100 watts PEP output at 14.2 MHz. This is a better-than-average result for a 12 volt powered amateur transceiver, but well down on the best I have measured.

Finally, power output was checked with the automatic antenna tuner matching a simulated 3:1 SWR at 14 MHz. The loss measured was about five watts with 100 watts output which is a reasonable figure.

As is often the case, the most interesting test was the overall SSB transmit frequency response measurement. This is a complete about-turn for Icom. The response with the DSP tone control set to zero showed the -6 dB points to be at 140 Hz and 2.6 kHz, with a very smooth curve in between.

Compare this to the test I did on the IC-706, published in the November 1995 issue of *Amateur Radio*. The difference in the low frequency response, in

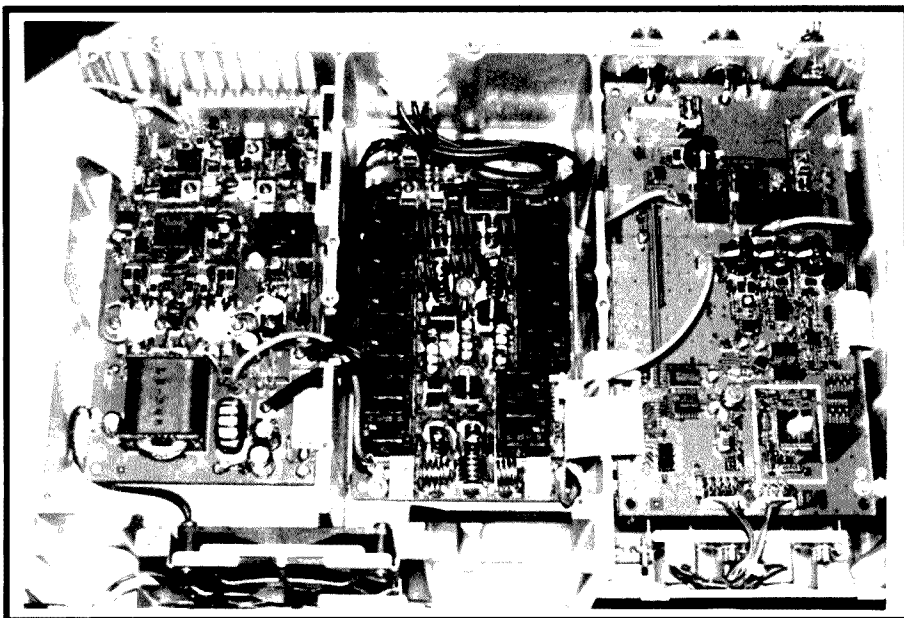
particular, is dramatic. The curves also show the effect of the tone controls. I have only shown the bass cut and the treble boost as I feel these will be the settings most used. At the high end I measured a peak of +9 dB at just above 2 kHz with the response extended to 3.1 kHz for the -6 dB point. The low frequency roll-off with the tone control set to -12 dB is very smooth and gentle with the 6 dB point moved up to about 300 Hz.

My on-air tests were carried out using an ICOM SM-6 desk microphone and an HM-12 hand microphone. No microphone was supplied with the review transceiver. I would certainly like to test the elegant looking SM-20 desk microphone which Icom offer as an option.

## Receiver Tests

As usual, the first test was to check the S meter calibration. It was nice to get back to an analogue meter again. For the same incoming signal, it's possible to get several different readings on the S meter. There are three positions of attenuation and two levels of pre-amplification.

The attenuator gives -6, -12 and -18 dB and the pre-amps give +10 dB each, or a total of 20 dB. My basic measurement was taken with both the pre-amps and the attenuator switched off. The figures were taken at 14.2 MHz.



**Top view of the IC-756 with the cover removed. Note the large cooling fan to the left immediately behind the front panel.**

S Meter Reading	Voltage Input
S1	3.2 $\mu$ V
S2	3.8 $\mu$ V
S3	4.5 $\mu$ V
S4	6.0 $\mu$ V
S5	8.0 $\mu$ V
S6	12 $\mu$ V
S7	19 $\mu$ V
S8	30 $\mu$ V
S9	54 $\mu$ V
S9+10 dB	280 $\mu$ V
S9+20 dB	.0015 volt
S9+40 dB	.008 volt
S9+60 dB	.045 volt

With pre-amp one switched in, the S9 figure drops to 18  $\mu$ V and, with pre-amp two in, this drops again to 6.1  $\mu$ V. Naturally, with the attenuator in, the amount of RF input to produce S9 will rise.

The band to band figures for S9 (pre-amp and attenuator out) were as follows:

Band (MHz)	Signal ( $\mu$ V)
1.8	49
3.6	50
7.1	45
10.1	56
14.2	54
18.1	54
21.2	61
24.8	74
28.5	72
52.0	80

The S meter reads the same on all modes for a given RF input. Receiver sensitivity was checked at 14.2 MHz. At the time I did this I did not have a copy of the specifications and took the input level as 0.2  $\mu$ V. Later, when I did receive an instruction book, I noted that the level should have been 0.16  $\mu$ V. However, I don't think the difference is great. I measured the following results.

With pre-amp 2 on - 0.2  $\mu$ V 12 dB S/N

With pre-amp 1 on - 0.2  $\mu$ V 11 dB S/N

With pre-amp out - 0.2  $\mu$ V 10 dB S/N

The sensitivity was very consistent right across the whole range, including six metres.

The receiver audio output was terminated with an eight ohm power meter and a noise and distortion meter with the following results. Maximum audio output was 2.6 watts with 16% distortion. The 10% distortion was at 2.2 watts output which exceeds the specified two watts for this amount of distortion. However, when the audio was reduced to a normal listening level of about 100 milliwatts the distortion did not drop below 2.5%. I am surprised at this high level. I would have expected this to be 1% or less. Although the specification is met, at normal levels this is the highest distortion I have measured for some years. However, I doubt that it will worry you very much unless you are a very critical CW operator.

Maximum audio output required an RF input of 3  $\mu$ V or more and the residual noise generated in the audio amplifier was measured at 75 dBm. You won't be troubled with hum or noise if you use headphones.

The received SSB audio response, like the transmitted response, was excellent. Using the 2.8 kHz filter, the 6 dB points were at 200 Hz and 2.8 kHz with very little variation in between. However, the big surprise was the AM audio response. With the full 15 kHz bandwidth selected, the 6 dB points were at 60 Hz and 5 kHz. With a good external speaker connected, broadcast stations sounded as good as my hi-fi system.

## The Instruction Manual

Unfortunately, I did not receive the instruction manual until a few days before I completed this review. To add to the problem, when it did come it was only a photo copy and most of the text had been reduced to half-size to save space. On this basis I would rather reserve comments until such time as I see the real thing full size. It appears to be typical Icom and well done. There was no circuit diagram or block diagram included with the copy supplied to me.

## Conclusions

The IC-756 certainly has a lot to offer. If you purchase a matching power supply you will be up for a total of around \$4,300. For a little less you can purchase a Yaesu FT-1000MP and the decision to pick the right one would be difficult. For a little more the Kenwood TS-870 could also be a contender but I feel it has been left behind by the newer models. There is a full list of options available to match your new IC-756 including narrow CW filters, narrow SSB filters (1.9 kHz), and even a wide SSB filter of 3.3 kHz. I would like to hear the latter in operation. Like many new transceivers you will have plenty to play with even if the bands are dead.

Our review transceiver was supplied by Daycom Communications Pty Ltd. For more information contact Daycom or Icom Australia Pty Ltd direct.

\*24 Sugarloaf Road, Beaconsfield Upper VIC 3808

ar

# Technical Abstracts

Gil Sones VK3AUI\*

## Simple Iambic Keyer

A simple iambic keyer was described in *RadCom* for March 1997 by Ben Spencer G4YNM. The keyer uses a Programmable Logic Device (PLD) to provide all the logic circuitry required by the keyer. A common CMOS IC is used to provide the keying clock and the sidetone generation, and a common NPN transistor is used to provide the keyed output. Power is obtained from the 12 volt supply using a three terminal regulator.

The circuit of the keyer is shown in Fig 1. The circuit is very simple and all parts, with the exception of the PLD IC2, are common items. The PLD is available from the author. The PLD contains all the logic circuitry.

The author is Ben Spencer G4YNM,

Enterprise House, 33 New King Street, Bath BA1 2BL. If you are interested, an SAE with the means for return Airmail Postage should provide information together with the cost of the PLD.

## Bar Graph Readout VHF SWR Meter

A simple direct reading SWR meter using a bar graph LED display was described in February 1997 *QST* by Bill Van Remmen KA2WFJ. The meter uses a sandwich of PCB as the directional coupler and makes use of an LM3914 bar graph driver IC to indicate the SWR.

Forward voltage is applied to the input connected to the internal divider network in the IC. This would normally be connected to a reference voltage. The reflected voltage is connected to the

signal input pin of the IC. The display outputs show the ratio of these voltages which is the VSWR. The internal resistance of the divider chain, together with an external 10 kilohm resistor, limits the maximum indicated VSWR to 3:1.

The circuit is shown in Fig 3. The display can be one of the bargraph LED display arrays or individual LEDs. The 1N34 germanium diodes in the original were selected from a bag of 10 obtained from Radio Shack. In Australia the equivalent supplier would be Tandy. The diodes were selected for near equal forward voltage drop.

The directional coupler construction is shown in Fig 2. The detector loops are thin bare wire. No 30 wire is quoted and the use of wire-wrapping wire with the insulation removed is mentioned. Grooves are scribed between the holes in the PCB to locate the wires in the sandwich during assembly. The two PCBs are glued together with epoxy. The PCB is common 1/16th inch FR4 or G10 glass epoxy board and only needs to be single sided. The 0.22 inch track provides a 50 ohm line.

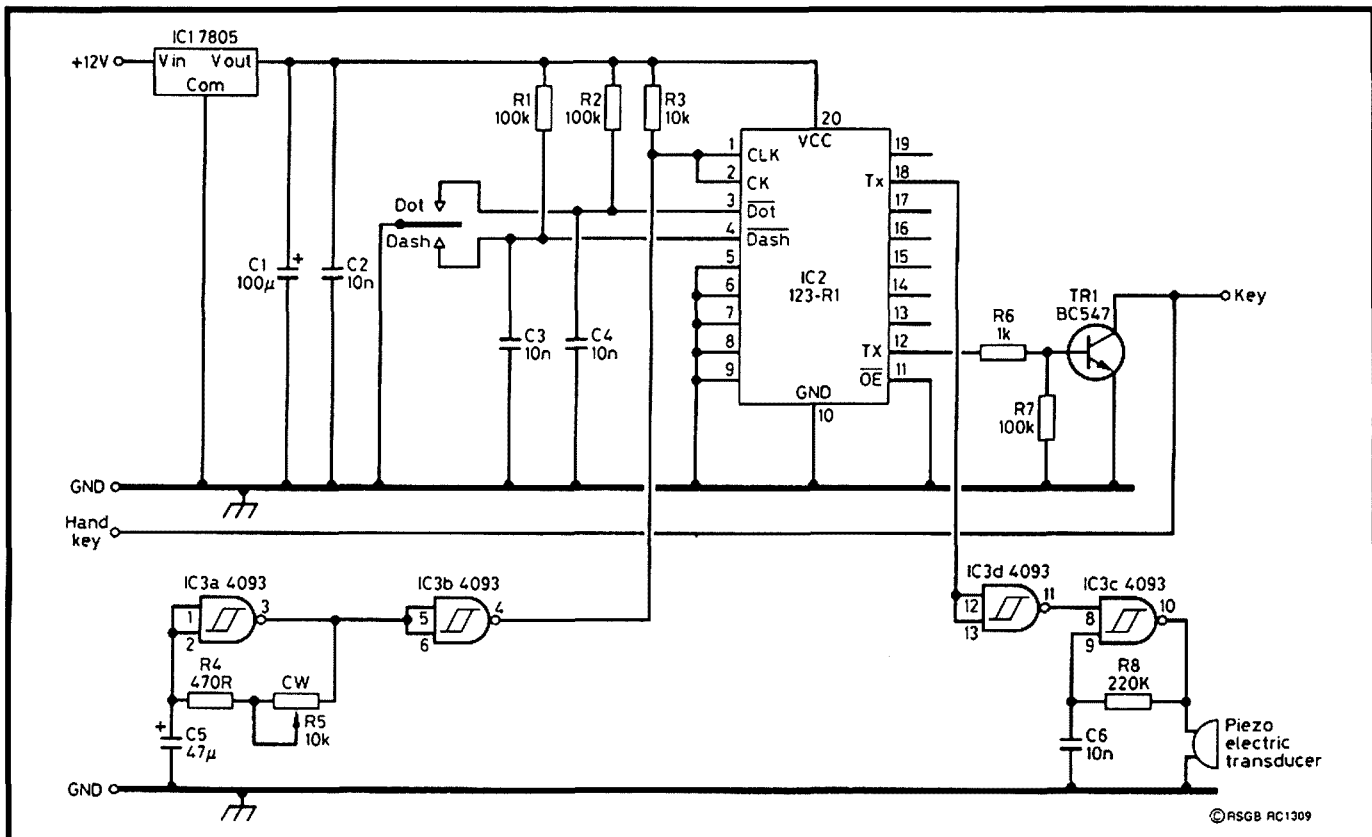


Fig 1 - Simple iambic keyer using PLD.

The loops of wire need to be carefully positioned and the holes through the board for their ends arranged so as not to short them out. Small trim pots are used to terminate the pickup loops at first. These are adjusted for minimum reflected voltage. A matched dummy

load should be used for the setting up tests. The trim pots are then measured and replaced by fixed resistors. In the prototype, pairs of 150 ohm resistors in parallel were used to provide 75 ohm terminations for the pickup lines.

The length of the coupler is up to you;

however, the original would appear to have been about 50 mm long. This is determined by the width of the box used to house the coupler. The box used would appear to have been similar to the locally available plastic Jiffy boxes.

The coaxial connectors were soldered to the sandwich of PCB. In the original, BNC connectors were used. These had to be modified by cutting away part of the metal neck at the rear of the connectors to allow the dielectric to lie flat against the substrate of the ground plane board. The connector is then soldered in position. The modification is shown in Fig 4.

### Measuring Internal Resistance of a Meter

A method of measuring the internal resistance of a meter appeared in the *Technical Correspondence* column in December 1996 *QST* which is edited by Paul Nagel N1FB. The item was submitted by Arthur C Erdman W8VWX.

The method uses a digital multimeter as a voltmeter to measure the voltage across the meter when a full scale current is applied. The voltage across a known resistor in series with the meter is also measured. This will allow the internal resistance of the meter to be determined. The current does not need to be that required for full scale but must be flowing through both the meter and the resistor.

The circuit of the test is shown in Fig 5. The variable supply can be any convenient supply and the adjustable resistor  $R_v$  is a value which will allow the current through the meter and  $R_x$  to be adjusted to a convenient value up to full scale deflection of the meter.

The digital voltmeter (DVM) is used to measure the voltage across the meter internal resistance and across  $R_x$ .

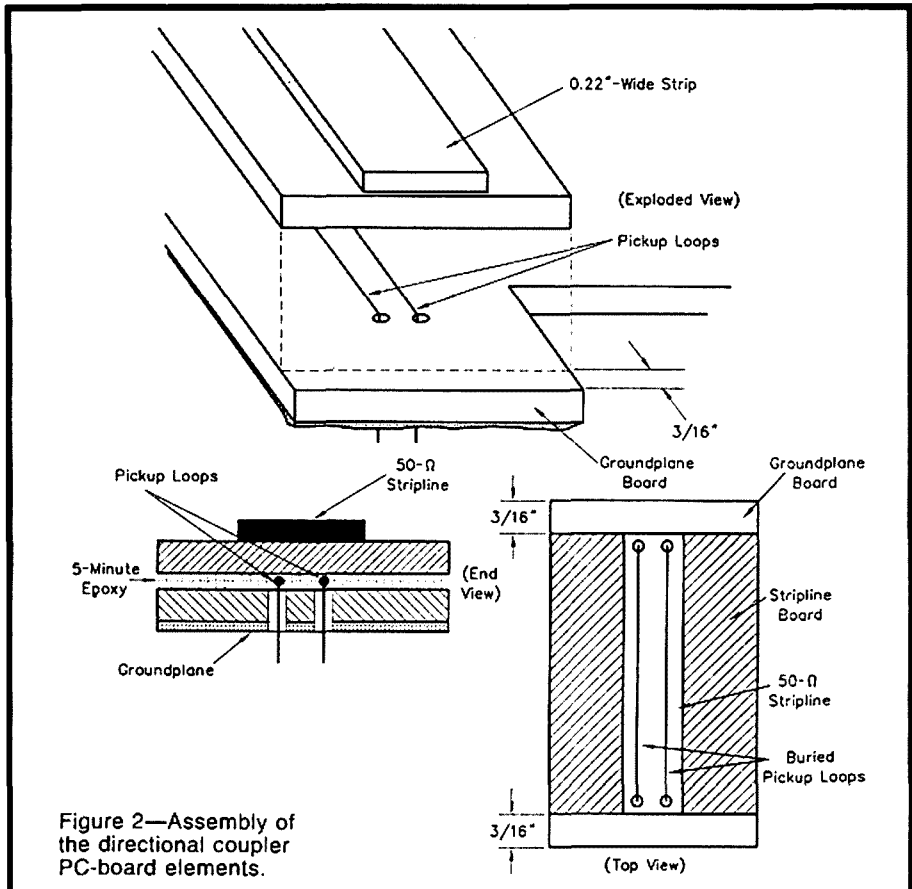


Figure 2—Assembly of the directional coupler PC-board elements.

Fig 2 - PCB directional coupler.

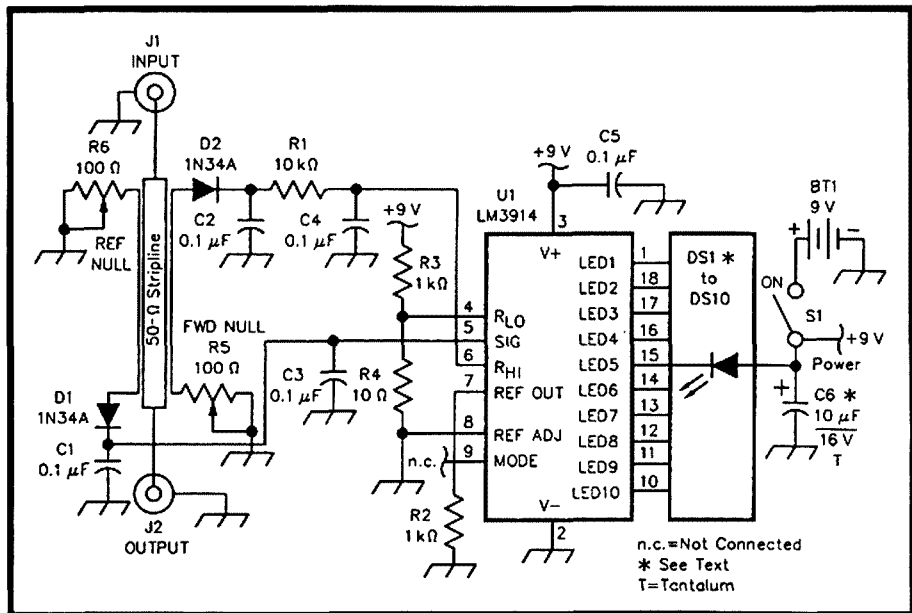


Fig 3 - Circuit of the bar graph VSWR meter.

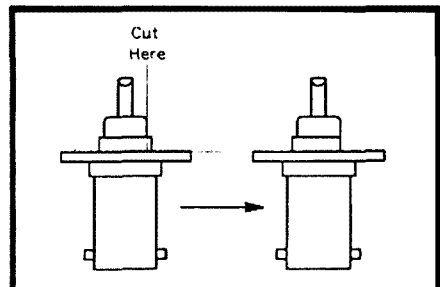
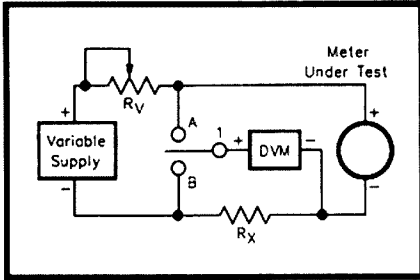


Fig 4 - Modification of BNC connector.



**Fig 5 - Using a voltmeter to measure the internal resistance of a meter**

The meter internal resistance is calculated by using the formula:  $R_{\text{Meter}} = (V_A / V_B) \times R_X$

The DVM should be a battery operated device as a mains operated device may introduce additional complications with earthing. The accuracy of the method is limited by the accuracy to which the value of  $R_X$  is known and the accuracy of the DVM. A 1% resistor and one of the common digital multimeters should give a good result.

\*C/o PO Box 2175, Caulfield Junction VIC 3161

ar

## WIA News

### International Call Book Goes CD-ROM Only

The international and North American radio amateur call books will be published on paper for the last time this year, and become available only on computer CD-ROM from 1998.

Published by Watson-Guption Publications in the US, the phone book-sized call books have been a tradition in international amateur radio since 1920. The publisher cited "rising cost and increasing demand for electronic publishing" as the reasons for their decision to concentrate on the CD-ROM version. (From the *ARRL Letter Online*).

A subcommittee of the WIA Federal Council is considering options regarding the next *Australian Amateur Radio Call Book*, looking at print and

digital publication of the call sign listings, allied amateur radio information and related issues.

### Canadian Amateurs Approach 50,000

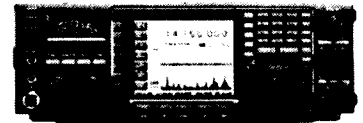
The number of amateur radio licensees in Canada totalled 47,745 as of mid-March, according to the national Canadian amateurs' organisation, the Radio Amateurs of Canada (RAC).

The largest number of licensees are in the VE3/VA3 call area of Ontario, there being 16,150. Quebec (VE2/VA2) is the next most-populous region for amateurs, with 11,618 licensees. The Canadian state with the least number of amateurs is the Yukon Territories, with only 87 licensees.

# Radio and Communications

INCORPORATING AMATEUR RADIO ACTION and CB ACTION

One of the most talked-about yet misunderstood HF antennas is the cubical quad. This month we guide you through building one, simply. We also look at Icom's new wonderbox, the IC-756...



Published by  
**ACP SYME  
MAGAZINES,**  
PO Box 119,  
Oakleigh,  
Vic 3166  
(03) 9567 4200

May's R&C is serious reading for amateur radio operators. These should keep you busy for ages...

- Is your radio out of alignment? Then you'd better read the Modifications column Before it's too late!
- Review: Icom IC-756. That screen works! Get IF DSP, 6M and IC-781 performance for under \$4000.
- Build a very compact antenna for 40 and 80 metres — with a big ferrite rod! (Yes, it really works!)
- Review: Kenwood TS-570S. Kenwood's latest HF box to sport 6M, with DSP, ATU and 100W on six!
- 50 Years of 50 Megs. Part Two of the story, narrated by Steve Gregory, VK3OT (VK's first 6M DXCC)
- The best IOTA column in Region 3, three DX columns and more... all the best regulars every month!

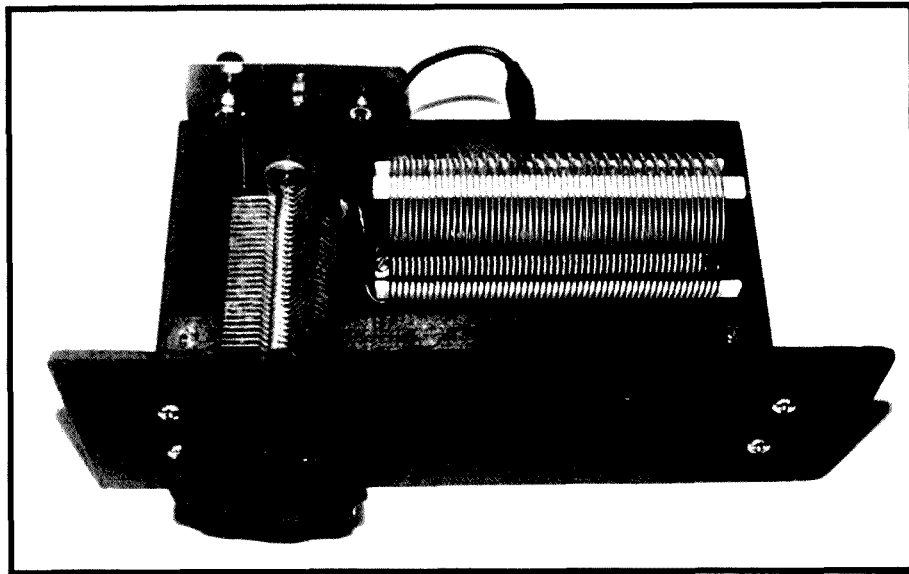
Don't miss out — **RADIO and COMMUNICATIONS** is great reading for amateurs!  
**Check your local newsagent today!**

(PS. This month sees our biggest-ever collection of radio-oriented Classified adverts (hundreds!). There's lots of them because they work so well. Ask your newsagent to keep a copy for you each month, or ring 1800 25 2515 for subscription details. Hurry — you might miss something!)

## ■ Antennas

# Random Radiators

with Ron Cook VK3AFW and Ron Fisher VK3OM\*



The simple "L" match ATU.

## Yet More on Simple ATUs

Often when writing a column like this, one Ron doesn't always know what the other Ron is thinking up for the next instalment. So, continuing on from last time, here is some more about a simple ATU for all HF band operation.

Might I say that there is nothing new to be presented here, but it did provide an easy solution to a small problem that cropped up with two local amateurs. The first, a Novice wanting to get on 80 metres, and the second heading off on a holiday to Norfolk Island and needing a simple antenna system to get on twenty metres. The solution to both was an "L" match ATU to load up a random length wire antenna. Note, I didn't say a long wire antenna because, in both cases, the length of the antenna probably would not exceed one wavelength for twenty metres and a quarter wave length on eighty metres. A true long wire would be several half waves in length.

The first requirement for the ATU was that it had to be built using bits from the junk box. The cost would be zero. The

photo shows how I did it but there are possibly a hundred ways to build the same thing using bits from your own junk box. There are only two main components, a coil and a variable capacitor. The other items needed are an SO-239 coax socket, a terminal to connect your wire antenna to the ATU, and a chassis or cabinet to build the whole thing into.

Again taking the "use-what-I-have approach", I really got down to basics and used an old wooden power board, a piece of scrap Masonite for the front panel, and a couple of right-angle metal brackets to keep the whole thing rigid.

A few words about the two main components. I was fortunate to find a piece of pre-wound coil stock which made tapping the coil easy. These things are getting hard to find. As an alternative, you can use a piece of plumbers plastic pipe about 50 mm (or two inches) in diameter and about 300 mm (or six inches) long. Wind on twenty turns of 18 gauge copper wire spaced over about 20 mm, then solder a tapping point to each turn so you can clip your tuning tap to it.

Now the tuning capacitor. You will

need to have at least 250 pF with reasonable spacing. A 1950's type broadcast radio tuning capacitor is fine. If you can only find a two gang, which was the most common type, simply wire up one section. Actually these were the capacitors that we used in the original "Z" match described some years ago. You can still find plenty at radio flea-markets

Now a few thoughts on using random wire antennas. One problem that you might encounter is RF feed back. Unfortunately, some transceivers are more susceptible to this than others. However, a few simple precautions will help. Firstly, a good earth is essential with antennas of this type. What, you ask is a good earth? Well, for a random wire antenna, I think that a counterpoise is the best way to go. Just run about 20 metres (not critical) of wire out the window and along the ground in a random fashion. It need not be in a straight line, so run it around the side of the house or along a fence. If you have a wire mesh fence, so much the better.

A good connection to a handy water pipe (metal, of course, not plastic), with a solid piece of wire, can also be effective. The braid from an old piece of RG-8 or RG-213 coaxial cable is an excellent choice. Keep it as short as possible. If you put the two above suggestions together you should have an effective earth system.

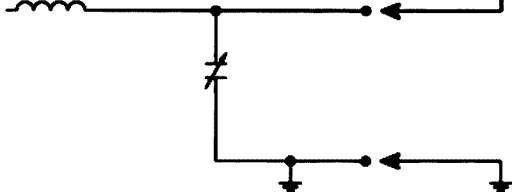
Now to the antenna itself. Some amateurs place great reliance on certain lengths of wire. Perhaps they have something, I'm not sure. I've always found that a length of wire that fits exactly between the ATU and the support at the other end is ideal. Seriously, though, you should have at least a quarter-wave length of wire, which means about 20 metres for 80 metre operation. In actual fact a few metres more this might be better as it helps to avoid a high voltage point at the ATU when you are operating on the higher frequency bands.

Maybe those amateurs who use the W3EDP antenna, which we described in *Random Radiators* a few years ago, have got the length right. To remind you, the W3EDP is 84 feet (or 27 metres) long and uses a counterpoise earth system.

Tuning up the whole thing is very

To transceiver  
via SWR meter

Antenna



© WA RanRad\_597

Earth or counterpoise

**Circuit diagram of the "L" match ATU. See the text for component values.**

easy. You will need an SWR meter, of course, and this should be connected in the usual way between the ATU and the transceiver. Start your tuning by setting the capacitor at maximum and adjust the tap on the coil to give a peak in received noise or signal. Now transmit a small amount of carrier (no more than 10 or 15 watts) and note the SWR. It will probably be high. Move the coil tap up and down a turn at a time until the SWR decreases. Adjust the capacitor for a further reduction in SWR. Repeat the above until the SWR is at a minimum and there you are.

By the way, after a successful trip to Norfolk Island, the ATU is now working well at a local Novice station, mainly on 80 metres.

### More on Coaxial Connectors

Our discussion on the problems of terminating coax connectors, a few months ago, brought a response from John Bird VK3BCQ.

"Your reference to problems with terminating coax cables to the standard PL-259 connector was very interesting. I often wonder how many people have

become frustrated in the exercise. I have seen the procedures described many times in various amateur radio publications; it all looks fairly simple until tried.

"One of the problems is that people forget the basics of soldering in that items to be soldered must have both surfaces tinned. Another problem, at least in my experience, is that when many PL-259s are heated to soldering temperature the solder will bead and not flow and tin correctly. This is because the average PL-259 is chrome plated and not silver plated.

"I have found the answer to this is to remove the plating around the soldering holes with a warding file and then use a small amount of "Bakers Fluid" as a tinning flux. Some may frown on this practice, but the connectors can be washed in warm soapy water and dried when clean. I use a very heavy iron at maximum heat to tin the braid and, when the coax is inserted into the connector, the same heavy iron is used to complete the soldering of the four holes. One of those miniature blow torches can also be used.

"Perhaps at some time you could publish an article by the experts on the fine art of terminating coax cables".

Thanks for your thoughts, John. Now, are there any coax experts out there who would like to share their expertise with us?

Well, that's your lot for this month, so it's 73 from him and 73 from me.

*The two Rons.*

\*C/o PO Box 2175, Caulfield Junction, VIC.3161

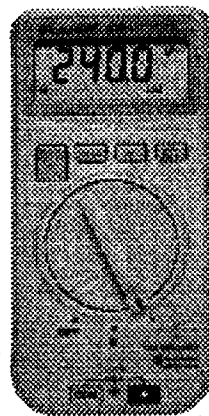
ar

**Help protect our frequencies - become an Intruder Watcher today.**



**YOUR HOBBY** **YOUR VOICE**  
Representing Radio Amateurs - Since 1910

**RECRUIT A MEMBER & THEY COULD WIN!**  
**THIS GREAT FLUKE 12B DIGITAL MULTIMETER WORTH \$195**



**THERE'S A WINNER EVERY MONTH FOR 1997 12 PRIZES TO BE WON**

This latest hand-held DMM, from the world-leading maker of digital test instruments, has advanced features yet is simple to use. Ideal for tyro & veteran.

#### The Fluke 12B measures:

- ac and dc voltage (with auto-selection)
- resistance & capacitance (.001-1000µ)

#### The Fluke 12B features:

- 4000-count liquid crystal display
- simple rotary dial
- diode and continuity testing
- indicates intermittent opens & shorts
- 2-year warranty

**Fluke 12B prizes generously donated by Philips Test & Measurement.**

Each month's prize is awarded by way of a draw among newly recruited members each successive month and presented to the winner at the earliest opportunity following the draw.

**To sign up a new member, use the back of your AR magazine address leaflet - or clip the coupon, have them fill it out and send it now.**

**SEND TO YOUR DIVISION'S ADDRESS, SHOWN ON PAGE 58.**

✂-----  
Please send me a membership application.

NAME .....

ADDRESS .....

..... P/code .....

Call Sign (if any) ..... [AR 1-11/97]

## ■ People

# Ham Camp in the Flinders Ranges

*Paul Meier VK5MAP\* tells of a fun weekend.*

During the last weekend in October 1996, a Ham activities camp was held by the Southern Flinders Ranges Appreciation Group at Ippinichie Creek, located just south of Wirrabara, in the Wirrabara Forest. The Group is made up of amateur radio operators who are present or past residents near the Flinders Ranges of South Australia, and others who value the area.

The meeting started well as some members arrived early to set up camp in the evening of 25 October. Those who arrived early had water boiling for late comers, and Friday evening merged into the early hours of Saturday morning as, aided by their favourite drink, everyone chatted around the camp fire. Neville VK5WG was noted as a connoisseur of

port, and others present included Tony VK5WC, Dave VK5ABI with Christene and Christopher, Peter VK5PJT with Maureen, Terry VK5LED, Roger VK5NWE, and Paul VK5MAP with Janet.

Saturday highlights included entertainment with the "Ball Popping Machine", supplied by Roger, and the arrival from Port Pirie of Karen, XYL of VK5LED, with their family. During the morning Neville, Terry and Roger visited the VK5RMN two metre repeater site at The Bluff. This is also the location of towers for the TV transmitters which serve the mid northern area of the state.

In the evening, Roger's request for permission "to stay in the bush for one more night" was granted by his wife. Ian

VK5KKT called on two metres before arriving in time to sample some bush damper which had been prepared and "cooked in the coals" by Neville and Terry.

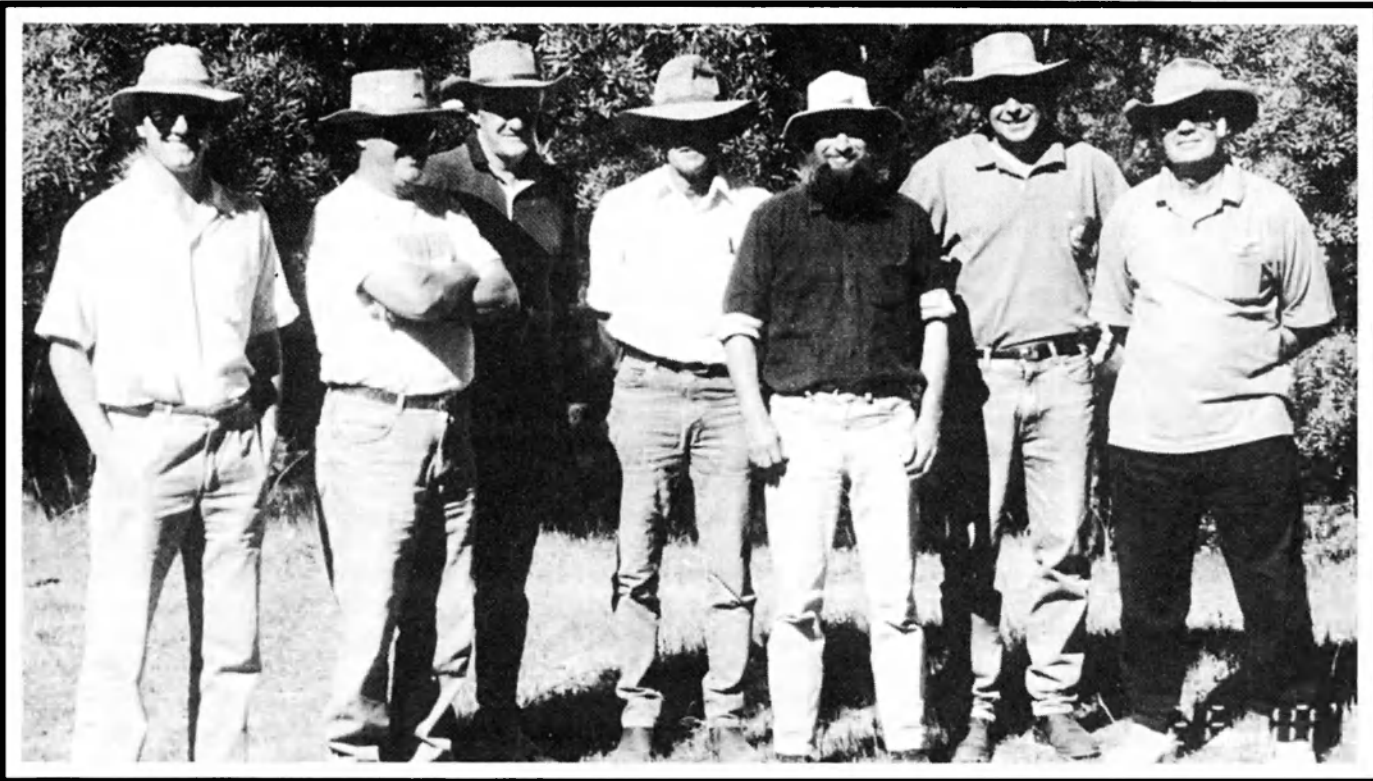
On Sunday morning, with the addition of Leo VK5SO, and his wife Hazel from Port Pirie, everyone set out for The Bluff. The trip was an opportunity for all to view the VK5RMN and television towers, and to see the picturesque landscapes surrounding Spencer's Gulf.

The return to the campsite was followed by an excellent BBQ lunch before packing for the journey home. The enjoyable weekend concluded by giving a special "Thank you" to Karen and Terry, who had supplied tents, bedding and cooking utensils.

All who were present agreed the weekend had been an ideal chance for them to have their first "Eyeball QSO" with other members, and hoped for similar gatherings in the future. All amateurs are welcome to join in with the regular SSB nets held by the group on Monday, Wednesday and Saturday evenings at 8.30 pm CST on 3.605 MHz.

*\*PO Box 76, Peterborough SA 5422*

ar



(l to r) Dave VK5ABI, Peter VK5PJT, Paul VK5MAP, Roger VK5NWE, Tony VK5WC, Terry VK5LED, Neville VK5WG. Absent were Ian VK5KKT and Leo VK5SO.



## ■ Membership

# Wanted: 100 Members to Replace the Dead!

## WIA Demographics Into the Next Century

*Peter Parker VK1PK\* explores the future of WIA membership.*

### Introduction

It is generally acknowledged that the amateur population is ageing. Since the heady days of the CB boom two decades ago, the number of people taking up amateur radio has fallen dramatically. With continued low recruiting rates and a population that is ageing several times quicker than Australian society generally, the Amateur Service faces a major challenge even to keep its numbers static.

A falling amateur population means a less active club scene, a declining ability to defend frequency allocations, and a moribund WIA that is less able to advance the interests of its members and amateur radio generally. Signs of the latter are already becoming apparent in some areas.

Making use of ABS and WIA data, this article attempts to gauge the order of magnitude of our demographic decline. Armed with this information, it is up to WIA office bearers, Club officials and individual amateurs to devise means to bring about a reversal in the trends described.

### Order of Magnitude

The major problem of a rapidly ageing population is its high mortality rate. Reference to ABS data reveals that once people move beyond their late forties, the probability of them dying (ie their age-specific death rate) rises markedly. With an average age in the fifties, it follows that even a relatively small ageing of the amateur population means a large increase in the annual intake of new amateurs is required to keep our numbers constant. Maintaining our share of the national population would be an even harder (though not insurmountable) task.

A recent WIA survey (Ref 1) revealed the demographics of WIA members.

These were under 50, 27%; 50-70, 48%; and 70+, 25%. The average age of survey respondents was 59. From this point onwards, I will assume that survey respondents are representative of the broader WIA membership.

As explained earlier, our mortality rate will be higher than for the general population, because of our higher average age. This is significant because of the need for an increasing number of new members joining each year just for our membership levels to remain static. This exercise attempts to quantify the amateur mortality rate, and thus the numbers of new members required for us to hold steady. For this reason this paper will be important for any budgeting or forward planning that the Institute may wish to undertake. Two estimates will be produced, each being based on different methods. The emphasis will be on producing estimates for WIA members. However, by assuming that the WIA is a

microcosm of the broader amateur population, multiplying the estimates given by three (roughly two-thirds of amateurs are not WIA members) may provide order of magnitude figures for the total number of VK amateurs who become silent keys.

### Estimate One

This is based on a simple survey of the *Silent Key* listings in *Amateur Radio* magazine. The deaths of some 80 amateurs were reported in the twelve months to February 1997. This corresponds to a mortality rate of approximately **16 per thousand** for the WIA member population.

Being based on real figures, this is an absolute bottom limit on the number of WIA members who die each year.

**Estimate One: 80 WIA members die each year**

### Estimate Two

This estimate is more speculative and makes more assumptions than does the first one. It is included here chiefly to demonstrate the effect that a small increase in our average age has on the intake needed to keep our numbers constant.

Reference to the West Australian Year Book (Ref 2) provides mortality data by age group for the Australian population as a whole. It states that the mortality rate for the Australian population as a whole is seven per 1000. That means that seven

### WIA MORSE PRACTICE TRANSMISSIONS

VK2BWI	Nightly at 2000 local on 3550 kHz
VK2RCW	Continuous on 3699 kHz and 144.950 MHz 5 wpm, 8 wpm, 12 wpm
VK3COD	Nightly (weekdays) at 1030 UTC on 28.340 MHz and 147.425 MHz
VK3RCW	Continuous on 145.650 MHz, 5 wpm, 10 wpm
VK4WIT	Monday at 0930 UTC on 3535 kHz
VK4WCH	Wednesday at 1000 UTC on 3535 kHz
VK4AV	Thursday at 0930 UTC on 3535 kHz
VK4WIS	Sunday at 0930 UTC on 3535 kHz
VK5AWI	Nightly at 2030 local on 3550 kHz
VK5VF	Continuous on 145.650 MHz, 5 wpm to 12 wpm
VK6RCW	Continuous on 147.375 MHz, 3 wpm to 12 wpm

people per thousand will die in a given year.

To calculate the figures for WIA members I will assume that the mortality rate of a member at a particular age is the same as for a non-amateur of the same age. For ease of calculation I will also assume that there are no amateurs under 20. Because of the broader age groupings in the WIA survey, I will have to assume that amateurs are evenly distributed across each range (which we know is not the case).

The demographic profile of WIA members is: under 50, 27%; 50-70, 48%; 70-84, 20%; and 85+, 5%. Note, that for reasons relating to the ABS data available, I have assumed that five percent of members are aged 85 or over. The ABS figures are in five-year age bands. They are for both men and women. I will combine these bands to make them suit those used in the WIA survey. Mortality rates for the general population (per 1000 in a given year) are as follows:-

Age cohort	Mortality Rate (/1000)
20-49	1.3
50-69	11
70-84	53
85+	156

By multiplying these figures by the proportion of members in each category, and then dividing this by 100, we come up with a weighted figure for WIA membership as a whole.

Thus the total member mortality rate =  $(1.3*27+11*48+53*20+156*5)/100 = 24$  per thousand.

Assuming a WIA membership of 5000 amateurs, 120 would die in a given year. Note that this estimate is 50 percent higher than Estimate One.

**Estimate Two: 120 WIA members die each year**

A number of factors influence the accuracy of this estimate. The ABS figures are for both males and females. Amateurs are predominantly male. Males have shorter life expectancies and higher mortality rates than females. Thus even the figure of 24 per thousand could be an underestimate. It would have been better to use male mortality figures rather than those for the population as a whole, but I didn't have these on hand.

However, the correctness of Estimate Two depends heavily on the represent-

ativeness of those *Amateur Radio* readers who filled out and returned the survey form. Even if they were only a little older on average than the general membership, our actual mortality rate would be significantly less than the estimate shows. Other factors, such as the use of the 85+ data may also affect the final figure.

**Our Rising Mortality Rate**

It was mentioned earlier that a greater proportion of a static, ageing population die with each passing year due to the rapid increase in age-specific death rates. While this exercise is highly speculative, let us see what happens if we increase our average age by just five years (to 64).

This change is quite likely to happen in the next several decades or so if little is done to change our demographic profile. For simplicity, we will use the *Amateur Radio* survey results, but increase the ages in each of the groups by five years; the percentages themselves stay the same.

Age range	% WIA pop	Mortality rate (Ref 2)
Under 55	27%	1.7 (20-55 figure used)
55-74	48%	17
75-89	20%	65 (75-84 figure used)
90+	5%	156 (85+ figure used)

Thus the total mortality rate =  $(1.7*27+17*48+65*20+156*5)/100 = 29$  per 1000.

Because of the unavailability of mortality rate figures for the upper age groups (the ABS figures include the 85+ as one group), this figure is probably an underestimate. Assuming a mortality rate 90/1000 for the 75-89 group, and 250/1000 for the 90+ group, we arrive at a figure approaching 40 per thousand. Remember that, as with the previous calculations, mortality figures are for the

population as a whole, and not merely the male component (which would more accurately represent the Amateur Service's composition).

**The Bottom Line**

- WIA members are dying at two to four times the rate applicable for the general population;
- An annual intake of between 80 and 120 new members is required just to replace deaths;
- This figure makes no provision for those who relinquish WIA membership due to ill-health;
- Nor does it make any allowance for members who resign for other reasons; and
- The 80-120 requirement will rise in future years if our average age continues to increase.

A mere five year increase in our average age could:-

- Increase our annual mortality rate by up to 50 percent;
- Mean that WIA members die at between three and six times the rate applicable for the general population; and
- Require an annual WIA membership intake of 120-180 just to replace deaths.

**Conclusion**

The above figures paint a grim picture of a WIA (and amateur service generally) in terminal decline. However, such a decline should not be accepted before it has happened; action should be taken to prevent or at least retard it. Membership and member services should be the WIA's number one priority. The WIA's survival demands nothing less.

**References**

1. *AR June 1996, Editorial*
  2. *WA Year Book 1992*
- \*7/1 Garran Place, Garran ACT 2605  
ar

**Sign up a new WIA member today – we need the numbers to protect our frequencies and privileges**

## ■ Book Review

# The Novice Operators Theory Handbook

**Author:** Graeme Scott VK2KE

**Reviewed by:** Evan Jarman VK3ANJ

*Third Edition 1996, paper cover,*

*96 pages 297 mm by 210 mm,*

*ISBN 0646301624.*

The second edition of this handbook was reviewed in *Amateur Radio*, March 1995, page 22.

This handbook has been written to help those wanting to obtain a Novice licence. Its success demonstrates a need by those who want to reach the licence stage and learn through experience rather than start as instant experts.

It is a series of simplified explanations of the core subjects of radio theory. It does not require intense concentration. In the text, each subject is kept to a few paragraphs and subtitled. Related subjects are grouped together in chapters. Diagrams are used liberally throughout the book.

The author is an experienced technical teacher and suggests a course of study in the introduction. It involves reading a chapter then using a series of test questions in the appendix to check comprehension. There are 12 chapters of theory with a couple of chapters on ancillary topics. The emphasis is on acquiring knowledge rather than reading a book.

On completion, the reader can get, at cost, a sample exam if they wish to test their overall knowledge.

Regulations and Morse code are not covered.

The third edition does not vary greatly from the second. The differences are obviously fine tuning. It was disappointing to note an omission which

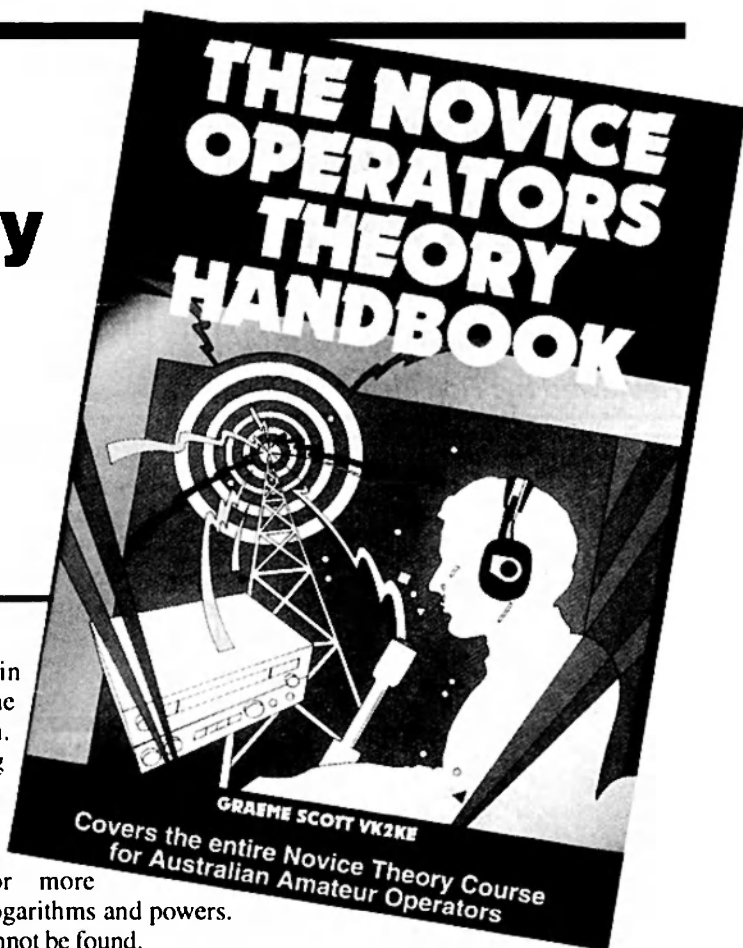
was referred to in the review of the previous edition. In discussing attenuators, the author did refer to the chapter on mathematics for more information on logarithms and powers. This entry still cannot be found.

Bruce Bathols in his review of the first edition (*Amateur Radio*, June 1982) said: "The authors are to be congratulated on their efforts, and a candidate who has fully studied this book, together with the SMA operator's handbook and Morse code require-

ments, should have little difficulty in passing the Novice operators examination."

The author, in this third edition, clearly wants to keep it that way for as many people as possible.

ar



## VK QSL BUREAUX

The official list of VK QSL Bureaux. All are Inwards and Outwards unless otherwise stated.

VK1		GPO Box 600 CANBERRA ACT 2601
VK2		PO Box 73 TERALBA NSW 2284
VK3	Inwards	Box 757G, GPO MELBOURNE VIC 3001
	Outwards	40G Victory Blvd ASHBURTON VIC 3147
VK4		GPO Box 638 BRISBANE OLD 4001
VK5		PO Box 10092 Gouger St ADELAIDE SA 5001
VK6		GPO Box F319 PERTH WA 6001
VK7		GPO Box 371D HOBART TAS 7001
VK8		C/o H G Andersson VK8HA Box 619 HUMPTY DOO NT 0836
VK9/VK0		C/o Neil Penfold VK6NE 2 Moss Court KINGSLEY WA 6026

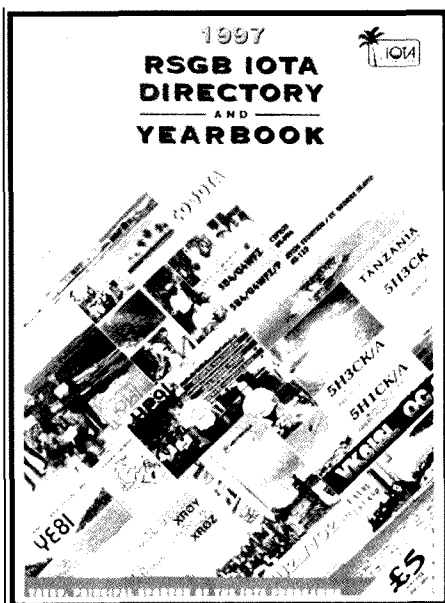
## ■ Book Review

# 1997 RSGB IOTA Directory and Yearbook

*Publisher: Radio Society of Great Britain*

*Edited by: Roger Balister G3KMA*

*Reviewed by: Ron Fisher VK3OM.*



popular amateur radio award programs. In order to participate, it is important to have all the information currently available.

There are fourteen chapters in the book and these certainly do give you all the information you will ever need. Let's look at a few of the headings. Chapter

one gives an introduction by Roger Balister G3KMA who explains how the millennium will be an exciting time starting with IOTA 2000. Sounds as if it might be worth waiting for. Following on are chapters on preparing for an IOTA DXpedition, validation of island operations, and the most wanted IOTA island groups.

The IOTA Directory is printed in A4 size, has a colourful soft cover and runs to 96 pages. Our copy was received direct from the RSGB but it should be available soon from your local WIA Bookshop or from Daycom Communications Pty Ltd in Melbourne. In the meantime, the price direct from the RSGB is \$US15 plus postage, or 25 IRCs plus four IRCs for air mail postage. The RSGB is also happy to accept orders by credit card.

ar

## ■ Power Supplies

# Power Supply Protection

*John Bedwell VK3EHZ\* describes a simple but effective means of protecting a power supply.*

What, I hear you say, is IOTA? Well, it's the latest craze for DXers. Islands On The Air. Find yourself an island, inhabited or not, and get on the air. One of the great things about IOTA is that your island doesn't have to be a thousand kilometres from anywhere.

But first a bit of history. The Islands on the Air (IOTA) awards program was created in 1964 by the late Geoff Watts, a leading short wave listener in the United Kingdom. It was taken over by RSGB (Radio Society of Great Britain) volunteers at Geoff's request in 1985. Since then it has grown enormously, with well over 8000 IOTA Directory holders world-wide and an estimated 20,000 amateurs pursuing IOTA contacts.

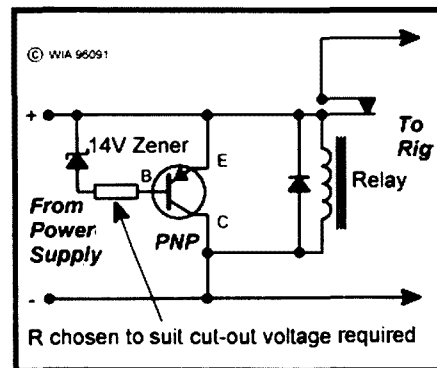
Well, after all that, it had to happen. The RSGB has released a complete guide and directory so now you can find out all about it. This book will prove invaluable to all HF DXers as the IOTA program is now one of the world's most

Are you sure that your power supply is fully protected? Or that your rig is fully protected from your power supply?

Well, think again! After a few years of faithful service my power supply decided it needed a rest, so promptly shorted out the driver transistor to the 2N3055 output transistors. This caused the full 28 volt rectifier voltage to be present at the output terminals and consequently the input to my TS-440s.

The rig lit up like a Christmas tree and my CW transmission was something to be heard. It says a lot for the rig that it survived the punishment but I was determined that such an event would not recur. As it turned out, just as well! An undetected intermittent fault in the power supply caused the same fault problem a couple of weeks later.

Having a large PMG relay in the junk box with a pair of normally closed contacts I made up the enclosed circuit



**Schematic of the VK3EHZ over voltage power supply protector.**

and fitted the whole thing in a plastic box. The resistor was chosen to suit the available zener diode and made to open the relay at approximately 15 volts. No doubt there is a better way to accomplish the same result but at least it works.

\*49 Winward Drive, Mooroolbark VIC 3188

ar

## ■ People

# Reg Busch VK3LS

*Allen Crewther VK3SM\* helped VK3LS celebrate his 90th birthday.*



**(l to r) Allen VK3SM, Dorrie, Reg VK3LS, Ian VK3XIS, Don VK3NP, Jack VK3BKN and Charlie VK3BIT at VK3LS's 90th birthday party.**

Reginald Busch was born on 29 January 1907. He grew up and gained an interest in radio, listening to VIM in Melbourne using a crystal detector. As he could not read Morse, but had learned to identify the VIM call, he would telephone the station and ask them

the name of the ship to which they had been "speaking". Amazingly, they would always tell him.

Reg progressed and learned Morse code, after which he could do without having to ring the VIM operator. In 1923 he obtained his amateur licence and

operated with the LS suffix of his current call, but the prefix varied from OA, to A, to VK3.

Always one to help others, Reg was seconded by the WIA to assist in the formation of an Emergency Radio Unit after the Second World War, and was successful in getting a frequency just outside the 7 MHz band allocated for this work. The unit was operated several times for fires and floods, before being swallowed up in the WICEN network.

Reg also spent some time as the treasurer of the Victorian Division of the WIA, and was made a life member.

He is still very active in his hobby and joins a small net on 144 MHz most mornings for a general natter. He is also developing antennas for 430 MHz and operating on the HF bands.

This year being his 90th birthday, the members of the early morning 144 MHz net travelled to Reg's house for a surprise party. This was very successful. Thanks to the co-operation of Dorrie, Reg's sister-in-law, a very good afternoon was had by all who attended. In addition to the guest of honour and Dorrie, the others were Chas VK3BIT, Jack VK3BKN, Don VK3NP, Allen VK3SM and Ian VK3XIS.

*\*28 Reynolds Parade, Pascoe Vale South VIC 3044*

ar

## ■ Equipment Review

# Revex W570

## 1.6 to 1300 MHz

# SWR/Power Meter

*Reviewed by Ron Fisher VK3OM\**

A couple of years ago I reviewed a Revex W502 SWR/Power meter. The W570 has the same appearance but the facilities offered are very different. The full range of Revex SWR/Power meters is available from Dick Smith Electronics.

The W570 features an extraordinarily wide frequency coverage. It covers 1.6 to

160 MHz, 400 to 525 MHz, 700 to 1100 MHz and 1240 to 1300 MHz. There are three power ranges of 5, 20 and 200 watts. It is also switchable for RMS or PEP power measurements. The four frequency ranges are selected with four interlocking push buttons on the rear panel of the meter. There are two sensors to cover the frequency range; one which is

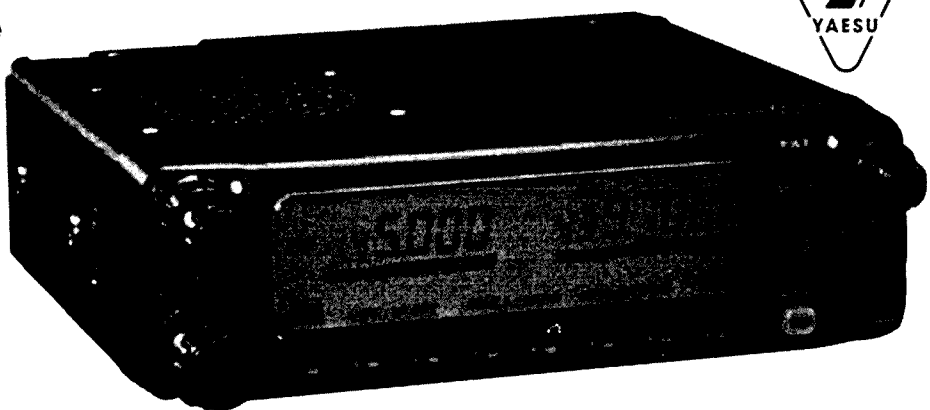
built into the meter which covers from 1.6 to 160 MHz and uses standard S0-239 coaxial sockets, and the other which is external, uses "N" type connectors, and is connected to the main unit with one metre of cable. As received, the UHF sensor is screwed onto the back of the main unit (see photo) but it can easily be separated and placed near the equipment in use.

# DICK SMITH ELECTRONICS



## YAESU FT-8000R 2m/70cm Mobile

The stunning new Yaesu FT-8000R is a state of the art 2m/70cm band mobile transceiver that introduces industry-first features in a very easy to operate combination. The first Amateur VHF/UHF mobile rig to provide superwide receiver coverage (110-550MHz and 750-1300MHz\*), together with MIL-STD-810 shock and vibration rating for years of reliable operation, it also features:



- Rear panel socket for 1200 and 9600 baud Packet operation
- 3 selectable power output levels
- Inbuilt antenna duplexer for immediate dualband antenna use.
- 110 memory channels for storage of your favourite frequencies
- Dual receive capabilities (VHF/UHF, VHF/VHF, UHF/UHF)
- Huge "Omni-glow" backlit LCD screen showing frequency, memory, and function activity.
- "Enhanced Smart Search" for automatic search and loading of active frequencies into 50 special memories.
- Inbuilt crossband repeater facility
- CTCSS for repeater access where sub-audible tones are required.
- Wide range of tuning steps, with different settings for each band

**Specifications:**

- Frequency coverage:
- Transmit : 144-148MHz, 430-450MHz
  - Receive : 110-550MHz, 750-1300MHz\*  
\*(800MHz Cellular locked out)
  - Transmit power: - 2m : 50w, 10w, 5w ,  
70cm : 35w, 10w, 5w
  - Size : 140mm x 40mm x 152mm (WHD without knobs)

**Supplied Accessories:**

- MH-42B6J handheld microphone.
- MMB-36 mobile mounting bracket
- Fused DC power cord.

Cat D-3316

**2 YEAR WARRANTY** **\$899**

## YAESU FT-736R VHF/UHF Base Station Transceiver

Whether your interest is in talking through your local repeater, operating SSB DX, or talking to the world via satellite, this high-performance multimode base station transceiver can do it all! In its standard form, the FT-736R provides 25W output on the 2m (144-148MHz) & 70cm (430-450MHz) bands in SSB, CW, and FM modes. Can be expanded to cover the 6m (50-54MHz) & 23cm (1240-1300MHz) bands by installing optional modules.

**Features:**

- Digital control with keypad or VFO frequency entry.
- Efficient switch-mode AC power supply.
- 100 general-purpose memories.
- 10 full-duplex crossband memories, 2 independent VFOs per band.
- 2 full-duplex VFOs - transmit & receive frequencies (and modes) can be tuned independently or synchronously for satellite operation.
- Adjustable IF Notch and IF Shift filters.
- Noise blanker, 3-speed selectable AGC.
- High-stability (+/- 1ppm) PLL reference oscillators.
- Speech processor and VOX for SSB.
- VFO or selectable channel steps on FM.
- Digital input connection for packet TNCs.



**2 YEAR WARRANTY**

**Specifications:**

- Modes: LSB/USB (J3E), CW (A1A), FM (F2D, F3E)  
 Receiver: 50, 144MHz: Dual Conversion  
 Other Bands, Triple Conversion  
 Sensitivity SSB/CW better than 0.2uV for 12dB S+N/N  
 FM: better than 0.35uV for 12dB SINAD  
 Dimensions: 368 x 129 x 286mm (WHD)

**\$2495**

Cat D-2920



*Offers expire 31/5/97*

**For further information, orders or the location of your nearest store call:  
1300 366 644 (Local Call Charge) Or Fax: (02) 9805 1986**

# Yaesu FT-1000MP

## Incredible Performance, Amazing Price!



Now's your chance to pick up Yaesu's latest high performance HF base transceiver, the new FT-1000MP, at a great new price. You'll be amazed at its incredible performance, but if you need convincing, just read what the experts have to say.

#### On Operation:

"I would classify the transceiver as 'user friendly' compared to some other modern transceivers I have operated." - CQ  
 "..... we found it to be a proficient performer." - QST  
 ".....In term of ergonomics my preference is marginally for the Yaesu.....The second receiver is certainly better implemented....."  
 - Radio Comms (UK)

#### On Documentation:

"In general, Yaesu's manuals are the epitome of clear, concise, and complete documentation, and the FT-1000MP's 104 page Operating Manual is no exception." - QST

#### On The Receiver:

"Its receiver is a real beauty ... its very clean and the audio is very clear and punchy ...." - Radio & Communications  
 "Measurement of second order intermodulation ... showed an average result for the IC-775DSP but the FT-1000MP was some 10dB better than any other radio measured." - Radio Comms (UK)  
 "The receiver is quiet and good at its job, and Yaesu's EDSP is icing on the cake." - QST  
 "Certainly, this receiver is designed to withstand the onslaught of very strong signals....." - CQ

#### On The Transmitter:

"CW operators will be impressed with the FT-1000MP keyer." - CQ  
 "The transmitter is good as well, with a lightning fast automatic tuner built in as standard." - Radio & Communications  
 "The FT-1000MP has excellent spectral purity of the output signal." - CQ

#### Digital Signal Processing:

"The EDSP filter operates smoothly and effectively in all of its modes." - CQ  
 "Having the DSP built-in means it works as well as possible - and is clearly better than most after-market add-ons." - Radio & Communications  
 "The double-whammy of crystal and mechanical filters plus DSP in the FT-1000MP is a killer combination." - QST

#### Conclusions:

"... I am unable to report finding even a picky fault with the FT-1000MP." - CQ  
 "So does the inbuilt DSP say 'buy me'? In this humble scribes opinion, you bet!" - Radio & Communications  
 "The FT-1000MP offers performance and flexibility in a quality radio." - QST

Interested in more information? Why not call us for a copy of Yaesu's 12 page colour booklet, 46 page Technical Overview, or for copies of various magazine reviews. We're sure you'll soon agree that the world of HF transceivers has just taken a giant leap forward.

QST - ARRL QST (USA) Magazine review April 1996  
 CQ - CQ (USA) Magazine review April 1996  
 Radio Comms - Radio Communications (UK) review  
 January 1996  
 Radio & Communications - Radio & Communications (Aust)  
 review July 1996

Cat D-3400

**\$3995**  
 2 YEAR WARRANTY

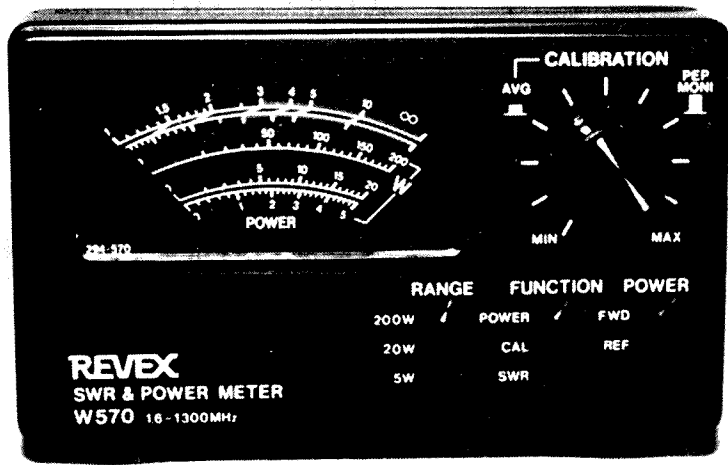


**For further information, orders or the location of your nearest store call:**

Ph: 1300 366 644 (local call charge)  
 Or Fax: (02) 9805 1986

**DICK SMITH**  
**ELECTRONICS**

B 2912



**The Revex W570 SWR/Power meter**

The meter measures 120 mm wide, 72 mm high and 85 mm deep. It weighs in at 830 grams. The finish is charcoal black.

### The W570 on Air

One thing missing from the W570, that was included with the earlier W502, is the meter illumination. While the scale is very clearly calibrated you will need a fair degree of room lighting. Of course the W502 required a 12 volt DC supply to power the lamps but this also served another important purpose. It powered an active circuit that operated the PEP metering function. This gave a very accurate PEP reading. The meter under review simply switches a 33  $\mu$ f capacitor across the meter circuit which is intended to charge up to the peak value and so produce a peak reading.

Unfortunately, this doesn't happen and so the PEP reads low by about 20 to 30%. The actual reading depends on the degree of compression applied to the transmitted signal, so a signal with no compression will read much lower than a highly processed signal even though the actual PEP might be the same. A test with a 100 watt transmitter showed about 70 watts with 10 dB of compression. With the processor switched out, the reading dropped to about 50 watts, although the scope was still showing 100 watts PEP. However, the W570 has too many good features to let this worry us too much.

Steady power measurements were within a few percent of my standard meters on HF and 146 MHz. The UHF

side of things proved somewhat harder to evaluate. All I can say is that with my 70 cm transceiver I did get very believable readings. I do not have a meter with which to compare it.

One thing worth noting is that no circuit of the UHF sensor is included. I believe that it is probably a strip line type with the sensitivity adjusted for each frequency range. For the price, this method is probably a reasonable solution.

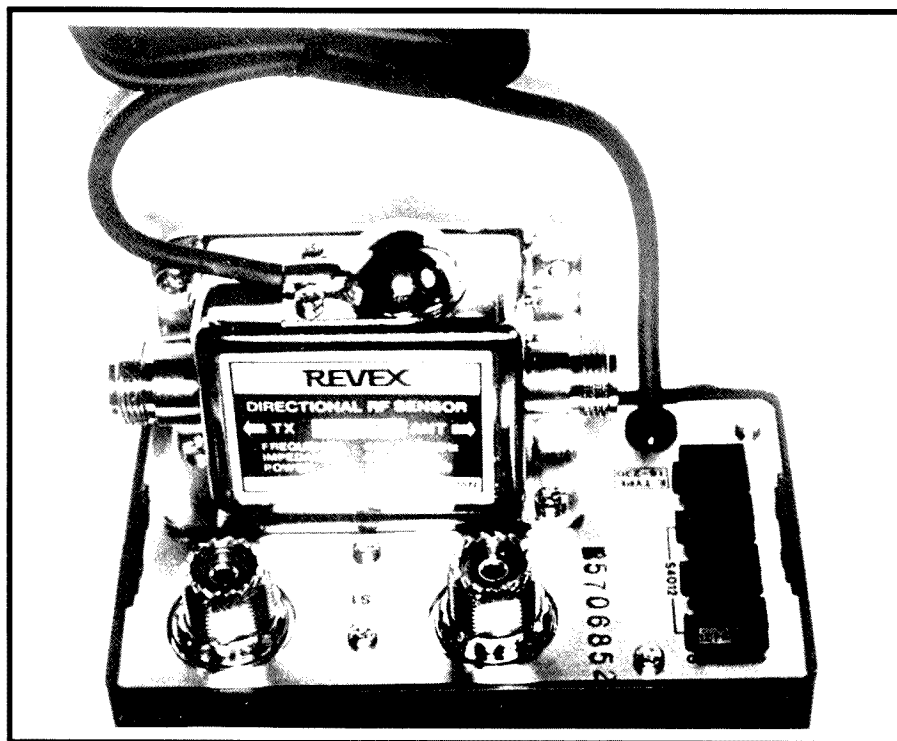
The instructions supplied consist of one and a half pages of text plus a circuit diagram which does not include either sensor unit. The same instructions are also printed in Japanese.

### The Bottom Line

At a retail price of \$369 the W570, which really takes the place of at least three ordinary SWR/power meters, is very good value. The construction quality is of a high standard and Dick Smith Electronics backs the instrument with a generous guarantee. The W570 is recommended.

*\*24 Sugarloaf Road, Beaconsfield Upper VIC 3808*

ar



**The UHF sensor attached to the back of the SWR/Power meter.**

Your  
Hobby



Your  
Voice

**Representing Radio Amateurs Since 1910**



# AMSAT Australia

Bill Magnusson VK3JT\*

## National co-ordinator

Graham Ratcliff VK5AGR

Packet: VK5AGR@VK5WI

E-mail: vk5agr@amsat.org

## AMSAT Australia net:

Control station VK5AGR

Bulletin normally commences at 1000

UTC, or 0900 UTC on Sunday

evening depending on daylight saving

and propagation. Check-ins

commence 15 minutes prior to the

bulletin.

Frequencies (again depending on

propagation conditions):

Primary 7.064 MHz (usually during

summer).

Secondary 3.685 MHz (usually

during winter).

Frequencies +/- QRM.

## AMSAT Australia newsletter and software service

The newsletter is published monthly

by Graham VK5AGR. Subscription is

\$30 for Australia, \$35 for New

Zealand and \$40 for other countries

by AIR MAIL. It is payable to AMSAT

Australia addressed as follows:

AMSAT Australia

GPO Box 2141

Adelaide SA 5001

Keplerian Elements

Current keps are available from the

Internet by accessing the AMSAT

FTP site, <ftp.amsat.org> and following

the sub-directories to "KEPS".

## Satellite User Numbers Update

It's a year now since I counted the number of station calls from our locality appearing on the digital satellites, KO-23, KO-25 and UO-22. I've continued to log new callsigns and the result is a bit disappointing.

VK4 and ZL1 each showed an increase of three. VK3 and VK6 increased by one each while ZL2 increased by two. Other states remained the same, although there were two extra in the "others" category, ie. SE Asia, Oceania and marine mobiles.

Now, my little survey is by no means exhaustive, but there certainly has not been a spectacular increase. Perhaps we should ask ourselves why. Is it too hard? Too expensive? Is the dreaded Internet keeping people away? Are amateurs still frightened by computers? Maybe we're not selling it effectively. What will happen when P3D comes on line later

this year? Will it be the same old callsigns again or can we look forward to some new blood?

My main activity is on the digital birds with occasional excursions to AO-10 and MIR. It would be nice to hear from someone who frequents the others with some better news regarding operator numbers. Sadly, my regular contact who reported on the RS and analogue birds is one of those who has given it all away.

## P3D - First the Bad News

It seems there has been another delay in the launch of P3D. It has been caused by a delay in the launch of the Ariane 502 vehicle which is to take P3D into orbit. While this will give the construction team a bit of breathing space, it will add to the cost of the launch. More as it comes to hand. The launch has been delayed until mid-September 1997.

## P3D - Some Good News

*(From the AMSAT News Service - While you are reading this you may care to ponder on the enormous amount of work put in by the members of the P3D team or our behalf).*

In a joint statement issued on 7 March, AMSAT-DL Vice President Werner Haas DJ5KQ, and AMSAT-NA Executive Vice President Keith Baker KB1SF, gave a brief run-down of the team's significant progress over the previous two weeks. "Phase 3-D is alive and doing very well!" said Werner. "We have now accomplished all the objectives we had hoped to achieve on this, our first major joint integration visit in Florida."

During this period, the combined team installed, powered-up and then extensively tested the satellite's main power and computer (IHU) systems, as well as transmitters for X-Band, V-Band and U-Band. All performed without problem. In addition, all of the spacecraft's many communications receivers have now been built into the satellite and they, too, were thoroughly tested and are now working well. Likewise, the SCOPE camera experiment built by JAMSAT, the Japanese AMSAT group, was successfully installed and powered up while in the spacecraft.

"First light" was also received via SCOPE during this test and the image quality of the initial pictures was absolutely superb. Besides installing the various transmitters and receivers, Phase 3-D's Intermediate Frequency (IF) switching matrix, a device that will allow almost any receiver to be cross linked to any transmitter, as well as the LEILA experiment (strong signal attenuator)

were also successfully brought on line in the spacecraft.

Another major integration milestone came late Tuesday afternoon, 4 March, when team members Werner Haas (DJ5KQ), Peter Guelzow (DB2OS), Keith Baker (KB1SF), Stan Wood (WA4NFY) and Lou McFadin (W5DID) completed the first QSOs via Phase 3-D's configuration U/V "transponder". For this test, P3-D's U-Band receiver was cross-linked to the V-Band transmitter through the IF Matrix. What's more, the distinctive "warble" warning tone and notch capabilities of P3-D's LEILA were clearly demonstrated when Stan Wood deliberately overpowered his SSB "uplink" signal, thus triggering LEILA to first superimpose its warning tone on his "downlink" signal. When Stan persisted in overpowering his uplink, team members then watched (in amazement!) as the LEILA cut his downlink signal via P3-D's V-Band amplifier from some 140 watts to about 2 watts! Needless to say, the members of the German communications team were most pleased to finally show their American counterparts the fine quality and function of Phase 3-D's extremely capable communications suite.

## Andrews Communication Systems

(EST. 1976 - ACN 001 968 752)

**WE WILL NOT BE UNDERSOLD  
ON ALINCO RADIOS**

- ★ IC-756 HF+6M, DSP, LCD
- ★ IC-R10 HAND HELD SCANNER
- ★ WS-1000E CUTE SCANNER
- ★ DX-70TH HF+6M 100W.
- ★ MFJ TUNERS AND CONTROLLERS
- ★ DX-1600 HF LINEAR AMP.
- ★ AR-5000 2.6GHz SCANNER

**3 YEAR WARRANTY ON  
OUR ALINCO RADIOS**

Call us now

**(02) 9636 9060** or (02) 9688 4301

SHOP 8, 41 BATHURST ST, GREYSTANES,  
N.S.W. 2145. FAX (02) 9688 1995



Antenna Sales International

HF- VHF - UHF MOBILE ANTENNA  
HF - VHF - UHF BASE ANTENNA  
CB - MARINE - AIRCRAFT

Monoband to Multiband  
Convert Now, to the all

New!

PERTH PLUS

HF Mobile antenna

with 80-40-30-20-17-15-12-10-6-2m Included

Also available

Coaxial Cables & Fittings  
HF Spring Bases, Trunk and Gutter Mounts.

Outbacker OB8 "Classic"  
Outbacker "Junior plus"

Split Models  
Helical Dipoles  
Long wire Dipoles  
Baluns

★ Free!

With Every Perthplus Purchase.

1 x AmSoft CD-ROM  
'94 Callsign Database

While current stocks last

Now available from:

MELBOURNE  
Daycom Communications  
Ph 03 6436444

ALICE SPRINGS.  
Farmer Electronics  
Ph 089522388

DARWIN.  
Integrated Technical Services.  
Ph 089-815411

SYDNEY.  
Andrews Communications  
Ph 02 6369060

PERTH.  
Tower Communications  
Ph 4701118

ADELAIDE  
Johnston Electronics  
Ph 08 2871061

<http://intercon.com.au/outbacker>

TERLIN AERIALS Ph +61 (09) 3545444  
5 Yampi Way Fax +61 (09) 3545455  
Willetton W.A. 6155



Send \$ 5.00 for a 15 minute informational video  
Refundable with every antenna purchase.

## How Do You Answer That?

"9600 baud!...that's so slow....why do you bother?" Anyone who has friends who "surf the net" has had to fend off questions like that. The point being discussed is, of course, the maximum baud rates that generally apply to the digital satellites and the packet radio network. "Come on now...anyone worth his salt is running 28.8k now and that's only if you don't have access to something faster". ("Thanks"...probably at work).

Well, just how do you answer questions like this? It's not easy. If the person is familiar with electronics you may be able to explain it away with terms like available bandwidth and modulation method limitations, lead design time of the satellites, etc, but this still leaves the basic question unanswered of why do we bother?

Well, why DO we bother? One way I've found that works is to point out that they (the net-surfers) "do it" over the telephone lines and, as such, are:

1. paying for the service; and
2. not in control of the service.

We "do it" by radio. Amateur radio. We use our amateur radio licence and equipment. We experiment with new and better ways of utilising the limited bandwidth. We push higher and higher in frequency. We build better antennas, pre-amplifiers and demodulators. We refine our operating techniques and employ the latest in amateur software and technology. WE BUILD AND CONTROL OUR OWN COMMUNICATION SATELLITES. All "they" do is plug in a modem and switch it on; and anyone can do that.

This approach can sometimes work. If the original remarks were more than merely flippant you may even gain a convert to our cause. For all its visual whiz-bangery, the net can have a certain numbing effect to the brain. A lot of thinking people turn off after a while. They are looking for something better. We know something better - amateur radio satellites. Slower perhaps, but the essential difference is that amateur radio is open-ended, expanding and, above all, stimulating.

## SatSpy Update

One of my great delights is satellite watching at night. I know a lot of others share this fascination. In the January 1996 column I first made mention of a tracking program with a difference. It's called SatSpy. Written by David Acappella and specially designed for keeping track of visible satellites, SatSpy offers great features for the satellite watcher.

David has recently updated the software. The thing that divides good from bad software is support. In the case of satellite tracking software the most crucial factor is



Your  
Hobby

Representing Radio Amateurs Since 1910

Your  
Voice

the availability of accurate keplerian elements. David's Web site has fresh keps each week for the 1200 or so most visible satellites. This service means you don't have to scrounge around looking through various sources for them, filtering the larger magnitude satellites from the ones too dim to see and putting them into a form that the program can use. It's all done for you. Now that's support!

Version 3 is on the drawing board at present and David is asking that users contact him with their "wish-list" of goodies they would like to see included. If you use SatSpy, think about any improvements you would like to see, and convey them to David. This is how good software evolves.

## SAFEX, MIR 70 cm Repeater

This repeater is reported to be operational. The uplink frequency is 435.750 MHz FM and the downlink frequency is 437.950 MHz FM. A sub-audible tone of 141.3 Hz is required for access. It must be remembered that Doppler shift on a fast moving satellite can be a problem on 70 cm and above. You should really have a method of compensation in place before you try to access this repeater.

## AO-10 and Its New Keps

The old bird is working very well. Surprisingly, not many stations are to be heard. I have called many CQs on an empty pass band recently. Good signals with just 10 watts of uplink power. Sometimes deep fading is evident. The keplerian element set has been updated and is now appearing on all sources.

## DO-17 (DOVE) 2.4 GHz Beacon Still On

DOVE is transmitting on S band 2401.220 MHz. The 0.8 W S band transmitter is being kept on as a test signal for those working on getting 2.4 GHz receive equipment going for the P3D satellite. The S band antenna is a whip located on top of the satellite. It points toward the earth in the southern hemisphere and is easy to hear. Doppler shift can change the downlink frequency up to 100 kHz during a pass.

RMB 1627, Milawa VIC 3678  
E-mail: vk3jr@amsat.org

ar

# ALARA

Sally Grattidge VK4SHE\*, ALARA Publicity Officer

## Welcome New Member

A warm welcome is extended to new member Eileen ZL1BRX, sponsored by Jean VK5TSX.

## Congratulations

Congratulations to Jenny VK5ANW on becoming an Australian citizen (after how many years?).

And congratulations to Deb VK5DEB for winning the first prize in the CJ Dennis Poetry Competition at the Auburn Festival in September with a poem about the death of her grandfather in a nursing home a few years ago. Also, for completing her Bachelor of Arts at Flinders University, and winning a scholarship to study English Honours at the University of Adelaide.

## Christine WB2YBA

Christine has been a member of ALARA for many years and was last in Australia in 1993 when she visited Mavis VK3XB. She took a lot of video footage during her stay and recently edited a video on "Australia's Unique Mammals". But she was disappointed with the result due to some editing equipment problems, so will have to do it again. She also did a video featuring Austine VK3YL shortly before she became a Silent Key. The next visit will see her camera aimed at birds and then flowers, so we may see her at the ALARA meet in Brisbane 1999?

Christine breeds and trains miniature

Schnauzer dogs, and was interested to see several dog shows while she was in Melbourne. A recent video she made on "Newark's Cherry Blossom Festival" has been accepted at an International Photography Salon, and she has received a prestigious award from the American Medical Women's Association.

## Silent Keys

From Christine WB2YBA comes news that Ethel Smith K4BML died on 5 February 1997 of breast cancer. A founder of YLRL, Ethel was a devoted member, and Editor of the newsletter, at the time of her death. She was resigned to her death and died without fear. The members are planning to use her call for YLRL, and name a scholarship fund in her honour.

Anny DF2SL (see photo) suffered a fatal heart attack on 23 March, and will be missed by her many friends around the world. Anny was involved in RTTY, telephone and CW in World War 2, serving in Brussels, France and the Netherlands, including a period of imprisonment in Wilhelmshaven before returning home in 1945.

She married in 1947 and had two sons. In 1969 she was a founder member of the radio club in Tilertissen where she was treasurer for ten years and taught CW. At first she was the only YL with 14 OMs. Now there are 75 members, four of which are YLs.

In 1974 she met Lia WA2NFY on-air,

beginning a lasting friendship and many meetings. Anny was a long-standing member of ALARA, enjoyed reading the Newsletter, and was hoping to work more VK YLs including Beth VK7YL, Mavis VK3KS and Yvonne VK5AYK when conditions improve.

## Phyllis KA1JC

Phyllis runs a YL Packet Group and welcomes new members. Find her at KA1JC@WA2LKI.#VEN.FL.USA.NA. She also runs the "Butterfly DX Net" on 14.226 MHz starting at 2000 UTC every Monday, Tuesday and Wednesday.

## New Souvenir

ALARA is to introduce a cloth badge, which should be a popular souvenir. It will be easy to send to DX members, and great to wear on public occasions.

## WARO HF Net

WARO holds a net on Mondays at 8.00 pm (ZL time) on 3.695 MHz. The second and fifth Mondays are now on 3.620 MHz.

## Apology

In April *Amateur Radio* I wrote a piece on the adventures of Kristi VK9NL in Svalbard and Vietnam, which was not correct. The story was in a letter from Kristi, but the adventurous YL was Unni Gran LA6RHA. Apologies to Kristi and Unni - that should teach me to read every word of what is sent to me before using it!

\*C/o PO Woodstock, QLD 4816

Tel: 077 788 642

Packet: VK4SHE@VK4RAT.#NO.QLD:AUS.OC

Internet e-mail: rgratid@ozemail.com.au

ar

## WIA News

The WIA bids a warm welcome to the following new members who were entered into the WIA Membership Register during the month of March 1997:

L21035	MR J J OKSIUTA
L30951	MR H TURNER
L60387	MR E G M GREEN
L60388	MR M MCCLINTOCK
VK1HCC	MR C HOLMES-CLARK
VK2ADG	MR R LOFTUS
VK2AO	MR D S A PEAKE
VK2ASW	MR D J POLLARD
VK2AYD	MR D PILLEY
VK2BKP	MR J K PICKETT
VK2EAU	MR M R HALLINAN
VK2EYC	MR I D MCKAY
VK2IEQ	MR P JENNI
VK2JPR	MR G F ENGLISH
VK2KKT	MR K J TOMSON
VK2KWY	MR D B HENDERSON

VK2KXN	MR N B MCLEAN
VK2PB	MR W P PAULL
VK2TUF	MR B A COADY
VK2VCR	MR A R WILLIAMSON
VK2VUB	MR L J BUTCHER
VK2WE	MR K W MATTHEWS
VK2WHD	MR W H DOUGALL
VK2XN	MR W R FOURACRE
VK3AEU	MR O R GELLERT
VK3BZP	MR J VALE
VK3HCP	MR G R PERRY
VK3NI	MR G DOLFEN
VK3OK	MR T MARLOWE
VK3YFG	MR J R POWELL
VK3ZK	MR J L WICKHAM
VK4HBA	MR A BANNAH
VK4WMC	MR W MCCARTHY
VK2XNZ	MR B FURBY
VK5KIC	MR I D CROMPTON
VK6MH	MR R A MACDUFF



Olive VE7ERA, Anny DF2SL and Lia WA2NFY.

# Awards

John Kelleher VK3DP - Federal Awards Manager\*

First and foremost, I must tender an apology to those several good people who have been waiting, in some cases, for what I would consider an unusual length of time, to receive their awards. It seems that a large, antiquated typewriter (capable of LARGE print for the awards) has been throwing a "wobbly", possibly due to old age. It would also appear that the vacant position of Federal Office Manager, upon whom I relied heavily, has not been filled.

The combination of the above is having a detrimental effect on the excellent rapport that has been built up over the last six years with my awards clientele. Maybe, as time passes, I may be allowed to process certificates personally.

Rumours indicate the possible loss of VS6/VR2 along with KH7 and KH9, and later KH5, KH5J/K.

I am about to check my DXCC files, removing some to inactive status. This applies to those who have not supplied any information for the last six years.

## Australian Awards

The following Australian Awards are listed in a prominent overseas Awards Directory. I would appreciate any information as to their viability.

1. ATV Award of Queensland.
2. Anzac Award.
3. Worked Australian State Police Award.
4. Blue Mountains Radio Club Award.
5. Brisbane Amateur Radio Club Award.
6. Bunyip Award.
7. HMAS Canberra Award.
8. Central Coast Award.
9. Bougainvillaea Award.
10. Top End Award.
11. Endeavour Award.
12. Coastal Towns Award
13. Port Phillip Bay Award.
14. Macarthur Award.

**Are you reading  
someone else's  
Amateur Radio?  
Call 03 9528 5962  
to find out how to  
get it every  
month!**

15. Mineral Fields Award.
  16. HMCS Protector Award.
  17. Worked All Queensland (Cities & Towns) Award.
  18. Worked All Queensland (Shires) Award.
  19. Rally Australia Award.
  20. Redcliffe City Award.
  21. Black Marlin Award.
  22. Rockhampton Award.
  23. Solitary Islands Award.
  24. HMAS Sydney Award.
  25. VK8 Outback Award.
  26. Wildcat Award.
- And Awards from the NSW Division of the WIA:
27. NSW Parks Award.
  28. NSW Cities, Municipalities & Shires Award.
  29. VK2 Division's 25's Award.
  30. VK2 Clubs Award.
  31. VK2 Special Award.

There are even more from VK5/6 listed elsewhere. I found myself checking frequencies and times, only to be met with absolute silence (over the QRN). I must point out that none of the awards listed above fall into my domain as Federal Awards Manager. I would like to hear some activity, as would we all. Maybe the approach of the millennium will grant our wishes. My reason for seeking information about the above Awards is to provide an accurate survey to local and overseas Awards Directory suppliers.

In the meantime, please answer those DX Amateurs who are frantically calling CQ VK/ZL. You may have already worked his/her country, but he/she would not be calling VK/ZL specifically, if they did not want you! Also remember that the final courtesy of a valid contact is a QSL card.

This month's awards come from Argentina, Austria, The Azores, and Belarus.

## LU25PX Award

This award is issued for contacting at least 25 Argentine prefixes since 12 January 1989. Endorsements are available for over 25 prefixes. There are separate certificates for mixed, phone, and CW. GCR accepted. The fee is \$US6.00 or 10 IRCs for the basic award. Endorsements are \$US2.00 or three IRCs. Apply to: Grupo Argentino de DX, Award Manager, PO Box 420, 1000 Buenos Aires, Argentina.

## From Austria - Worked Prefix Zone 15

Contact countries/prefixes in CQ Zone 15. These are FC/TK, HA, HV, I, IT, IS, OE, OH,

OK, OM, S5, SP, UA2, UP/LY, UQ/YL, UR/ES YU, ZA, 1A0, 4U1VIC, 9H1, and 9A1M1/T77.

Class I needs 15 countries and 50 prefixes, Class 2 needs 12 and 40, Class 3 needs 8 and 30, and Class T (160 m) needs three and 8.

The fee is 10 IRCs. GCR list is OK. Send your application to: Oesterreichischer Versuchssenderverband, Landesverband, Wien Diplomferat, PO Box 777, A-1062 Vienna, Austria.

## Azores Counties Award

Contact stations in different islands/counties of The Azores after 28 May 1986. There are three classes: Bronze for 15 counties, Silver for 17 counties, and Gold for all 19 counties. All bands and modes. Apply with cards or copies of the cards, plus a fee of \$US5.00 or 10 IRCs to: URA Award Manager, PO Box 140, P-9702 Agra Codex, Azores, Via Portugal.

## Counties List

- CUI. Island of Santa Maria. County Vilo Do Porto.
- CU2. Island of Sao Miguel. Counties of Ponta Delgada, Vila, Fraca Do Campo, Lagoa, Nordeste, and Povoacao.
- CU3. Terceira Island. Counties of Angra Do Heroismo, and Praia Da Vitoria.
- CU4. Graciosa Island. County of Santa Cruz Da Graciosa.
- CU5. Island of Sao Velas. County of Calheta.
- CU6. Island of Pico. Counties of Madalena, Lajes, Sao Roque.
- CU7. Island of Faial. County of Horta.
- CU8. Island of Flores. Counties of Santa Cruz and Lages.
- CU9. Island of Corvo. County Vila Nova Do Corvo.

## Belarus Award

Work UC/RC and EV/EW amateurs in Oblasts as indicated. Second Class, 20 stations in three Oblasts. First Class, 30 stations in four Oblasts. The Oblast list is:

Oblast	Suffix	Name
005	L	Brest
006	W	Vitebsk
007	O	Gomel
008	I	Grodno
009	C	Minsk
010	S	Mogilev
188	A	Minsk City.

For example UC2OXX would be Obl 007 and area of Gomel.

There are no band or mode restrictions. Provide a GCR list and a fee of seven IRCs to: Gene Zhukovski, PO Box 33, Minsk - 13, 220013 Belarus, Europe.

Good hunting!

\*4 Brook Crescent, Box Hill South, VIC 3128  
Phone (03) 9889 8393

ar

---

---

# Club Corner

---

---

## Summerland Amateur Radio Club

Our next major event will be the sponsoring of a Computer Expo, in the Lismore City Hall, on Saturday, 31 May. Many commercial displays have been organised and visitors will be able to get "hands on" experience, including the Internet. Bring and Buy tables will be open, there will be Lucky Door Prizes throughout the day and refreshments will be on sale. The doors will be open from 9-30 am to 4-30 pm. Admission \$3, or \$5 per family.

The Club has had an Internet site installed at the Clubrooms. This, and our other facilities, are available to members on Thursday evenings, Sunday afternoons and other times by mutual arrangement. A moderate charge, to cover expenses, will be levied for use of the Internet.

For more information on membership and all club activities, contact Bert VK2HIV on 066 243 239, or Graeme VK2GV on 066 851 336. Our e-mail address is [sarc@nor.com.au](mailto:sarc@nor.com.au)

Graeme VK2GJ  
Publicity Officer

## Oxley Region Amateur Radio Club

The Oxley Region Amateur Radio Club will, once again, be holding its Annual field Day at the Sea Scouts Hall, Buller Street, Port Macquarie, on 8 June 1997, commencing at 9.00 am.

The field day will have the usual events of food, fox hunts, trade displays and disposals.

All are welcome. For further information, please contact Dave Tarrant VK2HBC on 856 381.

Dave VK2HBC  
Secretary

## Urunga Radio Convention

The oldest Radio Convention in Australia was held over the Easter weekend at Urunga on the North Coast of NSW.

Urunga's old style hospitality attracted 67 registrations ranging in age from five years to 91 years. Foundation member Peter VK2PA and XYL Ina were there, and Paul K9CDW made the trip from Chicago especially for the weekend. The Urunga scramble, mobile and pedestrian fox hunts, and talk-ins were popular while a dozen or more quizzes and competitions kept the onlookers busy.

Next year will be the 50th Urunga Convention and we want to catch up with the old timers that attended the early

conventions. If you have attended previously, contact Arnold Austin VK2ADA at QTHR, or on (066) 54-1274.

Jamie Campbell VK2YCJ

## Radio Amateurs Old Timers Club (RAOTC)

Age is not a pre-requisite for membership of the RAOTC but, if it was, our latest applicant for membership would sail in on those grounds. Harry Angel VK4HA, who is now 105 years old, is our latest recruit.

Harry, who was first licensed with his current call in 1935, was an original ANZAC who reduced his age to join up, and fought again in World War 2. Harry rode at the head of the ANZAC parade in Brisbane last year and received wide-spread publicity for this. Welcome, Harry!

Allan Doble VK3AMD  
ar

---

---

## Contests

Peter Nesbit VK3APN - Federal Contest Coordinator\*

### Contest Calendar May - July 97

May 3/4	ARI DX Contest (CW/SSB/RTTY)	(Apr 97)
May 10/11	CQ-MDX Contest	(Apr 97)
May 17/18	Sangster Shield Contest	(Apr 97)
May 24/25	CQ WPX CW Contest	(Feb 97)
Jun 1	Portugal Day Contest (SSB)	
Jun 7/8	IARU Region 1 Field Day (CW)	
Jun 14	QRP Day Contest (CW)	
Jun 14	Asia-Pacific CW Sprint	(Jan 97)
Jun 14/15	ANARTS RTTY Contest	
Jun 14/15	South America WW Contest (CW)	
Jun 21/22	VK Novice Contest	
Jun 21/22	All Asia CW DX Contest	
Jun 28/29	ARRL Field Day	
Jul 1	Canada Day CW/Phone	
Jul 5	Australasian CW Sprint (80 m)	
Jul 5	NZART Memorial Contest	
Jul 12	Australasian Phone Sprint	
Jul 12/13	IARU HF Championship	
Jul 19	South Pacific 160 m Contest	
Jul 19	Colombian DX Contest (Phone/CW)	
Jul 26/27	RSGB IOTA Contest	

---

---

## WIA News

### British Amateurs Lose Part of 3 cm Band

Amateurs in the United Kingdom have lost part of the 10 GHz band, from 10.150 through 10.300 GHz, from 1 April 1997. It was withdrawn from the Amateur Service in the UK by the British regulatory authority, the Radiocommunications Agency.

The 3 cm amateur band in the UK is now in two segments, from 10 to 10,150 GHz, and from 10,300 to 10,500 GHz.

When I sat down to write this column this evening, I anticipated something brief followed by the fabled "early night". Several hours later I'm still sitting here, staring at seven pages of text, wondering how it managed to grow to such a length (it will condense down after typesetting).

Most of the effort in writing this column is not finding enough to say, it is pruning out the excess verbiage and packing the maximum information into every word. Mostly this is easy enough, but occasionally a contribution

arrives which is so convoluted as to almost require a QC to interpret it! Fortunately this is fairly rare.

Occasionally, contributions must be held over due to lack of space. I know the authors concerned sometimes feel aggrieved that their copy hasn't appeared immediately; however, if the same issue also contains the results of one or two large WIA contests, often there is little space left over for anything else. In this I am simply following normal editorial policy.

Possibly I could adopt that admirably devious tactic, seen in some overseas magazines, of spreading contest information into the DX column for instance (*No way, forget it!* – Editor). Don't worry, just joking!

For information and assistance this month, many thanks to VK2BQS, VK2SRM, VK3DID, VK3KWA, G3UFY, OE4BKU, VE2ZP, ZL1AAS, JARL and LCRA. Until next month, good contesting!

73, Peter VK3APN

### Portugal Day Contest (SSB)

0700-2400z, Sunday, 1 June

This contest takes place on the first Sunday in June each year. Use 80-10 m, SSB only. Send RS + serial number. CT stations will send RS + district code. Score two points per QSO with CT1-4 or EA1-5 and 7, one point per QSO with other countries, and zero for own country. Multipliers are the number of CT districts, plus DXCC countries, plus number of continents worked irrespective of band. Districts are AV BG BJ BR CB CO EV FR GD LR LX PG PT SR ST VC VR VS. Send logs to: "REP Contest Manager/DP91, Apartado 2483, 1112 Lisboa, Codex, Portugal" by 30 June.

### IARU Region 1 Field Day

1500z Sat to 1500z Sun, June 7/8

Expect plenty of European activity in this CW contest, which is a collection of regional field days. The rules depend on the sponsoring society but, in general, you send RST + serial, and score four points per QSO with each portable European station. The multiplier is the number of European countries worked. Send logs to: "RSGB (G3UFY), 77 Bensham Manor Road, Thornton Heath, Surrey CR7 7AF, England", postmarked within 30 days of the contest.

### 1997 QRP Day Contest

Saturday 14 June, 0200-1400z

Presented by Ian Godsil, VK3DID

Sponsored by the CW Operators' QRP Club, the object is for VK, ZL and P2 amateurs to work as many local and overseas stations as possible. Use CW in the normally recognised CW sections of 160-10 m (no WARC bands). The recognised QRP calling frequencies are 1815, 3530, 7030, 14060, 21060, and 28060 kHz (then QSY to a working frequency). Exchange RST + serial number starting at 001. Repeat QSOs are allowed between the same stations, on the same band, with at least three hours between subsequent QSOs.

For QSOs between VK/ZL/P2 stations, score five points for each QRP station worked, and one point for each QRO station worked. For QSOs between VK/ZL/P2 and those outside VK/ZL/P2, score 20 points for each QRP station worked, and 10 points for

each QRO station worked. Add a further five points per 10 m QSO, 10 points per 160 m QSO, 10 points per QSO made using a home brew transmitter, and five points per QSO made using a home brew antenna. QRP stations must not exceed 5 W carrier power to the antenna, and should sign /QRP.

Include full details of the equipment used, and send your logs to: "Ron Everingham VK4EV, 30 Hunter Street, Everton Park, Queensland 4053", by 15 July 1997. A comprehensive range of certificates will be awarded to the top scorers. Those interested in joining the CW Operators' QRP Club should write to: "Kevin Zietz VK5AKZ, 41 Tobruk Ave, St Mary's, SA 5042".

### ANARTS WW DX RTTY Contest

0000z Sat to 2400z Sun, 14/15 June

This contest is organised by the Australian National Amateur Radio Teleprinter Society, and runs on the second full weekend of June each year. The object is to contact as many stations locally and overseas as possible on 80/40/20/15/10 m, using any digital mode (RTTY, AMTOR, FEC, PKT, PACTOR, etc) (no satellite). Categories are single operator, multi-operator single transmitter, and SWL. Maximum operating time for single operators only is 30 hours. Rest periods can be taken at any time during the contest. Mark rest periods in log.

Messages comprise RST, time in UTC, and CQ Zone. For each valid QSO, points are claimed according to zone. Space precludes publishing a complete points table; however, the following extracts show the points claimable by entrants in zones 28, 29, and 30. The numbers show the number of points for QSOs with zones 1 to 40, working left to right, top to bottom (ie the first number shows the points per QSO with zone 1, second with zone 2, etc):

#### Your Zone = 28

31 40 40 44 45 49 53 51 55 54  
49 48 46 32 30 26 22 20 20 25  
20 11 14 10 15 05 07 02 10 17  
31 24 34 25 36 30 22 26 19 34

#### Your Zone = 29

39 50 43 52 54 47 49 54 52 44  
42 37 37 42 39 36 32 30 30 34  
28 21 24 20 23 16 15 10 02 09  
15 32 42 33 39 31 24 24 20 44

#### Your Zone = 30

35 50 35 44 46 38 40 44 45 37  
41 33 34 49 47 42 38 35 32 43  
37 29 30 24 30 22 18 17 09 02  
24 07 51 42 47 40 33 32 29 48

Countries are as per the ARRL DXCC list, except that each call area in mainland VK (1-8), VE, JA and W counts as a separate country. Mainland VK, VE, JA and W are not claimable. Call areas outside these mainland

areas (eg VK0, JD1, KL7, KC4) count as separate countries. One's own country (as defined herein) can be worked for QSO points, but not for a multiplier.

Points are determined for each band, using the relevant points table, and then added. Countries are similarly tallied. Continents are those worked irrespective of the band. Total score is points x countries x continents. Non-VKs should add a "VK Bonus" to their points tally, which is 500 points for each VK worked on 80 m, 400 on 40 m, 100 on 20 m, 200 on 15 m, and 300 points on 10 m.

Use a separate log for each band. Logs must show: Date, time, callsign of station worked/heard, messages sent and received, and points. The summary sheet must show: callsign, name and address, bands used, the points claimed for each band, the number of countries worked on each band, the number of continents worked, VK Bonus calculations for world stations, calculations, and declaration. Multi-op entries must show the signatures and callsigns of each operator, and single-op entries must show a summary of operating times. Please include a dupe sheet for any band log over 75 QSOs.

Send log and summary sheet to: "ANARTS Contest Manager, PO Box 93, Toongabbie, NSW 2146" by 1 September 1997. If required, a full page scoring table (last revised 1994), and log and summary sheets are available from ANARTS or myself upon receipt of a SASE.

### 1997 WIA VK Novice Contest

0800z Sat to 0800z Sun, 21/22 June

Presented by Ray Milliken, VK2SRM

The object of this contest is to encourage amateur operation in VK, ZL and P2, and to promote contacts with Novice and club stations. Only stations in VK, ZL and P2 are eligible to participate. Stations in the same call area may contact each other for contest credit.

All operation must be confined to the Novice frequency allocations in the 10, 15 and 80 m bands, viz 3.525-3.625 MHz, 21.125-21.300 MHz and 28.100-28.600 MHz. No cross-band operation is permitted.

Sections include (a) Phone (Novice/Full Call); (b) CW (Novice/Full Call); (c) SWL. Except for club stations, no multi-operator operation is allowed.

Phone stations should call "CQ Novice Contest", and CW stations "CQ N". Club stations should call "CQ Novice Contest, Club Station", followed by the callsign. Exchange a serial number comprising RS (or RST) followed by three figures commencing at 001 for the first contact, and increasing by one for each subsequent contact.

*All operators must, after making five consecutive contacts on the one frequency,*

*change frequency by at least 5 kHz for phone and 2 kHz for CW (stations using crystal controlled transmitters are exempt from this rule).*

Stations may be contacted twice per band, providing at least 12 hours have passed since the previous contact with that station. SWLs may log up to ten sequential contacts made by a station, and must then log at least five other stations before logging the previous station again. The five stations so logged need a minimum of one contact only logged.

Score five points for contacts with Novice or Combined Call stations, ten points for contacts with club stations, and two points for contacts with Full Call stations. SWLs score five points for Novice to Novice contacts, two points for Novice to Full Call or Full Call to Full Call contacts, and ten points for contacts made by a radio club.

Logs must show: Date/time UTC, Band, Mode, Station contacted, Report and serial number sent, Report and serial number received, Points. Each log sheet must be headed "VK Novice Contest 1997". The total claimed score for each page must be shown on the bottom of the page.

Logs must be accompanied by a summary sheet showing: callsign, name, mailing address, section entered, number of valid contacts, and claimed score. The summary sheet must include the following declaration: "I hereby certify that this station was operated in accordance with the rules and spirit of the contest". The sheet must be signed and dated by the operator, or in the case of a club station, by a responsible officer of the committee, or a licensed operator delegated by the committee to do so.

Entrants may submit only one contest log per mode. Logs for entries where an entrant uses more than one callsign whilst operating in the contest will not be accepted. Send entries to: "Novice Contest Manager, Westlakes ARC, Box 1, Teralba, NSW 2284", to arrive by Friday 18 July 1997.

The Keith Howard VK2AKX Trophy will be awarded to the Novice entrant with the highest phone score, and the Clive Burns Memorial Trophy to the Novice entrant with the highest CW score (these are perpetual trophies on permanent display at the Executive Office). In each case, the annual winner will receive a suitably inscribed wall plaque as permanent recognition. Certificates will also be awarded to the top scoring Novice station in each call area, the top scoring station in each section, and to any other entrant where meritorious operation has been carried out. Awards are at the discretion of the contest manager. A Certificate of Participation will be awarded to all operators who submit a log in the contest.

## All Asian DX Contest

CW: 0000z Sat to 2400z Sun, 21/22 June  
Phone: 0000z Sat to 2400z Sun, 6/7 September

The object is to contact as many stations in Asia as possible, on 160-10 m (no WARC bands). Classes are single operator, single and multiband; and multi-operator multiband. Call "CQ AA" or "CQ Asia". Exchange RS(T) plus two figures denoting your age (YLs send "00"). For each QSO score three points on 160 m, two points on 80 m, and one point on other bands. The multiplier is the number of different Asian prefixes worked per band, according to CQ WPX rules. Example: JS9ABC/7 counts for prefix JS7. Note that JD1 stations on Ogasawara (Bonin & Volcano) Isl belong to Asia, and JD1 stations on Minamitori Shima (Marcus) Isl belong to Oceania. Final score is total QSO points x total multiplier.

Use standard log and summary sheet format, clearly showing new multipliers when first worked. Send logs postmarked by 30 July (CW) and 30 Sept (SSB) to: "JARL, AA DX Contest, Box 377, Tokyo Central, Japan". Indicate phone or CW on envelope. Awards include certificates to the top 1-5 stations in each country on each band (depending on activity), and medals to the continental leaders. For full results please enclose an IRC and SAE with log.

Asian countries are: A4 A5 A6 A7 A9 AP BV BY CR9 EP HL/HM HS HZ/7Z JA-JS JD1 (Ogasawara) JT JY OD S2 TA U/R (CIS) VR2/VS6 VU VU4 VU7 XU XV/3W XW XZ YA YI YK ZC4/5B4 1S 4S 4X/4Z 7O 8Q 9K 9M2 9N 9V.

## RESULTS OF 1997 VHF-UHF FIELD DAY

*Presented By John Martin, VK3KWA*

The number of logs received this year was down from 1996. There was only one log each from VK1 and VK2, 11 from VK3, three each from VK4 and VK5, and one from VK7. Once again, VK6 was conspicuous by its absence.

In spite of the high level of activity in Victoria, it will come as a shock to the VK3s that the winners in two of the four sections came from other states! The main reason is the increasing use of higher bands. For the first time ever, logs were received for all bands up to and including 24 GHz: eight bands in all.

## Results

In the single operator section, this year's winner was Trevor Niven VK5NC, who operated from three different locations on seven different bands. No doubt some other entrants will be looking very closely at transverter designs for 2.4 GHz and above during the coming year!

Last year's second place-getter, Rob Ashlin VK3DEM, came second, and last year's winner, Brian Young VK3BBB, came third. In the six hour section, the winner is again Ron Cook VK3AFW, who operated from Mt Buller in north-east Victoria.

In the multi-operator section, the prize again goes to VK3ATL, the station of the Geelong Amateur Radio Club, with an excellent effort. VK41F came second, and no doubt will be trying even harder next year. VK3ER and VK5ARC also did very well, and there could be quite a battle between the club stations next year. Check those scores and see the advantage of having an extra band!

The top scoring home station was Max Pickering VK3TMP, followed by VK3CY and VK3BDL.

Congratulations to the winners, and also to those who entered for the first time this year.

## Next Year

This time last year I foreshadowed the dropping of six metres from the Field Day, because that seemed to be the view of the majority. I also mailed a copy of the proposed 1997 rules to all entrants with a request for comments. No responses were received, so it was done. However, when the 1997 Field Day arrived, many people expressed surprise and disappointment that six metres had been dropped, and a majority would now like to see it reinstated!

This can be done, but with the proviso that there will be a very clear restriction on the frequencies used. At the time of writing, six metre operators in many overseas countries are moving towards a new band plan with a dividing line around 50.150 MHz. The idea is that frequencies below 50.150 MHz should be reserved for weak signal work and international DX, with local and contest activity kept above 50.150 MHz.

I therefore plan to reinstate six metres for next year, but with contest operation restricted to 50.150 MHz and above.

The other area which needs looking at is the relative scoring value of grid squares versus individual contacts. The current system makes it well worthwhile to activate the higher bands, in spite of the smaller number of stations that can be worked. I think this should be retained, but with a close eye on the band multipliers to make sure that there is still a fair scoring balance across the spectrum.

As usual, comments would be much appreciated! The rules for the next Field Day will be finalised at the start of November, so that allows seven months for anyone wishing to make suggestions.

The following scores show each band with the QSO points first, followed by the number of locator squares worked.

Call	Name	Loc	144MHz	432MHz	1.2GHz	2.4GHz	3.4GHz	5.7GHz	10GHz	24GHz	TOTAL
<b>SECTION A – PORTABLE, SINGLE OPERATOR, 24 HOURS</b>											
VK5NC	T. Niven	QF01/02	556/8	518/3	740/3	–	992/2	992/2	992/2	992/2	5782
VK3DEM	R. Ashlin	QF42	744/10	987/8	1120/6	616/1	–	–	496/1	–	3963
VK3BBB	B. Young	QF32	1184/17	1407/12	1300/7	–	–	–	–	–	3891
VK5BW	A. Raftery	PF94	1400/23	875/7	580/3	–	–	–	–	–	2855
VK4OE	D. Friend	QG51	832/13	616/4	760/4	–	–	–	–	–	2208
VK3DQW	K. Asplin	QF12	744/12	–	–	–	–	–	–	–	744
<b>Section B – Portable, Single Operator, Six Hours</b>											
VK3AFW	R. Cook	QF32	640/11	896/9	–	–	–	–	–	–	1536
VK3KTO	M. Ide	QF21	480/7	350/2	–	–	–	–	–	–	830
VK2ANK	N. Kefford	QF35/45	400/5	217/1	–	–	–	–	–	–	617
VK1PK	P. Parker	QF44	304/4	–	–	–	–	–	–	–	304
<b>Section C – Portable, Multi-operator, 24 Hours</b>											
VK3ATL	(1)	QF22	1400/20	1596/12	1140/6	–	–	–	–	–	4136
VK4IF	(2)	QG62	1284/10	1183/5	960/4	468/1	–	–	–	–	3895
VK3ER	(3)	QF31	1196/19	1281/12	890/5	–	–	–	–	–	3367
VK5ARC	(4)	?	1004/9	1127/8	560/2	–	–	–	–	–	2691
<b>Section D – Home station, 24 Hours</b>											
VK3TMP	M. Pickering	QF21	660/10	735/6	790/4	–	–	–	–	–	2185
VK3CY	D. Clarke	QF13	572/9	609/5	–	–	–	–	–	–	1181
VK3BDL	M. Goode	QF22	592/10	504/4	–	–	–	–	–	–	1096
VK7XR	A. Hay	QE38	332/5	315/2	–	–	–	–	–	–	647
VK4PJ	P. Brown	QG62	180/2	315/2	–	–	–	–	–	–	495
VK3AIE	B. Gardiner	QF22	172/2	224/1	–	–	–	–	–	–	396

- (1) Brisbane VHF Group: J Morris VK4YOL, G Ryan VK4AR, M McIntosh VK4ZMM, E Fittock VK4NEF.  
(2) Geelong Amateur Radio Club: M Trickett VK3ASQ, K Jewell VK3AKK, J Barrand VK3DFL, L Sim VK3ZLS, C Gnaccarini VK3BRZ, A Gnaccarini VK3TU, L de Vries VK3PK, C Leone VK3BCL, D Learmonth VK3XLD, S Ludvig VK4HSL/3.  
(3) Eastern & Mountain District Radio Club: B Ackerly VK3YNG, J Bramham VK3WWW, J Longayroux VK3ZJH, S Fontana VK3VCL, A Tubb VK3BF.  
(4) South Coast Amateur Radio Club: B Bates VK5UBJ, S Callow VK5HAP.

\*PO Box 2175, Caulfield Junction, VIC 3175  
pnesbit@melbpc.org.au

ar

## Divisional Notes

### VK3 Notes

Jim Linton VK3PC

#### Articles of Association

The review and updating of our Memorandum and Articles of Association, which had been proposed by a resolution at the 1996 Annual General Meeting, has been completed in an exercise that took ten months to complete. A draft set of documents was made available to the membership for comment last October and, after member input, a Special General Meeting held on 19 March 1997 voted to adopt a number of changes. Those attending the meeting expressed their appreciation for the role of our Secretary, Barry Wilton VK3XV, in steering the complex process through all of the requirements.

As soon as final approval of the documents is received from the Australian Securities Commission, arrangements will be made for the printing of the Articles in booklet form, which will be made available to all members.

#### Annual General Meeting

The AGM of WIA Victoria will be held on 28 May at the St Michaels Hall, Ashburton.

Written advice about the AGM to members is either as an insert in this magazine, or by direct mail to those who don't subscribe to the WIA journal as part of their membership subscription.

#### Federal Convention

The 1997 AGM of Federal WIA is scheduled in the first week of this month. WIA Victoria has seven motions on notice for the meeting and will be represented by Barry Wilton VK3XV and Brenda Edmonds VK3KT.

WIA Victoria motions are directed toward a complete overhaul of the management of WIA Federal which has sustained a financial loss of \$45,000 for the year ended December 1996. It will also push strongly for a change to the manner in which the interests of our members are represented with the SMA in Canberra.

#### Councillors at Club Hamfests

Where possible, WIA Victoria will have a presence at major club conventions to promote the WIA and the hobby of an amateur radio. Such representation occurred at last month's Midland Convention, and is planned

for this month's Moorabbin Radio Club Hamfest '97.

Council intends for WIA Victoria to have a presence at as many conventions as possible during 1997-98, and to intensify its membership recruiting initiatives.

### "QRM" News from the Tasmanian Division

Robin L Harwood VK7RH

The Annual General Meeting of the Tasmanian Division was held in Hobart on March 22nd. There was an extremely disappointing attendance of 19, with nine apologies accepted. All the various reports were accepted by those present.

Terry Ives VK7ZTI gave his financial report, having stepped down from Council, and was congratulated on his efforts in turning around the Division's finances; he will be sorely missed on council. Terry is now the North-western Branch Treasurer.

It was revealed that, currently, the Tasmanian Division has 234 members with 45 of them classified as "X" grade membership. Membership is dropping despite new members joining. Concern was expressed at this and council wants some ideas on how to attract new members.



However, the problem of declining membership is not confined to this Division alone, being a nation-wide trend.

VK7JK was also thanked for doing an excellent job in preparing the weekly VK7WI broadcast, despite the occasional hiccups. It is worth noting that some Divisions no longer have regular weekly broadcasts and many interstate are listening to the HF relays. Of course, it would assist us greatly if we knew how many were listening to VK7WI. Please let the relay stations know that you are listening. You will find the frequencies listed in the Divisional Directory on page 56 of this magazine.

Changes to the Constitution were moved by our Honorary Solicitor, VK7ZAX, and approved by the meeting. This means that they are now in effect and can be added to the Articles of Association that were circulated last year. All branch secretaries will have an

updated master copy which can be printed up at a nominal charge.

The meeting expressed dissatisfaction at recent developments with examinations. A motion was moved by VK7BE, seconded by VK7ZDJ, that this Division expresses deep concern over the recent changes, as these alterations were found to be unworkable here in Tasmania. The motion was put and carried and it was further resolved that our Federal Councillor communicate our concerns and report back to the Division as soon as possible on this matter.

There were 12 candidates for Council. Elected were Ron Churcher VK7RN, Phil Corby VK7ZAX, Andrew Dixon VK7GL, Robin Harwood VK7RH, Barry Hill K7BE/VK7AUZ, Mike Jenner VK7FB, John Rogers VK7RH and David Spicer VK7ZDJ.

At a Council meeting following the AGM, the office bearers for the year were elected:

Patron, Col Wright VK7LZ; President, Ron Churcher VK7RN; Vice-President, David Spicer VK7ZDJ; Vice-President, Andrew Dixon VK7GL; Secretary, Barry E Hill VK7BE; Treasurer, Mike Jenner VK7FB; Councillors, Phil Corby VK7ZAX, John Rogers VK7JK, and Robin L Harwood VK7RH.

All ex-officio positions were to be chosen on 19 April in Launceston. They will be notified over VK7WI, and in this column next month.

Next year's Annual General meeting is likely to be held in the Northern branch following a recommendation from this year's AGM.

Please note that the address of the Tasmanian Division is now that of the new Divisional Secretary, Barry Hill VK7BE (see page 56), and amend your records accordingly.

ar

## How's DX?

Stephen Pall VK2PS\*

A few weeks ago I received a letter from an amateur who wanted some QSL information. The style of the signature and the style of addressing the hand-written envelope indicated to me the writer was an "old-timer". Among other things, he wrote: "I have only returned to active hamming in the past twelve months, and my preference is CW by hand-key, on 40 and 20 metres. I am still bemused by the callsigns of the new countries."

Having read his letter, I knew that he was a true old-timer, not only in age but also in amateur practice. He is not the only one who returns to an old hobby. As time goes by, many formerly active amateurs who have been inactive for many years due to marriage, raising a family, forging a career in their vocation, etc, will return to amateur radio because of changed circumstances in their personal life. Retirement, redundancy, unemployment, divorce or death of the partner, and so on will create more "free" time, and a chance for new directions such as taking up the "old hobby" under new and changed circumstances.

Adjustment to the new world of amateur radio will not be easy, and they deserve the support and assistance of those who remained active on the bands.

### World Telecommunication Day - AX2ITU

The special event station of the NSW Division of the WIA will be active on 17 May 1997 from 0001 to 2359 local time.

As a result of my submission to the SMA in February, and that of the WIA-SMA

liaison team earlier in December, the SMA has granted the use of the special callsign AX\*ITU (\* representing the State identifier) to all Divisions of the WIA requesting it. There will be only one special event station per Division (State) and that station has to be sponsored by the respective state Division of the WIA.

The special stations celebrate the establishment of the International Telecommunication Union (ITU), one of the United Nations agencies, which will be 132 years old on Saturday, 17 May 1997.

The ITU was founded in Paris in 1865 as the International Telegraphic Convention and changed its name to ITU in 1947. Its headquarters are in Geneva Switzerland. The organisation is the world regulator of international use of telegraph, telephone, radio and satellite communication services. It is the ultimate "Boss" of the amateur radio service around the world.

It is hoped that all the seven Divisions of the WIA will take up the challenge to activate their own AX\*ITU station and will provide QSL cards to acknowledge the contacts made within and outside Australia by appointing special QSL managers to handle the task.

QSL cards for AX2ITU will go the QSL manager VK2PS at the call book address or via the VK2 QSL Bureau.

### Yemen - 701A - and DXCC Status

The following news was released by the DXCC Desk of the ARRL on 5 March 1997: "Questions have been asked about the

status of the 701A operation from Aden, Yemen. ARRL HQ has been in communication with the Ministry of Communications, resulting in the following information: The Ministry of Communication in Sana'a, capital of Yemen, has advised us by both fax and telephone that, while it is aware of a document issued by its Aden office, the Ministry of Communication in Sana'a, the main body responsible for communications, had never issued an official authorisation for Amateur Radio.

"In accordance with this communication, the 701A operation cannot be accepted for DXCC credit."

### Rotuma - 3D2AG/P

I recently received a lengthy letter and some photographs from Antoine 3D2AG, detailing his activity as a portable station on the Island of Rotuma.

Antoine DRN'Yeurt is a marine biologist, who is working towards his final degree connected with his university studies. He also happens to be a well known DXer. Antoine started visiting Rotuma in July 1991, when he spent one month on the Island using the call 3D2AG/p. Further time was spent there in December 1991, December 1992, March 1993, and September 1993 to February 1994. His latest trip was from November 1996 to January 1997. All these visits were connected with his profession and amateur radio was an "attractive second activity".

Let's share some parts of Antoine's letter, full of practical information should you

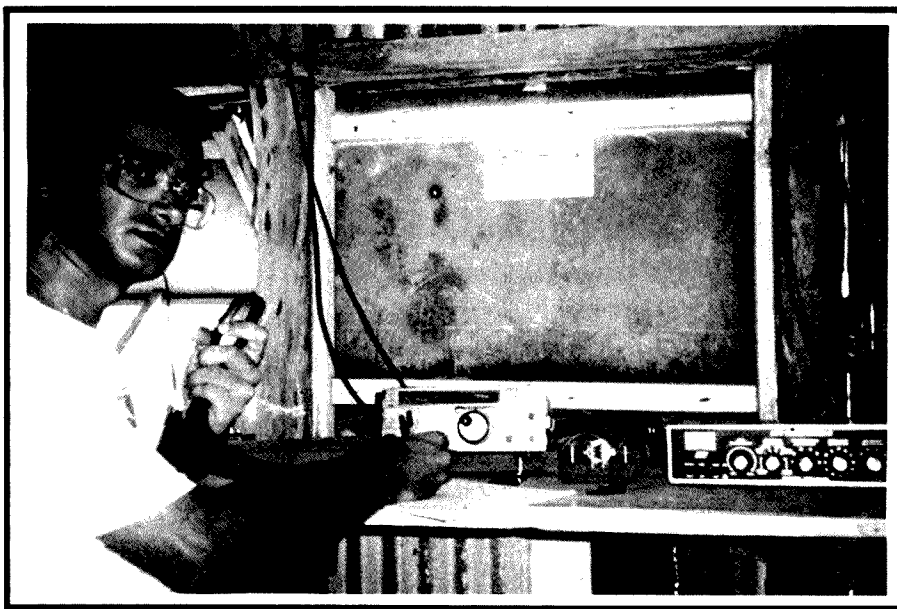
decide to undertake an individual DXpedition to the island.

*"The island of Rotuma is historically a part of the Fiji Islands. It is 400 miles north of Fiji (12°30'S and 177°E), and its relative isolation resulted in a population and culture distinctly different from any other Pacific island. It is nine miles long and three miles wide and has a population of about 3000.*

*"The island gained separate DXCC status in 1988, following the 3D2X activity of two weeks, with some 34,688 QSOs. Since then, a number of other amateurs have visited the island, including Ron ZLIAMO, the late "Bing" Crosby VK2BCH, etc, but there are no permanent radio amateurs on Rotuma to date.*

*"Foreign visitors to Rotuma first need an entry visa and, if amateur, need to obtain in advance a Fiji 3D2 licence and import permit for their equipment. Since Rotuma is politically part of Fiji, the 3D2 call is valid both in Fiji and Rotuma. However, one must bear in mind that tourism is neither encouraged nor catered for on Rotuma, in a bid to protect the traditional Rotuman culture and safeguard the pristine natural environment.*

*"Access to the island is limited, being restricted to weekly 25-seater flights from Suva and an irregular boat visit every two*



**Antoine 3D2AG in his Rotuma "shack".**

*Suva and an irregular boat visit every two months or so. The plane trip takes about two hours, while the boat takes two days. There are no regular hotels on the island and, in order to live there, one must know a family beforehand, and bear in mind that this is not a money-oriented society. In fact, all food except tea, sugar, etc is locally grown, and most islanders are occupied on their family plantations, where the fertile soil yields an abundance of root crops and tropical fruits. Hence, visitors to the island should either adapt to the local diet, or rely on expensive food imported from Fiji.*

*"The "capital" of the island is Ahau, where the local council, post office, police station (two policemen) and hospital are found. Unless they are there for a short holiday, foreign visitors should consult with the District Officer in Ahau to formalise their purpose of stay. There is no power supply on Rotuma, and many families rely on small petrol generators, or, alternatively, some villages have a communal diesel generator. However, in order to have a reliable source of power, one should take one's own generator, or use solar panels with a 12 V battery (the option I took).*

*"During my November 1996 to January 1997 visit, my base locality was the small village of Fapufa, located on the south-west coast. This village consists of three houses and a church, and is the smallest and most isolated village on the island. Also, it is one of the best DX locations. The "shack" consisted of a palm-frond hut, with provisions for a bed and operating table inside. The shack is located about 10 metres from a beautiful white sandy beach and crystal-clear lagoon.*

*"The antenna system consisted of a Hustler 4BTV vertical for 40-10 m and a*

*dipole antenna, strung between two coconut trees, for 80 m and the WARC bands. Unfortunately, the Cushcraft A3 tri-bander left earlier by the 3D2XX operation was no longer present, so it was very difficult to operate under the poor propagation conditions using only a vertical antenna and barefoot power. I used a Yaesu FT-757GX transceiver, coupled to a MFJ-941C antenna tuner and a Bencher CW key. Power was supplied by three 12 V/3 A solar panels connected to an N70 car battery, and the set-up worked very well. Needless to say, there is plenty of sunshine on Rotuma."*

*Antoine continues: "A total of 3,120 QSOs were made over a period of 42 days, with about 70% on CW and the rest on SSB.*

*"Overall, the expedition was successful, and it is hoped that many amateurs got a "new one" as a result. Next time, I hope to be able to take a beam antenna to the island, should someone be kind enough to assist me in getting one. My stay on the island also revealed to me the beauty and fragility of the Rotuman natural habitat, which is best kept in its present pristine state. The mainly Polynesian population is extremely kind and friendly, and crime is practically non-existent on the island. In order for this paradise-like situation to remain, it is imperative to restrict uncontrolled access to the island by western civilisation. For us amateurs, this would mean careful planning of our activities and behaviour, so that any future DXpedition would leave as little negative impact as possible on the islanders' way of life. In so doing, Rotuma will hopefully remain the tropical paradise and rare DX country it presently is."*

*So concludes Antoine's most interesting and informative letter.*



## AMATEUR TRANSCIVER RADIO CENTRE

ALL YOUR AMATEUR TRANSCIVER REQUIREMENTS.  
LEADING SUPPLY OF HF/VHF/UHF BASE - MOBILE - H/HELDS AT COMPETITIVE PRICES

**ALINCO** COMPLETE LEADING RANGE OF ALINCO TRANSCIVERS & ACCESSORIES  
AUTHORISED DEALER

**ICOM** AUTHORIZED DEALER

**KENWOOD** AUTHORIZED DEALER

**cushcraft**

No. 1 AMATEUR QUALITY ANTENNAS  
AUTHORISED DEALER

**AMERITRON** HF AMPLIFIERS FOR BEST PERFORMANCE

CALL FOR YOUR LATEST FREQUENCY FAVOURITE  
EXPAND YOUR COLLECTION

PHONE (02) 9896 2545

141 GILBA ROAD,  
GIRRAWEE, NSW 2145

## Huang Yan Dao - BS7H

According to previous news, this activity will take place in the first week of May 1997. Tim N4GN, in a news release, said that planning for the DXpedition to Huang Yan Dao (Scarborough Reef) is proceeding on schedule. Several team members, including Wang BA1OK and Kan JA1BK, met recently in Guangzhou to finalise all details regarding the ship with Captain Wang Jian-Xi and his crew. Arrangements were also made for generators fuel, food and the numerous other supplies necessary to ensure the success of the operation.

The following amateurs will be in the team of operators: Wang BA1OK (team leader), Gong BA1DU, Chen BA4RC, Wang BD4RX, Jian BD7JG, Zhang BG7KW, Kan JA1BK, Kazuo JAIRJU, Wayne N7NG, Jim W6EU (ex-WA6AUE), and Bob W6RGG. QSL via Kan JA1BK.

## Tunisia - TS40A

Tunisia is celebrating its 40 years of independence during the period of 10 April to 10 May with a special event station. Delegations from various amateur radio clubs, including the German DARC, will participate in the celebrations. During the last week of March, 3V8BB operated as TS8A to celebrate the eight years of the presidency of Mr Ben Ali, the President of Tunisia.

The newly founded Association of Tunisian Radio Amateurs (ASTRA) is applying to the IARU for membership. There is a possibility that Tunisia will be represented in Friedrichshafen, Germany at the traditional "Ham Radio 1977" Fair in June. In the meantime the DARC foreign department is co-ordinating the schedule of guest operator activity at 3V8BB.

## Future DX Activity

\* Five German amateurs will be visiting the Faroes(OY) between 7 and 20 June. They plan to operate on 160-10 metres using a variety of antennas (dipoles, verticals and Beverages). Look for the following call signs and operators: OY/DK6QW Michael, OY/DF8QJ Claus, 3Y/DL3QQ Joerg, OY/DL4YBZ Werner, and OY/DL7YFB Reinhardt. QSL for all the activity goes via Alfred DK4QQ.

\* Peter ON6TT has returned to his job in Uganda and was heard as 5X1T.

\* DJ0PJ will be active as FY/DJ0PJ from French Guyana until 6 May on 10116, 14060, 18080 and 21060 kHz.

\* After three years absence, PZ1BS is active again from Suriname.

\* Mike XU6WV is active from Cambodia on 3512, 7004 and 7007 kHz. QSL via K0TLM.

\* If you are lucky, you might catch Pierre



**The Hustler vertical antenna on top of an ironwood tree at Antoine's 3D2AG Rotuma QTH.**

HB9AMO operating from Kinshasa, Zaire as 9Q5BQ, on CW on 20 metres. QSL to home call.

\* Desmond ZD7DP is active from St Helena on 80 metres from the end of March with an inverted-vee and 400 W.

\* HB5CC is a special event station on air from the 1 April until 31 October. It is being operated by the ARC of St Gallen to celebrate the 50th anniversary of the foundation of USKA, the Swiss National Organisation for Amateurs. QSL via HB9BCK.

\* Ray ZD7RH is a newly licensed station on St Helena Island, active on 20-10 metres with an FT-101E and wire antennas.

\* Piero IK2BHX will be back in Zaire after Easter and hopes to be active again as 9Q5HX for six months. QSL via IK2MRZ.

## Interesting QSOs and QSL Information

\* 9K2GS/NLD - Abdul - 14200 - SSB - 0557 - Feb (E). QSL via WB6JMS, James L Arther Jr, POB 84, Atwood, CA-92601, USA.

\* J43CRN - Kosta - 14195 - SSB - 0606

- Feb (E). QSL via SV3YY, Kostas Nikola Kopoulos, PO Box 1236, GR-26332, Patra, Greece.

\* 5Z4FM - Jim - 14166 - SSB - 0610 - Feb (E). QSL via Bureau or via CBA, Cecil James Stewart, PO Box 34168, Nairobi, Kenya, Africa

\* JY9QJ - George - 14030 - CW - 0634 - Mar (E). QSL via DL5MBY, Ullrich Helgert, Appenzeller Str 53, D-81475 Munchen, Germany.

\* 7X4AN - Mohamed - 7008 - CW - 0717 - Mar (E). QSL to Mohamed Boukhiar, PO Box 263, Zeboun, 13200 Tiemcen, Algeria, Africa.

\* N4BQW/KH4 - Chuck - 14215 - SSB - 1148 - Mar (E). QSL via WA4FFW Mark D McIntyre Sr, 2903 Maple Ave, Burlington, NC 27215, USA.

\* GD3AHW - Rip - 7004 - CW - 1823 - Mar (E). QSL via the Bureau.

\* 8Q7BE - Hans - 14019 - CW - 1023 - Mar (E). QSL via DL8NBE, Hans Joachim Ingenhag, Grabinger Weg 8, D-97618, Unsleben, Germany.

\* FO0SSJ - Jim - 14164 - SSB - 0514 - Mar (E). QSL via K8JRK, Gerald C Totten, 5346, W Frances Road, Clio, MI 48420, USA.

\* FR5DD - Jean - 21020 - CW - 0527 - Mar (E). QSL via (CBA) Jean Pierrat, 8 Ave des Bandamiers Les Filaos, F-97434, Saint Gilles de Bains, France.

\* 9M6TCR - Charlotte - 21202 - SSB - 0648 - Mar (E). QSL via KQ1F, Charlotte L Richardson, 11 Michigan Drive, Hudson, MA 01749, USA.

\* K8VIR/ZL4 - Ed - 14222 - SSB - 0555 - Mar (E). QSL via Ed Hartz, PO Box 9, Te Anau, New Zealand.

## From Here and There and Everywhere

\* Merv VK4DV is "tickled pink" or, as he puts it, "I am like a dog with two tails at the moment". To understand Merv's joy, one must think back to the first activity of XY1HT from Myanmar. The Union of Myanmar (formerly Burma) was established officially in 1974 and amateur radio was banned. The first authorised operation of XY1HT as a demonstration station took place on 19 September 1994. Thirteen CW/SSB QSOs and four SSTV QSOs were made, all with East-Asian stations, except one. Merv VK4DV contacted them at 0725 UTC on 14 MHz SSB and received a report of 54. It took him almost three years before he was able to secure a QSL card for this historical occasion. Finally his prayers were answered. He received a card via Ray, one of the operators, who is now active in Malaysia as 9M2/G3NOM. Writes Ray to Merv: "I am sorry you have had to wait, but at least it is an

historic QSL, because you were the only contact outside East Asia". Congratulations Merv, well done!

\* VI4BEF and VI4MOO were special event stations operated by the Rockhampton Amateur Radio Club during the month of April, on the occasion of the "Beef Festival" which is held every two years in that city. QSLing will be automatic via the QSL bureau.

\* Percy VK4CPA (formerly VK3PA), the originator of the ANZA Net, started conducting the net on 20 May 1970, twenty seven years ago, on 21300 kHz, later moving to 21205 kHz. The net has operated since without any interruption. During the past three years the net opened up a secondary frequency on 14164 kHz, due to deteriorating propagation. It is active each day at 0500 UTC. Percy is in reasonable health despite a few health scares in the past two years. He is getting assistance in conducting the net from other willing helpers from Australia and New Zealand, but the strain of operating the daily net (or supervising when others are conducting it) does show up. He told me recently that he does not think he will last longer than two more years. Percy will be 88 years old this year and many of his friends, both in Australia and overseas, wish him continued good health, perseverance and a long healthy life. Please read the special article about this remarkable gentleman, in the true sense of the word, in the September 1990 issue of *Amateur Radio*.

\* There are still quite a number of very honourable QSL managers. Bruce BV2KI has returned the IRCs and "green stamps" to Hans, SWL40370, because Bruce, for a variety of reasons, was late sending the BO0KC QSL card.

\* A fax received by Austin VK5WO from DXCC indicates that there is no further news about Mani's activity on Andaman Island. Mani VU2JPS had been asked by the Indian Government to suspend operations pending further clearances. At present, the VU2JPS cards are not accepted for DXCC purposes.

\* The DXCC received 252 applications (24,436 QSLs) for endorsements and new awards during the month of February.

\* According to a small item in the 3 April issue of the *Sydney Morning Herald*, Tom Christian (also known as VR6TC), the great-great-grandson of the *Bounty's* Fletcher Christian, is in Australia seeking help to have an airstrip built on remote Pitcairn Island. Its population of about 200 in immediate post-war years is down to 40 and Tom thinks air access would boost tourism and keep young people from leaving. Tom says that if the population falls further, there won't be enough men to do essential work, and the island might have to be abandoned. Tom

wants to take a civil engineer back to Pitcairn to survey a runway of at least 2000 feet, which would allow an air link to Mangareva to the north-west and thence to Papeete. Aviator-adventurer Dick Smith (also known as VK2DIK) will pay the cost of getting the engineer to and from Pitcairn by ship and will help raise the money to build the airstrip.

\* Alan VK4AAR is now the QSL manager for Frank YJ8AA.

\* Ed K8VIR/ZL4 was active from Auckland Islands for a number of days early in April. He was part of a scientific expedition, therefore his amateur activity was limited. Despite all this, he regularly checked into the ANZA Net on 14164 and appeared also on the IOTA frequency of 14260 kHz. He prefers that QSLs from the Pacific Region should be sent to his New Zealand address, Ed Hartz, PO Box 9, Te Anau, NZ. Cards from the rest of the world should be sent to his home call address in the 1997 Call Book. He used two callsigns, K8VIR/ZL9 and ZL9DX.

\* The short DXpedition to St Peter Island, VK5ISL, was a success. Around 2000 contacts were made. A detailed report will follow in later issues.

\* The WIA Victorian Division, and the WIA Queensland Division, announced world-wide that they are the only IARU recognised QSL Bureaux in the VK3 and VK4 call areas. Cards via the Bureau system should be directed to the addresses below. Any other Bureau operating in the VK3 and VK4 call areas is privately operated and has no association or distribution agreement with the WIA. The VK3 and VK4 Bureaux will not process cards from, or to, any private bureau operating in the respective call areas. The inward official Bureau addresses are as follows: VK3 - Box 757G, GPO Melbourne, VIC 3001; and VK4 - Box 638, GPO Brisbane, QLD, 4001.

\* The well known DXer, Wayne Mills N7NG, has been appointed by the ARRL President as Chairperson for the DX Advisory Committee. Incidentally, Wayne will be one of the operators in the next Scarborough Reef activity.

\* Mamuka 4L2M, President of the National Association of Radio Amateurs of

Georgia, advises that the following callsigns are pirate stations: 4L2DX, 4L3Q, 4L44N, 4L50K, 4L55K, 4L6HMC, and 4L7F. All Georgian amateurs are using the 4L prefix and have only two letters in the suffix with one number. Extra class amateurs and club stations have one letter in the suffix with one number. The new address of the Georgia QSL Bureau is: PO Box 123, Tbilisi 380004, Republic of Georgia.

\* Larry F5PYI has announced that he is the QSL Manager for George 9J2GA in Zambia. He has the right to answer past dated QSOs but he will confirm those QSOs first via packet with George.

\* Stations active from Kure Island (OC-020) will have the letter K as the first letter of their call after the prefix, ie KH7K\*\*.

\* Peter ON6TT says Yaesu are sponsoring the TOOR, TOOR/mm and VK0IR colour QSL cards which are being printed in Germany.

\* Six new licences have been issued to local operators in Mali (TZ) but Yatt TZ6HY is the only one active on the bands. A club station is being built to enable other members without equipment to be on the air. QSLs to TZ6HY go direct to: BP 395 Segou, Mali, Africa. To confuse the issue, another DX publication gives Yatt's address as: BP 8044, Bamako, Mali.

\* Lithuanian amateurs are now permitted to operate on 1810-2000 kHz CW and 1840-2000 kHz SSB.

\* It has been reported that Chris ZS8IR has left Marion Island and returned home.

\* Dan N9XAG/XT2DP has returned home from Burkina Faso. QSL via WB2YQH.

\* Eric FT5ZG is a regular on 7004 kHz at 1730 UTC from Amsterdam Island. His QSL manager is F5RQQ. QSL via the Bureau to the manager or direct to F5RQQ, Jean Mare Vigier, 4 IMP Des Lys, 63800, Cournon D'Auverne, France.

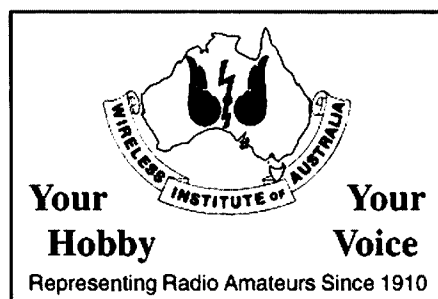
## QSLs Received

TR8XX (4 m op), FWZOI (4 m DJ401), T88T (4 m N50K), KC6AA and V63CQ (4 w JA6CM), BO0KS (8 m BV2KI), 3V8BB (3 m DL2HBX).

## Thank You

Many thanks to my amateur friends whose assistance is a great help in compiling these notes. Special thanks to VK2XH, VK2KFU, VK2TJF, VK4DV, WIA L40370, VK5WO, VK6LC, 3D2AG, K8VLR/ZL4, ARRL DXCC, *The Sydney Morning Herald*, *INDEXA*, *QRZ DX*, *The DX News Sheet*, *The 425 DX News* and the *GOLIST QSL Managers List*.

\*PO Box 93, Dural NSW 2158  
ar



---

---

# International Amateur Radio Union Monitoring Service (IARUMS) – Intruder Watch

---

---

Gordon Loveday VK4KAL\*

## Region 3 Monitoring Service News

In the main these notes are taken from the Region 3 February summary.

Amateurs in Northern parts of Australia are being hard hit by constant intrusions emanating from our nearest neighbour, Indonesia. One experienced observer notes, "The 7 MHz band is getting worse, masses of high powered transmitters make amateur radio operations impossible". Another source notes that all DX signals are obliterated and asks, "When can we see a stop to this horrendous intrusion on our amateur bands?"

The answer to this question is that a decrease of intruding signals cannot be expected until Indonesian authorities can get on top of unlicensed transmitters. Indonesia is made up of many islands and an Indonesian official told me that to mount a concerted effort against these transmitters would

present the administration with a huge co-ordination problem.

The best form of defence, therefore, would seem to be continued harassment of the unwanted signals in the portion of the band which you wish to use. Indeed, some VK and ZL operators are becoming very adept at this unwanted skill. Other possible aids are maybe the use of directional antennas and to employ filtering systems.

The Indonesian problem will be among those to be raised at the forthcoming Region 3 Conference in Beijing.

## Monitoring Service Update

As conditions improve, so do the number of intruders reported. Voice nets and links, illegally operating on most bands, seem to be the main problem we face. These unlicensed operators have been the subject of many investigations and their origin is well known to the monitoring services in our region. The

only defence we have is to attack by trying to drown them out and interfere with their communications.

At each triennial regional conference this problem is brought to the attention of those attending. The promises of action are many, but sadly the number of intruders of this type seem only to proliferate. All is not doom and gloom, however. We do have some successes in removing broadcast stations, particularly when the station engineers are made aware that they are causing problems. Other Government type stations are also prepared to move when they are presented with overwhelming data from the various monitoring stations.

So, keep the reports coming in – they are our best form of ammunition

## Stop Press

A note to hand from the DARC MS, ex TRT Ankara about changes to their 500 kW transmitters as of 27 Jan 97. The transmissions previously on 7.100 MHz have now been re-located to 7.300 and 8.040 MHz, so they are no longer intruders, provided they stay on frequency.

*\*Federal Intruder Watch Co-Ordinator, Freepost No 4  
Rubyvale QLD 4702 or VK4KAL@VK4UN-1  
ar*

---

---

# Over to You – Members' Opinions

---

---

All letters from members will be considered for publication, but should be less than 300 words. The WIA accepts no responsibility for opinions expressed by correspondents.

---

---

## A CW Only Licence?

Like Greg Short VK6JK (March *Amateur Radio*), for many years I have followed the for-and-against CW arguments. Recently I had a letter from Daniel Bischoff, FISVE. He saw my article **Morse Not Required** (*Amateur Radio*, May 1995) and he asked the WIA for permission to translate it and offer it for publication in the French ham magazine *Radio REF*. Permission was readily granted. Daniel did the translation and then he got cold feet.

Daniel hasn't taken the French Morse test and operates on 144 MHz and above. Consequently, he felt that he had no credentials to criticise the requirement of the Morse test. Furthermore, a year or so ago the *Big Brass* (sic) in France declared the Morse test sacrosanct and was not to be questioned. Daniel thus thought it likely that my article would be rejected.

Undeterred, Daniel has started learning Morse on his PC. Then, as he says, "...I shall redirect my guns on those who insist to keep the Morse test." Daniel is 61 and an

electronics engineer and became a ham three years ago. He says that "...some good 'souls' made me understand that one becomes a real (true) radio amateur only if one can work the decametre bands." So he tried to learn Morse but laboured under heavy handicaps: "...age, ears injured in military service and a total lack of dedication!" Thus he exclaims, "Why on earth do you have to know CW to be allowed to go around the world on decametric bands? When I can do it by satellite without knowledge of CW," Daniel felt that my article gave him a good answer. Daniel can be contacted by satellite or on e-mail: [svedan@worldnet.fr](mailto:svedan@worldnet.fr)

But where has all this CW chat got us? Or perhaps, more correctly, where is it supposed to be getting us? What is it that we seek? Quite frankly I'm not sure any more. In 1995 I was a zealot in the cause of scrapping CW as a mandatory requirement, but now I lean towards the notion that so long as the air is alive with CW an examinable provision is essential.

Are there snags with the idea of licensing

people purely for CW operation alone? Certainly it's much cheaper playing about with CW and a rich field to plough for QRP enthusiasts. But is a pure CW licence a reasonable proposition?

**Bob Hawksley VK2GRY**  
21 Wallumatta Road  
Newport NSW 2106

## Clandestine Radios

The writer is researching the history of the clandestine radios used by SOE and other secret intelligence organisations during WW2.

Significant quantities of two models, the Type 3 Mk 2 and Type "A" Mk 3, found their way to this part of the world and, after the cessation of hostilities, through government disposals mostly into the hands of equipment starved amateurs of the day.

Just how many came to Australia is one question of interest. If you possess either of these models I would greatly appreciate it if you would let me know the types and serial numbers of your equipment. In the case of the

Type 3 Mk 2, in addition to the stamped number on the receiver front panel, I would also like to know the numbers which can be found pencilled on the receiver and transmitter chassis, sometimes with some initials alongside (probably the wiring inspectors). It is believed that these pencilled numbers are the true chronological production numbers, whereas the external stamped number was arbitrarily inflated in order to confuse the enemy when equipment was captured.

As an example, a Type 3 Mk 2 which I am presently restoring bears the external stamped serial No 45975 and has the much more realistic pencilled numbers of 2107 on the transmitter and 1801 on the receiver.

If you once owned any of this equipment that you know has been scrapped, advice of this would also be useful in order to help build the complete picture.

**Bill Scovell VK2KFE**  
**13 Tulani Avenue**  
**Daleys Point NSW 2257**

### Morse an International Language?

How often have we heard that Morse is an international language? This was recently paraphrased by K Gerhardt in March *Amateur Radio*, where he stated, inter alia, "Also people in different countries with different languages can communicate effectively in Morse, as pronunciation of words is not relevant".

What a load of rubbish! Does he honestly mean that, if he was sent a message in Greek, Russian or Kata Kana Japanese, he would clearly understand it? If he does, then I congratulate him, but fear he must be a rather lonesome operator.

Please, no more of this nonsense. Morse is a method of communicating in a number of languages. But the sender and receiver must both be competent in the language used or the message will be incomprehensible.

On second thoughts, one could bump up the power several thousand watts; that was the way to get terrible ignorant foreigners to understand English - shout at them!

If Morse is so vital to emergency communications, why don't the emergency services use it, or at least have the equipment for use when necessary? Let us be honest. We are hobbyists and, like all good citizens, we help out as best we can when needed. Neighbours may drive ambulances or help feed evacuees, but does this mean they should have some special qualification? No, each helps out in a manner best suited to their ability and this is as it should be with amateur radio operators.

In the distant past there may have been a need for proficiency in Morse but that need

has long gone with the Dodo and the Latin language. Nobody has suggested that those who wished to should not study Latin, nor has it ever been suggested that those who wished to use Morse should not do so.

Compulsory proficiency in Morse makes as much sense as compulsory proficiency in Latin.

**D Palmer VK2TMP**  
**20 Elm Street**  
**Tamworth VIC 2340**

### Morse Gone but Not Missed

The use of Morse code at sea has almost disappeared and will have been totally phased out by 1999. At that time all ships will have to be fitted with radio communications fitting the GMDSS standard. This standard takes into account the area in which the ship operates, distance from shore and her size.

In the latter half of 1996 we saw the performance of the equipment specified by GMDSS when four yachts were found in the Southern Ocean. These boats were dismasted and upside down, the crews very cold and wet. I have done drills with survival suits similar to the gear worn by these survivors and I can assure readers that operation of a Morse key in the conditions these guys found themselves in is totally impossible.

Safety considerations aside, there are strong economic reasons Morse is disappearing very quickly. They are cost and convenience. The ships I work in are fitted with satellite systems, usually Marisat "C". The latest satellite system that I am aware of is Marisat "M". This works at up to 64 kbits/sec and it is possible to transmit video over the link. You can imagine the advantage of showing the manufacturer a picture of some malfunctioning equipment while being miles away, possibly at sea.

### MARISAT "C"

This is basically packet radio at 600 bits/sec. The message is either to a fax or telex machine, Internet, ISDN, or another Sat "C" installation. We use a type approved notebook computer and Thrane & Thrane transceivers. The antenna is about the size of two three-inch flower pots stuck open-ends together. In the trade journals a Sat "C" station will cost you from about \$5,000 to

\$10,000. Incidentally, there are a large number of trucks using this system to keep in touch with their head offices automatically. It is possible to have the GPS and engine log attached to the Sat C so the boss knows where you are and how your truck is, and tell you where to go next without the driver having to do anything other than read the printout.

Our provider's price lists are in three books about 2" thick each, so I have used messages to Australia as a guide. Basically your message goes to a land station (Perth) and then by land-line. Land-line charges can be extra if the address is overseas. This means the price is hard to work out here, but the relative price will be quite accurate in the following example:

### Costs

Current prices (as at February 1997): 1 SDR = \$US1.51 and 1 Gold Franc = \$US0.49.

Marisat A	TLX	SDR2.85/min
	TF & Fax	SDR3.752/min
Marisat B	TLX	SDR2.476/min
	TF & Fax	SDR2.47/min
Marisat M	TF & Fax	SDR2.66/min
Marisat C	TLX	SDR0.57/kbit
	Fax	SDR0.57/kbit
	Data	SDR0.57/kbit

### HF Services:

Telex over radio	4.66 Gold Francs/min
Radio Telephone	5.25 GF/min
Telegraphy (Morse)	2.33 GF/word

### A Sample Message

What does this mean in dollars? A fax using Sat "A" is about \$AUS10.00/page. A telex message using Sat "C" and five bit Baudot is about 0.5 cents/character. Sat "B" and "M" are cheaper because the speed is higher. Morse telegraphy is \$1.46 a word of 10 characters or less.

Using the last paragraph as an example, we have 215 characters and 49 words. To transmit it by Sat "C" would cost approx \$1.10 plus \$0.60 confirmation, if requested. However, the Morse telegram would cost about \$71.00.

Do you really believe that Morse is going to survive in the real world?

**Steve Truscott VK2SPT**  
**158 Regal Way**  
**Valentine NSW 2280**  
 ar

**Have you advised the WIA Federal Office of your new callsign? Use the form on the reverse of the Amateur Radio address flysheet.**

---

---

# Pounding Brass

Stephen P Smith VK2SPS\*

---

---

There has been a lot of discussion lately in relation to the beginning of Solar Cycle 23. Some believe it has already started, whilst others believe it will commence in the latter part of this year. However, it doesn't really matter who is right or who is wrong; what does matter is that band conditions are gradually improving, resulting in more contacts, both local and overseas, which brings me to the issue of operating practices.

## Operating Practices

One of the most important pieces of advice I ever received in relation to sending Morse over the air was to listen, listen, listen. It is better to take a couple of minutes to listen to the band before jumping in head first and calling CQ. Listening gives you the feel of the band; it tells you where the majority of signals are coming from, whether they are local or overseas, whether there is QRM, QRN or QSB. One can learn a lot by just taking the time to listen.

At one time or another in our operating career we have tuned up on frequency without listening and blindly called CQ, only to be politely told at the end of the call to QSY by an irate operator with whose contact you have doubled. So that the above situation doesn't happen to you, find a frequency you believe is clear, by listening first, and then send QRL (is this frequency clear). If there is no response, it's safe to assume the frequency is clear and you can proceed with your call.

There are two ways to initiate a contact. You can transmit a CQ call, or you can answer someone else's call. If you are a beginner to the band and feel a little nervous about sending your first call, don't worry; it's better to answer someone else's call than sit back and do nothing. Then, as your confidence and operating ability increases, your nervousness will be a thing of the past.

Whether you send or answer a call, be brief in your response. Use the recommended 3x3 call as laid down by the SMA in their regulations booklet.

To the beginner I recommend you stay with the 3x3 call as mentioned above, although you will hear stations shortening or lengthening the standard 3x3 call. Short calls have merits under certain circumstances, but long calls don't! Avoid picking up bad habits from other operators. If in doubt, use a 3x3 call.

## Short Call

A short call is only recommended for contest situations, or under very good

propagation conditions, especially on bands above 30 MHz where conditions can change within minutes.

For example: CQ test de VK2SPS **AR**

or: CQ CQ de VK2SPS **AR**

*Contest is abbreviated to test. **AR** = end of message (more on this later).*

## Long Call

Anything greater than the standard 3x3 call is not recommended. It just wastes time and reflects on one's operating ability as a poor operator. I once counted 18 CQs in one call from a JA station.

## Answering a Call

Send the station's call three times, followed by DE, then your call three times, followed by **AR** which signifies end of message.

For example: JA1XX JA1XX JA1XX de VK2XX VK2XX VK2XX **AR**

The line under **AR** signifies no break between the A and R; when sending, it should be sent as one letter.

Some operators substitute **AR** for **KN**. This is incorrect as we haven't yet established contact. Once contact is made and the QSO is in progress, **KN** can be sent. **KN** signifies that only that station should respond to that call.

Once contact is made, it is customary to send name, QTH and signal report on the first over, and rig, antenna and weather on the

next. Some operators send the above all in one over. It really depends on conditions at the time. Common sense dictates that the information should be sent in order of importance. Having exchanged the information with the other station a decision has to be made whether to continue the QSO or terminate it. To continue with the QSO you can talk about virtually anything, limited only by your imagination.

To terminate a QSO, it is better to follow the correct procedure by using SK. This signifies the end of the QSO.

For example: SK JA1XX de VK2SPS EE

The double E represents cheers, and is responded to with a single E. This practice is very common on the bands today.

If you want to go QRT, then you finish with CL, as this lets everybody know that you are clearing the frequency and don't want to make any more contacts.

For example: SK JA1XX de VK2SPS CL EE.

Some operators persist in calling, even after hearing the CL, just to make a quick contact or to add to their DXCC tally. Respect the operator's wishes and let him go; he/she will be on frequency another day.

## Summary

1. Listen to the band first.
2. Find a frequency you think is clear.
3. Send QRL?
4. If no response, send CQ.

See you next month with abbreviations used in QSOs.

\*PO Box 361, Mona Vale NSW 2103

ar

---

---

# Update

## The Heard Island Experience

I find that one of the easiest errors to make when preparing copy for *Amateur Radio* magazine is dyslexia of the fingers when keying in call signs. Such errors are also the hardest to pick up during proof-reading.

Also, a cardinal rule is that, if any errors are going to sneak through the system, at least ensure they do not occur on the front cover or in a prominent part of the lead article.

Who was it who said that rules are there to be broken? Unfortunately, the reversal of two

letters changed David Muller VK2JDM's call sign into VK2DJM in two major places in last month's *Amateur Radio*. Not only in the caption to his photograph at the head of the article on page 7, but also on the front cover!!

My humblest apologies, not only to David VK2JDM, but also to Jim, the real VK2DJM.

It might be a good idea to correct your copy of the April 1997 issue of *Amateur Radio* now.

Bill Roper VK3BR

ar

Your

Hobby

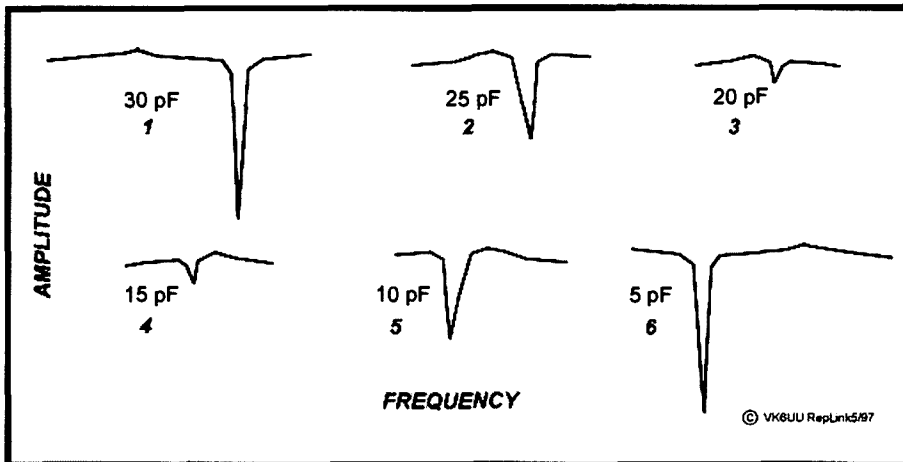


Your  
Voice

Representing Radio Amateurs Since 1910

# Repeater Link

Will McGhie VK6UU\*



## COMMERCIAL CAVITY FILTERS

Any amateur who has been involved in the construction and management of repeaters is most likely to have come across commercial cavity filters. In particular, the VHF type that tune to our two metre band. These high Q

filters, which stand some 0.6 m (2') high, are a basic requirement for most repeaters, even those using split antennas. The filters help to prevent the repeater's transmitter from interfering with the repeater's receiver. Also, cavity filters can greatly improve the repeater receiver's rejection of other signals, such as pagers.

## OPERATION

When cavity filters are used they can be configured to operate in two different modes. The first is as a band-pass filter. RF is fed into one connector and coupled through the filter to the other connector. Frequencies away from the frequency to which the cavity filter is tuned are attenuated. The further away the greater the attenuation. However, even in such a high Q filter, the amount of attenuation 600 kHz away (the repeater split on two metres) is only about 10 dB. For a 600 kHz split two-metre repeater to work, about 100 dB of attenuation is required. This would require 10 band-pass cavity filters, all connected in series. Ten filters per port are required for the repeater's receiver and transmitter, a total of 20 filters.

The loss per cavity is about 0.5 dB making a total of 5 dB loss in the receiver and transmitter of the repeater. As you can see, the band-pass mode of a cavity filter is not suitable with 600 kHz split two-metre repeaters. Twenty cavity filters make for a big duplexer.

The second mode of operation of a cavity filter is the notch mode. A capacitor or inductor is connected between the input and output connector of the cavity filter and the RF signal applied in the same way as the band-pass mode. The correct value of capacitor, added between the input and

output connector, results in a very sharp notch 600 kHz down from the pass frequency.

The inductor produces a notch 600 kHz above the pass frequency. This notch is typically 35 dB down 600 kHz away. When cavity filters are used in this mode, only three are required to produce the required 100 dB of attenuation. A total of six cavities is required for a duplexer, three in the receiver and three in the transmitter.

## DISTANCE APART

The difficulty with some commercial cavity filters is the distance apart of the input and output connectors. For 600 kHz separation, the inductor used to produce the notch above the pass frequency is a straight piece of wire soldered directly between the two connectors. However, the connectors have to be 64 mm (2.5") apart to produce the correct value of inductance. If the connectors are closer together this is not a problem, as the wire can be bent. But if the connectors are further apart than 64 mm, there is difficulty in reducing the resulting inductance and hence how far away the notch is. The larger value of inductance, due to the connectors being too far apart, results in the notch being greater than 600 kHz away.

This is a basic problem that is difficult to overcome in some commercial cavity filters. In some commercial cavities the input and output connectors are on opposite sides of the filter, while other filters have the connectors on the top. So, how can you use a cavity filter with the notch on the high side when the inductance, due to the distance apart of the connectors, is too high?

The answer is, like many problems, simple and not new. For some amateurs trying to modify commercial cavities, it may be what they are looking for.

Insert a capacitor in the wire inductor and cancel out some of the inductance. In effect, the length of wire becomes electrically shorter. The cavity's connectors may be too far apart but the series capacitor overcomes this.

## DIAGRAM

The accompanying diagram will make all this clearer. The typical response of a cavity filter connected in notch mode is just that, a fairly straight line with a notch in it. The line is not completely flat but has a small broad peak where minimum attenuation occurs. This minimum attenuation point, and the notch point, have to be 600 kHz apart for two metre repeaters.

Let's assume the input and output connectors are more than 64 mm apart, as is the situation with many commercial cavity filters, resulting in the pass-to-notch

## Radio Books for Australia

### Shortwave Eavesdropper CD-ROM

Gives instant access to well over 32,000 frequencies and 42,000 callsigns listing military, tactical, ships - naval and merchant, embassies, aeronautical, press agencies, weather stations and countless more. Also in-depth country by country information containing QSL addresses, schedules, examples of traffic, and maps, DX Edge.  
Price: £19.50 including airmail.

### Shortwave Maritime Communications

World's coastal stations and shipping frequencies are listed as well as detailed chapters on how best to monitor all the maritime bands.....£17.00

### Scanner Busters 2

Explains new technology, encryption used and how best to scan on VHF/UHF bands.....£7.50  
Prices included postage to Australia

Also books on Weather, Military and Scanning. Ask for FREE  
Catalogue of all books.

## INTERPRODUCTS (AR1)

8 Abbot Street, Perth. PH2 0EB, UK  
Tel. & Fax: 0011-44-1738-441199  
e-mail: interproducts@netmatters.co.uk



---

---

## Spotlight on SWLing

Robin L Harwood VK7RH\*

---

---

Sometimes I sit down at my computer and wonder what to write about in this monthly column. Usually there is a snippet of news that easily makes it, but there are times when it is difficult to find something worthwhile to report.

At present, there seems to be an air of gloom over the future of short-wave broadcasting from Australia. As you are aware, the Mansfield Report recommended that the ABC scrap its external radio and television broadcasting, to concentrate on domestic programming. Severe budgetary cuts were imposed on the ABC which required that the administrators look at ways to reduce the budget. Some thousands of employees were made redundant and some programming alterations have already been made, particularly to domestic radio.

The proposal to completely axe the external services seemed to win the endorsement of the Communications Minister, Senator Alston and some in the ABC hierarchy. However, it is apparent that there are quite a few loyal radio Australia listeners who are really worried that the short-wave service may be silenced. At the time of writing, a Senate select committee is investigating the future of the external services and the Minister was also reported in the *Sydney Morning Herald* as favouring a Radio Australia English service be continued via satellite but axing the various language services. It seems to have escaped the Minister's attention that satellite receiving equipment is not readily available to the public and what equipment there is, certainly is far more expensive than a cheap short-wave portable which is readily on sale in the targeted areas of Radio Australia.

The recent political developments within Papua-Nuigini which forced the resignation of the Prime Minister, Sir Julius Chan, following the use of mercenaries to reportedly train the troops to suppress the Bougainville uprising and the violent reaction of the PNG defence personnel to these events, clearly demonstrated the importance of Radio Australia's Tok Pidgin Service. News of the crisis was extensively broadcast from Melbourne as the local media was hesitant to become involved. I personally do not have audience figures but I would suggest that many in PNG and in the Melanesian region eagerly listened to what was happening via Radio Australia. And still largely rely on the service in the lingua franca of the region. Also, I believe that RA may be the sole international broadcaster in that

language. In fact, at the height of the crisis, RA came on in the morning with a special Tok Pidgin service covering the crisis. The service is easily heard here on 6020 kHz from Townsville and 6080 and 9710 kHz from Shepparton from 0800 till about 1200 UTC.

Whilst we are on PNG, the main national program from Port Moresby is also easily heard on 4890 kHz in our local evening hours and spasmodically runs throughout the night, depending on power availability. In the daytime it is also often heard on 9675 kHz. The various provincial stations are mainly heard on the 90 metre band, that is between 3.2 and 3.4 MHz, but these are mainly in local languages with occasional English identification. They mainly sign off at 1200 UTC. With the high levels of summer QRN behind us, it is now the best time to hear them.

Naturally we are now in winter and, down here in Tasmania, I am finding that the daylight hours provide the best listening on short-wave. The main broadcasting allocations seem to have signals there and it does not slack off until the local sunset. Around midday local time I do hear European stations come over the South Pole on 6 and 7 MHz and you can hear the distinctive flutter for about an hour until propagation changes from another direction.

Notice, too, that a prominent electronic short-wave store and publisher - Gilfer Short-wave in Parkridge, NJ, USA - has ceased trading. They published *Ferrell's Confidential Frequency List for Utilities* and it is a shame to see that disappear. Fortunately, the *Klingenfuss Utility Guide* from Germany is still in publication and will fill the gap because it is an annual publication compared to the CFL being somewhat irregularly produced.

Talking of publications, Bob Padula's *Electronic DX Press* has added a catalogue and product directory. Several overseas short-wave publications, including many from the Klingenfuss stable, are available as well as *The Australian Short-wave Guide*, which is out now. It contains details of short-wave stations broadcasting to this region up to October 31. Price of this is \$10 within Australia and \$12 in New Zealand. For further details write to Bob Padula, 404 Mont Albert Road, Surrey Hills VIC 3127.

Well, that is all for this month. Until next time, the very best of listening.

\*5 Helen Street, Newstead TAS 7250  
VK7RH@VK7BBS.LTN.TAS.AUS.OC  
Internet e-mail: robroy@tassie.net.au

ar

frequency separation being more than 600 kHz. The addition of a 30 pF capacitor will reduce the frequency difference between these two points to, let's say, 700 kHz, and this is represented by drawing 1. As the capacitance is reduced, the notch moves closer to the minimum attenuation point and, let's say, is 600 kHz away as in drawing 2. Note, as the notch becomes closer to the pass frequency, the notch depth decreases considerably. This is the nature of cavity filters. The closer the pass-to-notch frequencies, the smaller the notch depth. Drawing 2 is now achieving the desired 600 kHz notch above the pass frequency, even though the input and output connectors produce a value of inductance which is too large.

Drawings 3, 4, 5 and 6 show how the notch moves from being above the pass frequency to below the pass frequency as the series capacitor is reduced in value. Drawing 5 represents the notch 600 kHz below the pass frequency, and drawing 6 represents, say, 700 kHz below the pass frequency.

### COAX

I used a spectrum analyser to try this out and found the inductor could be coax. Place a T piece on both the input and output connectors so that a short length of coax can be used as the inductor between the input and output connectors. The length-cancelling capacitor is then inserted into the inner conductor of the coax. The advantage of using coax between the connectors is that there are no modifications to the cavity and therefore no need to open up the cavity filter. The outer braid is intact between the connectors; just open it up and insert the tuning capacitor.

The tuning up procedure I will have to leave to you, as I have used enough words just getting this far.

I hope this description, along with the simple diagram, is able to be understood. It is surprisingly difficult to put technical descriptions into words.

\*21 Waterloo Crescent, Lesmurdie 6076  
Packet: VK6UU @ VK6BBR  
E-mail: will@vate.faroc.com.au

ar

**Prevent pirates -  
make sure you  
sell your  
transmitter to a  
licensed amateur**

# VHF/UHF - An Expanding World

Eric Jamieson VK5LP\*

All times are UTC.

## VK Activity

Max VK3TMP at Somerville on the Mornington Peninsula had a variety of contacts during February. Here are some extracts from his log:

1/2:	1054	144	VK5AKK	5x3
	2308	144	VK6AS	5x2
2/2:	1338	144	VK5NC	5x7
4/2:	0945	144	VK7JG	5x9
	0950	432	VK7JG	5x2
8/2:	1211	144	VK5DK	5x7
14/2:	2320	144	VK5NC	5x9
	2323	1296	VK5NC	5x4
15/2:	2240	144	VK5NC	5x7
16/2:	2201	144	VK6AS	5x3
	1105	144	VK5KCA	5x7
	1215	144	VK5NC	5x9
	2154	144	VK5KCA	5x5
	1155	432	VK5DK	5x9
	1201	1296	VK5DK	5x6
17/2:	1012	1296	VK3ZQB	5x9
	1017	1296	VK5DK	5x1
18/2:	0907	144	VK7XR	5x9
	0930	432	VK7XR	5x7
	0934	144	VK7JG	5x3
	0933	1296	VK7XR	5x5
	0939	1296	VK7JG	5x3
19/2:	2152	144	VK7XR	5x9
20/2:	0926	144	VK7JG	5x7
	0930	432	VK7JG	5x2
21/2:	2201	144	VK5NC	5x7
23/2:	2231	144	VK5AKK	5x3
24/2:	0931	144	VK5MC	5x3
	0943	1296	VK3DEM	5x9
	1125	144	VK5KCA	5x5
25/2:	0937	144	VK5AKK	5x4
	0945	432	VK5AKK	5x1
	1001	144	VK5NY	5x5
	1008	144	VK5LP	5x1
28/2:	0916	144	VK5NC	5x1
1/3:	2150	144	VK2ZAB	5x2
3/3:	0957	144	VK5NC	5x1

It is an encouraging sign to see 1296 MHz contacts featuring more often in so many logs.

## Ross Hull Log

Andrew VK7XR, at my request, sent a copy of his recent Ross Hull log, which covered the full period of the contest. What stands out in the listing of 356 contacts is the daily consistency of being able to work across Bass Strait to several stations in Victoria on 50, 144, 432 and 1296 MHz, with VK3DEM, VK3TMP, VK3ST and VK3XRS on 1296 MHz with signals at times to 5x9.

Without detracting from Andrew's daily operating schedules, the log shows that there are advantages in being relatively close to areas of high operating density.

Andrew included a summary of stations worked and these were: VK1 x 2, VK2 x 20, VK3 x 30, VK4 x 28, VK5 x 9, VK6 x 1, VK7 x 1, ZL x 14.

## Dxpedition

Jack Haden VK2GJH advises that he will be flitting between islands in the Pacific from June onwards, on the small inter-island merchant ship *M/V Maasmond* and will attempt to activate the following islands on six metres, from ashore, radio permission having been obtained for the callsigns to be used.

3D2JH	28/6 - 29/6	Rabi Island
3D2JH	01/7 - 02/7	Suva (Fiji)
T20JH	05/7 - 07/7	Funafuti
T30JH	11/7 - 13/7	Tarawa
T33JH	15/7 - 23/7	Banaba (Ocean Island)
T30JH	27/7 - 28/7	Tarawa
3D2JH/p	01/8 - 02/8	Rotuma Island
3D2JH	05/8	Suva (Fiji)

Equipment used will be an Icom IC-736 HF-plus-six-metres transceiver with 100 watts on all bands including six metres. A trap dipole will be used on 80 to 10 metres and a vertical on six metres. As work takes priority during the trip, no scheds will be made or maintained, but an attempt will be made to activate each island. Any maritime mobile working will be using the callsign VK2GJH/mm. Six metre calls will commence on 50.110 MHz.

Hopefully, there will be some winter Es to allow contacts back to VK and ZL - the vertical antenna may or may not assist, depending upon the mode of propagation and general conditions.

QSL via Mr Jack D Haden, PO Box 299, Ryde NSW 2112. Return postage required for a QSL, and no cards through the Bureau please.

## Overseas

Chris Gare G3WOS, Chairman of the UK Six Metre Group, sent a press release on 20/3 stating that the UKSMG has been in communication with Ezzat Ramadan, SU1ER, President of the Radio Amateurs Assembly of the Radio Club of Egypt, in Cairo, on the basis of encouraging six metre activity from Egypt during their summer.

Ezzat already has ten watts on 50MHz and

the UKSMG will assist in procuring a 100 watt amplifier. Ezzat's house is 140 metres above sea level, and the building is 25 metres high with a Rohn tower 6 metres in height, therefore the total height will be 170 metres above sea level or 30 metres above the ground, so there should be a good take-off for 6 m.

Band 1 TV activity continues in Egypt and there is a 48 MHz TV transmitter north-west of Cairo so it is not possible to say what problems will eventuate.

The above is mentioned in these columns to inform DXers that this will be a new six metre country. VKs should make a note of possible Egyptian activity when Cycle 23 becomes alive.

The UKSMG Web site for further information is [www.uksmg.org/egypt.htm](http://www.uksmg.org/egypt.htm) and [g3wos@uksmg.org](mailto:g3wos@uksmg.org) is the e-mail address of Chris G3WOS.

Geoff GJ4ICD sent news from *Ham Radio Today (HRT)* as follows:

## Uganda on 144 MHz EME

On 11/3 history was made by 5X1D as he completed the first 144 MHz EME QSO with Dave W5UN. Gus (5X1D) only has one 17 element Boomer and 300 watts out. At present stations can only be worked when the moon is near the horizon. Scheds can be made via email to: [jageror@wfp.or.ug](mailto:jageror@wfp.or.ug)

## Microwave News

A new UK 24 GHz record of 391 km between G4KGC and PA0EZ. Charlie Suckling G3WDG reports in HRT:

*"An interesting 24 GHz QSO took place on 14/1/97. Following a phone call from Arie Dogterom PA0EZ, asking to check the 391 km path between IO92RG and JO22OF. We heard signals both ways and G4KGC and PA0EZ made the QSO at 0935.*

*"An hour later, after rushing home from work, G3WDG also made the contact and signals remained audible for a long time. Previous openings on 24 GHz from our station to the east coast to G3LQR and G4DDK were always very short lived. We have tried the path to PA0EZ several times when 10 GHz signals were extremely strong (more than 40 dB out of the noise) and 24 GHz never worked to the Netherlands during previous tropo ducting.*

*"We are not sure what made this QSO work - a combination of tropo ducting, relatively low humidity over land and a warm front - detailed weather information would perhaps be the key to predicting future openings. Temperature at ground level seems not to be a great issue, the temperature during the first QSO was slightly below freezing and then warmed to 9 degrees C when signals were still unchanged.*

"Equipment at our end was a WDG009/DB6NT Mk 2 transverter with a PA and LNA feeding a 10 inch offset dish. System NF is about 4 dB and power output is 400 mW into the dish. Thanks to Peter G3PHO for the information."

## Another World Record

"On 12/3/1997, a new world record for EME on 10 GHz was set in a QSO between Joe DJ7FJ and Greg ZL1GSG at 0830. DF7FJ operated from Schiltach in south western Germany and ZL1GSG from Awhitu Peninsula/Manukau Heads south west of Auckland, New Zealand. The great circle distance between the QTHs is approximately 18340 km or just under 10000 nautical miles. DF7FJ and his team were using a 4.5 m parabolic dish and a 50 watt travelling wave tube power amplifier, while ZL1GSG used a 3 m dish and a similar PA. "O" reports were exchanged both ways.

"Congratulations to Greg ZL1GSG and Joe DJ7FJ from their New Zealand ground support team of the day, Bill ZL1TTH, Tim ZL3VTV, and Ulrich ZL1DDL. Thanks go to many amateurs who helped with the provision of equipment, time, and a QTH."

News and views please to: Geoff Brown GJ4ICD, Belmont Rd, St Helier, Jersey CI. Tel/fax 01534 877067 or e-mail equinox@iit.net

## The VK 5.7 GHz Story

These columns have reported the progress of 5.7 GHz contacts in VK as they have occurred, which has been somewhat piecemeal. Here is a summary of all reportings:

20/10/96 VK6ZAY/6 to VK6ZWZ/6 236.0 km  
06/11/96 VK5KK/3 to VK3XPD/3 248.1 km  
11/11/96 VK6BHT/6 to VK6ZWZ/6 378.4 km  
11/01/97 VK6BHT/6 to VK6ZWZ/6 433.9 km  
18/01/97 VK5NC/5 to VK3XPD/3 501.5 km  
11/02/97 VK6KZ/6 to VK6BHT/6 379.0 km  
12/02/97 VK6BHT/6 to VK6ZWZ/6 544.0 km  
16/02/97 VK6BHT/6 to VK6ZWZ/6 614.3 km

For the present, the last named contact is a VK6 and national record. To really put the seal on the record it seems the next logical step is a contact across The Great Australian Bight. Who will be the first?

## New Records

John VK3KWA advises the following new records:

1. 144 MHz: New record VK3 and VK6  
VK3DEM - VK6KDC 16/01/97 2862.2 km
2. 432 MHz: VK2 record: Distance correction  
VK2ZAB - ZL1AKW 13/01/88 2305.1 km

3. 432 MHz: New VK3, VK6 and national record  
VK3DEM - VK6KDC 16/01/97 2862.2 km
4. 5.7 GHz: New VK6 and national record  
VK6BHT/6 - VK6ZWZ/6 16/02/97 614.3 km

## From the USA

Emil W3EP, in *QST's The World Above 50 MHz* for May, said that winter finally hit in February resulting in relatively sparse activity. "The lone 6 metre sporadic-E report came from Larry Lambert, ND8LL (EM09), who reported that Florida stations were working into his area of Kansas on 25 February around 1845 UTC.

"There was also an unusual early season duct between California and Hawaii. K6QXY (CM88) copied the 144 and 432 MHz KH6HME beacons on 17 February after 1600. The next day, K7JA (DM03) worked KH6HME (BK29) on 144.2 MHz around 2350.

"The only other news was the unexpected aurora and trans-equatorial opening over 17-18 February. The K index was as high as seven during the brief geomagnetic storm that evening. Stations as far south as a line from Virginia west to Kansas and on to Washington state reported good conditions on 50 and 144 MHz between 2300 and 0230.

"Trans-equatorial (TE) propagation often accompanies auroral conditions, and KP4EIT and WP4O (FK68) are in a prime location to work TE and had little trouble running a string of stations in Argentina and Uruguay on 50 MHz just about the time the aurora was in session. WP4O also found PY5CC. Stations from Florida to southern California are often able to work into TE propagation, but there were no reports from the mainland this time."

## Sporadic-E and FAI Programs

"Jim Roop K9SE, has announced the latest versions of his DOS-based SE-PROP and FLD-ALGN programs for plotting VHF paths via sporadic E, field-aligned irregularities (FAI), and aurora. Both programs now include maps for use virtually anywhere in the world. Windows versions of both programs will be available soon.

"SE-PROP has a number of interesting features, including MUF calculations and path prediction at any frequency based on a single known sporadic-E contact. It can also plot more complicated double-hop paths. FLD-ALGN displays the possibilities for FAI propagation based on a known active sporadic-E centre, among other features. In aurora mode, FLD-ALGN plots the region of possible aurora-scatter contacts based on the current geomagnetic K index and station location. Both programs can be downloaded

from Jim's Web page at <http://www.netcom.com/~wb9qiu>"

## Trans-equatorial Propagation

Openings on six metres via the TEP mode were noted around the world during March. *The Internet Six News* from Geoff GJ4ICD provides the best summary of events as follows:

2/3/97: JA to VK4 opening: 0312 46.170 VK4 TVQ-0 S7, 0442 VK4JH 5x9, 0452 VK4BKM 5x9, 0459 VK4FNQ 5x8, 0500 VK4WTN 5x5. ... de JA3EGE.

2/3: VK4 Ch 0 TV 46.17 video was strongly heard unusually late at 0730-0845 yesterday (1/3), but no success into VK4. 46.17 video appeared early at 0330 today (2/3) and JH1WHS (PM95) Yutaka worked VK4JH Joe at 0432 for the first time this year. JA1RJU (PM95) worked VK4BKM and VK4FNQ at 0434-0440. JA1VOK (QM05) exchanged 5x9 reports with VK4BKM, VK4FNQ and VK4JH and heard VK4BRG/b at 0436-0503, also 46.24 VK2 Ch 0 TV video at 0549 and 45.25 and 45.26 ZL Ch 1 TV video during the opening. JA5CMO (PM63) heard ZL Ch 1 TV sound on 50 MHz at 0530 for the first time this year after working two VK4s. JA6TEW (PM53) worked five VK4s at 0504-0606. VK4JH is believed to have worked into at least JA1/2/3/5/6/7/0 between 0432 and 0610. ... de JA1VOK.

John VK4FNQ from Townsville reports the opening in this manner: "2/3: 0430 BYTV From 0442 to 0511 the following were worked, most at 5x9: JA1VOK, JA3JTG, JF2HEV, JI2HCD, 7L2KOZ, JA0GSO, JN3PYQ/1, JH1WHS, JA1AUD, JK1DTO/1, JA2TKO, JI2EVL, JA2POK, JE4JFP, JL6FPH, JA6TEW, JJ4FHU, JH6RRR, JJ4WHO, JO6MEH and JR4XME. Heard JAs calling on 50.110 for another 15 minutes or so and BYTV faded soon after. Other stations heard working JAs were VK4JH, VK4BKM and VK4TL (Atherton)."

15/3: TEP JA-VK from JA3EGE: 0430 TVQ-0 video 46.170 S7, 0519 VK4JH 5x7, 0539 VK4WDM 4x3, 0545 VK4AR 5x5, 0557 VK4JSR 5x9, 0603 VK4GM 5x9 and 0611 VK6YBQ 5x9 - first opening JA to VK6 for 1997.

15/3: JA1VOK reports on TEP: "The 46.17 VK4 Ch 0 TV video appeared at 0353 this afternoon and quickly went to S9+. No VKs heard here, but JA3JTG (PM75) picked up VK4JH at 0524. Then VK4AR, 4EK, 4GM, 4DMI, 4JSR, 4WDM and VK6YBQ (OG86) were worked in JA1-6/0 area until 0630. VK6YBQ was worked as the first VK6 this year. I (QM05) exchanged 5x9 reports with VK4DMI/4JSR at 0603-0607. JA3JTG heard

two VK4 beacons and VK8RAS/b at 0530, but I heard VK8RAS/b 539-599 at 0600-0700 for the first time."

Scott VK4JSR refers to the opening on 15/3: "I worked the following JA stations via TEP, all contacts were SSB with signals 5x9: 0558 JA3EGE, 0559 JH0MHE, 0600 JA1RJU, 0601 JF2HEV, 0602 JH1IYD, 0603 JG2AJK, 0603 JK1DVK, 0604 JA1HEE, 0605 JA9IPF, 0607 JA1VOK, 0607 JH1PCS, 0608 JF2GWS, 0609 JH1ZKO, 0610 JA1VUT, 0611 JA1WUN, 0612 JA3JTG."

16/3: TEP update: JA1RJU worked VK4JH on 50.114 at 0544, JA1RJU worked VK4BKM on 50.130 at 0529. ... de VK3OT.

16/3: TEP into PY. Ed WP4O reported: "Weak TEP at 0015 into PY. It is interesting to note that TEP was produced in both JA/VK and PY/KP4 on the same day; what happened to EU/7Q/V51, were we not monitoring? Also, LU2EGQ reported hearing two stations in WP4 via TEP between 0027 and 0037."

23/3: VK TEP report: 0407 Vladivostok TV video on 49.759 MHz S2, last heard at 0550. ... de Scott VK4JSR.

26/3: V51VHF/b on 50.018 heard 529-579 at 1500 for first TEP opening to Italy for 1997. No South African stations were on the band. ... de Sergio IK0FTA.

27/3: 4X TEP opening: At 14.00 a very strong but short opening to V51 land! The V51VHF beacon was 59+ and after approximately 15 minutes faded away. Unfortunately, no stations were heard on six metres. We are still monitoring for further openings. This is the first TEP opening this year (as far as I know, talked also with 4X1IF). ... de Chris 4Z5JA.

It is interesting to note the world wide availability of TEP contacts in March 1997. A hint of better things to come? Because six metres has been available to VKs and JAs for many years, the TEP path between the two areas is legendary. However, it is now becoming obvious that those previously largely unexplored paths south from Europe to Africa and the USA to South America are possible. Best time for afternoon type TEP is from about 1200 to 1700 local time.

## Closure

Apart from the TEP openings to Japan, the equinox has been relatively quiet. So also the higher bands. Everyone must be concentrating on 10 and 24 GHz!

Closing with two thoughts for the month:

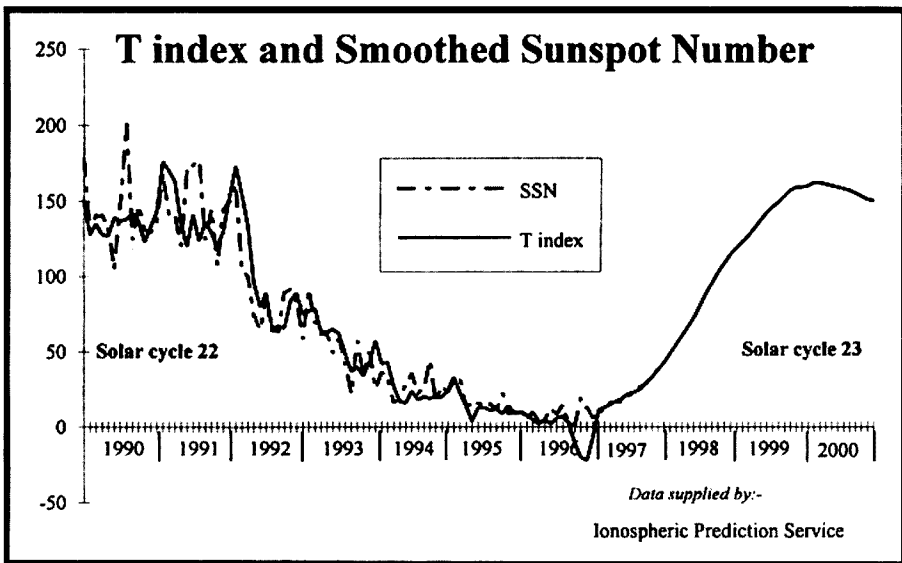
1. Whenever man begins to doubt himself, he does something so stupid that he is reassured, and

2. An argument is the longest distance between two points of view.

73 from *The Voice by the Lake*  
\*PO Box 169, Meningie SA 5264

# Ionospheric Update

Evan Jarman VK3ANI\*



## Solar Activity

Solar activity was predominantly at very low levels throughout the first quarter of 1997. Solar cycle 23 is now affecting activity. Observers are currently trying to work out when this turn around occurred. Early estimations point to around June last year. A cursory examination of the trend in the graphs of the daily T index over the this, and the last two updates (*Amateur Radio* November 1996, page 49 and February 1997, page 51), show a definite U turn in activity.

## Ionospheric Activity

There were some depressions in ionospheric conditions during the first quarter of 1997. These occurred around the periods of higher geomagnetic activity. The most severe were on 11, 27 and 29 January followed by 18 February. Maximum useable frequencies at these times were depressed by between 15% and 30%. On 10-12 February spread F was also observed in some southern regions of Australia.

## Geomagnetic Activity

There were several geomagnetic disturbances during the first two months of the year.

Two geomagnetic storm periods were reported on 10-11 January and 27-28 January when the Learmonth A index reached 26 and 27 respectively. In February the Ionospheric Prediction Service reported several geomagnetic disturbances. These disturbances could be grouped into three periods, 8-11 February, 16-17 February and 27-28 February. The largest disturbance was observed on 28

February when the Learmonth A index reached 26. March, by comparison, was quiet to unsettled.

## T Index

The Ionospheric Prediction Service revised the T index values in February. The new values are graphed. Predicted values have not changed. Only past values have been altered, particularly around the end of last year. A negative range has been added to the graph which shows how poor conditions were.

The monthly average T index in the graph of ionospheric indices is now increasing. This reinforces the feeling that the turn around in ionospheric activity is now underway.

## Geomagnetic Indices

The ionospheric update includes the Learmonth A index, which is provided by the Ionospheric Prediction Service. This index does not appear in textbooks that amateurs use, although the A index does. To prevent any misunderstanding, an explanation of this index, provided by the Ionospheric Prediction Service is included:-

[The geomagnetic] K indices are a measure of disturbance to the earth's magnetic field. Values are determined for three-hourly intervals and fall in the range 0 (quiet) to 9 (extremely disturbed).

The A index is calculated from three-hourly K index values and represents an overall magnetic activity index for a particular day. Although magnetic activity is

## Ionospheric indices

January to March 1997

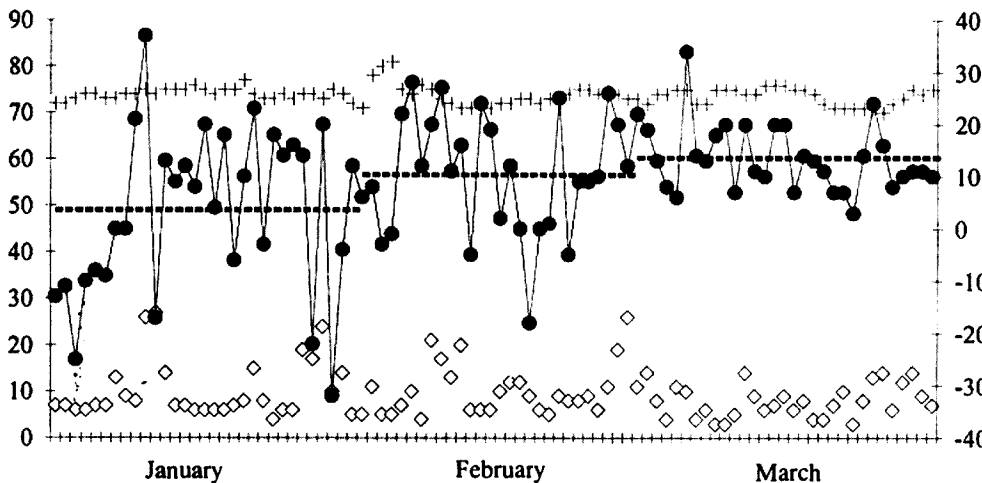
T index (right side scale)

Solar flux & A index (left side scale)

- |   |              |
|---|--------------|
| + | 10.7cm flux  |
| ◇ | A Learmonth  |
| ● | T (observed) |
| - | T (average)  |

*Data supplied by:-*

Ionospheric Prediction Service



a global phenomena, there are some differences between locations on earth. An A index can be defined for any magnetic observatory and will indicate activity for its region. The index from the Fredericksburg observatory in the USA is often [used] as a standard. The planetary index, Ap, gives a better guide to the world-wide level of

disturbance while local Australian indices from Learmonth are more appropriate for Australia.

The K index is a more immediate measure of geomagnetic activity. Three observatories, Canberra, Mundaring and Learmonth, provide the index. It is not presented here as the graph of ionospheric indices is a historical

reference.

Geomagnetic conditions and their corresponding ranges in the A index are: 0-7 (quiet), 8-15 (unsettled), 16-24 (active), 25-35 (minor storms) and above 36 (major storms).

*\*C/o PO Box 2175, Caulfield Junction VIC 3161*

ar

## Silent Keys

*Due to space demands obituaries should be no longer than 200 words.*

The WIA regrets to announce the recent passing of:-

DE	MACPHERSON	L21014
AH (Adrian)	CHRISTY	VK2ACY
A	HARRIS	VK2FFH
FA (Fred)	HULL	VK6FH

### Fred Hull VK6FH

It is with regret that we record the death of Frederick Atherley Hull on 27 January 1997 after coping courageously with a terminal illness.

Fred was born in Wellington, New Zealand on 12 October 1906. When he was about three years old his family, originally from New South Wales, moved back to Sydney where he received his schooling. The family moved to a farm at Pingrup in WA. Fred and his brother, Ray, who later became VK6RH, were both interested in wireless and in 1928 Fred left the farm and enrolled in Sydney with the Marconi School of Wireless. He qualified for a Commercial Operator's Certificate and joined the Institute of Radio Engineers. On his return to Western Australia he gained the AOCF and received the call sign VK6FH which he held until he died.

In 1930 the Japanese ship "Shunsie Maru" ran aground off Point Cloates near North

West Cape in WA and Fred was the radio operator on the salvage ship which towed the damaged ship to Surabaya.

When the first WA base of the Royal Flying Doctor Service was opened in Port Hedland in 1934 he was appointed as radio operator. These were the early days of Pedal Radio and School Of the Air and Fred's friendly voice became familiar to hundreds of outback people in the North West.

In 1937 Fred married Irene and they raised a family of two girls and a boy.

Fred was with the RFDS in Port Hedland until 1955, except for a break of four years in the RAAF. He studied the new techniques of Radar and in January 1942, with others, helped set up the first early warning system in Australia near Newcastle. In February 1942 he was involved in getting operational the AWS station at Darwin just after the first Japanese air raid and, in a short time, was placed in charge. Subsequently he was sent to set up the first operational AWS at Merauke in New Guinea. By the time he was discharged he held the rank of acting Squadron Leader.

At the end of the war Fred returned to Port Hedland. In 1955 he was appointed technical

and liaison officer for the RFDS in Perth and in 1967 became Managing Secretary for WA which position he held until retirement at the age of 70. He still maintained ties with RFDS on various Committees until failing health in the last few years curtailed this activity.

Fred was a member of the WIA and active in WICEN. He was awarded Amateur of the Year in WA in 1986. He was a foundation member of the AARTG (now called WAADCA). For many years he re-broadcast the ANARTS Sunday RTTY news. His efforts were recognised by the granting of life membership of WAADCA and the naming of a packet digipeater station VK6RFH at Wireless Hill. He was also active on the steering committee to establish the Telecommunications Museum at Wireless Hill. Despite his terminal illness, which extended for nine years, he maintained active interest in digital communications until a couple of months prior to his passing at the age of 90 years.

Fred's many amateur radio friends join in expressing their condolences to Fred's wife Rene and his family.

**Frank Taylor VK6JK and Patricia**

**Dicks VK6QL**

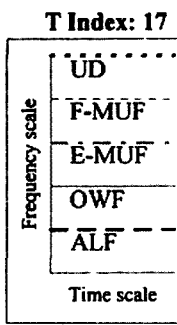
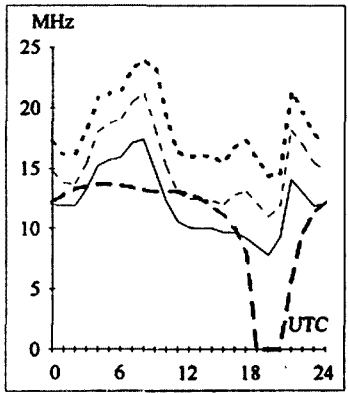
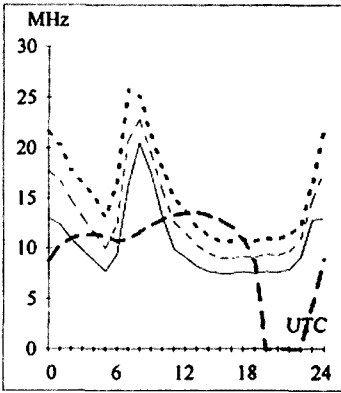
ar

**Adelaide-Dakar** 233  
First F 0-5 Short 16725 km

**Brisbane-Berne** 315  
First F 0-5 Short 16321 km

# HF Predictions

*Evan Jarman VK3ANI*



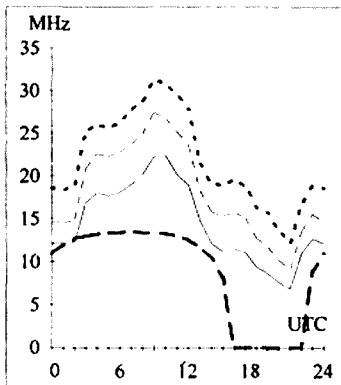
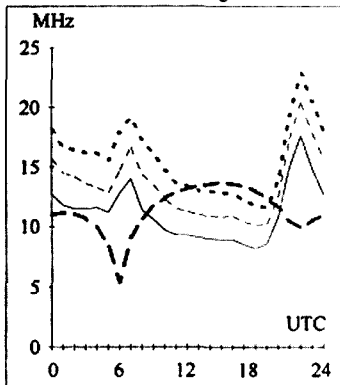
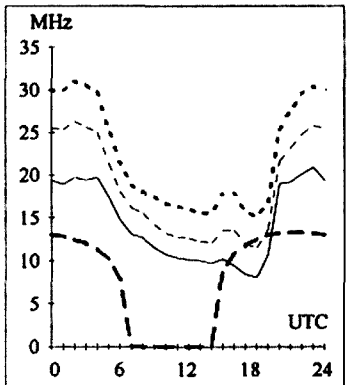
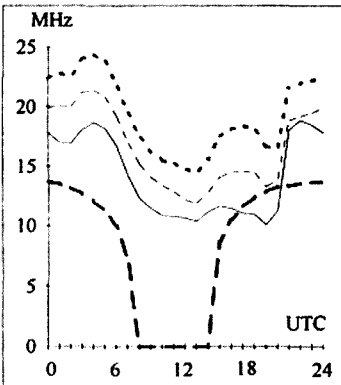
These graphs show the predicted diurnal variation of key frequencies for the nominated circuits. This also indicates a possibility of communication (percentage). The frequencies, identified in the legend, are:-  
 Upper Decile (F-layer, 10%)  
 F-layer Maximum Useable Frequency (50%)  
 E-layer Maximum Useable Frequency  
 Optimum Working Frequency (F-layer, 90%)  
 Absorption Limiting Frequency  
 The predictions were made with the Ionospheric Prediction Service program, ASAPS V3.2. The T index used is shown above the legend. The Australian terminal azimuth, path and propagation mode are also given for each circuit.

**Adelaide-Seattle** 51  
First F 0-5 Short 13413 km

**Brisbane-Los Angeles** 59  
Second 4F3-6 4E0 Short 11563 km

**Canberra-London** 136  
First F 0-5 Long 23042 km

**Darwin-Cairo** 298  
Second 4F2-7 4E0 Short 11609 km

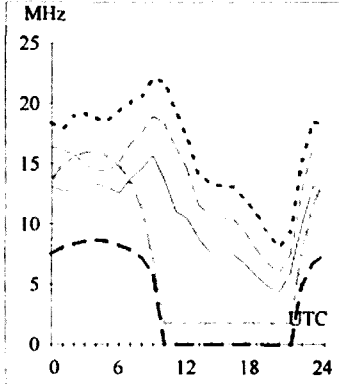
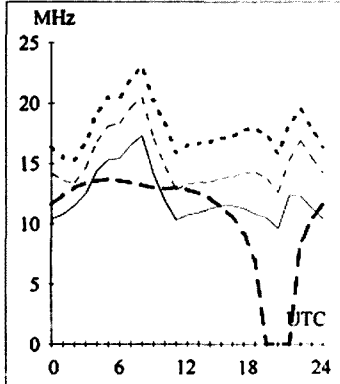
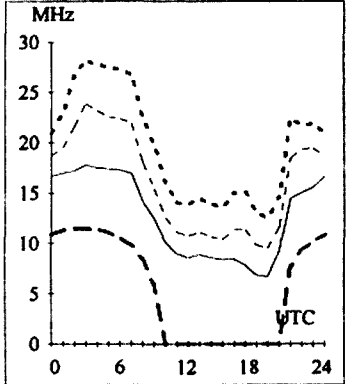
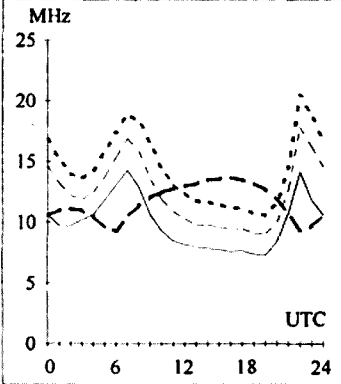


**Adelaide-Stockholm** 142  
First F 0-5 Long 25030 km

**Brisbane-Osaka** 344  
Second 3F6-10 3E0 Short 7149 km

**Canberra-London** 316  
First F 0-5 Short 16982 km

**Darwin-Manila** 340  
Second 2F12-21 2E2 Short 3198 km

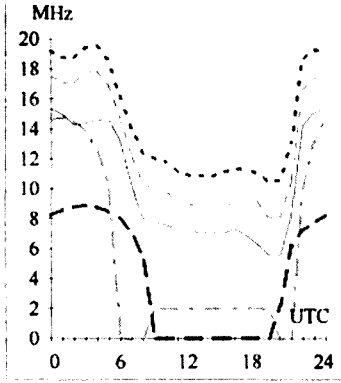
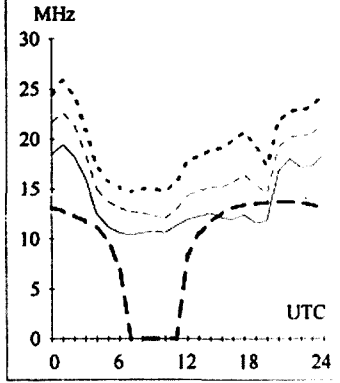
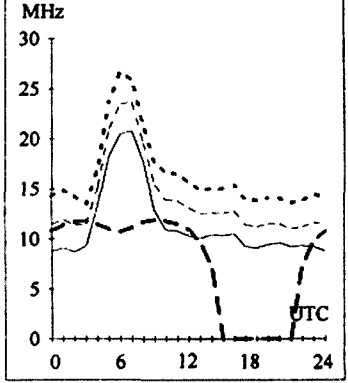
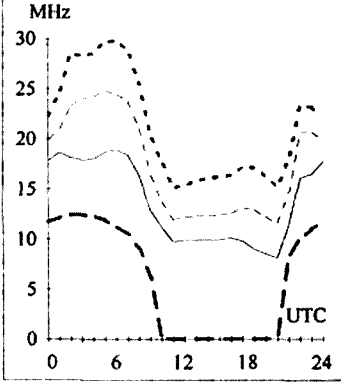


**Adelaide-Tokyo** 1  
Second 3F4-8 3E0 Short 7855 km

**Brisbane-Pretoria** 230  
Second 4F2-3 4E0 Short 11657 km

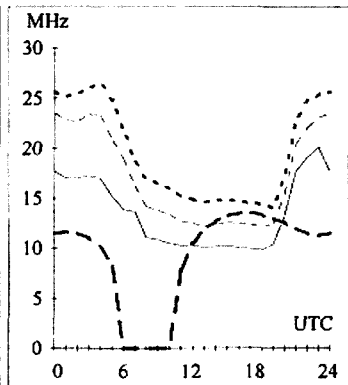
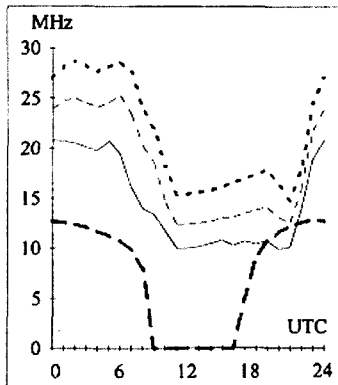
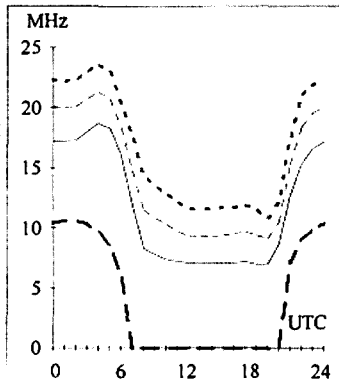
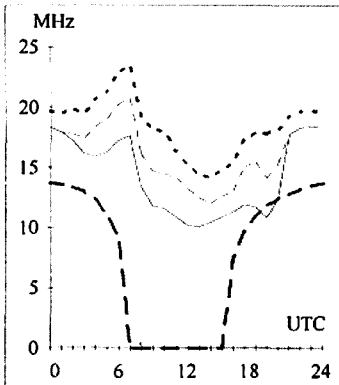
**Canberra-Washington** 70  
First F 0-5 Short 15939 km

**Darwin-Wellington** 135  
Second 3F11-13 3E1 Short 5321 km



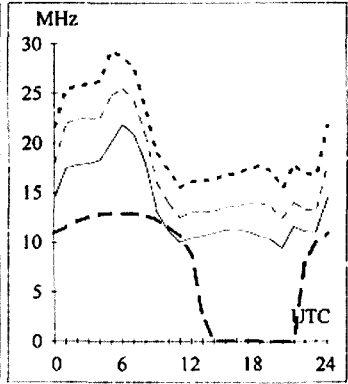
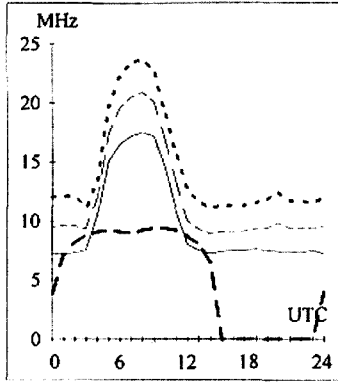
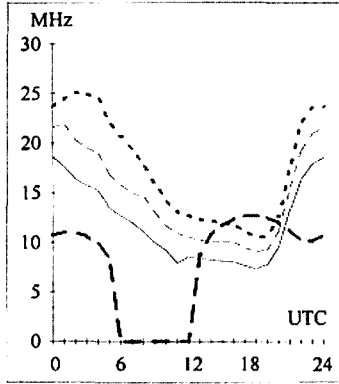
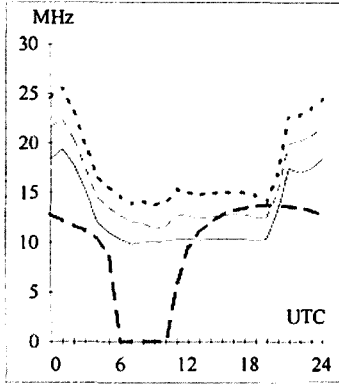
**Hobart-Anchorage** 28 **Melbourne-Auckland** 97 **Perth-Honolulu** 70 **Sydney-Barbados** 119

First F 0-5 Short 12872 km First 1F4-6 1E0 Short 2623 km Second 4F4-7 4E0 Short 10906 km First F 0-5 Short 16155 km



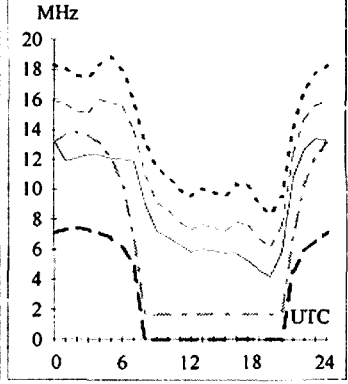
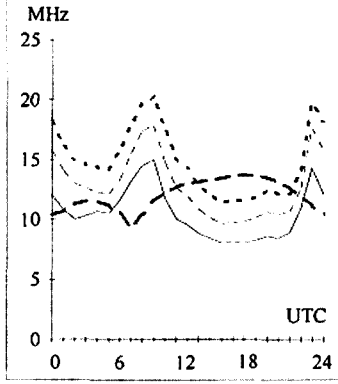
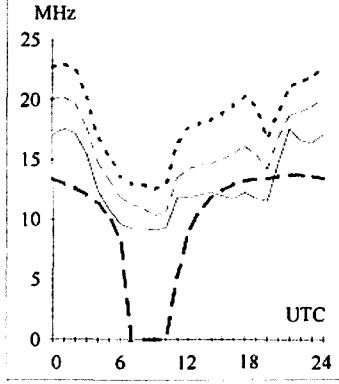
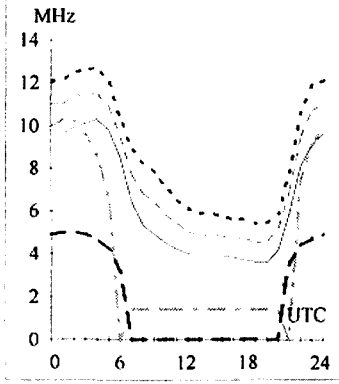
**Hobart-Boston** 78 **Melbourne-Lima** 133 **Perth-Johannesburg** 248 **Sydney-Islamabad** 304

First F 0-5 Short 16895 km First F 0-5 Short 12950 km Second 4F8-9 4E0 Short 8315 km Second 4F3-7 4E0 Short 11066 km



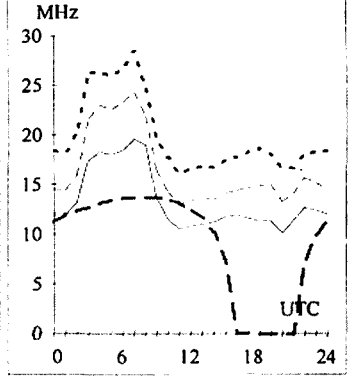
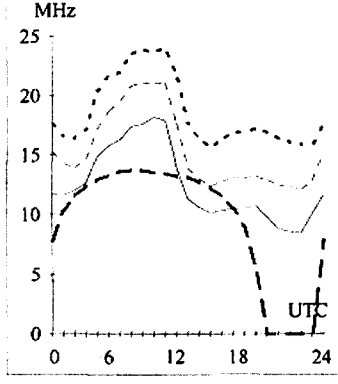
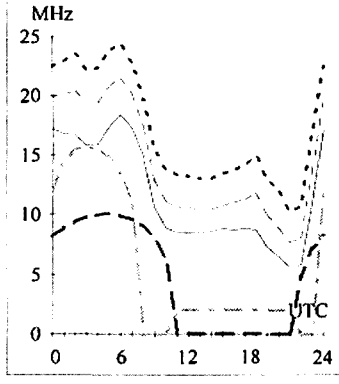
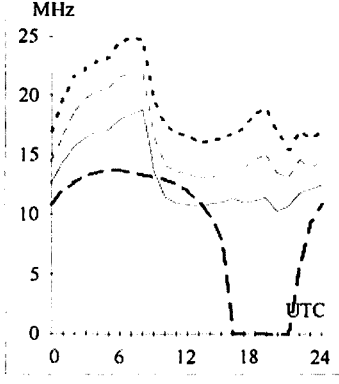
**Hobart-Christchurch** 101 **Melbourne-Montreal** 62 **Perth-London** 133 **Sydney-Port Moresby** 351

Second 2F23-26 2E7 Short 2040 km First F 0-5 Short 16733 km First F 0-5 Long 35543 km Second 2F16-19 2E4 Short 2740 km



**Hobart-Moscow** 312 **Melbourne-Singapore** 306 **Perth-London** 313 **Sydney-Tel Aviv** 287

First F 0-5 Short 14963 km Second 3F9-11 3E0 Short 6057 km First F 0-5 Short 14481 km First F 0-5 Short 14173 km



# HAMADS

- Hamads may be submitted on the form on the reverse side of the *Amateur Radio* address flysheet. Please use your latest flysheet where possible.
- Please submit separate forms for **For Sale** and **Wanted** items, and be sure to include your name, address and telephone number (including STD code) if you do not use the form on the back of the *Amateur Radio* address flysheet.
- Eight lines (forty words) per issue free to all WIA members, ninth and tenth lines for name and address. Commercial rates apply for non-members.
- Deceased estates Hamads will be published in full, even if the ad is not fully radio equipment.
- WIA policy recommends that the serial number of all equipment offered for sale should be included in the Hamad.
- QTHR means the address is correct in the current WIA Call Book.
- Ordinary Hamads from members who are deemed to be in general electronics retail and wholesale distributive trades should be certified as referring only to private articles not being re-sold for merchandising purposes.
- Commercial advertising (Trade Hamads) are pre-payable at \$25.00 for four lines (twenty words), plus \$2.25 per line (or part thereof), with a minimum charge of \$25.00. Cheques are to be made out to: WIA Hamads.
- Copy should be typed or in block letters, and be received by the deadlines shown on page 1 of each issue of *Amateur Radio*, at:

Postal: 3 Tamar Court, Mentone VIC 3194  
Fax: (03) 9584 8928  
E-mail: vk3br@c031.aone.net.au

## TRADE ADS

- **AMIDON FERROMAGNETIC CORES:** For all RF applications. Send business size SASE for data/price to RJ & US Imports, PO Box 431, Kiama NSW 2533 (no enquiries at office please ... 14 Boanyo Ave Kiama). Agencies at: Webb Electronics, Albury; Assoc TV Service, Hobart; Truscotts Electronic World, Melbourne and Mildura; Alpha Tango Products, Perth; Haven Electronics, Nowra; and WIA Equipment Supplies, Adelaide.
- **WEATHER FAX programs for IBM XT/ATs** \*\*\* "RADFAX2" \$35.00, is a high resolution shortwave weatherfax, Morse and RTTY receiving program. Suitable for CGA, EGA, VGA and Hercules cards (state which). Needs SSB HF radio and RADFAX decoder. \*\*\* "SATFAX" \$45.00, is a NOAA, Meteor and GMS weather satellite picture receiving program. Needs EGA or VGA & WEATHER FAX PC card, + 137 MHz Receiver. \*\*\* "MAXISAT" \$75.00 is similar to SATFAX but needs 2 MB of expanded memory (EMS 3.6 or 4.0) and 1024 x 768 SVGA card. All programs are on 5.25" or 3.5" disks (state which) plus documentation, add \$3.00 postage. ONLY from M Delahunty, 42 Villiers St, New Farm QLD 4005. Ph 07 358 2785.
- **HAM LOG v.3.1** - Acclaimed internationally as the best IBM logging program. Review samples....AR: "Recommend it to anyone";

The Canadian Amateur: "Beyond this reviewer's ability to do it justice. I cannot find anything to improve on. A breakthrough of computer technology". ARA: "Brilliant". Simple to use with full help, the professional HAM LOG is immensely popular (now in its 5th year), with many useful, superb features. Just \$59 (+ \$5 P & P), with a 90 page manual. Special 5 hour Internet offer. Demos, brochures available. Robin Gandevia VK2VN 02 369 2008 BH fax 02 369 3069.

Internet address rhg@ozemail.com.au.

- **Marconi Signal Generator CT452A**, 10kHz to 70 MHz, \$110. **AVO Signal Generator**, 2 MHz to 100 MHz, \$75. **Receiver-Exciter RT662/GRC106**, \$380. D Dauner Electronics, 51 Georges Crescent, Georges Hall NSW 2198, Tel 02 9724 6982, Fax 02 9725 7850.

## FOR SALE NSW

**Yaesu FT-101Z**, no mods, hand mike, manual, good condn, \$500. **Heathkit SB-100** with power supply, mike, manual, as is, \$300. **HCR-62** comm receiver, as is, \$50. **VK2YU**, QTHR, 045 677 483.

**Kenwood TS-680S**; **AT-230** tuner; **MC60** desk mic; **IC-02A** hand held; **Com-ant-ena** multi-band vertical; cartons, manuals, very good condn, \$1500 the lot. **Rod VK2BRW**, QTHR, 07 5524 3722.

**Dick Smith VK Power Master** power supply,

20 amp at 13.8 volts, assembled and working kit, \$180 ONO. **VK2BZE**, work phone 042 264 499 BH only.

**Deceased Estate: Kenwood TS-430S**, \$950. **PS-430** power supply, \$400. **AT-200** antenna tuner. **SP-280** speaker, \$100. **SM-220** station monitor, \$300. **Kenwood TS-120S**, \$450. **AT-130** antenna tuner. **SP-120** speaker, \$75. **Kenwood TM-201A** 2 metre, \$325. **Kenwood TR-8400** UHF, \$400. **Alinco DR-110T**, 2 metre, \$250. **Kenwood R-1000** receiver, \$300. And accessories. Licenced amateurs only. **John VK2FUR**, QTHR, 046 251 812.

**DG5 digital readout** for **Kenwood TS-520S**, s/n 730409, all leads, never been used since overhaul by Delta Base Comms, \$75, p&p free. **Bernie VK2IJB**, 068 921 302 anytime.

Two of **HP Vectra 286** PCs, EGA screens, 20 Mb HDDs, 4 x FDDs each, 2 x **HPIB Thinkjet** printers, mice, keyboards, books, \$45 each. **Honeywell XT PC**, keyboard, amber screen, no HDD, \$20. **John VK2WW**, 02 9546 1927.

**Kenwood TS-430** txcvr, manual, **Kenwood AT-200** antenna tuner, **heavy duty power supply** 25 amps plus, \$1000 ONO. **Peter VK2AGB**, QTHR, 042 948 423 AH, 02 9583 1046 Mon, Wed, Fri BH.

**TET HB33SP** three element tri-band beam, **KR400RC** rotator and controller, \$450 or exchange for HF6V or 5BTv vertical. Two section galv pipe mast with winch, \$100. **Alf VK2API**, 044 715 772.

**Kenwood TS-870S** txcvr plus **PS-53** PSU, \$3700. **TS-440SAT** txcvr, \$1350. **AEA AT-300** ATU, \$150. **VGC**, ONO. **Laurie VK2II**, QTHR, 02 9999 3993.

Special. **Yaesu FT-101E**, complete, excellent running order, s/n 4J319365, \$200. **Bob VK2GZ**, 434 George Bass Drive, Malva Bay NSW 2536.

## FOR SALE VIC

Entire station. **Kenwood TS-120S**, PSU, ATU, all cables, mike, Morse key; **Icom IC-2A** plus two batteries, charger, 12 V converter for car; **Yaesu mobile antenna** set; various bits including plugs and cables. Most items in original packing with manuals. **Jean VK3DJM**, QTHR, 03 9484 6361.

**Yaesu FT-10R**, 2 m FM handheld, s/n 6F08 0220, brand new (came as a bonus), \$300. **Jim VK3DBQ**, QTHR, 03 9811 9427 BH, 03 9467 1253 AH.

**Hi-Ace camper van**, suit the mobile ham, fully furnished, four antenna outlets, two batteries and wiring for comms equipment. **Wal VK3WD**, QTHR, 03 5435 2274.

**Kenwood TM-241A** mobile rig, s/n 42100431,



with **Brainer F23A** 5/8 wavelength vertical base antenna, **Diamond** mobile antenna, aluminium carry cradle for portable or home-base set-up, excellent condn, boxed, sales dockets available, \$500. **Kent Morse key**, solid brass, \$85. **Jack VK3AAC**, 03 5127 3905.

**FL-2100Z** linear amplifier, s/n 5D10025, \$600. **FT-290R** with mobile mounting bracket and nicads, s/n 3E270921, \$350. Instruction manuals for both. **Jim Payne VK3AZT**, 03 5427 2113.

**Kenwood TS-700SP** 2 m all mode txcvr, complete with external VFO, \$650. **Icom IC-730 HF** txcvr, \$600. Both units in good working condn. **Damien VK3RX**, 03 5427 3121.

**Kenwood TS-870 HF** txcvr, s/n 80300020, with hand-held mic, in very good condn, \$3100. **Kenwood PS-52** 20 A PSU, s/n 50700115, VGC, like new, \$460. **Jim VK3NR**, 03 9367 6920.

**Kenwood TS-930S HF** txcvr, 160-10 m, auto ATU built-in, IRC switchable narrow SSB filtering professionally installed, Shure 444 desk mic, users handbook and workshop manual, spotless as new condn, \$1445 ONO. **Bill VK3BR**, QTHR, 03 9584 9512.

#### FOR SALE QLD

**Kenwood TS-530S**, s/n 1121004; **MC-35S** mic; **MC-50** mic; **Datong AS** processor, 0-30 dB, s/n 2147/A; **MFJ941** tuner; **SX3** pre-selector; **Archer** high power low pass filter; **EP-2000** SWR meter; **Auto** rotator; **EB-31** tri-band dipole, 10-15-20 m; **Clipsal** 10 A power line filter. Only licensed hams to apply. **H Cox VK4OX**, QTHR, 07 5497 5308.

**Yaesu FT-747GX** with FM board, s/n 9M250558, original box, manual, \$800. **MFJ-949D** Versa Tuner, SWR meter, dummy load and 4:1 balun with manual, \$200. **Steve VK4EMS**, QTHR, 07 3261 3693.

**Rohde & Schwarz** signal generator SMS 302.4012.25, 0.1 to 520 MHz, AM/FM, digital readout of frequency, modulation, output level set by up/down buttons and keypad, three memories, hi-stability ref osc, precision instrument, \$650. **Hewlett Packard HP1740A** CRO, 100 MHz, dual channel, delayed/dual time-base, \$790. **Bird** Termline Model 6154 power meter/dummy load, 25 to 1000 MHz, 150 W in four ranges, N type connector, \$250. **Marconi TF2002AS** signal generator, 10 kHz to 72 MHz, AM/FM, int Xtal calibrator, large dial, two meters for output and modulation, output stepped attenuator, \$120. **K&L** tunable band-pass filter, 125 to 250 MHz, five section filter, calibrated vernier dial, N type connectors for in and out, 50 ohm, 50 W, \$990. **Andrew's** coax connectors 44ASW N type male, suit **FSJ4-50B** superflexible cable, \$15 each. **Gary VK4AR**, QTHR, 07 3353 1695.

#### FOR SALE SA

**Icom IC-W21A** 2 m/70 cm dual-band handheld with extended Rx 50-1000 MHz, AC charger, cig lighter adapter, antenna, **BPI 30** and **BPI 57** battery packs, belt clip, s/n 01642,

immaculate condn in original carton, \$450 ONO. **Hi-Mound HK-708** Morse key, as new, never used, \$35. **John VK5KBE**, 08 8250 7259. **Kenwood TR-2400** 2 m hand-held, s/n 0115168, complete with base stand, mains charger, Shure hand-held mic to match; **Dick Smith K-6313** 2 m 100 W linear amp, 12 V 15 A mains power supply, \$450 the lot. Will separate. **VK5JI**, QTHR, 08 8295 8094.

#### FOR SALE WA

**Kenwood TS-130S** HF txcvr, good condn with manual, s/n 1091546, \$550. **Geoff VK6AT**, 09 581 4596.

#### FOR SALE TAS

**Tono MR-150W** 2 m all-mode linear amp with pre-amp, mint condn, s/n 358157, \$450. **President HR-2510**, early model, perfect condn with mobile bracket and book, \$350. **David VK7ZDJ**, QTHR, 03 6425 2030 evenings only, or 0411 084 491.

**Racal RA17L** receiver with spare valves and workshop manual, \$300. **Nippon R5000** antenna rotator, suit 2 m/6 m, as new, \$100. **Waters** phone patch unit, Model 3001, \$70. **VK7BC**, QTHR.

#### WANTED NSW

**Military** equipment, radio set, any condn, AN/GRC-106, 109, 129 or similar. Also AN/PRC-25, 47, 74 or ex S4S rig. **Pascal VK2IHL**, QTHR, 0419 323 232, e-mail [drcod@onaustralia.com.au](mailto:drcod@onaustralia.com.au)

**Manuals** for **Marconi TF2006**, **TF2008** signal generators; **HP3406**, **HP3467A** voltmeters; **HP1615A** logic analyser manual and data probes; **Tektronix 575** transistor curve tracer. Also interested in other old equipment manuals and old test equipment catalogues. Please don't throw them away! **Gary Edwards VK2ATW**, 068 472 491 BH.

#### WANTED QLD

**Tetrode Tx valves** 4-400, 4-1000, 5-500 or similar. **RCA** receiving tube manual **RC28 1971/2**, name your price. **WE205** valve and suitable base (working). **Peter Hadgraft**, 17 Paxton St, Holland Park QLD 4121, 07 3397 3751.

#### WANTED WA

Copy of handbook/manual (or photocopy) for **JIL scanner Rx**, model **SX200**. Happy to meet expenses. **Beau VK6COP**, QTHR, 09 457 8179. **Circuit diagram and handbook for FTDX100**. I will pay for copy and postage to **PO Box 88 Yarloop**, WA 6218. **Con Murphy VK6PM**, QTHR, 097 334 224.

#### MISCELLANEOUS

• **THE WIA QSL Collection** (now Federal) requires QSLs. All types welcome especially rare DX pictorial cards special issue. Please contact **Hon Curator Ken Matchett VK3TL**, 4 Sunrise Hill Road, Montrose Vic 3765, Tel (03) 9728 5350.

ar

## An Amateur and His Station Peter VK5APS



**Peter Spencer VK5APS with his homebuilt 80 m SSB/CW transceiver built from Drew Diamond's article in October 1994 Amateur Radio.**

*(Photo by Jeff Wallace VK5BJF)*

*(An Amateur and His Station is an intermittently published segment. We are always looking for photos for this segment, preferably colour or black and white prints)*

# WIA Divisions

The WIA consists of seven autonomous State Divisions. Each member of the WIA is a member of a Division, usually in their residential State or Territory, and each Division looks after amateur radio affairs within its area.

Division Address	Officers	Weekly News Broadcasts	1997 Fees
<b>VK1</b> ACT Division GPO Box 600 Canberra ACT 2601	President Hugh Blemings Secretary John Woolner Treasurer Les Davey	VK1YYZ VK1ET VK1LD 3.570 MHz LSB, 146.950 MHz FM each Sunday evening commencing at 8.00 pm local time. The broadcast text is available on packet, on Internet <a href="http://www.radio.amateur.misc">aus.radio.amateur.misc</a> newsgroup, and on the VK1 Home Page <a href="http://email.nla.gov.au/~cmakin/wiaact.html">http://email.nla.gov.au/~cmakin/wiaact.html</a>	(F) \$72.00 (G) (S) \$58.00 (X) \$44.00
<b>VK2</b> NSW Division 109 Wigram St Parramatta NSW (PO Box 1066 Parramatta 2124 Phone 02 9689 2417 Freecall 1800 817 644 Fax 02 9633 1525	President Peter Jensen Secretary Eric Fossey Treasurer Eric Van De Weyer (Office hours Mon-Fri 11.00-14.00 Sat 1000-1300 Mon 1900-2100)  Web: <a href="http://marconi.mpce.mq.edu.au/wia">http://marconi.mpce.mq.edu.au/wia</a> e-mail address: <a href="mailto:wiansw@sydney.dialix.oz.au">wiansw@sydney.dialix.oz.au</a> Packet BBS: VK2WI on 144.850 MHz	VK2AQJ VK2EFY VK2KUR From VK2WI 1.845, 3.595, 7.146*, 10.125, 24.950, 28.320, 29.120, 52.120, 52.525, 144.150, 147.000, 438.525, 1281.750 (* morning only) with relays to some of 14.160, 18.120, 21.170, 584.750 ATV sound. Many country regions relay on 2 m or 70 cm repeaters. Sunday 1000 and 1930. Highlights included in VK2AWX Newcastle news, Monday 1930 on 3.593 plus 10 m, 2 m, 70 cm, 23 cm. The broadcast text is available on the Internet newsgroup <a href="http://www.radio.amateur.misc">aus.radio.amateur.misc</a> , and on packet radio.	(F) \$66.75 (G) (S) \$53.40 (X) \$38.75
<b>VK3</b> Victorian Division 40G Victory Boulevard Ashburton Vic 3147 Phone 03 9885 9261 Fax 03 9885 9298	President Jim Linton Secretary Barry Wiltton Treasurer Rob Hailey (Office hours Tue & Thur 0830-1530)	VK3PC VK3XV VK3NC VK3BWI broadcasts on the 1st Sunday of the month, starts 10.30 am. Primary frequencies 1.840 AM, 3.615 LSB, 7.085 LSB, and FM(R)s 146.700 Mt Dandenong, 147.250 Mt Macedon, 147.225 Mt Baw Baw, and 2 m FM(R)s VK3RMA, VK3RSH and VK3ROW. 70 cm FM(R)s VK3ROU and VK3RGL. Major news under call VK3WI on Victorian packet BBS.	(F) \$75.00 (G) (S) \$61.00 (X) \$47.00
<b>VK4</b> Queensland Division GPO Box 638 Brisbane QLD 4001 Phone 074 96 4714	President Geoff Sanders Secretary John Stevens Treasurer John Presotto e-mail address: <a href="mailto:wiaq@tmxbris.mhs.oz.au">wiaq@tmxbris.mhs.oz.au</a>	VK4KEL VK4AFS VK4WX 1.825 MHz SSB, 3.605 MHz SSB, 7.118 MHz SSB, 14.342 MHz SSB, 28.400 MHz SSB, 29.220 MHz FM, 52.525 MHz FM, 146.700 MHz FM, 147.000 MHz FM, 438.525 MHz (Brisbane only), regional VHF/UHF repeaters at 0900 hrs Sunday. Repeated on 3.605 MHz SSB & 147.000 MHz FM, regional VHF/UHF repeaters at 1930 hrs EAST Monday. Broadcast news in text form on packet under WIAQ@VKNET.	(F) \$74.00 (G) (S) \$60.00 (X) \$46.00
<b>VK5</b> South Australian Division 34 West Thebarton Rd Thebarton SA 5031 (GPO Box 1234 Adelaide SA 5001) Phone 08 8352 3428 Fax 08 8264 0463	President Peter Watts Secretary Maurie Hooper Treasurer Charles McEachern  Web: <a href="http://www.vk5wia.ampr.org/">http://www.vk5wia.ampr.org/</a>	VK5ZFW VK5EA VK5KDK 1827 kHz AM, 3.550 MHz LSB, 7.095 AM, 14.175 USB, 28.470 USB, 53.100 FM, 147.000 FM Adelaide, 146.700 FM Mid North, 146.800 FM Mildura, 146.825 FM Barossa Valley, 146.900 FM South East, 146.925 FM Central North, 147.825 FM Gawler, 438.425 FM Barossa Valley, 438.475 FM Adelaide North, ATV Ch 35 579.250 Adelaide. (NT) 3.555 USB, 7.065 USB, 10.125 USB, 146.700 FM, 0900 hrs Sunday. 3.585 MHz and 146.675 MHz FM Adelaide, 1930 hrs Monday.	(F) \$75.00 (G) (S) \$61.00 (X) \$47.00
<b>VK6</b> West Australian Division PO Box 10 West Perth WA 6872 Phone 09 351 8873	President Cliff Bastin Secretary Christine Bastin Treasurer Bruce Hedland-Thomas	VK6LZ VK6ZLZ VK6OO 146.700 FM(R) Perth, at 0930 hrs Sunday, relayed on 1.825, 3.560, 7.075, 14.116, 14.175, 21.185, 29.680 FM, 50.150 and 438.525 MHz. Country relays 3.582, 147.350(R) Busselton and 146.900(R) Mt William (Bunbury). Broadcast repeated on 146.700 at 1900 hrs Sunday, relayed on 1.865, 3.563 and 438.525 MHz; country relays on 146.350 and 146.900 MHz.	(F) \$62.00 (G) (S) \$50.00 (X) \$34.00
<b>VK7</b> Tasmanian Division PO Box 271 Riverside TAS 7250 Phone 03 6327 2096 Fax 03 6327 1738	President Ron Churcher Secretary Barry Hill Treasurer Mike Jenner	VK7RN VK7BE VK7FB 146.700 MHz FM (VK7RHT) at 0930 hrs Sunday relayed on 147.000 (VK7RAA), 146.725 (VK7RNE), 146.625 (VK7RMD), 3.570, 7.090, 14.130, 52.100, 144.150 (Hobart) Repeated Tues 3.590 at 1930 hrs.	(F) \$74.00 (G) (S) \$60.00 (X) \$46.00
<b>VK8</b> (Northern Territory is part of the VK5 Division and relays broadcasts from VK5 as shown received on 14 or 28 MHz).		Membership Grades Full (F) Pension (G) Needy (G) Student (S) Non receipt of AR (X)	Three-year membership available to (F) (G) (X) grades at fee x 3 times

Note: All times are local. All frequencies MHz.

## ADVERTISERS' INDEX

Amateur Transceiver Radio _____	40	WIA Recruitment _____	21
Andrews Communication Systems _____	31	WIA Membership Retention _____	3
Daycom _____	IFC		
Dick Smith Electronics _____	28, 29, IBC	<b>Trade Hamads</b>	
Interproducts _____	46	M Delahunty _____	54
ICOM _____	OBC, 5	RJ & US Imports _____	54
Radio and Communications _____	19	HAMLOG - VK2VN _____	54
Terlin Aerials _____	32	D Dauner Electronics _____	54

### TRADE PRACTICES ACT

It is impossible for us to ensure the advertisements submitted for publication comply with the Trade Practices Act 1974. Therefore, advertisers and advertising agents will appreciate the absolute need for themselves to ensure that the provisions of the Act are complied with strictly.

### VICTORIAN CONSUMER AFFAIRS ACT

All advertisers are advised that advertisements containing only a PO Box number as the address cannot be accepted without the addition of the business address of the box-holder or seller of the goods.

# Tough, Compact, Economical

## Yaesu FT-50R 2m/70cm Handheld

For the foremost in top performing, durable, and economical dualband handhelds, there's now only one choice, Yaesu's amazing new FT-50R!

Manufactured to rigid commercial grade standards, the FT-50R provides 2m and 70cm band transceive coverage plus an amazingly wide receiver range (76-200, 300-540, 590-999MHz\*), all in a compact package with water resistant construction that's tough enough to meet the USA MIL-STD-810 rating for shock and vibration resistance, yet is easy to hold and use.

Measuring just 57 x 99 x 30mm (WHD) with the supplied FNB-40 650mA/H Nicad pack, the FT-50R provides 2.0w RF output on the 2m and 70cm bands as standard, and can provide up to 5.0w output when operated from a 12v source (optional Nicad battery or vehicle lead). It also provides 112 memory channels including two Home memories, an Alphanumeric display for channel naming (ie. repeater locations or callsigns) with Omni-glow backlighting, and CTCSS encode for accessing repeaters that require a tone input. Selectable AM/FM receive modes allow for greater flexibility during extended receive operation.

For ease of use, the FT-50R provides super loud speaker output, an Auto Range Transpond System to determine if you are in range of another ARTS equipped transceiver, a Dual-watch system for monitoring sub-band activity, and four Battery saver systems for longer operating times. A selectable LCD voltmeter also allows you to monitor battery performance under load so you can estimate remaining battery life. You can also use the FT-50R with the optional ADMS-1C Windows based PC software/interface to quickly program features or clone programming to other compatible Yaesu radios.

The FT-50R is tough, easy to use, and one of the most economical dualband handhelds you can buy. There's now only one choice, the FT-50R from Yaesu.

(\* Cellular blocked)

D-3660



# \$599

## 2 year warranty

*Limited stocks of the earlier version, with standard keypad, are still available.  
D-3655 \$499*



**NEW MODEL**

Now with **FTT-12 keypad** for digital voice recording, DTMF paging, and CTCSS decode.

# DICK SMITH ELECTRONICS

WITH OUR RANGE, WE'RE TALKING  
SERIOUS PERFORMANCE TO SUIT EVERY POCKET.

Just arrived!  
**IC-706MkII**

With improved VHF band  
RF stage, boosted output  
power and more.



For years now, the Icom range has delivered truly professional features and performance to the ever changing world of amateur radio.

Take the IC-706...this unit is a world first combining the compactness of a mobile rig with the features of a top class base station...all at a very affordable price. It covers HF plus the six and two metre bands, all modes, to offer the serious enthusiast the power and functions to compete with the big rigs.

And if you are looking for absolute top-of-the-line performance and features, check out the IC-775 DSP. From its amazing digitally processed signal to a superb array of features, this is a radio that is hard to better in any class.

Icom radios give you a remarkably wide choice...but whatever your budget, you can be sure the rig you buy will be precision built with the quality and innovation that keeps Icom clearly ahead.



IC-775DSP

For more information see your nearest Icom Dealer, or call free on 1800 338 915, or write to:  
Icom Australia Pty. Ltd. 7 Duke St. Windsor VIC 3181 Ph (03) 8529 7582 Fax (03) 9529 8485

  
**ICOM**  
Clearly Ahead

# Amateur Radio

June 1997  
Volume 65 No 6



*Journal of the Wireless Institute of Australia*



*Full of the latest amateur radio news, information and technical articles including...*

- An RF Inductance Meter - Lloyd Butler VK5BR
- 70 cm from a Two Metre Rig - Peter Parker VK1PK
- WIA 1996 Annual Reports

**Plus** *lots of other articles, news and special interest columns*



## IC-756 HF + 6m 100W, auto-ATU, DSP

If you missed our Icom Day at the end of November you missed the opportunity to see the all new IC-756. It was pretty hard to see anyway with the crowd always around it!

- All bands 160-6 metres
- 100W output on all bands
- Auto ATU works on all bands
- Dual watch receivers
- Spectrum Scope (just like the IC-781!)
- Dual Pass-Band Tuning
- Adjustable threshold DSP noise reduction
- Audio Peaking Filter
- Automatic Notch filter
- Built-in CW memory keyer
- 100 alphanumeric memories

Some of the reactions: "how much will you give me for my FT-1000 as a trade-in?", "Probably the most innovative radio since the IC781 hit the market!", "This is really a radio for all reasons, easy to use but with all the features a contester or DXer needs."

In stock now, call to secure yours:

## \$3700

## R8500 HF/VHF/UHF receiver



The **NEW** Icom R-8500 receiver is here now!

It covers 100kHz to 2000MHz (no breaks) has 1000 memories and a host of features you wouldn't think possible at just \$3750. Get the full story, call for a brochure or look on the WEB at <http://www.daycom.com.au/>

introductory special price: **\$3400**

## MFJ Antenna Tuners

MFJ901B	200W Versatuner	\$149
MFJ910	Mobile antenna matcher	\$45
MFJ921	2 mtr 300W tuner	\$155
MFJ924	70 cm 300W tuner	\$155
MFJ931	Artificial ground tuner	\$169
MFJ941E	300W compact GP tuner	\$230
MFJ945E	300W mobile tuner	\$209
MFJ948	Deluxe 300W (no D/L)	\$270
MFJ949E	Deluxe 300W	\$299
MFJ962C	1.5kW tapped inductor	\$525
MFJ969	300W Roller inductor <b>NEW</b>	\$360
MFJ971	200W Portable tuner	\$190



MFJ986	3kW Diff-T roller inductor	\$629
MFJ989C	3kW Deluxe roller inductor	\$735

## ARRL 1995 Publications CD-ROM



A whole years QST, QEX and NCJ magazines in a single CD-ROM - how convenient! With power full reader technology the diagrams and photos appear inseparable windows. Fully searchable text. Requires 386 or better with Windows 3.1 or later.

## \$45



## HAMCALL 1996

Our most popular callbook CD-ROM with Windows, DOS and MAC search engines. Much new information this year including photos of many amateurs!

## \$25

# hy-gain

## HyGain DX77

### Advanced Vertical Window

- 7 Band Vertical
- 10-12-15-17-20-30-40 metres
- No ground radials required
- Tilt mount
- Height: 29 feet
- Power: 1.5kW
- Industrial grade construction
- Bandwidth (<2:1 SWR)
  - 10 metres 1.7MHz
  - 12 metres 100kHz
  - 15 metres 500kHz
  - 17 metres 100kHz
  - 20 metres 250kHz
  - 30 metres 100kHz
  - 40 metres 150kHz



Daycom and HyGain introduce the DX77 Advanced vertical Window with features surpassing any HF vertical on the market. The superior mechanical design, high power capability and 55% greater bandwidth than competitive verticals on 20 and 40 metres make it an exceptional value for a high performance system.

The unique design of this vertical antenna provides a no compromise performance without the need for ground radial wires. It puts the world at your fingertips on the HF ham bands, 10 through 40 metres, including the WARC bands! Capable of handling 750W average or 1500W PEP the HyGain DX77 won't balk at the output of your linear! Automatic band-switching and low angle of radiation allow for enhanced DX performance.

in stock now at

## \$875

# OPTOELECTRONICS XPLORER Test Receiver

All the information, in one hand!

In one convenient handful the amazing new Optoelectronics XPLORER Test Receiver not only finds signals for you, but it will tell you frequency and deviation as well as decoding sub-audible and DTMF tones. Sweeping the range 30 to 2000MHz in less than 1 second the Xplorer will lock on to any signal in the nearfield and demodulate the FM audio for monitoring. You also see frequency on the LCD display along with other information about the signal.

- Frequency range: 30MHz - 2GHz
- FM Deviation range: 100kHz
- Audio frequency response: 50 - 3000Hz
- Auto sweep time: <1 second 30-2000MHz
- Internal speaker, headphone jack, tape control jack, serial interface connector, rotary encoder & flexible push button panel.
- Easy to read LCD display with EL backlighting
- Internal 7.2V 850mAh NiCd battery
- Rapid charging (<1hr) with intelligent charging controller
- NMEA-01283 interface for GPS receiver

**XPLORER Test Receiver \$1700**



# TKIT

## The NEW Heathkit!



Help reclaim this fascinating band! Six metres is the VHF DX band and even now offers regular overseas contacts with just a little effort. The TT1208 kit is the ideal, low cost way, to get going on 6 metres and find out what only the elite have known for years!

- Requires 3-5W input on 20 metres
- Extremely simple hookup and operation
- Sensitive, low noise 50-54MHz front end
- Fast, silent PIN diode TR switch for QSK & data
- 8W output on 6 metres
- Requires 12-15V DC 3A power supply
- Simple switching between HF and 6 metres
- Rugged steel case

**TT1208 8W 6 metre transverter \$199**

# Amateur Radio



## Journal of the Wireless Institute of Australia

Vol 65 No 6

ISSN 0002-6859

June 1997

Amateur Radio is published by the Wireless Institute of Australia, ACN 004 920 745 as its Official Journal, on the last Friday of each month.

### Editorial

**Editor**

Bill Rice VK3ABP\*

**Production Manager**  
Bill Roper VK3BR

**Senior Technical Editor**  
Peter Gibson VK3AZL\*

**Technical Editors**

Evan Jarman VK3ANI\*

Gil Sones VK3AUI\*

Don Graham VK6HK

**Contributing Editor**

Ron Fisher VK3OM\*

**WIA News Editor**

Roger Harrison VK2ZRH

**Proof Readers**

Allan Doble VK3AMD

Jim Payne VK3AZT

Graham Thornton VK3IY

John Tutton VK3ZC

\*Publications Committee member

### Production

**Administration, Advertising, Drafting, Production**

vk3br Communications Pty Ltd  
3 Tamar Court, Mentone VIC 3194

**Typesetting and Printing**

Industrial Printing and Publishing Pty Ltd  
122 Dover Street, Richmond, VIC 3121.

**Mail Distribution**

Mail Management Australia Pty Ltd  
6 Garden Boulevard, Dingley VIC 3172

**New Advertising**

Eyvonne & Keith Tootell

Union Publicity Service Pty Ltd

PO Box 282, Toongabbie NSW 2146

Telephone: 1800 654 181 - 02 9831 1299

Fax: 02 9831 6161

### Amateur Radio Correspondence

All contributions, correspondence, Hamads and queries concerning the content of Amateur Radio should be sent to:

Amateur Radio

vk3br Communications Pty Ltd  
3 Tamar Court, Mentone VIC 3194

E-mail: vk3br@c031.aone.net.au

Phone and Fax: 03 9584 8928

Mobile: 0418 534 168

**Business Hours:** 9.30 am to 3.00 pm weekdays

### Amateur Radio Delivery

All correspondence and queries concerning the delivery of Amateur Radio should be sent to:

Amateur Radio

WIA Federal Office

PO Box 2175

Caulfield Junction VIC 3161

**Registered Office:**

3/105 Hawthorn Road

Caulfield North VIC 3161

Telephone: 03 9528 5962

Fax: 03 9523 8191

**Business Hours:** 9.30 am to 3.00 pm weekdays

### Editorial and Hamads Deadlines

July 09/06/97

August 07/07/97

September 11/08/97

### Receipt of Amateur Radio by Mail

The July issue will be delivered to Australia Post on Tuesday, 1 July 1997 for mailing to members.

If this magazine is not received by the 15th of the month of issue, and you are a financial member of the WIA, please check with the Post Office before contacting the registered office of the WIA. ©

© Wireless Institute of Australia 1997

### CONTENTS

#### Technical

An RF Inductance Meter \_\_\_\_\_ 7  
*Lloyd Butler VK5BR*

70 Centimetres From a Two Metre Rig \_\_\_\_\_ 10  
*Peter Parker VK1PK*

Equipment Review - Two Metre Amateur Band DF Receiver \_\_\_\_\_ 13  
*Gil Sones VK3AUI*

Technical Abstracts \_\_\_\_\_ 16  
*Gil Sones VK3AUI*

#### General

DXpedition to St Peter Island - VK5ISL \_\_\_\_\_ 14  
*Stephen Pail VK2PS*

New Zealand ARDF National Championships \_\_\_\_\_ 19  
*Mark Diggins VK3JMD*

WIA Federal 1996 Annual Reports \_\_\_\_\_ 20

#### Columns

Advertisers' Index \_\_\_\_\_ 56

ALARA \_\_\_\_\_ 24

AMSAT Australia \_\_\_\_\_ 25

Awards \_\_\_\_\_ 26

Club Corner \_\_\_\_\_ 32

Contests \_\_\_\_\_ 27

Divisional Notes

VK1 Notes \_\_\_\_\_ 33

VK5 Notes \_\_\_\_\_ 33

VK7 Notes \_\_\_\_\_ 33

Editor's Comment \_\_\_\_\_ 2

Education Notes \_\_\_\_\_ 34

Hamads \_\_\_\_\_ 54

HF Predictions \_\_\_\_\_ 52

How's DX? \_\_\_\_\_ 35

Morse Practice Transmissions \_\_\_\_\_ 31

Novice Notes \_\_\_\_\_ 38

Over To You \_\_\_\_\_ 46

Packet World \_\_\_\_\_ 40

Pounding Brass \_\_\_\_\_ 42

QSLs from the WIA Collection \_\_\_\_\_ 43

QSP News \_\_\_\_\_ 15, 23

Repeater Link \_\_\_\_\_ 44

Silent Keys \_\_\_\_\_ 51

Spotlight on SWLing \_\_\_\_\_ 45

Technical Correspondence \_\_\_\_\_ 47

Update \_\_\_\_\_ 50

VHF/UHF - An Expanding World \_\_\_\_\_ 47

VK QSL Bureaux \_\_\_\_\_ 46

What's New \_\_\_\_\_ 51

WIA News \_\_\_\_\_ 3, 12

WIA - Divisional Directory \_\_\_\_\_ 56

WIA - Federal Directory \_\_\_\_\_ 2

#### Cover

The crew of the IOTA DXpedition to St Peter Island standing in front of the 20 metre 4-Square vertical antenna array with the operating tent in the background. Standing (l to r) are Paul VK5MAP, Terry VK5IED, Mai VK6LC and Neville VK5WG, while kneeling is VK5 SWL John. See page 14 for full details of the DXpedition.

#### BACK ISSUES

Available direct from the WIA Federal Office, only until stocks are exhausted, at \$4.00 each (including postage within Australia) to members.

#### PHOTOSTAT COPIES

When back issues are no longer available, photocopies of articles are available to members at \$2.50 each (plus \$2.00 for each additional issue in which the article appears).

The opinions expressed in this publication do not necessarily reflect the official view of the WIA, and the WIA cannot be held responsible for incorrect information published.

# Amateur Radio Service

A radiocommunication service for the purpose of self-training, intercommunication and technical investigation carried out by amateurs, that is, by duly authorised persons interested in radio technique solely with a personal aim and without pecuniary interest.

## Wireless Institute of Australia

The world's first and oldest National Radio Society  
Founded 1910

Representing the Australian Amateur Radio Service -  
Member of the International Amateur Radio Union  
Registered Federal office of the WIA:  
3/105 Hawthorn Rd, Caulfield North, Vic 3161

All Mail to:

PO Box 2175, Caulfield Junction, VIC 3161  
Telephone: 03 9528 5962 Fax: 03 9523 8191

Business Hours: 9.30 am to 3.00 pm on weekdays

**Federal Secretary**  
Peter Naish VK2BPN

### FEDERAL OFFICE STAFF

June Fox	Book Keeper
Debby Johnston	Membership Secretary
Rita Trebilco VK3NRT	Examinations Officer

### COUNCIL

President	Neil Penfold	VK6NE
VK1 Federal Councillor	Richard Jenkins	VK1RJ
VK2 Federal Councillor	Michael Corbin	VK2YC
VK3 Federal Councillor	Brenda Edmonds	VK3KT
VK4 Federal Councillor	Ross Marren	VK4AMJ
VK5 Federal Councillor	Ian Watson	VK5KIA
VK6 Federal Councillor	Wally Howse	VK6KZ
VK7 Federal Councillor	Andrew Dixon	VK7GL

### EXECUTIVE

Peter Naish	VK2BPN
Rowland Bruce	VK5OU
Neil Penfold	VK6NE

### FEDERAL CO-ORDINATORS

AMSAT:	Graham Ratcliff	VK5AGR
Awards:	John Kelleher	VK3DP
Contests:	Peter Nesbit	VK3APN
Education:	Brenda Edmonds	VK3KT
EMC and Standards	Roger Harrison	VK2ZRH
FTAC:	John Martin	VK3KWA
Historian:	John Edmonds	VK3AFU
IARU:	David Wardlaw	VK3ADW
Int'l Travel Host Exch:	Ash Nallawalla	VK3CIT
Int'l Beacon Co-ord:	Roger Harrison	VK2ZRH
Intruder Watch:	Gordon Loveday	VK4KAL
ITU Conference and Study Group:	David Wardlaw	VK3ADW
Media:	Roger Harrison	VK2ZRH
QSL Manager (VK9, VK0):	Neil Penfold	VK6NE
Radio Sports:	Wally Watkins	VK4DO
Videotapes:	Bob Godfrey	VK4BOB
WICEN:		

### SMA LIAISON TEAM

Roger Harrison	VK2ZRH
David Wardlaw	VK3ADW
Neil Penfold	VK6NE

# Editor's Comment

## Broadening the Mind

I had not originally intended to base a "Comment" on the trip which my XYL and I made in April to Singapore and Malaysia, but the more I considered the more I asked myself, "why not?". My original reluctance was because the trip was primarily for family reasons and was unconnected with amateur radio, with one exception.

The exception was that I renewed acquaintance with an old friend, David Rankin 9V1RH, in his adopted country of Singapore. He still retains his original call of VK3QV for use on occasional trips to Australia. David is closely involved with the Region 3 administration of the IARU and is also active on 21 MHz, the more so since his recent retirement from full-time employment.

From conversation with David, and others also, both in Singapore and Malaysia, I gleaned a number of "bits of trivia" about both countries which may interest prospective visitors or migrants, whether amateurs or not.

One must reside in Singapore for at least six months before being permitted a 9V1 licence; a hand-held from the airport while passing through would not be welcome! Singapore packs about three million people into only about nine hundred square km, so most people live in high-rise apartments. Very few of the local amateurs can do more than dream about installing 20 m beams. Most roof-tops are covered with TV antennas anyway!

Something like six million tourists pass through Singapore each year, so if tourism is not the major industry, it must go close! The local taxis are all diesel-engined (by law); the traffic is almost incredibly dense but well organised. Private cars are discouraged in several ways (cost of registration, special permits for central city areas, cost of petrol) but the atmospheric pollution is considerable. Public transport is excellent and includes a largely underground MRT (Mass Rapid Transit) system.

Across the Strait of Johore into Malaysia and things are rather different. Malaysia has about the same population as Australia (18 million) but, although far smaller than Australia, it is far bigger than Singapore. It has plenty of private vehicles, excellent roads, including marvellous toll-ways (and the tolls are not prohibitive!), and not quite as much accent on high-rise, even in the cities (we saw Malacca, Kuala Lumpur and Penang).

However, Kuala Lumpur (KL to everyone) has what are claimed to be the world's highest twin towers, only just finished and ready for occupation. KL is frantically building in preparation for its hosting of the 1998 Commonwealth Games.

I hope this information is of interest about some of our near neighbours.

Bill Rice VK3ABP  
Editor

### CONTRIBUTIONS TO AMATEUR RADIO

*Amateur Radio* is a forum for WIA members' amateur radio technical experiments, experiences, opinions and news. Manuscripts with drawings and/or photos are always welcome and will be considered for possible publication. Articles on computer disk or via e-mail are especially welcome. The WIA cannot assume responsibility for loss or damage to any material. A pamphlet, "How to Write for *Amateur Radio*", is available from vk3br Communications Pty Ltd on receipt of a stamped, self addressed envelope.



---

## ■ WIA News

*Roger Harrison VK2ZRH, Federal Media Liaison Officer*

---

# Neil Penfold VK6NE Returned as Federal President

The Annual General Meeting (AGM) of WIA Federal, held over the weekend of 3-4 May, saw the Federal Council re-elect Neil Penfold VK6NE as Federal President for a fourth term. The position was contested by Peter Naish VK2BPN, who was nominated by the NSW Division.

Two directors were elected to the Federal Executive: Peter Naish VK2BPN, and Rowland Bruce VK5OU. Lance Bickford VK4ZAZ, who was a member of the Executive from 1995, did not re-nominate and no further nominations were received. The 1997-98 Executive comprises Chairman, Neil Penfold VK6NE (a position the Federal President holds automatically under the WIA Articles), Peter Naish and Rowland Bruce. The Executive subsequently returned Peter Naish as WIA Federal Secretary, which position he has held since 1995.

Apart from considering the annual financial report and report from the Executive, the WIA AGM dealt with annual reports from Federal Co-ordinators and a total of 14 motions on notice from Divisions, the largest number considered for many years. A number of motions sought changes to the WIA Federal Articles to permit some method of proportional voting by Divisions meeting as the Federal Council.

A special resolution proposed by the NSW Division and seconded by the ACT Division proposed a scheme of allocating voting blocks to Divisions according to membership numbers. Divisions, as the members of the WIA Federal company, each have one vote under the present Articles. The scheme proposed that the two largest Divisions could not act together to have a controlling vote. The support of another Division would be necessary. The motion was lost, as was another motion

from the Victorian Division, seconded by the ACT Division, that the Council take steps to amend the Articles to provide proportional voting on the basis of financial equity. The matter has been referred to the Federal Council sub-committee dealing with updating the Articles, working in conjunction with the Council's strategic planning initiatives.

A resolution to amend the Articles so that Divisions could only appoint an ordinary voting member of the Division as its Federal Councillor was proposed by the NSW Division and seconded by the ACT Division. The motion was lost following debate during which it was revealed that the proposal restricted the right of a Division as a corporate body to appoint whoever they wished and that the Corporations Law ensured this right. A Division could send its solicitor as its representative to the Federal Council, for example.

A motion from Victoria that Divisions, in the future, wishing to administer their own membership records receive a maximum rebate of \$1 in the Federal subscription component, was seconded by the NSW Division. The motion was passed. Queensland is the only Division currently administering its own membership records and receives a higher rebate following an earlier agreement with the Federal Executive.

The Federal Council has agreed to move on establishing the necessary administrative resources to take over the issuing of Amateur Certificates of Proficiency and the administration of call signs, should the Spectrum Management Agency, or the Australian Communications Authority (ACA), move to devolve the process in the future. The WIA proposed, and has adopted as policy, taking over these functions in the Amateur Licensing submission presented to the Minister for Communications in February. The WIA is to follow

up with a formal application to the authorities.

SMA liaison, or ACA liaison from July, will continue to be conducted by the WIA-SMA Liaison Team.

International representation was a major item for consideration by the Federal Council at the AGM. The Council voted to fully fund two delegates to attend the International Amateur Radio Union Region 3 Conference in Beijing in September. The IARU Liaison Officer, and the official delegate to the Conference, David Wardlaw VK3ADW, is automatically one of those. The Federal Council voted to send Federal President Neil Penfold VK6NE as the other fully funded member of the team. Wally Watkins VK4DO was previously elected as a self-funded member of the Conference team.

ITU Conference Co-ordinator, David Wardlaw VK3ADW, outlined the issues of concern to the Amateur Service on the agenda of the World Radio Conference, WRC-97, to be held in Geneva later this year, and advised the meeting that the costs for him to attend would be some \$10,500. A motion proposed by the ACT Division and seconded by NSW, that the Council send two people to Beijing, two people to the NZART annual conference (in May) and that no representative be funded for the WRC-97 Conference in Geneva, was lost. In debate, the consensus among Federal Councillors was that international representation at the ITU level was the WIA's highest priority, with IARU representation ranking second, a presence at any other regional events coming behind them.

In other discussions at the AGM, the Federal Council rescinded a move earlier this year to conduct licence examinations at eight fixed times through the year, the West Australian Division is to take over co-ordination of the VK/ZL/Oceania Contest, a proposal to move the Federal Secretariat to Sydney was rejected, the VHF/UHF Field Day and the South Pacific 160 m contests are to become official WIA-sponsored events, and the annual Call Book is to be replaced by another publication in view of moves by the SMA to publish the amateur call sign register on the Internet this year (see separate news item).

## Another VK2 Wins Recruitment Prize for March

New South Wales Division member, Mr D Peake VK2AO of Colo Vale, is the lucky winner of the Fluke 12B digital multimeter, the prize in the WIA's 1997 recruitment campaign for members who joined in the month of March.

The winner's name was drawn at the WIA Federal AGM held over 3-4 May. A NSW member also won the February draw.

Each month throughout 1997, a Fluke 12B digital multimeter, worth \$195, is given away to a lucky winner who joined a WIA Division in the previous month. The Fluke multimeter prizes have been generously donated by Philips Test & Measurement.

The Fluke 12B measures AC and DC voltage (with auto-selection above 4.5 V), resistance and capacitance from 1000 pF to 1000 µF. The instrument features a simple rotary dial, a 4000-

count liquid crystal display, and diode and continuity testing. Its "continuity capture" feature indicates intermittent open and short circuits. It comes with test leads and a two-year warranty. Fluke is the world's pre-eminent manufacturer of digital test instruments and the Model 12B is from their recently-released range of hand-held instruments.

Every newcomer to electronics and amateur radio needs a good multimeter, and every seasoned enthusiast could always do with another one!

Membership recruitment advertisements appear in each issue of *Amateur Radio* magazine, and in *Radio and Communications* magazine.

Membership recruitment and renewal advertisements are also on WIA Divisions' World Wide Web pages on the Internet.

## New Allocation Sought at 80 m

Members will be aware that the WIA is pursuing a new amateur allocation in the band 3750-3900 kHz, as secondary users, on a time-sharing basis, so that amateurs may use the allocation outside standard business hours. It is proposed this new allocation replace the existing "80m DX Window" at 3795-3800 kHz.

The WIA has suggested the lower 10 kHz of the proposed allocation, from 3750-3760 kHz, be reserved for emergency use, to provide a common allocation which would permit communication between government emergency services and WICEN stations during declared emergencies.

Times suggested for using the 3760-3900 kHz allocation are from 1700-0830 hrs local time, Monday evenings through Friday mornings, with 24-hour operation permitted over the weekends, commencing from 1700 hrs LT on Fridays through to 0830 hrs LT on Mondays.

The requested band allocation spans the variety of allocations available to amateurs in all three ITU regions. The WIA has suggested access to the allocation be permitted to amateurs holding Unrestricted and Intermediate licenses.

As government emergency services and state police use a series of channels between 3700 and 3750 kHz as principal communications channels, the WIA has not requested an allocation below 3750 kHz.

The WIA made a preliminary submission to the SMA in late 1995. Following discussions with the SMA, the WIA presented an updated proposal in mid-1996. The SMA then asked for further particulars to be researched and outlined and suggested the formation of a WIA-SMA working group. This working group, comprising the WIA's SMA Liaison Team and several officers from the SMA, has been conferring on the requirements of the WIA's submission for a new allocation, which was anticipated to be completed in May. No date for a decision on the proposed allocation has been indicated at this stage.

## All Amateur Licence Details on the Internet

By the time this is published, the SMA should have the complete register of amateur licence details available for access on the Internet, as the Agency planned to publish them early in June. The SMA has an obligation to make its register of licence details publicly available under the Radiocommunications Act 1992 and a Determination of 27 March 1997, to take effect from 2 June. This covers all Apparatus, Spectrum and Class licences.

For Apparatus licences, under which amateurs are currently licensed, the

details to be made available include the licensee's name and address (as shown on the licence), the call sign, the client number assigned by the SMA, the licence type, the dates of effect and expiry, the status (eg if suspended), and any special conditions, etc. Amateur licensees who previously had their details suppressed from publication will have the details published on the Internet and in the SMA's CD-ROM register as it is now required by law to publish them.

The SMA has advised the WIA that if amateurs wished to have only a postal address (eg a PO Box) related to their licence, rather than their home address, they can apply to their local SMA Area Office to change their licence details. The SMA advised that such changes would be made to the register within a day of receipt.

The SMA's Web site is at [www.sma.gov.au](http://www.sma.gov.au).

### *Audio, Broadcast & Radio Values*

*New:* 4CX250B, 4CX350A, 572B, 6146B, 807...  
Ceramic Sockets, Top caps...

*Rebuilding:* 4CX10-000D, Klystrons, Magnetrons...

Contact: Mohan or Rebecca Varkey Ph: 041 900 9115

*Australian Electric Valve Importers Pty. Ltd.*

 Factory 2, 22 Michellan Court, Bayswater, VIC 3153  
Mail: P.O. Box 1001, Bayswater, VIC 3153

# Licence Conditions Determination Replaces TLSs

The previous series of Technical Licence Conditions (TLSs) specifying the complete conditions pertaining to each Amateur licence type has been replaced with a single document, the *Radiocommunications Licence Conditions (Amateur Licence) Determination No 1 of 1997*.

The Amateur Licence LCD contains a number of changes sought by the WIA following the release of the TLSs in 1995, which were revised in 1996. Restrictions on club station operation have been relaxed, following representations from the WIA, as have some previous restrictions on repeater systems, among other changes. All the allocated bands and emission modes are provided in comprehensive tables.

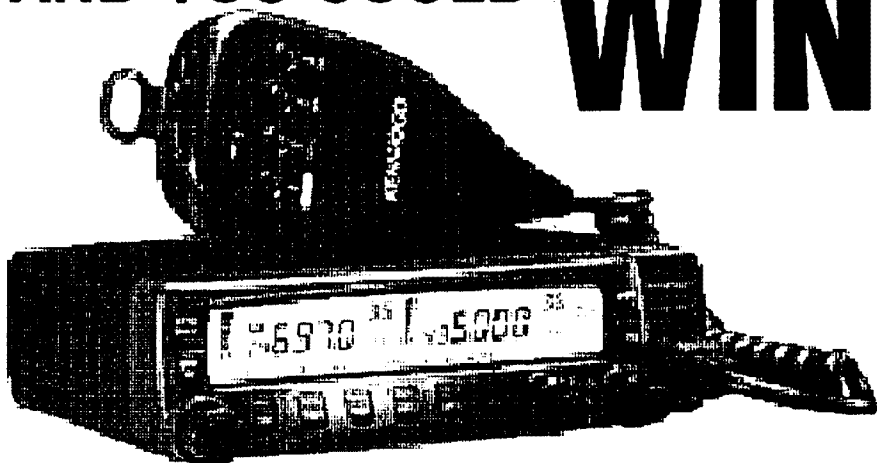
A number of issues relating to conditions imposed on amateur operations are still being pursued by the WIA with the SMA, including the operation of packet radio wormholes, remote control of repeaters and beacons, licence fee charges for beacons and repeaters, and the allocation of special event call signs.

The complete LCD is available from SMA Area Offices, or on their Web site at [www.sma.gov.au/support/legal/determination/lcd/amateur.htm](http://www.sma.gov.au/support/legal/determination/lcd/amateur.htm).

The SMA has also recently updated its information paper on the Amateur Apparatus Licence. This contains information in "plain language" (not the legal language of the LCD), regarding qualifications, licensing options, examinations, call sign allocation and use of special prefixes and suffixes, third party arrangements, JOTA station licensing, and fees, etc. Copies of this paper are also available from SMA Area Offices or on their Web site at [www.sma.gov.au/spectrum/licence/apparat/amat.htm](http://www.sma.gov.au/spectrum/licence/apparat/amat.htm).

**Amateur radio -  
helping our community**

# RENEW YOUR MEMBERSHIP AND YOU COULD WIN



**This outstanding KENWOOD TM-733A  
dual-band 2m/70cm FM/packet rig worth \$1255**

- 50 watts on 2m ● 35 watts on 70cm
- Simultaneous dual-band VHF-UHF reception
- Data connection for 1200/9600 baud packet radio

**All you have to do is  
renew your Division  
membership when it  
falls due.**

## WHO'S ELIGIBLE?

- members whose renewal falls due between 1/1/97 and 31/12/97
- current members who are on a 3-year membership
- life members
- all membership grades

The prize will be awarded by means of a draw, the result to be published and the prize to be presented to the winner at the first available opportunity early in 1998.

## MORE TM-733A FEATURES

- Switchable 10 W/5 W RF output
- 13.8 Vdc operation
- Large, high-visibility LCD panel
- Dual-channel Rx on VHF & UHF
- Automatic band change
- Multi-scan reception functions
- 70 multi-function memories
- Selectable frequency steps
- Audible frequency identification
- Auto repeater offset on 2m
- Repeater reverse & offset switches
- Tone signalling (DTSS).

TM-733A prize kindly donated by  
Kenwood Electronics Australia P/L,  
PO Box 504, Homebush 2140.  
Ph: (02) 9746 1888. Fax: (02) 9746 1609.



**YOUR HOBBY YOUR VOICE**

## Call Book to be Replaced With New Publication

The WIA Federal Council has a subcommittee working on proposals to replace the annual Call Book with another style of publication. A number of issues have prompted the move, including declining Call Book sales over the past four years, demand for a digital Call Book listing on disk, and recent moves by overseas publishers to only publish their call books in digital form on CD-ROM.

Discussions by the Federal Council over the future of the Call Book began in 1996 and a subcommittee was subsequently formed earlier this year.

From preliminary proposals discussed, it is anticipated that a replacement for the Call Book would be a more broadly-based publication containing reference material of wide interest among the amateur and short-wave listener community and related enthusiasts. Also being considered are providing the call signs listings in digital form and various options of providing amateur call sign listings in printed form for those who don't have suitable computer or Internet facilities.

The timing of release for the proposed new publication has not yet been settled.

## SMA Considering WIA Licensing Submission Proposals

The SMA is considering the proposals in the WIA's submission to the Communications Minister on Amateur Licensing in their review of non-assigned Apparatus licence types.

The acting executive manager of the SMA's Business Directions Group, Peter Stackpole, has written to WIA, advising that the courtesy copy of the submission sent to the then Spectrum Manager, Christine Goode, was passed to him for consideration. The WIA sent a copy of the submission to Christine Goode following its presentation to the Minister.

In his letter to the Institute, Mr Stackpole said, "The WIA's submission is timely, as we are presently reviewing our licensing arrangements for all non-assigned apparatus licence types. We will take into account the WIA's views

and proposals in our review, although our current review is working within the current framework of licensing established under the Radiocommunications Act 1992. Hence, our review will not be able to address the WIA's recommendations for the creation of a new form of licensing."

His letter went on to say that, "The proposal for an entirely new form of licensing for the Amateur Service is one which will have to be picked up in the review of the Radiocommunications Act, which we expect the Department of Communications and the Arts will commence in a few months."

Mr Stackpole said, "I understand that a copy of your submission has been presented to the Department, so we'll work with them in considering the WIA's proposals."

## World Amateur Radio Day

The WIA is supporting the promotion of *World Amateur Radio Day*, on Saturday, 20 September 1997. This date is for the promotion of amateur radio to the community, at local and national level. It is supported by the International Amateur Radio Union.

Divisions, amateur radio clubs and societies, WICEN groups and other interested individuals or groups, are encouraged to stage promotional displays and events to promote to their communities what amateur radio is all about. The event is designed to work as an adjunct to other public promotion opportunities in which Divisions, clubs or groups are involved.

WIA Federal President, Neil Penfold VK6NE, said: "Displays and demonstrations in shopping precincts and malls, in parks where the public gather, at Scout and Guide or specially-arranged school events are all suggested as ways and means of supporting World Amateur Radio Day."

Those planning World Amateur Radio Day events are urged to contact the WIA Federal Media Liaison Officer with details for inclusion in *WIA News*.

## Minister to Open North Qld Convention

The Minister for Communications and the Arts, Senator Richard Alston, has agreed to open the North Queensland Amateur Radio Convention, to be held over the weekend of 26-27 September, 1997.

Venue for the Convention is the James Cook University in Townsville. Events to be staged include displays, lectures, discussions and amateur radio activities such as fox hunts, a homebrew competition and an equipment auction. There will be a banquet on the Saturday night at Tumberton Lodge.

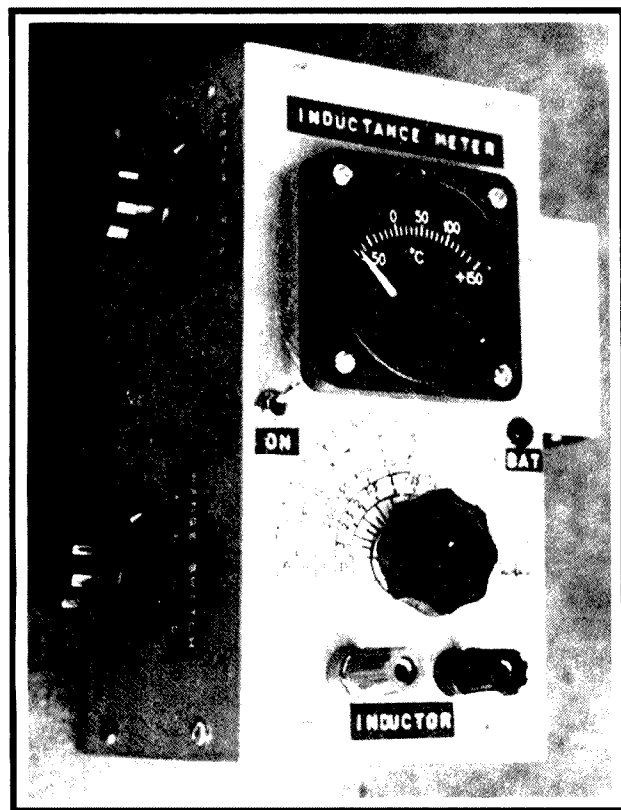
**When you buy something from one of our advertisers, tell them you read about it in the WIA Amateur Radio magazine**

ar

# Test Equipment

## An RF Inductance Meter

Lloyd Butler VK5BR\* has devised a simple unit which measures from 0.1  $\mu\text{H}$  to 3 mH.



The assembled and calibrated RF Inductance Meter.

### Introduction

If the radio amateur builds or services his own gear, he needs, if nothing else, some means to measure the basic units of resistance, capacitance and inductance. Most amateurs would have a multimeter which can measure resistance. Some digital multimeters include capacitance measurement. Bridges which measure both resistance and capacitance are quite common items in the radio shack but not many radio amateurs have the means to measure inductance.

If one has access to a Q meter, an unknown RF inductor can be resonated with the tuning capacitor on the Q meter.

are colour coded and some are marked in inductance value. They generally have quite high Q and measure quite close to their nominated value. I find these inductors very useful for application in filters and tuned circuits which use two pole inductors (ie no taps or secondary winding). Sometimes I find I am confused in reading the coded or marked value and need some means to check it out.

The inductance of air wound coils can be calculated by using established methods such as Wheeler's formula. The inductance of coils with ferro-magnetic cores can also be estimated using the Al

The inductance is then calculated from the frequency used and capacitance indicated on the tuning capacitor scale. This is a method I have used in the past but I felt I needed something which could give me a direct reading of inductance to eliminate the calculation and speed up the process.

For my own experimental use, I keep a range of miniature inductors (or chokes, as shown in the catalogues). These are made by a number of different manufacturers and are normally available from electronics stores in preferred values starting at 1 microhenry and sometimes going as high as 10 millihenries. Some look like small resistors and some like small capacitors. Some

factor data supplied by makers of the core material. However, a means to measure the inductance is useful to check if one is in the right ball game.

These are the reasons which led me to build the inductance meter described in this article. This instrument measures inductances from 0.1 microhenry to 3 millihenries divided into four ranges set by a switch. It operates from 12 volts, and is powered by eight AA type cells attached to the unit.

### Background

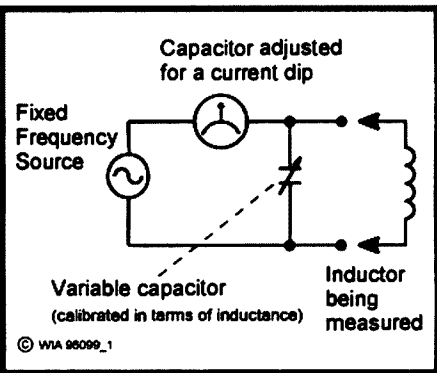
I initially referred to Drew Diamond's unit in *Amateur Radio*, November 1992 to see if it fitted my needs. Drew used a fixed crystal oscillator at around 3.5 MHz to source a bridge where he compared the unknown inductor against a known 5  $\mu\text{H}$  inductor. The bridge was balanced by adjusting a potentiometer which had its scale calibrated in terms of inductance. The meter measured a range of 0.5 to 20  $\mu\text{H}$ .

I needed a wider inductance range than this. Also, I was a bit concerned that no provision had been made in Drew's circuit to balance out the resistance components of the reference and unknown inductors. If the two resistance components were largely different, and particularly if one of them (the unknown) was fairly low in Q, the dip shown in the balance meter would occur with the pot reading offset from the calibration. I guess I could have modified the bridge to include resistance balance but I decided to operate my circuit in a different way.

I have used a fixed frequency source as in Drew's circuit but extended this to four frequencies to expand the inductance range. Instead of using the bridge, the unknown inductor is resonated by adjusting a variable capacitor in parallel with the inductor. The parallel tuned circuit is energised from the oscillator source via a meter which monitors the current into the circuit. The system is illustrated in Fig 1. Resonance is indicated by a dip in current as shown on the meter. A dial attached to the variable capacitor is calibrated in terms of inductance.

### Circuit Detail

Influenced by Drew's crystal-controlled, Colpitts type oscillator



**Figure 1 - RF Inductance Meter - principle of measurement.**

circuit, I wired up the circuit and proceeded to search through my box of crystals for precise crystals which would give me the frequency spread I needed.

This proved to be a bit difficult as I needed to space the frequencies carefully so that each inductance range just overlapped the adjacent one. I finally decided that crystal controlled stability was not needed and substituted selected inductors from my store of miniature chokes. I settled on four frequencies of 16 MHz, 5.2 MHz, 1.32 MHz and 350 kHz for four ranges labelled A, B, C and D.

The complete circuit of the inductance meter, which includes the oscillator (V1), is shown in Fig 2. The oscillator inductors L1 to L4, switched by S1a, are 1  $\mu$ H, 12  $\mu$ H, 180  $\mu$ H and 680  $\mu$ H. With capacitors C4 and C5 fixed, I found difficulty in making the circuit work over the whole frequency range without some other component change apart from the inductors. Switch S1b, ganged with S1a, connects in C2 and C3 on the lowest frequency, and R3 or R4 are paralleled with R5 to increase emitter current on the higher frequencies.

In retrospect, if I decided to build the unit again, I think I would prefer to use the lambda negative resistance circuit which I recently described in a dip meter. The lambda circuit did not require the extra switching and its waveform was much better.

The transistor used for V1 is a type 2N3563 but any other small signal NPN transistor with a high frequency cut-off would do the job.

The inductance measuring circuit is isolated from the oscillator by emitter follower stage V2. The tuning capacitor

C9 in the measuring circuit is a two gang 450 pF miniature variable with both sections paralleled to provide a capacitance range of around 40 to 900 pF.

The current into the measuring tuned circuit is monitored by a 50 micro-amp meter connected via an associated rectifier circuit. RF Drive is set by potentiometer RV1. This must be adjusted when making a measurement as the off-resonant current varies quite a bit, particularly in changing from one range to the other.

The test procedure is as follows: First set the drive to minimum. Connect the unknown inductor. Advance the drive to near full scale deflection. Adjust the capacitor for a dip and read off the inductance. Return the drive to minimum in case the meter goes beyond full scale next time it is used for a measurement.

Using the frequencies and variable capacitor nominated, the inductance range is as follows: Range A, 0.1 to 1.5 microhenries; Range B, 0.9 to 20 microhenries; Range C, 18 to 250 microhenries; and Range D, 240 to 3000 microhenries.

**Powering**

To make the unit more portable, it is powered from a dry battery. The oscillator was not stable at a supply voltage below 8V and operation could be marginal from a 9V battery when it is partly discharged. Because of this I decided to use a 12V battery and stabilise the voltage at 10V.

This is set by two 5.1V 400mW zeners (ZD1 and ZD2) connected in series, only because I didn't have a 10V zener on hand. The LED with the 9V zener (ZD3) in series is a little circuit to indicate when the battery needs replacing. Normally the LED glows dimly but, if the rail voltage falls much below 10V, the LED extinguishes. The type of LED shown has an internal series resistor. This is a type I had available but for the usual LED, an external resistor of at least 1000 ohms would be needed to limit current through the diode.

**Assembly**

Most of the components used, including the aluminium box, the 50  $\mu$ A meter and the variable capacitor, were

recycled from dismantled gear. The meter, mounted in a deep tubular housing and calibrated with a temperature scale, must have been originally recovered from an aircraft instrument panel (*where it measured exhaust manifold or cylinder head temperature! Ed*). The calibration in temperature was of no concern as the meter is only used to indicate the tuned circuit current dip.

Inductors L1-L4 and components C2, C3, R3 and R4 were mounted around rotary switch S1. The rest of the minor components were mounted on several single-row tag strips at convenient places inside the box.

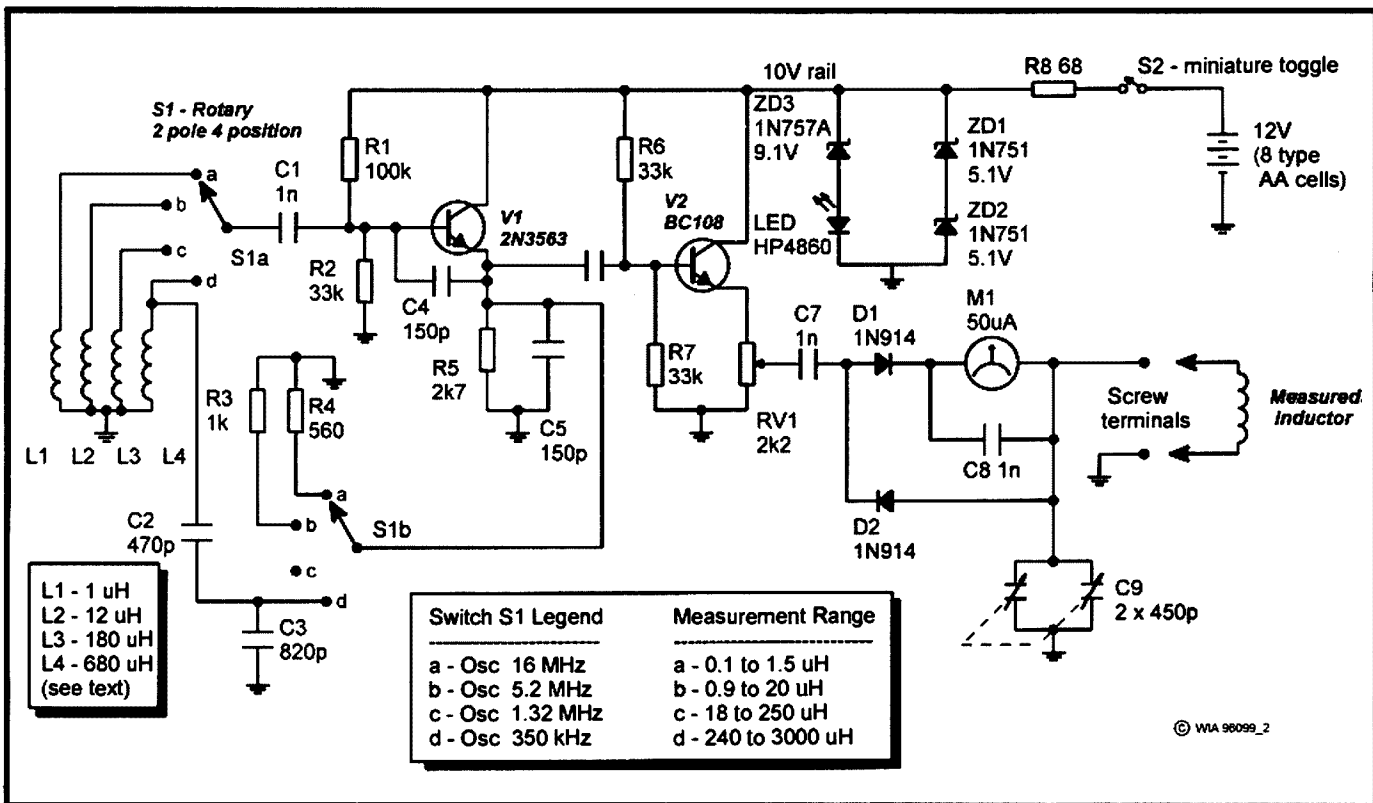
For the critical capacitors in the oscillator circuit (C1 to C5), silver mica was used (I have little faith in ceramic capacitors for such applications). There were no special precautions taken with the wiring and some leads were a little longer than they ought have been. However, I experienced no problems because of this and it all worked fine once I had won my battle with the oscillator. Minimising lead length between the variable capacitor and the test terminals is important as these add inductance in series with the test sample. This is corrected for in the calibration but it could be a problem in measuring small inductors if too large.

The layout of meter and controls is shown in the photograph. As the case was recycled it was not quite made to order. With the meter and calibrated scale on the top, there was insufficient room for the drive control and the range switch and these were mounted on the side. Also, whilst the inside was by no means cramped, there wasn't quite room to mount the 12V battery holder internally and this was fitted externally on the side opposite to the drive and range switch.

The dial calibration scale in four sections, but without calibration points, was drawn up on paper and glued to the box. Calibration points were added later. A cursor was made from perspex sheet and glued to a knob mounted on the variable capacitor shaft.

**Calibration**

Without access to another accurate



© WIA 96099\_2

Figure 2 - RF Inductance Meter - circuit diagram.

instrument calibrated for small values of inductance, a little bit of ingenuity was needed to calibrate the unit. In my case, I was able to make use of my own range of miniature chokes. Obviously these are made to a tolerance but, by using a number of samples, including different samples from different brands and using various combinations in series and parallel, I averaged out readings to obtain each calibration point marked on the scale.

Had the range of reference inductors not been available, I might have used the following method: Firstly a reference unit scale (say 0 to 100) is provided as a further scale section. Disconnect the variable capacitor from its circuit and, using a digital capacitance meter or a capacitance bridge, measure the capacitance at a number of points over its adjustable range. Record these capacitance values against the dial calibration points. For one of the four oscillator frequencies, calculate the inductance required for resonance at each capacitance value using the normal resonance formula. Using graph paper, inductance can now be plotted against calibration units by joining up the

reference points derived. Repeat the exercise for the other three frequencies resulting in a set of calibration curves to mark off the scale at will. Alternatively (but not so convenient), one might choose to only have the unit scale on the instrument and always refer to the calibration curves when taking a measurement.

Using this second method, a correction factor would need to be made on the lowest inductance scale because of inductance in the leads between the capacitor and the test terminals. For example, a lead length of 10 cm would add in around 0.1 uH. For the lowest scale, it would be wise to make up several small air-wound inductors, calculate their inductance using Wheeler's formula and use them as a reference for correction.

### Some Final Thoughts

The article describes a simple circuit which can check out inductors in the range of 0.1 uH to 3 mH. In fact, the main circuit complication is the provision of an oscillator which can work on four widely different frequencies. A Colpitts type oscillator has been used in the unit

described but any other form of oscillator could be made to do the job. The actual frequencies are not too important, except that they need to be spaced so that the inductance ranges are complementary and slightly overlap each other to ensure a defined dip. The frequency spacing might also be dependent on what variable capacitor can be obtained and what tunable capacitance range it can provide.

Concerning the oscillator as built, suitable frequencies were achievable using four fixed off-the-shelf inductors to set tuning for the oscillator. However, because of variations in tolerance of these components and associated capacitors, a repeat of the circuit might involve some trimming of the inductor values. One might also choose to wind up the coils, perhaps with provision of a tuning slug so that precise frequencies could be set.

Some ingenuity is needed to calibrate the unit and I have discussed ways of how this can be done. Having completed this, the unit becomes a very useful instrument to have at the test bench.

\*18 Ottawa Avenue, Panorama SA 5041

# Transmitters

## 70 Centimetres From a Two Metre Rig

Peter Parker, VK1PK\* describes an experimental frequency tripler.

If you are one of the many who would like to try 70 cm FM, but balk at the cost of a new transceiver, this project is for you. It is a simple diode frequency multiplier that will allow you to transmit on 70 cm FM with a two metre transceiver. The only requirement is that the two metre exciter must be continuously tunable, or almost so, if full coverage of all repeater and simplex frequencies is desired. The Yaesu FT290R two metre transceiver with 100 Hz stepped tuning and selectable 0.5/2.5 watt power settings is suggested as a suitable exciter with which to drive this multiplier. It is assumed that you already own a scanner receiver capable of receiving UHF signals.

### Circuit Description

This tripler is easy to build and uses just eight components. The multiplication is performed by a varactor diode. The basic design is not new; it appeared in the 1977 ARRL Handbook (Ref 1). The third harmonic of the 146 MHz input signal is taken off the varactor diode and fed to two tuned circuits on the output frequency. The second harmonic of 146

MHz is attenuated by a series-tuned idler circuit wired in parallel with the varactor diode – this is required for efficient operation.

### Construction

Most of the construction work in this project consists of cutting and soldering pieces of blank printed circuit board material together to form the enclosure and the two UHF inductors. Because it is so easy to cut, single-sided fibreglass circuit board stock is recommended.

The bottom panel of the enclosure should be cut first. Then mount the two vertical divider pieces and the strip of PCB material that forms L5. There are no nuts and bolts used in the construction of the tripler. Circuit board pieces are simply soldered together.

Working back from the output end, install C6 and C4 which, together with the two resistors and the varactor diode, support L4. Ensure component leads are kept as short as possible. One centimetre of wire at 400 MHz is equivalent to one metre of wire at 4 MHz. After constructing the 292 MHz series-tuned idler circuit, move on to the 146 MHz input tuned circuit.

Note that all trimmers are soldered to the bottom mounting board. Where mounting is difficult for C1, C2 and C3, use circuit board pins as stand-offs to minimise the risk of short circuits and to facilitate mounting the three VHF coils. Do not forget C5. This capacitance is simply two pieces of insulated wire loosely twisted together (see Tech Editor's Note).

Whereas L1 and L3 are made of tinned copper wire, L2 is wound from insulated wire to avoid it touching L1. Coil-winding details are provided in the parts list at the end of this article. A quarter wavelength piece of stiff wire 165 mm long is soldered to point "X" on L5 to form the antenna.

Once all components have been installed, attach the four sides of the box, not forgetting to first drill holes for the 146 MHz RF input socket and C4 and C6.

### Adjustment

Ideally, this device should be tuned-up with the aid of a frequency counter, 70 cm receiver and a spectrum analyser. Those without the latter could transmit on an unused two metre frequency on low power and find their third harmonic on 70 cm with the scanner without the tripler connected. This harmonic should be fairly weak when the scanner is moved away from the two metre transceiver. Adding the tripler and experimenting with the trimmer settings should yield a 70 cm signal which is much stronger.

The settings of all five trimmers are

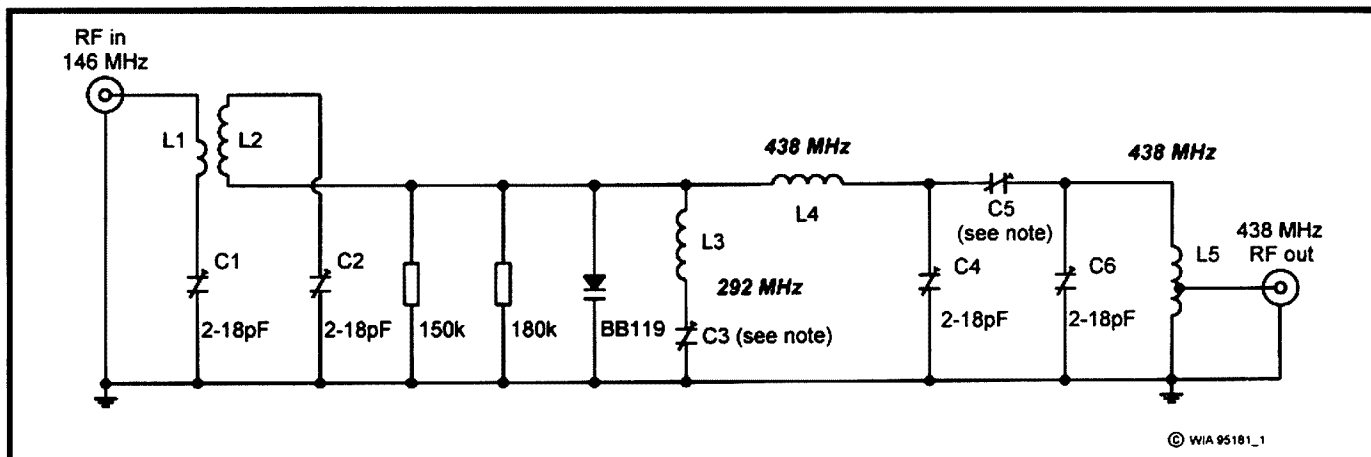


Fig 1 - Schematic diagram of the 2 m - 70 cm tripler.



critical and to some degree interdependent. Final tune-up could be done on a simplex frequency with another 70 cm-equipped station, perhaps mobile travelling away from you and stopping at regular intervals to monitor your signal. Liaison could be carried out on two metres simplex.

## Operation

Speaking into the two metre transceiver should result in a clear and undistorted signal from the repeater being received on the scanner. If the repeater drops out on voice peaks it is likely that you are speaking too close to the microphone. Multiplying an FM signal frequency also multiplies its deviation. This limitation must be accepted unless you are willing to live with low deviation on two metres. In this case the deviation of the two metre transceiver should be reduced to approximately 1.5 – 2 kHz. Nevertheless, in practice, operation of this tripler with an un-modified two metre transceiver has proven to be entirely satisfactory.

The efficiency of this tripler is not known. Nevertheless, with a quarter wavelength stiff wire antenna soldered direct to L5, 0.5 watts input on two metres is sufficient to produce a readable signal to a repeater located seven kilometres away (not line of sight), while 2.5 watts gives a noise-free signal from this location.

## Conclusion

Despite the hard-to-build reputation that UHF radio projects seem to attract, the prototype went together without a hitch with no changes to component values being required. While some values are slightly different from those specified in the original ARRL design, these substitutions were driven solely by component availability considerations and not by any difficulties with the original design. Note that this tripler is only suitable for CW and FM service and will not work on SSB.

While this has not been tried by the author, it might be possible to modify the circuit to multiply to other bands, for instance from 432 MHz to 1296 MHz. As well as transmitting applications, this

circuit may also lend itself for use in receiver local oscillator chains.

## Component List

### Resistors

- 1 150 k 1/4 watt
- 1 180 k 1/4 watt

### Capacitors

52-18 pF trimmers (salvaged from ex-commercial UHF equipment)

### Inductors

L1 3 turns, 10 mm ID, 10 mm long (partially inserted in the "cold" end of L2).

L2 6.5 turns 10 mm ID, 20 mm long (insulated wire).

L3 3.5 turns 10 mm ID, 12 mm long.

L4 strip of single-sided PCB material, 82 x 10 mm, mount 10 mm above base.  
L5 strip of single-sided PCB material, 86 x 10 mm, mount 10 mm above base, antenna tap "X" 25 mm from earthed end.

### Semiconductors

1 BB119 varactor diode (sold by the CW Operators QRP Club)



# Radio and Communications

Incorporating AMATEUR RADIO ACTION and CB ACTION

It started out as a nostalgic look at **50 Years of 50 Megs** — an impressive international DX record for a capricious band — but the third and final part of this fascinating yarn changes direction to teach the secrets of six metre propagation. We also check out a new *Australian TNC*.

Published by  
**ACP SYME MAGAZINES,**  
PO Box 119, Oakleigh,  
Victoria 3166  
(03) 9567 4200

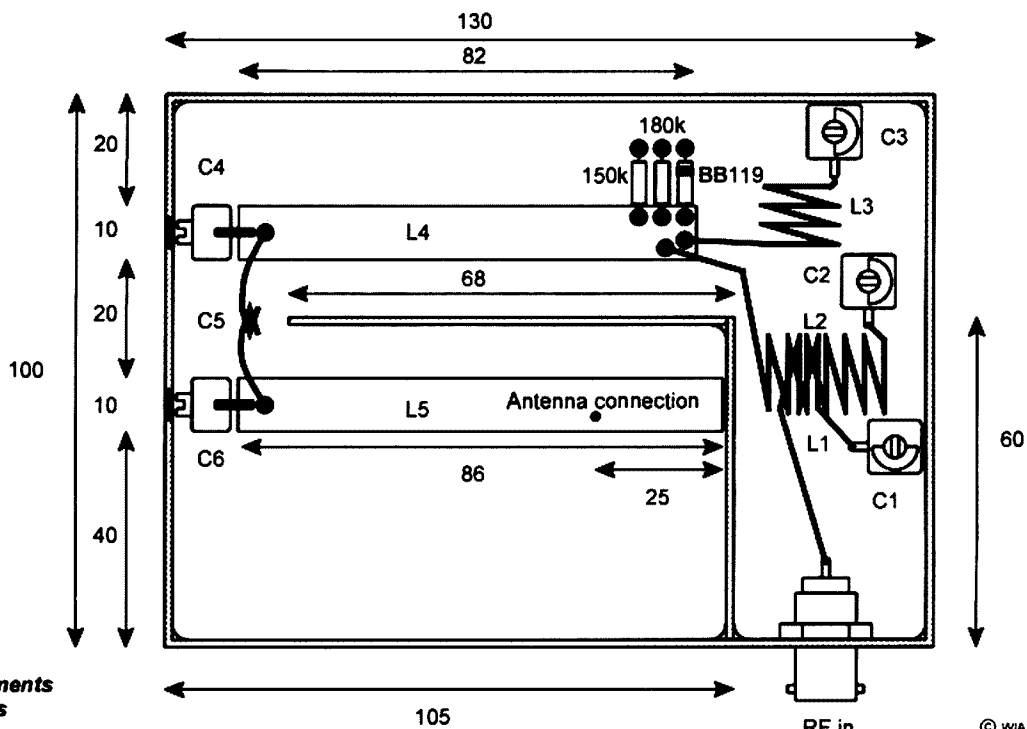


June's R&C is great reading for amateur radio operators. Don't miss any of our great features!

- Check out the latest Icom — a hand-held all-mode receiver covering 500kHz to 1300MHz!
- The Care and Feeding of Quad Antennas. Almost, anyway. A very good overall look at antennas.
- **FREE!** Your complimentary copy of the DICK SMITH ELECTRONICS catalogue — bristling with bargains!!
- Morse Code: on the way up or on the way out? We need *your* help to get Australia's answers.
- A quick look at Mir, the US Space Shuttle and the AMSAT / OSCAR birds. Check 'em all out...
- *The best IOTA column in Region 3, three DX columns, mods and more... the best stories every month!*

Don't miss out — **RADIO and COMMUNICATIONS** is great reading for amateurs!  
**Check your local newsagent today!**

(PS. We also have the biggest collection of radio-oriented Classified adverts in the country. There's lots of them because they work so well. Ask your newsagent to keep a copy for you each month, or ring 1800 25 2515 for subscription details. Hurry — you might miss something!)



© WIA 95181\_2

Not drawn to scale

Fig 2 - Internal construction (not to scale) of the 2 m - 70 cm tripler

### Miscellaneous

1 BNC socket, fibreglass printed circuit board material, small length of insulated wire.

### References

1. 1977 ARRL Handbook, page 218.

### Technical Editor's Note

Peter uses a gimmick capacitor for this coupling. Some experimentation will be required as the wavelength is 70 cm and the length may be short. The ARRL design used tabs 6 x 9 mm approx, spaced approx 3 mm. The UHF trimmers used in the ARRL design were 9 pF max, as against 18 pF, which may have some bearing on how critical adjustment becomes. Another alternative for the trimmers would be to use the high quality UHF piston types often available at hamfests.

\*7/1 Garran Place, Garran ACT 2605

ar

## WIA News

The WIA bids a warm welcome to the following new members who were entered into the WIA Membership Register during the month of April 1997:

L30952 MR M BRAUN  
 VK1AEP MR A E PEPPERCORN  
 VK1BKB MR H M DE ARMAS  
 VK1DC MR D R CAMERON  
 VK2ATP MR K E PETERS  
 VK2IHV MR A WETTASINGHE  
 VK2TJQ MR B WITHERS  
 VK3EQ MR D J WERKMULLER  
 VK3EWV MR M MACE  
 VK3FBR MR I DOWNIE  
 VK3PKQ MR D MUSGROVE  
 VK3VCL MR S FONTANA  
 VK5KAW MR A C WILLISS  
 VK5NB MR J A MCLACHLAN  
 VK5ZIP MR J G ROWLEY  
 VK6CTL MR J C LAIB  
 VK8NWF MR W P FEENSTRA

### Packet Radio Chip Seeks Manufacturer

While on business in Germany attending the 1997 Hanover Fair, the world largest industrial trade fair, WIA

News spotted an exhibitor displaying a system for wireless data transmission which employs the amateur packet radio protocol, based on KISS software embedded in an application specific integrated circuit (ASIC).

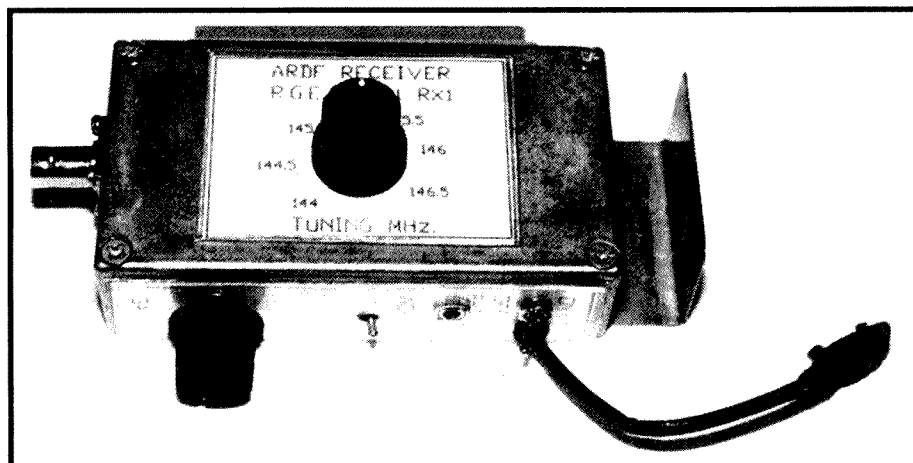
The single chip packet radio interface, devised by Bernhard Dwersteg of the University of Hamburg's department of computer science, employs the KISS (keep it simple, stupid) protocol, familiar to packet enthusiasts. Yes, Bernhard has his amateur licence.

The ASIC was developed in conjunction with Trinamic Electronic Design GmbH, and allows very compact packet data transmission systems to be built, Mr Dwersteg said. Apart from amateur packet radio, applications include commercial wireless data transmission systems and industrial data acquisition systems. They are looking for a manufacturer to incorporate the ASIC in transceivers for these applications.

## ■ Equipment Review

# Two Metre Amateur Band DF Receiver

Reviewed by Gil Sones VK3AUI\*



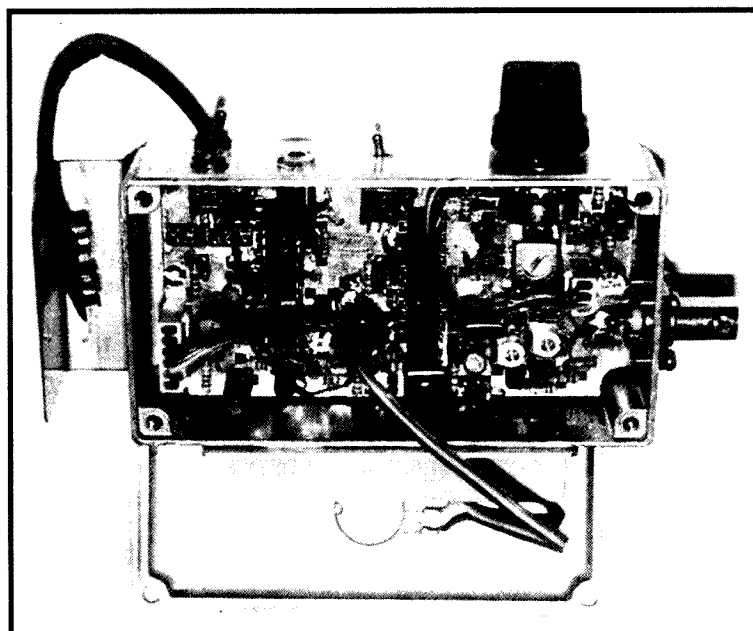
The Ron Graham Electronics ARDF 2 m receiver assembled from the kit-set by Gil VK3AUI.

ARDF has been growing in popularity. It is a mix of radio direction finding and orienteering. To take part you need simple but light and effective equipment. There are limited sources of ready built equipment which can be difficult to locate. Ron Graham Electronics has a kit which makes it possible to build a suitable 2 m DF receiver which runs off a 9 volt battery and is small enough to be mounted on the boom of a fox hunt Yagi beam antenna.

The receiver is a development of a design originally published in *Amateur Radio* magazine by Ian Stirling VK3MZ. The receiver uses an MC3662 IC together with a handful of other components to produce a small, sensitive and rugged receiver in a diecast box. Ron VK4BRG has developed and production engineered the design to produce a kit-set for those who need an ARDF receiver.

The kit comes complete

with all the required parts, and the board and case are pre-drilled. The PC board is fairly easy to assemble, although some thought and care is needed. There are a few coils to be wound and these should be wound carefully. Also, the design makes use of a number of component leads as connections between the two sides of the PCB and these connections,



An inside view of the ARDF receiver.

which are noted in the instructions, should be made carefully as they are needed for stability.

Instructions with the kit are good and should be read carefully as this is quite a sophisticated receiver project. It is helpful to lay out all the components prior to assembly and identify them. Also, check the fit of components prior to assembly as some pre-drilled holes may need to be eased.

A protective diode was found to have leads which were a trifle snug and the holes needed easing. Similarly, the potentiometers have locating lugs which need to be filed or holes drilled to accommodate them. The corners of the PCB need to be filed to allow it to be fitted into the diecast box. All fairly minor adjustments.

One thing to check was the connections of the BF981 RF amp as they were not in the instructions. Construction was simple and the kit operated when power was applied. Alignment is relatively straightforward with few adjustments needed to peak the tuned circuits and put the receiver on frequency.

The construction is simple and, while it is above the level of a basic constructor, it should be simple to anyone who has constructed other kits. Silk screening and plated-through holes would considerably reduce the level of skill required but these are luxuries which would require a much higher volume of production.

The documentation is good with only a few items needing attention. It is more than adequate and is better than some other kits.

The kit is a good way to build an ARDF receiver with little trouble and it eliminates the need to search for specialised parts. It should provide an entry into ARDF for anyone with a modicum of constructional ability.

The kit is available from Ron Graham Electronics, PO Box 323, Sarina Queensland 4737.

\*C/o PO Box 2175, Caulfield Junction VIC 3161

ar

# ■ Operating DXpedition to St Peter Island – VK5ISL

Stephen Pall VK2PS\*

South Australia has approximately 150 offshore islands, ranging in size from Kangaroo Island to tiny rocks and reefs only occasionally visible above the waves.

St Peter Island is located 32 degrees 16 minutes south, 133 degrees 34 minutes east, in the Nuyts Archipelago, Southern Ocean, Great Australian Bight (IOTA reference OC-220 – Zone 30).

The island is approximately 14 km long and 5 km wide, and lies approximately 15 km south-west from the port of Thevenard and the town of Ceduna. It is the home of the famous “King George Whiting” fish. Also resident are death adders, the dangerous black tiger snake, short-tailed Shearwater (Mutton Bird), seals and many arctic birds.

St Peter Island had a whaling and sealing station in the very early days of settlement and later was used for many years until 1987 as a pastoral lease for merino sheep and wool.

The island today is a wildlife conservation park under the management of the South Australian Department of Environment and Natural Resources.

St Peter Island was first recorded and named by Pieter Nuyts and Captain Francois Thyssen aboard the *Golden Leopard* sailing ship in 1627. Unconfirmed legend has it that it was this island where Jonathan Swifts’ fictional character “Gulliver” met the tiny people of Lilliput.

On 7 February 1802, Matthew Flinders anchored the *Investigator* near St Peter Island and parties were sent ashore, finding huge cliff faces, rocky outcrops, reefs, and exposed ocean beaches to sheltered mangrove-fringed tidal flats.

The IOTA DX group, VK5ISL, also landed about 300 m east from where our

early explorers landed, as this is the only place suitable for beach landings. The island today is in superb condition with low scrub bush vegetation and wild grasses, and a few narrow beaches.

I received two reports from the DXpeditioners and their activity which took place from 26 to 31 March 1997. Expedition leader, Mal VK6LC, a veteran of many island activities around Australia, writes:

*“This expedition had more personnel than usual, because it was also a great real-life training exercise. It was a challenge to convert a group of 80 m chit-chat amateurs into proper DX operators.*

*“Everything came together very well. The first two days were extremely hectic, what with the long distance drive, the loading and unloading of two tonnes of equipment, the sea voyage (two trips), the long hours establishing the camp and equipment, and finally determining the rostered operating shifts.*

*“Conditions were very good from 26 to 28 March. All the bands had some life, although I would say 40 m had the best activity, opening up to all paths as early as 1500 UTC and still being alive at 2300 UTC, 9.30 am local time in the morning. This was about the time when John, our “chef”, champion fisherman and logistics co-ordinator had caught and cooked our fresh fish breakfast which he sometimes served with “Vegemite”.*

*“Twenty and 15 metres were very patchy, but openings were there everyday. We shared equal propagation paths to Europe as well as to North America. The “trainee” members of the team also had a “ball” working VK/ZL on 80 m each night, and working around Asia and the Pacific on 15 m at other times.*

*“I am very happy now. The 20 and 40 m 4-Square arrays ran “red hot”. One of the major problems in achieving*

*maximum performance from these verticals is to be able to balance out the differential ground radiation resistance, as every island beach has a different mixture of sand which results in different sand resistance. This plays a major part in equalising the RF voltage at each element. The 4-Square configuration of my experiments has now been used for the third time and proved to be very successful.”*

The island DXpeditioners were Mal VK6LC the team manager, Neville VK5WG, Terry VK5LED, Paul VK5MAP and John, a VK5 SWL who looked after the needs of the group.

Neville VK5WG, who experienced his first Island DX activity, reported as follows:

*“.. for the road trip to Ceduna, and then the 14 km boat trip to the island, all equipment and supplies had to be weighed, sealed and branded in containers (to be carried by one person) to meet the total weight limit of two tonnes.*

*“The beach landings were completed by late afternoon on Wednesday, 26 March without any problems and all equipment was laid out on tarpaulins. Mal, being very focused on the job at hand, had us on the boil, erecting tents, and laying cables (control cables, power cables for lighting and operation). But, most importantly, the assembly of the 20 m 4-Square array with its 160 ground radials.*

*“Around midnight South Australian summer time all systems were ready to go and the 20 m station was fired up and tested. After the first calls all hell broke loose; we were faced with a dog-pile of IOTA chasers. Logging continued until the very early hours, when propagation was lost on 20 metres.*

*“On day two, Thursday morning, the 40 m 4-Square array, the four element 15 m Yagi and a 80 m inverted V were all assembled and erected. During daylight hours, with poor or no propagation, we spent our time in checking and cleaning our equipment. Mal conducted a lot of tests and checks on the 4-Square arrays to ensure their efficiency. Paul VK5MAP operated the 15 and 80 m stations, and Mal VK6LC, Neville VK5WG and Terry VK5LED operated the 20 and 40 m station. John, the VK5 SWL cooked all*



(l to r) Mai VK6LC, the DXpedition leader, and Neville VK5WG in the operating tent of VK5ISL.

the meals and supplied us with never-ending cups of coffee and toasted hot cross buns.

"Operations ceased in the early hours of Tuesday morning. By early afternoon we were all safely back in Ceduna on the mainland with trailer and cars fully loaded again for the trip home.

"From this DXpedition we, the VK5s, learned some valuable lessons and gained a wealth of experience from Mal."

As usual, Mal included a few interesting statistical notes. The total two wheel drive distance travelled was 5400 kilometres, and the total sea distance was 56 kilometres. 160 litres of Super fuel for

the two petrol generators was used and the party consumed 165 litres of water. The total weight carried was 2,000 kg.

Although total expedition time was seven days, there were only three operational days. Total QSOs on all bands was 2,200. 98 DXCC countries were worked, and they had contacts with 61 IOTA islands.

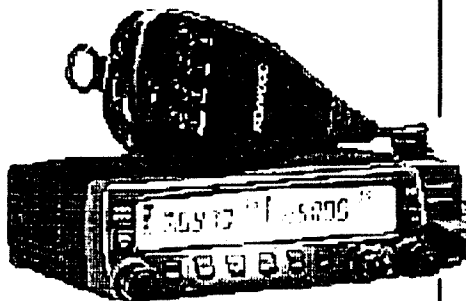
If you contacted the St Peter Island DXpedition and need a QSL card, QSL direct (with return postage and envelope) to the QSL Manager, Gjanni Vareto 11HYW, PO Box 1, 10060 Pancalieri, Italy.

\*PO Box 93, Dural NSW 2158 ar



YOUR HOBBY YOUR VOICE  
Representing Radio Amateurs - Since 1910

**RENEW  
YOUR MEMBERSHIP  
AND YOU COULD  
WIN**



**THIS KENWOOD TM-733A  
2m/70cm FM/packet rig  
worth \$1255**

50 W on 2m 35 W on 70cm  
Switchable 10 W/5 W RF output  
Simultaneous VHF-UHF reception  
Data input for 1200/9600 baud packet  
70 multi-function memories

**All you have to do is renew  
your Division membership  
when it falls due**

**WHO'S ELIGIBLE?** ● members whose renewal falls due between 1/1/97 and 31/12/97 ● current members who are on a 3-year membership ● life members, and ● all membership grades.

**The prize will be awarded by means of a draw, the result to be published and the prize to be presented to the winner at the first available opportunity early in 1998.**

TM-733A prize kindly donated by Kenwood Electronics Australia P/L, PO Box 504, Homebush 2140. Ph: (02) 9746 1888. Fax: (02) 9746 1509.

**QSP News**

**Electromagnetic Compatibility Society of Australia**

Eric Buggee VK3AX advises that efforts are currently being made to form an EMC Society of Australia.

At present there is no single professional forum representing the discipline of EMC engineering. It is felt that a need may exist for an EMC society due to the increasing implementation of EMC regulations

and limited tertiary tuition in the area at undergraduate level. A proposed charter providing for conventions, publications and support for a range of specialists and local interests has been devised.

If you would like to register interest in the EMC Society, or would like to become actively involved in its formation, please contact either Eric Buggee or Kingsley McRae at RFI Industries Pty Ltd on 03 9762 6733, or fax 03 9762 8501.

# Technical Abstracts

Gil Sones VK3AUI\*

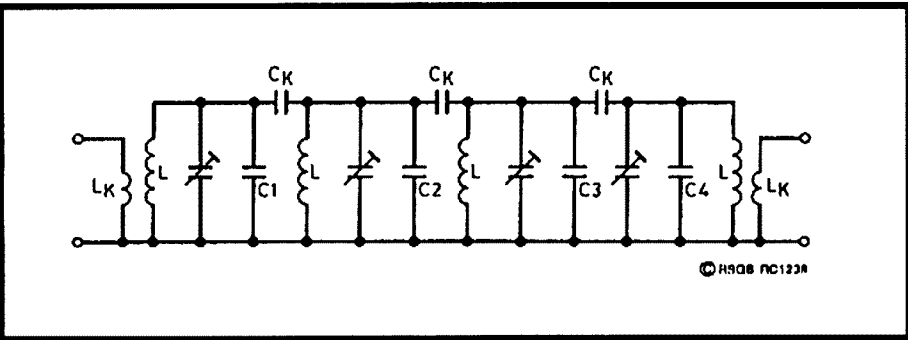


Fig 1 - Four section bandpass filter.

## Minimum Loss Bandpass Filters

In the January and April 1997 issues of *RadCom*, Pat Hawker G3VA, in his *Technical Topics* column features some interesting receiver filters designed and constructed by Dick Rollema PA0SE. These filters originally appeared in *Electron* for October 1996.

The filters are Cohn minimum loss designs and the alignment method of Milton Dishal, originally published in *Electrical Communications*, June 1952, is shown.

The filter type is named after the original work, by Seymour B Cohn of Stanford Research Institute, "Dissipation Loss in Multiple Coupled Resonator Filters", *Proc IRE*, August

1959. Further work is given in "Design of Minimum Loss Bandpass Filters" by Jesse Taub in *The Microwave Journal* for November 1963, and an earlier article in *Proc IRE* for May 1957 by Taub and Bogner.

The circuit diagram of PA0SE's four section filter, which is based on the Cohn minimum loss approach, is given in Fig 1. The filter is top coupled by small capacitors, and the coils have minimum self capacitance and mutual coupling. The coil and capacitor details are shown in Table 1.

Alignment is shown in Fig 2. This is self explanatory and uses an RF millivoltmeter and a temporary earth. The steps involve tuning for maximum and minimum as shown in Fig 2. An alternative to the earth is to detune the

resonators temporarily. The RF millivoltmeter must be very lightly coupled so as to have very little effect on tuning. PA0SE found that the filter response obtained by this tuning method could not be significantly improved upon by using sweep methods.

The 0.25 mm wire used for 160 m is enamelled copper wire and the 0.6 mm wire used for all other coils is polyurethane coated copper wire.

## Dirty Switch Effect

In *Technical Topics* in *RadCom* for March 1997, Pat Hawker G3VA mentions the "Dirty Switch Effect" in a contribution from Jakey Gould G3JKY. This is the effect in old equipment whereby normal operation can be restored by rotating a switch back and forth. This often occurs with the wave-change switch. The cause is contact oxidation and often cleaning fluids are used to reduce the problem.

A solution is outlined where a small DC current is made to flow through the contacts to overcome the effect. This is shown in Fig 3. This technique is known as contact wetting. It was well known to telephone engineers in the past when telephone exchanges used banks of relays and rotary switches.

A small current is all that is required and it is only necessary in circuits carrying signals where DC is not normally present. The resistors used should be of a high enough resistance so as not to affect the circuit operation.

## Noise Sources

A noise source is used when measuring noise figure, or as an

Table 1

Band m	Core toroid	Wire mm	Turns	L <sub>k</sub> turns	L μH	Q	R k	Cres pF	C1,C4 pF	C2,C3 pF	C <sub>k</sub> pF	Loss dB	Bandwidth kHz
160	68-2	0.25	100	5	54.5	178	25.8	131	129.1	125.8	3.3	4.0	66
80	68-2	0.355	60	6	19.4	217	6.41	97.8	91	84.2	6.8	1.2	408
40	68-6	0.6	34	2	5.72	282	15	89	87.5	86	1.5	4.0	184
30	68-6	0.6	35	2	5.74	241	22	43	42.3	41.6	0.68	4.0	226
20	50-6	0.6	25	2	2.67	240	12	47	46	45	1.0	3.0	510
17	50-10	0.6	25	2	2.08	194	10.7	37	36	35.2	0.82	4.0	458
15	50-10	0.6	20	2	1.43	193	7.49	39.2	38.2	37.2	1.0	3.5	653
12	50-10	0.6	16	2	0.973	187	5.31	41.7	40.6	39.4	1.2	2.5	947
10	50-10	0.6	16	3	0.973	170	3.68	28.5	30.6	29.1	1.5	2.2	2198



HF - VHF - UHF MOBILE ANTENNA  
 HF - VHF - UHF BASE ANTENNA  
 CB - MARINE - AIRCRAFT

Monoband to Multiband  
 Convert Now, to the all  
 New!

**PERTH PLUS**  
 HF Mobile antenna

With 80-40-30-20-17-15-12-10-6-2m Included

Also in Stock:

Coaxial Cables & Fittings  
 HF Spring Bases, Trunk and Gutter Mounts.

Outbacker OBB "Classic"  
 Outbacker "Junior plus"

Split Models  
 Helical Dipoles  
 Long wire Dipoles  
 Baluns

**\* Free!**

With Every Perthplus Purchase.  
 1 x AmSoft CD-ROM  
 '94 Callsign Database

While current stocks last

Now available from :

MELBOURNE  
 Daycom Communications  
 Ph 03 5436444

ALICE SPRINGS.  
 Farmer Electronics  
 Ph 089522388

DARWIN.  
 Integrated Technical Services.  
 Ph 089-816411

SYDNEY.  
 Andrews Communications  
 Ph 02 6369060

PERTH.  
 Tower Communications  
 Ph 4701118

ADELAIDE  
 Johnston Electronics  
 Ph 08 2871061

PERTH - Model

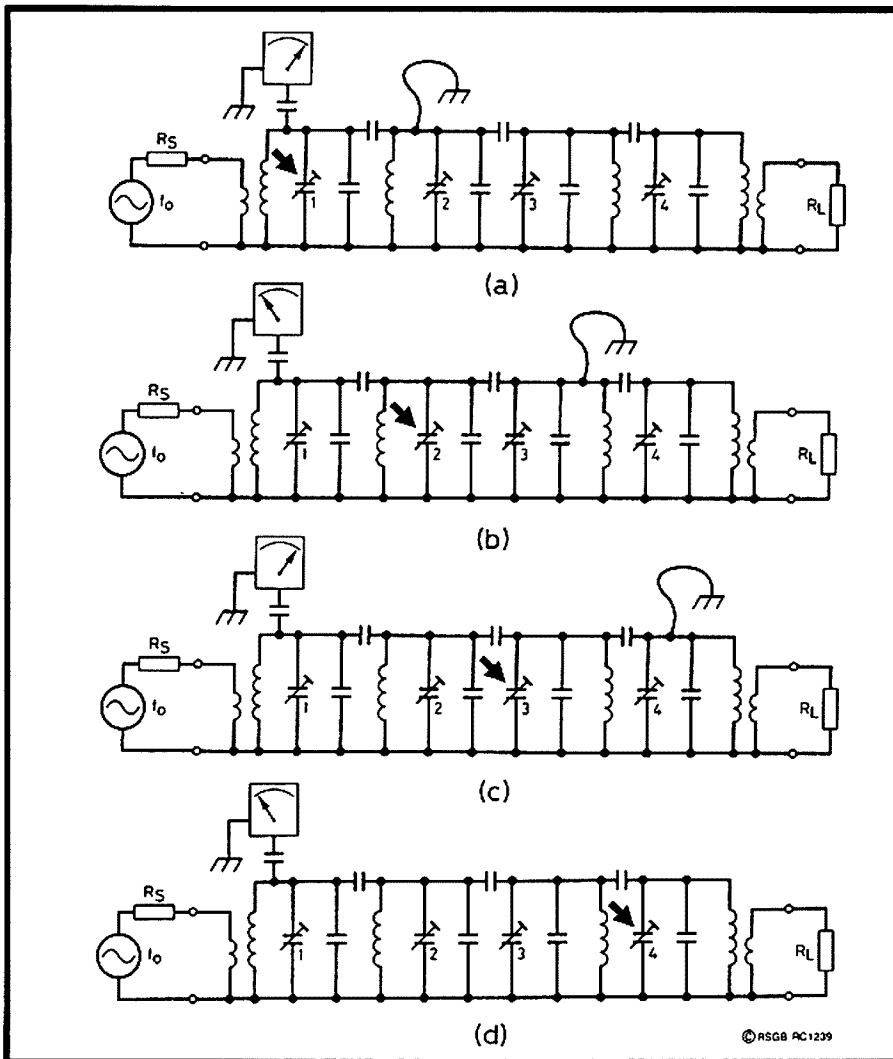
<http://intercon.com.au/outbacker>

TERLIN AERIALS  
 5 Yampi Way  
 Willetton W.A. 6155

Ph +61 (09) 3545444  
 Fax +61 (09) 3545455



Send \$ 5.00 for a 15 minute International video  
 Refundable with every antenna purchase.



© R5GB AC1239

**Fig 2 - Maximum/minimum alignment method.**

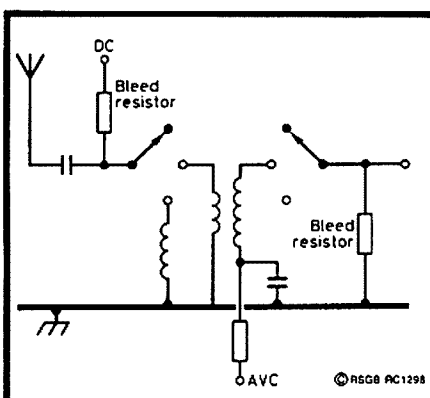
alignment aid for low noise preamplifiers. There are commercial calibrated sources and noise figure meters, but they are quite expensive. Occasionally they find their way onto the surplus market. However, a noise source

can be built and can be calibrated. There are also details of alignment aids which use a noise source.

In *QEX* for November 1996, Paul Wade N1BWT describes a number of noise sources and their use. Calibration can be carried out by comparison with a known source or device, and mention is also made of techniques to use sun and sky noise for calibration.

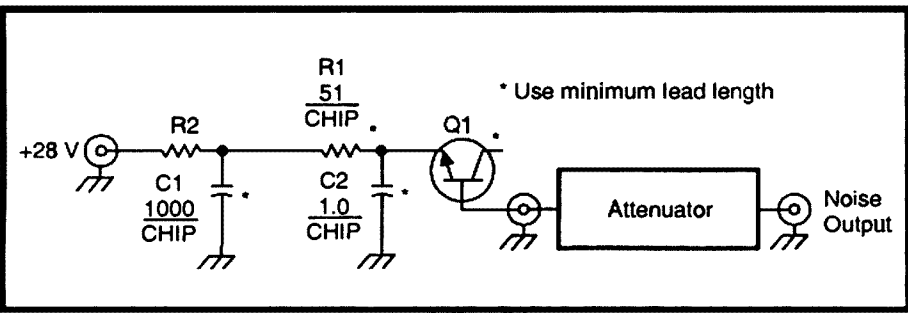
The first noise source described was built on an SMA connector and used the base emitter junction of a silicon NPN RF transistor. The transistor used was an NEC 68119. Chip resistors and capacitors were used. A surplus coaxial attenuator was used on the output to improve the return loss.

Low noise preamplifiers are very sensitive to the VSWR or return loss of the noise source. The circuit of the noise

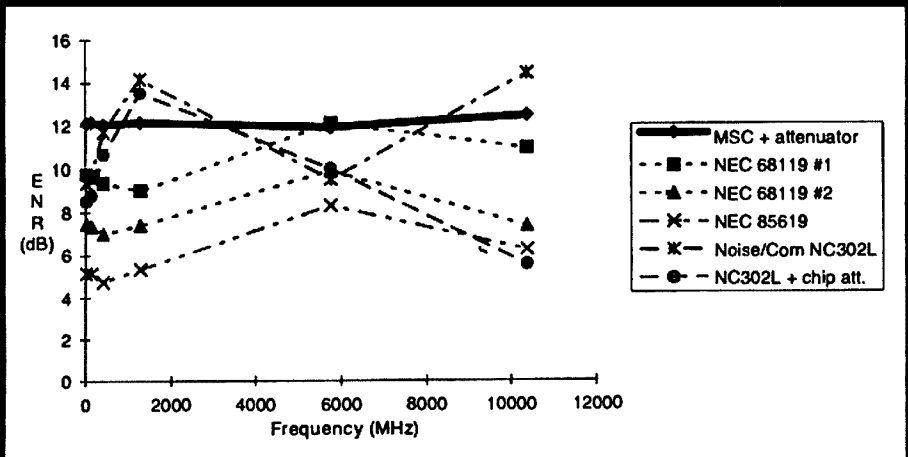


© R5GB AC1298

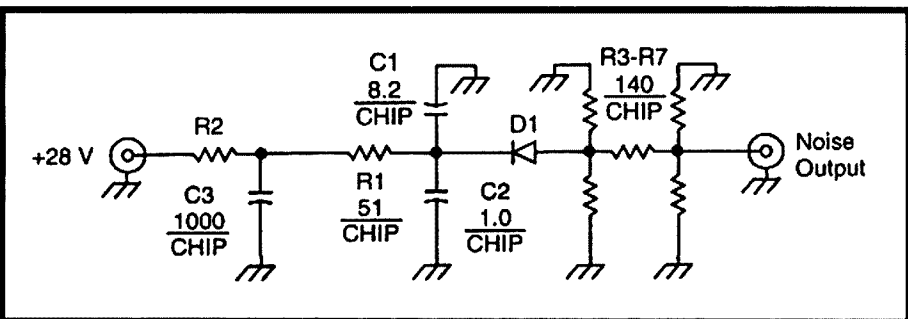
**Fig 3 - Provision of DC wetting current**



**Fig 4 - Noise source built on SMA connector.**



**Fig 5 - ENR performance of noise source of Fig 4.**



**Fig 6 - Noise source using noise diode and chip attenuator**

source is shown in Fig 4. R2 is selected to set the current for best noise output at the highest frequency of interest. The minimum value of R2 is around 1 kilohms. The performance of this noise source with several different transistors and noise diodes is shown in Fig 5.

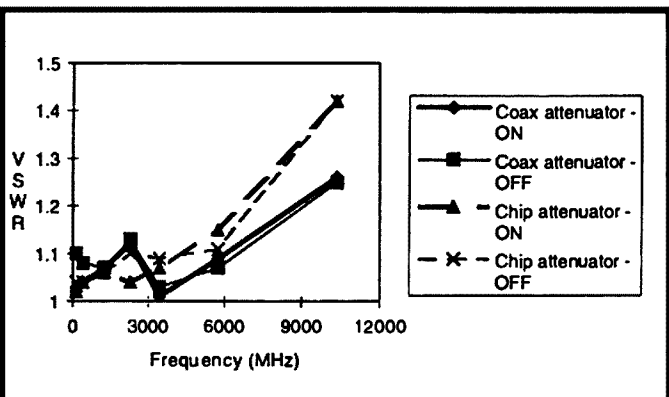
The second noise source used a noise diode which was a Noise/Com NC302L on a PCB stripline with a chip resistor attenuator. The circuit of this noise source is shown in Fig 6. R2 is adjusted on test for best noise performance. The VSWR performance of both noise sources is shown in Fig 7. The ENR performance is shown in Fig 8.

*QEX* is the ARRL experimenters' newsletter. If you wish to obtain it, Daycom Communications Pty Ltd have copies and could assist in obtaining it.

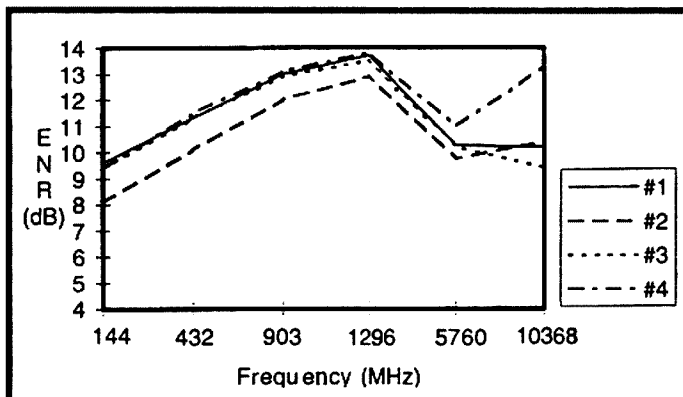
*\*Clo PO Box 2175, Caulfield Junction VIC. 3161*

ar

**Help stamp out  
stolen equipment  
- keep a record  
of all your  
equipment serial  
numbers in a  
safe place.**



**Fig 7 - VSWR performance of noise sources**



**Fig 8 - ENR of several PCB noise source units compared.**



## ■ Events

# New Zealand ARDF National Championships

*Mark Diggins VK3JMD\* reports on the recent ARDF fun in New Zealand*

Easter this year saw the first New Zealand ARDF event take place in Christchurch. This event, while being their National Championships, was also open to other countries in a friendship section.

A total of 12 competitors from Korea, Australia and New Zealand competed in both the 2 m and 80 m competitions. Representing Australia were Jason VK4YOL, Mark VK3JMD and Sue VK3LSL, while Ron VK4BRG was there as an official referee.

The opening ceremony was held on Easter Friday with practice on the Saturday morning. The 2 m competition was held at Spencer Park, a short drive north of Christchurch, on Saturday afternoon in fine and sunny conditions. The vicious starting corridor (overseen by Ron VK4BRG and Max ZL2MAX) brought competitors to the edge of a pine forest where the five transmitters were hidden. Navigation was difficult due to the dense forest but the terrain was mainly flat. The shortest route was approximately 4 km from start to finish by hunting the transmitters in order from one to five.

The hidden transmitters were on 144.7 MHz with the homing beacon being on 146.0 MHz. The transmitters were sequenced to come on in order for one minute each with constant carrier and keyed FM Morse identification.

The winner in the senior section was Bae HL5JVC, with Mark VK3JMD second and Jason VK4YOL, with a sprint to the finish, in third place. In the YL section, Anne ZL3VR won from Margaret ZL3UD, with Denise ZL3TDW in third place.

That evening we were informed that only two of the 80 m transmitters were working but, by the next morning, a dedicated team of organisers had all the transmitters going.

A late change in venue saw the 80 m competition being held at Spencer Park

also, but this time the weather was cloudy and cool. The start corridor from the 2 m event was used as the finish corridor for the 80 m event. The distance on this event was over 5 km and the winner of the senior section was Mark VK3JMD, with Bae HL5JVC second and Kim DS1CJK third.

In the YL section, first place went to

Sue VK3LSL, with Denise ZL3TDW second and Margaret ZL3UD third.

The championships concluded with dinner for the participants, referees and organisers, and the award ceremony. All participants were awarded certificates with the New Zealand place-getters being awarded medals.

Mark VK3JMD was the aggregate winner of the senior section together with Denise ZL3TDW who won the YL section.

The night finished with the traditional exchanging of small presents and a group photo. Many thanks to the hardworking organisers from North Canterbury who ensured the championships were a success.

*\*134 Howard Road, Dingley VIC 3172*

ar



**The VK ARDF team after presentation of the certificates. (l to r) Ron Graham VK4BRG, Sue Diggins VK3LSL, Mark Diggins VK3JMD and Jason Morris VK4YOL.**

### VHF Competition Results – Senior Section

Place	Name	Callsign	Txs	Time
1st	Bae Jong Hun	HL5JVC	5	0.40.30
2nd	Mark Diggins	VK3JMD	5	0.44.40
3rd	Jason Morris	VK3YOL	5	0.59.30
4th	Hwang Hyu Hwan			0.59.40
5th	Andrew King	ZL2UKF	5	1.37.00
6th	Kim Jong Mo	DS1CJK	4	1.01.05
7th	Ron Godkin	ZL3TO	1	2.11.14

### YL Section

1st	Anne McMaster	ZL3VR	4	1.31.30
2nd	Margaret McConnachie	ZL3UD	4	1.32.20
3rd	Denise Hider	ZL3TDW	3	2.02.35
4th	Sue Diggins	VK3LSL	1	1.31.50

### HF Competition Results – Senior Section

1st	Mark Diggins	VK3JMD	5	1.03.25
2nd	Bae Jong Hun	HL5JVC	5	1.17.10
3rd	Kim Jong Mo	DS1CJK	5	1.22.30
4th	Shin Sang Hee	DS5ANY	4	2.09.25
5th	Hwang Hyu Hwan		3	1.49.20
6th	Jason Morris	VK3YOL	3	1.55.20

### YL Section

1st	Sue Diggins	VK3LSL	4	1.35.20
2nd	Denise Hider	ZL3TDW	4	2.12.40
3rd	Margaret McConnachie	ZL3UD	3	2.05.30
4th	Anne McMaster	ZL3VR	2	1.29.00

# WIA Federal 1996 Annual Reports

Here are precis versions of those 1996 Annual Reports adopted by the Federal Council of the WIA at the 1997 Annual Federal Convention and approved for publication.

## Federal President

1996 was a year in which the Company sustained a major loss of funds, which has overshadowed all other activities. Major factors contributing to the loss were declining membership, and a Council motion to reduce the Federal component of the subscription (including G grade) by \$5.00. Most Divisions chose to absorb the \$5 into Divisional funds. In addition, the *Amateur Radio* apportionment was way below the actual cost of *Amateur Radio*.

The Office Manager, Donna Reilly, resigned to take up full time employment elsewhere and was not replaced. Her duties were devolved to the Book-keeper June Fox, the Auditor, the Company Secretary and the President. Some financial resources were saved, but not to the extent first envisaged. Whereas the Office Manager made the necessary day-to-day decisions, these had to be passed to the Secretary or President.

Divisions were asked to make a concerted effort to arrest the membership decline. Some Divisions did, and the monthly list of new members increased slightly. One Division invited approximately 1000 non-members to join, with a mail-out of material informing them of the WIA and its activities, etc. A 2.2 % success rate was achieved. Perhaps when the telephone companies start charging the Internet customers for timed

local calls some of them may turn to amateur radio.

An invitation to attend the ARDF function in Townsville was accepted. This activity was reported in *Amateur Radio* magazine, along with photographs, but could not convey the enthusiasm of the organisers and participants. The opportunity to meet and discuss amateur radio with two Directors of Region 3 and Chen Ping BAIHAM, Secretary CRSA, was opportune with the Region 3 meeting due later this year. Also attending the opening day of the ARDF activities were two members of Parliament. Both expressed their knowledge of our "Submission on Licensing" and a desire to assist the WIA.

The office staff continue to perform their duties well, particularly with the burden of not having an Office Manager/Secretary. Industry terminology is "resource re-balancing". Hopefully, the discussion regarding budget, staffing, etc, will give a clear picture of our future.

Neil Penfold, VK6NE  
WIA Federal President

## Federal Secretary

1996 has been a difficult year for the WIA. Membership levels were again down compared with the previous year. Income from advertising in *Amateur Radio* continued at a lower than desirable level. At the same time the costs associated with providing services to members did not reduce in the same proportion. The net result was an end-of-year deficit which has been met out of reserves.

Certain measures were proposed to Federal Council during the October Extraordinary Convention of Council which were aimed at reducing administration costs. These included a move to common renewal date for membership subscriptions and the out-sourcing of the production and supply of *Amateur Radio* magazine. Both of these measures were implemented from the beginning of 1997 and it is expected that cost savings in the operation of the Federal Secretariat in Melbourne will result. Inevitably, the transition period between cyclic billing dates and a common renewal date will cause some disruption and short term inconvenience, but by 1998 most of the problems should have been resolved.

During 1997, there will be a number of important overseas meetings to which the WIA will send expert representatives. These include the Region 3 IARU meeting in Beijing and an ITU-R meeting in Geneva. Funding for attendance at both of these events has been budgeted from WIA Federal financial resources.

A significant staffing change in the Federal Secretariat occurred during 1996 with the departure of our Office Manager, Ms Donna Reilly, who resigned to take up employment elsewhere.

The staff at the Secretariat in Melbourne continue to provide professional services to the Federal Executive and Council and their loyal and dedicated support is much appreciated. We rely on their proven capabilities in the day-to-day administration of our business activities affairs.

Peter Naish VK2BPN  
Federal Secretary

## AMSAT-Australia

This year has seen the loss of AMSAT-OSCAR-13 (AO-13) one of two highly elliptical orbit Amateur Satellites with a fiery re-entry into the earth's atmosphere in December. However, this year has also seen the successful launch of two new low earth orbit (LEO) Amateur Satellites, the Japanese satellite, JAS-2, 'Fuji-OSCAR-29' on 17 August 1996 and the Mexican satellite, UNAMSAT-B, Mexico-OSCAR-30 on 5 September 1996.

In December 1995 I was appointed by Hans van de Groenendaal the IARU Satellite Advisor as the IARU AMSAT Frequency Co-ordinator. This has involved attempting to co-ordinate the allocation of Amateur Satellite frequencies in the three IARU regions which have quite different band-plans, particularly in the 2 m band. The most perplexing problem has been trying to find 2 m frequencies acceptable in all three regions for use of Amateur Radio on-board Space Shuttle missions, the Soviet Space Station, MIR and the future International Space Station. To date I have been unsuccessful and, in October 1996, at the IARU Region 1 Conference in Tel Aviv, Israel recommended an uplink of 145.2 MHz and a downlink of 145.8 MHz which fits within the Region 1 VHF band-plan but not in Regions 2 and 3.

In this role I was fortunate enough to attend the AMSAT-UK Colloquium in July (funded by the IARU) and had the opportunity to discuss international Amateur Satellite issues with representatives from 17 countries and all continents. At this conference I presented a paper on analysing AO-13 telemetry and another prepared by Ed Krome on suggestions for Phase-3D ground-station configurations. I also chaired a meeting on Amateur Satellite frequency co-ordination issues.

Other milestones in 1996 were the launch of the Spartan Packet Radio Experiment (SPRE) on Space Shuttle mission STS-72. This experiment was designed to test satellite tracking using Amateur Packet Radio and the Global Positioning System (GPS). Another milestone was the activation of the German SAFEX II 70 cm repeater on-board the Soviet Space Station MIR.

The international Phase-3D Project progressed well in 1996 with the launch now slated on the European Space Agencies (ESA) Ariane 502 launch in July 1997. This project is the most complex Amateur Radio Satellite project to date with transponders covering frequencies from 29 MHz to 10 GHz. Phase-3D will also be in a highly elliptical orbit similar to AMSAT-OSCAR-10 and 13 but, unlike those earlier Phase-3 satellites, Phase-3D will have a 3-axis stabilisation system that will maintain the antennas pointed towards the centre of the earth throughout the entire orbit, meaning much better communication opportunities.

As proposed in last year's annual report, I did attend the Phase-3D Orbit/Mission Analysis and Command Station Meeting held in Marburg, Germany in May 1996. To maximise the benefit of this trip I visited both the Dayton Hamvention, Ohio and the Phase-3D Integration Facility in Orlando, Florida on the return journey. At Dayton,

## Andrews Communication Systems

(EST. 1976 - ACN 001 968 752)

**WE WILL NOT BE UNDERSOLD  
ON ALINCO RADIOS**

- ★ IC-756 HF+6M, DSP.LCD
- ★ IC-R10 HAND HELD SCANNER
- ★ WS-1000E CUTE SCANNER
- ★ DX-70TH HF+6M 100W
- ★ MFJ TUNERS AND CONTROLLERS
- ★ DX-1600 HF LINEAR AMP.
- ★ AR-5000 2.6GHz SCANNER

**3 YEAR WARRANTY ON  
OUR ALINCO RADIOS**

Call us now

**(02) 9636 9060** or (02)  
9688 4301

SHOP 8, 41 BATHURST ST, GREYSTANES,  
N.S.W. 2145. FAX (02) 9688 1995

I presented a report on the Marburg meeting and in Orlando I had the opportunity for the first time to view the Phase-3D spacecraft and to help set up the laboratory's command station hardware and software. This trip was funded by the Wireless Institute of Australia as its contribution to the Phase-3D Project.

Thanks again to Bill Magnusson VK3JT who has again continued to keep the readers of the *Amateur Radio* journal up to date with his timely AMSAT-Australia column in spite of having moved house during the year. Bill's effort continues to encourage newcomers into the area of the Amateur Satellite Service. In 1996, I received less than 300 requests for information on the Amateur Satellite Service via Australia Post but received over 400 e-mail requests. Similarly, with the wide-spread use of packet radio and the Internet for information dissemination, the number of subscribers to the AMSAT-Australia monthly NEWSLETTER has fallen to under 200, the lowest in five years!

Finally, I would like to thank the WIA for its continued support of the Amateur Satellite Service via the activities of AMSAT-Australia and ask that the 1997 Federal Convention recommend that the WIA continue to support AMSAT-Australia financially at the present level.

Graham Ratcliff VK5AGR  
AMSAT-Australia National Co-ordinator

## Awards

A general discussion on the relative prestige values of the WIA DXCC and that of the ARRL boiled down to a matter of costs. Our entry in the DXCC race costs a maximum of five dollars (free to WIA members), while the US counterpart can cost up to \$US75.00. I continue to push our own product here and overseas. The safe return of precious QSL cards can also be a problem from the other institution.

Overall, I have not encountered any serious problems. A short conversation with some of my associates generally smoothed out anything which had arisen.

John Kelleher VK3DP  
Federal Awards Manager

## Contests

### Introduction:

The five official WIA contests are managed by the following people:

John Martin VK3KWA: Ross Hull Memorial Contest

Phil Rayner VK1PJ: John Moyle Field Day

Ray Milliken VK2SRM: VK Novice

Alek Petkovic VK6APK: RD Contest

Myself: VK/ZL/Oceania DX Contest

There have been no changes to the contest management line-up since last year, and I wish to thank the managers of the first four contests for their excellent efforts. Some brief notes on each contest, listed according to their position in the calendar, appear below.

### Ross Hull Contest

After a three year trial period, it appears that the "best 100" scoring method might not be stimulating activity as expected, and has not relieved the pressure on entrants to spend large amounts of time in the shack. Also, a demand for 6 m operation has resurfaced, so it appears that some innovative thinking will be needed before the rules are finalised for next year's event.

### John Moyle Field Day

Last year, the manager (Phil Rayner VK1PJ) mentioned in *Amateur Radio* that he was considering a revision of the operating times for the 1997 event. This resulted in a flurry of letters to both Phil and myself, and as it quickly became obvious that the changes would inconvenience many people, plans to revise the times were dropped. Given the fact that the ideal start and finish times differ so much across the continent, and to allow entrants more time to drive to their destinations, set up and dismantle, I believe we should be seriously considering moving the contest to a long weekend, or perhaps the Christmas holiday period. Entrants would be less rushed, able to set up more ambitious stations, and would commence the contest in a more refreshed condition. It is significant that the Northern hemisphere field days are scheduled for holiday periods. Comments from members are invited.

### Novice & RD Contests

These are both running very smoothly, and no changes are envisaged for the coming year.

### VK/ZL/Oceania DX Contest

Following a survey of the 1995 contest, and discussions with entrants and the co-manager John Litten ZL1AAS of NZART, it was decided to drop 160 m from the 1996 event. This change was well received by entrants, and activity on the higher bands was noticeably more intense, so the change has been made permanent.

### 160 m Contest

Following the loss of 160 m from the VK/ZL/Oceania DX Contest, and to accommodate the many keen 160 m enthusiasts in VK and ZL who previously had no contest in which to test their stations and operating skills, a new 160 m contest was started last July in consultation with John Litten ZL1AAS. Over a hundred stations took part, including DX stations as far away as the USA, so it has been decided to make this an annual event. The new VK manager is Ian Dodson VK3DID, who has prior experience running the Annual QRP Day Contest, and who will share management duties with ZL1AAS, in much the same way as the VK/ZL/Oceania DX Contest is managed. Official WIA recognition of this contest is currently being sought.

### Contest Certificates

Last year, Council decided that the preparation and mailing of contest certificates would be no longer performed by Federal Office staff, but devolved to the individual contest managers. Unfortunately, this change has caused some problems, including the inability to double-check the list of winners and correct any errors before certificates are mailed, occasional long time delays before winners receive their certificates, a much greater burden of work on our contest managers, and the loss of the organisational skills of Federal Office staff.

This change has a major impact on our two biggest contests (the RD and the VK/ZL), which involve a huge amount of work for the relevant managers before the extra burden of certificates is even considered. The loss of Federal Office support is sorely missed, and it is hoped that the previous system will be restored as soon as possible. In the meantime, members are asked to be patient, and to advise the relevant contest manager if they fail to receive a certificate as

expected, or if they notice some other anomaly. I would like to take this opportunity to thank the Federal Office staff for their excellent support with contest awards over the last few years.

Several proposals relating to contests have been put before Council, and are summarised below:

1. Contest entrants are required to declare that they have operated "in accordance with the spirit of the contest". Unfortunately, this spirit has never been defined, and an ad-hoc definition would probably not survive a determined legal challenge. To close this loophole and allow contest managers more discretion in sanctioning entrants when warranted (ie if they act poorly or unethically), it is proposed that the essence of good amateur behaviour be defined in an Amateur's Code of Ethics, and promulgated through *Amateur Radio* and the *Call Book*.

2. Virtually all overseas countries offer a variety of special prefixes to their amateurs, usually for contests, but just as often for normal use. Australia and New Zealand are amongst the very few remaining countries which retain a rigid and old-fashioned approach to callsigns. To heighten overseas interest and activity in our premier international contest (VK/ZL/Oceania DX), it is proposed that permission to use the VI and/or AX prefixes be sought for the phone and CW weekends of this contest, and the week in between.

3. The VHF/UHF Field Day and 160 m contests are unique, and satisfy significant sections of WIA membership. To ensure their stability, longevity and proper promotion, it is proposed that they be added to the list of official WIA contests. As relatively few certificates are offered, and the 160 m contest is shared with NZART (who have already added it to their official list), the impact on WIA resources will be minimal.

Peter Nesbit VK3APN  
Federal Contest Co-ordinator

## Education

Early in 1996 the Question Bank committee decided that we had progressed as far as we could for the time and the Committee was disbanded at the request of the members.

By that time it had prepared all three question banks and submitted them to the SMA. Discussions with the SMA had been held on all syllabuses, but no final agreements had been reached by the end of the year. Most of the year has been spent waiting for the SMA to consider the submissions.

In July the SMA agreed that the Regulations question papers should be reviewed. This was held up to some extent by my health problem and also by the later request from the SMA that all questions on the papers be presented in the current terminology.

By the end of the year, the first set of five papers was almost ready for final approval, and the next five were partly revised.

The Examinations Committee has met several times to consider SMA comments, to respond to correspondence relating to examinations, to discuss examination questions or procedures, and to formulate policy.

It is pleasing that action has at last been taken on the revision of the SMA brochures. Drafts were received late in the year and comments prepared.

I would like to bring to the notice of the Council the fact that the number of candidates for examinations is dropping steadily. Between 1992 and 1995, the number has more than halved.

Admittedly, in some subjects the pass rate has increased slightly, but it is clear that the demand for examinations is decreasing, which means that the rate of recruiting of newcomers to the hobby has decreased.

If amateur radio is to remain as a viable interest in Australia, it is time for a concerted campaign to sell amateur radio to the public. The WIA can recruit members only from licensed operators. If there are too few new operators coming in, then the WIA is on the way out even if all new licensees become members.

In 1996 I provided publicity materials to three conferences of science teachers. There is room for an active campaign to target not only science teachers but also humanities teachers. The full potential for the use of amateur radio in Australian schools has not been explored. This may be where we need to seek our continuing recruitment from the younger generations.

**Brenda M Edmonds VK3KT**  
Federal Education Co-ordinator

## IARU Liaison

### Region 3 IARU activities

#### ARDF

Australia was privileged to host the second Region 3 ARDF Championships which were held in Townsville in July 1996.

These Championships were a great success with 110 participants from nine IARU societies.

Our thanks must go to the team of enthusiastic helpers who contributed to the success of the event.

#### Other Matters

Apart from ARDF there was little activity from Region 3 IARU during 1996. However, things will be very different in 1997 with the Tenth IARU Region 3 Conference to be held in Beijing China from 8 to 12 September.

Preparation for the conference is well underway with draft papers under preparation for discussion before forwarding to the conference.

### International Secretariat and Administrative Council Matters

#### Future of the Amateur Service Committee

The FASC committee, set up by the President of the IARU, has the task of giving guidance to the IARU in developing a position on any changes that would be desirable to article S25 of the ITU Radio Regulations titled the amateur and amateur-satellite services.

The International Secretariat of the IARU distributed the first draft report of the Future of the Amateur Service Committee early in the year. The WIA, after consultation, submitted a reply covering its views on this draft.

A further report has now come out, taking into account the comments on the first draft received from member societies. A working group consisting of David Wardlaw VK3ADW, Grant Willis VK5ZWI and Brenda Edmonds VK3KT is studying the report in order to assist the council develop the WIA position. The widest consultation possible will take place.

The working group were lucky to be able to invite Michael Owen VK3KI, the chairman of the FASC committee, along to a meeting to impart his ideas to us. The work of the FASC is very important to the amateur services as WRC 99 has a review of article S 25 of the Radio Regulations on its agenda. Article S 25 is the article that deals specifically with the operation of the amateur and amateur-satellite services.

It is essential that we get it right as, due to the pressures caused by the size of conference agendas, it is unlikely that a review of S 25 could possibly appear on the agenda of another WRC for many years.

#### 7 MHz Strategy Committee

A comprehensive report was received by the IARU Administrative Council and an approved action plan has been distributed to member societies. This is also very important as harmonisation between the amateur and broadcasting services at 7 MHz will be on the agenda for WRC-99.

#### The Strategic Plan for the Development of Amateur Radio

The Strategic Plan for the Development of Amateur Radio was updated by the Administrative Council.

#### IARU Region 3 Conference

This is the second of the triennial conferences of the IARU's three regional organisations to be held since the draft agenda of WRC-99 was determined.

As WRC-99 has on its agenda items vital to the amateur services, the conference will have to make decisions vital to the long term future of the amateur services. This conference will give the opportunity for the WIA to contribute to the debate on these matters.

WRC matters are not the only subjects that will

be covered by the extensive agenda for the conference. A number of IARU policy resolutions will need to be updated. For example the resolution concerning digital modes. The Asian Pacific Telecommunity will be increasing its involvement in the development in harmonisation of the proposals of Region 3 countries to WRCs. The IARU must monitor the situation and become involved if at all possible. Promotion of amateur radio in developing countries policies will need reviewing.

**David Wardlaw VK3ADW**  
IARU Co-ordinator

## International Amateur Radio Union Monitoring Service

The year closed with a much lower number of intrusions, mainly caused by the adverse propagation and not by any lessening of the illegal operations into our recognised bands. On the whole, the very poor conditions on 40 and 20 m have curtailed amateur operations, but not those of the intruding stations, who run much more power, and also in most cases blanket the world from many transmitting sites.

**40 m.** This band has been dominated by CIS transmissions, modes used being R7B, A1A, and the ever-present Single Letter Beacons (SLB) of the Russian Navy. An occasional broadcast station relieves the monotony with its fundamental or second harmonic (C2H).

We have had a breakthrough with Radio Taipei. A 7.080 "spur" of 7.105 MHz has been removed by the direct action of Col VK4AKX to the Technical Engineer of Radio Taipei. This type of direct action must be applauded and is finding favour with most IARUMS Co-ordinators - it does work!

**20 m.** Again CIS, SLBs, F1B, NON 6 POH, A1A, and 89W modes predominate across the whole band, with an odd J3 & A3 transmission just to even up the selection. VRQ left the scene during the year; this cut down the number of reports by about 50-plus observations a month.

**15 m.** North Korea seems to have dominated the band, when good propagation permitted. Mainly A1A signals; 21.114 MHz comes to mind - "P8M de P7A" can be heard often. China also with "BR6" sends CQ and traffic. Many carriers can be heard - these are mode NON.

On the WARC bands most intrusions seem to be in the 10 and 18 MHz segments. 18.075 and 18.155 MHz are the most popular frequencies, mainly from the Indian region, radio telephone links and military radio stations.

The only Intruder Watch Net appears to be conducted by Tom VK4BTW on 3578 kHz +/- QRM on Fridays at 0700 UTC. Tom is the VK4 State co-ordinator and is doing a great job. I would like to see the other states running a similar net; at Club level would be ideal.

"TT page 848" on the packet BBSs is being trialled, with monthly updates from the VK IW Co-ordinator ensuring new information, etc.

**Conclusions.** The MS definitely needs MORE observers, as most of those doing this IMPORTANT side of amateur radio are getting past their "use-by" date. Some are having serious health problems. VK4 lost another of its

# Radio Books for Australia

## Shortwave Eavesdropper CD-ROM

Gives instant access to well over 32,000 frequencies and 42,000 call signs listing military, tactical, ships - naval and merchant, embassies, aeronautical, press agencies, weather stations and countless more. Also in-depth country by country information containing QSL addresses, schedules, examples of traffic, and maps, DX Edge.

Price: £19.50 including airmail.

## Shortwave Maritime Communications

World's coastal stations and shipping frequencies are listed as well as detailed chapters on how best to monitor all the maritime bands.....£17.00

## Scanner Busters 2

Explains new technology, encryption used and how best to scan on VHF/UHF bands.....£7.50  
Prices included postage to Australia

Also books on Weather, Military and Scanning. Ask for FREE Catalogue of all books.

## INTERPRODUCTS (AR1)

8 Abbot Street, Perth. PH2 0EB, UK

Tel. & Fax: 0011-44-1738-441199

e-mail: interproducts@netmatters.co.uk

foundation members of IW. Ron Glassop VK4BG became a SK during the year. No younger person has seen fit to fill the gap.

The younger generation of amateurs, and maybe the not so young, seem to suddenly get COLD FEET when asked to spend a minimum of three hours a week to help protect our bands from illegal intrusions in VK. Maybe we should give a prize or have a contest? There is hardly a week that I do not receive at least one phone call about an intrusion. Where possible I follow this up with information, but it is rare to get a new observer for my trouble. Therefore, it seems to me that amateur radio is not worth the trouble of working for by the majority of operators. Come on. Prove me wrong!

My thanks to those observers and co-ordinators who have taken the time to send in observations during 1996.

Gordon Loveday VK4KAL  
Federal Intruder Watch Co-ordinator

## Publications Committee

### Achievements

Probably the most significant achievement of 1996 has been the regular production of *Amateur Radio* each month at a cost which is still much less than any similar technical/house monthly for a total membership of about 6000. The responsibility for production, including production administration, has been devolved, initially for two years, from the Federal body to a contractor. By this means Council has hoped to reduce production cost, or at worst to maintain it constant. It is too soon to say if costs are being reduced, but the successful contractor has a history of efficient management, being none other than Bill Roper VK3BR, the previous production editor, now operating as vk3br Communications Pty Ltd.

Council chose Bill's organisation from a total of five competitors. His contract continues up to the December 1998 issue of *Amateur Radio*. The Publications Committee remains as an interface between the WIA and the production firm and continues to provide editorial services.

### Problems

The Publications Committee has been very disappointed in the lack of liaison between Council and the Committee. In particular, there was a total lack of consultation by Council with the Committee before Council unilaterally took action to change the whole production system. Tenders were called without consultation with the Committee which could have advised in detail as to the requirements. The contractor was appointed to administer, produce, print, and deliver the magazine, again without consulting the Committee. It is indeed gratifying that the appointment resulting from this haphazard procedure fully meets with the Committee's approval.

Other problems during the year have involved personnel changes. Norm Eyres resigned in June and Bruce Kendall in August, followed by Bob Tait in December. All three had personal or family reasons for leaving. In July the Federal Office Manager, Donna Reilly, also resigned but, since the magazine administration has been "outsourced" this has reduced the additional load on the remaining office staff. Two new candidates,

Don Jackson and Murray Lewis, have offered to join the Committee.

During the year it became apparent that the magazine would even better represent the interests of all Divisions if each Division were to appoint one or more Divisional Sub-Editors, each with the responsibility for providing news and other material regarding activities in his/her Division which might be of wider interest. The Publications Committee would thus become more widely based rather than being perceived as a purely Melbourne group. The present Divisional Broadcast or Publicity Officers fill this role to some extent and there are also some interstate Technical Sub-Editors, but a Divisional Sub-Editor representing the Publications Committee in each State would be a logical improvement.

In conclusion, it is to be hoped that the administrative changes which are being made to the WIA will be successful in reducing costs, and even more desirably in increasing membership numbers. Our magazine *Amateur Radio* will continue to play a large part in these efforts.

Bill Rice VK3ABP  
Editor

## VK0/9 QSL Bureau

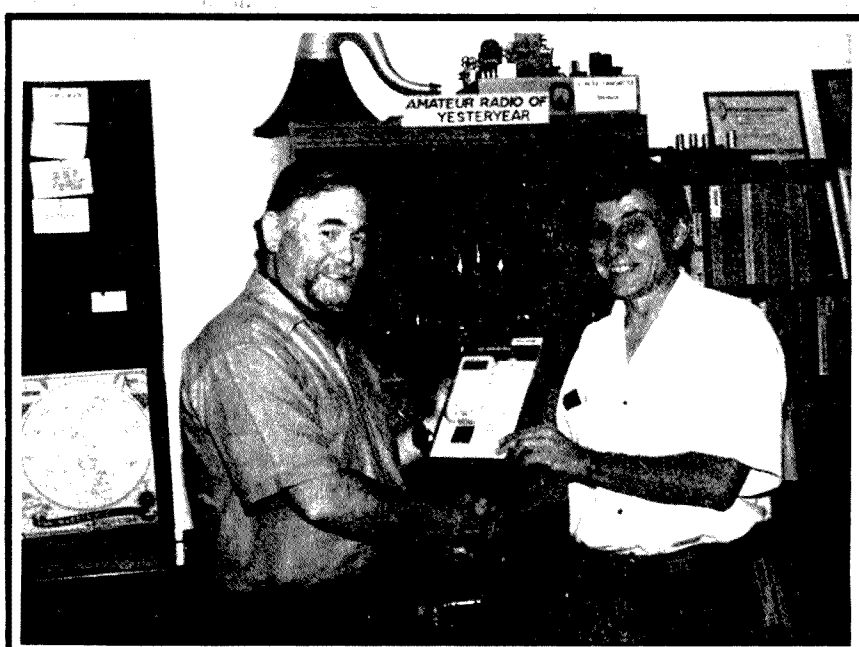
1996 saw an increase in visiting overseas amateurs to our island territories. However, no correspondence or instructions were received as to the forwarding of their Bureau cards. So many cards are returned as "Unclaimed from the Bureau".

Some time ago the first letter of the suffix was agreed between the SMA and the WIA to indicate the geographic location of the VK9 operator. This no longer takes place. It was also agreed that visitors being granted a VK9/0 callsign would have it endorsed "For operation within Australia and Territories". This came about because the VK9/0 callsigns were being used as portable stations by non-VK operators around the world. The latest is VK9XL, using this callsign in the R0 area. He holds his own callsign of UA0ZDA with a home address in Sebastopol, Russia. Is this another issue for the SMA/WIA Liaison committee to address?

All other activities of the Bureau have functioned normally during 1996.

Neil Penfold, VK6NE  
ar

## QSP News



### First New WIA Membership Prize Awarded

The first winner of a \$195 Fluke 12B digital multimeter in the WIA's 1997 *Recruit a Member* campaign was Mike Ramsay VK2VZQ.

As Mike is a shift worker, it was difficult to find a time which was convenient to both himself and the WIA. However, Mike came to

Amateur Radio House on Sunday, 6 April for the presentation, which was held during one of the Divisional Trash and Treasure Sales. Rumour has it that the new Fluke multimeter was not the only treasure Mike took home with him!

The presentation was made by the then Divisional President Peter Jensen VK2AQJ—he's the one with the beard!  
Eric Fossey VK2EFY

---

---

# ALARA

Sally Grattidge VK4SHE\*, ALARA Publicity Officer

---

---

## Congratulations

ALARA's outgoing president, Christine VK5CTY, was presented with life membership of ALARA at a recent luncheon in Adelaide in recognition of her work for ALARA going back eight years. Christine was so overwhelmed she was speechless – for a while anyway!

Mary VK4PZ and OM Gordon VK4GM received Honours Awards from WIAQ for their service to amateur radio. Mary is once again treasurer of the Rockhampton and District Amateur Radio club, as no-one else was willing to do it – sounds like a familiar story.

## Sympathy

Sam, OM of Christine WB2YBA, died suddenly in April from a heart attack.

## VK4 Net

This net on Friday nights at 0930 UTC on 3.565 kHz +/- has not been well attended lately. State Representative Robyn VK4RL has been working, studying and assisting Lorna (XYL of Ted VK4QI) who is seriously ill, so has not had much spare time. Mary VK4PZ calls when Robyn is not available, so, VK4 YLs and others, please try to be there when you can to keep this net going.

## Visiting

Ella G0FIP, BYLARA member, was staying with her brother in Brisbane, and took time to fly to Melbourne to see her sponsor, Gwen VK3DYL. They attended the VK3 April luncheon and a meeting of Gwen's local radio club, the EMDRC, so Ella was able to meet a few VK3 Amateurs.

Choon Taek Cho HL1ASD from Korea has been living in Sydney since last October and will be there until June or July. She is sponsored by Kay WA0WOF whom she met at the YL meet in Osaka in 1993. She gained her radio licence in 1983, was president of KLARC (Korean YLs) for many years, and is attending the Nepean Language Centre in western Sydney University learning "English for Academic Purposes". Her OM is HL1ALT. The Year 2000 YL meeting will be in Korea.

## Stormy Weather

The QTH of June VK4SJ in Caloundra was hit by a severe storm early in the year. They watched the guy wires on one side of the tower break, followed by the whole tower! The tower, rotator and TH6DXX were a write-off, and they have been reduced to

operating on a G5RV while waiting for a replacement.

Sally VK4SHE waited and watched as Cyclone Justin meandered about the Coral sea, and was fortunate that it brought only moderate winds and plenty of rain to her QTH. The road into town was cut for a couple of days, but it was worth it to break the six year drought.

## More Fun at Svalbard

This international YLMEET in Norway on 20-24 August 1998 is sounding better and better. Here are some of the things you can do while you are there. Fossil hunting by the Sverdrupbyen Glacier (hammer and chisel provided), glacier walking (don't forget your fur boots), kayak tour (no experience necessary – life jacket supplied), and dog-sledging on the Foxfonne Glacier (dogs provided). You must register for this meet before December this year.

## Jenny's Guides

Jenny Housden and her Guides were unable to take part in the World Wide Thinking Day due to extreme weather, but they are still radio active, and a training day was held in May for Patrol Leaders and Seconds (ages 8-14) building electronic kits. I hope Jenny had plenty of helpers, as she wanted the girls to see that women can do such things as well as men.

## More Guides from Clara Clarion

GOTA was a success in spite of the low point in the sun spot cycle. Unfortunately, the British version TDOTA (Thinking Day On The Air) was on a different weekend, but next year both sides of the Atlantic will get together on 21 February 1998. As with JOTA

the Guides love to talk to other Guides, but all stations are welcome to join in and tell the girls about their areas and activities.

## Grand Prix

Gwen VK3DYL was part of the team operating VIIGP, the Special Event station run by the EMDRC for the Grand Prix in Melbourne.

## Out West

The VK6 YLs hold regular luncheons, and would be delighted to have visiting YLs join them. If you are passing through Perth any time, phone Poppy VK6YF on 2762652.

## Helping Out

Vicki VE7DKS devotes much of her time volunteering for the Municipal Emergency Program which deals with disasters like earthquakes, chemical spills, fires, ash falls, train derailments and aeroplane crashes. Vicki started the program as Emergency Social Services Director in the city of Colwood, where she lives, a year ago, and takes care of basic training for the Greater Victoria Area, organising instructors and taking part in communications for community events.

## Elettra Marconi

Ruth IT9ESZ, DX correspondent for Elettra Marconi, participated in a DXpedition to Tunisia, with two OMs and a YL from the Czech Republic. This was the first time 3V8BB had been worked by YLs. Ruth is enthusiastic about the Berlin YL World Meet in 1996 and is saving to go to Svalbard.

In September she organised a YL DXpedition to San Marino T7OA together with other YLs from her local radio club. Four YL operators spent a pleasant weekend of hard work and fun despite rain fog and thunderstorms.

\*C/o PO Woodstock, QLD 4816

Tel: 077 788 642

Packet: VK4SHE@VK4RAT.#NQ.QLD.AUS.OC

Internet e-mail: rgratid@ozemail.com.au

ar

**Help stamp out stolen  
equipment – always  
include the serial  
number of you equipment  
in your HAMAD**

# AMSAT Australia

Bill Magnusson VK3JT\*

## National co-ordinator

Graham Ratcliff VK5AGR

Packet: VK5AGR@VK5WI

E-mail: vk5agr@amsat.org

AMSAT Australia net:

Control station VK5AGR

Bulletin normally commences at 1000 UTC, or 0900 UTC on Sunday evening depending on daylight saving and propagation. Check-ins commence 15 minutes prior to the bulletin.

Frequencies (again depending on propagation conditions):

Primary 7.064 MHz (usually during summer).

Secondary 3.685 MHz (usually during winter).

Frequencies +/- QRM.

AMSAT Australia newsletter and software service

The newsletter is published monthly by Graham VK5AGR. Subscription is \$30 for Australia, \$35 for New Zealand and \$40 for other countries by AIR MAIL. It is payable to AMSAT Australia addressed as follows:

AMSAT Australia

GPO Box 2141

Adelaide SA 5001

Keplerian Elements

Current keps are available from the internet by accessing the AMSAT FTP site, [ftp.amsat.org](ftp://ftp.amsat.org) and following the sub-directories to "KEPS".

## Phase-5...What on Earth is That?

A brief history lesson ... pens down and pay attention at the back!

The first amateur radio satellite, OSCAR 1 was launched on 1 Dec 1961. It was very simple. Its battery lasted about three weeks and new satellites followed in quick succession. OSCAR 5 was built at Melbourne University. OSCAR 6 in 1972 ushered in a new era of sophistication. It was the first to have its batteries recharged by solar cells. It was controllable from Earth and it had on-board CPU control. It lasted nearly five years. It was obviously a very different satellite from any of its predecessors. It was dubbed "phase-2" and the "phase-x" system of identification was born. Phase-2 satellites are still being built and launched. JAS-2 falls into this category.

Another leap forward occurred in May

1980. A new orbit, a new concept, phase-3a. Sadly, it failed to reach orbit due to a rocket failure. It wasn't until three years later in June 1983 that we had our first operational phase-3 bird which went on to become OSCAR 10. A little the worse for wear, it is still providing good communications today.

What was different about it to make it a different "phase"? Essentially, it's the orbit. Unlike previous phase-1 and phase-2 amateur radio satellites, OSCAR 10 was in an orbit pioneered by the Russians, a "Molniya" orbit, taking it out in a huge ellipse, some 40,000 km into space. Another new era in amateur radio communication. So now we have phase-1, phase-2 and phase-3 satellites.

In the late 1980s there was some preliminary development done on a proposed geo-stationary amateur radio satellite. It was abandoned due to funding uncertainty. Had it come to fruition it would have been a radical departure from any existing amateur radio satellite and would have been the first "phase-4" bird. There are some who still believe that "geo" is the way to go and that ultimately we will be served by a "constellation" of three interconnected geo-stationary satellites orbiting around the equator. I'll take a closer look at this point next month.

OK so far, but what is all this about a "phase-5" satellite? What could it possibly be? Surely "geo" is about as far as we can go. In strictly amateur radio terms this is probably true but, read on!

Dr Karl Meinzer DJ4ZC quite properly holds the honorary title of "Father of the phase-3 birds". It was Karl who put the concept together and pushed for it in the early days. Now he is on the job again. He has for some time nurtured the idea of an amateur vehicle going off to Mars. It has moved out of the idea stage and into the planning stage. It is not certain yet that it will carry an amateur radio package but it will follow along the lines of phase-3D in design and construction. It will be a scientific satellite and, like the UoSats from University of Surrey it will be a university project.

Last year a "kick-off" meeting was held in Marburg, Germany. At the meeting Karl proposed a vehicle modelled on phase-3D. Its engine would have enough thrust to propel it to Mars and insert it into orbit. The availability of solar energy was discussed. Mars is further from the Sun than Earth and the available solar energy is only half that available in earth orbit.

Communication would require a minimum of a three metre dish. The transponders would use "S" band up, and "X" band down. Tracking would not be easy and the rigorous standards involved would preclude the vast bulk of amateurs from participating directly, but the possibility of a few gateway stations feeding into the packet system or the Internet is still being considered. No doubt there are some among our ranks who would want to be more directly involved.

It's difficult to imagine a greater challenge. The primary purpose of the project would be to fly university-based scientific experiments to Mars orbit. It could also take part in the transfer of data between Mars land vehicles which NASA has planned, and Earth. Let's watch this project as it matures. If Karl's record is any indication it will be something for amateurs to point to proudly in the future.

## MO-30 ... What Happened?

Tom Clark W3IWI recently reported more details on the fate of MEXICO-OSCAR 30 (MO-30). The satellite, which also contained a 40 MHz meteor radar, was built at UNAM (The Autonomous University of Mexico) in Mexico City by David Liberman XEITU and his students. They have had rather bad luck in this project.

The first UNAMSAT was destroyed when its launch vehicle exploded shortly after the lift-off from Plesetsk in March 1995. UNAMSAT-1's spare parts were used to construct a replacement which was launched successfully on a different type of launch vehicle, also from Plesetsk. The new satellite transmitted telemetry for about one day.

Unfortunately, according to Tom, the launcher was very cold. MO-30 separated from the launcher at a temperature of about -30 degrees Celsius because the satellite was under the launcher shroud for a couple of hours. Apparently, the crystal oscillator in the uplink receiver's first local oscillator never started oscillating, so the satellite was totally "deaf".

Because there was no functioning uplink, battery charging parameters suitable for the unanticipated cold temperatures could not be loaded, and the satellite ran out of power. Later attempts to revive it were unsuccessful. MO-30 project managers have now concluded that it has been lost, apparently for good.

One feels for the project gang at UNAM and it brings to mind the old adage, "For the want of a nail the shoe was lost, for the want of a shoe the horse was lost, for the want of a horse the rider was lost, for the want of the rider the battle was lost, for the loss of the battle the war was lost". When you consider all the possibilities for similar small

component failures it's remarkable that any of these projects are completely successful. Our sympathy goes to the project people at UNAM, especially in this case as the problem was not within their control.

## Oils ain't Oils and Keps ain't Keps

It came to my notice recently when editing a block of kep elements that something was amiss. No matter how hard I tried to get my computer program to accept the keps, it kept telling me that such and such a satellite just wasn't there. To the naked eye it WAS there, right there in the middle of the rest of the keps. No doubt about it, there it was, DOS text doesn't lie ..... or does it?

I recalled a similar incident on my old faithful BBC Acorn computer some years ago. A closer examination revealed the culprit(s). The name of the satellite in question on line 1 was followed by four (quite invisible) spaces before the <CR>. Delete the spaces, save the file and presto, problem solved.

My program was looking for a satellite called "X" and it kept seeing a satellite called "X<spc><spc><spc><spc>" so it put up an error message. I remember agonising over this one back on the BBC. I only found it then because I had to edit the actual name of some weather satellites due to case sensitivity in the software. If you have problems with your computer program accepting some keps, check for trailing spaces after the satellite names. It can still happen. I contacted a CompuServe sysop about a similar occurrence quite recently. He was unaware and most apologetic. I have to say it didn't happen again.

## SunSat Latest

Launch is due on 14 August 1997. The satellite was designed and constructed by the students at the University of Stellenbosch. The main command station will be at Stellenbosch and another is planned for Johannesburg. The Johannesburg station will take care of the high-speed data link and the imaging system.

## Next Month

Six-monthly satellite status/frequency/mode report. Geo-stat or geo-sync, what's the difference? Exciting news from the Surrey team about some new high speed digital satellites. Rumours abound, but by next month I should have something confirmed regarding baud rates, purpose, orbits and equipment requirements.

\*RMB 1627, Milawa VIC 3678  
E-mail: vk3jt@amsat.org

ar

# Awards

John Kelleher VK3DP - Federal Awards Manager\*

Another half-year has gone, and conditions have not improved greatly. Sunspot figures have risen only marginally. The odd DX station is popping up, providing some relief to those avid DX chasers looking to upgrade their figures. Which reminds me to mention that upgrades must be in before the end of this month, if they are to appear in the DXCC listings in August.

Awards this month feature Belgium, Brazil, Canada, Canary Islands and Cuba.

## Worked All Belgian Provinces

Issued by Union Belge des Amateurs-Emetteurs (UBA) to all amateurs and SWLs. Contacts after 1 January 1995. All bands and modes. Europeans must contact all 10 Belgian Provinces, and the City of Brussels on at least two bands, 22 contacts in all.

DX stations need one QSO in each Province, and Brussels, 11 contacts. The Provinces are: Antwerpen (AN), Hainaut (HT), Luxembourg (LU), Brussels (BR), Limburg (LB), Namur (NM), Brabant Walon (BW), Liege (LG), Oost-Vlaanderen (OV), Vlaams-Brabant (VB), and West-Blaanderen (WV).

Contacts with VB and BW count only as from 1 January 1995. GCR list and fee of \$US7.00 or 10 IRCs go to: Danny Commeyne ON4ON, UBA Awards Manager, Rozenlaan 36, B-8890 Dadizele, Belgium.

## Worked All America (Brazil)

Confirm contacts with 45 countries in the American Geographic area. A PY contact is mandatory. CE Chile, VP8/LU Antarctica, PY Brazil, HR Honduras, CE0 San Felix, VP8/LU Sth Orkney, PY0 Trinidad, J7 Dominica, FG Guadeloupe, VP9 Bermuda, TG Guatemala, KG4 Guantanamo Bay, FO0X Clipperton, YN Nicaragua, VE Canada, KP5 Desecheo, FY French Guiana, YV0 Aves Island, VP2E Anguilla, KV4

Virgin Islands, HH Haiti, VP2M Montserrat, HI Dominican Republic, 8P Barbados, VP2V Brit Virgin Isl, PJ Neth Antilles, 9Y Trinidad/Tobago, PJ Sint Maarten, HK0 San Andres, CE0 Easter Isl, VP8 Falklands, PY0 F de Noronha, J3 Grenada, CO Cuba, VP8/LU S Sandwich, PY0 P/Paul Rocks, K,W USA, FM Martinique, XE Mexico, TI Costa Rica, KL7 Alaska, FP St Pierre/Miquelin, YS Salvador, V3 Belize, HC Ecuador, ZF Cayman Isl, V4 St Kitts, etc, LU Argentina, HK Columbia, 8R Guyana, OA Peru, HP Panama, CE0 Juan Fernandez, VP8/LU Sth Georgia, J6 St Lucia, CX Uruguay, VP8/LU S Shetlands, PZ Surinam, KC Navassa Isl, FO8 Fr Polynesia, XF4 Revilla Gigedo, TI9 Cocos, KP4 Puerto Rico, FS St Martin, YV Venezuela, V2 Antigua, HC8 Galapagos, ZP Paraguay, 6Y Jamaica, J8 St Vincent, OX Greenland, VP5 Turks/Caicos, HK0 Malpelos, and C6 Bahamas.

All contacts must be made from the same country, or within a radius of 125 miles (208 km). Contacts with ships (anchored or not) and aircraft are not acceptable. No date requirements. Three types of certificates are awarded, Mixed, Phone and CW. GCR is acceptable. The fee for this Award is 10 IRCs or equivalent. Any submissions should be sent to: LABRE Headquarters, Award Manager, PO Box 07-0004, 70 359-970 Brasilia DF, Brazil.

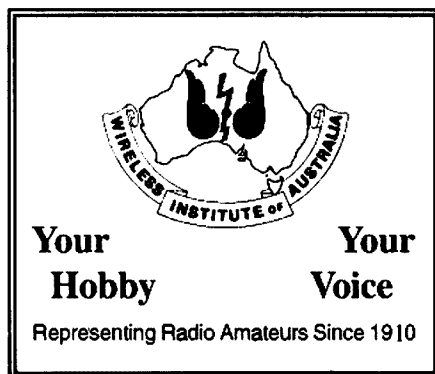
## CW Operators of the British Commonwealth (Canada)

Make CW contact with British Commonwealth stations after 1 January 1980. SWL OK. The Basic certificate is earned by completing the requirements for Class 1, then higher levels individually or all at once. Available in three classes.

Class 1 requires 1 QSO with ZL North Island; 1 ZL South Island; 3 VK 1 to 7; 1 V85, VS6 or 9M2,6,8; 1 VU2; 3 ZS 1 to 6; 2 VP2, or V2, 3, 4; 3 VE, VO VY2, 3; and 6 G. A total of 22 QSOs.

Class 2 required 1 QSO with ZK or ZL Island; 1 P2 or VK Island; 2 VK6 or VK8; 1 8Q, VU7, 4S7, or 9V; 1 C5, 9J, 9G, or ZD8; 1 VP8 or VP9; 4 VE2, VE3 or VY9; 3 VE4, VE5, VE6, or VE7; 3 each GI and GM; 2 GW; 2 GD, GJ, or GU; and 1 ZB2. A total of 28 QSOs.

Class A1 requires QSOs with 15 or more stations in 15 different call areas from the following list: A2, A3, C2, C6, H4, J3, J6, J7, S2, S7, T2, T3, VE8, VP5, VR6, VQ, VY1, YJ8, Z2, ZC, ZD7, ZD9, ZS8, 3B, 3D, 5B,





5H, 5N, 5W, 5X, 5Z, 6Y, 7P, 7Q, 8P, 8R, 9H, 9L, 9X, and 9Y. A total of 15 QSOs.

GCR list is accepted. No charge for award, but at least three IRCs are needed for airmail. Apply to: Vince Thorneycroft VE1RJ, 35 Clearview Avenue Fredericton NB, Canada E3A 1J9.

### Canary Islands Diploma

Work different EA8 stations since 29 April 1971 on all bands/modes. EU need 40, Spain and Portugal need 60. South America, Central America and Caribbean need 30. USA, Canada and Africa need 20. Asia and Oceania need 10. GCR list and a fee of 15 IRCs should be sent to: Alfonso L Hernandez EA8ZX, Box 221, 35080 Las Palmas, Gran Canaria, Spain.

### Caribbean Award (Cuba)

Class 1 Excellent. Work 30-32 of the 32 countries and call areas in the Caribbean including those countries with a coast on that area such as XE, V3, TG, HR, YN, TI, HP, and YV. Class 2, work 25-29 of the countries. Class 3, work 20-24.

A QSO with CO/CM is mandatory. KG4 is not acceptable. General requirements. All bands and modes. SWL OK. The fee required is 10 IRCs or \$US5.00. GCR accepted. Apply to: Luis Gomez CT1ESO, PO Box 207, 8900 V R St Ant, Portugal.

\*4 Brook Crescent, Box Hill South, VIC 3128  
Phone (03) 9889 8393

Canadian QSOs including VE0, and two points for others. Canadians with RAC suffixes are worth 20 points. Multiplier is Canadian provinces and territories (max 12), counted once per band and mode: VE1/CY9/CY0 (NS); VE2/VA2 (QC, QU or PQ); VE3/VA3 (ON); VE4 (MB); VE5 (SK); VE6 (AB); VE7 (BC); VE8 (NWT); VE9 (NB); VO1/VO2 (NF); Yukon (YU or YT); VY2 (PEI). Final score equals points x multiplier. Send your log and summary sheet by 31 July to: RAC, 720 Belfast Rd #217, Ottawa ON K1G 0Z5, Canada.

### Australasian CW & Phone Sprints

5 July (/CW), 12 July (Phone); 1100-1159z Sat.

Presented by David Box VK5OV

The Adelaide Hills Amateur Radio Society is pleased to announce the 12th Australasian Sprints, which are open to all amateurs and SWLs in VK, ZL and P2. The object is to make (and SWLs to hear and log) as many contacts with amateurs in VK, ZL and P2 as possible, without duplication, on 80 m during a one hour period. Groups of amateurs using a single callsign, eg clubs, are also eligible. Frequencies are 3500-3700 kHz (CW) and 3535-3700 kHz (phone). RS(T) is optional, and the minimum exchange is a serial number starting at any number between 001 and 999, reverting to 001 if 999 is reached. (Note: RS(T) may be required for contacts with participants in any other VK or ZL contests during the same period.)

For each QSO, logs must show the date and time (UTC), callsign worked (or both callsigns for SWLs), and serial numbers sent and received. Logs must be accompanied by a summary sheet showing the name and date of the sprint (CW or Phone), the operator's callsign, name and address, the total number of contacts claimed, and a declaration that the operator has observed the rules and spirit of the contest. Any special information should also be mentioned, eg QRP or mobile operation. Multi-operator/club entries must show the callsigns and names of all operators.

Send logs to: AHARS, PO Box 401, Blackwood, SA 5051 to be received by 15 August, with the envelope endorsed CW, Phone, or SWL Sprint. Alternatively, logs can be sent via packet to: VK5AFO@VK5WI.#ADL.#SA.AUS.OC or e-mail to [cavidj@picknowl.com.au](mailto:cavidj@picknowl.com.au)

Certificates will be awarded to the highest scoring station in each section in each VK, ZL, and P2 call area. Trophies will be awarded to the outright winners. A certificate will also be awarded to the highest scoring Novice entrant in the CW Sprint, providing that the recipient is not entitled to another

## Contests

Peter Nesbit VK3APN - Federal Contest Coordinator\*

### Contest Calendar June - August 1997

Jun 1	Portugal Day Contest (SSB)	(May 97)
Jun 7/8	IARU Region 1 Field Day (CW)	(May 97)
Jun 14	QRP Day Contest (CW)	(May 97)
Jun 14	Asia-Pacific CW Sprint	(Jan 97)
Jun 14/15	ANARTS RTTY Contest	(May 97)
Jun 14/15	South America WW Contest (CW)	
Jun 21/22	VK Novice Contest	(May 97)
Jun 21/22	All Asia CW DX Contest	(May 97)
Jun 28/29	ARRL Field Day	
Jul 1	Canada Day (CW/Phone)	
Jul 5	Australasian 80 m Sprint (CW)	
Jul 5	Jack Files Memorial Contest (CW)	
Jul 5	NZART Memorial Contest (Phone/CW)	
Jul 12	Australasian 80 m Sprint (Phone)	
Jul 12	Jack Files Memorial Contest (Phone)	
Jul 12/13	IARU HF Championship	
Jul 19	South Pacific 160 m Contest (Phone/CW)	
Jul 19	Colombian DX Contest (Phone/CW)	
Jul 26	Waitakere 80 m Sprint (Phone)	
Jul 26/27	RSGB IOTA Contest	
Aug 2	Waitakere 80 m Sprint (CW)	
Aug 2/3	YO DX Contest	
Aug 9/10	Worked All Europe (CW)	
Aug 16/17	Remembrance Day Contest	
Aug 16/17	Keyman's Club of Japan (CW)	

For information and assistance this month, thanks to VK4EFX, VK5OV, VE2ZP, ZL1BVK, RSGB, and ARRL. Until next month, good contesting!

73, Peter VK3APN

### Canada Day Contest (CW & Phone)

0000-2359z, Tuesday, 1 July

This contest, which runs on 1 July each year to celebrate Canada's confederation, takes place this year on a Tuesday.

Bands are 160-2 m, CW and phone. Suggested frequencies are: (CW) 25 kHz up from the band edge, and (SSB) 1850, 3775,

7075, 7225, 14175, 21250, and 28500 kHz. Check for CW activity on the half hour. Note there are to be no CW QSOs in the phone sub-bands, and vice-versa.

Any station can work any other, once per band and mode. Exchange RS(T) and serial number; Canadians will send RS(T) and province/territory. Score 10 points for

# DICK SMITH ELECTRONICS



## YAESU FT-8000R 2m/70cm Mobile

The stunning new Yaesu FT-8000R is a state of the art 2m/70cm band mobile transceiver that introduces industry-first features in a very easy to operate combination.

The first Amateur VHF/UHF mobile rig to provide superwide receiver coverage (110-550MHz and 750-1300MHz\*), together with MIL-STD-810 shock and vibration rating for years of reliable operation, it also features:

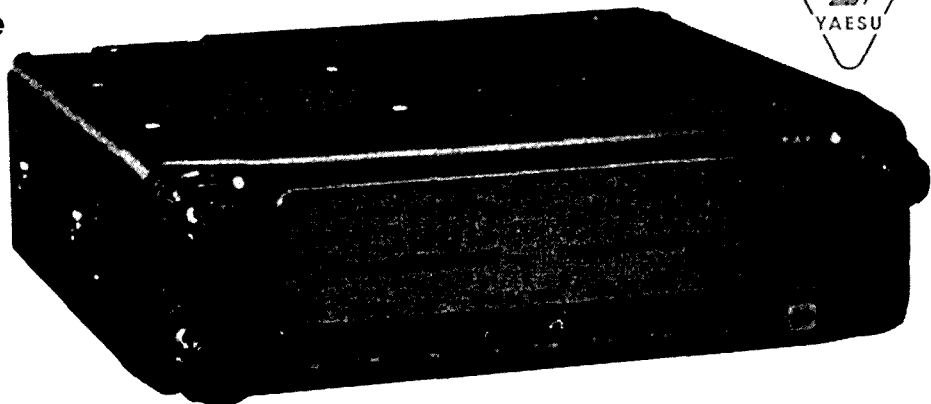
- Rear panel socket for 1200 and 9600 baud Packet operation
- 3 selectable power output levels
- Inbuilt antenna duplexer for immediate dualband antenna use.
- 110 memory channels for storage of your favourite frequencies
- Dual receive capabilities (VHF/UHF, VHF/VHF, UHF/UHF)
- Huge "Omni-glow" backlit LCD screen showing frequency, memory, and function activity.
- "Enhanced Smart Search" for automatic search and loading of active frequencies into 50 special memories.
- Inbuilt crossband repeater facility
- CTCSS for repeater access where sub-audible tones are required.
- Wide range of tuning steps, with different settings for each band

### Specifications:

- Frequency coverage:
- Transmit : 144-148MHz, 430-450MHz
  - Receive : 110-550MHz, 750-1300MHz\*  
\*(800MHz Cellular locked out)
  - Transmit power: - 2m : 50w, 10w, 5w,  
70cm : 35w, 10w, 5w
  - Size : 140mm x 40mm x 152mm (WHD without knobs)

### Supplied Accessories:

- MH-42B6J handheld microphone.
- MMB-36 mobile mounting bracket
- Fused DC power cord.



Cat D-3316

**2 YEAR WARRANTY**

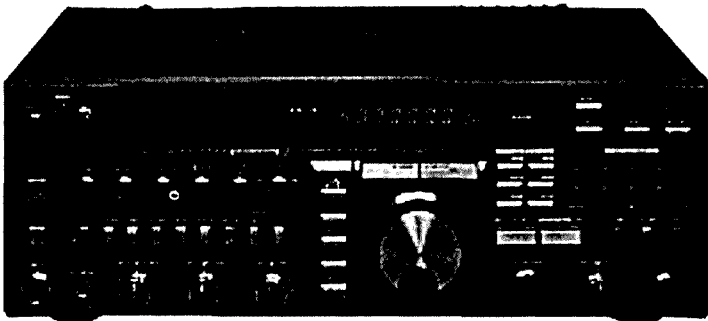
**\$899**

## YAESU FT-736R VHF/UHF Base Station Transceiver

Whether your interest is in talking through your local repeater, operating SSB DX, or talking to the world via satellite, this high-performance multimode base station transceiver can do it all! In its standard form, the FT-736R provides 25W output on the 2m (144-148MHz) & 70cm (430-450MHz) bands in SSB, CW, and FM modes. Can be expanded to cover the 6m (50-54MHz) & 23cm (1240-1300MHz) bands by installing optional modules.

### Features:

- Digital control with keypad or VFO frequency entry.
- Efficient switch-mode AC power supply.
- 100 general-purpose memories.
- 10 full-duplex crossband memories, 2 independent VFOs per band.
- 2 full-duplex VFOs - transmit & receive frequencies (and modes) can be tuned independently or synchronously for satellite operation.
- Adjustable IF Notch and IF Shift filters.
- Noise blanker, 3-speed selectable AGC.
- High-stability (+/-1ppm) PLL reference oscillators.
- Speech processor and VOX for SSB.
- VFO or selectable channel steps on FM.
- Digital input connection for packet TNCs.



**2 YEAR WARRANTY**

### Specifications:

- Modes: LSB/USB (J3E), CW (A1A), FM (F2D, F3E)
- Receiver: 50, 144MHz: Dual Conversion  
Other Bands, Triple Conversion  
better than 0.2uV for 12dB S+N/N
- Sensitivity SSB/CW: better than 0.35uV for 12dB SINAD
- FM: better than 0.35uV for 12dB SINAD
- Dimensions: 368 x 129 x 286mm (WHD)

*Offers expire 31/5/97*

**\$2495**

Cat D-2920



**For further information, orders or the location of your nearest store call:  
1300 366 644 (Local Call Charge) Or Fax: (02) 9805 1986**

# Yaesu FT-1000MP

## Incredible Performance, Amazing Price!



Now's your chance to pick up Yaesu's latest high performance HF base transceiver, the new FT-1000MP, at a great new price. You'll be amazed at its incredible performance, but if you need convincing, just read what the experts have to say.

#### On Operation:

"I would classify the transceiver as 'user friendly' compared to some other modern transceivers I have operated." - CQ  
 "..... we found it to be a proficient performer." - QST  
 ".....In term of ergonomics my preference is marginally for the Yaesu.....The second receiver is certainly better implemented....." - Radio Comms (UK)

#### On Documentation:

"In general, Yaesu's manuals are the epitome of clear, concise, and complete documentation, and the FT-1000MP's 104 page Operating Manual is no exception." - QST

#### On The Receiver:

"Its receiver is a real beauty ... Its very clean and the audio is very clear and punchy ...." - Radio & Communications  
 "Measurement of second order intermodulation ... showed an average result for the IC-775DSP but the FT-1000MP was some 10dB better than any other radio measured." - Radio Comms (UK)  
 "The receiver is quiet and good at its job, and Yaesu's EDSP is icing on the cake." - QST  
 "Certainly, this receiver is designed to withstand the onslaught of very strong signals...." - CQ

#### On The Transmitter:

"CW operators will be impressed with the FT-1000MP keyer." - CQ  
 "The transmitter is good as well, with a lightning fast automatic tuner built in as standard." - Radio & Communications  
 "The FT-1000MP has excellent spectral purity of the output signal." - CQ

#### Digital Signal Processing:

"The EDSP filter operates smoothly and effectively in all of its modes." - CQ  
 "Having the DSP built-in means it works as well as possible - and is clearly better than most after-market add-ons." -Radio & Communications  
 "The double-whammy of crystal and mechanical filters plus DSP in the FT-1000MP is a killer combination." - QST

#### Conclusions:

"... I am unable to report finding even a picky fault with the FT-1000MP." - CQ  
 "So does the inbuilt DSP say 'buy me'? In this humble scribes opinion, you bet!" - Radio & Communications  
 "The FT-1000MP offers performance and flexibility in a quality radio." - QST

Interested in more information? Why not call us for a copy of Yaesu's 12 page colour booklet, 46 page Technical Overview, or for copies of various magazine reviews. We're sure you'll soon agree that the world of HF transceivers has just taken a giant leap forward.

QST - ARRL QST (USA) Magazine review April 1996

CQ - CQ (USA) Magazine review April 1996

Radio Comms - Radio Communications (UK) review  
 January 1996

Radio & Communications - Radio & Communications (Aust)  
 review July 1996

Cat D-3400

# \$3995

2 YEAR WARRANTY



**For further information, orders or the location of your nearest store call:**

Ph: 1300 366 644 (local call charge)

Or Fax: (02) 9805 1986

**DICK SMITH**  
**ELECTRONICS**

B 2912

award in this Sprint. Other awards may be made at the Contest Manager's discretion. Standard disqualification criteria apply, and the Contest Manager's rulings and decisions are final.

These contests are recommended as a good Saturday evening's entertainment. If you have never entered a contest before, here is a good, friendly time to start.

### **Jack Files Memorial Contest**

5 July (CW), 12 July (Phone); 0800-1400z Sat.

*Presented by Peter Dawson VK4EFX*

This contest honours the late Jack Files, a long-serving VK4 WIA Councillor. The object is for amateurs throughout VK/P2/ZL to work as many VK4 Towns and Shires as possible, to encourage portable/mobile activity from the less populated VK4 towns and shires, and to serve as a warm-up for the Remembrance Day contest.

Sections are: (a) Single Operator Home; (b) Club Fixed; (c) Single Operator Mobile/Portable; (d) Club Mobile/Portable; (e) Stations outside VK; (f) SWL. Operate on 160, 80 and 40 m. Cross band contacts are not allowed.

Exchange RS(T) followed by a serial number starting at 001 and incremented by one for each QSO, continuing when changing bands. Multi-transmitter stations should use separate serial numbers starting at 001 for each band. VK4 entrants will send their two letter shire code after their serial number.

Score one point per QSO with non-VK6, and two points per QSO with VK6. Each VK4 Shire/Town Code per band counts as a multiplier, also each prefix per band. To stimulate portable/mobile activity, portable/mobile stations can also claim one multiplier per band for each VK4 Shire/Town from which they operate. The final score equals total points times total multiplier.

In this contest only, single operators are allowed to have a log keeper. Club stations can use multiple transmitters, providing there is only one station on each band at any one time. These transmitters need not be co-located, and may even be in different shires. *Note: Stations can be re-contacted on the same band after one hour.* Contacts with entrants in other contests are valid, as are DX contacts, and those with VK6 stations are encouraged.

Attach a summary sheet showing the name, address and callsign of the entrant, section entered, points claimed, and a declaration that the rules and spirit of the contest were observed. Send logs to: Jack Files Contest, GPO Box 638, Brisbane QLD 4001 to be received by Monday, 1 September 1997. Trophies will be awarded to the highest

scorer in each section and the highest Novice overall, providing there are at least five entrants in that section. Certificates will also go to the three highest scorers in each section.

VK4 City/Town/Shire codes are as follows:

AL Albert; AC Aramac; AN Arakun (R); AT Atherton; BL Baloone; BA Banana; BC Barcaldine; BO Barcoo; BH Bauhinia; BT Beaudesert; BY Belyando; BD Bendemere; BG Biggenden; BX Blackall; BV Boonah; BQ Booringa; BZ Bouila; BW Bowen; BN Brisbane; BS Broadsound; BP Bulloo; BU Bundaberg; BI Bungil; BK Burdekin; BR Burke; BE Burnett; CB Caboolture; CS Cairns; CL Calliope; CA Caloundra; CM Cambooya; CD Cardwell; CP Carpentaria; CT Charters Towers; CH Chinchilla; CF Clifton; CY Cloncurry; CK Cook; CN Crows Nest; CR Croeydon; DY Dalby; DL Dalrymple; DI Diamantina; DG Douglas; DU Duaringa; EA Eacham; ED Eidsvold; EM Emerald; EK Esk; ET Etheridge; FZ Fitzroy; FL Flinders; GT Gatton; GH Gayndah; GD Gladstone; GC Gold Coast; GI Goondiwindi; HT Herberton; HB Hervey Bay; HK Hinchinbrook; JE Jericho; JO Johnstone; JY Jondaryan; KY Kilcoy; KK Kilkivan; KG Kingaroy; KO Kolan; LA Laidley; LV Livingstone; LC Logan; LO Longreach; MC Mackay; MA Mareeba; MO Maroochy; MB Maryborough; MK McKinlay; ML Milmerran; MN Mirani; MV Miriam Vale; MT Monto; MZ Mornington (R); MI Mt Isa; MM Mt Morgan; MU Mundubbera; MY Murgon; MX Murilla; MH Murweh; NN Nanango; NE Nebo; NO Noosa; PO Paroo; PD Peak Downs; PY Perry; PR Pine Rivers; PT Pittsworth; QL Quilpie; RC Redcliffe; RD Redland; RI Richmond; RH Rockhampton; RM Roma; RO Rosalie; SA Sarina; ST Stanthorpe; TB Tambo; TA Tara; TM Taroom; TH Thuringowa; TI Tiaro; TO Toowoomba; TE Torres; TV Townsville; WG Waggamba; WO Wambo; WR Warroo; WA Warwick; WH Whitsunday; WI Winton; WD Wondai; WC Woocoo.

(R) = restricted area for radio transmission (Shire entry permit required).

### **NZART 80 m Memorial Contest (Phone/CW)**

0800-1400z, Saturday, 5 July

VKs are invited to join ZLs in this yearly contest to commemorate amateurs lost in World War II. It is open to single operator stations on 80 m, fixed and mobile. The contest has six operating periods, each of one hour, from 0800z-1400z.

A station may be contacted TWICE during each operating period (once on phone and once on CW), providing that such contacts are not consecutive. Exchange RS(T) plus

serial number commencing at any number between 001 and 300 for the first contact. On phone, score 15 points for the first QSO with a scoring area, 14 points for the second QSO with that area, descending to one point for the 15th and subsequent QSOs with that area. The same scoring system is used for CW, except that QSO points remain at five for the 11th and subsequent QSO with that scoring area. Scoring areas are VK and ZL prefixes/areas, and DXCC countries. The rules for SWL entrants are similar, except that the call signs of the stations heard and being worked must be given, and only the cipher of the station heard is required.

Send logs and summary sheets ASAP to: Memorial Contest, PO Box 20 332, Auckland 7, New Zealand. Nominate the category entered (Open; Phone; CW; Beginners CW; QRP; Home-made SSB), and include a points summary showing the number of QSOs and points for each VK/ZL call area worked. Certificates will be awarded to the top three scoring VKs.

### **IARU HF Championship (Phone/CW)**

1200z Sat to 1200z Sun, 12-13 July

This popular contest runs on the second full weekend of July each year. Bands are 160-10 m. Categories are single operator, CW only, phone only, mixed; multi-operator single transmitter mixed mode only. Multi-operator stations must remain on a band for at least 10 minutes at a time (exception: IARU member society HQ stations may operate simultaneously on more than one band with one transmitter on each band/mode, providing only one HQ callsign per band is used).

Exchange RS(T) and ITU zone (P2 = 51, VK4/8 = 55, VK6 = 58, and VK1/2/3/5/7 = 59). HQ stations will send RS(T) and official society abbreviation.

Claim one point for QSOs within own zone or with an HQ station, three points for QSOs with a different zone in own continent, five points for QSOs with different continents. Multiplier is total ITU zones plus IARU HQ stations worked on each band. Final score is total QSO points from all bands x sum of multipliers from each band.

Include a dupe sheet for 500+ QSOs. Send logs postmarked by 8 August to: IARU HQ, Box 310905, Newington, CT 06131-0905, USA. Official forms and an ITU zone/prefix/continent map can be obtained from the same address on receipt of a large SASE with two IRCs or equivalent. Certificates to the top scorers in each category, in each state, ITU zone, and DXCC country. Also, stations with 250+ QSOs or 50+ multipliers will receive achievement awards.

## 2nd South Pacific 160 m Contest

0700-2330z, Saturday, 19 July  
Presented by Ian Godsil VK3DID

This contest is scheduled for the third full weekend of July, and last year attracted large numbers of stations from Australia, New Zealand, and several DX countries. Since then a high level of overseas interest in this contest has developed. So, given the right conditions, there is a chance to make some good DX QSOs on this challenging band, in addition to many VK, ZL and (hopefully) P2.

The objective is for VK, ZL and P2 stations to work as many local and overseas stations as possible on 160 m. DX stations are also encouraged to participate, but can only work VK, ZL, and P2.

Sections are CW, Phone, and SWL (all single operator). Exchange RS(T) plus serial number. Stations should claim two points per QSO with their own call area, or five points per QSO for all other call areas. For VK and ZL entrants: if the number in your callsign differs from your actual location, please follow your callsign with the appropriate numeral to indicate your location.

The multiplier is the number of VK and ZL call areas worked, plus the number of DXCC countries worked, excluding one's own country. The final score equals the total QSO points times the multiplier.

Certificates will be awarded to the top scoring stations in each section, in each call area of VK and ZL, and each DXCC country. Send your log, signed summary sheet, details of your station, and any comments to: Ian Godsil VK3DID, 25 Monaco Street, Parkdale VIC 3194, Australia, to be received within six weeks after the end of the contest. For 1997, this is 29 August. Logs in 3.5" DOS format are most welcome.

## Colombian Independence Day Contest

0000-2400z, Saturday, 19 July

This is a world-wide contest, all bands 80-10 m. Categories are Phone and CW (not mixed): single operator (single and all band), and multi-operator (single and multi-transmitter). Exchange RS(T) plus serial number. Score five points per HK QSO, three points per QSO with stations in another country, one point per QSO with stations in same country, and 10 points for QSOs with official HK HQ Stations. The multiplier is the total countries including HK plus HK call areas worked on each band. "HK" includes all Colombian prefixes. Final score is total QSO points from all bands x sum of multipliers from all bands. At least 2% of QSOs must be with HK, and 10% with stations outside your country. Send logs postmarked by 29 August to: Colombian

Independence Day Contest, Apartado 584, Santa fe de Bogota, Colombia.

## Waitakere 80 m Sprint

Phone: 1000-1100z, Saturday, 26 July  
CW: 1000-1100z, Saturday, 2 August

This 80 m sprint contest is open to all VK and ZL amateurs. In fairness to other amateurs, it is requested that no linear amplifiers be used in the contest. Call "CQ Sprint", and exchange serial numbers commencing at 001 and incrementing by one for each contact. RS(T) is not required.

Logs must show the stations worked, and the serial numbers sent and received. Attach a summary sheet and send the log to: Sprint Contest Manager ZL1BVK, 14 Takapu Street, Henderson, Auckland 1208, New Zealand to arrive by 2 September. Alternatively, logs may be sent via packet, using three columns only with no commas or other delimiters, to: ZL1BVK@ZL1AB. Certificates will be awarded to the overall winner, the best score in each ZL call area, and the three best VK scores.

## RSGB Islands On The Air Contest (Phone/CW)

1200z Sat - 1200z Sun, 26-27 July

This contest is intended to promote contacts between qualifying IOTA island groups and the rest of the world, and to encourage expeditions to IOTA islands. Sections are: IOTA Island Stations (ie those with an IOTA reference); World; and SWL. You can enter as CW only, SSB only, or mixed mode. Single operator stations can enter as unlimited (no time limit), or limited (12 hours max, with off periods at least 60 minutes long and marked in the log).

Use 80-10 m, avoiding 3.56-3.6, 3.65-3.70, 14.06-14.125, and 14.3-14.35 MHz. Exchange RS(T) plus serial number, plus

IOTA reference number if applicable. Stations can be contacted on both phone and CW on each band. Use the same serial numbering system for both modes.

Score 15 points per QSO with an IOTA station (including UK), five points for contacts with stations in another DXCC country, and two points per QSO with one's own country or IOTA reference. The multiplier equals the total IOTA references per mode per band, added together. The final score equals the total QSO points x the total multiplier.

For each band (but not each mode), submit a separate log, multiplier list, and dupe sheet. Send your log and summary sheet to: RSGB IOTA Contest, PO Box 9, Potters Bar, Herts EN6 3RH, postmarked no later than 31 August. A comprehensive range of awards is offered to the leading stations in each category, section and continent.

## Results of 1995 ARRL 160 m DX Contest

(Score/QSOs/Mult)  
VK3DXI 32 4 4

## Results of 1995 ARRL 10m Contest

(Score/QSOs/Mult/Mode/Pwr)  
VK2APK 17,982 214 27 Mixed L  
VK4EMM 19,000 244 25 Mixed H  
VK4NEF 2,142 119 9 Phone QRP  
VK4XA 12,744 177 18 CW L  
VK4TT 2,016 72 7 CW L  
VK4XXV 784 49 4 CW L

## Results of 1996 ARRL RTTY Roundup

(Score/QSOs/Mult/Hours)  
VK6GOM 6,360 159 40 15

\*PO Box 2175, Caulfield Junction, VIC 3175  
pnesbit@melbpc.org.au

ar

## WIA MORSE PRACTICE TRANSMISSIONS

VK2BWI	Nightly at 2000 local on 3550 kHz
VK2RCW	Continuous on 3699 kHz and 144.950 MHz 5 wpm, 8 wpm, 12 wpm
VK3COD	Nightly (weekdays) at 1030 UTC on 28.340 MHz and 147.425 MHz
VK3RCW	Continuous on 145.650 MHz, 5 wpm, 10 wpm
VK4WIT	Monday at 0930 UTC on 3535 kHz
VK4WCH	Wednesday at 1000 UTC on 3535 kHz
VK4AV	Thursday at 0930 UTC on 3535 kHz
VK4WIS	Sunday at 0930 UTC on 3535 kHz
VK5AWI	Nightly at 2030 local on 3550 kHz
VK5VF	Continuous on 145.650 MHz, 5 wpm to 12 wpm
VK6RCW	Continuous on 147.375 MHz, 3 wpm to 12 wpm



# "VK3LZ calling!"

More sound information from your friends at Icom.

## MOUNT GAMBIER CONVENTION HERE AGAIN!

Doesn't time fly! We're almost half way through '97 which signals the annual S.E.R.G. convention at Mt. Gambier on the Queen's Birthday weekend on the 7th. and 8th. of June. We look forward to seeing all you regular attendees, plus newcomers to Mt. Gambier... it's a great weekend.

## THE IC-706MKII HAS ARRIVED

The much anticipated IC-706MKII has arrived in Australia so talk to your authorised Icom Dealer for the full information on this exciting update... it's quite a package!

## A NEW DUAL BANDER AT A SINGLE BAND PRICE!

The new IC-207H really offers the goods! A detachable front panel, 9600bps for packet operation, CTCSS encode/decode standard, ultra high speed scans and much more. See it for yourself very soon, we know you'll be impressed.

# "...73"

FreeCall 1800 338 915

290 -294 Albert Street  
Brunswick, Victoria 3056  
Tel : (03) 9387 0666  
Fax : (03) 9387 0022

ACN 006 092 575

LL BROWN ADVERTISING 8158

## Club Corner

### VI75RAAF

Well, VI75RAAF is well and truly over. Roy, our President, closed the Special Event when he worked ZL1AK at 2359z on 31 December, 1996. A sterling effort by you all. Well done.

We finished up with 5,976 QSOs and I have sent out 620 Awards and 1182 QSL cards. There will be a few more before my job is finished and I hope that I will have sufficient awards and cards for everyone. Band conditions have not been perfect, as you all know, so what we have achieved is outstanding and I am sure the RAAF have had value for their Award and QSL outlay.

Both the Award and QSL card have been well received world wide and I have had no adverse comments. As far as I know, only one award went astray and this was replaced promptly.

We worked into 95 countries spreading the word of our 75th Anniversary, and in doing so we made many new friends.

Thank you again for all of your efforts.

Brian Lavender VK4LV  
Awards Manager AFARN

### North West ATV Group

The North West (Tasmania) Amateur Television Group was recently asked to participate in the Australian National Rowing Championships being conducted at Lake Barrington on the six days of 1 to 6 April 1997.

The request from The Tasmanian Rowing Organising Committee was to provide video coverage of the rowing events, in particular from the start line through to the 1000 metre mark.

Several members of the group and other interested persons provided the facilities to allow the coverage to occur and were Ken VK7KKV, XYL Bet and granddaughter Karah; Max VK7KY and XYL Shirley; Bob VK7ZGR; Jim VK7JH; Barry VK7FR; John VK7KCC; Steve VK7UD; Ross VK7WP; Allan VK7KAN; and Tony VK7AX (a total of 13 personnel).

Cameras at various points carried the vision via cabling or off-air links to a central building. The start line signal was transported to the switching point via a 1250 MHz FM transmitter, the 750 m line via a 70 cm transmitter, and another 70 cm transmitter at the 1000 m line. The general "panoramic view" position, along with another camera at the finish line, was cabled to the switching centre.

From the switching centre the video and

sound commentary was fed to various television monitors via closed circuit cabling located in the commentary room (in the finish tower), the secretary/organising area, the facilities building (2), the canteen, the refreshment tent and the boat shed. Spectators and competitors were able to view the races from these monitors and were kept up to date with activities and events from the start line which cannot be seen from the general spectator areas.

"Mr Murphy" was present nearly every day. However, the technical problems were soon overcome as expected with true amateur spirit. One of the highlights, which was a hit with the organising committee and spectators alike, was the appearance of an echidna on the television monitors for a short period, the commentator suggesting that many people, including animals, were always striving to get a look at the rowing!

The organising committee have been full of praise to the ATV Group for the job they did and were very appreciative of our efforts, suggesting we conducted ourselves and produced results in a professional manner. To quote the committee, "Once again Tasmania has shown the mainland how it can be done".

I personally take the opportunity of thanking all personnel involved in the exercise for their enthusiasm and dedication. Whilst it was a lot of work, I trust they enjoyed themselves. Once again it shows what a group of enthusiasts can do and achieve when committed with a desire to work as a team.

Amateur radio has once again gained benefit from this latest publicity.

Tony VK7AX  
Group Leader  
North West (Tas) ATV Group

### Radio Amateurs Old Timers Club (RAOTC)

The office-bearers for 1997/8, elected at a committee meeting on Tuesday, 13 May, are: President and Broadcast Presenter, Allan Doble VK3AMD; Vice President, John Fullagar VK3VY; Secretary/Treasurer, Arthur Evans VK3VQ; Broadcast Co-ordinator, Ron Fisher VK3OM; Magazine Producer, Stewart Day VK3ESD; Historian, Bill Gronow VK3WQ; Membership Promotion, Milton Crompton VK3MN; and Ken Seddon VK3ACS.

Allan Doble VK3AMD  
President  
ar

---

---

# Divisional Notes

---

---

## Forward Bias - VK1 Notes

Hugh Blemings VK1YYZ

The new committee has all but settled into "office" and is looking forward to building on the work of its predecessor in the months ahead. As president, I would encourage you to contact me on any matter you feel should be brought to my attention. I can be contacted by phone on 0411 516 079 (business hours) and 06 254 7855 (home), or by email at [hugh@ecltech.com.au](mailto:hugh@ecltech.com.au).

The committee feels the Division is faced with both a number of challenges and some exciting opportunities. We would welcome, nay need, your input to ensure that the directions taken meet the needs, wants and preferences of the membership.

This *Forward Bias* is the first to appear after Peter Parker VK1PK stepped aside two months ago to pursue his many other interests in the hobby. His contribution was greatly appreciated by the Division and, I believe, by the many listeners to the VK1 Divisional broadcast. A hard act to follow. However, our new broadcast officers, Waldis VK1WJ and Bernie VK1KIP, have risen to the challenge and have been doing an excellent job of keeping us up-to-date. Peter is continuing to provide regular articles of interest to all for *Amateur Radio* and we wish him well.

Thanks to the efforts of Warren VK1XWT and Carl VK1KCM, the VK1 Division's Web site is ready to go on-line. We're expecting final configuration to be completed by the time you read this edition of *Amateur Radio*. Once operational, this site will have a calendar of coming events as well as contact details for the division etc. Have a look at <http://www.vk1.wia.ampr.org> and see what's there. Our thanks also to ADFA for allowing Warren's server to be used in this role.

In addition to the Web site, Internet based e-mail will be run from this site, allowing you to, for example, e-mail [president@vk1.wia.ampr.org](mailto:president@vk1.wia.ampr.org). Mail sent to these addresses will then forward to the committee members' personal account external to ADFA. This service is still being commissioned so, for now, use the existing contact arrangements.

Recent events for the Division have included a number of well-attended fox-hunts, an informative site tour around the facilities of the Australian Centre for Remote Sensing (ACRES), and three different communications exercises involving walkers, non-polluting water craft and rally cars. By the time you read this column, this list will

have been rounded out with an informal dinner.

## Coming Events

A foxhunt will be held on 15 June at 2 pm. Liaison for this event is on the Division's Black Hill repeater, 146.900 MHz. The fox will be operating on 146.5 MHz. The meet point is yet to be determined; listen to the broadcast or check the web site for further details.

23 June will see our usual general meeting held in the Griffin Centre at 8 pm. Note that we now meet in the downstairs meeting room, meaning easier access for all. This is particularly important on this occasion as we will be having an end-of-financial-year junk sale. So, clear out the shack and bring your best goodies along!

Our July meeting is scheduled to be a technical presentation on the Division's new 4800 baud bit regenerative packet repeater. Further details will be available on the web site.

## VK5/8 Notes

Ian Hunt VK5QX

The first formal meeting of the new South Australian/Northern Territory Divisional Council took place on Tuesday, 13 May 1997.

At this meeting the officers of the Council for 1997/8 were appointed: President, Ian Hunt VK5QX, 08 8250 1708; Secretary, Graham Wiseman VK5EU, 08 8443 7273; and Treasurer, Joe Burford VK5UJ, 08 8280 7555. The other members of Council are Don Christiansen VK5ADC, Jim McLachlan VK5NB, David Minchin VK5KK, Tony Van Lysdonk VK5WC, Phil Pavey VK5VB and Ian Watson VK5KIA.

The Council is comprised of those who nominated for the recent election, those who were continuing in office as part of the usual two year term, and members seconded to Council as a result of the lack of nominations prior to the recent Annual General Meeting.

Phil Pavey VK5VB is an "ex-officio" member of the Council by virtue of his position as WICEN Director. Ian Watson is currently representing our interests at Federal Council as an already accredited Alternate Federal Councillor, pending a final decision regarding permanent appointment to the Federal Councillor position.

The meeting was chaired by our interim chairman, Ben Broadbent VK5ABE, who had continued on Council as part of his elected second year term. At the meeting Ben

tendered his resignation as a member of Council. He explained that this was brought about due to pressure of family and work commitments which naturally had to take precedence over his amateur radio activities. He did say, however, that when the situation changed he would certainly like to again take a seat on the Divisional Council.

The Council reluctantly accepted Ben's resignation and thanked him for the contribution he had made during what had been his second term of service as a member of the Divisional Council. We wish Ben and his family all the very best in the pursuit of their activities.

Some of the additional portfolios to be held by members of Council have been allocated. A full list showing the various responsibilities and contact telephone numbers will be provided in the near future.

The new Council for the 1997/8 period looks forward to working closely with members of the South Australian/Northern Territory Division in such a way as to produce maximum benefit for all members and provide the representation that members desire.

## "QRM" News from the Tasmanian Division

Robin L Harwood VK7RH

There was a meeting of Divisional Council on 19 April in Launceston, following the AGM of this Division in late March. All councillors were in attendance, plus five observers present representing the branches. Ron Churcher VK7RN, the Divisional President, chaired the meeting.

The first part of the meeting was an exchange between Divisional and Branch officials on where this Division is going. Several ideas were discussed to breathe new life into the Division.

Following on from a recommendation from the AGM, it has been decided that the 1998 AGM of this Division will be held in the north of the state. Accordingly, a northern sub-committee will be created to organise this in conjunction with other activities, such as a hamfest or dinner. It was pointed out that the involvement of families was crucial to the success of this and other Divisional activities.

Publicity Officers have been appointed to conduct publicity campaigns to increase membership and promote activities within the Division. VK7ZDJ will be responsible for the north-west, with VK7RH and VK7TIM being responsible for the north, and VK7JK and VK7GL looking after the south.

The Division is shortly to have a Web site on Tasmania Online, an initiative of the State Library. Further details will be given over VK7WI as they become available. Also, the

# ATN Antennas P/L

ACN 062 557 644

Exported to 46 countries  
on all continents

56 Campbell St

(PO Box 80),

Birchip VIC 3483

Phone (03) 5492 2224

Fax (03) 5492 2666

- Australian made quality antennas. Log-periodics 7-30 MHz 11 el, 10-30-10, 13-30-6, 13-30-8, 13-30-9, 18-30-7, 20-30-6.6 models VHF/UHF LP to 50-1300-25. All alum tubing is 6353-T6, 15-25% higher tensile strength than imports. Insulators are Zytel, latest material, and all hardware is stainless steel.
- Monobanders, 40, 20, 15, 10, 6 and 2 m, 70 cm, HF and UHF CB, many models. Single band high gain VHF/UHF TV. Stacking harnesses + couplers, 2, 4, 6 and 8 antennas.
- Aluminium towers to 60 m. Many models incl fixed, tilt-over and Hazer tram where antenna and rotator can be lowered with no climbing.
- Create HD rotators, 5 models.
- Tower accessories, non conducting Kevlar guys and Dacron/polyester halyards, 3 sizes.
- Aluminium pulleys with Stainless Steel hardware.
- B&W continuous frequency coverage wire antennas, 1.8-30 and 3.5-30 MHz, 20/100 W and 1 kW.
- Baluns and power dividers.
- Diamond VSWR/Power meters, 10 models to 1300 MHz.
- 80/40 and 80-10 trap wire antennas.
- Single strand HD copper wire, insulators and accessories.
- Range of power transistors, driver and PA tubes; eg JAN (USA) 6146W, rugged, to replace 6146A, B and S2001, matched pair \$125 incl fragile pack/post.
- Matchall, all band, fully auto, antenna coupler, 1.8-30 MHz, 150 W, matches any wire length (random), \$285 incl p/post.
- Hi-Sierra remote controlled mobile whip, 3.5-30 MHz plus 6m, \$699 incl air freight Aust-wide.
- 4 Square vertical beams, 20, 40, 80 or 160 m, 8.2 dBd gain, 25 dB F/B, fraction of cost of 40/80 Yagi and tower.

Ask for **FREE** catalogue.

Bankcard, Mastercard and  
Visa acceptable.

Northern Branch will have a Web page and I am reliably informed that this could be online by now. Again, check VK7WI for details.

Divisional Council also made the following appointments to the ex-officio positions, following recommendations from the branches. It was further resolved that, in future, these appointments will be made at the AGM.

Tony Bedelph VK7AX was re-appointed as FTAC Officer; Reg Emmett VK7KK was re-appointed Divisional Education Officer; and Trevor Spargo VK7TS is now the QSL Bureau manager after VK7PP stepped down. Thanks Charles for your work in sorting out the many hundreds of incoming and outgoing cards.

Richard Rogers VK7RO continues as Divisional Historian; VK7RH is Intruder Watch Co-ordinator; a new Awards Manager was appointed, John VK7RT; John Rogers VK7JK still co-ordinates the weekly VK7WI broadcast; and VK7RH will continue compiling this column.

After some discussion, it was agreed that the Divisional WICEN co-ordination will be handled by a committee consisting of the President, together with the Southern and Northern Branch co-ordinators (the Northwest Branch having nobody in place at this stage). Phil Corby VK7ZAX will be our Honorary Solicitor; and the Honorary Auditor will continue to be Mr Justin Cook. A new position of Publicity Co-ordinator was created and this was filled by Tim Holloway VK7TIM.

There was also an election required for the position of the Federal Councillor as there were three nominations. Andrew Dixon VK7GL was elected and John Rogers was elected as alternate Federal Councillor. We wish to thank Jim Forsyth VK7FJ for his contribution as Federal Councillor for the past three years.

Don't forget, if you have any news for this column, send it to me at 5 Helen Street, Newstead TAS 7250, or to [robroy@tassie.net.au](mailto:robroy@tassie.net.au) ar

## Education Notes

*Brenda M Edmonds VK3KT\* Federal Education Coordinator*

My last column raised the problem of decreasing recruitment to the Amateur Service, and asked for comments from readers. I was pleased to receive some responses, but mostly they were directed towards agreeing with my comments, and deploring the lack of enthusiasm of teachers when demonstrations of amateur radio are offered.

In the UK it was recognised early that the success of any project to bring amateur radio into the classroom would depend on the enthusiasm of the teachers. With this in mind, there have been several successful weekend seminars to train the teachers. Some of these teachers have gone on to become licensed and to develop exciting school activities. Those who did not attempt to gain a licence still became more receptive to the idea of using amateur radio in the classroom.

I have been looking through the Proceedings of the two ICARE Conferences which have been held so far. They describe a number of projects being run in schools throughout Europe, North America and Africa. Some are designed as an introduction to electronics, eg construction of a rain detector. Others use short-wave listening to extend the curriculum. Others again use more sophisticated techniques to talk to satellites or access weather satellite information, to establish packet networks and to monitor balloon launches. I was very interested in the "Mars Base Simulation" in which a year of

science experiments was conducted over 36 hours in a mock-up of a module suitable for Mars. Information and experiment reports were passed by packet, 2 metre voice radio or closed circuit TV to the "Lunar Base" in the classroom.

There are now over twenty countries associated with ICARE, reflecting a diverse approach to a common aim. In most of the reports, the activities are being conducted at senior school level. I know that New Zealand has programs in some primary schools, but am not aware of any VK activity at that level. I would be most interested to hear of any such activity, or ideas which members consider could be used at primary level. It may be that we need to target the primary level rather than the secondary, to show that there can be fun in radios as well as in computers. We may need to develop simple kits or structured learning packages.

I begin to think that we will need a lot of assistants scattered throughout the country. One person per state at least would be useful, as the educational systems vary so much. I would be happy to receive names of volunteers who could either visit local schools to publicise amateur radio, assist with development of suitable projects, or be trouble shooters by mail or radio. I look forward to receiving a deluge of letters.

\*PO Box 445, Blackburn VIC 3130

ar



---

---

# How's DX

Stephen Pall VK2PS\*

---

---

It was reported in the last issue of *Amateur Radio* (May 1997) that the WIA submission on amateur radio licensing was presented to the Minister of Communications and, as a result, the Department of Communication will consider the submission when it reviews the Radio Communication Act later this year.

Do I hear somebody saying "about time!"? Hopefully, when the review takes place, it will also discuss and re-organise the present inadequate system of issuing full Australian call signs, reserved for the locals, valid for a year, to foreign amateurs who are visiting our country on a short term basis.

The European Community, known as the European Union, already has the CEPT licensing agreement which enables any amateur from any EU country to temporarily operate an amateur radio station in any other EU country and its territories by using the host's overseas country's prefix before the home call. There are plans on the move that a similar system is in place between the North and South American continents soon.

New Zealand has a simple and practical system which is not a licence but a written permit. It is issued for a determined period of number of months on a temporary basis to a visiting foreign amateur who uses his/her home call with the added ZL suffix.

Let me now illustrate to you, with a factual case, how, in the past, a visiting Russian amateur has misused our "easy" system to his advantage. The year is 1996. The amateur is Vlad I Pichelin, his home call is UA0ZDA, and his International Call Book (1996) address is given as: a ya 283.683000 Petropavlosk, Kamchatskij, Russia. Vlad applied for a short term licence to operate from Christmas Island, and he was given a reciprocal short-term visitor's licence with the call sign VK9XL.

When he applied for his licence he gave his home address as PO Box 21, Stavropol, 335002, Russia, a city which is not in eastern Siberia but in the southern part of Russia between the Black Sea and the Caspian Sea, many thousands of kilometres away. To my knowledge Vlad never operated from Christmas Island. QSL cards received by the VK90 Federal QSL Bureau indicate that he operated CW only from the following localities: 6 February 1996, Lord Howe Island; 16/17 February, VK6; 28/29 February, VK5; and on 29 February (leap year?) he used the suffix 4K5 which is Azerbaijan. On 5-10 March he was again on

Lord Howe Island, and on 10 April he was there again. Apparently he was not active in May or June 96. The question is, where was he?

On 4 July I had a contact with Vlad at 1218 UTC. He was on 40 metres CW using the call VK9XL/mm. He told me that he was near Kamchatka, and he was going to the IOTA Island AS-39, giving a Victorian amateur's two letter call sign as his QSL manager. I heard him again on 14 July 1996 on 20 metres CW at 1300 UTC giving his call sign as R0/VK9XL. Apparently he landed on that island.

QSL cards in the Federal QSL Bureau for the period 13 July to 20 September 1996 are proof that he used his temporary Australian call sign (which supposedly was issued for a short term to operate in Australia and Territories and for a portable activity for four months only) illegally many thousands of kilometres away. Why? Who knows? Was he in Australia at all? Hopefully, our immigration authorities have a record of his multiple entry/re-entry and departure dates.

Yes, I agree. It is about time that we re-organised the issue of licences to visiting foreign amateurs. A plea to the Spectrum Management Agency; please note the case of Vlad VK9XL.

## Macquarie Island VK0TS

Tom VK0TS has been on Macquarie island since late 1996. Heavy work schedules have prevented him from being active on the bands. His predecessor, amateur colleague Warren VK0WH, did his best to reduce the "world demand" for a Macquarie island contact. The demand is still there, and there are many, many more who need Macquarie Island as a "first one".

At the end of April I received a lengthy letter from Tom, written at the time when the last "summer" residents returned to the mainland. Here are some interesting bits. "I have been on air infrequently. The winter down here has commenced and things are less hectic, so I plan to be on air lots more. You will find me on 80 m and 40 m and maybe even 20 m. These are the only bands that I will be working. I have not set up to do CW but will do so very soon. The antenna I am using is an inverted Vee antenna supported very high and proving to be very effective towards Australia."

Tom then describes his actual workload on the island which is very diverse, from maintaining and repairing antenna systems, complex electronic equipment, and VHF

repeaters to repairing video equipment and photocopiers.

Tom continued, "My personal radio equipment is an ICOM IC-751 transceiver. The HF antenna system consists of many inverted Vee systems supported by 72 foot towers. I am not sure what (equipment) the other hams (VK0WG and VK0KBB) are using as they are not very active. As for myself, I will be talking to VK and ZL stations mainly, but I promised Jim VK9NS that I will try to keep in touch with him on 20 metres when time and circumstances permit me to do so."

Tom then gave a short profile of the island which is very interesting. "The island is remarkable. There are millions of penguins here, thousands of seals, and many birds, including different types of albatross. It is geographically located in a harsh climate, with westerly winds prevailing and usually continuous. Usually it is cloudy with rain, sleet or snow and bitterly cold with the wind blowing. The island is about 40 km in length and five km wide with a raised plateau on the centre part and coastal cliffs following the entire coastline to the plateau."

The next ship will visit the island in September. The last one, full of "summer season" scientists, returned to Hobart at the end of April. The DXing world, which eagerly waits on a VK0TS appearance on the bands, must accept the following facts:

a. Tom is there as an employee of the ANARE to do a job. Naturally, amateur radio is just a hobby, when and if he has time to indulge in it.

b. Tom is not on a DXpedition, and by nature he is not a keen DXer. He uses amateur radio as a means of communication with his family with the assistance of his VK1 friends, and for occasional QSOs with others.

c. He is unable to keep to predetermined schedules and he is unable to give a multi-band contact or a different mode on demand. Please do not even try. Be happy with the contact which you have.

d. I have not heard any of the two other amateurs on the bands. Most likely they are not DX orientated at all and, as Tom said, they are not very active.

I am sorry that I am not able to bring readers any better news of the state of DX from Macquarie Island.

## Heard Island Statistics VK0IR

In my interview with David Muller VK2JDM, our Australian participant on the Heard Island DXpedition (see May 1997 issue of *Amateur Radio*), I promised to give you more details about the VK and ZL participation. Here are some interesting figures.

The total number of Australian QSOs was

516, and of New Zealanders was 166, which gives a total of 682. The previous VK/ZL total was shown as 713, a difference of 31 QSOs. What happened? The answer is simple. Several DXpeditioners had individual VK0 call signs and made local QSOs on the island with VK0IR. When statistics were analysed in detail, these QSOs were removed from the official tally.

Amateurs in VK1 made a total of 15 contacts on four bands, six on CW and nine on SSB, 12 of them on 20 metres. Amateurs in VK2 fared better with a total of 74 contacts, 19 on CW, 54 SSB and one RTTY. Most of the contacts were on 20 metres and only seven contacts were on 80 metres.

VK3 figures were even better. Out of a total of 111 QSOs, 44 were on CW, 64 on SSB, two on RTTY and one SSB satellite contact. There were two 160 metre contacts and ten 80 m QSOs. VK4 did relatively well despite its northern geographical position. Out of a total of 80 contacts there were two satellite SSB, and 53 other SSB contacts, 24 CW and one RTTY, but only two QSOs on 80 metres. VK5 was at least 1000 km nearer to Heard Island but managed to make only 42 contacts. Nine on CW, 32 on SSB and one on RTTY. VK6, the closest to the expedition, was the best performer with a total of 138 contacts, being 40 CW QSOs (one on satellite), 95 SSB contacts and three RTTY contacts. There were 13 contacts on 80 metres and three contacts on 160 metres. VK7 was a slightly better performer than Canberra with a total of 24 QSOs, 13 on CW, 11 on SSB and two contacts on 80 metres. VK8 had a total of 24 contacts, 13 on CW and 11 on SSB. Norfolk Island VK9N had a total of eight contacts on three bands, being four SSB and four CW QSOs.

The most useable band was 20 metres with 318 contacts. There were 41 QSOs on 80 metres, 32 contacts on 15 metres, 33 contacts on 40 metres and six QSOs in total on 160 metres. There were four satellite contacts and four contacts on 10 metres.

The New Zealanders made 166 contacts, 59 CW, 102 SSB and five on RTTY. Twenty metres was the most useable band for the New Zealanders with 138 contacts; there were only eight QSOs on 80 m.

The maximum number of QSOs with Heard Island were 19 band-mode variations. CW on nine bands including satellite, SSB on seven bands plus satellite, 160 m on CW and RTTY on 20 metres.

There was only one amateur in the world who worked Heard Island on all bands and all modes, JA5EXW. Australia's most successful Heard Island chaser was Mike VK6HD with 15 band-modes.

The souvenir sale to balance the budget of

the DXpedition is now on. A 192 page, hard cover book with many colour photos is available for \$AUS40.00, coloured coffee mugs are \$AUS30.00 each, and the black and white ones for \$AUS20.00, Tee-shirts are \$AUS30.00 each, and a 55 minute video (PAL system) with original sound and music will set you back \$AUS50.00. Add \$AUS8.00 to each order for postage. Send a cheque with your order and size (shirt) requirements to: Heard Island Expedition, Locked Bag 29, Post Office, Rydalmere NSW 2116.

### Pacific Wanderings

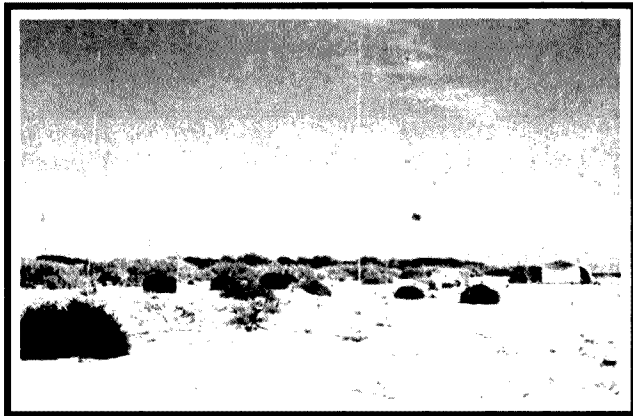
Jack VK2GJH, better known as T30JH, intends to visit several islands in the Pacific, beginning 27 June and ending around 5 August. Jack is not on a DXpedition and radio is a low key priority during the entire trip. He is on a vessel with a scientific group, in a working capacity both for the vessel charterers and for himself. There will be no maritime mobile operation using island call signs; any maritime contacts will be made using the callsign VK2GJH/mm.

As time and work commitments permit, Jack intends to be active on Rabi Island 3D2JH, 28 June; Suva 3D2JH, 1 July; Funafuti T20JH, 5 July; Tarawa T30JH, 11 July; Banaba T33JH, 15 July; Tarawa T30JH, 27 July; Rotuma 3D2JH/p, 1 August; and Suva 3D2JH, 5 August. The equipment to be used is an Icom 736, 100 W, HF/Six metre transceiver, a trap dipole for HF and a vertical for six metres.

A week ago Jack phoned me and told me that the Kiribati owner of the proposed charter vessel has withdrawn the boat due to a more lucrative offer from somebody else. The organisers of the charter are now searching desperately for a new vessel.

Jack says, *"If we are lucky the trip will take place. If no suitable seaworthy vessel can be found (and there are plenty of old "rust buckets" floating in that area) then luck is not on our side and the trip will be abandoned."*

However, it seems luck has returned to the group. I was about to finish off this column when Jack phoned again. His voice sounded happy. The organisers of the charter found another reliable boat, therefore the trip is on. Hopefully, all of you can work Jack from Banaba T33. Please note, all QSL cards are to go direct to PO Box 299, Ryde NSW 2112, Australia. No bureau cards please as Jack is not a member of the WIA QSL Bureau. Cards



**The 20m vertical array, accomodation and operating tents of the VK5ISL Dxpediton to St Peter Island.**

sent without a SAE and without return postage will not be answered.

### Future DX Activity

\* Frank YJ8AA goes to Emai Island, which is in the Shepherd Group of islands (OC-111) with Albert YJ8NKB on or about 1 June. This will be a real adventure as there are no roads, water or other facilities at all. They will take a TS-120 with them.

\* Later in the year, Frank intends to visit the Torres Island group (OC-110), which was devastated not so long ago by tidal waves.

\* Phillippe F5IVE (formerly TR8LVP) is now active from Guinea as 3XY3A, mainly on 14020 and 14130 kHz. He will be there until 15 June. QSL to his home-call.

\* The well known DXer Matt SM7PKK is in Uganda on a six months UN contract and will try to be active from that country. He will be also visiting 9Q (Zaire), 9X (Rwanda), 9U (Burundi), and 5H (Tanzania).

\* Sayed ST2SA is active, usually during the weekend (20-24 UTC) on 20 metres. QSL via the Call Book address.

\* A group of Hungarians will be active from Rhodes Island (SV5) from 3-17 June on all HF bands from 160 to 10 metres on CW, SSB and RTTY. Operators are: Laci SV5/HA0HW/p, Tomi SV5/HA4GDO/p, Laci SV5/HA6NL/p, Zsolt SV5/HA6PS/p and Tibi SV5/HA6ZV/p. QSL to home calls.

\* Sanyi HA7VK (ex-XU7VK) will be active as YI9VK from 12 May until 12 July on all HF bands. QSL to HA0HW.

\* Nick R1FJV is in Franz Josef Land until the end of the year. He is mainly on CW, 40-10 m. QSL via UA3AGS.

\* CY9AA will operate from St Paul Island (NA-094) from 26 June to 3 July.

\* Steve HA0DU reports that Zoli HA5PP will be stationed in Aden, Yemen, starting May 1997 for probably a year or so. He is going to get permission to operate from Aden but he wants his licence approved and confirmed by the authorities in San'a. He

plans to come on air in June and intends to make "side trips" to neighbouring countries E3, T5, ST, STO, and J2).

\* S79MAD Seychelles. Paddy will be active for the next four months, especially on the WARC bands. QSL via GW4WVO.

\* Ruth TF/IT9ESZ and Ruth TF/LA6ZH will be active from Reykjavik, Iceland from 13 to 20 June on CW: 7020-7030, 14020-14030, and 21020-2130 kHz; and SSB, 70060-7070, 14240-14250, and 21280-21290 kHz. QSLs to respective home addresses.

### Interesting QSOs and QSL Information

\* JW5NM – Mathias – 14195 – SSB – 1229 – (Apr). QSL via LA5NM Mathias Bjerrang, PO Box 498, 9170 Longyearbyen, Svalbard, Norway.

\* J77FT – Frank – 14164 – SSB – 0537 – (Apr). QSL via DL7FT Frank Turek, PO Box 1421, 14004 Berlin, Germany.

\* A71CW – Chris – 21025 – CW – (Apr). QSL via Chris Dabrowski, Box 22101, Doha, Qatar, Middle East.

\* JT1BH – Sur – 14005 – CW – 0936 – (Apr). QSL via PO Box 125, Ulan Bator 13, Mongolia, Asia.

\* JW0L – Dave – 14195 – SSB – 1214 (Apr). QSL via G8APB C D Plummer, 27A Thorns Lane, Four Marks, Alton, Hants, UK.

\* 8P6DU – Peter – 7188 – SSB – 0648 (Apr). QSL via Peter Austin, Mayers Road, My Lord's Hill, St Michael, Barbados.

\* TF3DX – Villie – 14012 – CW – 1311 (Apr). QSL via Vilhjalmur Thor Kjartansson, Silungakvisil 10, IS-109, Reykjavik, Iceland.

\* Y11US – Duraid – 14246 – SSB – 1144 (Apr). QSL via WA3HUP Mary A Cider, 2485 Lewisberry Road, York Haven, PA 17370, USA.

\* A41LZ – Murtadha – 21210 – SSB – 0600 (Apr). QSL via PO Box 2837, Ruwi, CP112 – Oman, Middle East.

\* T88CK – Albert – 14004 – CW – 1233 (Apr). QSL via HB9BCK Albert Zaehner, Scherzinger Str 539, CH-8595, Altnau, Switzerland.

\* 9X/RW3AH – Andy – 14164 – SSB – 0552 (Apr). QSL via Andy B Fyodorov, Box 899, 127018 Moscow, Russia.

\* T70A – 7048 – SSB – 2032 – (Apr). QSL via ARRSR Radio Club, PO Box 77 RSM-47031, San Marino A I, Republic of San Marino.

### From Here and There and Everywhere

\* The most important lesson one has to learn as a regular columnist is that "Murphy never sleeps". It was "Murphy" again at work in my column in the last issue (May 1997) of *Amateur Radio*. The QSL manager for FO0SSJ was given as K8JRK. The name and

address which followed were totally incorrect. The correct address is K8JRK James A Sansoterra, 801 S Oxford, Grosse Pointe, Woods, MI-48236, USA. Thanks to Ken VK5QW for pointing out the error. I should have been warned. "Murphy" has lurked around in past editions of my column. The callsign of our Heard Island DXpeditioner, David Muller, originally VK2TQM and now VK2JDM, appeared several times as VK2DJM. Apologies to both call holders for the mix-up.

\* Ed K8VIR/ZL4, K8VIR/ZL9, ZL9DX was active for a few days from Lord Howe Island as VK9EEH. He also plans to visit Niue on his return to the States. His address in NZ is in order (*Amateur Radio*, May 97). For those who want to send their cards to the USA, his new USA address is Ed Hart, K8VIR, PO Box 480, Green Valley, AZ-85622-0480, USA.

\* Ray VS6UW is a keen CW operator. He is also a Morse instructor and he would like to set up a museum type collection of vintage Morse keys for the historic education of his Morse students. He is looking for donations of old Morse keys and is willing to pay for the postage. Contact Raymond Lee, PO Box 62316, Kwun Tong Post Office, Hong Kong. E-mail [rcylee@krcrc.com](mailto:rcylee@krcrc.com).

\* Percy VK4CPA, the originator and chief controller of the "ANZA" net, received a Certificate of Distinction for services to amateur radio from the VK4 Division of the WIA in mid April. Congratulations Percy!

\* The operator of RO/UR8LV is Oleg and he is located at the northern-most part of Asia at Cape Chelyuskin, an arctic base, at latitude 77° 45' and 104° 20' E. It is a base and connecting point to the Severnaja Zemlya island group and to the arctic coast of Siberia. The base was built in 1934 and has a population of only 22 persons. Oleg is 26 years old, single and started his job in 1994 as a radio engineer with Aeroflot. He is now the "Chief" of the base. When I spoke to him, the weather was windy and the temperature was -17° C. He was using 1 kW into a very long, long-wire antenna. The time difference between Sydney and his base was only two hours. Living is not cheap in the Arctic. A return flight from Chelyuskin to Dickson (73° 30' N and 80° 35' E), a similar base on the northern part of Siberia, costs \$US1600 return. Oleg goes home in May for a well earned rest and returns to his base in the Arctic in September. QSL to his home call via the Ukrainian Amateur Radio League QSL Bureau, Box 56, Kiev, 252001, Ukraine.

\* Dave JW0L is a radio-telescope scientist on Svalbard Island and will be back in England by June if his contract is not extended. His home call is G3WFT, but his

QSL manager is G8APB. Dave carries a telescopic rifle with him when he is inspecting radio-telescope antennas as protection against polar bear attacks. His equipment is an old valve transmitter and he uses a dipole antenna with a 150 m coax lead-in. His IOTA island is EU-26, the locality is Nyvalesond at 79° 00' N and 12° 00' E.

\* Andy 9X/RW3AH has left Kigali, Rwanda and has returned to his home base in Moscow.

\* The recent Scarborough Reef BS7H DXpedition was a success. It was decided that the Japanese amateurs will QSL via JA1BK, but all others, including VK/ZLs, should send their cards via John Parrott W4FRU, PO Box 5127, Suffolk, VA-23435, USA.

\* According to some French DX Bulletins, the French authorities will introduce a new French novice licence with a "Regulations only" examination.

\* The station working as OH0/OZ1WF is a pirate.

\* The Scandinavian DX Net is now on the air again every Wednesday from 1330 to 1600 UTC on 14180 kHz. Net controller is Maurice LA3XIA.

\* The new QSL manager for AH8A is Ron AC7DX, PO Box 25426, Eugene, Oregon 97402, USA.

\* Bernhard DL2GAC, "The South Pacific Wanderer", advises that his address is correct only in the 1997 Call Book as Bernard Stefan, Moggenweilerstr 1, D-88677, Markdorf, Germany. However, he prefers QSLs via the Bureau.

### QSLs Received

\* 9U5CW (EA1FFC) – 4K70GT (3 m – PO Box 169, Baku Centre, 37000 Azerbaijan); EZ8AQ (Box 1, Ashabat, 744003 Turkmenistan); OX3SA (3 m – Sven Lutzen, Box 1602, DK-3900 – Nuuk, Greenland); FR5ZT/T (6 w – from VE2NW Zareth Amadiuny, 18 Nisko, DOM, Quebec, H9G-2R5, Canada); SV2ASP/A (6 w Monk Apollo, Dochiarou Monastery, GR-63087, Mt Athos, Greece).

### Thank You

Many thanks to my supporters who regularly supply me with news and information which makes this column possible. Special thanks to VK2XH, VK2JDM, VK2GJH, VK2KFU, VK2TJF, VK4CPA, VK6NE, VK0TS, K8VIR, VS6UW, JW0L, YJ8AA, RO/UR8LV and the DX publications *QRZ DX*, *The DX News Sheet*, *The 425 DX News* and the *GOLIST QSL Managers List*.

\*PO Box 93, Dural NSW 2158

ar

# Novice Notes

Peter Parker VK1PK\*

## Assembling a Station

### Introduction

The main interest of many amateurs is on-air operating. Indeed, that's the reason why many of you obtained your licence. It is more enjoyable if you can operate in comfort. Whether you already have a station (possibly from an interest in listening or CB), or have yet to establish one, this article should provide a few tips. Few original ideas are presented; most come from a blend of experience and reference to the standard handbooks.

### Location

Overseas, many amateur shacks seem to be in basements or attics. Unfortunately, this option is not available in most Australian houses. Backyard sheds or spare rooms are the popular choices here.

Both locations have their benefits and drawbacks. A garden shed means that radio equipment can be co-located with a workshop. As well, less feedline may be required than if the operating location was inside the house. This reduces both costs and signal loss, particularly on VHF/UHF. Noise

from crackling radios (outside) and household members (inside) may also make a stand-alone outside shack more attractive. Yet this very advantage has its problems in some situations, and some amateurs have had to install intercom systems between the shack and the house.

An indoor location has advantages, particularly in areas where extreme temperatures are common. Security may be better if equipment is kept inside the house. Access to power and telephone connections (if needed) may also be better indoors. However, it is usually more difficult to route feedlines and cables, and provide a short, direct connection to the station earth. Whatever location is chosen for the operating area, it should be well lit. Because of the potential of fluorescent lights to cause interference, incandescent lighting is suggested.

### Furniture

Most operating positions are built around some form of desk or table. However, the use of a cabinet with lockable doors may be safer if there is a danger that equipment may be accessible to prying fingers. This scheme

may be aesthetically more pleasing too, particularly if the operator has little choice but to use the corner of a kitchen, bedroom or lounge for a "shack".

An operating desk should be deep enough to allow sufficient space in front of the equipment for microphones, magazines, headphones, pens, etc. It should incorporate one or more shelves, for books, measuring equipment and station accessories. Having two or three drawers is an advantage. Some amateurs have successfully used an old door for a table top. While the natural impulse is to have it against the wall to maximise room for the operator, this might not always be the best plan. A better idea could be to place it a metre from the wall. This allows the operator easy access to the back panels of equipment without having to disconnect equipment and move the table.

### Equipment Layout

The layout of the equipment depends very much on the operator's main interests. Equipment should be positioned so that frequently used items can be used without leaving the chair or reaching over other pieces of equipment. Questions that could be asked when arranging equipment include:-

- Are the operator's interests primarily in HF, VHF, Morse, voice or digital communications?
- Is the operator left or right handed?
- How important is the computer to station activities? To what extent does it cause interference to receivers?
- Is there a separate space for constructional activities, or must these be done at the operating desk?
- Must the operator be able to change bands and/or antennas quickly?

Some amateurs mount equipment behind a console. While this looks impressive, it can prove inflexible if equipment or interests change. The effort involved is not inconsiderable either. It is suggested that beginners start simply with a desk and one or two shelves, rather than a console. Second-hand or ex-government furniture is recommended; more money can then be spent on equipment, components and QSL cards! Figure 1 shows what a well-equipped station, able to operate on all Novice bands, could look like. Further ideas can be obtained by visiting club stations or other amateurs. Particularly look for the way that they have solved common problems such as bringing feedlines inside and earthing. Their solutions may be of use in your own situation.

### Wiring

It is assumed that mains voltage is available at the operating position. If not, a licensed electrician will be required to install the extra wiring required. One or two more

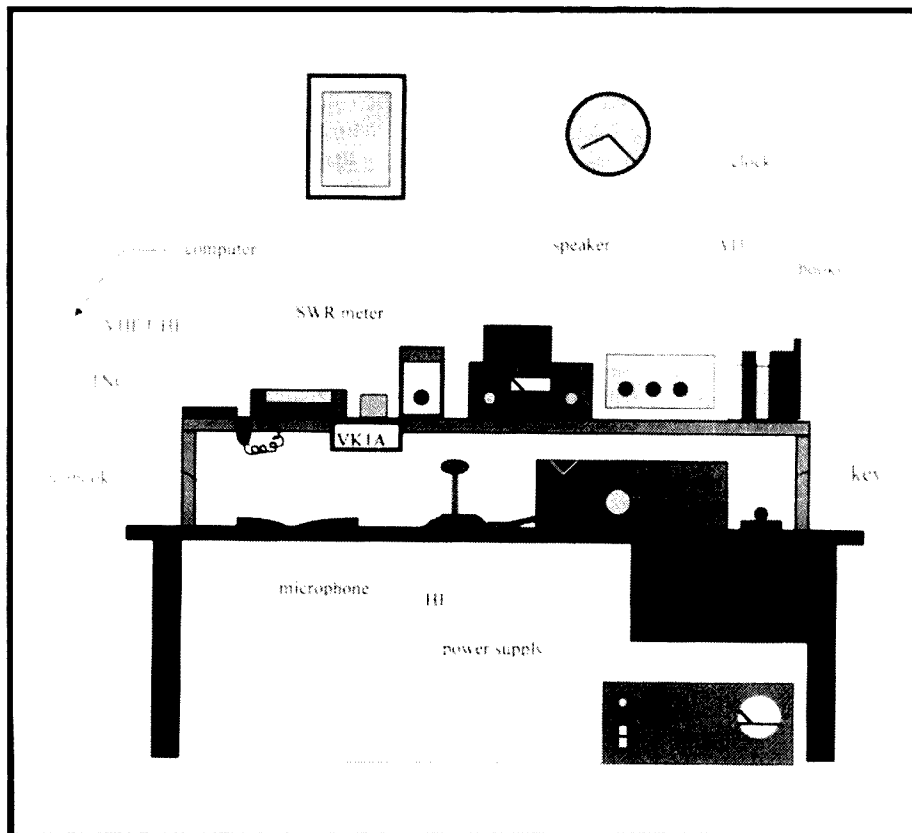
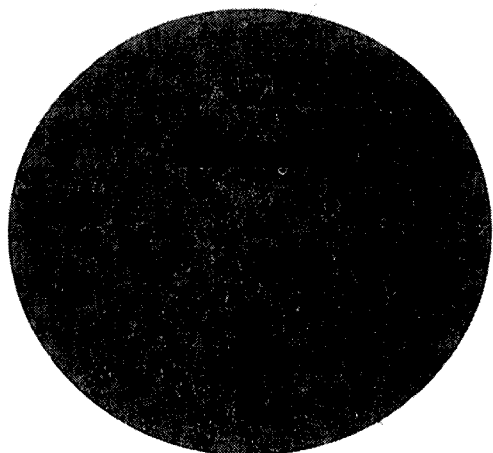


Fig 1 - Possible station layout.

positive

The polarity given is a guide; some may use the opposite polarity. Individuals should use one polarity only on all their equipment.

negative



**Fig 2 – A low voltage T-connector.**

power points than you think you'll ever need would not go astray. Alternatively, one of the multi-way power distribution boards could be used, if current ratings are observed.

The area behind the equipment is a veritable jungle in many shacks. It is often inaccessible and ill-lit, increasing the chance of error when changing connections to a piece of equipment. Cables should be labelled, as equipment damage can result from a wrong connection. Further information on labelling is given elsewhere.

All wiring in the shack is likely to be at the twelve volt level, unless very old valve equipment with separate power supplies is being used. Transceivers may have their own in-built supplies, or a high current 240 to 12 volt supply may be used to power the station. It is desirable that the supply be fitted with high-current polarised sockets, rather than simple binding posts to reduce the risk of the wrong polarity when connecting equipment. The T-type plugs and sockets (Fig 2), used in commercial low voltage systems are recommended. Power leads to transceivers should be thick and reasonably short to minimise voltage drop on transmit. Insulated automotive-type wire is suggested.

A difficulty for many people is finding a means of bringing feedline into the operating area. This is particularly true for VHF/UHF stations, where the use of the thick RG-213 cable (or better) is desirable to reduce losses. RG-58 is somewhat easier to bring indoors. Open wire feeder has its own problems; unlike coaxial cable, it is not good practice to run it near metal objects. All of the following

have been used by amateurs to bring feedlines inside:-

- through a ceiling ventilator;
- through a piece of wood mounted in a partially-opened window;

- through a short length of 50-75 mm PVC pipe mounted in the wall;
- through a louvre window; and
- under the house and through a hole drilled in the floor boards.

Other ideas no doubt suggest themselves to the reader. Any solution should:-

- not compromise household security;
- not increase the opportunities for vermin to enter;
- not cause antennas or feedlines to run near power lines or lead-ins;
- not impair operator comfort by reducing heat insulation;
- be reversible should the property be sold (or inspected by landlords);
- place as little stress as possible on incoming cables; and
- be amenable to expansion.

### **Earthing and Safety**

Have you ever felt a slight tingle when you touched the front panel or case of your transceiver whilst operating? If so, you have observed the effects of poor RF grounding. Effective RF grounding provides a low-resistance path to ground for any stray RF that may be floating around the shack. This reduces the chance of causing interference and the risk of RF "bites" from microphones and front panels. An RF ground consists of a direct connection from all equipment cabinets

## **Novice Plus – Helping You Get More from Amateur Radio**

### **Novice Contest This Month**

A reminder that the VK Novice Contest is on later this month. The contest exists to promote activity in the 80, 15 and 10 metre Novice segments. If you have not entered a contest before, this contest is a good place to start. It takes place over the weekend of June 20/21. Rules appeared in the May 1997 issue of *Amateur Radio*, page 37.

### **Labelling Leads**

In many radio shacks, there is a plethora of leads behind the equipment. It is very easy to make mistakes when changing connections. In extreme cases, this can lead to equipment damage; for example, when full power from a transceiver is applied to the antenna socket of a receiver. Cables should be labelled to minimise this risk. A good way is to write (with a ballpoint pen) labels onto strips of paper 5 mm wide and as long as the label requires. Clear adhesive tape is placed over the front of the label and around the cable. The tape is then continued so that it sticks to the back of the paper and around to the front of the label, where it is cut with scissors. The result is a descriptive "flag" at the end of the cable near the connector. A refinement could be to write on both sides of the paper strip instead of one.

### **Easy Equipment Feet**

To prevent equipment scratching your operating desk, it is a good idea for all gear to have rubber feet on the bottom of the box. Unfortunately, commercially-made feet are quite expensive. However, it is possible to make your own for very little effort.

Simply purchase a strip of 4-5 mm thick rubber from a swimming pool supplies shop. You won't need much; a one metre by 10 cm piece will last for years. With a pair of scissors (or Stanley knife and metal ruler), cut the rubber into squares. For small accessories, one centimetre squares are acceptable, but use bigger sizes for larger equipment. Glue a square near each corner of the base of the box. Before gluing, you may care to bevel the edge of the feet with sandpaper for a more professional appearance. That's it – now you can afford to have feet on all your equipment without spending a small fortune.

## Novice Notes on the Net!

To increase the exposure of Novice Notes columns to new and prospective amateurs, selected articles are being made available via the Internet. The new service, called Novice Notes Online, fills a gap in the provision of information to new amateurs. Already it contains material on operating, packet radio, VHF, home-brewing, buying equipment and more. Links are also provided to WIA and SMA home pages. If you have Internet access, visit Novice Notes Online today. You will find it at URL <http://www.pcug.org.au/~parkerp/nonline.htm>

Peter Parker VK1PK

## Packet World

Grant Willis VK5ZWI\*

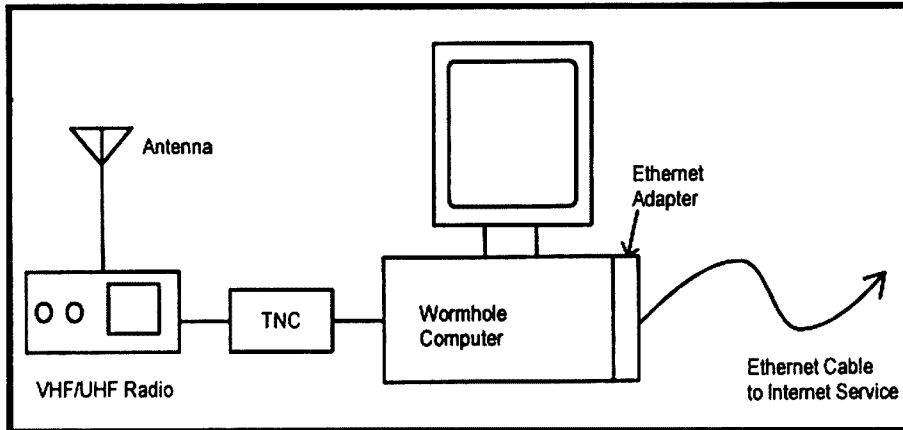


Fig 1 - The hardware required for an amateur packet wormhole station.

### Introduction - Amateur Packet Radio Wormholes

This month I commence a series looking at one of the more interesting activities to hit amateur packet radio in many years, the international amateur wormhole network. A "wormhole" is a type of amateur packet station which links to other amateur packet stations via a third party medium, often the Internet. This series will cover some of the basic principles of their operation, how to use them and what is possible on the worm hole networks.

### How Wormholes Function - A Layman's View

An amateur packet radio wormhole station requires similar equipment to a BBS or Node station. Typically, a wormhole will have a

computer (usually a 386 or better) with the usual hard disk, memory, monitor, keyboard, etc, a packet TNC, a transceiver and power supply, an antenna and, to provide the Internet link, typically an Ethernet Adapter (Ethernet is a computer interconnection system running at 10 Mbit/s using 50 ohm coax cable).

For the wormhole to work it must be located where it can access the Internet. As a result, they are often operated from within universities in conjunction with the computing engineering or science faculties as experiments in alternative forms of computer networking, managed by amateur operators within those institutions.

An amateur wormhole station utilises the TCP/IP packet protocols which were originally developed by the American

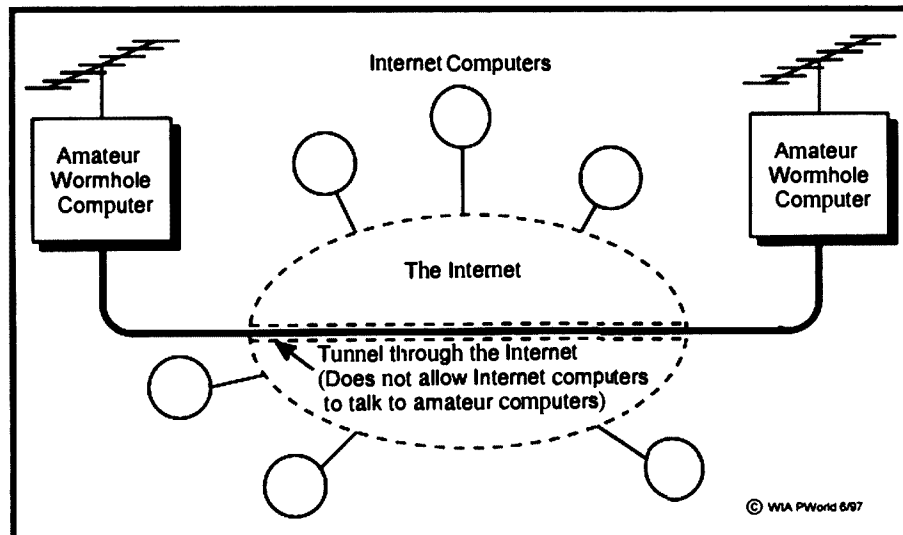


Fig 2 - Amateur wormhole station to amateur wormhole station communication via the Internet. Note that the tunnel through the Internet does not allow Internet computers to talk to amateur computers.

to an earth stake outside the shack. For best results, the lead between the equipment and the earth should be as short and stout as possible. Braid from a length of disused 50 or 75 ohm coaxial cable is ideal for this application. The cable's inner conductor is not used and can be disregarded.

In some situations, a short, direct connection to ground is not possible. An acceptable substitute can be made by running quarter-wavelength pieces of insulated wire from the transceiver. At least one wire per band is required. For the Novice, lengths of 2.5, 3.5 and 20 metres will suffice (being quarter wavelengths on 10, 15 and 80 metres respectively).

Amateur stations are safer today than they were thirty years ago. However, accidents can still occur. Precautions that should be taken include:-

- Use wire sizes and insulation commensurate with the current carried;
- Have a carbon-dioxide type fire extinguisher available near the shack;
- Inform others about the location of the station's main power switch; and
- Have family members able to perform cardiopulmonary respiration.

This list is not exhaustive, and can definitely be added to, especially if the shack includes high-powered amplifiers, high voltage power supplies (particularly those not contained within equipment). Reference 1 provides further information on electrical safety. Details of first aid in case of electric shock are given on the back cover of the WIA Call Book.

### Reference

1. ARRL, *The 1988 ARRL Handbook for the Radio Amateur*, American Radio Relay League, Newington, CT, 1987.

\*7/1 Garran Place, Garran ACT 2605  
VK1PK @ VK1KCM.ACT.AUS.OC

ar

Department of Defence in the 1970s. These are the same protocols which are used on today's Internet computer network.

A typical wormhole station uses TCP/IP to pass amateur radio packets to other wormhole stations via the Internet. To do so, a wormhole sets up a "tunnel" through the Internet which is then used to pass amateur radio traffic to other known amateur stations on the same network. The tunnel is established by the software running on the wormhole computer and, once established, will only allow information to be passed between manually configured amateur wormhole stations, ignoring all other information on the Internet (see Fig 2). A more detailed description of the packet formats is given in the sidebar.

## What Can Wormholes Be Used For?

### Extending the Range of Networks

One of the original aims that led to the design of the amateur packet radio wormhole system was to interconnect the amateur packet radio TCP/IP network (Network number 44) so that existing small pockets of this activity scattered around the globe could communicate with each other. Amateur packet radio TCP/IP stations (using NOS or similar software) in one city where a wormhole existed were then able to have real

time communications with their amateur counterparts in other cities and countries where there were wormholes too.

Amateur TCP/IP stations using wormholes today are able to have "telnet" (terminal style) connections with other amateur stations around the globe using very simple one-step commands. Many other features and powers of the TCP/IP protocols are able to be experimented with as a result of wormholes, including the routing, name serving and other services and activities. Wormholes are providing a bridge for amateurs to learn about computer networking and enter what, to some, is a fascinating aspect of digital communications.

From this simple beginning techniques were developed for linking all sorts of amateur packet radio systems together. One of the early extensions of wormhole technology was to adapt the tunnelling (encapsulation) to wrap amateur AX.25 packets inside Internet TCP/IP ones. This allowed amateur packet stations who were not running the NOS software and TCP/IP protocols to also access the wormhole's real time communications abilities over distances far greater than any existing VHF/UHF system would allow. This was achieved by the wormholes providing digipeater style interfaces between wormhole radios via the

Internet. These types of circuits are nicknamed "AX-IP" routes, because of the way they tunnel AX.25 inside TCP/IP packets.

Other protocols soon followed, with NET/ROM protocol connections being built into the wormhole software, which could then inter-link regional NET/ROM networks together. This removed the unwieldy digipeater interface and replaced it with something most packet operators were familiar with. Recently, the Rose X.25 amateur radio networking protocol has been adapted to wormholes which will allow the inter-linking of regional Rose networks in a similar fashion to the NET/ROM networks.

All of these different protocol systems, linked using wormholes, provide real time communications between amateur packet stations around the globe. This would never have been possible in the amateur community unless we developed our own geostationary satellites (something which is prohibitively expensive at present). All of the adaptations of amateur packet radio protocols for wormhole usage have provided a huge area of experimentation within the amateur packet radio community, and provided a number of advances in computer networking techniques.

### Expanding the Range of Activities on Amateur Packet Radio

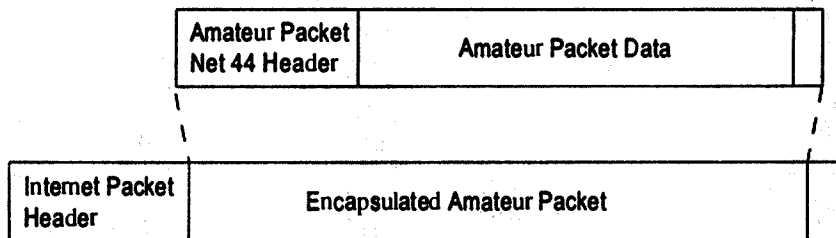
Other examples of experimentation in new services, and adapting old ones, include the world wide Converse network provided via the wormholes. The Converse network allows amateurs to connect to their local wormhole computer via packet radio, and have real time conversations with other amateur stations around the globe. The protocols driving the Converse system, while based in the Internet IRC style of system, were developed within amateur packet radio circles (a look at how to use the Converse network will be presented in the next *Packet World*).

A further example of how the wormholes have developed a service is to look at the DX-Cluster networks. DX-Clusters have previously not been hugely popular in VK, possibly due to the cost of the software and the lack of available long distance networks to interconnect them. Free or shareware software is now appearing and, with the advent of the wormhole systems, DX-Cluster inter-capital linking becomes feasible.

In some areas, wormholes are set up solely for packet BBS mail forwarding use. In the case of transporting international bulletins between continents, wormholes provide an invaluable resource as the amount of traffic on the global amateur packet BBS network today would completely swamp the HF bands with digital signals and totally

## Setting Up the Tunnel - Wormhole Packet Formats

Amateur packets are placed in the tunnel between wormhole stations by taking an amateur packet received from a radio interface, and wrapping that packet up in its entirety inside an Internet packet. That Internet packet is then forwarded to the destination wormhole computer, which will then unwrap the packet and send the original encapsulated packet out on the radio.



Internet computers can't access the amateur data because it is inside another packet. Likewise, amateur stations can't access Internet computers because their packets are never decoded by the Internet. For communications to take place, both ends of the connection need to be manually configured to accept the special Internet packets containing amateur packets. There are several security systems which are used on wormhole stations to prevent any unauthorised access between amateur and Internet systems.

There are several pieces of software which can perform this tunnelling, including the amateur xNOS packages as well as the Linux operating system. The overall level of functionality of a wormhole is very much determined by the type of computer and the operating system it is using.

overload the satellites. However, the trend towards installing wormholes instead of reliable VHF/UHF facilities should be avoided if at all possible.

Wormholes are still experimental devices and they do rely on third party systems. They are fun to experiment with and great for allowing real time long distance packet radio networking, but the bulk transfer of BBS mail, at least within regions where VHF access is possible, would be better served and be more reliable in the long term if amateurs continue to invest time and effort into building VHF/UHF networks. Likewise the wormholes should not be the first choice, in my opinion, for domestic mail and bulletin transfers where there are HF routes available. The data speeds available on the radio ports of most wormholes are not great and would be, I feel, better utilised teaching people about computer networking and being used for real time keyboard type communications. Wormholes for domestic traffic should be a second choice where there are alternatives available.

### Linking to Non-Amateur Networks

One of the most common questions asked about wormholes is "Can I access the Internet from a wormhole station using my packet radio station?"

No, it is not normally possible to access any Internet computers from an amateur packet wormhole and it is definitely not possible to access the Internet once your packets are encapsulated and in transit. There are a few instances where limited Internet services are available from some wormholes (usually from overseas wormholes where the amateur regulations are different) but, on the whole, Internet access is not available from amateur packet radio stations.

The amateur wormhole stations in Australia are unable to provide Internet access from packet radio, or access to packet radio from the Internet. This is because of the regulations which determine the content of amateur transmissions, and the regulations concerning the control of amateur transmitters. To ensure this, Australian amateur wormhole stations only talk with other amateur wormhole stations in Australia and around the globe.

### Conclusion

In the next *Packet World* I will take a detailed look at how to use the real-time conference networks available via wormholes, and also explain some of the methods for logging in and what all the commands are and how they can be used.

\*C/o GPO Box 1234, Adelaide SA 5001  
Packet: VKSZWI @ VKSTTY.#ADL.#SA.AUS.OC  
Internet: gwillis@dove.mtx.net.au

ar

## Pounding Brass

Stephen P Smith VK2SPS\*

VK2DER de VK2SPS GA OM es Tks fer call, VY nice sig hr today. Ur RST 599 599, name hr Steve Steve es Qth Newport. Hw cpy? VK2DER de VK2SPS KN.

Does the above sound familiar? This basic QSO scenario is being played out by telegraph operators the world over, but first glance by a beginner and he would be very confused indeed by the number of abbreviations used unless he had some basic training.

Abbreviations are used mainly in telegraph work as a means of shortening words and, in some cases, sentences so that the maximum amount of information can be transmitted in the shortest possible time.

In 1879, Walter P Phillips published a comprehensive list of abbreviations which was widely used by telegraph operators of the time. He named his publication the "Phillips Code" This publication became the telegraph bible to all commercial operators. Some organisations, especially the news services, could clear in a day's shift anywhere from 15,000 to 16,000 words, depending upon the operators' ability. Operators usually were paid per word.

Abbreviations used today are descended from the Phillips Code, modified slightly from landline American Morse to Continental Code as used by radio amateurs today. Some abbreviations have stayed with us whilst others have passed on with time.

Some of the most common abbreviations which you will encounter, especially during a basic QSO, are: U = You; Pse = Please; Cpy = Copy; Ur = Your; Vy = Very; Hr = Hour; Tk = Thanks; Ga = Good Afternoon; Sig = Signal; Fer = For; Gm = Good Morning; WX = Weather; Es = And; Ge = Good Evening; Temp = Temperature; Abt = About; Hw = How; Rig = Tx/Rx; Om = Old man; Rpt = Repeat; YL = Young Lady; RST = Readability, Signal and Tone; Ant = Antenna;

Lw = Long Wire; Vert = Vertical; 2EI = 2 Element; Gp = Ground Plane; Dple = Dipole; and Inv = Inverted Vee.

These are just some of the very common abbreviations encountered. Some other very common expressions are used as salutations. Ones which come to mind include "CUL" for "see you later", and "BCNU" for "be seeing you". "FB" is commonly used standing for "fine business" and is used as a form of compliment.

Abbreviations should be used where possible as they make life easier for both parties. Use a common sense approach to abbreviations and don't become a slave to them. Don't use abbreviations of unusual form as this sometimes creates difficulties for the other operator.

A good approach to follow is "when in doubt, spell it out".

One important point for beginners is the use of letters substituted for numbers, especially in contest situations. The letters are "N" and "T". The letter "N" is often substituted for the number "9" and "T" for the number zero (0). For instance, "599 001" (a contest number exchange) would be sent as "5NN TT1". Be aware of this. I recommend sending 599 (numbers) for normal QSOs and the letter/number combinations during contests.

A publication I highly recommend to all telegraph operators is **Radiotelegraph & Radiotelephone Codes, Prowords & Abbreviations** by John W Alcorn VK2JWA. It has taken John nearly 10 years to compile this book which is filled with a wealth of information. It is soft bound and A4 size with approximately 90 pages. Some of the chapters cover: Q-Code, Z-Code, Radiotelegraphy Abbreviations, Telegraph Transmission Codes, Machine Codes, Phillips Codes, Phonetic Alphabet and much more.

This book is a must and, selling at under \$AUS20, is very good value. Well done John for an excellent book.

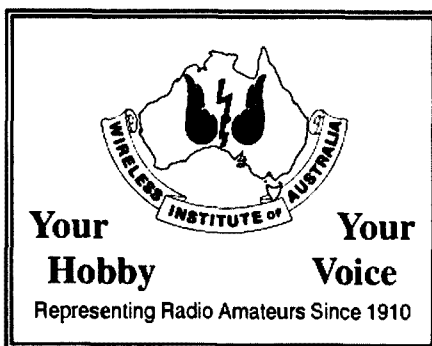
Further details can be obtained from: John W Alcorn VK2JWA, 33 Spring Street, Lismore NSW 2480, phone 066 215 217.

John is seeking information on the Heliograph Link between Cairns and Coffs Harbour. I'm quite sure a lot of readers will be able to assist John with this information.

Next month we will look at "Buying a Morse Key".

\*PO Box 361, Mona Vale NSW 2103

ar





# QSLs from the WIA Collection

Ken Matchett VK3TL \* Honorary Curator WIA QSL Collection

## W1EH

Whilst sorting out several thousand QSLs from the USA I was suddenly struck with the name on what looked like a very ordinary QSL card. The name of the sender was K B Warner and the card was dispatched from West Hartford, Connecticut.

Most hams will be familiar with the name of Hiram Percy Maxim, the founder of the Radio Club of Hartford, Connecticut, which in 1915 was to become the ARRL (American Radio Relay League.) This body of radio amateurs was truly a relay league, each with a commitment to relay messages across the country.

Relay was, of course, a necessity since the spark transmitters of those days had a very limited range indeed, despite their high power. It was Lieutenant Kenneth B Warner who became the first paid secretary of the ARRL in 1919 and who was given the responsibility for ensuring the success of a newly-published magazine called *QST*. In 1925, when Maxim became the first president of the IARL, it was Kenneth B Warner who became its first secretary.

## EA9DD

This QSL, one of a half dozen or so Rio de Oro QSL cards held by the WIA was, before its deletion as a DXCC country, one of the most sought-after cards. Rio de Oro (literally, River of Gold) was the coastal region of Spanish Western Sahara and became deleted after Spain relinquished control over the territory in 1976.

The territory is now part of "Western Sahara" (The Saharan Arab Democratic Republic, RASD).

## GB60BBC

The first broadcasting service in Britain began in 1922 and was run by the British Broadcasting Company, a group comprising major radio manufacturers. It was taken over in January 1927 by the British Broadcasting Corporation (BBC) under royal charter.

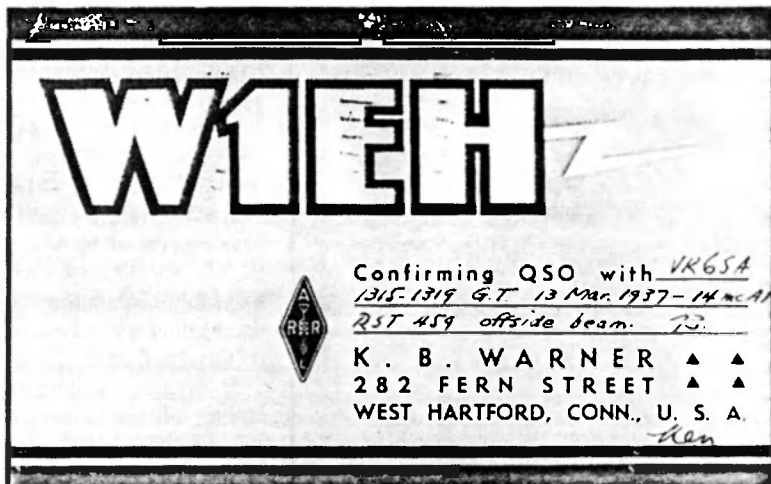
On 2 November 1936 the BBC introduced the world's first high definition television service. The special QSL shown, GB60BBC, (GB sixty BBC) was used by members of the Ariel (BBC) Radio Group throughout 1996 to celebrate the 60th anniversary of this event. Once most conservative in its issue of special call-sign prefixes, Britain has issued over a dozen numerical GB prefixes.

## Thanks

The Federal body of the WIA would like to thank Roth VK3BG, Geoff VK2UB, and Brian VK4LV for their kind donation of QSL cards. Also the family and friends of SKs Sam Watson VK6WW and Selwood (Jim) Austin OA6SA/VK6SA, both courtesy of John VK6XJ and John Holmes, President of the "Vintage Wireless and Gramophone Club of WA".

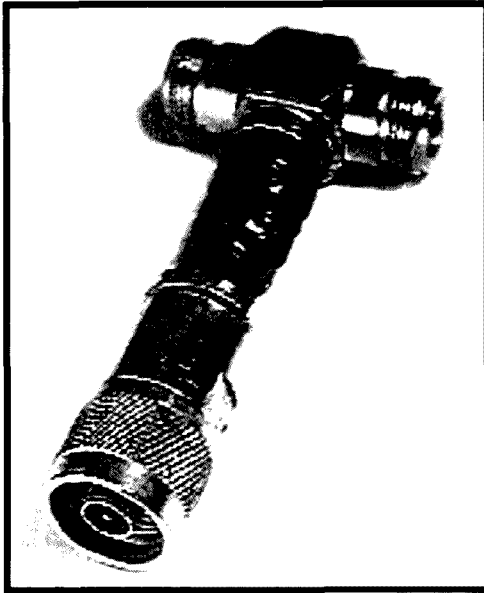
\*4 Sunrise Hill Road, Montrose VIC 3765  
Tel (03) 9728 5350

ar



# Repeater Link

Will McGhie VK6UU\*



**De-sense adapter.**

## 4027 Update

The latch circuit in *Repeater Link* for March 1997, page 45, received some helpful suggestions from Les VK2KYJ to improve its reliability and operation, particularly the false triggering that occurred when a relay is attached, requiring the 150K and 10 nF capacitor from pin 15 of the 4027. Les has some good ideas you might like to incorporate into the design. If you make the changes, let me know how they work. Thanks, Les, for taking the time and interest to improve the circuit.

## VK2KYJ Modifications

1. Place a diode (anode to ground) in parallel with the 12 k resistor. This will ensure that the 5  $\mu$ F capacitor is quickly discharged when power is removed, without giving the input protection diodes a hard time.

2. Try a Zener (say 15 V) in parallel with the BC337. The diode, as published, won't do anything to suppress the back-EMF spike from the relay which actually goes more positive (until the BC337 breaks down). Alternatively, connect the diode across the relay. You could also try a series RC (snubber) across the relay (say, 10 ohms and 100 nF). Another variation on this theme is to connect a Zener (say 15 V) from collector to base so that the transistor switch-off is controlled by the back-EMF spike. This partly depends on the base drive resistor.

3. Add a Schmitt trigger inverter between the 3.9 k/20 nF and the clock input. The 4027

data I have says the maximum rise time for the clock input is about 5  $\mu$ S. The 3.9 k/20 nF is probably a bit marginal. 74C14 (six inverters) or 4093 (four NAND gates).

4. The article claims that the BC337 will switch "over half an amp". My data (Philips) says that at 500 mA, DC current gain > 40. The 2.2 k can't supply enough base current at 12 V for a worst case BC337. The data also says that 500 mA is maximum continuous, 1 A peak. Reducing the 2.2 k to about 820 ohms would fix this, but then the 150 k is too big.

5. Suggest changing the BC548 to an emitter follower configuration so that the BC337 base drive resistor is not consuming power in the quiescent state (I guess it depends on which state the output spends most of its time); or use a FET such as a VNI0KM (200 mA maximum over temperature specification) for the output device and you probably won't need the BC548.

6. The 18 k pull-up would be better if it went direct to the input side of the 3.9 k, as it stops the voltage at pin three from falling below about 2.1 V, assuming the input actually pulls down to zero.

## De-Sense Testing

One of the fundamental tests required on a repeater is a de-sense test. Is the repeater's transmitter de-sensing the repeater's receiver? Inject a weak noisy signal into the repeater's receiver and turn off the repeater's transmitter. If the noise in the repeater's receiver reduces, then the repeater's transmitter is de-sensing the repeater's receiver. A simple but important test and there are a number of ways of obtaining the weak signal.

Ask any amateur to provide a weak signal for the test. This can work, provided you can find the right signal level. An even simpler method, is to take the antenna off a hand-held at the repeater site and, while it is on transmit, move the hand-held around until you find a weak signal into the repeater. This works but is not much use for accurate testing and alignment of a repeater for zero de-sensing. What is required is a variable signal level that, once set at a given level, remains at that level.

What is most important for adjusting a repeater/duplexer, is that the test signal has to be applied at the antenna port of the duplexer. If the test signal is able to enter the receiver path at any point other than the input, then the duplexer and/or the receiver can be misaligned.

But how can you apply a signal generator to the duplexer antenna port and turn the transmitter on, remembering the repeater's transmitter goes through the duplexer and appears at this same point, without blowing up the signal generator? The answer is a simple attenuator between the antenna duplexer port and the signal generator.

## De-sense Adapter

The de-sense test adapter, shown in the diagram and photo, connects between the antenna duplexer port and the antenna or power dummy load. There is no loss between the duplexer and antenna, but about 30 dB isolation between the duplexer and test signal source. This attenuation is made up of four 27 k 1/4 watt resistors connected in parallel to give 6.75 k, and two 100 ohm 1/4 watt resistors connected in parallel to give 50 ohms.

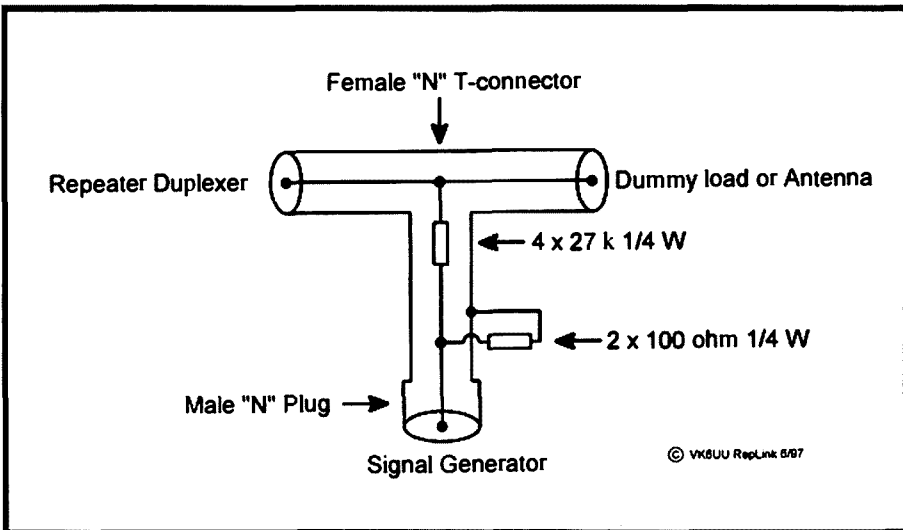
The diagram shows how the resistors are connected to give the 30 dB isolation between the duplexer and the test signal generator. You can use a 6.8 k resistor in place of the four 27 k resistors and a 56 ohm resistor in place of the two 100 ohm resistors. I found it easier to fit the parallel combinations inside the adapter, and the parallel combinations may provide better wide-band operation of the adapter. Use 1/2 watt resistors if you use the 6.8 k/56 ohm combination.

The attenuation that this adapter introduces between the signal generator and the repeater has to be overcome by increasing the signal level out of the signal generator by some 30 dB. The isolation protects the signal generator, reducing the repeater's transmitter by a thousand times, so 20 watts becomes 20 milliwatts. This level is safe for connecting to a signal generator. Extra attenuation can be added if you have any concern.

With the signal source connected to the adapter, and adjusted to give a weak signal, adjustments can be made to the duplexer and the repeater's transmitter and receiver for zero de-sense. While using this adapter to set up a UHF 70 cm repeater for zero de-sensing, I found improvements could be made with the transmitter's noise output and the receiver's best sensitivity, along with the best performance of the duplexer.

The adapter is made from an N type female T connector. Solder the 27 k resistors onto the centre pin of the T connector. The other end of the 27 k resistors goes to a male N type plug. This end of the 27 k resistors is also the connection point for the two 100 ohm resistors to ground. I found that an N type male plug, terminated with RG-213 coax with the coax cut to about three centimetres long, was the best way to put together the adapter.

The braid of the RG-213 is folded back



**Schematic of the de-sense adapter.**

and the centre conductor of the RG-213 is cut short to allow the 27 k resistors to be soldered to it. The two 100 ohm resistors are then soldered to earth, either to the braid of the RG-213 or to the T connector, whichever you find the easiest. Cover the resistors with heat shrink or insulation tape and then fold the braid back down to the T connector and solder the braid to the T connector outer. The attenuation resistors are then shielded by the RG-213 braid. Tape over the braid and you have a simple but very useful adapter for testing de-sensing and aligning repeaters.

### 29 MHz Again

To keep you up to date on our licence application for a 29 MHz gateway on to one of our existing 2 metre repeaters in VK6, there is still no licence. The formal

application went into our local VK6 WIA Council three years ago. Since then there has been a host of delays. I'm not having a go at anyone, or the WIA or SMA, because I have seen how the delays take place and have been part of the delay process as well. But we really do have to do better!

The bureaucratic process is mind numbing. Why such a simple application can take three years so far is the result of silly regulations, lack of clear regulations, lost applications, misplaced applications, people forgetting, letters going unanswered, people being on holidays; the list goes on! What I would like to know is how do the Eastern States do it?

\*21 Waterloo Crescent, Lesmurdie 6076  
 Packet: VK6UU @ VK6BBR  
 E-mail: will@vale.faroc.com.au  
 ar

## Spotlight on SWLing

Robin L Harwood VK7RH\*

It has been announced that another major short-wave broadcaster is permanently closing down. The Christian Science Publishing Society, which publishes the respected Boston weekday newspaper, *The Christian Science Monitor*, has placed their short-wave senders in Cypress Creek, South Carolina and on Saipan in the western Pacific, on the market. They also announced that they will be no longer producing their newscasts over the American Public Radio Network ((PRI) as from the 30 June.

Many of us have come to rely on Monitor Radio International for their balanced news reports and current affairs presentation and it

will be a pity to see them go. The weekday transmissions were run separately from the weekend releases which were produced by the Christian Science Church. In its press release, and on media interviews, it was stated that MRI was a commercial operation and consistently failed to recover costs from advertisements and was subsidised by the Church. Some years ago, the station sold the sender at Scotts Comer, Maine to a splinter Adventist group in Florida.

At the time of compiling this, there has been no further news on the fate of the two transmitting sites, although rumours are that the Radio Free Asia operation in Washington

could be a possible buyer of the Saipan site. Commercial operation over short-wave has never taken off compared to MW or FM.

Also, recently Joseph Costello died in New Orleans LA aged 53. He started the short lived revival of commercial short-wave broadcasts over WRNO, "The Rock of New Orleans", by breaking the monopoly and reluctance of the FCC to issue new licenses.

The majority of short-wave broadcasting licences issued over the past 20 years in the USA have been to religious stations broadcasting a veritable potpourri of different religious and political viewpoints. Perhaps the easiest heard is WWCR in Nashville Tennessee, which has expanded to four transmitters on-air simultaneously. Its programming has come under scrutiny since recent terrorist events within North America after it aired various program blocks from patriot and self-styled militia groups.

However, WWCR is a commercial operation and several of these groups were no longer heard when they did not pay for their airtime. Another interesting trend is that some international and foreign domestic networks are hiring airtime over WWCR to reach North America. The Croats were the first during the Yugoslavian civil war in 1992-3, and others followed. Now the Irish RTE network broadcasts to this region at 1000 UTC over WWCR for 30 minutes. Weekend programming is longer but is aired, I think, at 1100. Frequency is 5070 kHz.

The future of Radio Australia is still unclear. A few weeks ago, it was announced that three language services of French, Thai and Cantonese will close and staffing levels will be further reduced to about 80. Personally I find that axing Cantonese is puzzling in view of the hand-over of Hong Kong to China at the end of this month. More people there speak Cantonese than Putonghua (Mandarin) as do many ethnic Chinese in SE Asia. The results of the Senate Select Committee in Australia's external broadcasting is expected to be handed down by now and it is unclear what their findings are.

Hong Kong will be reverting to Chinese sovereignty on 30 June and I am expecting that the hand-over will be extensively covered by many broadcasters, including the BBC World Service as well as the short-wave relays of the Chinese domestic networks. The actual time of the ceremony is 1600 UTC which corresponds to midnight local time. China Radio International should carry highlights on 1 July in their English program to Australasia on 11755 and 15440 kHz from 0900 till 1100 UTC.

There are presently no short-wave broadcasts emanating from Hong Kong since

the BBC closed down and relocated to Thailand. However, I would not be surprised if the Chinese put up a short-wave service similar to that in Shanghai, Fujian and other coastal centres. The Cable and Wireless HF maritime station VRQ/VRX will revert to Chinese control and the callsign block VRA to VRZ will also be released to China from the UK. This will mean that Pitcairn Island VR6 will be under a new prefix soon. The VOLMET broadcasts from Hong Kong at 15 and 45 minutes past the hour continue on 8828 kHz as does ATC traffic on 8903 and 8942 kHz.

In January there were rumours that HCJB was planning to erect a transmitter in north-western WA following an item in an obscure DX bulletin quoting the President of HCJB, Ron Kline. I was informed then, as were some other HCJB personnel, that this was just speculation. Now the secret is out, in HCJB Australia's autumn mailing to their local supporters, that an 80 hectare property at Kununurra in the Kimberley was given to HCJB with the aim of establishing an international short-wave station there.

It will be a long haul for there are still several obstacles, including the acquisition of a licence as well as obtaining equipment, particularly power generators. Already, disused Australian military transmitting towers have been found before they could be sold for scrap and could be suitable for the site. In the meantime, the property will be used for Christian ministry through farming whilst awaiting further developments.

I was listening to the call back after the VK3BWI broadcast on 4 May, when I heard my name mentioned by Colin VK3LO whilst in contact with Roth VK3BG. Thanks for the kind comments Col and Roth. I only wish I had an operational rig at the time. Roth mentioned that he regularly listens to Radio Netherlands in English at 0730 but gave the frequency as 7920 kHz. Sorry Roth. All there is on that channel is a facsimile station! I think Roth meant 9720 as that is where Hilversum was at that time, and also 100 kHz up on 9820 kHz. Both are from Bonaire in the Caribbean. However, the audio is deliberately not synchronised with one being about 600 ms behind the other!

Well, that is all for this month. Don't forget that there are plenty of signals on the 49 and 41 metre bands around 0200z coming via the South Pole from Europe. This only happens for a few short weeks so make the most of it.

\*5 Helen Street, Newstead TAS 7250  
(03) 63 44 2324

VK7RH@VK7BBS.LTN.TAS.AUS.OZ  
Internet e-mail: robroy@tassie.net.au

ar

## Over to You - Members' Opinions

All letters from members will be considered for publication, but should be less than 300 words. The WIA accepts no responsibility for opinions expressed by correspondents.

### Morse and Exams

Steve Truscott's letter in *Amateur Radio*, May 1997 issue (*Morse Gone But Not Missed*) is lucid, and no doubt factual, but nevertheless substantially misses the point. We all know that commercial Morse telegraphy is uneconomic.

For instance, land-line Morse was phased out in Australia in the 60s, in favour of machine telegraphy (which could be worked at higher speeds by lesser skilled operators). That we are amateurs may have escaped the notice of some readers. According to the Macquarie Dictionary, an amateur is "someone who cultivates any study or art or other activity for enjoyment instead of professionally or for gain".

It is perhaps surprising to some members, but many of us actually enjoy using Morse, for its various operational and technical advantages. Have a quick listen on any DX band, especially when it is nominally "dead", and hear for yourself. CW is often the only "copiable" non-specialist mode.

Some persons, for various reasons, either cannot, or will not learn Morse. Fair enough. But I think it will generally be agreed that it is reasonable to expect that there should be some form of relevant practical skills test in addition to the theory and regulations in order to gain HF privileges. Without Morse as a "practical exam", it is difficult to know what to do.

Some alternatives have already been suggested. Let me add another; that the candidate may submit, to a suitably qualified examiner, a recent substantial radio project

which the candidate has successfully completed. S/he must be able to describe how it works, how it was made, with particular reference to any difficulties experienced, and how these were overcome. Or perhaps locate and repair set faults in a typical transceiver. I can already hear howls of "unworkable"! Really? It works in the TAFE courses. Would it be any more difficult to administer than the present Morse exam? "Easy got - soon forgot".

Drew Diamond VK3XU  
45 Gatters Road  
Wonga Park VIC 3115

### Regarding CW

The reasons for getting rid of CW appear limitless, the most dominant being that it is now obsolete in marine communications and the armed forces.

However, it must be remembered that all of those activities have nothing to do with the hobby of amateur radio. Nor do requirements suggest that, having passed the 10 WPM test (or 5 WPM for Novice), you ever have to use it again. Remember that in many other countries the CW exam is at 12 WPM with no errors!

Amateur radio is a world-wide hobby. The regulatory conditions are determined by international conferences, not by the comparatively miniscule number of amateurs here in Australia.

Les Daniels VK2AXZ  
9 Highfield Terrace  
Cardiff Heights NSW 2285  
ar

## VK QSL BUREAUX

The official list of VK QSL Bureaux. All are Inwards and Outwards unless otherwise stated.

VK1		GPO Box 600 CANBERRA ACT 2601
VK2		PO Box 73 TERALBA NSW 2284
VK3	Inwards	Box 757G, GPO MELBOURNE VIC 3001
	Outwards	40G Victory Blvd ASHBURTON VIC 3147
VK4		GPO Box 638 BRISBANE OLD 4001
VK5		PO Box 10092 Gouger St ADELAIDE SA 5000
VK6		GPO Box F319 PERTH WA 6001
VK7		GPO Box 371D HOBART TAS 7001
VK8		C/o H G Andersson VK8HA Box 619 HUMPTY DOO NT 0836
VK9/VK0		C/o Neil Penfold VK6NE 2 Moss Court KINGSLEY WA 6026

---

---

# Technical Correspondence

---

---

All technical correspondence from members will be considered for publication, but should be less than 300 words.

---

---

## Half Wave Antenna Formulas

After eavesdropping on some recent QSOs, may I suggest that the inexact and error prone formula for a half-wave HF wire antenna (468/F) enshrined in the ARRL Handbook is past retirement age and should be respectfully interred.

So am I, but I can still object.

In its day, this formula was no more than a conversion to feet with 5% deducted for "End Effects", or insulators and capacity to ground, etc.

Accuracy depended on wire size compared to height above ground and usually required a test and re-adjustment process to obtain a required 0.5% tolerance within a 2.5% bandwidth or thereabouts.

In this new age, we can refer to half the formula for wavelength (300/F) for a result directly in metres and, after test, subtract the percentage frequency error in centimetres direct from EACH half, viz a forty metre antenna of 10.5 m in each half can have 10.5

cm cut off both ends for each one percent error.

Unless you sell insulators, leaving out the obligatory "egg" insulator wired to a metal tower reduces the end capacity by 7 to 10 pF. To achieve this, one can use cordage of black polyester (Philastran), carbon fibre (Kevlar) or, even the "el cheapo" polypropylene (UV proofed baling twine) laced on to insulated wire to reduce end capacity and span weight. An overhand knot, very close to each end for 100 watts, and maybe a 2 cm loop for 1 kW or so, should control the brush discharge to atmosphere and keep St Elmo and his mates from firing up.

The original formula served its purpose in the days of feet and inches, but why do the conversion, with the inevitable errors, when we have readily available metric tapes?

**William McLeod VK3MI**  
42 Capon Street  
Chadstone VIC 3148  
ar

even though I am likely to become very busy again in a few weeks time."

Wally Howse VK6KZ writes that the following procedures have enabled 10 and 24 GHz contacts without any other liaison frequency.

"These procedures involve using the minutes past the hour as the determiner of who shall transmit and who shall listen. As I am the odd character (that's my claim anyway), I transmit the five minute intervals starting with the odd five minutes - for example from 12.25 to 12.30. Neil VK6BHT being very even handed (my comment), then transmits the five minutes that start at 12.30 (even five minutes). We agree on our likely starting time but, if early or late, adhere to the above arrangement.

"If no signals are heard in the first ten minute period then we repeat the cycle and, unless we have a sniff of signals, generally close down after a total of 20 minutes.

"If signals are heard in any of the five minute periods then the next transmitting period of five minutes is broken with short listening periods to attempt to complete a contact."

Wal VK6KZ also sent the following: "Skeds with Bill Hockley VK6AS in Esperance by Cec Andrews VK6AO and myself have been extremely rewarding, with at least CW signals being heard most mornings. The skeds precede the continuing successful ones Cec and I have with Wally VK6WG in Albany on 144/432 MHz. By the way, these skeds are always on 144.120, as I argue that 144.100 is a calling frequency and pre-arranged skeds should be away from that spot! Bill is 598.8 km from my QTH in Perth."

## The 17000 km Barrier

Steve VK3OT drew my attention to the fact that it appears, during Cycle 22, only three amateurs from VK broke the 17000 km barrier on the traditional VK/EU path. They were Steve VK3OT to G3UKV on 17/2/91 at 17084 km, Ken VK3AKK to Geoff GJ4ICD on 18/10/91 at 17108 km, and Moss VK7IK to PA0LSB on 8/2/92 at 17053 km.

Also of interest is the contact between Mike VK2FLR who worked CU/N6AMG in the Azores on 27/11/91 at 19424.1 km, the Azores being in the Atlantic Ocean and about 1500 km west of Lisbon in Portugal. The path to there would be at a different angle from those directly into Europe.

Steve said: "It is very difficult to break the 16000 km plus path, particularly where eastern Australia is concerned. That extra 1500 km down from VK8 and northern VK4 comes at the price of station development and operator proficiency. In Cycle 22, very few long haul 16500 km plus contacts were made

---

---

# VHF/UHF - An Expanding World

---

---

Eric Jamieson VK5LP

## TEP from Townsville

John VK4FNQ Townsville reports TEP on 7/4: "0455 BYTV 49.740 heard, 0458 JA1RJU CW 599 heard. From 0501 to 0538 worked JH7MSB, JH0MHE, 7M1FBN, JA1AUD, JK1DVX, JN1MKU, JA7QMH, JS1XGS, JH7DFZ, JA5FFJ, JE2DWZ and JA1RJU. Signals ranged from S9 to S1. Also heard JAs on 50.110 and BYTV for another 20 minutes then all faded".

## Interesting Information

Doug Friend VK4OE reports that The VHF/UHF Field Day Contest in January did draw a few more people on to the low ends of the bands, but a competitive field station these days needs to be having as many FM contacts as possible to get anywhere. The Brisbane VHF Group station VK4IF/4 succeeded in winning the multi-operator section of the Field Day Contest this year.

"The first reason has been that large numbers of general Brisbane region stations were willing to contact VK4IF/4 on FM simplex frequencies (perhaps other clubs

also have accommodating/supporting locals, but there was a big increase this year in our area). The second significant reason was that VK4IF/4 and VK2FZ/4 also had the extra band of 2.4 GHz using equipment modules built by me.

"I am looking seriously at having narrow-band capabilities on 10 GHz, in the not too distant future for home operation, and possibility for the field station as well. I do have a large amount of the necessary equipment ready to go. A small number of other Brisbane stations have also been proceeding slowly towards that end, so it is not all in vain.

"So that's about where I stand at the moment, Eric. I think that the most significant thing we can do is to keep publicising the good and challenging things that can be done and are being done by many people in the VHF/UHF world, and to present them in such a way that they do appear achievable without there being a need to be highly competitive. Thank-you for continuing to do your part. I'll be continuing to do what I can,

operators with a knowledge of the band and the ability to use it, which also included making use of early warning signals in the area below 50 MHz. It will be just as hard in Cycle 23."

Steve VK3OT also advised that Toshi JA1ELY, Editor of *The 59 Magazine*, reports a new ten metre beacon JA7ZMA on 28.188 MHz from grid square QM07. It runs 50 watts from a stacked turnstile dipole at 700 metres asl. It may be a useful pointer to an impending 50 MHz opening.

From Gareth Davey VK1ANF comes the following: "Re the *Something Different* section in last month's *Amateur Radio*, I remember when flying in the circuit at Bankstown Airport (1000 feet above ground) about 10-15 years ago, that it was not uncommon to hear aircraft in the circuit at Norfolk Island making their radio calls (same frequency, I think 118.1 MHz), during the summer months."

One never knows what responses come to unusual statements. Thanks Gareth.

### Microwaves

David VK5KK made a successful microwave outing on 13/4. He says: "Contact was made on 10368.100 MHz between VK5KK/p5 at Summertown (just north of Mt Lofty) at 1228 and Colin VK5DK/p5 at Cape Northumberland, who was accompanied by Trevor VK5NC. Signals were 5x5 both ways. Distance 385 km. Colin used a Qualcomm 10 GHz transverter with one watt to a 600 mm dish. VK5KK was running DB6NT with one watt into a 600 mm dish. Interestingly, signals on 144 MHz only averaged 5x1, with QSB, using 10 watts and a three element beam. 10 GHz signals were fluttery but more consistent! Signals were available on 10 GHz between VK5KK and VK5DK for the length of the test (till 1310) with little change in signal levels. Colin listened for the Adelaide beacon on 10368.45 MHz; however, did not report hearing anything.

"Keith VK5AKM was also on 10 GHz from his home QTH, however he did not hear Colin. VK5AKM uses a 600 mm dish at 13 metres with 250 mW. His location at Wasleys is about 60 km north of Adelaide, beaming through a saddle in the Mt Lofty Ranges. Signals between VK5KK/p5 and VK5AKM on 10 GHz (57 km path) were only 5x2 due to obstructions.

"At the same time, Russell VK3ZQB/p3 was at Pt Fairy. Signals were stronger from Pt Fairy on 144 MHz than from Cape Northumberland with both VK5KK/p5 and VK5AKM working Russell from 1220 to 1340. Various attempts were made on 10368.1 MHz from 1245, with some signals heard by VK3ZQB/p3 from VK5KK/p5 at 1310 and in the reverse direction at 1325, but signals did not peak long enough to establish contact.

"During the time of the attempts, Russell reported that the weather conditions at Pt Fairy changed from clear skies to heavy cloud as the front approached. Two metre signals gradually dropped after 1330. Weather conditions at VK5KK/p5 were typically damp with light rain that seems to exist with microwave openings at 600m asl, enough to get soaked. The rain had no effect on 10 GHz signals other than to scatter the beam heading about 10 degrees. Propagation was ahead of a front going through the bottom of SA/VIC ahead of a large high in the Bight (centre 1033 mb). Where were highs like this during summer?"

David VK5KK also sent this item from *The VHF/UHF/SHF Internet News*. It refers to microwave news from Sam Jewell G4DDK: "The "cold" high pressure system on 8/4 and 9/4 produced excellent conditions on 24 GHz across the North Sea. Simon G3LQR, worked PA0EZ on 8/4 for what I think is the second or third time this year

"On 9/4 I had my first QSO on 24 GHz with Ari PA0EZ for nearly two years. This was followed by an SSB QSO with Hans PA0EHG from his home QTH, for a new

"first" for me. The distance was a mere 225 km.

"Hans then left his Tx on for several hours whilst I monitored signal strength on my spectrum analyser (at 1F). In 3 kHz the signal reached 23 dB over average noise. With a lower noise figure, around 2 dB rather than my rather high 7.8 dB system NF at present, the signal to noise ratio would have been close to the magic 30 dB which would, perhaps, indicate the possibility of a 47 GHz QSO. As more PA0 stations gear up for 24 GHz home station operation, the potential of 24 GHz to carry DX is becoming clearer. With a little more power and a greater number of stations QRV, I think we might be surprised by the potential of this great band."

### Bass Strait

Andrew VK7XR reports that the scene has been quiet since the end of the Ross Hull Contest, only just making the regular early morning skeds to Ron VK3AFW and John VK3ATQ on two and six metres respectively. Usually 5x1 or 5x2.

"A slow moving high pressure system centred across Bass Strait for four days occurred from (UTC dates) 9/4 till 12/4. During this period of settled weather, numerous notings of beacons were recorded and various contacts made. Activity was low, but I guess everyone thinks the band is dead at this time of year."

9/4 2210 VK3CY 144 5x1 571 km Des;  
9/4 2212 VK3AFW 144 5x8 439 km Ron;  
10/4 2212 VK3AFW 144 5x5 Ron;  
10/4 2214 VK3CY 144 5x1 571 km Des;  
10/4 2217 VK3TMP 144 5x3 Max;  
11/4 1156 VK2TWR 144 5x3 592 km Rod;  
11/4 1203 VK2TWR 432 5x5 On FM;  
11/4 1232 VK2XPG 144 5x5 Andy;  
11/4 2226 VK3RGL 144 5x4 Beacon;  
11/4 2227 VK3DEM 144 5x7 405 km Rob;  
11/4 2236 VK3DEM 432 5x5 On FM;  
11/4 2247 VK3DEM 1296 5x2 Rob;  
12/4 0530 VK3RGL 144 5x7 Beacon;  
12/4 0540 VK3ATQ 50 5x1 332 km John;  
12/4 1050 VK3RGL 144 5x8 Beacon;  
12/4 1058 VK3BWT 144 5x5 513 km Warren;  
12/4 1128 VK3RTG 144 5x2 Beacon;  
12/4 2110 VK3RGL 144 5x9 Beacon;  
12/4 2111 VK3RTG 144 5x4 Beacon;  
12/4 2112 VK2RBC 144 5x1 Beacon;  
12/4 2235 VK2TWR 144 5x9 Very strong;  
12/4 2238 VK2VZ 144 5x9 Bob;  
12/4 2242 VK2TWR 432 5x5 On FM;  
12/4 2250 VK3JG 144 5x9 400 km Brian;  
12/4 2315 VK3TMP 144 5x9 358 km Max;  
12/4 2319 VK3TMP 1296 5x1;  
12/4 2324 VK3KLO 144 5x9 Charlie.

Andrew is doing very well considering he uses moderate power levels and basic antenna systems. He does not class his as a "super station", and so proves that results are attainable with a modest station if you work

**Have you advised the WIA  
Federal Office of your new  
callsign? Use the form on  
the reverse of the Amateur  
Radio address flysheet.**

at it. During the Ross Hull Contest he worked VK1, VK2, VK3, VK4, VK5 and VK7 on two metres.

On six metres, Andrew uses an Icom 551D at 100 watts to a six element Yagi NBS Style; and on two metres an Icom 290A at 120 Watts with a DL style 13 element. For 70 cm a homebrew transverter with 28 MHz IF at 50 watts is used to a 15 element NBS Yagi; and on 23 cm a homebrew transverter with 144 MHz IF at 10 Watts to a 20 element loop Yagi.

## ARRL Headquarters

A special bulletin to all amateurs reports: ARRL Headquarters was saddened to learn that VHF pioneer and former QST VHF Editor Ed Tilton W1HDQ, of Spring Hill, Florida, died on 1 March. He was 89. In December 1939, Tilton inaugurated the first QST column devoted to VHF. Originally called *On the Ultra Highs*, it eventually became *The World Above 50 MHz*. Tilton edited the VHF column until he retired from the ARRL staff in 1960, reporting on-the-air activity and encouraging experimentation, initially on the then 56 and 112 MHz amateur allocations and, later, on all VHF and UHF bands. The UHF DX Records box – the precursor of today's standings boxes – debuted in 1940.

During World War II, Tilton worked as a field engineer for the military on radar projects, mostly at Pearl Harbour and Guam, and became acquainted with the great technological progress the military was making in the VHF-UHF spectrum. Even while occupied with his military duties, he still managed to file occasional columns throughout the war years.

In 1947, Tilton established the first WAS standings box for six metres. In 1955 he proposed establishing the first calling frequencies for the six and two metre bands. Following his retirement, Tilton remained a QST Contributing Editor. He was the author of the ARRL's first VHF Manual and wrote numerous articles for QST.

Tilton's column inspired an entire generation of VHF and UHF enthusiasts and encouraged such activities as EME, meteor scatter and auroral propagation. He was considered an authority on sunspots and solar flares and their effects on propagation. As ARRL Executive Vice President David Sumner K1ZZ put it: *Ed Tilton was one of the outstanding amateur scientists of his generation. Perhaps more than any other individual, he led the exploration of the extended-range properties of the VHF and UHF bands.*

Tilton was a life member of the ARRL. He also belonged to the QCWA and the Spring Hill Amateur Radio Club. He was a native of Springfield, Massachusetts. His wife Leitha

died in 1995. His sister Ruby is among the survivors. He is to be interred in Canton, Connecticut. Donations in Ed Tilton's name may be made to the Hospice of the Florida Suncoast, 300 E Bay Dr, Largo, FL 34640. [End of message].

On behalf of the VHF fraternity in Australia, I wish to record our regret at the loss of Ed Tilton W1HDQ, who accomplished so much during a lifetime of dedication to the promulgation of VHF/UHF for the community in general and amateurs in particular. His legacy to VHF/UHF is recorded in the various books and articles he has written, and his long period as Editor of *The World Above 50 MHz*. We salute you Ed, the great pioneer of VHF and above.

## Internet Six News

*The Worlds Six Metre Magazine* for April, produced by Geoff GJ4ICD, has the following interesting snippets of information:

1/4: V73AT active again: New cycle, new opportunity. I have moved back to the Marshall Islands and will be very active during Cycle 23. The six metre antenna at the Kwajalein Amateur Radio club has been repaired and I am active starting today. Look forward to working you all during Cycle 23 from Kwajalein. QSL Manager is still K2CL. ... Tim McLaughlin V73AT (N2PC).

1/4: FR5 beacon QRT: I am advised by FR5DN that the Reunion Island beacon on 50.0215, FR5SIX, is no longer operational. No idea as to when it will be restored. ... Bill Hosie VK6ACY/ZS5BBG.

7/4: VK TEP report: 49.750 MHz Vladivostok TV into VK4 via TEP at S3 from 0510 6/4 for 30 minutes. No amateur signals on 50 MHz or 28.885 MHz. ... Scott VK4JSR.

16/4: New Solar Data Link: A new link has been found on the Internet that provides up-to-date solar data. The map covers two months of solar data and can be found on the 50 MHz section of our main WWW pages, Here! or the short cut is Here!

16/4: King Island info de VK3OT: "*Bob Jordan VK7JR was worked from King Island, Bass Strait, this morning. After a visit by VK3ATQ the quad antenna was repaired following reports of very poor signals. Bob is a blind op and drives an IC706 from a computer. Bob was 5x3 to 5x7 into Hamilton QF12 over a path of 300 km. It is unique in that he is at the intersection of four grid squares and four grid fields. This is the closest point for VK7 to VK3, being 59 nautical miles south of the Cape Otway Lighthouse in Bass Strait. Bob should be active most days at 0733 local time (2133 UTC), as well as Andrew VK7XR in Devonport, Tasmania.*"

19/4: Es in ZL: 0100 46.24 VKTV S2, 0440 VK7RAE beacon 519, 0440 46.17 TV up to S9 0442. 0523 VK4RGG beacon 539. 0557 worked VK4AR, VK4JSR. TV carriers 46.17, 46.26 audible to around 0820z. ... Bob ZL3TY:

## From the UK

Apart from daily contacts with G3CCH, and intermittently with SM7AED, Ted Collins G4UPS, had rather a quiet month during March. Hence, he has been watching the 28 MHz beacons as pointers to possible six metre contacts.

14/3: 1200 HV3SJ/b 599 on six metres; 30/3: 1017 SM5SMH 5x7, 1021: OZ6VHF/b 569, 1030: ES0SIX/b 559; 31/3: 0805 heard OZ2LD 559 via m/s. That's it!

## Web Page

Jim VK1ZFG advises that: "*Strictly 6 – Australia's own six metre Web page – has recently been updated to include a list of all known six metre capable radio's, with individual links, to further info on the Net. Hope you find it useful. E-mail: CanberraBoy@msn.com*".

## Meteor Scatter Experiments

On the mornings of 3/5, 4/5 and 5/5, Adrian VK2FZ/4 set out to use the Eta Aquarids meteor showers for propagation of signals on 144 and 432 MHz. Adrian is about 70 km north of Brisbane near Maleny and 500 m asl in the Blackall Ranges. He sent out, via Rod Preston VK4KZR, a quite elaborate set of procedures for the tests, and they will be valuable for anyone wishing to try contacts via meteors.

I hope to include the procedures at some time, but information can be obtained by e-mail from Rod Preston VK4KZR [rpreston@gil.com.au](mailto:rpreston@gil.com.au), Ron Cook VK3AFW [cook@rivett.mst.csiro.au](mailto:cook@rivett.mst.csiro.au) or general info from [vk-vhf@marconi.mpce.mq.edu.au](mailto:vk-vhf@marconi.mpce.mq.edu.au).

To give you some understanding of what went on during those three mornings, this summary from Ron VK3AFW is worth reading.

Saturday, am of 3/5:

5:15 to 6:30: Des VK3CY hears Adrian VK2FZ/4 and calls him frequently. Gavin VK3HY hears Adrian and calls to after 6:00. 6:08: Ron VK3AFW commences calling Adrian. QSO complete by 6:28:15. 26 reports both ways. David VK3AUU heard calling Adrian. Other stations known to have heard and called Adrian: Trevor VK5NC, Andrew VK7XR, Rob VK3DEM. Stations hearing Adrian but not calling – Alan VK3XPD, John VK3KWA.

Sunday, am of 4/5:

Gavin VK3HY hearing and calling Adrian to after 6:15. 6:20 VK3AFW commences calling and completes QSO at 6:38. 26

reports both ways. 9:00 VK3AFW alerts several VK3 Aircraft Enhancement operators or listeners to the experiment. Max VK3TMP hearing and calling Adrian but runs out of voice before Adrian has his call copied fully. Doug VK3KMN calls after a couple of big bursts, but no luck. Telephone call from VK2FZ/4 to VK3AFW to say he's heard bits of signals but no positive ID of any call. Gavin VK3HY returns to the fray and, after 30 minutes, completes a QSO. Pings heard up to cessation of transmissions at 12:00 noon.

Monday, am of 5/5:  
 VK3XPD listening, VK3AFW starts calling at about 6:10. Partial QSO with VK2FZ/4, abandoned at 06:43. Adrian stops sending at 06:45. VK4ZKR and VK2FZ/4 copied many pings from the Canberra 2 m

beacon on Sunday morning. Several VK2s heard by VK3AFW for periods up to 10 seconds on 144.2 between 8:00 and 9:00 am Sunday.

"A very interesting experiment which introduced a number of people to MS for the first time. It was disappointing that the forecast meteor shower did not occur during these tests. It seems the prediction program got it wrong, as all QSOs and received reports were from normal random meteors. Ping rate was around four per minute here. In any one hour there were many pings lasting a second, and from one to three bursts lasting for five seconds each hour."

Next month I will include the remainder of Ron's information which covers the lessons learned, as well as hints for intending MS operators.

**Closure**

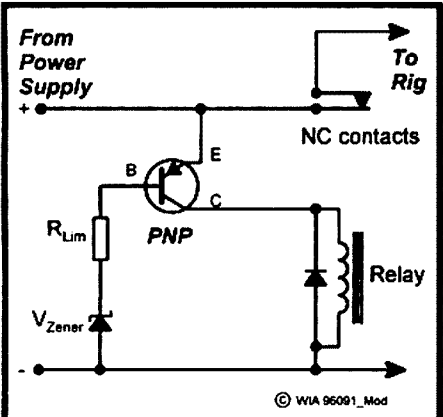
Several items have been held-over this month due to space limitations. I want to mention 50 years on 50 MHz soon. I already have input from Cliff ZL1MQ for his ZL view of that milestone.

By the time you read this we will be nearing the winter Es period, so watch six and two metres for those elusive contacts.

Closing with two thoughts for the month:  
 1. People who want by the yard but try by the inch should be kicked by the foot; and  
 2. Our faults irritate us most when we see them in others.

*73 from The Voice by the Lake*  
 \*PO Box 169, Meningie SA 5264  
 Fax: (085) 751 043  
 Packet: VK5LP@VK5WI.#ADL.#SA.AUS.OC  
 E-mail: vk3lp@ozemail.com.au  
**ar**

**Update**



**Corrected schematic of the VK3EHZ over-voltage power supply protection.**

**Power Supply Protection**  
*(Published on page 26 of the May 1997 issue of Amateur Radio magazine)*

As well as other readers, John Bedwell VK3EHZ contacted us and advised that "Unfortunately, Murphy took over my first attempt and somehow you ended up with an incorrect circuit".

John's corrected circuit has been further corrected by Peter Gibson VK3AZL, *Amateur Radio's* Senior Technical Editor (who actually built it to ensure it would work), and is published herewith.

- Peter offered the following comments:
1.  $R_{lim}$  limits the current into the PNP transistor, and 1.8 kilohms is a suitable value.
  2.  $V_{zener}$  sets the trip voltage which will be approximately  $V_{zener} + 0.6 V$ .
  3. Commonly available Zener diodes are

either 13 or 15 V, giving trip voltages of about 13.6 or 15.6 volts. Therefore, a 15 V Zener is considered to be the better value.

4. The diode across the relay can be any power diode with 100 or greater PIV.
5. For these voltages, a 12 volt relay works, although a small current limiting resistor could be put in series to limit the voltage across the relay to 12 volts.

It might be a good idea to correct your copy of the May 1997 issue of *Amateur Radio* now.

**Conversion of Philips FM92 E Band to Six Metres**

*(Published on page 9 of the May 1997 issue of Amateur Radio magazine)*

The authors of this interesting article advise of omissions to the conversion project.

Firstly, the coil winding for Main and Offset in the VCO. The same gauge of wire and same direction of winding is used in both cases, the Main being eight turns and the Offset six turns.

Secondly, 10 pF NPO capacitors are placed across each coil in the VCO in Mark I

units; but only across the Main coil in Mark 2 units.

Finally, the output filter in the Power Amplifier needs changing.

**Filter No 79 (see Fig 4)**  
 $FCO = 49.3 \text{ MHz}$ ,  $F3dB = 61.2 \text{ MHz}$ ,  $F20dB = 76.7 \text{ MHz}$ ,  $F40dB = 101.00 \text{ MHz}$ ,  $SWR = 1.03:1$ .

$CI, C7 = 39 \text{ pF}$ ;  $C3, C5 = 100 \text{ pF}$ ;  $L2, L6 = 0.203 \mu\text{H}$ ;  $L4 = 0.251 \mu\text{H}$ .

$L2, L6 = 5$  turns of 9.5 mm diameter, close wound, using 20 gauge (0.8 mm) wire.

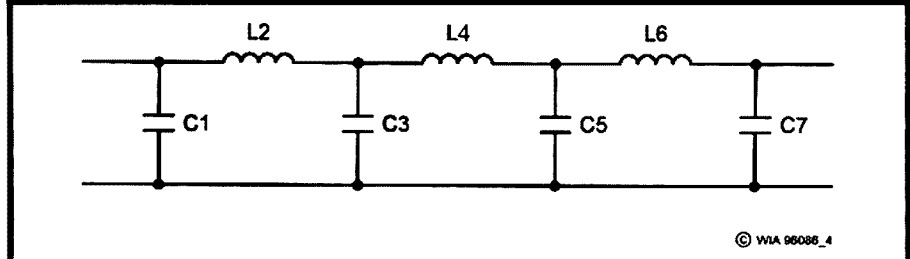
$L4 = 6$  turns of 9.5 mm diameter, spaced one wire diameter, using 20 gauge (0.8 mm) wire.

It might be a good idea to insert a reference in the original article to this *Update*.

**The DB-80, an 80 m SSB/CW QRP Transceiver**

*(Published on page 14 of the April 1997 issue of Amateur Radio magazine)*

We have just received notification that the excellent, full-page drawings appearing on pages 15 and 17 of this article were drawn for the author Dr T C Choy by Sergio Fontana VK3CWX.



**Figure 4**



---

---

## Silent Keys

*Due to space demands obituaries should be no longer than 200 words.*

---

---

The WIA regrets to announce the recent passing of:-

J (J)	GRAY	VK2BGJ
HE	WILTSHIRE	VK2DEW
T G	THORPE	VK2QT
M (Mal)	LE MAISTRE	VK3UE
E (Ted)	HOWELL	VK3ZKP
JA (Joe)	ELLIS	VK4AGL
DM (Dudley)	ROBSON	VK5PF

### Adrian Christy VK2ACY

Adrian VK2ACY passed away on 24 January 1997. Adrian's adolescence was spent in Cessnock where his training qualified him as a Dental Surgeon. He practised at Port Macquarie, Scone and finally at Wallsend.

Adrian's initial interest in amateur radio was stimulated by his life-long friend Chris Cowan VK2PZ, who passed away three years ago, and later by Peter Alexander VK2PA, obtaining his licence in 1961. His mellifluous and lucid articulation, combined with humorous anecdotes, qualified him as a predominant and easily identified rag-chewer.

A man who lived a full life, compassionate to all, especially the underprivileged, his retirement was at Silverwater where his main interests were gardening and wood-turning, and amateur radio to the end.

He leaves behind his work-mate and wife, Lexie, and son Jon VK2YJC, plus a lot of memories for all who knew him. Ade, you did it your way!

Les VK2AXZ

### George Sheeran VK2BGS

George Edward Sheeran of Mollymook NSW passed away on 26 March 1997. He had held an amateur radio licence since 1946.

George joined the RAAF in 1940 as a trainee W/T operator, and after training at the Marconi School in Melbourne and the RAAF

Signals School at Point Cook, he was posted to Parkes, Townsville, Port Moresby and East Sale. He was then sent to Watheroo Magnetic Observatory in Western Australia for duty involving radio propagation research and to assist and maintain the ionospheric recorder.

Since his discharge he maintained an active interest in amateur radio and kept regular scheds with friends in Melbourne, Wangaratta and Sydney, to name a few. He had been a member of the Mid South Coast Amateur Radio Club for 14 years and served as President and Treasurer of that Club.

George leaves his wife Bettie, son Roger, and four grandchildren. He will be sadly missed by all who knew him.

Stan Bourke VK2EL

### E (Ted) Howell VK3ZKP

Ted Howell passed away on 14 February 1997. Ted belonged to two radio clubs. First was *The Northern Suburbs Radio Group* which Ted joined in 1965. Ted didn't have a call sign, but the club members tutored him and he soon became VK3ZKP. He was an active club member until he died.

The second club was *The Western and Northern Suburbs Amateur Radio Club* of which Ted was a foundation member and Vice President when the club commenced in 1970. He was made a life member in 1985 and was a committee member several times during the intervening years. Ted was an active worker in club affairs and President of the Hall Management Committee at the time of his death.

Ted will be missed by all who knew him.

Tom VK3AGH, Bob VK3BU

ar

---

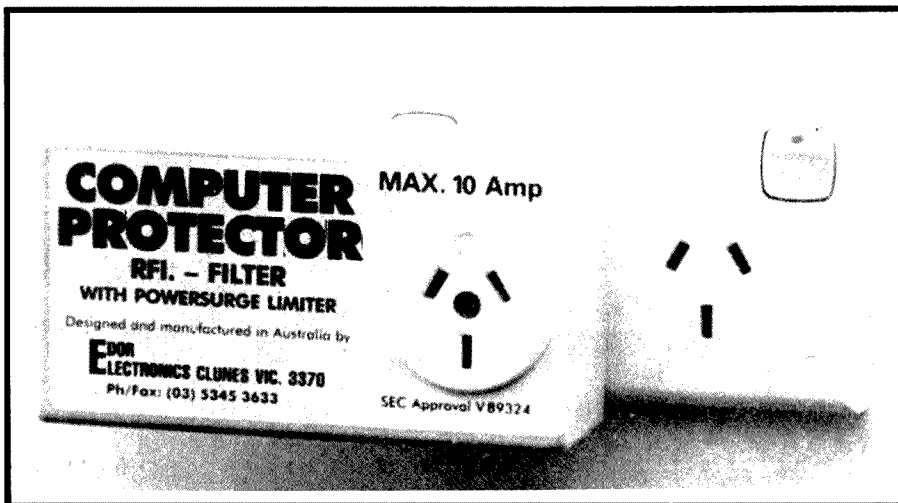
---

## What's New

*Don Jackson VK3DBB introduces new products of interest to radio amateurs*

---

---



### AC Filter

Worried about lightning strikes or power surges on your latest black box, computer or other high tech goodies?

EDOR ELECTRONICS has just released a new, fully approved device designed not only to protect micro-processor based equipment from lightning surges, but also from induced distant lightning pulses and RF interference.

The device is Australian made and has SEC approval V89324. It is said to incorporate four levels of protection, being primary and secondary RFI filters, a surge

voltage-limiting circuit, and an earth line choke.

About the same size as a double power point, the unit plugs directly into a 240 volt power point, and is claimed to have a maximum current carrying capacity of 10 amps at 40 degrees C. RF attenuation peaks at 74 dB, with particular attention given to 27 MHz.

Further details can be obtained direct from the manufacturer. Contact Fred Rode VK3AFR on 03 5345 3633.

\*55 Ryan Road, Pakenham VIC 3810

ar

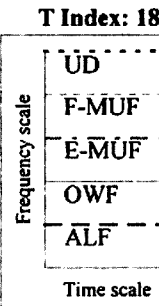
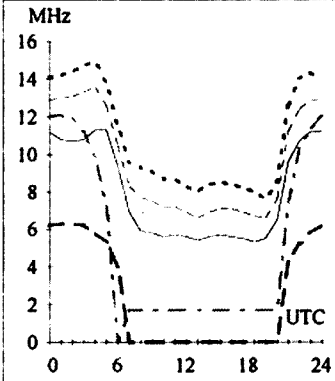
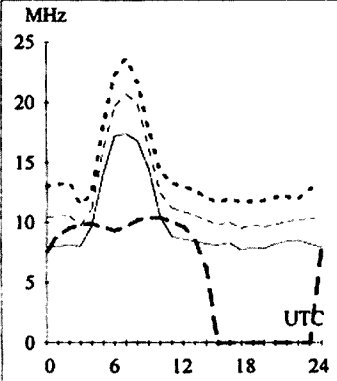
**Tell the  
advertiser you  
saw it in the WIA  
Amateur Radio  
magazine!**

**Adelaide-Johannesburg 237**  
 Second 4F5-6 4E0 Short 10042 km

**Brisbane-Christchurch 141**  
 Second 2F17-20 2E5 Short 2517 km

# HF Predictions

Evan Jarman VK3ANI



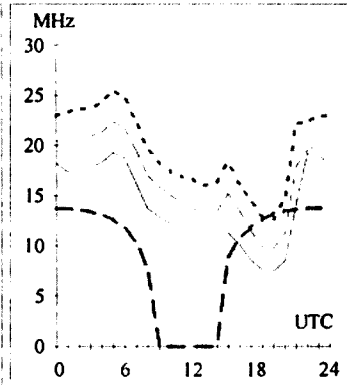
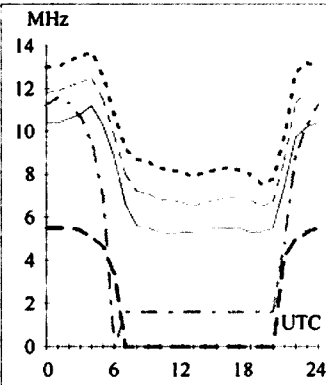
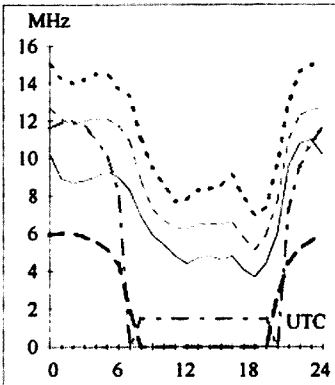
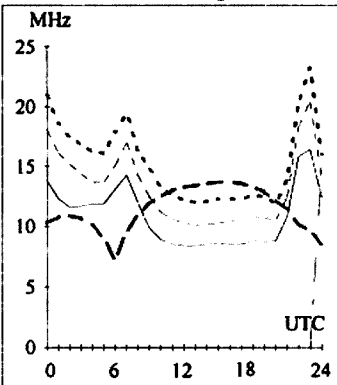
These graphs show the predicted diurnal variation of key frequencies for the nominated circuits. This also indicates a possibility of communication (percentage). The frequencies, identified in the legend, are:-  
 Upper Decile (F-layer, 10%)  
 F-layer Maximum Useable Frequency (50%)  
 E-layer Maximum Useable Frequency  
 Optimum Working Frequency (F-layer, 90%)  
 Absorption Limiting Frequency  
 The predictions were made with the Ionospheric Prediction Service program, ASAPS V3.2. The T index used is shown above the legend. The Australian terminal azimuth, path and propagation mode are also given for each circuit.

**Adelaide-London 132**  
 First F 0-5 Long 23755 km

**Brisbane-Honiara 21**  
 Second 2F21-25 2E7 Short 2131 km

**Canberra-Auckland 102**  
 Second 2F19-22 2E6 Short 2300 km

**Darwin-San Francisco 54**  
 First F 0-5 Short 12316 km

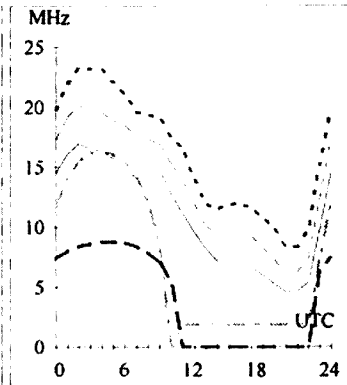
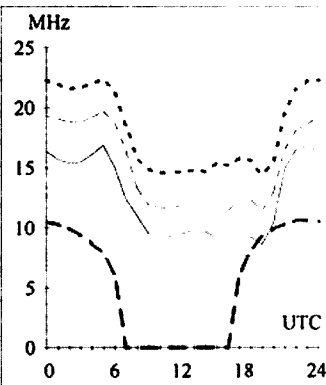
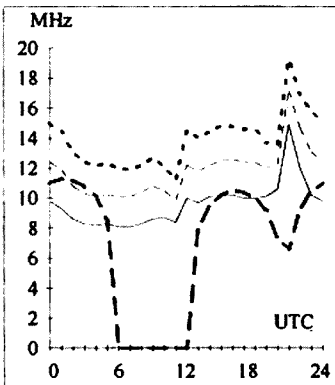
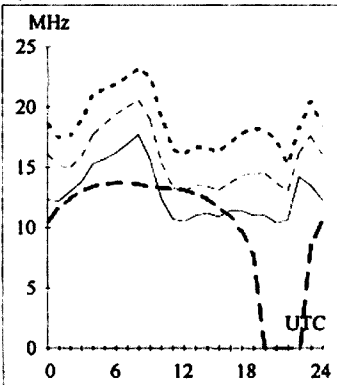


**Adelaide-London 312**  
 First F 0-5 Short 16269 km

**Brisbane-Montevideo 154**  
 First F 0-5 Short 12431 km

**Canberra-Honolulu 50**  
 Second 4F8-13 4E0 Short 8407 km

**Darwin-Singapore 295**  
 Second 2F12-17 2E2 Short 3351 km

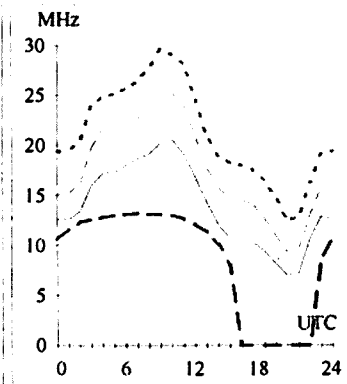
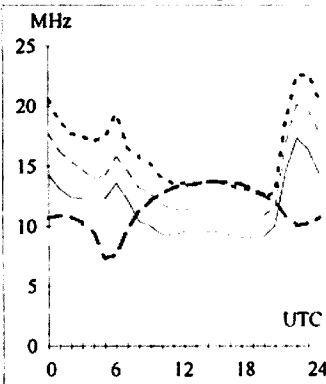
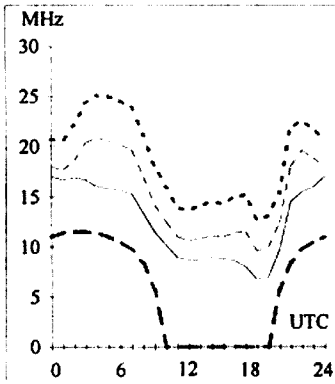
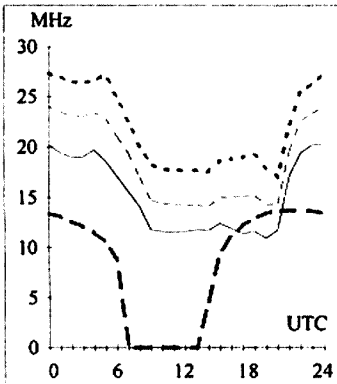


**Adelaide-Los Angeles 66**  
 First F 0-5 Short 13158 km

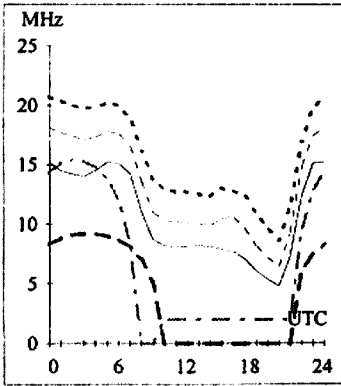
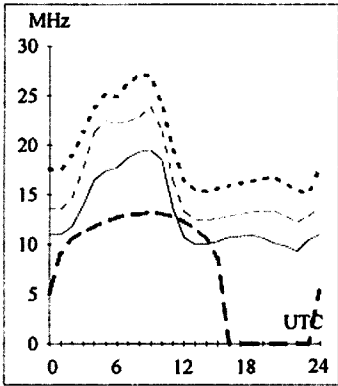
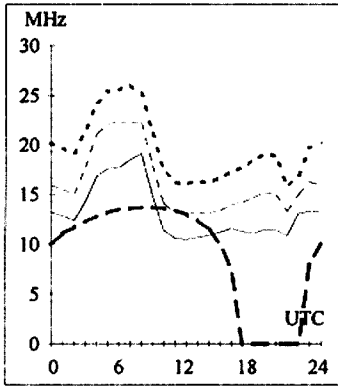
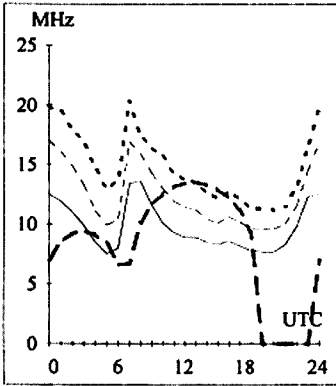
**Brisbane-Tokyo 348**  
 Second 3F6-11 3E0 Short 7159 km

**Canberra-Paris 130**  
 First F 0-5 Long 23102 km

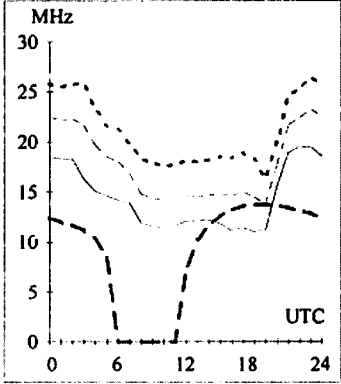
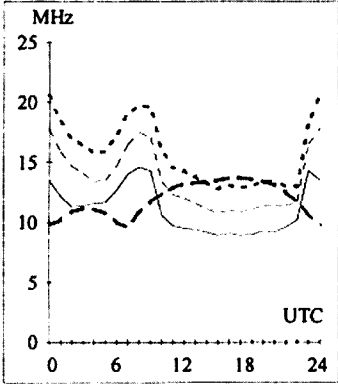
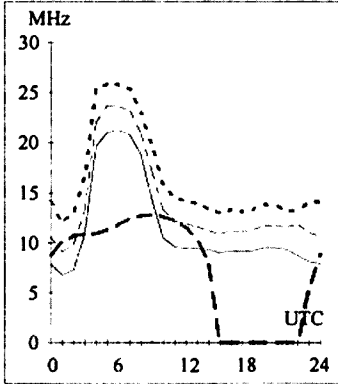
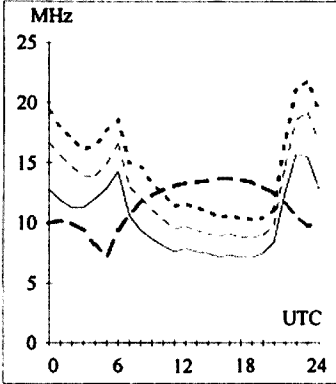
**Darwin-Tel Aviv 301**  
 Second 4F3-8 4E0 Short 11303 km



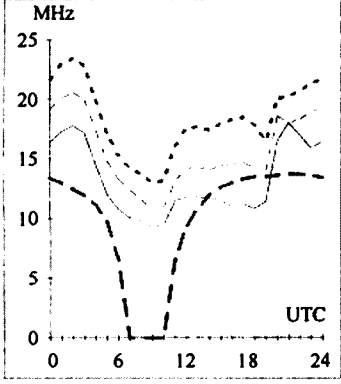
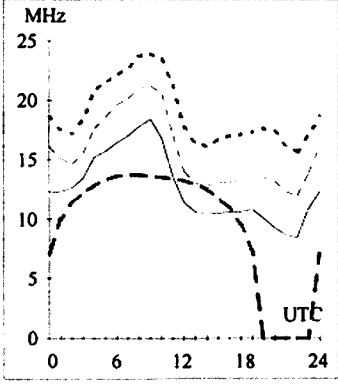
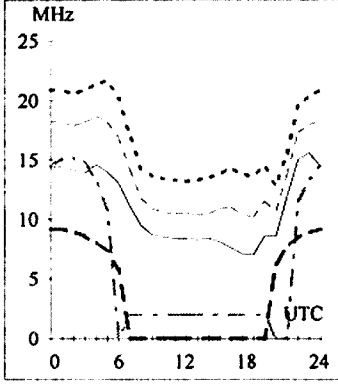
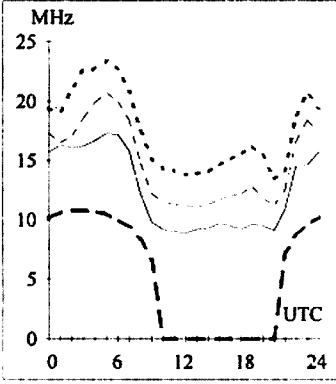
**Hobart-Dakar** 209 **Melbourne-Athens** 289 **Perth-Cairo** 298 **Sydney-Davao** 325  
 First F 0-5 Short 16556 km First F 0-5 Short 14950 km Second 4F3-7 4E0 Short 11263 km Second 3F11-14 3E1 Short 5289 km



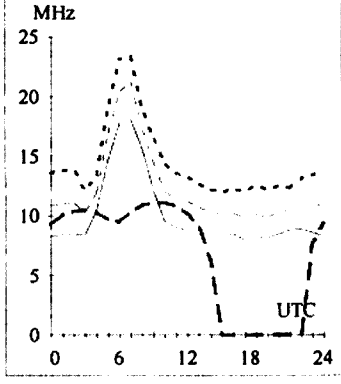
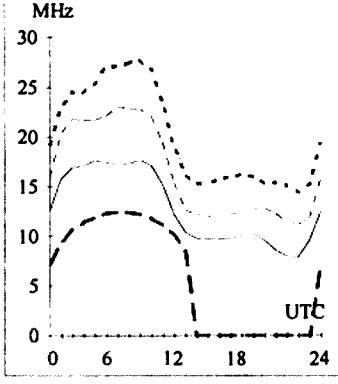
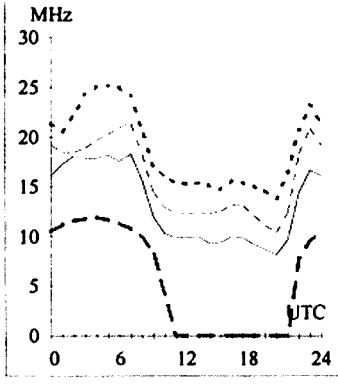
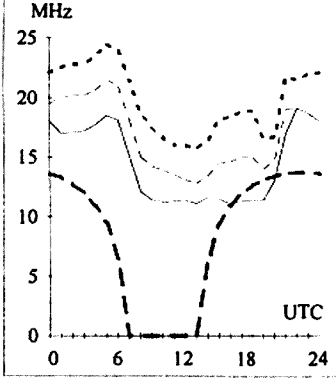
**Hobart-Berlin** 124 **Melbourne-Nairobi** 258 **Perth-London** 133 **Sydney-Miami** 86  
 First F 0-5 Short 23552 km Second 4F3-4 4E0 Short 11500 km First F 0-5 Long 25543 km First F 0-5 Short 15027 km



**Hobart-Osaka** 350 **Melbourne-Suva** 65 **Perth-London** 313 **Sydney-Ottawa** 58  
 Second 4F7-12 4E0 Short 8704 km Second 2F9-11 2E0 Short 3913 km First F 0-5 Short 14481 km First F 0-5 Short 15864 km



**Hobart-Vancouver** 49 **Melbourne-Taipei** 337 **Perth-New Delhi** 325 **Sydney-Pretoria** 230  
 First F 0-5 Short 13428 km Second 3F5-9 3E0 Short 7408 km Second 3F4-8 3E0 Short 7872 km Second 4F3-4 E0 Short 11063 km



# HAMADS

- Hamads may be submitted on the form on the reverse side of the *Amateur Radio* address flysheet. Please use your latest flysheet where possible.
- Please submit separate forms for **For Sale** and **Wanted** items, and be sure to include your name, address and telephone number (including STD code) if you do not use the form on the back of the *Amateur Radio* address flysheet.
- Eight lines (forty words) per issue free to all WIA members, ninth and tenth lines for name and address. Commercial rates apply for non-members.
- Deceased estates Hamads will be published in full, even if the ad is not fully radio equipment.
- WIA policy recommends that the serial number of all equipment offered for sale should be included in the Hamad.
- QTHR means the address is correct in the current WIA Call Book.
- Ordinary Hamads from members who are deemed to be in general electronics retail and wholesale distributive trades should be certified as referring only to private articles not being re-sold for merchandising purposes.
- Commercial advertising (Trade Hamads) are pre-payable at \$25.00 for four lines (twenty words), plus \$2.25 per line (or part thereof), with a minimum charge of \$25.00. Cheques are to be made out to: WIA Hamads.
- Copy should be typed or in block letters, and be received by the deadlines shown on page 1 of each issue of *Amateur Radio*, at:

Postal: 3 Tamar Court, Mentone VIC 3194  
Fax: (03) 9584 8928  
E-mail: vk3br@c031.aone.net.au

## TRADE ADS

- **AMIDON FERROMAGNETIC CORES:** For all RF applications. Send business size SASE for data/price to RJ & US Imports, PO Box 431, Kiama NSW 2533 (no enquiries at office please... 14 Boanyo Ave Kiama). Agencies at: Webb Electronics, Albury; Assoc TV Service, Hobart; Truscotts Electronic World, Melbourne and Mildura; Alpha Tango Products, Perth; Haven Electronics, Nowra; and WIA Equipment Supplies, Adelaide.
- **WEATHER FAX programs for IBM XT/ATs \*\*\*** "RADFAX2" \$35.00, is a high resolution shortwave weatherfax, Morse and RTTY receiving program. Suitable for CGA, EGA, VGA and Hercules cards (state which). Needs SSB HF radio and RADFAX decoder. \*\*\* "SATFAX" \$45.00, is a NOAA, Meteor and GMS weather satellite picture receiving program. Needs EGA or VGA & WEATHER FAX PC card, + 137 MHz Receiver. \*\*\* "MAXISAT" \$75.00 is similar to SATFAX but needs 2 MB of expanded memory (EMS 3.6 or 4.0) and 1024 x 768 SVGA card. All programs are on 5.25" or 3.5" disks (state which) plus documentation, add \$3.00 postage. ONLY from M Delahuntly, 42 Villiers St, New Farm QLD 4005. Ph 07 358 2785.
- **HAM LOG v.3.1** - Acclaimed internationally as the best IBM logging program. Review samples....AR: "Recommend it to anyone"; The Canadian Amateur: "Beyond this reviewer's ability to do it justice. I cannot find anything to improve on. A breakthrough of computer technology". ARA: "Brilliant". Simple to use with full help, the professional HAM LOG is immensely popular (now in its 5th year), with many useful, superb features. Just \$59 (+ \$5 P & P), with a 90 page manual. Special 5 hour Internet offer. Demos, brochures available. Robin Gandevia VK2VN 02 369 2008 BH fax 02 369 3069. Internet address rhg@ozemail.com.au.

## FOR SALE ACT

• **Hewlett Packard 410B** RF voltmeter to 700 MHz, \$125. **606A** signal generator to 65 MHz, \$475. **8900B** RF peak power meter to 2 GHz, \$465. **3476B** digital multimeter, portable, \$125. **5265A** digital voltmeter, plug-in, \$125. **HP5245** plug-in counter. Peter VK1CPK, 06 231 1790.

## FOR SALE NSW

- **Transmitting valves**, four only 805s, two only 813s, one only 5894. John VK2NDR, QTHR, 048 711 343.
- Estate late VK2VBG. **FT200**, s/n 351328, working, with homebrew PSU, manual and circuit; **Emtron EP2000** SWR meter, \$175 the lot, as is. VK2YO, QTHR, 066 742 095.
- **Log periodic beam**, all bands on HF, good condn, post COD anywhere, \$300 plus post. VK2EJV, 066 895 137 BH.
- **Yaesu FT-ONE** HF txcvr, s/n 1M010234, continuous coverage from 150 kHz to 30 MHz, complete with instruction and comprehensive workshop manuals, all options including FM, AM and CW keyer boards, FM, AM and CW (500 and 250 Hertz) filters, YM-35 dynamic and Shure 444 microphones, recently maintained by Agent DSE and little used since, \$1,000 cash. **Henry Tempo 50A10**, 144-148 MHz amplifier, s/n 34-2656, 10 W drive - 50 W output at 13.8 V, complete with manual, \$100. **Pakett 232**, PK-232 packet modem, s/n 8978, with all documentation, \$450. Transmitting valves, **Philips QQE06/40** at \$30, **QQE03/20** at \$20, brand new in original boxes. **AWA Voltomyst**, VTVM, s/n 368, as new condn in original box and complete with probe and manual, \$150. **Electro Parts Aust P/L VC-5**, 24 VDC to 12 VDC converter, 5 A continuous, 10 A peak at 13.6 V, \$50. Power supply, **Transwest MK IV**, s/n 2154, 13.8 V regulated at 6 A, 50% duty cycle, \$50. **DSE one Gigahertz frequency counter**, assembled

kit, works fine, \$150. **Yew photo tachometer model 2607**, s/n OJ2568, with instruction manual, in new condition in velvet lined case, \$150. All items available for inspection at QTHR. Cash only. Will deliver to Newcastle area but sorry will NOT pack and post. Les Baber VK2RJ, QTHR, 065 431 942, e-mail [lesbaber@aljan.com.au](mailto:lesbaber@aljan.com.au).

- **Paccom** pactor. **Altos 3068** computer, 4 Mb RAM, all manuals, software. **Hamtronics UHF Tx/Rx** converter. Homebrew 2 m power amp. Large aluminium loop antennas. **Sony ICF-2001** receiver. 40 m QRP rig. **Adrian VK2ALF**, QTHR, 064 525 555.
- **MFJ-748B** tuneable DSP filter, \$325. **VK2AYD**, QTHR, 065 85 2647.
- **572B/160TL** tubes, pair, new, made in USA by Cetron, suit **Yaesu FL2100B/Z** 1000 W amp, \$300 the pair. **Ted VK2EZQ/MM**, QTHR, 019 460 437 (leave message).

- Due to ill health I have dismantled my station and am selling all my equipment regardless of cost. Here is a chance of a bargain, so make me an offer! **Vintage book**, School Magnetism & Elec 1906 Ed; several old books on banking; **Radiotron** Amateur receiver; **Principles of Radar**; **Standard Handbook for Electrical Engineers** (7th Edition); **TH6DXX** 6 el Hy-gain ant; two **32 ft** lattice masts (one with pipe extension and rotator); five band **Hustler** vertical ant; **10 m** base station ant; **Novice** band vertical ant; **G-whip** mobile ant; **spring** mount for mobile ant; **magnetic** base for mobile ant; **30 m** unused **heavy duty** coax; **2** brand new **CV2245** power tubes, still in cartons; **two 572B** power tubes; **6 ft** steel **PMG-type** equipment rack; **Datong FL2** filter to reduce QRM (for CW & SSB); **Hi-Way** phone and mic headset, new dual floppy disk drive 5 1/4", **MK701** Hi-mount paddle key; code practice oscillator; **FT-ONE** txcvr in mint condn; **Tono 9000E** for CW and RTTY; variable DC PSU (0-20 V 200 mA); **Osker Block SWR** meter; **Heathkit VTVM** Model 1m-11; **Sony** desk mic and two h/held mics; **Hansen** multimeter Model FN. Offers and information Gordon VK2DGS, 02 9924 2052.

- Deceased estate of **VK2FFH**. **Kenwood TS-430S**, overhauled at Kenwood, with mic, manual, \$950. **Kenwood PS-430** PSU, \$300. **Kenwood SM-220** station monitor, \$200. **Kenwood TM-201A** 2 m txcvr, \$250. **Kenwood TR-8400** UHF txcvr, \$350. **Kenwood R-1000** comm receiver, \$250. **Alinco DR-110T** 2 m txcvr, \$250. **Azden PCS2000** 2 m txcvr, \$250. **John VK2FUR**, 046 251 812.

- **Yaesu FT-901D** txcvr, **YM-34** desk mic, service manual, \$550 ONO. **Yaesu FT-101ZD** txcvr, **YD-148** desk mic, \$550. **Yaesu FT-101E** txcvr, **YD-148** desk mic, \$500. **Yaesu FT-209RH** 2 m txcvr, car adapter, charger, speaker/mic, \$400. **Yaesu FV-901** scanning VFO, \$250. All items in VGC. **Peter VK2DBI**, QTHR, 063 675 095.

- 4 metre broadcast dish, two section, easy to transport, swap for amateur radio or ATV equipment. **Joe L21028**, 02 9608 1384.

## FOR SALE VIC

- **Kenwood TS-130V** (low power version of TS-130), 80 - 10 m (incl WARC bands) txcvr, IF shift, speech processor, CW filter, operating and workshop manuals, mic, DC cable, immaculate condn, \$400. **Reg VK3CCE**, QTHR, 03 9509 1471.

• **Kenwood TS-520S** HF txcvr, Kenwood **DG5** digital display, Kenwood **SP520** speaker, Kenwood **AT200** tuner, Kenwood **MC50** mike, \$750. Healesville ARC Inc. Contact Graeme **VK3CPT**, 03 5962 6098 (transmitting gear sold to licensed amateurs only).

• **Beam antenna, TET HB33M**, operating, \$300. **MD IB 8** microphone, as new, \$200. Peter Johnson **VK3AJP**, 03 9822 3783.

• **Icom IC-271H**, 2 m all mode base station, \$900. Bert **VK3DVF**, QTHR, 03 5221 6804.

• **Racal RA17L** communication Rx, excellent condn, no mods, with book and spare tubes, \$650. **Icom IC-2A**, VHF, with speaker mic, \$120. **BC312D** receiver, no PSU, has some mods, \$180. Peter **VK3IZ**, PO Box 212, Metung VIC 3904, 03 5156 2053.

• **Kenwood TL-922** linear amplifier, \$2250. Roy **VK3ARY**, QTHR, 03 9807 4798.

• **Kenwood TS-870** HF txcvr, s/n 80300020, with h/hold mic, in very good condn, \$3,100. **Kenwood PS-52 20 A** PSU, s/n 50700115, VGC, \$460. Jim **VK3NR**, QTHR, 03 9367 6920.

• **Kenwood TS-450SAT**, HF txcvr, auto ATU, speech board, in mint condn, little use, \$1350 ONO, or consider 440 trade-in. Graeme **VK3QS**, 03 9435 4336.

• **Yaesu FT-102** HF txcvr, 160 - 10 m plus WARC bands, CW, AM, SSB and FM, digital frequency display, excellent condn with copy of manual and hand mic, no mods, \$650. 2 m amplifier, FM/SSB, 12 V, in-built Tx/Rx switching and filters, UHF connectors, max input 5 W, output 25 W, large heat-sink, has been constructed from quality commercial kit, spare output transistor included, great for hand-helds and packet radio, \$100. Chris **VK3KCP**, 03 9629 2653.

• **Icom IC-271A** 2 m all mode base txcvr, complete with IC-PS25 internal 240 VAC power supply, MH-12 mic, manual, DC lead, VGC, s/n 2185, \$750. Brian **VK3KQB**, QTHR, 03 5453 1300.

• **Vibroplex iambic paddle**, good working condn, \$150. David **VK3DNG**, QTHR, 03 9859 4698.

• **MFJ-949** deluxe ATU, 300 W, in-built dummy load, 6 position antenna selector, 4:1 balun for balanced line and wire, crossed needle meter for forward/reflected power and SWR, as new condn with circuit and instructions, \$180. **Diamond GH62** vertical ant, single band 6 m, 6 dB, 200 W, full instructions, still in carton, mint condn, \$120. John **VK3CJA**, 03 5964 7520 (all hours).

• **New Penta 6146B** tubes, \$67.50 per pair. **HP Schottky diodes**, 5082-2800 series, matched pairs, \$2.80 per pair. John **VK3ATL**, 03 9481 6771.

• **Yaesu FT-290R II**, 2 m all mode txcvr, very good condn, carry case, original box, manuals, etc, \$500. **Philips FM-828s**, one each of VHF low, VHF, and UHF band radios, unmodified, \$50 each. Richard **VK3JFK**, 03 9693 4403 BH, 03 9354 8195 AH.

• **Icom IC-730** HF 100 W txcvr, 3.5 - 30 MHz incl WARC bands, SSB-AM-CW, twin VFO, mobile/home mic, manual, beaut condn, \$500. **Variac 0-280 V 2 A**, not perfect but good working order, \$5. **SWR/Pwr meter**, 50/70 ohm switch, two meters, illuminated, robust, \$10. Stan **VK3SZ**, QTHR, 03 9795 7848.

• **PK-232** multi mode data controller, s/n 14261, HF/VHF, with manual, no MBX, EC, \$275. **Himound HK-708** Morse key, EC, \$30. Bob **VK3CAY**, QTHR, 03 9398 2714.

• **Chirnside CE-35** five el tri-band antenna, \$250 (licensed amateurs only), 17 ft free standing aluminium tower, solid construction, \$150. Laurie **VK3DPD**, QTHR, 03 9818 6009.

• **Kenwood TS-700SP**, 2 m all mode txcvr, \$650 ONO. **Icom IC-730** HF txcvr, \$600 ONO. Damien **VK3RX**, 03 5427 3121.

• **Icom IC-725** HF txcvr, very good condn, \$995. Bill **VK3WK**, QTHR, 03 5561 1376.

• **Marconi TF144G/4** HF signal generator, working, battle-ship size, suit museum, \$200. **Ken KP-2022** 2 m 6 channel hand-held with crystals, \$50. **Icom IC-22S** 2 m mobile txcvr, \$150 ONO. Mike **VK3WW**, QTHR, 03 5433 3654.

• Deceased estate **VK3BHG**. Tower, self-supporting, 20 m triangular gal tubing, tilting top section, \$200. 75 ohm coax, 35 m, \$25. 75 ohm coax, 25 m, \$15. **Ernotator 502GAX** rotator, complete, \$250. **75/75 ohm balun**, \$20. 3/1 coax switch, \$40. **Sanyo VC700** security system, with intercom, monitor, cable and PSU, (2 only), \$250 each. **DSE Commander K6308** 2 m, \$150. **Roadsound 40 ch CB**, \$40. **GE 3-5105** cassette recorder, new, \$30. **Telesonic TE 225** video head tester, \$50. **UHF Yagi**, 18 el, \$200. **UHF Yagi**, 11 el, \$130. Keith **VK3AFI**, 03 5221 3658, or Ben, 03 5250 1605.

• **Regulated PSU**, fully protected and RF proof, 13.6 V 20 A continuous, tested at 25 A for 24 hours continuous, designed and built by **VK3AFQ**, only few hours use, \$325 ONO. Coax switch, five position, **Barker & Williamson USA**, \$30. Allan **VK3AMD**, QTHR, 03 9570 4610 any time.

#### FOR SALE QLD

• **Kenwood TS-530S**, s/n 1121004; **MFJ941** tuner; **Datong ASP: 2147/A SX3** preselector; **Archer low-pass filter**; **EP-2000** SWR meter; **MC50** mic; **EB31** rotator; **Tri-band dipole 20-15-10 m**; **Clipsal power filter**; etc. \$1100 the lot (licensed hams only). H Cox **VK4OX**, QTHR, 07 5497 5308.

• **Icom IC-275H**, VHF all mode txcvr, 100 W output, s/n 01918, near new condn, \$1500. **Yaesu FT-757GXH** HF txcvr, s/n R390286, excellent condn, \$800. **Goldstar oscilloscope**, 40 MHz, dual channel, s/n 9010560, near new condn, \$750. **VK4PO**, QTHR, 07 3408 6005.

• **Massive shack clearance!** Complete radio collection must go. 1000s of components, old and new. 100s of valves. Transmitters, receivers, ex-military, many in working order. Collectors send for complete lists (SAE) to **VK4DIT**, Box 6620, **GCMC QLD 4217**. Request list from [harvest@technet2000.com.au](mailto:harvest@technet2000.com.au) Visitors welcome, phone 018 752 467.

• **Drake's cyclopedia**, 1993 edition, covers frayed otherwise good condn, \$35. Peter **VK4APD**, QTHR, 07 3397 3751 AH.

• **Alinco DJ-GIT/G1E** VHF/FM hand-held txcvr, complete with extras, s/n TOC4261, as new, \$390. **Digitor D-2150** 2 m RF power amplifier, as new \$90. **Revex W540** SWR and power meter, 140-525 MHz, as new, \$90. Kevin **VK4MAA**, QTHR, 07 5446 3492.

#### FOR SALE SA

• **Yaesu FT-102** HF Txcvr, s/n 21030938. **FC-102** 1.2 kW ATU, s/n 21010284. **FT-707** HF txcvr, s/n OK101217. **FV-107** ext VFO, s/n 3F040334. **YD-148** desk mic, plus other bits and pieces. Phone for details. Can deliver anywhere in Australia or New Zealand. David **VK5AXW**, QTHR, 08 8370 1066 BH, 08 8370 9569 AH.

• **Kenwood TS-850SAT**, s/n 30801036, HF all bands/modes txcvr, general coverage Rx, auto ATU, complete with all optional xtal filters and matching **Kenwood PS-52** heavy duty PSU (s/n 30800299), including **MC60** desk microphone, **SP-31** speaker unit, and users handbook, little used, \$3,200. Dave **VK5NU**, QTHR, 018 811 070.

• **Yaesu FNB-14 7.2 V** 1000 mAh battery pack, new, never used, \$50. **FNB-II** 12 V 600 mAh battery pack, \$40. These suit FT-411 series, FT-23R series, FT-470, etc. **Dick Smith 27/28 MHz SWR/Field Strength Meter**, \$10. John **VK5KBE**, 08 8250 7259.

#### FOR SALE TAS

• **Kenwood TS-690SAT** txcvr, \$2000 ONO.

**Kenwood SP-23** ext spkr, \$80 ONO. **Kenwood PS-51** PSU, \$300 ONO. **Kenwood MB-430** mobile mount, \$30. **Icom FL102** AM filter, suit IC-760, 761, 765, 575, new, \$65. All above as new with manuals, boxes, etc. On behalf of **VK7ZA**, contact Al **VK7AN**, 03 6327 1171, mobile 0417 354 410.

• **Estate VK7WA**. **Kenwood TS-530S**, s/n 2040385; **Yaesu FT-77**, s/n 2N010082; **Yaesu FT-102**, s/n 2H010857; **Yaesu FT-200** txcvr, s/n 349385; **KDK 2 m** txcvr, s/n 003404; **Kenwood all mode 2 m** txcvr, s/n 5110105; **HF helical mobile whips**; **Datong RF** auto speech processor; **MFJ RF** noise bridge; **Electro-voice 638** dynamic mic; many valves, new. K A Hancock **VK7KH**, QTHR, 03 6431 2164.

#### WANTED NSW

• **Morse keys** and Australian semi-autos, especially **AutoMorse**, **Buzza 100** and **MacDonald Pendograph** (vertical bugs), pay top dollar for good condn keys. Steve **VK2SPS**, 02 9999 2933 after 6 pm.

• **Antennas: GAP Voyager**; 3 el 40 m **Yagi**, either **KLM**, **Hygain** or **Cushcraft**; base and chimney for 4-1000 valve; **SSB Electronics UEK2000S** converter; **Collins 51S-1** receiver; **Drake PS-7** PSU, **Ham-M** antenna rotator. Tom **VK2OE**, 046 461 024 evenings.

#### WANTED VIC

• **Tower sections**, approx 5 m, aluminium or steel (no rust), to build a small tower. Graeme **VK3QS**, 03 9435 4336.

• **Sat Track 4 track box kit**, or complete. Max Brighton **VK3ZMT**, 03 5023 2504, [vk3zmt@mildura.net.au](mailto:vk3zmt@mildura.net.au)

• **Dynamotor DM33**, used with modulator **BC-456** in Command Tx. Also modulator **BC-456** and Tx rack. **Tuning shafts** with spline for command Rx. Two only **12J5** valves, and any **SCR-274N** assemblies (Command). **Handbooks** for **AN/GRC-27** UHF Tx/Rx as used by **RAAF**. Peter **VK3IZ**, PO Box 212, Metung VIC 3904, 03 5156 2053.

• **Dud Yaesu FNB-4** battery pack, housing must be in good condn, reasonable price paid, John **VK3ATL**, 03 9481 6771.

• **Travelling wave tube RF power amplifiers**, **HP**, **Varian**, **Hughes**, etc to cover part or all of the range 1 - 18 GHz, power levels of 10 W or greater preferred, but all options will be considered. Eric **VK3AX**, 03 9762 6733 BH, 03 5968 4202 AH.

#### WANTED QLD

• **Circuit or workshop manual for Codan txcvr Type 6801 Mk2**. Please send details of cost and other expenses to Bert **VK4AO**, 41 Spenser Street, Iluka NSW 2466.

• **RCA receiving tube manual RC-28** 1971/2. **Tetrode Tx tubes** 4-400, 4-1000, QY5-500, etc. Peter **VK4APD**, QTHR, 07 3397 3751 AH.

• **Icom IC-2SR** 2 m hand-held txcvr and scanner. P Renton **VK4PV**, QTHR, 077 721 236 AH, 077 815 123 BH.

#### WANTED SA

• **Case for R-5223 Rx** made by TCA 1965, approx 410 mm W x 270 mm D x 215 mm H, with 24 holes for screws. **Circuit for Gonset GSB-100 Tx**. **Radio and Hobbies** October 1952, January 1943, May 1944; have various issues for swap. Andy **VK5AAQ**, phone/fax 08 8322 1010.

• **Fukiyama Multi 800D** 2 m mobile FM txcvr, in any condn, 25 W, 800 channels, **FDK-Multi**. Mervyn **VK5MX**, QTHR, 08 8346 7042.

#### MISCELLANEOUS

• **THE WIA QSL Collection** (now Federal) requires **QSLs**. All types welcome especially rare **DX** pictorial cards special issue. Please contact Hon Curator **Ken Matchett VK3TL**, 4 Sunrise Hill Road, Montrose Vic 3765, Tel 03 9728 5350.

# WIA Divisions

The WIA consists of seven autonomous State Divisions. Each member of the WIA is a member of a Division, usually in their residential State or Territory, and each Division looks after amateur radio affairs within its area.

Division	Address	Officers	Call Sign	Weekly News Broadcasts	1997 Fees
VK1	ACT Division GPO Box 600 Canberra ACT 2601	President Hugh Blemings Secretary John Woolner Treasurer Les Davey	VK1YYZ VK1ET VK1LD	3.570 MHz LSB, 146.950 MHz FM each Sunday evening commencing at 8.00 pm local time. The broadcast text is available on packet, on Internet <a href="mailto:aus.radio.amateur.misc">aus.radio.amateur.misc</a> newsgroup, and on the VK1 Home Page <a href="http://email.nla.gov.au/~cmakin/wiaact.html">http://email.nla.gov.au/~cmakin/wiaact.html</a> From VK2WI 1.845, 3.595, 7.146*, 10.125, 14.160, 24.950, 28.320, 29.120, 52.120, 52.525, 144.150, 147.000, 438.525, 1281.750 (* morning only) with relays to some of 18.120, 21.170, 584.750 ATV sound. Many country regions relay on 2 m or 70 cm repeaters. Sunday 1000 and 1930. Highlights included in VK2AWX Newcastle news, Monday 1930 on 3.593 plus 10 m, 2 m, 70 cm, 23 cm. The broadcast text is available on the Internet newsgroup <a href="mailto:aus.radio.amateur.misc">aus.radio.amateur.misc</a> , and on packet radio.	(F) \$72.00 (G) (S) \$58.00 (X) \$44.00
VK2	NSW Division 109 Wigram St Parramatta NSW (PO Box 1066 Parramatta 2124) Phone 02 9689 2417 Freecall 1800 817 644 Fax 02 9633 1525	President Geoff McGrorey-Clark Secretary Eric Fossey Treasurer Eric Van De Weyer (Office hours Mon-Fri 11.00-14.00)  Web: <a href="http://marconi.mpce.mq.edu.au/wia">http://marconi.mpce.mq.edu.au/wia</a> e-mail address: <a href="mailto:wiansw@sydney.dialix.oz.au">wiansw@sydney.dialix.oz.au</a> Packet BBS: VK2WI on 144.850 MHz	VK2EO VK2EFY VK2KUR	VK3BWI broadcasts on the 1st Sunday of the month, starts 10.30 am. Primary frequencies 1.840 AM, 3.615 LSB, 7.085 LSB, and FM(R)s 146.700 Mt Dandenong, 147.250 Mt Macedon, 147.225 Mt Baw Baw, and 2 m FM(R)s VK3RMA, VK3RSH and VK3ROW. 70 cm FM(R)s VK3ROU and VK3RGL. Major news under call VK3WI on Victorian packet BBS. 1.825 MHz SSB, 3.605 MHz SSB, 7.118 MHz SSB, 14.342 MHz SSB, 28.400 MHz SSB, 29.220 MHz FM, 52.525 MHz FM, 146.700 MHz FM, 147.000 MHz FM, 438.525 MHz (Brisbane only), regional VHF/UHF repeaters at 0900 hrs Sunday. Repeated on 3.605 MHz SSB & 147.000 MHz FM, regional VHF/UHF repeaters at 1930 hrs EAST Monday. Broadcast news in text form on packet under <a href="mailto:WIAQ@VKNET">WIAQ@VKNET</a> .	(F) \$66.75 (G) (S) \$53.40 (X) \$38.75
VK3	Victorian Division 40G Victory Boulevard Ashburton VIC 3147 Phone 03 9885 9261 Fax 03 9885 9298	President Jim Linton Secretary Barry Wilton Treasurer Rob Hailey (Office hours Tue & Thur 0830-1530)	VK3PC VK3XV VK3NC	1827 kHz AM, 3.550 MHz LSB, 7.095 AM, 14.175 USB, 28.470 USB, 53.100 FM, 147.000 FM Adelaide, 146.700 FM Mid North, 146.800 FM Mildura, 146.825 FM Barossa Valley, 146.900 FM South East, 146.925 FM Central North, 147.825 FM Gawler, 438.425 FM Barossa Valley, 438.475 FM Adelaide North, ATV Ch 35 579.250 Adelaide. (NT) 3.555 USB, 7.065 USB, 10.125 USB, 146.700 FM, 0900 hrs Sunday 3.585 MHz and 146.675 MHz FM Adelaide, 1930 hrs Monday.	(F) \$75.00 (G) (S) \$61.00 (X) \$47.00
VK4	Queensland Division GPO Box 638 Brisbane QLD 4001 Phone 074 96 4714	President Rodger Bingham Secretary Malcolm McIntosh Treasurer Bill Sebbens e-mail address: <a href="mailto:wiaq@tmxbris.mhs.oz.au">wiaq@tmxbris.mhs.oz.au</a>	VK4HD VK4ZMM VK4XZ	146.700 FM(R) Perth, at 0930 hrs Sunday, relayed on 1.825, 3.560, 7.075, 14.116, 14.175, 21.185, 29.680 FM, 50.150 and 438.525 MHz. Country relays 3.582, 147.350(R) Busselton and 146.900(R) Mt William (Bunbury). Broadcast repeated on 146.700 at 1900 hrs Sunday, relayed on 1.865, 3.563 and 438.525 MHz; country relays on 146.350 and 146.900 MHz.	(F) \$74.00 (G) (S) \$60.00 (X) \$46.00
VK5	South Australian Division 34 West Thebarton Rd Thebarton SA 5031 (GPO Box 1234 Adelaide SA 5001) Phone 08 8352 3428 Fax 08 8264 0463	President Ian Hunt Secretary Graham Wiseman Treasurer Joe Burford  Web: <a href="http://www.vk5wia.ampr.org/">http://www.vk5wia.ampr.org/</a>	VK5QX VK5EU VK5UJ	146.700 MHz FM (VK7RHT) at 0930 hrs Sunday relayed on 147.000 (VK7RAA), 146.725 (VK7RNE), 146.625 (VK7RMD), 3.570, 7.090, 14.130, 52.100, 144.150 (Hobart) Repeated Tues 3.590 at 1930 hrs.	(F) \$75.00 (G) (S) \$61.00 (X) \$47.00
VK6	West Australian Division PO Box 10 West Perth WA 6872 Phone 09 351 8873	President Wally Howse Secretary Christine Bastin Treasurer Bruce Hedland-Thomas	VK6KZ VK6ZLZ VK6OO	Membership Grades Full (F) Pension (G) Needy (G) Student (S) Non receipt of AR (X)	(F) \$62.00 (G) (S) \$50.00 (X) \$34.00
VK7	Tasmanian Division PO Box 271 Riverside TAS 7250 Phone 03 6327 2096 Fax 03 6327 1738	President Ron Churcher Secretary Barry Hill Treasurer Mike Jenner	VK7RN VK7BE VK7FB	Three-year membership available to (F) (G) (X) grades at fee x 3 times	(F) \$74.00 (G) (S) \$60.00 (X) \$46.00
VK8	(Northern Territory is part of the VK5 Division and relays broadcasts from VK5 as shown received on 14 or 28 MHz).				

Note: All times are local. All frequencies MHz.

## ADVERTISERS' INDEX

Andrews Communication Systems	20	Terlin Aerials	_____17
Australian Electric Valve	_____4	WIA Recruitment	_____15
ATN Antennas	_____34	WIA Membership Retention	_____5
Daycom	_____IFC		
Dick Smith Electronics	___28, 29, IBC	Trade Hamads	
ICOM	_____OBC, 32	M Delahunty	_____54
Interproducts	_____22	RJ & US Imports	_____54
Radio and Communications	_____11	HAMLOG - VK2VN	_____54

### TRADE PRACTICES ACT

It is impossible for us to ensure the advertisements submitted for publication comply with the Trade Practices Act 1974. Therefore, advertisers and advertising agents will appreciate the absolute need for themselves to ensure that the provisions of the Act are complied with strictly.

### VICTORIAN CONSUMER AFFAIRS ACT

All advertisers are advised that advertisements containing only a PO Box number as the address cannot be accepted without the addition of the business address of the box-holder or seller of the goods.

# Tough, Compact, Economical

## Yaesu FT-50R 2m/70cm Handheld

For the foremost in top performing, durable, and economical dualband handhelds, there's now only one choice, Yaesu's amazing new FT-50R!

Manufactured to rigid commercial grade standards, the FT-50R provides 2m and 70cm band transceive coverage plus an amazingly wide receiver range (76-200, 300-540, 590-999MHz\*), all in a compact package with water resistant construction that's tough enough to meet the USA MIL-STD-810 rating for shock and vibration resistance, yet is easy to hold and use.

Measuring just 57 x 99 x 30mm (WHD) with the supplied FNB-40 650mA/H Nicad pack, the FT-50R provides 2.0w RF output on the 2m and 70cm bands as standard, and can provide up to 5.0w output when operated from a 12v source (optional Nicad battery or vehicle lead). It also provides 112 memory channels including two Home memories, an Alphanumeric display for channel naming (ie. repeater locations or callsigns) with Omni-glow backlighting, and CTCSS encode for accessing repeaters that require a tone input. Selectable AM/FM receive modes allow for greater flexibility during extended receive operation.

For ease of use, the FT-50R provides super loud speaker output, an Auto Range Transpond System to determine if you are in range of another ARTS equipped transceiver, a Dual-watch system for monitoring sub-band activity, and four Battery saver systems for longer operating times. A selectable LCD voltmeter also allows you to monitor battery performance under load so you can estimate remaining battery life. You can also use the FT-50R with the optional ADMS-1C Windows based PC software/interface to quickly program features or clone programming to other compatible Yaesu radios.

The FT-50R is tough, easy to use, and one of the most economical dualband handhelds you can buy. There's now only one choice, the FT-50R from Yaesu.

(\* Cellular blocked)

D-3660



*Limited stocks of the earlier version, with standard keypad, are still available.  
D-3655 \$499*

# \$599

## 2 year warranty



# DICK SMITH ELECTRONICS



**NEW  
MODEL**

Now with FT-12 keypad  
for digital voice recording,  
DTMF paging, and  
CTCSS decode.

Serious Performance For Every Amateur

**ICOM**  
Clearly Ahead

**THE ICOM AMATEUR RANGE** Delivering true professional features and performance to the world of amateur radio... that's what keeps Icom clearly ahead. From our dual band handheld IC-77A, with amazing performance from such a small package... to our all mode transceivers led by the flagship of the range, the IC-756, with its array of features such as multi-function full dot LCD, and newly designed IF DSP. With Icom performance we'll take your operating experience to remarkable new levels.



For more information see your nearest Icom Dealer, or call free on 1800 338 915, or write to: Icom Australia Pty. Ltd. 290-294 Albert Street, Brunswick, Victoria 3056. Ph (03) 9387 0666 Fax (03) 9387 0022 A.C.N. 006 092 575

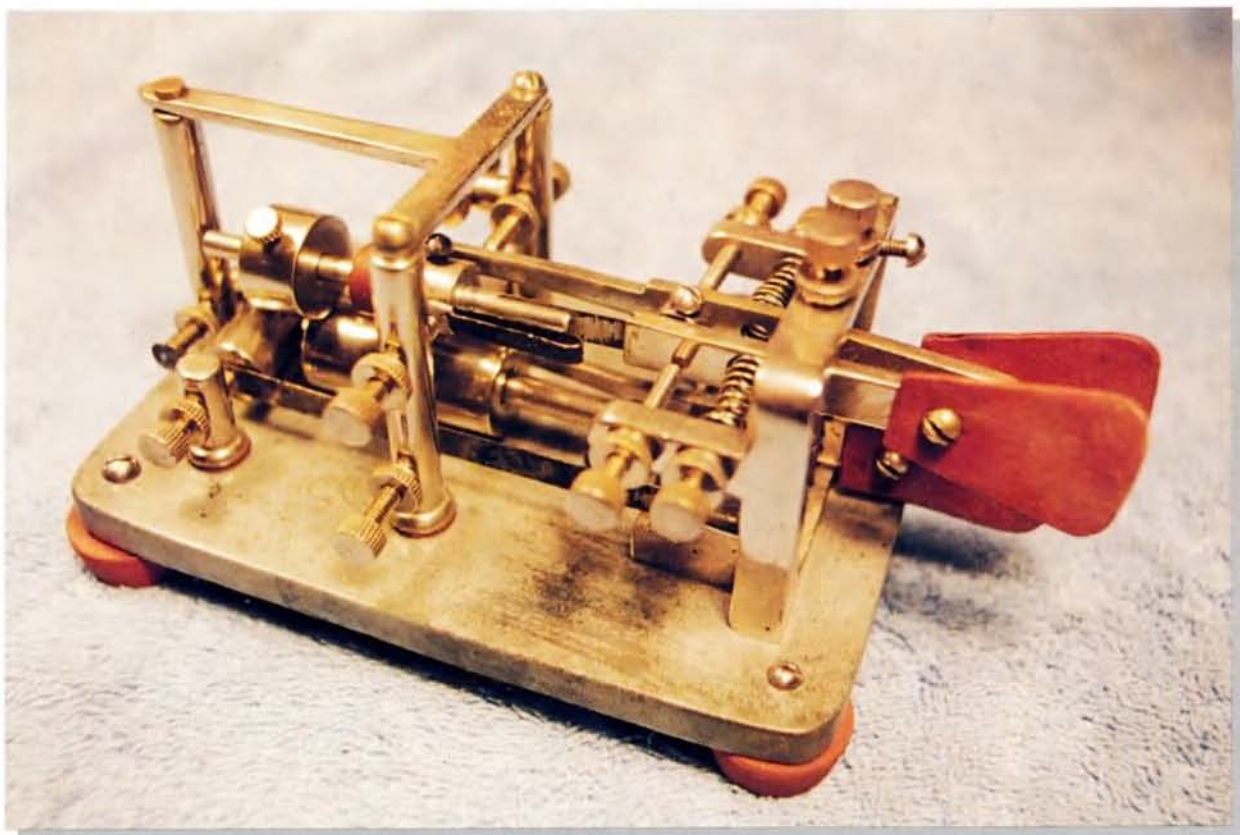


# Amateur Radio

July 1997  
Volume 65 No 7



*Journal of the Wireless Institute of Australia*



*Full of the latest amateur radio news, information and technical articles including...*

- **A Baycom Style HF PSK Modem**
- **Review of Yaesu's FT-8000R Dual Band Transceiver**
- **The Semi-Elevated Ground Plane - GIRFU Style**

**Plus** *lots of other articles, news and special interest columns*



### IC-756 HF + 6m 100W, auto-ATU, DSP

If you missed our Icom Day at the end of November you missed the opportunity to see the all new IC-756. It was pretty hard to see anyway with the crowd always around it!

- All bands 160-6 metres
- 100W output on all bands
- Auto ATU works on all bands
- Dual watch receivers
- Spectrum Scope (just like the IC-781!)
- Dual Pass-Band Tuning
- Adjustable threshold DSP noise reduction
- Audio Peaking Filter
- Automatic Notch filter
- Built-in CW memory keyer
- 100 alphanumeric memories

Some of the reactions: "how much will you give me for my FT-1000 as a trade-in?", "Probably the most innovative radio since the IC781 hit the market!", "This is really a radio for all reasons, easy to use but with all the features a contestor or DXer needs."

In stock now, call to secure yours:

## \$3400

### R8500 HF/VHF/UHF receiver



The Icom R-8500 receiver is here now! It covers 100kHz to 2000MHz (no breaks) has 1000 memories and a host of features you wouldn't think possible at just \$3750. Get the full story, call for a brochure or look on the WEB at <http://www.daycom.com.au/>

## \$3100

### MFJ Antenna Tuners

MFJ901B	200W Versatuner	\$149
MFJ910	Mobile antenna matcher	\$45
MFJ921	2 mtr 300W tuner	\$155
MFJ924	70 cm 300W tuner	\$155
MFJ931	Artificial ground tuner	\$169
MFJ941E	300W compact GP tuner	\$230
MFJ945E	300W mobile tuner	\$209
MFJ948	Deluxe 300W (no D/L)	\$270
MFJ949E	Deluxe 300W	\$299
MFJ962C	1.5kW tapped inductor	\$525
MFJ969	300W Roller inductor <b>NEW</b>	\$360
MFJ971	200W Portable tuner	\$190



MFJ986	3kW Diff-T roller inductor	\$629
MFJ989C	3kW Deluxe roller inductor	\$735

### NEW IC-207H

Twin band mobile with remote mount front panel & 9600 baud packet operation

## \$799



### HAMCALL 1997

Our most popular callbook CD-ROM with Windows, DOS and MAC search engines. This is the new April 1997 edition, just out!

## \$75

# hy-gain

## HyGain DX77

### Advanced Vertical Windom

- 7 Band Vertical
- 10-12-15-17-20-30-40 metres
- No ground radials required
- Tilt mount
- Height: 29 feet
- Power: 1.5kW
- Industrial grade construction
- Bandwidth (<2:1 SWR)
  - 10 metres 1.7MHz
  - 12 metres 100kHz
  - 15 metres 500kHz
  - 17 metres 100kHz
  - 20 metres 250kHz
  - 30 metres 100kHz
  - 40 metres 150kHz



Daycom and HyGain introduce the DX77 Advanced vertical Windom with features surpassing any HF vertical on the market. The superior mechanical design, high power capability and 55% greater bandwidth than competitive verticals on 20 and 40 metres make it an exceptional value for a high performance system.

The unique design of this vertical antenna provides a no compromise performance without the need for ground radial wires. It puts the world at your fingertips on the HF ham bands, 10 through 40 metres, including the WARC bands! Capable of handling 750W average or 1500W PEP the HyGain DX77 won't balk at the output of your linear! Automatic band-switching and low angle of radiation allow for enhanced DX performance.

in stock now at

## \$875

# OPTOELECTRONICS XPLORER Test Receiver

All the information, in one hand!

In one convenient handful the amazing new Optoelectronics XPLORER Test Receiver not only finds signals for you, but it will tell you frequency and deviation as well as decoding sub-audible and DTMF tones. Sweeping the range 30 to 2000MHz in less than 1 second the Xplorer will lock on to any signal in the nearfield and demodulate the FM audio for monitoring. You also see frequency on the LCD display along with other information about the signal.

- Frequency range: 30MHz - 2GHz
- FM Deviation range: 100kHz
- Audio frequency response: 50 - 3000Hz
- Auto sweep time: <1 second 30-2000MHz
- Internal speaker, headphone jack, tape control jack, serial interface connector, rotary encoder & flexible push button panel.
- Easy to read LCD display with EL backlighting
- Internal 7.2V 850mAh NiCd battery
- Rapid charging (<1hr) with intelligent charging controller
- NMEA-0183 interface for GPS receiver

XPLORER Test Receiver **\$1700**

# TKIT

The NEW Heathkit!



Help reclaim this fascinating band! Six metres is the VHF DX band and even now offers regular overseas contacts with just a little effort. The TT1208 kit is the ideal, low cost way, to get going on 6 metres and find out what only the elite have known for years!

- Requires 3-5W input on 20 metres
- Extremely simple hookup and operation
- Sensitive, low noise 50-54MHz front end
- Fast, silent PIN diode TR switch for QSK & data
- 8W output on 6 metres
- Requires 12-15V DC 3A power supply
- Simple switching between HF and 6 metres
- Rugged steel case

TT1208 8W 6 metre transverter **\$199**



Amateur Radio is published by the Wireless Institute of Australia, ACN 004 920 745 as its Official Journal, on the last Friday of each month.

### Editorial

#### Editor

Bill Rice VK3ABP\*

#### Production Manager

Bill Roper VK3BR

#### Senior Technical Editor

Peter Gibson VK3AZL\*

#### Technical Editors

Evan Jarman VK3ANI\*

Gil Sones VK3AUI\*

Don Graham VK6HK

Contributing Editor

Ron Fisher VK3OM\*

Don Jackson VK3DBB\*

#### WIA News Editor

Roger Harrison VK2ZRH

#### Proof Readers

Allan Doble VK3AMD

Jim Payne VK3AZT

Graham Thornton VK3IY

John Tutton VK3ZC

\*Publications Committee member

### Production

#### Administration, Advertising, Drafting, Production

Vk3br Communications Pty Ltd

3 Tamar Court, Mentone VIC 3194

#### Typesetting and Printing

Industrial Printing and Publishing Pty Ltd

122 Dover Street, Richmond, VIC 3121.

#### Mail Distribution

Mail Management Australia Pty Ltd

6 Garden Boulevard, Dingley VIC 3172

#### Now Advertising

Eyvonne & Keith Tootell

Union Publicity Service Pty Ltd

PO Box 282, Toongabbie NSW 2146

Telephone: 1800 654 181 - 02 9831 1299

Fax: 02 9831 6161

#### Amateur Radio Correspondence

All contributions, correspondence, Hamads

and queries concerning the content of

Amateur Radio should be sent to:

Amateur Radio

Vk3br Communications Pty Ltd

3 Tamar Court, Mentone VIC 3194

E-mail: vk3br@c031.aone.net.au

Phone and Fax: 03 9584 8928

Mobile: 0418 534 168

Business Hours: 9.30 am to 3.00 pm weekdays

#### Amateur Radio Delivery

All correspondence and queries

concerning the delivery of

Amateur Radio should be sent to:

Amateur Radio

WIA Federal Office

PO Box 2175

Caulfield Junction VIC 3161

#### Registered Office:

3/105 Hawthorn Road

Caulfield North VIC 3161

Telephone: 03 9528 5962

Fax: 03 9523 8191

Business Hours: 9.30 am to 3.00 pm weekdays

#### Editorial and Hamads Deadlines

August 07/07/97

September 11/08/97

October 08/09/97

#### Receipt of Amateur Radio by Mail

The August issue will be delivered to Australia Post

on Tuesday, 29 August 1997 for mailing to members.

If this magazine is not received by the 15th of the

month of issue, and you are a financial member of

the WIA, please check with the Post Office before

contacting the registered office of the WIA.©

© Wireless Institute of Australia 1997

### CONTENTS

#### Technical

A Baycom Style HF PSK Modem \_\_\_\_\_ 6

*Alan Cox VK4AOC*

Equipment Review - Yaesu FT-8000R Dual Band Mobile Transceiver \_\_\_\_\_ 10

*Ron Fisher VK3OM*

The Semi-Elevated Ground Plane - GIRFU Style \_\_\_\_\_ 13

*W A McLeod VK3MI*

10 MHz Modification for Flash PAD207 TNC \_\_\_\_\_ 16

*Ron Graham VK4BRG*

Technical Abstracts \_\_\_\_\_ 18

*Gil Sones VK3AUI*

Random Radiators \_\_\_\_\_ 21

*Ron Cook VK3AFW and Ron Fisher VK3OM*

#### General

UHF/Microwave Activity in Australia \_\_\_\_\_ 24

*Dr Walter J Howse VK6KZ*

Book Review - The CB PLL Data Book \_\_\_\_\_ 31

*Peter Parker VK1PK*

#### Columns

Advertisers' Index \_\_\_\_\_ 56

ALARA \_\_\_\_\_ 32

AMSAT Australia \_\_\_\_\_ 33

Awards \_\_\_\_\_ 35

Club Corner \_\_\_\_\_ 34

Contests \_\_\_\_\_ 36

#### Divisional Notes

VK1 Notes \_\_\_\_\_ 39

VK2 Notes \_\_\_\_\_ 39

VK3 Notes \_\_\_\_\_ 39

VK5 Notes \_\_\_\_\_ 40

VK7 Notes \_\_\_\_\_ 41

Editor's Comment \_\_\_\_\_ 2

Hamads \_\_\_\_\_ 54

HF Predictions \_\_\_\_\_ 52

How's DX? \_\_\_\_\_ 42

Intruder Watch \_\_\_\_\_ 46

Morse Practice Transmissions \_\_\_\_\_ 47

Over To You \_\_\_\_\_ 45

Pounding Brass \_\_\_\_\_ 46

QSP News \_\_\_\_\_ 32

Repeater Link \_\_\_\_\_ 47

Silent Keys \_\_\_\_\_ 55

Spotlight on SWLing \_\_\_\_\_ 48

Update \_\_\_\_\_ 45

VHF/UHF - An Expanding World \_\_\_\_\_ 49

WIA News \_\_\_\_\_ 3, 15, 17, 20, 23

WIA - Divisional Directory \_\_\_\_\_ 56

WIA - Federal Directory \_\_\_\_\_ 2

#### Cover

An M P Thomas Auto Morse Key, made by Hitchcox Brothers, Adelaide. This is one of the keys in the collection of Stephen Smith VK2SPS. Others are shown in the *Pounding Brass* column on page 46.

#### BACK ISSUES

Available direct from the WIA Federal Office, only until stocks are exhausted, at \$4.00 each (including postage within Australia) to members.

#### PHOTOSTAT COPIES

When back issues are no longer available, photocopies of articles are available to members at \$2.50 each (plus \$2.00 for each additional issue in which the article appears).

The opinions expressed in this publication do not necessarily reflect the official view of the WIA, and the WIA cannot be held responsible for incorrect information published.

## Amateur Radio Service

A radiocommunication service for the purpose of self-training, intercommunication and technical investigation carried out by amateurs, that is, by duly authorised persons interested in radio technique solely with a personal aim and without pecuniary interest.

## Wireless Institute of Australia

The world's first and oldest National Radio Society  
Founded 1910

Representing the Australian Amateur Radio Service -  
Member of the International Amateur Radio Union  
Registered Federal office of the WIA:  
3/105 Hawthorn Rd, Caulfield North, Vic 3161

All Mail to:

PO Box 2175, Caulfield Junction, VIC 3161  
Telephone: 03 9528 5962 Fax: 03 9523 8191

Business Hours: 9.30 am to 3.00 pm on weekdays

Federal Secretary  
Peter Naish VK2BPN

### FEDERAL OFFICE STAFF

June Fox	Book Keeper
Debby Johnston	Membership Secretary
Rita Trebilco VK3NRT	Examinations Officer

### COUNCIL

President	Neil Penfold	VK6NE
VK1 Federal Councillor	Richard Jenkins	VK1RJ
VK2 Federal Councillor	Michael Corbin	VK2YC
VK3 Federal Councillor	Brenda Edmonds	VK3KT
VK4 Federal Councillor	Ross Marren	VK4AMJ
VK5 Federal Councillor	Ian Watson	VK5KIA
VK6 Federal Councillor	Wally Howse	VK6KZ
VK7 Federal Councillor	Andrew Dixon	VK7GL

### EXECUTIVE

Peter Naish	VK2BPN
Rowland Bruce	VK5OU
Neil Penfold	VK6NE

### FEDERAL CO-ORDINATORS

AMSAT:	Graham Ratcliff	VK5AGR
Awards:	John Kelleher	VK3DP
Contests:	Peter Nesbit	VK3APN
Education:	Brenda Edmonds	VK3KT
EMC and Standards	Roger Harrison	VK2ZRH
FTAC:	John Martin	VK3KWA
Historian:	John Edmonds	VK3AFU
IARU:	David Wardlaw	VK3ADW
Int'l Travel Host Exch:	Ash Nallawalla	VK3CIT
Int'l Beacon Co-ord:	Roger Harrison	VK2ZRH
Intruder Watch:	Gordon Loveday	VK4KAL

ITU Conference and Study Group:	David Wardlaw	VK3ADW
Media:	Roger Harrison	VK2ZRH
QSL Manager (VK9,VK0):	Neil Penfold	VK6NE
Radio Sports:	Wally Watkins	VK4DO
Videotapes:	Bob Godfrey	VK4BOB
WICEN:		

### SMA LIAISON TEAM

Roger Harrison	VK2ZRH
David Wardlaw	VK3ADW
Neil Penfold	VK6NE

## Editor's Comment

### "United" States?

The title does not refer to America, but to our own Commonwealth, which has never claimed to consist of particularly "united" states anyway! However, it seems that the things that divide us are rather less important than the things that unite us. Originally there was even a possibility of New Zealand being part of the Federation, but not only did this not happen, but it was "touch and go" for a while whether Western Australia was going to join.

Nevertheless, Federation arrived on 1 January 1901, and the then six states agreed to hand over some of their responsibilities to the new Federal Government (at that time, the Northern Territory was part of South Australia). Relations between the States have had occasional rough spots since, but have generally displayed friendly rivalry at worst, and sometimes even total agreement.

A few years later, in 1910, the Wireless Institute of New South Wales came into being, with similar organisations in the other States joining in, so that by 1923 there was a Wireless Institute of Australia uniting the six Divisions.

In 1972 a further act of federation brought the now seven Divisions (including that of the Australian Capital Territory) into a joint arrangement for publishing this magazine (previously published for all Divisions by the VK3 Division), collecting membership subscriptions, negotiating with the Government rule-makers, and whatever else seemed better done by a collective body of all Divisions instead of each operating independently.

Over the last few years, it would seem that, as far as some Divisions are concerned, the things which divide us in the WIA have become more important than those which unite us. It would be a tragedy if the baby of unification were to be thrown out with the bath water of dissension!

Bill Rice VK3ABP  
Editor

### CONTRIBUTIONS TO AMATEUR RADIO

*Amateur Radio* is a forum for WIA members' amateur radio technical experiments, experiences, opinions and news. Manuscripts with drawings and/or photos are always welcome and will be considered for possible publication. Articles on computer disk or via e-mail are especially welcome. The WIA cannot assume responsibility for loss or damage to any material. A pamphlet, "How to Write for *Amateur Radio*", is available from vk3br Communications Pty Ltd on receipt of a stamped, self addressed envelope.

---

## ■ WIA News

*Roger Harrison VK2ZRH, Federal Media Liaison Officer.*

---

# WIA Wins Concession on Repeater and Beacon Fees

**L**icence renewal fees on repeaters and beacons will now cost only \$50 per call sign per site per year. This new arrangement replaces the previous charges, brought in last year, where repeater systems and beacons were charged at the annual rate of \$50 per transmitter frequency, links excluded.

A number of repeater system sponsors closed their repeaters when they could no longer afford the total licence fee, and many others informed the Institute they were considering following suit. In some instances, fees had leapt by a factor of six or seven, from under \$100 to \$500 a year between 1995 and late 1996.

After many months of representations to the Spectrum Management Agency, the WIA-SMA Liaison Team finally convinced the Agency that the charges were inequitable and the Institute was informed of the decision on 27 May.

Applications for new beacons or repeater systems will still attract an

“assignment” fee, which will be charged on an hourly basis, as is Government policy. However, the SMA said that, because the WIA State Divisions do an amount of preliminary work, through the Technical Advisory Committees, this charge will be minimised in line with the essential work which has to be performed by the SMA. The Institute expects to have further details on this in due course.

All SMA Area Offices should have been informed by now.

Where a single transmission site has a number of amateur repeater systems or beacons licensed under several different call signs, the licensee may choose to operate under a single call sign and pay only one licence fee.

The WIA adopted a “single fee per site” policy at its Federal Extraordinary Convention held in February this year (see WIA News, *Amateur Radio*, April issue, page 22).

proposed segment as secondary users. The spectrum from 3700 to 3900 kHz is presently allocated to the fixed and mobile services.

The requested allocation spans the variety of amateur bands allocated by other countries in all three ITU regions around the world. The WIA has suggested access to the allocation be permitted to amateurs holding Unrestricted and Intermediate licenses.

It is suggested the lower 10 kHz of the proposed allocation, from 3750-3760 kHz, be reserved for emergency use, to provide a common allocation with government emergency services which WICEN stations could use during declared emergencies, with 3757 kHz reserved for WICEN nets and exercises. The submission suggests Novices have access to this segment too, but only during emergencies, or to join WICEN nets and exercises.

The WIA submission for a new allocation at 80 m arose after surveys of commercial usage of the band to 3900 kHz. A survey of actual usage, involving listening observations from a number of amateurs at locations around Australia, was conducted over 21 months from January 1993 to September 1994. A questionnaire survey was mailed out in 1995 to all licensees between 3750 kHz and 3900 kHz.

Following the response from the questionnaire survey, to which 53% of licensees responded, a majority of whom did not object to sharing spectrum outside business hours, the WIA made a preliminary submission to the SMA in late 1995.

Subsequent to discussions with the SMA, the WIA presented an updated proposal in mid-1996. The SMA then asked for further particulars to be researched and outlined, especially with regard to possible interference risks, among other issues.

Having researched the requirements set out by the SMA, the submission was completed and delivered to the Canberra office on 23 May. The 5500 word submission, with 11 appendixes of tables, diagrams and maps, was preceded by a one-page, five-point summary.

In discussions with the SMA during May, it was indicated to the Institute that

# Submission on New 80m Allocation with SMA

**T**he WIA has finalised and delivered to the SMA the submission for a new amateur allocation of 150 kHz of spectrum above the present 80 metre band.

The Institute seeks a new amateur allocation extending from 3750 kHz to

3900 kHz, on a time-sharing basis, so that amateurs may use the allocation outside standard business hours, on weekday evenings and during weekends.

It is proposed this new allocation replace the existing “80 m DX Window” and that amateurs have access to the

# SMA Puts Amateur Licence Review On Hold

receipt of the submission begins the formal process of considering a new allocation, and that the time frame necessary to consult with users, planning groups within the Agency, the Radio Communications Consultative Council and international regulatory authorities, may be one to two years.

In addition, the SMA indicated that planning guidelines discouraged two high power services from sharing spectrum, and that an option to be considered might be to have separate, exclusive allocations to isolate the services.

Discussions between the WIA and the SMA will continue, so that we can move towards achieving the goal of a new allocation. However, instances of amateurs operating outside the conditions applicable to the present 80 m DX Window, of amateurs interfering with primary service users outside the allocation, as well as using transmitter powers above the legal limit, have continuously been brought to the WIA's attention, hampering discussions with the SMA.

The SMA monitors amateur usage of the 3794-3800 kHz allocation and has issued warning letters, about breaching licence conditions, to operators during the past few years. The WIA seeks the co-operation of all users and potential users of the present 80 m DX Window to stay within the limits imposed by the licence conditions, so as not further to jeopardise continuing negotiations.

The WIA-SMA Liaison Team would like specifically to thank Peter Forbes VK3QI, and those who assisted him, for their preliminary efforts towards the submission, from 1993 through 1995.

In separate correspondence to the WIA recently, the Spectrum Management Agency has indicated they have suspended their review of Amateur licences, and the Leader of the Opposition has promised to discuss the WIA's Amateur licensing submission with the ALP caucus.

The SMA's review of Amateur licensing was being carried out as part of a general review by the Agency of non-assigned Apparatus licence types (see WIA News, *Amateur Radio*, June issue, page 4).

The SMA has said that they will take no further action on reviewing Amateur licences until the Department of Communications and the Arts (DoCA) has concluded its review of the 1992 Radiocommunications Act. In its review of the Act, DoCA is considering the WIA's submission on Amateur licensing, given to the Minister, Senator Alston, in February.

In a letter from the Spectrum Management Agency in late May, Alan Jordan of the SMA's Business Directions Group, said: *"Following earlier consideration of the licensing arrangements applicable to Maritime and Outpost services, the SMA has carried out a preliminary review of the five personal categories of Amateur Licence taking into account the WIA's recent submission to the Minister for Communications and the Arts entitled 'Towards a New Licensing System.'*

*"As a result of this review, the Agency has concluded that it is not appropriate or cost effective at this time to consider the majority of matters raised by the WIA until the Department of Communications and the Arts has, in its wider review of the Radiocommunications Act 1992 (the Act), considered the WIA's principal contention that none of the licensing arrangements provided for under the Act*

*are suitable for licensing Amateur stations.*

*"In view of this decision, until the outcome of the Department's review of the Act is known, the existing arrangements for the licensing of Amateur stations will remain in place."*

WIA Federal President, Neil Penfold VK6NE, said: *"This welcome decision by the SMA vindicates the WIA's strategy and timing in presenting our submission to the Minister in February, and the effectiveness of the strong arguments in the submission that our present licensing system does not suit the Amateur Service."*

In concluding his letter to the WIA, Mr Jordan indicated that the SMA is considering making changes to the current arrangements regarding the issue of Amateur certificates of proficiency, in the context of work on Amateur examination approvals already under way.

Meanwhile, the Leader of the Opposition in the Federal Parliament, the Hon Kim Beazley (member for Brand in Western Australia), has written to WIA Federal President Neil Penfold regarding the WIA's submission on Amateur licensing.

Mr Beazley said, *"I have noted the contents of your submission and can see that it is a complex area which may be due for some degree of an overhaul.*

*"You would appreciate, in Opposition we are somewhat limited in what we are able to achieve. However, I have forwarded your submission to the Shadow Minister for Communications, Senator the Hon Chris Schacht, and will discuss the matter with him and with other members of the ALP caucus. Thank you for taking the time to write to me about this issue."*

The role of the SMA will be assumed this month by the new Australian Communications Authority.



Your  
Hobby

Your  
Voice

Representing Radio Amateurs Since 1910

# ITU Affairs

from David Wardlaw VK3ADW

## World Radio Conference Issues to Affect Amateurs

Frequency allocations for Low Earth Orbit (LEO) satellites and satellite-based radars are among the issues on the agenda of the 1997 World Radio Conference (WRC-97), to be held over October-November in Geneva, which will be likely to have an impact on amateur radio frequency allocations and amateur operations in the future.

The International Telecommunications Union (ITU) held a Conference Preparatory Meeting (CPM) for WRC-97 in Geneva in May, producing a 250-plus page book of technical considerations from preparatory groups around the world and concerns of ITU member states over issues to be considered.

According to the *ARRL Letter* of 16 May, issues of special interest to radio amateurs included the possibility of additional frequency allocations to the Mobile Satellite Service operating below 1 GHz - now familiar as "the little LEO issue." No specific frequencies were identified in the CPM report for reallocation. Although the report does address a number of sharing possibilities, it makes no mention of sharing with the Amateur Service.

In addition, a new concept of "broad allocations" for the Mobile Satellite Service was introduced. If adopted, this concept would result in individual nations being able to identify and allocate frequencies from a broad pool of service allocations. This concept, being quite new and unstudied, only resulted in a call for future studies by the ITU. However, it will require close watching from the radio amateur community as it might have the potential of representing a threat to our bands, cautioned the ARRL. However, it is likely that any such studies will be prolonged over a multi-year period.

The work of WRC-97 will be guided by specific proposals submitted by

individual nations. At present, countries have not yet finalised nor submitted their proposals. Until they do, the amateur community will not be able to accurately assess any threats to our bands which may arise for this conference.

Unfortunately, the Little LEOs are not the only new service searching for spectrum. Another is the Earth Exploration Satellite Service's use of synthetic aperture radar (EESS active). This involves a system of satellite-borne sensors designed to collect information about environmental issues and other similar data. A variety of frequencies is being sought, possibly including 430-440 MHz. The amateur and amateur satellite service status in this band is somewhat complex, varying by ITU

Region and even by individual country. So far, studies of sharing possibilities between the Amateur and EESS (active) services have not shown them to be compatible because of the interference level experienced when the two classes of stations are within line of sight.

There is also a type of EESS (active) which would make use of 1215 to 1300 MHz which is of concern to amateurs, affecting the 23 cm band. Studies here show compatibility with some types of services but still represent a potential source of interference to amateur operations.

From May through August, the various member countries of the ITU interested in seeking specific allocations for these services at WRC-97 will be making proposals for the work of the conference. Any possible future threats to amateur allocations and operations will only emerge once these proposals become public.

## VK3 Listener Wins April Recruitment Prize

Victorian Division member, **M Braun L30952**, is the lucky winner of the Fluke 12B digital multimeter, the prize in the April new members' draw in the WIA's 1997 recruitment campaign.

NSW Division members have scooped the pool so far, with new members winning prizes in each month for the first three months of this year.

Each month throughout 1997, a Fluke 12B digital multimeter, worth \$195, is given away to a lucky winner who joined a WIA Division in the previous month. The Fluke multimeter prizes have been generously donated by Philips Test & Measurement.

The Fluke 12B measures AC and DC voltage (with auto-selection above 4.5 V), resistance and capacitance from 1000 pF to 1000  $\mu$ F. The instrument features a simple rotary dial, a 4000-

count liquid crystal display, and diode and continuity testing. Its "continuity capture" feature indicates intermittent open and short circuits. It comes with test leads and a two-year warranty. Fluke is the world's pre-eminent manufacturer of digital test instruments and the Model 12B is from their recently-released range of hand-held instruments.

Every newcomer to electronics and amateur radio needs a good multimeter, and every seasoned enthusiast could always do with another one!

Membership recruitment advertisements appear in each issue of *Amateur Radio* magazine, and in *Radio and Communications* magazine.

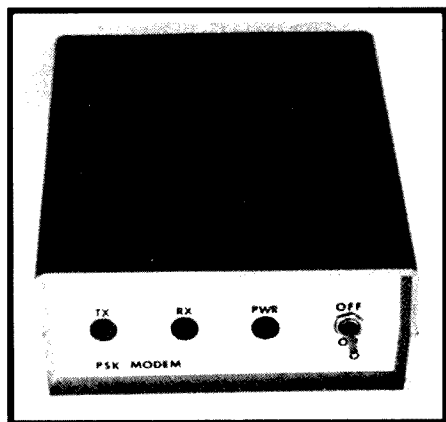
Membership recruitment and renewal advertisements are also on WIA Divisions' World Wide Web pages on the Internet.

ar

## ■ Digital

# A Baycom Style HF PSK Modem

*Alan Cox VK4AOC\* describes an interesting GCARS Inc Project.*



The HF PSK Modem in its case.

You might ask what is PSK Packet? Well, for a start PSK stands for Phase Shift Keying! PSK has quite a lot going for it, especially when you want to run high speed traffic on a reliable path. 1200 Baud on HF isn't a problem at all. Faster baud rates are quite possible.

Our first introduction to PSK Packet came about when the QDG group (Queensland Digital Group) asked us to consider setting up a PSK Link to VK7 as a message forward station. As the VK4WIG BBS had been set up as a club BBS within our club rooms, it was thought that we would be able to draw upon our resources to make the link a GOING THING.

A sub-committee was formed to investigate the possibility of such a setup. A crystal locked transceiver was provided on a loan basis to the club by Ed VK4JEN for our tests on 14 MHz. A TNC, which was modified for PSK use, was sent down from QDG for our tests. Not knowing a thing about PSK packet, we had quite a lot to learn.

The thing that stood out the most was the fact that not too many others really understood PSK either. We were faced with a steep learning curve, to say the

least. Then along came Doug VK4ZDR. It turns out he had been instrumental in setting up the PSK radio links for NASA during the 60s and 70s and, better yet, he is a member of our club. He is also a cosyop for our BBS VK4WIG.

Our resources had grown at a great rate in a short time. All we had to do now was put them all together. This is when it all went sour. We did put the set-up together after we were able to find out on what frequency to set the rig. Peter VK4XPD obtained a xtal that would let us work the frequency and tune the rig. The commands for the TNC were finally sorted out and, after a couple of weeks, we finally connected to VK7BBS. We thought we had it made!

However, a few more tests were done and then **disaster!** The TNC died! We didn't have another TNC modified for PSK use. What do we have to do to modify another TNC? Then we came across the G3RUH design for a PSK modem used for satellite communication in conjunction with a TNC. This turned out to be the basic set-up in the TNC we had.

As VK4WIG was running with Baycom style modems at the time, it was considered that there wasn't a great need to persist with a TNC based PSK set-up. Now we had to design a Baycom style PSK modem that would run into an FBB based BBS along with the other modems already in use.

The basic concept for the design revolved around the G3RUH design but utilising the principles as if it was a Baycom modem feeding the computer. The original design simply replaced the TCM3105 chip pins as in a Baycom modem set-up. A PCB was laid out to include the basic G3RUH design for terrestrial use and feed into a Baycom board. Initial tests were done on 2 m

between two local stations, Alan VK4AOC and Ausie VK4TN.

After we sorted out the filter restrictions that the rigs imposed upon us, it worked out quite well. But the next step took a while to finalise. As we had found out quite a while before, the original Baycom modem fed the computer via a 74HC04 chip which meant a pseudo RS232 level was presented to the serial port. This did cause problems with reliable operation, but was resolved by driving our serial port via MAX232 chips which deliver a standard RS232 level.

The next problem to overcome was to provide a stable 1500 Hz TTL level signal to feed the Tx Modulator as described in G3RUH's article. He had suggested that a frequency somewhere between 1400 and 1600 Hz would do the job. Our selection seemed to work out quite well, but it drifted. That problem was solved by the introduction of a low drift capacitor in the circuit. A 10 nF J Polyester with a 120 ppm/degree C was our choice. All our tests on the oscillator have shown a high degree of stability over weeks at a time with a 1 Hz drift.

We also required a time-out circuit to be incorporated with the design and the two spare inverters within the MAX232 were pressed into operation for that. A Tx/Rx LED was also required. The Tx LED wasn't a problem at all but the Rx LED required a bit of thought. It finally turned out to be the "LOCK" indicator LED in G3RUH's set-up.

A prototype PCB was laid out and built. Tests carried out provided instant success with connections to VK7, VK2, VK5 and VK4 stations.

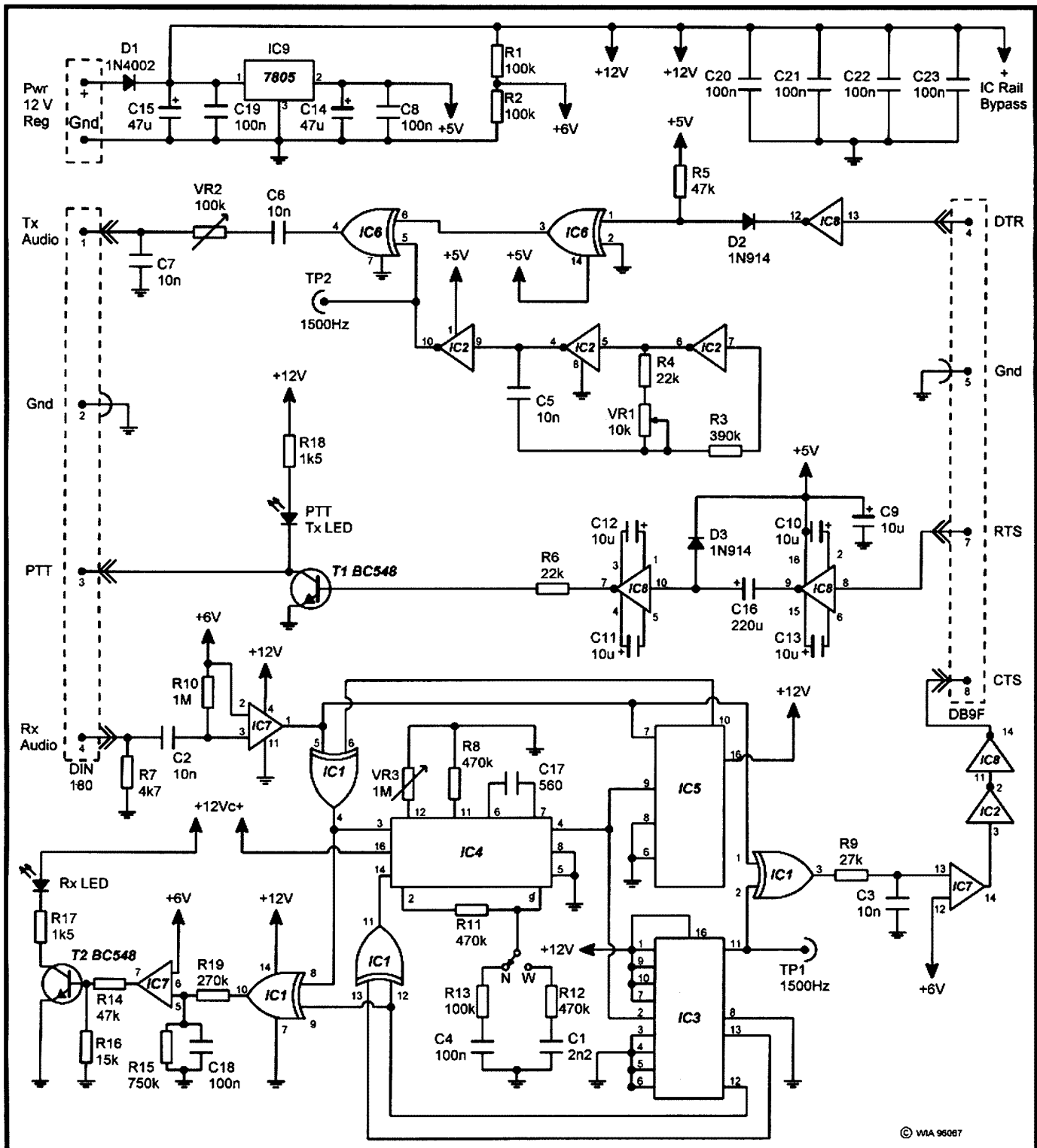
## Circuit Description

The circuit can be broken down to five parts consisting of the Tx modulator; the Rx demodulator; the Timeout + PTT circuit; the Rx LED circuit; and the power supply.

## Tx Modulator

The data from the computer is fed to a MAX232 gate which inverts and sets an RS232 level in case of long leads. This, in turn, is fed to the 4070 exclusive-OR gate. The output of that gate feeds another 4070 gate which is also fed by our 1500 Hz oscillator. The output of this





**Fig 1 - PSK Modem. IC1 4070, IC2 4049, IC3 40161, IC4 4046, IC5 4015, IC6 4070, IC7 TL084, IC8 MAX232, IC9 7805; T1 & T2 BC548, D1 1N4002, D2 & D3 1N914.**

the result of our combination and is coupled to the audio input of the radio. What we have as a result is PSK modulated audio. The level of audio is set with VR2 and the 1500 Hz is set via VR1 and tested on TP2. Please note C5 is

a high stability type, a "J" (120 ppm/dcgrce C).

**Rx Demodulator**

Apart from our inclusion of a MAX232 gate, this is part of the circuit

that G3RUH described for his JAS-1 Satellite Modem. It's extremely easy to set-up. All you have to do is adjust VR3 to obtain a 1500 Hz signal on TP1. You can choose two bandwidth settings, 20 Hz and 100 Hz. We have found 100 Hz to



HF - VHF - UHF MOBILE ANTENNA  
 HF - VHF - UHF BASE ANTENNA  
 CB - MARINE - AIRCRAFT

**Monoband to Multiband  
 Convert Now, to the all  
 New!**

**PERTH PLUS**  
 HF Mobile antenna

with 80-40-30-20-17-15-12-10-6-2m included

440 10 51008

Coaxial Cables & Fittings  
 HF Spring Bases, Trunk and Gutter Mounts.

*Outbacker OBB "Classic"  
 Outbacker "Junior plus"*

*Split Models  
 Helical Dipoles  
 Long wire Dipoles  
 Baluns*

**\* Free!**

With Every Perthplus Purchase.  
 1 x AmSoft CD-ROM  
 '94 Callsign Database

While current stocks last

Now available from :

**MELBOURNE**  
 Daycom Communications  
 Ph 03 5436444

**ALICE SPRINGS.**  
 Farmer Electronics  
 Ph 089522388

**DARWIN.**  
 Integrated Technical Services.  
 Ph 089-816411

**SYDNEY.**  
 Andrews Communications  
 Ph 02 6369060

**PERTH.**  
 Tower Communications  
 Ph 4701118

**ADELAIDE**  
 Johnston Electronics  
 Ph 08 2871061

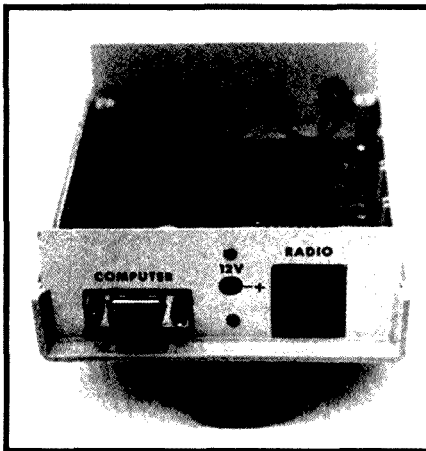
PERTH - Model

<http://intercon.com.au/outbacker>

TERLIN AERIALS Ph +61 (09) 3545444  
 5 Yampi Way  
 Willetton W.A. 6155 Fax +61 (09) 3545455



Send \$ 5.00 for a 15 minute international video  
 Refundable with every antenna purchase.



**A rear view of the modem out of its case and balanced on a 50 cent coin.**

be the best so far. Please note that C17 should be a polystyrene.

### Timeout and PTT Circuit

As we wanted to include a Tx timeout circuit, a decision had to be made as to which chip we could use. Because of the board location, the MAX232 spare gates won the job. C16 and the internal pull-up resistor in the gate set the timeout to approx 22 seconds. A simple NPN transistor is used to switch our PTT line LOW as well as drive a LED as the Tx indicator.

### Rx LED Circuit

This part of the project was described in G3RUH's satellite modem, but as a lock indicator. The only thing that has changed is the value of R15 from a 750 k to a 680 k. It gave a better indication of LOCK when using this modem on HF.

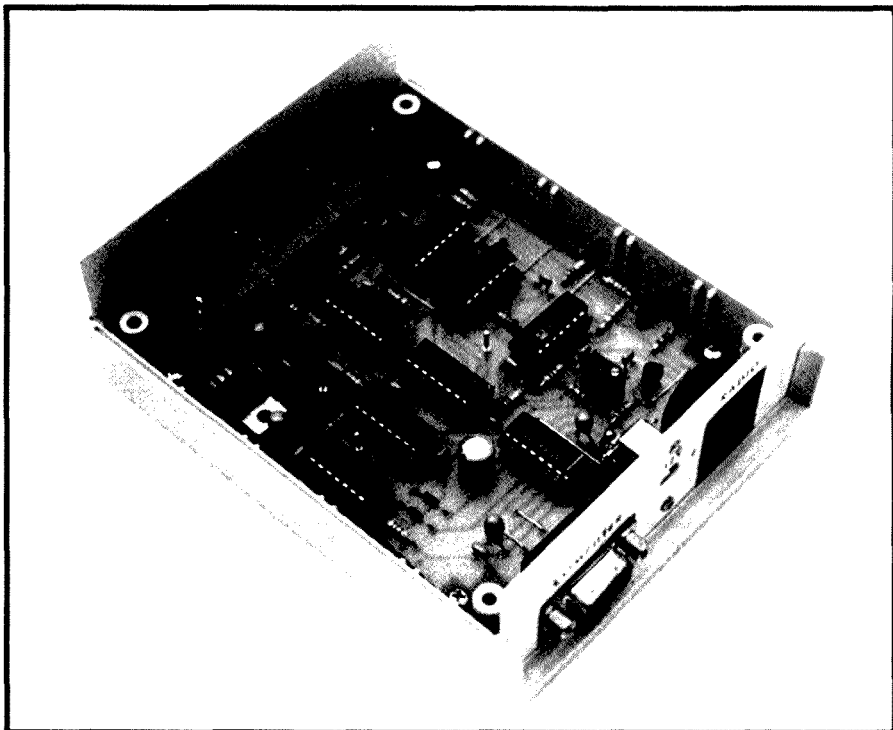
### Power Supply

12V DC is used to feed the modem but we did have to provide 5 V DC and 6 V DC as well. A three terminal five volt regulator has been employed along with a simple resistor divider to obtain the six volt line. Total current consumption is well under 100 mA. A well regulated 12 V supply should be used.

### Construction

To keep the project as neat as possible, the whole unit has been laid out on a PCB to fit a standard kit size box available at most electronic stores. The only components not mounted on the PCB are the LEDs, power input socket and an ON/OFF switch. We decided to use IC sockets in our first unit but they aren't necessary if you wish to omit them. However, the sockets can save you a few problems if you happen to have done something wrong when loading the board.

Remember to check your voltages



**Its professional construction is clearly seen in this view of the inside of the modem.**

around the board first before loading the ICs! Double check the IC layout, eg the location of pin one. Make sure you use a high stability capacitor for C5 in the 1500 Hz oscillator. The higher the stability the better. Use multi-turn pots to make the set-up dead easy. Also remember to put the links on to the board FIRST. There is one link required to go under the 40161 which can easily be missed out.

### Alignment

You will need access to a frequency counter for the set-up of the modem. First set TP2 to 1500 Hz by adjusting VR1. Next set TP1 to 1500 Hz by adjusting VR3. VR2 is set about half way for the Tx audio input and can be adjusted to suit the rig being used. The Rx audio input can be fed straight out of any SSB transceiver extension speaker output. Tune into a PSK station until you see the Rx LED on the modem light up.

You may find that, on some transceivers, the signal has to be fairly strong before you resolve anything at all. It is possible that the audio filters after the product detector are causing the problem. In that case, a simple tap prior to the product detector, with a small amplifier, may be in order. Most commercial rigs used for data do this.

I am using a YAESU FT-102 on 14 MHz at my QTH with a tap from the product detector to an external jack. Austen (Ausie) VK4TN uses a TS-520S with an external speaker jack as his Rx audio source.

### Comments

This project has been a challenge to all of us at the Gold Coast Radio Club involved in packet and general RF techniques. One thing that has stood out during the development of the project has been the spirit of amateur radio, and the helpfulness of the members that were interested. I personally would like to give credit to all those who participated in this project.

PC Boards for the HF PSK MODEM are available for \$45. The boards are professionally made and of high quality. Postage is included. All enquiries should be sent to: Gold Coast Amateur Radio Society Inc, PO Box 588, Southport QLD 4215.

\*10 Kinarra Street, Ashmore QLD 4214

ar

# RENEW YOUR MEMBERSHIP AND YOU COULD WIN



**This outstanding KENWOOD TM-733A dual-band 2m/70cm FM/packet rig worth \$1255**

● 50 watts on 2m ● 35 watts on 70cm

Simultaneous dual-band VHF-UHF reception  
Data connection for 1200/9600 baud packet radio

**All you have to do is renew your Division membership when it falls due.**

### MORE TM-733A FEATURES

- Switchable 10 W/5 W RF output
- 13.8 Vdc operation
- Large, high-visibility LCD panel
- Dual-channel Rx on VHF & UHF
- Automatic band change
- Multi-scan reception functions
- 70 multi-function memories
- Selectable frequency steps
- Audible frequency identification
- Auto repeater offset on 2m
- Repeater reverse & offset switches
- Tone signalling (DTSS).

TM-733A prize kindly donated by Kenwood Electronics Australia P/L, PO Box 604, Homobush 2140. Ph: (02) 9746 1888. Fax: (02) 9746 1509.

### WHO'S ELIGIBLE?

- members whose renewal falls due between 1/1/97 and 31/12/97
- current members who are on a 3-year membership
- life members
- all membership grades

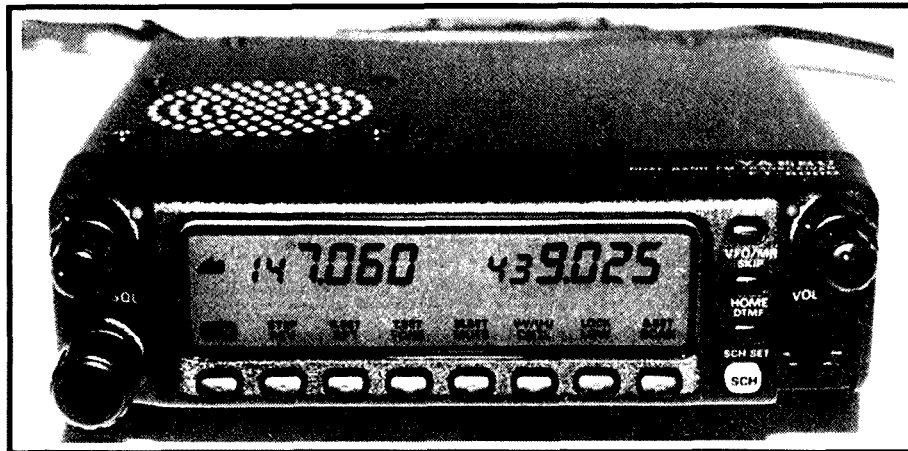
The prize will be awarded by means of a draw, the result to be published and the prize to be presented to the winner at the first available opportunity early in 1998.



## ■ Equipment Review

# Yaesu FT-8000R Dual Band Mobile Transceiver

Reviewed by Ron Fisher VK3OM\*



A front view of the FT-8000R, clearly showing the second row of functions above the remaining seven buttons when the "F/W" button is pushed.

(Photo by Ron VK3OM)

In the March 1997 issue of *Amateur Radio*, I reviewed the rugged Yaesu FT-2500M 2 metre mobile transceiver. This time I will look at the latest dual band mobile transceiver, the FT-8000R. This transceiver covers both the two metre and 70 cm bands with power outputs of 50 watts and 35 watts respectively.

Even with the addition of a considerable amount of electronics, the new dual bander is actually smaller than the current single band model.

The FT-8000R includes an efficient cooling fan attached to the rear heat sink panel. This operates at all times the transceiver is switched on with the fan speed increasing when the transmitter is keyed. The FT-8000R is supplied with a mobile mounting bracket, a hand held microphone and a generous length DC power lead.

The transceiver features a very wide receive coverage from 110 MHz to 550 MHz and from 750 to 1300 MHz, but with the cellular telephone frequencies

blocked out. Reception modes of both AM and FM are included with AM being selected automatically on the aircraft band. The transmitter uses FM and is configured for use on the two amateur bands only. The overall size is 140 mm wide, 40 mm high and 152 mm deep with a weight of just one kg.

The operational features of the FT-8000R include dual receive capability with either the same band or cross band operation. It is also possible to set the

transceiver up as a cross band repeater. There are 108 memory channels with 54 allocated to each of the two amateur bands. Packet operators are well catered for with both 1200 and 9600 bps operation available. A rear panel jack has been provided to allow easy interface for a packet modem.

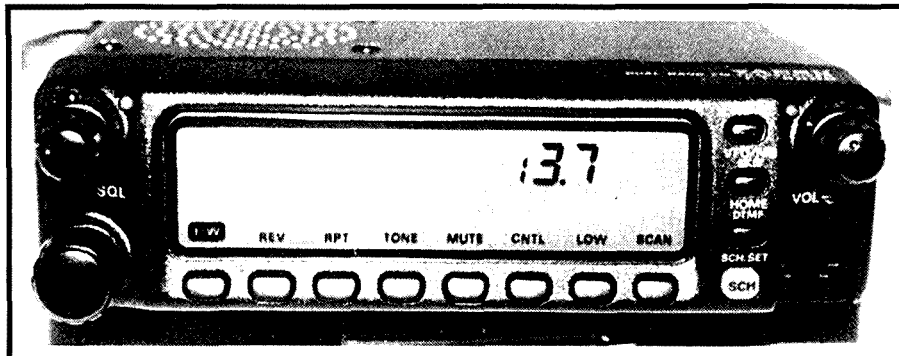
A new feature that Yaesu call "The Smart Search" automatically sweeps the band and loads active frequencies into dedicated memory banks. Yaesu claim that this feature can identify active repeater and simplex frequencies when you visit a new location. Of course, the frequencies have to be active for the feature to work.

The FT-8000R has a built in diplexer so there is only one antenna connector. There are advantages and disadvantages in this. It, of course, makes it easy for direct feed of a dual band antenna but, if you prefer a separate antenna for each band, you will need an external diplexer. The antenna connector is an SO-239 which just might raise a few eyebrows among dedicated 70 cm operators.

## FT-8000R On The Air

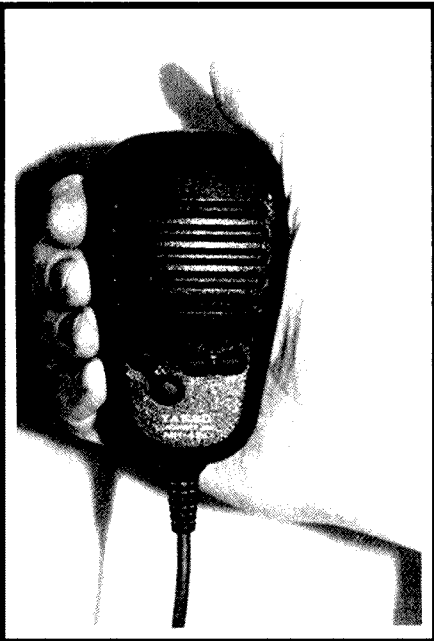
The FT-8000R is very easy to get on the air and this is certainly helped with the superb "Omni-Glow" LC display which gives all the information needed. Designations for the eight buttons under the display are shown on the display. When the "F/W" button is pushed, the remaining seven buttons have second functions which are displayed above the original designations. All very neat and you just cannot go wrong.

On initial switch-on for a couple of seconds, or at any time later by pushing and holding down the audio gain control on either side of the transceiver, the



The FT-8000R indicating power supply voltage (see text).

(Photo by Ron VK3OM)



**The MH-42B6j hand held microphone supplied with the FT-8000R. (Photo by Ron VK3OM)**

battery voltage is shown on the display (see photo). This is very handy to keep a check on the state of your car battery, or the power supply if you are using the transceiver at home.

Tuning the FT-8000R has been very well thought out. Let's go through the options. Firstly, the tuning steps via the main tuning control can be set to 5, 10, 12.5, 15, 20, 25 or 50 kHz segments. I usually chose 25 kHz steps as this fits in with the Australian band plan. If you want to tune through the general coverage receiver segments you can select either 10 MHz or 1 MHz steps to get to the frequency you want quickly.

The microphone supplied with the FT-8000R is the MH-42B6J. This has up/down buttons on the top and four small buttons on the lower front. Only one of these has any function on the FT-8000R. This is the "P" button, which allows VHF/UHF band changing from the microphone. One thing that I am not sure about is the modular connector for the microphone. The plastic plug is actually moulded on to the microphone cable so fitting a new one, if trouble occurs, would be virtually impossible. I guess time will tell just how reliable these connectors are.

However, the transmit audio quality was rated as excellent. Yaesu seem to

have solved the earlier problem of spitty speech. Even without asking, several stations commented on the almost broadcast quality of the transmitted signal. I wonder how it would sound with a MD-100 desk microphone connected.

A wonderful feature is the "time-out timer". Everyone should have one of these (and use it). This can be set in one minute intervals from one minute to sixty minutes (some repeater!), and the transceiver will return to receive mode after the pre-set time is exceeded, which saves the embarrassment of timing out the repeater.

**FT-8000R on Test**

The first test was for power output and current drain. My test showed that the specified power output was spot on. The transceiver produced 50 watts on two metres with 13.8 volts to the power cord (13.7 volts on the transceiver display) with a current drain of 10 amps. At 70 cm power output was measured at 37 watts and current drain at 8.5 amps.

I then reduced the voltage to simulate a rather sick car battery. At 11 volts the transceiver was still producing a healthy 30 watts output on two metres and, with the voltage down to 9.5 volts, the output was an amazing 15 watts. Below this the transceiver stopped transmitting and receiving. However, you will still be able to call for help long after the battery has stopped cranking the engine.

Power output is selectable at two lower levels if required. These are ten and five watts respectively and are the same for both bands. My tests showed these to be as specified.

The next important feature for a mobile transceiver is the audio output capability, both electrical and acoustic. The in-built speaker is built into the top of the cabinet. It is small, about 4 cm in diameter and has very limited power handling capability and low frequency response. In other words, an external speaker is a very desirable extra.

In fact there are two external speaker output sockets so that it is possible to feed a separate speaker from each of the two receivers. A mix of both sides is available on one socket. Measured power output across a four ohm load was 3.4 watts at maximum output with 14% distortion; at two watts output distortion

had dropped to 3.4%. The specification states 5% at two watts. These figures are very satisfactory and feeding a good external speaker you will make a lot of noise.

Talking of noise, the measured audio signal to noise ratio relative to full power output was -45 dB, a very reasonable figure. Receiver sensitivity is specified for both amateur bands for both the main and the sub receiver. There is no specification for out-of-band receiver performance so I decided to check sensitivity on the amateur bands and at 120 MHz in the aircraft band (which is probably the one I would use the most).

The radio switches to AM mode on the air band and sensitivity measured 10 dB S/N at 1 µV input. Sensitivity on the amateur bands for 12 dB SINAD is specified at 0.18 µV for the main receiver and 0.25 µV for the sub receiver. My measurements confirmed these figures with a generous margin.

In summary, the technical performance of the FT-8000R is first class and should please the most critical operator.

**Andrews  
Communication  
Systems**

(EST. 1976 - ACN 001 968 752)

**WE WILL NOT BE UNDERSOLD  
ON ALINCO RADIOS**

- ★ IC-756 HF+6M, DSP, LCD
- ★ IC-R10 HAND HELD SCANNER
- ★ WS-1000E CUTE SCANNER
- ★ DX-70TH HF+6M 100W
- ★ MFJ TUNERS AND CONTROLLERS
- ★ DX-1600 HF LINEAR AMP.
- ★ AR-5000 2.6GHz SCANNER

**3 YEAR WARRANTY ON  
OUR ALINCO RADIOS**

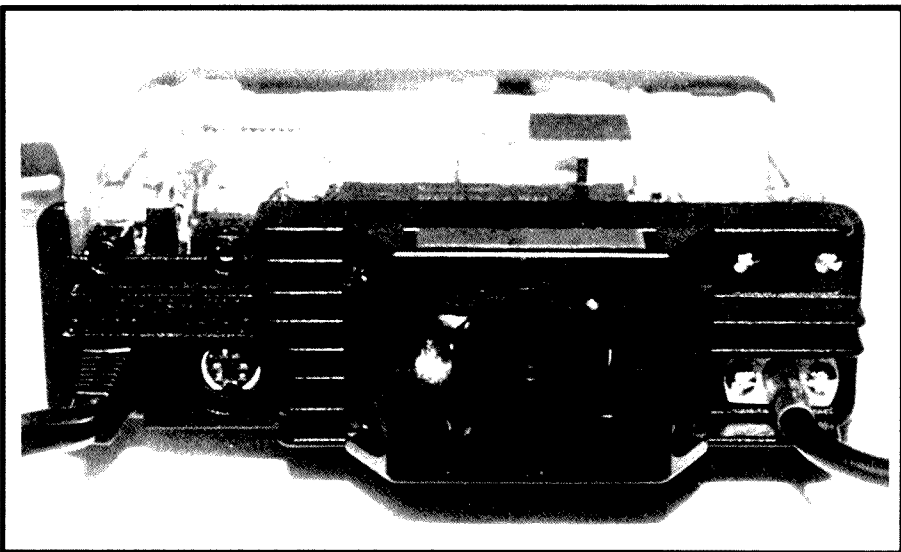
Call us now  
**(02) 9636 9060** or (02) 9688 4301

SHOP 8, 41 BATHURST ST, GREYSTANES,  
N.S.W. 2145. FAX (02) 9688 1995

## FT-8000R - The Bottom Line

At a new selling price of \$799 this transceiver is absolutely excellent value and, of course, Dick Smith offer a full two year warranty. With its Mil-spec approval this transceiver is designed for hard work so the chance of needing the warranty is fairly remote. Our transceiver was supplied to us by Dick Smith Electronics and you should contact them for any further details.

\*24 Sugarloaf Road, Beaconsfield Upper VIC 3808  
ar



A rear view of the FT-8000R with the covers removed. Note the large but quiet cooling fan.  
(Photo by Ron VK3OM)

### FT-8000R Instruction Book.

Yaesu seem to be setting the standard in excellent instruction books these days. First and foremost, you actually get a circuit diagram! Another thing that I find most useful is the "Quick Code Sheet"

which lists all of the hidden functions and tells how to access them quickly. Keep a copy in your glove box.

The instruction book runs to 64 pages and is very easy to follow. Top marks to Yaesu!



Your

Hobby

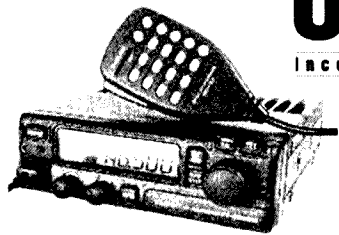
Your

Voice

Representing Radio Amateurs Since 1910

# Radio and Communications

Incorporating AMATEUR RADIO ACTION and CB ACTION



Don't grizzle that your new two metre rig is too hard to use if you've rushed out to buy the most complex radio on the market. This one is cheap, simple, easy to use, great in the mobile, and offers excellent performance, even near pagers. So what is it?

Published by  
**ACP SYME MAGAZINES,**  
PO Box 119, Oakleigh,  
Victoria 3166  
(03) 9567 4200

July's R&C is great reading for amateur radio operators. Don't miss any of our great features!

- REVIEW: Micro Orbiter satellite tracking program. Great stuff for those with a computer in the shack...
- Get a computer in the shack!! VK3DBP explains why you need to move into the 20th Century...
- REVIEW: Yaesu FT-2500M. This radio's track-tuned receiver really is special. Nice tx audio too...
- A superconducting HF antenna. A what?!! Come on, you *must* be kidding... Better check this out!
- REVIEW: AOR AR-7030 communications receiver. AOR... so it's a scanner? No way. This is no toy...
- As usual, we have our three DX columns, mods and more... the best stories and regulars every month!

Don't miss out — **RADIO and COMMUNICATIONS** is great reading for amateurs!  
**Check your local newsagent today!**

(PS. We also have the biggest collection of radio-oriented Classified adverts in the country. There's lots of them because they work so well. Ask your newsagent to keep a copy for you each month, or ring 1800 25 2515 for subscription details. Hurry — you might miss something!)

## ■ Antennas

# The Semi-Elevated Ground Plane - GIRFU Style

W A McLeod VK3MI\* brings us yet another fascinating article on antennas.

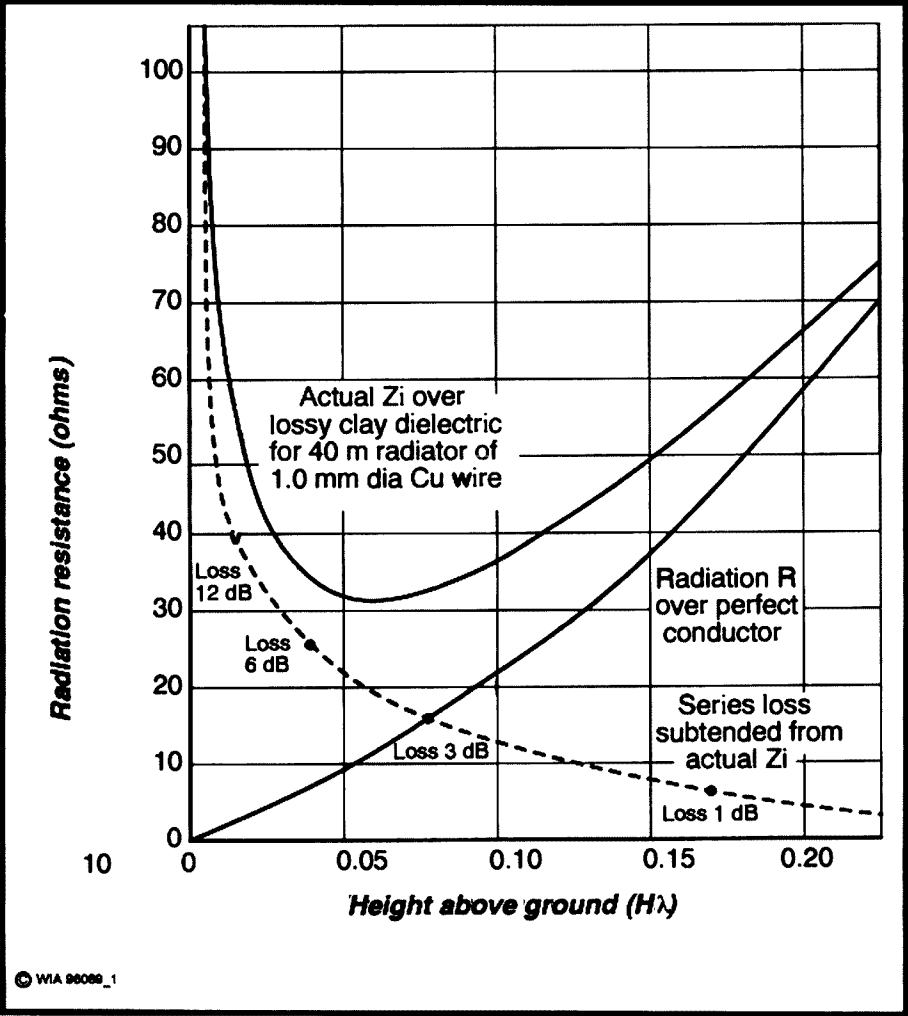


Fig 1 - Radiation resistance of a half-wave dipole less than a quarter-wave above ground.

Over the 100 years since Sir Henry Jackson experimented with vertical monopole radiators on Navy ships and Marconi, and then adapted the system for land use, there has been controversy as to the optimum type of counterpoise to use. For HF use, direct connection to earth, an extensive under surface ground mat,

an on-surface ground mat or tuned counterpoise, and an elevated tuned counterpoise have all been advocated. Recently the latter has been the popular choice and, compared to the losses to be expected in a surface dipole (see Fig 1), this choice is justified. Of course, as a counterpoise, the twin quarter

wavelength sections are driven in equi-phase parallel, rather than in series as for the dipole, but the capacitive coupling to ground still exists. The major effect of this is over the end 37% of each section, and this is the high voltage portion which must be elevated, while the remainder is less critical. Compare the effects of the "saggy" dipole with the "droopy" version at Table 1.

Then there is the multi-wire system of Admiralty handbook Vol 2, 1938 at Section "R" p 26 which "shows wires running radially outwards on insulated supports, without connection being made to earth plates at the outer ends of the system"; and "it should extend on all sides by a distance equal to the height of the aerial."

These observations are born out by computer simulation of similar systems by VK1BRH (*Amateur Radio*, October 1995) but the minimal practical requirement is for a two-dimensional system, even though with some slight loss compared with the three legged type of counterpoise. Even in wet weather most of the dielectric is air, giving a much more stable system than a direct ground, or a surface counterpoise which changes from a water dielectric ( $K = 80$ ) when flooded to dry clay ( $K = 4$  to 8) in drought!

These changes can affect the apparent length of the monopole by as much as 5% to a "direct" earth, and that of a surface counterpoise by a much greater amount. This necessitates the use of a variable tuner with modern transmitters and uncertain radiating efficiency generally.

It is probably these uncertainties which result in vague statements about "one quarter wavelength" for element lengths, but very little information is available for setting up a system. Actually, an electrical quarter wave surface counterpoise can be approximately 50% of the free space length and vary 10% from wet to dry conditions on a "common clay" surface. On a desert sand dune the same quarter wave can be expected to be 90% or so, and, of course, the wet conditions rarely occur!

To avoid these variations, a semi-elevated type counterpoise for a monopole radiator was selected for test at

**Horizontal dipole - 8.940 m + 8.940 m - nominal 33 uH**

	Shape	Height (metres) End - Centre - End			Freq kHz	Impedance Ω	"E" factor %	Measured C = pF
Level		2	2	2	7765	31.5	92.50	38
Saggy		2	1	2	7810	32.0	93.00	37
Level		1	1	1	7705	35.5	91.75	39
Droopy		0.05	1	0.05	6977	47.0	83.00	43
Level		0.05	0.05	0.05	4710	116.0	56.00	110

© WIA 96089\_T1

**Table 1 - Effects of shape, close to clay ground for dipole of 1 mm diameter PVC covered wire (hot, dry weather - green grass).**

10.125 MHz (Fig 2). With the high voltage ends of the quarter wave sections above ground by 1/30 wavelength (1 m) the ground loss should be reasonable, far less than the 8 dB for the dipole at Fig 1. This counterpoise can be physically accommodated some 150 mm offset from a non-metal fence with about one-third of each leg enclosed in the 12 mm polypropylene tubing used for watering systems as safety double insulation.

Available information on practical realisation of the system is minimal so the following get-it-right-first-up (GIRFU) method was adopted to have the unbalanced system resonant in both dimensions:-

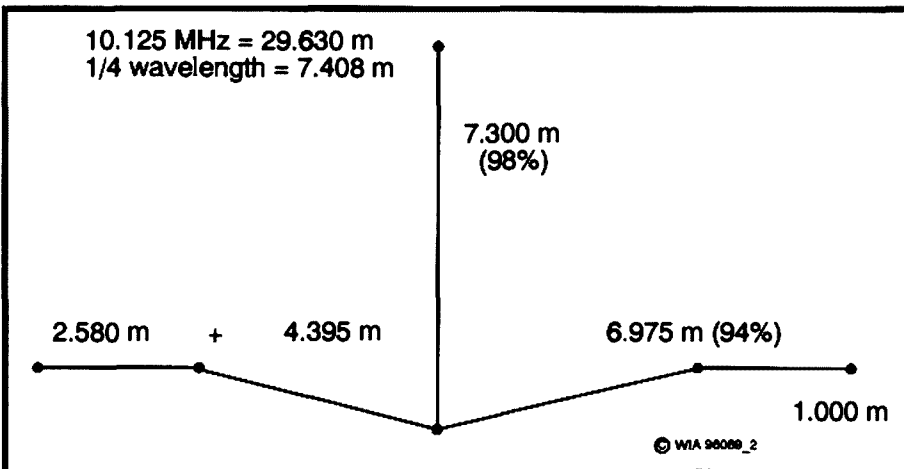
1. Set up the system with three nominal quarter wave sections of 300/F MHz divided by 4, using 2 mm insulated wire (7 x 0.66 mm electricians earth wire).

2. With the vertical section disconnected, check the resonant frequency of the two counterpoise sections connected in series as a balanced low dipole. Probably some 5% to 10% too low, so this number of centimetres for every metre of their length must be removed from BOTH legs. If in doubt, start with only 2/3 of this and test again before removing the remainder.
3. With the vertical section connected to each separate horizontal leg in turn, check the resonant frequency (not necessarily the design frequency) for a balance between the two. This vertical quadrant is quite an efficient radiator in its own right, but emits a horizontally polarised component which can be cancelled with the other leg of the counterpoise connected. If the two differ by more than 0.5%,

check for metal posts, standpipes, etc within two metres of one end or shallow water pipes under a leg. Re-siting may be necessary to avoid these unbalances.

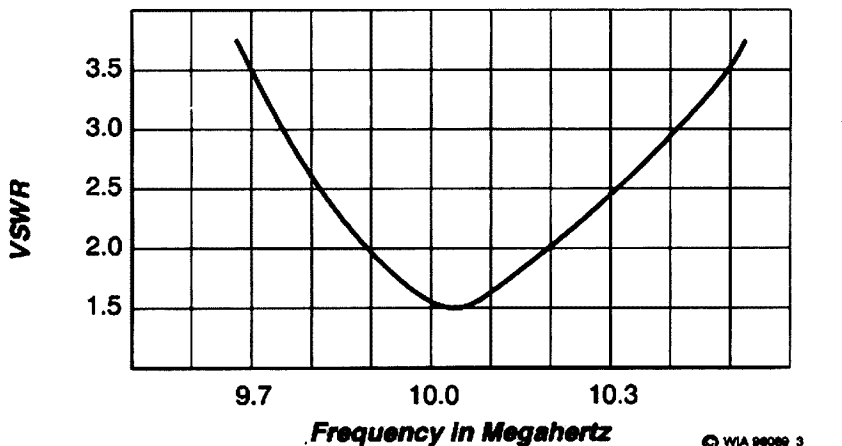
4. With the counterpoise legs balanced, tune the vertical radiator against either leg. That is, check resonance, which is probably too low by 3%, so remove that number of centimetres for each metre of length from the vertical radiator.
5. Connect both horizontal legs in parallel as a balanced counterpoise and check resonance against the vertical radiator. Now, it will be probably 1% too low with the additional capacitance to ground of the second leg. Once again, remove this amount in cm per metre from BOTH counterpoise legs and re-check the final result.
6. Measure the RF impedance of the system and connect a static bleed resistor of at least ten times this value between the counterpoise centre and an earth pin driven to at least 50 cm depth. For a 38 ohm impedance, a 10 watt wire wound resistor of 390 ohms, encapsulated in "Araldite", should be robust enough. A direct earth can increase loss and unbalance the system; isolation is essential.
7. For use with RF power less than 100 W, an additional static bleed non-inductive resistor of 10 kilohms at a 2 W rating is also recommended across the feed point to dissipate static build-up and absorb induced surges from lightning in the environs. For higher power a 240 volt appliance lamp rated for 10 W would be more appropriate.
8. Bury the co-axial feed cable run at right angle to the counterpoise for at least a similar length so that any outer screen current has negligible effect on the system.
9. Enclose the outer high voltage portion of each counterpoise leg in the 12 mm polypropylene tubing used for garden watering systems, even though the wire is insulated, as double insulation to prevent human contact. And, of course, it protects the possums as well!

The result is a vertical radiating system for DX with about 6 dB margin over a horizontal dipole at 4 m high for



**Fig 2 - 30 m vertical with two radials displaced by 1/30 λ above damp clay ground.**





**Fig 3 - SWR of 30 m vertical with two radials displaced by  $1/30 \lambda$  above damp clay ground.**

distances beyond 600 km. Of course, for shorter distances (less than 300 km), the low dipole has a similar margin by near vertical incidence skywave reflection.

As the dielectric from the counterpoise ends to ground is mostly air, even in heavy rain, the tuning does not alter appreciably from flood to drought as with a surface counterpoise or direct earth connection.

This stable tuned radiating system, with an input impedance of about 38 ohms will have a VSWR less than 1.5:1 to a 50 ohm transmission line with a bandwidth of 350 kHz at the 2:1 limits similar to the low horizontal dipole at 4 m high, so a similar efficiency can be expected.

The tuning system has been based on

VSWR as being more definite and suited to amateur practice. For those who wish to use resistive methods, the resonance point will occur about 150 kHz higher in frequency.

The get-it-right-first-up procedure should produce a satisfactory result when scaled for the other HF bands in locations where the configuration can be accommodated but, for 80 metres, the dimensions can become excessive. However the whole system does not need to be elevated, only the outer ends.

For further reading, the author's article *Low Radiators and High Ground Planes* in *Amateur Radio*, November 1994 is suggested.

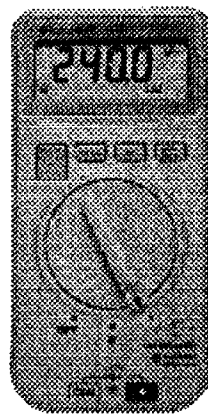
\*42 Capon Street, Chadstone VIC 3148

ar



**YOUR HOBBY** **YOUR VOICE**  
Representing Radio Amateurs - Since 1910

**RECRUIT A MEMBER & THEY COULD WIN!**  
**THIS GREAT FLUKE 12B DIGITAL MULTIMETER WORTH \$195**



**THERE'S A WINNER EVERY MONTH FOR 1997 12 PRIZES TO BE WON**

This latest hand-held DMM, from the world-leading maker of digital test instruments, has advanced features yet is simple to use. Ideal for tyro & veteran.

**The Fluke 12B measures:**

- ac and dc voltage (with auto-selection)
- resistance & capacitance (.001-1000 $\mu$ )

**The Fluke 12B features:**

- 4000-count liquid crystal display
- simple rotary dial
- diode and continuity testing
- indicates intermittent opens & shorts
- 2-year warranty

**Fluke 12B prizes generously donated by Philips Test & Measurement.**

Each month's prize is awarded by way of a draw among newly recruited members each successive month and presented to the winner at the earliest opportunity following the draw.

**To sign up a new member, use the back of your AR magazine address leaflet - or clip the coupon, have them fill it out and send it now.**

**SEND TO YOUR DIVISION'S ADDRESS, SHOWN ON PAGE 56.**

✂ .....  
Please send me a membership application.

NAME .....

ADDRESS .....

..... P/code .....

Call Sign (if any) ..... [AR 1-11/97]

## WIA News

### Under 21s Get Free Licences In UK

In a move to encourage more young people into amateur radio, British amateurs under 21 years of age get their licences free from 1 July. The UK regulatory authority, the Radiocommunications Agency (RA), made the announcement in May after consultation with the Radio Society of Great Britain (RSGB).

Previously, only British Novice

licence holders got their licence free if they were under 21 at the time of application or renewal. According to the RSGB's *GB2RS News* of 25 May, new applications registered on, or after, 1 July will be issued free of charge while existing licence holders under 21 years of age will not be charged a fee providing their licence expiry date is on, or after, that day.

## ■ Packet

# 10 MHz Modification for Flash PAD207 TNC

Ron Graham VK4BRG\* supplies some notes on upgrading performance of a popular kit TNC.

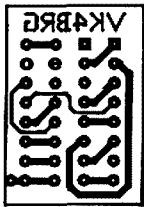


Fig 1 - Full size PCB layout (copper side).

Details of this TNC were described in an article by Colin MacKinnon VK2DYM, which appeared on page 14 of the March 1993 issue of *Amateur Radio* magazine.

This modification is easily reversible. After doing the 5 MHz modification as described in the original documents, the only on-board soldering is to change the crystal. The modification may be performed in stages and operation of the TNC verified at the conclusion of each stage.

The "serial bit rate" jumpers remain as per the original, with the exception being that the 38,400 rate will not be available. As a bonus, due to two chips being replaced with their CMOS equivalent, current consumption will be reduced from 400 to 200 mA approximately.

Recent TNC kits have been supplied with a 6 MHz CPU and SIO/0 Chip and a 150 nanosecond (ns) EPROM.

At this stage check your existing 27C256 EPROM. A 150 (ns) or faster device is required. This is normally indicated by a "-15" (for 150 ns) or "-12" (for 120 ns) appearing after the type number, eg 27C256-15. Should your TNC be fitted with a slower EPROM, you will have to transfer the contents to

the new faster device. You may need to seek out a friend with an EPROM programmer!

## Technical Details

It is easy to double the processor, or system, clock speed by simply changing the crystal and ensuring that the associated chips are capable of operation at the new speed. However, the original clock speeds must be maintained for other "essential" functions. These are the SIO (A) and (B) clocks, the TIC timer and, if the AM7910 modem is still used, its clock. This may be achieved by an extra division by two for those clock frequencies involved. In other words, as we have doubled the system clock frequency, we must halve the resultant

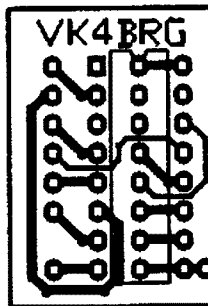


Fig 2 - View of the top of the PC board (150% of actual size) showing tracks and the 4020 IC on top of the board. Pins, protruding downwards, are initially soldered into the two rows of pads unoccupied by the 4020. These pins mate with the IC socket from which the 4040 IC on the TNC is removed. The pad on the bottom right hand side is for the flying lead to supply the clock signal to the on board 7910 modem, if required (see text for details).

new "other essential" clock frequencies before they may be utilised.

This is achieved by substituting a 74HC4020 divider in lieu of the original 74HC4040 and rearranging the connections. The new connection arrangement may be achieved in a suitable unit which is plugged into the 74HC4040 socket.

Thus, the whole modification is reversible by removing this "plug in" unit and refitting the 74HC4040. This makes quite a neat arrangement, apart from the modem (AM7910) clock.

As my reasons for this 10 MHz modification were to utilise the TNC for higher speed modem applications (wired via the optional 16 pin modem connector) the existing modem clock is not required. However, it is possible to connect the in-built modem's clock with a flying lead from the above mentioned "plug in" unit to the socket pin 6 of U9 (74HC107). The IC is removed from its socket, pin 9 of the IC is bent out by ninety degrees, the flying lead inserted into that socket hole, and the IC reinserted into the socket.

This connects a 2.45 MHz clock signal from pin 9 of the "plug in" 4020 unit to socket pin 6 of U9. That is a convenient input point for the modem clock.

By enabling the in-built modem as described above, one is able to verify the operation of the whole TNC at 10 MHz at, say, 1200 baud on VHF. This is a logical step prior to fitting a higher speed modem. Once that is in operation, the flying lead could be removed.

## Parts Required

- a)\* 3 pin header and shorting link to perform 5 MHz mod as per original documentation.
- b)\* 27C256-15 EPROM (see above).
- c)# Z84C0010 10 MHz CMOS CPU.
- d)# Z84C4010 10 MHz CMOS SIO/0.
- e)\* 9.8304 crystal. HC6U type.
- f)\* 74HC4020 IC
- g)\* 16 pin IC socket, or  
+ 74HC4020 modification kit (includes items f. and g. - details follow).

Available from:

\* Farnell Electronic Components, 72 Ferndell St., Chester Hill NSW 2162. 02 9644 8888.

# R & D Electronics, 4 Plane Tree Ave,  
Dingley VIC 3172. 03 9558 0444.  
+ see author, VK4BRG@VK4BRG, or  
PO Box 323, Sarina QLD 4737.

## 5 MHz Modification

Locate the L2 link (centre of board) and cut the track on the bottom of the board between pins 2 and 3 (pin 1 is towards rear of board). Install a 3 pin header in L2 and put a shorting link between pins 1 and 2. Confirm that your board is fitted with a 6 MHz CPU and SIO chip (otherwise you will have to install the new 10 MHz devices at this time). You should be now able to verify that the TNC is working at 5 MHz.

## Fitting 10 MHz Chips

Unless you were obliged to fit the fast chips for the 5 MHz test, now carefully remove the slow Z80 CPU, SIO and, if necessary, the EPROM. With the new chips correctly orientated, and taking care that all pins enter the socket correctly, insert these chips. Once again verify that the TNC is working.

## 74HC4020 Divider Assembly

There are three options available. The resulting units plug into the IC socket

originally occupied by the 74HC4040 divider. For options 2 and 3 I have designed a small circuit board which performs the interconnections between the new 4020 and the original 4040 divider.

### Options:

1. Make up the 4020 IC and 16 pin socket assembly. This does not use the circuit board. The 4020 is piggy backed onto the 16 pin socket with some pins inserted directly into the socket. The remainder are bent out and hard wired to the required socket pin.

*Advantages - cheap and uses commonly available parts.*

*Disadvantages - very fiddly, possibility of errors, assembly not very rugged.*

2. Make up assembly using the circuit board. Pins are removed from a 16 pin DIL component header and soldered to the board to form the plug. The 4020 may be soldered directly to the board. Alternatively, a 16 pin IC socket is soldered to the board and the 4020 fitted to that socket.

*Advantages - less chance of errors, more rugged assembly.*

*Disadvantages - necessity of obtaining board, must obtain a type of*

*component header with long pins, must align pins after soldering to board.*

3. Obtain the assembly already built. If there is the demand I am prepared to build up the assemblies at a reasonable cost.

## Update

There have been rumours that this TNC kit would soon be no longer available. I contacted the suppliers, World Wide Electronic Components in Perth early in May 1997 and was informed that there are still 25 kits in stock. He mentioned that a potential problem for the future would be supply of the AM7910 modem chip which is no longer being manufactured.

I have found these units provide the most economical stand-alone TNC, or building block to which other modems may be added via the optional internal modem disconnect socket.

I have developed and have PCB designs for:

a. A plug-in 1200 baud (TCM-3105 based) modem (to do away with the power hungry 7910) which is handy for solar powered sites (note, however, the TCM-3105 is also discontinued!); and

b. A 1200 baud PSK modem which interfaces to, and derives power and clock signals from, the TNC via ribbon cable to the modem disconnect socket.

\*PO Box 323, Sarina QLD 4737.

ar

## Connections

New	Old	Function	Frequency
4020	to 4040		
1	n/c		
2	1	TIC timer	600 Hz
3	n/c		
4	3	4800 baud	76,800 Hz
5	5	9600 baud	153,600 Hz
6	2	2400 baud	38,400 Hz
7	6	19,200 baud	307,200 Hz
8	8	ground	
9	9	modem clock	2.45 MHz
10	10	clock in	4.90 MHz
11	11	reset	
12	13	600 baud	9,600 Hz
13	4	1200 baud	19,200 Hz
14	12	300 baud	4,800 Hz
15	n/c		
16	16	+5V	

### Notes

1. Jumper positions L3 and L4 for both terminal and modem remain as original.
2. 38,400 baud position is not available.
3. Pin 9 connects to the "flying lead" which in turn connects to socket pin 6 of U9 to supply the modem clock to the in-built modem.

## WIA News

### New WIA Members

The WIA bids a warm welcome to the following new members who were entered into the WIA Membership Register during the month of May 1997.

L21037	MR D DOUGLASS
L50612	MR R BAX
VK2BFN	MR A A CLOUT
VK2BSR	MR O LOPEZ
VK2ERQ	MR F H GLEASON
VK2HBV	MR A W MADDEN
VK2KQ	MR J P AYLING
VK5AIC	MR I R CLAYTON
VK6BHY	MR M L TUTT
VK7HDM	MR D J MOSS

# Technical Abstracts

Gil Sones VK3AUI\*

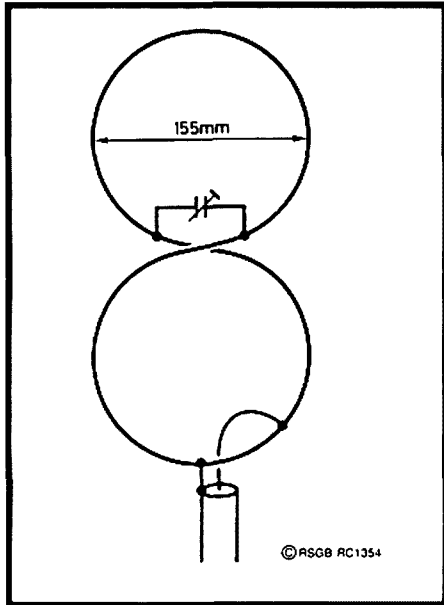


Fig 1 - PA0FRI magnetic 8 antenna.

## Magnetic Eight

An interesting double loop antenna was described in *Electron*, January 1997, by Frits Geerligs PA0FRI, and translated and reprinted in *RadCom*, May 1997, by Erwin David G4LQI in his *Eurotek* column. Frits PA0FRI has had a number of designs published.

The antenna consists of two loops, one above the other, hence the magnetic eight title. The loops both have a circumference of close to a quarter wave and are

connected in parallel with a capacitor at the crossover tuning them to resonance and serving to separate them at the crossover point. They are shown in Fig 1. The frequency is 145 MHz for the two metre band and is at band centre for Europe.

Matching arrangements are shown in Fig 2. Frits tried both a coupling loop as shown at Fig 2a, and a gamma match as at Fig 2b, and finally settled on a combination as shown at Fig 2c. He calls this a combi-match as it has elements of both the loop and the gamma match.

The loops were made from a one metre length of 3 mm diameter brass welding or brazing rod. A suitable pipe or can makes a good bending aid. The ends were joined by soldering into a sleeve at the bottom. The capacitor was a 10 pF ceramic piston trimmer. Attachment of the trimmer is shown in Fig 3. This is suitable up to 10 watts. Similar trimmers are available from time to time at hamfests. For outdoor use some sort of enclosure will be needed for the trimmer.

The trimmer must be adjusted with a non metallic tool. The trimmer is resonated and the match adjusted to give best SWR. Some interaction between adjustments is to be expected. A 2:1 SWR bandwidth of 1 MHz was obtained. Polarisation is vertical with a figure 8 radiation pattern. The pattern

and the narrow bandwidth may be of use to reduce signals from other services.

## Audible Meter Reader

In *QST*, March 1997, Anthony McCloskey WA3CAO described an audible meter reader. This is an aid which allows a meter reading to be converted into an audio tone. An adjustable reference tone is provided so that the reading can be determined by comparison between the two tones.

The circuit of the device is given in Fig 4. The loudspeaker used is a small eight ohm type. The oscillator IC U2 is a 74LS629 dual voltage controlled oscillator IC. This IC is available from at least one local source of components.

The reference oscillator is adjusted to zero beat with the oscillator driven by the amplifier U1. The position of the reference pitch potentiometer then corresponds to the input voltage. The gain of U1 is set by pre-set R2 so that the maximum audio frequency corresponds with the meter full scale reading. The gain of U1 can be varied over a considerable range so that a variety of meter sources can be accommodated.

The unit is battery powered and should be housed in a plastic case so that the unit is independent of earth. This allows the unit to be used in a variety of situations at modest potentials above equipment earth. However, it should not be used in a situation where it has to float at a dangerous voltage. Specialised construction techniques and components would be needed for such service. The insulation afforded by a plastic box should, however, allow use in low voltage circuits (operating up to 12 volts) without problems.

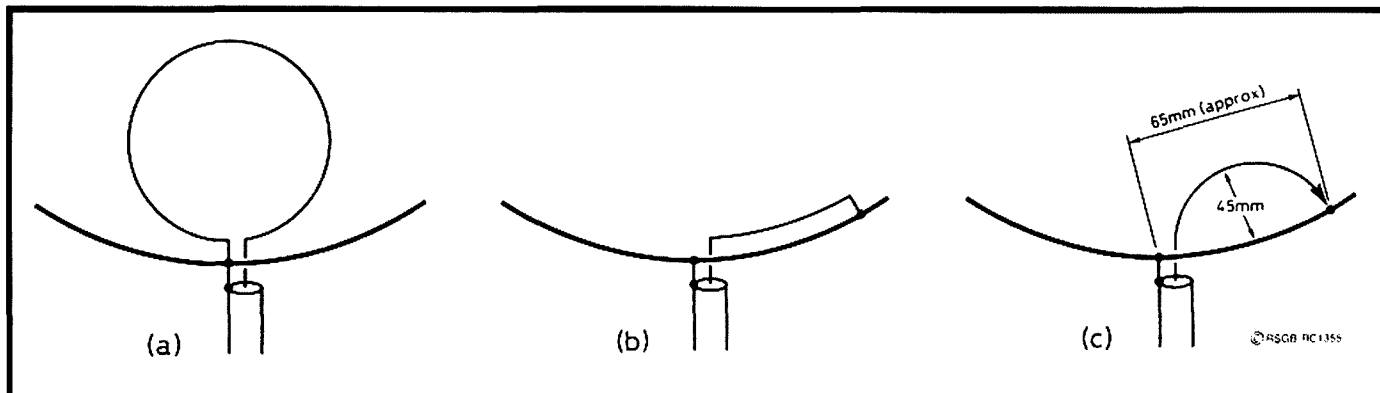
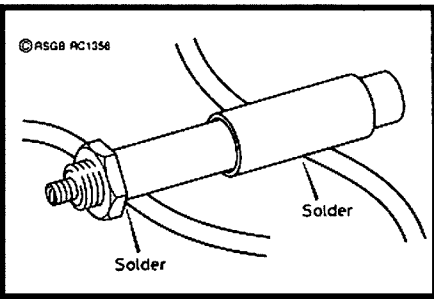


Fig 2 - Matching the magnetic 8.



**Fig 3 - Piston trimmer tuning capacitor mounting.**

**Fuses**

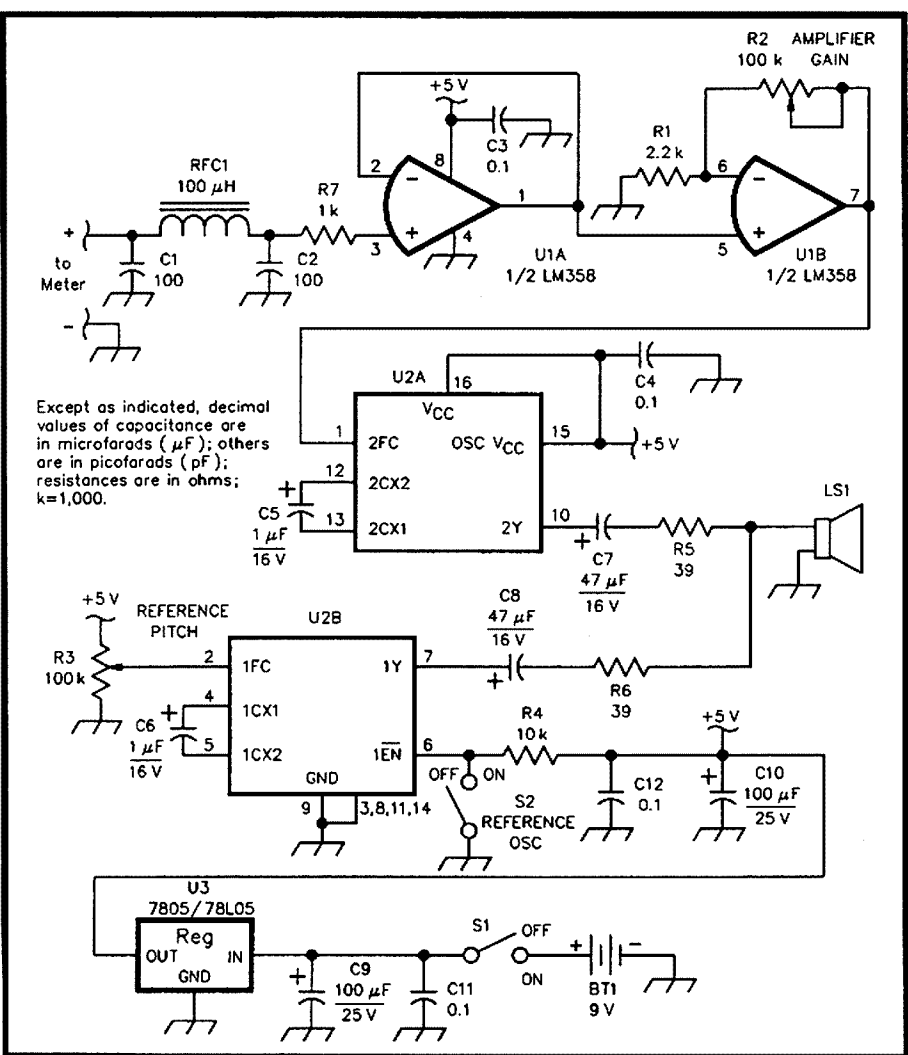
Interesting information concerning fuses is contained in the *In Practice* column of Ian White G3SEK in the February 1997 edition of *RadCom*. The use of fuses to protect equipment and wiring is common, but how they actually work is often not well understood.

Fuses can blow slowly under a

moderate overload or they can blow quickly under an extreme overload. They behave differently in these two cases. At the rated current of a fuse it will not blow and considerably more than the rated current is required before it will blow even after some time has elapsed.

A moderate overload results in heating of the fuse wire. The wire heats up until it is hot enough to melt and break the circuit. This may take some time for a moderate overload less than twice the rated current. In Fig 5 the typical time to blow is shown for a range of multiples of the rated current. Below twice the rated current the fuse could well last long enough for other devices to be barbecued. Most wiring has sufficient reserve to survive. Semiconductors may not have such reserves.

Overloads greater than five times the rated current will result in the fuse



**Fig 4 - Audible meter reader.**

**ICOM** Clearly Ahead



**"VK3LZ calling!"**

More sound information from your friends at Icom.

**AN ICOM WINNER!**

Congratulations to our Kiwi friend John Hyndman (ZL2WW), on winning the door prize at BARCFEST this year. John is now the proud owner of the state-of-the-art Icom IC-T7A dual band handheld transceiver. I'm sure John is pleased he made it across the Tasman for this year's memorable event!

**SPECIAL OFFER.**

Buy a fantastic new Icom IC-706 MKII from your nearest Authorised Icom Dealer between July 1st. and September 30th. 1997 and a CAHV quad band antenna (valued at \$250) is yours absolutely free! It's a great added value offer... and yet another example of the money saving opportunities you'll only get from Authorised Icom Dealers.

**MORE CONVENTIONS COMING UP :**

**WAGGA WAGGA** Sunday August 10th. '97

**SHEPPARTON** (Date T.B.A.) August '97

**TOWNSVILLE** September 26-28th. '97

**"...73"**

**FreeCall 1800 338 915**

**290 -294 Albert Street Brunswick, Victoria 3056**

**Tel : (03) 9387 0666**

**Fax : (03) 9387 0022**

ACN 006 092 575

ILL BROWN ADVERTISING 8158

## European Amateur Licences Upgraded

Amateurs in Finland and Poland have won more privileges in recent changes to their licence regulations and privileges.

The National Radiocommunications Agency of Poland has created two new types of Amateur Radio license, known as Class 3 and Class 4. Class 3 includes a 5 wpm Morse code test and authorises operation on 3,550-3,750, 28,050-28,500, 144-146, and 430-440 MHz. Class 4 has no Morse code examination and authorises operation only on 144-146 MHz. Morse code and voice operation is permitted using an output power of no more than 15 W. IARU band plans are to be observed. The minimum age is 12 years. Call signs begin with the prefix SQ, followed by the usual call-area numeral and a three-letter suffix.

Finnish amateurs have been granted more bands and higher power. The new privileges include:

(1) 135.7-137.8 kHz is available to all holders of general or technical (CEPT 1 or CEPT 2) licenses, with an output power limit of 100 W;

(2) 3400-3408 MHz is available to holders of general or technical licenses;

(3) The 160 metre band is expanded to 1810-1855, 1861-1906, and 1912-2000 kHz;

(4) Output power is increased to 1 kW on HF and 150 W CW or 600 W PEP on VHF;

(5) Telecommunications class ("VHF Novice Class") licensees have gained 144-MHz privileges plus all microwave bands allocated to the Amateur Service on a primary basis;

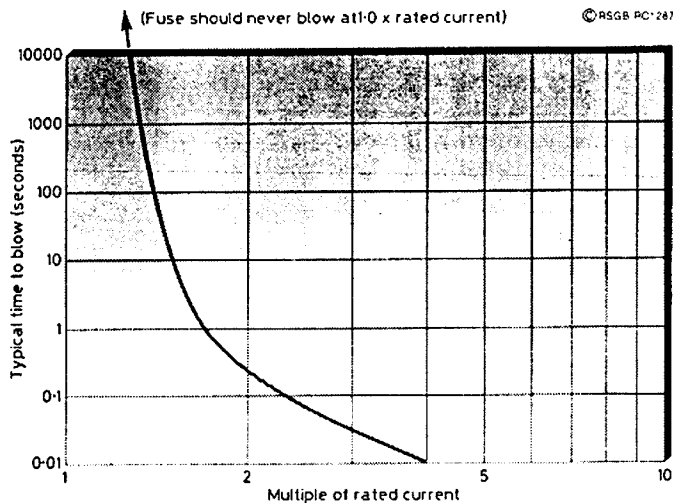
(6) The numeral in a Finnish call sign will no longer be tied to the station's location, except for the Aland Islands (OH0) - the SRAL encourages amateurs to continue the use of district numbers to indicate their location;

(7) Any available call sign may be requested, for a one-time fee of 2000 FIM (approximately A\$515!);

(8) Keeping a log book is no longer mandatory;

(9) Third-party traffic rules have been eased.

(Thanks to the *ARRL Letter*, 6 June 1997).



**Fig 5 - Typical time for fuse to blow.**

blowing quite rapidly. Normal fast acting fuses would blow within one AC cycle at 50 Hz or within 20 milliseconds for a five times overload.

When greater overloads occur the current possible is often far greater than that required to blow the fuse. In a high voltage or AC mains circuit an arc can develop as the fuse opens and the time taken to extinguish the arc can be significant. During the time that the arc exists, current continues to flow. This is shown in Fig 6. The time taken for the fuse action is extended. This could allow enough current to flow for long enough to rupture another fuse in the circuit. Thus, not only the fuse in the equipment could blow but also the fuse in the house switchboard might blow. Even more

embarrassing could be the supply authority fuse.

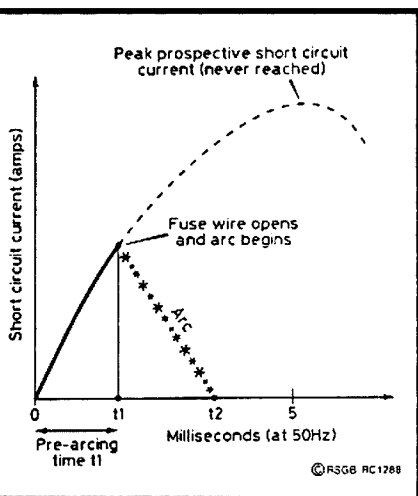
Some fuses are packed with powder to assist in extinguishing the arc, or incorporate other arc-snuffing features. This is particularly important for high voltage circuit fuses such as in a linear plate supply. Normal fuses are usually only rated to interrupt 240 volt AC mains.

"Slow Blow" fuses have modifications so that they take longer to heat up and so resist moderate overloads. They have a longer thermal time constant. They will, however, respond quickly to gross overloads. They are of use to cope with short duration moderate overloads.

Fuse manufacturers provide an indication of the performance of a fuse in the I squared t rating. This is the rupture current squared multiplied by the rupture time. The rupture time is made up of two parts as shown in Fig 6. The first part, or pre-arcing time, is independent of the supply voltage but the arcing time is dependent on the supply voltage. The arcing time is also different for AC and DC circuits as the AC assists in extinguishing an arc as it reduces to zero before reversing polarity during the course of an AC cycle. The use of this rating allows other components, such as semiconductors, to be rated so as to survive the blowing of a fuse. Most large power semiconductors also have an I squared t rating.

\*C/o PO Box 2175, Caulfield Junction VIC 3161

ar



**Fig 6 - Fuse blowing time showing rupture and arcing time.**

## ■ Antennas

# Random Radiators

with Ron Cook VK3AFW and Ron Fisher VK3OM\*

This month's column is mainly for the HF antenna experimenter and gives general information on two interesting verticals and a compact antenna.

### Portable Antenna for Outback Operation on 160 m

Rob VK8RC has made a number of coast to coast return crossings of the continent in his trusty Holden station-wagon. His most recent trip (May 1997) was along tracks that took him through Alice Springs. On this trip he has been operating mobile on 30 m during daylight hours and on 160 m during the evening and early morning. He maintained contact with stations in VK1, VK2, VK3, VK4, VK7, and VK8 throughout the trip. Quite probably he also worked the other States, but this wasn't during the few days I listened in. How do you maintain contact over 2,000 km when operating portable with 100 W? You need a very good antenna!

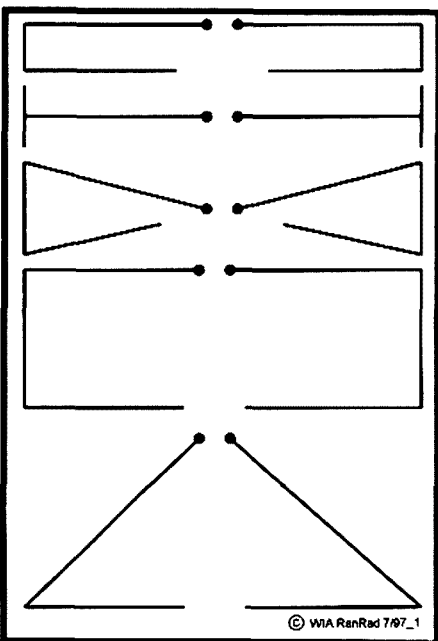


Fig 1 - Some ideas to shorten the length of a dipole.

Here are the details of the antenna as described to me by Eric VK3AX. It is a vertical made of metal tubes. The bottom section is just over 9 m (30 feet) high. A plastic laundry bucket serves as a former for the loading coil. The coil is 20 turns of 7/036 copper wire. The taper locks the turns in place. The top section is 3.3 m (10 feet) long and insulated from the bottom section. Large washers locate the inverted bucket.

Guys are attached about 2.3 m (7 feet) up the top section. The first 5 m (15 feet) are wires which provide some top loading. The remainder of the guys are nylon fishing line.

The base of the vertical sits on a wooden block. An insulating clamp holds the bottom section firmly to the wagon. Additional stabilising guys run from the 1.7 m (5 feet) level to the wagon.

Four radials, one quarter wavelength long, complete the antenna. A tuner ensures a 50 ohm load for the transceiver.

The efficiency of the antenna comes from the significant size of the vertical and the combination of inductive and capacitive loading. The dry desert soil may also assist the operation of the radials as these work best when above the effective ground.

### Improved Wide-band Antenna

Long time readers of *Amateur Radio* will recall references to wide-band dipoles and monopoles. The original concept should probably be credited to Altshuler, with improvements by Wu and King, all being well-known American investigators of antenna design. Two Australians, Guertler and Treharne also made significant contributions. There are several methods of broad banding an antenna.

One is to make the monopole or dipole element into a cone or fan. Another is to add reactive components to make a dedicated built-in ATU, although this

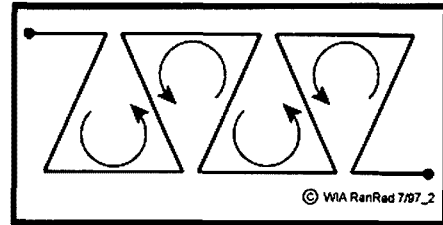


Fig 2 - Folding an antenna in this form cancels some of its natural inductance.

gives a lower efficiency than the first method. The third method is to terminate the antenna elements in a resistance equal to the characteristic impedance of the element.

The Terminated Rhombic is a well-known example of the third method. For single wires the terminating resistor is connected to the ground. If the element is not close to the ground, as is the case for most VHF antennas, this is not practical.

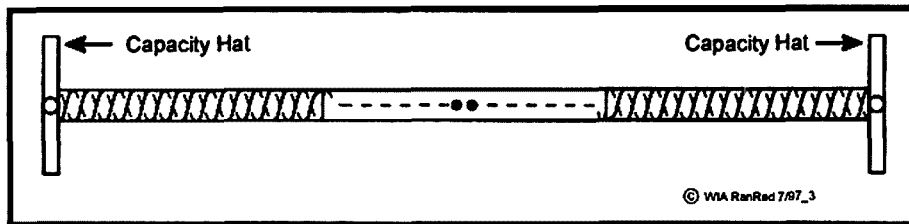
The Altshuler approach was to connect the terminating resistor to a quarter wavelength element. If the far end of a quarter wave element is in free space, the near end appears as a low impedance. So it provides an electrical ground for terminating resistors. The drawback is that the quarter wave element is only a quarter wave long at one frequency and at twice this frequency it is a half wave and "disconnects" the resistor.

Guertler used multiple wire terminating wires to get a broader bandwidth. Treharne tapered the wires of

Table 1

Resistance profile for 14 discrete loading points along the antenna.

Height (m)	Resistance (ohm)
0.208	0.419
0.625	0.489
1.041	0.581
1.458	0.699
1.874	0.859
2.290	1.080
2.707	1.401
3.123	1.889
3.539	2.689
3.956	4.129
4.373	7.131
4.789	15.102
5.205	49.473
5.622	786.910



**Fig 3 - A shortened dipole using the winding form shown in Fig 4.**

his sloping monopoles to maintain constant impedance and also used multi-wire terminations. Both used inductive shunts across the terminating resistors to extend the low frequency region. While both designs succeed very well, the bandwidth was still limited and efficiency was frequency dependent.

These antennas have essential constant-current levels from the feed point to the terminating resistor and are called travelling wave antennas. The conventional unterminated antenna has sinusoidal current variations with distance from the feed point and are called standing wave antennas.

In *Electronics World*, March 1997, Richard Formato describes a monopole design using small value resistors to load an element progressively and provide a broad band antenna. The example he gives is claimed to be twice as efficient as earlier continuously-loaded designs. Clearly the resistive loading absorbs power and reduces efficiency and the earlier designs which had a 5:1 frequency range had efficiencies that dropped to 10 – 15% in part of the range and often did not rise above 40%. Formato presents a design which he states has an average efficiency of 60% across the working range which is 36

MHz to 150 MHz for the 2:1 VSWR bandwidth. Useful operation from 11 to 150 MHz is claimed. The input resistance is 175 ohms.

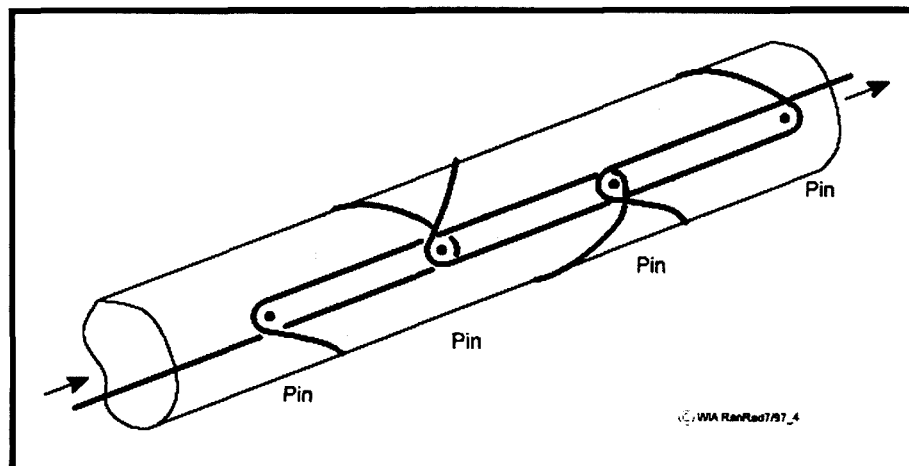
The monopole exhibits 1 to 4 dBd from 10 to 150 MHz. Table 1 gives details of the loading resistors and their placement. It should be possible to scale the antenna. For example, by increasing the spacing by a factor of ten it should produce an antenna which would be useful from 1 to 15 MHz.

These values are theoretical values and, in practice, resistances could not easily be obtained any closer than 5% of the values. The total height is equal to a quarter wavelength at 12.86 MHz, which will be 5.832 m for a thin wire. For a vertical of practical thickness all dimensions will need to be reduced. For a 2 mm wire a factor of 0.95 is suggested.

The performance was calculated by Formato for operation above a perfect ground plane. In practice a large number of radials 2.3 m long are suggested. Two monopoles could be used to give a wide-band dipole.

### Multi-Delta Antennas

Mark VK4MFX sent me a photocopy of an article from *Practical Wireless*, August 1995. Thanks Mark. In the



**Fig 4 - Winding details of the shortened dipole.**

article, Denis Payne G3KCR examines ways of reducing the length of dipole antennas.

The ends of a dipole can be bent so as to run at right angles, or, provided the spacing is not too small, run back parallel to itself. In the latter case the current near the end of the wire is smaller than the current closer to the feed point, so, although some cancellation of the radiated field may occur, the relative loss is acceptable. Some examples of more complex folding include dipoles in the shape of a rectangle, triangle or even a bow tie. Two wires at right angles to each other, placed at the end of a shortened dipole will provide capacitance to resonate the antenna. These designs are shown in Fig 1.

Denis has come up with a design that reduces the length of the dipole but, he claims, still maintains bandwidth and efficiency. Fig 2 shows a series of triangular loops, each one wound in the opposite direction to its neighbour. Figs 3 and 4 show the design Denis used for a 21 MHz dipole.

The loading coils have each turn alternately wound in opposite directions with capacitance hats to complete the arrangement. The coil is wound on a 25 mm diameter former with panel pins spaced at 43 mm along the former. The wire is 0.6 mm PVC insulated single strand copper. The capacitance hats are four 180 mm long rods, 3 mm in diameter. No other details are given.

How does this work?

Well, here is my interpretation of the operation. As the turns are separated by 43 mm their coupling factor is considerably less than one. The inductance would be very close to zero if they were perfectly coupled. As the field of one turn is not completely cancelled by the field of the adjacent coil we do have some net inductance, although there is much more copper used than would be the case if the coil were wound as a solenoid.

The Q of the coil will be reduced because of the higher resistance and also because some the energy in the coil will be lost as radiation. This will give a broader bandwidth for the 2:1 VSWR points. I'm not sure that the efficiency will be improved by this arrangement; indeed, I anticipate that it might be less



## Radio Sports on the Move

The sport of Amateur Radio Direction Finding (ARDF) is growing in followers and participants around Australia, as it is around the world. Equipment used at the Region 3 Championships held in Townsville last year (see *Amateur Radio*, September 1996, page 7) has been distributed around, with one set of four transmitters now residing with enthusiasts in Melbourne and the remaining sets in Queensland.

WIA Federal Radio Sports Coordinator, Wally Watkins VK4DO, advises that the Girl Guides in Adelaide are showing some interest in ARDF and hopes their efforts will meet with success.

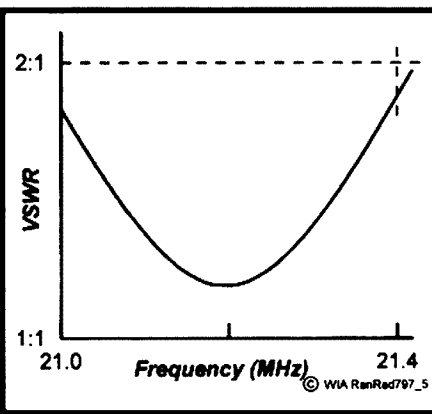
In August, Wally will be demonstrating ARDF at the Riverina Convention in Wagga Wagga, NSW, which is being held over the weekend of 9-10 August. On his way down to the Riverina event, Wally will fly the Radio Sports flag at the Sunshine Amateur Radio Club in northern NSW at the meeting on 5 August. Wally is a very entertaining presenter and his talks are always well supported with equipment, photos and videos. He is prepared to visit any club on his return journey from Wagga, to demonstrate equipment and answer questions. Contact him QTHR, or phone/fax: 079 47 1036.

The original triangular shape can be modified and a thin pyramid or tilted cube structure formed. Fig 6 shows Denis's 28 MHz version. He gives the overall length as 1.65 m and the feed resistance as 36 ohms. Contacts into the USA were one S point up on a ground plane. The 2:1 VSWR bandwidth is more than 1 MHz.

Unfortunately, there were no other construction details on this version. The intrepid experimenter will probably not be daunted by this as usually such a person adapts all design to suit available materials and personal preferences.

As always, your contributions to this column are sought. If sending in computer printouts, please note that antenna patterns printed with dot matrix printers will often prove impractical for reproduction, in which case you should describe the salient features in the main text.

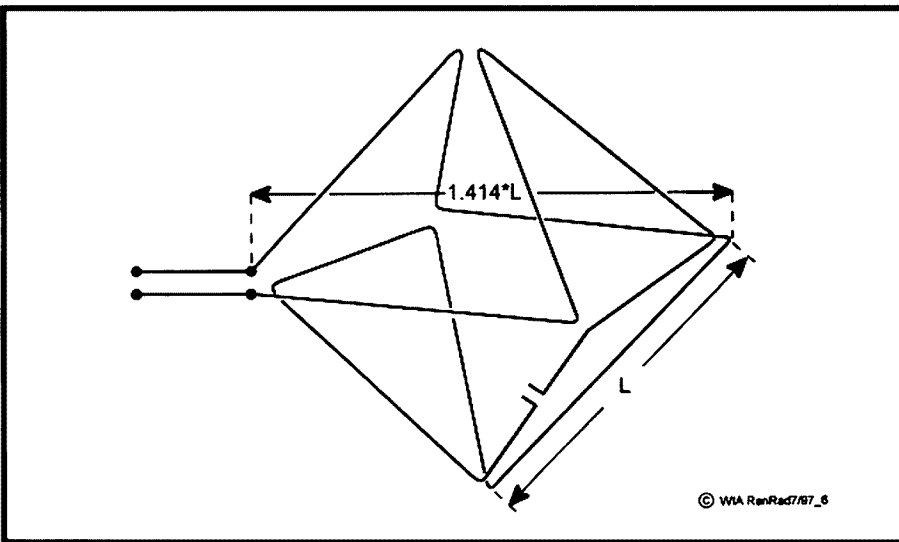
\*C/o PO Box 2175, Caulfield Junction, VIC 3161  
ar



**Fig 5 - VSWR curve of the 21 MHz antenna shown in Fig 3.**

than a conventional coil and capacitance hat system. The increased bandwidth could be sufficient compensation for the increased complexity and probable small drop in efficiency.

The VSWR curve of the 21 MHz antenna is shown in Fig 4. Good results were obtained with QSOs into Europe.



**Fig 6 - A 10 m diamond cage antenna.**

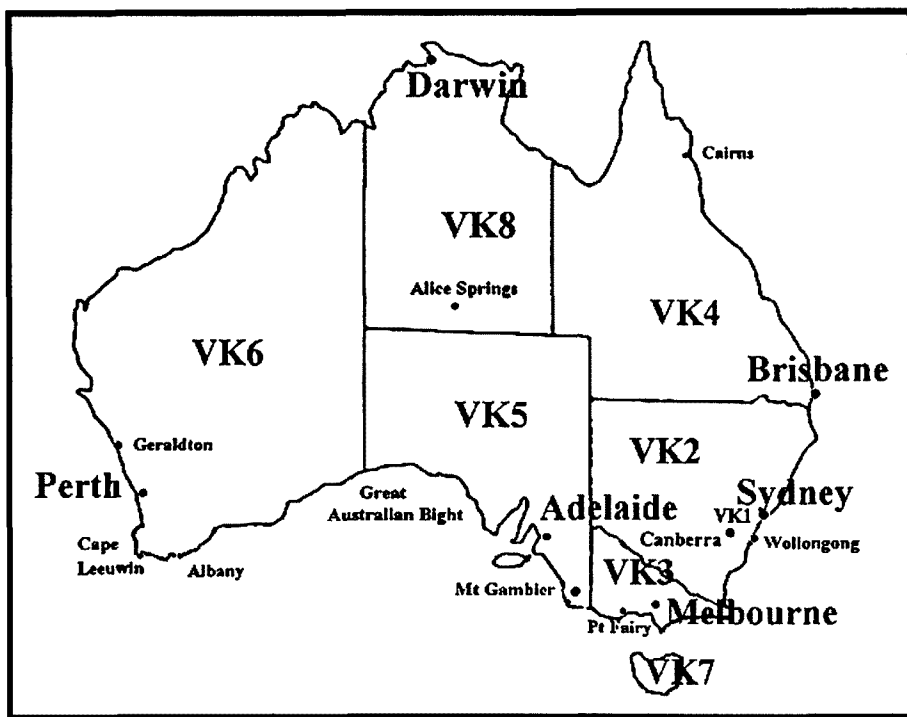
**Sign up a new WIA member today - we need the numbers to protect our frequencies and privileges**



**Your Hobby**      **Your Voice**  
Representing Radio Amateurs Since 1910

# UHF/Microwave UHF/Microwave Activity in Australia

Dr Walter J Howse VK6KZ\* gives a detailed run-down on what is happening on UHF and microwave in Australia.



## Summary

This article describes the current state of UHF/Microwave activity in Australia. Information is provided about propagation opportunities, distances worked, individual operators and equipment used. This article is based on observations by the author over an extended period, backed by visits during March 1996 to the most active microwave enthusiasts in southern and eastern Australia and aided by comments by other active operators during August 1996.

For the purpose of this article, the term "UHF/microwave" includes the bands from 1296 MHz up. Information about 1296 MHz FM, and FM repeaters, is not covered.

The first thing about these bands is that it is difficult to purchase commercial

equipment for them. Quite a number of the amateurs mentioned in this article have become very proficient in obtaining components and surplus equipment from specialist Australian suppliers and from overseas. Many would be very willing to assist others in building, testing and operating equipment on these higher bands.

The Equipment Supplies Committee of the Wireless Institute of Australia (run by the Elizabeth Radio Club) has played a very significant role in assisting Australian amateurs obtain components for home construction and for kits for some of the frequencies. They have their catalogue on the internet at [http://dove.net.au/~mark1/sa\\_vhf/esc\\_index.htm](http://dove.net.au/~mark1/sa_vhf/esc_index.htm)

In addition to *Amateur Radio*, most of

the active microwave constructors subscribe to (or read) more specialised publications. The most common journals are *QST*, *QEX*, *Radcom*, *Dubus*, *VHF Communications*, *North Texas Microwave Newsletter* and *RSGB Microwave Newsletter*. Many also have access to the Internet and use this for both e-mail and sourcing information.

## Centres of UHF/Microwave Activity

Proceeding in an anti-clockwise fashion around Australia, starting on the west coast in Geraldton (378 km north of Perth), Neil Sandford VK6BHT operates on 10 GHz and 24 GHz with 5.7 GHz under construction. Neil was formerly VK4ZT and held the national 1296 MHz record of 402 km from 1970 to 1971. He also holds the call VK1ZT. In Perth (population 1.2 million), those with equipment on 1296 MHz and above include Don Graham VK6HK, Alan Woods VK6ZWZ, Al Edgar VK6ZAY, Bruce Douglas VK6BMD and the author VK6KZ. On the south coast of Western Australia, Wally Green VK6WG in Albany has equipment for all bands to 10 GHz.

Adelaide (population 1.1 million) has beacons on 144 MHz, 432 MHz and 1296 MHz, 2.3 GHz and 10 GHz with beacons under construction for 3.5 GHz and 5.7 GHz. Those with equipment for 2.4 GHz and higher include David Minchin VK5KK, Roger Bowman VK5NY and Des Clift VK5ZO. Des Clift, under previous callsigns VK2AHC and VK5CU, held national records for 2.3 GHz (160 km 1973), 3.5 GHz (114 km 1977), 5.7 GHz (114 km 1975) and 10 GHz (114 km 1975).

Just south of Adelaide is Eric Jamieson VK5LP who has an international reputation as the author of the *VHF/UHF - An Expanding World* section of *Amateur Radio* magazine for nearly 28 years. Eric is very active on the VHF/UHF bands. A keen portable operator in his earlier days, he is now confined to a wheelchair which prevents him from operation on 10 GHz.

In south-eastern South Australia, active amateurs include Trevor Niven VK5NC and Chris Skeer VK5MC. Trevor, at Mt Gambier, is about 139 km from Russell VK3ZQB, 415 km from Melbourne and 350 km south of

Adelaide. Chris is active on 1296 MHz EME.

In western Victoria, Russell Lemke VK3ZQB is at Port Fairy, 295 km from Melbourne. In Melbourne (population 3.2 million) there are many SSB stations on 1296 MHz with emerging activity on the higher bands. Amateurs with equipment for the latter include Les Jenkins VK3ZBJ, Alan Devlin VK3XPD, Ian Berwick VK3ALZ and John Martin VK3KWA. In eastern Victoria, Rob Ashlin VK3DEM in Bairnsdale (270 km east of Melbourne) is active on 1296 MHz and 2.4 GHz, the latter being via an Icom 970.

Moving to New South Wales, Lyle Patison VK2ALU is active on 10 GHz EME in Wollongong, approximately 100 km south of Sydney. Activity on the higher bands in Sydney (population 3.7 million) is limited with 1296 MHz stations including Ross Usher VK2ZRU, Mike Farrell VK2FLR and Gordon MacDonald VK2ZAB. Alan Avery VK2AXA, Bill Cox VK2ZAC and Gary Beech VK2KYP operate on 10 GHz. About 280 km north of Sydney on the coast at Taree is R Barlin VK2DVZ who has EME potential on 1296 MHz.

In the Queensland capital of Brisbane (population 1.4 million), there are about 15 people with 1296 MHz SSB who include Rod Preston VK4KZR, Adrian Pollock VK2FZ/4, Glen McNeil VK4TZL, Doug Friend VK4OE, and Kim Harwood VK4KBH. Several are active on the higher bands.

In addition to a low population, there is little activity on the UHF/microwave bands across the northern part and the inland of Australia. The real enthusiast is Rex Pearson VK8RH in Darwin in the Northern Territory who has the only 1296 MHz and 2.3 GHz equipment in town! Maybe he will add 1296 MHz TEP contacts to those already achieved on 144 MHz to Japan!

## Propagation Opportunities

Perhaps the still most well-researched study of propagation around the Australian coastline was that carried out by Kerr<sup>1</sup>. His report was based on observations from 112 Royal Australian Air Force 200 MHz air warning radar stations near the coast of Australia during the period March 1944 to August 1945. It

was demonstrated that ducting in summer often extends over a large area of southern Australia simultaneously. The effects of ducting were most striking in north-west Australia and these peaked in winter. Conditions down the eastern coast of Australia produced infrequent ducting in the summer months. Interestingly this report was referred to in *Amateur Radio* for May 1950 but its significance appears to have been ignored.

Amateurs did not exploit the path across the Great Australian Bight until the WA VHF Group (Inc) installed a 144 MHz beacon in October 1968 at Mt Barker, 50 km north of Albany. This led to the first of many contacts on 144 MHz between Albany and Adelaide. This first QSO<sup>2</sup> was between Wally Green VK6WG and Mick McMahon VK5ZDR on 3 January 1969. Subsequently, the Great Australian Bight has been bridged on a number of the other amateur bands with first contacts made on:-

432 MHz on 11 December 1972 between VK6WG and VK5ZDY;

1296 MHz on 25 January 1977 between VK6WG and VK5QR;

2304 MHz on 17 February 1978 between VK6WG and VK5QR;

3456 MHz on 25 January 1986 between VK6WG and VK5QR; and

10368 MHz on 30 December 1994 between VK6KZ/p and VK5NY/p.

In addition to the Albany/Adelaide path of about 1885 km, contacts have been made over longer distances from points in the south west of WA as far west along the coast as Cape Leeuwin (on 144, 432 and 1296 MHz) by VK6KZ/p, and as far north from Perth (on the same bands) to points south and east of Adelaide and into Victoria. These contacts all cross the Bight and the longest distances worked have reached:

2223 km on 144 MHz, VK6HK Perth – VK3AUU South Drouin;

2715 km on 432 MHz, VK6KZ/p Cape Leeuwin – VK3ZBJ Melbourne;

2449 km on 1296 MHz, VK6WG Albany – VK3ZBJ Melbourne; and

1912 km on 10368 MHz, VK6KZ/p Torbay – VK5NY/p south of Adelaide.

These openings were dependent on the presence of a high pressure cell in the Great Australian Bight. For example, the weather map of 16 March 1988<sup>3</sup> (see Fig

1) was provided in a paper by Jamieson<sup>4</sup> illustrating the conditions of “a virtually stationary and typical high pressure system which produced outstanding results from Albany to Adelaide and Melbourne over a period of four days on all bands to 3.5 GHz”.

Contacts have been made along the north/south path along the Western Australian coast on 144 MHz from Cape Leeuwin as far north as Northwest Cape (1400 km). On 10 GHz, Neil Sandford VK6BHT in Geraldton and the author had 16 contacts and three incomplete ones over 27 days during the Ross Hull Memorial VHF/UHF Contest in December 1995/January 1996.

Along the north west Australian coast, there are very few amateurs using VHF SSB; the main activity is on 144 MHz FM. Contacts over 1000 km are frequent. Stations in Karratha and Port Hedland have also worked amateurs in Indonesia at Denpasar, Bali over a 1300 km path on FM.

## Activity on the Bands

### 1296 MHz Band

As in other countries, much of the early work on this band was based on varactor diode multipliers from 432 MHz using FM or CW. Having generated some power at 1296 MHz, air-cooled power amplifiers of the 2C39 variety were often used.

The two Australian amateurs noted for pioneering long distance contacts on bands from 1296 to 3456 MHz, along with unsuccessful efforts on 5760 MHz using this type of equipment, were Wally Green VK6WG based in Albany, Western Australia and Reg Galle VK5QR in Adelaide, South Australia. They were responsible for establishing world record distances of 1885 km across the Great Australian Bight on the lower three bands in the period 1977 to 1986. As mentioned earlier, the 1296 MHz contact was made on 25 January 1977, on 2304 MHz on 17 February 1978, and on 3456 MHz on 25 January 1986.

These world records stood for many years until the 1296 MHz one was broken by Chris Skeer VK5MC and the author, and then the others by Chip Angle N6CA and Paul Lieb KH6HME. Reg and Wally made a number of attempts to

repeat their home-to-home contacts on 5.7 GHz without success.

While CW was the main method of communication, SSB was generated by the Karl Meinzer DJ4ZC method involving division of an SSB signal at 20 MHz and then multiplication to the final frequency to restore the audio<sup>5</sup>. This used a division factor of three in generating a 1296 MHz signal. VK5QR re-designed this to give a division factor of six in order to produce SSB on 2304 MHz<sup>6</sup>. What is remarkable about these two operators is that they developed their equipment while separated by 1885 km and with no similarly inclined amateurs in their area. Additionally, neither has any professional training in radio and electronics, Reg Galle being a former high school teacher of English and Wally Green being a former tradesman working in the electrical, mechanical, fitting, machining and welding areas before retiring from his position as plant inspector. These two amateurs are still active at the age of 85 years. Wally Green has 10 GHz SSB equipment and is hoping to extend the author's 10 GHz world record!

Although there was similar varactor-oriented technology in use at that time by other operators elsewhere in Australia, none has stood out as much as these two.

Current technology in use is either home built transverters or commercial transceivers. A number have built the water cooled 2C39 design by Chip Angle N6CA; these were used by Cec Andrews VK6AO in Perth and Trevor Niven VK5NC at Mt Gambier in their SSB contact of 2364 km in February 1996, and by R Barlin VK2DVZ in Taree when working New Zealand. The late Dick Norman VK2BDN also worked ZL1AVZ in New Zealand over a 2132 km path in 1982.

EME activity began with Ray Naughton VK3ATN and then followed by the late Ron Wilkinson VK3AKC. Lyle Patison VK2ALU led the Illawarra Amateur Radio Society which operated EME under the callsign VK2AMW on 1296 MHz EME with 120 watts out to a nine metre dish from 1982 to about 1986. Chris Skeer VK5MC is the only current known operator.

With the more readily available "black box" technology for 1296 MHz (and much of it used on FM through

repeaters!) little further comment needs to be made on that band other than to draw attention to the extensive use made of aircraft paths to enhance signals and make routine SSB contacts over 600 km<sup>7</sup>. This is ably demonstrated each year in the near month-long Ross Hull VHF/UHF Memorial Contest when operators in Melbourne, Canberra, Sydney and Brisbane make contacts on 144, 432 and 1296 MHz at times based on the commercial airlines' timetables and flight paths. To the best of the author's knowledge, no one has yet tried the 2304 MHz band. Neil Sandford VK6BHT in Geraldton, 380 km north of Perth, did look at flight schedules with a view to trying aircraft enhancement with the author in Perth on 10 GHz but, unfortunately, the flight path was too far to the east to be successful.

### 2304 MHz Band

In addition to VK6WG, two Western Australian amateurs, Don Graham VK6HK and the author, built varactor multiplier-type transmitters for the 2304 MHz band and had contacts over distances of up to 274 km. Current activity on 2304 MHz in capital cities in Australia has had to be curtailed as pay television by MDS now overlaps the original narrow-band section.

Encouraged by the amateur satellite service Mode S, a number of people have built 2400 MHz receivers. For a while the Equipment Supplies Committee (referred to earlier) made available transverter kits based on the YU3UMV design<sup>8</sup> which enabled a number of VKs to transmit low power (500 mW) SSB signals. In Western Australia there are about three keen enthusiasts using such gear for terrestrial work up to about 150 km. The current kits are receive-only and are based on a design by VK5WA/VK5EME.

Alan Devlin VK3XPD and David Minchin VK5KK have transmitters producing five watts, and the former is carrying out tests with Rob Ashlin VK3DEM over the 270 km path.

In Queensland last summer, Doug Friend VK4OE with an Icom 970E, 1.5 watts and a 45 element loop Yagi, worked Adrian Pollock VK2FZ/4 who used a Down East Microwave transverter kit and five watts into a similar antenna over

a distance of 213 km for a new VK4 distance record.

### 3456 MHz Band

Although VK6WG, VK6HK and the author still have their original varactor multiplier equipment, activity on 3456 MHz is about to "explode" with a number of amateurs having completed (or have close to completion) transverters based on the Michael Kuhne DB6NT design<sup>9</sup> with about 250 mW power out. Oscillator injection is obtained using a Sam Jewell G4DDK001 design<sup>10</sup> followed by a MGF1302 tripler. On 10-11 August 1996, successful tests were carried out over a 130 km path using these transverters with a 600 mm dish and PCB triband feeds. Those involved were Alan Devlin VK3XPD, Russell Lemke VK3ZQB, Trevor Niven VK5NC, David Minchin VK5KK, and Colin Hutchesson VK5DK. Both VK3XPD and VK5KK have five watts capability with MGF0904/5s.

In Perth, Al Edgar VK6ZAY has designed and built his own transverter with about 50 mW output.

### 5760 MHz Band

The current Australian distance record<sup>11</sup> for this band is 191 km between D Apted VK7DA/p and Steve Hutcheon VK4ZSH/pVK7 made on 20 January 1991; this reflects the limited activity on that band. Steve used varactor multipliers. He travelled to VK1, VK2 and VK3 to establish records for those States as well as his home State of VK4. The record distance for VK5 is 176.4 km between N Tebneff VK5NT and Des Clift VK5ZO on 12 Nov 1989. There are no claims for VK6 or VK8.

As mentioned earlier, Reg VK5QR and Wally VK6WG made a number of unsuccessful attempts to bridge the Great Australian Bight on 5760 MHz. Their equipment used varactor multipliers but Wally Green did build two valve amplifiers based on the YD1060 tube. Don Graham VK6HK and the author built and still use varactor based equipment for this band.

In the last few years, a number of surplus 6 GHz receivers became available and several of these have been converted into low power SSB transmitters with a second one adapted

as a receiver. Al Edgar VK6ZAY and Alan Woods VK6ZWZ, using such equipment, have worked up to 150 km using coastal ducting.

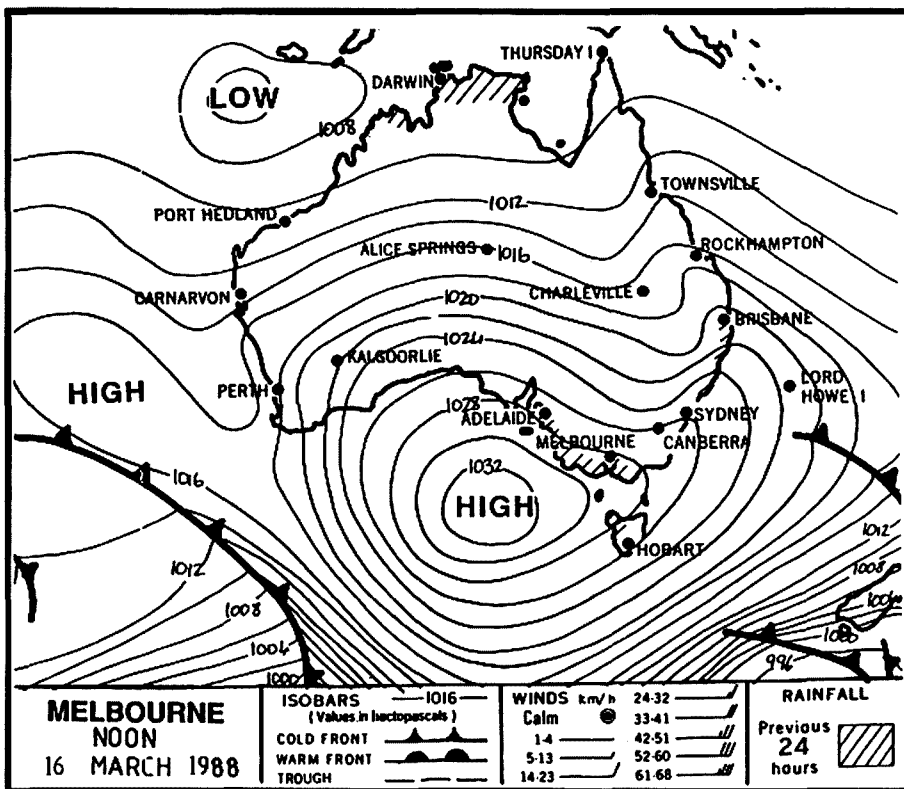
A concerted effort is being made by a group of amateurs in VK3, VK5 and VK6 to construct 5760 MHz transverters based on a DB6NT design<sup>12</sup>. The oscillator source is a Sam Jewell G4DDK006 design<sup>13</sup> with two MGF1302s following to 5616 MHz. Some of the completed transverters were used successfully on 10-11 August 1996 over the 130 km path, with the same dishes mentioned above, for 3.5 GHz. VK3XPD is experimenting with IMFET IM5964-3s to generate higher power and is building a hybrid combiner to use five of these devices to produce 16 watts.

## 10 GHz

Early pioneers of this band include Lyle Patison VK2ALU and Des Clift VK5ZO (formerly G3BAK, VK5CU and VK2AHC), Bill Cox VK2ZAC and the late Dick Norman VK2BDN. Their work was carried out with klystrons like the 723A/B and later Gunn diodes, gunplexers and narrow-band waveguide mixer transverters. Des is believed to have had the first QSO on 10 GHz in Europe in about 1950, and in Australia in the late 1960s. He has published articles and contributed to RSGB VHF/UHF Manuals, given many lectures on microwaves and currently provides a lot of assistance (and components) with antennas and feeds. The first 10 GHz operators in Western Australia in the early 1980s were Colin Murphy VK6CM and Roger Nottage VK6NR who used gunplexers to work distances up to about 70 km.

In 1992 Barry Grey VK6ZSB built and later published<sup>14</sup> the design for a 10 GHz transceiver based on an X-band alarm module with a 5 mW Gunn diode and in-line diode detector. The article included PCB layouts to allow home construction and 25 boards and modules were sold by Barry. There was a flurry of activity using these but the novelty appears to have worn off and those remaining in use are probably in point-to-point voice and/or data links.

Also in 1992 some surplus surveying tellurometers (Model MRA301) became available. These were constructed around a klystron providing 30 mW



Weather map of 16 March 1988

output between 10.05 and 10.45 GHz. Quite a few amateurs got their first taste of 10 GHz through these and some of the activity was focused on extending the Australian distance record. The Australian distance record for this band remained at 114 km from 1975 until it was extended to 170 km in 1981. Before tellurometers were used to accomplish greater distances, narrow-band designs became available.

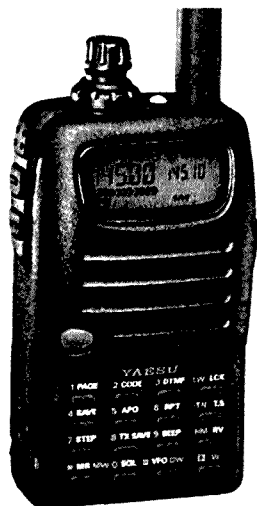
The designs by Charles Suckling G3WDG<sup>15</sup> and Michael Kuhne DB6NT<sup>16</sup> demonstrated that stable SSB equipment with higher power and improved noise figures for reception were within the capabilities of experienced amateurs. In the case of the Suckling design, the availability of critical components from the UK Microwave Committee Component Service was significant. Independently of, and unknown to each other, in Western Australia, Neil Sandford VK6BHT in Geraldton and the author chose that design while David Minchin VK5KK and Roger Bowman VK5NY chose the DB6NT route and these were joined by Trevor Niven VK5NC, Chris Skeer VK5MC, Russell Lemke VK3ZQB and Alan Devlin VK3XPD.

The first contact by the author with SSB was with VK6BHT/p over a 378 km path for a new Australian distance record, beating one of 290 km made between VK5NY/p and Chris VK5MC. This distance<sup>17</sup> was then extended in a flurry of contacts in 1994 in VK3, VK5 and VK6 until the current world record of 1912 km was achieved by Roger Bowman VK5NY/p (with 180 mW) and the author (100 mW and both with 450 mm dishes) on 30 Dec 1994. Since then VK6BHT and the author have added the G3WDG006 amplifier to get in excess of 200 mW while VK5NY has upped his power to one watt.

Wally Green VK6WG in Albany has a Toshiko Takamizawa JE1AAH transverter<sup>18</sup> with a G3WDG006 amplifier. He is well placed to break the world record. In Sydney the DB6NT design has been followed by Alan Avery VK2AXA and Garry Beech VK2KYP. Bill Cox VK2ZAC is using the Zack Lau KH6CP/1 design and Ross Usher VK2ZRU has modified satellite LNBS to get a transceiver. Alan VK2AXA also has a G3WDG transverter. Recently a number of amateurs have obtained Qualcomm amplifiers and have retuned these to 10 GHz with power output levels

# DICK SMITH ELECTRONICS

## Great Savings On Communications



### FT-10R 5 Watt 2m Hand-Held

A compact 2m hand-held with a unique clam shell design and rear-mounted NiCad battery pack that provides 5W RF output as standard through the use of a MOSFET power amplifier and extensive component miniaturisation. Built to a tough MIL-STD 810 rating for shock and vibration resistance, the FT-10R also uses gasket seals for improved weatherproofing.

#### Features:

- Tx 144-148MHz, Rx 140-174MHz
- RF Output: 5.0, 2.8, 1.0, 0.1W
- Dual watch facility
- Large Omni-Glow backlit display
- High efficiency speaker for super loud audio
- CTCSS encode/decode
- Auto battery save, Tx save & Auto power off for longer operating times
- 12V DC socket for charging and power
- Keypad frequency entry
- 99 memories
- Digital code squelch

Size: Just 62 x 100 x 42mm (WHD)

Comes with FNB-41 9.6V 600mA/H NiCad, A16D version keypad, belt-clip and AC charger.

Cat D-3650

STILL JUST  
**\$399**



2 YEAR WARRANTY

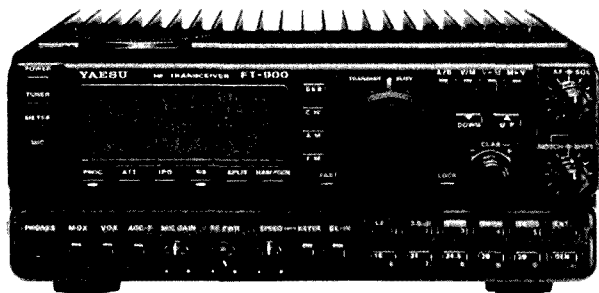
### FT-900 Deluxe HF Mobile Transceiver

The Yaesu FT-900 is a revolutionary new 100W HF transceiver that answers the need for a truly practical mobile radio, but without the performance compromises of most micro-sized rigs when used in base station installations.

For convenient mobile operation, a lightweight front sub-panel with access to commonly used controls can be easily mounted away from the transceiver's body using an optional mounting kit. The large "Omni-Glow" backlit LCD screen provides high visibility over a wide range of viewing angles, while the voice and data between the sub-panel and the transceiver are digital to minimise RF feedback or noise pick-up problems. A tough diecast top panel/heatsink and duct-flow cooling systems allows extended transmission periods, while still allowing the optional ATU-2 auto antenna tuner to be mounted inside the transceiver.

Cat D-3280

2 YEAR WARRANTY



**\$1895**

**BONUS**  
Half-price ATU-2 auto antenna tuner when purchased with your FT-900. SAVE \$249

### FT-990 HF All-Mode Base Transceiver

We're overstocked on ex-demo transceivers, so take advantage of this opportunity to save on an excellent HF base-station rig! The FT-990 offers many of the features of the legendary FT-1000, only in a more compact and economical base station package. Together with clear front-panel layout and labelling, its large back-lit meter and uncluttered digital display allows for easy operation. The receiver uses a wide dynamic range front end circuit and two DDS to provide a very low noise level and excellent sensitivity over the 100kHz to 30MHz range. Transmitter output is 100W PEP on all HF Amateur bands (SSB, CW, FM) with high duty cycle transmissions allowed. The internal auto antenna tuner and an in-built power supply are standard features, while the customizable RF speech processor and switched capacitance audio filtering facilities are unique to the FT-990. Other features include IF Shift and IF Notch filters, IF bandwidth selection, 90 memories and one-touch band selection.

Cat D-3260

Clearance

Only **\$2495**

2 YEAR WARRANTY



## FT-8500 Deluxe 2m/70cm Mobile

An exciting model from the Yaesu mobile lineup, the FT-8500 2m/70cm FM transceiver introduces the advantages of a large remountable Omni-Glow™ display with all major controls on an easy to use hand microphone, and MIL-STD 810C ruggedness. The FT-8500 provides three dual-band receive configurations (VHF+VHF, UHF+UHF, VHF+UHF), allowing cross-band full-duplex as well as standard single band operation. A unique Spectra-Analyzer™ with selectable channel and indicator widths shows station activity and relative signal strength above and below the current operating frequency or selected memory bank. Simple menu programming with alphanumeric labelling also covers most transceiver functions. Other features include 110 memory channels, inbuilt CTCSS encoder, a 1200/9600 baud data socket for Packet operation, Battery voltage readout, DTMF paging, and extensive scanning facilities. Supplied with MH-39 hand mic, DC power lead and instruction manual.

**\$999**

**Specifications**  
Frequency Range:

Tx 144-148, 430-450MHz  
Rx 110-174, 300-500MHz  
2m - 50, 10, 5W  
70cm - 35, 10, 5W

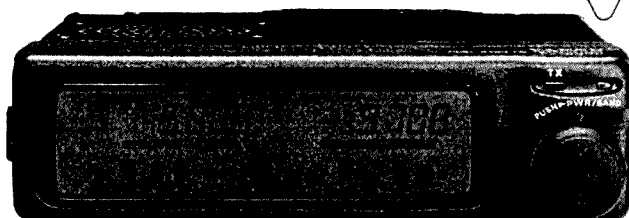
RF Output:

Sensitivity (Ham bands):  
Dimensions:

0.18uV (Main Rx), 0.25uV (Sub Rx)  
140 x 40 x 160mm (WHD)

Cat D-3318

**2 YEAR WARRANTY**



## 2m/70cm Mobile Antenna

An easy way to go mobile, the new fibreglass M270 antenna with standard 5/16" thread can be used with existing base/lead assemblies you may already have in place on a vehicle. Constructed on a strong fibreglass rod and covered with long-life polyolefin heatshrink, this 975mm long antenna covers 144-148MHz and 430-440MHz with a maximum power rating of 200W FM.

Cat D-4808

**MOBILE ONE**

**\$34<sup>95</sup>**



## 2m 1/2 Wave "On-Glass" Antenna

A high quality ground-independent mobile antenna that's easy to install without drilling holes. It's low-angle radiation pattern, slim radiator and an efficient coupling system provide excellent mobile performance. Provides 3dB gain, with power rating of 50W continuous (100W intermittent).

Cat D-4206



**\$99<sup>95</sup>**

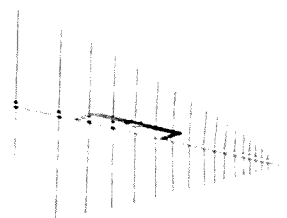


## LP-1300 Log Periodic Yagi

The Maldol LP-1300 is a Log Periodic Yagi beam antenna designed to provide useful gain across the 100 to 1300 MHz range, making it ideal for scanner enthusiasts and ham operators who need a directional wide-band antenna. The LP-1300 consists of a 17 element Yagi with a special feed system that provides low SWR (less than 2.0:1) across the 100-1300MHz range, and can handle up to 500W FM when used for transmitting.

Gain: 6.0dBi to 10.0dBi  
(depending on frequency)  
Boom length: 1.46m  
Longest element: 1.35m  
Weight: 2.3kg  
Suitable mast: 28-60mm diameter  
(not supplied)  
Max wind speed: 40m/sec  
Connector: SO-239  
Cat D-4828

**\$249**



## Rugged HF 5-Band Trap Vertical Antenna

The rugged 5BTV incorporates Hustler's exclusive trap design (25mm solid fibreglass formers, high tolerance trap covers and low loss windings) for accurate trap resonance with 1kW PEP power handling. Wide-band coverage is provided on the 10, 15, 20 and 40m bands (SWR typically 1.15:1 at resonance, < 2:1 SWR at band edges) with 80kHz bandwidth typical on 80m at less than 2:1 SWR. An optional 30m resonator kit can be installed without affecting operation of other bands. High strength aluminium and a 4mm (wall thickness) extra heavy-duty base section guarantee optimum mechanical stability. At just 7.65m, the 5BTV can be ground mounted (with or without radials, although radials are recommended), or it can be mounted in an elevated position with a radial system. Unlike other antenna designs, the 5BTV can be fed with any length of 50-ohm coax cable.

Cat D-4920

**HUSTLER**

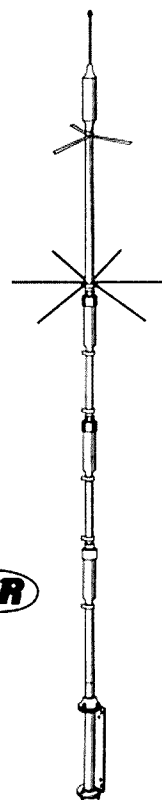
**\$349**

### 30m Resonator Kit

Adds 30m coverage to the 5BTV, and includes all hardware.

D-4921

**\$89.95**



Offers expire 31/7/97.

For further information, orders or the location of your nearest store call:

Ph: 1300 366 644 (local call charge)

Or Fax: (02) 9805 1986

**DICK SMITH**  
**ELECTRONICS**

B 2970

of about one watt. Complete Qualcomm units are being imported from the USA and a number of other operators are expected to appear on the band or to upgrade their power levels.

As far as EME is concerned, there are two operators, Lyle Patison VK2ALU in Wollongong about 100 km south of Sydney and Alan Avery VK2AXA in Sydney. Alan Devlin VK3XPD will soon have EME capability with a 50 watt TWTA into a two or three metre dish. Roger Bowman VK5NY has been experimenting with two TWTA's but has not publicly committed himself to using these for EME.

After working Jim Vogler WA7CJO using a 1.75 metre dish and a Siemens RW1125D TWTA providing 16 watts<sup>19</sup>, Lyle was determined to work Charles Suckling G3WDG on 10 GHz EME. In order to overcome site limitations in the direction of Europe, Lyle mounted his 3.7 metre EME dish with a Gregorian feed on a car trailer which is towed from its parked position at the side of the house to the front of his driveway. Lengthy control cables run from the transmit and receive equipment mounted at the rear of the dish to the receive/transmit IF of 144 MHz and the control circuitry in his garage. Lyle worked Charles Suckling G3WDG and Petra Suckling G4KGC on 18 August 1996 over a 17000 km path.

Lyle has a one watt portable station based on the G3WDG design (Lyle was a beta tester of portions of that transverter). Lyle holds the VK1 and VK2 distance records with a contact of 218 km to Bill Cox VK2ZAC by operating portable from Canberra.

Alan Avery VK2AXA is located in the northern suburbs of Sydney. He is completing a 10 GHz EME station using a TWTA sent originally to Adrian Pollock VK2FZ. Due to zoning restrictions on the use of an approximately four metre dish, it is mounted on a cliff face at the back of a family property and is painted green and black so as to be inconspicuous.

## 24 GHz

Several amateurs are known to have experimented in this band using gunplexers. These included Keith Bainbridge VK6XH and Greg Hatcley VK6YBI in Perth. Ashley Anderson VK2XSO in Sydney used wide band FM

klystron tellurometers to work 40 km from Kurrajong on the edge of Sydney down to Castle Hill.

Wideband 24 GHz gear with about 40 mW and a small horn is about to be tested by Alan Devlin VK3XPD, Russell Lemke VK3ZQB, Trevor Niven VK5NC and David Minchin VK5KK.

At this time, the only two narrow-band operators are Neil Sandford VK6BHT and the author, VK6KZ. They decided to operate on the 24048 MHz portion of the band. First contacts were made using the DB6NT Mark 2 transverter design<sup>20</sup> with about 400 microwatts output and at distances to 69 km. The oscillator chain used the G4DDK006 design with a G3WDG009 multiplier<sup>21</sup>) to obtain injection of 11952 MHz. Neil then built, for the author and for himself, HEMT power amplifiers (again a DB6NT design with board obtained from the UK Microwave Committee Components Service) comprising a 2SK1844 HEMT followed by two MGF1303s and finally two MGF1303s in parallel. These are used with a four port waveguide switch in both the receive and transmit roles. With these, tests were carried out up to distances of 86 km on 6-7 July when Neil was in Perth. Serious testing with ducting along the Western Australian coast commenced in the summer of 1996/97.

## Above 24 GHz

The Australian record distance for 47 GHz is 18.3 km between Alan Anderson VK3KAJ/p (now VK3CV) and K Harbeck VK3ZKH, with the contact made on 9 February 1995. It is believed they used Gunn diode technology.

No activity has been reported on any higher bands.

## Concluding Comments

Despite its vastness and low overall population, Australia has microwave operators who make up for their lack of numbers with undeniable enthusiasm. Nowhere more visible than this enthusiasm has been the occasions when the author has been portable along the south coast of Western Australia. Hourly skeds during the night accompanied by long distance driving (for example, Roger VK5NY and David VK5KK covering 400 km before returning home

the next day) or tenacity such as exhibited by Trevor VK5NC who worked Cec Andrew VK6AO in Perth on 1296 MHz SSB over a distance of 2364 km within five hours (at 01.44 local time) of returning from hospital after a heart attack. After a further three hours he went out portable to carry out unsuccessful tests over a 2050 km path on 10 GHz with the author who was portable near Albany.

The less visible enthusiasm is that shown by the individuals building the gear often without, or access to, sophisticated test equipment.

It is hoped that the successful launch of the Phase IIID satellite will encourage more activity on the microwave bands for both satellite and terrestrial working.

## Acknowledgments

The author thanks the many amateurs who offered hospitality on his interstate travels and, in particular, Don Graham VK6HK, David Minchin VK5KK, Eric Jamieson VK5LP, Alan Devlin VK3XPD, Lyle Patison VK2ALU, Alan Avery VK2AXA and Rod Preston VK4KZR who provided comments on an earlier draft of this paper. The author remains responsible for any errors.

## References

- (1) Kerr F J, "Radio Super-refraction in the Coastal Regions of Australia", *Australian Journal of Scientific Research (Physical Sciences)*, Dec 1948, pp 443-463.
- (2) West Australian VHF Group Bulletin, May 1969, p 3.
- (3) Commonwealth Bureau of Meteorology, Australia.
- (4) Jamieson E, "Propagation on the Bands 50 MHz to 1296 MHz", unpublished paper presented to South Australian Technical Symposium, South Coast Amateur Radio Club, Saturday 24 July 1993, p 12.
- (5) Meinzer K, "An SSB Transmitter for the 13 Cm Band", *VHF Communications*, 3/1971, pp 172-176.
- (6) Galle R V, "A New Method of Frequency Multiplication for VHF and UHF SSB", *VHF Communications*, 2/1979, pp 76-84.
- (7) McArthur Doug, "Aircraft Enhancement of VHF/UHF Signals", *Amateur Radio*, July 1985, p 4-6 (for details of 144 and 432 MHz), and



Suckling Charles, "Microwaves: Aircraft scatter propagation", *Radcom* May 1983, p 434.

(8) Vidmar Matjaz, "Microstrip Transverters for 23 and 13 cm", *VHF Communications*, 2/1986, pp 96-107 and 3/1986, pp 143-164.

(9) Kuhne Michael, "Transverter for 3.4 GHz", *Dubus Technik III*, 1992, pp 163, 291-300.

(10) Jewell S T, "Microwaves: A local oscillator source", *Radcom*, March 1987, pp 199-201; see also Dixon M W, *Microwave Handbook Volume 2*, Radio Society of Great Britain, 1991, pp 8.8-8.12.

(11) "VHF/UHF Records", 1996 Call Book, Wireless Institute of Australia, p 46.

(12) Kuhne Michael, "Transverter for 5.7 GHz", *Dubus*, 3/1991, pp 11-23.

(13) Jewell S T, "An oscillator/multiplier chain for the frequency range 2.0 to 2.6 GHz", *Radcom*, August 1990, pp 35-38; see also Dixon M W, *Microwave Handbook Volume 2*, Radio Society of Great Britain, 1991, pp 8.12-8.16.

(14) Grey Barry, "Build a wideband FM TV transceiver for 10 GHz", *Amateur Radio Action*, Vol 15 No 12, pp 36-40.

(15) Suckling Charles, "Modern 10 GHz transverter System Part I", *Dubus*, 3/1993 pp 22-33; "Part II" *Dubus*, 4/1993, pp 21-46; "Part III", *Dubus*, 1/1994, pp 5-22; see also Dixon M W, *Microwave Handbook Volume 3*, Radio Society of Great Britain, 1991, pp 18.100-8.

(16) Kuhne Michael, "A Simple 10 GHz Transverter", *Dubus*, 1/1991, pp 3-11.

(17) Jamieson E, "VHF/UHF - An Expanding World: World Record 10 GHz Contact", *Amateur Radio*, February 1995, p 46.

(18) Takamizawa Toshiko, "10 GHz T/R Module", *Dubus*, 2/1990.

(19) "Activity News: Australia to the USA via the Moon", *RSGB Microwave Newsletter*, October 1994, p 11.

(20) Kuhne Michael, "Simple transverter for 24 GHz (MKII)", *Dubus*, 1/1993, pp 5-9.

(21) Suckling Charles, "WDG009 Multiplier", unpublished.

\*4 Renton St, Melville WA 6156  
howse@cleo.murdoch.edu.au

ar

## ■ Book Review

# The CB PLL Data Book

**Publisher:** CB City International

**Author:** Lou Franklin K6NH

**Reviewed by:** Peter Parker VK1PK\*

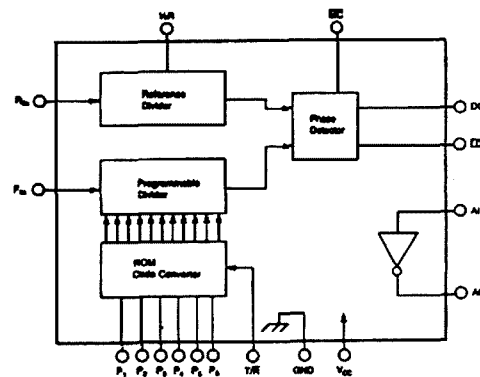
Rising solar activity will mean better conditions soon on ten metres. While it will be a year or more before the band reaches its peak, sporadic-E propagation makes solid interstate contacts possible even in low sunspot years. A lot of power and a big antenna is not necessary, and many operators find that a 27 MHz CB radio converted to ten metres is ideal, particularly for mobile and portable operation. Converting CB radios to ten metres is neither difficult nor expensive, but there are traps for the unwary. These include some newer radios not being easily modifiable, and information on many sets being hard to come by.

The eighty-page CB PLL Data Book should help the newcomer grasp what is involved in converting a CB to ten. Indeed, it should be possible to modify many models of set, armed solely with the information contained within the book. The first section contains a thirteen-page explanation of phase-locked loops, with particular reference to CB radios. The author's clear, crisp writing style is definitely a plus, and I would commend the chapter for those seeking to understand the operation of phase locked loops and frequency synthesisers.

The next section talks about modification methods. This is eighteen pages long, and goes through various means to modify radios, including altering division ratios, changing crystal frequencies, EPROMs, etc. Coverage is also given to truth tables and binary programming. It points out that the simpler the CB PLL circuitry, the harder it is to modify, and those with a single 10.240 MHz crystal are almost impossible to convert.

## THE CB PLL DATA BOOK

Lou Franklin



**A Repair & Modification Reference**  
Includes American, British, & European CB Radios  
AM, FM, & SSB Circuits

Most of the rest of the book contains information about specific PLL circuits and ICs used in American, European and even Australian CB models. The book was last revised in 1991. Unfortunately only block diagrams are given; it would have been good to have complete circuits for those who want to use ex-CB PLL chips in homebrew projects.

Overall, I would recommend the book as a good starting point for licensed amateurs interested in modifying CB radios or learning more about frequency synthesisers.

The review copy cost \$19.95 and was supplied by Dick Smith Electronics.

\*7/1 Garran Pl.  
Garran, ACT 2605  
VK1PK@VK1BBS  
parkerp@pcug.org.au

ar

# ALARA

Sally Grattidge VK4SHE\*, ALARA Publicity Officer

## Life for Christine

Jean VK5TSX

The VK5s changed their normal monthly luncheon in April so that it could include the presentation to Christine VK5CTY of Life Membership of ALARA. The excuse given to Christine for the change of date was that, as it was school holidays an extra body or two may be able to attend, and she fell for it.

There was an excellent turn up; Lorraine VK5LM and OM came down from Mallala, Jenny VK5ANW rearranged her lunch break, and Maria VK5BMT was actually in Adelaide for the event. Jean VK5TSX had such a long lunch break, she never made it back to work, and there were twelve members present altogether.

It was a momentous occasion, and Christine was rendered speechless, not just for a moment, but for a full twenty minutes! Tina VK5TMC had made up a certificate and had it framed to be presented by Denise VK5YL, and Jean produced a cake which was cut by Christine with great ceremony. A good time was had by all, and the whole affair got a mention on the local Sunday morning broadcast as well.

Christine has worked for ALARA for the past eight years in the positions of Minute Secretary, Vice President, and most recently as President, always devoting time and effort far in excess of the duties as prescribed. Congratulations again Christine.

Christine and OM Geoff are currently overseas exploring ruined castles, admiring great cathedrals and even experiencing real snow!

## A Little Bit of DX

Tiny ON4CAT, president of the Belgian YL Club, tells me that the club is having a special event station on 21 July with the callsign ON4YLC. On 26 and 27 July the club will be active again for two days from an International Hot Air Balloon Meeting using the callsign ON4EBM (Eelko Balloon Meeting)

Lydia DF3BN says there is an active YL packet net in Germany, so if you send bulletins mentioning YL in the subject you will mostly likely reach them.

## "New" Committee

ALARA's AGM was held Monday, 26 May on 3.5775 MHz in remarkably good conditions. Incoming president Judy VK3AGC did a great job controlling the net, as we all knew she would, and may have set

some kind of record for the shortest AGM ever held.

On the net were Judy VK3AGC, Bev VK4NBC, Gwen VK3DYL, Bev VK6DE, Poppy VK6YF, Mary VK3FMC, Marilyn VK3DMS, Robyn VK3ENX, Meg VK5AOV, Margaret VK4AOE, Jean VK5TSX, Tina VK5TMC, Maria VK5BMT, Val VK4VR, Sally VK4SHE, June VK4SJ, Bron VK3DYF, Pat VK3OZ/5 and Dot VK2DDB.

Office bearers are as follows: Executive President, Judy VK3AGC; Senior Vice President, Bev VK4NBC; Junior Vice president, Margaret VK3DML; Secretary, Tina VK5TMC; Treasurer/Souvenir Custodian, Margaret VK4AOE; Minute Secretary, Bron VK3DYF; Publicity Officer, Sally VK4SHE; Newsletter Editor, Dot VK2DDB; Awards Custodian, Jessie

VK3VAN; Contest Manager, Marilyn VK3DMS; Sponsorship Secretary, June VK4SJ; and Librarian, Kim VK3CYL. State Representatives are: VK1/2, Dot VK2DDB; VK3, Bron VK3DYF; VK4, Robyn VK4RL; VK5/8, Jean VK5TSX; and VK6, Bev VK6DE.

The position of Historian is not filled but may be taken by Christine VK5CTY, who has been deeply involved with ALARA's History Project. Margaret VK4AOE has agreed to another year as Treasurer, but will definitely go after that, and is very willing to assist anyone who would be prepared to do the job, but perhaps does not feel confident about handling it. Sally VK4SHE would like to vacate the position of Publicity Officer after this year, also. We have no VK7 Representative at this time, so any VK7 member reading this please volunteer.

\*C/o PO Woodstock, QLD 4816

Tel: 077 788 642

Packet: VK4SHE@VK4RAT.#NQ.QLD.AUS.OC

Internet e-mail: rgrattid@ozemail.com.au

ar

## QSP News

### Birthday Greetings Scouts turn 90 JOTA turns 40

The 40th birthday of JOTA will occur on 18 and 19 October 1997. To celebrate the event the Scout Radio and Electronics Service Unit, in conjunction with several Victorian amateur radio operators, are going to give Jamboree On The Air an added meaning, with a big balloon launch.

The balloon is to carry several Special Radio Stations including a Voice Beacon, Packet Beacon and a four channel Cross Band Repeater.

The good thing about this is that Scouts can listen to the Voice Beacon during the flight from even simple VHF scanners. The Beacon Frequency is 145.700 MHz. Scout JOTA Stations are invited to use the Cross Band Repeater for JOTA contacts.

The Amateur Radio Fox Hunting Teams are planing to recover the equipment once it comes back to earth.

How about launching your own smaller balloons from your JOTA sites with a stamped self-addressed envelope and a message inviting the return of your payload.

Transmission mode will be FM. Output power will be 100 mW continuous which will increase to approx one watt for the data bursts.

There will be a four-channel cross band repeater which will operate on the following frequencies at approximately 100 mW per channel:

Channel	Uplink	Downlink
1	432.900	145.300
2	432.925	145.325
3	432.950	145.350
4	432.975	145.375

Launch will be on Saturday, 18 October 1997 at 11 am at the Police Paddocks VK3SAC campsite, dependent on weather.

The mode of transmission will be FM in all cases. Telemetry will be 1200 Baud Packet and FM voice. Estimated coverage will be NSW (VK2), VIC (VK3), SA (VK5), and TAS (VK7) when at peak altitude (line of sight coverage to sea level over flat terrain is approx 500 km at 20 km altitude, and 350 km at 10 km altitude - higher sites may extend the range up to a further 2-300 km). Antenna polarisation will be vertical, estimated peak altitude will be 20+ km, and estimated flight time is three hours.

Further details and (JOTA Badges) from the Scout Radio and Electronics Service Unit (Victoria), PO Box 311, Box Hill, VIC 3128.

Philip Adams VK3JNI  
03 9438 3013 AH

# AMSAT Australia

Bill Magnusson VK3JT\*

## National co-ordinator

Graham Ratcliff VK5AGR

Packet: VK5AGR@VK5WI

E-mail: vk5agr@amsat.org

## AMSAT Australia net:

Control station VK5AGR

Bulletin normally commences at 1000

UTC, or 0900 UTC on Sunday

evening depending on daylight

saving and propagation. Check-ins

commence 15 minutes prior to the

bulletin.

Frequencies (again depending on

propagation conditions):

Primary 7.064 MHz (usually during

summer).

Secondary 3.685 MHz (usually

during winter).

Frequencies +/- QRM.

## AMSAT Australia newsletter and

software service

The newsletter is published monthly

by Graham VK5AGR. Subscription is

\$30 for Australia, \$35 for New

Zealand and \$40 for other countries

by AIR MAIL. It is payable to AMSAT

Australia addressed as follows:

AMSAT Australia

GPO Box 2141

Adelaide SA 5001

## Keplerian Elements

Current keps are available from the

Internet by accessing the AMSAT

FTP site, <ftp.amsat.org> and following

the sub-directories to "KEPS".

## Geo-Stationary or Geo-Synchronous, What's the Difference?

The possibility of a future amateur radio satellite(s) being placed into a geo-stationary orbit is once again being discussed. The forthcoming P3D will be placed into a synchronous orbit. But what exactly do these terms mean?

It's easy to be confused by them and believe they are all interchangeable. In retrospect, it was Arthur C Clarke, of "2001: a Space Odyssey" fame, who noted (in 1945!) that a satellite in a circular, equatorial orbit with a radius of about 42,242 km would have an angular velocity that matched that of the Earth and would therefore appear, to an observer on the ground, to always stay in the same spot in the sky. That was 12 years before SPUTNIK-1 and 18 years before the first geo-stationary satellite was launched. Good work, Arthur.

The easiest way to visualise this is to recall

that most low-earth orbits require a satellite to go around the Earth some 13 to 15 times per day. At the other end of the scale we have a satellite like the Moon which orbits at about 1/28th of one orbit per day. The controlling variable is their altitude.

The low-earth satellites are just outside the atmosphere, some 500 to 1000 km above the Earth. The Moon is, on average, between 358,000 and 400,000 km away. If it were closer it would orbit faster; if further away it would take longer than 28 days to complete one revolution.

It occurred to Clarke that, in between these two extremes, there should be an orbital height which would support an orbit of exactly ONE revolution per day. Well, as it turns out, he was correct. His contribution is honoured by the naming of the "Clarke Belt", a circle about 42,240 km radius and in plane with the equator. This is where all the geo-stationary satellites are orbiting. The result is, as Clarke suggested, that although they are racing around the Earth like any other, these satellites appear to be stationary to a ground based observer.

Now, satellites don't care what time it is on Earth. Their orbits are referenced back to the inertial sky, ie the star background, as is the Earth's real rate of rotation. The Clarke Belt is therefore at an altitude that supports approximately 1.0027 revolutions per (clock) day because that is what the Earth actually does in relation to the inertial sky.

If you have a look at the keplerian elements of a geo-stationary satellite you will see that the mean motion figure is about 1.0027. As Clarke said, this gives the satellite the same angular velocity as the Earth. Each geo-stationary satellite can "see" almost half the Earth; therefore three such satellites placed into orbit 120 degrees from each other will all be able to "see" each other around the Earth. Messages can therefore be relayed between them to cover almost the entire Earth. Almost, because they still miss a bit close to the poles.

A good example of this occurs at the Antarctic bases which are mostly located around the coast of the frozen continent, a distance from the South Pole. At these bases the INMARSAT dishes are virtually pointing at the horizon. Much further south and you could not use any geo-stationary satellite. They would be below your horizon.

Many satellites are in an orbit of the same radius as the Clarke Belt but their orbit is inclined. They pass through the Clarke Belt

twice every revolution. To a ground based observer they will not be stationary. They will trace out a short line or arc in the sky, sometimes a thin ellipse or "figure of eight". You can pick them from a kep element list by their mean motion figure of about 1.0027 and the fact that their inclination is NOT zero degrees. For stations at high latitudes they offer good communications with minimum tracking effort. These satellites are said to be geo-synchronous rather than geo-stationary.

As I said at the beginning, it is easy to confuse the two terms but they have quite different meanings. AMSAT's new flagship P3D will be in an orbit which brings it back over the same ground trace once every three revolutions. This is called a "Synchronous" orbit. Its period will ensure that the apogees will occur spaced 120 degrees of longitude apart so that after three orbits it will pass over the same (or close to the same) ground point. It will have three apogees in each 48 hours so every two days it will appear to be in the same part of the sky. It will not be stationary but will move, albeit more slowly, rather like AO-10 and AO-13. Some commercial satellites are placed into synchronous orbits to exploit similar orbital characteristics.

## Radio Books for Australia

### Shortwave Eavesdropper CD-ROM

Gives instant access to well over 32,000 frequencies and 42,000 call signs listing military, tactical, ships - naval and merchant, embassies, aeronautical, press agencies, weather stations and countless more. Also in-depth country by country information containing QSL addresses, schedules, examples of traffic, and maps, DX Edge.

Price: £19.50 including airmail.

### Shortwave Maritime Communications

World's coastal stations and shipping frequencies are listed as well as detailed chapters on how best to monitor all the maritime bands.....£17.00

### Scanner Busters 2

Explains new technology, encryption used and how best to scan on VHF/UHF bands.....£7.50  
Prices included postage to Australia.

### Also books on Weather, Military and

Scanning. Ask for FREE

MasterCard

Catalogue of all books.

## INTERPRODUCTS (AR1)

8 Abbot Street, Perth. PH2 0EB, UK

Tel. & Fax: 0011-44-1738-441199

e-mail: [interproducts@netmatters.co.uk](mailto:interproducts@netmatters.co.uk)

## Mid-year Amateur Radio Satellite Status Update

This year has seen the loss of MO-30, the possible loss of RS-10/11, and RS-16. Operations were suspended on MIR for some time as a result of a couple of nasty mishaps. Not a good start. Thankfully there have been no other major upheavals in the status of the OSCARs since January so I'll confine this report to an update of operations rather than an exhaustive list of frequencies/modes etc.

### MIR

Uplink 145.2 MHz FM, Downlink 145.8 MHz FM. Note, the above split is used for both packet and voice operation.

### SAFEX, MIR 70 cm Repeater

Uplink 435.75 MHz FM, Downlink 437.95 MHz FM, sub-audible tone 141.3 Hz. Many reports have been received indicating that Astronaut Mike Foale KB5UAC has been quite active on two metre FM as ROMIR from the MIR space station. Neither the packet station nor the SAFEX module have been re-activated after the recent suspension of operations.

### AO-10

Uplink 435.030-435.18 MHz CW/SSB, Downlink 145.975-145.825 MHz CW/SSB. AO-10 goes to sleep now and then as it is only being powered by the solar cells. At the time of writing it is going into eclipse and will be out of service for a few weeks at least.

### RS-10/11

Uplink 145.865-145.905 MHz CW/SSB, Downlink 29.36-29.4 MHz CW/SSB. No signals, beacon or transponder have been reported for some weeks. We may have lost RS-10/11.

### UO-11

Downlink 145.825 MHz FM, 1200 Baud PSK. Beacon 2401.500 MHz. Operating normally. Telemetry and bulletins only. This satellite does not have a transponder or user uplink of any sort.

### RS-12/13

Uplink 21.21-21.25 MHz CW/SSB, Downlink 29.41-29.45 MHz or 145.91-145.95 MHz CW/SSB. RS-12/13 is operational.

### RS-15

Uplink 145.858-145.898 MHz CW/SSB, Downlink 29.354-29.394 MHz CW/SSB. Be aware that RS-15 has battery charging problems, particularly when out of sunlight.

### RS-16

RS-16 signals have not been heard for some time and it may not be operational. No word from the control station. It is still possible that the switch-off is part of the commissioning process.

### AO-16 (PACSAT)

Uplink 145.9, 145.92, 145.94, 145.86 MHz FM, 1200 bps Manchester FSK. Downlink 437.0513 MHz SSB, 1200 bps RC-BPSK. Beacon 2401.1428 MHz.

### DO-17 (DOVE)

Downlink 145.825 MHz FM, 1200 Baud AFSK. Beacon 2401.220 MHz. Work is continuing on reloading DOVE software after the recent crash. Dove has no user uplink or transponder.

### WO-18 WEBERSAT

Downlink 437.104 MHz SSB, 1200 Baud PSK AX.25. Webersat is currently broadcasting telemetry only.

### LU-19 LUSAT

Uplink 1200 bps Manchester encoded FSK. Uplinks: 145.84, 145.86, 145.88, 145.9 MHz FM, Downlink 437.125 MHz SSB, 1200 bps RC-BPSK.

### FO-20

Uplink 145.9-146.0 MHz CW/LSB, Downlink 435.8-435.9 MHz CW/USB. Operating normally. Strong downlink signal.

### UO-22

Uplink 145.9, 145.975 MHz FM, Downlink 435.12 MHz FM, 9600 Baud FSK. Operating normally, carrying mostly SatGate traffic as usual.

### KO-23

Uplink 145.85, 145.9 MHz FM, Downlink 435.175 MHz FM, 9600 Baud FSK. KO-23 is operating normally, it has recovered from its recent QSY and over-deviation problems.

### KO-25

Uplink 145.980 MHz FM, Downlink 436.5 MHz FM, 9600 Baud FSK. KO-25 is operating normally. Lots of BBS traffic. Good signals.

### IO-26 ITAMSAT

Uplink 145.875, 145.9, 145.925, 145.95 MHz FM. Downlink 435.822 MHz SSB, 1200 Baud PSK. IO-26 controllers report that the new ROBOT software is currently undergoing tests. They ask that ground stations please do not transmit on any of the satellite's uplink frequencies for the time being.

### AO-27

Uplink 145.85 MHz FM, Downlink 436.792 MHz FM. This satellite is only switched to amateur service at weekends and only then in the northern hemisphere.

### FO-29

Voice/CW Uplink 145.9-146.0 MHz CW/LSB, Downlink 435.8-435.9 MHz CW/USB. Digital Uplink 145.85, 145.87, 145.910 MHz FM, Downlink 435.910 MHz FM 9600 baud BPSK. As usual with the Fuji satellites it is difficult to get a hard and fast operating schedule.

### New Surrey Satellites

No news to hand yet on these exciting new birds, perhaps next month.

\*RMB 1627, Milawa VIC 3678  
E-mail: vk3jt@amsat.org

ar

---

---

## Club Corner

### ANARS (Australian Naval Amateur Radio Society)

**C**Q CQ CQ all radio amateurs and interested SWLs who have a professional naval or marine background. ANARS offers you the opportunity to enjoy amateur radio activities in company with kindred souls of the sea.

Join one of our Navy Nets, QSO/QSL with the crew and/or DX.

Weekly Nets are: Mondays on 3532 kHz, 0930 UTC, CW mode; and Wednesdays on 3620 kHz, 0930 UTC, SSB mode.

Daily SSB Nets are: 7075 kHz, 0400 UTC (Net Control VK2SEA); and 14175 kHz, 0430 UTC, "The Seven Seas Net" (Net Control VK7SEA).

ANARS promotes various awards and publishes regular issues of QUA, the official Journal of the Society. Articles contributed by members include topical, historical,

technical and biographical items from home and abroad, along with general business items of the Society.

For further information, please write to The Secretary ANARS, 13 Brothers Road Dundas, NSW 2117; or phone 02 9638 3569; or e-mail [fayem@sydney.dialix.oz.au](mailto:fayem@sydney.dialix.oz.au); or simply join one of our nets for a cordial welcome.

Our common bonds are the sea and radio.

Doug Charlton VK7DK

ar

**Prevent pirates –  
make sure you  
sell your  
transmitter to a  
licensed amateur**

# Awards

John Kelleher VK3DP - Federal Awards Manager\*

It is really gratifying to note that, after the publication of a list of Australian awards, I have received information on three of those awards, verifying that they are still viable. These are the Wildcat Award, the Pelican Award, and a small group of RNARS sponsored awards, including the H M Colonial Ship Protector Award.

## The Wildcat Award

This award, with its central motif of a marine oil rig, depicts the discovery of oil in Bass Strait, off the Gippsland coastline, during the 1960s, hence the name Wildcat. Set into each corner is a small picture displaying the four major industries of Gippsland, brown coal power generation, a large dairy industry, coastal fishing, and a coastline of magnificent beaches for the surfer and tourist traveller. The certificate is printed in two colours, blue and black, on a white background.

The Eastern Zone of the Wireless Institute of Australia (Victorian Division) has made this award available to DX operators. The aim is to promote DX activity, and interest in the Gippsland region of Australia.

The Award will be granted to any operator outside Australia who has made two-way contact with five stations resident in the Gippsland Zone on or after November 1967.

Contact with Gippsland stations operating portable or mobile within the Zone boundaries will be accepted.

Claims should be lodged with proof of log contacts, plus five IRCs to: Award Manager, David V Scott VK3DY, 174 Johnson Street, Maifra VIC 3860. Packet address is: VK3DY@VK3BVP.

This award is also available to VHF operators. Basic rules are the same, except that the distance between operator and claimant MUST be 50 miles or further. All contacts should have occurred on or after 1 November 1970.

The frequency in use must be 50 MHz or above using any mode, but excluding recognised repeater or net frequencies. Claimants should forward three stamps, together with proof of log, to the Award Manager, VK3DY.

Both awards are for two-way contact, and as such are not available to SWLs.

## The Pelican Award

This award is sponsored by The Sunshine Coast Amateur Radio Club Inc which conducts a net each Thursday night commencing at 0900 UTC on 3.595 MHz, to encourage participation in the award.

1. The award is available to licensed amateurs and SWLs.

2. Contacts on or after 1 July 1980 are valid.

3. The award may be issued for contacts using all bands and modes, including contacts via repeaters during tropospheric ducting.

4. Stations in Australia require 10 certified contacts with different members of the Sunshine Coast Amateur Radio Club. All other stations require five certified contacts. The Club Station VK4WIS counts as two contacts.

5. All contacts are to be made from the same location. The "same location" being taken to mean within a radius of 240 km (150 miles) of the original location.

6. A list showing full details of contacts should be certified by two licensed amateurs. QSL cards not required.

7. The fee for the award is \$AUS2.00 or one IRC.

8. Address applications to: The Awards Manager, Sunshine Coast Amateur Radio Club Inc, PO Box 80, Nambour QLD 4560.

## South Australian Group of the RNARS

The following information arrived by mail from the South Australian Group of the Royal Naval Amateur Radio Society (RNARS), sent by their Secretary, Eric Leach. He states that, in addition to the Awards issued under the control of other Branches of the RNARS, the South Australian Group control:

1. The H M Colonial Ship Protector Award. The Custodian is Jack Peatfield VK5AF, 1 Filmer Avenue, Glengowrie SA 5044. The fee is \$AUS5.00 or seven IRCs.

2. The H M Bark Endeavour Award. The Custodian is Eric Leach VK5AFN, 37 Hallett Avenue, Tranmere SA 5073. The fee is also \$AUS5.00 or seven IRCs.

Rules for these two awards were not readily available at the time of printing, so interested parties may feel free to drop a line to Eric Leach at the above address.

## The W3USS Award

Make one contact with W3USS, the club station of the Capitol Hill ARS, whose QTH is in the historic Russell Senate Office Building. GCR list and a fee of \$US1.00 or four IRCs to: Certificate US Senate, Box 73, Washington DC 20510, USA.

## The El Paso Award

Contact 15 El Paso, Texas stations on any band or mode. No time limitations. No charge, but suggest you send postage, and GCR list, including the name of the operators you worked, to: El Paso ARC, 2100 San Diego Avenue, El Paso TX 79930, USA.

\*4 Brook Crescent, Box Hill South, VIC 3128  
Phone (03) 9889 8393

ar



The Wildcat Award. The original certificate is in blue, black and white, and measures 264 mm wide by 210 mm.

# Contests

Peter Nesbit VK3APN - Federal Contest Coordinator\*

## Contest Calendar

### July - September 1997

Jul 1	Canada Day CW/Phone	(June 97)
Jul 5	Australasian Sprint (CW)	(June 97)
Jul 5	Jack Files Memorial Contest (CW)	(June 97)
Jul 5	NZART Memorial Contest (Phone/CW)	(June 97)
Jul 12	Australasian Sprint (Phone)	(June 97)
Jul 12	Jack Files Memorial Contest (Phone)	(June 97)
Jul 12/13	IARU HF Championship	(June 97)
Jul 19	South Pacific 160 m Contest	(June 97)
Jul 19	Colombian DX Contest (Phone/CW)	(June 97)
Jul 26	Waitakere 80 m Phone Sprint	(June 97)
Jul 26/27	RSGB IOTA Contest	(June 97)
Aug 2	Waitakere 80 m CW Sprint	(June 97)
Aug 2/3	YO DX Contest	
Aug 9/10	Worked All Europe CW	
Aug 16/17	Remembrance Day Contest	
Aug 16/17	Keyman's Club of Japan (CW)	
Sep 6/7	All Asia DX Contest Phone	(May 97)
Sep 6/7	Bulgarian DX Contest	
Sep 13/14	Worked All Europe Phone	
Sep 20/21	SAC DX CW	
Sep 27/28	SAC DX Phone	
Sep 27/28	CQ WW RTTY DX Contest	

might be privy to, not realising that their project was blindingly obvious from the parts in their self-service tray.

This developed into a rather fiendish game. Occasionally a young customer would wander around collecting things like a 9" by 6" chassis, a crystal socket, one or two five pin ceramic sockets, large top caps, etc. After coming to the counter they would nervously look around, and in hushed tones ask about ceramic switches or Airdux coil stock, as if they were buying certain items from a chemist's shop. This was my cue. "Ahem", I would say, doing my best to look official, "the Postmaster General's Department has asked us to be on the lookout for people building unlicensed transmitters. You DO have a licence for the equipment you're building, don't you Sir?"

Their jaws would drop and faces go red, and eventually they would blurt out "Of course! Of course!" I was never able to hold a straight face for long, however, and after a good laugh and obvious relief from my victims, many good friendships were made from these and other encounters in that wonderful place.

Many thanks this month to VK6APK, DL2DN, JA1DD, and 9V1YC. Until next month, good contesting!

73, Peter VK3APN

## Worked All Europe DX Contest

9/10 August (CW), 13/14 September (SSB), 8/9 November (RTTY); 0000z Sat - 2400z Sun.

The object is to work European stations (except in the RTTY section, where anyone works anyone). Bands are 80-10 m. In the contest, avoid 3550-3800 and 14060-14350 kHz on CW, and 3650-3700, 14100-14125 and 14300-14350 kHz on SSB. The minimum time of operation on a band is 15 minutes, although bands may be changed within this period, if and only if, the station worked is a new multiplier. Categories are single operator all bands; multi-operator single transmitter; and SWL all bands. DX cluster support is allowed. A maximum of 36 hrs is allowed for single operator stations, with up to three rest periods (mark them in the log).

Exchange RS(T) plus serial number. Additional points can be gained reporting QTCs, as follows: after working a number of European stations, details of those previous QSOs (ie QTCs) can be reported during a current QSO with a European station. In the CW and phone sections, QTCs are sent from non-European stations to European stations. In the RTTY section, QTCs can be sent to any station, including non-Europeans, outside one's own WAC continent. A QTC contains the time, callsign, and QSO number of the

A friend came to visit from interstate recently and, as we discussed old times, we realised how many years had passed since our first meeting.

The year was 1964, and we were both 15, introduced by a mutual friend at the old WIA rooms in East Melbourne. As part of a larger group of half a dozen or so other teenagers, we were full of enthusiasm for our hobby, and spent most of our spare time tinkering with an assortment of home made transmitters and receivers, in between pedalling our push bikes between our respective houses.

As our major source of components was old radios, it was no surprise that our transmitters often comprised 6J7 or 6BQ5 oscillators, and 6V6GT or 6BM8 power amplifiers. As time went by, we experimented with various other tubes, eventually graduating to what we thought was the ultimate in "high power", ie the venerable 807, and other less conventional devices.

One of the weirdest was a PT15, obtained from a surplus WW2 radar exciter by a friend. This tube was reputed to be *even more powerful than an 807*, but was notoriously unstable. However, this made my friend's signals very easy to find, as all one had to do was tune across the band in the direction of greatest noise, in the middle of which he

could be heard muttering oaths like "damn PT15... bloody oscillating again!" Then one day, without warning, he appeared with a much weaker signal, but clean at last. He explained to me that the PT15 had "acted stupid just once too often", so he had put it out of its misery with a brick. My feelings of relief were mixed with disappointment, because I had long admired the enormous signal put out by that tube, even if it did sound like the arrival of the Tardis from Dr Who.

As a student, I was lucky enough to have a part-time job at the well-known Melbourne electronics retailer J H Magrath & Co. That company is, unfortunately, long gone, but during the sixties it was THE meeting place for anyone and everyone interested in electronics on Saturday mornings. Some days there were over a hundred customers in the store, all at the same time, and it was almost impossible to cross the floor between the counters. Many were the times that after shutting the doors at midday, we would still be clearing customers an hour and a half later.

As a keen home brewer and amateur, I developed a good eye for what people were building according to the parts they bought, and would often startle them by making some casual remark about what they were building. "How did you know that?" they would stammer, worried what other deep secrets I

station being reported, eg: "1307/DA1AA/431" means you worked DA1AA at 1307z and received serial number 431. Commence QTC traffic by sending the QTC series and number of QSOs to be reported, eg "QTC 3/7" indicates this is the third series and that seven QSOs will be reported. A QSO may be reported only once, and not back to the originating station. A maximum of 10 QTCs can be sent to the one station, who can be worked more than once to complete the quota. Only the original QSO, however, will have points value.

The multiplier on each band equals the number of European countries worked on that band (or on RTTY only, the number of DXCC/WAE countries), times a band factor. The band factors are four for 80 m, three for 40 m, and two for 20/15/10 m. Add the band multipliers together, and multiply by the sum of (QSOs + QTCs) to obtain the final score.

SWLs may log each station heard, European and non-European, once per band. Logs must contain both call signs and at least one of the control numbers. Count one point for each station logged, and one point for each complete QTC received (max 10 per station). It is possible to claim up to two multipliers per logged QSO.

Use standard log and summary sheet format. Include a checklist for more than 100 QSOs on any band and, if more than 100 QTCs have been sent, include another checklist to show that the quota of 10 QTCs per station is not exceeded. Logs can be submitted in ASCII on DOS disk, providing a paper summary sheet is included. Send logs to: WAEDC Contest Committee, Box 1126, D-74370 Sersheim, Germany. Deadlines are 15 Sept (CW), 15 Oct (SSB), and 15 Dec (RTTY). Comprehensive awards are offered.

European countries are: C3 CT1 CU DL EA EA6 EI EM/N/O ER ES EU/V/W F G GD GI GJ GM GM (Shetland) GU GW HA HB HB0 HV I IS IT JW (Bear) JW (Spitzbergen) JX LA LX LY LZ OE OH OH0 OJ0 OK/L OM ON OY OZ PA RI/FJL RI/MVI R/U (Russia) RA2 S5 SM SP SV SV5 (Rhodes) SV9 (Crete) SV (Mt Athos) T7 T9 TA1 TFK UR-UZ (Ukraine) YL YO YU Z3 ZA ZB2 1A0 3A 4U (Geneva) 4U (Vienna) 9A 9H.

### Keyman's Club of Japan (CW)

16/17 August, 1200z Sat – 1200z Sun.

This contest is designed for CW enthusiasts, and will particularly suit those who are collecting Japanese prefectures for awards. The only category is single operator multi-band. Suggested frequencies are 1908-1912 (split), 3510-3525, 7010-7030, 14050-14090, 21050-21090, and 28050-28090 kHz. Exchange RST plus continent code (OC); JAs will send RST plus district code.

Score one point per QSO. The multiplier on each band is the total number of JA districts (max 62 per band). Final score equals total points-x total multiplier. Show duplicate QSOs with zero points, attach a summary sheet showing all usual information, and send the log to: Yasuo Taneda JA1DD, 279-233 Mori, Sambu Town, Sambu, Chiba 289-12, Japan, postmarked no later than 17 September 1997. ASCII logs on DOS disk are most welcome. I have complete rules and district codes (SASE please).

### 1997 REMEMBRANCE DAY CONTEST

*Presented by Alek Petkovic, VK6APK*

I take pleasure in presenting the rules for this year's contest. The rules are unchanged from last year, except for the addition of a multi-operator category, in response to requests from several people following last year's contest. This means that single operator entrants need no longer feel overshadowed by the large multi-operator stations, which often amass very large scores and can be very difficult to beat, as they will now have a much better chance to obtain a certificate and receive due recognition for their efforts in the results.

I have also clarified the wording of the rules in a couple of places, and added a step by step description of the determination of the winning Division (taken from the results published last December). These changes do not affect the contest.

I would like to wish everyone a most enjoyable event, and look forward to seeing you all in it. Good luck!

**Purpose:** This contest commemorates the amateurs who died during WWII, and is designed to encourage friendly participation and help improve the operating skills of participants. It is held annually on the weekend where the Saturday is closest to 15 August, the date when hostilities ceased in the south-west Pacific area.

It is preceded by a short opening address by a notable personality, transmitted on various WIA frequencies during the 15 minutes immediately before the contest. During this ceremony, a roll call of those amateurs who paid the Supreme Sacrifice is read.

A perpetual trophy is awarded annually to the WIA division with the best performance. It is inscribed with the names of those Australian amateurs who made the Supreme Sacrifice, to perpetuate their memory throughout amateur radio in Australia.

The name of the winning Division each year is also inscribed on the trophy, which is presented at the Annual Federal Convention. The winning Division holds the trophy for the following 12 months, and receives a

certificate. The leading entrants will also receive certificates.

**Objective:** Amateurs in each VK call area will endeavour to contact other amateurs in other VK call areas, P2 and ZL, on 1.8-30 MHz (10, 18 and 24 MHz excluded). On 50 MHz and above, amateurs may also contact other amateurs in their own call area.

**Contest Period:** 0800 UTC Saturday, 16 August to 0759 UTC Sunday, 17 August 1997. As a mark of respect, stations are requested to observe 15 minutes silence prior to the start of the contest, during which the opening ceremony will be broadcast.

#### Rules:

1. The contest categories are:
  - (a) High Frequency (HF) – for operation on bands below 50 MHz;
  - (b) Very High Frequency (VHF) – for operation on the 50 MHz band and above.
2. Within each category the applicable sections are:
  - (a) Transmitting Phone (AM, FM, SSB, TV);
  - (b) Transmitting CW (CW, RTTY, AMTOR, PACTOR, packet, etc);
  - (c) Transmitting Open (a) and (b);
  - (d) Receiving (a), (b) or (c).
3. All amateurs in Australia, Papua New Guinea and New Zealand may enter the contest, whether their stations are fixed, portable or mobile.
4. Cross mode and cross band contacts are not permitted.
5. Call "CQ RD", "CQ CONTEST", or "CQ TEST".
6. On bands up to 30 MHz, stations may be contacted once per band using each mode, ie up to twice per band using Phone and CW.
7. On the 50 MHz band and above, the same station in any call area may be worked using any of the modes listed at intervals of not less than two hours since the previous contact on that band and mode.
8. Both single and multi-operator entries are permitted. To be eligible as a single operator, one person must perform all operating and logging activities, without assistance, using his or her own call sign. More than one person can use the same station and remain a single operator, providing that each uses his or her own call sign, submits a separate log under that call sign, and does not receive operating or logging assistance from anyone else during the contest.
9. Multi-operator (club) stations may be operated by any number of people, but only one person may operate at any time, ie no multi-transmission.
10. For a contact to be valid, numbers must be exchanged between the stations making

the contact. The number will comprise RS (for phone) or RST (for CW), followed by three figures commencing at 001 for the first contact, and incrementing by one for each successive contact.

11. Contacts via repeater (including satellite) are not permitted for scoring purposes. Contacts may be arranged through a repeater. The practice of operating on repeater frequencies in simplex is not permitted.

12. On all bands, except 160 m, score one point per completed valid contact, and on 160 m, score two points per completed valid contact. On CW, score double points.

13. Logs should be in the format shown below, and accompanied by a summary sheet showing the following information:

- Call sign;
- Name;
- Address;
- Category (HF or VHF);
- Section (Phone, CW, Open, or Receiving);
- For multi-operator stations, a list of the operators;
- Total score;

Declaration: "I hereby certify that I have operated in accordance with the rules and spirit of the contest."

Signed: Date:

14. Entrants operating on both HF and VHF are requested to submit separate logs and summary sheets for HF and VHF.

15. VK entrants temporarily operating outside their allocated call area, including those outside continental Australia as defined for DXCC, can elect to have their points credited to their home Division by making a statement to that effect on their summary sheet/s.

16. Forward the log/s and summary sheet to: RD Contest Co-ordinator, A Petkovic VK6APK, 26 Freeman Way, Marmion, WA 6020. Endorse the envelope "Remembrance Day Contest" on the front outside. Entries must be forwarded in time to reach the Contest Co-ordinator by Friday, 19 September 1997.

17. Certificates will be awarded to the leading entrants in each section, both single and multi-operator, in each Division, P2, and ZL. Entrants must make at least 10 contacts to be eligible for awards, unless otherwise decided by the Contest Co-ordinator.

18. Any station observed as departing from the generally accepted codes of operating ethics may be disqualified.

**Determination of Winning Division:**

Unless otherwise elected by the entrant concerned, the scores of VK0 stations will be credited to VK7, and the scores of VK9 stations will be credited to the mainland VK call area which is geographically closest. The

scores of P2, ZL, and SWL stations will not be included in these calculations.

For each Division, an "improvement factor" will be calculated as follows:

(a) For transmitting logs only, HF and VHF "benchmarks" for each Division will be established, against which its performance for the current year is judged. The same formula will be used for HF and VHF, inserting the HF or VHF figures as appropriate:

$$B = 0.25 P + 0.75 L$$

where B = this year's benchmark, P = last year's total points, and L = last year's benchmark.

(b) For each Division, HF and VHF Improvement Factors will then be calculated. Once again, the same formula will be used for HF and VHF, inserting the HF or VHF figures as appropriate:

$$I/F = \text{Total points (this year)} / \text{Benchmark}$$

where I/F = improvement factor.

(c) For each Division, the HF and VHF Improvement Factors will then be averaged:

$$\text{Overall I/F} = (\text{HF I/F} + \text{VHF I/F}) / 2$$

(d) The Division which achieves the highest overall Improvement Factor will be declared the winner.

**1997 Benchmarks**

These are the total scores which must be obtained, by each Division, to improve on its results for the previous year:

Div	HF	VHF
VK1	813	260
VK2	4347	74
VK3	4413	11695
VK4	3283	1181
VK5/8	3746	1352
VK6	2959	7078
VK7	1927	190

**Receiving Section Rules**

1. This section is open to all SWLs in Australia, Papua New Guinea, and New Zealand. No active transmitting station may enter this section.
2. Rules are the same as for the Transmitting Section, as applicable.
3. Only completed contacts may be logged, ie it is not permissible to log a station calling CQ. The details shown in the example must be recorded.

4. The log should be in the format shown below.

**Example Summary Sheet**

Remembrance Day Contest 1997  
 Callsign: VK1XXX  
 Name: Joe E Brown  
 Address: PO Box 123, Farm Orchard, ACT 2611  
 Category: HF  
 Section: Transmitting phone  
 Total Score: 515  
 Declaration: I hereby certify that I have operated in accordance with the rules and spirit of the contest.  
 Signed: J E Brown Date: 23/8/97

**Example Transmitting Log**

Remembrance Day Contest 1997  
 Callsign: VK1XXX  
 Category: HF  
 Section: Transmitting phone

Date	Band	Mode	Call	No Sent	No Rcvd	Pts
0801	14	SSB	VK2QQ	58001	59002	1
0802	14	SSB	VK6LL	59002	59001	1
0806	14	SSB	VK5ANW	59003	58011	1
0808	14	SSB	ZL2AGQ	56004	57004	1
0811	7	SSB	VK4XX	59005	59008	1

**Example Receiving Log**

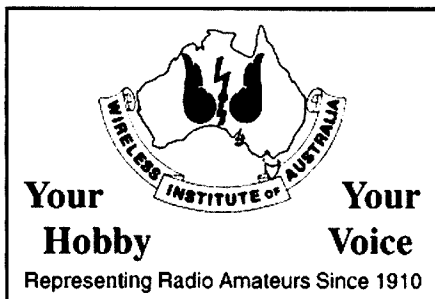
Remembrance Day Contest 1997  
 Name/SWL No: L30371  
 Category: HF  
 Section: Receiving phone

Date	Band	Mode	Calling	Calling	No	No	Pts
Time (MHz)					Sent	Rcvd	
0801	14	SSB	VK1XXX	VK2QQ	58001	59002	1
0802	14	SSB	VK1XXX	VK6LL	59002	59001	1
0805	14	SSB	VK5ANW	VK1XXX	58011	59003	1
0807	14	SSB	ZL2AGQ	VK1XXX	57004	56004	1
0809	14	SSB	VK7AL	VK2PS	59007	58010	1

**Results of Asia-Pacific Sprints**

- (\* T-Shirt winner)
- 1st Sprint (16 July 1995):**  
 VK5GN 23 x 17 391
- 2nd Sprint (30 Sept 1995):**  
 VK5GN\* 40 x 33 1320  
 VK4TT 34 x 29 986  
 VK1FF 20 x 19 380  
 (op. WB2FFY)
- 3rd Sprint (24 March 1996):**  
 VK4EMM\* 34 x 29 986
- 4th Sprint (8 June 1996):**  
 VK1FF\* 34 x 27 918  
 VK2AYD 24 x 21 504  
 VK4TT 14 x 18 324
- 5th Sprint (19 October 1996):**  
 VK5GN\* 32 x 27 864
- 6th Sprint (8 Feb 1997):**  
 No VK entrants

\*PO Box 2175, Caulfield Junction, VIC 3175  
 pnesbit@methpc.org.au





---

---

# Divisional Notes

---

---

## Forward Bias - VK1 Notes

*Hugh Blemings VK1YYZ*

As pre-empted in last months *Forward Bias*, the Division's web site is now on line. You can point your browser at <http://www.vk1.wia.ampr.org> for more details. Incidentally, if you have had some experience in web page design and would like to contribute to the Division's site, please drop me a line at [president@vk1.wia.ampr.org](mailto:president@vk1.wia.ampr.org)

## New Contact Details

Our Divisional e-mail addresses are now operational. You can contact the committee as a whole by sending mail to [committee@vk1.wia.ampr.org](mailto:committee@vk1.wia.ampr.org) Broadcast items can now be sent to [broadcast@vk1.wia.ampr.org](mailto:broadcast@vk1.wia.ampr.org) We have also set up addresses for individual office holders such as Secretary, Treasurer, QSL, etc. A complete list is available on the web site.

On a quieter note, it is with regret that we note the passing of a friend and long time member of the WIA, Don Hume VK1DH after a long illness. Don's contributions to amateur radio were many and he will be missed by all. Don's obituary will appear in next month's *Amateur Radio*.

## Coming Events

By the time you read this, the fox will have been hunted and junk bought and sold, as a Foxhunt and Buy-and-Sell night round out the June activities for the Division.

Looking to July's general meeting, we will have Dr Rod Boswell from the ANU's Research School of Physical Sciences and Engineering as a guest speaker. Dr Boswell has worked in a wide range of areas within the physical sciences, most recently in Plasma Physics. His background extends into such diverse areas as radio propagation, space-borne antenna systems and semiconductor fabrication. He has declared his intention to talk about things of interest to the audience rather than things that are not, so this will be an evening not to be missed!

August will see the presentation on packet radio and the Division's soon-to-be-installed bit regenerative repeater which has been held over from July. Again, details will be available on our web site.

Look forward to seeing you at the next meeting!

## VK2 Notes

*David Thompson VK2NH*

Well, here we are in a new financial year and most of the Board of Directors from last year have been returned to office in the annual elections. However, there are

some new faces and these are Owen Holmwood VK2AEJ, Pat Leeper VK2JPA and David Thompson VK2NH.

Our new President is Geoff McGrorey-Clark VK2EO. There was one resignation, that of Peter Jensen VK2AQJ, last year's Divisional President. Thank you, Peter, for your work in your position with the executive.

There have been many tasks handed out to the Councillors. These include planning for the Year 2000 Olympics and the role amateur radio will take in that, Public Relations for the organisation, and representation of the VK2 Division at a Federal level, among many other roles essential to the running of the Division. We in the New South Wales Division are looking forward to building on the successes of the past year and positively facing the challenges in the lead-up to the Year 2000 Olympics. However, we can only achieve by a partnership existing between all of us as members of the Division. We need your input to make this great hobby even better.

The VK2 Council, with some designated portfolios, is: Geoff McGrorey-Clark VK2EO, President, Alternate Federal Councillor, NTAC Chairman, and QSL Bureau Co-ordinator; Michael Corbin VK2YC, Vice President, Federal Councillor, Deceased Estates, and Regional Representative (South); Brian Kelly VK2WBK, Vice President, Education (Country), and Regional Representative (North); Eric Fossey VK2EFY, Secretary, Membership, Administration, Bookshop, Parramatta Property, and Alternate Federal Councillor; Eric van de Weyer VK2KUR, Treasurer, and Security; Ken Westerman VK2AGW, Affiliated Clubs, and Regional Representative (West and Riverina); Pat Leeper VK2JPA, Trash and Treasure, and Education (City); Owen Holmwood VK2AEJ, Dural Officer, and Chairman Policy and Strategy Committee; and David Thompson VK2NH, Olympic Games Year 2000, and Public Relations.

Affiliated Clubs Officer Ken Westerman VK2AGW reports that the Conference of Affiliated Clubs held on Saturday, 10 May 1997 was a great success. Many club delegates and Councillors have reported that they enjoyed the day at which many new friends were made. A lot of enthusiasm was projected in plans to highlight the aims and interests of the hobby and the interests of members of the Wireless Institute VK2 Division. Thanks to those who have already fed back to the executive on the conference.

We need to hear your views to know how to serve you best.

Ken VK2AGW is doing a great job with the affiliated clubs. It is essential that we foster the interests of members all over New South Wales. This is the reason we have assigned Councillors to cover specific areas of the state which, for the purpose, has been divided into North, South and West regions. Those Councillors are nominated above.

Last month the VK2 Division marked 40 years at Dural. This length of time broadcasting from one location is a great achievement, deserving special recognition of the broadcast teams, past and present, who have given so much to keeping the site up-to-par.

As you know, the VK2 Division brings you its weekly news broadcast at various times and on numerous frequencies. A new frequency has been added, one which will no doubt become increasingly popular, both domestically and overseas, as the sunspot cycle progresses. You will now find the Divisional broadcast on 20 metres on the nominal frequency of 14.160 MHz. All the other frequencies for the broadcast are found on page 56 of this publication.

If you would like to contact the VK2 Division regarding your hobby, please do not hesitate to contact the office or any of the Councillors. We will be only too pleased to hear from you. If you would like to get in touch with an individual Councillor, just contact our Divisional office and it will be arranged. Our freecall phone number is 1 800 817 644 and our address can be found on page 56.

In ending the VK2 notes for this month, a big vote of thanks goes to our Office person, Pixie Chappell VK2KPC. Thanks, Pixie! everything goes much more smoothly with you at the helm.

Next month we'll have more to report but, if you have anything you would like us to include as VK2 news, send it to me at PO Box 82, Springwood or by e-mail to [dthom@penrithcity.nsw.gov.au](mailto:dthom@penrithcity.nsw.gov.au)

## VK3 Notes

*Jim Linton VK3PC*

## WIA Victoria AGM

The Annual General Meeting was held on 28 May. There were no Motions on Notice, and the official business consisted of the election of Councillors and the appointment of Auditors.

The Council remains unchanged; however, it has been reduced in numbers by two in accord with the new Articles of Association. Serving Councillors are: Jim Linton VK3PC, Barry Wilton VK3XV, Rob Hailey VK3NC, Bill Trigg VK3JTW, George Hunt VK3ZNE, Peter Mill VK3APO, Jerry

Viscaal VK3MQ, and Steve Bushell VK3HK. Messrs Barnard Baudinette & Co Pty Ltd were re-appointed as Auditors.

The new Council, at its inaugural meeting on 3 June, re-appointed the Secretary, Barry Wilton VK3XV, and President, Jim Linton VK3PC. Bill Trigg VK3JTW was appointed Vice President. The Treasurer, Rob Hailey VK3NC, was re-appointed last December with that office's term aligned to WIA Victoria's financial year which ends on 31 December.

Among the topics discussed by the 1997/98 Council were financial matters, particularly those in the WIA Federal arena, changes in repeater and beacon licensing fees, the future of the VK3BWI broadcast, the 80 metre DX window submission, membership services and recruitment.

The Council faces an enormous challenge in the next three years due to a number of factors, including a slump in exam candidate numbers and new licensees.

### Articles of Association

The revised Memorandum and Articles of Association for the WIA Victorian Division have been approved by the Australian Securities Commission. A copy will be posted to all members who attended the Special General Meeting which endorsed the new M&As for submission to the ASC, and those who provided input to their revision. They will also be provided to all new members joining WIA Victoria.

Current members who require a copy will be able to obtain one from the WIA Victoria office, or by post if a SASE is provided.

### Federal Affairs

The WIA Victoria Council is reviewing the position of our Company and its ongoing relationship with the WIA Federal body, with a view to providing a number of member services which are currently undertaken by the Federal Office.

Whilst we believe it is necessary to support the Federation of the WIA in the best interests of the hobby, the Directors of the WIA Victorian Division are required to act at all times with "due care and diligence" in the financial management of WIA Victoria.

WIA Victoria considers it to be in the best interest of the hobby and our members for Victoria to continue to provide financial support for a number of important functions undertaken by the Federal body – specifically, International representation, IARU representation, SMA Liaison, and the publication of *Amateur Radio* magazine. We are not prepared to contribute membership funds for excessive expenditure over which we have no apparent control.

A number of alternatives are being

investigated and financially analysed, and will be discussed with our auditors. Members will be kept advised.

### Turbo Tutorial

WIA Victoria is considering running another of its highly successful Turbo Tutorials, an intensive weekend AOCF theory bridging course. These are designed to help Novice licensees to increase their theory knowledge to the AOCF level, so they can upgrade.

If you would like to benefit from a Turbo Tutorial, please register your interest immediately with the WIA Victoria office. If there's sufficient demand the specialised theory weekend will be confirmed.

### VK5 Notes

Ian Hunt VK5QX

### Interview with Graham Kemp VK4BB for VK4 Division Broadcast

Recently I was interviewed by Graham R VK4BB for a segment of the Queensland Divisional News Broadcast. He asked me two questions. The first was roughly "What are you doing in VK5 to facilitate the running of the Division?" The second was "What can the members and non-members do to help?" My answers were as follows:

"Well, Graham, in answering your first question I would like to comment that, although we live in an ever changing world, I believe at least two things should remain constant. These are honesty and integrity in our dealings with each other. They seem to be lacking in a major way in our society.

"Here in the VK5/VK8 Division the Council sees it necessary that our actions must be seen as being for the good of amateur radio in general and the members in particular. Our aim is to gain the respect and trust of the members. We know that this is something which does not come automatically and that we must earn this respect and trust.

"The Council is a Council of consensus and this consensus includes the membership. The approach is to include them as part of the

decision-making process and to involve them in as many issues as possible. This means that policy will be decided on the basis of the opinions expressed by the members. It also means that members will feel that they do play a part in the running of their own organisation.

"It is hoped that, as a result, members will come to take an even greater interest and become more involved in what is going on.

"The Council also actively encourages the members to keep a watchful eye on what is done and to correct us if they feel that we are not following the right path. In this way we feel that the best interests of all will be served.

"In talking with the members of the Divisional Council recently, I suggested to them that one thing that turns people away from full participation is a situation where their views and opinions cannot be expressed or are suppressed. It is a well known fact that, even at the highest levels of law in our country, a minority judgement on a matter can be published.

"Thus, even where the Divisional Council has come to a decision on a matter, a member of Council or any other member must still be free to make their feelings known should they disagree with a particular point. In that way a healthy discussion can still ensue in providing a balance and check on our actions.

"In answer to your second question, in the matter of involvement of members and non-members, an approach based on what I have just said is most desirable.

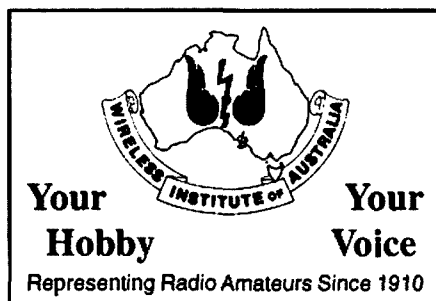
"I must comment that we actively encourage the participation of members in the running of the Division. But we need to know what the members feel and think regarding the things that should be done to further the cause of amateur radio.

"Ensuring that the opinions of members are respected goes a long way to increasing their desire to participate and help in Divisional activities. As well as expressing their opinions, members will hopefully come to realise that practical support is also needed.

"Attendance at meetings is just one way in which they can help. Being prepared to participate by taking on tasks which need to be assigned such as arranging programs and events, maintaining of physical and other facilities for amateur radio purposes, being willing to serve on the Council and other committees, all play a part in the better running of our organisation.

"Much the same can also be said about non-members of the WIA.

"The Wireless Institute of Australia is the only organisation which is officially recognised by the authorities, be they State or



*Federal or even International bodies, as representing amateur radio in Australia.*

*"This being the case, we must also find out as far as possible what others, and that includes non-member amateur radio operators, think about matters and issues which affect amateur radio in this country.*

*"I suggest that, to this end, non-members should look closely at the WIA and see what it does. They should let us know how they feel about things and we should, at the very least, take note of whatever knowledge and understanding we can gain from them.*

*"In doing this, non-members should also consider where they stand and think seriously about contributing where they see things being done for the benefit of amateur radio as a whole, by supporting the things that the Institute does.*

*"It is a fact that many services are provided as a result of WIA activities. It is also true that, irrespective of membership, the actions of the WIA affect every amateur radio operator in the country. This fact needs to be kept in mind by all, particularly the officers of the WIA.*

*"I hope, Graham, that these thoughts give you some insight into the approach being adopted here in the VK5/VK8 Division and I wish the VK4 Division well in its efforts to contribute to the cause of amateur radio."*

Perhaps this material will assist readers towards an understanding as to how the VK5 Divisional Council views the running of the Division.

Contact information for the VK5/VK8 Division is: President, Ian Hunt VK5QX, 8 Dexter Drive, Salisbury East 5109, tel 08 8250 1708; Secretary, Graham Wiseman VK5EU, 19 Washington Street, Hilton 5033, tel 08 8443 7273; and Treasurer, Joe Burford VK5UJ, 7 Trevilla Road Humbug Scrub 5114, tel 08 8280 7555.

### **Apology**

Recently we announced the passing of Don Wilton VK5KDW who had been a member of Council and held the portfolio of Education and Examinations. Due to an unfortunate oversight, his name was listed in the June issue of the Divisional Journal as still holding that position. The Journal Editor and President offer their apologies for this incorrect information.

Matters concerning Examinations should be directed to Tony Van Lysdonk VK5WC, 37 Gum Crescent, Gawler West 5118, tel 08 8522 4218.

### **Correspondence**

Sometimes correspondence can go astray. We received mail from a very large national business organisation which could be expected to run business vehicles, many of them fitted with two-way radio

communications equipment. The mail was addressed to the Spectrum Management Agency but was marked with our Box Number, 1234 GPO Adelaide. It was a tempting proposition to open the mail with the likelihood of it containing a large cheque for licensing radio installations in the fleet of vehicles. Perhaps we then could have on-forwarded the mail to the SMA with a request for a large handling commission fee! We resisted the temptation and re-addressed it unopened!

### **"QRM" News from the Tasmanian Division**

*Robin L Harwood VK7RH*

We are now in mid winter and most activity is naturally indoors. This means that many are probably engaged in projects in the shack, ready for the warmer months. Activity on VHF also seems to drop off mid year and I would expect that this, too, will be back to normal in summer.

Members of the Northern Branch have been recently considering the future of the Mount Barrow two metre repeater (VK7RAA) after a bill was received from Air Services Australia for site fees. There has been quite a deal of discussion as to its future viability as the amount of use on 147.000 MHz has markedly decreased. Many days the repeater is quite silent, with little or no activity, which is in contrast with what it was five years back. We apparently will be receiving quarterly accounts, so the Branch will be constantly reviewing various options. The majority of repeater activity is now on VK7RAB on 70 cm but, as this is solar powered, activity is restricted at this time of year to daylight hours. VK7RAB is linked to VK7RAF in Hobart and VK7RNE at Tower Hill, Fingal.

The Northern Branch has also been rationalising their financial outlays since the bill for site fees has come in and has decided to dispense with several calls when next they become due next year. These include VK7NB, the club callsign, which has not been used since a JOTA activity a few years ago. The Packet BBS callsigns will also probably revert to the current SYSOP. Also, the Branch has decided to clean out the

equipment cupboard and several items were recently put out to tender.

The Divisional President, Ron Churcher VK7RN, paid a visit to the Northern Branch in May and encouraged the Branch members to unite and work together. Recent developments have made it imperative for amateurs to work together as our hobby is constantly under threat. He also reported on the recent Federal Convention. After the meeting, Ron showed a video of his tour of Europe and Canada in 1996 including the famous Radio Museum in Guelph, Ontario. Sadly, since that video was made this historic collection had to be dismantled and placed in storage until they could find a new location. Ron is hoping to show this video later this year to the Southern Branch and it is well worth seeing.

The Divisional Awards officer is now John Bates VK7RT in Hobart. He has proposed some new awards and is wanting comments on the Awards structure to put in a submission to Divisional Council. The proposed awards are for the following planned Special Events: (a) Tall Ships 1998; (b) Sydney to Hobart yacht race; (c) Melbourne to Hobart yacht race; (d) Targa Tasmania; and (e) Southern Safari.

Also, he is considering updating the existing awards, namely the famous Tasmanian Devil Award and the Tassie Trout Award, as well as a proposed "Worked All VK7 Division Award". If you have comments or suggestions, please contact John as soon as possible at: John W Bates VK7RT, PO Box 151, Rosny Park TAS 7018; or by e-mail to [batesjw@southcom.com.au](mailto:batesjw@southcom.com.au)

Meetings for this month are: Southern Branch on Wednesday, 2 July at 2000 hrs at the Domain Activity Centre, Hobart; North-western Branch on Tuesday, 8 July at 1945 hrs at the Penguin High School, Dial Road, Penguin; and Northern Branch on Wednesday, 9 July at 1930 hrs at the Launceston Institute of TAFE, Alanvale Campus Block "C".

Also note that there will be a meeting of Divisional Council on 19 July with the North-western Branch hosting. The actual venue will be given over the Divisional broadcast before the meeting. All Divisional members are welcome to come and observe.

ar

**Are you reading someone else's  
Amateur Radio? Call 03 9528 5962 to  
find out how to get it every  
month!**

# How's DX

Stephen Pall VK2PS\*

Some time ago I was looking through old copies of *Amateur Radio*. My attention was drawn to an article written by Don Hopper VK7NN in the May 1996 issue of the magazine, in which he details his past experiences and activities as a volunteer with the Marine Rescue Co-ordination Centre in Canberra, handling maritime mobile emergencies.

Such an emergency became a reality for the participants of the ANZA Net on 19 May. One of the amateur operators on the Russian Antarctic Base Mirny had called in, advising the net controller that a Russian Yacht near the Kerguelen Islands had lost its rudder and required assistance. The whole net became a hive of activity and finally the message was relayed to the rescue authorities in Canberra.

I followed the fate of this yacht for a number of days. There were 12 people aboard and the yacht was drifting slowly in a north-easterly direction at a speed of about 2 1/2 knots. The yacht radio and aerials were tuned to several amateur radio frequencies of which 14182.50 kHz was used most of the time at 0600 UTC between the yacht and Perth Coastal radio. At one stage the rudder of the yacht was repaired by a passing ship sailing in a westerly direction. However, this temporary measure became ineffective and the yacht began drifting again. In two weeks it managed to change its location from 46° 50' S and 86° 15' E to 39° 00' S and 100° 47' E. At this speed it will take them weeks to reach Fremantle. Hopefully they will make it. I relayed this small story to you because it illustrates that amateur radio, despite modern marine communication systems and satellite technology, still plays a vital part in emergency situations, a fact which the authorities are very reluctant to recognise and give credit for.

A few days later I read the sad news in the local press that, due to Government economic measures, two key monitoring communication stations, Darwin and Townsville, will be closed, leaving only Perth and Brisbane to look after the 47 million square kilometres of sea for which Australia is responsible under international treaties. These two stations are manned around the clock by one person, on a 12 hour shift, on 12 HF channels, listening for possible distress signals.

It seems to me that there is an opening for some reliable individual to prove the usefulness of our hobby and to serve the community, provided the authorities will allow him to do so.

## Wahroonga VK2WAH to WAUNFAWR GB2VK

Jo Harris VK2KAA, the historian of the NSW Division of the WIA, is on a special mission. She is travelling to Waunfawr, near Caernarvon, Wales in the UK to honour a special event.

The event occurred on 22 September 1918 (79 years ago) when the then Prime Minister of Australia, Billy Hughes stood by Guglielmo Marconi in Wales, and witnessed the first wireless contact between the United Kingdom and Australia.

On the Australian end was Ernest Fisk who was the managing director of AWA, and who lived on the corner of Cleveland and Stuart Streets, Wahroonga. The "Great War" (1914-1918) put great pressure on the need for a wireless transmission as it was feared contact between the UK and Australia could be lost. Fisk and Marconi had tried for a year to link up the two countries when they finally succeeded on 22 September 1918.

In honour of that event, Ku-ring-gai Council, The Historical Society of NSW, and Amalgamated Wireless of Australia (AWA) in 1935 jointly founded the building of a monument which now stands on the corner of Stuart and Cleveland Streets.

However, a few years ago in 1993, when the 75th anniversary of the transmission was celebrated, Jo discovered that there was no monument at the senders' end at Waunfawr in Wales.

Jo decided, off her own bat, to have a

replica built of the monument, and to send it to Wales. The monument shows Mercury with winged sandals standing, or rather running, around the globe. Mercury was the messenger of the Gods and the God of roads and travel in Roman mythology. Since its completion the replica has been exhibited at various amateur gatherings and a number of individual amateurs made donations towards the cost of this expensive project.

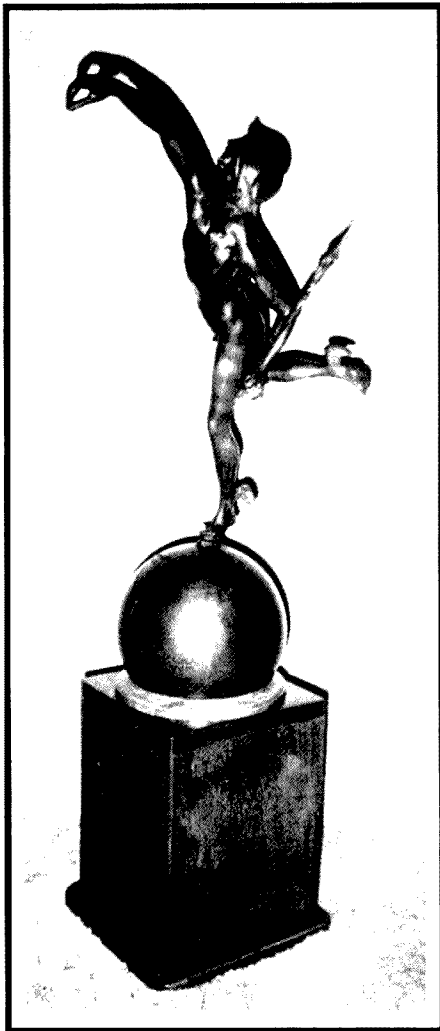
Jo left Sydney on 24 May to travel to the UK. The unveiling of the replica will take place at a special ceremony on 12 July 1997, at the old transmitting station which was established by Marconi at Waunfawr near Caernarvon. A number of local amateur radio clubs, politicians, press, and radio and television reporters will attend the unveiling of the replica which will be put into a glass case and displayed at the old Marconi transmitting building which, these days, is used as a mountaineering station because of its proximity to Wales famous Snowdon Mountain (1085 m). The replica has a plaque attached to it with the message: "From this site on the 22nd September 1918, Guglielmo Marconi transmitted the first direct wireless message to Australia where it was received by Ernest Fisk at Wahroonga, NSW. Presented by Jo Harris VK2KAA on behalf of friends of Wireless in NSW Australia. July 1997." Well done Jo! Congratulations.

## Scarborough Reef - BS7H - Huang Yan Dao

This long awaited activity started at 0445 UTC on 30 April and finished unexpectedly at about 0645 on 3 May after only three days of operation during which the expedition made approximately 13,000 contacts.



The old Waunfawr station in Wales (see text). The transmission hall is at the back-left; the experimental section at the front was known as "The Extension".



**The replica of the Wahroonga monument to be unveiled in Wales (see text).**

There were lots of rumours about the cause of the sudden close-down, even bad weather and an approaching "Taifun" was mentioned.

On 24 May 1997, "The Sydney Morning Herald" published a 410 word report which gave some indication as to what really happened in the South China Sea surrounding the reef. Here are some quotations from the newspaper article. "China has demanded that the Philippines halt its "invasion" of a rocky shoal in the South China Sea but the Ramos Government says it will resist China's attempts to enforce its claim over the disputed territory."

The article continued further, "China's Foreign Ministry spokesman Mr Shen Guofang said on Thursday that the Philippines had no right to raise its flag over Huang Yan island, the rocky outcrop that Manila calls the Scarborough Shoal. He accused the Philippines of harassing a "non-governmental Chinese organisation which

had sponsored an International radio venture on the island."

The article continued, quoting other allegations and counter allegations, but for our purpose the above news supplies an adequate explanation.

A detailed explanation came from Tim Trotten N4GN, who obtained the following information by telephone from several of the BS7H 1997 team members on their return to Guangzhou. "The Philippine Government announced on the 28th of April (within hours of the BS7H/mm departure from Guangzhou) that three Chinese military ships had been spotted in the area around Mischief Reef in the Spratly Islands. Mischief Reef is claimed by both the Philippines and China. Philippines President Fidel Ramos immediately lodged an official diplomatic protest with Beijing, and ordered increased Navy and Air Force presence in the area. Although the Spratly Islands lie some 300 miles to the south of Scarborough Reef, news of the escalating tensions in the region was immediately relayed to the BS7H crew. The expedition to Scarborough actually involved two Peoples Republic of China Ocean Bureau vessels (one carrying the BS7H team with an Ocean Bureau crew, the other carrying only Ocean Bureau personnel). The two Ocean Bureau captains were disturbed by the news from the Spratly Islands, but everyone agreed to press on toward Scarborough. On the first day of on-the-air operations by BS7H (30 April), two Philippine military reconnaissance jets overflew the reef at low altitude. Then, late on 1 May a Philippine Navy ship arrived at the reef, eventually followed by a second military vessel. Philippine Navy officers visited each of the three BS7H operating sites.

"In discussions with the BS7H team and the captain of the lead Ocean Bureau vessel, however, the officers asserted the Philippine position that Scarborough Reef lies within the 200 nautical mile Exclusive Economic Zone (EEZ) claimed by the Philippines. It is important to note that the Philippine Officers admitted that there is no Philippine claim to the Reef itself. The Captain of the lead Ocean Bureau ship, of course, stated the Chinese position that Scarborough reef is PRC territory and provides the base line for a 12 nautical mile Territorial Sea (TS) surrounding the reef

"At first the Philippine Navy seemed to be concerned that the amateur radio operations of BS7H were somehow an "economic activity" subject to treatment under an EEZ claim similar to fishing or oil drilling. But, after observing the pile-up operations, this concern was apparently satisfied. Still, the Navy officers insisted that it was OK for the

PRC ships to safely pass through the Philippine-claimed EEZ, but they could not stop in any one place for a prolonged period of time. The captain of the lead Ocean Bureau ship was unable to reach any agreement with the Philippine Navy officers on this point. Finally, wishing to avoid a further escalation of tensions, the Ocean Bureau captains made the decision to leave the reef and to return to Guangzhou, cutting the planned seven day BS7H operation down to only three days"

If you managed to have a contact with BS7H, consider yourself to be lucky. It is my considered opinion that it will be now a long, long time before any amateur radio DXpedition can land on the rocky outcrops of Scarborough Reef which is situated at 117° 45' E and 15° 10' N about 210 km due west from the Philippine mainland.

### **St Paul Island CY9AA**

Mike VE9AA, Doug VE1PZ and Dennis K7BV will be active from St Paul Island from 26 June to 3 July. Their goal is to make as many contacts as possible on CW and SSB on all bands from 160 to 2 metres. QSL via VE9AA, Michael Smith, 271 Smith Road, Waterville, Sunbury Co NB, E2V 3V6, Canada. They will be active on the usual DX frequencies

### **Annabon Island 3C0DX**

This DXpedition was ready to go for a seven day activity to this quite rare DXCC country situated opposite the Gabon coastline and belonging to Equatorial Guinea in Africa. There was a lot of freight and only two small aeroplanes to fly on from Libreville to the small island airport. However, the expedition had to be cancelled as the Guinean authorities, at the very last minute, would not grant 11 operators (out of 13) entry visas. The expedition now hopes to be on the air at a later date, possibly on the 11 October.

### **Malyj Vysotskij Island - OH5AB/MVI-R1MVI**

This is a unique DXCC country, known by its former prefix of 4J1. The island is located in the territory of Russia, but is under the control of Finland. Malyj Vysotskij (Russian name) or Ravansaari (Finnish name) is located in the bay of Vyborg, north-west of St Petersburg. The DXpedition of twelve operators, five from Finland and seven from Russia, was planned to take place from 5 to 16 June. The all-band all-mode activity planned to run at least three complete stations 24 hours a day on the usual CW, SSB and RTTY frequencies. The two callsigns to be used were OH5AB/MVI and R1MVI. QSL manager for both callsigns is Orvo Arkko OH5NE, Muukko, Fin-53400, Lappenranta, Finland.

## Future DX Activity

- \* Gus SM3EVR/BV2 is active from Taiwan until October. QSL via home call.
- \* Marc ON5FP and Kristof ON6NN will be in Monaco with the additional prefix 3A/ (SSB only) from 21 to 24 July. QSL via ON5FP.
- \* Zoli HA5PP will be in Aden at the end of June (not in May as previously reported) and hopes to be active in September either as 7O/HA5PP, 7O8DX or 7O8CW. QSL via HA5YPP.
- \* Eric FT5ZG has received an amplifier from the Clipperton DX Club and is now active again from Amsterdam Island. QSL via F5RQQ.
- \* Tim N2PC is active from Marshall Islands as V73AT for the next few years. QSL via K2CL.
- \* Nancy N3NS is now active in Senegal as 6W6/N3NS.
- \* 8J1RL is the Japanese Antarctic Research Expedition station at Showa Base on Ongul Island in the Antarctic. Can be heard on most weekends around 1000-1100 UTC, CW and SSB on 20 and 15 m. QSL via JARL.
- \* Fernando EA4BB has received his Angolan licence D2BB. He will be working in Angola and plans to stay for a year and half.



## AMATEUR TRANSCIVER RADIO CENTRE

ALL YOUR AMATEUR TRANSCIVER  
REQUIREMENTS.  
LARGEST SUPPLY OF HF/VHF/UHF  
TRANSCIVERS AT COMPETITIVE  
PRICES

**ALINCO** SYDNEY'S LARGEST  
ALINCO RANGE OF  
TRANSCIVERS & ACCESSORIES  
AUTHORISED DEALER

**ICOM** IC-756 IC-706MKII  
IC-207H IC-T7A

**KENWOOD** TS-570S TM-V7A  
TM-251

**Cushcraft**

No. 1 AMATEUR QUALITY ANTENNAS  
AUTHORISED DEALER

**AMERITRON** HF AMPLIFIERS  
FOR BEST PERFORMANCE

LOTS MORE NOT LISTED  
EXPAND YOUR COLLECTION TODAY

PHONE (02) 9896 2545

141 GILBA ROAD,  
GIRRAWEE, NSW 2145

QSL via EA4BB via the Bureau, or direct.

\* Iran. Ali EP2MKO was heard on CW on 20 metres. QSL via UA6HCW.

\* Laurance GM4DMA will be active from Namibia until 17 August as GM4DMA/V5. QSL via his home call.

\* JE3XRX is in Honduras, wants to stay for two years, and hopes to be heard with the HR1XRX callsign.

\* Mike K3UOC is active from Riyadh, Saudi Arabia as 7Z5OO until the end of July. QSL via W1AF.

\* Lee N5HG is now active in Tanzania as 5H3HG for the next 12 months. QSL via home call or via WY3V.

\* Charles K4VUD intends to be active from Nepal 9N for 20 days beginning 8 July on 14195 and/or 14226.5 kHz around 1300 UTC. QSL to home call.

## Interesting QSOs and QSL Information

\* V31ZA - Keith - 14164 - SSB - 0530 - Apr. QSL via PO Box 1879, Belize City, Central America.

\* BS7H - 21295 - SSB - 0558 - May. QSL via John Parrott W4FRU, PO Box 5127, Suffolk, VA-23435, USA.

\* 4K52V - 14022 - CW - 1302 - May. QSL via 4K7DWZ, Club Station, POB 165, 370000 Baku, Azerbaijan.

\* R60UPOL - Oleg - 14226 - SSB - 1334 - May. QSL via UR8LV Ukrainian QSL Bureau, Box 56 Kiev, 2520001, Ukraine; or direct to Oleg Satyrev, PO Box 9909, 310070, Kharkov, Ukraine.

\* 5H3JB - Bill - 14222 - SSB - 0558 - May. QSL via Hayden M Nadel NK2T, 22 Springtime Lane E, Levitown, NY 11756, USA.

\* 6K97EAG - 14007 - CW - 0734. QSL via Korean QSL Bureau.

\* V73NN - Jim - 14028 - CW - 0657 - May. QSL via N3OA via Bureau.

\* VK0TS - Tom - 14260 - SSB - 0606 - May. QSL via S N Trotter VK1AUS, PO Box 2063, Kambah Village, ACT 2904, Australia.

\* HK0TCN - Victor - 14164 - SSB - 0546 - May. QSL via Victor M Tesone, PO Box 464, Island of Sant Andres, Colombia.

\* CO2JD - Juan - 7018 - CW - 1113. QSL via Julio E Henriques HI3JH, Box 122, Santiago, Dominican Republic, Caribbean.

\* V73EX - George - 14252 - SSB - 0638 - May. QSL via George Beckley, Box 3012, Majuro, MH 96960 Marshall Islands.

\* V44NEF - Earl - 14190 - SSB - 0037 - May. QSL via Earl Francis, PO Box 565, Charlestown, Nevis Island, West Indies, Caribbean.

## From Here and There and Everywhere

\* Despite very bad propagation and a massive solar flare at 1800 UTC on 15 May,

which sent the A Index (geomagnetic activity) to a record height of 33. AX2ITU managed to contact 381 stations on a variety of HF bands, 2 metres and 70 cm. A total of 109 CW and 272 SSB QSOs were made with 24 DXCC countries and the VK1 to VK7 Divisions.

\* QSLing directly. This seems to be a problem with VK amateurs. Within a week after the AX2ITU activity, as QSL manager I received about two dozen cards for direct reply. Quite a number of amateurs, mostly VKs I am sorry to say, did not include self addressed and stamped reply envelopes with their cards, yet all of them indicated that they expect a direct reply. What is the cause of this? Ignorance, forgetfulness or the perceived attitude that the "Divisions have the money". These special event callsigns are self funded activities and a self addressed and stamped reply envelope is a necessity for direct reply. If you sent a card without the return postage, our reply will go by the QSL Bureau system; we hope that you are a member of your local QSL Bureau, otherwise our card will never reach you.

\* Calling all the VK6 amateurs who are employed by Telstra Australia. Did you know that your employer provides you with a nicely designed QSL card?

Such a card arrived the other day displaying the Telecom logo and the Telecom message proudly proclaiming that "This card was provided by Telecom Australia to Staff involved in Amateur Radio". There was no return postage attached to it!

\* The Western Samoan (5W) QSL Bureau has closed down. There are only four active permanent resident stations on the island.

\* The new QSL manager for R1FJZ is now Boris, U3AJ.

\* Did you know that a new International Beacon is operating in Western Australia? Martin G3USF, IARU Region 1 HF Beacon Co-ordinator reports that the VK6RBP beacon is sited 28 km south east of Perth. This beacon is similar to all the other IBP (International Beacon Project) beacons and is one of the 14 beacons on the air sponsored by the Northern California DX Foundation (NCDXF). The power of the beacons is 100 W which steps down to 0.1 W in four stages, transmitting for 10 seconds on the IBP frequencies on 14, 18, 21, 24 and 28 MHz.

\* Chris ZS8IR left Marion Island on 24 May for Cape Town. The future of amateur radio on the Island is uncertain, due to regulatory changes in the South African Environmental Affairs Department.

\* On 1 June the "World's Longest Bridge over Ice Covered Water" was opened in Canada. The Bridge connects Prince Edward Island to the mainland and is 12.9 km long

with the highest span 60 metres above water. To commemorate this occasion, Industry Canada (the regulatory body) and Radio Amateurs of Canada (RAG) have granted all amateurs of Prince Edward Island the use of the special prefix XN0 in place of the VY2 prefix. Operation will be from 29 May until 1 September.

\* L70FM in Argentina was active celebrating the seventh anniversary of "Radio Club Rosario". QSL via LU4FM.

\* Atif 7X2RO reports that the enclosures of nearly all arriving letters were stolen. He now asks that all QSLing to be done via F6FNU or OM3CGN.

\* Chris ZS8IR on Marion Island reported, before his departure, that all the rhombic antennas, including the towers, were dismantled. The HF system on the island is being downgraded to a single dipole and a single tower.

\* The Radio Amateur Callbook, with its distinctive "Flying Horse" logo, was first published in 1920 and its 75th anniversary edition (for 1997) appeared at the end of 1996.

A few months later came the news that the printed version of the Callbook will be discontinued. In future the Callbook will only be available on CD-ROM for computer use.

\* R60UPOL was a special event station operated by Oleg UR8LV at Chelyuskin Polar Base, celebrating the 60th Anniversary of the first QSO from the North Pole by the Russian Arctic Explorer Krenkel.

\* Chuck N4BQW/P/KH7 was heard on 17 May from Kure Island. QSL via WA4FFW.

\* Tom VK0TS came up on 14260 kHz on 26 May. Jim VK9NS was running a list for him.

\* Gary N7EKX from the State of Washington in the USA used an old Heathkit two watt QRP rig and a two element Quad at 16 m high to make a CW contact with AX2ITU. He received a 339 report from Sydney.

## QSLs Received

VS97UW (2 w op); 4L5O (24 m - TA7A); FW2EH (6 m - DJ2EH); XZ1N (5 m - W1XT); ZY0SK (2 m - PS7KM); ZD9CR (3 m - KA1DE).

## Thank You

Many thanks to all those who took the trouble to supply me with news and other information. Special thanks to VK2XH, VK2KAA, VK2KFU, VK2TJF, N7EKX, the *North Shore Times*, the *Sydney Morning Herald*, and the DX publications *QRZ DX*, *The DX News Sheet* and the *425 DX News*.

\*PO Box 93, Dural NSW 2158

ar

---

---

# Over to You - Members' Opinions

All letters from members will be considered for publication, but should be less than 300 words. The WIA accepts no responsibility for opinions expressed by correspondents.

---

---

## Morse: Communication and Languages

I must give D Palmer (VK2TMP) a bit more "rubbish" and "nonsense" in reply to his *Over to You* in *Amateur Radio*, May 1997.

1. When I worked in Korea and Japan I found that many people were proficient in written English but could not pronounce it. We therefore often had to use written messages to communicate.

2. I can make contacts and pass on written messages in CW, eg in Finnish, Croatian and Vietnamese without speaking a word of the language. Try this with SSB.

3. The ultimate emergency is at war. The military signal corps is still using Morse code and requires it in their aptitude test. Anyway, most commercial HF transceivers have a CW option.

4. If one tunes around, many CW signals outside the amateur bands can be heard. Are all of these coming from Dodos or idiots?

5. Radio amateurs can (and will) play a vital role in emergency situations, if all other services fail. It is one of the very few justifications for our continued allocation of valuable HF spectrum. Practically the only distinguishing advantage of a fully fledged HAM over others is his ability (to send, at least) Morse code. That's why we must keep it; if only for survival!

6. By the way, I learned (compulsory) Latin at school and I am still grateful for it. Apart from other advantages, I learn scientific terms and names much easier because I understand what they mean.

Kris Gerhardt VK4CPG  
26 Mitchell Avenue,

Hervey Bay QLD 4655

email: gerhardt@ozemail.com.au

## CW Obsolete?

Thanks to Les Daniels VK2AXZ (*OTY* June 1997) for pointing out that the anti-CW lobby claims that "[it] is now obsolete in marine communications and the armed forces".

At a recent briefing, conducted by the Royal Australian Corps of Signals, it was revealed that the Corps requires its operators to be proficient in Morse at 12 wpm.

Whatever the pros and cons of the current CW debate, the argument that it is obsolete in the armed forces is without validity.

Graham Thornton VK3IY  
17 Britannia Creek Road  
Wesburn VIC 3799.

## Proposed New Format for the Call Book

The *WIA News* item about proposed changes to the method of publication of the Call-Book seems to ring alarm bells for some of us retirees without computers and with failing eyeballs!

The suggestion only to publish the Call Book in digital form on CD-ROM has prompted the writer to ask your sub-committee to keep in mind those of us who rely on the existing format for access to the Ham fraternity.

My XYL and I keep a copy of the Call Book in the car and another in the shack of course, and not a week passes without these books being used. The only criticism we have of the present Book is that the print size of the listings is a bit too small for many of us.

Max Morris for M Morris VK3GMM  
and W J Morris VK3AWM

PO Box 222

Rye VIC 3941

ar

---

---

# Update

## New Zealand ARDF National Championships

(Published on page 19 of the June 1997 issue of *Amateur Radio* magazine)

We have received an e-mail from Mark Diggins VK3JMD pointing out that he had incorrectly inserted Jason VK4YOL's callsign as VK3YOL in both the VHF and HF results table.

It might be a good idea to correct your copy of the June 1997 issue of *Amateur Radio* now.

## Equipment Review - Two Metre Amateur Band DF Receiver

(Published on page 13 of the June 1997 issue of *Amateur Radio* magazine)

We accidentally omitted giving credit to Ron Fisher VK3OM for the two photos of the DF receiver.

It might be a good idea to correct your copy of the June 1997 issue of *Amateur Radio* now.

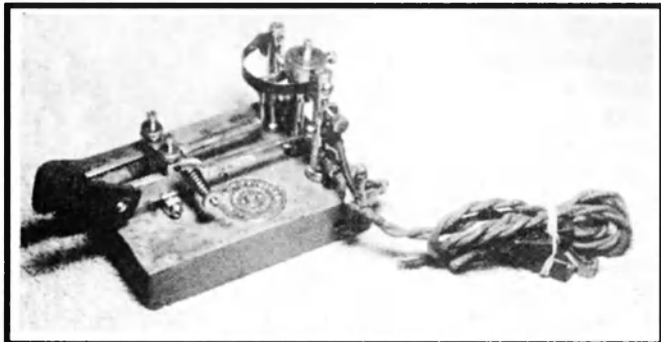
ar

# Pounding Brass

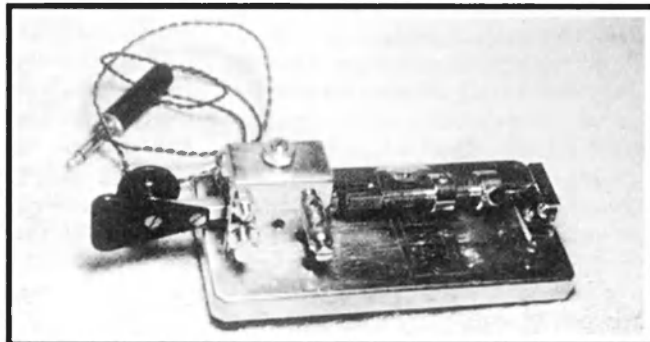
Stephen P Smith VK2SPS\*

This month, something a little different. A look at some Australia semi-automatic keys, ranging from 1925 to 1965, as used by the old Post Master General's Department (PMG).

I will include some historical hand keys in a future column.



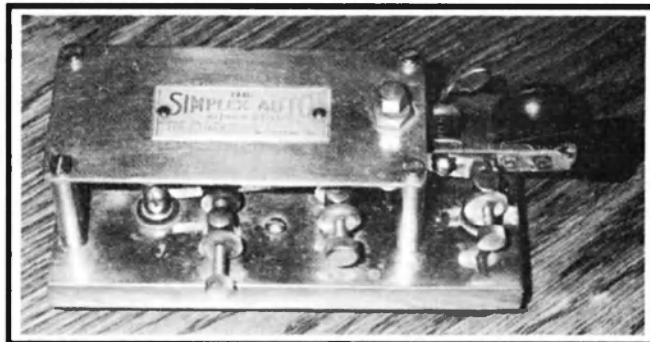
A MacDonal's Pendograph, patent number 11389, made in Adelaide.



An Autoplex, by J Vaile, Leslie Crt, Burwood, Victoria.



A Simplex Auto, by Leo G Cohen, Melbourne, Victoria.



A variation of the Simplex Auto, by Leo G Cohen, Melbourne, Victoria.

\*PO Box 361, Mona Vale NSW 2103

ar

## International Amateur Radio Union Monitoring Service (IARUMS) - Intruder Watch

Gordon Loveday VK4KAL\*

### Return of the Prodigal!

We can well do without this one! The Russian Woodpecker is back in our midst again, this time on 18.130 to 18.160 MHz, and maybe other bands as well. Strengths of S9 are being heard. At my QTH it has been 45444 (SINPO), which is about S7.

It has also been heard in VK2 and VK3, but the Intruder Watch Service needs many more observations and beam headings (in degrees). The general direction has been given as south of east from the Melbourne area.

It is not the Australian Jindalee OTHR, as this operates at a much higher frequency and appears as a "swishing sweep" (and high speed at that) across most frequencies.

### 80 m Intruder

Another encroachment is in the 80 m band. It is coming from south of New Zealand, bearing around 170 degrees, signs in A1A (CW) on frequencies from 3.543 to 3.616 MHz from 1945 to 2100z daily. The call signs are those we normally associate with the UK, ie GKE 1 and GKY 1. Other call signs being used are SXA and SXH. Data

is usually passed, but it has also been heard using LSB.

Logs to hand have reports of over 60, but here again we need more information from VK3 and VK5. I've not heard any signals this far north and west.

A reminder. The IWS needs frequency, date, UTC and beam headings in degrees. Please forward to the address at the foot of the column. Unfortunately, no packet at present!

### Stop Press

Just to hand by fax. Alex VK6APK has received confirmation of removal of VOA on 14.270 MHz as heard on 31 May 1997 at 2333 from Phil Goodman@beng.voa.gov. It was a harmonic from the Philippines. Congratulations Alex.

\*Federal Intruder Watch Co-Ordinator, Freepost No 4 Rubyvale QLD 4702 or VK4KAL@VK4UN-1

ar



---

---

# Repeater Link

Will McGhie VK6UU\*

---

---

The Internet system that allows amateurs and voice repeaters to be transmitted via the Internet, is in the news in VK6 of late. Readers of this column may remember the article in the December 1996 issue of *Amateur Radio* about using the Internet to talk from Australia to voice repeaters in other parts of the world. The next step has been taken in VK6, with the reverse situation. Amateurs are appearing on some of our local repeaters from the USA and Canada. A local VK6 amateur is using his Internet set-up to link amateurs from these countries into our voice repeaters in Perth.

The link up is not automatic or permanent, but requires an amateur to do the operation from his Internet computer and then provide the radio link, into and out of the local voice repeater. At all times the system is monitored, operated and controlled by the local amateur doing the link.

A further step to be taken could be to connect a voice repeater into a permanent automatic Internet system just like is being done in other parts of the world. At this stage there are thoughts to do just that in VK6, and I would imagine in other areas of Australia, but we have a problem. The problem is that amateur regulations prevent connecting voice repeaters directly or indirectly to the public telephone network. The latest regulations on voice repeaters say just that, directly or indirectly. Connecting the Internet via a radio link is an indirect connection.

However, I could be completely wrong. What happens in Australia is that regulations are written to contain the amateur service and then we amateurs spend a lot of time arguing about what they mean. This is happening right now with the Internet connection situation. The SMA have been written to, asking if connecting the Internet to a voice repeater in the method described, via a radio link, is legal. This letter originated from an individual amateur straight to the SMA, the WIA were not involved. Interestingly, the letter went to the SMA and not to the WIA. The WIA should know if such a connection is legal or not.

Now before you begin to think I'm going to start having a go at the WIA this is not the case. I have had many conversations with John Martin of FTAC, who has to try and understand the detail and intent of the regulations the SMA lay on us. John is in the best position to have a good grasp of the intent of amateur regulations and has many times pointed out complexities in their

wording and interpretation. At times John amazes me at what he can see in the wording. Now that the Internet link situation has occurred, the meaning of direct or indirect connection to the public telephone network for voice repeaters is being looked at.

It is important to understand this regulation. Any amateur can link other amateurs via the Internet onto an amateur band. It is just phone patch in a modified form. The strange situation is that that same amateur cannot shift the frequency of the link onto a repeater frequency. Why, I hear you ask? I don't know for sure, but it could be concern that non-amateurs may be transmitted from the Internet to amateur voice repeaters. But why the distinction between a simplex frequency and a voice repeater?

The point needs to be made that the software that controls the repeater link system requires those wishing to use the system to register their call sign and other details. These details are then checked with a list of amateur call signs on CD ROM. Sure, you could just look up a given amateur and type in the details, but the person doing this has his e-mail address riding along with the information. This non-amateur could be tracked down. This is a lot more secure than any non-amateur buying a transceiver and going on air. This, of course, happens from time to time and we have to live with it. I don't know if the Internet connection to amateur repeaters has been pirated, but it is a lot more difficult to do.

Once again regulations are applied to the voice repeater service that restrict experimentation and no reasons are given. Why can we transmit Internet voice on one frequency on two metres and not another because it is a repeater frequency? All along, we amateurs, particularly the ones actually doing the experimentation, are being limited for unknown reasons.

## New Regulations

The long awaited new repeater and beacon regulations have become law. It took about eight years to get to this point and, in my opinion, the wait was not worth it. These regulations are not new, as they have been about for a couple of years; they just never became law. All the other TLSs relating to amateurs became law a few years ago, but the repeater and voice TLSs did not. Up until now, repeaters and beacon have been operating under the original RIBs.

There have been gains with these repeater TLSs, but not in the spirit that was discussed with the SMA some eight years ago. We must just keep slogging along, trying to achieve enlightened voice repeater regulations, but I don't think it will be in my lifetime.

## Site Fees to Change

We have had a win that should never have been necessary. Repeater and beacon licence fees are to change back to the original system, of one fee for a given site call sign. However, the site investigation fee for new licences will remain and, I have been told, increased. The fee structure was changed a while back to a fee for each transmitter, a cost burden that saw some repeaters and beacons shut down.

In VK6 the cost increase was about three times for our repeater club. As a result,

## WIA MORSE PRACTICE TRANSMISSIONS

VK2BWI	Nightly at 2000 local on 3550 kHz
VK2RCW	Continuous on 3699 kHz and 144.950 MHz 5 wpm, 8 wpm, 12 wpm
VK3COD	Nightly (weekdays) at 1030 UTC on 28.340 MHz and 147.425 MHz
VK3RCW	Continuous on 145.650 MHz, 5 wpm, 10 wpm
VK4WIT	Monday at 0930 UTC on 3535 kHz
VK4WCH	Wednesday at 1000 UTC on 3535 kHz
VK4AV	Thursday at 0930 UTC on 3535 kHz
VK4WIS	Sunday at 0930 UTC on 3535 kHz
VK5AWI	Nightly at 2030 local on 3550 kHz
VK5VF	Continuous on 145.650 MHz, 5 wpm to 12 wpm
VK6RCW	Continuous on 147.375 MHz, 3 wpm to 12 wpm

several licences were not renewed. It will be interesting to see if the SMA charge a fee to have these licences re-instated. After all, the site investigation has already been done.

Also, will money be refunded that was paid under the cost per transmitter system? Not only money was involved but a lot of time spent trying to minimise costs by repeater clubs. A costly change to the amateur service that should never have happened.

## 29 MHz Gateway Update

The years keep rolling along and still no licence for the 29 MHz gateway in Perth. It does look like it has taken another step, with the license application generating a query from the SMA to the Federal WIA asking if it conforms to the WIA band plan. It does, and this information was supplied by the VK6 WIA in their application to the SMA. But I gather we have to be sure. Yet another delay.

While on the subject of the 29 MHz gateway and the band plan, three channels have been allocated by FTAC. They are 29.120, 29.140 and 29.160 MHz. The Perth gateway is to go onto 29.120, and it is recommended that all 29 MHz gateways go onto the same frequency of 29.120 MHz. Gateways will require CTCSS input access and, as the 29 MHz gateway transmitters will not be encoded with CTCSS, they will not link. If this linking restriction is lifted by the SMA, then automatic linking could occur when band conditions allowed.

The recommended CTCSS tone to access the 29 MHz gateway on 29 MHz is 141.3 Hz. For an amateur to access a 29 MHz gateway on 29 MHz, this 141.3 Hz tone will be required. This will require you to construct a CTCSS encoder, as HF equipment does not normally come with CTCSS encode or decode.

If all gateways operate on 29.120 MHz, all using the same CTCSS tone, it will make monitoring and using the gateways easier. Any interference between gateways, when propagation allows, should be seen as a bonus for now. Let us see how the single gateway frequency works in practice first. If there are problems, then frequency changes could be made. It is important to remember that the single frequency idea makes it easy to link these gateways, if the regulation preventing this is removed. Yet another silly regulation.

It was a bit of a rush putting this together this month, as I have been busy. I hope the information is accurate. Now to e-mail it to *Amateur Radio*. That is the easy bit.

\*21 Waterloo Crescent, Lesmurdie 6076  
Packet: VK6UU @ VK6BBR  
E-mail: will@vale.faroc.com.au

ar

# Spotlight on SWLing

Robin L Harwood VK7RH\*

News has come through that Radio Australia is drastically reducing its services as from this month. No date has been given yet so it may have already happened. In last month's column, I reported that several language services have been axed, namely French, Thai and Cantonese. Also, English programming is being reduced. Reportedly the Darwin site is being closed, which I stated was incomprehensible because the bulk of Radio Australia's audience is in SE Asia and the Pacific. The primary reason is budgetary but there have been reported comments from some Federal parliamentarians that Radio Australia should not be broadcasting news of what is happening within the target areas and should be concentrating on Australian news and information.

I am compiling this in early June so I do not know what will have happened to Monitor Radio International, which was scheduled to close on June 30. The parent organisation, the Christian Science Publishing Society, did indicate that they may be continuing solely with their religious programming if the senders had not been sold before then. Sadly, their excellent news and current affairs will be no more. I did like their balance and coverage compared to the official VOA news which, naturally, reflects US government foreign policy, although they say they are independent.

It was confirmed that the Voice of Greece in Athens will be using VOA senders in the USA to rebroadcast to the Americas and is likely to commence in September. Up to 12 hours per day will be aired. The VOA has been broadcasting from Greece and Rhodes for many decades and now Athens will be using the VOA to increase their range to where there are substantial ethnic Greek communities in the States and South America.

As many of you are aware, there are some international and domestic broadcasters who have been putting up their audio on their Internet web pages. To get this, naturally, you will need the appropriate software such as

Real Audio TM or Streamworks, which can be easily downloaded. However, the majority of program makers seemingly have opted for Real Audio. It is very strange listening to a news broadcast or a missed episode of "Communications World" on the VOA through your sound card. Sometimes it will flow very well but, if the traffic on the net is heavy, the feed can be disjointed or disrupted.

The audio quality usually depends on your modem speed and the amount of Internet traffic. However, I still prefer short wave as it is reliable and doesn't cost anything compared to paying for access to the Internet. My ISP costs \$4.50 per hour at peak rates so you can readily appreciate that I mainly restrict my surfing to off-peak hours.

I recently received a letter from an English reader of this column. Nice to know that I am being read throughout the world! BH of Nottingham wrote to tell me that amateurs and professional HF users in the Middle East are being plagued by deliberate interference from Arabic speaking stations, particularly in 5B4 land. It appears that the increasing number of non-licensed operators or pirates using HF has escalated the use of satellites and other digital forms of communications by legitimate operators.

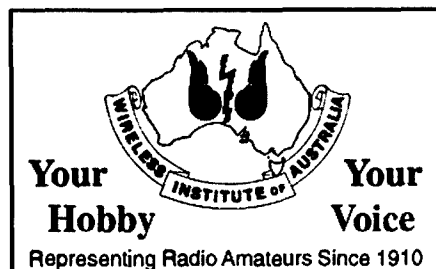
The HF maritime allocations where you could find CW are rapidly shrinking and should be gone by 1999. However, many stations are not waiting till then, pulling the plug earlier as the number of users of the key has dramatically shrunk in the past 12 months. Just tune between 8.44 and 8.7 MHz and note the number of remaining stations there compared to 10 years ago when it was heavily congested. There appear to be a number of HF pirates popping up there now, judging by the amount of Asian operators recently heard there.

Note that the Southern Cross DX Club now has a Web page. It has details of the club with links to other users. It can be found at <http://tolstoi.saccii.net.au/~stephenn>. The New Zealand Radio DX League can also be found at <http://navigator.co.nz/nzrdxl>. Another link to SWL sites has been put up by a friend, David VK3NDS, at <http://www.tbsa.com.au/~dsimp/>. The Electronic DX Press can be found at <http://www.wp.com.edxpl/>.

Well, that is all for this month. Until next time, the very best of listening.

\*5 Helen Street, Newstead TAS 7250  
(03) 63 44 2324  
VK7RH@VK7BBS.LTN.TAS.AUS.OZ  
Internet e-mail: robroy@tassie.net.au

ar



# VHF/UHF – An Expanding World

Eric Jamieson VK5LP\*

All times are UTC.

## Meteor scatter propagation – Part 2

Ron VK3AFW says the following points are worthy of consideration when it comes to using meteors for contacts on two metres:

1. MS in VK isn't easy and doesn't compare to the Northern Hemisphere conditions;
2. The minimum station requirements for average conditions are 100 watts to a 13 dBd gain antenna in the clear and a 2 dB NF receiver with effective noise limiting;
3. Paths up to around 1600 km can be spanned on two metres most days via meteor scatter scheds;
4. The meteor rate is higher before and just after local sunrise than later in the day; and
5. Meteor shower prediction is not a mature accurate science, or the science is not widely known.

These facts are not new but it is useful to re-confirm them. The following hints are offered to would-be MS operators:

1. Strict adherence to an agreed protocol is necessary. Stray from it and you will confuse the other station and probably miss out;
2. Be within 100 Hz of the other station's frequency and stay there. Make adjustments with your RIT to clarify the other station's speech if necessary. I use a timer to switch the rig on two hours before a sched to minimise my drift.
3. Persist with calling. You can't hear the meteor that is going to propagate your signal. You can't see or predict it either. To win against the statistics you must call in every one of your time slots for up to an hour. You might complete in the first 10 seconds, but it's just as likely that you might not complete until the 59th minute. Have a glass of water and some lozenges handy. Don't give up. The next interval might be the one when a huge piece of space junk falls out of the sky, ionising the ED layer from here to Darwin.
4. Speak quickly but distinctly. I can (when fully wound up) get five sets of callsigns or ten reports out in five seconds, so a one second burst conveys one set of info. If you take five seconds for two sets of callsigns your chances of completing are more dependent on longer bursts which are rarer. It's not easy to keep this up for 30 minutes. You will feel self conscious and a bit stupid.
5. Expect the unexpected. A loud and long burst after listening to the ambient noise is disconcerting. My brain used to freeze for five seconds when this happened, causing me

to miss transmitting back on the tail of the burn. There are too few long burns not to use every one. This disorientation happens to most people starting out on this mode and experience is probably the only way to overcome it.

Many thanks to Adrian VK2FZ/4, for his long hours on the band and persistence in listening for weak signals on differing frequencies. Adrian's telephone number is 07 5499 9869 but don't necessarily expect him to answer during any sched times! ... de Ron VK3AFW.

Dale Cavies VK5AFO asks: "Is any one out there able to conduct some experiments using meteor scatter? I'm in a position to give it a go from Mt Barker in South Australia PF94 locator, using two nine element Yagis at 50 ft and 80 watts. I've not heard a squeak from the beacons in Sydney whilst listening in the evenings. Any pointers would be handy."

Mike VK2FLR replied: "I am surprised that Dale has not heard the VK2RSY beacon via MS on 144 with his 2x9 element Yagis. VK2RSY is currently exactly on 144.420 and should be audible via meteors. I certainly hear VK5VF via MS".

Mike suggests to Dave, and any others interested, to try in the mornings when random meteor activity is much greater than in the evenings. If Dave can hear VK2RSY/b then Mike will set up some scheds.

Part three of meteor scatter experiments next month.

## Six Metre Web Page

A message from Jim Cotterill VK1ZFG sent to [vk-vhf@marconi.mpce.mq.edu.au](mailto:vk-vhf@marconi.mpce.mq.edu.au) and relayed via Ron VK3AFW, states that "Strictly 6 – Australia's six metre Web page has recently been updated to include a list of all known six metre capable radios with individual links to further info on the Net. Hope you find it useful at <http://www.qsl.net/vk1zfg> Jim's own e-mail is [CanberraBoy@msn.com](mailto:CanberraBoy@msn.com)."

## Notice of Proposed DXpedition

Steve Gregory VK3OT at [steve.vk3ot@h140.aone.net.au](mailto:steve.vk3ot@h140.aone.net.au) advises he proposes visiting SEANET 1997 next November. He may activate Melville and Bathurst Islands, about 100 km north of Darwin, and will consider going to Christmas Island to survey it for future operations during Cycle 23.

He first activated VK9X in 1980 and again in 1982 and made over 16,000 six metre QSOs to 25 countries including 9N1 and HS1. He also activated VK9Y in 1982 and heard FY7 long path.

This prompted him to supply VK9YJ with a 9 el Yagi in expectation of his success from there. VK9YJ worked all continents in 48 hours and around the world both ways to South America using just 100 watts and the 9 el Yagi, which now graces the VK3SIX site.

WA6BYA has indicated he will visit Seychelles in Cycle 23 and Steve will also consider FR7.

"So the Indian Ocean is the place to go as well as rare grid squares in the north-west of VK6 for QSOs to Europe. Ideas wanted please." ... VK3OT QF12ag.

## Microwave Tests From Port Lincoln

David Minchin VK5KK advises that following a visit to his brother Hans VK5NME, Hans is now operational from Port Lincoln, using a Philips FM900, an FM rig of about 30 watts, and a three element horizontal beam. He operates most nights from 1030 UTC on 146.425 MHz. Hans has worked his father VK5AKM at Wasleys and David at Salisbury Heights, both over the same path distance of 265 km, and would welcome contacts.

David VK5KK said: "I took the 2.4 GHz and 10 GHz gear to Port Lincoln to listen to the VK5VF beacons and try to work VK5AKM. I expected to hear the 2.4 GHz beacon and maybe something on 10 GHz from VK5AKM as we could hear him on two metres at 5x2. We ended up on Winters Hill at Port Lincoln, about 130 m ASL, at 0230 with plenty of cloud and wind but no rain or unusual propagation. The 10 GHz beacon was audible at S1. Over the next half hour the signal rose to S5 (20 dB over the noise) with QSB, but never disappeared. VK5VF runs 20 watts EIRP on 10 GHz from 600 m ASL. Path distance 269 km.

"VK5AKM (from home at Wasleys) then ran a carrier. As has been noted of late, the stable TCXOs that are being run by various 10 GHz operators mean that you don't always need to go tuning; in this case I heard the carrier switch on! We made a two way SSB contact on 10,368.455 MHz at 0240 (5x2 sent, 5x3 received), path distance 268 km with about 190 km over land. VK5AKM is about 100 metres above sea level, running 250 mW into a 600 mm dish, mounted 13 metres above ground. QSB was evident but not as marked as the beacon. The contact lasted for about 20 minutes.

"With our current equipment, under "normal" conditions it looks like 268 km might be close to the limit on the water paths we have around Adelaide. The usual effects on 10 GHz signals over a water path were evident – multi-path plus or minus 10 degrees. Again a lack of propagation on the lower VHF frequencies doesn't always

correspond with a lack of enhancement above 1 GHz.

"The 2.4 GHz beacon was a consistent 25-30 dB over the noise (S7-9) using a 600 mm dish. While the beacon has better than 200 watts EIRP to the west, the 12 dB drop in receiving gain of a 600 mm dish on 2.4 GHz should level this out. The results showed that 2.4 GHz performed 6-10 dB better than 10 GHz over the path; well, at midday on a cloudy day anyway! The QSB effects observed on 10 GHz had no correlation to those on 2.4 GHz. In fact, the QSB was less than that observed on two metres before. One explanation for the consistency of the 2.4 GHz signals is the cloud cover. I have noted enhancement before with clouds at 3-4000 feet. Certainly worthy of more study!"

### UKSMG Membership

Adam Maurer VK3ALM, VK Country Manager for the UKSMG, is seeking more applicants to join. At present VK1ZFG, VK3ALM, VK3ANP, VK3OT, VK3ZNF, VK4APG, VK5LP and VK7ZO represent the VK members – only a handful of operators.

He says: "Some operators have thanked me for the offer to join, but state they get all the news they need from the Internet. True, there is certainly a lot on the Net, but it doesn't materialise out of nowhere.

"There is a group of thankless individuals out there pulling all this together, for other operators to enjoy. The UKSMG WWW site is a fine example. There would be no WWW site if there wasn't a membership base from which to begin!

"UKSMG funds are ploughed back into DXpeditions around the globe and includes DXpeditions that will be worked in Australia in Cycle 23. An example of their support for six metres is the provision of equipment for SUIER in Egypt to come on the band.

"The quarterly magazine "Six News" is becoming more focussed on in-depth articles that are best published on paper rather than electronically. The WWW site is the best site for transitory news. They are entirely different media, so even if you are on the Net you will be missing out!

"If you would like further information please send a business sized SASE to: Adam Maurer, VK Country Manager, 1 Jeffrey St, Dandenong Nth, VIC 3175. E-mail address is: adam@rint.com.au.

"Please note, due to the "chalk and cheese factor" regular packet operation has ceased from this station (like many others) in favour of the Internet. Any ZL membership enquiries can be directed to Bob McQuarrie ZL3TY. Bob's e-mail address is bmcquarrie@minidata.co.nz."

From Ron VK3AFW: "10/5 East Coast

Aircraft Net, 144.200 MHz. 2236 VK3AFW worked Les VK1BUC 5x1 5x2, 2240 Peter VK1RX 5x6 5x8, 2243 Chris VK1DO 5x7 5x8. Later, on 144.100 Ron worked Barry VK3TBM/p near Moe. He was QRP with a single quad loop.

"13/5: 144.080 weekday morning Bass Straight Net. 2211 Andrew VK7XR worked Ron VK3AFW 5x9 5x9, Max VK3TMP 5x7 5x7, and Des VK3CY 5x1 5x2. Ron was also heard by Andrew on 432 FM at 5x2 but equipment malfunction prevented a two-way QSO. Who said tropo enhancement is a summertime thing?

"17/5: East Coast Aircraft Net, 144.200 MHz. 2200-2315 Quentin VK3DUQ and Max VK3TMP worked VK2ZAB and VK1VP Ron VK3AFW and Max VK3TMP worked VK2TWR. At 2253 Max and Ron copied VK2DVZ (presumably off a meteor) at 5x4/5x5. VK2DVZ was possibly calling VK2TWR, signals in very briefly and only the callsign heard once. Later that morning Max VK3TMP had further QSOs with Rod VK2TWR on both 2 m and 70 cm. Rod is only running 20 W on 70 cm at present.

"On UTC day 24/5 from 2243 to 2246, I worked the following via aircraft enhancement. Rod VK2TWR, Chris VK1DO, Les VK1BUC, all Q5 and between S3 and S6. Chris VK1DO also worked Gavin VK3HY, Ken VK3DQW and Les VK3ZLS. 2303 VK3AFW to Trevor VK5NC, conditions patchy; 2331 to Barry VK3TBM/m 5x3. He was running less than three watts to a Vee-dipole from Mt Tarrengower near Castlemaine, about 130 km NNW from Melbourne."

### Geelong Beacon Update

Charlie VK3BRZ advises of the recent update to the Mt Anakie two metre beacon antenna system.

"Previously the beacon was fitted with a crossed-dipole arrangement. Tests using an identical antenna revealed that it was far from omni-directional, behaving more like an ordinary single dipole. Also, reports from operators to the north-east seemed to indicate a lower than expected signal strength compared to the repeater on Mt Anakie.

"I replaced the old antenna with a pair of four element Yagis, fed via a two-way power splitter. One Yagi is pointed at 35 degrees, ie north-east, and the other at 293 degrees, ie Adelaide direction. The gain of each Yagi is 8 dBd, so that with the power split two ways, there should be an 8 dB increase in signal strength over a true omni-directional antenna (I suspect it will be more in fact, since the crossed dipoles shoot an appreciable signal straight up in the sky).

"The beam width of each antenna is 50

degrees at the -3 dB points, and the beam width at which the gain drops to 0 dB (ie back to what a dipole would be) is 84 degrees. If you transfer these figures to a map you will see that the beacon covers the main areas of significance to us. Most DX users should observe an improvement of between 3 and 8 dB at least. Already reports from VK2TWR at Nimitabel, VK2EMA at Tottenham and VK5LP at Meningie confirm this. Unfortunately, the signal to VK7 will have all but disappeared. You can't have everything! Perhaps Ron VK3AFW might be persuaded to re-locate the VK3RTG beacon so as to cover the north-west/south-east paths."

Charlie would appreciate reception reports, not only from those in the favoured directions but those to the sides and from VK7.

Ron VK3AFW replies: "Charlie VK3BRZ has wanted to set up the VK3RGL beacon with a beam towards VK6 for some time. On 19/5 Andrew VK7XR worked Rod VK2TWR on two metres SSB and was told that the VK3RGL beacon had two beams connected, one towards the north and one towards the west. This means that Andrew, and the other VK7s are without a useful propagation indicator. Because the Geelong beacon was to the west of Melbourne and sited with an unobstructed view of the horizon, it was heard under different conditions from the Melbourne beacon. Its hard to know what's best – probably a mix of beamed and omni-directional beacons in close proximity is the answer.

"Regarding VK3RTG/b, I would like to change the aerial and its site and also rebuild the keyer and the RF deck, but my own station needs some attention and will get priority. VK3RTG/b runs only seven watts to a halo and is screened by nearby higher buildings, except to the east and south-east. I hope to erect a 3 dB gain antenna and increase the power to 25 watts in the next 12 months. The changes to VK3RGL/b have made an upgrade more important. I'm not sure about an alternative site."

### Portable Operation

I received a letter from Andrew Miller VK5DL who operated portable from Hampden via Eudunda, 100 km NNE of Adelaide on 15/4/97. Andrew used 100 watts to a GST3 2/70 vertical antenna.

During the course of that evening he set out to work as many two metre repeaters as could be found, ending with 2 x VK7, 2 x VK2, 10 x VK3 and 11 x VK5, as follows: 146.625 VK7RMD, VK5RLZ; 146.650 VK5RNC, VK3RGV; 146.675 VK5RSV; 146.700 VK5RMN; 146.750 VK5RLC, VK3RBA; 146.800 VK3RMA; 146.825 VK5RBV; 146.850 VK2RGF, VK5RHO;

146.900 VK3RSH; 146.925 VK5RLH; 146.950 VK3RWZ; 147.000 VK5RAD, VK2RBH, VK3RGL; 147.025 VK3RMK; 147.050 VK3RVL; 147.075 VK7RWC; 147.150 VK3RCV; 147.200 VK2RWB; 147.275 VK3ROW; 147.925 VK5RLD. He found it an interesting experience to access simultaneously repeaters in Adelaide, Broken Hill and Geelong.

Responding stations were VK5OZ, VK5KCX, VK7NDH, VK7KY, VK7EQ via VK7RWC/VK7RMD, VK5NFJ, VK3TD, VK3IP, VK3DBL, VK3UWW, VK3JGF, VK3MLZ, VK3HMA and VK3XC. Several better equipped Adelaide stations received excellent reports from VK7 – these included Steve VK5OZ and Barry VK5KCX.

On 24/4 between 2200 and 0100 (25/4) he worked VK2KAW, VK2ZMP, VK2BGA, VK2APP, VK2DPG, VK3MV, VK2KVV, VK2FBK, VK1ZQR, VK3ZGL, VK2HI, VK3TCM/5 and a few others using 146.650 VK5RNC, 146.750 VK2RWG and VK5RLC, 146.800 VK3RMA and VK2RTD, 146.850 VK2RGF, 146.900 VK3RSH, 146.950 VK3RMZ and 147.000 VK5RAD and VK2RBH. Unlike the previous occasion none of this activity could be heard in Adelaide.

## Melbourne Area

Max VK3TMP at Somerville on the Mornington Peninsula worked the following: 5/4: 2246 Gordon VK2ZAB 432 5x1; 12/4: 2245 Joe VK7JG and 2315 Andrew VK7XR 144 5x9+, strongest ever heard, 2316 VK7XR 1296 5x4; 15/4: 0857 Phil VK5AKK 144 5x5, 1110 Barry VK5KCX 144 5x2, 1111 Steve VK5OZ 144 5x3, all Adelaide area; 15/4: Colin VK5DK Mt Gambier worked on 144 at 1001 and on 432 at 1040, but unable to work him on 1296 MHz; 23/4: 0534 Rob VK3DEM and 0536 Roger VK3XRS, both Bairnsdale on 1296 and 5x5.

## Channel 1 in New Zealand

Adam VK3ALM reported on 26/5: "Bob ZL3NE received a letter from Radio Operations saying that from the 16/06/97 TV4 will be operating on Ch 1 horizontal from Auckland sky tower!

"All Auckland stations will need to be re-tested and will not be permitted to operate on 50 MHz until this is done! Not good news. NZART had a meeting with TV3 and were told that there would not be any transmitters or translators operating on Ch 1 for TV4, but this appears to be not true. A concern to all of us but what can we do?"

Andrew Hay VK7XR says that although overall the bands have been relatively quiet, there are still days when things happen. The following are some entries from his log book:

20/4: 2134 VK3ATQ 50 519, 2213 VK3AFW 144 529; 21/4 2215 VK3AFW 144 529; 23/4: 2132 VK3ANP 50 5x5; 27/4: 2212 VK3AFW 144 5x2; 29/4: 2213 VK3AFW 144 529; 30/4 2214 VK3AFW 144 519.

13/5: 0915 VK2TWR 144 5x6, 0921 VK2TWR 432 5x1, 0925 VK3BWT 144 5x1, 1025 VK2TWR 432 5x9, 1029 VK2RBC/b 432 S7, 1030 VK2RBC/b S9, 1036 VK3BWT 144 5x1, 2127 VK2RBC/b 144 S5, 2127 VK2RBC/b 432 S3, 2130

VK3RGL/b 144 S1, 2133 VK3ATQ 50 5x5, 2135 VK3BQS 50 5x5, 2211 VK3AFW 144 5x9, 2212 VK3TMP 144 5x7, 2215 VK3CY 144 5x2.

## That 17000 km Barrier

Further to the listing of three amateurs breaking the 17000 km distance to the UK/EU area in June *Amateur Radio*, it now appears that the contact between Steve VK3OT and Martyn G3UKV is 16818.9 km, so that leaves Ken VK3AKK to GJ4ICD and Moss VK7IK to PAOLSB as the claimants.

After receiving notification from Geoff GJ4ICD that the VK3OT contact was less than 17000 km, I spent some time reviewing the matter and came up with a few interesting observations.

Chris G4IFX supplied me with the latitude and longitude of Martyn G3UKV, which then gave me his grid square to six places. I used the Latitude and Longitude co-ordinates for both parties rather than the grid squares, thus achieving greater accuracy.

Also, I ran some checks from between the UK and south-eastern Australia and came up with the following answers:

1. From Hamilton there is nowhere in England, Scotland or Wales which is 17000 km or more. From Melbourne most of the western side of those areas are a little more than 17000 km, also Jersey Island at 17144 km.

2. From Hamilton, the east coast of Ireland in IO64, IO63 and IO62 are all more than 17000 km, as are IN78 on the tip of France, IN58 and other places on the western coast of Portugal, IN53 in Spain and IM78 in Gibraltar. The angle of the path to G3UKV is 313 degrees which crosses the equator at about 45 degrees; the others range from 324 degrees at the north-western tip of Scotland, 316 degrees to Northern Island down to 282 degrees at Gibraltar. That gives you some idea of the spread of the area involved.

3. So unless you live on the eastern side of Melbourne or other points further east, or Tasmania, then you will not make 17000 km to the UK or Europe.

I also mentioned the contact on 27/11/91 between Mike VK2FLR and Joel CU/N6AMG in the Azores at 19424.1 km.

Neville VK2QF and David VK2BA also made contact with CU/N6AMG on that day. As far as I can ascertain no other amateurs from south-eastern Australia made it to the Azores.

## Overseas

Geoff GJ4ICD: from *HRT News* and *Internet Six News* supplies the following:

"After a successful two day visit to Egypt by Chris G3WOS and Nick G3KOX, Ezzat SUIER is now active on six metres from Cairo, using a 100 watt amplifier and PSU donated by the UKSMG, and a three element Yagi.

"On 9/5 Ezzat SUIER worked an IT9 for his first station on 50 MHz. As of 22/5 Ezzat had worked IT9, I, 9H1, SV, YU, EH5, 4X, SM, OZ, S5, F, G, SP, YT, LZ, 9A3, IO, DL, YO, ON and Geoff GJ4ICD; the latter at 1644 on 22/5 at 5x9 – a good signal for double-hop. [Shows what can be achieved if you live in a place within range of scores of countries. When F2 returns, Egypt will be within useful range of Australia. Note it down. . . de VK5LP]

"A large aurora occurred in Europe on 15 May, John G4SWX reported SM and GM strong on 144 MHz. At 1446 LY2WR on 432 reported hearing SM3AKW 59A." [That's interesting. It had always been my prior opinion that aurora on 432 was questionable, like Es. . . de VK5LP]

"17/5: 9M into JA: Tex 9M2TO (ex.JAODMV) in Penang Island (OJ05) was worked by Eric 7J6CCU and other JR6s in PL36 by Es on 50.110 CW/SSB at 0849-0913 for the first time. Tex is operational with 150 W and four element beam ... de JA1VOK. [VK amateurs – write this one down.]

"20/5: V73 TO JA: First JA opening since returning to V73 land in March. Copied the following beacons: 0715-0742 JA7ZMA 50.027.0, 0757-0840 JA2IGY 50.010.0, 0801-0810 JA6YBR 50.017.3, 0816-0822 JA1 ??? 50.023.8. Only heard JA1RJU on 50.110 but was unable to work. ... Tim V73AT. [VKs note this one too.]"

## Closure

Again, quite a lot of information but more of a general nature. Perhaps there will be some winter Es to report next month.

Closing with two thoughts for the month:

1. Fame is a vapour, popularity an accident, riches take wings. Only one thing endures – character; and

2. The clothes you don't like are the most durable you ever bought.

73 from *The Voice by the Lake*

\*PO Box 169, Meningie SA 5264  
Fax: (085) 751 043  
Packet: VK5LP@VK5WI#ADL#SA.AUS.OZ  
E-mail: vk5lp@ozemail.com.au

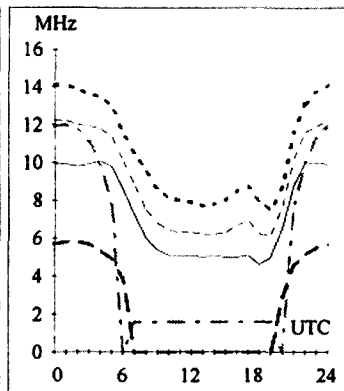
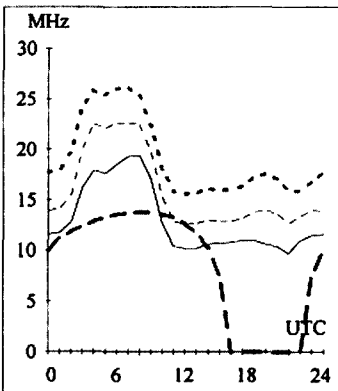
ar

**Adelaide-Amman** 292 **Brisbane-Auckland** 123

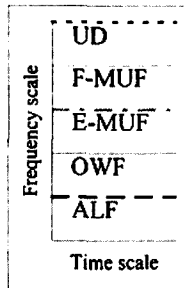
First F0-5 Short 13022 km Second 2F19-23 2E6 Short 2289 km

# HF Predictions

*Evan Jarman VK3ANI*



**T Index: 21**



These graphs show the predicted diurnal variation of key frequencies for the nominated circuits. This also indicates a possibility of communication (percentage). The frequencies, identified in the legend, are:-  
 Upper Decile (F-layer, 10%)  
 F-layer Maximum Useable Frequency (50%)  
 E-layer Maximum Useable Frequency  
 Optimum Working Frequency (F-layer, 90%)  
 Absorption Limiting Frequency  
 The predictions were made with the Ionospheric Prediction Service program, ASAPS V3.2. The T index used is shown above the legend. The Australian terminal azimuth, path and propagation mode are also given for each circuit.

**Adelaide-Invercargil** 126

Second 2F15-18 2E4 Short 2795 km

**Brisbane-Dakar** 217

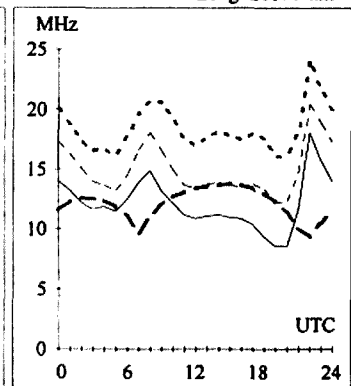
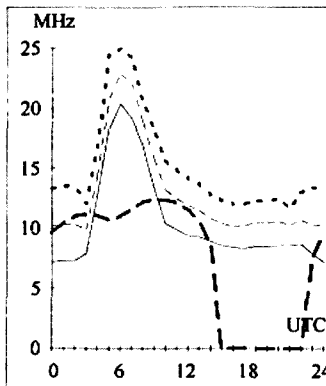
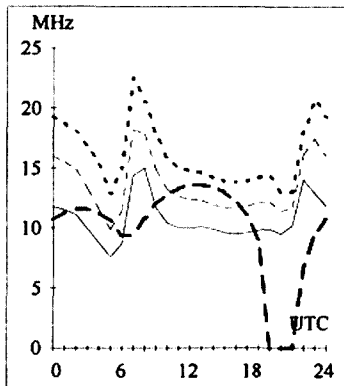
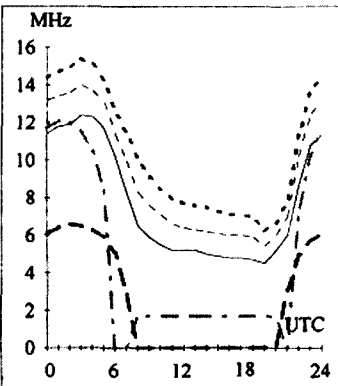
First F0-5 Short 18280 km

**Canberra-Lusaka** 239

Second 4F2-3 4E0 Short 11620 km

**Darwin-London** 145

First F0-5 Long 26170 km



**Adelaide-New York** 67

First F0-5 Short 17092 km

**Brisbane-Honolulu** 49

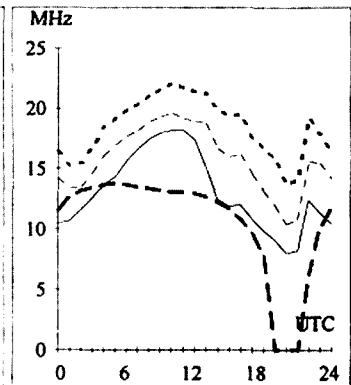
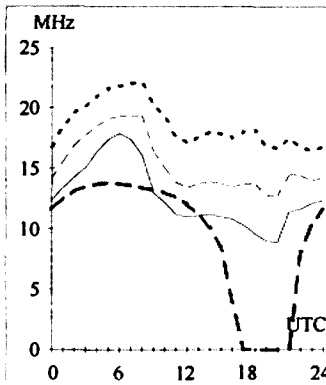
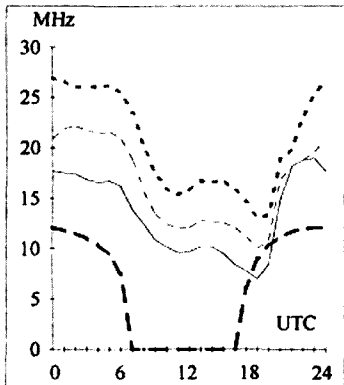
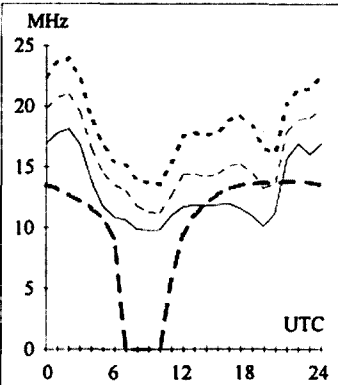
Second 3F5-9 3E0 Short 7569 km

**Canberra-Moscow** 317

First F0-5 Short 14481 km

**Darwin-London** 325

First F0-5 Short 13854 km



**Adelaide-Rome** 296

First F0-5 Short 15337 km

**Brisbane-Singapore** 293

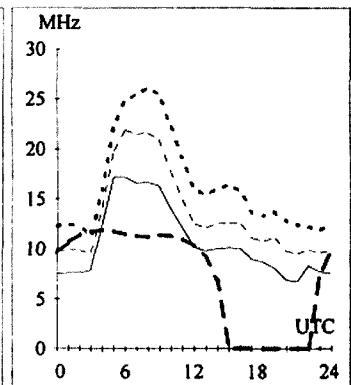
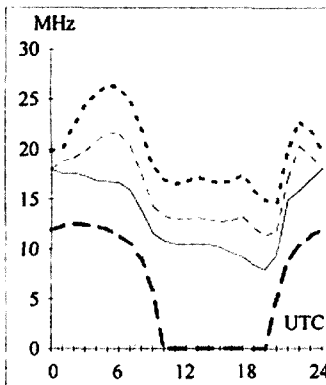
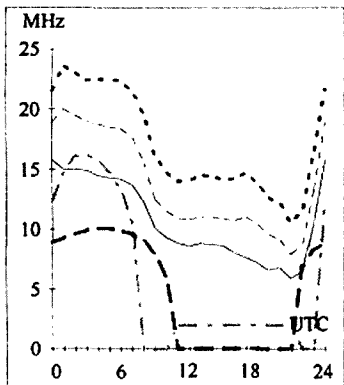
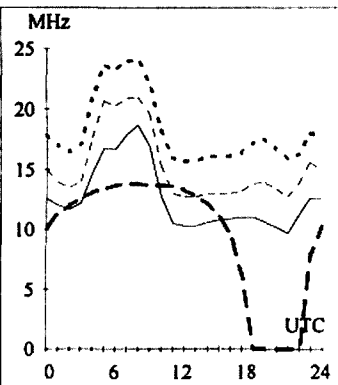
Second 3F8-12 3E0 Short 6147 km

**Canberra-Tokyo** 352

Second 3F4-8 3E0 Short 7948 km

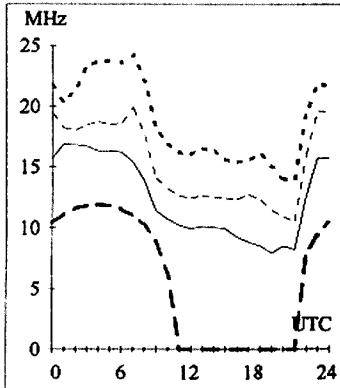
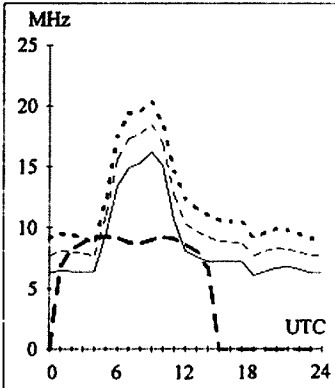
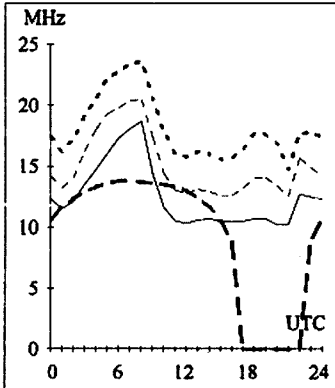
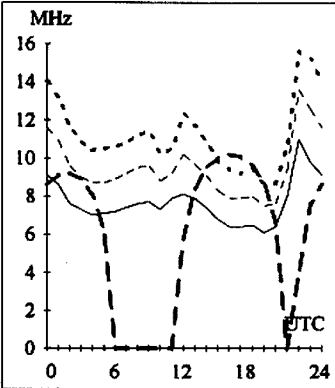
**Darwin-Pretoria** 242

Second 4F4-5 4E0 Short 10639 km



**Hobart-Montevideo** ### **Melbourne-Budapest** 302 **Perth-Capetown** 237 **Sydney-Hong Kong** 323

Second 4F3-4E0 Short 11043 km First F 0-5 Short 15556 km Second 4F7-9 4E0 Short 8702 km Second 3F5-10 3E0 Short 7369 km

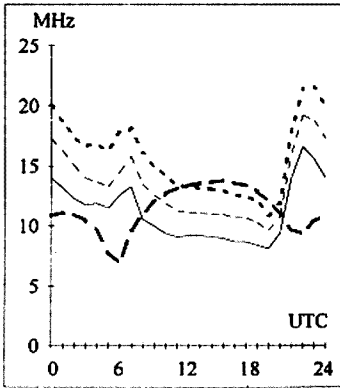
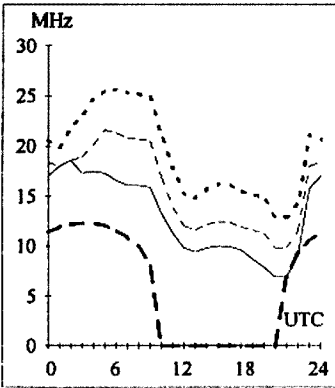
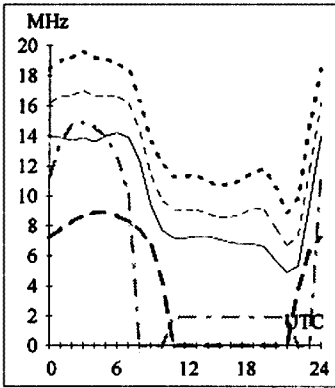
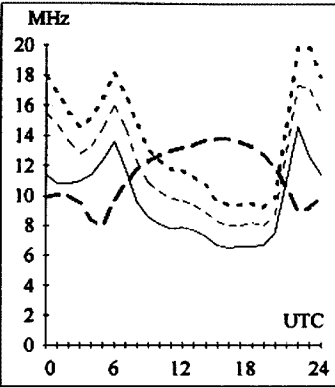


**Hobart-Stockholm** 136  
First F 0-5 Long 23871 km

**Melbourne-Jakarta** 303  
Second 3F11-14 3E2 Short 5214 km

**Perth-Osaka** 17  
Second 3F4-9 3E0 Short 7684 km

**Sydney-London** 139  
First F 0-5 Long 23032 km

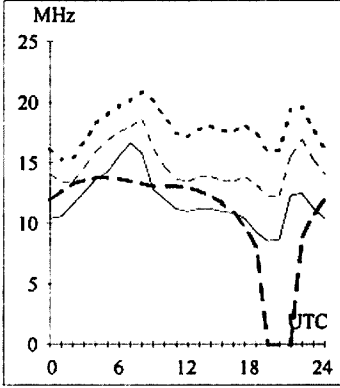
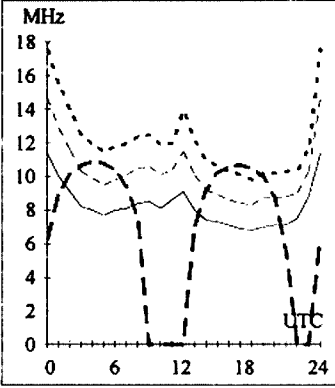
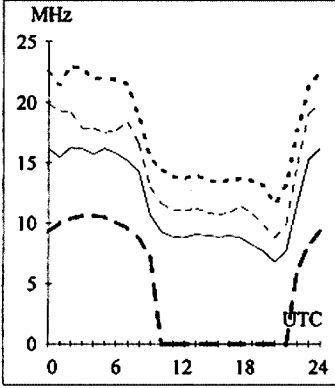
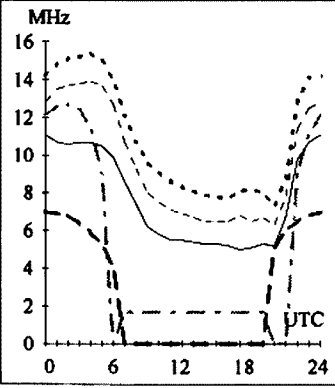


**Hobart-Suva** 56  
Second 3F16-19 3E4 Short 4011 km

**Melbourne-Manila** 332  
Second 3F8-12 3E0 Short 6342 km

**Perth-Santiago** 174  
First F 0-5 Short 12709 km

**Sydney-London** 319  
First F 0-5 Short 16992 km

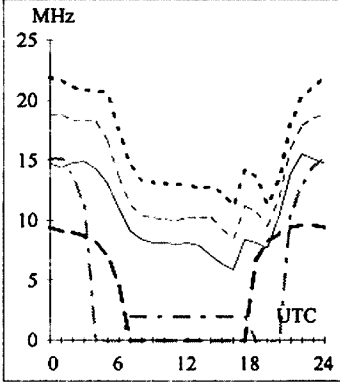
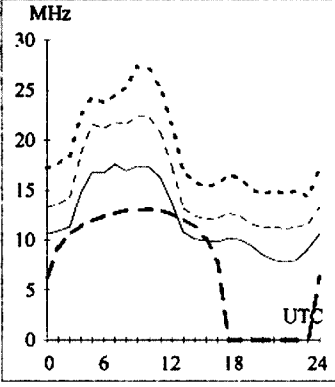
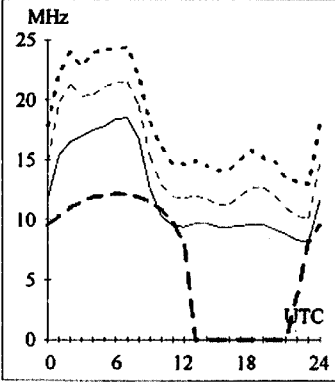
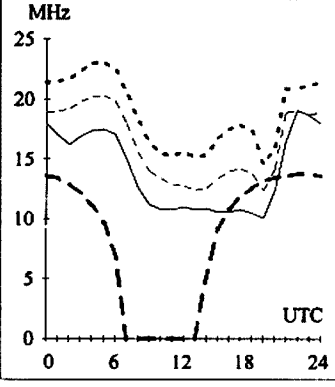


**Hobart-Vancouver** 49  
First F 0-5 Short 13428 km

**Melbourne-New Delhi** 306  
Second 4F5-9 4E0 Short 10201 km

**Perth-Tel Aviv** 302  
Second 4F3-8 4E0 Short 11091 km

**Sydney-Papeete** 88  
Second 3F8-10 3E0 Short 6122 km



# HAMADS

- Hamads may be submitted on the form on the reverse side of the *Amateur Radio* address flysheet. Please use your latest flysheet where possible.
- Please submit separate forms for For Sale and Wanted items, and be sure to include your name, address and telephone number (including STD code) if you do not use the form on the back of the *Amateur Radio* address flysheet.
- Eight lines (forty words) per issue free to all WIA members, ninth and tenth lines for name and address. Commercial rates apply for non-members.
- Deceased estates Hamads will be published in full, even if the ad is not fully radio equipment.
- WIA policy recommends that the serial number of all equipment offered for sale should be included in the Hamad.
- QTHR means the address is correct in the current WIA Call Book.
- Ordinary Hamads from members who are deemed to be in general electronics retail and wholesale distributive trades should be certified as referring only to private articles not being re-sold for merchandising purposes.
- Commercial advertising (Trade Hamads) are pre-payable at \$25.00 for four lines (twenty words), plus \$2.25 per line (or part thereof), with a minimum charge of \$25.00. Cheques are to be made out to: WIA Hamads.
- Copy should be typed or in block letters, and be received by the deadlines shown on page 1 of each issue of *Amateur Radio*, at:

Postal: 3 Tamar Court, Mentone VIC 3194  
Fax: (03) 9584 8928  
E-mail: vk3br@c031.aone.net.au

## TRADE ADS

**AMIDON FERROMAGNETIC CORES:** For all RF applications. Send business size SASE for data/price to RJ & US Imports, PO Box 431, Kiama NSW 2533 (no enquiries at office please ... 14 Boanyo Ave Kiama). Agencies at: Webb Electronics, Albury; Assoc TV Service, Hobart; Truscotts Electronic World, Melbourne and Mildura; Alpha Tango Products, Perth; Haven Electronics, Nowra; and WIA Equipment Supplies, Adelaide.

• **WEATHER FAX programs** for IBM XT/ATs \*\*\* "RADFAXZ" \$35.00, is a high resolution short-wave weather fax, Morse and RTTY receiving program. Suitable for CGA, EGA, VGA and Hercules cards (state which). Needs SSB HF radio and RADFAX decoder. \*\*\* "SATFAX" \$45.00, is a NOAA, Meteor and GMS weather satellite picture receiving program. Needs EGA or VGA & WEATHER FAX PC card, + 137 MHz Receiver. \*\*\* "MAXISAT" \$75.00 is similar to SATFAX but needs 2 MB of expanded memory (EMS 3.6 or 4.0) and 1024 x 768 SVGA card. All programs are on 5.25" or 3.5" disks (state which) plus documentation, add \$3.00 postage. ONLY from M Delahuntly, 42 Villiers St, New Farm QLD 4005. Ph 07 358 2785.

• **HAM LOG v.3.1** - Acclaimed internationally as the best IBM logging program. Review samples....AR: "Recommend it to anyone":

The Canadian Amateur: "Beyond this reviewer's ability to do it justice. I cannot find anything to

improve on. A breakthrough of computer technology". ARA: "Brilliant". Simple to use with full help, the professional HAM LOG is immensely popular (now in its 5th year), with many useful, superb features. Just \$59 (+ \$5 P & P), with a 90 page manual. Special 5 hour Internet offer. Demos, brochures available. Robin Gandevia VK2VN, 02 369 2008 BH, fax 02 369 3069. Internet address rh@ozemail.com.au.

• **US Army Morse key J-45**, \$17. US Jeep antenna, \$42. Marconi Signal Generator TF-144, \$110. Transceiver RT-662/GRC-106, \$380. D Dauner Electronics, 51 Georges Crescent, Georges Hall, NSW 2198. Phone 02 9724 6982 Fax 02 9725 7850.

## FOR SALE NSW

- **Yaesu FT-290RH** 2 m handheld, new battery, case, YH2 headset with VOX, VGC, s/n 180658, \$250. Bruno VK2BPO, QTHR, 02 9713 1831.
- **572B/160TL** tubes, pair, new, made in USA by Centron, suit Yaesu FL2100B/FL2100Z, 1000 W HF amp, \$300 pair. Ted VK2EZQ/MM, 019 460 437 and leave message, or write QTHR.
- **Yaesu FT-101B** HF txcvr with two spare output tubes, spare driver tube, low pass filter, s/n 5E321218, \$400 ONO. Yaesu FC-101 ATU, s/n 0J050218, \$200 ONO. Yaesu FT-208R 2 m handheld txcvr, no battery pack, s/n 3M340464, \$150 ONO. Peter VK2AXJ, 044 540 727 or 044 551 311.
- **Yaesu FT-780R** 70 cm mobile txcvr, SSB, CW, FM, s/n 3F070718, as new condn, \$375. John

VK2ZHM, QTHR, 02 9417 5338.

## FOR SALE VIC

- **Admiralty Wavemeter G93** (1945), covers 920 to 1080 MHz. AM Testset Type II. RAAF target oscillator, 17.5 to 160 MHz. RAF Wavemeter W1117, 125 kHz to 20 MHz, charts etc, working. USAF altimeter RT-7/APN-1, 400 MHz. Miscellaneous parts. \$160 ONO. SAE for details of more rcvrs, xmtrs, test units. Ken VK3JII, QTHR, 03 9580 5347.
- **Emtronics EPS205** switch mode power supply, 13.8 V 20 amp peak, as new (unused) in carton, s/n 00209, \$175. Andy VK3UJ, QTHR, 03 9726 8879.
- **Kenwood TL-922**, \$2500. **Kenwood TS-940S**, \$2200. **Icom 726** and **PS-55**, \$1200. **Drake L4B** plus PSU, \$1500. **Gem quad**, 4 el 6 band, remote switching, \$1000. **MFJ 989C** tuner, \$500. **Emotator 1103MXX** rotator, \$400. **Digital weather station**, \$400. **Daryl VK3DKC**, QTHR.
- **Kenwood TS-520S**, VGC, \$375. **Yaesu FT-101ZD**, EC, \$450. **Icom service manuals** for IC-745/751/720A/02A, \$10 each. **Kenwood TS-120V**, EC, \$325. Two of 2 m Slim Jim antennas, free to good home. Ron VK3OM, QTHR, 03 5944 3019.
- **New Penta 6146B** tubes, \$67.50 per pair. **HP Schottky diodes**, 5082-2800 series, matched pairs, \$2.80 per pair. John VK3AJL, QTHR, 03 9481 6771.

## FOR SALE OLD

- **Kenwood TS-530S**, GC, new finals, mic and operator's handbook, s/n 1112027, \$600. **Yaesu FT-208R** handheld with charger, speaker/mic, pan adaptor and operator's handbook, s/n 1K052889, \$180. Don VK4DS, QTHR, 07 3379 6341.

## FOR SALE SA

- **Yaesu clearance**. **FT-102** HF txcvr, s/n 21030938. **FC-102** 1.2 kW ATU, s/n 2J010284. **FT-707** HF base/mobile txcvr, s/n 0K101217. **FV-107** ext VFO, s/n 3F040334. **YD-148** desk mic. Phone me for details and a good deal! Can deliver to you - no problem. David VK5AXW, 08 8370 1066 BH, 08 8370 9569 AH.
- **Log periodic**, 8 el. \$450. **CRO**, probes, RF adaptors, mobile antennas, much more. Send SASE for list. Paul VK5MAP, PO Box 76, Peterborough SA 5422. Phone/fax 08 8651 2398.
- **Kenwood SSB filter YK-88SN**, new, still in box, with installation instructions, \$75 ONO. Hank VK5NCA, 08 8272 7435.

## FOR SALE WA

- **Kenwood TS-711A** 2 m all mode. **Kenwood TS-811A** 70 cm all mode. Both 25 W, excellent condn, \$900 each. **Yaesu FT-650** 6 m all mode, excellent condn, \$1100. Darrell VK6KDC, QTHR.
- **Kenwood TS-130S** HF SSB/CW txcvr, 80-10 m including WARC bands, good condn, complete



with mic, manual and 500 Hz CW filter, \$450. Steve VK6VZ, 08 9298 9330.

### WANTED NSW

• Antennas: **GAP Voyager**; **3 el 40 m Yagi** - KLM, HyGain or Cushcraft. **Base and chimney** for 4-1000 valve. **SSB Electronics UEK2000S** converter; **Collins 51S-1** receiver; **Drake PS-7** PSU; **Ham-M** antenna rotator. Tom VK2OE, 046 461 024 evenings.

• **IC type SL610, SL1610 or equivalent**, voltage controlled RF/IF 30 MHz amp as used in G3TSO txcvr (*RSGB Handbook*, 5th Edition). Pat Brennan VK2ABE, QTHR, 067 681 470 (BH).

### WANTED VIC

• "Learning the Morse Code for Amateur Radio Purposes" by Roger Davis VK4AAR, and

its associated booklet. Ian VK3KCM, QTHR, 03 9335 8529 BH, 03 5428 7364 AH.

• Copy of **handbook to suit Welz SP-300** SWR/power meter. All costs refunded. Mark VK3ZR, QTHR, 03 5986 5779.

• **Dud Yaesu FNB-4** battery pack, housing must be in good condn, reasonable price paid. John VK3AJL, QTHR, 03 9481 6771.

• **2C39** tubes type 7289. Roger VK3XRS, 03 5152 1163.

### WANTED QLD

• **EHT transformer** for Tektronix CRO Model 545B. C Cogzell VK4CI, QTHR, 07 3888 5013.

• **Tx tetrodes** 4-400, 4-1000, QY5-500, etc. **RCA receiving tube manual RC28** (1970/71). **Tail T373 VHF AM** airband txcvr, **T286 PSU**. Collins radio accessories, military avionics and radios

1960s and later. Peter VK4APD, QTHR, 07 3397 3751 AH.

• **1296 converter**. John VK4TL, QTHR, 070 968 328.

### WANTED SA

• **Voltmeter 0-20 volts** to fit 65 mm round hole. Must be in good condn and good working order. "Please help. I want it for my power supply." Paul VK5MAP, phone/fax 08 8651 2398.

### MISCELLANEOUS

• **The WIA QSL Collection** (now Federal) requires QSLs. All types welcome, especially rare DX pictorial cards, special issue. Please contact the Hon Curator, Ken Matchett VK3TL, 4 Sunrise Hill Road, Montrose VIC 3765, tel 03 9728 5350. ar

## Silent Keys

*Due to space demands obituaries should be no longer than 200 words.*

The WIA regrets to announce the recent passing of:-

PA (Peter)	ALEXANDER	VK2PA
AH (Adrian)	CHRISTY	VK2ACY
M K (Morton)	WILLIAMS	VK2DEX
SI (Stan)	ZEUNERT	VK3SZ
LOC (Len)	BAKER	VK50C

### Morton Williams VK2DEX

1940 - 1997

"Mort" was one of those people quietly helping others, whilst keeping his private life to himself. As a result, he joined WICEN, and became Deputy State Co-ordinator.

About 15 years ago he was working as a storeman when he decided to make a change and took a redundancy. After a trip around Australia with his father, he was having some difficulty finding work. It was suggested that he try for a job that would allow him to further his interest in his electronics hobby.

The ABC's Engineering Research Laboratory had a vacancy, but Mort had none of the required qualifications. At an interview he so impressed them with his practical knowledge that they hired him into a different position, and never looked back.

Mort was able to solve their mechanical problems and learn more about the subject which had been his hobby. As an adult student he went on to qualify for the Electronic Engineering Diploma. Not only did he pass, but he won a prize for high academic achievement. He became the "source" of information on all things mechanical and many things electronic.

Farewell, Mort, you were one of the "good guys."

Dave Horsfall VK2KFU  
WICEN (NSW) Vice-President

### Len Baker VK50C

It is with regret that we announce the passing of Len Baker on Sunday, 25 May 1997, after a short illness. Len had not been active in recent years. However, in the past he had been a great supporter of the Division and had also done many things in the field of Amateur Radio.

For most of his working life Len was a member of the Royal Australian Air Force and stationed at the Edinburgh Base near Salisbury SA for a large part of that time. He worked in the engineering field and operated with a separate call sign from a station set up with permission within the domestic area of the base as well as from his home station at Belair.

One of Len's activities back in the 1950s and 1960s was to make regular contact with personnel located at the various Australian bases in the Antarctic. Len used to receive mail and telephone calls from friends and

relatives of people stationed in the Antarctic; and was thus able to forward items of family news to those remote locations. This was well before Third Party Traffic was allowed; however, it has been said that somehow the authorities might have had reception difficulties had they tried to intercept such transmissions from Len.

One of my first encounters with Len was when I stayed for a weekend at his home soon after I moved to Adelaide from Melbourne. On Sunday morning Len awakened me, saying the Remembrance Day Contest was on and we had to make at least 100 contacts towards the Division's score before lunch time. He made a point of supporting the Division each year in the Contest.

Ian Hunt VK5QX  
President VK5/VK8 Division  
8 Dexter Drive  
Salisbury East SA 5109  
ar

**Repeaters - additions,  
deletions, alterations.**  
**Have you advised the WIA of  
changes needed to the  
Repeater List?**

# WIA Divisions

The WIA consists of seven autonomous State Divisions. Each member of the WIA is a member of a Division, usually in their residential State or Territory, and each Division looks after amateur radio affairs within its area.

Division	Address	Officers	Call Sign	Weekly News Broadcasts	1997 Fees
VK1	ACT Division GPO Box 600 Canberra ACT 2601	President Hugh Blenings Secretary John Woolner Treasurer Les Davey	VK1YYZ VK1ET VK1LD	3.570 MHz LSB, 146.950 MHz FM each Sunday evening commencing at 8.00 pm local time. The broadcast text is available on packet, on Internet <a href="http://www.vk1.wia.ampr.org">www.vk1.wia.ampr.org</a> newsgroup, and on the VK1 Home Page	(F) \$72.00 (G) (S) \$58.00 (X) \$44.00
VK2	NSW Division 109 Wigram St Parramatta NSW (PO Box 1066 Parramatta 2124) Phone 02 9689 2417 Freecall 1800 817 644 Fax 02 9633 1525	President Geoff McGrorey-Clark Secretary Eric Fossey Treasurer Eric Van De Weyer (Office hours Mon-Fri 11.00-14.00)	VK2EO VK2EYF VK2KUR	From VK2WI 1.845, 3.595, 7.146*, 10.125, 14.160, 24.950, 28.320, 29.120, 52.120, 52.525, 144.150, 147.000, 438.525, 1281.750 (* morning only) with relays to some of 18.120, 21.170, 584.750 ATV sound. Many country regions relay on 2 m or 70 cm repeaters. Sunday 1000 and 1930. Highlights included in VK2AWX Newcastle news, Monday 1930 on 3.593 plus 10 m, 2 m, 70 cm, 23 cm. The broadcast text is available on the Internet newsgroup <a href="http://www.vk2.wia.ampr.org">www.vk2.wia.ampr.org</a> and on packet radio.	(F) \$66.75 (G) (S) \$53.40 (X) \$38.75
VK3	Victorian Division 40G Victory Boulevard Ashburton VIC 3147 Phone 03 9885 9261 Fax 03 9885 9298	President Jim Linton Secretary Barry Wilton Treasurer Rob Halley (Office hours Tue & Thur 0830-1530)	VK3PC VK3XV VK3NC	VK3BWI broadcasts on the 1st Sunday of the month, starts 10.30 am. Primary frequencies 1.840 AM, 3.615 LSB, 7.085 LSB, and FM(R)s 146.700 Mt Dandenong, 147.250 Mt Macedon, 147.225 Mt Baw Baw, and 2 m FM(R)s VK3RMA, VK3RSH and VK3ROW. 70 cm FM(R)s VK3ROU and VK3RGL. Major news under call VK3WI on Victorian packet BBS.	(F) \$75.00 (G) (S) \$61.00 (X) \$47.00
VK4	Queensland Division GPO Box 638 Brisbane QLD 4001 Phone 074 96 47 14	President Rodger Bingham Secretary Malcolm McIntosh Treasurer Bill Sebbens e-mail address: <a href="mailto:wiaq@tmxbris.mhs.oz.au">wiaq@tmxbris.mhs.oz.au</a>	VK4HD VK4ZMM VK4XZ	1.825 MHz SSB, 3.605 MHz SSB, 7.118 MHz SSB, 14.342 MHz SSB, 28.400 MHz SSB, 29.220 MHz FM, 52.525 MHz FM, 146.700 MHz FM, 147.000 MHz FM, 438.525 MHz (Brisbane only), regional VHF/UHF repeaters at 0900 hrs Sunday. Repeated on 3.605 MHz SSB & 147.000 MHz FM, regional VHF/UHF repeaters at 1930 hrs EAST Monday. Broadcast news in text form on packet under WIAQ@VKNET.	(F) \$74.00 (G) (S) \$60.00 (X) \$46.00
VK5	South Australian Division 34 West Thebarton Rd Thebarton SA 5031 (GPO Box 1234 Adelaide SA 5001) Phone 08 8352 3428 Fax 08 8264 0463	President Ian Hunt Secretary Graham Wiseman Treasurer Joe Burford  Web: <a href="http://www.vk5wia.ampr.org/">http://www.vk5wia.ampr.org/</a>	VK5QX VK5EU VK5UJ	1827 kHz AM, 3.550 MHz LSB, 7.095 AM, 14.175 USB, 28.470 USB, 53.100 FM, 147.000 FM Adelaide, 146.700 FM Mid North, 146.800 FM Mildura, 146.825 FM Barossa Valley, 146.900 FM South East, 146.925 FM Central North, 147.825 FM Gawler, 438.425 FM Barossa Valley, 438.475 FM Adelaide North, ATV Ch 35 579.250 Adelaide. (NT) 3.555 USB, 7.065 USB, 10.125 USB, 146.700 FM, 0900 hrs Sunday. 3.585 MHz and 146.675 MHz FM Adelaide, 1930 hrs Monday.	(F) \$75.00 (G) (S) \$61.00 (X) \$47.00
VK6	West Australian Division PO Box 10 West Perth WA 6872 Phone 09 351 8873	President Wally Howse Secretary Christine Bastin Treasurer Bruce Hedland-Thomas	VK6KZ VK6ZLZ VK6OO	146.700 FM(R) Perth, at 0930 hrs Sunday, relayed on 1.825, 3.560, 7.075, 14.116, 14.175, 21.185, 29.680 FM, 50.150 and 438.525 MHz. Country relays 3.582, 147.350(R) Busselton and 146.900(R) Mt William (Bunbury). Broadcast repeated on 146.700 at 1900 hrs Sunday, relayed on 1.865, 3.563 and 438.525 MHz; country relays on 146.350 and 146.900 MHz.	(F) \$62.00 (G) (S) \$50.00 (X) \$34.00
VK7	Tasmanian Division PO Box 271 Riverside TAS 7250 Phone 03 6327 2096 Fax 03 6327 1738	President Ron Churcher Secretary Barry Hill Treasurer Mike Jenner	VK7RN VK7BE VK7FB	146.700 MHz FM (VK7RHT) at 0930 hrs Sunday relayed on 147.000 (VK7RAA), 146.725 (VK7RNE), 146.625 (VK7RMD), 3.570, 7.090, 14.130, 52.100, 144.150 (Hobart) Repeated Tues 3.590 at 1930 hrs.	(F) \$74.00 (G) (S) \$60.00 (X) \$46.00
VK8	(Northern Territory is part of the VK5 Division and relays broadcasts from VK5 as shown received on 14 or 28 MHz).			Membership Grades Full (F) Pension (G) Needy (G) Student (S) Non receipt of AR (X)	Three-year membership available to (F) (G) (X) grades at fee x 3 times

Note: All times are local. All frequencies MHz.

## ADVERTISERS' INDEX

Amateur Transceiver Radio _____	44	WIA Recruitment _____	15
Andrews Communication Systems _____	11	WIA Membership Renewal _____	9
Daycom _____	IFC		
Dick Smith Electronics _____	28, 29, IBC	<b>Trade Hamads</b>	
ICOM _____	OBC, 19	M Delahunty _____	54
Interproducts _____	33	RJ & US Imports _____	54
Radio and Communications _____	12	HAMLOG - VK2VN _____	54
Terlin Aerials _____	8	D Dauner Electronics _____	54

### TRADE PRACTICES ACT

It is impossible for us to ensure the advertisements submitted for publication comply with the Trade Practices Act 1974. Therefore, advertisers and advertising agents will appreciate the absolute need for themselves to ensure that the provisions of the Act are complied with strictly.

### VICTORIAN CONSUMER AFFAIRS ACT

All advertisers are advised that advertisements containing only a PO Box number as the address cannot be accepted without the addition of the business address of the box-holder or seller of the goods.

# Yaesu FT-1000MP

## Incredible Performance, Amazing Price!



Now's your chance to pick up Yaesu's highest performance HF base transceiver, the new FT-1000MP, at a very attractive price. You'll be amazed at its incredible performance, but if you need convincing, just read what the experts have to say.

### On Operation:

"I would classify the transceiver as 'user friendly' compared to some other modern transceivers I have operated." - CQ  
 "..... we found it to be a proficient performer." - QST  
 ".....In term of ergonomics my preference is marginally for the Yaesu.....The second receiver is certainly better implemented....."  
 - Radio Comms (UK)

### On Documentation:

"In general, Yaesu's manuals are the epitome of clear, concise, and complete documentation, and the FT-1000MP's 104 page Operating Manual is no exception." - QST

### On The Receiver:

"Its receiver is a real beauty ... its very clean and the audio is very clear and punchy ...." - Radio & Communications  
 'Measurement of second order intermodulation ... showed an average result for the IC-775DSP but the FT-1000MP was some 10dB better than any other radio measured." - Radio Comms (UK)  
 "The receiver is quiet and good at its job, and Yaesu's EDSP is icing on the cake." - QST  
 "Certainly, this receiver is designed to withstand the onslaught of very strong signals....." - CQ

### On The Transmitter:

"CW operators will be impressed with the FT-1000MP keyer." - CQ  
 "The transmitter is good as well, with a lightning fast automatic tuner built in as standard." - Radio & Communications  
 "The FT-1000MP has excellent spectral purity of the output signal." - CQ

### Digital Signal Processing:

"The EDSP filter operates smoothly and effectively in all of its modes." - CQ  
 "Having the DSP built-in means it works as well as possible - and is clearly better than most after-market add-ons." - Radio & Communications  
 "The double-whammy of crystal and mechanical filters plus DSP in the FT-1000MP is a killer combination." - QST

### Conclusions:

"... I am unable to report finding even a picky fault with the FT-1000MP." - CQ  
 "So does the inbuilt DSP say 'buy me'? In this humble scribes opinion, you bet!" - Radio & Communications  
 "The FT-1000MP offers performance and flexibility in a quality radio." - QST

Interested in more information? Why not call us for a copy of Yaesu's 12 page colour booklet, 46 page Technical Overview, or for copies of various magazine reviews. We're sure you'll soon agree that the world of HF transceivers has just taken a giant leap forward.

QST - ARRL QST (USA) Magazine review April 1996  
 CQ - CQ (USA) Magazine review April 1996  
 Radio Comms - Radio Communications (UK) magazine review January 1996  
 Radio & Communications - Radio & Communications (Aust) magazine review July 1996

Cat D-3400

# \$3995

2 YEAR WARRANTY



B 2971 Col.

For further information, orders or the location of your nearest store call:

Ph: 1300 366 644 (local call charge)

Or Fax: (02) 9805 1986



Serious Performance For Every Amateur

**ICOM**  
Clearly Ahead

**THE ICOM AMATEUR RANGE** Delivering true professional features and performance to the world of amateur radio... that's what keeps Icom clearly ahead. From our dual band handheld IC T7A, with amazing performance from such a small package... to our all mode transceivers led by the flagship of the range, the IC-756, with its array of features such as multi-function full dot LCD, and newly designed IF DSP. With Icom performance we'll take your operating experience to remarkable new levels.



For more information see your nearest Icom Dealer, or call free on 1800 338 915, or write to: Icom Australia Pty. Ltd. 290-294 Albert Street, Brunswick, Victoria 3056. Ph (03) 9387 0666 Fax (03) 9387 0022 A.C.N. 006 092 575

# Amateur Radio

August 1997

Volume 65 No 8



*Journal of the Wireless Institute of Australia*



*Full of the latest amateur radio news, information and technical articles including...*

- **Intermodulation Performance and Measurement**
- **Simple Peak-Reading Watt-Meter**
- **A Two Metre X-Beam**

**Plus** *lots of other articles, news and special interest columns*

## hy-gain

### HyGain DX77

#### Advanced Vertical Windom

- 7 Band Vertical
- 10-12-15-17-20-30-40 metres
- No ground radials required
- Tilt mount
- Height: 29 feet
- Power: 1.5kW
- Industrial grade construction
- Bandwidth (<2:1 SWR)
  - 10 metres 1.7MHz
  - 12 metres 100kHz
  - 15 metres 500kHz
  - 17 metres 100kHz
  - 20 metres 250kHz
  - 30 metres 100kHz
  - 40 metres 150kHz



Daycom and HyGain introduce the DX77 Advanced vertical Windom with features surpassing any HF vertical on the market. The superior mechanical design, high power capability and 55% greater bandwidth than competitive verticals on 20 and 40 metres make it an exceptional value for a high performance system.

The unique design of this vertical antenna provides a no compromise performance without the need for ground radial wires. It puts the world at your fingertips on the HF ham bands, 10 through 40 metres, including the WARC bands! Capable of handling 750W average or 1500W PEP the HyGain DX77 won't balk at the output of your line! Automatic band-switching and low angle of radiation allow for enhanced DX performance.

in stock now at  
**\$875**

## TKIT

### The NEW Heathkit!



Help reclaim this fascinating band! Six metres is the VHF DX band and even now offers regular overseas contacts with just a little effort. The TT1208 kit is the ideal, low cost way, to get going on 6 metres and find out what only the elite have known for years!

- Requires 3-5W input on 20 metres
- Extremely simple hookup and operation
- Sensitive, low noise 50-54MHz front end
- Fast, silent PIN diode TR switch for QSK & data
- 8W output on 6 metres
- Requires 12-15V DC 3A power supply
- Simple switching between HF and 6 metres
- Rugged steel case

**TT1208** 8W 6 metre transmitter **\$199**

### MFJ Antenna Tuners

MFJ901B	200W Versatuner	\$149
MFJ910	Mobile antenna matcher	\$45
MFJ921	2 mtr 300W tuner	\$155
MFJ924	70 cm 300W tuner	\$155
MFJ931	Artificial ground tuner	\$169
MFJ941E	300W compact GP tuner	\$230
MFJ945E	300W mobile tuner	\$209
MFJ948	Deluxe 300W (no D/L)	\$270
MFJ949E	Deluxe 300W	\$299
MFJ962C	1.5kW tapped inductor	\$525
MFJ969	300W Roller inductor <b>NEW</b>	\$360
MFJ971	200W Portable tuner	\$190



MFJ986	3kW Diff-T roller inductor	\$629
MFJ989C	3kW Deluxe roller inductor	\$735

### NEW IC-207H

**Twin band mobile with remote mount front panel & 9600 baud packet operation**

**\$799**



### HAMCALL 1997

Our most popular callbook CD-ROM with Windows, DOS and MAC search engines. This is the new April 1997 edition, just out!

**\$75**



### IC-756 HF + 6m 100W, auto-ATU, DSP

If you missed our Icom Day at the end of November you missed the opportunity to see the all new IC-756. It was pretty hard to see anyway with the crowd always around it!

- All bands 160-6 metres
- 100W output on all bands
- Auto ATU works on all bands
- Dual watch receivers
- Spectrum Scope (just like the IC-781!)
- Dual Pass-Band Tuning
- Adjustable threshold DSP noise reduction
- Audio Peaking Filter
- Automatic Notch filter
- Built-in CW memory keyer
- 100 alphanumeric memories

Some of the reactions; "how much will you give me for my FT-1000 as a trade-in?", "Probably the most innovative radio since the IC781 hit the market!", "This is really a radio for all reasons, easy to use but with all the features a contestor or DXer needs."

In stock now, call to secure yours:

**\$3400**

### R8500 HF/VHF/UHF receiver



The Icom R-8500 receiver is here now! It covers 100kHz to 2000MHz (no breaks) has 1000 memories and a host of features you wouldn't think possible at just \$3750. Get the full story, call for a brochure or look on the WEB at <http://www.daycom.com.au/>

**\$3100**

## OPTOELECTRONICS XPLORER Test Receiver

All the information, in one hand!

In one convenient handful the amazing new Optoelectronics XPLORER Test Receiver not only finds signals for you, but it will tell you frequency and deviation as well as decoding sub-audible and DTMF tones. Sweeping the range 30 to 2000MHz in less than 1 second the Xplorer will lock on to any signal in the nearfield and demodulate the FM audio for monitoring. You also see frequency on the LCD display along with other information about the signal.

- Frequency range: 30MHz - 2GHz
- FM Deviation range: 100kHz
- Audio frequency response: 50 - 3000Hz
- Auto sweep time: <1 second 30-2000MHz
- Internal speaker, headphone jack, tape control jack, serial interface connector, rotary encoder & flexible push button panel.
- Easy to read LCD display with EL backlighting
- Internal 7.2V 850mAh NiCd battery
- Rapid charging (<1hr) with intelligent charging controller
- NMEA-0183 interface for GPS receiver

**XPLORER** Test Receiver **\$1700**



# Amateur Radio



## Journal of the Wireless Institute of Australia

Vol 65 No 8

ISSN 0002-6859

August 1997

### CONTENTS

#### Technical

Intermodulation Performance and Measurement of Intermodulation Components <i>Lloyd Butler VK5BR</i>	6
Simple Peak-Reading Watt-Meter <i>Jon Lindstad VK2WF</i>	13
A Two Metre X Beam <i>Paul Clutter VK2SPC</i>	14
Technical Abstracts <i>Gil Sones VK3AU</i>	18
Constant-K Filters <i>Ian Berwick VK3ALZ</i>	21

#### General

An Enjoyable Weekend in Central Queensland <i>Jeff Aust VK4ABJ</i>	16
CD-ROM Review - <i>ARRL Handbook</i> and <i>QST</i> 1985-1989 <i>Peter Gibson VK3AZL</i>	20
Book Review - The LF Experimenter's Source Book <i>Gil Sones VK3AU</i>	42

#### Columns

Advertisers' Index	56	HF Predictions	52
ALARA	24	How's DX?	36
AMSAT Australia	25	Ionospheric Update	50
Awards	26	Novice Notes	39
Club Corner	45	Over To You	42
Contests	30	Pounding Brass	43
Divisional Notes	31	QSP News	14, 24, 55
VK1 Notes	31	Repeater Link	44
VK2 Notes	31	Silent Keys	49
VK5 Notes	32	Spotlight on SWLing	46
VK7 Notes	33	VHF/UHF - An Expanding World	47
Editor's Comment	2	WIA News	3, 33
Education Notes	35	WIA - Divisional Directory	56
FTAC Notes	34	WIA - Federal Directory	2
Hamads	54		

#### Cover

August is the month of the Remembrance Day Contest, a contest held to commemorate those radio amateurs who died during World War II. Featured on the front cover this month is a WWII vintage Type 3 Mk II, 3-15 Mcs (MHz), CW only, "spy" transmitter/receiver from the collection of Ron VK3OM. The transmitter sits at the top of the left hand side of the open case, with the receiver below it. In the right hand part of the open case, on the left hand side, is the PSU (which runs from 100-250 V AC and 6 V DC) with, alongside it, the spares compartment (holding spare valves and additional Tx final coils) with the Morse key fastened to the front panel. In the foreground is a set of WWII vintage headphones and Morse key. The background is a WWII poster and QSL cards with a military connection from the WIA Historical QSL Collection, courtesy of the Hon Curator, Ken Matchett VK3TL.

(Photo by Ron Fisher VK3OM)

#### BACK ISSUES

Available direct from the WIA Federal Office, only until stocks are exhausted, at \$4.00 each (including postage within Australia) to members.

#### PHOTOSTAT COPIES

When back issues are no longer available, photocopies of articles are available to members at \$2.50 each (plus \$2.00 for each additional issue in which the article appears).

The opinions expressed in this publication do not necessarily reflect the official view of the WIA, and the WIA cannot be held responsible for incorrect information published.

Amateur Radio is published by the Wireless Institute of Australia, ACN 004 920 745 as its Official Journal, on the last Friday of each month.

#### Editorial

##### Editor

Bill Rice VK3ABP\*

Production Manager

Bill Roper VK3BR

Senior Technical Editor

Peter Gibson VK3AZL\*

##### Technical Editors

Evan Jarman VK3ANI\*

Gil Sones VK3AU\*

Don Graham VK6HK

Contributing Editor

Ron Fisher VK3OM\*

Don Jackson VK3DBB\*

##### WIA News Editor

Roger Harrison VK2ZRH

##### Proof Readers

Allan Doble VK3AMD

Jim Payne VK3AZT

Graham Thomson VK3IY

John Tutton VK3ZC

\*Publications Committee member

#### Production

Administration, Advertising, Drafting,

##### Production

Vk3br Communications Pty Ltd

3 Tamar Court, Mentone VIC 3194

##### Typesetting and Printing

Industrial Printing and Publishing Pty Ltd

122 Dover Street, Richmond, VIC 3121.

##### Mail Distribution

Mail Management Australia Pty Ltd

6 Garden Boulevard, Dingley VIC 3172

##### New Advertising

Eyvyonne & Keith Tootell

Union Publicity Service Pty Ltd

PO Box 282, Toongabbie NSW 2146

Telephone: 1800 654 181 - 02 9831 1299

Fax: 02 9831 6161

#### Amateur Radio Correspondence

All contributions, correspondence, Hamads and queries concerning the content of Amateur Radio should be sent to:

Amateur Radio

Vk3br Communications Pty Ltd

3 Tamar Court, Mentone VIC 3194

E-mail: vk3br@c031.aone.net.au

Phone and Fax: 03 9584 8928

Mobile: 0418 534 168

Business Hours: 9.30 am to 3.00 pm weekdays

#### Amateur Radio Delivery

All correspondence and queries concerning the delivery of Amateur Radio should be sent to:

Amateur Radio

WIA Federal Office

PO Box 2175

Caulfield Junction VIC 3161

Registered Office:

3/105 Hawthorn Road

Caulfield North VIC 3161

Telephone: 03 9528 5962

Fax: 03 9523 8191

Business Hours: 9.30 am to 3.00 pm weekdays

#### Editorial and Hamads Deadlines

September 11/08/97

October 08/09/97

November 13/10/97

#### Receipt of Amateur Radio by Mail

The September issue will be delivered to Australia Post on Tuesday, 2 September 1997 for mailing to members.

If this magazine is not received by the 15th of the month of issue, and you are a financial member of the WIA, please check with the Post Office before contacting the registered office of the WIA.

© Wireless Institute of Australia 1997

## Amateur Radio Service

A radiocommunication service for the purpose of self-training, intercommunication and technical investigation carried out by amateurs, that is, by duly authorised persons interested in radio technique solely with a personal aim and without pecuniary interest.

## Wireless Institute of Australia

The world's first and oldest National Radio Society  
Founded 1910

Representing the Australian Amateur Radio Service -  
Member of the International Amateur Radio Union  
Registered Federal office of the WIA:  
3/105 Hawthorn Rd, Caulfield North, Vic 3161

All Mail to:

PO Box 2175, Caulfield Junction, VIC 3161  
Telephone: 03 9528 5962 Fax: 03 9523 8191

Business Hours: 9.30 am to 3.00 pm on weekdays

Federal Secretary  
Peter Naish VK2BPN

### FEDERAL OFFICE STAFF

June Fox	Book Keeper
Debby Johnston	Membership Secretary
Rita Trebilco VK3NRT	Examinations Officer

### COUNCIL

President	Neil Penfold	VK6NE
VK1 Federal Councillor	Richard Jenkins	VK1RJ
VK2 Federal Councillor	Michael Corbin	VK2YC
VK3 Federal Councillor	Brenda Edmonds	VK3KT
VK4 Federal Councillor	Ross Marren	VK4AMJ
VK5 Federal Councillor	Ian Watson	VK5KIA
VK6 Federal Councillor	Wally Howse	VK6KZ
VK7 Federal Councillor	Andrew Dixon	VK7GL

### EXECUTIVE

Peter Naish  
Rowland Bruce  
Neil Penfold

VK2BPN  
VK5OU  
VK6NE

### FEDERAL CO-ORDINATORS

AMSAT:	Graham Ratcliff	VK5AGR
Awards:	John Kelleher	VK3DP
Contests:	Peter Nesbit	VK3APN
Education:	Brenda Edmonds	VK3KT
EMC and Standards	Roger Harrison	VK2ZRH
FTAC:	John Martin	VK3KWA
Historian:	John Edmonds	VK3AFU
IARU:	David Wardlaw	VK3ADW
Int'l Travel Host Exch:	Ash Nallawalla	VK3CIT
Int'l Beacon Co-ord:	Roger Harrison	VK2ZRH
Intruder Watch:	Gordon Loveday	VK4KAL
ITU Conference and Study Group:	David Wardlaw	VK3ADW
Media:	Roger Harrison	VK2ZRH
QSL Manager (VK9,VK0):	Neil Penfold	VK6NE
Radio Sports:	Wally Watkins	VK4DO
Videotapes:	Bob Godfrey	VK4BOB
WICEN:		

### SMA LIAISON TEAM

Roger Harrison	VK2ZRH
David Wardlaw	VK3ADW
Neil Penfold	VK6NE

# Editor's Comment

## Road Testing New Rigs

At last month's Publications Committee meeting a comment was made that several months' issues this year have contained no *Equipment Review*. This is not a reflection on the output of our industrious regular reviewer, Ron Fisher VK3OM. It is more in realisation that there is a limit to how much one person can achieve!

Consider the task faced by most of our regular columnists, and even more by your Editor. We acquire facts from various sources and then put together sufficient words to review or discuss the material. Ron has to do that too. But first he has to help in temporarily acquiring from the relevant dealer the equipment to be tested. Then he has to set it up in his home shack and learn to operate it almost instantly! He has to use it in all modes of which it may be capable. He has to connect it to various items of test equipment and, as far as possible, determine how good it is quantitatively and how it compares with other makes and models. Then, and only then, he can start writing.

It is surprising, isn't it, that each year, for decades now, there have been as many as six or seven *Equipment Reviews* by VK3OM? Wouldn't it be good to have one each month? It would be amazing, but it is more than one person can do.

This is not to ignore the various contributors (VKs 2ZIP, 3IY, 3UV, 3WL, 3AFW, 3AUI, and 3DIP) who have also provided reviews over the years. But we need more of them! It would be marvellous if we could achieve a regular *Equipment Review* every month. But Ron would be the first to agree that he's already pushed to the limit and would like "a bit of a rest".

We know from our survey in December 1995 that *Equipment Reviews* are one of the most popular segments of *Amateur Radio*. You would all like to see them more often. So, is there anyone out there who would like to take over a fraction of the work and help spread the effort more widely?

If you would like to help us, we would be delighted to hear from you at vk3br Communications Pty Ltd. You need not be in Melbourne, but it would be logistically preferable.

How about it?

Bill Rice VK3ABP  
Editor

### CONTRIBUTIONS TO AMATEUR RADIO

*Amateur Radio* is a forum for WIA members' amateur radio technical experiments, experiences, opinions and news. Manuscripts with drawings and/or photos are always welcome and will be considered for possible publication. Articles on computer disk or via e-mail are especially welcome. The WIA cannot assume responsibility for loss or damage to any material. A pamphlet, "How to Write for *Amateur Radio*", is available from vk3br Communications Pty Ltd on receipt of a stamped, self addressed envelope.



## ■ WIA News

Roger Harrison VK2ZRH, Federal Media Liaison Officer.

# New Class Licensed Devices Likely to Affect 430 MHz

The Australian Communications Authority (ACA) has advised the WIA that they will proceed with plans to Class Licence new "low interference potential devices" (LIPDs) using a variety of new frequency band allocations, but of particular concern to amateurs is the new allocation at 433.05-434.79 MHz.

Designated as an "All Transmitters" allocation, which means transmitters using this new allocation could serve a wide variety of applications including, according to the ACA, wireless stereo headphones, motor vehicle radio keys and low powered data transmission systems. Such applications on this frequency range are supported by the self-same allocation in a number of European countries. The specified maximum transmitter output is 25 mW equivalent isotropically radiated power (EIRP).

While low power transmitters operating in this frequency range will be likely to cause interference to amateur FM voice and packet reception under some circumstances, the greater problem for amateurs arises from receivers for these applications being blocked by amateur 70 cm transmissions. This is a potentially severe problem where the receivers are on all the time, such as with "wireless" audio links between a CD or cassette player and the associated amplifier.

Wireless links for audio equipment is a new trend in this consumer product category. Source equipment, such as CD or cassette players, have an in-built transmitter with the amplifier, or stereo tuner-amplifier, having an in-built 433 MHz receiver. Without the trailing audio

cables, the equipment does not need to be stacked together, but can be placed anywhere convenient in a room. Also in this category are wireless amplifier-loudspeaker combinations and wireless headphones. European manufacturers such as Philips, Sennheiser, Sony and Vivanco, launched a range of wireless-linked audio products onto the market there last year. However, they ran into problems in some countries (see *WIA News* in *Amateur Radio*, March 1997, page 5). Radio keys using the 433 MHz band caused considerable consternation for car owners as amateur, land mobile and military stations blocked the door lock receivers for considerable distances.

The WIA has twice raised objections with the Spectrum Management Agency to the proposed new allocation in the 70 cm band. First, in reply to a letter from the SMA in December last year (again, *WIA News* in *Amateur Radio*, March 1997, page 5), and second in a formal submission in reply to the SMA's proposal in April this year.

The ACA noted in their Information Package issued in April, which proposed a series of updates to the 1993 Class Licence for LIPDs, that there was "... a

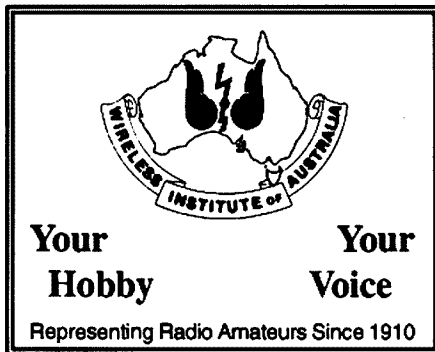
growing interest in this band for low powered applications sourced mainly from Europe . . . and related to the long standing designation in that Region, of the band 433.05-434.79 MHz for industrial, scientific and medical (ISM) applications."

The WIA's response, delivered to the SMA on 2 May, pointed out the likely interference problems from amateur 70 cm operations, even from stations using frequencies well outside the 433.05-434.79 MHz band. The WIA band plan provides for FM simplex and repeater operation, RTTY, SSTV, WICEN and packet radio. The receiver sensitivities in wireless audio equipment, for example, are apparently on the order of 100-500 microvolts per metre. Amateur stations operating between 430 and 440 MHz are capable of causing widespread interference, the WIA warned the SMA.

A modest amateur home station operating packet radio or FM voice in the 433-434 MHz segment, running powers of typically 25-50 watts output to a small gain antenna (typical), would likely cause blocking at distances up to 1 km in a suburban neighbourhood. The receiver bandwidths of 433 MHz wireless audio links are such that sensitivity likely falls off only modestly 5 MHz either side of centre frequency. A 100 watt SSB amateur home station, with a modest Yagi of 10 dB gain could wreak havoc with such wireless systems at distances up to 5-10 km in suburban situations.

With the foreshadowed introduction of the Class Licence permitting use of devices such as wireless audio equipment and radio vehicle keys, the WIA is writing to the Consumer Electronics Suppliers Association and relevant Motor Traders Associations to warn of likely problems should equipment operating on 433.05-434.79 MHz be introduced here, and pointing out alternatives.

The WIA's submission in May to the SMA on the LIPD proposal also raised objections concerning the proliferation of devices on the 13 cm, 6 cm and 1.25 cm amateur bands, particularly where amateur satellite allocations are affected. The lower 50 MHz of the 1.25 cm (24 GHz) band is the first primary amateur band segment above two metres, and is a satellite band.



# International Affairs

from David Wardlaw VK3ADW

## Second Report from the Future of the Amateur Service Committee

Changes to simplify and clarify the wording of the International Regulation which defines the Amateur Service have been recommended by the International Amateur Radio Union's (IARU) Future of the Amateur Service Committee (FASC) in its latest report, released in June.

The FASC, chaired by IARU Vice President, Michael Owen VK3KI, released a Discussion Paper in April 1996 to foster debate among the world amateur community about the issue of Article 25 in the International Regulations which defines the Amateur and Amateur-Satellite services, and the issue of retention of testing Morse code proficiency being retained or not as a treaty obligation (see IARU News, *Amateur Radio*, October 1996, page 4).

A first report following circulation of that Discussion Paper was issued in mid-1996, which was considered by the IARU Region 1 Conference in Tel Aviv over late-September, early-October that year. At the time, the FASC proposed to prepare a second report for consideration by the Region 3 Conference, to be held in Beijing next month.

The aim of the IARU is to form a global policy after each Region association has expressed their views. The formulation of that policy will be delegated to the IARU Administrative Council after the Region 2 Conference in 1998, to inform amateur delegations attending the World Radio Conference (WRC-99) in 1999 where the issues raised will be on the conference agenda.

The draft new wording for Article 25, and the accompanying discussion are too lengthy to reproduce here, unfortunately. The FASC's Second Report should

appear on the IARU's Web site, at [www.iaru.org](http://www.iaru.org) in due course, where the original Discussion Paper and the First Report can also be found. However, copies have already been distributed to Divisions for comment. If you want a copy for your own interest, a request to your Division Federal Councillor or Division Secretary with an A4 SASE or larger should get you one. Comment can be sent to your Federal Councillor, or to IARU FASC, c/o IARU International Secretariat, PO Box 31095, Newington, CT 06131-0905 USA, or by e-mail to [iaru@iaru.org](mailto:iaru@iaru.org), subject "To IARU FASC".

## Region 3 Conference Preparation

Preparations for the IARU Region 3 Conference in Beijing are well under way, with conference and briefing papers completed, or being prepared, covering amateur examinations in Australia, the WIA's submission to the Government on amateur licensing, EMC and Standards developments and future issues, RF safety and health issues in Australia, recent developments in radiocommunications licensing in Australia, Australian participation in the IARU beacon project, progress in various amateur pursuits in Australia (ARDF, satellites, packet radio, VHF-UHF and microwave, etc), further plans for the "Support for the Amateur Radio Service in Region 3" (STARS\*\*\*) project, WRC issues, and other matters.

## Brisbane Listener Wins May Recruitment Prize

The lucky recruit from May's crop of new WIA members to win the Fluke 12B digital multimeter is a YL from Donnybrook, in Brisbane's north, Ms **T Johnston L40380**, a member of the Redcliffe Radio Club.

There's a multimeter to be won every month throughout 1997 in a draw from among new WIA recruits joining in any particular month. So far, three lucky new members of the NSW Division, one from the Victorian Division and now one from the Queensland Division have been rewarded with this great prize. The Fluke 12B digital multimeter is worth \$195, and the 12 prizes have been generously donated by Philips Test and Measurement. Fluke is the world's pre-eminent manufacturer of digital test instruments and the Model 12B is from their latest range of hand-held instruments.

The Fluke 12B measures AC and DC voltage (with auto-selection above 4.5 V), resistance and capacitance from 1000 pF to 1000 µF. The instrument features a simple rotary dial, a 4000-count liquid crystal display, and diode and continuity testing. Its "continuity capture" feature indicates intermittent open and short circuits. It comes with test leads and a two-year warranty.

Every newcomer to electronics and amateur radio needs a good multimeter, and every seasoned enthusiast could always do with another one. And the chances of winning are very good!

Membership recruitment advertisements appear in each issue of *Amateur Radio* magazine, and in *Radio and Communications* magazine.

Membership recruitment and renewal advertisements are also on WIA Divisions' World Wide Web pages.

**Have you advised the SMA of your new address?**

# Packet Wormholes Close

The new Telecommunications Act, which took effect from 1 July, has been responsible for the closure of amateur packet wormhole stations at a number of tertiary education institution sites around Australia. It is believed at least eight wormhole sites have been affected.

Amateur wormhole stations link to other wormhole stations via a "virtual tunnel" through the Internet, the tunnel providing a "barrier" to non-amateur network computer systems connected to the Internet (see *Packet World* in *Amateur Radio*, June 1997, page 40). There is some contention that this sort of amateur station-to-station linking falls within the Australian amateur licence conditions. The issue has been under discussion between the WIA and the SMA (now the Australian Communi-

cations Authority) for the past several years.

Wormhole stations associated with private network facilities are believed to be unaffected, as yet.

University administrations began advising amateur wormhole station operators in late June that their connections would likely make the institutions a telecommunications "carrier" under the new Telecommunications Act. It is understood other services, not being directly faculty staff or students, which use tertiary institution network facilities, have also been affected.

One university obtain-

ed advice on the issue from the Department of Communications and the Arts (DoCA), which read: "If a network unit has one owner (eg xxU) and is used to supply point-to-point carriage services, it is being used to supply a service to the public if BOTH end-users are outside the immediate circle (employees and students) of the owner (section 44(c)(i))."

The WIA is monitoring the situation to keep abreast of further developments.

ar

## Audio, Broadcast & Radio Valves

New: 4CX250B, 4CX350A, 572B, 6146B, 807...  
Ceramic Sockets, Top caps...

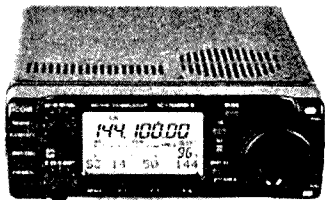
Rebuilding: 4CX10-000D, Klystrons, Magnetrons...

Contact: Mohan or Rebecca Varkey Ph: 041 900 9115

Australian Electric Valve Importers Pty. Ltd.



Factory 2, 22 Michellian Court, Bayswater, VIC 3153  
Mail: P.O. Box 1001, Bayswater, VIC 3153



## Radio and Communications

Incorporating AMATEUR RADIO ACTION and CB ACTION

When Icom sat down to design the original IC-706, it produced a quite unique radio with no peers... small — tiny, even — but a full 100 watts on all HF bands and six, plus 10 watts on two, and a general coverage receiver all the way to 200MHz. So what could it do to surpass that? We tell you all...

Published by  
ACP SYME MAGAZINES,  
PO Box 119,  
Oakleigh,  
Victoria 3166  
(03) 9567 4200

August's R&C is jam-packed with great features for amateur radio operators. Here are just a few of them...

- The MIR Space Station. Have a chat with a cosmonaut! We have the frequencies, times, the lot...
- DX Daily. This new daily on-line DX report promises a lot. Here's how to get hooked up to it...
- REVIEW: Universal M-8000 data decoder. Now you can understand those funny noises on HF!
- Earthing your amateur station. We all know we *should* earth everything. Now here's how and why.
- REVIEW: Yaesu ADMS software. Bought a recent Yaesu VHF or UHF rig? You *must* read this!
- As usual, we have our three DX columns, mods and more... the best stories and regulars every month!

Don't miss out — RADIO and COMMUNICATIONS is great reading for amateurs!  
**Check your local newsagent today!**

(PS. We also have the biggest collection of radio-oriented Classified adverts in the country. There's lots of them because they work so well. Ask your newsagent to keep a copy for you each month, or ring 1800 25 2515 for subscription details. Hurry — you might miss something!)

ce

## ■ Test Equipment

# Intermodulation Performance and Measurement of Intermodulation Components

*Lloyd Butler, VK5BR\* describes in detail what intermodulation performance should be expected, and how to measure it.*

### Introduction

To define the performance of a receiver or transmitter, various specifications are recorded which are obtained from measurements carried out. Perhaps the least understood of these in amateur radio circles is intermodulation performance and how it is measured. The aim of this article is first to discuss intermodulation products and how they are produced and then look at how they are defined and measured.

### What are Intermodulation Products?

When a single frequency ( $f_1$ ) is fed through a device whose output is not a linear function of its input, harmonics of  $f_1$  are generated, ie  $2f_1$ ,  $3f_1$ ,  $4f_1$ ,  $5f_1$ , etc (no device is perfect and so harmonics are always generated even at low levels).

Now, if two separate frequencies exist together in a non-linear device, sum and difference frequencies are also produced in addition to the harmonics. This can be shown mathematically to be the result of a multiplication process between the two original frequencies and hence the two new frequencies are called products. If the two original frequencies are  $f_1$ ,  $f_2$  and the highest frequency is  $f_2$ , then we can expect two other components (or products) of  $(f_1+f_2)$  and  $(f_2-f_1)$ . However, it doesn't stop there. Since there are harmonics of  $f_1$  and  $f_2$ , then there will be sum and difference products between all of the harmonics and the

fundamentals and between each other. These are the intermodulation products which are frequency components distinct from the harmonic components discussed in the previous paragraph. Of course, if there are more than two fundamental frequencies, then the multitude of products is compounded further.

It can be shown, using a mathematical series, that when harmonics are generated, the harmonics extend upward in frequency to approach infinity, progressively decreasing in amplitude as the frequency increases. Likewise, the intermodulation products could also be considered to be infinite in number. However, we are only really interested in those of practical significance, that is of

such a level that they might deteriorate the quality of our signal beyond an acceptable level.

To examine intermodulation products we will consider two frequencies  $f_1$  and  $f_2$  and some of the orders of intermodulation products. To define the order, we add the harmonic multiplying constants of the two frequencies producing the intermodulation product. For example,  $(f_1+f_2)$  is second order,  $(2f_1-f_2)$  is third order,  $(3f_1-2f_2)$  is fifth order, etc. Let's consider  $f_1$  and  $f_2$  to be two frequencies of 100 kHz and 101 kHz respectively, that is 1 kHz apart. We now prepare Table 1 showing some of the intermodulation products.

Looking carefully at the table, we see that only the odd order intermodulation products are close to the two fundamental frequencies  $f_1$  and  $f_2$ . One third order product  $(2f_1-f_2)$  is 1 kHz lower in frequency than  $f_1$  and another  $(2f_2-f_1)$  is 1 kHz above  $f_2$ . One fifth order product  $(3f_1-2f_2)$  is 2 kHz below  $f_1$  and another  $(3f_2-2f_1)$  is 2 kHz above  $f_2$ . In fact it is the odd order products which are closest to the fundamental frequencies  $f_1$  and  $f_2$ .

Let's expand further the odd order products as shown in Table 2.

The series of odd order products can be seen to descend and ascend progressively in increments of 1 kHz from the two fundamental frequencies  $f_1$  and  $f_2$  respectively. A typical spectrum produced could be depicted as shown in the chart of Figure 1.

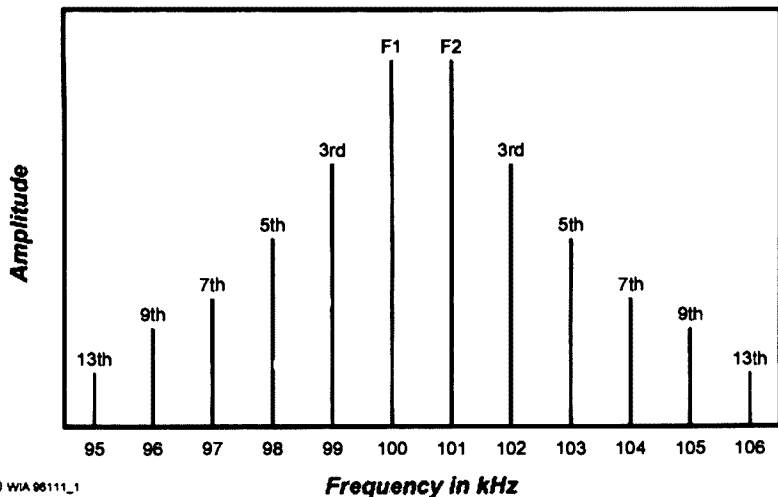
Of all the harmonics and

**Table 1 - Intermodulation Products**

1st Order	$f_1$ ,	$f_2$	100 kHz	101 kHz
2nd Order	$f_1+f_2$ ,	$f_2-f_1$	201 kHz	1 kHz
3rd Order	$2f_1-f_2$ ,	$2f_2-f_1$	99 kHz	102 kHz
	$2f_1+f_2$ ,	$2f_2+f_1$	301 kHz	302 kHz
4th Order	$2f_2+2f_1$ ,	$2f_2-2f_1$	402 kHz	2 kHz
5th Order	$3f_1-2f_2$ ,	$3f_2-2f_1$	98 kHz	103 kHz
	$3f_1+2f_2$ ,	$3f_2+2f_1$	502 kHz	503 kHz
Etc.				

**Table 2 - Odd Order Products**

3rd Order	$2f_1-f_2$ ,	$2f_2-f_1$	99 kHz	102 kHz
5th Order	$3f_1-2f_2$ ,	$3f_2-2f_1$	98 kHz	103 kHz
7th Order	$4f_1-3f_2$ ,	$4f_2-3f_1$	97 kHz	104 kHz
9th Order	$5f_1-4f_2$ ,	$5f_2-4f_1$	96 kHz	105 kHz
Etc.				



© WIA 96111\_1

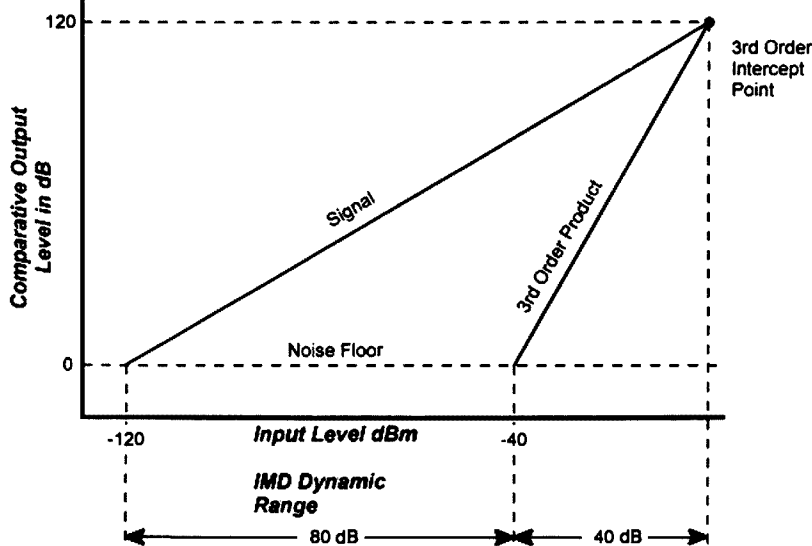
Frequency in kHz

**Fig 1 - Spectrum of intermodulation components.**

intermodulation components produced, we are often only interested in those which fall in the passband of our equipment and, in the case of the intermodulation components, those which happen to be closest to our fundamental frequencies. The third order components are the closest and also usually the highest in amplitude. Because of this, they are usually the products of most concern and are those which are commonly measured and defined in transmitter and receiver performance specifications.

### Effects of Intermodulation Components

The existence of intermodulation components affects the performance of equipment in various ways. First let's look at audio amplifiers. The presence of any component at the output of an amplifier, but not fed into it, degrades the quality of the signal being amplified. We call this distortion, which can be the result of non-linearity in the amplifier causing the generation of harmonics of



© WIA 96111\_2

**Fig 2 - Receiver intermodulation performance curves.**



**YOUR HOBBY** **YOUR VOICE**  
 Representing Radio Amateurs - Since 1910

**RENEW**  
**YOUR MEMBERSHIP**  
**AND YOU COULD**  
**WIN**



**THIS KENWOOD TM-733A**  
**2m/70cm FM/packet rig**  
**worth \$1255**

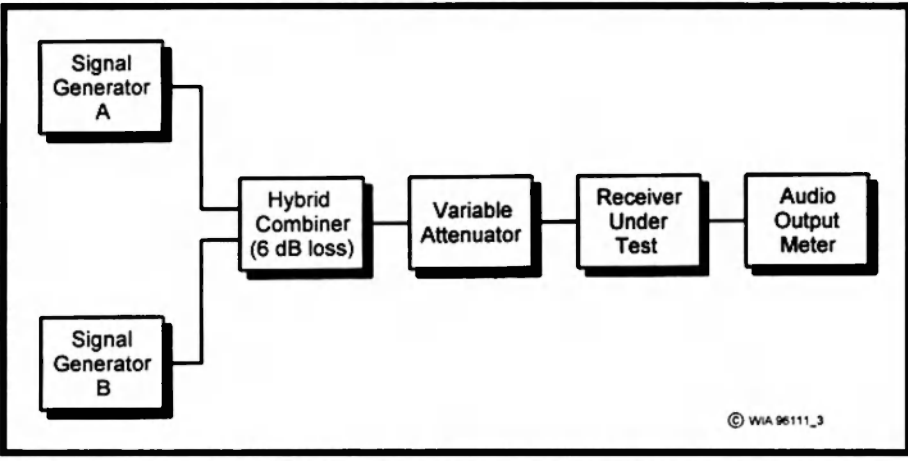
50 W on 2m 35 W on 70cm  
 Switchable 10 W/5 W RF output  
 Simultaneous VHF-UHF reception  
 Data input for 1200/9600 baud packet  
 70 multi-function memories

**All you have to do is renew**  
**your Division membership**  
**when it falls due**

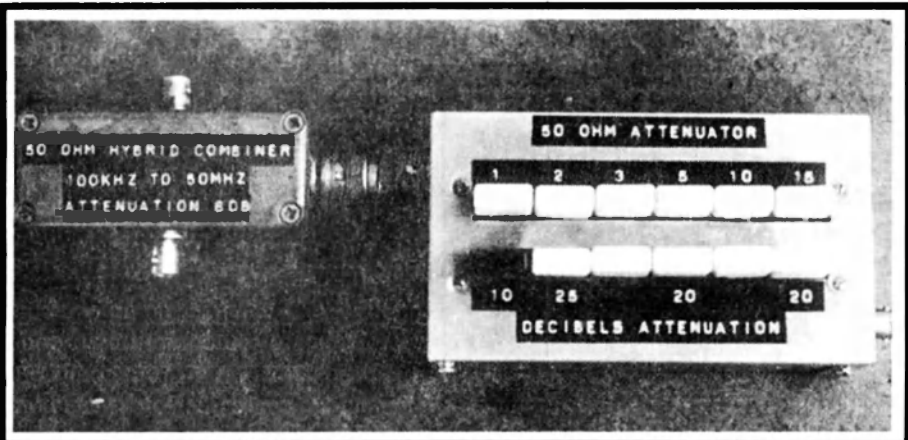
**WHO'S ELIGIBLE?** ● members whose renewal falls due between 1/1/97 and 31/12/97 ● current members who are on a 3-year membership ● life members, and ● all membership grades.

The prize will be awarded by means of a draw, the result to be published and the prize to be presented to the winner at the first available opportunity early in 1998.

TM-733A prize kindly donated by  
 Kenwood Electronics Australia P/L,  
 PO Box 504, Homebush 2140.  
 Ph: (02) 9748 1888. Fax: (02) 9748 1509.



**Fig 3 - Testing of receiver for third-order intermodulation performance.**



**Fig 4 - Hybrid combiner and 50 ohm attenuator assembled by VK5BR.**

the signal frequencies and, in turn, intermodulation components. So we have harmonic distortion and intermodulation distortion which can individually be defined. We often see intermodulation distortion abbreviated to IMD.

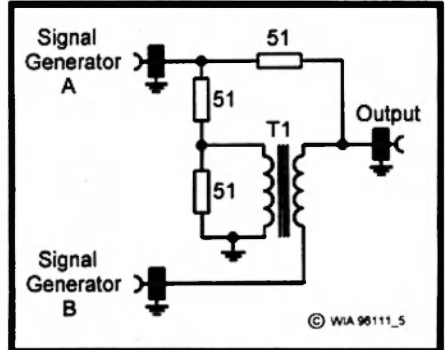
Some different effects can be experienced when non-linearity exists at RF in a transmitter and, in particular, in the final linear amplifier of the transmitter. Consider the amplifier delivering sideband components to the antenna at radio frequencies and, because of non-linearity, harmonics of the various sideband components are generated plus various intermodulation components. The harmonic components and the even-order intermodulation components will be well spaced away from the operating frequency, and hopefully attenuated by the tuned amplifier tank circuit and the antenna tuning system. Not so for the odd-order intermodulation components which are

closely spaced around the fundamental components from which they were generated. First of all they will show up as audio distortion after being received and detected by the radio receiver. However, that's not all! We have seen from the previous paragraphs that the odd order components spread out either side of the fundamental components in progression gradually decreasing in amplitude. The effect is to broaden the radiated signal and, in receiving the signal, we experience the familiar sideband splatter. As most of us well know, this causes interference to others trying to use another channel near in frequency.

Another application where those odd order intermodulation components are of considerable concern is in the first mixer stage of a superheterodyne receiver. The special function of the mixer stage is to produce some form of non-linearity so that an intermediate lower frequency is formed from the sum

or difference between the incoming RF signal frequency and a local oscillator frequency. The mixer stage is, therefore, a prime spot for other intermodulation products which we might not want. Let's look at an example. Our receiver is tuned to a signal on 1000 kHz but there are also two strong signals, f1 on 1020 kHz and f2 on 1040 kHz. The nearest of these (f1) is 20 kHz away and our sharp intermediate frequency (IF) stage filter of 2.5 kHz bandwidth is quite capable of rejecting this signal. However, the RF stages before the mixer are not so selective and the two signals f1 and f2 are seen at the mixer input, free to produce intermodulation components at will. Now work out the third order intermodulation component (2f1-f2) and we get (2x1020-1040) = 1000 kHz, right on our signal frequency. This is just one example of how intermodulation components or out-of-band signals can cause interference within the working band.

Another form of interference in receivers which results from the mixing of intermodulation components is Cross Modulation. This becomes more apparent when dealing with AM signals and the modulation on a strong out-of-band signal transfers itself across to modulate the signal being received. The process is probably complex but, due to non linearity in the receiver, one can well imagine the carrier and sideband frequencies of the out-of-band modulated signal mixing to produce difference second-order components at the audio frequencies of modulation. Due to the same non-linearity, the unwanted audio components intermodulate the signal being received. If the receiver is designed



**Fig 5 - Hybrid combiner (based on a circuit from the ARRL Handbook, ref 2). T1 consists of 10 turns bifilar wound on FT50-72 core.**

for good intermodulation immunity, it will also have good cross modulation immunity.

### Receiver IMD Performance

To assess the receiver for its tolerance against interference from internally generated intermodulation products, the receiver is tested for its sensitivity to third-order products using two equal-level signals fed to its input and typically 20 kHz apart. The receiver is tuned to the frequency of one of the third order products derived from the two signal frequencies. The level of the combined signals at the input is adjusted until the detected output level is equal to that generated by the receiver's self noise. That is, there is a 3 dB change in output level between when the signals are on and when they are off. The level of the third order product necessary to produce output equal to the receiver "noise floor" is recorded. For the purposes of following discussion we will call this level IMD Threshold.

We also need to know the normal signal input level which produces audio output equal to that of the receiver's own inherent noise or its noise floor. This is done by tuning the receiver to one of the two frequencies and again adjusting input level to give an output level 3 dB above the noise output level. For the purposes of the discussion we will record this input level as the Signal Threshold. The difference in dB between the IMD threshold and the signal threshold is called the Intermodulation Dynamic Range or IMD Dynamic Range. The higher the difference, the better the immunity to interference from IMD products.

Now, there is an important characteristic of the third-order products which makes their presence more of a problem than one might first imagine. Assuming no compression (due to AGC, etc), output from a fundamental signal is proportional to input, ie for 10 dB rise in input level there is 10 dB rise in output level. However, the output of the third order product is proportional to the cube of

signal input level and, for a 10 dB change in input level, the product increases by 30 dB.

Now refer to Figure 2. One curve plots a linear rise in output level against input level for the fundamental signal frequency. The other plots the level of third-order IMD products against input level, the output rising 30 dB for every 10 dB change in input level. At an output level equal to the noise floor, the two curves are separated by an input level difference equal to the IMD Dynamic Range. As the intermodulation curve rises with greater slope than the fundamental curve, they cross at a point called the Third-Order Intercept Point where the intermodulation product output level is equal to the fundamental signal output level.

The Third-Order Intercept point is normally a theoretical point well above the receiver overload level. However, it is often specified to define intermodulation levels, and particularly in specifications for mixer packages.

The Third-Order Intercept point can

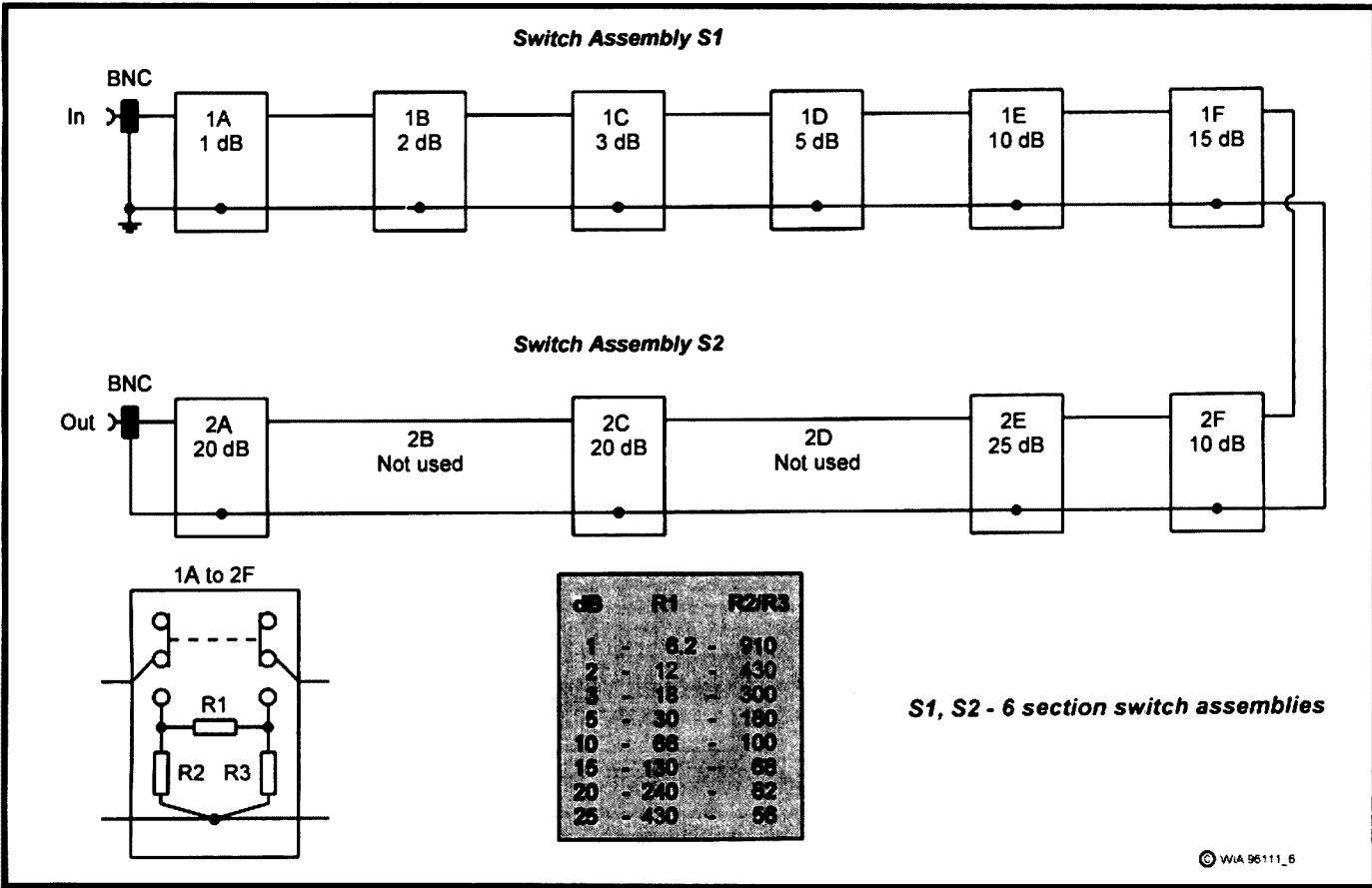
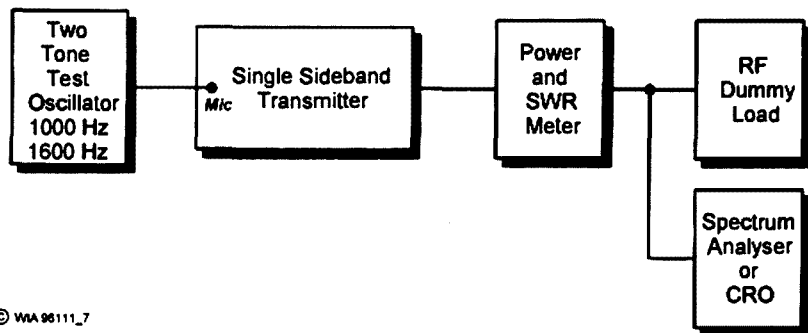


Fig 6 - Circuit diagram (simplified version) of the VK5BR 50 ohm attenuator.



© WAA 96111\_7

**Fig 7 - SSB transmitter test arrangement for IMD performance.**

be derived on decibel scales by first extending the signal curve linearly from the signal threshold point on the noise floor axis so that output level increase in dB equals input level increase in dB. Mark the IMD threshold point on the noise floor axis. This is at an input level higher than signal threshold by an amount equal to the IMD dynamic range. Mark another point on the noise floor axis beyond the IMD threshold point by an amount equal to half the IMD dynamic range. Extend this point vertically to cross the signal curve and this is the Third-Order Intercept point. Join this point to the IMD threshold point to complete the curves such as is shown in Figure 2. In the diagram, the noise floor input level is -120 dBm, the third order components become detectable at -40 dBm and the IMD dynamic range 80 dB. The theoretical third-order intercept occurs at an input level of 120 dB above the noise floor input level.

It can be seen from the curves of Figure 2 that, above the IMD threshold level, the IMD products can become quite a problem. In the example, IMD products from out-of-band signals at an input level of -40 dBm would barely be apparent. Increase the level by a mere 10 dB and the interference from these products would increase by 30 dB.

## Receiver Measuring Gear

To carry out intermodulation performance on a receiver, the set-up shown in Figure 3 is required. The RF outputs of two signal generators are combined in a hybrid circuit designed to prevent interaction between the two generators. A hybrid circuit is balanced so that a

signal at any one input port cannot reach the other. However, both signals appear combined at an output port.

The combined output is fed to the receiver via an adjustable attenuator with a range up to around 80 dB and resolution of 1 dB. Assuming that the receiver has an input resistance of 50 ohms, both the combiner and attenuator are designed for a circuit impedance of 50 ohms.

A hybrid combiner and attenuator assembled by the writer is shown in Figure 4. The hybrid circuit, Figure 5, is one taken from the *ARRL Handbook*. The combiner has an insertion loss of 6 dB for each signal channel.

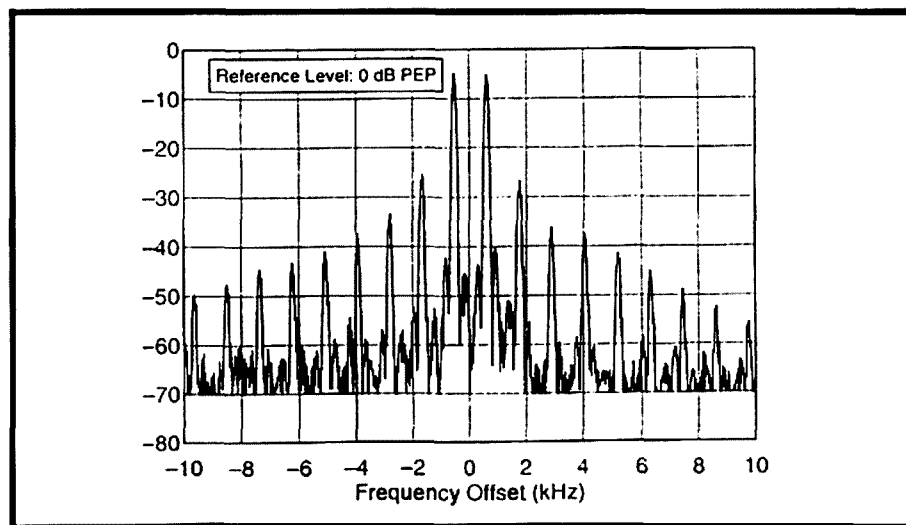
The attenuator was made up using two mechanically interlocking, in-line switch assemblies of the type similar to those used in older style push-button car radios. The assemblies, each of six switches, were recovered from some old

intercom units and each switch came with plenty of change/over contacts to switch in or out an attenuation pad. One assembly switches in 1 dB, 2 dB, 3 dB, 5 dB, 10 dB and 15 dB pads. The other switches in 10 dB, two of 20 dB and 25 dB pads. Up to three switches on each assembly can be simultaneously pressed to lock in so that up to six pads can be in circuit together to provide a continuous selection of total attenuation between 1 and 95 dB. The circuit diagram of the complete attenuator is shown in Figure 6.

The only other device necessary is some form of AC voltmeter to measure the comparative level of audio signal at the receiver output. All it is required to do is to record a 3 dB change in level above the receiver noise floor. In terms of voltage increase, this is a rise of 1.4 times.

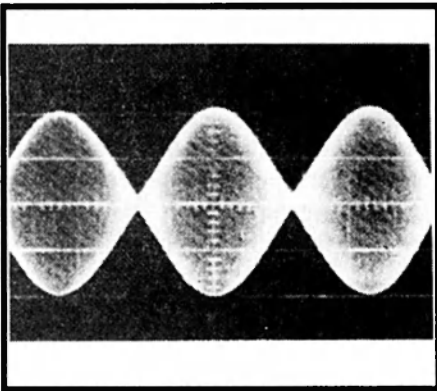
Our references have so far been made to levels in dBm, or decibels referred to one milliwatt. However, signal generator outputs are commonly calibrated in microvolts and millivolts with scales in multiples of 10. To convert between units, 1 mV across 50 ohms is -107 dBm. Each time the voltage is multiplied by 10, add 20 dB so that 10 mv is -87 dBm, 100 mV is -67 dBm, etc.

To find the signal threshold, set one signal generator to a fairly low level (say 10 mV or -87 dBm) and tune the receiver to the signal generator frequency. Adjust the attenuator so that the signal raises the audio output signal just 3 dB (1.4 times volts) above the noise level (measured

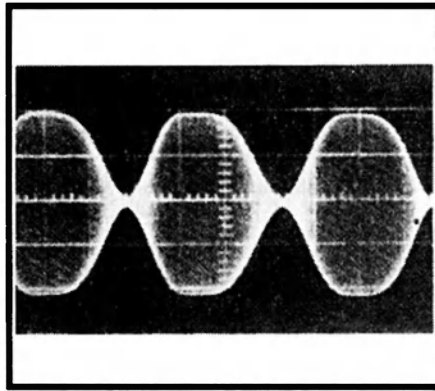


**Fig 8 - Typical spectral display from the RF output of a SSB transmitter using two tone modulation and showing the intermodulation products generated (sample from ARRL test in March 1996 issue of QST).**





9A



9B

**Fig 9 - SSB two tone test showing RF waveform on a CRO. (a) Good waveform. (b) Peaks compressed (IMD high, sideband splatter).**

with signal off). The signal threshold in dBm is equal to -87 dBm, minus the loss in dB set by the attenuator, minus 6 dB loss in the hybrid combiner.

To find the third-order IMD threshold, set the two generators (20 kHz apart in frequency) to an equal level somewhat higher, such as 10 mV (-27 dBm). Tune the receiver to the frequency of one of the third-order products. Adjust the attenuator until the audio output from the third-order signal is just 3 dB above the noise level. The IMD threshold is equal to -27 dBm, minus the loss in dB set by the attenuator, minus 6 dB loss in the hybrid combiner.

**Transmitter Tests**

To check out a single-sideband transmitter for those intermodulation components which cause sideband splatter, we need a two tone audio generator to feed into the microphone input of the transmitter. This can be quite a simple test unit, consisting of two fixed frequency oscillators delivering the same

output level into a resistive network which combines the two signals. Simple two tone generators have been presented in *Amateur Radio* from time to time. In the March 1983 issue, the writer described one using two FX205 Tone Generator packages. In this one, frequencies were set at 1000 Hz and 1600 Hz.

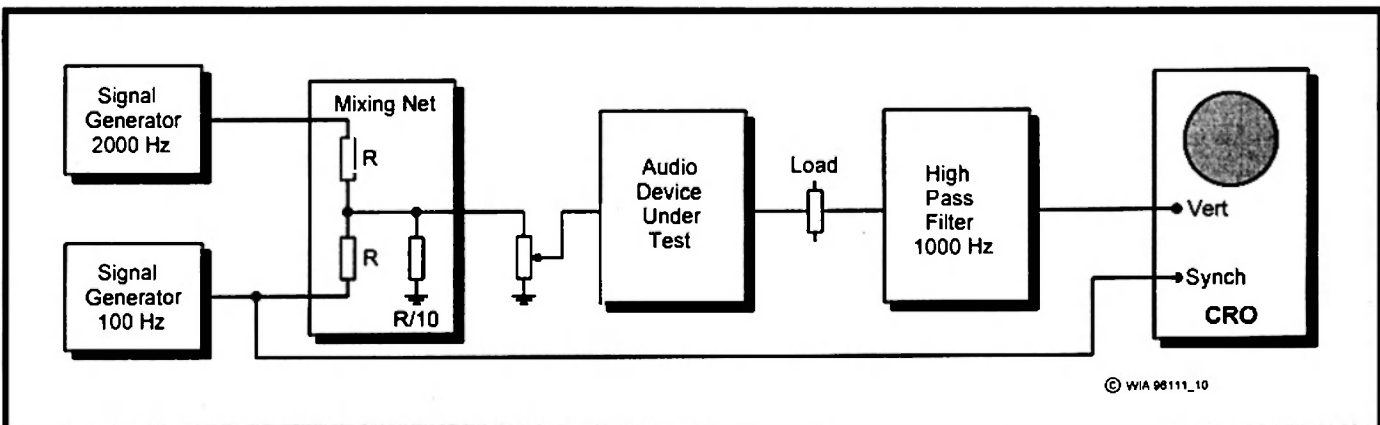
A test arrangement for the transmitter is shown in Figure 7. The two tone oscillator level is adjusted to provide full RF power from the transmitter into a dummy load. Power can be monitored with the usual Power/SWR meter. Apply the audio signal in short bursts as most single-sideband transmitters are designed for speech and the final amplifier stage might be damaged if sustained on continuous full power. The best way to monitor the level of the various intermodulation sideband components is to examine the RF output signal using a Spectrum Analyser.

Figure 8, taken from March 1966 issue of *QST*, is a typical spectrum

analyser display of the RF output of a single-sideband transmitter fed with two audio tones 1000 Hz apart. Two fundamental RF sideband frequencies are created but we can also see a family of odd-order intermodulation frequencies either side of the two fundamentals with all frequencies spaced 1000 Hz apart. The display shows that the third order products are around 21 dB below the fundamentals, the fifth order 30 dB below, the seventh order 33 dB below, etc, in decreasing amplitude as the order progresses.

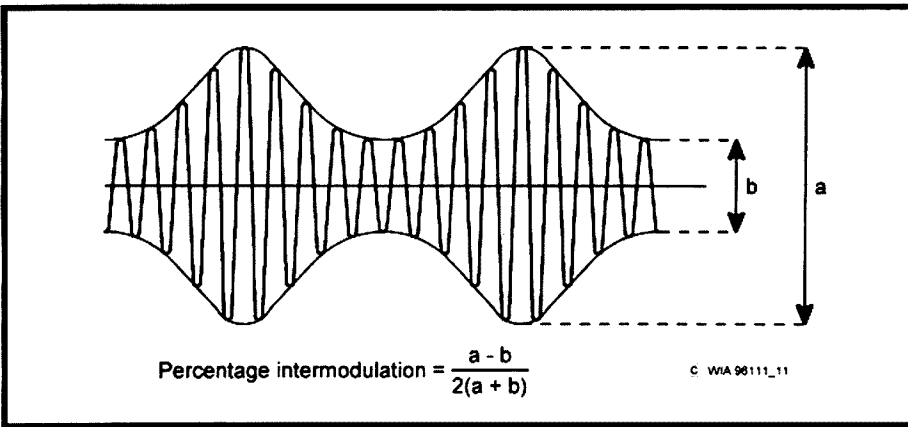
Whilst the spectrum analyser is the order of the day in the modern electronics laboratory, not many radio amateurs could boast of one in the radio shack. However, the Cathode Ray Oscilloscope (CRO) is a more common piece of test gear, and with this we can get some idea of whether there might be an excessive spread of intermodulation sideband components. Figure 9, taken from the *ARRL Handbook*, shows CRO displays of the RF output generated from a two tone audio source fed to the transmitter. In diagram A, the waveform is quite good and we could expect a fairly clean signal transmitted. In diagram B, compression of the waveform peaks is occurring, possibly because the final amplifier is being driven too hard into a state of poor linearity. If there is poor linearity, then we can expect intermodulation components to be generated and sideband splatter.

Another test that might be applied is to demodulate the transmitter so that we get the two tones back as audio. Perhaps a station receiver can be used for this purpose if it can be prevented from being



© WIA 90111\_10

**Fig 10 - Test for audio intermodulation distortion using a CRO display.**



**Fig 11 – CRO display waveform of intermodulation and method of measurement.**

overloaded by the transmitter. The audio intermodulation distortion tests as described in the following paragraphs can then be carried out. The tests could apply to any mode of transmitter and matching receiver whether it be SSB, AM, or FM (for AM, a simple rectifier and RF filter would be adequate for demodulation). The only problem with this form of test is that the distortion measured is the combined distortion of both transmitter and receiver. If excessive distortion occurred, one would have to be certain that it wasn't caused by the receiver.

### Measurement of Intermodulation Distortion at Audio Frequencies

As with other tests described, two audio signals at different frequencies are fed through the device to be tested and the output is monitored. If a modern spectrum analyser is available, the relative amplitudes in decibels from all components at the output can be displayed. As the X axis of the analyser display is calibrated in frequency, the various intermodulation components can be identified and their amplitudes recorded relative to the two fundamental frequencies.

Another instrument of a past era, but which can do a similar job, is the Heterodyne Wave Analyser. This is, in effect, a sharp tuneable filter which achieves its sharpness and tuneability by heterodyning the measured signal with a tuneable oscillator and passing the difference frequency through a sharp

fixed 50 kHz crystal filter. By adjusting the tuneable oscillator, the various frequency components can be selectively tuned in and the outputs at 50 kHz can be compared. The Wave Analyser was described in the writer's previous article on Measurement of Distortion, *Amateur Radio* June 1989.

Another method to measure the intermodulation level is to make use of a CRO display as shown in Figure 10. Two audio signals of widely different frequency are combined and fed into the device under test. The lower frequency signal has an amplitude four times that of the higher frequency signal. The output of the device is fed to the CRO vertical plates via a high pass filter which removes the low frequency signal. The CRO time base is externally synchronised to the low frequency signal. Intermodulation is shown on the display as an amplitude modulation waveform of the lower frequency on the higher frequency carrier. The reason for the four to one signal amplitude ratio is to amplify the apparent modulation and improve resolution in reading the display. The test set-up, shown in Figure 10, uses a 100 Hz low frequency signal and a 2000 Hz high frequency signal. A simple resistive mixing network is used to prevent interaction between the audio generators. Referring to Figure 11, percentage intermodulation is calculated from a and b scaled on the CRO display as: % Intermod =  $(a-b)/2(a+b)$ .

In this test, it should be clear that we are essentially measuring the effect of the second-order intermodulation components at  $(f_2-f_1)$  1900 kHz and

$(f_2+f_1)$  2100 kHz. This should not be confused with the fact that at radio frequencies we had been mainly concerned with the odd-order products because it was those which appeared in close to our tuned band. However, at audio frequencies, both odd and even products fall within the audio band.

### Summary

Intermodulation products have been discussed with particular attention to how their presence affects our transmitter and receiver circuitry. In audio circuits, they are one of the contributing distortion factors which deteriorate audio reproduction quality. At radio frequencies in transmitters, they appear as what we recognise as sideband splatter. In receivers, circuits susceptible to their generation encourage interference from signals outside the receiver pass-band.

Various ways have been explained as to how intermodulation components can be measured and how the equipment performance in terms of IMD susceptibility can be specified. The reason why the third order performance is usually defined in RF circuits has also been discussed.

### References

1. Lloyd Butler VK5BR: *Measurement of Distortion – Amateur Radio*, June 1989.
2. ARRL Handbook 1989: Chapter 25 – Test Equipment & Measurements; Chapter 18 – Voice Communications.
3. Jon Dyer G4OBU: *High Frequency Receiver Design – Radio and Electronics World*, July 1983.
4. Lloyd Butler VK5BR: *A Discussion on Mixers – Amateur Radio*, April 1988.
5. Lloyd Butler VK5BR: *Two Tone Test Oscillator for SSB – Amateur Radio*, March 1983.

\*18 Ottawa Avenue, Panorama SA 5041

ar

**Tell the advertiser  
you saw it in the  
WIA Amateur  
Radio magazine!**

## ■ Measurement

# Simple Peak-Reading Watt-Meter

Jon Lindstad VK2WF\* describes how to convert your watt-meter to a PEP reading meter.

Most watt-meters used by amateurs are average reading voltmeters calibrated in watts at 50 ohms. These watt-meters will indicate the power level transmitted by a steady carrier, or if you whistle into the microphone while in SSB mode. During normal speech, however, these watt-meters indicate considerably less than the actual PEP output. The watt-meter described below is a peak-reading voltmeter calibrated in watts at 50 ohms. It is quite simple and will indicate the peak power output during normal speech.

Referring to Fig 1, you will see that the circuit is a simple HF rectifier. Without the meter circuit and the six 1 megohm equalising resistors, C would be charged to the positive peak voltage of the transmitted signal and stay charged. The meter, and meter resistance  $R_s$ , form a discharge path and, with a proper discharge time constant, the circuit will operate in much the same way as the S-meter in your transceiver; that is it will respond quickly to the peak output level and discharge slowly enough to enable you to read the power level.

So, how does this circuit differ from

the more common output meters? The difference is in the discharge time constant. This circuit utilises the full voltage on the transmission line and charges the capacitor to the peak Tx-line voltage. The required discharge current is determined by the sensitivity of the moving coil meter, say 100  $\mu$ A full scale. The value of the meter resistor  $R_s$ , and hence the time constant, is then proportional to the available voltage on the capacitor C. Note that the time constant will be modified by the six equalising resistors.

PEP, or "peak envelope power", is the power that would have been transmitted if the signal shown in Fig 2a had been a sine wave with the same peak voltage as shown in Fig 2b across the same resistive load. So, if  $V_p$  in Fig 2a is, say, 80 volts, then:

$$PEP = (V_p * 0.707) / 50 = 64 \text{ watts}$$

If  $R_s = 1$  megohm then the meter current would be:

$$I = 80 / 10^6 = 80 \mu\text{A}$$

Note that the notation  $10^6$  means 1 times 10 to the power 6.

## A Design Example

Let's say we want to build a watt-meter indicating 400 watts PEP at the 80  $\mu$ A mark using a meter movement with 100  $\mu$ A full scale deflection (FSD). For convenience we will disregard the small voltage drop across the diodes and the resistance of the meter movement itself. The following variables are used:

$V_p$  - peak voltage on transmission line

P - power represented by sine wave with same  $V_p$  as SSB signal

I - meter current

RL - Tx line and Load impedance

$R_s$  - meter circuit resistance

C - holding capacitance

T - discharge time constant

We then have:

$$V_p = \sqrt{2 * P * RL}$$

$$= \sqrt{2 * 400 * 50} = 200\text{V}$$

That is, C will be charged to 200 volts if 400 W PEP is being transmitted. To get 80  $\mu$ A current through the meter:

$$R_s = V_p / I = 200 / 80 \times 10^{-6} = 2.5 \text{ megohm}$$

Note that the notation  $80 \times 10^{-6}$  means 80 times 10 to the power -6 or 80/1000000.

## Andrews Communication Systems

(EST. 1976 - ACN 001 968 752)

**WE WILL NOT BE UNDERSOLD  
ON ALINCO RADIOS**

- ★ IC-756 HF+6M, DSP, LCD
- ★ IC-R10 HAND HELD SCANNER
- ★ WS-1000E CUTE SCANNER
- ★ DX-70TH HF+6M 100W
- ★ MFJ TUNERS AND CONTROLLERS
- ★ DX-1600 HF LINEAR AMP.
- ★ AR-5000 2.6GHz SCANNER

**3 YEAR WARRANTY ON  
OUR ALINCO RADIOS**

Call us now

**(02) 9636 9060** or (02) 9688 4301

SHOP 8, 41 BATHURST ST, GREYSTANES,  
N.S.W. 2145. FAX (02) 9688 1995

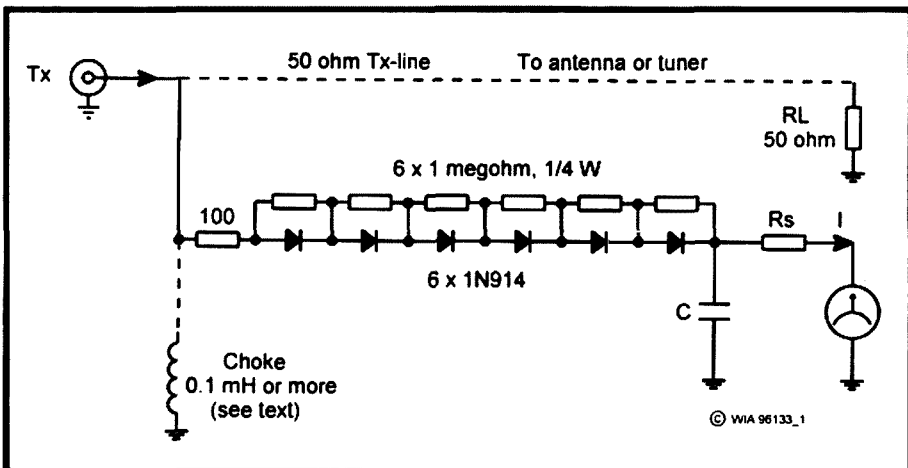
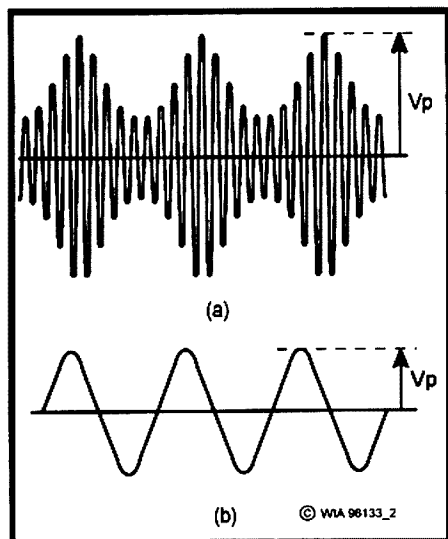


Fig 1 - Circuit of the peak-reading meter.



**Fig 2 - (a) SSB waveform.  
(b) Sine wave.**

The value of C should be between 2 and 5  $\mu$ F. The combined discharge resistance is 2.5 megohm in parallel with 6 megohm. However, the six 1 megohm resistors will only draw current from C half the time, but then towards a varying negative potential. My "guesstimate" is 2.5 megohm in parallel with 9 megohm,

ie approximately 2 megohm. With a C of 5  $\mu$ F the time constant would be:

$$T = 2E6 * 5E-6 = 10 \text{ seconds}$$

Try experimenting with the value of C. The inertia of the meter movement will probably influence your choice.

### Calibrating the Scale

With the 400 watt mark at 80  $\mu$ A, you would have 100 watts at 40  $\mu$ A and 25 watts at 20  $\mu$ A. If you want to calibrate the scale in more detail, the following equations will give the figures:

$$V_p = \sqrt{2 * P * 50}$$

and

$$I = V_p / 2.5E6$$

This yields the following table:

PEP	$V_p$	I ( $\mu$ A)
400	200	80
300	173	69
200	141	56
100	100	40
75	86.6	35
50	71	28
25	50	20

At full scale (100  $\mu$ A), the PEP would be 625 watts.

### Final Notes

1. A small light weight  $\mu$ A-meter will respond quicker than a larger one and will be more accurate in spite of the smaller scale.

2. The capacitor C will be charged to  $V_p$  so, on the negative half cycle of the signal, the reverse voltage across the diodes will be  $2 * V_p$ . Note, however, that this is only so if the SWR on the line is 1:1. A high SWR will result in a significantly higher reverse voltage. This has to be taken into account in the selection of diodes and the number used in series. The author has used five diodes (1N914) during the last two sunspot cycles when a 400 W homebrew amplifier was used a lot. The diodes were blown twice in this time span due to high SWR (forgetting to tune up!). At least six diodes is recommended.

3. The choke L shown in Fig 1 between the Tx-line and ground is only necessary if your Tx output does not have a low resistance path to ground. Most transmitters do. Try without the choke first. If it does not work, put one in.

\*PO Box 457, Armidale NSW 2350

ar

## QSP News

### Changes to Search and Rescue

Effective from 1 July 1997, Aviation and Marine Search and Rescue functions in Australia will become the responsibility of a new national SAR organisation which will be known as AUS-SAR. AUS-SAR will combine the Search and Rescue roles currently provided by Aircservices Australia and the Australia-Maritime Safety Authority Rescue Co-ordination Centres.

Services are accessible on the following 1800 numbers:

Aviation 1 800 815 257  
Aviation 1 800 624 077  
Aviation 1 800 640 507  
Maritime 1 800 641 792  
FAX 1 800 622 153

(information from Damien VK3RX)

## Antennas

# A Two Metre X Beam

Paul Clutter VK2SPC\* describes a compact beam for 2 m.

After acquiring a two metre handheld transceiver, the next obvious task was organising suitable antennas. The rubber ducky and various other telescoping mobile antennas served their limited purposes and a 5/8 vertical kept me in touch while searching through handbooks and antenna books for something better.

After considering all the pros and cons of Yagis, quads, Js, and Vs, etc, I decided to try an X beam which appeared in the *ARRL Handbook* and *Antennas Compendium Vol 1*. This antenna was developed by W9PNE and is a compact version of the two element. However, the handbook did not include any details above 28.2 MHz, but the formulas were

developed after many measurements on a large number of X beams.

One reason for selecting this antenna was that no matching network is needed. A 50 ohm coax feeder goes directly to the driven element. Also, the frame is easily constructed, the antenna is broadband with low SWR, and a long boom is not needed.

The first beam, not included in Fig 1, was made with 1/2 inch diameter tubing, ex-TV antenna, with 12 gauge B&S self-supporting wire for the tails. No frame was needed as the tubing was saddle-clamped on a piece of Perspex. As the antenna was used vertically, a 24 inch (600 mm) long piece of timber, 1/2 x 1 inch (12.5 x 25 mm), was attached at the hub to bring the coax away from the

necessary with horizontal polarisation as the coax would be running down at right angles to the plane of the elements.

Trimming the tails at 146 MHz, the best SWR was 1.5:1 and comparison tests with other antennas gave an indication of some gain. I decided to make another beam (beam No 2) as the arm length to diameter ratio was 32 to 1 (16 inches long x 1/2 inch diameter), whereas the handbook specification suggested a 200 to 1 ratio. This first beam was later dismantled after making the second and third beams.

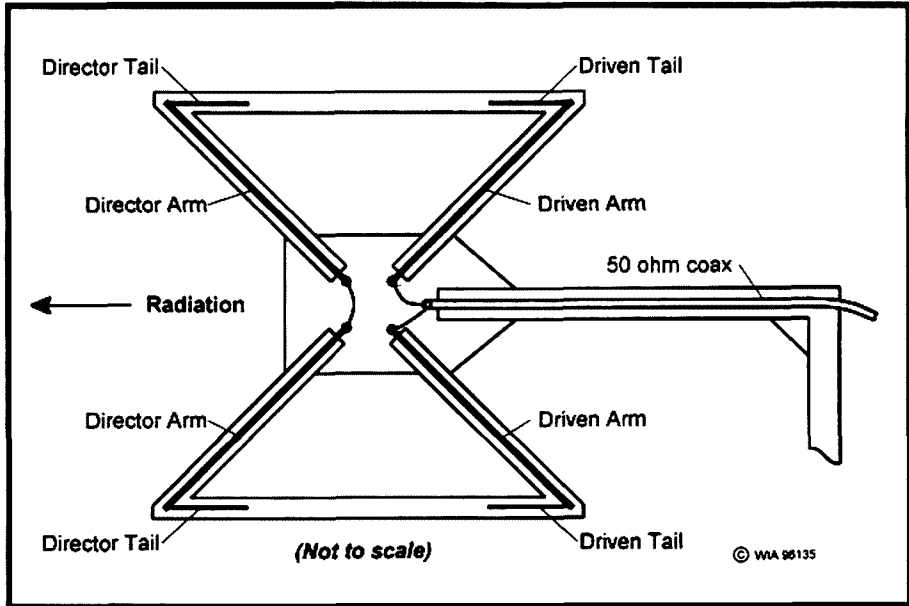
The second beam (see Fig 1) was made with arms of the aluminium from the connecting rods of the ex-TV antenna. The dimensions were 0.158 inch diameter and 16 inches long (4 x 406 mm approx). The ends were flattened and drilled to bolt the tails on with 8 BA screws. This gave the arms a diameter to length ratio of 101 to 1. Many sizes of tail wires were tried. Nos 12, 16, 18, 20, and 24 gauge were tried and the best SWR and bandwidth was obtained using No 24 B&S (0.020 inch or 0.5 mm).

As the SWR and bandwidth were much better with the second beam, I decided to make number three with smaller diameter arms to get the length to diameter ratio closer to 200 to 1. Ideally, a 12 gauge B&S (0.080 inch or 2 mm) wire for the arms would give the 200 to 1 ratio but, as I did not have enough 12 gauge wire left from a secondary transformer rewind, I looked around for something near to the size. I found a bundle of coat hangers in the garage which looked promising. After measuring several I found enough to make the arms with a diameter of 0.085 inches. This wire was easily soldered and the size resulted in a 188 to 1 ratio with the bandwidth even better than the No 2 beam.

During the process of trial and error testing I put a 1/4 wave matching stub (bazooka or Pawsey stub) on all beams and found no advantage; I then removed them. The gain is approximately 6 dBd and the front to back ratio is at least 12 dB.

\*52 Keats Avenue, Bateau Bay NSW 2261

ar



**Fig 1 - X beams layout. The arms and tails are laced to the frame with waxed cord.**

**Second beam details:**

Frame	1/4 x 3/4 inch timber strips mounted on a 3/16 inch, 3 ply centre piece.
Arms	Aluminium rods 0.158 inch diameter x 16 inches long. Length to Diameter ratio 101 to 1.
Driven tails	No 24 B&S (25 BSWG) wire (0.020 inch) x 5 1/8 inches long.
Director Tails	No 24 B&S (25 BSWG) wire (0.020 inch) x 4 1/4 inches Long.
SWR Readings	144 MHz 1.08:1 145 MHz 1.04:1 146 MHz 1:1 (0 reading on reverse of SWR meter) 147 MHz 1.04:1 148 MHz 1.08:1

**Third beam details:**

Frame	Same as second beam.
Arms	Coat hanger wire - 0.085 inch diameter x 16 inches long. Length to Diameter ratio 188 to 1
Driven tails	Same as second beam x 4 inches long
Director tails	Same as second beam x 3 inches long
SWR Readings	144 MHz 1.04:1 145 MHz 1:1 (0 reading on reverse of SWR meter) 146 MHz 1:1 (0 reading on reverse of SWR meter) 147 MHz 1:1 (0 reading on reverse of SWR meter) 148 MHz 1.04:1

**Sign up a new WIA member today - we need the numbers to protect our frequencies and privileges**

## ■ Events

# An Enjoyable Weekend in Central Queensland

*Jeff Aust VK4ABJ\* reports on the 1996 RADAR Club convention.*



**Jack VK4JRC, one of the winners in the home brew competition, receiving his prize from President, Lyle VK4ALD.**

Amateurs and enthusiasts came from all over Queensland, even NSW and New Zealand. The convention was organised by the Rockhampton and District Amateur Radio Club Inc, the "RADAR Club" and held at the YWCA Hall, Robinson Street in North Rockhampton over the second last weekend of September.

Visitors were welcomed and greeted with a specially designed courtesy bag full of relevant goodies. Amongst them were tickets for the venue, Saturday's local newspaper plus tourist info, lucky door and free barbecue tickets. This promised to turn into a pretty good weekend; indeed, the warm welcome did not go unnoticed, nor did the twelve degree drop in temperature in the evening.

What a pleasant surprise for most of us when we learned that our registration ticket qualified for one of many door

prizes. Someone mentioned that at least one in every 20 registrations would be a winner. Obviously, the "most wanted" tangible was unquestionably the new IC-T7A dual-band 2 m/70 cm hand held radio valued at \$765 and sponsored by Kevin Cavanagh VK4SP in association with Icom. Kevin and his wife Diane arrived several hours early to set up a big and magnificent display of equipment; everything an amateur could wish for, from budget priced hardware to the very latest in transceivers with modern digital communication modems.

The WIAQ's executive, among a bus load of twelve, also arrived early. All came from South East Queensland, paid their own way to meet local amateurs and set up an impressive display including a book shop and QSL bureau. One should recognise that all these people have spent a lot of their own time promoting amateur radio state wide at

several venues this year. Geoff VK4KEL spoke on the WIAQ role and objectives, WIA federal liaison, membership and promotion.

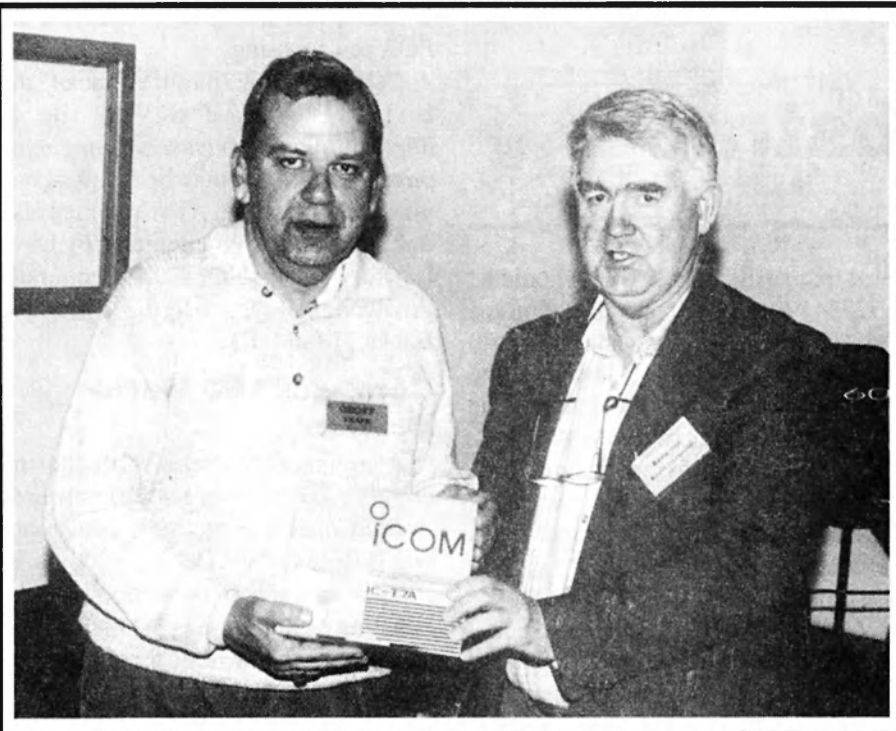
The convention was officially opened by Ron VK4KJ. We were able to sit down and learn from several technical talks. Brian Powell from Access Electronics presented a commercial approach regarding repeater linking and displayed locally manufactured equipment. The talk by Kevin VK4SP on digital communications provided us with some insight into digital compression techniques.

Jack VK4JRC set up a TV transmitter and generated some live and recorded TV transmissions from the site on UHF. The WIAQ Broadcast by Graham VK4BB also originated from the site, and there was some packet activity. Well restored antique broadcast radios were displayed by Ian Long.

Radio Sport has come a long way in recent years and some good direction finding equipment was displayed and explained by Ron VK4BRG and Jeff VK4ABJ. Following that presentation, several transmitters were activated in an open area nearby, so that interested people could familiarise themselves with this equipment. The transmitters identified themselves, radiating AM-modulated CW bursts and only transmitting for one minute in every five.

The real test, though, was kept for the next day when Frank VK4CAU and Jim VK4AJS went hiding in some bush land just outside Rockhampton and activated a fox for a mobile competition. Against all the international rules, this fox was a devious one. Instead of a non-directional antenna, it had a Yagi that produced some considerable reflecting lobes, that would easily "throw off course" any experienced hunter. Five teams left in their cars, but only three teams were successful in finding the location.

The other group making amateur radio more diverse in recent years is ALARA. The ladies of this group organised a display of their interest and activities and entertained the evening gathering. And guess who organised that stunning presentation! A comedy romp that was funny, sexy and facetious. Most of us would never have seen anything like this. Well done ladies! That was unique and very entertaining! Their



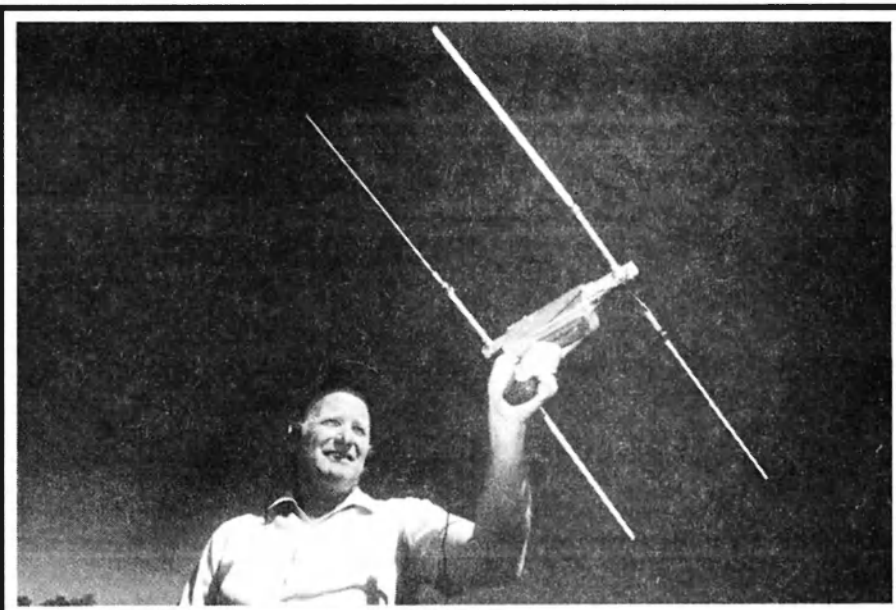
**Geoff VK4FK won the door prize raffle, an IC-T7A sponsored by Kevin Cavanagh VK4SP in association with Icom.**

presence and assistance was much appreciated and makes us realise that the hobby is not just male orientated.

Peter Naish VK2BPN, one of our WIA federal directors, provided an excellent talk on future directions and commitments by the WIA. It gave us some insight into how much work, cost and activity is required to preserve and protect the current privileges of our

hobby. Little do we realise that amateur radio, as we know it, would cease to exist eventually, were it not for the endless dedication and time these people devote to the WIA.

Clive VK4ACC, assisted by John VK4EII and Shawn, soon provided excellent barbecue lunches – hot dogs and sausage sizzles. It was over these delicacies we discovered that a few OMs



**Frank VK4CAU testing his ARDF equipment.**

hadn't met nor seen each other for 10 or 20 years. In several cases they did not even recognise each other until introduced. I found myself in one of these pleasant situations.

And Rodney Harold's Laser Display! It seems amazing how small mirrors can be moved and stopped so fast and with such precision, deflecting a laser beam repeatedly drawing a picture. The resulting image is one that is smoothly updated by computer, providing impressive motion and visual effects.

The weekend wound up with the presentation of prizes, including one for the visitor who travelled the longest distance. It went to a New Zealand visitor, Harry ZL4AB. More prizes were awarded for home brew equipment and handicraft ware, software design and radio sport competitions, etc. All in all this event was deemed long overdue for Central Queensland amateurs. The organisers and helpers deserve credit for their efforts including the splendid dinner function on Saturday night.

*\*85 Conner Street, North Rockhampton QLD 4701*

ar



**AMATEUR  
TRANSCIVER  
RADIO CENTRE**

ALL YOUR AMATEUR TRANSCIVER REQUIREMENTS.  
LARGEST SUPPLY OF HF/VHF/UHF TRANSCIVERS AT COMPETITIVE PRICES

**ALINCO** SYDNEY'S LARGEST ALINCO RANGE OF TRANSCIVERS & ACCESSORIES AUTHORISED DEALER



IC-756 IC-706MKII  
IC-207H IC-T7A

**KENWOOD** TS-570S TM-V7A  
TM-251



No. 1 AMATEUR QUALITY ANTENNAS  
AUTHORISED DEALER

**AMERITRON** HF AMPLIFIERS  
FOR BEST PERFORMANCE

LOTS MORE NOT LISTED

EXPAND YOUR COLLECTION TODAY

**PHONE (02) 9896 2545**

**141 GILBA ROAD,  
GIRRAWEE, NSW 2145**

# Technical Abstracts

Gil Sones VK3AUI\*

## 13 cm ATV Exciter

A simple synthesised 13 cm ATV exciter appeared in *CQ-TV* No 178, Spring 1997 edition. The exciter has an output of 10 mW and it produces an FM ATV signal. The exciter was the work of Jan F Bennett G6TVJ and uses a Plessey SP5070 synthesiser together with some MMICs and a few common components.

The synthesiser chip has a divide-by-256 stage built in and so a fairly standard crystal can be used. The MMICs are standard MMICs and should not present any difficulty. The VCO trimmer is one of the SKY trimmers used in the UK and it is a 5 pF maximum type.

The circuit is shown in Fig 1. It is a fairly simple circuit. The crystal for the

local frequency of 2439 MHz should be 9.527344 MHz. Our band allocation is a little different from that in the UK due to the allocation of Pay TV Channels. The capacitors in the 2.4 GHz parts of the circuit should be microwave SMD types. The circuit board is double sided with only one side etched. The two sides ground planes are connected by a number of soldered pins.

The circuit layout of the critical parts is shown in Fig 2. The circuit board tracks are shown in Fig 3. The PCB in Fig 3 is scaled even though Fig 3 is not to scale as printed. There is a 2 cm bar shown so you can adjust it to size. Bear in mind, though, that the sort of PCB will have a bearing on the Microstrip track

widths. These should be 50 ohms for the PCB you are using.

*CQ-TV* is the publication of the BATC. They have a Web site at <http://ourworld.compuserve.com/home/pages/batc> which may be of interest if you are interested in ATV. You may also direct membership enquiries to Dave Lawton G0ANO, "Greenhurst", Pinewood Road, High Wycombe, Bucks, HP12 4DD.

## Compact 160 Metre Vertical

A compact 160 metre vertical using commercial 160 metre whips appeared in *RadCom* for June 1997. The author was B Rose G3WWO.

The whips are used both as the radiating element and as the radials. The configuration of a vertical quarter wave equivalent and two radials is the simplest form of the original ground plane design.

The radiator consists of the mobile whip mounted on top of an extension made up of a four metre aluminium tube

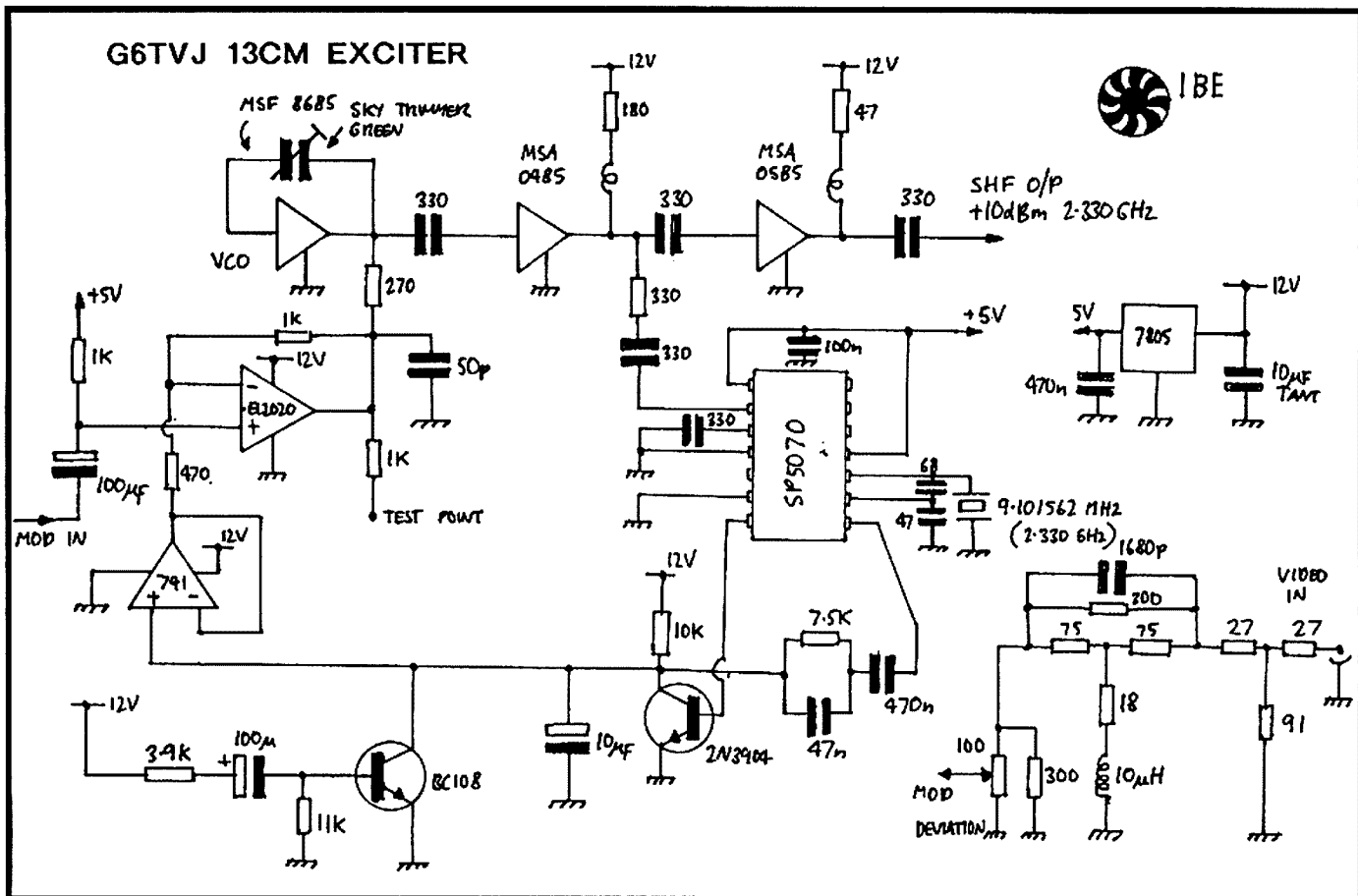
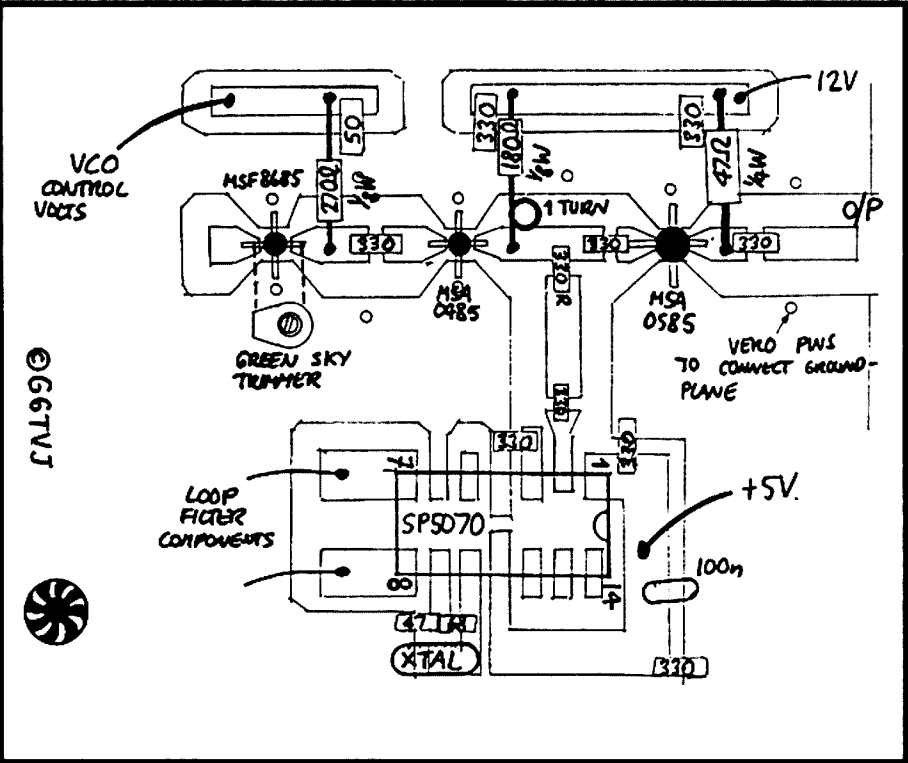


Fig 1 - G6TVJ 13 cm Exciter.





**Fig 2 - Layout of critical components.**

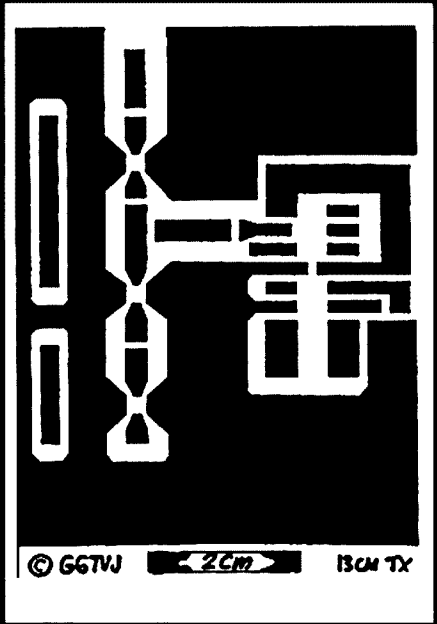
of 38 mm diameter and 10 gauge wall thickness, and a 1.8 m top section of 28 mm 17 gauge aluminium. The total length of the lower aluminium radiator is just less than 6 metres. The joint was made by having a joining piece turned up, and the mounting plug at the top was

also turned up to fit, at a local engineering works. The top 1.8 m tube was of a hardened aluminium alloy. The whips used were 2.4 m long so the total length of the radiator is around eight metres. The antenna is shown in Fig 4.

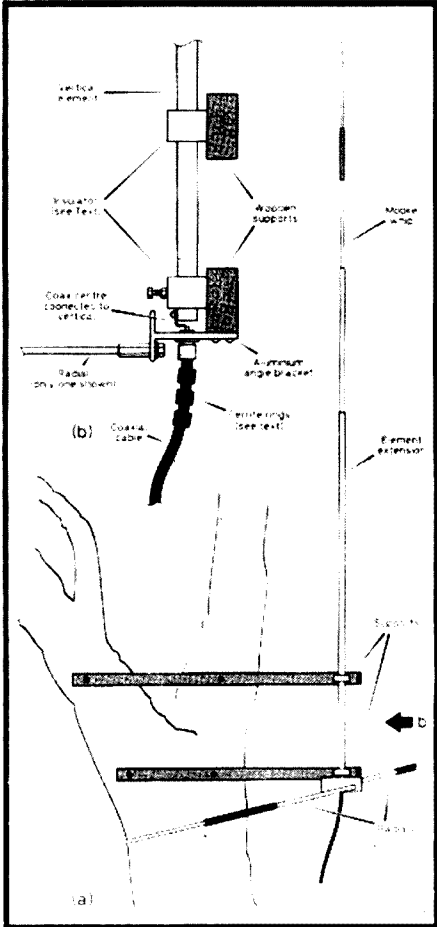
The radiator is mounted on two wooden supports. It is insulated from them by two blocks of Teflon or PTFE. The radials are fixed to a piece of Tee section aluminium which is attached to the lower wooden support. The weight of the antenna vertical radiator should be taken by a sheet of the Teflon or PTFE between the bottom of the radiator and the aluminium Tee section. The feeder connection should be waterproofed

The whole antenna should be mounted above head height. The original is shown mounted to a tree trunk but a post or the side of a building could be used.

The current on the outer of the coax should be suppressed by the use of ferrite rings or beads slipped over the feeder near the feed point. The antenna is not matched to the feeder at the feed point but is matched at the end of a short feed line in the shack. At 1.8 MHz most feed lines are short. The base impedance of the radiator is less than the cable



**Fig 3 - PCB Layout (not to scale - use 2 cm bar to determine sizes).**



**Fig 4 (a) General arrangement of 160 metre antenna. (b) Detail of fixing and connections.**

impedance. The whips are resonated to the frequency of interest. The bandwidth is, of course, limited but it can be used over a slightly wider range by judicious use of an ATU. The original provided an SWR of 1.4 : 1 at resonance.

\*Clo PO Box 2175, Caulfield Junction VIC 3161  
ar

**Your Hobby** **Your Voice**  
Representing Radio Amateurs Since 1910

## ■ CD-ROM Review

# ARRL Handbook CD-ROM Version 1.0 (one CD) QST View CD-ROM 1985-1989 (three CD Set)

*Publisher: The American Radio Relay League*

*Reviewed by: Peter Gibson VK3AZL*

In the March 1997 issue of *Amateur Radio* magazine, the CD ROM version of the 1995 editions of three of the ARRL's popular publications was reviewed. We have now had the opportunity to review two more offerings from the ARRL.

### ARRL Handbook CD-ROM Version 1.0 (1997)

This publication includes all of the content of the paper-based Handbook whilst adding many additional features only possible with computer accessible information. It is laid out in the same order as the paper Handbook and is extensively indexed such that subject, titles, or even words can be used for a search. Frequently used areas can be book-marked and the history of searches or browsing is available for later study.

The software that has been included in the back of recent Handbooks is also included on this disk.

The information is arranged in topics with internal and external linking to related topics and drawings. It is possible to zoom in on both text and drawings in each topic. Hardcopy can be produced on a printer connected to the computer.

Two nice touches on the CD are that many of the pictures are in colour and it is also possible to listen to sound samples where appropriate.

### QST 1985-1989 CD-ROM

The important difference between this CD-ROM and the ones reviewed above (and last March) is that this one consists totally of scanned-in images. Whilst being perfectly useable, the images are not as sharp as on the other disks and, at

worst, can require some interpretation.

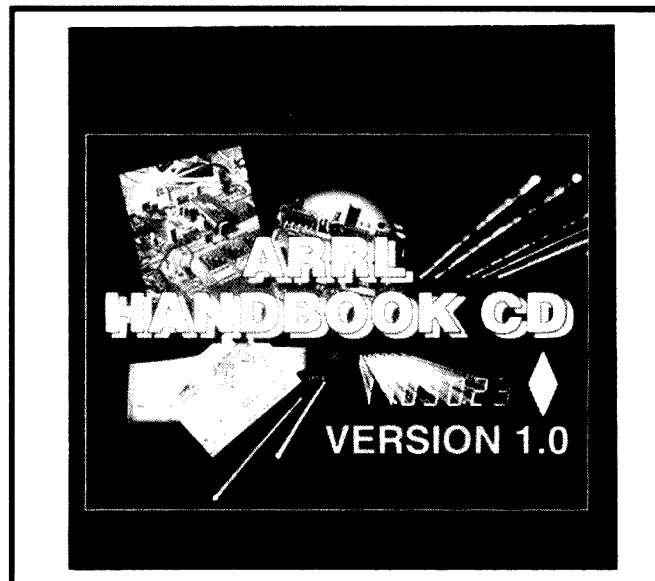
In addition, the ability to search is not quite as extensive as the others, although it is still perfectly good enough for most purposes. It does not seem possible to search the advertisements. As well as being able to search for specific items, it is possible to browse from page to page, as in the real magazine. The images can be output to a printer connected to the computer.

In summary, both of these disks offer a very useful, compact and cost effective way of having a large amount of information at hand. In addition, it is in a form that allows it to be accessed easily. Can you imagine looking for an article in the 60 issues of *QST* represented by the three CDs?

Both disks are completely self contained and contain all of the driving software, but need Windows 3.1 or later as the operating system. They require an IBM/C personal computer with 8 Mbytes of RAM (the handbook can run with 4 Mb but prefers 8 Mb). Likewise, a 386 can be used for both, but a 486 or better is recommended.

A hard disk capacity of 14 Mb is needed for the *QST* CD and 6 Mb for the Handbook. At least VGA graphics of 640x480, 256 colour, is needed, with higher performance graphics cards looking even better. Obviously, CD-ROM drives are needed and a sound card is needed for the Handbook.

The review disks were provided by Daycom Communications and are both priced at \$69. Very good value for money. ar



# Filters

## Constant-K Filters

Ian Berwick VK3ALZ\* discusses the assembly of the constant-K variety of filter and examines all the formulae required to build your own.

### Introduction

Constant-K Filters were pioneered by G A Campbell of Bell Telephone Laboratories circa 1920. The advantages they have include:-

1. the mathematics are easy to understand;
2. the power transmitted is limited only by the current and voltage ratings of the coils and capacitors; and
3. no special components are required.

The design formulae are given in most amateur radio handbooks (but without any theory); however, the theory is essential if one is to understand the design procedures.

### Constant-K Filter

Standard circuits and notation:

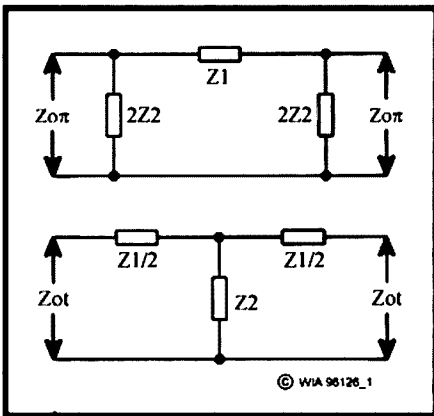


Figure 1

Note:

- \* The filters are symmetrical.
- \* The reactances of the series and shunt arms are of the opposite type.
- \* The product of the series and shunt reactances is independent of frequency; hence the name "constant-k".

For example, for the Pi-Section LPF,  $Z1 = j\omega L$ ,  $Z2 = 2 / j\omega C$ . Hence,  $j\omega L * 2 / j\omega C = 2L / C = \text{constant}$ .

### Pi-Section

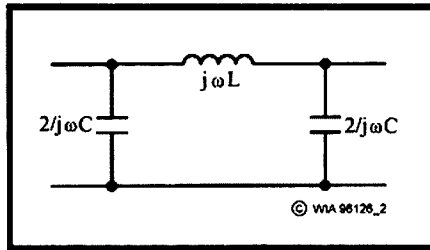


Figure 2

To find  $Z0\pi$  in terms of  $Z1$  and  $Z2$ :

We use  $Z0\pi = \sqrt{Zsc * Zoc}$

$$Zsc = \frac{2 * Z2 * Z1}{2 * Z2 + Z1} \text{ and}$$

$$Zoc = \frac{2 * Z2(Z1 + 2 * Z2)}{4 * Z2 + Z1}$$

$$Zsc * Zoc = \frac{4 * Z2 * Z2 * Z1}{4 * Z2 + Z1}$$

$$Z0\pi = 2 * Z2 \sqrt{\frac{Z1}{4 * Z2 + Z1}}$$

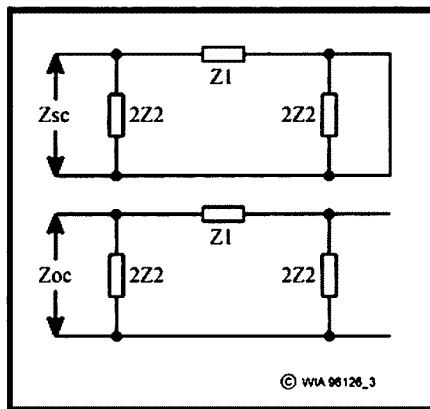


Figure 3

### T-Section

In a similar fashion we can show:

$$Z0t = \sqrt{Z1 * Z2(1 + Z1 / 4 * Z2)}$$

We proceed now to derive the cut-off frequency for the Low Pass and High

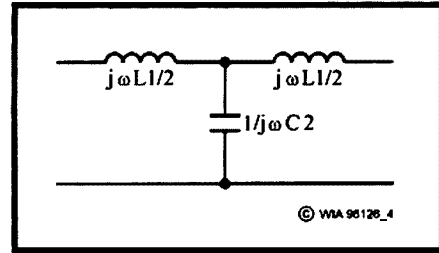


Figure 4

Pass T-Section filters.

Given that  $\omega = 2\pi f$  radians per second (f in Hz),

$$Z1 = j\omega L, Z2 = 1 / j\omega C$$

(Note: j is the vector operator. =  $\sqrt{-1}$ ).

Substitute in:

$$Z0t = \sqrt{Z1 * Z2(1 + Z1 / 4 * Z2)}$$

We get

$$Z0t = \sqrt{L1/C2(1 - \omega * \omega * L1 * C2 / 4)}$$

Then

$$Z0t = 0 \text{ when } \omega * \omega * L1 * C2 / 4 = 1$$

This is the condition for cut-off.

Writing  $\omega c$  for  $\omega$ , we have:

$$\omega c = 2 / \sqrt{L1 * C2}$$

$$fc = 1 / \pi \sqrt{L1 * C2}$$

In a similar fashion we can show for the High Pass Filter T section:

$$fc = 1 / 4\pi \sqrt{L2 * C1}$$

The  $fc$  for the Pi section is the same as for the corresponding T section.

### Low Pass T Section

Given  $fc = 1 / \pi \sqrt{L1 * C2}$  and  $Rk = \sqrt{L1 / C2}$ , to find  $L1$

$$\text{and } C2 \quad L1 = C2 * Rk * Rk$$

$$1 / L1 = C2 * fc * fc * \pi * \pi$$

$$C2 = 1 / (\pi * fc * Rk)$$

$$L1 = Rk / (\pi * fc)$$

### High Pass T Section

In a similar fashion we can show that:

$$C1 = 1 / (4 * \pi * fc * Rk)$$

$$\text{and } L2 = Rk / (4 * \pi * fc)$$

The L and C values for the Pi Section are the same as for the T Section.

### The Variation of and with Frequency in the Pass Band

We know the Constant-K section is symmetrical. We can cascade T sections or Pi sections with perfect matching.

We would like  $Z0t$  or  $Z0\pi$  to equal  $Rk$  across the passband, but unfortunately this is not so.

For the low pass,  $Z0t = Rk$  only at low frequency; likewise for  $Z0\pi$ .

For the high pass,  $Z_{ot} = R_k$  only at high frequency; likewise for  $Z_{or}$ .

$Z_{ot}$  and  $Z_{or}$  are plotted against frequency in Fig X in the Appendix.

## M-Derived Termination

To overcome the foregoing problem, the m-derived terminating half section was devised. We start by splitting a Constant-K Pi section in two to obtain an L network. This L network is modified as per Fig 5. With  $m = 0.6$  this network has a  $Z_{in}$  of  $R_k$  across most of the passband and a  $Z_{out}$  of  $Z_{ot}$ . Therefore, it is a good termination for the constant-K T Section.

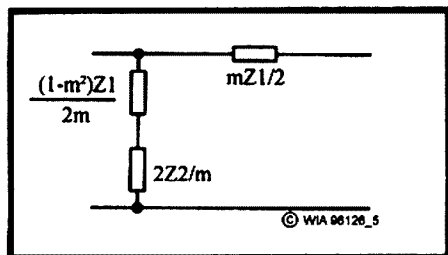


Figure 5

The composite filter is shown in Fig 6.

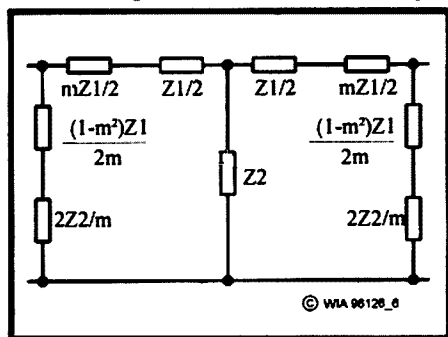


Figure 6

With  $m = 0.6$  we have:

$$(1 + 0.6) * Z_1 / 2 = 0.8Z_1$$

$$(1 - (0.6 * 0.6)) * Z_1 / (2 * 0.6) = 0.5333Z_1$$

$$2Z_2 / 0.6 = Z_2 / 0.3$$

Redrawing the composite filter using these values we have Fig 7. For the Low Pass we get Fig 8 and for the High Pass, Fig 9.

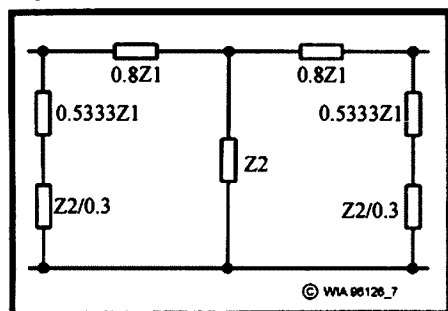


Figure 7

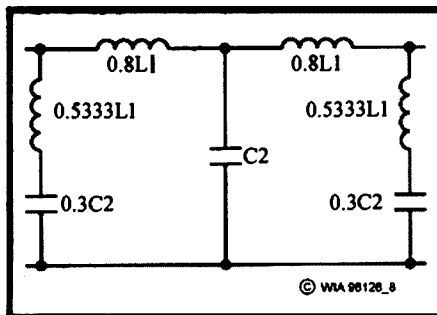


Figure 8

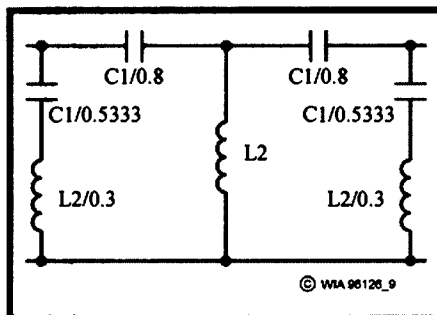


Figure 9

For transmitting we require two Constant-K sections. The filter is then as per Fig 10.

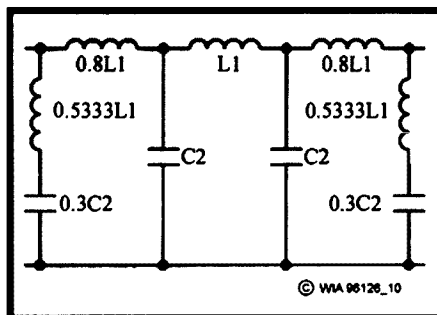


Figure 10

## Steps in the Design Process

- Assume the LPF, for example.
  - Given  $F_w$  (working frequency), compute  $F_c$ :
 
$$f_c = \frac{4}{3} * f_w \text{ for LPF}$$

$$f_c = \frac{3}{4} * f_w \text{ for HPF}$$
  - Select desired  $R_k$ , eg 50 ohms.
  - Compute  $L_1$ ,  $C_2$ ,  $0.8L_1$ ,  $0.5333L_1$  and  $0.3C_2$ . Double check your calculations when designing your own filter. This can save embarrassment later on. Follow through a worked example if in doubt.
  - Wind the coils – more on this later.
  - Make up the capacitors by series/paralleling standard values. Use silver

mica for HF and plastic trimmers for VHF.

Assuming component accuracy to 5% is achieved, assemble filter and check VSWR (refer to Fig 11). Don't use the linear amplifier for a VSWR check as there will be harmonics present which will cause a VSWR error. The VSWR should be 1.1:1 or better.

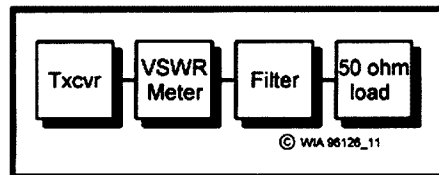


Figure 11

## Worked Examples

- Design a two section LPF with terminations for 160 m.  $R_k = 50$  ohms,  $f_w = 1825$  kHz (refer to Fig 10).

$$f_c = \frac{4}{3} * 1825 = 2433.33 \text{ kHz, say } 2500 \text{ kHz.}$$

$$L_1 = R_k / \pi f_c = 50 / (3.14159 * 2.5 * 10^6) = 6.3662 \text{ microhenries.}$$

$$C_2 = 1 / (\pi R_k f_c) = 1 / (3.14159 * 50 * 2.5 * 10^6) = 2546.4 \text{ pF.}$$

$$0.8L_1 = 5.093 \text{ microhenries.}$$

$$0.5333L_1 = 3.3951 \text{ microhenries.}$$

$$0.3C_2 = 764 \text{ pF.}$$

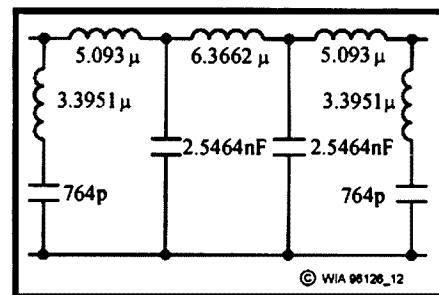


Figure 12

The series coils are wound on Amidon T200(2) powdered iron toroids with 16 B&S enamelled wire. The shunt coils are wound on Amidon T50(2) cores with 18 B&S wire.

## Coil Winding Data

Coils are wound using the Amidon formula:

$$\text{Turns} = \sqrt{L / (A\mu)} \text{ where } A\mu \text{ is obtained from the Amidon data sheet (L is in microhenries).}$$

For T200(2),  $A\mu = 120$  and for T50(2)  $A\mu = 49$ . This gives the following result:

$$6.3662 \text{ microhenries} = 23 \text{ turns}$$

$$5.093 \text{ microhenries} = 20.6 \text{ turns}$$

$$3.3951 \text{ microhenries} = 26.3 \text{ turns.}$$

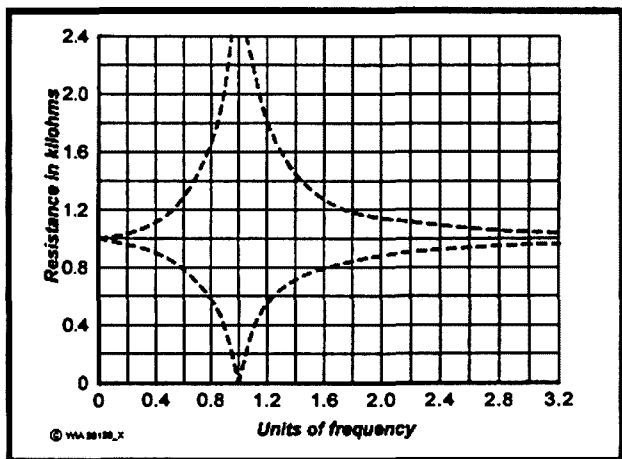


Figure X

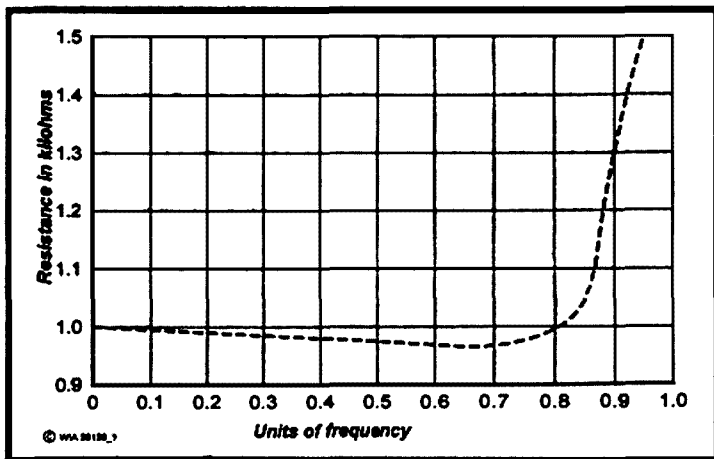


Figure Y

**NOTE:** For solid state linear amplifiers a separate LPF is required for each band.

The foregoing procedure can be used for higher bands just by changing fw and hence fc in the formula for L1 and C2. Use red mix (2-mix) core for 80 m, yellow mix for 40 and 20 m, and air wound coils for higher frequencies.

The Al values for yellow (6) mix are: T200 = 100; T50 = 40.

**2. Design a LPF for a valve linear amplifier working in the range 1.8-30 MHz.**

We can assume that the properly adjusted Pi tank will have sufficient harmonic attenuation in the 3-40 MHz range for the services operating therein. Our only worry is TVI, mainly to CHI from 28 MHz and CH2 from 21 MHz. We choose an fc of 43 MHz, with Rk = 50 ohms. The circuit is the same as in example 1.

We compute the components as follows:

- L1 = 0.37 microhenries
- 0.8L1 = 0.296 microhenries
- 0.5333L1 = 0.197 microhenries
- C2 = 465 pF
- 0.3C2 = 139.5 pF.

All coils are air wound, self supporting using 16 B&S. I use the inductance chart in the *RSGB VHF Handbook*, but other charts may work equally well. **NOTE!** Don't use this filter with solid state linears.

**3. Design a single section HPF to eliminate interference in the 2 m band from a high power FM broadcaster (refer to Fig 9).**

For the HPF we have:

- 0.8L1 becomes C1/8
- 0.5333L1 becomes C1/5.333

- L2 no change
- L2/0.3 no change
- Rk = 50 ohms.

Choice of fc:

Using  $fc = \frac{3}{4} * fw$  we get  $fc = \frac{3}{4} * 144 = 108$  MHz.

This is too low, so we choose 115 MHz.

$C1 = 1 / (4 * \pi * Rk * fc) = 1 / (4 * 3.14159 * 50 * 115 * 10^6) = 11pF$

$L2 = Rk / (4 * \pi * fc) = 50 / (4 * 3.1459 * 50 * 115 * 10^6) = 34.6nH$

$C1 / 0.8 = 13.75pF$

$C1 / 0.5333 = 20.6pF$

$L2 / 0.3 = 115nH.$

**Note:** Mica capacitors are difficult to obtain in this country. The best source is: Communication Concepts Inc, 508 Millstone Drive, Beavercreek, Ohio 45434-5480, USA.

For Amidon Data sheets and cores, contact Amidon Inc, 3122 Alpine Ave, Santa Ana, CA 92704, USA.

The local Amidon suppliers have a limited range of cores, but some may be in short supply.

**Conclusion**

Other filters which can be designed using Constant-K technology are band pass and band stop filters. I can supply this information if needed. If required, the reference used for this article was *Alternating Current Circuits* by R M Kerchner and G F Corcoran, Chapter 9 "Electric Wave Filters".

**Appendix**

(A) Fig (X) Variation of Zot and Zop with frequency.

(B) Fig (Y) Zin versus frequency for m-derived half section.

(C) Attenuation in the stop band for a single section Constant-K LPF:

Where  $\omega_0 = 1 / \sqrt{L1 * C2} = \omega_c / 2$

Angular Frequency ( $\omega / \omega_0$ )	dB
2	0
2.5	12
3	16.8
4	22.8
5	30.6
8	35.8

**(D) Phase Shift**

In the passband, phase shift is 0 degrees at DC, increasing to 180 degrees at cut-off. It remains at 180 degrees in the stop band. The filter is therefore unsuitable for base band video signals.

\*107 Loangana Avenue, Glenroy VIC 3046 ar

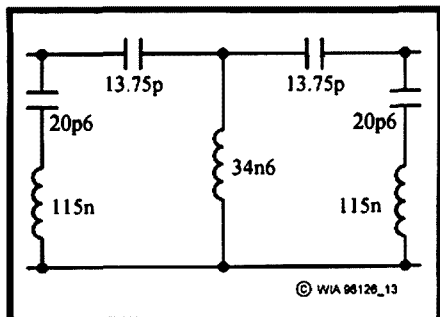


Figure 13

**Prevent pirates -  
make sure you sell  
your transmitter to  
a licensed amateur**

---

---

# ALARA

Sally Grattidge VK4SHE\*, ALARA Publicity Officer

---

---

## No News is No Good

Well, my *Amateur Radio* folder is almost empty this month so I will use that well-worn media trick of telling you what I have been doing and pretending it is news.

The method of gathering and moving information is slowly catching up with modern technology and the ALARA column now gets to Melbourne via e-mail which saves almost a week while chasing the deadline. News comes to me by e-mail, packet, telephone, mail and, yes, even occasionally by radio. Noise and distance make the Monday night net hard to copy and many good stories miss out on publication because important details are not heard.

Packet has problems too. Being out of town and therefore a weaker signal than most of the local users, I frequently get stuck (ignored) when there are several operators on the repeater. Not being blessed with endless patience I usually walk away when this happens, so messages are not read promptly. Packeteers, please send copy at least a week before the end of the month if possible!

I have joined, or tried to, the YL Packet net run by Phyllis KAIJC. This first venture into sending bulletins has produced some interesting results. At first I was unable to read the USA YL bulletins, but had some passed my way by an OM in UK! An ever-helpful local SYSOP e-mailed some to me but my computer refused to read them. When I finally got to see them listed, there were so many, I decided to read them later (which has not happened yet) and hope to find some interesting DXYL news among the chit chat.

## Super (Souper) Gwen

Gwen VK3DYL won the VK Award in the recent WARO 80 m Thelma Souper Contest. Well done, Gwen! VK YLs really should make the effort to try this contest and support the ZL YLs the way they support us in the ALARA Contest.

Gwen is going to the CLARA GALA later in the year. After the Convention she plans to go to Churchill, Manitoba and observe polar bears from a Tundra Buggy with windows 10 feet above the ground, hoping she does not meet up with any 11 foot tall bears. Looking forward to some hair-raising yarns from that trip, Gwen.

## That Crocodile Family - Bev VK4NBC and Graham VK4BGC

When the nice bright crocodile and the big green crocodile left for the ALARAmeeet in

Perth last year, Judy VK3AGC told them to leave room in the boot for a large box. When they met in Kambalda the box was handed over and found to contain a his-and-hers pair of concrete crocodiles complete with bathers and sunglasses!

These well-travelled crocs having been to Perth, around the south west corner of WA, across the Nullarbor and points north, now reside in Bev's Brisbane garden, adding to her considerable collection.

## The Lament of a Roller Blader - Dot VK2DDB

*Now I'm not what you would call one of the younger maids,*

*But still went out and bought myself some nice black roller blades.*

*I thought a practice on the flat was really quite sufficient*

*Because I skated when I was young and was generally proficient.*

*Up and down the verandah I skated with great glee,*

*Never even landed hard down upon one knee.*

*Then popped out to the carport without a worry or care.*

*It's all flat and well-swept so I felt safe out there.*

*Next to the turning circle and driveway with a slope.*

*Mmmm, I'm going faster, but not too fast I hope!*

*For fully fifteen minutes I criss-crossed about the drive.*

*The adrenaline was racing and I really felt alive.*

*Well my skating time was over so I made towards the door.*

*It was time to do the dusting and wash the kitchen floor.*

*My head was full of things to do as I rolled down one last time.*

*The next verse is the reason why I wrote this little rhyme!*

*As I nearly reached the house, I braked to slow me down*

*And stretched a hand out to the wall not to tumble like a clown.*

*Now the brake made one foot stop, with the other racing faster*

*And that is why I sit forlorn, with my left arm in plaster.*

*I've watched the children while they cook, and hang washing on the line,*

*I've told them what to pack for lunch, instructed how to iron*

*"Oh aren't you lucky it's not your right? Your left hand is it sore?"*

*"No not now, but I'm left-handed and use my southern paw!"*

*(some people will do anything to get out of doing the dishes)*

\*C/o PO Woodstock, QLD 4816  
Tel: 077 788 642

Packet: VK4SHE@VK4RAT.#NQ.QLD.AUS.OZ  
Internet e-mail: rgrattid@ozemail.com.au

ar

## QSP News

### Regulations Exams Papers

The SMA has advised that the content of the "Licence Conditions Determination for Amateur Operators" (LCD) has been released to the public by means of the Internet. It can be found at the ACA (SMA) Web site <http://www.aca.gov.au>. Photocopies of this document are available from the ACA State Offices.

As a result of this publication, the WIA Exam Service will start examining on the matters contained in this document as from 15 September (unless further delay is necessary for new papers to be approved).

\* Examiners/invigilators are requested to refrain from ordering Regulations examination papers for one month to ensure a simple change over.

\* Orders received before 15 August will be filled from the present bank.

\* After 15 September, papers will contain questions on the updated conditions, frequencies, power and permitted modes.

It is expected that a revised version of the "Information for the Amateur Service" will appear on the above site shortly. At present, it is not expected that the above publications will be released in the brochure form with which we are familiar, but will be available from the Net or from ACA offices. This allows easier modifications if required.

Members who require a hard copy of the LCD are advised to obtain it from the nearest ACA office.

Further information will be published as it comes to hand.

# AMSAT Australia

Bill Magnusson VK3JT\*

**National co-ordinator**  
Graham Ratcliff VK5AGR  
Packet: VK5AGR@VK5WI  
E-mail: vk5agr@amsat.org

**AMSAT Australia net:**  
Control station VK5AGR  
Bulletin normally commences at 1000 UTC, or 0900 UTC on Sunday evening depending on daylight saving and propagation. Check-ins commence 15 minutes prior to the bulletin.

Frequencies (again depending on propagation conditions):  
Primary 7.064 MHz (usually during summer).

Secondary 3.685 MHz (usually during winter).

Frequencies +/- QRM.

**AMSAT Australia newsletter and software service**

The newsletter is published monthly by Graham VK5AGR. Subscription is \$30 for Australia, \$35 for New Zealand and \$40 for other countries by AIR MAIL. It is payable to AMSAT Australia addressed as follows:

AMSAT Australia  
GPO Box 2141

Adelaide SA 5001

**Keplerian Elements**

Current keys are available from the Internet by accessing the AMSAT FTP site, <ftp://amsat.org> and following the sub-directories to "KEPS".

## More Problems for MIR Operations

At the time of writing the MIR crew is in more trouble than Flash Gordon. A mishap in the form of a collision with a cargo ship caused some damage to solar panels and possibly to the hull itself. Although this incident happened during an experimental test of a new automatic docking apparatus, the potential for such a collision is always there. I recall Musa Manarov telling a story to a group of us in Melbourne a few years ago. He said that any docking is a dangerous procedure and when one was in progress the crew would retreat back into the escape module and were always ready to get away should a bad mishap occur. He called it his "Little Space-Ship". The current problems reflect this concern. A rescue mission and several space walks are planned; however, in the meantime power has been reduced on board MIR so amateur radio activity may take a back seat for a while.

## International Space Station

Yes, folks, it's under way. The first bit, a 20 tonne pressurised module made in Russia,

will soon be lifted into orbit by a Proton rocket from Baikonur. It will be joined by other units transported up by space shuttle and fitted into place by MIR Cosmonauts and Shuttle Astronauts. There are seven planned shuttle missions concerned with ISS in 1998 alone.

Of great interest to us is the amateur radio station which will be part of the ISS. At present, Canada, France, Germany, Great Britain, Italy, Japan, Russia and the United States have representatives on a planning board. Initially space on ISS will be limited but the planners have been allocated a full height, 19 inch standard rack and panel cabinet for equipment which will be housed in the "Hobby and Utilities" area. This area is available to all personnel on board ISS. This is a most exciting project and it will no doubt do its bit to ensure the survival of amateur radio space related activities well into the next century.

## SPUTNIK-1 Files Again?

I still remember that exciting day in 1957 when it was announced that Russia had launched the first artificial satellite, SPUTNIK-1. The signals were loud and clear on 20 MHz (the old Eddystone S-680-X, which still sits on my operating bench, was quite new then) and the "bip-bip-bip" was re-broadcast by just about every news agency in the world. Well, here we are some 40 years on and guess what? For the 40th anniversary of that historic launch, l'Aeroclub of France and the Russian Astronautical Federation are combining to produce a fitting commemoration. In the process they hope to excite the interest of as many young people as possible in space matters.

Pupils from two French schools are working on a replica SPUTNIK-1 miniature satellite. It will be hand thrown by a cosmonaut from MIR. The satellite body will be built in Russia and the transmitter will be made by the French pupils. When in orbit it will emit a bip-bip-bip similar to the original SPUTNIK-1, but not on 20 MHz. It will transmit on the 2 metre amateur band. Many schools world wide can gain access to 2 metre receiving equipment due to their association with amateur radio operators. It is planned that it will start operating on 4 October 1997. Its battery should give it a life of about a month.

## Web Sites Contain Useful Information

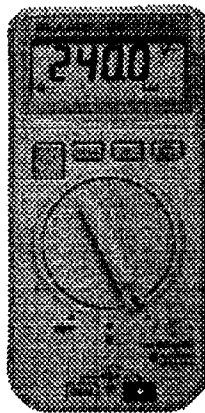
Those with internet and world-wide-web capability may find the following web sites of interest:

<http://www.grove.net/~tkelso/> for just about any kep element set you can imagine.



**YOUR HOBBY** **YOUR VOICE**  
Representing Radio Amateurs - Since 1910

**RECRUIT  
A MEMBER &  
THEY COULD  
WIN!**  
**THIS GREAT  
FLUKE 12B  
DIGITAL  
MULTIMETER  
WORTH \$195**



**THERE'S A WINNER  
EVERY MONTH FOR 1997  
12 PRIZES TO BE WON**

This latest hand-held DMM, from the world-leading maker of digital test instruments, has advanced features yet is simple to use. Ideal for tyro & veteran.

### The Fluke 12B measures:

- ac and dc voltage (with auto-selection)
- resistance & capacitance (.001-1000µ)

### The Fluke 12B features:

- 4000-count liquid crystal display
- simple rotary dial
- diode and continuity testing
- indicates intermittent opens & shorts
- 2-year warranty

**Fluke 12B prizes generously donated by Philips Test & Measurement.**

Each month's prize is awarded by way of a draw among newly recruited members each successive month and presented to the winner at the earliest opportunity following the draw.

**To sign up a new member, use the back of your AR magazine address leaflet - or clip the coupon, have them fill it out and send it now.**

**SEND TO YOUR DIVISION'S ADDRESS, SHOWN ON PAGE 56.**

✂-----  
Please send me a membership application.

NAME .....

ADDRESS .....

..... P/code .....

Call Sign (if any) ..... [AR 1-11/97]

<http://nssdc.gsfc.nasa.gov/spacwarn/spx/511-glonass.html> for information on new launches and decays and current situation.

<http://www.physics.usyd.edu.au/~ptitze/vrml/vk2thn.wrl> – Paul VK2THN informs me that he has established this site at Sydney University for space/astronomy related topics.

<http://dhcom.com/astronomy/pathfinder.htm> for images from the Mars Pathfinder probe.

## Field Day operations via Satellite

I couldn't help noticing during the recent ARRL field day that there were dozens of stations operating via the digital satellites, mainly KO-23. Now this is no mean feat! I have often operated from mountain tops via various amateur satellites but never tried to get a digital station up and running on the mountain. When you reflect on the equipment requirements you can't help but admire those who put in the effort. Many (I'd guess most) of the field day stations were running WiSP as their software package. That would require at least a good lap-top computer or PC. One multi-band or two single band transceivers would be needed and the associated TNC/modem combination is a must. Then we come to the antenna system. I know from experience that simple antennas can work wonders from a remote location but I also know that many of the stations logged were running tracking antennas. More gear to co-ordinate. Tracking software and rotator interface units, etc all add to the complexity during field day operation.

I "dips me lid" to these heroes. In many cases it was a co-operative club effort but, club or single operator, either way it's deserving of admiration. Maybe one of these days on Mt Skene...hmmm.

## Welcome Newcomers

Still on the subject of the digital birds, I noticed four new stations up and running this past month. Two VK2s, one VK3 and one VK4. Congratulations to all and welcome aboard!

## AO-10 Visible!

Up there in the sky ... is it a bird? ... is it a plane? ... no! ... it's OSCAR-10! A rather remarkable piece of news appeared in a matter-of-fact way around the traps recently. I still find it astonishing even after several readings. This guy has actually SEEN OSCAR-10 in orbit. Read on.

Regular satellite users will be familiar with the fact that the keps for AO-10 have been somewhat out of date for some time now and several attempts have been made to update them by mathematical and other means. NORAD reported back in February that AO-10 had been in a difficult orbit to track optically for some time, hence the lack of

new keps. A request was made to Paul Malay of the Johnson NASA space centre to have a look for AO-10.

Why Paul? It appears he's something of an expert at this business of tracking satellites visually. He scored a brilliant success with a video of the GALILEO spacecraft when it was some 600,000 km away. Yes, that's right, 600,000 km! Well, he was successful with OSCAR-10 too. He reported seeing it through 150 mm binoculars when at a range of 10,403 km. He could see seventh magnitude flashes diminishing to around ninth magnitude (that's very faint) over a period of 162 seconds.

He reported seeing nothing else in

between the flashes in the way of background reflection, so presumably he was catching the sun glinting off the solar panels. He was splitting the difference between two sets of mathematically generated keps to do the observation and from his visual observation he was able to generate an even more accurate set of keps. So there you are. Next time you doubt that a set of keps is accurate, the answer is simple. Go outside one night and have a look! But don't try it unless you have all the good gear.

\*RMB 1627, Milawa VIC 3678

E-mail: vk3jt@amsat.org

ar

---

---

## Awards

*John Kelleher VK3DP - Federal Awards Manager\**

---

---

In an earlier publication of *Amateur Radio I* listed some thirty local Awards which had come under scrutiny, purely because they had been listed in an overseas awards directory and, to my way of thinking, needed to be revised to bring them up to standard.

The overall response was, in my impression, very poor. Some of the replies have subsequently been published, and I sincerely thank those who did reply to my request. It is still my intention to publish any or all local awards which appear on my desk.

On the international scene, the total of DXCC countries is reduced to 328 countries with the loss of VS6/VR2 Hong Kong. The situation in Zaire has yet to be resolved. The DXCC listings which follow will still include Hong Kong and Zaire. The February 1998 listings will, however, be complete. I am saddened by the fact that a recent operation from CY9 was aimed at northern hemisphere countries, with little opportunity for VK/ZL to participate.

## The Blue Mountains Radio Club Award

This award is given for contacting any five club members on any amateur bands. Contacts may (but need not) include the Club Station VK2HZ. Log extracts verified by another licensed amateur are acceptable evidence of contact, subject to possible verification against members' log books. The award is free.

The Blue Mountains Amateur Radio Club holds weekly nets for members, and visitors are always welcome to join these nets every Tuesday night on 3.543 MHz, and every Wednesday night on the Club repeater on 147.050 MHz. Both nets commence at 2000 hrs local time, ie 1000Z in the Australian winter months, and 0900Z in the summer

months. This information was supplied by Guy Fletcher VK2BBF, Hon Secretary, Blue Mountains Amateur Radio Club Inc, PO Box 54, Springwood NSW 2777.

## Vanuatu Amateur Radio Society Award

This award is a standard size certificate printed in the four colours of the Vanuatu flag, and containing a scale map of the archipelago.

The award is offered to all licensed amateur radio operators and SWLs who qualify. To obtain this award, the applicant must have made not less than six (6) contacts with Vanuatu stations carrying the YJ8 prefix and who are members of the VARS. Note that YJ0 prefixes DO NOT qualify as a contact for this award.

Contacts made from Vanuatu Independence Day (July 30th 1980) are acceptable. Contacts may be made on CW, SSB, FM or RTTY. Two or more contacts with any one YJ8 station will be accepted, provided that these contacts are on different days, AND on different bands or different modes.

A log extract from the applicant, showing the contacts claimed, and duly certified by the signatures of two other licensed amateurs, will be accepted. QSLs are not required. This claim will be checked and confirmed against the logs of the YJ8 stations worked.

Endorsements are available for all one mode, one band, or additional stations worked. The fee for the award is \$US2.00 or near equivalent, or 10 IRCs to cover International postage.

Please address all enquiries and submissions to: Awards Manager VARS, PO Box 665, Port Vila, Vanuatu.

This information supplied by Frank Palmer YJ8AA.



**WIA DXCC Listings****Honour Roll – SSB**

VK5MS 328/381  
 VK5WO 328/360  
 VK6LK 328/352  
 VK4OH 328/344  
 VK3QI 328/341  
 VK3DYL 328/333  
 VK5QW 328/333  
 VK3AKK 327/338  
 VK4LC 327/333  
 VK2FGI 327/332  
 VK6RU 326/380  
 VK4KS 326/372  
 VK6HD 326/350  
 VK4RF 326/344  
 VK1ZL 326/331  
 VK4UA 325/338  
 VK6NE 322/337  
 VK5EE 322/327  
 VK3AMK 320/338  
 VK2AVZ 320/330  
 VK7BC 320/329  
 VK3YJ 318/323  
 VK3CSR 317/325  
 VK2DEJ 317/322  
 VK4AAR 317/320  
 VK6VS 316/319

**Honour Roll – CW**

VK3QI 328/339  
 VK6HD 324/344  
 VK3XB 316/350

**Honour Roll – Open**

VK5WO 328/364  
 VK3QI 328/342  
 VK7BC 328/336  
 VK5QW 328/333  
 VK3AKK 327/338  
 VK6RU 326/380  
 VK4KS 326/372  
 VK4RF 326/361  
 VK6HD 326/351  
 VK4UA 325/340  
 VK3JA 324/327  
 VK3AMK 322/340  
 VK2AVZ 320/330  
 VK3XB 318/347  
 VK3OT 318/330  
 VK4AAR 317/320

**Ordinary Listings – SSB**

VK6AJW 312/317  
 VK6APK 311/315  
 VK5WV 307/326  
 VK6PY 307/312  
 VK3RF 304/311  
 VK6RO 302/307  
 VK3JI 298/312  
 VK4DP 294/305  
 VK3IR 295/298  
 VK2WU 292/296  
 VK4BG 287/302  
 VK3CYL 283/288

VK5OU 281/286  
 VK4OD 276/279  
 VK3VU 272/275  
 VK4SJ 268/...  
 VK3GI 264/267  
 VK3VQ 259/276  
 ZS6IR 259/262  
 VK5IE 259/261  
 VK3DP 257/260  
 VK4QO 251/255  
 VK6ANC 245/248  
 VK2PU 244/247  
 VK3UY 243/244  
 VK6YF 238/241  
 VK4CY 237/238  
 VK2CKW 234/237  
 PS7AB 233/237  
 VK4ICU 232/234  
 VK3DS 226/236  
 VK2ETM 226/227  
 VK3SM 222/242  
 VK5BO 218/222  
 VK3CIM 218/221  
 VK6APW 216/217  
 VK3DD 214/217  
 VK4LV 210/212  
 VK7TS 210/211  
 VK4XJ 204/216  
 VK3DVT 202/204  
 ON6DP 200/202  
 VK4KRP 199/201  
 VK2VFT 198/201  
 VK4BAY 190/192  
 VK4AU 190/...  
 VK6BQN 186/190  
 VK4IL 176/...  
 KA1TFU 175/178  
 VK4EJ 174/176  
 WA1MKS 171/...  
 VK2BQS 162/165  
 VK2NO 157/...  
 VK4IT 154/155  
 VK4CHB 152/153  
 VK4ARB 149/150  
 7J1AAL 149/150  
 VK4DMP 147/148  
 VK2SPS 141/143  
 VK3DNC 141/142  
 VK6LC 139/140  
 VK2EQ 139/...  
 VK6LG 135/...  
 TI2YLL 129/...  
 VK3DQ 127/141  
 YC8BWN 127/...  
 YC8EMH 126/127  
 VK6ABS 126/...  
 SM6PRX 124/126  
 VK3TI 122/125  
 HL4YD 118/119  
 VK4VIS 116/118  
 VK7WD 115/116  
 VK3BRZ 114/116  
 VK4NJQ 111/115

VK6NV 111/113  
 C21DJ 109/...  
 VK5GZ 108/110  
 VK2HV 108/...  
 JE9EMA 108/...  
 WA6NLJ 107/109  
 HC2HYB 107/107  
 VK5UO 105/107  
 VK4LW 105/...  
 N4JED 104/105  
 VK3EHP 103/105  
 JN6MIC 103/104  
 VK4BJE 102/104  
 KB2NEK 102/103  
 C21NJ 102/...  
 JH3OHO 101/103  
 VK2CMV 100/102  
 VK5CJE 100/102  
 VK6APH 100/101  
 ON4BCM 100/...

**Ordinary listings – CW**

VK5WO 312/327  
 VK4RF 306/332  
 VK3KS 303/330  
 VK6RU 275/319  
 VK3AKK 270/275  
 VK3JI 267/291  
 VK4LV 235/242  
 VK7BC 234/243  
 VK3DP 234/237  
 VK2CWS 233/235  
 VK4DA 221/223  
 VK3DQ 218/245  
 VK3EBP 210/212 (RTTY)  
 VK4ICU 208/...  
 VK4DP 205/216  
 VK3CIM 202/203  
 VK6MK 195/197  
 VK4OD 192/195  
 VK6PY 191/194  
 VK6HW 179/182  
 VK5GZ 175/177  
 VK4CY 172/...  
 VK5BO 159/184  
 VK5UO 156/157  
 VK3DNC 154/157  
 VK4XJ 150/163  
 VK7TS 147/...  
 WA5VGI 146/148  
 VK4UA 143/155  
 EA6AAK 138/...  
 VK7DQ 137/138  
 VK4AAR 131/133  
 VK4KS 127/135  
 VK2TB 123/125  
 VK3AGW 119/120  
 VK4CMY 117/119  
 VK2BQS 115/117 (RTTY)  
 SP1AFU 112/113  
 VK5BWW 110/111  
 VK6NV 109/110  
 OK1FED 109/...  
 VK5QJ 107/109

VK2FYM 106/108  
 VK8KV 102/103  
 VK8XC 101/103  
 VK3AMK 100/102

**Ordinary listing – Open**

VK3JI 311/319  
 VK4DP 310/323  
 VK6PY 309/316  
 VK6RO 308/313  
 VK3UY 308/310  
 VK3DP 303/307  
 VK4DV 300/314  
 VK4BG 294/312  
 VK4OD 287/290  
 VK3CYL 283/288  
 VK4CY 280/283  
 VK3VQ 274/291  
 VK5BO 264/301  
 TF5BW 260/264  
 VK4ICU 257/259  
 VK4LV 252/259  
 VK3CIM 252/255  
 VK6ANC 247/250  
 VK5UO 241/244  
 VK2CWS 239/241  
 VK2ETM 239/240  
 VK3DQ 233/262  
 VK4XJ 233/249  
 VK7TS 229/230  
 VK6APW 223/224  
 VK4DA 222/224  
 WA5VGI 216/218  
 VK2VFT 202/205  
 VK6MK 202/204  
 VK3DNC 185/187  
 VK5GZ 185/187  
 VK2BQS 176/179  
 PR7CPK 174/175  
 VK6NV 172/173  
 VK4CHB 160/162  
 VK2NO 158/...  
 VK8XC 150/152  
 VK6LC 142/144  
 VK2SPS 142/144  
 VK4NJQ 133/139  
 VK4EZ 129/138  
 YB8GH 127/129  
 VK3VB 126/128  
 VK4CMY 120/122  
 VK7HV 114/117  
 SP1AFU 114/115  
 VK2FYM 113/115  
 VK5BWW 111/112  
 VK2HV 109/...  
 VE7BS 106/107  
 VK3OZ 104/105  
 VK3COR 102/104  
 SM7WF 100/101

\*4 Brook Crescent,  
 Box Hill South, VIC 3128  
 Phone (03) 9889 8393

ar

# DICK SMITH ELECTRONICS



## Great Savings On Communications



### FT-10R 5 Watt 2m Hand-Held

A compact 2m hand-held with a unique clam shell design and rear-mounted NiCad battery pack that provides 5W RF output as standard through the use of a MOSFET power amplifier and extensive component miniaturisation. Built to a tough MIL-STD 810 rating for shock and vibration resistance, the FT-10R also uses gasket seals for improved weatherproofing.

#### Features:

- Tx 144-148MHz, Rx 140-174MHz
- RF Output: 5.0, 2.8, 1.0, 0.1W
- Dual watch facility
- Large Omni-Glow backlit display
- High efficiency speaker for super loud audio
- CTCSS encode/decode
- Auto battery save, Tx save & Auto power off for longer operating times
- 12V DC socket for charging and power
- Keypad frequency entry
- 99 memories
- Digital code squelch

Size: Just 62 x 100 x 42mm (WHD)

Comes with FNB-41 9.6V 600mA/H NiCad, A16D version keypad, belt-clip and AC charger.

Cat D-3650

STILL JUST  
**\$399**



2 YEAR WARRANTY

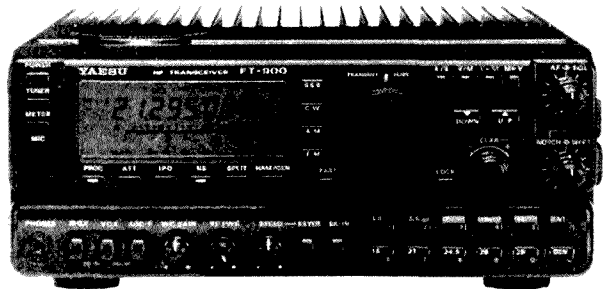
### FT-900 Deluxe HF Mobile Transceiver

The Yaesu FT-900 is a revolutionary new 100W HF transceiver that answers the need for a truly practical mobile radio, but without the performance compromises of most micro-sized rigs when used in base station installations.

For convenient mobile operation, a lightweight front sub-panel with access to commonly used controls can be easily mounted away from the transceiver's body using an optional mounting kit. The large "Omni-Glow" backlit LCD screen provides high visibility over a wide range of viewing angles, while the voice and data between the sub-panel and the transceiver are digital to minimise RF feedback or noise pick-up problems. A tough diecast top panel/heatsink and duct-flow cooling systems allows extended transmission periods, while still allowing the optional ATU-2 auto antenna tuner to be mounted inside the transceiver.

Cat D-3280

2 YEAR WARRANTY



**\$1895**

**BONUS**  
Half-price ATU-2 auto antenna tuner when purchased with your FT-900. SAVE \$249

### FT-990 HF All-Mode Base Transceiver

We're overstocked on ex-demo transceivers, so take advantage of this opportunity to save on an excellent HF base-station rig! The FT-990 offers many of the features of the legendary FT-1000, only in a more compact and economical base station package. Together with clear front-panel layout and labelling, its large back-lit meter and uncluttered digital display allows for easy operation. The receiver uses a wide dynamic range front end circuit and two DDS to provide a very low noise level and excellent sensitivity over the 100kHz to 30MHz range. Transmitter output is 100W PEP on all HF Amateur bands (SSB, CW, FM) with high duty cycle transmissions allowed. The internal auto antenna tuner and an in-built power supply are standard features, while the customizable RF speech processor and switched capacitance audio filtering facilities are unique to the FT-990. Other features include IF Shift and IF Notch filters, IF bandwidth selection, 90 memories and one-touch band selection.

Cat D-3260

Clearance

Only **\$2495**

2 YEAR WARRANTY



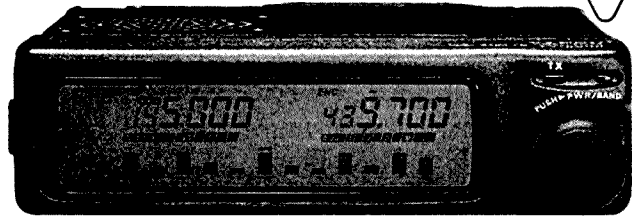
## FT-8500 Deluxe 2m/70cm Mobile

An exciting model from the Yaesu mobile lineup, the FT-8500 2m/70cm FM transceiver introduces the advantages of a large removable Omni-Glow™ display with all major controls on an easy to use hand microphone, and MIL-STD 810C ruggedness. The FT-8500 provides three dual-band receive configurations (VHF+VHF, UHF+UHF, VHF+UHF), allowing cross-band full-duplex as well as standard single band operation. A unique Spectra-Analyzer™ with selectable channel and indicator widths shows station activity and relative signal strength above and below the current operating frequency or selected memory bank. Simple menu programming with alphanumeric labelling also covers most transceiver functions. Other features include 110 memory channels, inbuilt CTCSS encoder, a 1200/9600 baud data socket for Packet operation, Battery voltage readout, DTMF paging, and extensive scanning facilities. Supplied with MH-39 hand mic, DC power lead and instruction manual.

### Specifications

Frequency Range: Tx 144-148, 430-450MHz  
Rx 110-174, 300-500MHz  
2m - 50, 10, 5W.  
70cm - 35, 10, 5W  
Sensitivity (Ham bands): 0.18uV (Main Rx), 0.25uV (Sub Rx)  
Dimensions: 140 x 40 x 160mm (WHD)  
Cat D-3318

**2 YEAR WARRANTY**



**SAVE \$100 \$899**

## 2m/70cm Mobile Antenna

An easy way to go mobile, the new fibreglass M270 antenna with standard 5/16" thread can be used with existing base/lead assemblies you may already have in place on a vehicle. Constructed on a strong fibreglass rod and covered with long-life polyolefin heatshrink, this 975mm long antenna covers 144-148MHz and 430-440MHz with a maximum power rating of 200W FM.

Cat D-4808



**\$34<sup>95</sup>**



## 2m 1/2 Wave "On-Glass" Antenna

A high quality ground-independent mobile antenna that's easy to install without drilling holes. It's low-angle radiation pattern, slim radiator and an efficient coupling system provide excellent mobile performance. Provides 3dB gain, with power rating of 50W continuous (100W intermittent).

Cat D-4206



**\$99<sup>95</sup>**

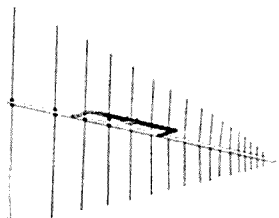


## LP-1300 Log Periodic Yagi

The Maldol LP-1300 is a Log Periodic Yagi beam antenna designed to provide useful gain across the 100 to 1300 MHz range, making it ideal for scanner enthusiasts and ham operators who need a directional wide-band antenna. The LP-1300 consists of a 17 element Yagi with a special feed system that provides low SWR (less than 2.0:1) across the 100-1300MHz range, and can handle up to 500W FM when used for transmitting.

Gain: 6.0dBi to 10.0dBi (depending on frequency)  
Boom length: 1.46m  
Longest element: 1.35m  
Weight: 2.3kg  
Suitable mast: 28-60mm diameter (not supplied)  
Max wind speed: 40m/sec  
Connector: SO-239  
Cat D-4828

**\$249**



## Rugged HF 5-Band Trap Vertical Antenna

The rugged 5BTV incorporates Hustler's exclusive trap design (25mm solid fibreglass formers, high tolerance trap covers and low loss windings) for accurate trap resonance with 1kW PEP power handling. Wide-band coverage is provided on the 10, 15, 20 and 40m bands (SWR typically 1.15:1 at resonance, < 2:1 SWR at band edges) with 80kHz bandwidth typical on 80m at less than 2:1 SWR. An optional 30m resonator kit can be installed without affecting operation of other bands. High strength aluminium and a 4mm (wall thickness) extra heavy-duty base section guarantee optimum mechanical stability. At just 7.65m, the 5BTV can be ground mounted (with or without radials, although radials are recommended), or it can be mounted in an elevated position with a radial system. Unlike other antenna designs, the 5BTV can be fed with any length of 50-ohm coax cable.

Cat D-4920



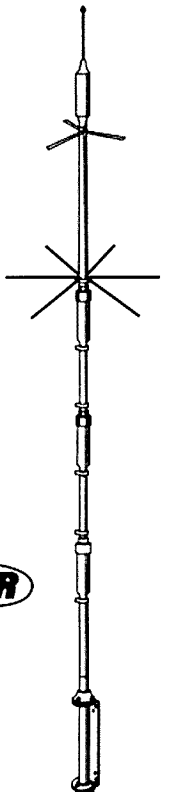
**\$349**

### 30m Resonator Kit

Adds 30m coverage to the 5BTV, and includes all hardware.

D-4921

**\$89.95**



Offers expire 30/8/97

For further information, orders or the location of your nearest store call:

Ph: 1300 366 644 (local call charge)  
Or Fax: (02) 9805 1986



B 2970

# Contests

Peter Nesbit VK3APN - Federal Contest Coordinator\*

## Contest Calendar August - October 1997

Aug 2	Waitakere 80 m CW Sprint	(June 97)
Aug 2/3	YO DX Contest	
Aug 9/10	Worked All Europe CW	(July 97)
Aug 16/17	Remembrance Day Contest	(July 97)
Aug 16/17	Keyman's Club of Japan (CW)	(July 97)
Sep 6/7	All Asia DX Contest Phone	(May 97)
Sep 7	Bulgarian DX Contest	
Sep 7	Panama SSB Contest	
Sep 13/14	Worked All Europe Phone	(July 97)
Sep 20/21	SAC DX CW	
Sep 27/28	SAC DX Phone	
Sep 27/28	CQ WW RTTY DX Contest	
Oct 4/5	VK/ZL/Oceania DX Contest (Phone)	
Oct 5	RSGB 21/28 MHz Contest (Phone)	
Oct 11/12	VK/ZL/Oceania DX Contest (CW)	
Oct 18	Asia-Pacific CW Sprint	(Jan 97)
Oct 18/19	Worked All Germany Contest (Mixed)	
Oct 19	RSGB 21/28 MHz Contest (CW)	
Oct 25/26	CQ-WW DX Contest (Phone)	

Many thanks this month to HPICDW, LA9HW, OE4BKU, PA3EBT, and CQ. Good contesting!

73, Peter VK3APN

count as area 0, eg G3XYZ/LA counts as LA0. OH0 and OJ0 are separate call areas. The final score is total QSO points (all bands) times total multiplier (all bands).

Use standard format for logs and summary sheets. Show duplicate QSOs with 0 points. Dupe sheets are required for 200+ QSOs. Forward separate logs for CW and phone sections. Logs on 3.5" DOS disk are welcome, and must be in ASCII, one QSO per row, and labelled with the call, contest name, section/s, and contest date. Include an SASE if you want your disk returned. Summary sheet must be on paper. The mailing address alternates between SSA (Sweden), NRRL (Norway), EDR (Denmark) and SRAL (Finland) in that order. For 1997, send your log postmarked by 31 Oct to: NRRL HF Contest Manager, Jan Almedal LA9HW, Tunet, N-1825 Tomter, Norway. Logs can also be e-mailed to: [sac@contesting.com](mailto:sac@contesting.com)

## CQ-WW RTTY DX Contest

27/28 September, 0000z Sat - 2400z Sun.

In this contest, the object is to contact as many stations world-wide as possible using digital modes (Baudot, ASCII, AMTOR (FEC & ARQ), packet) on 80-10 m (no unattended operation or operation through gateways or digipeaters), etc. Note new rule: all stations may now operate for the full 48 hours.

Categories are: single operator unassisted, single and multi-band; single operator assisted, all band; multi-operator single Tx, all band ("10 minute" rule applies to this category EXCEPT that one - and only one - other band may be used during the 10 minute period, if - and only if - the station worked is a new multiplier); multi-operator multi-Tx, all band. Single operator entrants can enter the low power section (up to 150 W) or high power (more than 150 W).

Stations may be contacted only once per band, regardless of the mode used. Send RST plus CQ zone; W/VE will send RST, state or area, and CQ zone. Count one point for each QSO with stations in your own country, two points for each QSO outside your country but inside the same WAC continent, and three points for each QSO with stations outside your continent. On each band the multiplier equals the sum of US states (max 48) and Canadian areas (max 13) PLUS DXCC countries (including W and VE) PLUS CQ zones (max 40). Note: KL7 and KH6 are claimable as country multipliers only, not state multipliers. Canadian areas are VO1, VO2, VE1 (NB), VE1 (NS), VE1 (PEI), VE2, VE3, VE4, VE5, VE6, VE7, VE8, VY. The final score equals total QSO points times total multiplier from all bands.

Submit a single summary sheet, including

## Bulgarian DX CW Contest

7 September, 0000-2400z Sun.

This contest runs on the first Sunday of September each year on 80-10 m, CW only. Exchange RST plus ITU zone (P2 = 51, VK4/8 = 55, VK6 = 58, VK1/2/3/5/7 = 59). Score six points for each QSO with an LZ, three points for each QSO outside your WAC continent with a non-LZ, and one point for each QSO within your WAC continent. SWLs score three points if both exchange numbers are copied, and one point if only one exchange number is copied. Multiplier equals the total ITU zones worked on each band. The final score equals the total QSO points (all bands) times the total multiplier (all bands). Send logs postmarked within 30 days (Oct 1) to: Central Radio Club, Box 830, 1000 Sofia, Bulgaria.

## Panama Anniversary Contest (SSB)

7 September, 0001-2359z Sun.

The Panama Radio Club invites all radio amateurs to participate in their 25th annual contest. The only category is single operator, SSB, all band 40/20/15 m. Exchange RS plus serial number. Score two points for QSOs with HP stations, and one for others. The multiplier is the total DXCC countries worked on all bands. Certificates of participation will be sent to all amateurs working 10 or more HP stations, upon receipt

of three IRCs, and a plaque to the highest scoring station in each continent. Send log postmarked by 28 November to: Radio Club Panama Contest, Box 10745, Panama 4, Panama, or via packet to [HP1BYS@HP1CDW.PANCTY.PAN.CEAM](mailto:HP1BYS@HP1CDW.PANCTY.PAN.CEAM), or via e-mail to [hlewis@supremepity.com](mailto:hlewis@supremepity.com)

## Scandinavian Activity Contest

20/21 September (CW), 27/28 September (Phone), 1500z Sat - 1800z Sun.

The CW and phone sections of this contest run on the third and fourth full weekends of September respectively, each year. The object is for amateurs world-wide to contact as many stations in Scandinavia as possible, on 80-10 m (no WARC bands). Scandinavian prefixes are: LA/LB/LG/LJ (Norway); JW; JX; OF/OG/OH/OI (Finland); OF0/OG0/OH0 (Aland Isl); OJ0 (Market Reef); OX; OY; OZ/5P (Denmark); SI/SJ/SK/SL/SM/7S/8S (Sweden); TF.

Categories (all band only) are: single operator; single operator QRP (max 5 W O/P); multi-operator single transmitter; SWL. Exchange RS(T) plus serial number starting at 001. For each QSO, score one point on 20, 15 and 10 m, and three points on 40 and 80 m. The multiplier is the number of call areas (0-9), not prefixes, for each Scandinavian country worked on each band. Portable stations without a district number

scoring calculations for all bands, plus, for each band a separate log, duplicate check list, and multiplier check sheet. Send logs postmarked by 1 December to: Roy Gould KT1N, CQ WW RTTY Contest Director, Box DX, Stow, MA 01775, USA. A comprehensive range of plaques and certificates is offered.

### Results of 1997 PACC Contest

(QSOs/mult/score)

VK8AV	78	23	1794
VK2APK	44	18	792
VK4XA	39	11	429
VK4ICU	9	6	54
VK4TT	6	4	24

### 1997 VK/ZL/OCEANIA DX CONTEST

*Note: Rules are the same as last year.*

**DATE:** This contest takes place each year on the first and second full weekends of October (Phone and CW sections respectively). For 1997, the dates will be:

Phone: 4/5 October 1997, 1000 UTC  
Saturday to 1000 UTC Sunday

CW: 11/12 October 1997, 1000 UTC  
Saturday to 1000 UTC Sunday

**OBJECT:** The object is for stations throughout the world to contact as many stations as possible in VK, ZL and Oceania (WAC boundaries apply), on 80, 40, 20, 15 and 10 m. Contacts between different countries in Oceania are permitted, but contacts within the same country are not permitted.

**CATEGORIES:** Single operator all band; multi-operator all band; and SWL. Single operator stations are where one person performs all operating, logging, and spotting functions.

**EXCHANGE:** RS(T) plus a three or four digit number starting at 001 and incrementing by one for each contact.

**MULTIPLIER:** On each band this is the number of prefixes worked on that band. A "prefix" is the letter/numeral combination forming either the first part of the callsign, or else the normal country identifier for stations using their home callsign in another DXCC country. For example, W8, AG8, HG7 and HG73 are all separate prefixes. The prefix for both N8ABC/KH9 and KH9/N8ABC is KH9. Portable designators without numbers are assumed to have zero after the letter prefix, eg N8ABC/PA becomes N8ABC/PA0. Any calls without numbers are assumed to have a zero after the first two letters, eg RAEM becomes RA0EM. Suffixes indicating maritime mobile, mobile, portable, alternate location, and licence class do not count as prefixes (eg /MM, /M, /P, /A, /E).

**SCORING:** For each contact score 10 points on 80m; five points on 40m; one point

on 20m; two points on 15m; and three points on 10m. The final score will be the total QSO points multiplied by the total number of prefixes worked. The same prefix can be claimed on different bands.

**LOGS:** Use a separate log for each band, with times in UTC. Show new prefix multipliers the first time they are worked. Logs should be checked for duplicates, correct points, and multipliers. Logs should be accompanied by a list of prefixes worked on each band, and a summary sheet showing callsign, name, address, category, number of valid QSOs, points and multipliers on each band, claimed score, and a signed declaration that contest rules and radio regulations were observed. Logs may also be submitted on DOS disk in ASCII format, although the summary sheet must be on paper. Comments and interesting anecdotes are invited.

**SWL LOGS:** SWL logs should show date/time, the callsign of the station heard, the callsign of the station being worked, RS(T) and serial number sent by the heard station, points claimed, and new multipliers.

**LOG SUBMISSION:** The mailing

address alternates between NZART and WIA. For 1997, send logs postmarked within six weeks (24 November) to: VK/ZL/Oceania Contest Manager, c/o WIA, Box 2175, Caulfield Junction VIC 3161, Australia. Overseas entrants please use airmail.

**AWARDS:** Special certificates will be awarded to the top scorers in each category, in each continent, country, and VK, ZL, and JA call area. Where justified, single band awards may also be made at the discretion of the Contest Manager.

The CW entrant with the highest score will be awarded the Frank Hine VK2QL Memorial Trophy, and receive an attractive wall plaque in permanent recognition of his or her achievement.

**DISQUALIFICATION:** Entrants may be disqualified for taking credit for excessive duplicates, unconfirmed QSOs or other scoring discrepancies, or unsporting conduct. In matters of dispute, the Contest Manager's decision will be final.

\*PO Box 2175, Caulfield Junction, VIC 3175  
pnesbit@melbpc.org.au

ar

## Divisional Notes

### Forward Bias - VK1 Notes

*Hugh Blemings VK1YYZ*

I'm pleased to report that the buy and sell/junk night was the usual success. I limited myself to an old UPS and some data books, thus leaving the shack no more cluttered than before. Other members didn't do so well, however, with one individual being seen to depart with a large number of diecast boxes, BNC connectors and other odds and ends to stock the junk box. Another stall selling all sorts of small signal components was also well patronised and was rather reminiscent of the 20 cent jars at milk bars of old.

The large turnout was particularly encouraging. If you're finding that the meeting topics as we organise them aren't meeting your areas of interest, please let the committee know what you would like to see and we'll do what we can to oblige!

There has been quite some activity on the contesting front this month with Jim VK1FF organising participation in the CW Australasian Sprint and IARU Contest as a Headquarters station. The hope is that both stations will draw on the expertise of a number of local amateurs operating under the call VK1WI.

### Coming Events

Our August meeting will have a digital theme. We will be hearing about the Division's bit regenerative repeater which will be installed on Mt Ginini in spring of this year. This project promises to greatly improve the performance of the local packet network and the Packet Group have been going to some lengths to make this a facility accessible to all.

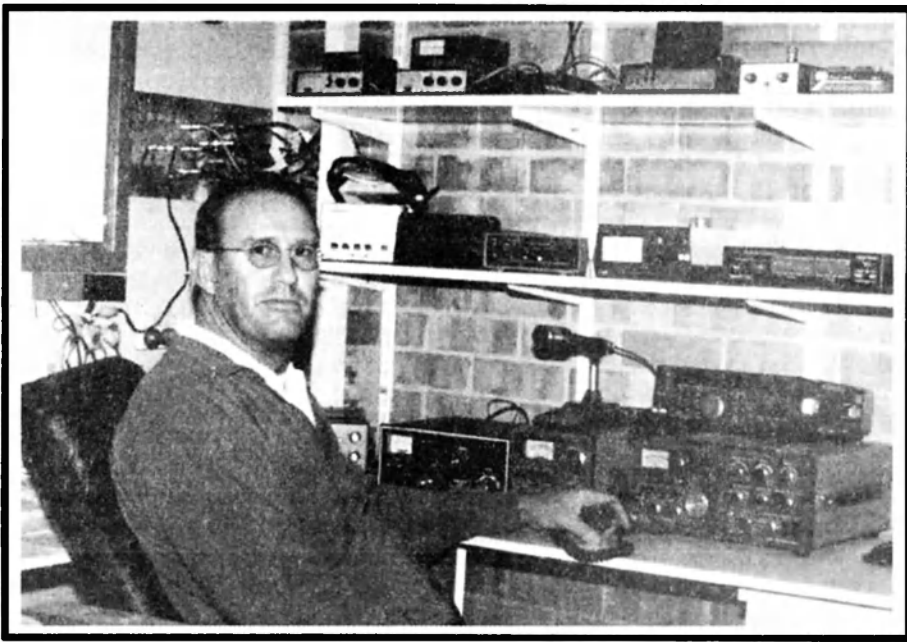
A second presentation will be on some unique packet software that uses the sound card in your PC as a modem and TNC. This is a great way to try your hand at packet with a minimum amount of fuss. Just install a cable from the sound card to your radio and you're ready to go. Doesn't get much easier than that! We'll have a live station operating so you can see it in action.

As usual we'll have coffee and tea available (we're working on cappuccino!). Look forward to seeing you there!

### VK2 Notes

*David Thompson VK2NH*

Hello, again, as we enter wintery August. Depending on where you are it will soon be time, especially here on the east coast of Australia, to wind down your tower in preparation for the winds.



**The VK2 Division President, Geoff McGrorey-Clark VK2EO.**

Last month we told you about our new directors and the jobs they have to attend to. This month it is time to look a little more deeply at the man at the top in VK2, our President, Geoff McGrorey-Clark VK2EO.

Geoff first became interested in radio in 1978, when CB radio was first legalised, and says he worked his CB DXCC logging some 150 countries on 27 MHz. In 1986, while living in Melbourne, Geoff made friends with a Novice operator, Phil VK3PJZ, who he says helped him greatly. Geoff went on to get his full call in 1991, after sitting for the CW exam a few times. He then called in to the SMA, where he picked up the callsign VK2EO.

One of the main interests for Geoff is packet radio. He operates a Packet Bulletin Board and was President and founder of the Newcastle and District Packet Radio Group. He is also an avid DX chaser and can be found on all bands through 160 to 6m, and as he travels around in his business. Most mornings he can be found mobile on 80 metres somewhere in northern New South Wales as he is travelling around with his business hat on.

Since becoming President of the VK2 Division, Geoff, who holds the portfolios of Chairman of the NSW Technical Advisory Committee and QSL Bureau Liaison Officer, says he intends to continue the good work by both Michael Corbin VK2YC and Peter Jensen VK2AQJ. In Geoff's own words "*The Division is running quite smoothly now and it is my intention to keep it that way. I see the Olympic Games as being our biggest challenge yet. It will put the VK2 Division and all VK amateurs firmly in the international spotlight.*" Geoff went on to say

that one of his priorities is to further increase membership of the Wireless Institute, NSW Division.

Geoff concluded by calling on all to join together for the betterment of amateur radio as a hobby. As you can see by the accompanying photo, Mr President does actually find time to sit down in the chair with his equipment.

### **Other VK2 Division News**

The WIA (New South Wales Division) has decided to make a post office box available to those members who have suppressed details of their call signs and addresses in published call books. It has come to our notice that the Australian Communications Authority (ACA), formerly the SMA, is to publish on the Internet all callsigns and full details of licensed operators, including those amateurs who have requested suppression of details in the WIA-issued call book. If you're interested, contact the Divisional office. The post office box should only be used for amateur radio related mail, not as a general post box.

Last month I mentioned that we had held a celebratory day to mark the fortieth birthday of the Dural site to the north-west of Sydney. This is where we house our beacons and it is the station location for our Divisional broadcasts. It was decided by Council that fortieth anniversary certificates would be issued to those who have donated time or money to setting up of the Dural site, or who were present at the opening of the facility in 1957.

The response from those who have so far received these certificates has been very

positive and believe me, on behalf of all in the Division, it is a pleasure to have been able to mark such an historic event in this way.

During July, I visited the Hornsby and District Amateur Radio Club monthly meeting to talk about the WIA, the present and the future (from a Divisional perspective). It was a very great pleasure to do so. Highlighted to me was the importance of promoting amateur radio, by simply talking to people and thereby spreading the good news. On the night I took along with me some "New Member Kits". If you know anyone who is a candidate for some information, contact our Divisional office and it will be arranged for a kit to be sent on.

If you would like to contact the VK2 Division regarding your hobby, please do not hesitate to contact the office or any of the Councillors. We will be only too pleased to hear from you. If you would like to get in touch with an individual Councillor, just contact our Divisional office and it will be arranged. Our free call phone number is 1 800 817 644 and our address can be found on page 56 of this magazine.

Next month we'll have more to report, but if you have anything you would like us to include as VK2 news, send it to me at PO Box 82, Springwood or by e-mail to [dthom@penrithcity.nsw.gov.au](mailto:dthom@penrithcity.nsw.gov.au)

### **VK5 Notes**

*Ian Hunt VK5QX*

### **Change, Progress and Communication**

Last night I watched an historic event. This was the handing over of the Territory of Hong Kong from British authority to the administration of China. History was being made before our eyes and at the same time past history was vital to understanding of what was really taking place.

We need to recognise that change is an inevitable on-going process. We also need to understand the nature of these changes. I believe this is relevant to our hobby of amateur radio.

If ever there was a branch of technology that has shown constant change it is that of electronics and communications. Hardly a day goes by when we do not hear of some new development. A new approach to control or legislation often results. Community protests can result from such developments and changes.

What we need is a balanced understanding of how this affects us.

One aspect is modernisation of our equipment and techniques. Digital technologies have played a major part in our life from items such as programming of washing

machines to complete control, if desired, of our amateur radio station by computer – and all this at quite moderate cost. The costs in human terms can be great or small according to the wisdom applied in introduction of the technologies.

In encountering change we need to understand the realities it represents.

Not unlike Hong Kong, we have had administrative change in the South Australian Division of the WIA, ie a new Divisional Council. As with China, necessarily, people will be watching to see what we do. Only thoughtful consideration and supervision permits an organisation or a country to be run to the lasting benefit of all. Critical assessment of our leadership and decision making, can only be of advantage if problems are pointed out. So those in charge must be as aware of this as those watching.

**Two way communication between those two groups must occur, and a spirit of trust must exist, otherwise chaos can result.**

Harking back to technology, let us consider as one example the Internet.

To some this may be seen as a "monster" which is increasingly intruding into our lives. To others it can be seen as a major step forward and a great boon to society. I would suggest that the real answer lies somewhere in between.

But the inevitability of change does not mean that we simply have to lie down and accept whatever we are given. Each of us must find out just how we can utilise developments to our own benefit.

It may be coincidence that the major change taking place in personal international communications brought about by the Internet has occurred during the periodic and marked downturn in HF radio communications due to the effects of the sunspot cycle.

It has been said that we are losing more and more people from amateur radio to the Internet. Well, maybe. However, have you thought that here is an opportunity for people (amateur radio operators) to establish and strengthen ties with each other and, at the same time, spread the "gospel" of amateur radio before radio communication conditions improve out of sight.

The Internet provides a medium whereby our message can be spread. I am being naturally optimistic in taking this line. However, I am sure that the fascination of direct radio communication will result in an upsurge of interest by many who do not know about it now.

Likewise, by wisely utilising the new approaches in technology, as I have tried to show in this example, we can turn so many of these developments to our own benefit.

I am sure that many clever amateurs can look at what is being offered and from these produce effective strategies to guide the rest of us.

This does not mean that we ignore the history of the past. Past history is a very important component in considering the events which affect us all. To ignore lessons learned from experience is to fly in the face of danger. Balance is essential. A mix of the old and new, of youth and experience seems to me to be the most likely way to produce a very useful result.

Thus we can work to strengthen our hobby to benefit all. The desire of the South Australian Divisional Council is that we all work together towards this end. We ask only that you consider these matters and trust that, as a result, you will determine to support your Division in both word and deed. The hobby of amateur radio can certainly benefit from your acceptance and adoption of such ideals.

With this issue of the magazine, Divisional members will have received a copy of our bi-monthly Divisional Journal. In that insert you can read more about plans that the Divisional Council is making on your behalf.

### **"QRM" News from the Tasmanian Division**

*Robin L Harwood VK7RH*

This month there seems to be very little news to report. Your Divisional Council was scheduled to meet on 19 July and a further report will be given in next month's column.

Last month, some vital work on the Mount Duncan site (VK7RMD) was done by Terry, VK7ZTI assisted by Alan VK7KAN. Others were also assisting and I believe even a helicopter was planned to be employed to bring in the heavy batteries. Our thanks to all who participated. Also the North-western branch has been conducting a raffle with a 286 as first prize.

The May meeting of the Northern branch had two interesting guest speakers. One was Doug Charlton VK7DK, who spoke on open wire feeders and antenna matching. Doug is active with the Australian Naval Amateur Radio Society nets on 14 MHz. The second speaker was Marcomm-Watson and was an interesting talk on satellite telephones. The latest handheld INMARSAT model was shown and it is very compact compared to earlier models. Not only does it handle voice traffic but is easily adaptable for FAX or e-mail. All one does is point it in the direction of the satellite, look at the pointers indicating signal level, and then dial your wanted number. The price of this model was just under \$5,000. However, the minimum cost of a call was \$1.99 per minute. One also had to

dial your international code to first get into Australia. We could foresee that these phones could rapidly replace mobile phones in areas which are not at presently covered, for example the east coast and the rugged west coast or at sea. These models have world wide portability provided you have INMARSAT, yet there are blank spots to this world wide coverage, namely New Zealand and Antarctica.

Last month, the Southern branch WICEN group was involved in the Saxon Southern Safari Motor rally in the central highlands, providing vital communications. The North-western branch has also been involved in similar rallies over the past and some branch members will continue these in the future.

Our Divisional president has called on all Tasmanian amateurs to increase their participation in this month's Remembrance Day Contest. Last year, this Division won, yet there is room for an increased participation rate from all amateurs. Check out the rules in the July issue of *Amateur Radio*, and get organised.

Meetings for the month of August are: **South**, Wednesday, 6 August at 2000 at the Domain Activity Centre, Hobart; **North-western Branch**, Tuesday, 12 August at 1945, Penguin High School; and **Northern Branch**, Wednesday, 13 August at 1930, Launceston TAFE, Alanvale Campus, Block "C", Level 3.

ar

## **WIA News**

### **New WIA Members**

The WIA bids a warm welcome to the following new members who were entered into the WIA Membership Register during the month of June 1997:

VK2ARA	E C THRIFT
VK2BZA	P L H HILL
VK2FED	S NORMAN
VK2LK	B T TURNER
VK2DCA	A C M ANDERSON
VK2EMQ	J P MOODY
VK2XRA	A ROBERTSON
VK2AJF	J B FREEDMAN
L21050	R J BARNES
VK2DSO	D P WOOD
VK2JRL	R L TORV
VK2EZD	D DOWNIE
VK2AYC	J E COLLITON
VK2BVR	V A ROCHFORD
VK3TPJ	R HAMMENT
VK3AZE	C SALGER
VK3JAJ	A JUDSON
VK3HCD	A COLE

---

---

# FTAC Notes

John Martin VK3KWA, Chairman, Federal Technical Advisory Committee\*

---

---

## Six Metre Band Plan

I have received further comments on the 50 MHz band plan, which was discussed in my column in the March issue of *Amateur Radio*. Of the responses received, there is almost unanimous agreement that frequencies below 50.150 MHz should be kept clear for international DX and not used for local or regional operation. Other countries in Regions I and II have agreed on the 50.150 MHz dividing line, so it is logical for us to follow suit.

There have been some suggestions overseas to move the international DX calling frequency from 50.110 to 50.125 MHz. If this happens, we should again follow suit. But at least for now, the international DX calling frequency is unchanged at 50.110 MHz.

The upper half of the 50 MHz window, from 50.150 to 50.300 MHz, has plenty of room for contacts within Australia. There is strong support for the idea of adopting 50.200 MHz as the new calling frequency for contacts within Australia.

The suggested new band plan is as follows:

50.000 – 50.100	CW and Beacons
50.080 – 50.100	International CW only
50.100 – 50.150	International CW and SSB only
50.110	International DX calling frequency
50.150 – 50.300	Local and regional SSB
50.200	Local and regional calling frequency

With this plan, anyone trying to make or hear international DX calls could use 50.110 without interference from strong local stations. Also, anyone wanting to make local or sporadic E contacts would have a calling frequency which would not cause any clashes with DX operators. Everyone should be able to co-exist happily. It only takes a press of a button to scan the band or check the other calling frequency.

This proposal is now offered for final comment before being finalised and presented to Federal Council with a recommendation that it be formally adopted before next summer. Any comments would be appreciated by the end of August, by mail or via packet @ VK3BBS.

I would like to thank David McNaughton VK2BA for collating the opinions of a number of amateurs and passing them on to me. Written comments were also received from David Waring VK3ANP and Guy Fletcher VK2BBF.

## 160 Metre Band Plan

On a similar topic, I have had a number of responses to my comments on the 160 metre band plan. They fall into two groups. One view is that the existing band plan is satisfactory and should not be changed. One amateur pointed out that if any DX signals are heard around 1825 kHz, they have priority over any local contacts and the frequency is cleared.

I can't help but think that there might be some slips between cup and lip here. No-one would have to move if there was no local activity in the DX window in the first place. And I wonder how strong a DX signal needs to be before it can be heard underneath strong local signals.

The other viewpoint is best summed up in these excerpts from a letter from a VK6 amateur.

*"For the past ten years, 1820 – 1840 kHz has been the de facto world-wide DX window for 160m CW. Almost all countries with a 160 m allocation have their CW section in this window.*

*"Despite the generous frequency allocation for VK amateurs on 160 m, some insist on working SSB in this window. This operating habit is now confined to amateurs who operate from Eastern Australia. The individuals concerned regularly ruin CW DXing chances for those in the West – some unwittingly – by operating SSB in this portion of the band.*

*"With the exception of a few countries, 1840 – 1850 kHz serves as the phone DX window world-wide. This window is often used by amateurs rag-chewing with their mates, ruining the DX possibilities for amateurs in other parts of Australia.*

*"If only all VK amateurs would carry out local SSB QSOs above 1850 kHz. VK6 rag-chewers operate above 1860 kHz. It is time we fell into line with what happens on 160 m around the world and observed the internationally agreed DX windows."*

It seems that it would be a good idea to make more use of the mostly empty space above 1850 kHz for local contacts, and leave the DX window clear for DX. The SMA ban on operation around 1870 kHz has been withdrawn, so the band is clear all the way to 1875 kHz.

In the current band plan, 1815 – 1835 kHz is shown as the "DX Window". This should be adjusted, and the band plan should also recognise the SSB DX window. This is the suggestion:

1800 – 1820	Local CW and FSK
1820 – 1840	CW DX Window
1840 – 1850	SSB DX Window
1850 – 1875	Local SSB, AM, fax, etc.

As an "easterner" and an occasional listener on 160, I realise that it may not be easy to change the operating habits of many years. But I think the attempt should be made, in the interests of a fair go for everyone.

This proposal is offered for any further comments, which would be appreciated by the end of August if possible. If there are no major objections I would suggest that it be formally adopted.

## Long Delayed Mail

Several weeks ago I received a batch of mail, including letters posted as long ago as March. I am ploughing my way through them and should have responded to everything by the time this goes to print. But if you have written to me and received no answer yet, please bear with me.

## Database Update

I am doing the annual update of the database of beacons, repeaters, links, and packet systems. Any additions, deletions or corrections to the lists in the last *Call Book* would be much appreciated. If you are the licensee of a beacon, repeater, or packet system, or if you have any information on what is operating where in your part of the country, I need it! Please post to me c/o the WIA Federal Office, or QTHR, or via packet: VK3KWA @ VK3BBS.

## SSTV "Repeaters"

A new version of the SSTV program MSCAN allows an SSTV station to operate unattended and to automatically replay images received from other stations. There are now several stations running this system, which they call "SSTV repeaters".

There has been some uncertainty as to whether it is legal to run this kind of station unattended without a repeater licence. The answer is yes!

Clause 9 (1) of our Licence Conditions Determination allows us to operate an unattended station without a repeater licence if the station is under computer control and uses a store/forward mode. If the computer complies with the regulations on identification, retransmission and so on, the licensee does not have to be present. The best example is a packet BBS or digipeater, which can operate unattended without needing a repeater licence. A computer controlled station running MSCAN fits in the same category.

Clause 9 (1) is intended to cover stations using store/forward techniques. That means that the station does not automatically retransmit everything it receives: it stores the



data and forwards it later. This is the way packet stations operate, and an MSCAN station which retransmits a received image back to the originating station is operating in much the same way.

So, to get to the point. If anyone can operate an SSTV "repeater" without a repeater licence, why not a voice repeater? How about a dual band radio set up as a cross-band repeater?

The answer to that is NO. The fact that someone refers to a station as a "repeater" doesn't mean that it is one. An unattended packet or SSTV station is legal because it is NOT a repeater: it is a computer controlled store/forward station. If it was a repeater - a

station that receives signals on one frequency and instantaneously retransmits them on another - it would need a repeater licence. So, there is no loophole here for unlicensed "private repeaters".

A final point on SSTV. Some Novices believe that it is legal for them to use SSTV. Not so! The SMA regulations include a list of the modes Novices are permitted to use, and SSTV is not in the list. If you are a Novice, don't believe anyone who tells you otherwise. Get a copy of the Licence Conditions Determination and check it for yourself!

\*PO Box 2175, Caulfield Junction, VIC 3161  
ar

ICOM Clearly Ahead



**"VK3LZ  
calling!"**

More sound information from your friends at Icom.

**DISCONTINUED ICOM  
ACCESSORIES SUPER SALE!**

Direct from Icom Australia.  
50% off everything!

That's right, 50% off...it's your chance to really grab a bargain, but be quick because once they're gone, they're gone!

These fantastic offers are available to Australian residents only, and you can use your Visa, Mastercard or Bankcard over the phone.  
Just call Freecall 1800 338 915

**ANOTHER VERY SPECIAL  
ICOM OFFER.**

Buy a new Icom IC-706 MKII from your nearest Authorised Icom Dealer before September 30th, 1997 and a CAHV quad band antenna (valued at \$250) is yours absolutely free! It's a great added value offer... you'll only get from your Authorised Icom Dealer.

**DON'T FORGET THESE  
CONVENTIONS COMING UP :**

**WAGGA WAGGA**  
Sunday August 10th, '97

**SHEPPARTON**  
Sunday September 14th, '97

**TOWNSVILLE**  
September 26-28th, '97

**"...73"**

FreeCall 1800 338 915

290 -294 Albert Street  
Brunswick, Victoria 3056  
Tel : (03) 9387 0666  
Fax : (03) 9387 0022

ACN 006 092 575

ILLUSTRATION BY BROWN

## Education Notes

Brenda M Edmonds VK3KT\* Federal Education Coordinator

It was very pleasing to receive some comments on my last two columns, including ideas for school projects and support for the aims which I had stated. I would still like to hear from readers who may be able to give time to one or more schools, or who have ideas for ways to reach junior students.

### Regulations Examinations

In my column in the February issue of *Amateur Radio*, I noted that I was hoping to receive news of the revised Regulations brochures. Unfortunately, there have been further delays. The SMA, very busy with the re-organisation involved in the changes required by the formation of the new ACA (Australian Communications Authority), has had to devote its time to the 98.5% of its territory which is not related to amateur radio.

Mostly this does not affect amateur operators. However, it does cause a problem with the examinations of new recruits. All candidates must pass the Regulations examination to achieve a Certificate of Proficiency. But not all the material which is to be examined is available to either the candidate or the examining body.

The WIA Exam Service is still working from the Regulations question bank which was in place when the WIA assumed

responsibility for the amateur examinations. A revised and extended draft question bank was submitted to the SMA for approval last year, but it cannot be finalised until all the revised brochures are available.

The operating conditions (including frequencies bands, power and modes for each type of station) are published in the "Radiocommunications Licence Conditions (Amateur Licence) Determination" (LCD) which, I understand, is available from the Internet at <http://www.aca.gov.au>. It is also available in hard copy from ACA (SMA) offices. A draft of the accompanying document, "Information for the Amateur Service", has reached the WIA, but it is not yet ready for public release.

To ensure a smooth changeover to the newer version, the *WIA Exam Service* is asking examiners/invigilators to refrain from ordering Regulations examination papers for a month (or until approval of the new papers is received). Orders received up until 15 August will be filled from the current question bank. After 15 September papers will contain questions on the contents of the above LCD.

Readers who require a copy of the LCD are advised to contact the nearest SMA office.

\*PO Box 445, Blackburn VIC 3130  
ar

**Remember to leave a three  
second break between overs  
when using a repeater**

# How's DX?

Stephen Pall VK2PS\*

As I write these lines in front of my transceiver, my eyes are on the nearby TV screen. I am searching on 20 metres for VS97SAR. I want to work this station as the last one from British Hong Kong before midnight. No success. The operator of the Special Administrative Region amateur radio station – hence the suffix "SAR" – is probably watching on his own TV screen the proceedings of the peaceful hand-over ceremony of the British ruled Hong Kong to the Peoples Republic of China. Hopefully, I can catch the same station after midnight with the new prefix VR97SAR. Yes, the prefix of Hong Kong is now VR, and all the VS prefixes sooner or later will be changed over to VR.

Suddenly it dawns on me. What about the DXCC? Will Hong Kong continue to be a separate DXCC country after the unification with the Peoples Republic of China, or will the VS/VR2 prefix follow many others into the deleted countries repository?

I have a feeling that the DXAC is already working on this "diplomatically delicate" problem. Ever since the DXCC was caught in the controversy and diplomatic pressure of amateur and other interests by admitting Pratas Island BV9P, Scarborough Reef BS7H, and North Korea P5 (the latest with only a handful of contacts) into the DXCC countries list, the organisation has had "international headaches".

The fiasco about Romeo's XY0RR 1991

Myanmar activity, and the non-recognition of Mani VU2JPS's Andaman contacts, show the delicacy of the situation in which the DXCC finds itself today.

The first of July is also important not only because we start a new financial and taxation year, but because our master regulator, the SMA is no more, as such. The Spectrum Management Agency and the Telecommunication regulator AUSTEL were absorbed into the Australian Communication Authority (ACA), as from 1 July 1997. This means that the doors are open for total deregulation of the communication industry. Already there are pages and pages of newspaper advertisements announcing new telephone companies and the new discounted (mainly STD) rates.

I wonder in which way, and to what extent, this new change will influence the present and future of the radio amateur service. Hopefully, the new decision makers for the amateur service will have enough background knowledge about our hobby to make sensible decisions about the future of our service (it is more than just a hobby!).

Finally, did you notice that the day was longer on 1 July? Yes, longer by a full second. The "Sydney Morning Herald" quoted Dr Richard Brittain, the secretary of the National Time Committee, that a second was added to the world's time system known as Co-ordinated Universal Time. The second is added to keep the clocks in step with the

Earth's rotation. UTC is measured by atomic clocks which are more constant than the speed at which the Earth rotates. According to these sources there have been 21 seconds added to the time system over the past 25 years.

We all know now why mankind lives longer. The secret is with the International Earth Rotation Service which is located in France. Au revoir!

## Willis Island VK90C – 007

The Oceania DX Group has announced that it has organised a DXpedition to Willis island.

Willis Island lies about 300 miles east-north-east of Cairns, Queensland in the Coral Sea at latitude 16° S and longitude 150° E. It consist of a group of islets, the largest of which is occupied. The maximum elevation is 30 feet above sea level. The island is administered by the Australian Bureau of Meteorology and is manned by four bureau officers who spend a six months tour of duty there carrying out weather and other observations.

The expedition will depart Cairns on 9 September in the 60 foot vessel "Floreat". The journey to the North Islet will take approximately 30 hours, after which ten operators, and three tonnes of equipment (including 800 litres of petrol) will be unloaded for a 12 day stay. The group intends to set up two separate campsites with six complete HF stations and one station on six metres. They will carry with them 22 antennas hoping that there will be enough space to place them.

On the route back they intend to stop at Holmes Reef for a 30 hour stay before returning to the mainland. The DXpeditioners are three YLs (Ann WA1S, Elvira IV3FSG and 7K3EOP) and seven men (Jon K7CO/VK2DXT, OM3CUU/VK2AEA, Bob VK4MR, Eric FK8GM, AF7Y, AF7O, and Bill VK4FW). It is intended that they will be active on SSB, CW, RTTY, 10 metre FM and, hopefully, also on six metres, on the following SSB frequencies (all in kHz): 3620 (listening also 3785-3805 and 1900 for JAs), 7085, 14195, 14235, 14255, 18145, 21295, 24945, and 28480. The six metre frequency will be announced later.

For the USA the frequency will be 7150-7160. VK Novices: 3600, 21255, 3530, 21130 – 28130. CW 1810, 3505, 7005, 10103, 14020, 18070, 21020, 24895, and 28005. FM: 29200. RTTY: 14080, and 21080. Generally they will listen 5-10 kHz up.

All landing permissions have been granted and received. Donations and QSL cards to be sent to ODXG Willis Effort, PO Box 929, Gympie, QLD 4570, Australia.



Rashid A71AN and his German visitor Thomas DL9FCQ.

## **Malyj Vysotskij Island OH5AB/MVI and R1MVI**

I reported about this activity in the July issue of *Amateur Radio*. The disturbing news came after the deadline of this column. The group started operations as planned on 5 June but ran into many problems. The original landing dock used on previous occasions was unusable – it was destroyed. So was the old barrack building which the expedition intended to use for the two stations. They had to use ordinary tents as shelter.

The new landing place was quite a distance from the original one. The group was so exhausted after transporting all the gear over the distance that they slept through the first night. Generators were also a major problem, and it is suspected that the fuel which the group bought was contaminated.

Here on the east coast of Australia they had a very weak CW signal and were working USA on their short-path. The SSB station R1MVI had a better signal strength and was also working mostly the USA and the Middle-East. They left the island at 0330 UTC on 16 June after making 30,000 contacts.

### **North Cook – ZK1**

The Date Line DX Association is in the final stages of planning an activity from North Cook Islands, specifically from Penrhyn Atoll OC-082, which will take place from 20 to 27 September. Priority will be given to low bands and the east coast of USA and Europe is targeted. Three radios will be operated, one of them for RTTY. The team is N7RO, N4RF, WA4YBV, KI6AN, K8XP, and Chris ex-ZS8IR. The team still needs another operator, someone with medical qualifications. Donations should be sent to WA4YBV, Robert Pond, 9 River Cove, Portsmouth, VA 23703, USA.

### **State of Qatar – A71**

Some time ago I received a number of photographs, QSL cards and a nice letter from Rashid A71AN. As I held the envelope in my hand looking at the commemorative stamps reminding me of International Nursing Day, the question popped into my mind, where exactly is Qatar? Somewhere in the Persian Gulf, I thought. I quickly looked up my reference books. Here is the interesting background to the story of Rashid.

Qatar is a small Arab country on a desert peninsula that juts from Eastern Arabia into the Persian Gulf (25° N – 51° E). The area of the country is 11,000 square km. The greatest distances are, north to south 185 km, and east to west 89 km. People have lived in the area for thousands of years. It was only in the late 1700s that the variety of tribes became united

under the Wahhabis, an Islamic sect from Saudi Arabia. The mid 1800s saw the Ottoman Turks taking over Qatar. During World War One it became a British protectorate (in 1916) and gained full independence in 1971.

The country is governed by an Emir with the assistance of a Council of Ministers and an advisory Council. Discovery of oil made Qatar a rapidly developing country.

Rashid A71AN is a relatively new amateur, licensed in July 1993. He enjoys amateur radio immensely and is often heard on the CW band segment. He uses a TS-850S and a TH-11DX antenna as his basic equipment. He is also teaching Morse code to intending amateurs at courses run by the Qatar Amateur Radio Society. According to the International Callbook there are now more than 50 amateurs licensed in Qatar and about 20 of them are very active on the bands in all modes including digital. Rashid lives in the capital city of Doha and he is the proud father of five children. He is also well known among visiting amateurs.

### **Future DX Activity**

\* The correct callsign of the Swedish operator from Taiwan who will be there until October is SM3SGP/BV2. QSL goes via SM3EVR.

\* The IOTA (Islands-of-the-Air) contest will take place from Saturday, 26 July at 1200 UTC to Sunday, 27 July at 1200 UTC. This event will give many DXers the opportunity to work a few new countries.

\* Sam is active from Riyadh, Saudi Arabia as HZ1CCA. He was heard on 7060, 21235 and 18135 kHz. QSL via K8PYD.

\* Hiro JA6WFM is on the bands from Nicaragua as YN6WFM until December 1997. He was heard on 14190 around 2315 UTC. QSL via JA6VU.

\* PA3AWN will be active in Ghana until the end of 1997 as 9G1AA. QSL to H V Dousterhoot, Bosbesplein 15, NL-3355 S G Papendrecht, The Netherlands.

\* Charly OE3KLU and others from the ICOM-Austria Radio Club will be in Libya from 28 August until 7 September as 5A28.

\* Jamal Al Maktoum A61AO is a newly licensed operator from the United Arab Emirates. QSL via KV5V.

\* Mark La Point (ex-J5UAI) will be active from Yaounde, Cameroon, as TJI1US. He plans to be active on all bands on CW, SSB and RTTY. He is with the US Embassy for the next two years. QSL via NW8F.

\* Steve 7Q7SB will return to Malawi in September or October and will stay there as a missionary for the next two to three years. QSL via AB4IQ.

\* Unni LA6RHA will operate as JW6RHA from Svalbard Island from 14 to

29 August mainly on SSB. Check 7048, 14248, 21248, or 28448 kHz. Some of the activity will be battery operated so please be brief and exchange RST only. QSL via LA6RHA, Unni Gran, Mellomaasveien 128, N-1414, Trollasen, Norway.

\* Christine, a YL operator, is active from Kiambu as 5Z4LL. She was heard around 1500 UTC on 18145 kHz. QSL via Box 14425, Nairobi, Kenya.

\* Paul ZK2PJ and Janice ZK2JJ will be on Niue Island for the next two years. QSL via VK4AAR Alan Roocroft, PO, Dalveen QLD 4374.

### **Interesting QSOs and QSL Information**

\* TG9NX – Franco – 14164 – SSB – 0537. QSL via Callbook address or via, Francisco E Capuano N4FKZ, 2500 SW, 6th Street 501, Miami, FL-33135, USA.

\* TK5BF – Jacques – 14203 – SSB – 0615. QSL via Jacques Godard, Alle du Maquis, Portgiolo, F-20138, Coti Chiavari, France.

\* OH5AB/MVI – 14024 – CW – 1224. QSL via Orvo Arkko OH5NE, Muukko, Fin-53400, Lappenranta, Finland.

\* Z32XA – Ozren – 14012 – CW – 0540. QSL via Mike Jakiela KM6ON, PO Box 286, Poway, CA 92074, USA.

\* JY9QJ – George – 14028 – CW – 0546. QSL via Ullrick Helgert DL5MBY, Appenzeller Str 53, D-81475, Munchen, Germany.

\* VP5/K5YG – Bill – 14205 – SSB – 0115. QSL via K5YG, via the QSL bureau.

\* JT1FBB – Paul – 14192 – SSB – 1213. QSL via Sanford C Swartzendruber W9JOE, 16722, CO RD 40, Goshen, IN 46526, USA.

\* YJ8UU – Stuart – 14164 – SSB – 0545. QSL via A E Law ZL2HE, 68 Ruahine St, Dannevirke, 5491, New Zealand.

\* ZP7OCM – Arthur – 14193 – SSB – 2239. QSL via Radio Club Loma Plata ZP1LL, PO Box 512, Asuncion, Paraguay, South America.

\* SV5/HA4GD/O/P – 14013 – CW – 0630. QSL via HA4GD via QSL Bureau.

\* OH0KMG – Antii – 14210 – SSB – 1214. QSL via Antii Nevantaus OH2KMG, Kartanont, 5 A I, SF-00330, Helsinki, Finland.

\* 5X4F – Paul – 14164 – SSB – 0555. QSL via James D Kulp K3SW, Signal Hill Farm, 88 Signal Hill Ln, Middletown, VA 22645, USA.

### **From Here and There and Everywhere**

\* A few issues ago I said that “Murphy never sleeps”. He is still active! In the June 1997 issue of *Amateur Radio*, page 15, the photo referring to the St Peter DXpedition shows Mal VK6LC with another amateur

described as Neville VK5WG. The smiling face in the background is actually Paul VK5MAP and not Neville. Apologies to Paul VK5MAP and to Neville VK5WG for the mix-up.

\* If you worked VI8NTD on 15 metres on 1 July 1997, it was Stuart VK8NSB assisted by Fred, a VK8 short-wave listener. Stuart was activating the special event station from Darwin celebrating self government in the Northern Territory which was granted in 1978. The activity was from 6 am local time until midnight on 21280 kHz SSB. Propagation was not the best, but Stuart still managed to work some good DX, such as 3W4EZD, V31PC, HH1A, VR97SAR and others on 15 m. A double sided QSL card will be sent to those who require it. QSL manager is Henry Anderson VK8HA, PO Box 619, Humpty Doo NT 0836 direct or via the bureau.

\* The YJ8AA activity on Emai Island (OC-111) which was projected for early June, was postponed to the middle of July. The boat which was to carry them there needed further maintenance.

\* It was widely reported in a number of DX Bulletins that Mani VU2JPS on Andaman Island had moved back to the Indian mainland as his tour of duty of three years had ended. He left the island on 12 June. After years of negotiations Mani finally received his modern equipment around Christmas time in 1996 by courtesy of HIDXA and Jim VK9NS. Unfortunately, his activity was not accepted by the DXCC desk due to some missing paperwork.

\* The two Macquarie stations, VK0TS and VK0GW, have been active from time to time on the 80 m phone band talking to their friends in VK. VK0TS has skeds on Tuesdays and Wednesdays and sometimes even on weekends on 14222 kHz. Jim VK9NS is the net facilitator.

\* Had a very pleasant, long QSO with Paul JT1FBB who was 59 plus in Sydney. Paul is an American electronics engineer with Mongolia's first commercial TV station which is a joint venture between the Mongolian Broadcasting Corporation and American interests. He is on a two year contract and his amateur station is located in the TV station building using a TS-445S and amplifiers with a 1500 W PEP output to a vertical Antenna. The TV station plays a lot of sports programs including even an occasional Australian rules football match. Paul mentioned that from 8 to 13 July a joint Mongolian American DXpedition was to be active from the northern edge of the Gobi desert at Juulchin. The station probably used the JT4 prefix.

\* The ANARE (Australian National

Antarctic Research Expeditions) celebrated 50 years of Antarctic activity with a number of mid-winter parties on all ANARE bases including Macquarie Island. It was reported that Tom VK0TS had made about 300 QSOs so far, and Graham VK0GW had about 90 contacts.

\* Bill VK4UA is temporarily off-air as his antenna suffered major accidental damage during maintenance. Fortunately Bill was not injured.

\* "Dusty" ZL2VS, the well known DXer and IOTA Chaser has been in hospital for a major operation. He is now slowly recovering at home.

\* Nabil OD5NA is often heard on the bands. His QSL manager is Veronica Della Dora IK3ZAW, Piazza Flume 14, I-30126, Lido Di Venezia, VE Italy.

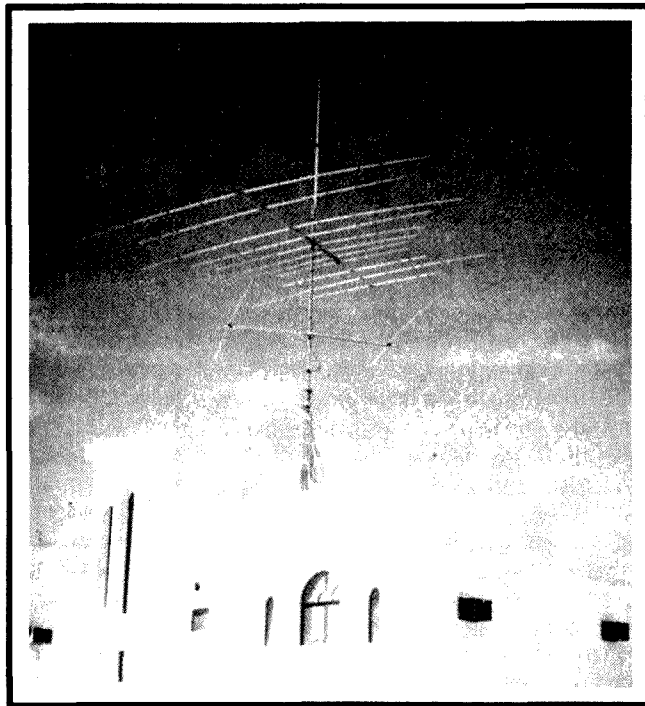
\* Special event station VU4NG97 celebrated the 4th National Games of India.

\* Alain (ex-5U7NU, TZ6NU and XT2BR) is now active as Z21KM from Zimbabwe. It is possible that he might be active from Zambia as 9J1AE or from Malawi as 7Q7/9J2AE. QSL via F6FNU.

\* There has been a reorganisation of the Taiwanese prefixes. Here are the changes: BO1xx, Matzu Island; BO2xx, Kin Men Island; BO2YA, CTARL (Chinese Taipei Amateur Radio League) Kin Men Island club station; BV0xx, special event stations; BV1-8xx, Taiwan areas; BV9, islands near Taiwan; BV9A, Penhu Island; BV9O, Orchid Island; BV9G, Green Island; BV9P, Pratas Island (DXCC country); BV1-8Yx, CTARL Branch club stations; BV9AYA, CTARL Penhu Island club station; BV4YL, CTARL YL/XYL club station, mid Taiwan area; BV2Y, CTARL Taipei office station; BV5Y, CTARL HQ station. The address of the BV QSL Bureau is PO Box 73, Taipei 100, Taiwan.

\* HB6FG is a special call activated by Cedric HB9HFN in celebrating the 60th anniversary of the Fribourg Section of the Swiss Ham Radio Association (USKA). QSL via HB9FG or via the Bureau.

\* LY97XA was a Lithuanian station celebrating the 300th anniversary of Vilkaviskis town.



The TH-11DX antenna system at A71AN.

\* The DXCC desk has announced that the number of unprocessed applications at the end of May 97 was 350 (28,736 QSLs). The total number of applications during May was 443 which shows an increasing trend against the April total of 313 applications and the March total of 322 applications.

\* The correct QSL manager for Den A35DB is W7TSQ and not W7SNH as reported in some other publications.

\* The address of the Moldavian National QSL Bureau has been changed since 15 April 1997 to: National QSL Bureau of Moldavia (ARM), PO Box 9537, Kishinev, MD-2071, Moldova, Europe.

\* Stuart YJ8UU is working for the Vanuatu Civil Aviation Authority for the next two to three years. He intends to operate from 2 to 160 metres once all his antennas are in place. He is constructing his 6 m antenna now, and soon will construct several other loop antennas, one specially for 2 metres. His QSL manager is ZL2HE, and he requires two IRCs for a reply.

\* To celebrate the 100th anniversary of Belo Horizonte City the special event station ZW100BH will be active until 14 December on all bands and all modes. QSL via PY4AA, LABRE/MG PO Box 314, Belo Horizonte/MG, 301323-970, Brazil.

\* VK0IR is the title of the book which is the story of the recent Heard Island DXpedition. The book is hard cover, contains 224 pages (not 192 as indicated earlier) and has many excellent colour photographs. It also contains a list of financial support donors. Whilst the author of the book

## Novice Notes

Peter Parker VK1PK\*

(KK6EK) acknowledges that the list is not complete and contains only those donations which arrived before the printing deadline (15 April), the lack of VK/ZL support is remarkable. I could detect only two VK amateur clubs, one individual donation from VK5, one individual donation from VK8 and one individual donation from ZL. Out of the seven WIA Divisions only the New South Wales Division (VK2) supported the expedition. If you want to order the book, contact the Heard Island Expedition, Locked Bag 29, PO Rydalmere NSW 2116 (see my June '97 column for details).

\* The Polish special event station 3Z2GD was active during July celebrating the 1000th anniversary of Gdansk city. QSL via SP2FOV.

\* Mats SM7PPK is in Uganda working for the United Nations. He received his Ugandan licence with the call 5X1Z. He is currently working on his antennas; the first one to go up will be probably on 40 metres. Mats is a keen CW operator so there is the opportunity for the CW enthusiasts to secure this country on their favourite mode. QSL via Mats Persson SM7PCK, Zenithgatan 24 #5, SE-212 14 Malmoe, Sweden (new address).

\* HG5UFO was active from Hungary during the June celebration of the International Exhibition of Space in Budapest. QSL via PO Box 17, Budapest 1456, Hungary.

\* It is nice to be remembered. I received a short note from Warren VK4WH (formerly VK0WH) thanking me for the articles and news which I published in my column about his activity whilst he was on Macquarie island.

\* Ken VK5QW was in hospital in Adelaide for a complicated surgical procedure. I am sure he will be happy to receive your get well cards. His many friends wish him a speedy recovery.

### QSLs Received

J77FT (1 m - PO Box 1421, Berlin 14004, Germany); 9M6TPR (2 m - KQ1F); FS5PL (2 m - KF0UI); CO8LY (2 m - op); 3B8/IK2GNW (4 m - IK2GNW); A71BH (6 w - OE6EEG).

### Thank You

Many thanks to my amateur friends whose assistance is a great help in compiling these notes. Special thanks to: VK2XH, VK2KFU, VK2TJF, VK4WH, VK5MAP, VK5WO, VK8NSB, YA8AA, YA8UU, JT1FBB, A71AN, KK6EK and the publications *Sydney Morning Herald*, *Oceania DX Group*, *QRZDX*, *The DX News Sheet*, and the *425 DX News*.

\*PO Box 93, Dural NSW 2158

ar

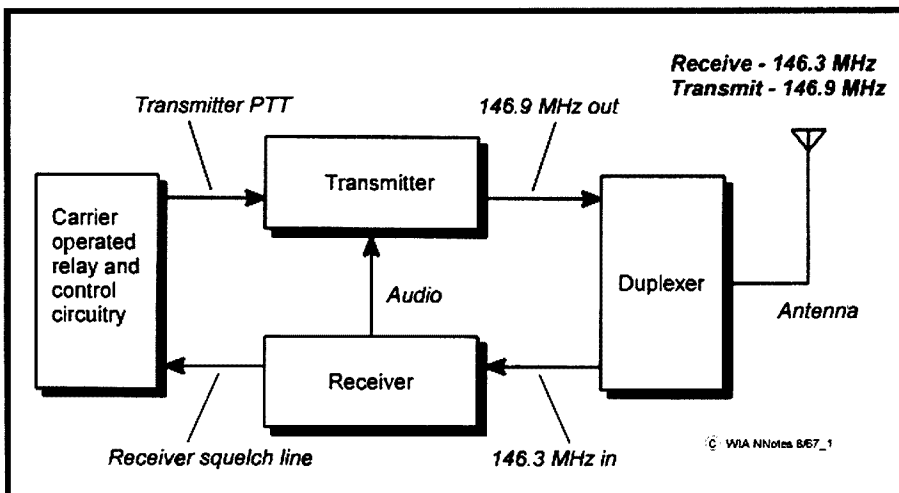


Fig 1 - Block diagram for a two metre repeater operating on 146.900 MHz (6900).

### Voice Repeater Basics

Repeater operating is one of the most popular facets of amateur radio. For the Novice Limited licensee, restricted to 30 watts on 2 m and 70 cm, repeaters offer a means to make longer distance VHF/UHF contacts, especially when operating mobile and away from home. This article looks at the technical aspects of amateur voice repeaters; other topics such as equipment and operating procedure were covered in October 1995's column (Ref 1).

### Introduction

Voice repeaters extend a station's transmitting range by receiving incoming transmission and simultaneously retransmitting them on another frequency. They consist of a receiver, transmitter, filter, antennas and timing/control circuitry. Repeaters are normally situated on hill tops or high buildings for best coverage of a particular area.

### Operation

Repeaters use two frequencies; an input (or receive) frequency and an output (or transmit) frequency. These frequencies are 600 kHz apart for two metre repeaters and 5 MHz apart for repeaters operating on 70 centimetres.

For a repeater to transmit, it needs to be activated by a sufficiently strong signal on its input frequency. The presence of such a signal activates the repeater's squelch or mute circuit. This causes the repeater to start transmitting. The audio from the receiver is fed direct to the transmitter. The result is that,

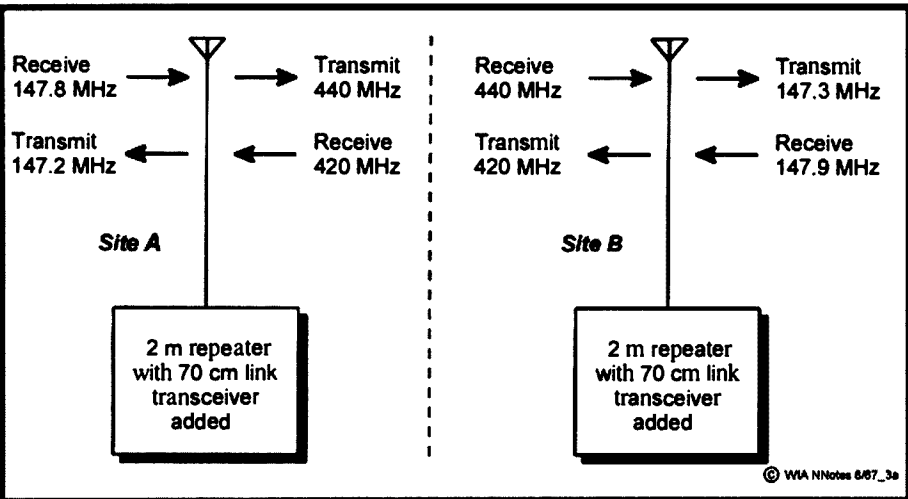
for as long as there is a strong enough signal on the repeater's input, the transmitter is activated. Those listening to the repeater's output frequency will then hear a stronger, re-transmitted version of the signal on the input. Fig 1 shows a block diagram for a basic voice repeater.

### Repeater Equipment

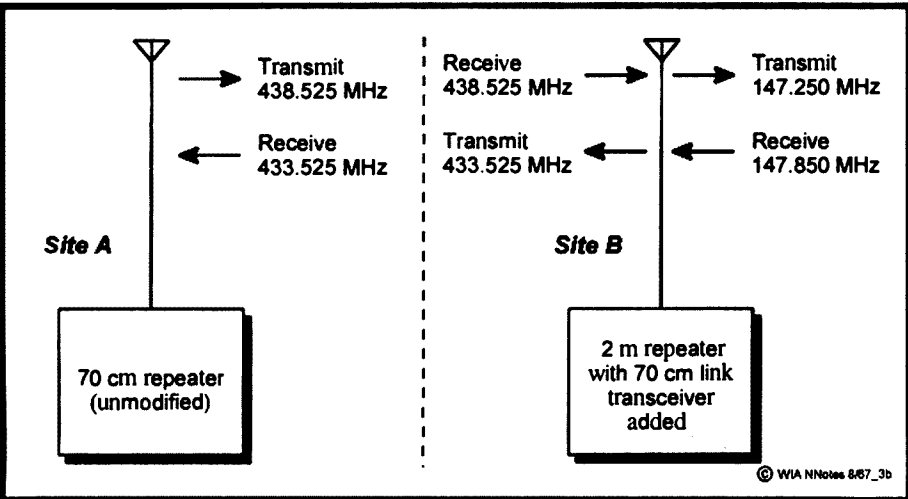
Ex-commercial VHF FM transceivers, such as the Philips FM 828, are often used in amateur repeaters due to their low cost, good performance, and easy availability. Depending on the availability of power at a repeater site, wind, solar or 240 volt mains may be used to run the repeater. Rechargeable lead acid batteries are often used to provide backup during power failures. Because their receivers are operating 24 hours per day, even very quiet repeaters draw appreciable amp-hours. Antennas used in repeaters must be built to withstand adverse weather. This is because access to a site may be difficult or time-consuming, particularly if it is shared with other users or is in a remote location.

### Desensing

The main difficulty when designing a voice repeater is the closeness of the transmit and receive frequencies. This small difference makes it very easy for the repeater's receiver to be overpowered (desensed) by the strong signal from the repeater's own transmitter. Failure to cure this problem makes the repeater unable to receive weak input signals. Repeater builders separate the transmit and receive antennas and install banks of cavity filters before the



**Fig 2a - A pair of linked two metre repeaters.**



**Fig 3a - A pair of off-air linked repeaters.**

repeater's receiver and after the transmitter to eliminate desensing.

Cavity filters are simply very sharp (high Q) tuned circuits. Depending on how they are connected, they can be made to act like band pass or notch filters. The notch filter connection is used when you want to attenuate deeply signals on a particular frequency, but want little attenuation of signals on other frequencies. This would be useful at a repeater's receiver, where it is important to attenuate the signal transmitted by the repeater's transmitter (to prevent desensing) but allow good sensitivity at the repeater's input frequency.

**Repeater Control and Timing Systems**

As well as transmitting, receiving and filtering equipment, repeaters include timing and control circuitry. The sophistication of this varies between repeaters. The following are some functions performed by these circuits:-

- \* Voice or Morse identification;
- \* Time-out (repeaters may not transmit for more than 10 minutes continuously);
- \* Fault protection (shuts down the repeater if it develops a fault);
- \* A "tail" (this keep the repeater transmitting even when a station's signal temporarily drops below the repeater's receive threshold);
- \* Sub-tone encoding of the repeater's transmissions to reduce the effect of pager interference to suitably equipped users; and
- \* Accessing links to other repeaters.

Modern repeaters use a control board featuring an EPROM microprocessor IC to perform many of these functions. By programming this chip, repeater builders can customise the functions provided to suit their needs.

**Repeater Access**

Most repeaters are open access. This means that a carrier signal on the right input

frequency is all that is required to operate the device. However, a few repeaters are "closed", that is they require special tones to be transmitted before they will operate.

For example, a UHF repeater may include a user-controlled cross-band link to a repeater on 29 MHz FM. By transmitting a suitable tone to activate the link, the user can enjoy contacts on ten metres FM, even though they themselves do not possess HF equipment. Signals with no access tone will be retransmitted on the UHF repeater output only.

Where a repeater is installed near high-powered VHF or UHF transmitters, it may continually be triggered by spurious signals or mixing products. Making the repeater's mute tone-activated means that only amateurs sending the required tone can open the repeater. This makes monitoring the repeater more pleasant - an important consideration given that far more people listen to repeaters than actually talk on them!

Repeater builders may have other reasons for making their repeater tone access only. The frequencies of the tones used by these repeaters are given in the repeater section of the *Australian Call Book*.

So what are the main ways to control access to a repeater or repeater link? There are at least three methods. These are as follows:-

**Tone-burst.** Requires users to transmit a short 1750 Hz tone to open the repeater. Usually an audio oscillator on the correct frequency is required, although a high-pitched whistle may do the job. This system is technically primitive, unpleasant to the ear and is not used in Australia. However, because it is common in Europe, many rigs have this feature built in. Owners of such rigs can be recognised by the very annoying high-pitched squeal at the start of each of their transmissions. If you have such a rig, do your fellow amateurs a service and ensure that this facility is disabled each time you transmit.

**CTCSS sub-tone.** This stands for Continuous Tone Coded Squelch System and is more advanced than the tone-burst system. Tones are transmitted continuously and are at frequencies below those of the human voice, so that their presence does not disrupt communication. A choice of standard tones gives the system greater versatility than the tone-burst system. Typical applications include reducing the effects of 148 MHz pager transmitters on two metre receivers, activating links for WIA broadcasts and cross-band repeater linking. Many modern VHF/UHF transceivers include this facility as standard.

**DTMF.** Dual Tone Multi Frequency. A similar system to that used in modern tone-

dial telephones. Each number has a unique combination of two tones. Useful for remote control of repeater sites due to the large number of combinations possible. DTMF may also be used for activating links to other repeaters. Many newer VHF/UHF amateur rigs include DTMF facilities as standard.

### Repeater Linking

As mentioned before, two or more repeaters may be linked together so that users of one repeater can talk to users of another. This is done for the following reasons:-

- \* To allow longer distances to be covered on the VHF/UHF bands;
- \* To increase activity on two or more repeaters serving a sparsely populated area;
- \* To promote activity on lesser used bands (such as linking 10 m and 70 cm repeaters); and
- \* For experimental purposes.

In places where activity is sparse (eg country areas), repeater sponsors usually want to have the link operational at all times. Where there is more activity or links are used for special purposes only, users may wish to switch links on and off. This can be done by installing special tone decoding circuitry at the repeater. It is then up to the operator to decide whether to activate the link by transmitting the correct CTCSS or DTMF control tone.

Linked repeaters must have better than average receive and transmit quality. This is because each transmitter and receiver in the chain between the transmitting and receiving station degrades the quality of the signal slightly. Generally speaking, the simpler the link, the greater its reliability and the better the recovered audio.

In repeater linking there is considerable scope for ingenuity and experimentation. The following are examples of the types of links that are possible:-

**Conventional linking.** This method is used when linking two repeaters transmitting on the same band. The method requires an extra transmitter and receiver at each site to be linked. A typical application for conventional linking is when it is desired that

## Other Types of Repeaters

All repeaters listed in the *Australian Call Book* use at least two frequencies and operate on FM. However, not all repeaters operate like this. This section introduces the reader to some lesser-known types of repeaters.

### "Parrot" Repeaters

A parrot repeater differs from a conventional repeater in that it uses one frequency only. Its name is very apt. Incoming signals are recorded on a digital voice recorder inside the repeater. When the user stops transmitting, the repeater switches to transmit and plays back the recording. This retransmission is heard by all stations monitoring the frequency. In other words, whereas conventional repeaters retransmit the incoming signal on a different frequency *while* the user is talking, parrot repeaters retransmit a recording of the signal immediately *after* the user has finished. Thus, unlike a normal repeater which transmits as it receives, the parrot repeater is either receiving or transmitting and does not do both simultaneously.

This need for repetition makes communicating via parrot repeaters slower than through conventional repeaters. As well, there is a risk of users accidentally transmitting over one another. For this reason, parrot repeaters are most useful during emergency-type communication exercises where transmissions are normally kept short.

Parrot repeaters are very simple to build – no cavity filters or separate antennas are required. Those with some constructional expertise may wish to build their own by adding a digital voice recorder and associated control circuitry to a standard amateur mobile or hand-held transceiver.

### Linear Translators

Conventional repeaters transmit and receive FM only and relay only one transmission at a time. Linear translators, in contrast, can relay many signals at once. They work by receiving a segment of frequencies in one amateur band and retransmitting it in another band. Any signal, whatever its mode, appearing within the linear translator's receive passband is retransmitted. This means that a linear translator with a sufficiently wide passband (say 50 kHz or more) can relay several Morse, voice and data transmissions simultaneously. Tuning across the output of a linear translator is a lot like tuning across an amateur HF band, where signals of several different modes can be heard.

Unlike FM repeaters, which demodulate the incoming signal and use the resulting audio to operate the transmitter section, no demodulation takes place within linear translators. Instead, linear translators use a mixing, filtering and conversion process, similar to that which operates in a superheterodyne radio receiver. Again like superhet receivers, linear translators incorporate automatic gain control (AGC) circuits to prevent strong signals from overloading the system.

Most amateur satellites incorporate linear translators. However, their use on land is limited, and none is licensed in Australia. Because they can relay SSB and CW signals alongside FM transmissions, a terrestrial linear translator could have better coverage than a conventional FM repeater at the same site. As well, they make possible activities such as full-duplex voice operation (similar to speaking on a telephone) and transmitting slow-scan television images simultaneously with a voice commentary. For the experimenter, a linear translator would be an advanced project calling for a high level of expertise and access to test equipment.



Your  
Hobby

Your  
Voice

Representing Radio Amateurs Since 1910

## Novice Plus

Helping you get more from amateur radio

### RD Contest This Month

A reminder that the Remembrance Day Contest is on later this month. The contest exists to remember the amateurs who died during World War Two. This is Australia's biggest contest, and there is activity on most amateur bands. On VHF and UHF try listening around the FM simplex calling frequencies (146.500, 439.000 MHz). On HF, you will find activity on 80 metres on the Saturday evening and Sunday morning, and (possibly) on 15 and 10 metres during daylight hours. It takes place over the weekend of 16 and 17 August. Rules appeared in last month's *Amateur Radio* on page 37.

a pair of two metre repeaters be linked. Installation of a link transmitter/receiver operating on 70 centimetres at each repeater site allows a station operating through one repeater also to be heard on the other. Figure 2a shows a pair of two metre repeaters that have been linked via UHF.

**Off-air linking.** This technique is useful when linking repeaters transmitting in different bands (for example, linking a two metre repeater to a seventy centimetre device). It is simpler than conventional repeater linking because only one extra transmitter/receiver installed at one site is required to link two repeaters (Fig 2b). RF spectrum is conserved as no special link frequencies are required.

An off-air link does not have to be between two repeaters. By replacing the two metre repeater at site B in Fig 2b with an ordinary two metre transceiver set to an unused simplex frequency, it is possible to provide access to the 70 cm repeater at site A to stations transmitting on two metres. This could be useful where operators in a particular locality wish to use the UHF repeater at site A, but cannot do so due to local topography. A remote link comprising a UHF transceiver connected to a two metre rig on a nearby hill could provide access without the need for a full repeater. Such installations are particularly attractive for coverage of small geographic areas, or where activity is insufficient to justify the installation of a stand-alone repeater.

**Simplex gateways.** A simplex gateway is a means to allow access to a simplex frequency by users of a repeater, or vice versa. In its simplest form, it consists of a single frequency FM transceiver wired to a conventional repeater. A typical application is to provide access to ten metres FM to UHF repeater users. This allows UHF operators to enjoy interstate and overseas contacts given favourable conditions on 29 MHz.

### Conclusion

This article has given the reader a quick tour of the various types of voice repeaters, with special emphasis given to repeater linking and control. More information about all aspects of repeaters can be obtained from your local repeater committee or group. Also, see the *Repeater Link* column elsewhere in this issue. I would like to thank Will McGhie VK6UU for his assistance in the preparation of this article.

Copies of the 1995 Novice Notes can be obtained through the Internet Novice Notes Online service at <http://www.pcug.org.au/~parkerp/nonline.htm>

\*7/1 Garran Place, Garran ACT 2605  
VK1PK @ VK1KCM.ACT.AUS.OC  
[parkerp@pcug.org.au](mailto:parkerp@pcug.org.au)

ar

---

---

## Over to You – Members' Opinions

*All letters from members will be considered for publication, but should be less than 300 words. The WIA accepts no responsibility for opinions expressed by correspondents.*

---

---

### Misbelief on New Format for the Call Book

The letter from Max Morris in July's *Over to You* column (page 45) about proposed changes to the method of publication of the *Call Book*, highlights a misunderstanding about the *WIA News* item in the June issue of *Amateur Radio* (page 6), titled "Call Book to be Replaced With New Publication."

It has not been proposed that the *Australian Call Book* be published ONLY in digital form on CD-ROM. To believe this is a mistake. The second paragraph of the *WIA News* item explained the approaches being considered as follows: "From preliminary proposals discussed, it is anticipated that a replacement for the *Call Book* would be a more broadly-based publication containing reference material of wide interest among the

amateur and short-wave listener community and related enthusiasts. Also being considered are providing the callsign listings in digital form and various options of providing amateur callsign listings in printed form for those who don't have suitable computer or Internet facilities."

The Council and the *Call Book* sub-committee are only too well aware that not all amateurs have access to or use computers, because even some Federal Councillors are similarly handicapped!

However, the *WIA News* item did note that there is a local demand for an *Australian Call Book* in digital form and that overseas publishers had recently moved to publish their foreign call books only on CD-ROM.

**Neil Penfold**

WIA Federal President

ar

---

---

### Book Review

## The LF Experimenter's Source Book

*Publisher: The Radio Society Of Great Britain*

*Author: Peter Dodd G3LDO*

*Reviewed by: Gil Sones VK3AUI*

In the United Kingdom, amateurs have a new amateur band at 73 kHz which is 2.8 kHz wide. It extends from 71.6 kHz to 74.4 kHz which would permit reduced bandwidth SSB but which is really more suitable for narrow band modes such as CW. It has provoked a lot of interest and is an experimenter's band where the very different techniques and propagation can be explored.

Around the world there are several LF bands available to amateurs and some which can be accessed under special licences. There have been many articles about equipment, aeriels and techniques for LF experiments. It is rather different from MF, HF, VHF, and UHF with which we are more familiar.

The RSGB have published a collection of articles from around the world on various aspects of LF operation. Whilst LF was the area where much early communication was carried out in the early 20th century, it is little known to amateurs today. This publication is designed to provide a collection of LF articles.

The book provides general LF information together with more specific information on propagation, receiving and transmitting, aeriels and propagation, and specialist techniques and test equipment. It is a very

interesting collection of information about a fascinating area for experimentation. Hopefully, in Australia we will one day have an LF allocation and not have to depend on the special experimental licences which have been necessary to date.

The LF Experimenter's Source Book is recommended to anyone with an interest in LF. It provides interesting reading with many practical pieces of equipment and aeriels described. LF is an interesting area for experimentation even if you can only listen. There are allocations in both New Zealand and Papua New Guinea as well as a few experimental licenses in Australia.

The review copy came direct from the RSGB. The LF Experimenter's Source Book should be available from the usual outlets for RSGB publications.

ar

**Tell the advertiser you  
saw it in the WIA  
Amateur Radio  
magazine!**



---

---

# Pounding Brass

---

---

Stephen P Smith VK2SPS\*

---

---

I hope you enjoyed last month's issue showing a selection of Australian Semi-Auto Keys as used by ex-PMG operators of the past. As you are aware, some of these keys are still in use today, such as the Simplex-Auto, a key that is getting rather difficult to come by these days.

Obtaining a good quality Morse key today is not as easy as it was some years ago when telegraphy was at its peak. The workmanship was magnificent with each key a labour of love which showed in its appearance and operation whereas today's keys are usually made with a combination of plastic and chrome-plated metals, not at all like the polished brass and smooth operation of a past era.

The number of Australian manufacturers are all but gone these days as keys are mainly imported from Japan and America. Also some from the UK, such as the "Kent" range (normally in kit form) which are quite good quality keys at a moderate price.

Morse keys are like motor cars in that it's always better to test drive before you buy. However, this is not as easy as it sounds as we usually decide to purchase a key either through somebody's recommendation or having read about it through advertising in the pages of an amateur radio catalogue. Then, perhaps, we borrow money from the XYL for the purchase of the key, are disappointed with its performance and never use it again or, in extreme cases, give up telegraphy altogether.

If only we could borrow the key for several days to try it out! If you belong to a club, or borrow from a friend, you will be better off. It may take an operator a number of keys before he finds that perfect key. Again, it comes down to practice and experience.

May I suggest the beginner, with limited funds and little experience, try the following:

1. Ask a friend who may be a keen CW operator (they usually have more than one key and would most likely lend you one);

2. Become a member of a local radio club where you can obtain the information on various keys from the more experienced members who would usually be only too happy to help you;

3. Have a look through the *Call Book* for amateurs within your general area and drop them a line with name and phone number. I'm quite sure they will assist you and perhaps lend you a key (you never know until you try!).

In order to obtain a good quality key in Australia, we are faced with three options:

1. Buying from local companies (in this case it will be an imported key, probably a Hi Mound from Japan, or a Vibroplex, Bencher or MFJ from America, to name a few);

2) Buying second hand from Hamads, etc; or

3) Buying directly from an overseas manufacturer.

Let's take a look at each of the above. For example, two companies who sell keys are Dick Smith and Daycom Communications. Dick Smith offers three keys, the economy Morse Key catalogue number D-7105, the Model HK-707 by Hi-Mound (cat D-7107) and the Model MK-706 (cat D-7108) also produced by the Hi-Mound company of Japan.

The economy key sells for \$9.95. This key is basically a copy of an American landline key as used in the second half of the last century. The key consists of a plastic base with chrome plated metal. The base will require to be weighted or attached to a wooden support or screwed to the bench. I hesitate to recommend this key for use either on-air or for practice because of its construction.

The Model HK-707 sells for \$79.95. This is a more up-market key, again following the American style, being low in profile yet having a large knob similar to our own PMG keys. This key handles well during operation although I had to add weight to the base to stop chasing it around the table. Another option is to use blue-tack and stick it to the bench.

The last key (or I should say paddle) offered is the Model MK-706 single paddle selling for \$109.95. It has a solid metal non-slip base, adjustable spring tension and a clear plastic dust cover (a good idea these days). Unfortunately, I have not used this key. I have spoken with operators who have used it and they have told me it handles quite well.

The company selling the largest range of keys in Australia is Daycom Communications Pty Ltd in Melbourne. Most of the keys are imported from America, with a small range from the UK. The keys offered from America come from such companies as Vibroplex and Bencher. Vibroplex only manufacture semi-automatic keys along with a range of Vibrokeyers and Vibroplex iambic models. These keys are top quality, top performance keys that send beautiful Morse when correctly adjusted and used by an experienced operator who is familiar with these types of keys. Each key comes in three models from "standard" to "presentation".

Bencher products include the Bencher iambic keyer, single lever key and logic key CMOS keyer. Again, sale prices range from standard to the more exotic and expensive models. I will not go into the specific details of each key as this would require a number of pages. However, if anyone has any questions in relation to any of the keys mentioned please drop me a line or, you can contact Daycom for further information on a specific model.

The majority of the market seems to be dedicated to the iambic or double/single combinations. It's a shame not to see more hand keys being offered for general use.

Next month I will continue with second-hand keys and buying direct from an overseas company.

\*PO Box 361, Mona Vale NSW 2103

ar

## VK QSL BUREAUX

The official list of VK QSL Bureaux. All are Inwards and Outwards unless otherwise stated.

VK1		GPO Box 600 CANBERRA ACT 2601
VK2		PO Box 73 TERALBA NSW 2284
VK3	Inwards	Box 757G, GPO MELBOURNE VIC 3001
	Outwards	40G Victory Blvd ASHBURTON VIC 3147
VK4		GPO Box 638 BRISBANE QLD 4001
VK5		PO Box 10092 Gouger St ADELAIDE SA 5001
VK6		GPO Box F319 PERTH WA 6001
VK7		GPO Box 371D HOBART TAS 7001
VK8		C/o H G Andersson VK8HA Box 619 HUMPTY DOO NT 0836
VK9/VK0		C/o Neil Penfold VK6NE 2 Moss Court KINGSLEY WA 6026

---

---

# Repeater Link

Will McGhie VK6UU\*

---

---

## Vertical Solar

You may remember the cover of *Amateur Radio* for October 1996, showing a photo of vertically mounted solar panels. An accompanying article in *Repeater Link* described the mounting of these panels.

The reason for mounting the panels vertically was simply to make the job easier. There would be a reduction in overall output from the panels due to them not being at the recommended angle, but how much? The two panels shown in the photo did not face north. One panel faced north east and the other north west. My question was, if a solar panel was mounted vertically facing north, how much would the output be down on a panel with the correct angle facing north?

An opportunity to do some measurements occurred and, using a small panel, I recorded the following results.

The time of year was mid winter. The first three measurements were done at 9.30 am. Firstly, the panel was connected to charge a battery through a meter. The panel was faced towards the sun for highest output. This resulted in a current of 107 mA. Next, the panel was faced north and angled at the recommended angle of 35 degrees. The resulting current was 80 mA. The final measurement was with the panel vertical and facing north, resulting in a current of 75 mA.

The same three measurement were again taken at midday, with the following results: directly at the sun, 118 mA; recommended angle, 114 mA; and vertical, 102 mA.

What the results show is that mounting a solar panel vertically does not reduce the output of the panel by much. If you only compare the 35 degree angled panel with the vertical panel, then there is about a 7% reduction at 9.30 am, and about an 11% reduction at midday. Not a lot, considering the ease of mounting a solar panel vertically. Other benefits could be less dust build up on the vertical panel over the angled panel, and not damaging a panel by dropping an object on to it from above.

The closer to the equator the poorer the output from the vertical panel of course but, for most of Southern Australia, the idea could offer an easy and effective solution to mounting solar panels.

While doing the measurements on the small panel, it was easy to see how little effect the sun angle had on the output of the panel. This may vary with panels that have different types of construction, but it appears there is little need to spend too much time and money getting the panel spot on, angle wise. Pointing north for Australia is the most important, and vertical a useful alternative for ease of construction.

## Getting Ready

One of our repeaters in VK6 has been off-air for well over a year. The repeater, VK6RCT at Cataby, about 150 km north of Perth, has only one user living in the area, and mainly services mobile traffic on the Brand Highway. The reasons for the repeater being

off-air for so long are many, but the main reason is the lack of any person to do the work to put the system back on air.

However, at long last a replacement repeater was finished and finally put under test in Perth. This replacement repeater was soak tested by replacing one of Perth's repeaters for a couple of months. With all the bugs sorted out, the time had come to take it to Cataby and install it.

This is what this article is about, getting the replacement repeater ready for installation. Sounds easy does it not? The repeater had been under test for two months and the few noticed bugs had been sorted out. However, with the repeater now out of its on-air testing phase, the time had come to finally set up the repeater for installation.

It is easy to say, take a working repeater that has been under test and install it at its new location. However, it is not so easy to do.

The repeater had been on 6750 and had to be re-crystalled for 7200. The receiver had to be peaked on 147.800 MHz from its previous 146.150 MHz and accurately netted to this new frequency. Next, the transmitter had to be accurately netted on to frequency. This repeater uses direct frequency modulation of the transmit crystal, and all crystals produce different amounts of deviation for the same audio input, so the transmit deviation had to be set up.

The repeater was now lined up on the new repeater channel. Next came the change of call sign. This required programming the EPROM in the control board. The changes are written on the computer and, as I don't have an EPROM blower, the EPROM was programmed at work.

This repeater is also interfaced with a UHF link transceiver that also had been under test, and the next set of final tests were to do with the link repeater interface operation. The DTMF remote control via the link worked on the bench, but not via the local Perth UHF repeater that was to be linked to Cataby. The problem was found to be incorrect frequency response to the DTMF controller, the UHF Perth repeater adding just that little bit more error. The DTMF decoder was modified and the remote control now worked.

Next was adjusting the low voltage warning tone contained in the repeater. This had been set up before but needed a final check. Added to the repeater and link system was a low voltage cut-out circuit that disconnects the repeater and link if the battery voltage falls below 10.5 volts. Final tests needed to be done on this unit in conjunction with the low voltage tone warning.

Then came finishing the labelling of the various inputs and outputs of the repeater and link, along with the various controls. Also, covers fitted back into place, as the system was open for modifications and fault finding.



The Cataby repeater site. (Colour original inserted)

Any last minute changes were entered on to the circuits in the computer. All circuits had been drawn using Draft Choice and, even though this design has been used for several repeaters, each repeater has some differences. By the way, this information is worth all the effort. The time it takes is more than offset by the time and frustration it saves.

If all this was not enough, the Cataby site already had a UHF link antenna pointing to Perth. This had been installed many years before, but when last checked had a high SWR. Perhaps the beam was faulty, so a replacement antenna had to be made ready. Rather than swap the antennas if the existing beam proved faulty, the replacement beam was put together with mounting hardware and coax. Not remembering how the on-site beam had been installed meant difficulty in sorting out mounting hardware for the replacement beam. A complete ready-to-be-installed beam, mounting hardware and coax would mean less time required on site. This is important, particularly as the total driving time from Perth is five hours out of the working day.

### Loading the Car

These final checks and construction all took place on the Saturday morning prior to travelling to Cataby on the Sunday. Next came loading up the car. This is the bit I hate most. There is so much to remember to take to a remote repeater site, particularly this one, as much of the condition of the site was unknown.

To give you some idea, here is a short list. RF signal generator for testing and aligning the duplexer, VHF and UHF SWR meter, multimeter, soldering iron, inverter to power soldering iron, solder, coax leads, nuts and bolts for UHF beam, low voltage cut out switch, 12 volt power cable, coax adapters, insulation tape, tools, the list goes on and on. And this does not include the important bits like replacement repeater, link transceiver and associated power cables.

### On Site

That took care of all day Saturday, just getting ready to go. Sunday it rained all day

but the installation went without a hitch. I could even drive right to the top of the hill after having some doubt about the condition of the gravel track.

Also, this was the first time to try out the de-sense adapter, as described in June *Amateur Radio*, page 44, in a real field situation. I did some initial SWR measurements on the duplexer that had been left at the site, and it showed the duplexer was misaligned badly. Using the adapter, signal generator and SWR meter I was able to do a perfect line-up of the entire duplexer. The result was minimum loss through the duplexer, good SWR and zero desensing. The de-sense adapter really worked in a practical situation. It made the line-up easy and fast.

The purpose of putting this on to paper is to give you some idea of the amount of effort to put a repeater back on air. It may sound easy, but it does require lots of effort, preparation and time, along with travelling expense. Those of you who maintain repeater sites will have many stories to tell. How about a couple, so the amateurs who use these systems can better understand the effort, and why some systems remain off-air for so long?

### At Last

The licence for our 29 MHz gateway has, at long last, been issued. From first writing to our local WIA to start the effort to allow 29 MHz gateways, until the licence was issued, took almost three years!

We have a hobby which changes due to technology and requires ongoing regulation updates, but we must do better than three years. We could be in a situation where a completely new technology could be redundant and replaced by the next round of technology before the relevant regulations are changed to allow use of the first technology change. What we need is less regulation. Did someone mention de-regulation of the amateur service a while back?

\*21 Waterloo Crescent, Lesmurdie 6076  
Packet: VK6UU @ VK6BBR  
E-mail: will@vale.faroc.com.au

ar



HF - VHF - UHF MOBILE ANTENNA  
HF - VHF - UHF BASE ANTENNA  
CB - MARINE - AIRCRAFT

Monoband to Multiband  
Convert Now, to the all

New!

PERTH PLUS

HF Mobile antenna

with 30-40-30-20-17-15-12-10-6-2m included

contains

Coaxial Cables & Fittings  
HF Spring Bases, Trunk and Gutter Mounts.

Outbacker OBB "Classic"  
Outbacker "Junior plus"

Split Models  
Helical Dipoles  
Long wire Dipoles  
Baluns

★ Free!

With Every Perthplus Purchase.  
1 x AmSoft CD-ROM  
'94 Callsign Database

While current stocks last

Now available from :

MELBOURNE  
Daycom Communications  
Ph 03 5436444

ALICE SPRINGS.  
Farmer Electronics  
Ph 089522388

DARWIN.  
Integrated Technical Services.  
Ph 089-816411

SYDNEY.  
Andrews Communications  
Ph 02 6369060

PERTH.  
Tower Communications  
Ph 4701118

ADELAIDE  
Johnston Electronics  
Ph 08 2871061

PERTH - Model

<http://intercon.com.au/outbacker>

TERLIN AERIALS  
5 Yamp! Way  
Willetton W.A. 6155

Ph +61 (09) 3545444  
Fax +61 (09) 3545455



Send \$ 5.00 for a 15 minute international video  
Refundable with every antenna purchase.

ar

## Club Corner

### SADARC Hamfest

The Shepparton and District Amateur Radio Club will hold a Hamfest on 14 September 1997, commencing at 10.00 am, at a new, expanded venue, the Mechanics Institute in Wyndham Street, Shepparton.

Ideally located in the central business district, with off-street parking available in Welsford Street, the Mechanics Institute is between Nixon and Fryers Streets. All amenities are nearby. Check out the Club net on Wednesday evenings at 8.00 pm on 146.650 for further details. Hope to see you there!

MaryAnn Williamson  
Secretary.

ar

---

---

## Spotlight on SWLing

Robin L Harwood VK7RH\*

---

---

There is quite a lot of news this month, following the closure of Monitor Radio International. As I have previously reported, the owners, the Christian Science Publishing Society, decided to close down the weekday "Monitor Radio International" and put the short-wave senders for sale. It initially appeared that another Boston newspaper was going to acquire the Monitor Radio International, which included a syndicated news service on one of America's public radio networks, yet this fell through because many of these stations were not interested in taking it. Many preferred, instead, to run the BBC World Service, which gave the "Beeb" a big boost to their placements in North American domestic markets. The final MRI programs came out on 27 June but I believe that weekend religious programming will be continuing over short-wave, as has been the case since the Christian Science Church launched the service.

Radio Australia also made significant alterations to their schedule on 30 June, after their budget was slashed. Several prominent language sections were also axed, including Cantonese, Thai and French. All remaining language services were reduced in output, including English.

The Cantonese Service actually closed on 29 June. This was only 24 hours prior to the hand-over of Hong Kong to the Peoples' Republic of China by the UK Government. As you may be aware, Cantonese is the lingua franca of Hong Kong and most of southern China, with many overseas Chinese also fluent in this dialect. Radio Australia's Cantonese service was listened to across Asia and with the continuing uncertainty regarding Hong Kong's status as a special administrative region within the PRC, many were relying on Radio Australia's voice to report on what is happening.

Another major decision was to mothball the transmitters on Cox's Peninsula just east of Darwin and solely rely on Shepparton (VIC) and Brandon (QLD). This decision will likely mean that signals will not get into Asia as easily as they do from Darwin. The future focus of Radio Australia seems to be the Pacific, as the Niugini service is unaffected by the cuts. Because the Darwin site is not being utilised, other international broadcasters, including Radio Free Asia, the BBC World Service, Radio Netherlands, Deutsche Welle, plus some religious organisations, have expressed interest in using the senders. Fortunately, they have not

been dismantled but can be brought online at a moment's notice.

Recently I was tuning across the 25 metre broadcasting allocation, when I came across a religious program "Through the Bible" which is carried over many evangelical stations including HCJB and Trans World Radio. I naturally assumed it was one of those but, when I heard the address at the end of the program, I thought I had come across TWR Swaziland. However, my Klengenfuss CD-ROM said that Swaziland was not on that channel and the TWR programming was coming from Meyerton, South Africa. I quickly consulted the SENTECH web site and confirmed that it indeed emanated from there. Apparently SENTECH is very similar to our National Transmission Authority yet is commercial, hiring airtime over their senders. Clients include Channel Africa, the BBC World Service, Radio France International, Radio Netherlands and Deutsche Welle.

Trans World Radio has also hired airtime to reach African audiences. The Meyerton site is also engaged in clandestine broadcasting, yet this does not appear on their web site information. Several Nigerian political dissident organisations are known to be broadcasting via Meyerton back to Nigeria.

I am surprised that the signals from Meyerton are so clear and reliable, as African signals are usually very patchy here in Tasmania. However, the 11730 kHz signal is quite good between 0600 and 0645 (when it closes). The signal level does slowly drop off to be almost unreadable by then. The information on the site says that it is beamed to West Africa using a 500 kW sender. Presumably we are getting the signal off the back of the beam. I have already forwarded an e-mail report to SENTECH and have had this confirmed by return with a proper QSL apparently on the way via snail mail. Their e-mail address is [ottok@sentech.com.za](mailto:ottok@sentech.com.za).

I have recently tried out a Radio Shack

amplified short-wave antenna, which is currently available from Tandy stores nationwide. The unit is very small and compact and requires a 9 volt battery or an AC adapter. It comes with a 3.5 mm connecting cord between the radio and the unit. I tried it out with a cheap multi-band radio I have had for a while and the unit does work but easily overloads. The unit has two ranges, one from 3 to 10 MHz and the second from 10 to 30 MHz. In reality the range is from 4 to 9 MHz and the upper range does not work satisfactorily as tuning is very critical with hand capacitance making it difficult. The unit sells for \$49.95 and I am a little disappointed; but it would probably be worthwhile on the lower bands as it does peak up signals on the whip on the unit. I haven't tried it with an external antenna.

There was another bit of radio history on 30 June/1 July, when the Crown Colony of Hong Kong was returned to China. This event was covered extensively by the world's media and many stations, including most HF outlets of the Chinese domestic services, broadcast the hand-over ceremonies live. The BBC World Service also covered it. It was strange hearing the speech by the Prince of Wales in English live and without translation via the Chinese outlets, particularly on 6115 and 7504 kHz. I also found the various satellite feeds were at different times, with the short-wave feeds being a good second ahead of the television audio. Incidentally the call sign block VRA to VRZ on the ITU lists should now be modified to the PRC as the UK Government relinquished it on 1 July.

I am also informed that VIS Sydney Radio is closing, with the Doonside/Bringelly sites and the remaining senders being remotely controlled from either Brisbane or Melbourne. VIT Townsville is also being remotely controlled from Brisbane on voice, whilst the ICW is being controlled from Melbourne. VID Darwin is also being remotely controlled from Perth Radio. Vale VIS!

Well, that is all for this month. Until next time, the very best of monitoring and 73.

\*5 Helen Street, Newstead TAS 7250

(03) 63 44 2324

VK7RH@VK7BBS.LTN.TAS.AUS.OC

Internet e-mail: [robroy@iassie.net.au](mailto:robroy@iassie.net.au)

ar

**Repeaters - additions, deletions, alterations. Have you advised the WIA of changes needed to the Repeater List?**

---

---

# VHF/UHF – An Expanding World

---

---

Eric Jamieson VK5LP\*

All times are UTC.

## Six Metres 50 Years Ago

As I advised a couple of months ago, in this August issue I planned to remember the 50th anniversary of the World Record contact between Clarrie VK5KL and Eugene W7ACS/KH6 which took place at 1240 CST (0310 UTC) on 26 August 1947 on the six metre band, 50 to 56 MCs (at that time, frequencies were referred to as Megacycles or MCs, or megs for a short title). Clarrie made the contact while he was living in Darwin. VK5 callsigns then were used for South Australia and the Northern Territory. The distance was considered to be 5350 miles or 8610 km. I presume Clarrie will open a bottle of champagne to celebrate the memory of that contact 50 years ago!

I wrote to Clarrie VK5KL, who lives in the Adelaide suburb of Enfield, where he is still active on six metres, these days with 10 watts but this was sufficient to give him contacts to OZ1LO, SM7FJE, IN4KST and OK3RV on 8 February 1992.

Clarrie sent me the following information: "Pleased to receive your letter. It is great to know that a few still remember that contact as it is a long time since the event occurred.

"I passed the AOCPE exam in October 1933 but had to wait until my 18th birthday in December before I could apply for a licence. I came on air in early 1934. I operated on the old 56 MCs band (five metres) and in late 1934 had my first QSO with VK5IT. A joint portable operation with Bill Lloyd VK5HD and Pete Bowman VK5FM at The Hummocks north of Adelaide produced a VK5 record five metre contact with Max Farmer VK5GF, who operated from Mount Lofty.

"Soon after, I joined Bill VK5HD and took part in timing the Australian Speed Boat Championships held at Murray Bridge. We used portable transceivers!

"My pride and joy was building a long-line oscillator using copper tubing in both the grid and plate circuits, and this was displayed during a lecture by Professor Kerr Grant at the University of Adelaide.

"During World War II I served in the RAAF as a Wireless Operator Mechanic in Darwin from early 1942 until late 1945. On demobilisation I transferred from the PMG Dept to DCA (Dept of Civil Aviation) and took over the operation of Civil Aeradio early in 1946.

"After World War II, amateur radio licences were issued for the band 50 to 54 MHz, replacing the pre-war 56 to 60 MCs allocation. Following the good results already being attained in the USA, we made efforts to build equipment for the new band. I planned to make a converter to feed into my AR7 receiver, but small variable condensers (now capacitors) were not available. This was overcome by asking one of the Qantas pilots flying to London to buy some Eddystone capacitors for me. The resulting converter used a 956 RF stage,

detector and 955 oscillator. It was a rather rough affair as parts were scarce.

"During 1946, whilst working W7ACS/KH6 on 28 MHz, we had discussed operation on 50 MHz. Eugene mentioned that a scientist from the Ionospheric Weather Station had suggested we change from vertical to horizontal polarized antennas as this might improve the chances of reflection from the ionised Heavyside Layer.

"Both of us constructed three element horizontal Yagis. Mine was made from electrical conduit. There being no one else on six metres in Darwin, on a visit to Melbourne I took the converter to Max Howden VK3BQ to check that it would receive 50 MHz. It did!

"At a disposals sale I had bought a T1131 transmitter. It was made for the Air Ministry as a ground-control transmitter and brought to Australia for use with the Spitfire Squadrons. It ran 100 watts of CW or AM from a pair of 834s, and covered 100 to 125 MHz. I changed the coils to tune 50 MHz.

"Each month, using the Ionospheric Prediction charts issued from Mount Stromlo, careful watch was kept when the MUF charts showed around 50 MHz. This paid off on 26 August 1947, when, soon after 12 noon (0230 UTC), a weak signal was heard just inside the 50 MHz band. The signal increased in strength until I identified W7ACS/KH6 calling CQ six metres. The QSO finally occurred at 1240 pm (0310 UTC)."

This world record QSO on six metres was reported in QST under *The World Above 50 Mc* for October 1947, conducted by the late Ed Tilton W1HDQ. He wrote: "That 27th again! For the fourth consecutive month, the lead paragraphs of this department are being rewritten to report extraordinary happenings on the 27th of the month. This is an important date to remember, [and still is ... VK5LP], because it gives a good indication of the period to watch each month for DX opportunities through the fall season. Between 25 and 27 August there were at least three events that are front-page news to VHF enthusiasts: the first two-way work between Australia and the Hawaiian Islands on 50 Mc, the first Mexico-Argentina 50 Mc QSO, and a new DX record for home-station worked on 144 Mc.

"The 50 Mc record passed 5000 miles at 1700 Hawaiian Time, on 25 August, when W7ACS/KH6 at Pearl Harbor worked VK5KL, Darwin, Australia, a distance of 5350 miles (5349.8 according to W7ACS!). This contact renewed interest in the possibilities for 50 Mc communication over this path, and though no new VK or ZL contacts have been reported at this writing, the prospects remain good through the fall."

The QST article included a copy of VK5KL's QSL to W7ACS/KH6 and a picture of his three element coaxial fed beam, 0.2 wavelength spacing.

Emil W3EP, in response to a request from me for information about the contact, replied that

during the 1946-47 winter, W7ACS/KH6 was active on 50 MHz, with much written about him and the main story being his contact with J9AAK. Here is a bit from May 1947 QST (page 62 in the *World Above 50 Mc* column: "W7ACS/KH6 has been trying to duplicate his feat with J9AAK and VKs, but without much success, except for some very brief exchanges between W7ACS/KH6 and VK4HR of Brisbane, Australia." [the text which followed revealed the pair heard one or the other, but not a two way, on Feb 27, Feb 28, and Mar 2.]

In the light of the above, Clarrie was fortunate to have been the first to make a two-way contact with Hawaii.

*Amateur Radio* for October 1947 contained an article under the heading *50 MC'S WORLD RECORD* and is based on a letter from Clarrie VK5KL advising of his contact with W7ACS/KH6. Excerpts read as follows: "DX on 50 Mc is not a dream any longer. In all my 14 years of amateur radio nothing has thrilled me so much, not even that first ever QSO or working an elusive South American. Ever since 1934 when I first QSOed VK5IT on the old 56 Mc band using a battery operated super-regen receiver and an ultra-audio circuit transmitter, I have dreamed, planned and strived for better equipment and more co-operation to popularise the band.

"The war years intervened, then 1946 and back on the air. Allotted 50 to 54 Mc and a real chance now as 50 Mc comes well within reach of MUF prediction, when high enough. Improved techniques, superhet receivers, crystal controlled transmitters and multi-element beams all in the right trend to bring that dream true.

"December 1946. The band looked like opening. Interstate DX was achieved, honours to VK2NO and VK3MJ. Encouraged by activity in Honolulu, Japan, Okinawa, Singapore and India, the chance of real DX might yet be achieved. Close study of MUF Prediction Charts and ionospheric prediction issued by Mount Stromlo followed

"On 22 August a severe disturbance took place and the usual watch was kept when at home, usually around noon. Skeds were being kept with VK5NR and VK3BQ. Arriving home at 1200 hours on 26 August, the beam was swung in the direction of VK3, a weak signal was heard and fading rapidly - it was W7ACS/KH6 at Pearl Harbour calling 'CQ six metres.'

"Rushing outside to manipulate the ropes on the beam I became entangled amongst them in my haste. Return inside and frantic calling. Almost unable to hold microphone and speak at the same time. No reply.

"At 1215 W7ACS/KH6 called CQ, R3 S5. I called on 51.5 and 50.025 with no result. At 1230 he called again, I peaked the beam and called again. Perspiration stood out on my forehead as he answered QRZ? Again I called long and loud, at fever pitch now for the reply. Time was 1240 and the greatest moment of my life passed as W7ACS/KH6 answers calling VK5KL Darwin and saying: "Well! Well! This is one for the books", and offering congratulations.

"His signal came up to S7 and he gave me S3. We continued for several overs describing each other's gear. We arrange a sked for 1200 each day. His signal reached S8, as can be vouched for by my neighbour VK5SA, who came to witness the

closing overs. The contact lasted ten minutes and closed with both looking for other stations.

"I relaxed with radiant joy as I realised that I might have the coveted honour of being the first VK to work outside Australia on 50 Mc."

[It must be remembered that both stations were crystal-locked, there was no such thing as answering on the other party's frequency as we do today. The contact was completed because W7ACS/KH6 continued to call CQ and tuning, though apparently not hearing any replies in the early stages, he obviously thought it worthwhile to continue. ... VK5LP.]

Part 2 of *Six Metres 50 Years Ago* next month.

## Geelong Beacon

Last month I outlined the changes which had been made to the Geelong beacon VK3RGL on 144.530, by Charlie VK3BRZ.

On numerous occasions, morning, day and night time, I have listened for the beacon and on every occasion it has been audible. Signal levels vary from just audible to S5, depending upon propagation conditions. When it is weak I need to use the masthead pre-amp, but on many occasions it is audible without its use. The distance to Meningie is about 550 km.

Upon advising Charlie, the following e-mail was received: "Thank you for your feedback concerning the Mt Anakie beacon. It's very gratifying to see that it's producing the results I was hoping for. I'm especially looking forward to reports from VK6 later this year. Is there anyone at Port Augusta who might look for it?"

"The VK2s are certainly benefiting from the increased signal level towards them. I have been informed that even Gordon VK2ZAB hears the beacon regularly via aircraft enhancement, which is pretty good going. Mark VK2EMA at Tottenham (almost 700 km) hears it continuously (throughout the day, even), as does Rod VK2TWR at Nimitabel."

## Two Metres Propagation

Charlie VK3BRZ added the following to his e-mail: "Mark VK2EMA phoned me Sunday 9/6 to say he was hearing our beacon at S3-5. I couldn't get to my rigs there and then, so we made a sched for that evening at 12:00.

"At the appointed time, Mark called me first on 80 metres (we use 3.690 MHz to avoid QRM from the ATV chaps a little higher up the band). We went to 144 and worked with 5x9 signals both ways. At one point Mark dropped his power to five watts and was still comfortable copy (we normally both run 400 W for these contacts).

"From 144 we went to 70 cm and made a comfortable 5x3 contact both ways. Things were looking pretty good, so I tried to raise some activity from Melbourne. John VK3KWA responded and worked Mark easily on 144, then went to 70 cm. He has a single Yagi and defunct pre-amp on 70 cm, but still managed a contact.

"The pair then went to 1296 MHz, where they struggled for an hour on CW, finally completing an unconvincing contact at 1330. We all went back to 144 and 70 cm, finding signals on 70 cm had increased to S9+20! We enjoyed a three-way QSO on that band for a while and, before closing, Mark and John (sounds biblical, doesn't it?) returned to 1296, this time easily working on SSB with very

good signals, so much so that John was able to relay proceedings to me via 2 m.

"Now for the clincher. I suggested to Mark that he ought to check the Mt Lafty beacon VK5VF, and he reported that he was hearing it quite well. No VK5s though, who by now were probably sensibly tucked up in bed. But had they been around earlier, they would have had a ball.

"For the record, the distances are: VK2EMA to VK3BRZ 700 km, VK2EMA to VK3KWA 650 km. Not bad for winter, eh? Of course, everyone knows VHF DX is only a summertime phenomenon!"

## New Records

John VK3KWA advises of two new records which can be added to the list published in May *Amateur Radio*. They are:

1296 MHz: VK2 record: VK2ZAB - ZLIAVZ 21/01/97 2145.7 km.

2400 MHz: Mobile record: VK3TMJ - VK3XXX 11/01/97 180.5 km.

The 2400 MHz mobile contact was from Mt Kosciusko to Mt Buller. Mode FM, both stations one watt to vertical antennas.

John also advises that anyone who is interested in operating on this band, should note that the CW/SSB calling frequency has moved to 2403.1 MHz, but should not be used for FM. The national FM simplex calling frequency is 2425.000 MHz.

## VK to UK/EU Data List

Thank you to those people who responded to my request in the April issue for details of contacts between VK and the UK and Europe.

The final tally of contacts came to 2943. I know that this is not all the contacts made, but was the most I could assemble with the provided information.

The list has been sorted into six files in strict order of progression: date and time, time, VK call signs, VK grids, UK/EU call signs, UK/EU grids. There is also a statistics file which is a breakdown of the information for comparison purposes and is a very valuable file.

All the information comes to 928 kB, far too large to send by e-mail at STD rates with my phone line limit of 9600 bps. Therefore, all the information is contained in seven files on a virus free 3.5 inch IBM brand-name 1.44 mB computer disk. The six main files are in six columns in ASCII text which allows conversion to your own format. It readily converts to an Excel spreadsheet.

The disk is being made available at cost only, including return postage, for seven 45c stamps from VK amateurs. Overseas amateurs send \$US4.00 for airmail return postage with disk sent in a PostPak Computer Disk Mailer for safe delivery. Orders by letter only, accompanied by funds.

## Overseas

Chris Gare G3WOS reports that the first transatlantic six metre QSO this year took place on 08/06/97 at 1217 between Doug VE1PZ and Frank PA3BFM. VE1PZ was once again alerted by the EU video carriers on 48.250/.242 and 49.730/.750/.760.

Ted Collins G4UPS reports in his May notes the dates and times of the first openings "across the pond" from his station in IO80 as follows:

06/06/88 1513 WD4KPD

24/06/89 1422 W1AMG  
21/06/90 1243 VE3KLL  
24/08/91 1233 K1JRW/VE1/VE3  
13/05/92 2013 VEIRG  
05/06/93 2139 VEIYX  
19/06/94 1948 VEIRAA/FP  
19/06/95 2046 W1/2/3/4/VE1  
28/05/96 1806 VE1/W1/W8/FP  
1997: No openings in May

Usually, the openings are preceded by hearing 10 metre beacons or contacts. It is interesting to note that Canadian stations often feature in the first openings. The other point of interest is that, as Cycle 22 moved towards its peak, the openings commenced earlier in time.

However, despite no openings "across the pond" in May, Ted managed contacts with the following countries: 4X1, 9A, CT, CU3, D, EH, EH6, EH8, EH9, ES, EU, F, G, GM, GW, HB9, I, IS0, JY, LA, LY, LZ, OD, OE, OH, OK, OM, OZ, PE, S5, SM, SP, SV, YO, YU, Z32, ZB2. That's 37 countries and he heard SUIER from Egypt but was unable to contact him due to QRM from other stations in a pile-up. Overall, quite a good effort for the first month of summer Es contacts. Also, 19 beacons were heard.

## Internet Six News

The following snippets of news come from Geoff GJ4ICD who reports that, on 3/6 at 0700, six metres was wide open with 4X, SU and JY4MB into Europe. He logged 45 countries for the day in GJ! Lots of new rare grid squares were active, such as UR4LL in KO70, EW8DD/KO42, ES3RM/KO28, SV7BVZ/KN21, SM4HEJ/JP43. [They certainly get it easy in Europe ... VK5LP.]

On 5/6 Tim V73AT, on Kwajalein in the Marshall Islands, had a JA opening between 0730 and 0900, working JA2, JA3 and JA9 stations and hearing VS97XVD. [Tim should be a possible contact from VK at least during September or October.]

8/6: Mike ZL3TIC at 0440 worked VK3DUT 50.130 5/9+, also VK2s on band, and 46.240 5x9 for two hours.

11/6: Doug VE1PZ had a superb opening at 1200 to 1315 into G, GW, PA, ON, GJ, at 599 and 5x9 SSB, making 37 contacts!

18/6: Further big six metre openings in Europe, including 144 MHz Es contacts. 5B4 beacon heard for more than 12 hours, but still no major opening between Europe and USA.

20/6: VS6 news: From 28/6 to 2/7, Hong Kong will be on holiday to celebrate the change over to Chinese rule. A special event station VS97SAR and VR97SAR will be operational, including six metres. There is a rumour that Hong Kong will become a deleted country from DXCC.

22/6: Further widespread Es openings across Europe. At 1830-1840 VE1PZ to GJ4ICD at 599.

## From the USA

Emil W3EP in *The World Above 50 MHz* advises that during June Sporadic E in the US had been generally poor. Openings have been short and not spectacular, with very few double hop coast-to-coast contacts. No one in the US has worked Europe. Caribbean contacts were very scarce, even for W4s.

"This was in stark contrast to the spring and summer sporadic-E season which got off to a

roaring start. Six metre operators reported openings across the US on 27 of the 31 days of May. Most of these were the usual single-hop affairs. Stations along the East Coast, from Nova Scotia to Florida, also heard 48.242 and 48.250 MHz European television video signals from Spain and Portugal on 10 days. This is also an auspicious start, but there were few other signs of transatlantic propagation.

"There was 6 metre E-skip propagation somewhere in the US on every day of the month except May 1, 16, 17, and 30. Nearly all of these openings were brief and involved only single-hop contacts out to 2200 km or so. Opportunities for real DX were scarce and there were seemingly fewer openings to the Caribbean than in previous May's. Perhaps May 25 was the best single day for 6 metre sporadic E, with double-hop across North America and some encouraging transatlantic signs."

### Progress on 50.200 MHz

Emil continues: "Several reports included comments on the improved operating habits heard on six metres in recent months. During nearly every opening in May, stations were calling CQ on 50.2 MHz and getting quick replies but, more significantly, they could be found all up and down the band. I found it relatively easy to make more than 35 QSOs in an hour or so by calling CQ on 50.205 MHz during the Six Meter Sprint - and the band was not open! Crowding around 50.125 MHz has diminished considerably and there is already good activity at 50.200 MHz and higher. Six metre operators seemed to be enjoying themselves much more, primarily because QRM, splatter, and jostling around the low end of the band has been reduced considerably. Please continue to explain gently to those who have not received the word that domestic activity starts around 50.200 MHz and spreads out from there."

[I hope that during our next Es season in VK that I can say the same thing about VK operating habits, and also those of the JAs who seem habitually to inhabit 50.110, in some cases repeated QSOs by the same station being noted.]

W3EP also reported news from JA1VOK that the Es season in Japan started well during May. Many Japanese six metre operators have worked HL, BV, VS6 and DU stations. Other more exotic catches for the Japanese included XU2A (Cambodia), BS7H (Scarborough Reef), 9M2TO (West Malaysia), JD1BIY (Minami-Torishima), V73AT (Kwajalein), and KH2D (Guam). Those are scarce DX countries on any band!

### Closure

Closing with two thoughts for the month:

1. Courage in people is like a tea bag. You never know the strength until they're in hot water, and
2. Anybody who doesn't cut his speed at the sight of a police car is probably parked.

73 from *The Voice by the Lake*.

\*PO Box 169, Meningie SA 5264

Fax: (085) 751 043

Packet: VK5LP@VK5WI.#ADL.#SA.AUS.OC

E-mail: vk5lp@ozemail.com.au

ar

## Silent Keys

Due to space demands obituaries should be no longer than 200 words.

The WIA regrets to announce the recent passing of:

MH (Maxwell) MURPHY VK3ACF  
FW (Frederick) MILLS VK6MN

### Stanley Ivan Zeunert VK3SZ

Stan Zeunert VK3SZ passed away on Tuesday, 3 June. A number of amateur friends took part in a well attended funeral service on the following Friday.

Stan grew up near Hamilton where he obtained his licence and callsign in 1938 at the age of 17. World War II cut short his use of the call.

In 1941 Stan went to Melbourne to enlist in RAAF Signals. He was told there were no vacancies in signals, but he would be welcome to join a new top secret unit. And so he became an early trainee in radar. On completion of his training his unit was sent to Darwin to set up a radar station which they did shortly after the first Japanese bombing raid. Later he was transferred to Metung on Victoria's south coast and later to Victoria Barracks in Melbourne to write instruction manuals. He was discharged late in 1944 - the year he was married - with the rank of Warrant Officer. In civil life he specialised in the design and manufacture of car radios. First with Healings for a total of 35 years, then Astor radio and, finally, Philips. He retired from Philips in 1986 at the age of 65. On company business, he visited England and Holland followed by many visits to Japan.

As an amateur Stan used phone rather than CW and, in later years, kept a regular afternoon sked on 80 metres. The antenna he used is another story.

Stan was a member of the WIA, the Moorabbin and District Radio Club and the Radio Amateurs Old Timers Club. He was a dedicated home brewer and a meticulous perfectionist.

He is survived by his wife Wilma, his children David, Meredith and Roslyn, their partners, and eight grandchildren.

A lot of people will miss Stan, that's for sure.

Allan Doble VK3AMD

### Keith Schleicher VK4KS

Past President WIAQ 1947

After suffering indifferent health for some time, OOTer Keith VK4KS became an SK on 24 May 1997. He was 78 and had been licensed since 1937.

In his own quiet way VK4KS proved to be a man of outstanding ability and

achievement. Forced to leave school at primary or scholarship level because of the great 1930-1932 depression, his first job, in what was to become a lifetime career in electronics was as a chassis wirer in a Brisbane broadcast factory.

From this point on, purely by self motivation, home study and diligence, Keith went on to become highly skilled in the state of the art.

In SE Queensland he pioneered two-way radio in taxi cabs. This facility considerably speeded up the cab-at-the-front-door service as never before.

The magnitude of this accomplishment by VK4KS seems all the greater when it is known that Keith designed, hand built, installed and maintained, including the Mt Cootha repeater, all the equipment by his own effort (no helpers).

This smooth and efficient service gradually extended its umbrella to cover Toowoomba and Tweed Heads in NSW.

At the time of Keith's retirement in the late 1960s, the number of taxi cabs equipped with his two-way radio system was approaching 200, all homebrewed and, of course, professional in appearance.

In amateur radio he became one of VK's greatest Dxers, remaining at the top of the DXCC ladder for many years.

Keith VK4KS is survived by his YL Gwen and daughters Joyce and Dawn. He will be sadly missed by his peers in this part of the Sunshine State.

Inserted by two of his lifelong mates,  
Fred Lubach VK4RF and  
Alan Shawsmith VK4SS

ar

**Help stamp out  
stolen  
equipment -  
always include  
the serial  
number of your  
equipment in  
your HAMAD.**

# Ionospheric Update

Evan Jarman VK3ANI\*

## Solar Activity

Solar activity was very low to low during the quarter. Two flares (class M1.9 at 1348 UTC, 1 April and class M1.3 at 2015 UTC, 21 May) saw activity rise to moderate level. There were also several geo-effective coronal mass ejection (CME) events.

## Ionospheric Activity

In April there was an ionospheric depression observed on 22 April due to geomagnetic activity on the previous day. A depression was also observed around Darwin from 26 to 30 April, cause unknown.

Around 15-16 May a disturbance made the ionosphere highly variable.

## Geomagnetic Activity

There were several disturbances during the quarter. They were related to CME events. The strongest were on 11 April and 15 May. A smaller disturbance at the beginning of May was also CME related. Activity in June was quiet, increasing to unsettled late in the month.

## T Index

The Ionospheric Prediction Service revised the T index values in June. Again, it was just fine tuning, particularly during 1997 as shown on the graph.

## Solar Cycle 23

As stated in the last quarterly update

(*Amateur Radio* May 1997, page 50) conditions are now under the influence of a new solar cycle, number 23. It is now accepted that this cycle's influence started affecting activity in early 1996. It has taken a little time to confirm this, mainly due to some unexpected activity.

The sunspot number first rose, then declined, confusing observers. After the sunspot number resumed rising, the minimum has been fixed at May 1996. The new solar cycle is not rising as quickly as its predecessors. It is the fifth slowest of the observed cycles based on observations to date. This does not reflect on the eventual cycle peak as these are still early days.

## Vale Solar Cycle 22

The passing of a solar cycle, one of old Sol's better efforts, cannot be left un-noted.

Solar cycle 22 had the shortest rise time, from minimum to maximum, of any cycle in recorded history. People were predicting that it would be larger than cycle 19, the highest on record. The rise in cycle 22, however, abated in early 1989 and then it peaked in July. There was then a gradual decline to the minimum in activity in May last year. The cycle was very active which should be reflected in log books. It also produced some remarkable activity for observers.

To quote from an Ionospheric Prediction Service Summary:-

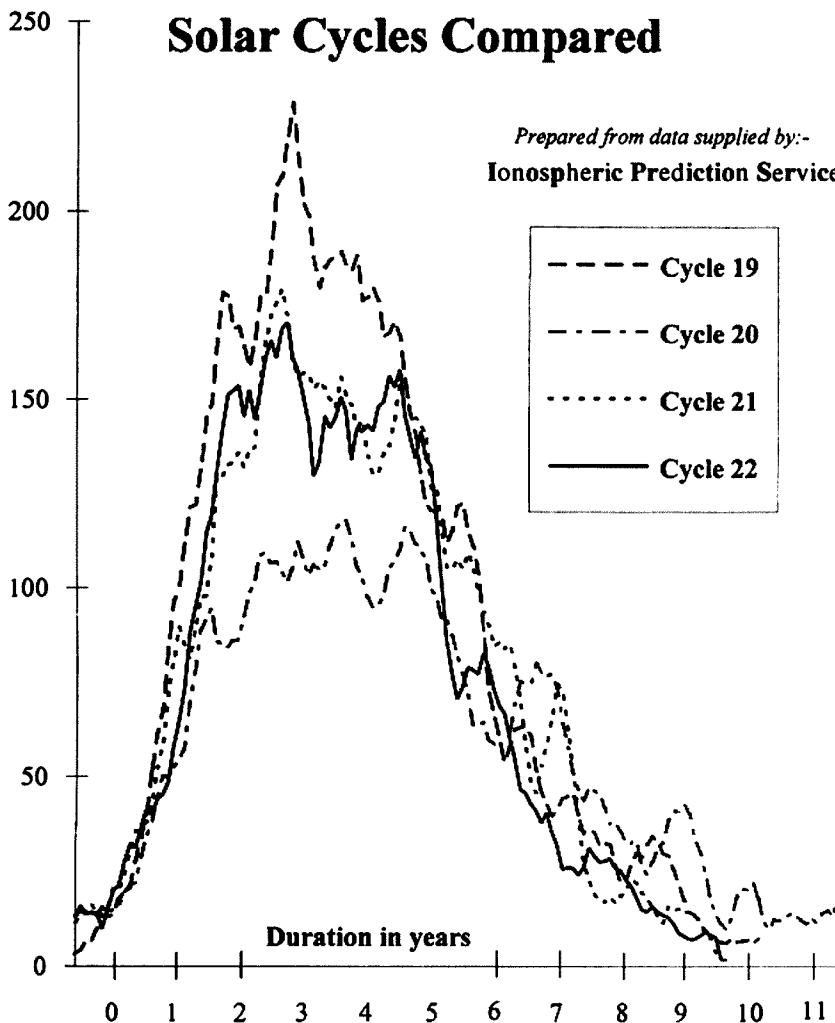
"Prime was the March 1989 period which started on 6 March with the appearance of a large sunspot region on the eastern edge of the sun. The next 14 days produced 11 "X-class" flares (the largest category in X-ray emission) and 48 "M-class" (still very large flares). However, the most outstanding feature occurred on 13-14 March with one of the largest geomagnetic storms in the last 50 years.

"The storm had an amazing list of effects on earth and in space. Power systems in Canada and Sweden failed as large electric currents were induced in power lines and tripped protective relays. Increased atmospheric drag resulting from the

## Sunspot Number

# Solar Cycles Compared

Prepared from data supplied by:-  
Ionospheric Prediction Service



Your

Hobby

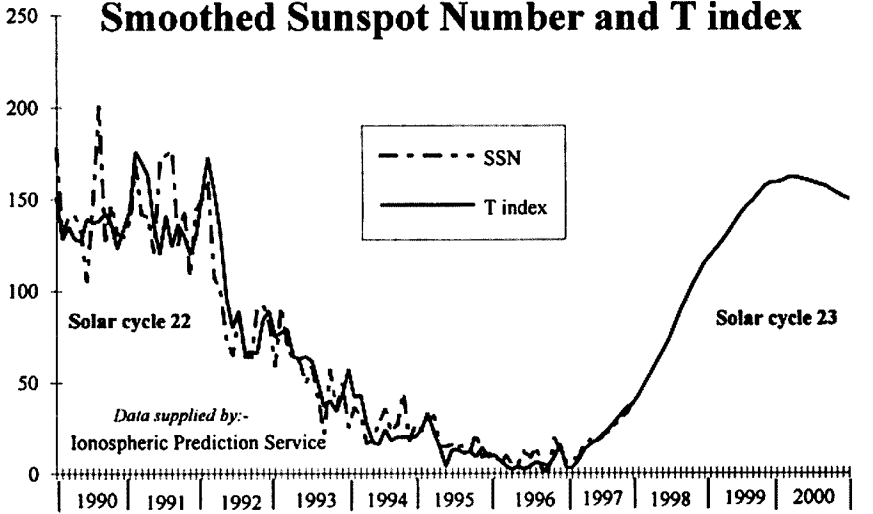
Your

Voice

Representing Radio Amateurs Since 1910



## Smoothed Sunspot Number and T index



during the month. These abrupt changes in the terrestrial magnetic field arise because of rapid ionisation of the D-layer of the ionosphere during a large solar flare (this is the same effect which causes short-wave fadeouts when HF signals are absorbed in the highly ionised D-layer).

"Magnetic crochets are rarely observed because a flare must be both energetic in X-rays and also occur close to local midday. In Sydney, at the IPS Space Forecast Centre, we saw three in one week. June 1991 was quite remarkable!

"The maximum phase of the cycle appeared to end rather abruptly in early 1992 when the monthly values of sunspot numbers dropped significantly. The decline of Cycle 22 to its minimum in May 1996 was also remarkable because of its lack of major flare activity. The cycle had a multiple personality - malevolent in its first half and quite benign in its decline. This contrasts with cycle 21 which was more active in its decline than during its rise or even its maximum. The cycle was less than 10 years in duration - a fair bit shorter than the "traditional" eleven year cycle.

"However, it is an interesting fact that all but one of the last seven cycles have been less than eleven years (Cycle 20 was the exception)."

A comparison graph overlaying the last four solar cycles shows how cycle 22 fared. The values used are running averages of five smoothed sunspot numbers (two preceding, two future and the current month). This crude filter removes minor perturbations but retains the shape of each solar cycle.

There were only three larger solar cycles (18, 19 and 21) and they were all exceptional.

\*C/o PO Box 2175, Caulfield Junction VIC 3161

ar

expansion of the earth's outer atmosphere during the disturbance, altered the orbits of many satellites with the result that NASA lost track of several of them for a short period. Satellite navigation systems failed to operate and High Frequency (HF) communications systems were also out of action.

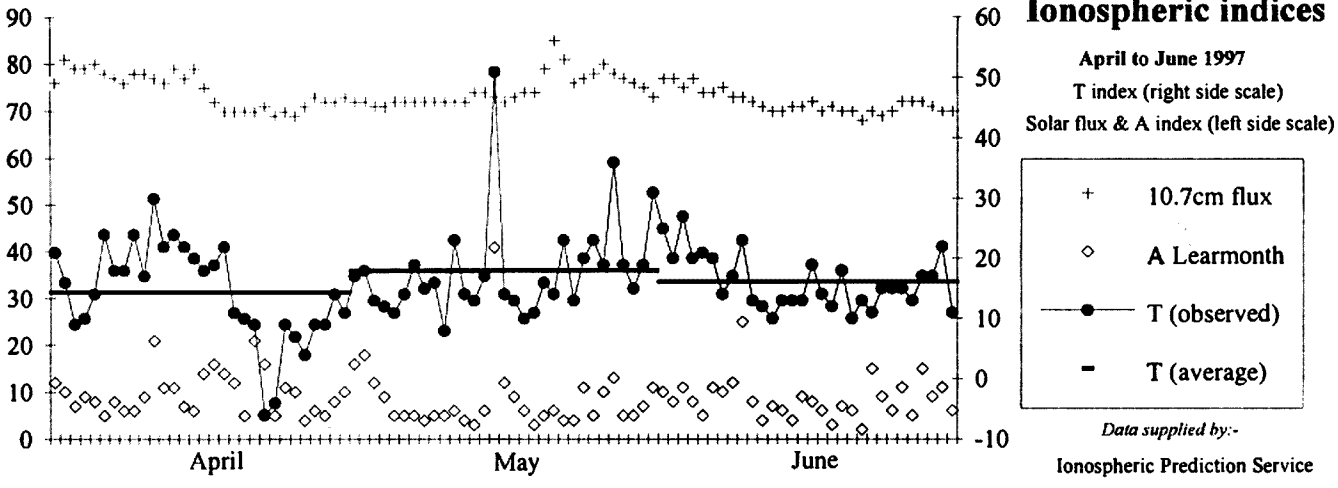
"Aurorae were sighted at quite high equatorial latitudes. The southern regions of Australia were under cloud but numerous sightings were made into Queensland and even Exmouth in Western Australia (which is north of the tropic of Capricorn)...

"June 1991 was the most outstanding solar flare activity of this cycle, and probably the largest since the peak of record Cycle 19. The interval from 1 to 17 June was filled with numerous intense solar flares. An interesting indicator of the strength of this activity came

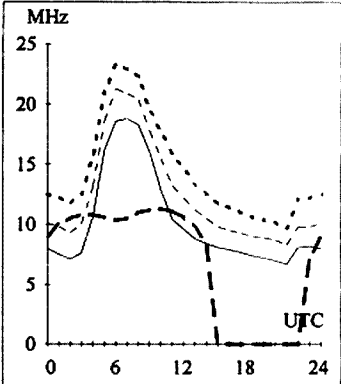
from the US GOES satellites which measure the X-ray output of flares. X-ray detectors on GOES saturated during five flares over the period. Other Flares have occasionally saturated the detectors but it was a unique event for more than one flare from a single region to achieve this feat.

"If saturation of the GOES detectors is a measure of strength, as in old time carnivals, then solar activity in June 1991 "rang the bell" like never before!

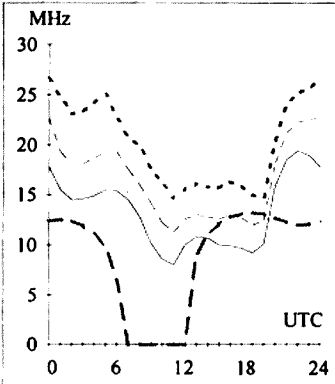
"In Australia, we were well placed to see the fireworks because, by sheer chance, many of the large flares occurred during the middle of our day. This meant that many local HF communications were badly disrupted by short-wave fadeouts which cut circuits for many hours. An interesting side effect was the occurrence of several magnetic crochets



**Adelaide-Botswana** 236  
Second 4F4-6 4E0 Short 10250 km



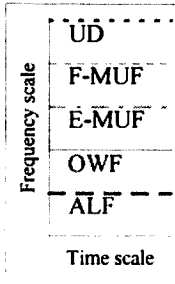
**Brisbane-Lima** 122  
First F 0-5 Short 13056 km



# HF Predictions

Evan Jarman VK3ANI

T Index: 24

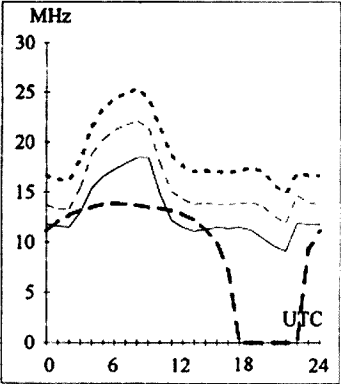


These graphs show the predicted diurnal variation of the key frequencies for the nominated circuits. This also indicates a possibility of communication (percentage).

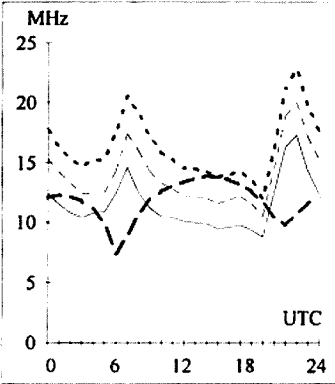
- The frequencies, identified in the legend, are:-
- Upper Decile (F-layer, 10%)
- F-layer Maximum Useable Frequency (50%)
- E-layer Maximum Useable Frequency
- Optimum Working Frequency (F-layer, 90%)
- Absorption Limiting Frequency

The predictions were made with the Ionospheric Prediction Service program, ASAPS V3.2. The T index used is shown above the legend. The Australian terminal azimuth, path and propagation mode are also given for each circuit.

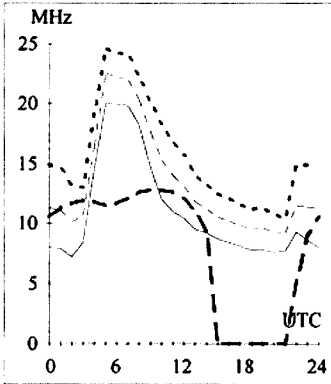
**Adelaide-Budapest** 305  
First F 0-5 Short 14908 km



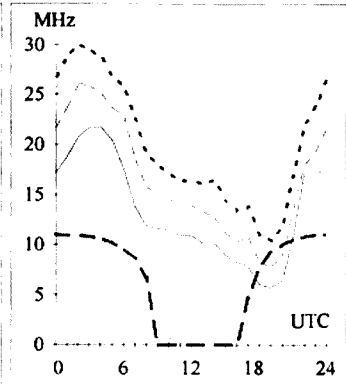
**Brisbane-London** 147  
First F 0-5 Long 23498 km



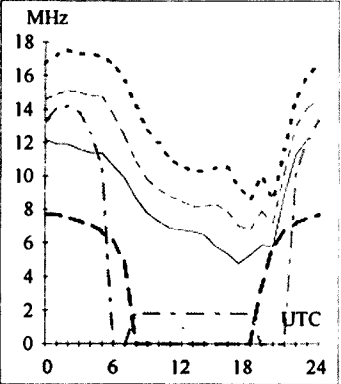
**Canberra-Lusaka** 239  
Second 4F2-4 4E0 Short 11620 km



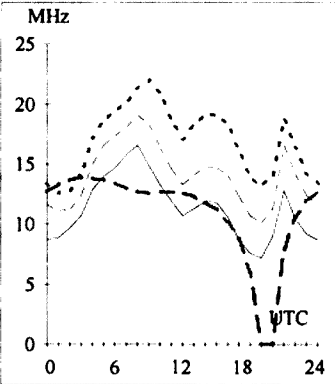
**Darwin-Honolulu** 65  
Second 4F7-12 4E0 Short 8636 km



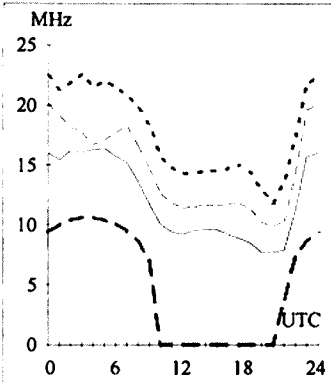
**Adelaide-Suva** 75  
Second 3F15-18 3E3 Short 4339 km



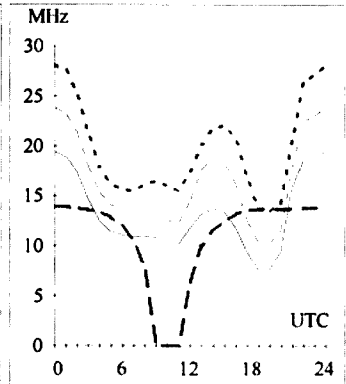
**Brisbane-London** 327  
First F 0-5 Short 16526 km



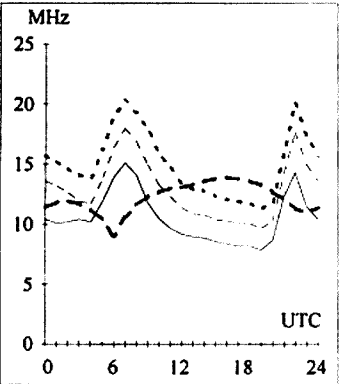
**Canberra-Manila** 327  
Second 3F8-13 3E0 Short 6286 km



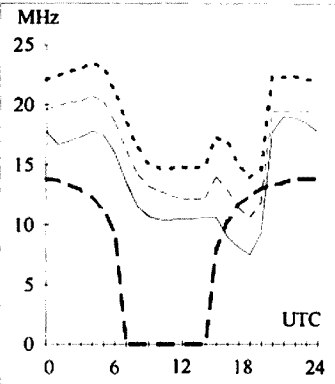
**Darwin-Miami** 61  
First F 0-5 Short 16443 km



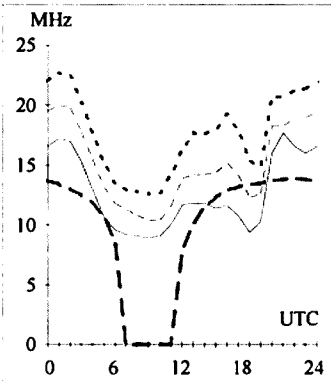
**Adelaide-Warsaw** 132  
First F 0-5 Long 25205 km



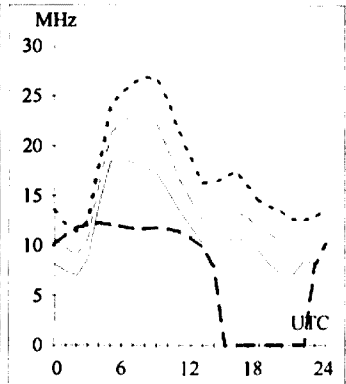
**Brisbane-Seattle** 44  
Second 4F2-6 4E0 Short 11845 km

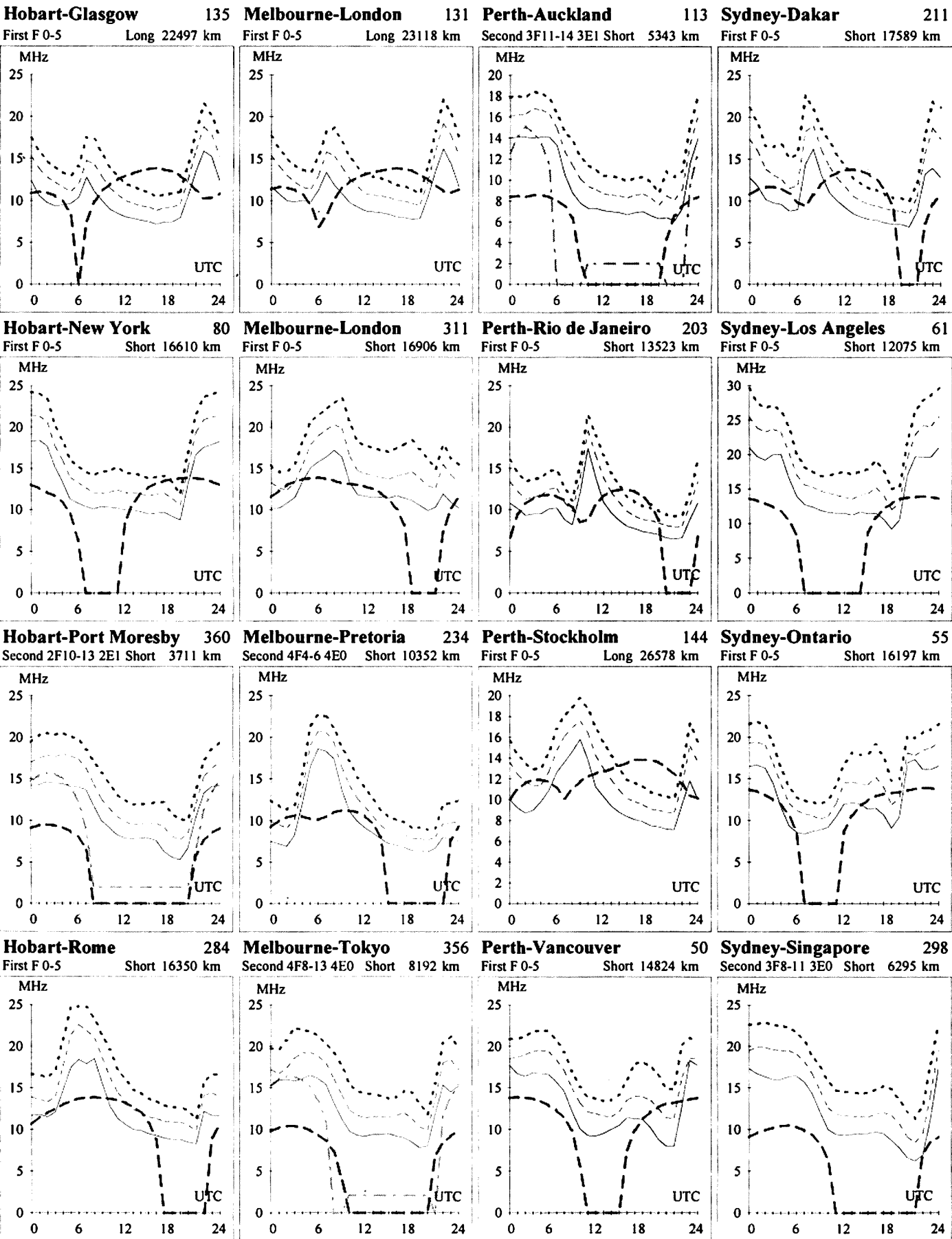


**Canberra-Ottawa** 59  
First F 0-5 Short 16100 km



**Darwin-Johannesburg** 241  
Second 4F4-6 4E0 Short 10639 km





# HAMADS

- Hamads may be submitted on the form on the reverse side of the *Amateur Radio* address flysheet. Please use your latest flysheet where possible.
- Please submit separate forms for For Sale and Wanted items, and be sure to include your name, address and telephone number (including STD code) if you do not use the form on the back of the *Amateur Radio* address flysheet.
- Eight lines (forty words) per issue free to all WIA members, ninth and tenth lines for name and address. Commercial rates apply for non-members.
- Deceased estates Hamads will be published in full, even if the ad is not fully radio equipment.
- WIA policy recommends that the serial number of all equipment offered for sale should be included in the Hamad.
- QTHR means the address is correct in the current WIA Call Book.
- Ordinary Hamads from members who are deemed to be in general electronics retail and wholesale distributive trades should be certified as referring only to private articles not being re-sold for merchandising purposes.
- Commercial advertising (Trade Hamads) are pre-payable at \$25.00 for four lines (twenty words), plus \$2.25 per line (or part thereof), with a minimum charge of \$25.00. Cheques are to be made out to: WIA Hamads.
- Copy should be typed or in block letters, and be received by the deadlines shown on page 1 of each issue of *Amateur Radio*, at:

Postal: 3 Tamar Court, Mentone VIC 3194  
Fax: (03) 9584 8928  
E-mail: vk3br@c031.aone.net.au

## TRADE ADS

- **AMIDON FERROMAGNETIC CORES:** For all RF applications. Send business size SASE for data/price to RJ & US Imports, PO Box 431, Kiama NSW 2533 (no enquiries at office please ... 14 Boanyo Ave Kiama). Agencies at: Webb Electronics, Albury; Assoc TV Service, Hobart; Truscotts Electronic World, Melbourne and Mildura; Alpha Tango Products, Perth; Haven Electronics, Nowra; and WIA Equipment Supplies, Adelaide.
- **WEATHER FAX programs** for IBM XT/ATs \*\*\* "RADFAXZ" \$35.00, is a high resolution short-wave weather fax, Morse and RTTY receiving program. Suitable for CGA, EGA, VGA and Hercules cards (state which). Needs SSB HF radio and RADFAX decoder. \*\*\* "SATFAX" \$45.00, is a NOAA, Meteor and GMS weather satellite picture receiving program. Needs EGA or VGA & WEATHER FAX PC card, + 137 MHz Receiver. \*\*\* "MAXISAT" \$75.00 is similar to SATFAX but needs 2 MB of expanded memory (EMS 3.6 or 4.0) and 1024 x 768 SVGA card. All programs are on 5.25" or 3.5" disks (state which) plus documentation, add \$3.00 postage. ONLY from M Delahunty, 42 Villiers St, New Farm QLD 4005. Ph 07 358 2785.
- **HAM LOG v.3.1** - Acclaimed internationally as the best IBM logging program. Review samples....AR: "Recommend it to anyone"; The Canadian Amateur: "Beyond this reviewer's ability to do it justice. I cannot find anything to improve on. A breakthrough of computer technology". ARA: "Brilliant". Simple to use with full help, the professional HAM LOG is immensely popular (now in its 5th year), with

many useful, superb features. Just \$59 (+ \$5 P & P), with a 90 page manual. Special 5 hour Internet offer. Demos, brochures available. Robin Gandevia VK2VN, 02 369 2008 BH, fax 02 369 3069. Internet address rh@ozemail.com.au.

## FOR SALE ACT

- **Log periodic antenna**, 8 el, 13-30 MHz, B Runnstrom VK1ABR, QTHR, 06 286 5652.

## FOR SALE NSW

- **Vernus regulated 25 amp PSU**, 50% duty, 13.8 V, 2 separate outlets, 5A metered 13.8 V, 1 x 32 V AC outlet unregulated, \$125 ONO. 6 M vertical antenna complete with loading coil, \$30 ONO. Harry VK2MNZ, QTHR, 063 771 040.
- **Kenwood TS-440S**, auto ATU, general coverage Rx, VGC, s/n 9020751, original packaging, \$1450 ONO. Paul VK2HV, 049 335 995.
- **Yaesu FT-101ZD**, VGC, new finals, mic, copy manuals, \$500. VK2UJ, QTHR, 068 653 213.
- **Realistic HTX-100** 10 m SSB/CW 25 W txcvr, good condn, \$140. Chris VK2YMW, QTHR, 02 9487 2764.
- **Cushcraft tri-band beam**, 10-15-20 m, with Emotator rotator and 7 metre mast with all guys and accessories ready to mount, plus 2 m 12 el antenna, everything in very good condn, the lot \$500. Ernest VK2BED, 02 9532 0175.
- **Kenwood TS-430S**, mic, manuals, \$950. PS-430 20 amp PSU, \$350. TR-8400 UHF txcvr, mic and manuals, \$350. Kenwood SM-220 station monitor with bandscope, \$350. **Reven Wave** monitor scope with manual, \$350. Kenwood AT-200 ATU, \$250. Daiwa four-way coax switch, \$50. Drake low-pass filter, \$50. John VK2FUR, 046 251 812.

- **Kenwood R1000** rcvr, s/n 0079614, good condn, instruction book, service manual, \$200. VK2AVT, QTHR, 02 9580 4325.
- Deceased estate: **FT-767GX HF**, 6, 2 and 70 cm txcvr, desk mike, \$2,900. Alinco DJ120, spkr mike, \$225. Yaesu FT-290R, AC PSU, \$300. KP600 rotator, \$300. Kenwood DS-900 12 V - 240 V inverter, offers to VK2AYD, 065 85 2647.
- **Icom IC-490A** 70 cm multi-mode txcvr, s/n 04182, plus Microwave Modules 70 cm 50 watt linear, s/n L432/507792010, \$550.00. Gecol GV-16 2 m h/held FM txcvr, s/n 000051, plus Alinco 2 m 30 watt linear amp, s/n 152101033, \$150.00. Randall VK2EFA, QTHR, 08 8087 5285.
- **Philips FM828 E Band** with details and components (not xtals) for conversion to six metres, \$50. W1Band, c/w speaker and mic, \$40. David VK2BDT, QTHR, 048 215 036.

## FOR SALE VIC

- **Plessey MTR-8000** 6 metre FM txcvr, 40 W output, 12 repeater channels, 12 simplex channels, remote head, hand mic and cables, \$150. Ray VK3RD, 03 9726 9222.
- **Kenwood TM-241A** 144 MHz txcvr, s/n 20702418, c/w mounting bracket for mobile use, phones and manual, \$490, negotiable. Kenwood TS-520S HF txcvr, s/n 810719, c/w phones, mic, manual, crystals on four ham bands, \$450 negotiable. Joe VK3DPB, 03 9306 9231.
- **Trio/Kenwood CS-1560A** 15 MHz dual trace oscilloscope, complete with probes and handbook, excellent condn, \$385 ONO. Akai 4000D reel-to-reel tape recorder and quantity of tapes, excellent condn, \$120 ONO. Ross VK3FCE, QTHR, 03 5442 8022.
- **Tektronix plug-ins** for 7000 series oscilloscopes. Wide range of pre-amps and time bases - 7A15, 7A16, 7A18, 7A24, 7B50, 7B53, 7B85 and more. Also HP, GR and Marconi and other test equipment. Prices from \$40 to \$150. All items VGC. Bob VK3BRF, QTHR, 03 9878 6613.
- **Shack clear out - Philips 815 and 814** (UHF are MK 1 & VHF MK 3) 50 watt base station transmitters, in-built 10 amp 13.8 volt power supply, \$100.00 each. LDF4/50 heliax cable (1.42 dB attenuation/100 ft at 400 MHz), length approximately 25 metres with terminated type N male and female connectors, \$125.00. **Rangemasters** converted to 6 metres FM, one with repeater VK3RMS and 53.5 MHz simplex, the other with repeater VK3RMS only, units physically small, with internal speaker, Tx power 25 watts, \$60.00 and \$45.00 respectively, ONO. Icom 551D 6 metre all mode 80 watt, with FM board, \$550.00. 160 metre AM transmitter, de-rated to 150 watts, has broadcast specs, complete with audio mixer, limiting amp, modulation monitors and dummy load, \$300.00, ONO. Military Radio Collectors Items: AT5/AR8 combination transmitter receiver with AC type S power supply and cables, handbook, \$320.00, ONO; No 19 set complete with handbook and spare chassis, \$250.00, ONO; No 22 set,

complete, \$250.00, ONO; **AR7 receiver**, unmodified, in mint condition, complete with handbook, \$200.00. Ian VK3AYK, 03 9585 1123 AH.

• **Icom IC-725 HF txcvr**, EC, \$995. **Icom IC-706**, all HF bands plus 6 and 2 m txcvr, EC, \$1650. Bill VK3WK, QTHR, 03 5561 1376.

• **IC-271A 2 m all mode txcvr**, internal PSU, \$850. **FM-321 80 channel 70 cm**, \$150. **TS-430S**, \$850. **IC-2GAT**, carry case, \$280. **FT-209RH**, \$220. **FT-209R**, \$150. **FT-23**, carry case, \$190. **IC-2SAT**, ext Rx, \$220. **BC-36 charger**, \$95. **FT-101ZD**, \$600. **FC-901 500 W ATU**, \$250. **FV-101DM digital ext VFO**, \$190. **FT-223 2 m FM mobile**, rpt 2-8, chan 50/54, \$95. **FM-92R 70 cm**, 99 chan, \$275. Lee VK3GK, QTHR, 03 9544 7368 or 015 810 101.

• **Icom IC22S 2 m txcvr**, complete with manuals, circuits, mobile bracket, original packing, etc, plus external switching system to get any frequency from 144 up, working at the moment, \$150. **PacComm Tiny-2 packet modem**, complete with instruction manuals, computer lead, original packing, little used, \$200. **Topward Model TFC 1207 frequency counter**, range 10 Hz to 1 GHz, complete with instruction manual and leads, EC, \$200. **Logitech ScanMan 256 hand scanner**, B&W, for Windows 3.1 and 95, as new with all hardware and software, original packing, had very little use, \$75. **ATN log periodic 8 el beam**, GC, see/hear working, 14 - 30 MHz cont, \$400. Bob VK3AQK, QTHR, 03 5744 1676.

• **Icom IC-471H UHF all mode txcvr**, s/n 03154, 13.8 V DC 75 W, unmodified, VGK, \$1160. Des VK3CY, QTHR, 03 5494 3156.

• **Alinco DR-599 2 m/70 cm 50 W mobile txcvr**, CTCSS/DTMF, as new, \$720. **Handi-Packet portable TNC**, \$150. **Tiny-2 TNC**, \$80. **DRSI packet computer card**, \$95. **Tokyo Hy-Power HL-62V 2 m 50 W amplifier with Rx pre-amp**, as

new, \$85. Kevin VK3ASM, QTHR, 03 9874 2046.

• **Kenwood AT-250 auto ATU**, 160-10 m, as new, boxed, \$200. **Kenwood PS-30 20 A PSU**, as new, boxed, \$175. **Terlin Outbacker type mobile whip**, 80-10 m and some RFDS frequencies, with matching HD spring base, \$150. **Mirage 80 W 2 m amp with Rx pre-amp**, \$125. Ron VK3OM, QTHR, 03 5944 3019.

• **Icom IC-701 solid state 100 W txcvr with desk mic**, GC, \$375 ONO. Bjill VK3DQS, QTHR, 03 9791 2947.

• **Kenwood TS-820S HF txcvr**, s/n 740961, excellent condn, overhauled by Kenwood in Sydney, mic, ext spkr, manual, DC converter, \$450 the lot, ONO. Gordon VK3ABI, QTHR, 03 5289 1812.

• **Two bedroom house**, Frankston South, well maintained, ducted heating/air conditioning throughout, land 800 sq metres, two street entrances, ideal ham site, includes Nally tower, TH6DXX, Council approved three unit site, \$129,000 ONO. VK3CLV, QTHR, 03 9787 4915.

### FOR SALE QLD

• **Yaesu FTI txcvr**, s/n 060010, passed OK by DSE, \$625, buyer collects. **Yaesu FT7 HF txcvr**, s/n 090745, \$300. **Yaesu HF whips with 2 m stub and gutter mount**, \$90. VK4KD, QTHR.

• **Radiotron Designer's Handbook 4th edition 1955**, \$40. **Henney Radio Engineering Handbook**, 3rd edition 1941, \$25. **Earth strap**, heavy copper braid inch wide, \$2 per metre. Peter VK4APD, QTHR, 07 3397 3751 AH.

### FOR SALE SA

• **Yaesu Musen FV-101 remote VFO for FT-101B**, \$100. **Icom IC-551 50 MHz transceiver fitted with FM and IF bandpass modules**, \$500. **GME Electrophone Model TX475S hand-held UHF 40 channel FM transceiver**, \$250. **KLM PA 10 160LB 160 watt 144 MHz amplifier**, \$350. Lunar

**ML432/50 432 MHz amplifier with pre-amp**, \$300. **MFJ-752 Signal Enhancer**, \$200. **Rustrak 88 chart recorder**, \$80. **Model 837-7 decibel meter in fine wooden case**, \$70. **Lunar PAG 432 MHz pre-amp**, \$150. **Lunar 6M3-50P 50 watts 50 MHz amplifier**, \$200. **MFJ six position switched attenuator**, suit EME station, \$150. **Speech processor**, \$40. **Air blowers**, two large, \$40 each. Set of five **mobile whips for HF bands** (will not split), \$120. Everything in very good condition. Eric VK5LP, QTHR, 08 8575 1531 (not able to answer before 0000 UTC), e-mail [vk5lp@ozemail.com.au](mailto:vk5lp@ozemail.com.au)

• **Yaesu FT-707 HF mobile or base station txcvr**, s/n 0K101217, mic, manual, etc, \$550 ONO, will deliver anywhere (if you don't know this txcvr, will send copy of review to you). David VK5AXW, 08 8370 1066 BH, or 08 8370 9569 AH.

### FOR SALE WA

• **QTH**, 3 bedroom, lockup garage, shack, Council approved mast, coastal location 65 km north of Perth, \$97500. David VK6ADP, 4 Dawes Court, Two Rocks, WA 6037, 08 9561 1865.

• **Kenwood TL-922 1 kW linear amplifier**, recent 3-500ZGs and spare pair, \$2100. Phil VK6APH, 08 9245 2973.

### WANTED ACT

• **Bird Model 43 or similar thru line power meter**. VK1BUC, QTHR, 062 916 187 (AH) or 062 613 019 (BH).

### WANTED NSW

• **Philips FM920 W1 or U band radio for modification to 70 cm**. Gary VK2TSR, 02 9631 9005 (Bus).

• **70 cm or dual-band SSB txcvr**, AC powered, eg Kenwood TS-780 or similar. What offers? Gordon VK2ZAB, QTHR, phone of fax 02 9456 4163.

• **Xerox of the Quick Reference instructions for a Mark II Avo valve tester**. Ben Furby VK2XNZ, QTHR, 02 9787 1353.

• **Yaesu FL-2100B or FL-2100Z linear amplifier**, must be VGC, prefer VK2 area but others considered. Paul VK2HV, 049 335 995.

• **Bird Thru-line wattmeter model 43**, in good order, preferably with plug-in sensor elements for 144, 432 and 1296 MHz. Guy VK2BBF, QTHR, 047 516 726

• **Resonators for Scalar Trident mobile whip**, 20 and 15 m. VK2ASI, QTHR, 067 657 947.

### WANTED VIC

• **AR7 communications receiver**, in any condn, and any spare coil boxes. Howard, 03 9408 7597.

• **Icom filters**, FL-223 1.9 kHz, FL-52A 500 Hz, and FL-53A 250 Hz.

Adam VK3ALM, QTHR, 03 9794 7873, e-mail: [adam@rint.com.au](mailto:adam@rint.com.au)

### WANTED QLD

• **RCA Receiving Tube Manual**, RC28 1970/1. Peter VK4APD, QTHR, 07 3397 3751.

### WANTED WA

• **3-500Z tubes and chimney**. HV filter capacitors. Henry VK6HJT, 08 9426 5809 (AH).

### MISCELLANEOUS

The **WIA QSL Collection** (now Federal) requires QSLs. All types welcome, especially rare DX pictorial cards, special issue. Please contact the Hon Curator, Ken Matchett VK3TL, 4 Sunrise Hill Road, Montrose VIC 3765, tel 03 9728 5350.

## QSP News

### Honorary Life Membership for Gary Herden VK5ZK

At the June General meeting of the VK5 Division, members voted unanimously to confer Honorary Life membership of the Division upon Gary VK5ZK.

Gary Herden has, over the years, made a major contribution to the cause of amateur radio. I believe that he has held his licence for something in the order of 35 years. He has served on the VK5 Council for at least 11 years and held office as Divisional President for two terms as well as the consequent two years as Immediate Past President.

Amongst the many things which Gary has done in contributing to the hobby are originating the Sunday broadcast from his own home in the 1960s era, co-ordinating the construction and installation of the original Adelaide two metre repeater at Crafrers, being involved in many facets of development of the packet radio system in South Australia, providing satellite

gateway facilities from his home station, serving as chairman on a variety of committees including the SA Technical Advisory Committee and SAPUG, acting as an OSCAR co-ordinator, being on the Sunday broadcast operators' roster, and providing liaison with the SMA on behalf of the Amateur Radio operators of South Australia. He was also involved in many hours of work during the period of conversion of the old Thebarton Council "incinerator" into what is now our Divisional Headquarters, the Burley Griffin Building.

There can be no doubt whatsoever that Gary has certainly more than earned the privilege of Life Membership. Congratulations are extended to Gary on behalf of all amateur radio operators and the many others of his friends. It is intended that a suitable presentation will be made to Gary at the July General meeting of the Division. (information from Ian J Hunt VK5QX, VK5 Division President)

# WIA Divisions

The WIA consists of seven autonomous State Divisions. Each member of the WIA is a member of a Division, usually in their residential State or Territory, and each Division looks after amateur radio affairs within its area.

Division	Address	Officers	Call Sign	Weakly News Broadcasts	1997 Fees
VK1	ACT Division GPO Box 600 Canberra ACT 2601	President Hugh Blemings Secretary John Woolner Treasurer Les Davey	VK1YYZ VK1ET VK1LD	3.570 MHz LSB, 146.950 MHz FM each Sunday evening commencing at 8.00 pm local time. The broadcast text is available on packet, on Internet <a href="http://aus.radio.amateur.misc">aus.radio.amateur.misc</a> newsgroup, and on the VK1 Home Page <a href="http://www.vk1.wia.ampr.org">http://www.vk1.wia.ampr.org</a>	(F) \$72.00 (G) (S) \$58.00 (X) \$44.00
VK2	NSW Division 109 Wigram St Parramatta NSW (PO Box 1066 Parramatta 2124) Phone 02 9689 2417 Freecall 1800 817 644 Fax 02 9633 1525	President Geoff McGrorey-Clark Secretary Eric Fossey Treasurer Eric Van De Weyer (Office hours Mon-Fri 11.00-14.00)	VK2EO VK2EFY VK2KUR	From VK2WI 1.845, 3.595, 7.146*, 10.125, 14.160, 24.950, 28.320, 29.120, 52.120, 52.525, 144.150, 147.000, 438.525, 1281.750 (* morning only) with relays to some of 18.120, 21.170, 584.750 ATV sound. Many country regions relay on 2 m or 70 cm repeaters. Sunday 1000 and 1930. Highlights included in VK2AWX Newcastle news, Monday 1930 on 3.593 plus 10 m, 2 m, 70 cm, 23 cm. The broadcast text is available on the Internet newsgroup <a href="http://aus.radio.amateur.misc">aus.radio.amateur.misc</a> , and on packet radio.	(F) \$69.00 (G) (S) \$66.00 (X) \$41.00
		Web: <a href="http://marconl.mpce.mq.edu.au/wia">http://marconl.mpce.mq.edu.au/wia</a> e-mail address: <a href="mailto:wiansw@sydney.dialix.oz.au">wiansw@sydney.dialix.oz.au</a> Packet BBS: VK2WI on 144.850 MHz			
VK3	Victorian Division 40G Victory Boulevard Ashburton VIC 3147 Phone 03 9885 9261 Fax 03 9885 9298	President Jim Linton Secretary Barry Wilton Treasurer Rob Hailey (Office hours Tue & Thur 0830-1530) Web: <a href="http://www.tbsa.com.au/~wivk/">http://www.tbsa.com.au/~wivk/</a>	VK3PC VK3XV VK3NC	VK3BWI broadcasts on the 1st Sunday of the month, starts 10.30 am. Primary frequencies 1.840 AM, 3.615 LSB, 7.085 LSB, and FM(R)s 146.700 Mt Dandenong, 147.250 Mt Macedon, 147.225 Mt Baw Baw, and 2 m FM(R)s VK3RMA, VK3RSH and VK3ROW. 70 cm FM(R)s VK3ROU and VK3RGL. Major news under call VK3WI on Victorian packet BBS.	(F) \$75.00 (G) (S) \$61.00 (X) \$47.00
VK4	Queensland Division GPO Box 638 Brisbane QLD 4001 Phone 074 96 4714	President Rodger Bingham Secretary Malcolm McIntosh Treasurer Bill Sebbens e-mail address: <a href="mailto:wiaq@brisbane.dialix.com.au">wiaq@brisbane.dialix.com.au</a>	VK4HD VK4ZMM VK4XZ	1.825 MHz SSB, 3.605 MHz SSB, 7.118 MHz SSB, 14.342 MHz SSB, 28.400 MHz SSB, 29.220 MHz FM, 52.525 MHz FM, 146.700 MHz FM, 147.000 MHz FM, 438.525 MHz (Brisbane only), regional VHF/UHF repeaters at 0900 hrs Sunday. Repeated on 3.605 MHz SSB & 147.000 MHz FM, regional VHF/UHF repeaters at 1930 hrs EAST Monday. Broadcast news in text form on packet under WIAQ@VKNET.	(F) \$74.00 (G) (S) \$60.00 (X) \$46.00
VK5	South Australian Division 34 West Thebarton Rd Thebarton SA 5031 (GPO Box 1234 Adelaide SA 5001) Phone 08 8352 3428 Fax 08 8264 0463	President Ian Hunt Secretary Graham Wiseman Treasurer Joe Burford Web: <a href="http://www.vk5wia.ampr.org/">http://www.vk5wia.ampr.org/</a>	VK5QX VK5EU VK5UJ	1827 kHz AM, 3.550 MHz LSB, 7.095 AM, 14.175 USB, 28.470 USB, 53.100 FM, 147.000 FM Adelaide, 146.700 FM Mid North, 146.800 FM Mildura, 146.825 FM Barossa Valley, 146.900 FM South East, 146.925 FM Central North, 147.825 FM Gawler, 438.425 FM Barossa Valley, 438.475 FM Adelaide North, ATV Ch 35 579.250 Adelaide. (NT) 3.555 USB, 7.065 USB, 10.125 USB, 146.700 FM, 0900 hrs Sunday. 3.585 MHz and 146.675 MHz FM Adelaide, 1930 hrs Monday.	(F) \$75.00 (G) (S) \$61.00 (X) \$47.00
VK6	West Australian Division PO Box 10 West Perth WA 6872 Phone 09 351 8873	President Wally Howse Secretary Christine Bastin Treasurer Bruce Hedland-Thomas	VK6KZ VK6ZLZ VK6OO	146.700 FM(R) Perth, at 0930 hrs Sunday, relayed on 1.825, 3.560, 7.075, 14.116, 14.175, 21.185, 29.680 FM, 50.150 and 438.525 MHz. Country relays 3.582, 147.350(R) Busseton and 146.900(R) Mt William (Bunbury). Broadcast repeated on 146.700 at 1900 hrs Sunday, relayed on 1.865, 3.563 and 438.525 MHz; country relays on 146.350 and 146.900 MHz.	(F) \$62.00 (G) (S) \$50.00 (X) \$34.00
VK7	Tasmanian Division PO Box 271 Riverside TAS 7250 Phone 03 6327 2096 Fax 03 6327 1738	President Ron Churcher Secretary Barry Hill Treasurer Mike Jenner	VK7RN VK7BE VK7FB	146.700 MHz FM (VK7RHT) at 0930 hrs Sunday relayed on 147.000 (VK7RAA), 146.725 (VK7RNE), 146.625 (VK7RMD), 3.570, 7.090, 14.130, 52.100, 144.150 (Hobart) Repeated Tues 3.590 at 1930 hrs.	(F) \$74.00 (G) (S) \$60.00 (X) \$46.00
VK8	(Northern Territory is part of the VK5 Division and relays broadcasts from VK5 as shown received on 14 or 28 MHz).			Membership Grades Full (F) Pension (G) Needy (G) Student (S) Non receipt of AR (X)	Three-year membership available to (F) (G) (X) grades at fee x 3 times

Note: All times are local. All frequencies MHz.

## ADVERTISERS' INDEX

Andrews Communication Systems	13	Terlin Aerials	45
Amateur Transceiver Radio	17	WIA Recruitment	25
Australian Electric Valve	5	WIA Membership Retention	7
Daycom	IFC	<b>Trade Hamads</b>	
Dick Smith Electronics	28, 29, IBC	M Delahunty	54
ICOM	OBC, 35	RJ & US Imports	54
Radio and Communications	5	HAMLOG - VK2VN	54

### TRADE PRACTICES ACT

It is impossible for us to ensure the advertisements submitted for publication comply with the Trade Practices Act 1974. Therefore, advertisers and advertising agents will appreciate the absolute need for themselves to ensure that the provisions of the Act are complied with strictly.

### VICTORIAN CONSUMER AFFAIRS ACT

All advertisers are advised that advertisements containing only a PO Box number as the address cannot be accepted without the addition of the business address of the box-holder or seller of the goods.

# Yaesu FT-1000MP

## Incredible Performance, Amazing Price!



Now's your chance to pick up Yaesu's highest performance HF base transceiver, the new FT-1000MP, at a very attractive price. You'll be amazed at its incredible performance, but if you need convincing, just read what the experts have to say.

### On Operation:

"I would classify the transceiver as 'user friendly' compared to some other modern transceivers I have operated." - CQ  
 "..... we found it to be a proficient performer." - QST  
 ".....In term of ergonomics my preference is marginally for the Yaesu.....The second receiver is certainly better implemented....."  
 - Radio Comms (UK)

### On Documentation:

"In general, Yaesu's manuals are the epitome of clear, concise, and complete documentation, and the FT-1000MP's 104 page Operating Manual is no exception." - QST

### On The Receiver:

"Its receiver is a real beauty ... its very clean and the audio is very clear and punchy ...." - Radio & Communications  
 "Measurement of second order intermodulation ... showed an average result for the IC-775DSP but the FT-1000MP was some 10dB better than any other radio measured." - Radio Comms (UK)  
 "The receiver is quiet and good at its job, and Yaesu's EDSP is icing on the cake." - QST  
 "Certainly, this receiver is designed to withstand the onslaught of very strong signals....." - CQ

### On The Transmitter:

"CW operators will be impressed with the FT-1000MP keyer." - CQ  
 "The transmitter is good as well, with a lightning fast automatic tuner built in as standard." - Radio & Communications  
 "The FT-1000MP has excellent spectral purity of the output signal." - CQ

### Digital Signal Processing:

"The EDSP filter operates smoothly and effectively in all of its modes." - CQ  
 "Having the DSP built-in means it works as well as possible - and is clearly better than most after-market add-ons." - Radio & Communications  
 "The double-whammy of crystal and mechanical filters plus DSP in the FT-1000MP is a killer combination." - QST

### Conclusions:

"... I am unable to report finding even a picky fault with the FT-1000MP." - CQ  
 "So does the inbuilt DSP say 'buy me'? In this humble scribes opinion, you bet!" - Radio & Communications  
 "The FT-1000MP offers performance and flexibility in a quality radio." - QST

Interested in more information? Why not call us for a copy of Yaesu's 12 page colour booklet, 46 page Technical Overview, or for copies of various magazine reviews. We're sure you'll soon agree that the world of HF transceivers has just taken a giant leap forward.

QST - ARRL QST (USA) Magazine review April 1996  
 CQ - CQ (USA) Magazine review April 1996  
 Radio Comms - Radio Communications (UK) magazine review January 1996  
 Radio & Communications - Radio & Communications (Aust) magazine review July 1996

Cat D-3400

**\$3995**  
**2 YEAR WARRANTY**



For further information, orders or the location of your nearest store call:

Ph: 1300 366 644 (local call charge)

Or Fax: (02) 9805 1986



Serious Performance For Every Amateur

**ICOM**  
Clearly Ahead

**THE ICOM AMATEUR RANGE** Delivering true professional features and performance to the world of amateur radio... that's what keeps Icom clearly ahead. From our dual band handheld IC-T7A, with amazing performance from such a small package... to our all mode transceivers led by the flagship of the range, the IC-756, with its array of features such as multi-function full dot LCD, and newly designed IF DSP. With Icom performance we'll take your operating experience to remarkable new levels.



**IC-821H**



**IC-T7A**



**IC-756**



**IC-706MK II**



**IC-207H**

For more information see your nearest Icom Dealer, or call free on 1800 338 915, or write to: Icom Australia Pty. Ltd. 290-294 Albert Street, Brunswick, Victoria 3056. Ph (03) 9387 0666 Fax (03) 9387 0022 A.C.N. 006 092 575



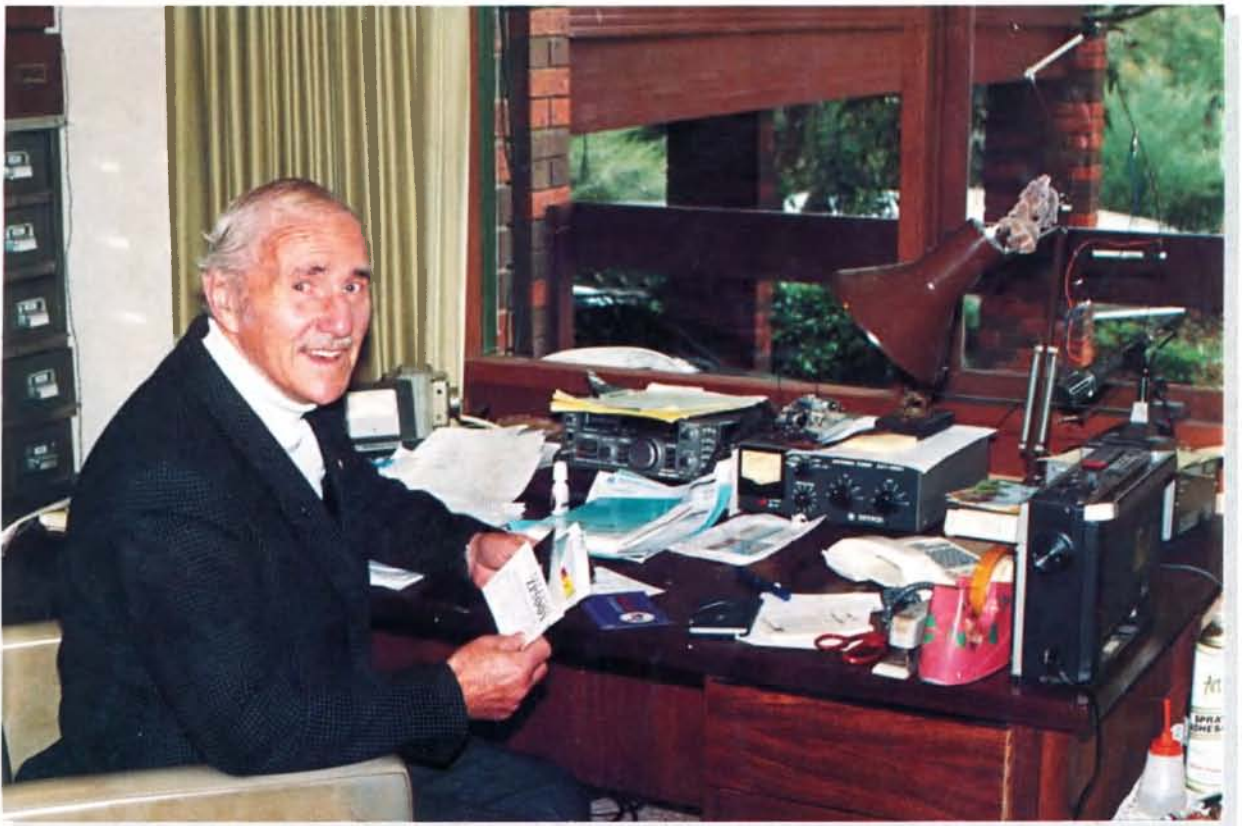
# Amateur Radio

September 1997

Volume 65 No 9



*Journal of the Wireless Institute of Australia*



*Full of the latest amateur radio news, information and technical articles including...*

- **A Receiver for the Garran**
- **10/14 MHz Vertical Antenna**
- **Time and Frequency**

**Plus** *lots of other articles, news and special interest columns*

## MFJ

### Performance you can afford!



**MFJ1278B** Multimode data controller, 10 modes including Pactor, AMTOR, RTTY, Packet, CW, SSTV, FAX and more. Latest version with enhanced mailbox.  
**MFJ1278B \$599**



**MFJ1276** Packet and PACTOR controller for HF/VHF Packet and HF PACTOR. Best value PACTOR around!  
**MFJ1276 \$349**



**MFJ1270C** The latest version of this popular VHF packet controller. 32K enhanced mailbox supplied. Best value packet on the market today!  
**MFJ1270C \$229**



**MFJ1214PC** for FAX, WeFAX, RTTY, ASCII and CW. Receive only or transmit operation possible. Supplied with all necessary IBM-PC software, works with any HF receiver.  
**MFJ1214PC \$299**

### MFJ784 DSP signal processor



Automatically eliminates heterodynes, reduces noise and interference on SSB, AM, CW packet, AMTOR, PACTOR, RTTY, SSTV, WEFAK and FAX as well as weak signal EME and VHF signals.

**MFJ784** DSP signal processor **\$499**

### MFJ Antenna Tuners

MFJ901B	200W Versatuner	\$149
MFJ910	Mobile antenna matcher	\$45
MFJ921	2 mtr 300W tuner	\$155
MFJ924	70 cm 300W tuner	\$155
MFJ931	Artificial ground tuner	\$169
MFJ941E	300W compact GP tuner	\$230
MFJ945E	300W mobile tuner	\$209
MFJ948	Deluxe 300W (no D/L)	\$270
MFJ949E	Deluxe 300W	\$299
MFJ962C	1.5kW tapped inductor	\$525
MFJ969	300W Roller inductor <b>NEW</b>	\$360
MFJ971	200W Portable tuner	\$190



MFJ986	3kW Diff-T roller inductor	\$629
MFJ989C	3kW Deluxe roller inductor	\$735

### MFJ969 NEW 300W tuner



Another MFJ innovation! Here at last is an economical 300W rated antenna tuner with the matching performance of a roller inductor. And even better still, it works all the way through 6 metres. Here is an all new tuner based firmly in the MFJ tradition of performance and value.

- Frequency range: 1.8-54MHz, all HF bands + 6m
- Huge low loss roller inductor
- Flexible antenna switching
- Built-in 300W dummy load
- Peak or average power reading on crossed needle SWR/Power meter
- Optional rear illumination of meter

**\$360**

# hy-gain

## HyGain DX77

### Advanced Vertical Window

- 7 Band Vertical
- 10-12-15-17-20-30-40 metres
- No ground radials required
- Tilt mount
- Height: 29 feet
- Power: 1.5kW
- Industrial grade construction
- Bandwidth (<2:1 SWR)
  - 10 metres 1.7MHz
  - 12 metres 100kHz
  - 15 metres 500kHz
  - 17 metres 100kHz
  - 20 metres 250kHz
  - 30 metres 100kHz
  - 40 metres 150kHz



Dayom and HyGain introduce the DX77 Advanced vertical Window with features surpassing any HF vertical on the market. The superior mechanical design, high power capability and 55% greater bandwidth than competitive verticals on 20 and 40 metres make it an exceptional value for a high performance system.

The unique design of this vertical antenna provides a no compromise performance without the need for ground radial wires. It puts the world at your fingertips on the HF ham bands, 10 through 40 metres, including the WARC bands! Capable of handling 750W average or 1500W PEP the HyGain DX77 won't balk at the output of your linear! Automatic band-switching and low angle of radiation allow for enhanced DX performance.

in stock now at  
**\$875**

## OPTOELECTRONICS XPLORER Test Receiver

All the information, in one hand!

In one convenient handfull the amazing new Optoelectronics XPLORER Test Receiver not only finds signals for you, but it will tell you frequency and deviation as well as decoding sub-audible and DTMF tones. Sweeping the range 30 to 2000MHz in less than 1 second the Xplorer will lock on to any signal in the nearfield and demodulate the FM audio for monitoring. You also see frequency on the LCD display along with other information about the signal.

- Frequency range: 30MHz - 2GHz
- FM Deviation range: 100kHz
- Audio frequency response: 50 - 3000Hz
- Auto sweep time: <1 second 30-2000MHz
- Internal speaker, headphone jack, tape control jack, serial interface connector, rotary encoder & flexible push button panel.
- Easy to read LCD display with EL backlighting
- Internal 7.2V 850mAh NiCd battery
- Rapid charging (<1hr) with intelligent charging controller
- NMEA-0183 interface for GPS receiver

**XPLORER Test Receiver \$1700**



## TT KIT

### The NEW Heathkit!



Help reclaim this fascinating band! Six metres is the VHF DX band and even now offers regular overseas contacts with just a little effort. The TT1208 kit is the ideal, low cost way, to get going on 6 metres and find out what only the elite have known for years!

- Requires 3-5W input on 20 metres
- Extremely simple hookup and operation
- Sensitive, low noise 50-54MHz front end
- Fast, silent PIN diode TR switch for QSK & data
- 8W output on 6 metres
- Requires 12-15V DC 3A power supply
- Simple switching between HF and 6 metres
- Rugged steel case

**TT1208 8W 6 metre transverter \$199**

# Amateur Radio



## Journal of the Wireless Institute of Australia

Vol 65 No 9

ISSN 0002-6859

September 1997

Amateur Radio is published by the Wireless Institute of Australia, ACN 004 920 745 as its Official Journal, on the last Friday of each month.

### Editorial

#### Editor

Bill Rice VK3ABP\*

#### Production Manager

Bill Roper VK3BR

#### Senior Technical Editor

Peter Gibson VK3AZL\*

#### Technical Editors

Evan Jarman VK3ANI\*

Gil Sones VK3AUI\*

Don Graham VK6HK

#### Contributing Editor

Ron Fisher VK3OM\*

Don Jackson VK3DBB\*

#### WIA News Editor

Roger Harrison VK2ZRH

#### Proof Readers

Allan Doble VK3AMD

Jim Payne VK3AZT

Graham Thornton VK3IY

John Tutton VK3ZC

\*Publications Committee member

### Production

#### Administration, Advertising, Drafting, Production

vk3br Communications Pty Ltd  
3 Tamar Court, Mentone VIC 3194

#### Typesetting and Printing

Industrial Printing and Publishing Pty Ltd  
122 Dover Street, Richmond, VIC 3121.

#### Mail Distribution

Mail Management Australia Pty Ltd  
6 Garden Boulevard, Dingley VIC 3172

#### New Advertising

Eyvonne & Keith Tootell

Union Publicity Service Pty Ltd

PO Box 282, Toongabbie NSW 2146

Telephone: 1800 654 181 - 02 9831 1299

Fax: 02 9831 6161

#### Amateur Radio Correspondence

All contributions, correspondence, Hamads and queries concerning the content of Amateur Radio should be sent to:

Amateur Radio

vk3br Communications Pty Ltd

3 Tamar Court, Mentone VIC 3194

E-mail: vk3br@c031.aone.net.au

Phone and Fax: 03 9584 8928

Mobile: 0418 534 168

Business Hours: 9.30 am to 3.00 pm weekdays

#### Amateur Radio Delivery

All correspondence and queries concerning the delivery of Amateur Radio should be sent to:

Amateur Radio

WIA Federal Office

PO Box 2175

Caulfield Junction VIC 3161

#### Registered Office:

3/105 Hawthorn Road

Caulfield North VIC 3161

Telephone: 03 9528 5962

Fax: 03 9523 8191

Business Hours: 9.30 am to 3.00 pm weekdays

#### Editorial and Hamads Deadlines

October 08/09/97

November 13/10/97

December 10/11/97

#### Receipt of Amateur Radio by Mail

The October issue will be delivered to Australia Post on Tuesday, 30 September 1997 for mailing to members.

If this magazine is not received by the 15th of the month of issue, and you are a financial member of the WIA, please check with the Post Office before contacting the registered office of the WIA. © Wireless Institute of Australia 1997

### CONTENTS

#### Technical

A Receiver for the Garran	8
<i>Peter Parker VK1PK</i>	
10/14 MHz Vertical Antenna	11
<i>Rodney Champness VK3UG</i>	
Random Radiators	15
<i>Ron Cook VK3AFW and Ron Fisher VK3OM</i>	
Technical Abstracts	17
<i>Gil Sones VK3AUI</i>	
Converting a Linear Reading Meter to SWR Figures	20
<i>Paul Clutter VK2SPC</i>	

#### General

Time and Frequency	12
<i>Paul Clutter VK2SPC</i>	
1997 Remembrance Day Contest Opening Address	19
Book Review - Build Your Own Intelligent Amateur Radio Transceiver	21
<i>Bill Rice VK3ABP</i>	
An Amateur and His Station - VK2EKY	55

#### Columns

Advertisers' Index	56	Intruder Watch	39
ALARA	22	Morse Practice Transmissions	51
AMSAT Australia	23	Over To You	40
Awards	25	Pounding Brass	42
Club Corner	35	QSLs from the WIA Collection	44
Contests	27	QSP News	40
Divisional Notes		Repeater Link	45
VK1 Notes	32	Silent Keys	50
VK2 Notes	32	Spotlight on SWLing	46
VK3 Notes	33	Update	50
VK5 Notes	33	VHF/UHF - An Expanding World	47
VK7 Notes	34	VK QSL Bureaux	20
Editor's Comment	2	WIA News	3, 10, 14, 22, 26, 31, 43, 46, 51
FTAC Notes	35	WIA - Divisional Directory	56
Hamads	54	WIA - Federal Directory	2
HF Predictions	52		
How's DX?	36		

#### Cover

Ken Matchett VK3TL, quite apart from being an active radio amateur and a notable marathon runner, particularly considering his age, is also Honorary Curator of the WIA QSL collection. Ken has built this QSL collection up into what is considered to be the biggest and most comprehensive collection of its kind in the world. (Photo by Ron Fisher VK3OM)

#### BACK ISSUES

Available direct from the WIA Federal Office, only until stocks are exhausted, at \$4.00 each (including postage within Australia) to members.

#### PHOTOSTAT COPIES

When back issues are no longer available, photocopies of articles are available to members at \$2.50 each (plus \$2.00 for each additional issue in which the article appears).

The opinions expressed in this publication do not necessarily reflect the official view of the WIA, and the WIA cannot be held responsible for incorrect information published.

# Amateur Radio Service

A radiocommunication service for the purpose of self-training, intercommunication and technical investigation carried out by amateurs, that is, by duly authorised persons interested in radio technique solely with a personal aim and without pecuniary interest.

## Wireless Institute of Australia

The world's first and oldest National Radio Society  
Founded 1910

Representing the Australian Amateur Radio Service -  
Member of the International Amateur Radio Union  
Registered Federal office of the WIA:  
3/105 Hawthorn Rd, Caulfield North, Vic 3161

All Mail to:

PO Box 2175, Caulfield Junction, VIC 3161  
Telephone: 03 9528 5962 Fax: 03 9523 8191

Business Hours: 9.30 am to 3.00 pm on weekdays

Federal Secretary  
Peter Naish VK2BPN

### FEDERAL OFFICE STAFF

June Fox	Book Keeper
Debby Johnston	Membership Secretary
Rita Trebilco VK3NRT	Examinations Officer

### COUNCIL

President	Neil Penfold	VK6NE
VK1 Federal Councillor	Richard Jenkins	VK1RJ
VK2 Federal Councillor	Michael Corbin	VK2YC
VK3 Federal Councillor	Brenda Edmonds	VK3KT
VK4 Federal Councillor	Ross Marren	VK4AMJ
VK5 Federal Councillor	Ian Watson	VK5KIA
VK6 Federal Councillor	Wally Howse	VK6KZ
VK7 Federal Councillor	Andrew Dixon	VK7GL

### EXECUTIVE

Peter Naish	VK2BPN
Rowland Bruce	VK5OU
Neil Penfold	VK6NE

### FEDERAL CO-ORDINATORS

AMSAT:	Graham Ratcliff	VK5AGR
Awards:	John Kelleher	VK3DP
Contests:	Peter Nesbit	VK3APN
Education:	Brenda Edmonds	VK3KT
EMC and Standards	Roger Harrison	VK2ZRH
FTAC:	John Martin	VK3KWA
Historian:	John Edmonds	VK3AFU
IARU:	David Wardlaw	VK3ADW
Int'l Travel Host Exch:	Ash Nallawalla	VK3CIT
Int'l Beacon Co-ord:	Roger Harrison	VK2ZRH
Intruder Watch:	Gordon Loveday	VK4KAL
ITU Conference and Study Group:	David Wardlaw	VK3ADW
Media:	Roger Harrison	VK2ZRH
QSL Manager (VK9,VK0):	Neil Penfold	VK6NE
Radio Sports:	Wally Watkins	VK4DO
Videotapes:	Bob Godfrey	VK4BOB
WICEN:		

### SMA LIAISON TEAM

Roger Harrison	VK2ZRH
David Wardlaw	VK3ADW
Neil Penfold	VK6NE

# Editor's Comment

## Oiling The Works

By "works" I mean the administrative machinery which, every month, purrs into action and produces yet another issue of *Amateur Radio*. It's operating pretty smoothly now, this being the ninth issue produced by vk3br Communications, but there are still a few little "glitches" needing a drop of "glitch oil"!

Glitch 1. Hamads are now processed directly by vk3br Communications, NOT by the Federal Office. If you send your Hamad form to the Office, as some still do, it may take another couple of days before it arrives in the right place and can be dealt with. BUT, if you are using the dual purpose form on the back of the flysheet to notify a change of address or callsign, then it must go to the office, because membership records are still an office responsibility (except in VK4 where the Division keeps the records). BUT, if you want to do both at once, that is notify a change AND insert a Hamad, then please use two separate forms. You get one every month as an address label so save a few just in case. But please don't use your change notification form to give your Hamad address. That should be part of the Hamad!

Glitch 2. Still on Hamads! Please make an effort to do your best block capitals when you fill in your Hamad details. A few are still not as legible as they could be. This is particularly important for model numbers, addresses, and phone numbers, and even more so if sent by fax. Some faxes are not as clear as others!

Glitch 3. This one has been with us since the magazine began. Our stock of technical articles is getting rather low. In other words, we are printing them faster than you are writing them. I know some of you have far exceeded the call of duty and sent in dozens if not hundreds of articles over the years! But we would like to see articles from new authors too! There must be dozens of readers out there with all kinds of expert knowledge. We would love to help you share it with your fellow amateurs.

Item 4. This is not a glitch, but another way of doing things (thereby avoiding glitches!). If your news item, column, article, etc includes photographs there is always a risk they could be

*Continued on page 51*

### CONTRIBUTIONS TO AMATEUR RADIO

*Amateur Radio* is a forum for WIA members' amateur radio technical experiments, experiences, opinions and news. Manuscripts with drawings and/or photos are always welcome and will be considered for possible publication. Articles on computer disk or via e-mail are especially welcome. The WIA cannot assume responsibility for loss or damage to any material. A pamphlet, "How to Write for *Amateur Radio*", is available from vk3br Communications Pty Ltd on receipt of a stamped, self addressed envelope.

## ■ WIA News

Roger Harrison VK2ZRH, Federal Media Liaison Officer.

### Further Concessions on Repeater and Beacon Fees

In confirming the \$50 per call sign per site per year renewal fees for amateur beacons and repeaters, the Australian Communications Authority (ACA) has advised further concessions.

The fee for new beacon and repeater applications will be the same as for renewals, that is, \$50. There will be no assignment fee. In addition, where beacon and repeater licensees wish to vary an existing licence, to add additional beacon frequencies or repeater systems for example, then a \$30 charge per variation to the licence will be payable, according to the ACA who wrote to the WIA in July.

The original verbal advice of proposed changes to the beacon and repeater fees regime, given to the WIA in

May from the then-SMA, warned that new applications might attract an "assignment fee", charged on an hourly basis. However, the level of the fees to be charged for new applications was subject to further advice, the WIA was told at the time, and this was indicated in the WIA News release of 28 May, and published in the July issue of *Amateur Radio* magazine (p 3).

The new licensing arrangement for beacons and repeaters was confirmed in written advice to the WIA from the ACA on 14 July. The letter said: "All Amateur Repeaters operated by one licensee at a site may now be authorised under a single Amateur Repeater licence. Under such an arrangement it is necessary for all Amateur Repeaters to operate under

the same callsign. Where different callsigns are required for every repeater they will have to be licensed separately.

"All links associated with the above Amateur Repeaters may also, providing they operate within amateur spectrum, be authorised under the one Amateur Repeater licence.

"Similar arrangements also apply to Amateur Beacons. Note that Amateur Repeaters and Beacons cannot be authorised on the one licence.

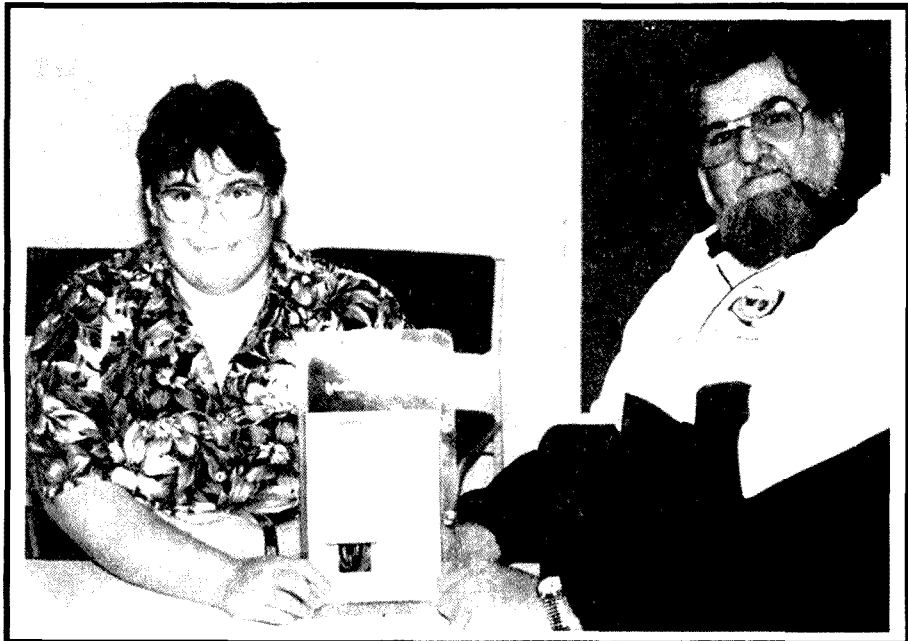
"Arrangements to change existing individual arrangements will only be made at the request of a licensee. All of the work to convert existing Repeater or Beacon licences will be done free of charge by the ACA."

The ACA added that any new applications will be treated in accordance with the new licensing policy, and that relevant policy and procedural documentation will be amended to reflect the changes. The ACA is writing to all repeater and beacon licensees on their register.

[Released 18/7/97. Updated 8/8/97].

### Winners are Grinners!

Happy with her windfall, is Trish Johnston of Donnybrook in Brisbane, winner of the Fluke 12B digital multimeter from the month of May's new WIA recruits, presented by WIAQ President, Rodger Bingham VK4HD. Trish decided to join the Queensland Division and filled out her subscription at the Brisbane Amateur Radio Club's BARCfest on May 3. (Picture courtesy of Laurie Pritchard VK4BLE).



Winners are Grinners!

## Andrews Communication Systems

(EST. 1976 - ACN 001 968 752)

**WE WILL NOT BE UNDERSOLD  
ON ALINCO RADIOS**

- ★ IC-756 HF+6M, DSP.LCD
- ★ IC-R10 HAND HELD SCANNER
- ★ WS-1000E CUTE SCANNER
- ★ DX-70TH HF+6M 100W
- ★ MFJ TUNERS AND CONTROLLERS
- ★ DX-1600 HF LINEAR AMP.
- ★ AR-5000 2.6GHz SCANNER

**3 YEAR WARRANTY ON  
OUR ALINCO RADIOS**

Call us now

**(02) 9636 9060** or (02)  
9688 4301

SHOP 8, 41 BATHURST ST, GREYSTANES,  
N.S.W. 2145. FAX (02) 9688 1995

# World Amateur Radio Day Events in Australia

Saturday, 20 September is *World Amateur Radio Day*, an International Amateur Radio Union – and WIA – supported activity for the promotion of amateur radio to the community. Amateurs in Queensland, South Australia and Victoria are organising events for the day.

The WIA Federal Council agreed earlier this year to support the event, which was announced in May and published in June *Amateur Radio* magazine (p 6).

The South Side Amateur Radio Society in Brisbane is organising a promotional event in the Market Mall at the Triple-C Shopping complex in Woodside. The complex is located at the corner of Wembley and Kingston roads. As Adam Jaroszuk VK4LAJ told *WIA News*, they're planning a 2 m packet radio station and a 2 m voice station working through the club's repeater, which is linked to 10 m. They'll be using the Society's call, VK4WSS.

To broaden the attraction, they'll have another computer system showing satellite tracks on-screen, with the intention of demonstrating that radio amateurs are involved in the exciting world of satellites and space technology. The SSARS is only planning a static HF display as the environment doesn't lend itself to HF operation, although they might be able to organise reception on the HF bands. The SSARS will be running their display over the hours the Mall is open, from 8.30 am to 5 pm. Contacts for further details are: Adam Jaroszuk VK4LAJ on 041 227 1095 (after 4 pm), or Barry Travers VK4BAZ on 07 3299 2739.

A joint effort between amateurs in South Australian and Victorian amateurs for World Amateur Radio Day is the Amateur Radio Balloon Experiment (ARBE), encouraging school science classes to participate. The mission is to launch a balloon from Gawler High School in South Australia, the anticipated flight path being across eastern South Australia into central northern Victoria. A payload package will carry a series of environmental

sensors and a 2 m FM beacon with voice-synthesised and data telemetry transmissions. At the flight's end, a self-deploying drag parachute will see the payload package returned safely to the ground.

The estimated flight duration is four to six hours from launch. The balloon is anticipated to reach altitudes of 60,000 to 80,000 feet, which would enable slant reception ranges for the 2 m telemetry beacon to be more than 500-600 km, so it should be able to be heard over quite a wide area. Only simple equipment will be needed to hear it, such as a 2 m FM receiver or a scanner with "NBFM" reception ability. A simple 2 m antenna, such as a ground-plane, or a wide-band antenna such as a discone, should be enough to hear the balloon's beacon

within the general flight zone. As it has voice telemetry, a cassette recorder can be used to record signals. A computer and simple decoder and terminal program can be used to receive ASCII telemetry.

The project is being co-ordinated by Tony Van Lysdonk VK5WC, SA Division Education Co-ordinator. The flight package is being built by Geoff Baxter VK3ZVW, while Glenville Sawyer VK5ZCF is providing downlink telemetry evaluation and has written a Web site for the project. Check it out at <http://dove.net.au/~gsawyer/balloon1.html>.

If any other Divisions or groups organised events for World Amateur Radio Day, let *WIA News* know, via e-mail to [rogerh@apogee.com.au](mailto:rogerh@apogee.com.au), fax to (02) 9327 7985, or regular mail to LMB 888, Woollahra NSW 2025.

[Released 11/8/97]

## 25th SEANET Convention for Darwin

The 25th annual convention of the South East Asia Amateur Radio Network will be held this year in Darwin over 14-16 November, hosted by the Darwin Amateur Radio Club Inc (DARC).

The SEANET convention is held each year in November at a venue somewhere in the South East Asian Region. This is the second time that Darwin has hosted the convention. The last occasion was in 1992, which the Federal Government used to announce changes to the amateur radio licensing regime, which subsequently led to the introduction of the new Novice Limited licence and the creation of the Intermediate licence.

SEANET is an informal network of

amateurs from the South East Asian region who hold a nightly net on 14,320 kHz at 1200 UTC. It began in 1964.

The official SEANET station for the event, VK8SEA, will be in operation over the weekend of the convention. So, there'll be some operating between eyeball QSOs, partying, touring and attending seminar sessions. Further details from DARC President, Spud Murphy VK8ZWM on 08 8983 2456 (after hours), or to DARC at PO Box 41251, Casuarina NT 0811. Web surfers should check out [www.topend.com.au/~seanet](http://www.topend.com.au/~seanet).

[Released 11/8/97]

**Help stamp out stolen equipment  
- always include the serial  
number of your equipment  
in your HAMAD.**

## Flukes for Recruits!

The prize draws for both June's and July's crop of new recruits are available this month, so we have two winners to announce, who will each receive a Fluke 12B digital multimeter donated by Philips Test & Measurement.

A YL from Indianapolis, Indiana, in the USA won the June prize draw. She is the second YL and the second Queensland Division member to win the Fluke 12B digital multimeter in the WIA monthly recruitment draw. She's **Roberta Barmore KB9GKX**, who works as an executive in the local television station. Roberta was recruited on-air by past Queensland Division President, Murray Kelly VK4AOK. Apparently, either the prize or Murray's persuasive tones were irresistible - she signed up for a three-year membership!

Another Johnston won the July prize draw, the same name as won the May draw. However, **A S Johnston VK6SWR**, hails from Western Australia and scooped the pool from a total of 34 new members for July!

To date, three NSW Division members have taken the Fluke 12B multimeter prize, all in the first three months of the year, and one Victorian Division member. Now, the WIA's recruitment drive is world-famous and, for the first time, a prize goes west!

There's a multimeter to be won every

month throughout 1997 in a draw from among new WIA recruits joining in any particular month. The Fluke 12B digital multimeter is worth \$195, and the 12 prizes have been generously donated by Philips Test & Measurement. Fluke is the world's pre-eminent manufacturer of digital test instruments and the Model 12B is from their latest range of hand-held instruments.

The Fluke 12B measures AC and DC voltage (with auto-selection above 4.5 V), resistance and capacitance from 1000 pF to 1000 µF. The instrument features a simple rotary dial, a 4000-count liquid crystal display, and diode and continuity testing. Its "continuity capture" feature indicates intermittent open and short circuits. It comes with test leads and a two-year warranty.

Every newcomer to electronics and amateur radio needs a good multimeter, and every seasoned enthusiast could always do with another one. And the chances of winning are **very** good!

Membership recruitment advertisements appear in each issue of *Amateur Radio* magazine, and in *Radio and Communications* magazine. Membership recruitment and renewal advertisements are also on WIA Divisions' World Wide Web pages on the Internet.

[Released 14/8/97]

## Amateurs in New Zealand Restricted by New TV Station

With the installation of a TV translator near Auckland, operating on New Zealand Channel 1 (44-51 MHz), amateurs in Auckland were notified by letter on 28 June 1997 that they were to cease operation on the 50.0-50.15 MHz band.

In New Zealand, the Amateur Service is a secondary service on the two 6 m bands allocated there, of 50.0-50.15 MHz and 51-53 MHz. The 6 m "DX Window" at 50 MHz is allocated in New Zealand only on "a temporary basis".

The NZART's Terry Carrell ZL3QL said that the Association previously had received assurances from the local broadcaster that they would not take up use of Ch 1 in Auckland.

In any case, use of the 6 m band by any amateur station requires approval from the New Zealand Ministry of Commerce Communications Division. It is understood that some amateurs in the Auckland area may gain access to the 6 m band on a non-interference basis following the submission of new permit applications and testing and approval by the authorities. New Zealand amateurs have something less than a secondary status in the 50.0-50.15 MHz band.

[Released 12/7/97. Updated 8/8/97].



**YOUR HOBBY** **YOUR VOICE**  
Representing Radio Amateurs - Since 1910

# RENEW YOUR MEMBERSHIP AND YOU COULD WIN



**THIS KENWOOD TM-733A  
2m/70cm FM/packet rig  
worth \$1255**

50 W on 2m 35 W on 70cm  
Switchable 10 W/5 W RF output  
Simultaneous VHF-UHF reception  
Data input for 1200/9600 baud packet  
70 multi-function memories

**All you have to do is renew  
your Division membership  
when it falls due**

**WHO'S ELIGIBLE? ● members  
whose renewal falls due between  
1/1/97 and 31/12/97 ● current  
members who are on a 3-year  
membership ● life members, and  
● all membership grades.**

**The prize will be awarded by means  
of a draw, the result to be  
published and the prize to be  
presented to the winner at the first  
available opportunity early in 1999.**

TM-733A prize kindly donated by  
Kenwood Electronics Australia P/L,  
PO Box 504, Homebush 2140.  
Ph: (02) 9746 1888. Fax: (02) 9746 1609.

# Impact on Amateur Bands from Recent Radcom Licensing Changes

Further to last month's news about new Class licensing changes affecting 430 MHz, that news item also revealed that the WIA had raised concerns with the SMA about the proliferation of permitted devices on the 2.3 GHz, 5.65 GHz and 24 GHz bands.

However, the Class licence for "low interference potential devices" (LIPDs) updated in June also provided new access for RF identification (RF ID) transmitters at 2.93-3.58 MHz and 7.2-10.01 MHz, which potentially impacts the 80 m and 40 m bands. The 80 m band has been shared with Class-licensed "RF tag" devices (for 3.5-3.7 MHz operation) since 1990 (see WIA News, *Amateur Radio* magazine, April 1990, p 3).

RF tags are a technology used for 'wireless' identification or security of merchandise. However, with radiated powers of 30 picowatts, their signals fade into the general urban noise level within 30-40 metres of where the devices are installed. The new allocations for RF ID applications are authorised for a maximum power of 100 picowatts (EIRP), which means that about 100 m or more away from the source, the signal falls below the general urban RF noise levels. If you're unlucky enough to live next door to a location where one is installed and it interferes with 80 m reception, a polite approach to the

operator and local ACA area office should open the way to solving the problem. As a taxpayer and a fee-paying licensee, you're entitled to relief from interference.

While the earlier LIPD Class licence which the June issue replaced provided access for telecommand/telemetry and RFID transmitters of 1 W on 2400-2450 MHz, and 5725-5875 MHz, devices having 2 W output are now permitted on 5795-5815 MHz. The previous access for 1 W devices has been split into two sub-bands, at 5725-5795 MHz and 5815-5875 MHz. Any devices operating in 5815-5875 MHz may affect satellite reception as 5830-5850 MHz is the amateur satellite downlink segment on the 6 cm band. The only saving grace (?) is that these devices are intended for in-building applications and employ low-gain antennas. Amateurs are a secondary service on this band, and that includes amateur satellites. Radiolocation (radar) is the primary service, so there's going to be more sharing.

The situation on 13 cm (2300-2450 MHz) has been deteriorating in recent years and the outlook for amateur operations on the band is not bright. Already, activity has been affected since the introduction of microwave distribution services (MDS) in 1993, using 2300-2400 MHz for Pay TV

distribution and for commercial high speed data links. Installations have proliferated in Adelaide, Brisbane, Melbourne and Sydney. Both narrow-band and wide-band amateur activities have been affected in these cities, in areas surrounding MDS installations. In addition, wireless local area network (wireless LAN) systems are an application for which a special Class licence was created in 1996, licensing spread spectrum modulation equipment for powers up to 4 W, specifying bands at 2400-2483 MHz and 5725-5875 MHz.

Other applications include wireless PABXs, wireless barcode readers and point-of-sale (POS) networking. Transmitter power of 200 mW is allowed in 2463-2483.5 MHz, 4 W in 2400-2463 MHz, and 1 W in 5725-5875 MHz. These applications are also generally meant for in-building installations and employ low-gain antennas.

As amateur activity is "retreating" to 2400-2450 MHz, the 4 W power for devices using 2400-2463 MHz represents an additional potential threat to amateur operations, especially considering the 2400-2403 MHz Amateur satellite segment and other weak-signal segments above 2403 MHz. Permission for 1 W devices in this band was brought in with the 1993 LIPD Class licence.

The finalisation of IEEE Standard 802.11 applicable to wireless LAN technology is likely to lead to an explosion in development and sales of technology exploiting the standard and thus of systems making use of 2400-2483 MHz and 5725-5875 MHz.

With transmitter powers of 1 W permitted on 2400-2450 MHz and 24-24.25 GHz under the LIPD Class licence, the WIA raised particular objection to the latter, as the lower 50 MHz of the 1.25 cm (24 GHz) band is the first primary amateur band segment above 2 m, and is an amateur satellite band.

LIPD applications have something less than secondary status, and the licence conditions offer no protection from interference. But that's of little consequence when an attempted contact fails as a result of random or intermittent interference which is hard to track down.

[Released 11/8/97]

---

## A Right Royal Contact!

Queen Elizabeth II made ham radio history on Wednesday, 25 June 1997 when she took the microphone at special event station VO500JC at Signal Hill in Newfoundland to transmit a message to GB500JC in Bristol, to commemorate the 500th anniversary of the voyage of British explorer John Cabot aboard the vessel "Mathew" sailing from Bristol, England, to Newfoundland in what is now Canada.

The Radio Society of Great Britain's GB2RS News service reported that, despite poor propagation conditions between Newfoundland and Bristol at the time, good contact was made between 1801 and 1805 UTC on 20 m SSB.

Her Majesty the Queen, speaking in English and French, said: "*I am speaking to you now from Signal Hill National Historic Site, d'ou Guglielmo Marconi a recu le premier signal transatlantique de radio. I am happy to know that Newfoundland and Labrador is still in the forefront of the communications industry and is working closely with other leaders in this field across the Atlantic.*"

The RSGB said that they believed this was the first time that a reigning British monarch had transmitted on amateur radio.

[Released 12/7/97].



# Common Date Membership Renewal Abandoned

The WIA Federal Executive has abandoned common-date membership renewals as a result of a review of the system's impact following a phase-in period over January to June this year.

Anticipated cost savings could not be achieved owing to the necessity of having to accept new memberships as recruits joined and the ongoing cost of maintaining new member record-keeping, together with the cost of training casual staff planned to be employed during the renewals peak period. Some loss of members resulted from the issuing of renewals for longer than 12-month periods in the quarter before 1 July.

Membership renewal has returned to the anniversary system where members' renewals are sent out the month before the anniversary of their joining. Those who renewed during the common-date adjustment period to 1 July will receive renewals in 1998 according to when they renewed this year.

**Renew for a chance to win!** For those whose renewal is still to come between now and December, remember that you stand to win a fabulous Kenwood TM-733A dual-band 2 m-70 cm transceiver worth \$1255 - that's around 18 to 20 years worth of membership!

This outstanding rig, generously donated by Kenwood Electronics Australia, features FM and packet radio operation, 50 watts output on 2 m, and 35 watts on 70 cm. In addition, it features simultaneous dual-band VHF-UHF reception, and dual-channel reception on VHF and UHF.

The TM-733A also has a data connection for 1200 or 9600 baud packet radio, switchable 10 W/5 W RF output, automatic repeater offset on 2 m, selectable frequency steps, 70 multi-function memories, and a large, high-visibility LCD panel.

All you have to do to be in the draw for this great rig is renew your Division membership when it falls due.

The prize will be awarded by means of a draw, the result to be published and the prize to be presented to the winner at the first available opportunity early in 1998.

All members whose renewal falls due between 1 January and 31 December 1997 are eligible, and all membership grades are included, as well as life members and current members who are on a three-year membership.

*[Released 12/7/97. Updated 11/8/97]*

---

## Review of Radcom Act Under Way

The opportunity Australia's amateur radio community has been waiting for, to have the amateur licensing system reviewed so that we can "get out from under" the wholly unsuitable commercial framework of Apparatus Licensing, has arrived with the foreshadowed review of the Radiocommunications Act 1992 and recent amendments, announced by the Department of Communications and the Arts (DoCA) at the end of July.

This review is where the WIA's submission, "*Towards a New Licensing System*", is to be considered. The submission, presented to the Minister for Communications in February, has already been passed from the Minister's office to DoCA for this review.

In opening the review, the Department called for public submissions, requesting comment on:

- How the appropriateness, effectiveness and efficiency of spectrum management should be assessed;

- What, if any, special provisions need to apply to particular classes of spectrum users;

- Any difficulties experienced with current arrangements, including any excessive red tape, paper work or compliance burdens (particularly for small business); and

- Alternative spectrum management options that should be considered by the review.

The WIA submission sets out that Australian radio amateurs require:

- individual licences,
- certainty of licence tenure,
- where fees are applicable, an equitable fees framework,
- certain and continuing access to frequency bands throughout the radio-frequency spectrum, and
- continuing participation in spectrum management processes at local, national and international levels.

The deadline given for receipt of public comment was 29 August.

The WIA submission calls for amendment of the Radiocommunications Act, to create a fourth licence type, simply titled *The Amateur Licence* which, for anyone meeting the requirements of the appropriate AOC, would be issued once-only, for life, or alternatively, issued for terms of five years, with renewal. The submission's approach in putting an "either/or" case for issuing licences (whole of life, or five-year terms) was done after considering tactical approaches used by lobbyists, lawyers and legislators. Where any situation is open to negotiation, everyone knows there is no "one right way". Providing alternate approaches acknowledges this and substantially reduces the risk of outright rejection or diminishing recommendations or claims, and forces wider consideration of arguments and supporting evidence.

The WIA's position is that, for the purposes, role and activities of radio amateurs, the current three licensing systems have conflicting limitations, restrictions and administrative constraints. In addition, the fees framework of the Apparatus Licence system embodies the concept of "spectrum denial" and employs a Spectrum Access Tax (SAT) formula that values scarcity and demand, and acts as "a rationing device." These are all precepts of a commercial, economic nature and not applicable to the Amateur Service which is a voluntary, non-pecuniary service, the WIA submission points out, and impossible to apply to Amateur licences.

The submission points out that there is scope to waive amateur licence fees, as has been done in the USA, but if the government is determined to charge, then we would be better served by a more equitable licence fee regime that reflected the value to the community of

the Amateur Service. To support this, the submission demonstrates with documented instances how the Amateur Service:

- creates within the community a pool of technically knowledgeable people trained in communications operations,
- motivates young people to take up scientific or technological careers,
- contributes to the advancement of scientific knowledge,
- contributes to the development of technology and the communications infrastructure,
- enhances international understanding and goodwill, and
- provides communications support during emergencies and for community activities.

The submission calls for waiving the Spectrum Access tax and reducing administrative charges (currently \$36), to be achieved by reducing amateurs' 'engagement' with the ACA through devolving more administrative work to the amateur community, such as issuing Certificates of Proficiency, and call sign management. The issuing of licences can be separated from the allocation of call signs. The licence itself is a legal document, while your call sign is a convenient means of individual on-air identification. One can be issued without the other. If the ACA issued licences and the WIA (as the peak body) allocated call signs, and administered the relinquishment or changing of call signs, the Authority's administrative costs would fall. Likewise, if licences were issued only once and either never renewed, or renewed at less frequent intervals than yearly, costs would fall. Everyone, administrators and amateurs alike, would benefit. Here's hoping the WIA's submission receives favourable consideration.

[Released 11/8/97]

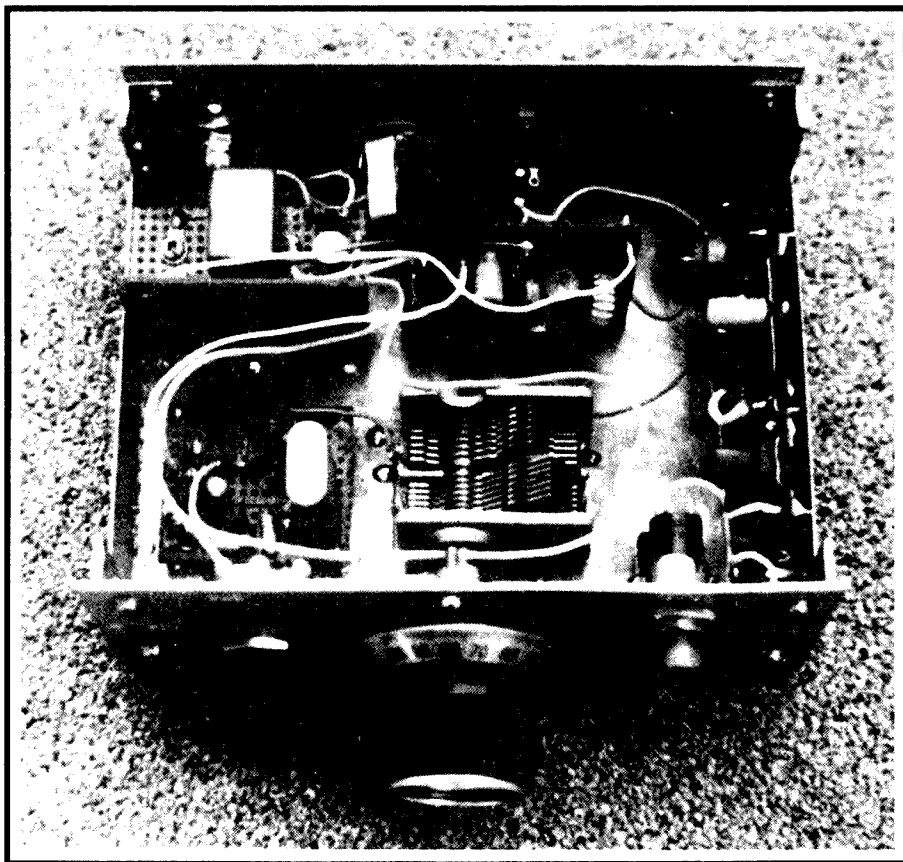


Your Hobby Your Voice  
Representing Radio Amateurs Since 1910

## ■ Transceivers

# A Receiver for the Garran

*Peter Parker VK1PK\* describes a matching receiver for his Garran CW QRP transmitter.*



**The Garran Transceiver. Clockwise from the tuning capacitor the circuit boards are VXO and buffer, keying stage, transmitter driver/power amplifier, and receiver section.**

## Introduction

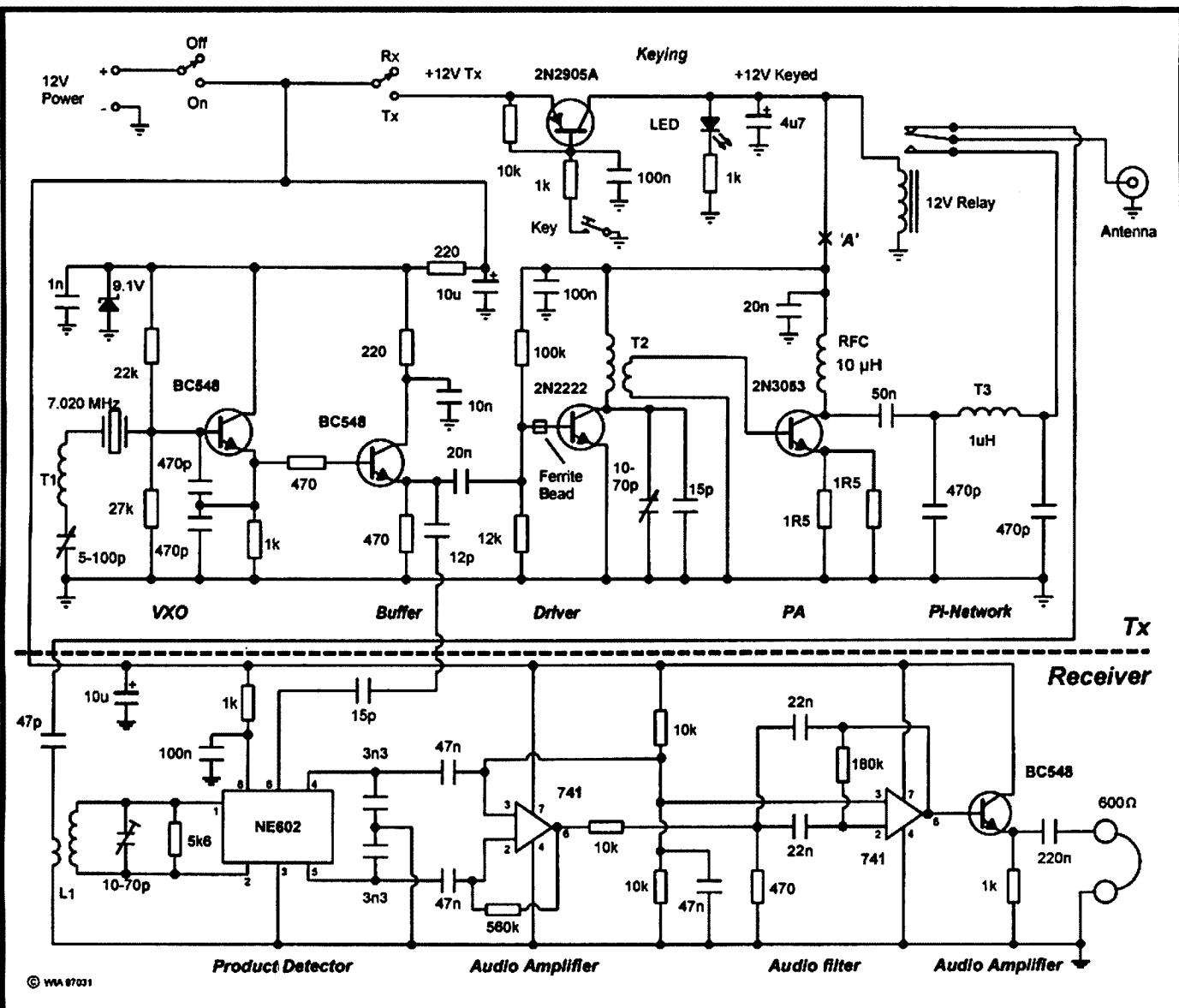
As anyone who has done much portable QRP work knows, a transceiver is far easier to operate than a separate transmitter and receiver. The space saved is welcome too!

Experience with the Garran 40 m CW QRP transmitter (Reference 1) was encouraging. This article describes how a receiver section was added to the prototype. The unit pictured is a basic transceiver without frills like sidetone, metering and automatic transmit/receiver frequency offset. However,

these can be added if desired.

The receiver itself is a direct conversion type similar to that used in a more elaborate QRP transceiver (Reference 2). However, because headphone-only reception was required, less audio gain is provided. The circuit shown gives adequate volume into a pair of 600 ohm headphones.

Fig 1 shows the schematic diagram of the Garran transceiver. The previously published circuit of the transmitter has been modified so that the oscillator runs continuously. Note that some of the



**Fig 1 - Schematic diagram of the Garran 40 metre CW QRP transceiver. The transmitter section (above the dotted line) is as previously published, with only minor modifications. The receiver, the subject of this article, is below the dotted line. L1 consists of 20 turns wound on a 9 mm ferrite toroid, 4c6 material, with an antenna coupling link of three turns.**

buffer's output is fed to the receiver's product detector. This is why the VXO and buffer need to operate continuously. The only other connections between the transmitter and the new receiver are the +12 V power and receiver antenna connections. While power to the receiver could be removed during transmit, additional circuitry or a dual pole relay would be required. This circuit economises by using only a single pole relay and leaving the receiver powered on while the key is down. The resulting noise in the headphones while transmitting is by no means unpleasant, and serves as a poor man's sidetone.

An active audio filter provides some audio selectivity. Additional filtering is provided by the careful selection of the capacitor values used between the product detector and the first audio amplifier.

**Construction**

As can be seen from the photograph, the entire transceiver is built on pieces of unclad matrix board. The receiver board is mounted vertically and is to the right of the main tuning capacitor.

L1 and the 10-70 pF trimmer capacitor resonate on 7 MHz. The inductor is wound on a 9 mm ferrite

toroid, 4c6 material. This is Philips part number 4322-020-97160. Undoubtedly, other toroids could be used, with appropriate changes in the number of turns required. The tuned circuit is the only adjustment in the receiver. It is fairly sharp, and needs to be peaked carefully for best receiver performance.

The rest of the circuit is not critical. Use IC sockets so that chips can be replaced if needed.

**Operating**

With no front panel controls apart from the VXO adjustment and the on/off switch (the potentiometer pictured hides

## International HF Beacon Network Continues to Expand

The world-wide HF 5-band beacon network, a project sponsored by the International Amateur Radio Union (IARU) and the Northern Californian DX Foundation, now has its 15th beacon established, signing OA4B from Peru, in South America. Eighteen beacons are planned for the network.

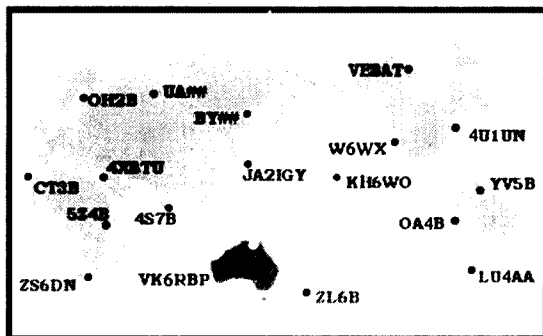
Each beacon transmits on 14.1, 18.11, 21.15, 24.93 and 28.2 MHz in sequence over a 50-second period, spending 10 seconds on each frequency. A transmission consists of

the call sign of the beacon sent at 22 wpm followed by four one-second dashes. The call sign and the first dash are sent at 100 watts, the remaining dashes at 10 W, 1 W and 100 mW. Each station in the network transmits in turn and each transmission is repeated every three minutes.

The equipment at each site includes a Kenwood TS-50S transmitter, a Cushcraft R-5 vertical antenna, a Trimble Navigation Acutime&trade global positioning system (GPS)

receiver (for accurate sequencing of the transmission) and a controller built by the NCDXF.

The accompanying table gives the transmission schedule, the operator and status of all stations in the network as at 7 August 1997. The world map here shows the location of the stations,



present and planned, in the beacon network (courtesy of Will McGhie VK6UU). Further details from [www.ncdxf.org/beacon.htm](http://www.ncdxf.org/beacon.htm), where you'll find details on how to get software for monitoring the beacon network.

Details of the VK6RBP beacon installation at Roleystone, 25 km south-east of Perth, can be found at [www.faroc.com.au/~vk6wia/hf-bcn.htm](http://www.faroc.com.au/~vk6wia/hf-bcn.htm) on the Web.

[Released 11/8/97]

a mistakenly drilled hole!), using the transceiver is simplicity itself. Just press the key and you're on the air. Let go of the key and you are receiving.

However, you will need to manually adjust your frequency every time you go from transmit to receive (and vice versa). When calling a station, make a mental note of the dial's logging scale and then move the VXO so that the pitch of the incoming signal falls so low that you can no longer hear it. Make your call on this frequency and move back to your original VXO setting to receive the next transmission from the other station. Similarly, when calling CQ, move the VXO's setting after each call so that any answering station will create an audio beat note in your headphones. While it sounds complicated, after a little practice the whole process takes less than a second.

## Results

Since the receiver was added in April 1995, contacts with five VK call areas and ZL have been had. Most were made during the day. Experience with an earlier transmitter showed that contacts of up to 3000 km are possible with this type of equipment around dusk. While the rig in its present form is entirely satisfactory for casual operating, a larger tuning range, RIT, better audio filtering and (possibly) a stronger receive front end would be required for serious QRP DX work.

## References

1. *Amateur Radio magazine*, January 1996, page 10 (see also February 1996 issue, page 55)

2. *Diamond D, "Little Mate" CW Transceiver*, *Amateur Radio magazine*, June 1996, page 5.

\*7/1 Garran Place, Garran ACT 2605  
e-mail: [parkerp@pcug.org.au](mailto:parkerp@pcug.org.au)  
at

Slot	Country	Call	14.100	18.110	21.150	24.930	28.200	Operator	Status
1	United Nations	4U1UN	00:00	00:10	00:20	00:30	00:40	UNRC	OK
2	Canada	VE8AT	00:10	00:20	00:30	00:40	00:50	RAC	OK
3	USA	W6WX	00:20	00:30	00:40	00:50	01:00	NCDXF	Not yet on 18 or 24 MHz
4	Hawaii	KH6WO	00:30	00:40	00:50	01:00	01:10	UHRC	Not yet on 18 or 24 MHz
5	New Zealand	ZL6B	00:40	00:50	01:00	01:10	01:20	NZART	Not yet in service
6	Australia	VK6RBP	00:50	01:00	01:10	01:20	01:30	WIA	Low output on 18 MHz
7	Japan	JA2IGY	01:00	01:10	01:20	01:30	01:40	JARL	OK
8	Russia	UA...	01:10	01:20	01:30	01:40	01:50	?	Does not exist
9	China	BY...	01:20	01:30	01:40	01:50	02:00	CRSA	Does not exist
10	Sri Lanka	4S7B	01:30	01:40	01:50	02:00	02:10	RSSL	No output on 18 MHz
11	South Africa	ZS6DN	01:40	01:50	02:00	02:10	02:20	ZS6DN	OK
12	Kenya	5Z4B	01:50	02:00	02:10	02:20	02:30	RSK	Off air: bad power supply
13	Israel	4X6TU	02:00	02:10	02:20	02:30	02:40	U Tel Aviv	Off air: bad TS-50S
14	Finland	OH2B	02:10	02:20	02:30	02:40	02:50	U Helsinki	OK
15	Madeira	CS3B	02:20	02:30	02:40	02:50	00:00	ARRM	All at 100 watts
16	Argentina	LU4AA	02:30	02:40	02:50	00:00	00:10	RCA	OK
17	<sup>NEW</sup> Peru	OA4B	02:40	02:50	00:00	00:10	00:20	RCP	OK
18	Venezuela	YV5B	02:50	00:00	00:10	00:20	00:30	RCV	Intermittently garbled

**Your Hobby**      **Your Voice**

Representing Radio Amateurs Since 1910

## Antennas

# 10/14 MHz Vertical Antenna

Rodney Champness VK3UG\* describes a versatile dual band vertical antenna.

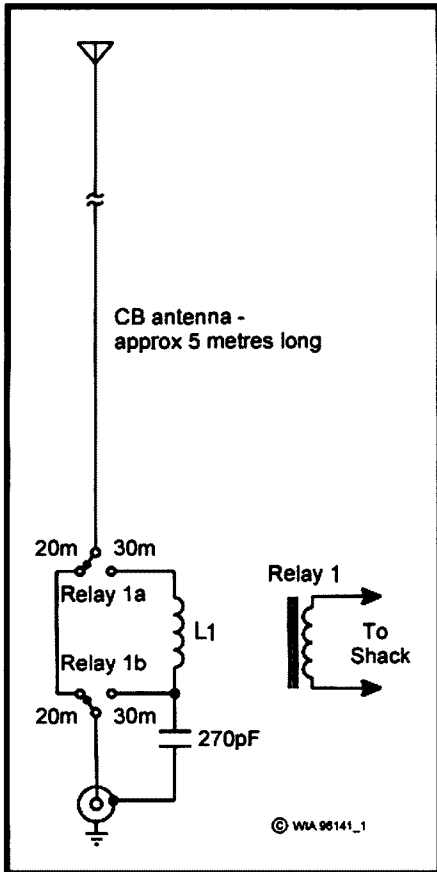


Fig 1 - 10/14 MHz vertical antenna.

This antenna started out as a mono band 14 MHz quarter wave vertical antenna mounted on my garage roof. I felt it was time to try 10 MHz so modified the antenna accordingly to achieve dual band performance.

The 14 MHz antenna can be made from an old 1/2 or 5/8 wavelength CB vertical system. Adjust the length of the antenna for minimum SWR; it is likely to be a bit long to start with, and the ultimate length will be about five metres. The adjustment can be done by sliding the elements inside one another, hence, if

you make it too short, you can slide the element out a bit. The SWR on the antenna will be below 1.5:1, particularly as the roof slopes away from the apex. The roof is the earth/groundplane and I have found that the antenna is more effective than my 5/8 wavelength 14 MHz antenna.

Having tuned up the 14 MHz antenna it is time to insert the band switching relay and tuning/matching components for 10 MHz. 14 MHz is selected with the relay in the un-energised condition. Once inserted in the antenna line you may find that the antenna has to be shortened a few centimetres.

The antenna is, of course, too short for 10 MHz so a base loading coil is switched in by the relay. It is wound on a piece of 32 mm o/d plastic water pipe. The wire is 18 B&S enamelled copper and approximately 12 turns are wound over a length of 7 cm to tune to 10 MHz. The antenna will be approximately tuned to 10 MHz but, as it is physically shorter than 1/4 wavelength, the feed impedance will be considerably lower than 50 ohms. Therefore, the 270 pF mica capacitor is put in the line to match the antenna to the 50 ohm line.

With this in line (as shown in Fig 1), adjust the number of turns for the lowest SWR. If you have a noise bridge, or an antenna analyser, it will be much easier to do. The antenna is switched to 10 MHz when the relay is energised.

Another possibility is to make the antenna a 1/4 wavelength on 10 MHz, and over a 1/4 wavelength on 20 metres. With this configuration there may be slightly more ERP.

Most of my antennas are remotely controlled for convenience. The switching network needs to be protected from the weather and I leave that for you to do. I used plastic storm-water piping

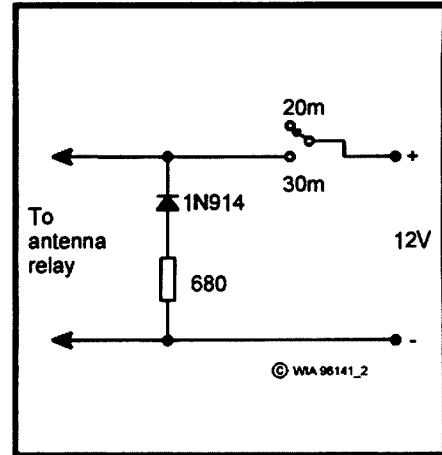


Fig 2 - Band change switching circuit.

with plastic ends, and butyl rubber to seal the holes where the cables entered the pipe. The antenna works very well on both bands, as it has quite a good groundplane. The base is only 4 metres above ground level.

\*17 Helms Court, Benalla VIC 3672

ar

## AMATEUR TRANSCIVER RADIO CENTRE

LARGEST SUPPLY OF HF/VHF/UHF  
TRANSCIVERS AT COMPETITIVE  
PRICES

**ALINCO** SYDNEY'S BEST  
ALINCO RANGE OF  
TRANSCIVERS & ACCESSORIES  
VHF UHF MOBILES HAND HELDS  
SALE CLEARANCE ON  
FOLLOWING MODELS  
DR-150T DR-605T DR-140T  
NEW DR-130T DJ-191T DJ-S11 DJ-S41  
LOTS MORE NOT LISTED PHONE  
FOR LOWEST PRICES

<b>ICOM</b>	IC-756 IC-706MKII IC-207H IC-T7A
<b>KENWOOD</b>	TS-570S TM-V7A TM-251
<b>cushcraft</b>	
<b>AMERITRON</b>	HF AMPLIFIERS EXPAND YOUR COLLECTION TODAY

**PHONE (02) 9896 2545**  
**141 GILBA ROAD,  
GIRRAWEE, NSW 2145**

Scientists could not make any progress or promote knowledge without suitable timepieces relevant to their particular time in history. The earliest record of devices to measure time and/or to segment the day into parts goes back to about 3000 BC when sundials, shadow sticks, and obelisks gave a rough estimate of short intervals of time. Progress was slow with the hourglass, marked candles, incense burning, and water devices which started the first recorded escapement principle (725 AD).

Gradually, crude clocks appeared in Europe made mostly with carved wooden gears, etc. These were called "turret" clocks and had no hands but struck a bell or gong every hour. The word "clock" comes from the Latin "clocca", meaning a bell. Horology is the art or science of making timepieces or of measuring time.

One of the first mechanical advancements was a mainspring axle drive (1500 AD), replacing large suspended weights, leading to smaller hand watches. By 1656, Huyghens, a Dutch scientist, built the first pendulum clock accurate to a few seconds per day. It may not have had a "minute" hand as the earliest record of minute hands was about 1670 AD.

## Navigation

During the years when clocks were slowly improving, navigation methods were undergoing a similar process. It became obvious that an accurate timepiece was needed which could be taken on ships for calculation of longitude. The only accurate clocks before 1734 were pendulum types. The British Government in 1714 offered 20,000 pounds for a suitable clock accurate to half a degree longitude. From 1726 to 1734, John Harrison produced a monster weighing 72 pounds. This was tried and proved encouraging after which the Government gave him 500 pounds to update more clocks.

In 1761, Harrison produced his No 4 clock, about the size of a modern alarm. In a five month voyage it lost only 15 seconds (accurate to 1/50th degree) and was a huge success. Harrison received more money in 1773, three years before his death. Other chronometers followed

## History

# Time and Frequency

*Paul Clutter VK2SPC\* gives a brief history of the events leading to the present standards of time and frequency.*

Most of this article deals with "time" as apart from frequency but, without the precise duration of the second, our standard of frequency would not be possible.

The subjects related to the development of our present standards are:

1. History of calendars;
2. Solar system;
3. History of clocks;
4. International Bureaus on UTC;
5. Motions of the earth;
6. Millisecond pulsars;
7. WWV and VNG time and frequency signals; and
8. Navigation, plus a few minor related subjects.

The complete story of all these subjects would make a substantial book, so obviously I can cover only the important highlights from each subject.

## The Beginning

For people who lived before the dawn of history, there was no such thing as a timepiece or awareness that the earth was moving. Their world was a small patch of land bounded by distant hills and perhaps the blue line of the sea. Overhead was the rising and setting of the sun and the brilliant stars at night. A few inquiring minds became the first astronomers watching the sky and making crude observations. They

numbered the days, divided the daylight into 10 parts plus one for dawn and one for dusk, and divided the night into 12 parts by the constellations. They thus established the 24 hour period, without clocks to equalise each hour.

Also, at this stage there was no accepted knowledge of the rotation of the earth. It was not until 1543 AD, when Copernicus published his book "On the Revolutions of the Heavenly Spheres", that serious studying of the earth's and planets' movements was started by Galileo, Kepler, Newton, and other astronomers. This book was finished in 1530 AD but Copernicus (then 57 years old) waited 13 years before publishing it, in fear of reprimand from the Church. He died a few days later. His book was immediately put on the forbidden list by the Church and was not removed until 1757 when finally the weight of proven scientific knowledge forced the Church to remove it.

In the early years of 1600 AD, Galileo believed Copernicus was right in his thinking and studied through his crude "optic tube" (telescope). He published his observations that the sun was the centre of the solar system. When the Pope heard of this, he issued a decree declaring the earth was the centre of the whole universe!

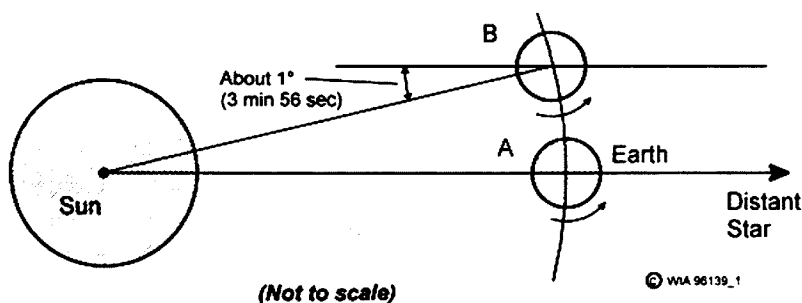


Fig 1

from many clock makers and there were at least six different types of escapements, lever, anchor, deadbeat, recoil, gravity, and chronometer style.

## Time Standards

Meanwhile, as clocks progressed, astronomers were busy studying the timing of the earth trying to establish duration standards for the hour, minute, and second. In 1820, a French committee of scientists recommended the second to be  $1/86,400$ th of the mean solar day averaged over a year ( $60 \text{ sec} \times 60 \text{ min} \times 24 \text{ hrs} = 86,400 \text{ sec}$ ). This, of course, was to keep in step with the earth which dictated the time of rotation.

In 1875, representatives of about 17 nations set up the beginning of the BIPM, the Bureau International des Poids et Mesures (International Bureau of Weights and Measures) under various other technical committees with an international staff of about 60 scientists. In 1884, Greenwich Mean Time was adopted as the international standard, but not completely unified for the whole world. In 1900, the National Physical Lab in Teddington, England was established. In 1901, the National Bureau of Standards was started at Washington, DC (after 1980 this became the National Institute of Standards and Technology – NIST).

In 1912, the French Bureau of Longitudes called for an international scientific conference to consider a worldwide unification of time keeping. In 1913, 36 nations adopted the Association and Bureau of the Hour (BIH), but it was not ratified until 1920 due to the outbreak of World War I.

However, the BIH began operations at the Paris Observatory. In 1919, the International Astronomical Union (IAU) was started and a time commission set up. Finally, on 1 January 1920, the BIH was established on an international basis and, until 1960, the international time scale was still based wholly on the earth's rotation,  $1/86,400$  for the second.

From 1920, for about the next 40 years, clocks steadily improved. The best at 1921 was W H Shortt's double pendulum clock accurate to one second in 10 years. In 1928, W B Marrison and J W Horton produced the first quartz clock accurate to  $1000$ th of a second per day.

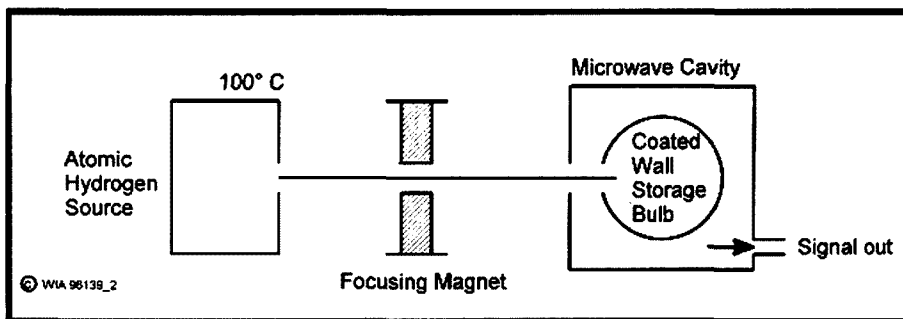


Fig 2.

## Slowing Down

During these years, many astronomers and scientists observed the inevitable; the earth was not keeping accurate time (it was slowing down). Then, in 1939, H Spencer Jones (an English astronomer), startled the scientific world by being the first to announce that the earth was not keeping accurate time.

From the 1940s, various laboratories were busy working on atomic clocks to increase the accuracy and stability of time keeping. In 1955 the US Naval Observatory and the National Physical Lab in Teddington jointly established the natural resonant frequency of Cesium 133 to be  $9,192,631,770 \text{ Hz}$ . Then, in 1957, the National Bureau of Standards in the USA completed two Cesium beam devices after which the BIH established the resonant frequency of Cesium 133 which became TAI (International Atomic Time).

Before TAI was established, the time commission between 1960 and 1967 decided to use EPHEMERIS timing which is the duration of the earth around the sun. This amounts to  $31,556,925.9747$  seconds (based on the year 1900) with an annual increase of  $.0001$  second. Thus, the second became  $1/31,556,925.9747$  (plus annual increases), but only for seven years.

## Leap Seconds

From 1967, time was returned to the earth's rotation while atomic time continued but no correction was made until 1 Jan 1972 when 10 seconds was added to bring them into alignment. Thereafter, "leap" seconds are added on an average of about 16 months but at predetermined times as set up by the time commission now known as the IERS (International Earth Rotational Service).

The slowing is about 0.9 second (900 milliseconds). Leap seconds are inserted at the end of June or December with second preference on 31 March or 30 September. When added, the leap second becomes the 61st second of the last minute of the month, followed by the first second of the next month. For example, from 1955 until 1990 (35 yrs), the earth has lost 25 seconds and if leap seconds were not added, there would have been an accumulated discrepancy between atomic clocks and earth's timing.

The timing of the earth is done by a PZT (Photographic Zenith Tube) and atomic clocks. The PZT is a vertically mounted (fixed) telescope with a camera at the bottom. Distant known stars are photographed periodically and logged on a graph (accurate grid) against atomic clocks which show how much shift occurs over a given period of time. The SIDEREAL time of rotation is 23 hours, 56 minutes, and four seconds plus a changing fraction (milliseconds).

Now, while the 360 degrees is taking place, the earth has advanced more than 1.5 million miles (A to B in Fig 1) in orbit and the centre line through the earth to the stars no longer points to the centre of the sun. To acquire SOLAR time, another three minutes and about 56 seconds (one degree of rotation) is needed to complete the solar time of 24 hours. Thus, the extra three minutes and 56 seconds adds up over four years to an extra day, ie 29 February each leap year.

## Masers

From 1947, N F Ramsey, H M Goldenberg, and D Kleppner worked at Harvard University constructing the first hydrogen "MASER" (Fig 2 shows the

basic elements). Maser is derived from Microwave Amplification by Stimulated Emission of Radiation. From 1962, the hydrogen maser increased the accuracy and stability above that of the Cesium clock from 1 second in 30,000 years to 1 second in at least 100,000 years which makes it the most stable oscillator known.

The basic principle of atomic clocks is obtaining resonance by excitation of atoms which separates the electrons from the nucleus but the natural coupling pulls them back into orbit. This disturbance of the coupling creates oscillatory energy which is given off at the resonant frequency of that particular atom. The preparation of the atoms is by heating and magnetic fields which dissociate molecules into a beam of atoms. These enter a bulb (also called a "rhumbatron") inside a resonant cavity where interaction and recombination produces the energy. The natural resonant frequency of a particular atom is determined by the amount of energy in Joules produced under excitation divided by Planck's Constant (6.6262 x 10 to the minus 34th). The following example uses the hydrogen atom as it is the most active and stable.

$\text{Freq (Hz)} = \text{Energy in Joules} / 6.6262 \times 10^{-34} = 940.9204 \times 10^{-27} / 6.6262 \times 10^{-34} = 142 \times 10^7 \text{ Hz} = 1420 \text{ MHz}.$

The maser storage bulb is usually teflon lined quartz, but experiments by coating it with carbon tetrafluoride at -248 degrees C or liquid helium at 0.5 degrees Kelvin, increased the accuracy and stability considerably but for shorter

periods of time. A special type of bulb allows liquid helium to flow through it.

The maser is the largest, consumes the most power and is the most expensive of all atomic clocks, but may become the standard for UTC in the future.

## Precision

Examples of modern uses of precision timing with atomic clocks are:

1. Redefining the standard length of the metre which was previously (before 1983) measured by an "invar" rod at the French Bureau of International Weights and Measures. After 1983, the standard length is the distance travelled by light in a vacuum during the interval of  $7/299,792,458$ th of a second (light travels at 299,792,458 metres per second).

2. An aircraft flew for 15 hours at 50,000 ft. with an atomic clock and gained 45 nanoseconds with respect to ground clocks, being in agreement with Einstein's theory of relativity - gravitational potential difference.

3. Atomic clocks are carried on numerous satellites to give accurate time and to facilitate Global Positioning Service and electronic navigation systems.

The time and frequency broadcast formats of WWV and WWVH are given in most ARRL Handbooks (not the 1992 edition). The accuracy and stability of WWV and WWVH are referred to the primary NIST frequency standard and related NIST atomic time scales in Boulder, Colorado. The frequency as transmitted is accurate to about one part in 100 billion and about 0.01 millisecond for timing. The day to day deviations are normally less than one part in 1000 billion. However, the RECEIVED accuracy is far less due to various propagation effects. The usable received accuracy is about one part in 10 million for frequency and about one millisecond for timing.

The history of VNG is well covered on page 26 of the June 1993 edition of *Electronics Australia*. A Cesium beam frequency standard comes from the Telstra Standard Lab in Melbourne via land-line to the VNG complex at Llandillo (about three miles north of Penrith, NSW).

Finally, one other timing object (not man made) is the millisecond pulsar. The

fastest and strongest of over 500 known and catalogued, has been timed twice weekly since 1984 and, at 642 pulses per second, has not varied by more than plus or minus two microseconds between pulses. This pulsar is designated as PSR 1937+21 at 1.5578 milliseconds between pulses.

## Frequency with Earth Timing Only

You may well ask why a clock cannot be set simply to run at exactly the slowing rate of the earth's rotation, thus achieving the same result as adding leap seconds. Referring to the 25 seconds lost between 1955 and 1990, the duration of the second would be, for example,  $1/86,400$ th of the mean solar day in 1955. However, the duration in 1990 would be  $1/86,425$ th as the rotation would be 25 seconds longer. When you divide a quantity into more parts, each part becomes smaller, obviously. When you measure a fixed number of vibrations in a given interval of time, the frequency reduces in proportion to the lower duration of the second. Therefore, frequencies would keep changing in step with the second, dictated by the slowing rotation of the earth.

It may be of interest to note that millions of years ago the earth rotated faster, say between 18 and 22 hours which would make the second much longer than it is now. Thus, by adding leap seconds, the precise duration of "atomic" seconds is maintained while keeping in step with the slowing earth.

If we measure the resonant frequency of a particular coil and capacitor to be 1000 Hz, then seal it up for a few hundred years and re-measure with "solar time" ( $1/86,400$ ), assuming about a 10% slowing of the earth, it will measure about 900 Hz. However, by counting the number of vibrations from one to 9,192,631,770 inherent in the Cesium 133 atom, and from one to 1,420,000,000 in the hydrogen atom (oscillations at resonance which never change), the exact duration of the second is established and this becomes universal so long as the atomic structure is the same. Therefore, the coil and capacitor will still measure 1000 Hz by the "atomic" second.

\*52 Keats Avenue, Bateau Bay, NSW 2261

ar

## WIA News

### D-I-Y Ham Magazine Folds

The Radio Society of Great Britain's 'do-it-yourself' *D-I-Y Magazine* ended with the July-August issue, the *ARRL Letter* for 8 August reported.

Pitched at the newcomer to amateur radio, and having an emphasis on construction, *D-I-Y Magazine* was closed for financial reasons. The RSGB intends to expand the 'Down to Earth' column in their official journal, *RadCom*.

[Released 11/8/97]



## Antennas

# Random Radiators

with Ron Cook VK3AFW and Ron Fisher VK3OM\*

First of all, a thought for the month. Have you ever noticed (or is it just something that happens to me) that, whenever you connect up an SWR meter to your transceiver and then sit the meter on top of the transceiver, the input and output leads are always the wrong way around? I always seem to finish up with crossed leads. Perhaps SWR meter manufacturers and transceiver manufacturers don't speak to each other!

Now, on with the subjects in hand for this month.

### Random Wire Antenna Tuner

Further to our description of a random wire antenna tuner of a few months ago, we received an interesting letter from Lloyd Butler VK5BR pointing out a few limitations and improvements for our simple system. We will let Lloyd tell the story.

"In your Random Radiator column of Amateur Radio, May 1997, you discussed an 'L' Match ATU which used series inductance facing the transmitter and shunt capacity across the antenna load of a random piece of wire operated against ground.

"You talked about cutting the length of wire at least a quarter wave length long. The interesting thing about this is that, if the wire happens to be near an exact electrical quarter wave, the antenna would present a purely resistive load of quite a low value and for this condition the 'L' network could not reflect the desired 50 ohms resistive load back to the transmitter.

"An 'L' network of this form cannot theoretically reflect back the 50 ohms resistance if the shunt resistive load is less than 50 ohms. In fact, the minimum load is even more than 50 ohms because of practical limits in the variable range of L and C in the tuner itself.

"Fortunately, however, if the antenna is not an electrical quarter wave, then the low resistance load is in series with

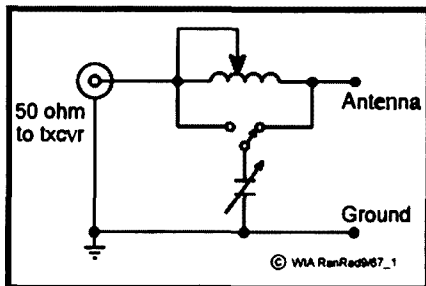


Fig 1

series reactance and the tuner output looks into an equivalent parallel impedance of shunt reactance and shunt impedance. When there is no series reactance, the shunt value of resistance is the same as its series value, but with series reactance, the equivalent shunt resistance is a higher value. If the series reactance is sufficient, the shunt resistance is reflected as a value well above 50 ohms and the L match can be adjusted to reflect the desired 50 ohms resistance back to the transmitter.

"This is fine, but clearly there is a 'No-Go' region when the load is purely resistive or near resistive and of low resistance value. In an article on the Z match by Graham Thornton VK3IY and myself (Amateur Radio, March 1997), we discussed in detail the theory of this phenomena. The only difference with the Z match is that its output coil introduces its own series inductive reactance and its 'No-Go' region occurs when this is cancelled by antenna capacitive reactance. Again the 'No-Go' anomaly is a function of the L network section of the Z match tuner being presented with a low value near resistive load.

"Having pointed out the 'No-Go' condition, I might make some suggestions on how to improve the simple L match described by the "two Rons". One simple addition is a change-over switch so that the network can be operated with the variable capacitor across the transmitter side of the network (see Fig 1). In this form, the network can reflect back 50 ohms resistance for

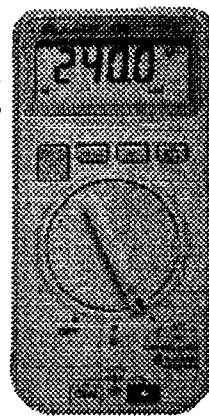


YOUR HOBBY

YOUR VOICE

Representing Radio Amateurs - Since 1910

**RECRUIT  
A MEMBER &  
THEY COULD  
WIN!  
THIS GREAT  
FLUKE 12B  
DIGITAL  
MULTIMETER  
WORTH \$195**



**THERE'S A WINNER  
EVERY MONTH FOR 1997  
12 PRIZES TO BE WON**

This latest hand-held DMM, from the world-leading maker of digital test instruments, has advanced features yet is simple to use. Ideal for tyro & veteran.

#### The Fluke 12B measures:

- ac and dc voltage (with auto-selection)
- resistance & capacitance (.001-1000µ)

#### The Fluke 12B features:

- 4000-count liquid crystal display
  - simple rotary dial
- diode and continuity testing
- indicates intermittent opens & shorts
- 2-year warranty

**Fluke 12B prizes generously donated by Philips Test & Measurement.**

Each month's prize is awarded by way of a draw among newly recruited members each successive month and presented to the winner at the earliest opportunity following the draw.

**To sign up a new member, use the back of your AR magazine address leaflet - or clip the coupon, have them fill it out and send it now.**

**SEND TO YOUR DIVISION'S ADDRESS, SHOWN ON PAGE 56.**

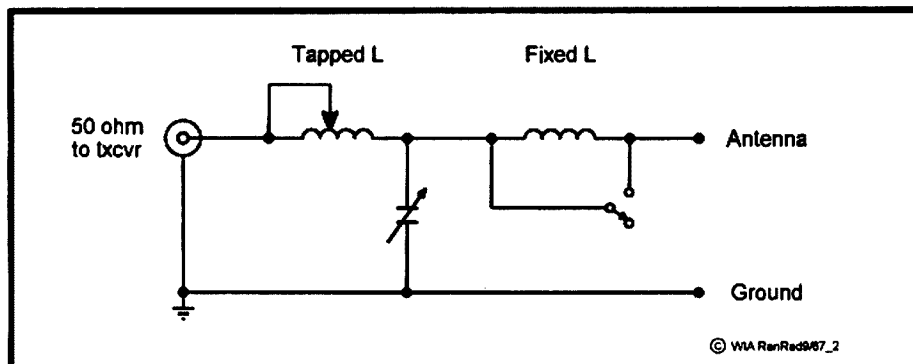
Please send me a membership application.

NAME .....

ADDRESS .....

P/code .....

Call Sign (if any) ..... [AR 1-11/97]



**Fig 2**

resistive loads of less than 50 ohms (but not above). This will stop-gap most of the 'No-Go' region except when the pure resistive load is around 50 ohms. In that case, reactive values necessary for a match in the L network approach zero or infinity and hence are likely to be outside the adjustment range of the variable L and C. On this, I must add a VK3IY comment: If the load is a pure resistance of 50 ohms, one does not need an ATU at all, so that the ATU could be bypassed.

"Another idea which we originally suggested in our article for the Z match, is to provide a small fixed inductance that can be switched in series with the antenna when required (see Fig 2). This simply shifts the 'No-Go' region out of the resistive range into the capacitive range and out of the way for the purposes of the resistive load situation.

"The third idea is undoubtedly the simplest. If you want the L match to adjust up nicely, just make sure the piece of wire is not too near a resonant quarter wave length. If you fluke the critical length, make the wire a bit longer or a bit shorter".

Thanks for all of that Lloyd. That all makes the operation of the L match coupler easier to understand and I hope will enable our readers to get maximum use out of this simple antenna tuner.

## The Single Band Log Yagi

It was several years ago that the single band log Yagi came into prominence amongst DXers. After all, it was claimed by no less an authority than the ARRL Antenna Book that this antenna could produce several dB more gain than a conventional Yagi of the same boom length.

Several DX stations were using these antennas with excellent results so perhaps they were as good as the Antenna Book stated. The only one that we know about in VK3 is owned by Fred VK3AQN. On long-path into Europe, Fred puts out an unbeatable signal but then he does also have an unbeatable location for that direction. Lets have a look at the published data on this antenna.

In the 1988 edition of the ARRL Antenna Book (15th edition) the following figures are quoted for a six element log Yagi. This consists of four elements in the log cell plus a normal director and reflector. The log cell has a boom length of 10 feet with a total boom length of 26.5 feet for the whole antenna. This equates to the boom length of a normal four element Yagi such as the HyGain 204BA or similar antenna.

ARRL quote the forward gain of the log Yagi as an incredible 11.5 dB with a front-to-back ratio of an equally incredible 32 dB. The text of the article states: "The log Yagi provides higher gain and greater directivity than would be realised with either the LPDA (wide band log antenna, ie 14 to 30 MHz) or a Yagi array alone. The Yagi array requires a long boom and wide element spacing for wide bandwidth and high gain. This is because the Q of the Yagi system increases as the number of elements is increased and/or as the spacing between the adjacent elements is decreased. The log Yagi overcomes this difficulty by using a multiple element 'cell' designed in accordance with the principles of the log periodic dipole array. Since this log cell exhibits both gain and directivity by itself, it is a more effective radiator than a simple dipole driven element."

Just how much gain the log cell produces is not stated anywhere that we can find but, to reach the stated gain figure of 11.5 dB it would need to be about 6 dB over a three element mono-band Yagi. Quite a gain figure for a 10 foot long log cell driven element system!

Well, it seems that some time after all this was written by the ARRL, they had a change of heart and later editions of the ARRL Antenna Book give the gain at a somewhat more realistic 6.7 dB. Why the difference?

My good friend Morrisson VK3BCY became interested in these antennas and decided to ask a few questions on the Internet. He was surprised when the following answer came back from the editor of the ARRL Antenna Book, Dean N6BV. And we quote "The problem is that the gains in editions (of the ARRL Antenna Book) earlier than the 17th Edition were stated in dBd (relative to a free space dipole) but over ground. The restated gain in the 27th edition is for the LPDA in free space (hence the gain is deflated by almost 6 dB) and is stated in dBi. The 6.7 dBi stated for the LPDA in free space would gain about 5.5 dB for typical horizontal reflection coefficient (ie reasonable, but not perfect, ground) for a gain of 12.2 dBi peak at maximum lobe. This is equivalent to about 10 dBd referenced to a dipole in free space. Either way is fair provided you specify the conditions. We're being very clear in the 17th and 18th Editions; the earlier editions left too much to the fertile imagination of amateurs. The simple optimised Yagis described in Chapter 11 (Yagi arrays, ARRL Antenna Book) have more gain, better F/R pattern over the whole band, a wider SWR bandwidth and are also far, far simpler mechanically than any LPDA design with parasitic elements. Simplest is best!"

Thanks Morrisson for passing on this fascinating information. It's often the way, simplest is best in more ways than one.

And with that, it's goodbye from me and goodbye from him!

**The two Rons.**

\*C/o PO Box 2175, Caulfield Junction, VIC 3161

ar

# Technical Abstracts

Gil Sones VK3AUI\*

## Crystal Regenerative Receiver

A novel regenerative receiver which uses a crystal as the frequency determining element is described in *QST*, May 1997. The crystal used is a colour burst crystal on 3,579 kHz and it allows the receiver to receive W1AW transmissions on 3,581.5 kHz. The circuit is the work of Charles Kitchin N1TEV and Mike Murphy WB2UID who are both employed by Analog Devices.

The receiver circuit is shown in Fig 1. The receiver uses two common silicon transistors, a germanium diode and an LM386 audio amplifier IC. The first transistor is used as an untuned RF amplifier which isolates the regenerative

stage from the antenna. The second transistor is a regenerative stage. The coil is tuned to the 3.5 MHz band. The coil provides feedback and its tickler winding inductance helps determine the frequency of operation with the crystal. R5 adjusts regeneration and has some effect on the tuning allowing approx 2 kHz adjustment of the beat note. The audio amplifier gain and hence volume can be controlled by the components, R6 and C8, shown dotted.

The diode detector or mixer uses the diode reverse resistance as the DC return path.

A certain amount of fiddling is required initially. The link or tickler winding may need to be reversed in order to obtain regeneration. The components

are all fairly non critical and should be easy to obtain. Other frequencies will require different frequency crystals and one of the ceramic resonators may allow a wider tuning range in association with a tuning capacitor. The 1N34 for the original was obtained from Radio Shack as Tandy is known in the USA.

## Sensitive Antenna Bridge

Antenna bridges operating at low power levels suffer from low sensitivity due to the characteristics of the detector diodes used at low signal levels. This can be overcome by using an amplifier. A DC amplifier, however, does not overcome the diode characteristics at low signal levels. An RF amplifier before the diode can be useful but needs a balanced input. A suitable design appeared in *RadCom*, July 1997 from Ian Braithwaite G4COL. This design uses an IC RF amplifier NE592 as a bridge amplifier.

The circuit of the bridge is given in Fig 2. The parts should be readily available. The NE592 was obtained from the UK parent of RS Components and their UK

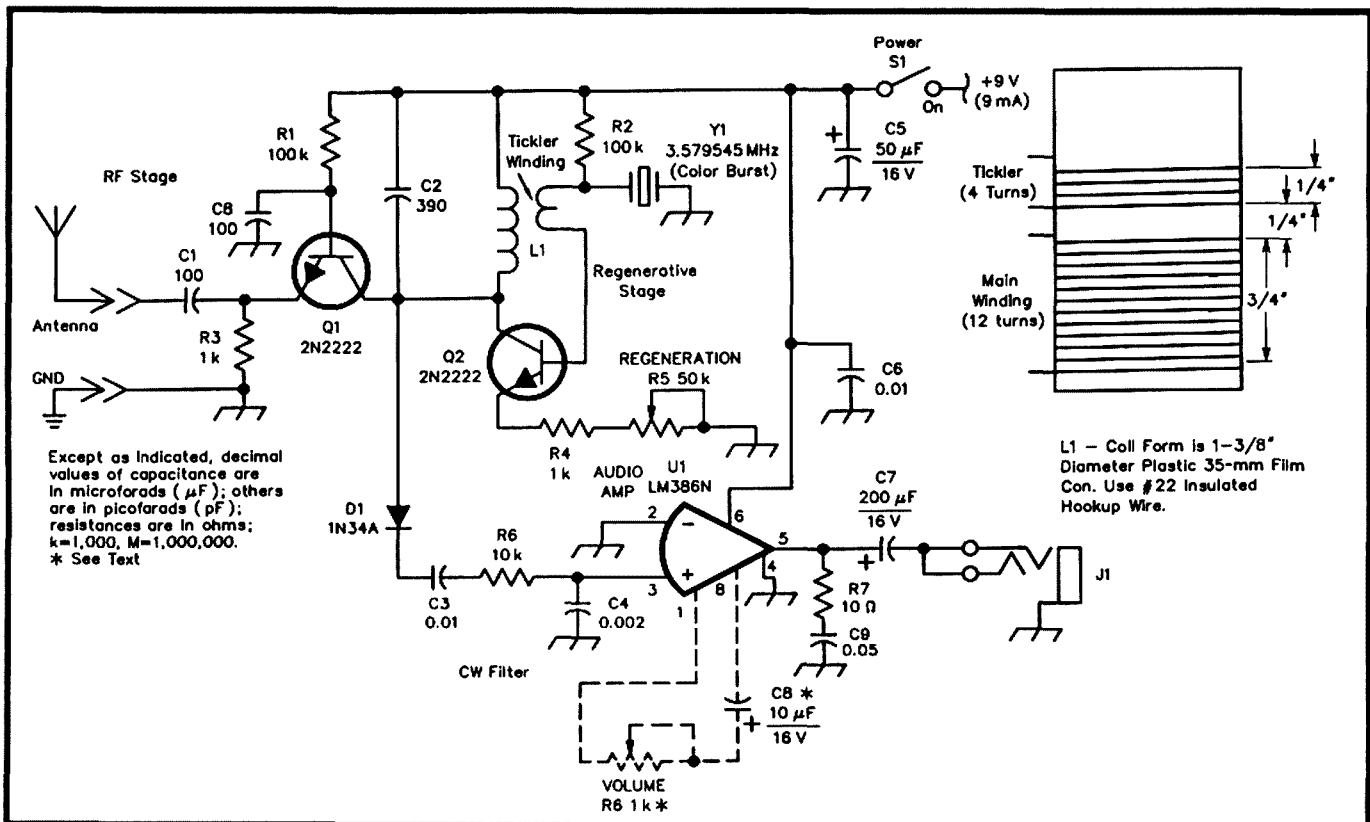


Fig 1. Crystal regenerative receiver.

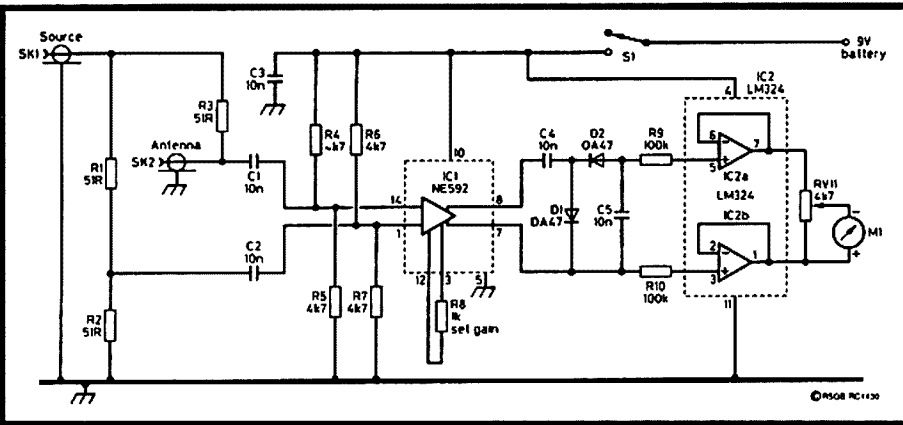
**Have you  
advised the  
ACA of your  
new address?**

wire. The reflector is a sheet of 2.5 mm thick aluminium, 400 mm square. The stand-offs were 20 mm diameter Teflon and were 60 mm long. The phasing wires should not touch at the crossover points and a slight bend is in order.

The radome is a plastic food container. A small sample could be tested for RF absorption in a microwave oven, but remember to use a glass of water in the microwave as a load. If the sample is cool when the water boils the container should be suitable.

\*C/o PO Box 2175, Caulfield Junction VIC 3161

ar



**Fig 2. Sensitive antenna bridge.**

part number is 301-583. Sensitivity can be adjusted by varying the value of R8. Raising the value lowers gain and increases bandwidth and the converse is also true. The original was useful from 160 to 6 metres. The meter used was a 250 micro-amp type. Calibration can be established with a set of suitable resistors.

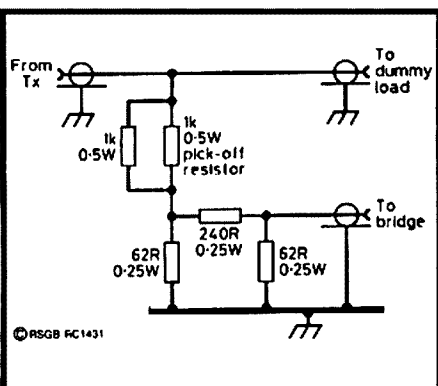
The signal to drive the bridge can be obtained from a signal generator or from a transmitter with a suitable attenuator. A suitable attenuator arrangement for up to a 10 watt transmitter is shown in Fig 3. The dummy load should be able to dissipate the transmitter output. This should suit most transceivers which can reduce power to the 10 watt mark.

**Wide Band 23 cm Beam**

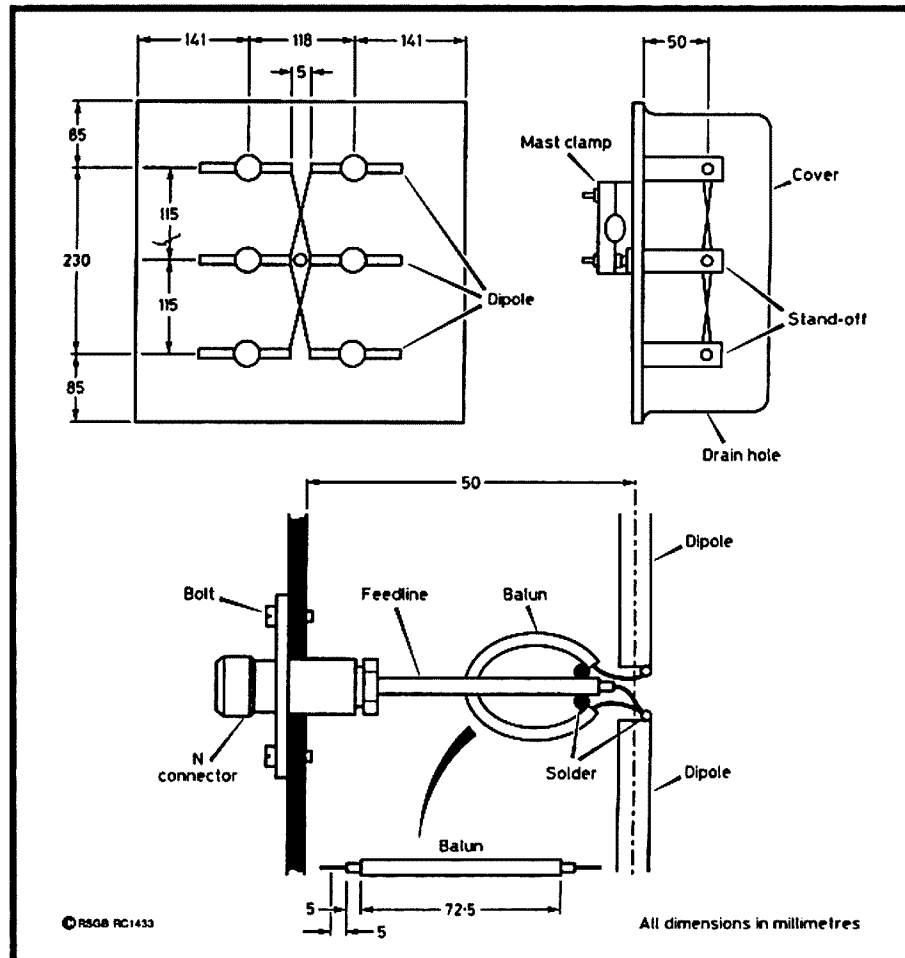
A useful wide-band 23 cm beam appeared in the *Eurotek* column of Erwin David G4LQI in *RadCom*, July 1997. The beam originally appeared in *Radio REF*, January 1997 and the author was Noel Hunkeler F5JIO. The beam is an array of six half wave dipoles in front of

a reflector screen. The antenna array is housed inside a radome made from a plastic food container.

The antenna is shown in Fig 4. The coax used is the semi-rigid type which has Teflon insulation. The dipoles are 108 mm long and are 6 mm in diameter. The phasing lines are 2 mm diameter



**Fig 3. Attenuator.**



**Fig 4. Wide-band 23 cm beam.**

---

# ■ Operating 1997 Remembrance Day Contest Opening Address

---

The 1997 Remembrance Day Contest Opening Address was delivered by Mr Bruce Ruxton AM OBE, President of the Victorian Branch of the Returned & Services League since 1979.

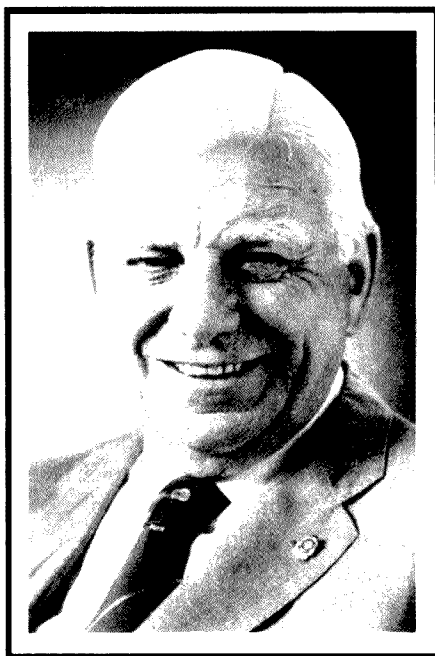
Bruce is well known in Australia and around the world for his outspoken comments on many matters, all of which are part of the RSL's policy.

Mr Ruxton is a returned serviceman – he served in the 2125 Battalion of the 7 Division, and served in the SWPA. He was at the landing at Balikpapan and was later with the Commonwealth Occupation Forces in Japan. His life is devoted to the RSL and its members. Each morning in his office at Albert Park he sees ex-servicemen and women and their families to assist them in dealing with any problems to do with repatriation, health, pensions and other related matters.

Afternoons usually find him at Anzac House where he handles the day to day issues of the RSL. At all times he is prepared to talk to anyone who wants to see him. He does his work full-time, unpaid.

In the course of his work, Bruce Ruxton has visited Russia four times, Taiwan three times, Turkey (including Gallipoli) three times, Canada twice, New Zealand three times, United Kingdom five times, Belgium, France five times and South Africa twice, as well as making many trips to South East Asia, including China twice, Malaysia and Indonesia.

He believes he is sometimes misrepresented in the press, particularly on immigration and aboriginal issues. A real concern he has is what he terms the foreign take-over of Australia, the buying up of real estate. This is a concern



**Mr Bruce Ruxton AM OBE**

widely held in the Australian community, yet Bruce Ruxton believes he is unfairly portrayed as a racist. He sees himself as "a good bloke, a simple bloke" whose most important job is to speak up for the veterans.

Bruce Ruxton is much in demand throughout Australia as a vital, interesting and witty speaker. His audiences are never disappointed.

## **The Opening Address**

*"As the Victorian State President of the RSL and the Deputy National President of the RSL, I'm honoured to have been asked to give the opening address for this Remembrance Day Contest which marks the 52nd anniversary of the end of World War II and the 79th anniversary of the ending of World War I.*

*"I just want to say a few words about Gallipoli if I may.*

*"I've been there a few times, fortunately, and of course I would like to go back again and again because each time one goes back there one learns something more. In 1990 I had the privilege of helping to make a film, a documentary, on that Campaign and it was a one hour documentary which was shown on television and that was a great experience for me.*

*"But prior to that in 1987 I led a large group of people to ANZAC Cove for ANZAC Day and I had the added privilege of giving the Dawn Service address. That morning, I might add, the service started off in the dark and we had little candles to read the program we'd had run off and out of the darkness that morning, loomed, and I use that word, some 350 young people. Mainly Australians, but there were English and New Zealanders amongst them and each year up until 1990 that figure increased dramatically because in 1990 when that 75th Anniversary of the landing at Gallipoli took place some 8000 young people left the shores to go to that Service and each year since then there's been between three and four thousand. Even during the Gulf War, which was on at the time, just down the road, 3000 young people attended the Dawn service at Gallipoli.*

*"Now to you people who are wireless transmitters. Wireless. That's a name that of course older Australians are well conversant with. The wireless. You don't hear it said very often. As a matter of fact it puts a time on you. But I would suggest to you, all of you, your predecessors in particular have played an enormous part in the defence of this country and in war An enormous part. I know from my own mates who were in the New Guinea Air Warning Wireless. Many of them were Amateur Radio Operators before the war and, of course, those men with the coast watchers were out behind lines sending back the signals that virtually saved Australia.*

*"So thank you very much all of you for allowing me to speak to you. I now open this Remembrance Day contest and wish you all well."*

**ar**

# ■ Measuring Converting a Linear Reading Meter To SWR Figures

*Paul Clutter VK2SPC\* describes how to work out SWR calibrations for a linear meter.*

If you require any meter to give SWR figures, but the scale is not marked as such, as could be the case for homebrew construction or when replacing a meter in an SWR device, the easy formulas given here can be used to calculate the SWR reading using the meter scale. The first and most important thing needed is the fractional power related in figures to the meter scale.

Assuming a meter has 50 divisions, as a 0-50 micro-ammeter has, it follows that half scale at 25 would be 25% power relative to the power at full scale deflection (FSD). This is simply because half scale is half voltage and half current, and this produces quarter power (25%). Likewise, one third scale is one ninth of full scale power. The exact amount of

power for full scale deflection does not matter because SWR figures are only ratios and these hold true for all FSD values.

An example is, after calibrating FSD on forward, a reading of 5 is obtained in the reverse or reflected mode on the SWR meter. The reading of 5 is one tenth of the FSD of 50 and so is one tenth voltage and one tenth current, which represents one hundredth power. Therefore, the reflected power is only one hundredth of the forward power. Next the reflection coefficient is needed and is calculated by taking the square root of the reflected power divided by the forward power. The reflection coefficient is designated by the Greek letter rho ( $\rho$ ).

$$\rho = \sqrt{(P_{rev}) / P_{fwd}}$$

Using 50 watts for forward power one hundredth of 50 watts equals 0.5 watt of reflected power.

$$\rho = \sqrt{(0.5) / (50)} = \sqrt{(0.01)} = 0.1$$

So the reflection coefficient is 0.1 and it is related to SWR by the formula:-  
SWR = ((1+ $\rho$ )/(1- $\rho$ ))  
So, when the reflected meter reading is 5, the SWR is:-  
SWR = ((1+0.1)/(1-0.1)) = 1.1/0.9 = 1.22:1  
The SWR for a reflected reading of 5 is 1.22:1.

Well, what if the FSD is only five watts instead of 50 watts, and you still get a reverse reading of 5 on the meter? Again, five is one tenth of FSD and power is still one hundredth of FSD. One hundredth of five watts is 0.05 watt.

So:-

$$\rho = \sqrt{(0.05 / 5)} = 0.1$$

and

$$\text{SWR} = ((1+0.1)/(1-0.1)) = 1.22:1$$

which is the same as with 50 watts of forward power.

Another example is when the meter is divided into 30 divisions, and using five watts of forward power (FSD) resulting in five for the reflected reading. This gives a reflected reading of one sixth of the forward reading which is one thirty sixth of the forward power which is 0.1389 watts.

$$\rho = \sqrt{(0.1389 / 5)} = 0.167$$

$$\text{SWR} = ((1+0.167)/(1-0.167)) = 1.4:1$$

Now comes the obvious question. Why do we get a different coefficient of reflection and SWR when we get the same reflected reading of five? The answer is that the ratio of five divisions to 50 divisions is one tenth, and is different from the ratio of five divisions to 30 divisions which is one sixth. Therefore, we get different reflection coefficients and SWR values.

Now that we can calculate an SWR reading for any number of divisions of the meter scale, here are tables of reflection coefficients and SWR values for meters scaled 0 to 50, and 0 to 100 divisions.

Table 1 is for meters scaled 0 to 50, and Table 2 is for meters scaled 0 to 100.

## VK QSL BUREAUX

The official list of VK QSL Bureaux. All are Inwards and Outwards unless otherwise stated.

VK1	GPO Box 600 CANBERRA ACT 2601
VK2	PO Box 73 TERALBA NSW 2284
VK3	40G Victory Blvd ASHBURTON VIC 3147
VK4	GPO Box 638 BRISBANE QLD 4001
VK5	PO Box 10092 Gouger St ADELAIDE SA 5000
VK6	GPO Box F319 PERTH WA 6001
VK7	GPO Box 371D HOBART TAS 7001
VK8	C/o H G Andersson VK8HA Box 619 HUMPTY DOO NT 0836
VK9/VK0	C/o Neil Penfold VK6NE 2 Moss Court KINGSLEY WA 6026

**Table 1 - Meters scaled 0 to 50.**

Reflected Meter Reading	Reflection Coefficient	SWR
0.5	0.01	1.02
1	0.02	1.04
2	0.04	1.08
3	0.06	1.13
4	0.08	1.17
5	0.1	1.22
6	0.12	1.27
7	0.14	1.33
8	0.16	1.38
9	0.18	1.44
10	0.2	1.5
15	0.3	1.86
20	0.4	2.33
25	0.5	3.0
30	0.6	4.0
40	0.8	9.0

**Table 2 - Meters scaled 0 to 100**

Reflected Meter Reading	Reflection Coefficient	SWR
0.5	0.005	1.01
1	0.01	1.02
2	0.02	1.04
3	0.03	1.06
4	0.04	1.08
5	0.05	1.11
6	0.06	1.13
7	0.07	1.15
8	0.08	1.17
9	0.09	1.12
10	0.1	1.22
15	0.15	1.35
20	0.2	1.5
25	0.25	1.67
0	0.3	1.86
40	0.4	2.33
50	0.5	3.0
60	0.6	4.0
80	0.8	9.0

**Technical Editors Note**

The accuracy of most SWR meters is such that the readings are subject to considerable error. This should be borne in mind when carrying out the calculation of SWR. They do, however, provide a basis of comparison when matching an antenna, and provide an indication of any change in the feedline and antenna.

\* 52 Keats Avenue, Bateau Bay, NSW 2261  
ar

**Book Review****Build Your Own Intelligent Amateur Radio Transceiver****Publisher:** McGraw-Hill**Author:** Randy L Henderson

**Reviewed by:** Bill Rice VK3ABP – review copy direct from McGraw-Hill – ISBN: 0-07-028263-3 – hard cover – retail price \$69.95.

Very few amateurs in these past 20 or 30 years have built their own “state of the art” SSB transceivers. The art has progressed beyond the average amateur, and a commercial rig with all the “bells and whistles” only needs money to acquire it.

I speak as one who built his own all-analogue transceiver early in the 70s and operated it both fixed and mobile for close on 20 years. But the more recent microprocessor-controlled gear, I thought, was beyond all but the commercial engineers.

Now we find that this “ain’t necessarily so”. Randy Henderson, who has been a Technical Editor with the ARRL for much of his career, has shown us in this book how digital control and synthesis can be designed almost on the kitchen table, and made to do what one expects from a modern transceiver.

All the necessary circuitry is described in detail, its theory explained, and its practical realisation shown. Even things such as the optical shaft encoder for the main tuning control are skilfully achieved using readily available domestic hardware.

In total, the book is not only a “how to do it” text, but is also a handbook of modern engineering practice and its theoretical background. I found it enthralling (not a word one usually

**BUILD YOUR OWN INTELLIGENT AMATEUR RADIO TRANSCEIVER**  
Randy L. Henderson

applies to textbooks!), and if I had a little more spare time, a digital transceiver would be starting to appear on my drawing board too.

The only mystery still unsolved is “what is Randy’s callsign?” Nowhere in the book does it appear. His XYL gets a mention (NSIZZ) but not his own call. No doubt there is a good reason for this.

But whether he has a current callsign or not, his book may well get on to the air many new home-brew digital synthesis transceivers.

It IS possible after all!

# ALARA

Sally Grattidge VK4SHE\*, ALARA Publicity Officer

## New Members

A warm welcome is given to new members Trish VK6QL and Joy G4OUZ.

## Congratulations

We all offer our congratulations to Pat VK4PT and Ted VK4EWR for their Golden Wedding anniversary on 12 July this year.

## This and That

Tina VK5TMC and Jean VK5TSX are attending Morse code classes ready to upgrade and are finding it slow work. Don't give up girls.

YL lunches are held monthly in Adelaide, Melbourne and Perth. If you find yourself in one of these cities, contact one of the locals for more information.

Dot VK2DDB is going to learn botanical drawing, and wondering if she will be able to design a new plant.

Choon HL1ASD is back in Korea after visiting her children at boarding school in Sydney. She visits Sydney about four times a year for this reason, and likes to keep in touch with VK YLs as much as she can.

Raija SM0HNV, who attended the ALARAMEET in Perth last year, celebrates 40 years on the air this year. Her original callsign was OH2GX. Is this a record? Raija put a very nice report, complete with photograph, about the Perth ALARAMEET in the YLRL official publication, *YL Harmonics*, May/June issue.

Angelika G0CCI went to Germany for the Friedrichshafen Amateur Radio Convention (the biggest in Europe). She has been going since 1985 and has made many friends. Angelika particularly enjoys the UL Social where 200 or more YLs gather. Friedrichshafen is on the Swiss border, making it a good destination to include in a holiday trip.

## Happy Birthday

CLARA is 30 this year and they are celebrating with a Gala on 26 to 28 September. Gwen VK3DYL will be there, but if you can't wait for her report try <http://www.osh.igs.net/~Isolomon/clara/c/ara.htm> or <http://www.yoy.net/~rfi/yl.htm>

Other ALARA YLs who will be there include Elizabeth VE7YL, Lois WB3EFQ, Aola ZL1ALE and Biny ZL2AZY.

## ZL News

from Marg ZL3UD

Due to lack of response to a change of frequency, all nets will be on 3.695 MHz +/-.

The NZ WARO Achievement Award, the Myrtle Earland Rosebowl, was awarded this year to Celia ZL1ALK for outstanding services to WARO over the past 36 years. A certificate for 30 years continuous membership was presented to Aola ZL1ALE. Congratulations Celia and Aola.

The WARO Youth Examination Award went this year to Gloria Hewer ZL2WGH who is only 10 years old.

WARO is considering holding a DX YL meet in the year 2000, and a sub-committee has been formed to look into the idea.

## Contests

The YLRL Sponsored Contest Howdy Days on CW and SSB will be held from 1400

UTC on Thursday, 18 September to 0200 UTC on Saturday, 20 September.

The 26th JLRS Party Contest Phone section will take place from 0300 UTC on Saturday, 27 September to 0300 UTC on Sunday, 28 September; and the CW section will take place from 0300 UTC on Saturday, 4 October to 0300 UTC on Sunday, 5 October (details in the July Newsletter).

## Convention

If you are in North Queensland in September, call in to Townsville and join in the fun at the North Queensland Convention on 26, 27 and 28 September. There is usually a good roll up of YLs, plenty of interesting activities, and plenty of tropical sunshine to enjoy.

\*C/o PO Woodstock, QLD 4816  
Tel: 077 788 642

Packet: VK4SHE@VK4RAT.#NQ.QLD.AUS.OZ  
Internet e-mail: rgrattid@ozemail.com.au

ar

## WIA News

### New WIA Members

The WIA bids a warm welcome to the following new members:

JM	Grodzicky	L10170
R	Manning	VK1ZRM
K	Yamashita	VK2IY
J	Nelson	L21053
RC	Selby	VK2MNP
H	Johnson	VK2GLX
GD	Cole	VK2WPM
IS	Wilkinson	VK2PKB
EN	Napper	VK2FIN
B	Van Der Broek	VK2FAU
NHE	Weste	VK2AKR
W	Memphis	VK2TEV
B	Walker	VK2HOT
G	Pierce	VK2TMM
MC	York	VK2MY
ES	Dening	VK2IF
PL	Portelli	VK2DNL
A	Bode	VK3AIB
G	Jarry	VK3MIL
G	Ganegoda	VK3TXL
B	Dusting	VK3FHY
S	Brown	VK3MEQ
L	Ligt	L31543
JW	Stacpoole	L31544
C	Engler	VK3HCE
M	Van Bladel	VK3JJB
M	Smith	VK3MDS
P	Lindsay	VK4TO
R	Barmore	KB9GKX
R	O'Mahoney	VK4TUP
B	McCarthy	VK4WMC

T	Johnston	L40380
R	Mattiske	VK4KIE
J	Couvaras	VK4DAB
E	Davis	VK4KR
E	Reynolds	VK4BER
M	Patterson	VK4HBO
J	Maudsley	VK4YJV
DP	Taylor	VK5WA
CR	Willmer	VK5NEW
GD	Mair	VK5HII
GD	Orr	VK6ZGD
AS	Johnston	VK6SWR

### Teen Amateur Net

For the younger amateur, there's an on-air net happening every Tuesday night, which may be found on 3613 kHz from 0730 UTC. An initiative of Dean ZL1JJ, based on a similar concept operating in Europe, the net's been going since August 1996. First meeting on the ZL national UHF system, the 80 m frequency was added in July.

If you're on packet, you can send a message to Dean at his packet address, [ZL1JJ@ZL1AB.#11.NZL.OC](mailto:ZL1JJ@ZL1AB.#11.NZL.OC). TeenNet is also on the international teletext system. Log on to your local BBS and type TT at index page 109. For Web surfers, hit the TeenNet home page at [www.fibo.hogent.bel/~on4bds/TeenNet.html](http://www.fibo.hogent.bel/~on4bds/TeenNet.html). Thanks to *Qnews*, from Graham Kemp VK4BB, for that.

[Released 11/8/97]



# AMSAT Australia

Bill Magnusson VK3JT\*

## National co-ordinator

Graham Ratcliff VK5AGR

Packet: VK5AGR@VK5WI

E-mail: vk5agr@amsat.org

AMSAT Australia net:

Control station VK5AGR

Bulletin normally commences at 1000 UTC, or 0900 UTC on Sunday evening depending on daylight saving and propagation. Check-ins commence 15 minutes prior to the bulletin.

Frequencies (again depending on propagation conditions):

Primary 7.064 MHz (usually during summer).

Secondary 3.685 MHz (usually during winter).

Frequencies +/- QRM.

AMSAT Australia newsletter and software service

The newsletter is published monthly by Graham VK5AGR. Subscription is \$30 for Australia, \$35 for New Zealand and \$40 for other countries by AIR MAIL. It is payable to AMSAT Australia addressed as follows:

AMSAT Australia

GPO Box 2141

Adelaide SA 5001

Keplerian Elements

Current keps are available from the Internet by accessing the AMSAT FTP site, [ftp.amsat.org](ftp://ftp.amsat.org) and following the sub-directories to "KEPS".

Integration Laboratory in Orlando, Florida to manufacture and install the recommended structural parts necessary to increase the spacecraft's vibration and acceleration capability.

At a meeting in mid-July attended by Dr Karl Meinzer DJ4ZC, ESA officials reiterated their intent to launch A-502 at the end of September and said that the launch campaign for this flight had already begun. They stated that, as part of this launch campaign, the Phase 3-D spacecraft must arrive in Kourou by 10 August 1997.

Dr Meinzer made it clear to the ESA officials that this work, made necessary by ESA's new environmental information, would prevent AMSAT from delivering the spacecraft to Kourou by the specified 10 August 1997 date. Thus, it was the conclusion of the meeting that, as a result of these ESA specification changes, the Phase 3-D schedule and that of ESA for Ariane 502 are not compatible. Therefore, unless something changes, which ESA does not presently contemplate, Phase 3-D will not be able to be launched on Ariane 502.

To compound the bad news, in order to maintain the planned mass characteristics of the Ariane 502 vehicle, AMSAT must supply a mass simulator representing the Phase 3-D spacecraft to be sent aloft on the flight. This must be in Kourou by 5 September 1997. Despite this very bad news, Dr Meinzer and other AMSAT officials expressed some degree of confidence that the Phase 3-D may yet fly on Ariane 502. They based this on a number of activities taking place in the preparation of the launch vehicle that they believe could cause a slip in the currently published ESA schedule.

The ESA officials attending the Marburg meeting said that, if a slip should occur, which they do not currently contemplate, which results in the two schedules again becoming compatible, efforts would be made to substitute the Phase 3-D spacecraft for the mass simulator. Therefore, AMSAT is continuing the work of completing the necessary structural modifications to the spacecraft, and conducting environmental testing. AMSAT-NA President Bill Tynan W3XO pointed out that revelations such as the increased vibration and acceleration requirements now imposed on the Phase 3-D spacecraft are not all that unusual in a development program such as the Ariane 5. He felt sure that the situation is as unpleasant for ESA as it is for AMSAT, and believes that

ESA will be working on ways to reduce the environments on future Ariane 5s, possibly even on 502. Bill stressed that this situation is NOT a matter of poor engineering, or bad faith, on the part of ESA, but merely what sometimes happens when the state of the art is being pushed. The above information supplied by Karl Meinzer and Bill Tynan.

## MIR Space Station Still in the News

News of the on-going problems on board the "crippled" MIR still dominate the evening news broadcasts. It seems that a "rescue mission" is under way as this goes to press. I was prompted to see if all the news was indeed bad so I tried for a connect to the MIR PMS a week or two ago and was pleasantly surprised to find the device responding as usual.

Mike Foale has reported a couple of occasions since the collision when the TNC suffered a power outage causing loss of all data stored in memory. Hopefully, a new TNC with memory backup will be carried to MIR shortly. On mentioning this to some friends they suggested that a few paragraphs on the mechanics of working MIR might not be a bad idea to spur some activity and perhaps give someone the slight push needed to get started in satellite working. So here goes...

Nowadays, the majority of crew members on MIR are licensed amateur radio operators, but they are very busy people. Their day to day chores take precedence over any recreational activity like amateur radio. To complicate matters even further, they have to sleep! They also work to Moscow time on the MIR so all this means your chances of having a voice QSO are pretty remote. Most of the voice QSOs I have had over the years have been a result of scheds.

It was much easier a few years ago. The schedule seems to be a lot tighter these days. You hear of people having unscheduled contacts but they are rare .... you can be lucky!

The packet radio set-up on MIR has a special significance in that it is turned on most times and it is by far the easiest of all amateur radio space contacts to make. The equipment requirements are modest and the signal is strong and reliable. In fact, making contact is a piece of cake. The only hard part is knowing when to try and when NOT to try. MIR is like any other satellite in low-earth-orbit in that it orbits the Earth many times per day and therefore moves rapidly across the sky of any earth-bound observer. If you have even the simplest 2 metre packet radio station, the only other thing you will need is a tracking program. The keps elements needed to keep it up to date are posted frequently

## Possible Further Delay in the Launch of Phase 3-D

It was announced late in July that there may be a further delay in the launch date of the Phase 3-D satellite. AMSAT was informed some months ago by the European Space Agency (ESA) that, following analysis of data from the Ariane 501 flight, they had significantly increased their estimates for the acceleration and vibration environments which spacecraft riding on Ariane 502 are expected to encounter. As a result of this new information, AMSAT has been re-evaluating the structural capabilities of the Phase 3-D space frame. An independent structural engineer was brought in to review the spacecraft's design and construction. His report stated that, in order to be confident of surviving these increased launch environments, a number of modifications must be made to the spacecraft. Substantial effort has been taking place at the Phase 3-D

(some would say TOO frequently) on packet BBSs.

The callsign of the MIR PMS is r0mir-1 (that 0 is a zero). The frequency in use at present is 145.985 MHz (simplex). There is some Doppler shift and to compensate for this requires a lot of practice and separate control of transmit and receive frequencies or a computer program and interface.

With a simple set-up it's best not to worry about it. Just try to make your contact with MIR is close to your QTH rather than when it is just coming up or going down. You will hear of stations using elaborate, high gain tracking antenna systems but it is quite possible to make contact using nothing more than a ground plane and a few watts. Here is a typical packet radio contact with the MIR PMS, taken from my WinPack capture file.

**R0MIR-1>CQ <UIR>:**

**c r0mir-1**

**\*\*\* CONNECTED to R0MIR-1**

**Logged on to R0MIR's Personal Message System**

**CMD(B/H/J/K/KM/L/M/R/S/SR/V/?)>**

**j**

**VK3JT 07/14/97.10:50**  
**ZL3UCP 07/14/97.10:50**  
**VK7KT 07/14/97.10:50**  
**ZL3GF 07/14/97.10:50**  
**VK5AJW 07/14/97.10:48**  
**VK5PGT 07/14/97.10:48**  
**VK2JYE 07/14/97.10:47**  
**FITRE 07/14/97.10:12**  
**LZ3RC 07/14/97.10:12**  
**UT4NF 07/14/97.10:12**  
**DG2TOM 07/14/97.10:10**  
**IK6UGE 07/14/97.10:10**  
**F6CBL 07/14/97.10:10**  
**ON1APG 07/14/97.10:10**  
**F5BQP 07/14/97.10:09**  
**F5THQ 07/14/97.10:09**  
**F1OXT 07/14/97.10:08**  
**P14NAF 07/14/97.10:08**  
**CMD(B/H/J/K/KM/L/M/R/S/SR/V/?)>**

**l**

Msg #	Stat	Date	Time	To	From	@	BBS	Subject
168	P	07/14/97	09:56	KB5UAC	VOICAT		MIR	
167	P	07/14/97	09:55	KB5UAC	VOICAT		Repairs etc	
166	P	07/14/97	08:33	R0MIR	DG2TOM		Wishes	
165	P	07/14/97	06:57	MIR	IK6ZDF			CHAO !!!
164	P	07/14/97	06:24	N6CO	LW7EDS			hello from lw7eds
163	P	07/14/97	06:23	R0MIR	LW7EDS			question 4.crew
162	P	07/14/97	05:20	R0MIR	F5ASD			HELLO MIKE!
161	P	07/14/97	04:51	N6CO	LW7EDS			Hi from Mar del Plata
160	P	07/13/97	23:32	NASA5	N6CO			WINPACK
159	PR	07/13/97	23:31	ALL	N6CO			2 Line MIR Keps 7-13

10062 Bytes free

Next message Number 169

**CMD(B/H/J/K/KM/L/M/R/S/SR/V/?)>**

**b**

**cmd:\*\*\* DISCONNECTED**

### From The Top.....

The first line is an unproto CQ frame from MIR PMS. Remember it is a single connect system. It is not a BBS. If someone else is connected it is no use calling until MIR PMS disconnects and is listening. To do so only slows the system down and delays the time when you or others will be able to connect. Wait until you see a <DM> frame or CQ call as above.

The next line is my call for a connect to r0mir-1. The next three lines are the response from MIR PMS. From the prompt line I have picked j as the next command. This requests a list of stations recently connected to MIR PMS. The response from MIR PMS is the list of such stations. I have then sent an l command to obtain a list of messages on the PMS. This is followed by the response showing the list of 10 most recent messages and again, the prompt line. There were no messages I wanted to read so I then sent the command b to disconnect. Note that the commands are not case sensitive. As with any PMS you can obtain a complete set of command instructions by sending ? or h.

The entire process only took a minute or two and that left it possible for someone else to make a connect during that pass. It is very important that you disconnect before MIR goes out over your horizon. If you remain connected after you lose the signal you will not be able to disconnect and others along MIR's route will have to wait until the system times out before they can make contact. Note also that the MIR PMS is designed as a service to the MIR crew. It is not good practice to leave messages for other amateurs. The device has limited memory and messages to crew members may be "pushed off the end" if the PMS is over-used by third party traffic.

### New Service Gives Regular Satellite Status Reports

Over the years that I've been writing this column I have tried to keep readers informed

of the status of the OSCARs by including a six monthly update in the column each January and July. Things are apt to change rather quickly in the amateur radio satellite field and copy deadlines make it inevitable that occasionally some information is out-of-date before it is printed.

In recent months a new service has appeared that has the potential to solve this problem. A weekly update list is being distributed via the packet radio network by KTOH and via the internet by ve7vdx@dowco.com and is also available at the following locations:

Web.....<http://www.umecut.maine.edu/~baack/freqguide.html>

Newsgroups...[rec.radio.amateur.space](http://rec.radio.amateur.space)

.....[aus.radio.amateur.misc](http://aus.radio.amateur.misc)

.....[uk.radio.amateur](http://uk.radio.amateur)

Mail List...[amsat-bb@amsat.org](mailto:amsat-bb@amsat.org)

Comments, congratulations, errors or omissions to [ve7vdx@dowco.com](mailto:ve7vdx@dowco.com)

The current list is too long to reproduce here but I strongly urge satellite enthusiasts to look at it every now and then. Quite a lot of work goes into collecting and collating the information needed each week to update the file....great job, guys. A weekly update means a high degree of reliability. The list is exhaustive and contains many items of news interest as well as the current status. It should be much appreciated by all operators. Information for inclusion in the list may be forwarded directly to VE7VDX at the above internet address.

### RS-10 Problems

Leonid Labutin UA3CR has reported that, after a conversation with the controller of RS-10, he does not hold much hope of recovery of this satellite. The estimate was only about 1-2% possibility. They were awaiting the return from vacation of one of the experts to properly assess the situation.

\*RMB 1627, Milawa VIC 3678

E-mail: [vk3jt@amsat.org](mailto:vk3jt@amsat.org)

ar

**Are you reading  
someone else's  
Amateur Radio?  
Call  
03 9528 5962  
to find out how  
to get it every  
month!**

# Awards

John Kelleher VK3DP - Federal Awards Manager\*

## DXCC

Over the past months I have dealt with a variety of correspondence, mainly to do with DXCC and the listings arising. Some confusion with additional countries, and deletions to DXCC, still remain. To this end, I have decided to publish relevant information on this subject.

### Additions

4J1	Malyj Vysotskij Island	May 1989
3D2	Rotuma Island	May 1989
T33	Banaba (Ocean) Island	May 1990
ZS9	Walvis Bay	May 1990
7O	Yemen	Mar 1991
ZS0/1	Penguin Island	Sep 1991
9A/YU2	Croatia	Jan 1993
S5/YU3	Slovenia	Jan 1993
T9/4N4		
4O4/YU4	Bosnia-Herzegovina	Jan 1993
Z3/4N5		
YU5	Macedonia	Jun 1993
OK/OL	Czech Republic	Jun 1993
OM	Slovak Republic	Jun 1993
P5	North Korea	Oct 1995
BV9P	Pratas Island	Apr 1996
BS7	Scarborough Reef	Apr 1996

### Moved from Deleted List to Active Status

E3	Eritrea	Feb 1994
----	---------	----------

### Moved to Deleted List

DM/Y2-9	German Dem Republic	Mar 1991
4W	Yemen Arab Rep (North)	Mar 1991
7O	PDR of Yemen (South)	Mar 1991
A1	Abu Ail Island	Jun 1993
OK/OM	Czechoslovakia	Jun 1993
ZS0/1	Penguin Island	Jul 1994
ZS9	Walvis Bay	Jul 1994

To answer one outstanding question, Yugoslavia has NOT been deleted. It remains, represented by YU1, 6, 7, 8, 9 and 0. The breakaway republics of 9A, S5, T9, and Z3 are now separate DXCC countries under their own right.

The question of VS6/VR2 Hong Kong remains status-quo, until the ARRL DXCC Desk decides otherwise.

## Air Mail Postage Rates

The world is divided into five Postal Zones. The APO rates in dollars applying to these zones are:

	Zone 1	Zone 2	Zone 3	Zone 4	Zone 5
P/Cards	0.70	0.80	0.09	0.95	1.00
Econ/air	0.65	0.70	0.75	0.80	0.85
Letters	0.75	0.85	0.95	1.05	1.20
Econ/air	0.70	0.80	0.85	0.90	1.00
Packets	1.90	2.20	2.50	2.70	3.20
Econ/air	1.70	2.00	2.20	2.50	2.70

Economy Air is virtually by air over water, and by land to destination.

**Zone 1** Papua New Guinea, New Caledonia, New Zealand, Solomon Islands, and Vanuatu.

**Zone 2** Brunei, Fiji, Fr Oceania, Indonesia, Kiribati, Malaysia, Nauru, Niue, Samoa, Singapore, Tokelau, Tonga, Tuvalu, Wallis Is and Cook Islands.

**Zone 3** Bangladesh, Bhutan, Cambodia, Caroline/Marshall Is, China, Guam, Hong Kong, India, Japan, Korea, Laos, Macau, Maldives, Marianas, Micronesia, Myanmar, Nepal, Pakistan, Palau, Philippines, Pitcairn, Sri Lanka, Taiwan, Thailand, and Vietnam.

**Zone 4** Afghanistan, Bahrain, Canada, Cormoros, Cyprus, Hawaii, Iran, Iraq, Israel, Jordan, Kuwait, Lebanon, Madagascar, Mauritius, Mexico, Oman, Qatar, Reunion, St Pierre & Miquelon, Saudi Arabia, Syria, United Arab Emirates, USA, Yemen.

**Zone 5** Should include all of those countries not listed above. If you have plotted the above lists, you will find that Europe, Africa, South America and the West Indies are missing, along with some Atlantic Islands and outer Asia.

## RTTY DXCC

I have had a request to publish the standings for RTTY DXCC. Here is the complete list, including those who are Silent Keys:

Cert No	001	VK2SG	S Molen	07.10.83
	002	VK2EG	W Storer	26.05.84
	003	VK5RY	R Collins	27.02.85
	004	VK2BQS	J Swan	07.05.87
	005	VK3EBP	P Styles	11.05.91
	006	VK3AMK	G Wilson	11.07.97

## Grid Square Listing

There has also been a request for the Grid Square listings. This list is not necessarily in order of proficiency but in certificate number order:

	2 m	6 m	10 m	15 m	20 m	40 m	80 m	70 cm	23 cm
VK3BRZ	42	67						19	17
VK3DP					109				
VK3KWA									30
VK2CMV			104	104	104	104			
VK3TU		62							
T30JH		56							
VK4ARB				89	143		100		
VK4SIX		52							
VK3WAB					101				

## European World wide Award

During last month I received a letter from Hans Kiesinger L40370 (VK4/HE9RFF) ex HS1ALK, with the rules for the European World Wide Award, which is sponsored by the Council of Europe. The information received by Hans was in French, so Hans translated it.

The European World Wide Award (EWWA) was created by the Radio Club of the Council of Europe, and is available to all licensed Radio Amateurs and SWLs fulfilling the following conditions:

### 1. HF

A. Mixed (CW-Phone-RTTY): 200 confirmed contacts with 200 different countries on the EWWA/DXCC list.

B. CW: Same as above, but in CW.

C. SSB: Same as above, but in SSB.

D. RTTY: Same as above, but in RTTY.

E. Monoband 200: confirmed contacts with 200 countries on the bands 20, 17, 15, 12 or 10 metres. 100 confirmed contacts on the bands 160, 80, 40 and 30 metres, in modes Mixed, SSB, CW or RTTY.

F. 5 Band EWWA: 100 contacts ON EACH of 80, 40, 20, 15 and 10 m. Mixed, SSB, CW or RTTY.

G. 9 band EWWA: as for 5 band, but in the following: 160, 80, 40, 30, 20, 17, 15, 12 and 10 metres.

H. Top List HF EWWA: Requires a total of 300 confirmed countries, either Mixed, CW, or RTTY. Members of "Top List" receive a personalised pennant in addition to the diploma.

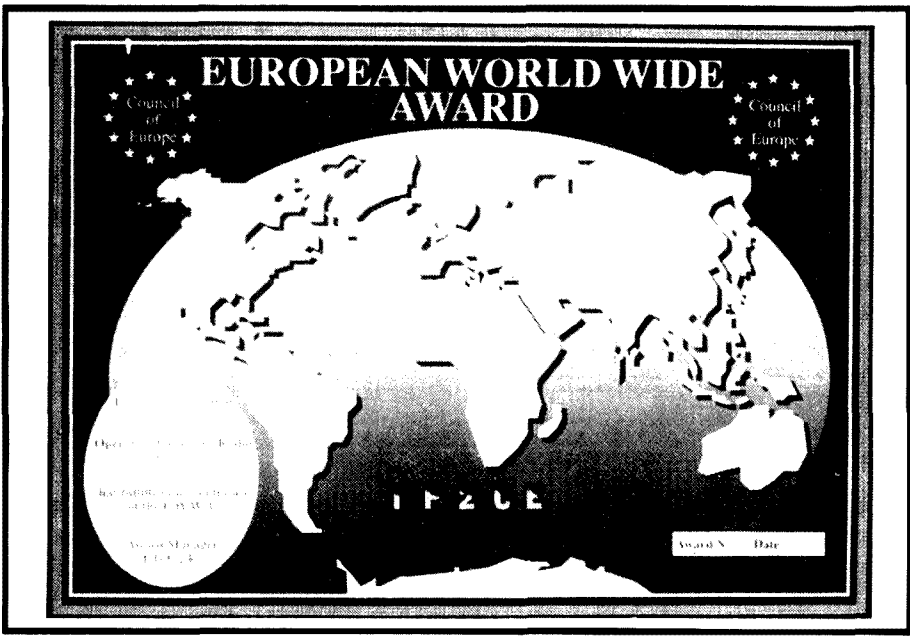
### 2. VHF

A. 144 or 50 MHz: 50 confirmed countries FM, SSB, CW or Mixed.

B. Satellite: 100 confirmed countries.

Log copies/list (confirmed by two amateurs) stating call, country, mode, frequency or band, date and time, should be sent to: Awards Manager, Francis Kremer F6FQK, 31 Rue Louis Pasteur, F 67490 Dettwiller, France.

The fee is 50 FFrs or \$US10.00. Contacts from 1 January 1980 are valid. The worked stations must be land-bound, not /MM or /AM. All stations must be worked from the same country.



counts as 15 points; Antarctic stations and stations on ships in the Arctic 10 points; stations on Arctic Islands, and stations located north of 70 degrees North are five points. Other stations within the Arctic circle are two points each.

Point values are doubled for South American, African, and Oceanian stations. All QSOs (except those with RAEM while alive) must have been made since 24 December 1972.

**General Award Requirements**

GCR list is acceptable. Fee is one Rouble (roughly translated to about \$AUS2.20). SWL OK. Minimum reports 337 or 33. Allow six months for processing. Apply to: The Central Radio Club USSR, PO Box 88, Moscow, Russia. (Correspondence received as late as 1996 indicates that awards are still being processed and issued from the above address.)

**November**

I have set aside information for the November issue for the exclusive use of YLs and XYLs, so PLEASE ladies, send me award information which I can print for your advantage.

\*4 Brook Crescent, Box Hill South, VIC 3128  
Phone (03) 9889 8393

ar

The EWWA countries list I received appears to be identical to the current DXCC list, so I see no immediate problems in using the latter.

**The RAEM Award**

This award was founded in 1972 in memory of the Arctic explorer Ernst T Krenkel, who died in 1971. He was given the

privilege of using this special call in honour of his contributions in exploration of Arctic Islands. The award is given for contacting Soviet stations within the Northern and Southern polar circles. The award is issued ONLY for CW contacts.

Earn 68 points as follows: a contact with RAEM when operated by Ernst Krenkel

**WIA News**

**Records Fall on UK LF Band**

Since getting access to 73 kHz recently, UK amateurs have not wasted time in establishing, and then breaking, a series of distance records.

The distance for conventional (aural) reception of CW signals on the 73 kHz band stood at 99.9 km until late July, when G4JNT and G2AJV made contact over a distance of 173 km.

However, earlier, on 12 July the signal of G4JNT near Southampton was heard by G3PLX at Kendal in Cumbria, a distance of 393 km. Very slow CW transmission, generated by software, was used with digital signal processing to receive the signal in a bandwidth of 25 millihertz (you read that correctly – that's 0.025 Hz!), the Radio Society of Great Britain's *GB2RS News* reported.

The signal was displayed on a grey-scale "waterfall" display on a PC. The CW used a dot period of 100 seconds, G4JNT's call sign taking 1.7 hours to send. Each dot period also included one full call sign sent at 10 wpm to keep within the UK licensing requirements and to assist any local listeners.

On 27 July, when the 99.9 km record fell, G3LDO, having built a 1.2 m diameter multi-turn receiving loop, heard G4JNT on sched on its first test – a distance of 59 km. On switching his receiver bandwidth from 250 Hz to 500 Hz, G3LDO heard G2AJV as well. This established two firsts: the first random (ie non-sched) reception of another amateur on 73 kHz and the first time that two stations were heard simultaneously. Well, that's the way it goes – no sooner does a band open for use than there are dog-piles to cope with!

**Business Journal Highlights Ham Radio Magic**

The US business magazine, *Forbes*, carried a complimentary article on amateur radio in its 7 July issue, which was on-sale in Australia on 11 July. Written by staff journalist and long-time radio amateur, James Clash WA3JID, the article, titled "There's magic in it", highlights the worldwide growth in radio amateurs' numbers, pointing out that when the Internet started to become popular, "... ham ranks have jumped an average 6% annually."

The two-page article is illustrated with pictures of the author as a young enthusiast, ex-US senator Barry Goldwater K7UGA, country singer Patty Loveless KD4WUJ and astronaut Blain Hammond KC5HBS, and a variety of QSL cards from around the world.

Clash writes about the magic of getting on the air and how the Internet has become a help-mate to amateurs around the world, helping the hobby to thrive. He quotes ARRL executive vice president David Sumner K1ZZ, in explaining the magic of ham radio: "There's nothing to connect you – no telephone wires, no computer modems – just air, yet you're linked with someone on the other side of the world."

Asked why not use Internet e-mail to reach someone in Siberia, for example, Sumner explained to Clash: "People who think like that just don't get it. They've never run a marathon, climbed a mountain or sailed a 14-foot boat across the Atlantic. They don't see the attraction of challenging themselves."

[Released 12/7/97].

# Contests

Peter Nesbit VK3APN - Federal Contest Coordinator\*

## Contest Calendar September - November 1997

Sep 6/7	IARU Region 1 Field Day	
Sep 6/7	All Asia DX Contest Phone	(May 97)
Sep 6/7	Bulgarian DX Contest	(Aug 97)
Sep 7	Panama SSB Contest	(Aug 97)
Sep 13/14	Worked All Europe Phone	(Jul 97)
Sep 20	Atlantic QSO Party Phone	
Sep 20/21	SAC DX CW	(Aug 97)
Sep 20/21	Atlantic QSO Party Phone	
Sep 27/28	SAC DX Phone	(Aug 97)
Sep 27/28	CQ WW RTTY DX Contest	(Aug 97)
Oct 4/5	VK/ZL/Oceania DX Contest (Phone)	(Aug 97)
Oct 5	RSGB 21/28 MHz Contest (Phone)	
Oct 11/12	VK/ZL/Oceania DX Contest (CW)	(Aug 97)
Oct 18	Asia-Pacific CW Sprint	(Jan 97)
Oct 18/19	JARTS WW RTTY Contest	
Oct 18/19	Worked All Germany Contest (Mixed)	
Oct 19	RSGB 21/28 MHz Contest (CW)	
Oct 25/26	CQ-WW DX Contest (Phone)	
Nov 1/7	HA QRP Contest	
Nov 8/9	WAE RTTY DX Contest	(Jul 97)
Nov 8/9	OK-DX CW Contest	
Nov 15/16	IARU Region 1 160 m Contest	
Nov 15/16	All Austria CW Contest	
Nov 22/23	CQ World-Wide DX CW Contest	

with the Field Day Contest.

For information and assistance this month, thanks to VK1PJ, VK4FW, 9A2EU, 9V1YC, DL2DN, LZ1BJ, VE2ZP, RSGB, and CQ. Until next month, good contesting!

73, Peter VK3APN

## Amendment to Rules of Bulgarian DX Contest

The latest rules for this contest have just been received. Please note that it now runs from 1200z on Saturday, 6 September, to 1200z on Sunday, 7 September. Logs should be addressed to BFRA, not Central Radio Club. All other details remain the same, as shown in last month's column in *Amateur Radio*.

## First Atlantic QSO Party (Phone)

Sat, 20 September, 0000 - 2359z

Run by the Loyalist City ARC in NB Canada, the object is to work as many Atlantic province stations in Canada as possible. These include those in New Brunswick, Newfoundland, Nova Scotia, and Prince Edward Island.

Categories are low and high power (up to and over 100 W respectively). Use phone only, 160-10 m. Send RS + country (VK); Atlantic province stations will send RS + county. Score one point per QSO, and multiply by the number of counties worked. Send logs to: Atlantic QSO Party, Loyalist City ARC, Box 6552 Stn B, Saint John, NB E2L 4R9, Canada postmarked within four weeks.

## RSGB 21/28 MHz DX Contest

Phone: Sun, 5 October, 0700 - 1900z  
CW: Sun, 19 October, 0700 - 1900z

The object is to work as many UK stations as possible on 21 and 28 MHz (UK includes GI, but not EI). Categories (single or multi-operator) are: open, restricted, QRP, and SWL. In the restricted section, only one antenna is allowed, which must be a single element no more than 15 m high, and 100 W max O/P. The open section has no antenna or power limitations.

Send RS(T) plus serial starting at 001; UK stations will add their county code. Score three points per QSO. The final score equals the total points times the total multiplier (counties worked on each band added together). Use a separate log for each band. Send logs and summary sheets, postmarked by 14 November, to: RSGB HF Contests Committee c/o G3UFY, 77 Bensham Manor Road, Thornton Heath, Surrey CR7 7AF, England. A comprehensive range of awards is offered.

SWLs may only log UK stations making contest QSOs with overseas stations. SWL logs should be headed time UTC; callsign

It's amazing how normally quiet bands come to life whenever there is a contest on, and one wishes it was more like this all the time.

The ability of contests to prove that the bands are open more than we realise was demonstrated to me during the IARU Contest a few weeks ago, in July. For various reasons I did not take part, so there I was late on Sunday morning, pottering around the shack with the receiver sitting on 7005 kHz and the gain turned down. A weak CW station was calling CQ, but assuming it was semi-local, I didn't pay it much attention. That is, until I heard Ade OH7... A mad scramble to fire up the transmitter followed and, wonder of wonders, a QSO ensued. The time was 11.55 am!

After doing a few somersaults, I rushed out and dragged the XYL into the shack to show her the signal. Although she didn't have a clue what any of it meant, she could see how excited I was, and for once said all the right things, bless her soul.

This got me thinking. My station is nothing special, and my suburban QTH is far from ideal. How much more could be achieved with a better station and quieter location? In fact, there are already plenty of

amateurs with such stations, so what do they work at unusual times, when the rest of us are not usually listening? I really am interested in this, so if you've had QSOs at seemingly impossible times, or worked a station on an incredibly long path, please let me know. If the response is sufficient, I'll endeavour to summarise the results in an article. I know this is a bit off the contest track, but it's still of interest, so what the heck!

Getting back to contests, Phil VK1PJ has advised that he will no longer be handling the John Moyle Field Day Contest. On behalf of all the entrants in this contest over the years, many thanks Phil, and we hope you enjoy your retirement.

I am pleased to welcome the new manager for this contest, Eric Fittock VK4NEF. Eric has been keenly interested in this contest for some time, and has kindly volunteered to take it over. I'm sure you will all join me in wishing Eric all the best in managing this popular event.

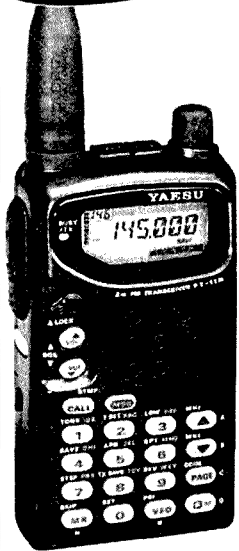
We had hoped to float some ideas regarding the Field Day for your consideration, however time (and space) have run away, so it will have to wait until next month. In the meantime, have a think about what YOU would like to see happening

# DICK SMITH ELECTRONICS

## Performance That Sends Out The Right Signals

Whether its transceivers, hand-helds, antennas or software, Dick Smith Electronics has everything you're looking for. At prices that communicate great value.

**SAVE \$100**



### FT-11R Micro Deluxe 2m Hand Held

One of the world's smallest 2m FM hand helds with a full-size keypad, the Yaesu FT-11R has been reduced in size but not in features. Designed to fit comfortably in your hand, it weighs just 280g.

- Large backlit LCD with full frequency readout
- 150 memories (75 in alphanumeric readout)
- Easy SET mode for customising functions
- Thumb-controlled volume and squelch
- Auto battery save, TX saver and power off
- Efficient FET RF amp with 1.5W RF output as standard, 5W with optional battery or DC adaptor
- DTMF-based selective calling and paging
- Extended 110-180MHz receiver coverage
- Naming of memory channels
- DTMF message paging with up to 6 alpha-numeric characters
- Australian version auto repeater shift
- 57 x 102 x 26mm (W.H.D.)
- With FNB-3 1 600mA/H NiCad pack, belt clip, AC charger, CA-9 charge adaptor and antenna

D 3640

**\$399**

**2 YEAR WARRANTY**

### YAESU FT-736R VHF/UHF Base Station Transceiver

Whether your interest is in talking through your local repeater, operating SSB DX or talking to the world via satellite, this high-performance multimode base station transceiver can do it all! In its standard form, the FT-736R provides 25W output on the 2m (144-148MHz) and 70cm (430-450MHz) bands in SSB, CW and FM modes. Can be expanded to cover the 6m (50-54MHz) and 23cm (1240-1300MHz) bands by installing optional modules.

- Digital control with keypad VFO frequency entry
- Efficient switch mode AC power supply
- 100 general purpose memories
- 10 full-duplex memories, 2 independent VFOs per band
- 2 full-duplex VFOs: transmit and receive frequencies can be tuned independently or synchronously for satellite operation
- Adjustable IF notch and IF shift filters
- Noise blanker and 3-speed selectable AGC
- High stability (+/- 1ppm) PLL reference oscillators
- Speech processor and VOX for SSB
- VFO or selectable channel steps on FM
- Digital input connection for packet TNCs

D 2920

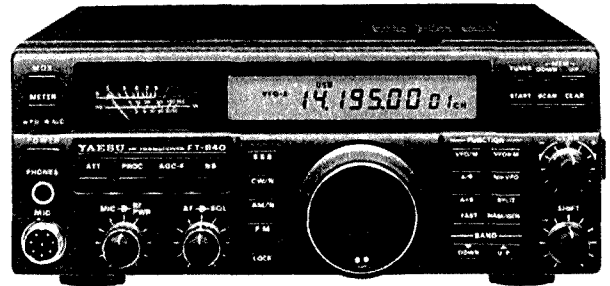
**2 YEAR WARRANTY \$2695**

6m module D 2921

**\$499**

23cm module D 2922

**\$899**



### FT-840 Economical HF Mobile Transceiver

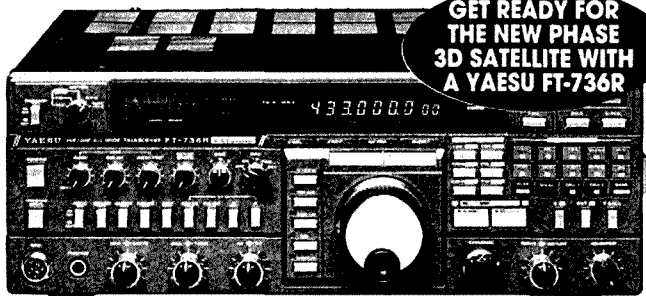


A serious HF transceiver that won't break the bank and doesn't compromise performance at home like many current micro-rigs. The Yaesu FT-840 gives you full 160m to 10m amateur band coverage with 100W PEP output on SSB/CW/AM, continuous receiver coverage (100kHz-30MHz), 100 memory channels, a large backlit LCD screen, an effective noise blanker and an uncluttered front panel. The FT-840 is simple to use, with useful features like an SSB speech processor for added audio punch, IF shift to fight interference, and Direct Digital Synthesis oscillators for cleaner transmit and improved receiver performance. Includes DC power lead and hand microphone... just connect your power supply and antenna and start having fun.

D 3275

**2 YEAR WARRANTY**

**\$1395**



**GET READY FOR THE NEW PHASE 3D SATELLITE WITH A YAESU FT-736R**

#### Specifications

Modes: LSB/USB (J3E), CW (A1A), FM (F2D, F3E)  
 Receiver: 50, 144MHz - dual conversion; other bands triple conversion  
 Sensitivity: SSB/CW - better than 0.2uV for 12dB S+N/N;  
 FM - better than 0.35uV for 12dB SINAD  
 Size: 368 x 129 x 286mm (W.H.D.)

Offers expire 30/9/97

# Our Antenna Deals Are Making Waves

## 2m/70cm Mobile Antenna

An easy way to go mobile, the new fibreglass M270 antenna with standard 5/16" thread can be used with existing base/lead assemblies you may already have in place on a vehicle.

Constructed on a strong fibreglass rod and covered with long-life polyolefin heatshrink, this 975mm long antenna covers 144 to 148MHz and 430 to 440MHz, with a maximum power rating of 200W.

D 4808



**\$34<sup>95</sup>**

## 2m/70cm Dualband Handheld Antenna

This flexible antenna covers the 2m and 70cm amateur bands, providing better performance than the standard ones supplied with latest version dualband transceivers such as the Yaesu FT-50R. The antenna consists of a thin, flexible metal whip section which is joined to an SMA-type male connector, providing 1/4 wave performance on the 2m (144 to 148MHz) band and 5/8 wave performance on the 70cm (430 to 450MHz) band. Made in Japan.

D 4338

**\$39<sup>95</sup>**

## 6m 1/2 Wave Base Antenna

A rugged, Australian-made vertical antenna designed to cover the 5.1 to 54MHz range, with minimum SWR around 53MHz.

Built using high tensile T8 1 grade aluminium, it's just 2.9m long with a sealed base section and 100W minimum power rating. Complete with mounting hardware.

D 4825

**D & G Antennas**

**\$69<sup>95</sup>**

## Advanced Data Mangement Software

An advanced way to programme a variety of the functions on many of the latest Yaesu handheld and mobile transceivers. Each package consists of an interface that plugs into both the serial port of your PC and connects to the transceiver via its microphone socket (for handhelds) or its packet socket (for mobiles). Also provided is easy-to-use 3.5" format PC software with pull down menus that allow for programming and naming of memory channels, selection of output power, CTCSS tones, scan and battery saver operation, plus much more.

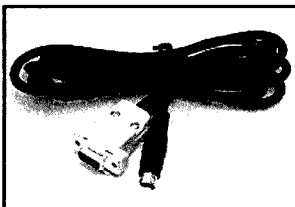
ADMS-1C for FT-10R/11/50 and 51R  
D 3752

**\$85**

ADMS-2C for FT-3000M/8000R  
and 8500

D 3758

**\$85**



Phone, Fax and Mail Orders—1300 366 644 (Local Call)  
or Fax: (02) 9395 1155 or visit us on the Internet  
at [www.dse.com.au](http://www.dse.com.au)

## High Performance 2m F-23A Base Antenna

The Diamond F-23A is a stacked, collinear style base antenna, providing high gain, wide bandwidth and low radiation angle for extended range. The fibreglass reinforced polyester outer radome and gasket seals provide excellent all weather operation, and it comes supplied with compact ground-plane radials for a clean pattern. Stainless steel mounting hardware ensures a long, trouble-free life and it is supplied with instructions for easy set-up.

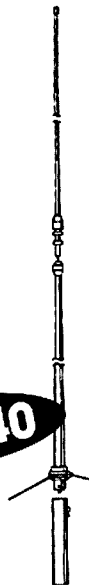
### Specifications

Frequency:	144 to 148MHz
Gain:	7.8dB
Max power:	200W
Length:	4.53m
Maxwind:	40m/s
Type:	3 x 5/8λ
Connector:	SO239 socket

D 4850

**SAVE \$40**

**\$195**



## Rugged HF 5-Band Trap Vertical Antenna

The rugged 5BTV incorporates Hustler's exclusive trap design (25mm solid fibreglass formers, high tolerance trap covers and low loss windings) for accurate trap resonance with 1kW PEP power handling. Wide band coverage is provided on the 10, 15, 20 and 40m bands (SWR typically 1.15:1 at resonance, <2:1 SWR at band edges) with 80kHz bandwidth typical on 80m at less than 2:1 SWR. An optional 30m resonator kit can be installed without affecting operation of other bands. High strength aluminium and 4mm (wall thickness) extra heavy-duty base section guarantee optimum mechanical stability. At just 7.65m, the 5BTV can be ground mounted (with or without radials, although radials are recommended), or it can be mounted in an elevated position with a radial system. Unlike other antenna designs, the 5BTV can be fed with any length of 50-ohm coax cable.

D 4920



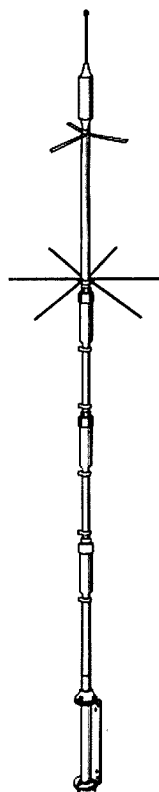
**\$349**

### 30m Resonator Kit

Adds 30m coverage to the 5BTV, and includes all hardware.

D 4921

**\$89.95**



B 3049



heard; number sent by that station; callsign of station being worked; new multipliers; points. In the column headed "station being worked" the same callsign may only appear once in every three QSOs except when the logged station counts as a new multiplier.

### Asia-Pacific Sprint (revised rules)

According to the new rules, the June date has been changed from CW to SSB. This will affect the contest scheduled for 13 June 1998.

Suggested frequencies are 7015-7040 and 14030-14050 kHz for CW, and 7060-7080 and 14250-14280 for SSB. On SSB, the called station must QSY at least 6 kHz after a QSO.

Winners must now make at least five valid QSOs to be eligible for a prize. Results will be posted to: [CQ-CONTEST@contesting.com](mailto:CQ-CONTEST@contesting.com) and [AP-SPRINT@dumpty.nal.go.jp](mailto:AP-SPRINT@dumpty.nal.go.jp)

All other rules, published last January, remain the same.

### JARTS World Wide RTTY Contest

18/19 October, 0000z Sat – 2359z Sun

This RTTY contest runs on the third full weekend in October each year. Categories are Single Operator Multi-band, Multi-operator, and SWL. Bands are 80-15 m. Exchange RST + age; YLs send RST + 00. Score two points per QSO with own continent, and three points per QSO for other continents. The multiplier is the total number of DXCC countries and W/VE/JA/VK call areas worked on each band, with all bands added together. Send your log to arrive by 31 December to: AJARTS Contest Manager, Hiroshi Aihara JH1BIH, 1-29 Honcho 4, Shiki, Saitama 353, Japan.

### Worked All Germany DX Contest (CW and Open)

18/19 October, 1500z Sat – 1500z Sun

In this contest, which occurs on the third full weekend every year, the world works Germany. Categories are: Single operator all band (CW, mixed, and mixed QRP max 5 W output); Multi-operator single TX; SWL. Use 80 – 10 m, and exchange RS(T) plus serial number. German stations will add their DOK (location code). Each station may be worked once per band per mode.

Score three points per QSO, and determine the final score by multiplying by the total number of German districts (first letter of DOK) worked on each band regardless of mode. Send logs, summary and dupe sheets to arrive by 20 November to: Klaus Voigt DL1DTL, PO Box 720427, D-01023 Dresden, Germany. Logs on DOS disk are welcome, if accompanied by a signed summary sheet.

### CQ WW DX Contest

Phone: 25/26 October, 0000z Sat – 2400z Sun  
CW: 22/23 November, 0000z Sat – 2400z Sun

Sponsored by *CQ Magazine*, these contests are undoubtedly the premier HF events of the year, and present the opportunity to work many rare countries and zones even with modest equipment. They are open to all stations world-wide, on 1.8-30 MHz (no WARC bands). Categories are: single operator; single operator low power (max 100 W output); single operator QRPp (max 5 W output); single operator assisted (for those using DX spotting nets); multi-operator single transmitter; and multi-operator multi-transmitter.

Single operator stations can enter as single or all band, and can change bands at will. Multi-operator stations must enter as all band. Multi-operator single Tx stations must stay on a band for at least 10 minutes, EXCEPT that one – and only one – other band may be used during the 10 minute period, if – and only if – the station worked is a new multiplier. Multi Tx stations are exempt from this rule, but can only radiate one signal per band at any one time.

Exchange RS(T) plus CQ zone. Score three points for QSOs with stations in a different continent, and one point for QSOs with stations in the same continent (for VKs this means Oceania as defined for WAC). Stations in the same country or call area can be worked for additional multiplier credit, but have zero points value. The total multiplier is the number of DXCC countries plus zones worked. Final score equals total points times total multiplier.

Use a separate log for each band. Show new multipliers in the log the first time they are worked, and duplicates with zero points. Entrants are encouraged to include a "dupe sheet" for each band, which becomes mandatory for 200 QSOs or more. Computer logs are welcome, and must be in ASCII on DOS disk, using separate files for each band, eg VK7AAA.20 for a 20 m log; alternatively in K1EA "CT" .BIN format, eg VK7AAA.BIN. Label the outside of the disk with the callsign, the files included, mode, and category. Disks MUST be accompanied by a paper printout satisfying logging instructions. The committee may request a disk from high scoring stations to enable the log to be checked by computer, if the log originally submitted was a computer printout.

Include a signed summary sheet, showing power output for low power and QRPp entries, and send the log postmarked by 1 December (phone) or 15 January (CW) to: *CQ Magazine*, 76 North Broadway, Hicksville, NY 11801, USA. Indicate Phone

or CW on the envelope. Numerous awards, trophies and plaques will be awarded to the leading entrants in the various categories and countries.

### Results of 1997 Australian Postcode Contest

Congratulations to VK4NSW for achieving first place world-wide. Australian scores are as follows:

VK2LEE	952
VK3CAT	23,128
VK4NSW	584,064
VK4FW	149,340
VK4LMB	8,800
VK4JAE	252
VK6LG	48,256
VK8AV	32,844
VK8NSB	2,618
VK4KIW/M	(check log)

### Results of 1996 Bulgarian Contest

(call/band/QSOs/pts/mult/score)  
VK4TT 14 77 291 13 3,783

### Results of 1996 Canada Winter Contest

(call/QSOs/mult/score)  
VK2APK \* 68 4 872

### Results of 1996 Croatian DX Contest

(call/QSOs/pts/mult/score)  
VK2APK \* 409 1611 87 140,157  
VK8AV \* 241 924 75 69,300  
VK4TT 27 106 8 848

### Results of 1997 John Moyle Field Day Contest

Here are the results of the 1997 John Moyle Field Day Contest, a month later than intended. The computer file accidentally got deleted, so the results all had to be keyed in again from scratch. Field Day would be incomplete without a visit from Mr. Murphy!

Many thanks to all those who took part. A magnificent effort saw entries up almost 50% from last year, with 55 logs vs 38 last time. Scores were also well up on last year, with VK3ER taking top honours with 5746 points. Hot on the heels of the VK3ER gang were VK3APC and VK4WIS, with 5230 and 4936 points respectively. Well done everybody!

The top home station score was achieved by ZL2AWH, who receives a certificate for his efforts, and an SWL entry was received from Andrew Robertson in VK1. Well done Andrew, and we look forward to seeing you in the contest with a full call before too long.

Unfortunately, the President's Cup could not be awarded this year, because of the lack of portable CW entries. Although many CW QSOs were made, they were made by stations in the mixed section (ie phone and CW), who are not eligible. It is clear that



more CW activity is needed, to make portable CW-only operation more attractive, and this aspect will be examined further before the next running of the contest.

So without further ado, here are the results. See you all next year!

Results are in the following order: Callsign, Multi/Single, Mode (All, Phone, CW), Band (All, HF, VHF), and Score. Certificate winners are highlighted with an asterisk (\*).

**Portable, Six Hour**

VK4YH	Mult	All	All	862	*
VK2FRE	Mult	All	All	780	*
VK3GH	Mult	All	All	390	*
VK2ENG	Mult	All	All	372	
VK5BAR	Mult	All	All	192	
VK4WIN	Mult	All	HF	516	*
VK3CMZ	Mult	All	HF	106	*
VK2IRP	Mult	All	HF	102	*
VK2BOR	Mult	All	HF	58	
VK3SAA	Mult	All	VHF	2086	*
VK1PK	Sngl	All	HF	106	*
VK5AJS	Sngl	Phone	All	78	*
VK3TLW	Sngl	Phone	VHF	668	*
VK2ANK	Sngl	Phone	VHF	508	*
VK3KTO	Sngl	Phone	VHF	440	*
VK1PK	Sngl	Phone	VHF	120	

**Portable, 24 Hour**

VK3ER	Mult	All	All	5746	*
VK3APC	Mult	All	All	5230	*
VK4WIS	Mult	All	All	4936	*
VK4WID	Mult	All	All	3922	
VK2FBK	Mult	All	All	1888	
VK6ANC	Mult	All	All	1012	
VK2WG	Mult	All	All	442	
VK7OTC	Mult	All	All	360	
VK2EWC	Mult	All	All	264	
VK4IZ	Mult	All	HF	1416	*
VK1VK	Mult	All	HF	620	*
VK4CHB	Mult	All	HF	490	*
VK5GRC	Mult	All	HF	410	
VK2IBT	Mult	All	HF	188	
VK3BML	Mult	All	HF	178	
VK4WIT	Mult	All	HF	136	
VK6PM	Mult	All	HF	82	
VK5UE	Sngl	All	All	98	*
VK4EV	Sngl	All	HF	182	*
VK5AIM	Sngl	Phone	All	122	*
VK4JAE/3	Sngl	Phone	All	18	
VK5ANB	Sngl	Phone	HF	352	*
VK3TBM	Sngl	Phone	VHF	1732	*
VK4IS	Sngl	Phone	VHF	664	*
<b>Home</b>					
ZL2AWH	Sngl	Phone	HF	215	*
VK2APK	Sngl	All	HF	119	
VK3CAT	Sngl	All	All	112	
VK5XE	Sngl	CW	All	70	
VK4MOJ	Sngl	Phone	HF	44	
VK3ALD	Sngl	Phone	HF	41	
VK4JR	Sngl	CW	HF	35	
VK8AV	Sngl	All	All	30	
VK3XB	Sngl	CW	HF	27	

VK4ICU	Sngl	CW	HF	21	
VK2RJ	Sngl	All	HF	16	
VK3KS	Sngl	CW	HF	14	
VK3AMD	Sngl	Phone	All	10	
VK3CY	Check Log				
<b>SWL</b>					
Andrew Robertson (VK1)					
	Sngl	Phone	HF	108	*

**Some Comments from Logs**

All bar one of the stations contacted on VHF did not know their grid square, which makes for a lot of extra work. I would have operated much longer, but it's hard to stay motivated with no points for repeat contacts...(VK3CY) Antenna was just a bit of wire slung over the roof, short, low and random...(VK3KS) Thanks for your efforts with the contest. We had a good time and the weather was much better this time...(VK3ZPF for VK3SAA) Camped out on a sheep station. Charged the battery from a 40 W solar panel...(VK4EV) I use three RACQ maps joined together with circles drawn on, and am constantly amazed how

stations manage to keep off the lines! (VK4IS) The weather was perfect, and the location choice. VK1s and 6s were hard to find, but the DX stations were more than willing to give a number...(VK4GZ for VK4WIS) Something for everyone, and a good social occasion...(VK4ZZ for VK4WIT) Good contest, after El Presidente VK4PGF learnt how to connect the antenna BEFORE checking the SWR...(VK4WJT for VK4YH) Good conditions, and I got two more contacts than last year at 1/10th the power...(VK5ANB) Pleasant weather, but poor conditions except on 15 m. A good time was had by all...(VK6NU for VK6ANC) The VHF and UHF logs should be acceptable, but when you see the HF logs you will either break into maniacal laughter or weep silently. Next time we will ensure ALL operators are trained how to fill out log sheets...(VK7KSC for VK7OTC) Thanks for a very enjoyable contest...(ZL2AWH)

\*PO Box 2175, Caulfield Junction, VIC 3175  
puesbit@melbpc.org.au

ar

**WIA News**

**Wireless Data Link Equipment Uses 433.92 MHz**

A British company has developed a 'wireless' transceiver for short-range computer serial data communications operating on 433.92 MHz for use where cabling is difficult or impossible.

Developed by Low Power Radio Solutions (LPRS), the equipment is made in different versions, using different frequencies, to suit the domestic UK and European markets.

Models destined for the European market operate on either 418 MHz or 433.92 MHz, which are European industrial-scientific-medical (ISM) bands not requiring equipment licensing, while the UK product operates on 458 MHz, a UK ISM band.

The European units have an output power of 0.25 mW, while the UK units have a much higher output of 10 mW. RS232 data at the standard 9-pin D-type transceiver input socket is transmitted in packets with a header and checksum. The receiver verifies the checksum and removes the header. Narrow-band modulation is used and the maximum data rate is 1200 baud, said LPRS, but this means they are less prone to noise than higher speed, wide-band units.

The line-of-sight range of the transceivers is about 120 metres, which falls to 30-50 m inside buildings, according to LPRS. Suggested applications include data

communications from sensors, such as temperature and pressure, or data from swipe card readers.

The Australian Communications Authority has recently Class-licensed the 433.05-434.79 MHz band in Australia for such applications (see *Amateur Radio*, August 1997, p 3), upgrading the original 1993 Class licence. The LPRS wireless data link units are not presently available in Australia, but represent the sort of equipment for which the "low interference potential devices" (LIPD) Class licence was created.

[Released 11/8/97]

**New Presidents in NZ and UK**

The New Zealand Society of Amateur Radio Transmitters (NZART) and the Radio Society of Great Britain (RSGB) have each announced their results of elections for the position of president.

In New Zealand, Alan Wallace ZL1AMW, is the new president, replacing Jim Meachen ZL2BHF, who served the organisation for the past five years. Alan Wallace comes from the city of Hamilton and has been on the NZART Council for ten years.

The RSGB has re-elected Ian Kyle G18AYZ. The *GB2RS News* said that this is the first time in several decades that an incumbent president has been elected for a second consecutive term.

[Released 11/8/97]

---

---

# Divisional Notes

---

---

## Forward Bias – VK1 Notes

Hugh Blemings VK1YYZ

This month we welcome Sakari Matilla VK2XIN/OH2AZG into the role of webmaster for the Division. Sakari has authored a number of excellent web pages and will be bringing these skills to bear on the Division's site ensuring that it is both an informative and entertaining place to visit. If you have contributions or suggestions, please e-mail them to Sakari at [website@vkl.wia.ampr.org](mailto:website@vkl.wia.ampr.org)

Simon VK1AUS has been doing much behind-the-scenes work in revamping WICEN in the ACT and, as part of this process, recently attended the WICEN NSW AGM in Sydney. In addition to briefing this meeting on the activities of the Division, Simon also presented some useful background information from his work with RAYNET in the UK. During the Division's committee meeting this evening he presented a report on the AGM and made note of the warm reception this renewed activity in the ACT has received.

WICEN ACT is responsible for the ACT/Monaro region which extends right down to the Victorian border, Simon being assisted in his role as State Co-ordinating Officer by the Deputy State Co-ordinating Officer, Phil Longworth VK1ZPL.

As well as fulfilling an important role in providing emergency communications, WICEN represents an enjoyable and challenging facet of the hobby and all are encouraged to participate in upcoming training sessions and exercises. Simon would welcome your enquiry on air or by phone on 0419 439 925.

This month marks the half way point in the present committee's "term of office"; whilst it is understood a number of office bearers will be continuing in their present positions, some will not. Why not give some thought to being on the new committee? I'd particularly encourage newer members to consider nomination as fresh ideas are always welcome.

All going to plan, September's meeting will discuss lightning and how to protect against it, an important topic for all amateur operators. There'll be tea and coffee too. Why not come along?

## VK2 Notes

David Thompson VK2NH

Judging by all the good local signals heard on the Remembrance Day contest weekend,

there were a lot of New South Welsh-persons on air. Here's hoping for a good tally for VK2 when the scores are all added up.

It was terrific to see and hear a lot of friends from all over Australia and New Zealand up and piercing the ether with their radio waves at a time of remembrance of those who gave their lives for our freedom.

Things have been moving along very well with the New South Division, including plans for the refurbishment of our transmitting site at Dural. Already we have decided to have a working bee before the end of this year.

On Sunday, 27 July, we held a Trash and Treasure day at Dural after the broadcast. There were many bargains to be had and some of those who attended the day walked away with a new treasure for their shack. Although the day began fairly cold and overcast, the rain cleared along with the clouds and the sun appeared to provide a very pleasant setting for the day.

We had some visitors from one of our affiliated clubs! The Goulburn Amateur Radio Society came up to have a look at Dural and fire up the Dural barbecue. Thanks to President Geoff for organising the new plate, which was well used by the time the visitors had lunch. Mind you, we reckon there is enough RF floating around at Dural, that the food cooks itself by just being there! Thank you to the Goulburn people who came all that way. We enjoyed having you visit.

It has been a rather quiet August, with not too many controversies, thank goodness. The one big event that has occurred and has been of interest is the name change of the Spectrum Management Agency (SMA) to the Australian Communications Authority (ACA). In reading a newspaper report, I was interested to see a piece about the changed prefixes for telephones referred to as having come from the Australian Communications Authority, formerly known as Austel. Well at least the scribe was half right.

The NSW Division has been doing rather well lately in the membership stakes. Welcome those new members who you will see mentioned in *Amateur Radio*. There were nine full and three associate memberships approved at our August Council meeting. That takes the membership tally to 89 since the end of January 1997. In the words of Secretary Eric VK2EFY, "We trust that these new members will have a long and happy association with the VK2 Division". The new members go into the monthly draw for the Fluke Multimeter.

It is worth a thought about the bravery of

all who assisted in some way during the Thredbo emergency, giving their energy and dedication. Although the Wireless Institute Civil Emergency Network (WICEN) was not activated to provide emergency communications, there were several people, who apart from being members of WICEN, are also in the SES and Cave Rescue and are members of other groups of helpers, who assisted in some way.

The Jamboree of the Air is on again this year on the weekend of 18 and 19 October 1997. I hope you can see your way clear to help your fellow amateurs or your local scout group set up and operate a station for at least some of the weekend, giving people the chance to make some contacts with other groups of like mind, on the other side of town and, if propagation permits, on the other side of the world.

## Affiliated Clubs Net

The NSW Division runs an Affiliated Clubs Net on selected Sunday mornings with VK2 Councillor and Affiliated Clubs Officer Ken Westerman VK2AGW in the chair. This is the perfect opportunity for affiliated clubs and interested persons from all over the state to get together and discuss issues of concern and meet each other on air.

The net can be heard on 3.595 kHz at 0900 hrs on the first and third Sundays of the month. Ken gets lonely if you're not there.

Just a reminder that the next Conference of Affiliated Clubs will take place on Saturday, 15 November 1997, starting at 0900 local. Registrations are being called for now. The venue is, of course, Amateur Radio House at Parramatta.

As I mentioned in the last issue of *Amateur Radio*, August is just that time for a gust or two of wind. I'm sure that is why they named it August, here in the Mountains anyway. As I write this column, I just took a break to wind down my tower due to strong winds. It is hard to sleep at night with the wind racing through the bush and buffeting all in its way. That's when my (understanding) wife says to me "If I grew antennas out of my head, would you like me more?" The answer is, "Dear, I love you just the way you are and the antennas just where they are!"

A quick reminder that the VK2 Division has made available a post box for amateurs to use as their postal address for amateur radio related mail. This move was made after it was learned the ACA was to publish on the Internet full details of licensed amateurs, suppressed or otherwise. If you are interested, please contact the Divisional office.

Before I leave you this month there is the matter of a change of Divisional e-mail address. If you are addressing e-mail to the

office, please do so at [vk2wi@ozemail.com.au](mailto:vk2wi@ozemail.com.au).

If you would like to contact the VK2 Division regarding your hobby, please do not hesitate to contact the office or any of the Councillors. We will be only too pleased to hear from you. If you would like to get in touch with an individual Councillor, just contact our Divisional office and it will be arranged. Our free-call phone number is 1 800 817 644 and our address can be found on the WIA Divisions' page.

Next month we'll have more to report, but if you have anything you would like us to include as VK2 news, send it to me at PO Box 82, Springwood 2777 or by e-mail to [dthom@penrithcity.nsw.gov.au](mailto:dthom@penrithcity.nsw.gov.au)

### VK3 Notes

Jim Linton VK3PC

#### Spring Has Arrived

What a cold miserable *el nino* winter we've just had. But that's behind us as we enter the more pleasant months of spring, and traditionally, just like coming out of hibernation, many of us become more active and alert.

A few of us will be looking around for new things to try, or complete, in relation to our hobby, or just getting on air more often. Some, I know, have set a personal goal of upgrading their licence, including those already enrolled in next month's WIA Victoria Turbo Tutorial.

To be enrolled in this intensive AOC theory two day weekend course being held on 18-19 October, you must already have a Novice licence, and a keen desire to upgrade. An actual AOC theory examination will be conducted at the end of the course on the Sunday. For more information, contact the WIA Victoria office.

Another activity on the same weekend will be JOTA. Whether you have or haven't taken part in this event previously, now is the time to give it some thought. Sadly, this once premier activity has waned in recent years due to a number of factors. These include poor HF band conditions, and changed attitudes to JOTA by both the amateur radio fraternity and the scout/guide associations. The perception is that the scouting movement, which has undergone organisational structure changes, no longer embraces JOTA in many districts. Where JOTA does survive it is doing so mostly because the Internet is now a formal activity.

As ready access to the Internet spreads through our schools, homes and society generally, I suspect the information superhighway won't be the panacea to keep JOTA into the new millennium. Our hobby

has much more to offer. It is my hope that the slump experienced by amateur radio and JOTA are only cyclic, and that we're headed for better times.

If you're looking for some way of helping your hobby, or putting something back into what has given you enjoyment and sense of achievement, then think seriously about what you can personally do to help rekindle JOTA.

#### Internet Homepage

The WIA Victoria homepage on the Internet is slowly but surely taking shape. It is primarily targeted at creating an interest in our hobby among computer users. Specially written material is being put on the homepage to raise an awareness of amateur radio, and provide background information on what radio amateurs do, both in a contemporary and historical context.

Although a lot of further development is needed, the WIA Victoria office has already received a positive response from Internet users. The web site gives information about the membership services provided by WIA Victoria and it has been successful in recruiting new members.

I would welcome any short written contributions on the various aspects of our hobby – foxhunting, DXing, packet/digital, contesting, home-brewing – to give Internet browsers a taste of our hobby. It already contains information on the history of QSL cards and the requirements of our QSL Bureaux, the amateur licence system, and an item on QRP technique.

The WIA Victoria homepage address is [www.tbsa.au/~wiavicl](http://www.tbsa.au/~wiavicl)

#### News and Information

WIA Victoria will be using its web site regularly to distribute its news and information. We are also investigating a direct electronic mailing service of news to those members who have e-mail facilities. A register is being compiled of members with e-mail addresses who would like have news directly sent to them. Inclusion on the e-mail register is to be a new free membership service.

#### Articles of Association

The revised Memorandum and Articles of Association have been printed. A copy was sent to those members who provided input to the review process either by correspondence or attendance at the Special Meeting to approve them.

All new members now automatically receive a copy of the booklet format document. Any member can obtain a copy by calling at the WIA Victoria office. If you require a copy by post you must supply a self addressed and stamped envelope with 85c in

postage affixed. The envelope needs to be at least half A4 in size.

The printing has been a costly process and copies will only be available until 1 October 1997, at no cost. After this time a small charge will be made to recoup some of the expense involved.

### VK5 Notes

Ian Hunt VK5QX

Most of the following is taken from the President's Notes portion of a Sunday morning broadcast by VK5WI. In view of the important nature of the material, I decided also to provide it through *Amateur Radio* magazine.

#### The Burley Griffin Building

I now wish to address you regarding our occupancy of the Burley Griffin Building as our Divisional Headquarters. In line with your Divisional Council's policy of keeping the membership as fully informed as possible, the current situation was explained in some detail to those present at the recent General Meeting.

I will attempt here to provide an explanation as to what is occurring. A number of possibilities may arise and need to be considered in the near future.

You may be aware that the building was initially an incinerator used for destruction of waste materials within the Thebarton Corporation district, however it had been unused for many years. Unlikely though it may seem in the case of an incinerator, this building is of heritage value having been designed by Walter Burley Griffin who is more famous for having had much to do with the design of our National Capital, Canberra.

Walter Burley Griffin had formed a company known as the Reverberatory Incinerator Company which built a number of these edifices around Australia. To the best of my knowledge there are only three still in existence, one being in another Adelaide suburb and possibly one somewhere in Queensland.

In writing contracts to build these units, Burley Griffin always insisted on inclusion of a clause which gave him the right to design the external appearance of the building according to his personal wishes. This led to the completion of buildings with attractive additions to the exterior such as artificial and decorative columns on the tops of chimneys and elaborate "frieze" type decorations around openings and on outside walls.

The National Trust had seen fit to place their plaque on such buildings so as to preserve them for posterity. Thus the Thebarton Corporation were unable to demolish the building and were at a loss as to

what could be done with it. (Incidentally, the State Department of Environment and Conservation are now responsible for implementing any actions needed to ensure preservation of such property. The National Trust still maintains an interest in such occupancy.)

The late Rob Wilson VK5WA who, incidentally, was an Honorary Life Member of the Institute, saw a potential for the building and, with others of the then VK5 Council, was able to negotiate permission for the Division to carry out work to make the building habitable. With a lot of hard work, this was eventually achieved and the Division has occupied the building for some time originally on a lease and later on a permit type of occupancy.

Relatively recent cost rationalisation by officer(s) of the Thebarton Corporation led to some negotiations with regard to rental of the building. It seemed that those concerned were intent on obtaining a very high rental return for occupancy of the building.

The previous (Divisional) Council had attempted negotiation on this matter but negotiations appear to have stalled for various reasons. In the meantime an amalgamation of two Councils took place and the area now comes under the control of, and is owned by, the City of West Torrens Thebarton.

Following on from an interim arrangement, the current Divisional Council took steps to ensure that a rental fee was paid that provided occupancy up until the end of December 1997.

We have now been informed by letter by an officer of the "new" Council that a review of rates of use and tenancy arrangements for Council owned buildings is to be conducted. The letter includes the wording, "and so on in this period to earmark some properties for disposal". It then, in another paragraph, says that, "one such property is the Thebarton Council Depot with or without the incinerator". It then states that, "The property was one which both former Councils agreed should be sold as soon as possible".

Such an approach provides us with quite a problem, as you can well imagine. However, your Council believes that a very persuasive case can be made as to why the WIA should be allowed to retain occupancy of the building and that this should be achievable with goodwill on the part of both parties involved and within the frame-work of sustainable costs for the South Australian Division of the WIA.

It is necessary that some aspects of the negotiations being conducted by the VK5 Division must, for the present time, be kept in

confidence; however, your Council believes that members have the right to be made aware of the situation.

Meantime, we also must be prepared to develop a "fall back" position in the event that we are not successful in retaining the occupancy that we desire.

### Future Action

I will address you further to keep you informed, in due course, and also hope to suggest some ways in which members may be able to help. This will, of course, depend upon how we fare in the current action.

Let me assure you that your Divisional Representatives regard this matter with concern as the Burley Griffin Building still plays a major part as a strategic location for the WIA in this State. They will be doing their very best to protect your interests and those of amateur radio generally.

The Divisional Council desires members be kept aware of activities being pursued within the Division. Other members of the Council will be speaking to you on the weekly news broadcasts from time to time.

So, I hope that in the not too distant future I will be able to announce a satisfactory conclusion to this particular saga.

### "QRM" News from the Tasmanian Division

Robin L Harwood VK7RH

Your Divisional Council met in Penguin on Saturday, 19 July 19. Unfortunately, our Divisional secretary unexpectedly fell ill the evening prior, and your scribe was surprised to find himself recording the minutes. All councillors, with the exception of VK7BE and VK7JK, were in attendance and John Bates VK7RT, who happens to be Southern Branch secretary, was in attendance as Divisional Awards Manager.

In the three hour meeting, quite a lot of ground was covered with emphasis on the recent Federal Convention, attended by Andrew VK7GL who is now our Federal Councillor.

Several ideas were canvassed on how to promote the hobby and the Division. Ideas suggested included personalised number plates, publicising Amateur Radio Day on milk cartons, utilising various community notice boards in the media, and circulating flyers at various tertiary institutions. Also, the Divisional secretary has written to other Divisions to ascertain what they are using to promote the hobby.

Plans were discussed for the proposed Divisional Annual General Meeting, which is six months away, and Council confirmed that it will be held in Launceston. The Northern Branch is investigating possible venues and

also staging other related events together with the AGM. They will report back at this month's Council meeting in Hobart.

VK7RT discussed the Divisional awards and the apparent lack of interest and enthusiasm following his recent request for input on these. After discussion, we decided to concentrate on the Tassie Devil Award, as this is clearly the most popular award interstate and overseas. A proposed Worked All VK7 Award, based on local government boundaries, has had to be put on hold awaiting legislation to define local government boundaries. The present 29 could be reduced to 15, or even three. So it is prudent to see what does happen before formulating an award.

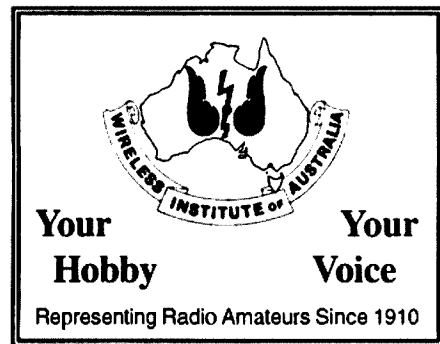
Anthony J Cope VK7CAJ was admitted to the Division as a member. The next meeting is proposed to be on Saturday, 20 September at the Domain Activity Centre. Hobart to commence at 10.30 am.

Ron Churcher VK7RN, our president, recently visited the Southern branch general meeting and also showed a video of his recent trip to Canada and Europe.

Last month, the Northern Branch had a very interesting lecture by one of its members on the mobile communications trunking system that is being installed in Tasmania. This month's meeting will not be at the TAFE College but at a welding workshop. This has been arranged by Elwyn VK7ZEH. For directions, listen to VK7WI. I am certain that somebody will be up on the repeaters for those who may get lost.

Don't forget to put in your Remembrance Day Contest logs as soon as possible to assist VK7's effort this year.

Meetings this month are: Southern Branch on Wednesday, 3 September at 2000 hrs at the Domain Activity Centre; North-western Branch on Tuesday, 9 September at Penguin High School, Dial Road, Penguin to commence at 1945 hrs; Northern Branch on Wednesday, 10 September at 1930 hrs, the venue to be advised on VK7WI; and Divisional Council on Saturday, 20 September 20 1030 hrs at the Domain Activity Centre, Hobart.



---

---

# FTAC Notes

John Martin VK3KWA, Chairman, Federal Technical Advisory Committee\*

---

---

## 160 Metre Band Plan

Last month's notes on 160 metres have stirred up hornets, with some complaints that I intended to rush in with band plan changes without consulting with the users of the band. In my defence I would point out that if I didn't intend to find out what people wanted, I wouldn't have asked for comments! As it happens, I have received some strong objections to last month's proposal, so it is obvious that it needs a closer look.

The following comments were received from Bob VK3ZL, Ian VK3DID, and Eric VK3AX. I have edited them together to save space.

*"The band below 1825 kHz is used for all mode operation and there is little or no DX activity there. Europeans do not operate below about 1835 kHz because of QRM from other services. Most DX is found between about 1828 and 1838 kHz, and this is where the DX window should be.*

*"Stations which are capable of working DX are able to hear weak signals regardless of local activity, especially if they use fast AGC. With the high noise levels on 160, a station that is strong enough to be heard above the noise is also strong enough to break in.*

*"The primary amateur allocation extends only up to 1825 kHz, so why try to move most of the activity into the secondary allocation where commercial users have priority? Confining local contacts to 1850 kHz and above is not appropriate with a band that extends only to 1875 kHz. It would be different if we had the same 200 kHz allocation as other countries.*

*"The majority of 160 metre operators already manage the band quite efficiently and with excellent co-operation. If anyone wishes to try to work a DX station, the group is only too happy to wait or to change frequency.*

*"The band plan must be consistent with actual operating habits. If these changes are adopted, most 160 metre operators will simply ignore the band plan and continue to operate as they do now." I can accept that the majority of 160 metre operators are co-operative and willing to stop transmitting or change frequency if anyone hears a DX station and wishes to call him. On the other hand, not all of us feel comfortable about having to ask another amateur to change frequency, no matter how willing he may be to do it.*

So, we have had one correspondent who says that there is a QRM problem, and this month three who say that there isn't. Who is right? I think they all are. What is acceptable to one person can be a problem to someone else whose operating habits are different. There needs to be a compromise, so that the band plan can reflect the wishes of all of the users of the band. Not an easy task!

To keep the pot boiling, here is the suggestion made by VK3ZL:

1800 – 1825 All modes\

1828 – 1838 CW DX window

1838 – 1875 All modes including SSB  
DX and local

Any further comments would be much appreciated.

## Interference Problems in Store on 70 cm?

As reported last month, the ACA has decided to go ahead with class licensing for LIPDs (Low Interference Potential Devices) in the band 433.05 – 434.79 MHz. It is interesting that the name of these devices has been changed: they used to be called LPDs (Low Power Devices). Maybe the change of name will reduce the possibility of interference!

There have been many reports in Europe of serious problems with devices such as car door locks, because of the poor selectivity and blocking characteristics of their receivers. It is a shame that we always seem doomed to repeat the mistakes made in other countries. I wonder how much inconvenience the manufacturers would have suffered if they had been required to put them on a more suitable frequency.

I am especially concerned about wireless headphones. Some amateurs may receive music from their neighbours if they operate simplex around 434 MHz. It is also possible that headphones could key up repeaters, but unlikely because most repeaters are not in residential areas.

A worse problem is the fact that an amateur could wipe out a neighbour's headphones, even if he transmits outside the LIPD allocation. These devices have no interference protection, so the amateur would not get a "bluey" from the ACA. But he could receive a brick from his neighbour. Another case of the amateur being forced into an unpleasant situation even though he is not at fault.

These devices are on the market already, so it won't be long before we start finding out what the problems are. I would be very interested in any reports.

\*PO Box 2175, Caulfield Junction, VIC.3161

ar

---

---

## Club Corner

---

---

### Radio Amateurs Old Timers Club of South Australia

The annual luncheon of the RAOTC of South Australia will be held on Thursday, 23 October 1997 at 12 noon at the Aviation Institute Club, James Schofield Drive, Adelaide Airport (opposite the International Airport Terminal).

If you are going to attend, please RSVP before 19 October to either Jack Townsend VK5HT on 9295 2209; Ray Deane VK5RK on 8271 5401; or Lew Schaumloffal VK5AKQ on 8263 0882.

The cost of the two course meal will be \$12.50 per head, to be paid at the door. If you will be coming by public transport, take T/Ad 278 to stop 9.

Ray Deane VK5RK  
Secretary

### Radio Amateurs Old Timers Club of Australia

Our usual luncheon will be held on Tuesday, 16 September at the Bentleigh Club in Yawla Street, Bentleigh. Doors open at

12.30 for lunch at 1.00 pm and the cost will be \$24.00 per head inclusive.

The speaker will be Dr David Warren PhD, the man who invented and developed the 'Black Box' flight recorder now widely used in aircraft. Dr Warren is very much in demand as a very interesting speaker and we are grateful that he agreed to speak to us.

Amateurs who are not members of the RAOTC will be welcome to be with us for the lunch provided a firm booking is made with the Secretary, Arthur Evans VK3VQ, 3/237 Bluff road, Sandringham 3192 not later than Thursday, 11 September.

Allan Doble VK3AMD

ar

**Support the  
advertisers who  
support Amateur  
Radio magazine**

# How's DX?

Stephen Pall VK2PS\*

All of us, especially those who are interested in propagation and ionospheric predictions on the HF bands, are wondering how this new solar cycle 23 will shape up in the future. It is now widely known that cycle 22 died, reaching its minimum during May 1996.

Since then we are all hoping, some of us week by week, that the instant 'wonderful DX' is just around the corner.

"Not quite so", says Dr Richard Thompson, one of the scientists at the Australian Ionospheric Prediction Service. In a telephone discussion early in August 1997, he stated that the new cycle is coming up very slowly, compared with cycle 22 which rose rapidly from the bottom.

"Since May 1996 the smoothed sunspot number rose by only 2.5 in eight months, and reached 10.7 in January 1997. It is possible that by August it had risen to 25. There are quite a number of regions on the surface of the sun, showing growing sunspots; however, these regions tend to collapse prematurely and the whole process then stops. There is no constant growth yet as in previous cycles."

Dr Thompson hopes, however, that the coming months will show an accelerated rise in the sunspot numbers.

## VK2WAH - GB2VK

On 22 September 1918 the first direct wireless message was transmitted from the United Kingdom to Australia. The message was sent by the then Australian Prime

Minister, Billy Hughes. It was transmitted by Guglielmo Marconi from Carnarvon, Wales and received by Ernest Fisk at Wahroonga, 20 kilometres north of the City of Sydney. Members of the Wahroonga Amateur Historical Radio Association will celebrate the 79th anniversary of this historical event by activating the special event station VK2WAH for 24 hours on 22 September, on CW, SSB and FM operation on a variety of bands.

On the same day, 22 September, the Dragon Amateur Radio Club in Wales will also celebrate the same event by activating the special event station GB2VK. QSLs to VK2WAH may be sent to VK2KAA via the QSL Bureau, or direct to Jo Harris, PO Box 600, Wahroonga, NSW 2076 Australia, with a SAE and return postage.

## Libya - 5A

Here is an opportunity to work Libya, if you missed the previous activities.

A group of Austrian amateurs OE1AOA, OE2GRP, OE2KTO, OE3ICS, OE3SGU, and OE6DGG will be active from Libya with Charly OE3KLU from 28 August to 7 September with the special callsign 5A28, a callsign which celebrates the 28th anniversary of the Libyan revolution. They will also take part in the All Asia DX SSB contest. Operating frequencies are CW: 1838, 3508, 7008, 10108, 14028, 18078, 21028, 24898 and 28028 kHz; SSB: 1848, 3798, 7048, 14198, 18148, 21298, 24948 and 28498 kHz; RTTY: 14088, 21088 and 28088;

and 6 m on 50.098, 50.128 and 50.208 MHz. QSL to OE2GRP, Recep Gursoy, Moserkellergasse 16, A-5202, Neumark AW, Austria; or to OE2GRP via the QSL Bureau.

If you were unable to contact the Austrian group, wait until November when a group of four German operators will be on the air from the Tripoli Club station 5A1A. This operation will begin on 24 November and will last until 4 December 1997. The group plans a serious entry in the CQ WW DX Contest. Activity will be on all bands including WARC and 160 metres with operations on CW, SSB and possibly RTTY. The Germans will have two stations with amplifiers on the air simultaneously as often as possible. Operators will be Andy DJ7IK, Dieter DL3KDV, Felix DL8OBC and Thomas DL1GGT. The QSL manager (for this operation only) will be DL3KDV. Please send your QSLs via the Bureau to DL3KDV, or directly to Dieter Voss DL3KDV, Friedrichsthal 21, D-51688, Wipperfuert, Germany.

## Montague Island VK2IOM

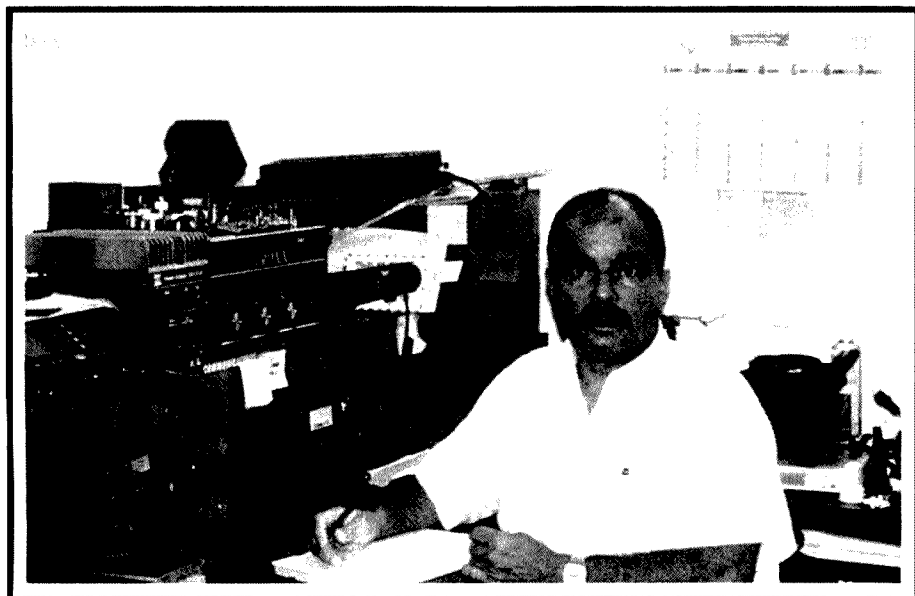
The JARA Group (Japanese Amateur Radio in Australia) is planning to activate a new island for the IOTA (Islands on the Air) program. Activity should take place on the weekend of 13 and 14 September from approximately 0000 UTC on the 13th to about 0400 UTC on the 14th.

The group received permission from the NSW National Parks and Wildlife Service, Narooma District, to operate from the island using the callsign VK2IOM. Proposed frequencies are SSB: 7055, 14260 and 21260 kHz; and CW: 7006, 14026 and 21026 kHz.

Montague Island is 7 km off Narooma, is the largest inshore island on the NSW coast, and was discovered in 1790. Because of its importance to shipping, a lighthouse was erected there in 1881. The JARA Group consists of Ken Arakawa VK2IAZ, Ken Yamashita VK2IY, Atsu Asahina VK2BEX and Kyoko Tanabe VK2TJH. QSL to VK2BEX via the QSL Bureau, or direct to VK2BEX, PO Box 195, Killara, NSW 2071. Unfortunately, Ken VK2IAZ had to withdraw from the activity because his employer decided that he should take up a new assignment in New York. The sudden change might cause the abandonment of the expedition.

## Australian Amateurs on the ARRL DXCC Honour Roll

The July issue of *QST* has published the list of the DXCC Honour Roll members as at 30 September 1996. The following Australians were mentioned. Mixed - 328: VK3DYL/333, VK3QI/341, VK5QW/333, VK5WO/363, VK6HD/353 and



Jean Claude TR8XX is often heard on the DX bands.

VK9NS/333; 327: VK2FH/338; 326: VK3EW/331, VK6RU/380 and VK9NL/331; 325: VK1DH/330 (now SK); 320: VK2AVZ/330. Those who worked P5 (North Korea) to make 329 were five JAs and OH3YI.

Phone - 328: VK3DYL/333, VK5MS/379, VK5QW/360, VK6HD/352, VK6LK/350 and VK9NS/333; 326: VK1ZL/331, VK3QI/338, VK4LC/365, VK4RU/379 and VK9NL/331; 325: VK3AKK/327; 323: VK3SX/323; and 322: VK1DH/326 (now SK). Only two stations worked the P5 to make 329 and they were JA1BK and OH3YI.

CW - 328: VK9NS/333; 326: VK9NL/330; and 324: VK6HD/333. Four JAs worked the P5 for 329 on CW.

### DXCC Countries Approved

In a press release dated 10 July 1997 the DXCC advised that documentation has been received and approved for the following DX activities: 3A/DJ7RJ, 3B8/DL6UAA, 3B8/EA3ELM, 3C5Z, 3D2UK, 3XY03A, 8Q7AF, 9H3VG, 9H3VH, 9H3WD, 9H3WM, 9K2/YO9HP, 9U5T, BS7H, C50YL, C53HP, C93/JA6SJN, C93/JG6BKB, C93/JR6XIW, D25L, D2FIB, D68KS, ES1HR, ET3FB, HS9AL, J3X, J6/F5CCO, J75T, J77C, J77FT, J79BP, J79QA, J79RC, J79WP, PJ8DX, S07NY, SM5ENX/DU1, T32HA, TI8/AA8HV, TI/ON7ZM, TL8EJ, TN7A, TO5C, TT6FNU, TY1RY, V5/DK2WH, V5/W8UVZ, VK0IR, VK9FL, VK9PG, XT2GA, XZ1N, YV7/AH6OM, YV7/WH6DAG, Z2/SM0FIB, and ZK1JOO.

### Future DX Activity

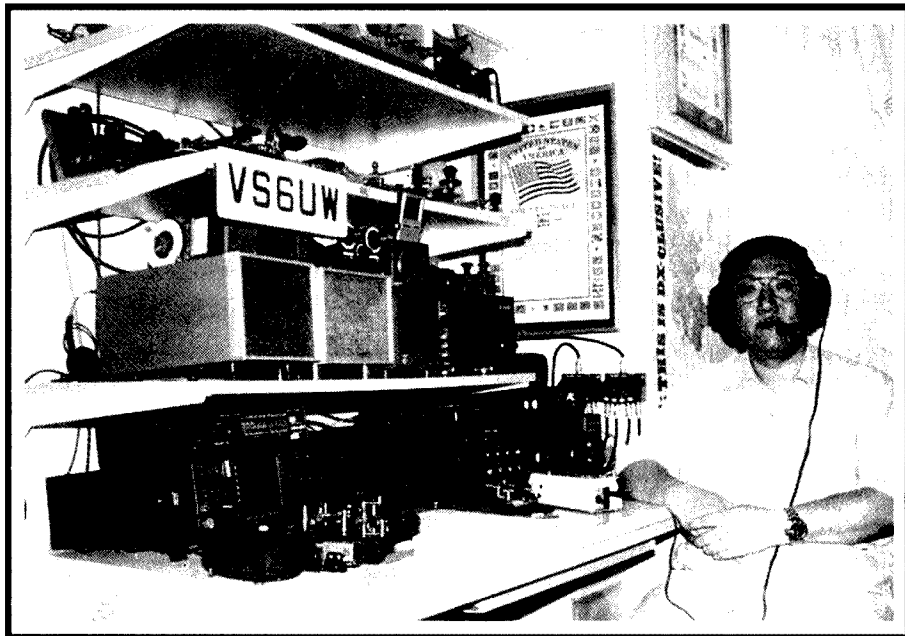
\* Sergio (ex-VU3CUR) is in Pakistan for a couple of years on business. He operates now from the club station AP50WAP whilst waiting on his personal call. QSL via IK4ZGY.

\* Lou VA3RU will use the call CY9DX from St Paul Island from 12-22 September. QSL via VA3RU.

\* Hans PA3GKI will be in the Philippines between 8 August and 18 October. He will try to operate as 4F2DX from a number of IOTA groups. QSL to the Dutch DX Group, PO Box 232, 7670 AE, Vriezenveen, Netherlands.

\* Masa JH6VLF and Seiji JH6RTO will be active from Northern Mariana Island, with the additional prefix of KH0 and also as AH0R between 12 and 16 September. QSL via the home call. JH6RTO's new address is S Fukushima, 1182-1 Hase, Atsugi 243 Japan.

\* Scott AE4FY will be stationed for the



**Ray VS6UW, the well known DXer and CW operator.**

next two years in Iceland from where he will be active as TF/AE4FY QSL via K4GZ.

\* Charlie W0YG plans to be active on CW only from Namibia as V5/ZS6YG during the months of August and September. QSL direct to Charlie Summers, 6746 North Yucca Trail, Parker, CO 80138-6110, USA.

\* Larry WB6VGI will be active for about one month starting on 20 August from Guantanamo Bay on CW and SSB as KG4ML.

\* Alex RA1PC is currently active from Heys Island, Franz Josef Land as R1FJR. He also operates the club station R1FJL. QSL via RK1PWA.

\* The World Bank Amateur Radio Club station 4U1WB is active, mainly on 20 metres SSB after 2100 UTC. QSL via KK4HD.

\* Jame, the operator of KC4AAC at Palmer Station on Anvers Island is on 14175 kHz everyday at 1800 UTC until October.

\* It is rumoured that an all-band, all-phone DXpedition to Kure Island KH7K, involving five to six operators, will be active in the second part of September for one week.

\* Pai VU2PAI will activate the special event station VU2PAI/50 until 30 September 1997, to celebrate 50 years of India's independence. QSL direct via Box 730, Mangalore 575003, India. Pai is an avid stamp collector.

\* Gary S92AT is now active in Sao Tome using CW and SSB. QSL via NJ2D. Claude TL8BC can be found between 14118 and 14132 kHz around 1600 to 1700 UTC. QSL via F5IPW.

\* Jan Pierre F5TRP was heard from Chad using the callsign TT8LJP both on CW and

SSB. He will be there until 15 October. QSL via the home call.

\* Francois TK5AE will be active from 12 August to 22 September as HS0/TK5AE or as HS0AC on 3770, 7077, 14177, 21277 and 28477 kHz and also on CW at the lower edge of the band. QSL via the home call.

\* Alain F2HE will be active as FG/F2HE until 25 September from Guadeloupe Island, mostly on CW.

### Interesting QSOs and QSL Information

\* 5B4/G3LNS - 14024 - CW - 0454 - June. QSL to home call via the QSL Bureau.

\* 7Q7JL - John - 14222 - SSB - June. QSL via Allan Hickman G0IAS, The Conifers, High St, Elkesley, DN22 8AJ, Retford, Notts, UK.

\* SV5/G4FMK - AI - 14164 - SSB - 0517 - June. QSL to AI Smith, PO Box 20, Kalamnos 85200, Greece.

\* ZF2MD/8 - David - 14164 - SSB - 0601 - June. QSL via David Monette K7JI, 6918 NE 79th Ct, Portland OR 97218, USA.

\* XW1 - Zorro - 21295 - SSB - 0623 - July. QSL via Yasuo Miyazawa JH1AJT, PO Box 8, Asahi, Yokohama 341, Japan.

\* CY9AA - 7024 - CW - 0613 - July. QSL via M Smith VE9AA, 271 Smith Rd, Waterville, Sunbury CO, NB E2V 3V6, Canada.

\* OJ0/N4GN - Tim - 14195 - SSB - 0616 - July. QSL via KJ4VH. Timothy B Totten, 8309 Dawson Hill Road, Louisville, KY 40299 - 5317, USA.

\* 9J2DR - Rich - 14005 - CW - 0637 - July. QSL via Box 30062, Lusaka, Zambia.

\* T33JH - Jack - 14222 - SSB - 0553 -

July. QSL via Jack Haden VK2GJH, PO Box 299, Ryde NSW 2112, Australia.

\* JT1BG – Bator – 14193 – SSB – 1239 – July. QSL via S Bator, Box 158, Ulan Bator 13, Mongolia.

\* CH6RCH – Heinz – 14255 – SSB – July. QSL via Thomas Henry Evans VE6BEX, RR1, Andrew, Alberta, TOB OCO, Canada.

\* VK9LL – Hiro – 3503 – CW – 1107 – July. QSL via Junichi Tanaka JH4RHF, PO Box 61, Toyonaka, Osaka 560, Japan.

### From Here and There and Everywhere

\* It was reported by Luciano IOJBL that the operators of HV3SJ, HV1CN and HV2VO left the Vatican some time ago and the stations have closed down. It appears that the only station active from Vatican City is HV4NAC, which is operated from the Pontifical North American College.

\* The special prefix AP50 will be used by the Pakistani amateurs until 30 September to celebrate the 50th anniversary of Pakistani independence.

\* JW0M (op Jack) is located at the Polish Academy of Science on Svalbard. QSL direct to PO Box 35, 80-325, Gdansk 37, Poland.

\* Tensai ET3BT has no manager. QSL direct to Tensai, PO Box 6228, Addis Ababa, Ethiopia.

\* If you worked VI0ANARE, that station was not located anywhere in Antarctica. The custodian of the callsign is Trevor VK4ARB. The special event callsign commemorates the 50th anniversary of the establishment of ANARE, Australian National Antarctic Research Expeditions, in 1947. The callsign is operated by a few Queensland amateurs and will be on the air until the end of October. QSL direct to Alan Roorcroft VK4AAR, Post Office Dalveen, QLD 4374, or via the QSL Bureau to VK4ARB.

\* The operator at 5A1A, Abubaker, reports that he can QSL any 5A1A contacts starting August 1995. He cannot use a QSL Manager, and he suggests the use of registered Air Mail and two green stamps, as IRCs are not useable in Libya. Abubaker is 25 years old and he is employed as an electronic engineer. His address is Abubaker Alzway, PO Box 74421, Tripoli, Libya, Africa.

\* Do not expect a QSL card from Ahmed (YI1AU). Unfortunately, Ahmed was killed

in a motor car accident. He was 30 years old and by profession a medical doctor.

\* The new address for the Polish QSL Bureau is PO Box 42, 64-100 Leszno 7, Poland.

\* CH6RCH was a special event station celebrating the 100th anniversary of the establishment of the Orthodox Church in Canada.

\* Pavel UX2HO is active as EM1HO from the Ukrainian Vernadsky Base until February 1958. QSL via I2PJA.

\* Rolf SM5MX is again on the bands as XV7SW until mid-September when his tour of duty will terminate and he will return to Sweden.

\* Zoli HA5PP was supposed to be in Yemen in June. Unfortunately, his work assignment has been cancelled, so for the immediate future there is no prospect to work Yemen (70).

\* Tim N4GN and the group made 11,000 QSOs (including 600 on RTTY) during their three days stay on Market Reef using the call OH0/N4GN. Martti OH2BH, a member of the expedition, reported that the weather on Market Reef was not very good and they had to use a helicopter for landing on the reef.

\* A new group has recently taken over the responsibility for the United Nations HQ amateur radio station 4U1UN. They intend to be active more often. QSLs as from 1 April 1997 go to W6TER.

\* Gilbert ZD7BG is active on CW on 80-10 metres. He was heard around 14015 kHz between 1900 and 2100 UTC. QSL to PO Box 157, Jamestown, St Helena Island.

\* If you worked OA176QV, it was Cesar OA4QV celebrating the 176 years of Peru's independence. QSL direct with a SAE plus two IRCs to Cesar Aguirre, PO Box 957, Lima 18, Peru, South America.

\* I heard Tom VR6TC saying on the band that the present population of Pitcairn Island is now 29, plus one nurse, one school teacher and one pastor. Many members of the younger generation (among them licensed amateurs) have left the island to seek their future in New Zealand, Norfolk Island and Australia.

\* The boat which was to take Frank YJ8AA to Emai Island in the Shepherd group of islands (see June 97 *Amateur Radio*) was still in the hands of marine engineers at the end of July. The new schedule of the

proposed expedition will allow for three to four short trips from Thursdays to Tuesdays, and the working days will be on Friday, Saturday, Sunday and Monday.

\* Jack has managed to operate from Banaba, despite earlier boat problems.

\* VK9LL was Hiro JH4RHF on Lord Howe Island. Please note that this is a re-issued call. Do not confuse it with Duane W6REC who operated with this call from Lord Howe in April 1984.

\* There was some confusion about the correct QSL Manager's address for Tom, VK0TS. The manager is S N Trotter VK1AUS, PO Box 2063, Kambah Village, ACT 2902, Australia.

\* The Kermadec DX Association, who had a successful activity on Raoul Island in May 1996 as ZL8RI, is now preparing for a major expedition to Campbell Island in January 1999. They intend to stay on the island for three weeks. The estimated cost of the expedition is \$US45,000. If you can help, send your donations to Ken Holdon ZL2HU, expedition leader of the Association at PO Box 56099, Tawa, Wellington, New Zealand.

\* The first DXpedition to Libya took place in July 1995 when Toly UT3UY led a small party of Ukrainian amateurs and operated from Tripoli. The activity was finally recognised and accepted by the DXCC in May 1996. Twelve months later, in July this year, a pleasant surprise landed in my letterbox, a QSL card from 5A1A for the CW contact made two years ago. "Toly" advises that QSL cards for the contacts made in July 1995 can be obtained from him at the following address: Anatoly Kirilenko, PO Box 439/3, Kiev-151, 252151, Ukraine. I sent him two IRCs and a reply address label only instead of a reply envelope. I used a printed postal label instead of stamps on my envelope.

### QSLs Received

K8VIR/ZL9 and ZL9DX (3 m – op Ed Hartz, PO Box 480, Green Valley, AZ 85622-0480, USA); 7Q7JL (3 w – GOIAS); YI1US (3 w – WA3HUP); A41LZ (4 w – op Murtadha Ahmed Sultan, PO Box 2837, Ruwi, Muscat 112, Oman); ZL8RI (3 w – ZL2HU); 9M6TCR (2 w KQ1F).

### Thank You

Many thanks to all those who supply me with news and other information which helps putting these notes together. Special thanks to VK2XH, VK2IAZ, VK2KAA, VK2KFU, VK2TJF, VK5WO, VK6WR, UT3UY, ARRL DXCC Desk, Dr Richard Thompson of IFS, INDEXA, *QRZ DX*, *The DX News Sheet*, and *The 425 DX News*.

\*PO Box 93, Dural NSW 2158

ar

**Prevent pirates – make sure you sell  
your transmitter to a licensed  
amateur**



# International Amateur Radio Union Monitoring Service (IARUMS) – Intruder Watch

Gordon Loveday VK4KAL\*

## Mode R7B

For the new observer (and the not-so-new observer can be reminded), this mode is amplitude modulated, reduced carrier, multi-channel, voice frequency telegraphy. In other words, it sounds very much like a large circular saw in operation. Observation of this mode should be very detailed as to bandwidth, which can be up to 7 kHz. Where possible, sufficient time should be given to "pin-point" the centre frequency, and also the band edge frequencies.

If your receiver has one of those "old fashioned BFOs" it is not so hard, otherwise your familiarity with your receiver will pay dividends.

It is desirable for the observer to spend some time on the frequency, stating time of observation, length of observation (which should be no less than 10 minutes), number of times heard, etc.

The ACA are in a position to extract enough information as to the location of the

intrusion, etc, provided we give them sufficient information as above.

## Mode B9W

This mode is very similar in sound to R7B. It has one or two guard carriers about 3 kHz apart, and sounds like a distant "jet aero engine". In the past, a lot of B9W modes, on closer checking, have actually been R7B. So check, and then double check!

## Harmful Interference

Owing to the complexities of the band sharing in the three IARU Regions, reportable harmful interference can only be considered if the operating amateur is UNABLE to move his transmitter frequency, eg close to a band edge. Where able to QSY, it becomes "nuisance category only"; in other words, the amateur may have to put up with it!

This applies in shared bands, 80 m for instance. 3500 – 3700 and 3794 – 3800 kHz in IARU Region 3 is shared with the fixed

services. It is NOT exclusive to the amateur service! RTTY (FIB) and CW (AIA) non-amateur signals cannot be considered intruders, but broadcast stations are!

On 1825 – 1875 kHz the amateur service is secondary.

7100 – 7300 kHz is shared by international broadcast stations only. Any non-amateur signal, other than broadcasters, in this band can be considered as an intruder. Likewise non-amateur FIB and AIA signals are intruders.

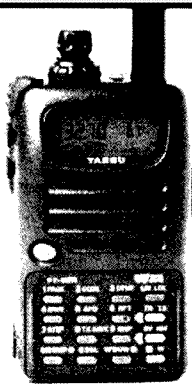
The 12, 17 and 30 m bands are shared bands, as is 14250 – 14350 kHz with Iran, Peoples Republic of China, and USSR (CIS) fixed services. Other broadcast stations are intruders.

When logging broadcast stations, pay particular attention to general remarks which could lead to identification; also any address given plus details of traffic, signal strength, and beam headings if possible. If a dipole is used, supply the direction of the antenna, eg north/south, east/west, etc. Be specific, please!

I do not have e-mail, but messages can be left for me c/o [vk4un@tpgi.com.au](mailto:vk4un@tpgi.com.au). I am back on packet.

\*Federal Intruder Watch Co-Ordinator, Freepost No 4  
Rubyvale QLD 4702 or [VK4KAL@VK4UN-1](mailto:VK4KAL@VK4UN-1)

ar



## Radio and Communications

Incorporating AMATEUR RADIO ACTION and CB ACTION

Published by  
ACP SYME MAGAZINES,  
PO Box 119,  
Oakleigh,  
Victoria 3166  
(03) 9567 4200

It's hard to believe that one little hand-held dual-band radio could almost single-handedly redefine the concept of what an HT should be able to do, but the radio at left, Yaesu's FT-50R, has done just that. It's now been enhanced with new features — and this month you could win one.

Your September R&C is a 'must read' for all amateur radio operators. This month's features include...

- OUR BANDS UNDER THREAT! The WIA's Roger Harrison examines some disturbing developments.
- REVIEW: Kenwood TM-V7A. A new remote-control dual-band mobile which looks really different.
- CONSTRUCTION: Build a BFO, then build a ATU. Two projects, with complete details and schematics.
- REVIEW: Yaesu FT-50R. More features for the same old price. Is it now an answering machine?
- PHASE 3-D. The most ambitious amateur satellite project ever. With great AMSAT-supplied photos!
- As usual, we have our three DX columns, mods and more... the best stories and regulars every month!

Don't miss out — RADIO and COMMUNICATIONS is great reading for amateurs!  
Check your local newsagent today!

(P.S. We also have the biggest collection of radio-oriented Classified adverts in the country. There's lots of them because they work so well. Ask your newsagent to keep a copy for you each month, or ring 1800 25 2515 for subscription details. Hurry — you might miss something!)

cc

# Over to You - Members' Opinions

All letters from members will be considered for publication, but should be less than 300 words. The WIA accepts no responsibility for opinions expressed by correspondents.

## Morse Clarification

I am concerned that anyone reading paragraph four of Mr Gerhardt's reply in *Over To You* in the July issue of *Amateur Radio* may erroneously believe that I referred to Morse code users as idiots or dodos. I did not use the term idiot or imply it in respect of anyone. Dodo was used in reference to the NEED for Morse being as dead as the dodo. Further, lest it be raised later, reference to "shouting at terrible ignorant foreigners" is well known in stories of bad behaviour in the days of the British Empire. I do not resort to gratuitous name calling to support my point of view.

With the Editor's indulgence I will answer the points he raised as follows:

1. A good example of the sender and receiver using a common language. Remember some people use various

languages and have neither the ability to speak or hear.

2. Reminds me of my days in sending five letter groups of coded messages. Now, however, we can use fax, RTTY and packet and a copy of the message as sent kills any argument as to whether an error was made.

3. Ever heard of Ebola, mass starvation, or Aids? (*Worse than war. Ed*)

4. I have heard CW signals outside amateur bands and many sound machine perfect, if you get my meaning.

5. I agree with the amateur's role in emergencies. However, other bands in the spectrum are in far more danger than HF at this time. It is interesting to note that in the country most likely to have most to say regarding the retention of Morse code, the USA, one is now examined only on receiving and not sending Morse.

6. I am pleased Mr Gerhardt finds his

knowledge of Latin useful, however my occupation required a knowledge of both Latin and Greek terms and names, gained without the trauma of compulsory school studies of either language, which are of no earthly use to the vast majority of people.

If anyone wishes to use Morse, so be it, and I for one will respect and support their right to do so, but let us not still consider it a sacred cow that all must bow down to. The only thing that will save our share of the RF spectrum is the number of persons using it and the "political clout" that number represents, not the modes we use. Anything which prospective amateurs perceive as irrelevant to this day and age, and dissuades them from joining the ranks, only hastens the demise of amateur radio, like it or not!

D Palmer VK2TMP  
20 Elm Street  
Tamworth NSW 2340

## Why Join?

Whilst I was out walking at about 3 pm on Wednesday, 23 July, I was listening to the VK3RML repeater when I heard two amateurs in conversation. One was a member of the WIA, the other said he was not. He indicated the reason was that DX was not coming in and he was not expecting any QSL cards. Therefore, as he was not using any WIA service, he saw no reason to join.

I will not quote call signs, because it was difficult to distinguish between an "M" and an "N" in one call sign, and an "F" and an "S" in the other. Therefore I don't want to cause any embarrassment by misquoting a call sign, but the member concerned will know who I mean.

Isn't it strange (or is it?) that a non-member can be so ignorant of what the WIA does that he says he doesn't use WIA services, when he commented that he would talk to his friend the following week on the VK3RSG repeater. I wonder who he thinks supplies the repeaters, pays the licence fees and maintains them? The mysterious 'they' I suppose.

I would have made my point personally but I couldn't trip the repeater at the time with my hand-held radio.

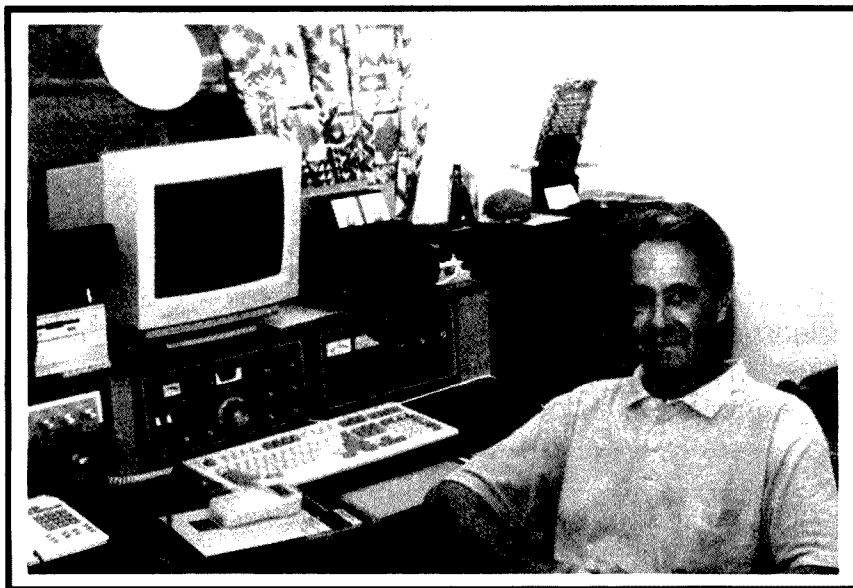
Don Jackson VK3DBB  
55 Ryan Road  
Pakenham VIC 3810

## Federal Finances

The June issue of *Amateur Radio* carried reports of Institute activities which, while admirable in their detail, omitted to reflect or provide information on two of the most important areas of immediate concern: finances and future directions.

If one did not listen to Divisional Sunday broadcasts, one could believe that Institute

## QSP News



John Oswald VK2BOJ seated at his very neat amateur radio station. His newly awarded Fluke 12B digital multimeter membership prize, still in its wrapping, is on the desk near John's elbow.

## Another New WIA Membership Prize to VK2

Another \$195 Fluke 12B digital multimeter prize in the WIA's Recruit a Member campaign has been won by a VK2 new member, this time by John Oswald VK2BOJ from Taree.

The presentation to John was made by the WIA NSW Division President, Geoff McGrorey-Clark VK2EO.  
Congratulations, John.

affairs, financially and administratively, were in the best of health. Omitting to publish a balance sheet with the Annual Report roused my curiosity, so I arranged to see a copy of the financial statements; non-publication made sense, if saving face was the main issue.

A loss of over \$44,000 for the current year, added to those of previous years and, no doubt, one to be recorded for the year ahead, is of immediate concern. Contributing factors are, of course, a large drop in membership, and less income from investments. The costs of printing and mailing *Amateur Radio* exceed income from advertising and the like by some \$80,000 and, while membership subscriptions are supposed to fund the publication of a monthly journal, the magnitude of the discrepancy must be open to question.

It would appear that the future viability of the WIA is at stake. Falling membership is a reflection of the lack of interest in radio communication/experimentation vis-à-vis computers and their off-shoots which presumably demand the attention of today's youth.

Policy and planning on future direction of amateur radio was given two lines on p22 of June's *Amateur Radio*. The non-addressing of problems of fundamental importance and a reform of the administrative structure with attendant finance requirements are sins of omission.

What is the purpose of detailed discussion and costly visits to overseas societies and ITU conventions if delegates have no idea as to where or what amateur radio will be in two, five or ten years time? With the Institute strapped for cash, surely it would be wiser to devote energies to examining our future at home as communicators/experimenters – much more productive than discussing the minutiae of band plans, awards and the fluff on the periphery of amateur activity.

Financially, money saved, at least in the short term by not socialising around the region on expensive conventions, would be better spent in reducing losses (black holes?). Telecommunications has come a long way in recent years; the same results could be achieved as effectively and more cheaply with teleconferencing. Institute administration and methodology seem to have changed little in thirty years; the rest of the world has raced ahead.

I have previously espoused the view that Divisional amalgamation/pooling resources must be considered; what's to stop a trans Tasman amalgamation? The NZART may well be amenable to an economy of scale.

**Peter D Williams VK3IZ**  
**PO Box 212**  
**Metung VIC 3904**

## Blaming the WIA

There never seems to be an end to correspondence blaming the Wireless Institute of Australia, Internet and Morse Code for the shrinkage of the ranks of amateur radio operators. Or should we say the replacement of Silent Keys by up-and-coming youngsters. These excuses fall into the same category as immigration, dole bludgers and high wages being used as excuses for national economic problems. They are scapegoats because they happen to be visible and handy targets.

Let's take the first-mentioned three, eliminate them, and then have a look at some other reasons that seem to be ignored by the purists.

The WIA is only an organisation; it is not a decision making entity in itself. It is us amateurs who are the WIA, so if the WIA is to blame, then we are to blame.

Internet is to blame? What a lot of hogwash. Voice is still the biggest user of communication resources throughout the world and nobody expects that to change significantly within the foreseeable future. It requires the minimum of hardware and gives the maximum interpersonal human communication benefit. After all, we all speak a language don't we? We would rather hear a reassuring word than read it, wouldn't we? Where else can you have an open line to the world for a mere \$50 per year?

Morse code, the good old whipping post of non-amateurs, or should I say amateurs and non-amateurs who wish they had access to the premium bands. I'm not going to get into this fray as I see pluses and minuses for all arguments for and against its abolition. But the fact remains, it's not up to us here in Australia. International treaty decides the fate of Morse code on international bands, so why waste valuable time chasing a horse that is not due to be ridden again until the year 2000. Don't fight each other over the subject, lobby the ITU.

Now that we've got rid of that lot, let's have a look at some facts that certainly do not help recruit new blood to the hobby of amateur radio.

I have on many occasions tuned up on 40 metres and put out a call asking someone to come back and talk to my grandson. No reply! Even though, if I call CQ not long after, I get replies.

Why is it that all the amateurs disappear when JOTA takes to the air once a year? I attend most JOTAs and sometimes it's impossible to get another scout/guide station. What's wrong with a local amateur calling in for a rag chew? Also I have heard complaints from 2 m users that scouts/guides should not be using repeaters during JOTA. OK, what's

ICOM Clearly Ahead



# "VK3LZ calling!"

More sound information from your friends at Icom.

## TURN YOUR PC INTO AN ICOM RECEIVER!

Icom's new IC-PCR1000 receiver connects to your desktop or laptop computer to give you all-mode receiver capability.

That's WFM, FM, AM, SSB and CW with a range of 0.01 - 1300 Mhz.

The IC-PCR1000 features a choice of three different interface screens, real-time handscope function and an unlimited number of memory channels. For more information call Icom or your nearest authorised Icom dealer.

## SPECIAL OFFER ON IC-706 MKII CONTINUES.

Icom's free antenna offer is still on. Buy a new Icom IC-706 MKII from your nearest Authorised Icom Dealer before 30 September, '97 and a CAHV quad band antenna (valued at \$250) is yours absolutely free! It's a great added value offer... you'll only get from your Authorised Icom Dealer.

## DON'T FORGET THESE CONVENTIONS COMING UP:

**SHEPPARTON**  
Sunday 14 September, '97

**TOWNSVILLE**  
Fri 26 - Sun 28 September, '97

**GYMPIE**  
Sunday 5 October, '97

# "...73"

**FreeCall 1800 338 915**

**290 -294 Albert Street**  
**Brunswick, Victoria 3056**  
**Tel : (03) 9387 0666**  
**Fax : (03) 9387 0022**

ACN 006 092 575

wrong with 70 cm repeaters opening up for a rag chew with the scouts/guides? Come on, fair go, one day of the year as a PR exercise shouldn't be too much a price to pay to secure the future of the hobby that gives us so much enjoyment, and keeps us out of the pub or from aimlessly wandering the streets in search of personal fulfilment.

When was the last time a communications magazine published how to build a simple receiver, or how to make a very cheap CW transceiver. How many people know that you don't have to be a millionaire to be a radio ham, but can get an the air for under \$500, using second hand equipment? Cheaper than that if you haggle at a hamfest.

I hope by now I have made my point. I am sure there are others who could add more.

**Kevin Jones VK4AKI**  
178 Scarborough Road  
Scarborough QLD 4020

### **Federal Problems**

If one were to write a history of WIA federal affairs over the last ten years, what would be in it? It is likely that there would be much said about competition for shrinking resources between the seven Divisions on the one hand, and the Federal body on the other. Other matters, such as the general betterment of amateur radio, member services and the need to align the organisational structure to the needs of the membership would rate hardly a mention. Often the important seems to be ignored in favour of the urgent, so though there is movement, progress is rare.

Over the last decade, the WIA has consistently failed to attract and retain members. This has placed the Institute in an unsustainable position, trapped in a spiral of declining membership, falling income and poorer services to the members who remain. The current Federal Council understands this only too well.

However, I am concerned that in the name of saving money, Federal Council (with the best of intentions) is hastening the decline. This is most apparent in the running down of the Federal Office and the departure of dedicated, professional staff over the last few years. This has weakened the institute and has the potential to force more administrative work onto Divisional volunteers that are ill-equipped to handle it.

Maybe you do not see this degradation as a problem. Think again! Our most tangible member service, namely *Amateur Radio* magazine, is funded from the federal component of your membership subscription. The WIA's main reason for being, that of representing the amateur service to government and lobbying for the maintenance of our privileges, is a federal responsibility. Other WIA activities, such as

contests, Intruder Watch and FTAC are also co-ordinated at the national level. It is essential that a strong federal organisation exists to support these functions.

Amateurs expect the WIA to be their national organisation. They become disappointed when told that they do not belong to the Federal body, but are members of a state Division. Though Institute broadcasts and *Amateur Radio* articles have tried to explain this, it is a message that people do not want to hear. People want to be members of a strong national WIA. We will not have a strong national body if current moves to downgrade federal activities go unchallenged.

Federal Council is right. Economies must be made to balance the Institute's budget. However, emasculating the Federal body is not the way to do it. Instead, attention must be drawn to the high cost of the current Divisional/Federal structure. An organisation having less than 5000 members should not need seven divisional councils and one federal council to manage its affairs! Doing nothing to change this is costing the Institute dearly, both in volunteer time and money.

The WIA Divisions are aptly named. They have outlived their usefulness and should be abolished. State-based WIA/PMG Amateur Advisory Committees disappeared long ago. Changing patterns of urban settlement have caused the rise of suburban clubs and the decline of the Divisions. People are now more likely to assist in the activities of their local club than their state Division, particularly in the larger cities. It is no accident that the two Divisions that have the highest ratio of WIA members to licensees (VK1 and VK7) are more like clubs than the larger Divisions whose membership ratios are less. The WIA's structure should change to reflect the preferences of its membership.

To prove that we could do without the Divisions, we should look at what they actually do. Such an exercise would reveal that most functions could either be taken over by a stronger Federal body or devolved to a local club. A professional Federal Office could handle administrative tasks such as membership processing. In contrast, clubs and special interest groups, brimming with the "get up and go" attitude lacking in many Divisions, could easily run services such as classes, exams and repeaters that were formerly performed by the Division. Divisions that wish to continue could change to become strong suburban-based radio clubs affiliated with the Federal body.

It seems to me that the best way forward is to have every WIA member belong to a unified Federal body to which geographic and special interest clubs could affiliate. The Federal body could be governed by a member-elected Federal Council, the size of which would be similar to the present Council. Because the Divisional component of the membership fee would no longer exist, more resources could be provided to the Federal body without raising overall subscriptions. Affiliated clubs could receive a small payment from Federal for each member who is also a member of the WIA to encourage club affiliation and WIA membership.

There will be complications in any reform, particularly for Divisions with significant property assets. However, the worth of members and volunteers to the Institute far outweighs that of bricks, mortar and land. The current structure is not serving members well and needs to be reformed before unpleasant change is forced upon us.

**Peter Parker VK1PK**  
7/1 Garran Place Garran ACT 2605  
[parkep@pcug.org.au](mailto:parkep@pcug.org.au)

ar

---

---

## **Pounding Brass**

*Stephen P Smith VK2SPS\**

---

---

**C**ontinuing from last month's issue, we will have a look now at the second hand market for Morse keys. You have to be extremely lucky to pick up a key that is in mint condition and on sale at a reasonable price, as the majority of keys offered for sale range in condition from near mint to broken and battered relics that are only good for paper weights.

I find a good place to start looking is the Hamads section in this magazine and other similar type magazines. You will find that

some operators purchase a key, find it unsuitable to their needs, and sell it, usually at a much reduced price to what they paid for it. Other sources are deceased estates where you are probably buying sight unseen and the description some people give leaves a lot to be desired. Usually, when dealing with these people, I ask them to describe the key to me as best as they can, and then make them a reasonable offer on what I believe the key to be worth. However, some people think that because the key looks old it must be valuable

and try to hang out for higher offers. If you feel this is the key you want and think the price is right, buy it. If not, don't worry, you will pick up the right key eventually.

Second hand shops and junk shops are another good source for keys, although you will have to be prepared to do a lot of walking and searching. It's amazing what you find in old boxes of junk.

Other sources are radio fairs, hamfests and garage sales. Condition plays a major factor in key sales. Happy hunting!

Buying direct from an overseas manufacturer does have its merits with the only drawback being the cost of shipping the article whether by surface mail (around 12 weeks) or the more expensive air mail (anything up to two weeks). If you are lucky, you (or friends) may be able to visit the country of manufacture for other reasons, thus saving yourself quite a bit of cash.

Some of the keys manufactured overseas by skilled craftsmen (especially from Britain and Germany) are magnificent. The workmanship is something to behold, and they feel and operate as well as they look. I have compiled the following list of manufacturers whose keys I have used and believe to be at the top of the market. If you are interested all you have to do is drop them a line with some IRCs enclosed (for return

postage) for a current listing of their products.

### Britain

Derek Stillwell, Instrument Maker, 27 Lesley Owen Way, Shrewbury, Shropshire, England SY14RP. Makes straight keys only.

G4ZPY Paddle Keys International, 41 Mill Dam Lane, Burscough, Ormskirk, Lanks, England L407TG. Makes a range of straight keys, paddles and iambic keyers.

### Germany

Klaus Gramowski, Kaiserin - Augusta - Allee 91, D - 10589 Berlin, Germany.

Makes a range of paddles and hand keys, including a small mobile hand key.

Englmar Wenk DK1WE, Hubenring 4, 88048 Friedrichshafen, Germany. Makes mini hand keys called Twinkey and Minkey.

On a sadder note I've recently been informed that Steve Nurkiewies N2DAN, maker of the Mercury Paddles, died suddenly. Steve will be a great loss to the amateur fraternity.

I intend to compile a listing of all key manufacturers I know and will advise you through this column when completed. If you are interested in obtaining a copy just drop me a line with return postage enclosed and I will send one to you.

\*PO Box 361, Mona Vale NSW 2103

ar

## WIA News

### New Record Claimed for 24 GHz

Distance records for the 24 GHz band tumbled twice in succession over two days in July. Two amateurs in Western Australia now lay claim to a new Australian distance record for the 24 GHz band.

As reported to the Australian VHF-UHF Internet e-mail reflector, on Friday 18 July 1997, Neil Sandford VK6BHT, portable at Quinns Beach a suburb north of Perth, worked Walter Howse VK6KZ, portable at Falcon, a suburb of Mandurah, south of Perth, on 24 GHz over a distance of 102.7 km. Using SSB, reports each way were 5-4 at 0453 UTC. It was an over-the-sea path with both stations about 10 metres above sea level. This contact exceeded the current Australian distance record of 85 km held by the same operators.

Tests from Two Rocks over a longer path were unsuccessful, although Neil VK6BHT did hear brief snatches of VK6KZ transmissions.

The following morning, with each operator rising at 5 am local time, they

ventured to Two Rocks and Falcon hoping for better propagation. At 0037 UTC on 19 July, contact was established with VK6BHT/p at Two Rocks giving VK6KZ/p at Falcon a report of 3-1 (later amended to 4-1) whilst VK6KZ/p gave a 3-1 report. This contact on 24 GHz was also over an ocean path; the distance of 120.6 km will be the basis of a claim for a new Australian distance record.

The current world record is 396 km for a two-way contact and the one-way record about 410 km.

Gear at both ends of the paths was similar, with DB6NT Mark 2 transverters providing noise figures of about 4 dB and power outputs of about 20 mW. Dishes of 570 mm diameter with 'penny' feed were used. Temperatures were 11 degrees and relative humidity 64%, according to Wally House's report. Both operators are looking forward to the summer months, he said!

Wally House VK6KZ is the current WIA Western Australian Division President and Federal Councillor.



HF - VHF - UHF MOBILE ANTENNA  
HF - VHF - UHF BASE ANTENNA  
CB - MARINE - AIRCRAFT

Monoband to Multiband  
Convert Now, to the all

New!

PERTH PLUS

HF Mobile antenna

with 80-40-30-20-17-15-12-10-6-2m included

also in stock

Coaxial Cables & Fittings  
HF Spring Bases, Trunk and Gutter Mounts.

Outbacker OBB "Classic"  
Outbacker "Junior plus"

Split Models  
Helical Dipoles  
Long wire Dipoles  
Baluns

Now available from :

MELBOURNE  
Daycom Communications  
Ph 03 5436444

ALICE SPRINGS.  
Farmer Electronics  
Ph 089522388

DARWIN.  
Integrated Technical Services.  
Ph 089-815411

SYDNEY.  
Andrews Communications  
Ph 02 6369060

PERTH.  
Tower Communications  
Ph 4701118

ADELAIDE  
Johnston Electronics  
Ph 08 2871061

PERTH - Model

<http://intercon.com.au/outbacker>

TERLIN AERIALS Ph +61 (08) 9455 4288  
11 McCulligott Court Ph +61 (08) 9455 4289  
Canning Vale WA 6155

NEW VIDEO

Send \$ 5.00 for a 15 minute informational video  
Refundable with every antenna purchase.

# QSLs from the WIA Collection

Ken Matchett VK3TL \* Honorary Curator WIA QSL Collection

## Z-4AA

This QSL, dated 15 November 1924, is one of the treasures of the WIA National QSL Collection. It was sent to an Australian station A2DS by Frank Bell, a pioneer of early amateur radio. It was Frank Bell who, on 19 October 1924 (barely a month before the date of this QSL), made the first two-way contact on amateur frequencies between Great Britain and New Zealand. His English contact was Cecil Goyder G2SZ of Mill Hill, London. On Frank Bell's QSL he also claims to be the first NZ station to contact Australia and the first Australasian station to QSO North America.

## G2SZ

This pre-war QSL, post-marked 13 May 1928, was sent to a short wave listener, Mr L S Bolger of Malvern, Victoria by Cecil W Goyder of Mill Hill, London. The WIA is indeed very fortunate in possessing one of this operator's QSL cards. This card was sent about four years after the operator's historical QSO with New Zealand. On the QSL can be read, "We were the best station in the old 200 meter (sic) test 1923-24 (here he is referring to the series of Trans-Pacific Tests - VK3TL). This station opened up two-way communication with the Antipodes by working Z4AA, 12,000 miles distant in October 1924, on 90 metres."

## DLOXR

This special DOK "XRAY" was issued by the Club station of the OV Remscheid, Germany (OV = Ortsverband or Local Association). The popular German award, DOK, stands for *Distrikts und Ortsverbands-Kenner* (District and Local Identification). In the DOK W32 the W would indicate the district (one of 25) of Germany, and the 32 the particular local radio club. In addition, there have been issued a considerable number of so-called *Sonder DOK* or Special DOKs issued to celebrate special occasions.

The QSL shown was issued by the friends and supporters of the German Roentgen Museum in Remscheid. It was in this town in 1895 that Professor Wilhelm Roentgen discovered X-rays quite by accident whilst experimenting with a Crookes Tube (a vacuum tube through which are directed cathode rays). Some of the energy lost when the rays hit a fluorescent screen was converted into X-rays (so called because of their puzzling nature, particularly their ability to pass through solid matter). Germans still refer to X-rays as *Roentgenstrahlen*.

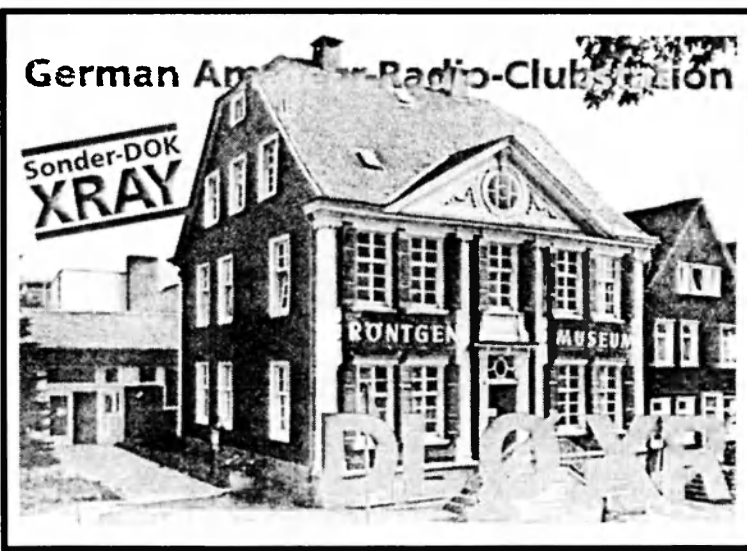
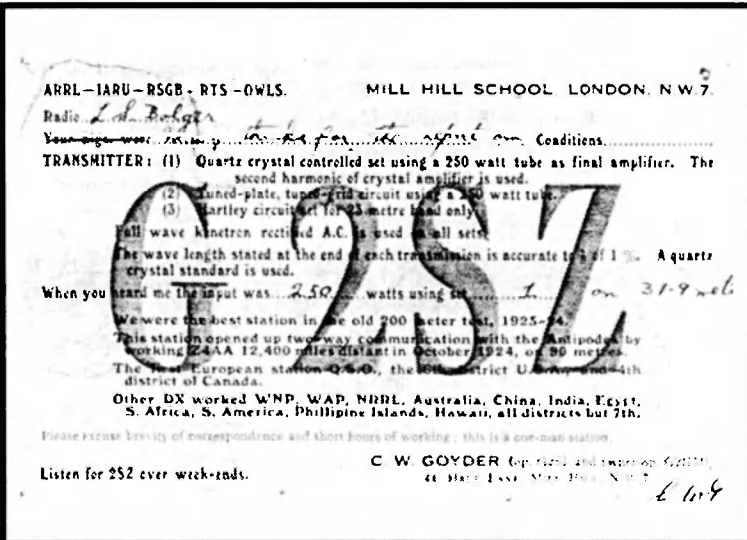
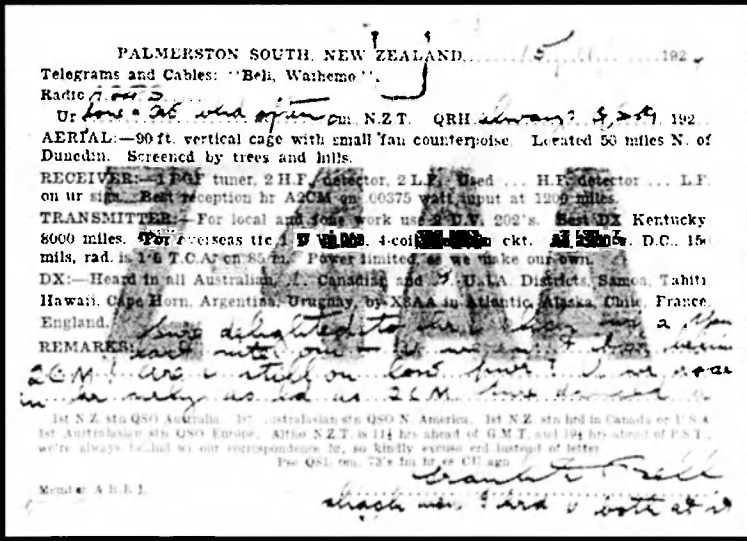
## Thanks

The WIA would like to thank the following for their thoughtful donation to the Collection: Leo L20468, Brian VK4LV, Mr Frank McGurgan (courtesy of Gordon VK5KGS), Jim VK1FF, Fred VK4RF, Bill VK4FW, Hans WIA L40370, Gwen VK3DYL and Bert VK3NXQ.

Also the friends and relations of the following Silent Keys: Len "Sandy" Powell (courtesy of Ray VK7RQ) and Bill Sievers VK3CB (courtesy of Alf VK3LC.)

\*4 Sunrise Hill Road, Montrose VIC 3765  
Tel (03) 9728 5350

ar



---

---

# Repeater Link

Will McGhie VK6UU\*

---

---

## Catby Update

Even though this repeater site is in VK6, it could be at any remote location in Australia, and this story could equally apply to any remote amateur repeater site.

You may recall the re-installation of the Catby repeater VK6RCT in last month's *Repeater Link*. It did not take long for a problem to emerge. The link between the site and Perth developed a fault condition within a few days. There appeared to be a signal opening the mute on the link receiver. The link was shut down and a site visit was planned for the following weekend.

## Not Working

The morning of travelling to Catby required a visit first to the other end of the link between Catby and Perth, at Roleystone. A minor adjustment was needed on the UHF repeater to which Catby was linked. On arrival at the site it was discovered the UHF repeater would not transmit! I stood there looking at the UHF repeater not believing my eyes and ears. Yesterday the repeater was working, this morning it would not transmit. I had not tried the repeater on the way to the site as there was no need; it had been working for months without any problems. Why did it choose this very morning not to work? The very day it was needed to sort out the other end of the link at Catby.

After the initial "the world is mad and I'm part of it" feelings subsided, a closer look at the UHF repeater was required. Most of our repeaters use a particular control board that has had a small problem from time to time. Now you may not believe this, but trust me, it is true. The control board is fitted to about 10 repeaters in VK6 and works well. It is a CMOS design using an EPROM. However, if one of these controllers is left without power for several weeks, it will not work! Placing it in a repeater and applying power results in the controller not performing any of the functions it is required to do, including turning the repeater transmitter on when the repeater mute opens. The fault is "fixed" by turning the power on and off many times, or running your hand over the circuit board. Now those of you who think this is a bit of black magic may well be right. But trust me, this fixes the "no work" condition. This happens with any board left without power for several weeks, so it is not a dry joint, etc.

Knowing this could be the problem, I turned the power on and off on the UHF repeater several times. Still no go. Next I ran my hand over the circuit board. Still no go. However, further black magic by running my hand over the circuit board resulted in the repeater working. Why had the circuit board failed in the manner others had (no power

applied for several weeks)? This board was powered up. There was one other variable in all this, and that was Perth's record low temperatures. That particular morning the temperature had dropped to a record zero degrees, cold for Perth. Could this strange fault not only be caused by a lengthy lack of power to the controller, but also low temperatures?

There was no time to sort it out now as Catby is over two hours drive away. At least the UHF repeater was working and available for testing of the link to Catby. Just to be sure the UHF repeater control board did not fail again, if it was due to the low temperature, I left a small soldering iron under the repeater to raise the temperature a little, and headed off North to Catby.

What luck though, having to go to the Perth site. I might not have tried the UHF repeater until I was well on my way to Catby.

## Instability

Arrival at Catby showed the fault on the link receiver to be a signal all right. The S meter showed a 5  $\mu$ V signal. It was within the receiver. Eventually it was tracked down to an unstable 455 kHz IF. Some extra bypassing on the 10 volt supply rail right at the IF amplifier sorted out the receiver which is a Philips FM747. The board had been removed from its mobile container and mounted in a rack mounting box. The different mounting location perhaps caused the problem, as FM747s do not have this problem to my knowledge. However, if you look at the supply rail that feeds the IF amplifier, you will notice a long track that is not bypassed right at the IF amplifier.

## MAR-6

With the instability fixed, the link now functioned again. The signal strength over this link path from Perth to Catby is only about a microvolt under normal propagation conditions. The distance is 165 kilometres, but the location of Catby is only about 100 metres above the average terrain, resulting in the poor link path. The FM747 receiver is not particularly sensitive, so I had made up a UHF pre-amplifier for installation in the link receiver. An interesting design was tried using a monolithic amplifier, the MAR-6. For those of you not familiar with the MAR-6, they are simple in design. The amplifiers are 50 ohm in 50 ohm out. Most designs you see show the MAR-6 used as a broadband, untuned amplifier. I added a tuned circuit at the input and output. With a noise figure of around 3 dB, the MAR-6 amplifier improved the FM747 receiver by about 6 dB. Next month's *Repeater Link*, time permitting, will feature the MAR-6 design.

## Good News

With so much bad news on the repeater scene over the past few years in regard to licence conditions, new regulations delays, and rising costs, it is a great pleasure to comment on some good news. As you should be aware, the ACA (SMA) changed repeater and beacon licence cost conditions well over a year ago. This resulted in many repeater site licence costs increasing two or three times. Added to this, a very big increase in new or changing licences would have resulted in the demise of many repeaters and beacons. In fact, some repeater and beacon licences were cancelled or placed under limited operation in VK6 due to the cost increases. It was not just the possibility of change, change had already taken place due to the licence changes. Changes that had not had a consultation process beforehand with the WIA. The changes were just announced by the then SMA.

It's a great relief to see that the licence cost structure has been changed. As of now, a repeater, beacon or digipeater licence will cost \$50; and, if more than one system shares the same site and callsign, the total cost is still just \$50. Beacons and repeaters, however, cannot share the same callsign, and hence must be licensed separately, each incurring a \$50 fee.

What is even more pleasing is that the investigation fee has been reduced to \$30 for new or existing licences. Any new licence, or change to an existing licence, is now \$30; and this \$30 is a flat \$30, with no additional time cost. Also, all work to convert existing repeater or beacon licences will be done free of charge by the ACA (SMA).

Well done to the WIA and all amateurs who opposed the fee rises; and well done to the ACA (SMA) who structured the changes. It is disappointing that the original changes took place. It cost amateur radio time and money. Can we recover licence costs that have been paid under the past system? I believe we can. It depends on whether it is to our overall benefit to do so, and if we have the resolve to do so.

## ACA Internet Site

The ACA (SMA) have an Internet site at <http://www.sma.gov.au/> (by the time you read this the sma may have changed to aca). There is a lot of information on the site and well worth the visit. I did notice some of the information relating to repeaters to be incorrect, as it is now outdated. Regulations only permitting a maximum of three repeaters to be linked hopefully will be corrected. Have a look at the site if you have Internet access. By the way there is also a link from the VK6 WIA Home Page at <http://www.faroc.com.au/~vk6wia/>.

\*21 Waterloo Crescent, Lesmurdie 6076

Packet: VK6UU @ VK6BBR

E-mail: [will@vale.faroc.com.au](mailto:will@vale.faroc.com.au)

ar

# Spotlight on SWLing

Robin L. Harwood VK7RH\*

I have now seen the revised schedule for Radio Australia, following the severe budgetary cutbacks experienced as from 1 July. As reported here and elsewhere, the site near Darwin has been mothballed leaving only the Shepparton (VIC) and Brandon (QLD) senders to carry RA's programming to Asia and the Pacific. As one would expect, signal levels are markedly down with Shepparton only having outmoded 100 kW senders and those at Brandon even older and only rated at 10 kW. Darwin had several 250 kW senders and was easily heard in SE Asia and beyond. Budgets have been pruned for programming and for transmission time and the staff has been reduced from 144 to 67.

Since the implementation of these radical changes, I have found it very difficult to even hear them, even though I am only 300+ miles from their main senders. I know that several listeners overseas are upset that they cannot hear RA as easily as before. I know that the weekend sporting panel with descriptions was utilised by many listeners but they have had difficulties finding it amongst the other short-wave powerhouses. Will RA eventually return to its former levels? It is hard to say. The external television service was also privatised and is now owned by the Seven Network, although the ABC still retains the independent news and current affairs segments.

I am now hearing the Voice of Greece in the early evenings in Greek and ending with a 10 minute English news bulletin. However, it is coming from Delano, California as part of a reciprocal agreement for the VOA to continue using their senders in Greece. Frequency is 9775 kHz between 0600 and 0950 UTC. Athens comes in well on 9425 kHz from 0400 UTC from transmitters in Greece.

There was a short-lived broadcast from "Radio Emerald" and, as you would expect, it was from Eire. It was via WWCR and was not associated with the official RTE organisation which also uses WWCR at other times. These programs were produced by students at a technical college. However, DXers balked at the asking fee of \$US5 for a QSL card. The same outfit also had a web-site with Real Audio.

There have been moves to get a consensus amongst the various Australian DX clubs. All clubs have experienced plummeting membership reflecting the rapid world-wide decline in short-wave listening. One Club did peak at 600 yet only 10% now remain as

members. A conference was due to be held in Melbourne on 10 August, facilitated by the Electronic DX Press (Bob Padula), to discuss the future of the hobby in Australia. It is too early to say what outcomes will emerge but I am expecting that an organisation could be established based on the Internet for the pooling and sharing of resources in the hobby.

Talking of the Internet, the Newcastle Scanner Group, via Martin Howells VK2TJO, has announced that they have a web-site. It is at <http://www.swl.net/nsg>. E-mail enquiries go to [nsg@swl.net](mailto:nsg@swl.net) or [nsg@hunterlink.net.au](mailto:nsg@hunterlink.net.au).

The end of September usually is the end of the European summer when clocks are wound back and seasonal alterations are made. However, a decision was made last year to changeover at the end of October. Broadcasts to non-European targets are likely to be altered on the first Sunday in September from 0100 UTC.

Please delete my packet address as I rarely use it these days. Personally I prefer the Internet as it is fast and reliable compared to packet. Mail from HB9 was sent via packet and I haven't received it yet. E-mail copies of the identical traffic were here within minutes of being sent. I am wondering how much longer packet will be around.

Well that is all for this month. Until next time, good listening!

\*5 Helen Street, Newstead TAS 7250 (03) 63 44 2324  
Internet e-mail: [robroy@tassie.net.au](mailto:robroy@tassie.net.au)

ar

## WIA News

### WIA Member Morse Survey

Returns from the June survey of WIA members' opinions on whether the requirement for Morse qualification in amateur licensing should be retained in the International Radio Regulations as a treaty requirement, or be left up to each country's administration, have been preliminarily assessed, with some interesting results.

With more than 1600 surveys returned, members voted 2:1 in favour of maintaining it in the International Radio Regulations. Seven members expressed no opinion either way, as was provided for on the survey form circulated with the June issue of *Amateur Radio* magazine. Detailed breakdowns on voting by licence type, and other statistics, were not available at deadline time.

The survey's purpose was to provide an updated assessment of opinion since the member survey on the same subject conducted more than a year ago. The issue is on the agenda for the International Amateur Radio Union (IARU) Region 3 Conference being held in Beijing over 8-12 September and the WIA delegation to the Conference needed an assessment to provide guidance as to the feeling of WIA members on the issue.

The matter was discussed at the IARU Region 1 meeting in Tel Aviv last year.

The retention of the Morse requirement in the Radio Regulations of the International Telecommunications Union (ITU) is an issue which is anticipated to be

among a variety of amateur radio matters on the agenda for the ITU's World Radio Conference in 1999 (WRC-99).

The Morse issue is, however, only one of eight raised by the IARU's "Future of the Amateur Service Committee" (FASC). The eight issues dealing with the International Radio Regulations are:

- definition of the amateur service,
- international communication between different countries,
- international communications message content,
- international communications third party traffic,
- Morse code,
- examination standards,
- power levels and spurious emissions, and
- definition of the amateur-satellite service.

As can be appreciated from the foregoing, the issues are not simple and are interrelated. The WIA originally publicised the IARU's initiative in 1995, and the FASC's later publications in 1996, and sought comment from the Australian amateur community. The FASC's original Discussion Paper, their First Report and Second Report are available from the IARU's Web site at [www.iaru.org](http://www.iaru.org). If you haven't got Internet access, ask for copies from your local WIA Division.

[Released 11/8/97]



---

---

# VHF/UHF – An Expanding World

---

---

Eric Jamieson VK5LP\*

All times are UTC.

## Six Metres of 50 Years Ago (Part 2)

Frequency allocations to Australian amateurs for five/six metres have varied over the years. The following is a brief summary.

Pre World War II: 56 to 60 MHz  
01/01/46 to 30/12/63: 50 to 54 MHz\*  
01/01/64 to 30/06/89: 52 to 54 MHz  
From 01/07/89: read on.

\* With the introduction of Channel 0 television transmitters to VK2, 3 and 4, plus the expansion from an 11 channel TV band to 13 channels, which included Channels 0 and 5A (these were completely at odds with the rest of the world but Australia seems to have a habit of doing strange things at times) at the end of 1963 we were limited to 52 to 54 MHz until 30/6/89 when portions of the band from 50.000 MHz were again available, on a non-interference basis to Channel 0 television stations.

Six News, the UK Six Metre Group Newsletter of October 1991, provides further insight into the establishment of six metres in an article *The History of Six* compiled by Neil Carr G0JHC from Harry School's (KA3B) *Six Metre Digest 1987*, also from an article by Brian Bower G3COJ for the UK Six Metre Group. Excerpts are worthy of inclusion on this occasion, permission having been established.

It appears that a conference in Washington DC in 1927 made a world-wide allocation of 50 to 60 MHz. The distance record for 56 MHz (five metres) was 2500 miles established by a contact between W1EYM and W6DNS on 22 July 1938. On 56 MHz, G5BY was the first station to span the Atlantic when heard by W2HXD on 27 December 1936, which period would have been during the peak of Cycle 17. G5BY and GM6RG were each heard in the USA in 1938. At the Cairo WARC of 1939, the allocation was reduced to 58.5 to 60 MHz to make way for Band 1 television. At the 1947 WARC, amateurs in Europe were no longer permitted to operate between 29.700 and 144 MHz, while Oceania received 50 to 56 MHz.

"The band 50 to 54 MHz became available to amateurs in the USA from 1 March 1946, with the first aurora/Es contact between WILSN and W9DWU on 23 April 1946 at a distance of 1100 miles. This was extended to 2590 miles on 14 June 1946 by a contact between W6OVK and W2BYM,

becoming a new six metre record. The same afternoon a contact between WILLL and W6NAW became the second trans-continental QSO.

"By September 1946 there was considerable six metre activity in the US and Canada. VK stations on six metres were appearing in all states, and New Zealand.

"During June and July of 1946, each Sunday from 1300 UTC, G5BY made automatic CW transmissions on 58.632 MHz using high gain antennas beamed at the US, from a site situated on a 400 foot cliff overlooking the sea.

"For transmitting G5BY used two 4 element W6QLZ arrays stacked vertically and fed in phase. For receiving he used a rhombic, 240 feet on each leg.

"In September 1946 F2 skip began to appear and during a 27 day recurrence cycle in late October, American FM stations near 45 MHz were heard in England.

"Anticipating a peak in the F2 season to take place in November 1946, G6DH Dennis Heightman of Clacton-on-sea, Essex, England, suggested a series of daily schedules with W1HDQ on 28 MHz. These schedules started on November 13th and took place each morning at 8.15 am EST.

"On several days signals were heard on both sides of the path on frequencies as high as 48 MHz. Test after test was made on 50.002.3 MHz with no results. On Sunday morning, November 24th signals in the 47-48 MHz range were heard on both sides of the Atlantic. Many of them were S9 and higher. Arrangements were made whereby W1HDQ would transmit for 5 minute periods each 15 minutes, listening on 28 MHz for replies from G6DH.

"The first transmission was made at 11.15 am in the form of a QST on voice to all 50 MHz stations, to the effect that an opening across the Atlantic was imminent, and urging all stations to get on and transmit. The QST was continued for 4 minutes, followed by a 1 minute call to G6DH. G6DH heard W1HDQ and the first transatlantic VHF QSO was on. (A VHF 2-way was attempted on 5 metres to 6 metres but the MUF didn't go quite high enough to permit G5BY to make it on 58.632 MHz with W1BEQ in Connecticut.) W1HDQs signal faded out at 12.00 pm (43 minutes later) at G6DH and at 12.25 pm with G5BY. Hilton O'Heffernan. Although G5BY intercepted W1HDQs signal first, it was G6DH who made the first contact."

Next month the above article continues

with a segment called 1947 – *The Year of Firsts*, and hopefully space for the first part of a series covering interesting aspects of VK six metre operating during the period from 1946 to 1950.

In addition, with assistance from a number of our senior VK5 amateurs, I am assembling information on the 5 metre band in the period before World War II. I think you will like reading about that article when it appears in print.

As a result, I would welcome input from any amateurs who operated on five metres before the War. Information I could use would include a list or photocopy of log entries of the time, also receivers, transmitters and antennas used, plus any relevant snippets or jottings made in your log at the time; a photo of yourself too, if available.

## Newsorthy Items

Andrew Davis VK1DA reports: "That since the upgrade to antennas at VK3RGL/b, Chris VK1DO hears the beacon better. Even I have heard it. On 24/7 at 2000 I was copying the callsign at 219; that's good as I have only a single 10 el DL6WU Yagi at 20 ft (on the roof) fed with ordinary coax into a 1C271H with no pre-amp and SSB bandwidth. My lookout to VK3 is reasonable."

Ron Cook VK3AFW writes: "I've often read about the northern hemisphere's winter Es season but did not know if it existed down south. Well, it does. Several stations have been making 6 m Es contacts in June for many years. On 28/6, Gavin VK3HY worked VK4WPN. Gavin and Andrew VK7XR, and others, have also heard lots of ZL TV, but no ZLs.

"Using aircraft enhancement, on 21/6 I worked a new VK1 call, Reg VK1MP. On 5/7 Felix VK3CAD, at Eildon for the first time. His QTH is in a deep valley and very little signal makes it to Melbourne without assistance. Also heard calling were VK3ANJ, 3DUQ, 3TMP, 3HY, 3II, 3JG. VK1DO and VK2TWR are still regulars on the net. Gordon VK2ZAB is believed to be having TVI problems and has not been heard lately. VK1BUC and VK1RX appear with good signals from time to time.

"Norm VK3DUT reports working a number of ZLs on six metres over the last month. His present QTH at Lakes Entrance is 200 km closer than the old one and that seems to make a lot of difference to the number and strength of signals from ZL.

"The large high pressure system in The Bight has brought some enhanced propagation, in spite of the lower winter temperatures. At various times from 19/7, for a week or more, there were the following occurrences:

"Rod VK2TWR copied the VK72 m and 70 cm beacons near Devonport, but Andrew VK7XR, south of Devonport, was away. VK3AFW worked Andrew VK7XR, on 2 m 5x8, and on 70 cm 5x1. Distance about 440 km. Des VK3CY at Wedderburn, Central Victoria, also worked Andrew on 2 m 5x3 and again on 1/8 at 5x2. Distance about 550 km. Andrew cannot hear the VK3RGL/b since the antenna direction has been changed.

"Barry VK3TBM, has been mobile on 2 m SSB around Melbourne and the nearby country areas. Running 25 W to a halo he has worked in excess of 120 km while mobile. Max VK3TMP, inspired by this, has now built a halo for his vehicle and worked Des VK3CY over 230 km on 2 m SSB. Try that on 2 m FM simplex! Others using mobile are David VK3AUU, Max VK3TMP, and Felix VK3CAD.

"Graeme VK3GRL at Narre Warren has a respectable signal from an 11 element Yagi and 25 watts.

"Aircraft enhancement net on 144.200: Peter VK1RX, worked VK3s AFW, KLO, AJN. Also heard in Melbourne, VK1MP, VK2TWR, VK3s HY, TMP, DUQ, ZXR, JG.

"On a lighter note, Andrew VK7XR has pointed out that we have, over six years, completed QSOs most days of the week on 2 m CW. I figure that is more than 1200 2 m CW QSOs! As the distance is more than 400 km, it appears we've worked over 500,000 km on 2 m. Hmmm, is that a record?"

Barry Miller VK3TBM in his first report to me advises: "On 20/7 I travelled to a hill just outside Maryborough, in Central Victoria. I carried some two metre gear, a halo for mobile work, and a 5 el NBS Yagi for portable operation.

"On the way from my QTH in Box Hill South, at 2254 I worked Gavin VK3HY, and had a lengthy contact with Ron VK3AFW from 2304. Initial contact with Ron was made at Bacchus Marsh, on the Western Freeway, and continued with good signals till after I left the freeway at Bungaree, and was 10 km SE of Creswick. Signals varied from 5x9+40 to 5x1. Two further brief contacts were made with Ron; 2352 at Clunes 5x1, and 0020 at Maryborough 5x1.

"Mobile set-up consists of a halo mounted centrally above a roof rack, with an FT-290R MK1 driving a 30 watt amplifier (MRF-240 transistor).

"Using the portable antenna, nothing much was heard until 0635, when Rod VK3DQJ near Lancefield answered a call with signals 5x9.

"On the outskirts of Melbourne, while returning home, I worked John VK3ACA, at Oak Park; signals averaging 5x5.

"Planning and preparing for plenty of

portable operations later this year. I'll let you know details of these further down the track."

Nev VK2QF at Hargraves NSW has almost completed an upgrade of his six metre station, in readiness for Cycle 23.

The antenna is an eight element optimised Yagi with chrome steel boom, copper driven element and coaxial gamma feed. Gain is quoted as 15 dB and he has measured a 35 dB front to back ratio, so it should work well. Despite the steel it weighs less than 20 kg, which is reasonable for a 9 m boom. Feedline is Times Microwave LMR 600 coax with a nominal OD of 16 mm and very low loss.

All is mounted on a 24 m KVC Southern Cross free-standing tower, held in place with 16 tonnes of steel, concrete and soil. The coax is fully enclosed in conduit. Transceiver is the faithful Kenwood TS600.

Nev said his location leaves much to be desired, with towering hills much closer than before, but he believes F2 propagation will find its way into difficult sites.

Joe Gelston VK7JG writes: "On 9/2/1986 during a large auroral opening I worked David VK3AUU on 432 with 3-2 3-4 reports exchanged; I believe this to possibly be the first contact on this band for VK using that mode. I also worked four VK3s and three VK5s as well on two metres. I was running a 8874 to an 88 element Jaybeam with a mast head pre-amp.

"I have now completed a VK4OE design solid state 1296 power amp using 4 x 25 watt power modules; this, combined with a LNA of 0.22 dB noise figure, should be ready for the next DX season. I will be using a single 27 el Loop Yagi at the top of the tower at about 50 feet."

On 10/7 at 1340, Bill VK6AS in Esperance, for the first time heard his moon echoes on 144 MHz. Wal VK6KZ said that he was "over the moon" literally after hearing those echoes for about 10-15 minutes. He will keep trying for more echoes and may move to set up some skeds.

Graham VK6RO advises that for 14 minutes on 12/7 at 0413 on 57.250 MHz, he received Channel 1 from Port Pirie at S9. He called on 50.110 CW but received no replies. Part of winter Es?

Steve VK3OT reports that on 20/7 via mid-winter Es from ZL, 45.2502 video and 50.750 sound. At 0645 the sound rose to S9 with full quieting; called on 50 MHz but no replies. VK3SIX to ZL3TIC 0430 50.125 Sunday 13/07/97 at 5x5.

Steve said that, as part of his 1998 travel arrangements, he plans to visit KL7 in BP51 and, hopefully, operate from there during Dec/Jan/Feb. Arrival date in Wasilla, Alaska is 27 December. Also to operate from HL9 in Feb 1998. To be confirmed later.

Stuart YJ8UU has moved to Vanuatu and will be on six metres after 19/7. Six metre activity is scheduled for 0630 on 50.110 MHz. He will be there for three years. QSL via ZL2HE.

## The Geelong Beacon

Dale Cavies VK5AFO at Mount Barker has been checking for the beacon on 144.530. He heard it positively for the first time at 1200 on 31/7 at S1. That's a start.

The beacon continues to be available to VK5LP at Meningie on a daily basis; whenever I have checked it has been audible, with signals varying between S1 and S5.

## Microwave News

Wal VK6KZ reports that on 18/7/97, Neil Sandford VK6BHT/p at Quinns Beach (suburb north of Perth) worked Walter Howse VK6KZ/p at Falcon (suburb of Mandurah south of Perth) on 24 GHz over a distance of 96.7 km with SSB reports each way of 5x4 at 0453. This was over a sea path. This contact exceeded the current Australian distance record of 85 km. Tests from Two Rocks over a longer path were unsuccessful, although Neil did hear brief snatches of VK6KZ transmissions.

The following morning (with a 5 am local time rising) each ventured to Two Rocks and Falcon hoping for better propagation. At 0037 on 19/7 contact was established with VK6BHT/p at Two Rocks giving VK6KZ/p at Falcon a report of 3x1 (later amended to 4x1) whilst VK6KZ/p gave a 3x1 report. This contact on 24 GHz over an ocean path of 120.6 km will be the basis of a claim for a new Australian distance record.

Gear at both ends of the path has not changed from the previous contacts with approx 20 mW and 600 mm dishes.

[Readers: wait for some special microwave reports next month. ... VK5LP.]

## Melbourne 70 cm Beacon

Ian Glanville VK3AQU advises the following: "For many years I have run the Melbourne 70 cm beacon. Recent efforts, in conjunction with John Martin VK3KWA, to relocate it out of Melbourne and shift its frequency to conform with the band plan have run into a number of difficulties, mostly in regard to finding it a new home. Consequently, I am seriously considering closing it down. I'm sure you'll agree this would be a sad loss to the hobby.

"What I am proposing is that if any club (preferably), or individual who is interested in taking over my beacon can have it completely free of cost provided they do so on the understanding that it is to be returned to service.

"Any interested party can contact me via packet @VK3EEE, QTHR or via this e-mail

address: lorian@albury.net.au (Ian Glanville)."

So now it is over to the VK3 amateur fraternity to do something about it.

## Internet Six News

**Geoff GJ4ICD** in his *Internet Six News* provides the following:

From 10/7/97 radio amateurs of Ukraine can use the 6 m band (50.080-50.280 MHz), 10 watts out, CW and SSB only, exception is for areas with TV Ch1 broadcasting. There are more than 14,000 amateur stations in Ukraine and it is good ground for future high activity.

After a quiet period, on 9/7 a dramatic increase of X-ray flux levels occurred. 10/7 saw the best Es of the year with an opening most of the day to VE/W on 50 MHz. VO1ZA/b was heard for over four hours in Europe. W1/2/3 and VE were still being worked at 1630.

There was also an opening at 1200 on 144 MHz from G/GJ to LY/SM0/3/4/5. We are trying to plot 1996 against 1997 X-ray and other characteristics which we now have access to on the Internet and will bring you more news later. ... de GJ4ICD.

**Ken SM7CMV** reported that on 10/7 there were 38 countries into Sweden on one day - rather unusual for him with "normal" equipment (20 watts to 5 el). The countries were: YM7PA, I, LZ, Z3, OE, SV, YU, DL, ISO, 9H, HB9, EH, OK, OM, 9A, S5, YO, ER, YL, ES, PA, F, G, GW, GJ, GM, GI, SP; OH, VE, W; LA, TF, ON, OZ, OY, SM.

12/7: **Doug VE1PZ** had 51 contacts with 15 countries in Europe. They were HB9, F, I, OE, S5, OZ, SP, SM, DL, OK, CT, CT3, G, GJ and CU, between 1110 and 1419.

17/7: **WAI0UB** reports that this season so far has produced 111 transatlantic QSOs with the longest to YU1EU at 4355 miles.

29/7: **Neil G0JHC** provides the following F2 Cycle news: "My first F2 QSO (not TE/ES link-up) of Cycle 22 came on 11 December 1988, at month 28 of the cycle. According to NOAA Cycle 23 began May 1996, month 28 takes us to August next year (1998), allowing for month 28 occurring in the summer time. The autumn/fall of 1998 might just see the first signs of things picking up? However, Cycle 22 did start with a smoothed sunspot number of 12.2, whereas Cycle 23 started at 8.1, the last smoothed SSN data (December 1996) was 10.6, still somewhat behind the start figure for Cycle 22. I have no idea if the experts read anything into SSN cycle start figures being directly proportional to cycle peaks, does anyone else know?"

## DXCC via Es/Tropo on 50 MHz?

Could it ever be completed? **Neil G0JHC** pointed out some interesting statistics on 50

MHz. During the past ten years he has worked a total of 89 countries via Es. This does not include any stations further south than 5T5, so TEP/Es modes can be ruled out.

**Geoff GJ4ICD** looked into what had actually been worked in Europe/GJ including the ones he worked and missed over the past ten years and came out with the following data via Es/Tropo.

"In Europe, 63 countries, nine countries in Asia, nine countries in Africa, (none lower than 5T5), 13 countries in the USA/Caribbean, and one country in South America, a total of 95 Countries via Es/Tropo only. Add to this JW/CY9/5A which have been worked in Europe via Es now brings the total to 98, add 4U1UN which would be easy if QRV in the summer months and CO2 which should also be easy to work and there it is! DXCC via Es/Tropo in Europe. It can be done!"

31/7: **Will AA6DD** in his interview on *Ham Radio & More* concluded that he has current proof that Cycle 23 will be a bumper cycle! Will has examined cycles going back and found a pattern between them; we hope to bring you this exciting news later.

Massive 144 MHz tropo opening: On 7/7 W6s in California started to report the KH6 beacon in Hawaii; later in the day many W6s actually worked KH6 on the band, followed by an opening on 432 MHz!

**Ted Collins G4UPS** during June noted reception of 24 beacons and four keyers.

From his location, the first contact "across the pond" was on 11 June to VE1PZ. Ted had Es contacts on every day in June. His log record occupies 11 A4 pages of closely written text! His operating day begins from as early as 0530 (his local time which, for the purposes of this report, is the same as if VK stations commenced at the same time), and concludes as late as 2140 on some days. A very long day indeed. The reward of course is the working of 40 or more countries during the month.

Ted's log makes fascinating reading. I wish I had the space to show readers the dedication he gives to the band and the meticulous details that he keeps of each day's activities.

## From the USA

**Emil Pocock W3EP** writing in *The World Above 50 MHz* for September QST, notes the following regarding 50 MHz transatlantic contacts: "Perhaps we have been spoiled the past three years. In 1994, 1995, and 1996, there were an average of 13 days with sporadic-E propagation to Europe from the US and Canada during June. Even during the 14 years from 1980 to 1993, there were at least two or three such openings reported each June. This year, there was not a single 6

metre contact from the US to Europe during the month!

"There were some tantalising indications though. Six-metre operators from the Maritimes into the Carolinas (including VE1PZ, VE9AA, KITOL, WAI0UB, WIRA, W3EP/1, W3BO, WB4WTC, and others) heard Spanish 48.25 MHz TV video on many mornings. On a few rare days, video was accompanied by other encouraging signs, such as the VO1ZA and CU3URA beacons. WAI0UB heard a Spanish 6 metre beacon briefly on June 6. That was it for the month from the US!

"Conditions were somewhat more favourable from Nova Scotia. Even so, VE1PZ (FN85) and VE1ZZ (FN74) made the only transatlantic contacts from mainland North America during the month. VE1PZ's initial European contact was with OK2BGW on June 8, snagged on a CQ! The best of Doug's five openings came on June 11, when he ran off 37 Europeans with very loud signals both ways. J6/W6JKV made the only other reported transatlantic contacts on June 24, 25, and 28.

"Japanese 6 metre operators continue to work the likes of BV, VR2, DU, and HL. In June, they added JD1BJP, KH2D, 9M2TO, UAOCQ and UAOZBK to their logs. T88JZ on Palau, operated by JE7RJZ, perhaps caused the most excitement. On June 1, he made nearly 900 contacts in Japan - all by two and three sporadic-E hops. The distances are equivalent to those between North America and Europe. (Thanks to JA1VOK.)"

## Closure

September is the start of the equinox and this may lead to extended contacts, particularly on six metres.

**Please note that my Fax number has changed to 08 8575 1043.**

Closing with two thoughts for the month:

1. If you pay as you go these days, you may not have enough left to get back, and
2. Maybe it is better to trust the man who is frequently in error than the one who is never in doubt.

73 from *The Voice by the Lake*.  
PO Box 169, Meningie SA 5264  
Fax: 08 8575 1043

Packet: VKSLP@VK5WI.#ADL.#SA.AUS.OC  
E-mail: vk5lp@ozemail.com.au

ar

**Amateur radio  
- helping our  
community**

---

---

## Silent Keys

Due to space demands obituaries should be no longer than 200 words.

---

---

L W (LEN)	ADAMS	L20485
E E	HAYLES	VK2AHY
S J (STAN)	PARR	VK2ASP
R	BURTON	VK2EJE
J I (JEANETTE)	WILEY	VK2EJW
B	FALKENBERG	VK3FA
R (BOB)	WILSON	VK4IT
D E	WILTON	VK5KDW
E C	MACHIN	VK6VM

### Maxwell Emanuel (Mannie) Austin VK2KZ

Mannie passed away on 13 June 1997 at age 88. He had held his amateur radio licence, certificate No 477, since February 1929.

He was born and lived in the same house in Kurri Kurri for 83 years, and this was where he spent all of his active radio days.

Mannie was a very enthusiastic radio amateur. He was zone correspondent for our amateur radio magazine and wrote several articles on improving equipment in the pre-war years. He was an executive member of the Kurri Kurri Radio club; a keen DXer who built all his own equipment, including antennas and was able to QSO every state in the USA on 10 m with a modest 25 watts; he was admired for his CW sending; he was a member of the Old Timers Club; and he received many certificates for his efforts in amateur radio.

Mannie was a good community man. He obtained his instructors certificate in 1940 with the St John Ambulance Association and received "Distinguished Service" mentions in the minutes of the NSW Executive Committee in 1952, 1960 and 1980.

He married Doris (now deceased) and had two sons, Max and Ron, who made him a proud grandfather.

With failing health, he moved to Budgewoi in 1992 to live with Max's family, but died in the Henry Kendall Nursing Home.

Farewell, Max. You were a great guy.

Bill Hall VK2XT

### Arthur Harris VK2FFH

Arthur passed away on 28 February 1997 just a short time before the commencement of the Friday night Fishers Ghost ARC weekly 80 metre net. He was a life member of the Fishers Ghost club and the Friday night net was probably the one Arthur was best known for. He often used the phonetics Freddie Fishers Helper for his call sign.

Most of us will best remember Arthur as one of our first contacts on the 80 metre band where he welcomed us to the air waves and

guided us through the protocol of working awards and how to conduct ourselves on nets generally. He was a mentor to many of us and his warm and friendly manner in helping us as newcomers was the very basis of his character.

Most nights of the week Arthur could be found between 3.550 and 3.625 MHz on one or other of the regular weekly nets. Frequently he would venture up the band to

---

---

## Update

---

---

### Intermodulation Performance and Measurement of Intermodulation Components

(Published in the August 1997 issue of Amateur Radio magazine, commencing on page 6)

In Fig 6 - Circuit diagram (simplified version) of the VK5BR 50 ohm attenuator, the strap between the two sections of the switch bank was inadvertently omitted (see Fig 1 for the amended circuit part).

Also, although the formula shown in Fig 11, and in the text near the bottom of column two on page 12, is correct, expressed as a percentage it should have included a multiplying factor of 100, eg % Intermod =  $100(a-b)/2(a+b)$ .

### Simple Peak-Reading Watt-Meter

(Published in the August 1997 issue of Amateur Radio magazine, commencing on page 13)

The PEP formula near the foot of column two on page 13 should have showed that the  $(V_p * 0.707)$  part of the formula was squared, eg:

$$PEP = (V_p * 0.707)^2 / 50 = 64 \text{ watts.}$$

3.677 MHz to join his many ZL friends on the New Zealand Counties Net. He was an avid award chaser and was quite proud of the numerous folders he had containing award certificates.

On behalf of all his many friends in amateur radio may I say how grateful we are to have had Arthur as a friend and colleague and one who we now sincerely miss as a result of his passing. To Bidy and her family we extend our sincere condolences. May he rest in peace.

Kevin Mulcahy VK2CE  
Port Macquarie NSW.  
ar

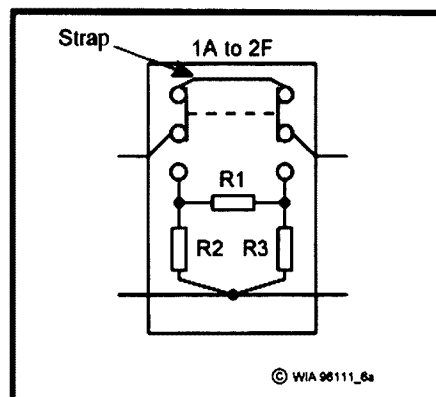


Fig 1 - Amended switch circuit for Fig 6 on page 9 of August 1997 Amateur Radio.

### Novice Notes

(Published in the August 1997 issue of Amateur Radio magazine, commencing on page 39)

The second of the diagrams appearing on page 40 and labelled "Fig 3a" should be "Fig 2b".

It might be a good idea to make the above corrections to your copy of the August 1997 issue of Amateur Radio NOW!

ar

## Remember to leave a three second break between overs when using a repeater

## Ham Astronaut Calls Houston After Space Prang

Astronaut Mike Foale KB5UAC, aboard the Russian MIR space station when it had a mishap during docking practice in late June, spoke to fellow American astronauts at the Johnson Space Centre in Houston, Texas, within hours of the event using the amateur radio station on board MIR.

Foale spoke to astronauts at the Johnson Space Centre ham radio station, W5RRR. The room was packed, according to fellow astronaut and amateur, Matt Bordelon. He said ninety per cent of those in the room at the time were also ham-licensed astronauts.

As the MIR space station came over the horizon on its orbit the morning of the mishap, nobody knew if Mike Foale would come on, with power cut by half and all nonessential equipment turned off. Before they had a chance to call up to the stricken space station, Foale called them. The room heaved a collective sigh of relief, according to the report in the *ARRL Letter* issued the week after the event.

Group chairman of the Houston-based Shuttle Amateur Radio Experiment (SAREX), Roy Neal K6DUE, said that ham radio had again proved an invaluable

aid to health and welfare during a critical time.

Speaking at the world-televised NASA press briefing immediately after the MIR crisis, fellow American astronaut, Jerry Linenger KC5HBR, who had spent four months aboard the MIR space station immediately before Foale, who had replaced him, said it was premature to comment on what this latest incident may mean for MIR's future. The 11 year-old craft has already outlived by six years its anticipated five-year life.

During his stay aboard MIR earlier this year, Linenger and the Russian crew had experienced coolant system leaks, a near collision with another cargo rocket and worst of all, a fire.

Meanwhile, Foale KB5UAC has been back on the air from MIR, not only having contacts with earth-based stations, but the first spaceship-to-spaceship contact between MIR and the US shuttle Columbia on Saturday, 5 July 1997. The historic SAREX/MIREX contact happened at 1205 UTC during a "conjunction" of the two spacecraft while orbiting over the Indian Ocean, when they were only 50 nautical miles apart in space. The contact lasted less than a minute, the *ARRL Letter* for 11 July reported.

However, they repeated the feat at 1306 UTC the same day while both spacecraft were over the Pacific Ocean. On the following Tuesday, 8 July, Foale aboard MIR, had a phone patch contact with the shuttle Columbia crew for 10 minutes. Foale jokingly invited the Columbia crew to visit MIR, which they respectfully declined.

The *ARRL Letter* for 8 August noted that Mike Foale was still active on the amateur bands from MIR as he and his two Russian crew companions aboard the stricken spacecraft awaited the arrival, in early August, of two cosmonauts to help repair the ship. He was using 145.985 simplex over the US and 145.200/800 MHz split elsewhere. Packet operation was curtailed owing to a faulty TNC, which was to be replaced with the arrival of the two cosmonauts in August. Foale is scheduled to remain aboard MIR until mid-September when he will be replaced by David Wolf KC5VFP, a medical doctor.

Web surfers can keep up with MIR's progress at [www.hq.nasa.gov/office/pao/NewsRoom/today.html](http://www.hq.nasa.gov/office/pao/NewsRoom/today.html). Details on SAREX are found at [www.arrl.org/sarex](http://www.arrl.org/sarex).

[Released 12/7/97. Updated 8 August].

## Editor's Comment

*Continued from page 2*

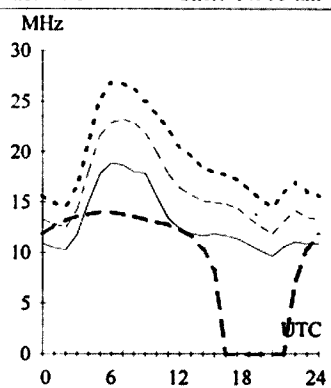
lost even though all involved take the greatest possible care. There is now a better alternative. Digital cameras have arrived and a photo can be sent on disk. If no digital camera is available perhaps a scanner can be used to digitise your print (a flat-bed scanner at 300 DPI is ideal). But now that your photo (or Hamad or whatever) is in digital form, you need not send a floppy disk! You can send it digitally by e-mail and, better than "snail mail" or fax, you get acknowledgement of receipt. The photos on pages 32 and 44 of August *Amateur Radio* were sent this way. Their resolution and greyscale are excellent. The marvels of modern technology are becoming available to all!

**Bill Rice VK3ABP**  
Editor

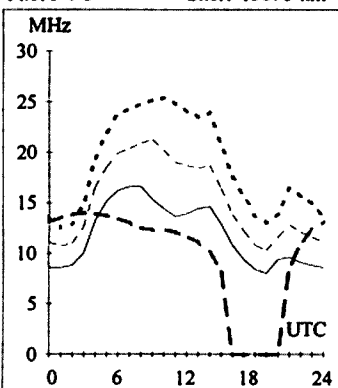
## WIA MORSE PRACTICE TRANSMISSIONS

VK2BWI	Nightly at 2000 local on 3550 kHz
VK2RCW	Continuous on 3699 kHz and 144.950 MHz 5 wpm, 8 wpm, 12 wpm
VK3COD	Nightly (weekdays) at 1030 UTC on 28.340 MHz and 147.425 MHz
VK3RCW	Continuous on 145.650 MHz, 5 wpm, 10 wpm
VK4WIT	Monday at 0930 UTC on 3535 kHz
VK4WCH	Wednesday at 1000 UTC on 3535 kHz
VK4AV	Thursday at 0930 UTC on 3535 kHz
VK4WIS	Sunday at 0930 UTC on 3535 kHz
VK5AWI	Nightly at 2030 local on 3550 kHz
VK5VF	Continuous on 145.650 MHz, 5 wpm to 12 wpm
VK6RCW	Continuous on 147.375 MHz, 3 wpm to 12 wpm
VK6WIA	Nightly (weekdays) at 2000 UTC on 3.555 MHz

**Adelaide-Budapest 305**  
First F 0-5 Short 14908 km



**Brisbane-Berlin 321**  
First F 0-5 Short 15678 km



# HF Predictions

Evan Jarman VK3ANI

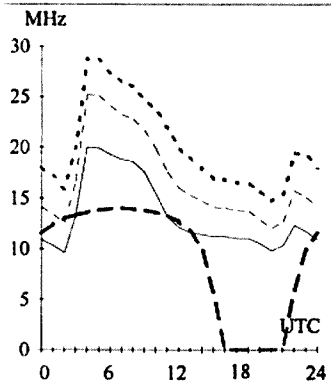
**T Index: 28**

UD
F-MUF
E-MUF
OWF
ALF

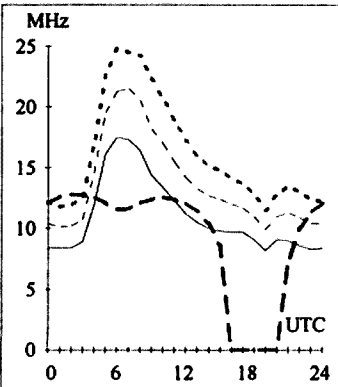
Frequency scale  
Time scale

These graphs show the predicted diurnal variation of key frequencies for the nominated circuits. This also indicates a possibility of communication (percentage). The frequencies, identified in the legend, are:-  
 Upper Decile (F-layer, 10%)  
 F-layer Maximum Useable Frequency (50%)  
 E-layer Maximum Useable Frequency  
 Optimum Working Frequency (F-layer, 90%)  
 Absorption Limiting Frequency  
 The predictions were made with the Ionospheric Prediction Service program, ASAPS V3.2. The T index used is shown above the legend. The Australian terminal azimuth, path and propagation mode are also given for each circuit.

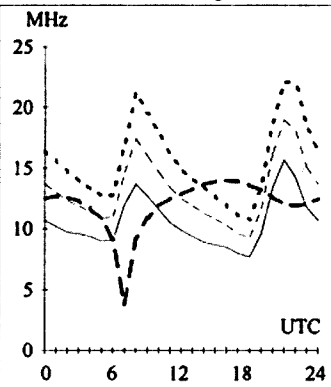
**Adelaide-Cairo 288**  
First F 0-5 Short 13332 km



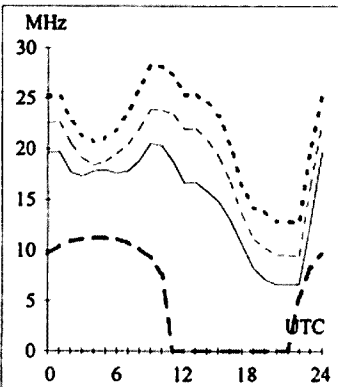
**Brisbane-Capetown 218**  
Second 4F3-5 4E0 Short 11683 km



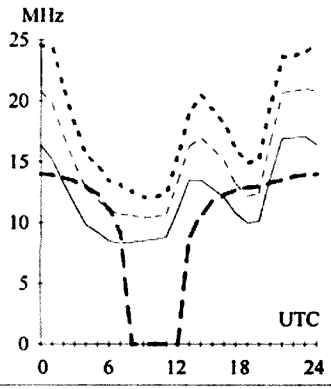
**Canberra-London 136**  
First F 0-5 Long 23042 km



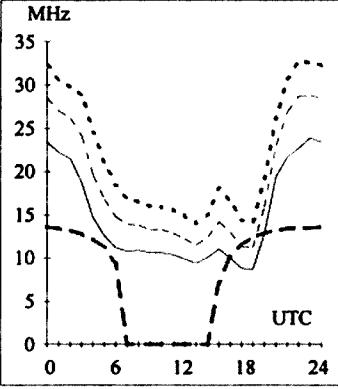
**Darwin-Bangkok 310**  
First 2F7-15 2E0 Short 4435 km



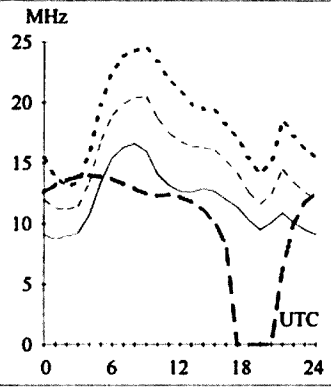
**Adelaide-Ottawa 58**  
First F 0-5 Short 16901 km



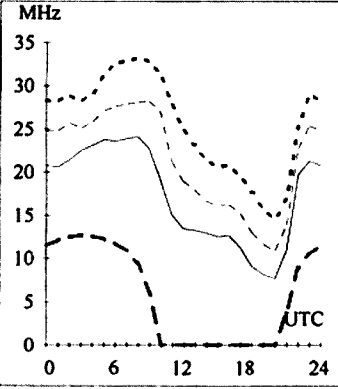
**Brisbane-Los Angeles 59**  
Second 4F3-6 4E0 Short 11563 km



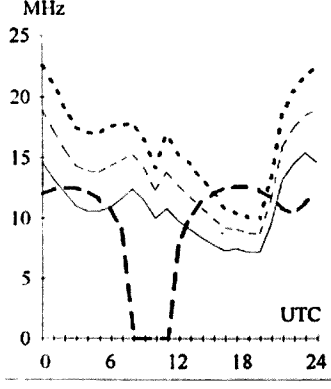
**Canberra-London 316**  
First F 0-5 Short 16982 km



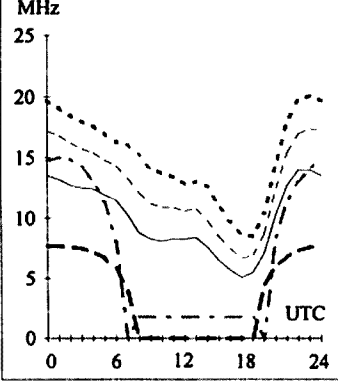
**Darwin-Osaka 5**  
First 2F4-9 2E0 Short 5263 km



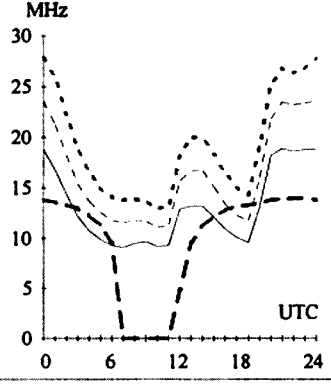
**Adelaide-Santiago 155**  
Second 4F2-4 4E0 Short 11818 km



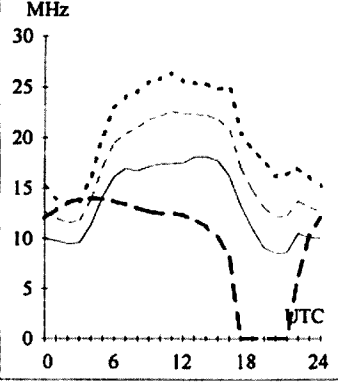
**Brisbane-Suva 74**  
Second 2F16-19 2E4 Short 2795 km



**Canberra-New York 68**  
First F 0-5 Short 16218 km

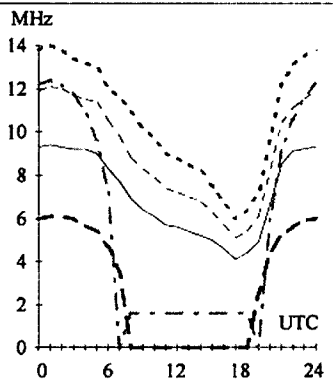
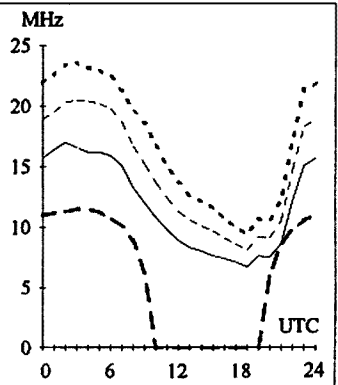
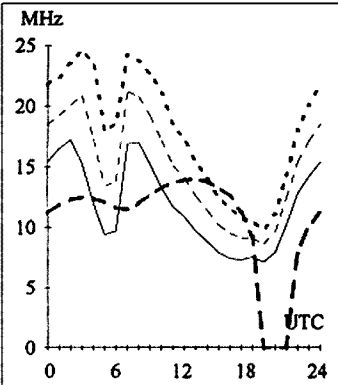
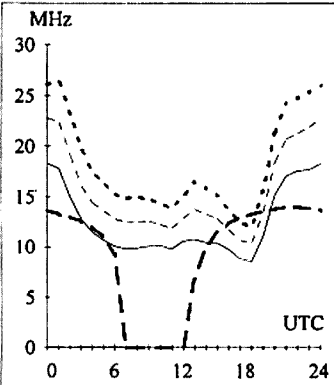


**Darwin-Paris 322**  
First F 0-5 Short 13818 km



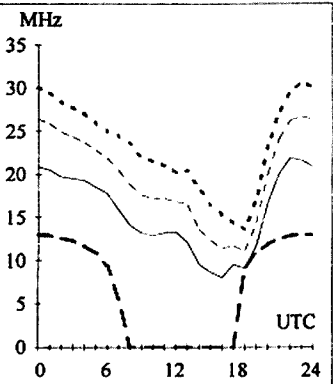
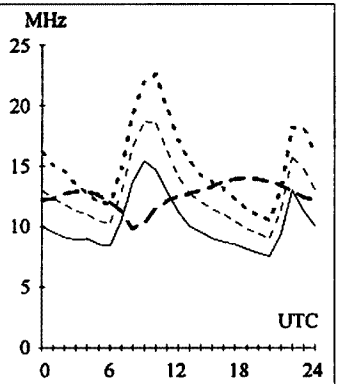
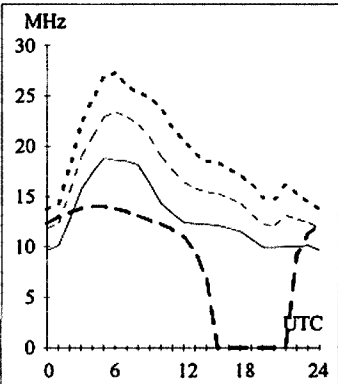
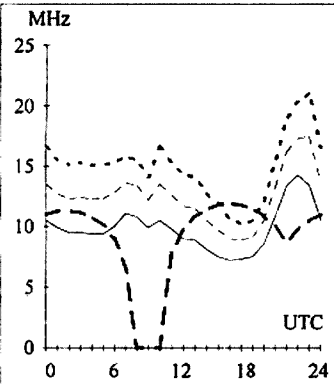
**Hobart-Chicago** 72 **Melbourne-Dakar** 219 **Perth-Christchurch** 122 **Sydney-Auckland** 106

First F 0-5 Short 15576 km First F 0-5 Short 16909 km First 2F5-8 2E0 Short 5050 km Second 2F22-27 2E7 Short 2459 km



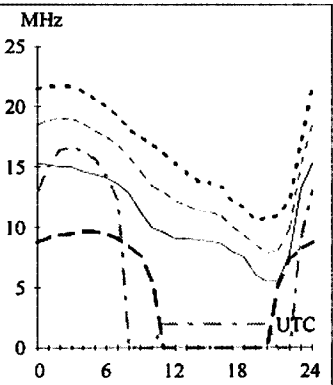
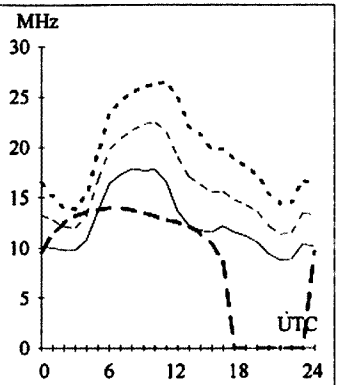
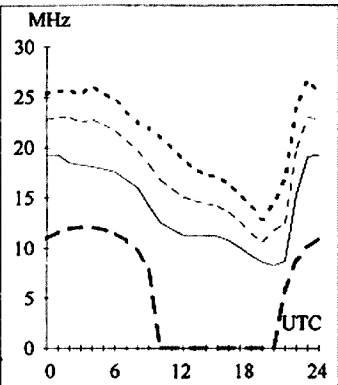
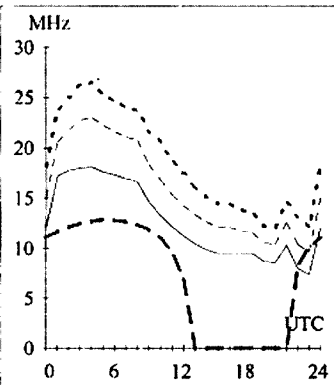
**Hobart-Montevideo** 161 **Melbourne-Moscow** 316 **Perth-London** 133 **Sydney-Honolulu** 49

Second 4F4-5 4E0 Short 11043 km First F 0-5 Short 14428 km First F 0-5 Long 25543 km First 3F3-7 3E0 Short 8169 km



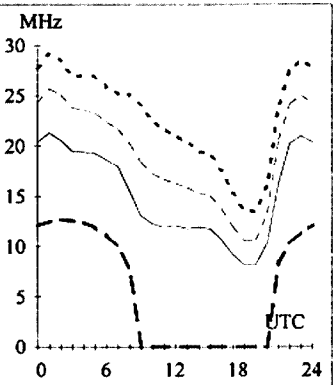
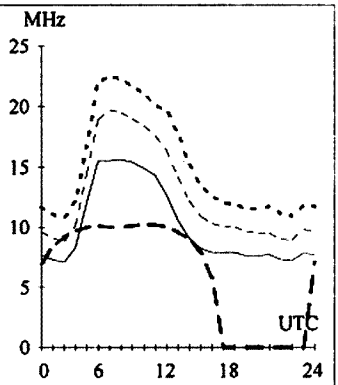
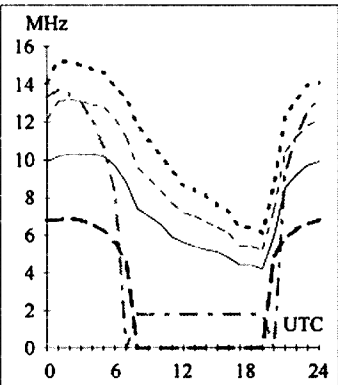
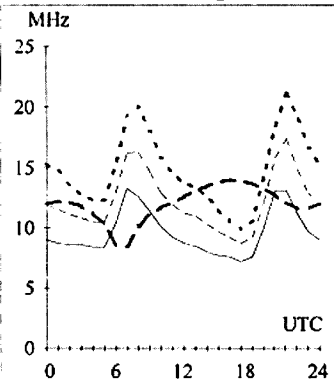
**Hobart-New Delhi** 304 **Melbourne-Taipei** 337 **Perth-London** 313 **Sydney-Jakarta** 294

Second 4F4-9 4E0 Short 10687 km Second 3F5-10 3E0 Short 7408 km First F 0-5 Short 14481 km Second 3F10-14 3E1 Short 5498 km



**Hobart-Stockholm** 136 **Melbourne-Wellington** 108 **Perth-Pretoria** 249 **Sydney-Tokyo** 350

First F 0-5 Long 23871 km Second 2F18-23 2E5 Short 2571 km Second 4F8-11 4E0 Short 8327 km Second 3F4-8 3E0 Short 7825 km



# HAMADS

- Hamads may be submitted on the form on the reverse side of the *Amateur Radio* address flysheet. Please use your latest flysheet where possible.
- Please submit separate forms for **For Sale** and **Wanted** items, and be sure to include your name, address and telephone number (including STD code) if you do not use the form on the back of the *Amateur Radio* address flysheet.
- Eight lines (forty words) per issue free to all WIA members, ninth and tenth lines for name and address. Commercial rates apply for non-members.
- Deceased estates Hamads will be published in full, even if the ad is not fully radio equipment.
- WIA policy recommends that the serial number of all equipment offered for sale should be included in the Hamad.
- QTHR means the address is correct in the current WIA Call Book.
- Ordinary Hamads from members who are deemed to be in general electronics retail and wholesale distributive trades should be certified as referring only to private articles not being re-sold for merchandising purposes.
- Commercial advertising (Trade Hamads) are pre-payable at \$25.00 for four lines (twenty words), plus \$2.25 per line (or part thereof), with a minimum charge of \$25.00. Cheques are to be made out to: WIA Hamads.
- Copy should be typed or in block letters, and be received by the deadlines shown on page 1 of each issue of *Amateur Radio*, at:

Postal: 3 Tamar Court, Mentone VIC 3194  
Fax: (03) 9584 8928  
E-mail: vk3br@c031.aone.net.au

## TRADE ADS

- **AMIDON FERROMAGNETIC CORES:** For all RF applications. Send business size SASE for data/price to RJ & US Imports, PO Box 431, Kiama NSW 2533 (no enquiries at office please ... 14 Boanyo Ave Kiama). Agencies at: Webb Electronics, Albury; Assoc TV Service, Hobart; Truscotts Electronic World, Melbourne and Mildura; Alpha Tango Products, Perth; Haven Electronics, Nowra; and WIA Equipment Supplies, Adelaide.
- **WEATHER FAX programs** for IBM XT/ATs \*\*\* "RADFAXZ" \$35.00, is a high resolution short-wave weather fax, Morse and RTTY receiving program. Suitable for CGA, EGA, VGA and Hercules cards (state which). Needs SSB HF radio and RADFAX decoder. \*\*\* "SATFAX" \$45.00, is a NOAA, Meteor and GMS weather satellite picture receiving program. Needs EGA or VGA & WEATHER FAX PC card, + 137 MHz Receiver. \*\*\* "MAXISAT" \$75.00 is similar to SATFAX but needs 2 MB of expanded memory (EMS 3.6 or 4.0) and 1024 x 768 SVGA card. All programs are on 5.25" or 3.5" disks (state which) plus documentation, add \$3.00 postage. ONLY from M Delahunty, 42 Villiers St, New Farm QLD 4005. Ph 07 358 2785.
- **HAM LOG v.3.1** - Acclaimed internationally as the best IBM logging program. Review samples....AR: "Recommend it to anyone"; The Canadian Amateur: "Beyond this reviewer's ability to do it justice. I cannot find anything to improve on. A breakthrough of computer technology". ARA: "Brilliant". Simple to use with full help, the professional HAM LOG is

immensely popular (now in its 5th year), with many useful, superb features. Just \$59 (+ \$5 P & P), with a 90 page manual. Special 5 hour Internet offer. Demos, brochures available. Robin Gandevia VK2VN, 02 369 2008 BH, fax 02 369 3069. Internet address [rhg@ozemail.com.au](mailto:rhg@ozemail.com.au).

## FOR SALE ACT

• **Amateur Radio Action magazines**, 141 issues from issue one to October 1995, any offers? **2 m collinear antenna** made in copper tube on 3 m wooden pole, \$15.00 ONO. VK1US, QTHR, 06 281 3587.

## FOR SALE NSW

- **HP ES12 Vectra 286 PC**, EGA screen, 20 Mb HDD, 4x FDDs, HP-IB Thinkjet printer, mouse, keyboard, books, 2.8 Mb RAM, \$45.00. HP original **Vectra 286 PC**, 640 k RAM, rest as above, \$45.00. John VK2WW, 02 9546 1927.
- **AKD HF3 Target SW receiver**, 30 kHz to 30 MHz, AM, USB, LSB, with PSU, as new \$250, or swap for HF ATU. David VK2XDD, AH 049 820 360.
- **Yaesu FRG100 receiver**, current model, as new, s/n 31100166, \$600. Robert VK2MAN, 066 585 169.
- **Kenwood TS-690SAT HF/50 MHz txcvr**, \$1750 ONO. **Kenwood TS-440SAT HF txcvr**, \$1400 ONO. Both Kenwoods in excellent condn with all filters and manuals. **Alinco DJF1T 2 m hand-held**, accessories, \$200. **DSP-9**, \$200. **TNC 320**, \$150. **Philips Condor 70 cm FM**, OK for 9600/1200 baud packet, \$250. **IBM computer**, excellent for packet, \$100 ONO. Frank VK2EKY, QTHR, 02 9896 5859.

- **Yaesu FT-209RH hand-held txcvr**, 140-150 MHz, 5 W output, new battery, case and YH2 headset/mic for hands-free work with VOX, VGC. \$290 the lot. Bruno VK2BPO, QTHR, 02 9713 1831.
- **Trade journals** - radio history: Philips Tech Communication 1937-55, bound 1946-52. STC Components Review 1966-73. AWA/RCA Components circ 1965. AWA Radiotronics 1959-69. Acme Components circ 1970. \$30 ONO. Useful for research historians. VK2IK, QTHR, 02 9874 8994.
- **Icom IC-271A all mode base**, 2 m, \$600. **Icom PS-15 PSU**, \$300. **Kenwood TH-78 dual band hand held**, spkr/mic, \$500. Geoff VK2GRM, 047 351 415, 018 205 387.

## FOR SALE VIC

- **Icom IC-745 HF txcvr with PSU**, VGC, \$850. Ted VK3NIZ, 03 5332 3340 (all hours).
- **Linear amplifier**, 600 watts, s/n AL81113539X, practically new, reasonable offer accepted. Antonio VK3ALA, QTHR, 03 5728 6624 (any time).
- **TET HB33M 3 el mini-beam**, 20, 15 & 10 m, good performer, owner upgrading, \$300. **MD1B8 desk microphone**, as new, suit Yaesu rigs, \$200. Peter VK3AJ, 03 9822 3783.
- **Telescopic masts**, one 30 ft and one 40 ft, guys, egg insulators, one mast with light rotator, worth \$4-500, sell \$195. Graeme VK3QS, QTHR, 03 9435 4336.
- **Yaesu FT-290R 2 m txcvr**, \$250. **Lunar Electronics 2M4-40P 2 m linear amp**, \$60. **AEA PAKRATT PK232 TNC**, c/w manuals and program, \$300. **Yaesu FLDX-2000 linear amplifier**, \$250. **Ham-M antenna rotator**, c/w control panel and 60 ft control cable, \$400. **Cushcraft ATB-34 20-15-10 m Yagi antenna**, \$300. **Hills crank-up tower**, 2 piece extends to 48 ft, c/w winch, etc, \$350. John VK3FH, QTHR, 03 5986 1592.
- **Yaesu FT-75B HF txcvr with manual**, cradle and **FV107 VFO**. **NEC CQ-110E txcvr with manual**, spare boards and tubes. Both rigs need service. Accept reasonable offer. Max VK3GMM, QTHR, 03 5985 2671.
- Deceased estate. **Icom IC-45A 70 cm**, \$345. **Kenwood DFC-230 controller**, \$150. **Tokyo 70 cm linear amplifier**, \$100. **AT computer complete with monitor**, 2x FDDs, HDD, ergonomic multi P desk with packet software, \$145 complete. **Marconi TF2300A deviation meter**, \$525. **Marconi TF995B5 signal generator**, \$275. All items can be viewed at WIA Victorian Division office. 03 9885 9261.
- **80 m ARDF sniffer kits**, VK3MZ design, features xtal filter and "whoopie" mode. For details contact Mark VK3JMD, AH 03 9558 2959.
- **House for sale at Frankston South**, two bedrooms, well maintained, ducted heating air conditioning throughout, land 800 m<sup>2</sup>, two street entrances, ideal for ham, including Nally tower, TH6DXX. Council approved three unit site. VK3CLV, 03 9787 4915.



• Yaesu FT-101E HF txcvr incl CW filter, \$300. Yaesu FL-2100Z linear amplifier, \$700. 144 MHz linear amplifier, 30 W, \$80. Ken VK3DQW, 03 5251 2557.

### FOR SALE QLD

• AWA RT85 VHF mobile txcvr, 25 watt, 64 channels programmed with popular simplex, repeater and packet frequencies, c/w mic, I/C cable, remote head and cradle, \$130. Will reprogram to your frequencies, add \$30. Avometer Model 8, meter good condn, case F/C, no leads, \$45 ONO. QB3-300 valves (sim 4-125), new in cartons, \$25 each. Malcolm VK4ZMM, QTHR, 07 3298 5454.

• Kenwood TS-120S with mobile mount, \$450 ONO. R Elliott VK1IAN, Ashmore QLD, 04 18937 468.

• Yaesu FL-7000 solid state HF amp, four button switchable model, SSB, RTTY, etc, comes with Yaesu FAS-1-HR remote antenna switch, fully tested and in original condition, hams only! Dennis VK4SX, 071 515 041, e-mail dennis.edey@b130.aone.net.au

• Kenwood TS-430S txcvr, s/n 4071773, selling for estate of Jack VK8ZL/4, all functions 100%, DC lead, mic, extremely clean, operators manual and circuits, \$700. Donald VK4GP, QTHR, 07 3408 2763.

### FOR SALE SA

• Brother HR-10 daisywheel printer, works well, VGC, suit packet station, \$30 ONO. Maestro 9600XR fax/data modem, \$30 ONO. Hank VK5NCA, 08 8272 7435.

• Drake L4B linear amplifier, ticks over at legal limit, controls measure to 3000 watts, never again miss DX, covers 10-80 m, value \$4000, sell \$1950. Several 3000 V working filter capacitors up to 100 mfd, sell \$1.50 per mfd. "Whisper" cooling fans, new, offers wanted. Two stereo speakers in resonant baffle boxes, cross-over networks, handle up to half kW of stereo audio, freq 20-20000 Hz, 4 inch flush panel meters, total of ten speakers, value \$400 each, sell \$295. VK5DC, QTHR, 08 8431 4194.

• Prime Focus 2.76 m dish, as new, solid spun heavy duty aluminium, with heavy duty, hot dipped polar mount and tripod, all mounted on a heavy duty tandem trailer with stabilisers, ideal for tropospheric work, best offer. Bob VK5UL (ex VK5BJA), QTHR, 08 8362 2251 (BH), 08 8267 5859 (AH).

• 8 el log periodic antenna, "must sell", \$450 negotiable. Also antennas and bits and pieces. Paul VK5MAP, QTHR, phone/fax 08 8651 2398.

### FOR SALE WA

• Yaesu FT-707 HF mobile/base txcvr, 80 thru 10 m inc WARC bands, s/n OH020981, good condn, \$650 ONO. Geoff VK6NPN, 099 491 934.

• Racal RA-17-C12 receiver, restored, great performance and appearance, complete with MA-197C pre-selector, and RA-121B & RA-98B ISB adapters, offers or swap. Looking for good Hammarlund SP-600, Collins 51J4, etc. Bring a strong lad to carry the Racal gear! John VK6XJ, QTHR, 08 9295 3333, fax 08 9295 3535.

• Yaesu FT-290RH 2 m hand-held, 10 memories, scanning, etc, s/n 360200, \$200 ONO. Kenwood TH-27A 2 m hand-held, Rx 136-170 MHz, 40 memories, compact unit, s/n 30200950, \$300 ONO. Chris VK6KCH, 08 9354 8826, e-mail vk6kch@amsat.org.

• ATN log periodic antenna, 13 to 54 MHz

inclusive, 12 el, unused due to Council problems, less than half price at \$800 or swap for good 12 V txcvr, or what-have-you. Don Peterkin VK6DJP, 08 9458 3449.

### FOR SALE TAS

• Kenwood TS-690S, ATU, manual, original packaging, s/n 30800239, deceased estate, VGC, make a reasonable offer. Bryan VK7ZBE, 03 6424 3685.

### WANTED NSW

• Short-wave or communications receiver, PLL type with memories, capable of receiving all VNG frequencies 2500, 5000, 8638, 12984 and 16000 kHz AM. Peter VK2BEU, 02 9872 3381 (AH).

### WANTED VIC

• Eddystone EC-10 receiver, clean, good condn, reasonable price. Ken VK3JIL, QTHR, 03 9580 5347.

### WANTED QLD

• ECH42 valve, Realistic DX-160 receiver circuit diagram. VK4AXM, 07 3287 5655.

• 1296 MHz converter. John VK4TL, 070 968 328.

• Kenwood RD-300 dummy load. Kenwood ATU. Aubrey VK4HBA, QTHR, 07 3410 0004.

• Books and/or circuits for: Metrix 920C signal generator; Leader LSW250 sweep generator; Mullard E7555/2 VTVM. Connectors for General radio equipment, in particular for type 1215-B and 1602-B UHF admittance meter. Will pay all costs. Malcolm VK4ZMM, QTHR, 07 3298 5454.

• R1155 receiver, any condn, for restoration, appreciate parts or circuits, etc. Howard, VK4NX, QTHR, 07 5546 7916, 0418 710 599.

### WANTED SA

• Philips valve colour TV, probable model X25K, probably purchased from H C Robinson, Queenstown. VK5ZST, QTHR, 08 8520 2988.

• Yaesu FT-726. Valve communications receiver, eg Eddystone, Collins, etc. High voltage relays suitable for switching open wire feeder coil, any operating voltage OK. David VK5AXW, 08 8370 1066 (BH), 08 8370 9569 (AH).

• Kenwood TS-430S FM board. Hank VK5JAZ, 08 8272 7435.

• Yaesu SP-102 external speaker, as used on Yaesu FT-102 and FT-726R. Kevin VK5BCB, 08 8725 9248 (AH), fax 08 8723 9350 (24 h), e-mail vk5bcb@seol.net.au

• Photocopy of Micronta multimeter model 22-202B operators instructions, all costs refunded. Paul VK5MAP, QTHR, phone/fax 08 8651 2398.

### WANTED WA

• 3-500Z tube socket, must be Eimac SK-410 or equivalent. Henry, 08 9478 1993 (phone/fax), e-mail henryt@perth.dialix.oz.au.

### WANTED TAS

• Philips 828 modification kit sourcing details to provide frequency synthesis. Advert appeared in *Amateur Radio* and answered, but nothing heard. Has anyone bought? How does it perform? Thought to be VK3 origin. Several VK7s would like to make use of such facility. Incurred costs covered. Rod VK7TRF, QTHR, 03 6227 8925.

### MISCELLANEOUS

• The WIA QSL Collection (now Federal) requires QSLs. All types welcome, especially rare DX pictorial cards, special issue. Please contact the Hon Curator, Ken Matchett VK3TL, 4 Sunrise Hill Road, Montrose VIC 3765, tel 03 9728 5350.

## ■ An Amateur and His Station



**Frank Murdzia VK2EKY and his neat, compact amateur station.**

*(An Amateur and His Station is an intermittently published segment. We are always looking for photos for this segment, preferably colour or black and white prints.)*

# WIA Divisions

The WIA consists of seven autonomous State Divisions. Each member of the WIA is a member of a Division, usually in their residential State or Territory, and each Division looks after amateur radio affairs within its area.

Division	Address	Officers	Call Signs	Weekly News Broadcasts	1997 Fees
VK1	ACT Division GPO Box 600 Canberra ACT 2601	President Hugh Blomings Secretary John Woolner Treasurer Les Davey	VK1YYZ VK1ET VK1LD	3.570 MHz LSB, 146.950 MHz FM each Sunday evening commencing at 8.00 pm local time. The broadcast text is available on packet, on Internet <a href="http://www.amsat.org.au/aus.radio.amateur.misc">aus.radio.amateur.misc</a> newsgroup, and on the VK1 Home Page <a href="http://www.vk1.wia.ampr.org">http://www.vk1.wia.ampr.org</a>	(F) \$72.00 (G) (S) \$58.00 (X) \$44.00
VK2	NSW Division 109 Wigram St Parramatta NSW (PO Box 1066 Parramatta 2124) Phone 02 9689 2417 Free call 1800 817 644 Fax 02 9633 1525	President Geoff McGrorey-Clark Secretary Eric Fossey Treasurer Eric Van De Weyer (Office hours Mon-Fri 11.00-14.00)	VK2EO VK2EFY VK2KUR	From VK2WI 1.845, 3.595, 7.146*, 10.125, 14.160, 24.950, 28.320, 29.120, 52.120, 52.525, 144.150, 147.000, 438.525, 1281.750 (* morning only) with relays to some of 18.120, 21.170, 584.750 ATV sound. Many country regions relay on 2 m or 70 cm repeaters. Sunday 1000 and 1930. Highlights included in VK2AWX Newcastle news, Monday 1930 on 3.593 plus 10 m, 2 m, 70 cm, 23 cm. The broadcast text is available on the Internet newsgroup <a href="http://www.amsat.org.au/aus.radio.amateur.misc">aus.radio.amateur.misc</a> , and on packet radio.	(F) \$69.00 (G) (S) \$56.00 (X) \$41.00
VK3	Victorian Division 40G Victory Boulevard Ashburton VIC 3147 Phone 03 9885 9261 Fax 03 9885 9298	President Jim Linton Secretary Barry Wilton Treasurer Rob Hailey (Office hours Tue & Thur 0830-1530) Web: <a href="http://www.tbasa.com.au/~waviac/">http://www.tbasa.com.au/~waviac/</a>	VK3PC VK3XV VK3JNC	VK3BWI broadcasts on the 1st Sunday of the month, starts 10.30 am. Primary frequencies 3.615 LSB, 7.085 LSB, and FM(R)s VK3RML 146.700, VK3RMM 147.250, VK3RWG 147.225(X) and 70 cm FM(R)s VK3ROU 438.225, and VK3RMU 438.075. Major news under call VK3WI on Victorian packet BBS and WIA VIC Web Site.	(F) \$75.00 (G) (S) \$61.00 (X) \$47.00
VK4	Queensland Division GPO Box 638 Brisbane QLD 4001 Phone 074 96 4714	President Rodger Bingham Secretary Malcolm McIntosh Treasurer Bill Sebbens e-mail address: <a href="mailto:wiaq@brisbane.dialix.com.au">wiaq@brisbane.dialix.com.au</a>	VK4HD VK4ZMM VK4XZ	1.825 MHz SSB, 3.605 MHz SSB, 7.118 MHz SSB, 14.342 MHz SSB, 28.400 MHz SSB, 29.220 MHz FM, 52.525 MHz FM, 146.700 MHz FM, 147.000 MHz FM, 438.525 MHz (Brisbane only), regional VHF/UHF repeaters at 0900 hrs Sunday. Repeated on 3.605 MHz SSB & 147.000 MHz FM, regional VHF/UHF repeaters at 1930 hrs EAST Monday. Broadcast news in text form on packet under WIAQ@VKNET.	(F) \$74.00 (G) (S) \$60.00 (X) \$46.00
VK5	South Australian Division 34 West Thebarton Rd Thebarton SA 5031 (GPO Box 1234 Adelaide SA 5001) Phone 08 8352 3428 Fax 08 8264 0463	President Ian Hunt Secretary Graham Wiseman Treasurer Joe Burford Web: <a href="http://www.vk5wia.ampr.org/">http://www.vk5wia.ampr.org/</a>	VK5QX VK5EU VK5UJ	1927 kHz AM, 3.550 MHz LSB, 7.095 AM, 14.175 USB, 28.470 USB, 53.100 FM, 147.000 FM Adelaide, 146.700 FM Mid North, 146.800 FM Mildura, 146.825 FM Barossa Valley, 146.900 FM South East, 146.925 FM Central North, 147.825 FM Gawler, 438.425 FM Barossa Valley, 438.475 FM Adelaide North, ATV Ch 35 579.250 Adelaide. (NT) 3.555 USB, 7.065 USB, 10.125 USB, 146.700 FM, 0900 hrs Sunday. 3.585 MHz and 146.675 MHz FM Adelaide, 1930 hrs Monday.	(F) \$75.00 (G) (S) \$61.00 (X) \$47.00
VK6	West Australian Division PO Box 10 West Perth WA 6872 Phone 09 351 8873	President Wally Howse Secretary Christine Bastin Treasurer Bruce Hediand-Thomas Web: <a href="http://www.faroc.com.au/~vk6wia">http://www.faroc.com.au/~vk6wia</a>	VK6KZ VK6ZLZ VK6OO	146.700 FM(R) Perth, at 0930 hrs Sunday, relayed on 1.825, 3.560, 7.075, 14.116, 14.175, 21.185, 29.680 FM, 50.150 and 438.525 MHz. Country relays 3.582, 147.350(R) Busselton and 146.900(R) Mt William (Bunbury). Broadcast repeated on 146.700 at 1900 hrs Sunday, relayed on 1.865, 3.563 and 438.525 MHz; country relays on 146.350 and 146.900 MHz.	(F) \$62.00 (G) (S) \$50.00 (X) \$34.00
VK7	Tasmanian Division PO Box 271 Riverside TAS 7250 Phone 03 6327 2096 Fax 03 6327 1738	President Ron Churcher Secretary Barry Hill Treasurer Mike Jenner	VK7RN VK7BE VK7FB	146.700 MHz FM (VK7RHT) at 0930 hrs Sunday relayed on 147.000 (VK7RAA), 146.725 (VK7RNE), 146.625 (VK7RMD), 3.570, 7.090, 14.130, 52.100, 144.150 (Hobart) Repeated Tues 3.590 at 1930 hrs.	(F) \$74.00 (G) (S) \$60.00 (X) \$46.00
VK8	(Northern Territory is part of the VK5 Division and relays broadcasts from VK5 as shown received on 14 or 28 MHz).			Membership Grades Full (F) Pension (G) Needy (G) Student (S) Non receipt of AR (X)	Three-year membership available to (F) (G) (X) grades at fee x 3 times

Note: All times are local. All frequencies MHz.

## ADVERTISERS' INDEX

Amateur Transceiver Radio _____	11	WIA Recruitment _____	15
Andrews Communication Systems _____	3	WIA Membership Retention _____	5
Daycom _____	IFC		
Dick Smith Electronics _____	28, 29, IBC	<b>Trade Hamads</b>	
ICOM _____	OBC, 41	M Delahunty _____	54
Radio and Communications _____	39	RJ & US Imports _____	54
Terlin Aerials _____	43	HAMLOG - VK2VN _____	54

### TRADE PRACTICES ACT

It is impossible for us to ensure the advertisements submitted for publication comply with the Trade Practices Act 1974. Therefore, advertisers and advertising agents will appreciate the absolute need for themselves to ensure that the provisions of the Act are complied with strictly.

### VICTORIAN CONSUMER AFFAIRS ACT

All advertisers are advised that advertisements containing only a PO Box number as the address cannot be accepted without the addition of the business address of the box-holder or seller of the goods.

# Yaesu's Done It Again



## FT-920 HF/6m Transceiver With DSP

Now there's no excuse for not taking advantage of the latest advances in Digital Signal Processing, transceiver design plus the fun of 6m operation. The stunning new Yaesu FT-920 is a high performance HF/6m multi-mode receiver that provides 100W PEP output on the 160-6m bands, incredible front-end performance based on the FT-1000MP design, and a huge array of features that make it a pleasure to use.

At first glance Yaesu's renowned Omni-Glow LCD screen is obvious, and its wide-angle view provides a wealth of information about the transceiver's operating status with multi-function metering, dual frequency displays and an Enhanced Tuning scale for DSP bandwidth, CW tuning, FM discriminator and more. Inside, the FT-920 is built around a rugged diecast unibody chassis which provides excellent heatsinking for the low distortion dual MRF255 160-6m FET power amplifier.

For more comfortable operating when weaker signals are present Yaesu's engineers dedicated themselves to enhancement of real-world signal to noise ratios, and after thousands of hours of design and testing have produced an industry-leading 33.3MIPS (millions of instructions per second) processing speed DSP in the FT-920 that provides a two-parameter noise reduction system with 32 steps of front panel adjustment. This amazing system also provides dual control DSP passband tuning, DSP auto-notch filter, an amazing new transmit Digital Speech Processor, DSP mic

equalisation, fast acting DSP VOX circuitry as well as a Contest-ready Digital Voice Recorder!

Other features include an all-band (160-6m) auto antenna tuner which also provides greater receiver band-pass protection, Direct Digital Synthesis for clean local oscillators, selectable frequency-optimised receiver front-end pre-amps, and a Shuttle Jog tuning ring for fast QSY. A Dual Watch receive system allows you to check for band openings, especially handy when monitoring 6m. Also provided are SSB/CW/FM operation (AM with optional filter), 127 memories with alphanumeric labelling, IF shift and IF noise blanker to fight interference, plus an extensive menu system for selecting most "set and forget" functions.

The FT-920 is supplied with an MH-31B8 hand mic, DC power lead and comprehensive instruction manual.

Why not call for a copy of the Yaesu 6 page FT-920 colour brochure to learn more about this efficient transceiver that's without peer in its price class.

D 3420



# \$2995

**2 YEAR WARRANTY**

DICK SMITH  
ELECTRONICS  
direct link

Phone, Fax and Mail Orders - 1300 366 644 (Local Call)  
or Fax: (02) 9395 1155 or visit us on the Internet  
at [www.dse.com.au](http://www.dse.com.au)

B 3050 col  
**DICK SMITH**  
ELECTRONICS

Serious Performance For Every Amateur

**ICOM**  
Clearly Ahead

**THE ICOM AMATEUR RANGE** Delivering true professional features and performance to the world of amateur radio... that's what keeps Icom clearly ahead. From our dual band handheld IC-T7A, with amazing performance from such a small package... to our all mode transceivers led by the flagship of the range, the IC-756, with its array of features such as multi-function full dot LCD, and newly designed IF DSP. With Icom performance we'll take your operating experience to remarkable new levels.



For more information see your nearest Icom Dealer, or call free on 1800 338 915, or write to: Icom Australia Pty. Ltd. 290-294 Albert Street, Brunswick, Victoria 3056. Ph (03) 9387 0666 Fax (03) 9387 0022 A.C.N. 006 092 575

L.L. BROWN 6/97

# Amateur Radio

October 1997

Volume 65 No 10



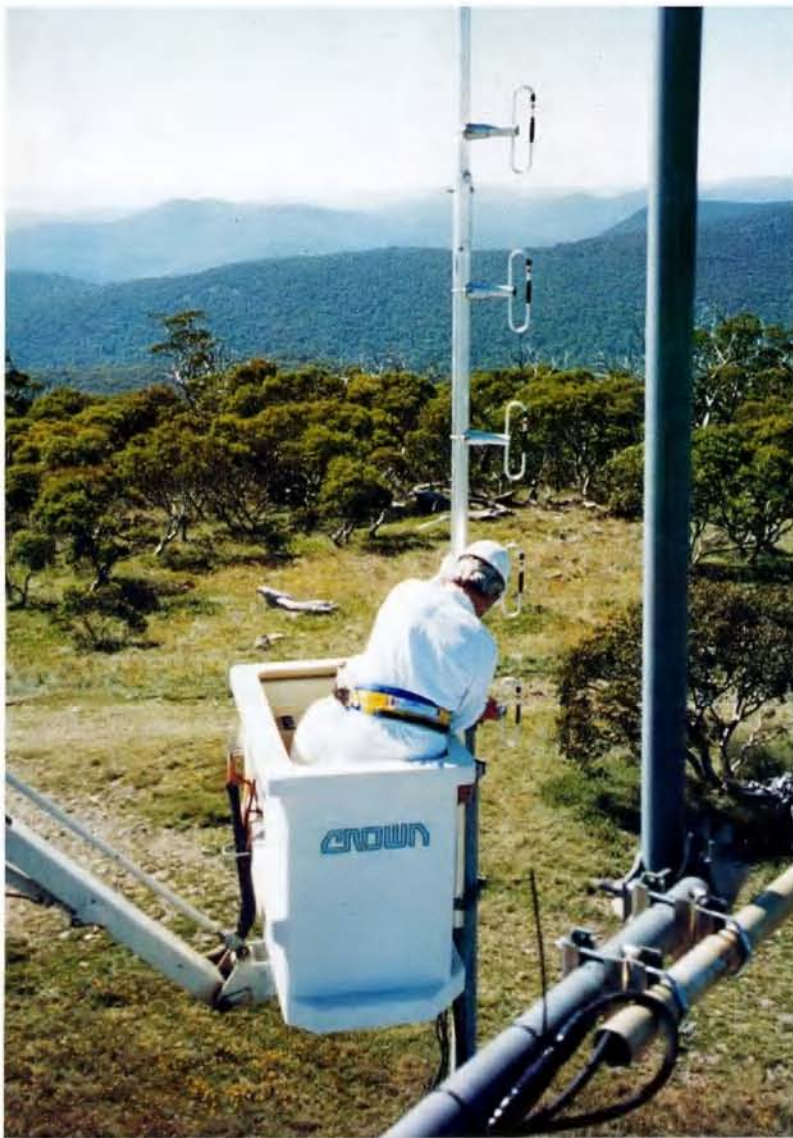
*Journal of the Wireless Institute of Australia*

## IN THIS ISSUE:

- \* A Home-Brew HF Balun
- \* Receive SSB on Your Shortwave AM Radio
- \* Parallel Resistance Formula & Chart
- \* Producing an Amateur News Broadcast

## Plus

*lots of amateur radio news, information, other articles and special interest columns.*



## MFJ

### Performance you can afford!



**MFJ1278B** Multimode data controller, 10 modes including Pactor, AMTOR, RTTY, Packet, CW, SSTV, FAX and more. Latest version with enhanced mailbox. **MFJ1278B \$599**



**MFJ1276** Packet and PACTOR controller for HF/VHF Packet and HF PACTOR. Best value PACTOR around! **MFJ1276 \$349**



**MFJ1270C** The latest version of this popular VHF packet controller. 32K enhanced mailbox supplied. Best value packet on the market today! **MFJ1270C \$229**



**MFJ1214PC** for FAX, WeFax, RTTY, ASCII and CW. Receive only or transmit operation possible. Supplied with all necessary IBM-PC software, works with any HF receiver. **MFJ1214PC \$299**

### MFJ784 DSP signal processor



Automatically eliminates heterodynes, reduces noise and interference on SSB, AM, CW packet, AMTOR, PACTOR, RTTY, SSTV, WEFAX and FAX as well as weak signal EME and VHF signals.

**MFJ784** DSP signal processor **\$499**

### MFJ Antenna Tuners

MFJ901B	200W Versatuner	\$149
MFJ910	Mobile antenna matcher	\$45
MFJ921	2 mtr 300W tuner	\$155
MFJ924	70 cm 300W tuner	\$155
MFJ931	Artificial ground tuner	\$169
MFJ941E	300W compact GP tuner	\$230
MFJ945E	300W mobile tuner	\$209
MFJ948	Deluxe 300W (no D/L)	\$270
MFJ949E	Deluxe 300W	\$299
MFJ962C	1.5kW tapped inductor	\$525
MFJ969	300W Roller inductor <b>NEW</b>	\$360
MFJ971	200W Portable tuner	\$190



**MFJ986** 3kW Diff-T roller inductor \$629  
**MFJ989C** 3kW Deluxe roller inductor \$735

### MFJ969 NEW 300W tuner



Another MFJ innovation! Here at last is an economical 300W rated antenna tuner with the matching performance of a roller inductor. And even better still, it works all the way through 6 metres. Here is an all new tuner based firmly in the MFJ tradition of performance and value.

- Frequency range: 1.8-54MHz, all HF bands + 6m
- Huge low loss roller inductor
- Flexible antenna switching
- Built-in 300W dummy load
- Peak or average power reading on crossed needle SWR/Power meter
- Optional rear illumination of meter

**\$360**

# hy-gain

## HyGain DX77

### Advanced Vertical Windom

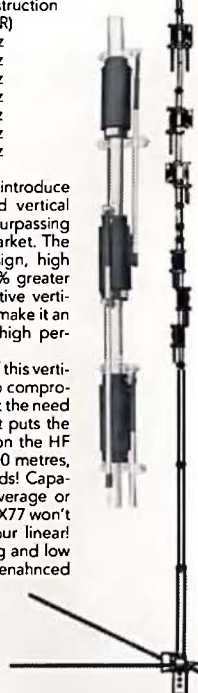
- n 7 Band Vertical
- n 10-12-15-17-20-30-40 metres
- n No ground radials required
- n Tilt mount
- n Height: 29 feet
- n Power: 1.5kW
- n Industrial grade construction
- n Bandwidth (<2:1 SWR)
  - 10 metres 1.7MHz
  - 12 metres 100kHz
  - 15 metres 500kHz
  - 17 metres 100kHz
  - 20 metres 250kHz
  - 30 metres 100kHz
  - 40 metres 150kHz

Dayom and HyGain introduce the DX77 Advanced vertical Windom with features surpassing any HF vertical on the market. The superior mechanical design, high power capability and 55% greater bandwidth than competitive verticals on 20 and 40 metres make it an exceptional value for a high performance system.

The unique design of this vertical antenna provides a no compromise performance without the need for ground radial wires. It puts the world at your fingertips on the HF ham bands, 10 through 40 metres, including the WARC bands! Capable of handling 750W average or 1500W PEP the HyGain DX77 won't balk at the output of your linear! Automatic band-switching and low angle of radiation allow for enhanced DX performance.

in stock now at

**\$875**



# OPTOELECTRONICS XPLORER Test Receiver

All the information, in one hand!

In one convenient handfull the amazing new Optoelectronics XPLORER Test Receiver not only finds signals for you, but it will tell you frequency and deviation as well as decoding sub-audible and DTMF tones. Sweeping the range 30 to 2000MHz in less than 1 second the Xplorer will lock on to any signal in the nearfield and demodulate the FM audio for monitoring. You also see frequency on the LCD display along with other information about the signal.

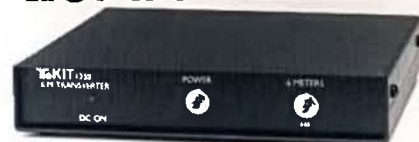
- Frequency range: 30MHz - 2GHz
- FM Deviation range: 100kHz
- Audio frequency response: 50 - 3000Hz
- Auto sweep time: <1 second 30-2000MHz
- Internal speaker, headphone jack, tape control jack, serial interface connector, rotary encoder & flexible push button panel.
- Easy to read LCD display with EL backlighting
- Internal 7.2V 850mAh NiCd battery
- Rapid charging (<1hr) with intelligent charging controller
- NMEA-0183 interface for GPS receiver

**XPLORER Test Receiver \$1700**



# TKIT

## The NEW Heathkit!



Help reclaim this fascinating band! Six metres is the VHF DX band and even now offers regular overseas contacts with just a little effort. The TT1208 kit is the ideal, low cost way, to get going on 6 metres and find out what only the elite have known for years!

- Requires 3-5W input on 20 metres
- Extremely simple hookup and operation
- Sensitive, low noise 50-54MHz front end
- Fast, silent PIN diode TR switch for QSK & data
- 8W output on 6 metres
- Requires 12-15V DC 3A power supply
- Simple switching between HF and 6 metres
- Rugged steel case

**TT1208 8W 6 metre transverter \$199**

# Amateur Radio



## Journal of the Wireless Institute of Australia

Vol 65 No 10

ISSN 0002-6859

October 1997

### CONTENTS

Amateur Radio is published by the Wireless Institute of Australia, ACN 004 920 745 as its Official Journal, on the last Friday of each month.

#### Editorial

##### Editor

Bill Rice VK3ABP\*

##### Production Manager

Bill Roper VK3BR

##### Senior Technical Editor

Peter Gibson VK3AZL\*

##### Technical Editors

Evan Jarman VK3ANI\*

Gil Sones VK3AU1\*

Don Graham VK6HK

##### Contributing Editor

Ron Fisher VK3OM\*

Don Jackson VK3DBB\*

##### WIA News Editor

Roger Harrison VK2ZRH

##### Proof Readers

Allan Doble VK3AMD

Jim Payne VK3AZT

Graham Thornton VK3IY

John Tutton VK3ZC

\*Publications Committee member

#### Production

##### Administration, Advertising, Drafting,

##### Production

vk3br Communications Pty Ltd

3 Tamar Court, Mentone VIC 3194

##### Typesetting and Printing

Industrial Printing and Publishing Pty Ltd

122 Dover Street, Richmond, VIC 3121.

##### Mail Distribution

Mail Management Australia Pty Ltd

6 Garden Boulevard, Dingley VIC 3172

##### Now Advertising

Eyvonne & Keith Tootell

Union Publicity Service Pty Ltd

PO Box 282, Toongabbie NSW 2146

Telephone: 1800 654 181 - 02 9831 1299

Fax: 02 9831 6161

##### Amateur Radio Correspondence

All contributions, correspondence, Hamads and queries concerning the content of

Amateur Radio should be sent to:

Amateur Radio

vk3br Communications Pty Ltd

3 Tamar Court, Mentone VIC 3194

E-mail: vk3br@c031.aone.net.au

Phone and Fax: 03 9584 8928

Mobile: 0418 534 168

Business Hours: 9.30 am to 3.00 pm weekdays

##### Amateur Radio Delivery

All correspondence and queries

concerning the delivery of

Amateur Radio should be sent to:

Amateur Radio

WIA Federal Office

PO Box 2175

Caulfield Junction VIC 3161

Registered Office:

3/105 Hawthorn Road

Caulfield North VIC 3161

Telephone: 03 9528 5962

Fax: 03 9523 8191

Business Hours: 9.30 am to 3.00 pm weekdays

##### Editorial and Hamads Deadlines

November 13/10/97

December 10/11/97

January 01/12/97

##### Receipt of Amateur Radio by Mail

The November issue will be delivered to Australia Post on Tuesday, 4 November 1997 for mailing to members.

If this magazine is not received by the 15th of the month of issue, and you are a financial member of the WIA, please check with the Post Office before contacting the registered office of the WIA.©

© Wireless Institute of Australia 1997

#### Technical

A Home-brew HF Balun \_\_\_\_\_ 5

*Drew Diamond VK3XU*

Receive SSB on Your Shortwave AM Radio \_\_\_\_\_ 8

*Peter Parker VK1PK*

Parallel Resistance (Formula and Chart) \_\_\_\_\_ 11

*Paul Clutter VK2SPC*

Technical Abstracts \_\_\_\_\_ 15

*Gil Sones VK3AU1*

Emotator Antenna Rotator Model 501-CXX \_\_\_\_\_ 20

*Ted Wraight VK3ALT*

#### General

Producing an Amateur News Broadcast \_\_\_\_\_ 12

*Peter Parker VK1PK*

Internet Radio Mailing Lists and How to Use Them \_\_\_\_\_ 17

*Richard Murnane VK2SKY*

#### Columns

Advertisers' Index \_\_\_\_\_ 56

ALARA \_\_\_\_\_ 21

Amateurs in Action \_\_\_\_\_ 45

AMSAT Australia \_\_\_\_\_ 22

ARDF \_\_\_\_\_ 24

Awards \_\_\_\_\_ 25

Club Corner \_\_\_\_\_ 26

Contests \_\_\_\_\_ 30

Divisional Notes

VK1 Notes \_\_\_\_\_ 32

VK2 Notes \_\_\_\_\_ 32

VK5 Notes \_\_\_\_\_ 33

VK7 Notes \_\_\_\_\_ 34

Editor's Comment \_\_\_\_\_ 2

Education Notes \_\_\_\_\_ 35

Hamads \_\_\_\_\_ 54

HF Predictions \_\_\_\_\_ 52

How's DX? \_\_\_\_\_ 35

Intruder Watch \_\_\_\_\_ 38

Morse Practice Transmissions \_\_\_\_\_ 55

Novice Notes \_\_\_\_\_ 39

Over To You \_\_\_\_\_ 41

Pounding Brass \_\_\_\_\_ 44

QSP News \_\_\_\_\_ 10, 51

Repeater Link \_\_\_\_\_ 42

Silent Keys \_\_\_\_\_ 50

Spotlight on SWLing \_\_\_\_\_ 43

Update \_\_\_\_\_ 49

VHF/UHF - An Expanding World \_\_\_\_\_ 45

VK QSL Bureaux \_\_\_\_\_ 21

What's New \_\_\_\_\_ 48

WIA News \_\_\_\_\_ 3, 11

WIA - Divisional Directory \_\_\_\_\_ 56

WIA - Federal Directory \_\_\_\_\_ 2

WICEN \_\_\_\_\_ 49

#### Cover

Gil VK1GH and Paul VK1BX (partially hidden) were part of a VK1 Division team who recently erected a high quality broadband UHF dipole array on Mt Ginini in the Brindabella Mountains on the western edge of the ACT. This elevated site is subject to severe winds and ice build-up in winter; regular failure of most antennas is common. The new antenna is an RFS model SU1-4C, a flexible broadband 400-520 MHz eight dipole array, and all the 70 cm amateur services at Mt Ginini are coupled to this single unit.

#### BACK ISSUES

Available direct from the WIA Federal Office, only until stocks are exhausted, at \$4.00 each (including postage within Australia) to members.

#### PHOTOSTAT COPIES

When back issues are no longer available, photocopies of articles are available to members at \$2.50 each (plus \$2.00 for each additional issue in which the article appears).

The opinions expressed in this publication do not necessarily reflect the official view of the WIA, and the WIA cannot be held responsible for incorrect information published.

## Amateur Radio Service

A radiocommunication service for the purpose of self-training, intercommunication and technical investigation carried out by amateurs, that is, by duly authorised persons interested in radio technique solely with a personal aim and without pecuniary interest.

## Wireless Institute of Australia

The world's first and oldest National Radio Society  
Founded 1910

Representing the Australian Amateur Radio Service -  
Member of the International Amateur Radio Union  
Registered Federal office of the WIA:  
3/105 Hawthorn Rd, Caulfield North, Vic 3161

All Mail to:

PO Box 2175, Caulfield Junction, VIC 3161  
Telephone: 03 9528 5962 Fax: 03 9523 8191

Business Hours: 9.30 am to 3.00 pm on weekdays

Federal Secretary  
Peter Naish VK2BPN

### FEDERAL OFFICE STAFF

June Fox	Book Keeper
Debby Johnston	Membership Secretary
Rita Trebilco VK3NRT	Examinations Officer

### COUNCIL

President	Neil Penfold	VK6NE
VK1 Federal Councillor	Richard Jenkins	VK1RJ
VK2 Federal Councillor	Michael Corbin	VK2YC
VK3 Federal Councillor	Brenda Edmonds	VK3KT
VK4 Federal Councillor	Ross Marren	VK4AMJ
VK5 Federal Councillor	Ian Watson	VK5KIA
VK6 Federal Councillor	Wally Howse	VK6KZ
VK7 Federal Councillor	Andrew Dixon	VK7GL

### EXECUTIVE

Peter Naish	VK2BPN
Rowland Bruce	VK5OU
Neil Penfold	VK6NE

### FEDERAL CO-ORDINATORS

AMSAT:	Graham Ratcliff	VK5AGR
ARDF	Wally Watkins	VK4DO
Awards:	John Kelleher	VK3DP
Contests:	Peter Nesbit	VK3APN
Education:	Brenda Edmonds	VK3KT
EMC and Standards	Roger Harrison	VK2ZRH
FTAC:	John Martin	VK3KWA
Historian:	John Edmonds	VK3AFU
IARU:	David Wardlaw	VK3ADW
Int'l Beacon Co-ord:	Roger Harrison	VK2ZRH
Intruder Watch:	Gordon Loveday	VK4KAL
ITU Conference and Study Group:	David Wardlaw	VK3ADW
Media:	Roger Harrison	VK2ZRH
QSL Manager (VK9, VK0):	Neil Penfold	VK6NE
Radio Sports:	Wally Watkins	VK4DO
Videotapes:	Bob Godfrey	VK4BOB
WICEN:		

### SMA LIAISON TEAM

Roger Harrison	VK2ZRH
David Wardlaw	VK3ADW
Neil Penfold	VK6NE

# Editor's Comment

## What is Time?

This topic was raised by several recent items. Firstly there was the excellent review article by Paul Clutter VK2SPC in September *Amateur Radio*, more on the subject of time measurement than time itself.

Then there was the awareness of a deadline fast approaching and an editorial still unwritten! To add to this, a feature article in the week-end newspapers discussed a new theory of the origin of the Universe, involving time as well as space contracting to near zero before the next "Big Bang". And due to happen rather sooner, the "Millennium Bug" which is going to foul up all our computers!

Finally there was a plea from our Production Manager for us to reach agreement about how we should specify dates.

Time is the common factor in all these topics. Once simply believed to be smooth progression, second by second, minute by minute and so on to year by year, century by century.

"Time, like an ever-rolling stream, bears all its sons away", as the 1719 hymn by Isaac Watts puts it, incidentally ignoring the daughters! But now modern physics has envisaged elastic time, along with curved space; fortunately being of little immediate relevance to those of us who don't explore the galaxies at the speed of light!

How about the Millennium Bug? I am not one of the computer "cognoscenti", but from what I can deduce from conversation with people who know more than I (almost everyone!), it will be unavoidable except by total software update, and time (that word again!) is running out. Its biggest impact will be in financial circles still operating with outdated systems on vast volumes of information. Almost certainly, there will not be sufficient experts available to put everything right before 31 December 1999. As the clock ticks over to 1 January 2000, many outdated systems will interpret the change from 99 to 00 as a regression to 1900. Think of the implications of 100 years negative interest on your term deposit, etc!

Continued on page 51

### CONTRIBUTIONS TO AMATEUR RADIO

*Amateur Radio* is a forum for WIA members' amateur radio technical experiments, experiences, opinions and news. Manuscripts with drawings and/or photos are always welcome and will be considered for possible publication. Articles on computer disk or via e-mail are especially welcome. The WIA cannot assume responsibility for loss or damage to any material. A pamphlet, "How to Write for *Amateur Radio*", is available from vk3br Communications Pty Ltd on receipt of a stamped, self addressed envelope.



## ■ WIA News

Roger Harrison VK2ZRH, Federal Media Liaison Officer

# Australian Amateurs May Need to Meet RF Emission Limit Standards

The WIA understands the Australian Communications Authority (ACA) is examining the issue of having all licensed radiocommunications users meet radio frequency emission limit standards defined in the current Australian Standard, AS 2772.

The ACA is working on the matter in conjunction with the Radiocommunications Consultative Council (RCC), on which the WIA represents the Amateur Service as a radiocommunications user group.

Australian amateurs will have to face the likelihood that we will have to eventually comply with RF exposure limits set down in the standard.

Controversy over possible health hazards relating to exposure to RF energy were thrust into prominence in Australia during 1996, and again early this year, principally over emissions from cellular mobile telephones, cellular base stations and television station transmissions linked to studies on the incidence of certain cancers in the community.

There is considerable contention over the possible connection between exposure to electromagnetic energy and the development of cancers. While studies conducted around the world over decades have yet to show a causal link between exposure to either specific or general RF emissions, the scientific community is cautioning that no one can unequivocally say that RF energy, even at comparatively low powers, does not cause cancers.

There are ongoing international research projects into the effects of non-

ionising electromagnetic radiation, coordinated under the auspices of the World Health Organisation. In late 1996, the Australian government announced funding for ongoing research support and public education on the issue, to be paid for by a 1% levy on radiocommunications licence fees. The greater proportion of the \$4.5 million allocated over three years is targeted for public education campaigns.

Standards development on non-ionising radiation in Australia has been ongoing for some years, and is continuing through a joint Australian-New Zealand standards committee. The WIA is represented on this committee by an amateur who is a qualified medical doctor (Dr Vince McKenna VK3AOY).

So, in advance of any action by the ACA, how does the 'average' amateur station measure up in regard to the limits presently set under the standard, AS 2772, without going into the technicalities of the 'specific absorption rate' of RF energy by the human body, power densities and safe exposure limits? According to Dr Andrew Corney ZL2BBJ (also a member of the joint Australian-NZ Standards committee), a 100 W HF rig running into a wire dipole or vertical in the backyard is most unlikely to generate RF fields above the limits, even a few metres from the antenna. A three-element beam driven by a 100 W PEP HF rig is probably within bounds, too, but 400 W PEP could approach or exceed limits in suburban settings. On VHF, a 10-element 2 m beam driven by a 100 W rig generates

fields just on the standard's limits 10 metres away.

Many claims made regarding the RF emission levels of, for example, cellular mobile base station towers are unsustainable by the technical facts, Dr Corney points out, but this has not dissuaded community lobby groups as can be noted by newspaper reports in recent years.

US amateurs will have to meet RF exposure limits from 1 January 1998, with the technical specifications based on American Institute of Electrical and Electronics Engineers (IEEE) standards. However, US stations meeting given power output levels on specified bands, according to a sliding scale, are 'deemed' to comply, but those with higher powers will have to comply by changing station equipment and antenna specifications or locations, according to advice from the American Radio Relay League.

The WIA is monitoring developments in the Australian situation through its presence on the Radiocommunications Consultative Council. [Released 7/9/97]

## Andrews Communication Systems

(EST. 1976 - ACN 001 968 752)

**WE WILL NOT BE UNDERSOLD  
ON ALINCO RADIOS**

- ★ IC-756 HF+6M, DSP LCD
- ★ IC-R10 HAND HELD SCANNER
- ★ WS-1000E CUTE SCANNER
- ★ DX-70TH HF+6M 100W
- ★ MFJ TUNERS AND CONTROLLERS
- ★ DX-1600 HF LINEAR AMP.
- ★ AR-5000 2.6GHz SCANNER

**3 YEAR WARRANTY ON  
OUR ALINCO RADIOS**

Call us now

**(02) 9636 9060** or (02) 9688 4301

SHOP 8, 41 BATHURST ST, GREYSTANES,  
N.S.W. 2145. FAX (02) 9688 1995

# Commemorative Sputnik on 2 m?

The 40th anniversary of the launching of the first artificial earth satellite, Sputnik 1, will be celebrated this month with the launch of a working scale model of that first satellite on 4 October 1957. The commemorative model, built by Russian and French school students, will transmit on the 2 m band.

The 58 cm diameter sphere of Sputnik 1 weighed 83 kg and carried a dual-frequency transmitter, operating on 20.005 and 40.002 MHz, powered by chemical batteries. It was launched into a low earth orbit of 947 km apogee and 228 km perigee, with an orbital period of around 96 minutes.

Secondary school students from Naltchik in Russia and the French-owned Reunion Island are building a 1:3 scale model of the original Sputnik 1, which is scheduled to be launched by

cosmonauts from the MIR space station, providing MIR's recent problems have been overcome and it will be in operation in time for the launch.

The project came about following the signing of an agreement between Russia and France last February to organise a commemoration for the 40th anniversary of the launch of the first artificial earth satellite, Sputnik 1.

The satellite's body assembly is being made by the Russian students, while the French students are making the transmitter. This will transmit on the two metre amateur band, on a frequency somewhere between 145.810 and 145.850 MHz. Power output will be around 100-200 mW. It is anticipated the commemorative satellite will be able to be heard by earth-based listeners using simple equipment. The project

organisers anticipate school children should be easily able to participate in listening to the satellite.

The student-built 4 kg satellite will be battery powered and is expected to have a lifetime of between one and two months. Cosmonauts on board MIR will launch it by hand during a scheduled space walk, so its initial orbit will be close to that of the space station.

The commemorative satellite's transmitter will emulate the "beep-beep" tone signal transmitted by Sputnik 1. The transmitter will be frequency modulated with a 1300 Hz tone, the pitch of which will vary with the satellite's temperature. Listening for the satellite and 'taking its temperature' makes an ideal school project, one of the goals of the exercise.

Details can be obtained from the Internet, at <http://www.oceanes.fr/~fr5fc/angspoutnik.html>, as well as the Amateur Satellite (AMSAT) Corporation web site at [www.amsat.org](http://www.amsat.org).

ar



## Radio and Communications

INCORPORATING AMATEUR RADIO ACTION and CR ACTION

Published by  
**ACP ACTION**,  
PO Box 119,  
Oakleigh,  
Victoria 3166  
(03) 9567 4200

Here's the all-new Yaesu FT-920. It's sort-of like a sawn-off FT-1000MP, with six metres thrown in. Take out the power supply, the second receiver and the first-generation DSP, then add six metre operation, the fantastic 33.3MIPS DSP, a digital voice recorder — and the best transmit audio we've heard in years, and you get this appealing sub-\$3K package.

Your October R&C has loads of 'must read' articles. This month's features include...

- More crazy 'fix-it' yarns from a Yaesu tech, this time concentrating on the venerable FT-757GX.
- REVIEW: Yaesu FT-920. A full-size HF plus six metre transceiver at a sawn-off price. Good stuff.
- CONSTRUCTION: Finish building your BFO, then polish off the ATU. Two separate projects...
- Radio Netherlands. An in-depth examination of a respected international broadcaster.
- Digital HF car alarm shock! Imagine great slabs of HF handed to an alarm system. It's happened!!
- As usual, we have our three DX columns, mods and more... the best stories and regulars every month!

Don't miss out — **RADIO and COMMUNICATIONS** is great reading for amateurs!  
**Check your local newsagent today!**

(PS. We also have the biggest collection of radio-oriented Classified adverts in the country. There's lots of them because they work so well. Ask your newsagent to keep a copy for you each month, or ring 1800 25 2515 for subscription details. Hurry — you might miss something!)

## ■ Antennas

# A Home-brew HF Balun

*Drew Diamond VK3XU\* details how to build an effective HF balun.*

Most transceivers are designed to operate into a nominal 50 ohm unbalanced load, connected by a length of coax cable. However, many antenna configurations, including the ubiquitous dipole, are supposed to be balanced.

An antenna such as the G5RV, or an open-wire fed dipole, would normally be fed via an ATU which, in addition to impedance matching duties, also converts the coax output/input of a transceiver to a "balanced" feed of the antenna. But, if we simply use coax cable to connect our radio to a resonant single band or trapped dipole, whose feed point hopefully presents a balanced load, we may, under some unfortunate circumstances, find that RF energy sneaks back down the outside of the coax feed and finds its way into the shack. Some of the effects can be; small but annoying tingles from station equipment, squawks and feedback when transmitting voice modes, higher than expected SWR readings or changes in SWR when different length cables are added or subtracted from the feeder length, higher than expected noise pick-up on receive, and interference to other equipment.

To convert a BALANCED load to an UNBALANCED source (in our application, a transmitter), or a balanced source (a dipole) to an unbalanced load (a receiver) the traditional approach is to use a balun.

### Operation

A fair analogy of the job that a balun must do, is the way in which a vehicle is driven. Imagine that the engine is the transmitter, the tail-shaft is our coax transmission line, and the road surface represents the balanced load. If all of the engine's output was simply applied to the road through one rear wheel, the handling of the vehicle would be unsatisfactory. Yet a solid rear axle is no solution because, on turning, the rear wheels would be required to rotate at different speeds, and any change in direction of the vehicle greatly resisted (go-karts and ride-on mowers get around the problem by "slippage").

As everyone knows, large vehicles use a differential between the tail-shaft and driving wheels. A solution in radio work, therefore, is to interpose a device, a sort of differential, which allows balanced and unbalanced circuits to be connected together with minimum power loss.

In practice, a nominally balanced antenna may be far from perfectly balanced. For instance, one end of the dipole may be closer to ground than the other, or one side may pass near a large metal object, such as an iron roof, and so on. A well-made balun, by performing the balanced to unbalanced conversion, prevents out-of-balance current from travelling down the outside of the coax

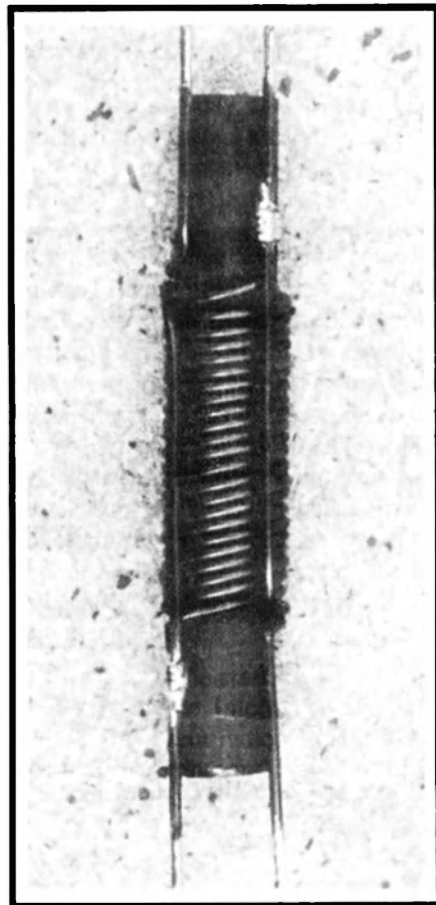


Photo 1 - The balun before potting.

feedline by effectively creating a high impedance to such longitudinal currents at the antenna/coax interface.

A device with some 1:1 "balun-like" characteristics may comprise a pair of enamelled wires about 300 mm long, whose characteristic impedance ( $Z_0$ ) approximates that of the coax and the load, wound upon a suitable ferrite rod or toroid. In practice we find that, for the system to be truly balanced, the load resistance must be grounded at its centre; the "balun" by itself cannot force a condition of balance. Oscilloscope measurements prove this.

When the load is 50 ohms, comprised

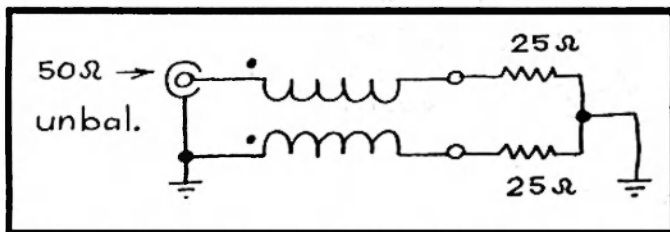


Fig 1

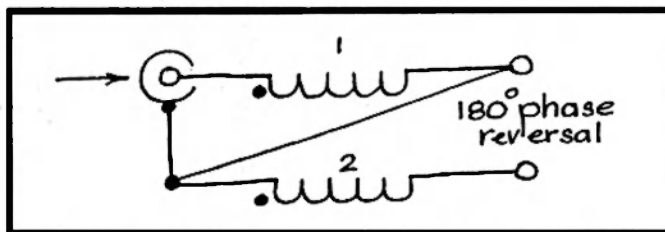
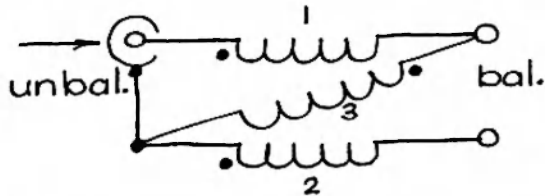


Fig 2



**Fig 3**

of two 25 ohm resistors in series with the centre connection grounded, exactly half the input voltage (applied at the coax end) appears 180 degrees apart across the ends of the total resistance (Fig 1). Now, if the load resistance is allowed to "float" by removing the ground, uncontrolled stray inductance and capacitance causes the voltage, measured at the ends of the load resistance with respect to ground, to be of different values at most frequencies

in the HF range, and to be not easily predictable. This device is therefore not a true balun. What is interesting to observe, however, is that if the device is connected as in Fig 2, we get a phase shift occurring as the signal travels along the pair. In this instance, over the 1.5 to 50 MHz range the signal leaving the pair will have been phase-shifted 180 degrees without the ferrite core, the useful range is only about 15 to 50 MHz, so the core becomes increasingly necessary as the frequency is lowered.

The beauty of the coiled "balun" of

Fig 2 is that, within limits, it will always provide a 180 degree phase shift regardless of frequency – a tremendously useful feature – and forms the basic building block for all practical wide-band baluns.

If a third winding is added and connected as shown in Fig 3, we obtain a true 1:1 balun. Although not strictly applicable to transmission line transformers, winding (or line) starts are shown with a dot. The windings have near unity coupling; that is, anything happening in one winding will intimately affect the other two, forming a triad.

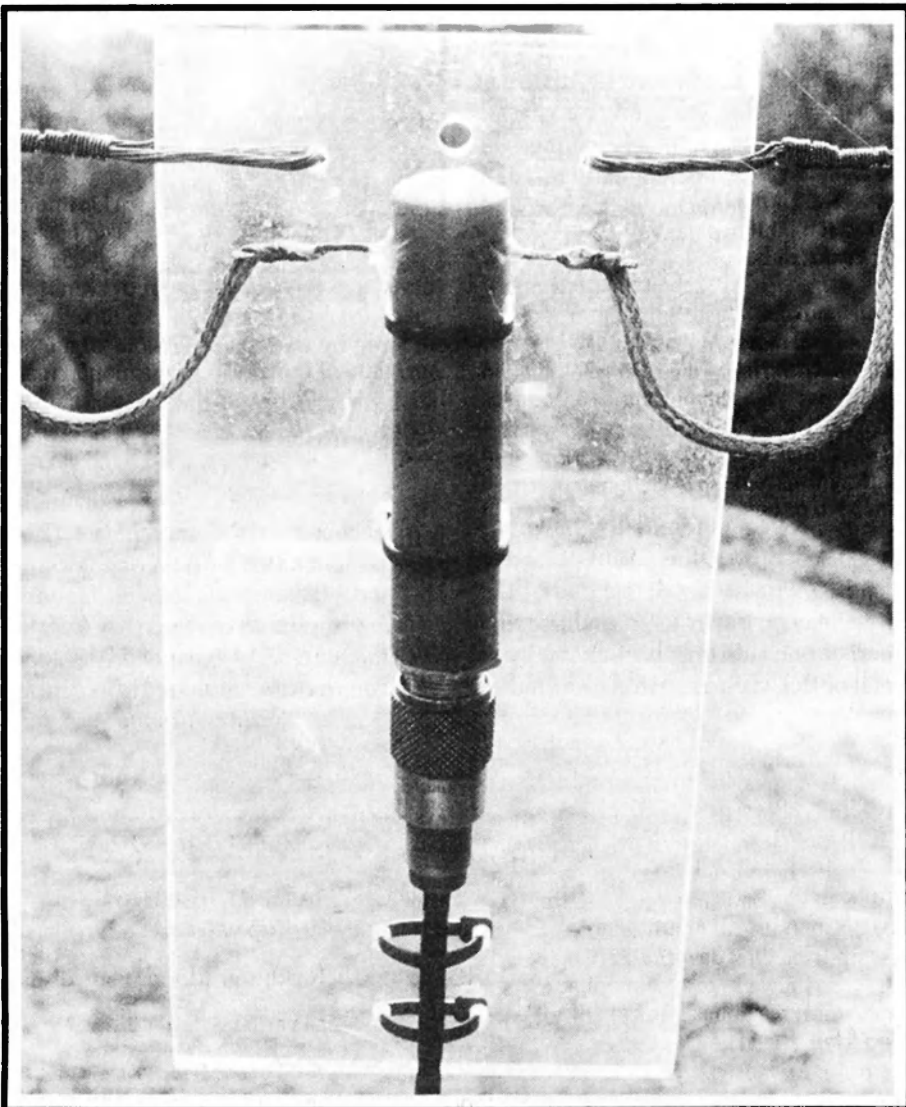
The third winding provides a path for any magnetising current necessary to maintain balance. Within reasonable limits, should any imperfection exist, either in the balun itself (stray capacitance or inductance for example) or the load (an imperfectly balanced dipole), the third winding will source or sink to and from the other two lines, with sufficient current to restore balance.

In practice, resistance, dielectric, core and radiation losses for home-made baluns are such that a transmission loss of less than 0.5 dB is typical. When a resistive 50 ohm load is connected, SWR is less than 1.1 from 3.5 to over 50 MHz, rising to about 1.2 at 1.5 MHz.

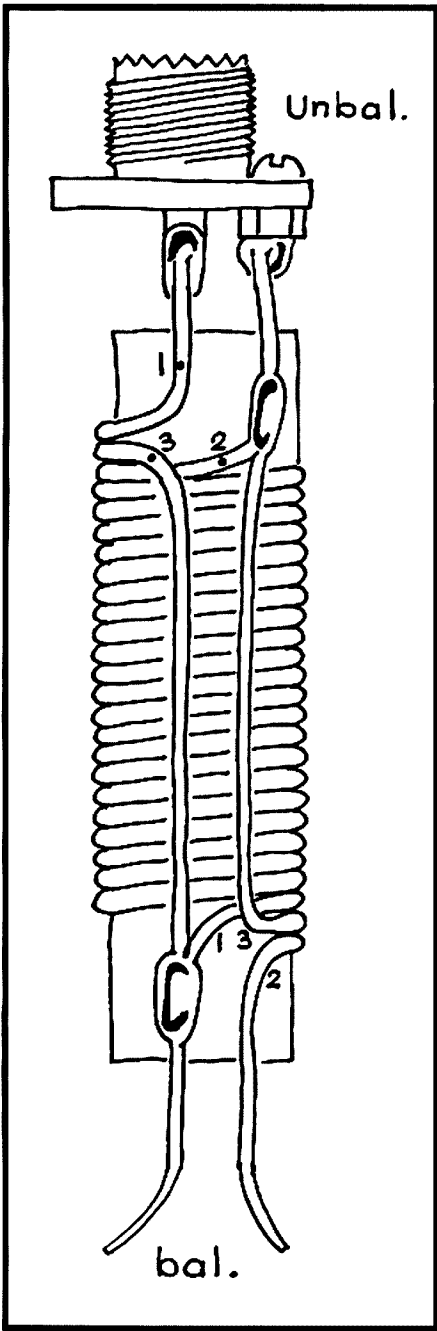
### Construction

After numerous experiments with HF baluns, using both toroidal and rod cores, twisted and side-by-side windings, it appears that the simple rod configuration with side-by-side windings, being the easiest to make, is as good as any of the more difficult toroidal patterns over the 1.8 to 50 MHz range. Furthermore, being a rod, with an open magnetic path, saturation is highly unlikely to occur at permitted Australian amateur power levels. The rod is wound with a trifilar of three enamelled copper wires of about number 16 gauge B & S (or 1.25 mm), each about 300 mm in length.

Two or three of the usual electronics suppliers have ferrite rods, or "loopsticks", intended for MW receivers. These are ideal for the application, although three times as long as needed. The rod may be cut by grinding a small v-groove around the circumference where required. Grip the rod with



**Photo 2 - The potted and mounted balun. Note the flexible connections (connector uncovered for clarity).**



**Fig 4**

thumbs each side of the groove, then snap, as you would break a stick. Round off sharp edges with emery or glasspaper. A small flat style loopstick will also serve (tested), although a stack of three or four provides a better cross-sectional form. They should be glued together, then given one or two layers of Teflon tape to soften the corners.

Any small bumps and wrinkles in the wires must be removed. Anchor one end in a vice, then grip the free end with pliers and give each wire a firm tug. Align your three straight wires together side-by-side

as a triplet, then carefully wind on seven or eight turns (total 21 or 24 "loops", see Photo 1). Connect the "windings" as shown in Fig 4.

Note that the start (dot) of the second winding is connected to the end of the third winding, and the start of the third winding is connected to the end of the first winding. The balun will not function correctly if these connections have not been strictly observed. The drawing shows the connections pictorially. The enamel may be removed by careful scraping with a sharp pen-knife or similar. Try not to nick the wire, and leave no trace of enamel where connections are required. Your balun is probably going aloft for a long time, to become one of those "forgotten" components, so make each solder connection as near perfect as you can.

Transmission loss increases alarmingly when the windings are wet, or even damp, so the balun must be "potted", or enclosed in a water-proof casing (or both). Careful measurements on back-to-back baluns potted in two-part epoxy (Araldite™) and non-acid silicone (for guttering) showed no increase in loss. Silicon is suggested, however, because it is far cheaper than epoxy, and cures more rapidly. For improved durability, the balun should be fitted inside a plastic conduit tube. The silicon, when squeezed in, must be free of any voids or bubbles.

For a long, trouble-free life of the device, coax and antenna connections must be "relieved" of any strain; do not simply connect these to the balun! A popular and effective method is to mount the balun, using plastic cable ties or similar, to a suitably sized and shaped piece of Perspex or polycarbonate sheet (Photo 2). The coax connector is optional. If used, it must be taped to prevent ingress of moisture, and the cable tied to the sheet as shown. In any event, your coax must not simply hang unsupported from the balun.

**Parts**

Loopstick ferrite rods should be available from Rod Irving Electronics

(see ads in local electronics journals) and Truscotts Electronic World {(03) 9723 3860}, who can also supply winding wire, Perspex sheet, cable ties and SO-239 (f) style connector.

**References**

There has been a lot written about baluns, in both amateur and professional journals. Some of it is very good, but a significant amount, in my humble opinion, is badly written, too reliant on mathematical theory, muddled, misleading and, in at least one instance, just plain wrong. In all my researches on this subject (and it has been exhaustive), I have to admit that not a single "intuitive" model has so far been found which satisfactorily explains the observation that conventional transformer action appears to predominate at the low end (which is easily understood, and the core is essential), and that transmission line or "directional coupler" action predominates at the high end (where the core is hardly necessary), there being a smooth transition from one mode to the other as frequency is increased. Indeed, my own feeble attempt in "Operation" above does not touch upon how the device actually works. Nevertheless, the curious are pointed to the following articles in amateur journals which, I feel, are rather good.

- 1. *High Performance Broadband Balun - Nagle; K4KJ, in Ham Radio (USA) February 1980.*
- 2. *A Balun Essay - Sevick; W2SM1, in CQ June 1993.*
- 3. *Testing Baluns - Nagle; K4KJ, in Ham Radio (USA) August 1983.*
- 4. *Balanced to Unbalanced - White; G3SEK, in Radio Communication December 1989.*

\*45 Gatters Road, Wonga Park VIC 3115

**Audio, Broadcast & Radio Values**

*New:* 4CX250B, 4CX350A, 572B, 6146B, 807...  
Ceramic Sockets, Top caps...

*Rebuilding:* 4CX10-000D, Klystrons, Magnetrons...

**Contact: Mohan or Rebecca Varkey Ph: 041 900 9115**

*Australian Electric Valve Importers Pty, Ltd.*

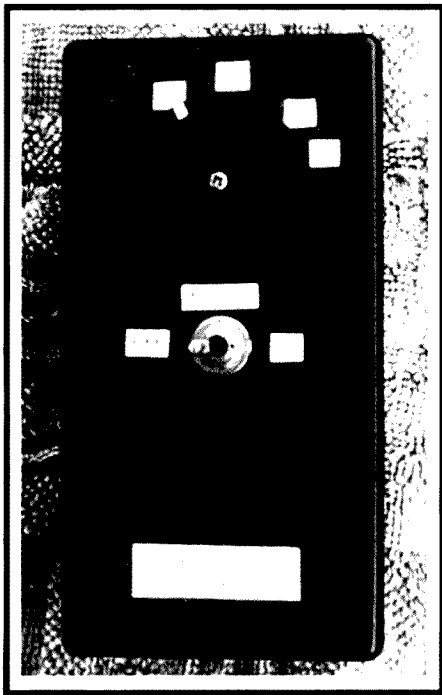
**FD** Factory 2, 22 Michellian Court, Bayswater, VIC 3153  
Mail: P.O. Box 1001, Bayswater, VIC 3153

## Receivers

# Receive SSB on Your Shortwave AM Radio

(Hear amateur activity for under \$15!)

Peter Parker VK1PK\* explains how you can listen to SSB signals on an AM radio.



Signal Frequency BFO.

**Project Level:** Beginner.

**Cost:** Very Low.

**Parts Procurement:** Easy.

### Introduction

The days when you could listen to amateurs on a simple shortwave AM receiver are with us again, thanks to the development of this one-transistor, frequency-agile signal frequency beat frequency oscillator. When teamed up with a low-cost AM set covering 3.5 and 7 MHz, this device provides effective reception of local eighty and forty metre SSB transmissions.

It is an ideal project for aspiring amateurs, as it allows them to monitor amateur activity. Its usefulness, low cost, and ease of construction would make it a

good group project for schools, radio clubs or amateur theory classes.

The device is a miniature transmitter. It provides a steady carrier signal to the receiver to replace that suppressed within the transmitter (refer to any radio theory book for a more detailed explanation). It is the ultimate in simplicity, employing but eight components. The unit costs approximately ten dollars to build from all-new parts, and requires no alignment or connections to the receiver. Anyone with basic soldering skills can construct this project, and have it working first time.

Though receivers covering the short wave bands are no longer in every home, suitable sets can be picked up cheaply at garage sales and swap meets. Tuning the medium wave and one or two short wave bands, their performance is lacking in many respects. Nevertheless, they work better than might be expected when used with this circuit. The reasons for this are given later.

### Circuit Description

This unit is a one transistor 3.5 MHz RF oscillator whose frequency can be varied (Fig 1). As mentioned before, it replaces the carrier in the receiver that was suppressed during the transmitter's SSB generation process.

A 3.58 MHz ceramic resonator sets the oscillator frequency. This two-dollar component is similar to a crystal. Its main advantage is that it can be shifted over a 100 kHz frequency range by connecting a variable capacitor in series with it. While the frequency stability is somewhat inferior to that of a crystal, it is still acceptable for stable SSB reception.

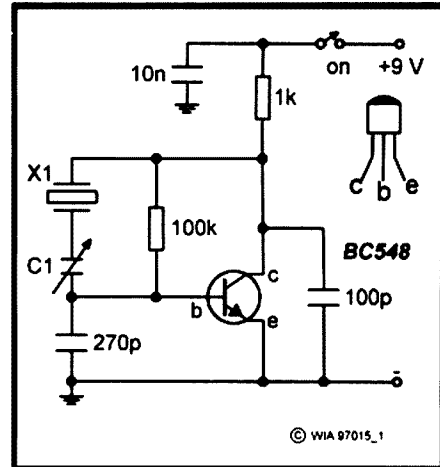


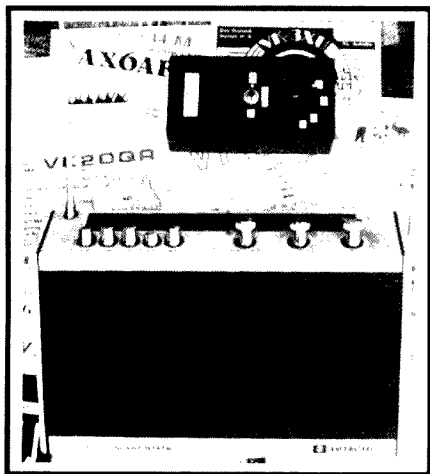
Figure 1 - Signal Frequency BFO schematic diagram. X1 is a 3.56 MHz ceramic resonator. C1 is a 60/160 pF variable capacitor with both sections connected in parallel.

Because the BFO operates directly on the received frequency, many of the limitations of low cost AM receivers (such as frequency drift, coarse frequency readout, hand-capacity and difficulty of tuning) are either eliminated or made less apparent. This is because the tuning in of SSB transmissions is effectively performed by a stable, easy to tune BFO, rather than the unstable free-running coarse-tuning local oscillator within the receiver. The latter would have been the case had a conventional 455 kHz fixed-frequency BFO been employed.

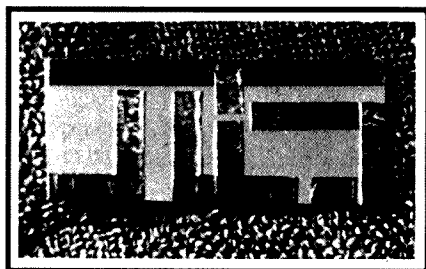
The circuit shown covers the popular 3.525 - 3.625 MHz frequency range. This permits reception of CW and SSB activity, WIA Divisional Broadcasts and Morse practice transmissions. The second harmonic of this range covers the 7.050 to 7.250 MHz segment of forty metres, while the fourth might be useable for twenty metre reception.

### Construction

Virtually any construction method may be used to assemble the BFO. However, large stray capacitances must be avoided if the full tuning coverage is to be obtained. Several prototypes were built. The one in the photos uses a conventional single-sided etched printed circuit board. However, many other techniques are quicker, simpler and work just as well.



**Signal Frequency BFO with typical AM short wave receiver.**



**Completed circuit board.**

At a certain point on the dial, the receiver will go quiet; all normal background noise will be silenced. Switching off the BFO will restore the normal band noise, while adjusting the BFO's **Tune** control will move the "silence" to a different frequency. If the BFO passes these two checks, you know that it works.

Now switch off the BFO, attach a piece of wire (preferably outdoors) to the receiver's telescopic antenna, and tune in a strong SSB signal for maximum volume. Assuming the received signal is within the BFO's tuning range, it will be possible to resolve the signal by correctly adjusting the BFO. Place the BFO near the receiver, and adjust the BFO's tune control until the receiver quietsens. Move the BFO away from the set, and adjust it carefully until the SSB signal is intelligible. Note that this setting is critical; the BFO's frequency must be equal to that of the transmitter's suppressed carrier.

While at first this process is somewhat fiddly, it becomes easier with practice. For optimum results, experiment with the physical distance between the BFO and the receiver; weaker signals require less signal from the BFO (ie a greater separation). However, it should be possible to find a compromise position for the BFO where reception from all stations is satisfactory.

### **Conclusion**

A novel device to allow the reception of amateur signals on domestic AM-only short wave receivers has been described. It is cheap, very simple to build, and can be expected to work first time. It fills a definite need amongst potential amateurs, and has the advantage of being expandable to a direct conversion receiver or CW/DSB transmitter or transceiver as interest develops.

A method used by the author is to make a circuit board from a piece of cardboard (or plastic) and 5 mm-wide self-adhesive copper foil. This copper foil is sold on rolls at stained glass craft shops. Its adhesive is strong enough to withstand the heat from a soldering iron. Pieces of this tape are placed on a piece of cardboard (see photo). Where a bend is required, use two overlapping pieces.

Components are then soldered straight to the foil; use the schematic diagram and the photo for guidance. Areas where two pieces of tape overlap are soldered over to ensure a good connection. While the pictures depict the use of a piece of plastic for the board, this is not recommended as it tends to bend under heat. Instead, a piece of fairly rigid cardboard (eg from the side of an old cardboard box) is suggested. A blob of Blutak™ or similar may be used to mount it inside the case.

Full frequency coverage will only be obtained if leads are kept short. Those to the ceramic resonator and variable capacitor are particularly critical. Whereas most RF projects are built in metal cases to provide shielding, the BFO's operation depends on there being a lack of shielding between it and the receiver. Thus either a plastic or wooden box is recommended.

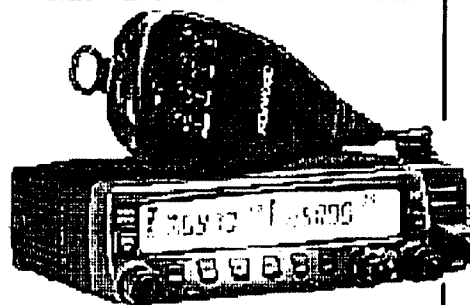
### **Testing/Operation**

To verify BFO operation, your AM short wave set is required. Position the receiver near the BFO, and tune it across the 3.5–4 or 7–8 MHz frequency range.



**YOUR HOBBY** **YOUR VOICE**  
Representing Radio Amateurs - Since 1910

# **RENEW YOUR MEMBERSHIP AND YOU COULD WIN**



## **THIS KENWOOD TM-733A 2m/70cm FM/packet rig worth \$1255**

50 W on 2m 35 W on 70cm  
Switchable 10 W/5 W RF output  
Simultaneous VHF-UHF reception  
Data Input for 1200/9600 baud packet  
70 multi-function memories

**All you have to do is renew  
your Division membership  
when it falls due**

**WHO'S ELIGIBLE? ● members  
whose renewal falls due between  
1/1/97 and 31/12/97 ● current  
members who are on a 3-year  
membership ● life members, and  
● all membership grades.**

**The prize will be awarded by means  
of a draw, the result to be  
published and the prize to be  
presented to the winner at the first  
available opportunity early in 1998.**

TM-733A prize kindly donated by  
Kenwood Electronics Australia P/L,  
PO Box 504, Homebush 2140.  
Ph: (02) 9746 1888. Fax: (02) 9746 1509.

## Obtaining ceramic resonators

The 3.58 MHz ceramic resonator used in the prototype was purchased over the counter from RS Components (catalogue no. 656-170). RS has outlets in most capital cities. The Melbourne supplier Vorlac has also advertised ceramic resonators. Note, however, that there are variations between different brands of resonator, and you may need to experiment with component values. Full details are provided in the parts list.

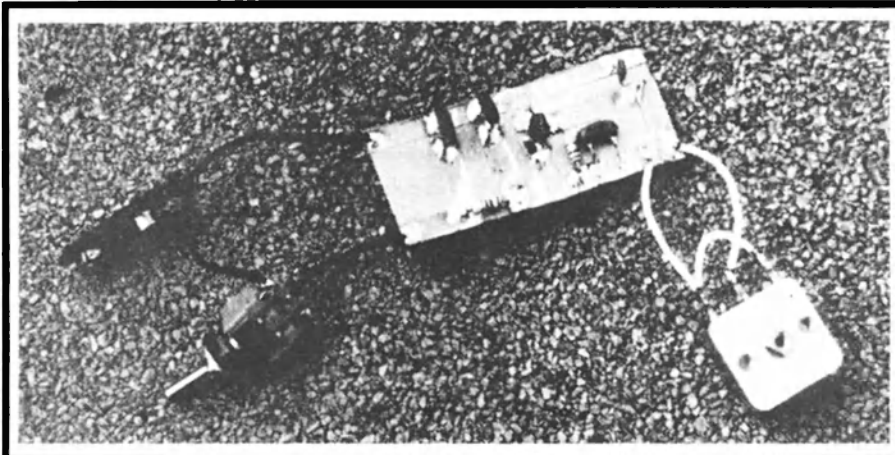
To assist those unable to obtain ceramic resonators for themselves, the author is able to supply free ceramic resonators to *Amateur Radio* readers on receipt of a stamped, self-addressed envelope sent to the address at the end of this article. Note that this offer is only valid for six months after the publication of this article, and for the first fifty people who respond.

### Parts List

- 1 1 kilohm resistor
- 1 100 kilohm resistor
- 1 100 pF disc ceramic capacitor (See Notes 1 and 2)
- 1 270 pF (or 15 pF) disc ceramic capacitor (See Notes 1 and 2)
- 1 0.01  $\mu$ F (10 nF) disc ceramic capacitor
- 1 60/160 pF transistor radio variable capacitor
- 1 3.58 MHz ceramic resonator (see shaded panel)
- 1 BC548 NPN transistor
- 1 SPST switch
- Case, wire, solder, 9 volt battery snap, etc.

### Notes:

1. These values provided a 3.525-3.625 MHz pulling range with the blue coloured ceramic resonators (as supplied by RS Components). If using one of the yellow ceramic resonators (as stocked by Vorlac), replace the 270 pF capacitor with one for 15 pF. This will provide a tuning range of about 3.550 - 3.610 MHz. Coverage down to 3.500 MHz is available by raising the value of the 15 pF capacitor. However, this will be at the expense of frequencies at the top of the range.



Completed BFO - built on a piece of plastic.

2. The use of polystyrene capacitors will improve the stability of the BFO, and would be desirable if the BFO is to be used for 20 metre reception. For the lower bands (particularly 80 metres), the

disc ceramic capacitors specified are more than stable enough.

\*7/1 Garran Place, Garran ACT 2605  
parkerp@pcug.org.au

ar

## QSP News

### JOTA Balloon Launch

The JOTA Balloon Launch is a joint venture between the Scout Radio and Electronics Service Unit (Victoria) and the Eastern and Mountain Districts Radio Club Inc.

### Change of Launch Time

The time of the Balloon Launch has been changed to provide better utilisation by the Scouts at JOTA (the 11.00 am launch would have been a bit early for many stations). This new time will also assist the re-transmission of the JOTA opening broadcast at 2.00 pm EST (04.00 hrs UTC).

The new launch time is 1.00 pm EST (03.00 hrs UTC) on Saturday, 18 October 1997.

### Slow Scan TV on board the JOTA Balloon

The Balloon will carry a Slow Scan TV Transmitter along with the other advertised payload.

Balloon slow-scan telemetry is in monochrome using the Robot 36 mode. This can be received using the public domain JV-Fax software and a fairly cheap and simple "Hamcom" interface.

The beacon frequency will be 145.700 MHz, which is the frequency of the ARDF homing beacon.

Transmission mode will be FM. Output power will be 100 mW continuous which will increase to approx one watt for the data bursts.

There will be a four-channel cross band repeater which will operate on the following frequencies at approximately 100 mW per channel:

Chan	Uplink	Downlink	Usage
1	432.900	145.300	JOTA Traffic
2	432.925	145.325	JOTA Traffic
3	432.950	145.350	JOTA Traffic
4	432.975	145.375	General Traffic

### Flight Details

The place of launch will be confirmed 24 hours before the launch and will be either the Police Paddocks near Dandenong (southerly winds), Geelong (westerly winds), or Bendigo (northerly winds).

Anticipated coverage when at peak altitude will be NSW (VK2), VIC (VK3), SA (VK5), and TAS (VK7). Line of sight coverage to sea level fiat terrain will be approximately 500 km at 20 km altitude, and 350 km at 10 km altitude. Higher sites may extend the range up to a further 2-300 km. Antenna polarisation will be vertical, and the estimated flight time is three hours.

The mode of transmission will be FM in all cases, with FM voice telemetry, 1200 baud packet, and SSTV sent once every two minutes.

Further details may be obtained from the Scout Radio Electronics Service Unit, PO Box 311, Box Hill VIC 3128, or by contacting Philip Adams on 03 9438 3013 (AH) or 03 9262 1073 (BH).



The WIA bids a warm welcome to the following new members who were entered into the WIA Membership Register during the month of August 1997:

- L10171 MR D E SCOGGINS
- L21054 MR T FAKE
- L21055 MR P R B MCRAE
- L21056 MR K ASHFORD
- L31545 MR J HAMLETT
- VK2ANN MR D W MORRIS
- VK2BTT MR P A ORCHARD
- VK2GNL MR R W SAUNDERSON
- VK2KCN MR N C CORNISH
- VK2MD MR W S IRELAND
- VK2PTK MR T K BAKER
- VK2WL MR E W BASTOW
- VK2WRP MR R F PETTIT
- VK2XFS MR B BOWLER
- VK3BAF MR J E KERR
- VK3FEN MR C P CARROLL
- VK3FHV MR J D HARRISON
- VK3HX MR W JAMIESON
- VK3WTM MR W MULDER
- VK5KMI MR J R ELLIOTT
- VK5NR MR R J DAYMAN
- VK6KRG MR R A GREEN

## Resistance

# Parallel Resistance

### (Formula and Chart)

*Paul Clutter VK2SPC\* makes it easier to find the right resistance.*

The following formula and chart will show how to obtain a desired resistance when the existing resistor is not quite the value needed or not the preferred value.

It relies on the formula for parallel resistors:

$$R_p = (R_1 \times R_2) / (R_1 + R_2)$$

where  $R_1$  = existing resistor,  $R_2$  = desired resistor, and  $R_p$  = resistance to add in parallel.

A little mathematical rearranging gives:-

$$R_1 = (R_2 \times R_p) / (R_1 - R_p)$$

where  $R_p$  is the resistance you want,  $R_1$  is the resistor you have and  $R_2$  is the resistor you need.

Say, for example, you need a 1% resistor of 100 ohms, but searching through your bins you find only a few 105 ohm (5%) resistors. By the formula:

$$105 \times 100 / 105 - 100 = 10,500 / 5 = 2100 \text{ ohms.}$$

A 2200 ohm resistor (preferred value) will give you 100.2169 ohms (within 1%) and if your bin does not produce a lower value, then a 5% over that (2310 ohms) will get you 100.434 ohms, still within 1% of 100.

\*52 Keats Avenue, Bateau Bay NSW 2261  
ar

### VK2SPC Parallel Resistor Selection Chart

	10	12	15	18	22	27	33	39	47	56	68	82	
10	5.00	10.71	13.04	15.25	18.03	21.26	24.81	28.06	31.97	35.90	40.48	45.05	100
12	5.45	6.00	13.33	15.65	18.59	22.04	25.88	29.43	33.77	38.18	43.40	48.71	120
15	6.00	6.67	7.50	16.07	19.19	22.88	27.05	30.95	35.79	40.78	46.79	53.02	150
18	6.43	7.20	8.18	9.00	19.60	23.48	27.89	32.05	37.27	42.71	49.35	56.34	180
22	6.88	7.76	8.92	9.90	11.00	24.05	28.70	33.13	38.73	44.64	51.94	59.74	220
27	7.30	8.31	9.64	10.80	12.12	13.50	29.41	34.08	40.03	46.38	54.32	62.90	270
33	7.67	8.80	10.31	11.65	13.20	14.85	16.50	34.88	41.14	47.88	56.38	65.68	330
39	7.96	9.18	10.83	12.32	14.07	15.95	17.88	19.50	41.95	48.97	57.90	67.75	390
47	8.25	9.56	11.37	13.02	14.99	17.15	19.39	21.31	23.50	50.04	59.41	69.82	470
56	8.48	9.88	11.83	13.62	15.79	18.22	20.76	22.99	25.55	28.00	60.64	71.53	560
68	8.72	10.20	12.29	14.23	16.62	19.33	22.22	24.79	27.79	30.71	34.00	73.18	680
82	8.91	10.47	12.68	14.76	17.35	20.31	23.53	26.43	29.88	33.28	37.17	41.00	

Values above diagonal use right side scale, all others use left side scale

Diagonal is from top left to bottom right

**VK2SPC parallel resistor selection chart. Pick the resistance that you require in the body of the chart. The two parallel resistors will be given by the values on the axes.**

---

## ■ News Broadcasts

# Producing an Amateur News Broadcast

*Peter Parker VK1PK\*, VK1WI's former producer, gives some tips on Divisional broadcast production.*

---

## Introduction

A good broadcast is a must for any effective WIA Division. Whether used to maintain interest in amateur radio, keeping listeners up to date with the latest developments, or raising the profile of your Division, a broadcast plays a key role in disseminating information.

More immediate, more frequent and cheaper to produce than a newsletter, a weekly broadcast gives WIA Divisions a facility not enjoyed by most other voluntary organisations. With its broad audience, a well-produced bulletin can be an effective advocate for amateur radio and the WIA. A newsworthy broadcast boosts member morale (thus aiding retention), and enhances the credibility of the local Division in the eyes of the amateur fraternity. Many amateurs derive their news from no other source.

Whether a broadcast officer, contributor or committee member, this article gives some tips on how your Division can advance itself through providing a better news service. I also hope that this article will encourage more to contribute to their local broadcast.

## The Role of a Broadcast

A Divisional broadcast has several functions. Some of these are as follows:-

- \* To provide reliable, up to date and impartial reporting on current amateur radio happenings;
- \* To foster interest in amateur radio activities amongst both existing and prospective amateur licensees;
- \* To promote WIA Federal, Divisional and Club events and member services; and
- \* As a means of articulating and

reinforcing ourselves as radio amateurs.

Different Divisions have differing emphases; some aim to provide a service for members only, while others favour a broader role encompassing all people with an interest in amateur radio, including non-WIA amateurs and those yet to be licensed. My personal preference is for the more inclusive approach.

## What Makes a Good Broadcast?

Having established the purposes of a broadcast, we can now look at the ingredients of a successful and respected news service. These fall under the following headings:-

- i. Content and structure;
- ii. Technical quality;
- iii. Accessibility; and
- iv. Presentation.

After elaborating on each of these points, some general thoughts on broadcast organisation and production are given near the end of the article.

## Content and Structure

To preserve listener interest, the content of a Divisional broadcast must appeal to a wide cross-section of the amateur fraternity. As well, transmitted material should take into account the limitations of the broadcast medium. Whereas a reader can skip material not of interest in a book, he/she has no such control when listening to a broadcast. For this reason, a larger number of brief stories is preferable to a smaller number of longer items. While exceptions can always be made when an item is of exceptional importance and/or topicality, broadcast officers should keep items short to sustain audience interest.

For the same reason, complex descriptions, detailed contest rules, and addresses are not particularly suited to the broadcast medium. However, thanks to digital communication, such information can be distributed easily via packet radio or Internet.

It is desirable that bulletins follow a set structure. Introductions should be short and to the point; other information (such as about the Division) is better placed at the end of the broadcast. The placement of immediate, brief and newsworthy items near the beginning of the bulletin, with features, opinion, technical and longer pieces near the end is a good format. A brief mention of coming stories before each station identification helps keep listener interest. Figure 1 shows a format that has worked successfully for the VKI broadcast.

## Technical Quality

Important to a successful broadcast is its audio quality. Achieving quality is harder than one might think, particularly when producers use a variety of audio sources, such as live voices, tape recordings, or telephoned material. Additional challenges arise when the broadcast is fed through linked repeaters and/or relayed on HF.

Any effort to improve audio quality is time well spent; WIA broadcasts are regarded as standard setters in the amateur community, and are expected to be of superior quality. Poor audio is never appreciated by listeners, particularly those in areas where signals are marginal.

## Accessibility

This means the extent to which listeners are able to avail themselves of broadcast contents. In a large state, this could entail making the broadcast available on several HF frequencies or a network of linked repeaters, so that as many as possible have the opportunity to listen.

Transmitting a repeat of the broadcast at another time can also add to its accessibility. Those dependent on HF relays may find that sometimes only the repeat edition is audible.

Another means of improving access is to post a written copy of the bulletin on packet radio and/or the Internet. Such a practice also has the potential to reduce

the broadcast officer's workload, as the sharing of written broadcast material between states is made easier. Service reliability here is essential; people will not become accustomed to using the service otherwise.

### Presentation

A clearly articulated and well-presented effort is much more likely to capture the interest of listeners.

When compiling a broadcast, please remember your more distant and interstate listeners, who may be listening under difficult conditions. For this reason, slow speech, clear pronunciation, and repetition of important information are essential for any announcer. More information on such matters can be found in your local library under topics such as "public speaking" or even "broadcasting". Experts in the field say that the control of breathing is most important.

Divisional broadcasts should not be monologues; a change of voice at least every ten minutes is desirable. This can be achieved through the use of extra announcers or taped segments. However, there is nothing worse than hearing an unpractised announcer stumbling through a piece of unfamiliar text that he/she does not understand. To alleviate this, the use of material read by those with a special interest in the topic is preferred. Such contributions, separated by the main presenter's commentary, can then form a coherent bulletin.

Though some presenters can string together sentences from a page of rough notes, there is nothing wrong with relying on a well-written script. Such a script need not be in paper form; the screen of a laptop computer can serve well, and eliminates the need for a print-out to be made. A benefit of a comprehensive script (particularly one available on computer disk) is that it can form the basis of the packet/Internet edition of your broadcast, and even be of use when compiling the Divisional newsletter or *Amateur Radio* column.

At VK1W1, the main activity has been the production of a single script from a variety of news sources, be they notes from meetings, mailed contributions, telephone calls or packet radio messages. Work on the script normally begins at

least a week prior to the bulletin's transmission. Should a deluge of contributions be received late in the week, less urgent items can simply be transferred to the following week's script.

### Broadcast Organisation

#### Relationship with Divisional Council

Being a broadcast officer is one of the most demanding tasks in any Division. Therefore, it is seldom possible for the broadcast officer to occupy other substantial positions in the Division, and do them both justice. Indeed, there is merit in the broadcast officer having a degree of independence. However, the broadcast officer should be in a position to report on Divisional council meetings. The relationship between the broadcast and Council varies between states, from cases where the Secretary effectively determines news content to one where this responsibility is delegated to the news editor.

I personally prefer the latter approach (allowing for committee intervention in special circumstances), as independence is likely to boost the credibility of a broadcast amongst listeners (particularly non-members). In the longer term, this can only raise the esteem with which the Institute is held in the general amateur community.

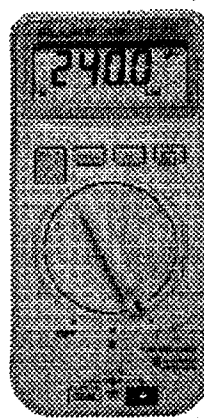
### Contributions

A Divisional broadcast is almost insatiable in its appetite for contributions; for a 30 minute bulletin, 3000 plus words per week is normally required. To satisfy this need, it is imperative that the broadcast officer develop good links with regional and special-interest clubs, whose activities provide the "raw material" required to sustain a broadcast. In addition, individual amateurs with expertise in a particular facet of amateur radio (such as DXing, contesting, ATV, WICEN, etc) have much to offer a news service. The use of such broad input is likely to add to the respect that the broadcast commands amongst its listeners. As well, coverage of a range of viewpoints will help remove any perception that the bulletin is simply propaganda compiled by a few diehards in an isolated bunker far



**YOUR HOBBY** **YOUR VOICE**  
Representing Radio Amateurs - Since 1910

**RECRUIT A MEMBER & THEY COULD WIN!**  
**THIS GREAT FLUKE 12B DIGITAL MULTIMETER WORTH \$195**



**THERE'S A WINNER EVERY MONTH FOR 1997 12 PRIZES TO BE WON**

This latest hand-held DMM, from the world-leading maker of digital test instruments, has advanced features yet is simple to use. Ideal for tyro & veteran.

#### The Fluke 12B measures:

- ac and dc voltage (with auto-selection)
- resistance & capacitance (.001-1000μ)

#### The Fluke 12B features:

- 4000-count liquid crystal display
- simple rotary dial
- diode and continuity testing
- indicates intermittent opens & shorts
- 2-year warranty

**Fluke 12B prizes generously donated by Philips Test & Measurement.**

Each month's prize is awarded by way of a draw among newly recruited members each successive month and presented to the winner at the earliest opportunity following the draw.

**To sign up a new member, use the back of your AR magazine address leaflet - or clip the coupon, have them fill it out and send it now.**

**SEND TO YOUR DIVISION'S ADDRESS, SHOWN ON PAGE 56.**

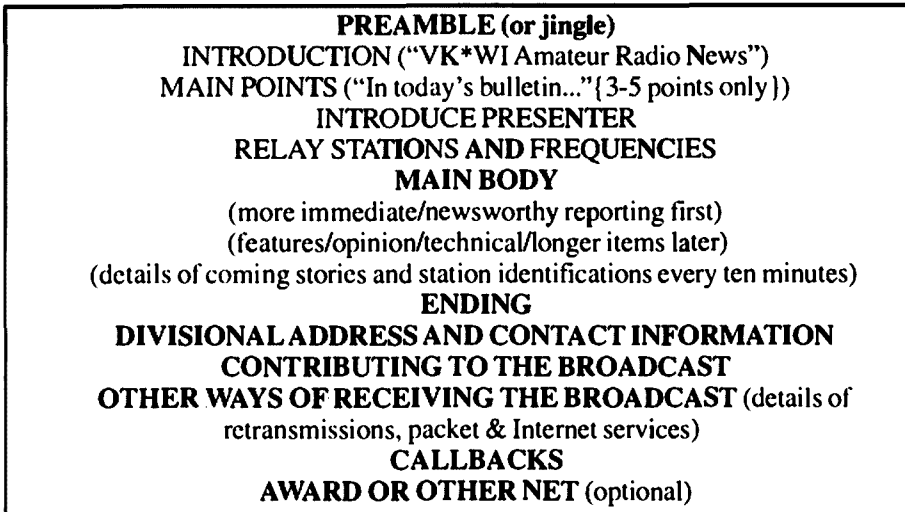
✂ Please send me a membership application.

NAME . . . . .

ADDRESS . . . . .

. . . . . P/code . . . . .

Call Sign (if any) . . . . . [AR 1-11/97]



**Figure 1 – A Possible Broadcast Structure**

removed from mainstream amateur activity!

A successful broadcast is the product of considerable editing. This may be due to space limitations, or the need to repeat vital information. As well, contributors vary considerably in the lucidity of their prose. Items submitted may also be incomplete, and require the broadcast officer to provide additional background information.

Contributors should be able to lodge items by as many means as possible, such as post, telephone, packet radio, computer disk, facsimile and Internet e-mail. Broadcast editors are not always inundated with contributions, so it is best to make contributing as easy as possible. Despite the additional lead time required, the use of a single prepared news script is advantageous, as material can be accepted even if scrawled on the back of the proverbial bus ticket.

## **Broadcast Production**

### **Length**

A length of thirty to forty minutes is regarded as the optimum length of a Divisional broadcast, unless the gravity of the subject matter or the presenter's skills are sufficient to hold the listener's attention for longer. When tuning around the HF bands on a Sunday, you will find that most Divisions conform to this pattern. In the past, some compilers have been prone to over-estimating the time that a listener will remain beside the radio. For this reason, brevity, tight editing and a clear, crisp writing style

will win the appreciation of many listeners.

### **Newsworthiness**

The immediacy of a radio news bulletin is perhaps its greatest strength vis-a-vis magazines and newsletters. It is for this reason that weekly broadcasts are far preferable to fortnightly or monthly bulletins. Broadcast producers should exploit this immediacy through giving prominence to current happenings by including them near the beginning of the bulletin.

### **What Should Not Go on a Broadcast?**

Broadcast officers come across considerable amounts of information when compiling a bulletin. Most of this material, whether from individual contributors, clubs, packet radio or the Internet may be of interest to the listener, and deserving of airing. However, one occasionally comes across items that have no place on a Divisional broadcast. Good judgement and editorial discretion are required to ensure that your Division's broadcast remains credible. Even leaving aside ethical and legal considerations, the WIA is widely viewed as a standard-bearer, and the airing of personal grievances, disguised as "news", through Institute facilities is unlikely to curry much favour with those listening.

The following have no place on a Divisional bulletin:-

- \* Denunciations of individuals, clubs or other parts of the Institute (this

never has the desired effect and invariably reflects badly on the news editor and the WIA);

- \* Other material likely to defame; and
- \* Editorial opinion disguised as factual reporting.

Nevertheless, there is considerable room on Divisional broadcasts for creative expression, satire and humour, particularly of the type that mocks irrational prejudices or exposes traits peculiar to radio amateurs as a group. Such material is eminently broadcastable as it assists in defining who we are and questions conventional wisdom that might have outlived its usefulness. When in doubt, the final test of the suitability of any item is whether its airing is in the best interests of amateur radio.

### **Accuracy**

As a broadcast is seen as being the product of a Division and not of those who produce it, there is a need to ensure the veracity of material broadcast. This is not easy; even the SMA (ACA) has, on occasion, given conflicting advice when approached by broadcast officers, individual amateurs and other WIA officials. However, one may safely place more credence in, say, a press release from WIA Federal, than a comment overheard on air. In the worst case, should you be wrong, you can readily refer people to the source of the material.

The standard of proof required for broadcast items should reflect their materiality; a packet message or telephone call is adequate for most items, which are comparatively unimportant, but greater standards of evidence may be desirable for more substantial stories. Due to the news editor's limited time, it is often a question of appropriate risk management; one should ask oneself the consequences of getting a story wrong. In extreme cases, it is safer not to run the story at all, if there are doubts about its veracity.

### **Technology in Broadcast Production**

In progressive Divisions the work of the news editor has changed markedly in the last decade. News gathering has been revolutionised by computers, packet radio and the Internet. Australian broadcast officers now have the

opportunity to exchange material through the WINEWS packet radio server, developed by Graham Kemp VK4BB. Information on a wide range of amateur activities can be obtained through the packet radio Teletext system, also developed in VK4. WIA Federal now sends news via e-mail. Rather than having to listen at a specified time for the voice bulletin, amateurs in some states can stay in touch by reading the broadcast on packet radio or telephone bulletin boards. It is only a matter of time before it will be possible to listen to recordings of voice broadcasts through the Internet.

All this has changed the skills required by the broadcast producer; with the emphasis shifting towards editing masses of information to produce a bulletin suitable for a range of distribution methods. The new technologies mean that it is now possible to produce a higher quality product in

less time than ever before. However, technology should be used only to the extent that it remains a servant and does not become a master, distracting the user from primary duties.

### Additional Services

A weekly broadcast (and associated packet/Internet bulletins) need not be the only product of a Divisional News Service. To keep amateurs better informed, while raising the standing of your Division, urgent or very important items could be issued as special stand-alone bulletins on packet radio and/or the *aus.radio.amateur.misc* Internet newsgroup. This exploits the immediacy that data communication offers, and helps to dispel the notion that the WIA is unable to act quickly when required. Updated or more detailed information could always be included on the next available regular broadcast. The main risk to watch for here is the possibility of

issuing an erroneous bulletin, hastily written on the basis of incomplete or incorrect information.

Another service, possibly forming part of your Division's publicity strategy, is a series of short bulletins (of no more than a few paragraphs each) detailing WIA Federal or Divisional achievements and member services. These bulletins could either be aired on the regular Sunday news, or presented as a series of stand-alone messages on packet or the Internet.

### Conclusion

This article has given a few hints for those engaged in Divisional broadcast production. In doing so, it is hoped that it will give listeners a clearer idea of a broadcast's role, and encourage greater involvement in Divisional bulletins amongst the general membership.

\*7/1 Garran Place, Garran ACT 2605  
parkep@pcug.org.au

## Technical Abstracts

Gil Sones VK3AUI\*

### Twelfth Wave Transformer

The quarter wave transformer used to match two impedances is well known. However, the use of a quarter wave transformer often requires the fabrication of a suitable section of line as the impedance required is often a non standard value. There is, however, a way to match two different coaxial lines using only the lines themselves. This is the so called twelfth wave transformer. The penalty is the need for an extra pair of connectors.

In *QST*, June 1997, Darrel Emerson AA7FV/G3SYS described the twelfth wave transformer. The technique has been around for some time and was first described by Bramham in 1961 and in *QST* by Frank Regier OD5CG in 1978.

The equation for a quarter wave transformer is:

$$Z_0 = \sqrt{Z_1 \times Z_2}$$

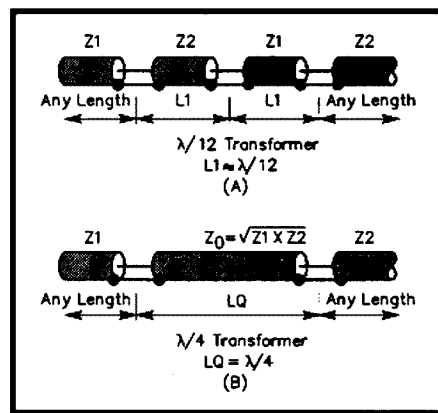


Fig 1 (A) and 1 (B)

The quarter wave transformer is shown in Fig 1 (B).

A common problem is matching cheap and good 75 ohm cable into a 50 ohm system. The 75 ohm cable used for Cable TV is often available cheaply and is of very good quality. For 50 ohm cable to be matched to 75 ohm cable the matching section is 61.2 ohms. This is a non standard cable impedance.

The twelfth wave transformer is shown in Fig 1 (A). The line sections are of equal length and are close to a twelfth of a wavelength long. The exact length required is given by equation 2:

$$L = \frac{\arctan \sqrt{\frac{B}{B^2 + B + 1}}}{2\pi}$$

where  $B = Z_1/Z_2$ , the ratio of the impedances to be matched, and arctan is in radians.

The result of calculating equation 2 is shown in Fig 2 where the length of the matching sections is graphed against the ratio of the impedances to be matched.

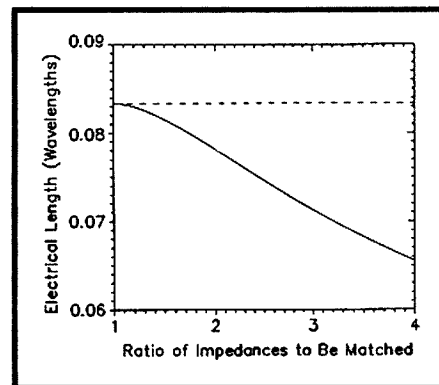
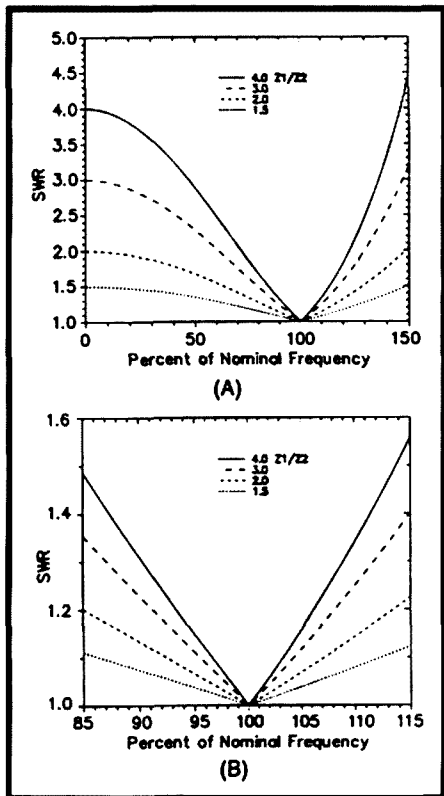


Fig 2 - Electrical length of cable sections.



**Fig 3 - Bandwidth of Twelfth Wave Transformer. For impedance transformation ratios of 1.5, 2, 3, and 4, 75 to 90 ohms is a ratio of 1.5. (A) Shows SWR from DC to 1.5 times the design frequency. (B) Shows SWR within +/- 15% of the design frequency.**

The result is fairly tolerant of errors in the cutting of the cables and has a reasonably broad bandwidth of match. The matching bandwidth is shown in Fig 3.

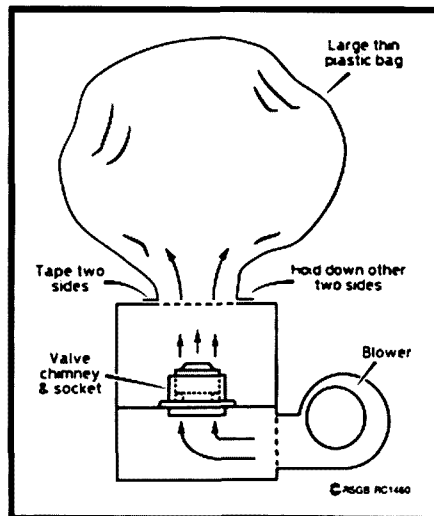
The cable lengths used must be adjusted for the velocity factor of the cables used. For convenience, and subject to the availability of connectors, RG11 and RG213 style cables could be used to match to TV cable. The connectors for the TV cable can be difficult to obtain and may need to be concocted and fabricated.

### Measuring Airflow

Builders of linear amplifiers using power valves often have difficulty in measuring the volume of the cooling air flow. Too little air can lead to overheating and premature failure of the power valve. This is particularly important for ceramic metal valves. The cooling fins result in significant back pressure which reduces the efficiency of the blower.

A simple test was described by Ian White G3SEK in the "In Practice" column in *RadCom*, August 1997. The method described originated in a *QST* article by George Daughters AB6YL/W6TG. The method consists of timing the filling of a thin plastic bag at the air output.

The method is illustrated in Fig 4. The bag must be thin and light and a supermarket bag is ideal. The bag handles are removed and the bag is taped to one side of the duct. Crumple the bag so as to expel air. Then turn on the blower and allow it to come up to operating speed. Quickly move the mouth of the bag across the air outlet and clamp it so as to minimise leakage. Time the inflation time and release the seal when the bag is fully inflated. Repeat the procedure several times and average the result.



**Fig 4 - Measuring air flow by inflating a plastic bag.**

A British supermarket bag was estimated to hold 16 litres or 0.6 cubic feet. Local bags are probably similar but would need to be estimated. You could try filling one with water but watch out for a wet floor. You may be able to fill one with a known volume of water without bursting. The experiment would be best performed outside or in a bath or wash trough.

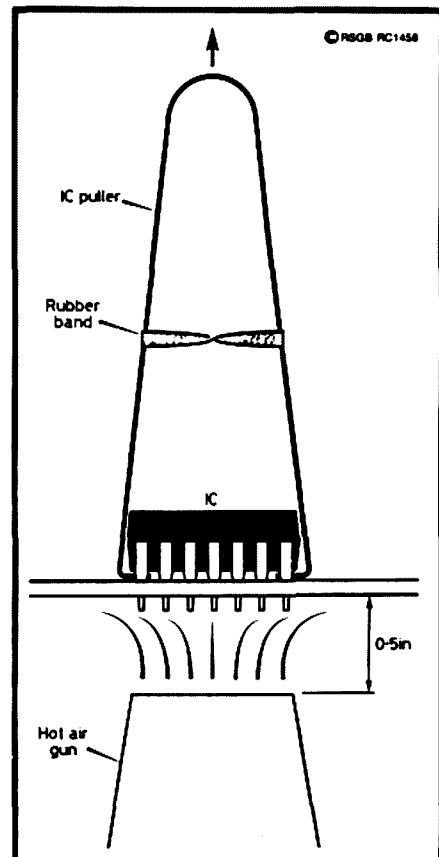
### Integrated Circuit Desoldering

A technique for desoldering and removing integrated circuits from printed circuit boards was described in

the "In Practice" column of Ian White G3SEK in *RadCom*, August 1997. The technique was originally described by Michael Covington N4TMI.

The technique involves the use of a hot air gun to melt the solder on all pins simultaneously. The printed circuit board is mounted vertically in a vice so as to allow access to both sides. An IC puller is attached to the IC using a rubber band to tension the puller. Then the solder side of the board is heated with the hot air gun. The gun nozzle should be held 13 mm from the board and moved about so as to heat all connections to the IC. The gun nozzle should be about 13 mm diameter. After about 30 seconds the solder should be melted and you should be able to pull the IC out. Clean up the holes with copper braid.

The method is illustrated in Fig 5. If your heat gun is of a larger size you may be able to mask off other areas of the board with aluminium foil. The secret to minimal damage is to apply heat for only a short time and only as long as is necessary to melt the solder and remove the IC.



**Fig 5 - Using a hot air gun with an integrated circuit puller.**

## LF Across the Tasman Sea

On 30 August 1997 between 0800z and 1000z a two way low frequency contact took place across the Tasman sea. Two way contact was made between Dave ZL3FJ and Robert AX2TAR/VK7ZAL using both SSB and CW. Richard VK7RO took part, also

receiving signals from New Zealand. The signals were on 176.5 kHz CW and 177.5 kHz SSB.

The ZLs had the use of a 122 metre broadcast tower which was due for demolition. The tower had a very good earth mat in place from the broadcast days. The ZLs made good use of the few days use of the tower and the two way contact resulted.

In New Zealand there is an LF allocation, while in Australia an experimental or scientific licence and frequency allocation were used. Congratulations to ZL3FJ, VK7ZAL/AX2TAR, and VK7RO. Thanks to Robert VK7ZAL for the information.

*\*C/o PO Box 2175, Caulfield Junction VIC 3161*

ar

# Internet Radio Mailing Lists and How to Use Them

*Richard Murnane VK2SKY\* explains that there is more to the Internet than the World Wide Web.*

Last year, I gave a brief introduction to the World Wide Web, and how amateur operators can make use of it [Ref 1]. However, the Web, while new and glitzy, represents only a small amount of Internet activity.

In some respects, Internet mailing lists are less of a culture shock to the average amateur, yet they offer a rich source of information, and allow amateurs and non-amateurs alike to exchange views on an incredibly wide range of topics, without many of the limitations of our current packet radio network.

At this point, I should reiterate my position that I see Internet, not as a substitute for amateur radio, but as a valuable adjunct to our fine hobby. And, with Internet on the verge of becoming the next television, we can use it to bring the joys of amateur radio to millions of technically-oriented prospective amateurs out there.

## Internet Mail and News v Packet

So let's get right into it. As a way of easing you into the world of Internet, I'll draw some comparisons with an area familiar to many amateurs: packet radio. Many amateurs obtain an account with their local Internet Service Provider (ISP), and use a terminal emulation program on their PC to access that account. Conceptually, this is like getting your packet station together and logging on to your friendly local packet BBS. More recently, easy to use programs aimed mainly at "Web Surfers" have

come on the market; however, the basic mechanism is still the same.

Having signed on, the packet operator usually lists the available messages (eg L), to see if anything is of interest, perhaps checking for topics of particular interest (eg L> WIA). He might send a bulletin for others to read (eg SB WIA @ VKNET), or perhaps a private message to another amateur (eg SP VK2SKY).

On the Internet, things are a bit different, due to the scale of the thing. Whereas a busy packet BBS might store a few hundred messages, a typical ISP would typically have tens of thousands. Even with the higher bandwidth afforded by modern modems (typically 33.6 kbps vs 1200 bps still commonly in use on packet), the subject lines alone would be too much to read in one session.

In addition, because the users are much more socially diverse, most of the messages would be of little or interest to any particular user. For this reason, messages are divided into discussion forums or newsgroups. These are structured as a huge tree, as reflected by the newsgroup names, for example:

The range of newsgroups available is truly astounding. A typical ISP would provide access to hundreds of these discussion forums, so you can get some idea of the volume of traffic involved. The topics range from the ordinary to the very strange, so there is something to suit every taste.

Fortunately, you can subscribe just to the newsgroups of interest to you, and

ignore the rest. Even so, it's quite possible to spend so much time reading Internet news that your friends on air start wondering if you're still alive.

Another alternative is to subscribe to an Internet mailing list, so that the interesting traffic will come to you in the form of electronic mail. Simply subscribe to the lists of interest, connect

rec.radio.amateur.antenna  
Recreation - radio - antennas  
rec.radio.amateur.homebrew  
Recreation - radio - radio home  
brewing  
rec.food.cooking  
Recreation - food - cooking  
discussions  
aus.radio.amateur.misc  
Australian - general Amateur Radio  
topics  
aus.radio.amateur.wicen  
Australian - WICEN activity  
alt.psychology.nlp  
Neuro-Linguistic Programming (a  
pet topic of mine)

to your ISP every so often, download your mail, log off again, and read your mail at your leisure.

## Mailing List Servers

A list server is a program which keeps track of a list of subscribers, and distributes e-mail messages amongst them. These servers are set up by interested individuals for the use of groups of people sharing specialised interests.

Usually, anyone can subscribe to an Internet mailing list, simply by sending

## Some Radio-oriented Internet Mailing Lists

Lists at [majordomo@contesting.com](mailto:majordomo@contesting.com) :

*Note: the lists shown here are also available in digest form (append -digest to the list name, eg amps becomes amps-digest)*

List Name	Description
amps	RF Amplifier Discussion List
cq-contest	CQ Contest Mailing List
tentec	TenTec Amateur Radio Mailing List
topband	Top Band Reflector
towertalk	Tower Talk Reflector
yaesu	Yaesu Amateur Radio Mailing List

Lists at [majordomo@qth.net](mailto:majordomo@qth.net) :

*Note: the lists shown here are also available in digest form (append -digest to the list name, eg 50mhz becomes 50mhz-digest)*

List Name	Description
50mhz	6 Metres only Amateur Radio List-Server
alinco	Alinco Amateur Radio List-Server
aprs	APRS Amateur Radio List-Server
ares-races	ARES-RACES Amateur Radio List-Server
bpsk	BPSK/DSP Weak-Signal Detection Amateur Radio List-Server
cw	CW Amateur Radio List-Server
emwin	Emergency Manager's Weather Information Net Amateur Rad
ham-books	HAM-BOOKS Amateur Radio List-Server
ham-software	HAM-SOFTWARE Amateur Radio List-Server
handi-hams	Handicapped Hams Amateur Radio List-Server
homebrew	Homebrew Amateur Radio List-Server
icom	Icom User's Amateur Radio List-Server
kenwood	Kenwood Amateur Radio List-Server
meteor-scatter	Meteor Scatter Amateur Radio List-Server
mobile-portable	MOBILE-PORTABLE Amateur Radio List-Server
packet-pbbs	Packet and PBBS Amateur Radio List-Server
sstv-atv	SSTV and ATV Amateur Radio List-Server
vintage-radio	Vintage Radio and AM Amateur Radio List-Server
wsvhf	International Weak-Signal VHF Amateur Radio List-Server

Lists at [majordomo@netcom.com](mailto:majordomo@netcom.com) :

List Name	Description
barc-races	Radio Amateur Civil Emergency Service
ham-tech	Amateur Radio Technical Discussions
letter-list	Amateur Radio - The ARRL Letter
newslines-list	Amateur Radio Newslines

Lists at [listserv@ucsd.edu](mailto:listserv@ucsd.edu) :

List Name	Description
ham-am	Amplitude Modulation in Amateur Radio special interest list
ham-amtor	Amateur Radio AMTOR special interest mailing list
ham-ant	Bidirectional mailing list with Usenet group rec.radio.amateur.antenna
ham-atv	Amateur Radio Fast-Scan Television
ham-boatanchors	Old klunky but still usable massive amateur ("ham") radio gear.
ham-digital-voice	Amateur Radio digital voice special interest list
ham-digital	Bidirectional gateway with Usenet newsgroup(s) rec.radio.amateur.digital.
ham-dx	Bidirectional mailing list with Usenet group rec.radio.amateur.dx
ham-dxing	Amateur Radio DX (long distance communications) special interest
ham-eme	Amateur Radio Earth-Moon-Earth special interest
ham-equip	Bidirectional gateway with Usenet newsgroup rec.radio.amateur.equipment
ham-exotic-modes	Amateur Radio exotic modulation methods and other strange interests
ham-fax	Amateur Radio FAX
ham-fm	Amateur Radio F.M. (primarily VHF/UHF FM and repeaters)
ham-hf	Amateur Radio High Frequency (below 30 MHz) communications
ham-homebrew	Bi-directional gateway with Usenet newsgroup rec.radio.amateur.homebrew
ham-mods	Modifications to commercially-made Amateur Radio equipment
ham-morse	Morse code in amateur radio
ham-nocode	Eliminating the Morse Code examination requirement for Amateur Radio
ham-packet	Amateur Packet Radio
ham-rtty	Amateur Radio Teleprinter special interest
ham-slowscan	Amateur Radio Slow-scan Television special interest
ham-space	Bi-directional gateway with Usenet newsgroup rec.radio.amateur.space
ham-spread	ham-radio spread spectrum techniques and applications
ham-ssb	Amateur Radio Single Sideband techniques special interest
ham-uwave	Discussion of Amateur Radio Microwave experimentation (> 1,000 MHz)
ham-vhf-uhf	Amateur Radio VHF and UHF communications special interest
nos-hacks	KA9Q 'NOS' Amateur Radio networking package and derivatives



an e-mail request to the server (although some lists are private or have a membership controlled by a human moderator.) If you later decide that you are no longer interested, another e-mail to the server automatically ends your subscription.

So, how do you find out what lists are available? If you have web access, check out <http://www.neosoft.com/internet/pamll/> or <http://catalog.com/vivian/interest-group-search.html>; alternatively, using an Internet news reader, check out the **news.answers** newsgroup. Periodically, the *List of Publicly Accessible Mailing Lists* appears there.

To save you some initial searching, I have listed in the tables several mailing lists of interest to Amateur operators.

### Using a List Server

The easiest way to find out how to use a particular mail server is to ask it. Simply send e-mail to the server, placing the word "help" in the body of the message, like this:

**To:** majordomo@contesting.com  
**Subject:** anything you like – the server ignores this part

help

Within a few minutes, you will receive an email back from the server, detailing the commands that the server understands.

Two flavours of mailing list server are commonly in use on the Internet: **MajorDomo** and **ListServ**. They both offer essentially the same services, but the commands they understand are slightly different. They are generally distinguishable by the form of their e-mail addresses (see Table 2).

To send a command to a list server, you simply send e-mail to it, placing the desired command in the body of the message, for example:

**To:** listserv@ucsd.edu  
**Subject:** anything you like – the server ignores this part

subscribe ham-ant

When you subscribe to a list, the server will send you another e-mail, usually describing the subscribed list, and how you can end your subscription. It's a good idea to save this message for later reference. As a subscriber, you will now receive a copy of every message that the other subscribers send to the list.

At this point, it's important to distinguish between the list server, and the list itself. You send mail to the **list** (in this example, **ham-ant**) to communicate with the other subscribers; you send e-mail to the **server** to end your list subscription, check out other lists, and similar administrative type functions.

In our example, I sent mail to **listserv@ucsd.edu** (the *server*) to subscribe to **ham-ant**, the amateur antennas list. I can then communicate with the other list subscribers, like this:

**To:** ham-ant@ucsd.edu  
**Subject:** Help – portable HF ant recommendations?

Hi everyone,

Can anyone recommend a good compact HF antenna for portable use?  
 Thanks & 73 Richard VK2SKY

### Indigestion

Normally, if ten list subscribers send messages to the list, you will receive ten e-mails, one from each subscriber. On

lists with lots of traffic, this means your e-mail "in tray" can look very full each day! Some people may prefer the *digest* form, where the day's submissions are gathered together and sent out as a single message. If a list is available as a digest, its name usually reflects this (see tables.)

### Mailing List Etiquette

When you first subscribe to a mailing list, it's a good idea to be "read-only", until you get a feel for the kind of messages that are appropriate for the group. If you find you want to discuss a topic that is outside the guidelines for the list, then find a more appropriate list. Apart from that, what guides your behaviour on-air should serve you well on the net.

### The End of Amateur Radio?

As I said at the start, I'm not out to "prove" that the Internet will be the demise of amateur radio, rather to show that it is different, and useful to us in many respects. Whether it's digging up a modification for your old rig, finding out the latest DX news or propagation conditions, or arranging a sched with other amateurs who share your special interests, I hope you'll find the Internet an enjoyable addition to your on-air activities.

If you have any questions, please feel free to email me at the address below.

### Reference

[1] *A Radio Amateur's Guide to the World Wide Web, Amateur Radio, July 1996*

\* PO Box R153, Royal Exchange, Sydney NSW 1225  
 Internet: richardm@ceta.org.au  
 Web: <http://www.ceta.org.au/~richardm/>

ar

	MajorDomo servers	ListServ servers
	majordomo@world.std.com	Listserv@ucsd.edu
	majordomo@contesting.com	
	majordomo@qth.net	
	majordomo@NETCOM.COM	
Here are a few of the most useful commands for these servers:		
	MajorDomo	ListServ
To get a full list of available server commands:	help	help
To find out what lists are available on this server:	lists	index (list names only), or
longindex (with details)		
To join the xyz mailing list:	subscribe xyz	subscribe xyz
To remove yourself from the xyz list:	unsubscribe xyz	unsubscribe xyz

Table 2

**Don't buy stolen equipment – check the serial number against the WIA Stolen Equipment Register first**

## ■ Rotators

# Emotator Antenna Rotator Model 501-CXX

*Ted Wraight VK3ALT\* performs some fault rectification on his antenna rotator.*

Does your Emotator rotator need a little attention? Well, maybe this information will help somewhat.

I had a problem with my Emotator 501-CXX not locking, allowing it to rotate according to the wind. There was no alternative but to drop the antenna and remove the rotator for inspection. Having already taken it down on a number of occasions I was not too confident that I would find where the locking devices were. Removing it from the tower was the easy part; here is a description of the harder part.

Placing it on the bench I removed the six screws from the top of the main body, being careful not to lose the top row of ball bearings located just above the large gear within the top section of the housing. In order to remove the screws you have to have the rotator upside down, with the mast housing on the bench. Hold it there while you gently turn over the main bottom section above it, allowing any bearings that have a mind to roll away to roll into the upturned top section. Leave them there until needed for refitting after you have cleaned and regreased the housing.

Before you put the main body of the rotator down on the bench, remember that there is a second run of bearings on the bottom section. Be very careful that these do not drop away from the underside of the main housing or you will spend the rest of the day trying to locate the little blighters. If you are lucky, like I have been on all occasions that I have dismantled mine, they should behave and stay stuck in place with the help of the grease, and also the neoprene seal if it has not deteriorated too much. You may wish to drop the ring with the bottom bearings, but I did not find it necessary to do so.

Turn the body over, placing the flat to the bench and remove the screws holding the micro-switches and the actuating lever between them. Check the switches to see they are not burnt or corroded; replace if necessary. Next, take out the three screws holding the two plates, laying the heavy thick plate aside to provide enough room to remove the gear train without straining the wiring to the potentiometer.

The first gear to come out is the one which protrudes out the side of the housing and drives the ring gear. With this one out, it's time to take the loose ring away to enable the remainder of the gears to be removed, taking care, again, not to lose the spacer from the underside of the gear. You should now be looking at the centre of the motor shaft right about where that tiny little gear (less than 10 mm) lives and which drives your great beam around. Don't be deceived! Under that tiny little gear with its plastic housing is not an oil wick to an oilite bearing but a clutch and housing. No wonder I failed to see it the first few times around! To get at it you must first remove a very small circlip. A small screwdriver to the side will take it out but watch that it does not take off to somewhere where you can't find it.

Next, remove the diecast section with the two legs that project down into the housing, noting carefully which way it is to be returned against the spring within.

Two screws hold the plastic/nylon housing. Remove them and withdraw the housing, together with the spring, again noting its position in relation to the centre shaft section.

The experts will tell you that it is not correct to lubricate certain nylon and metal combinations. So, with that in mind, on this occasion I cleaned them and replaced them.

I put the lot back together again and on to the tower. Yes, you guessed it, still not locking! I should have known better as, in the past, I have found that the only way to stop wear on these parts, as well as make for smoother running, was to lubricate them. So before you put it back, lubricate it!

So, I pulled it down again and lubricated it with just a smear of silicone grease which I had occasion to use in the service industry. You may do just as well with an alternative such as automotive grease, which is what I used for the bearings and gear train. Don't forget the circlip after you put the diecasting, with the gear on top of it, into the nylon housing.

As you assemble the unit you may still find that it does not point where you want it

to. Good old Murphy! Well, you will notice all the Japanese lettering around the top of the pot with the only thing recognisable being one arrow. This must point to a small dot on the centre gear, the one with the arm on it. You will have to look quite closely to see it. Rotate the centre gear until they match exactly opposite each other. The arm attached to the centre gear appears to serve no other purpose than to facilitate the rotation process for this adjustment.

Having arrived this far, we now proceed to the refit of the first two sets of gears, then the ring, and finally the remaining gears, with the one that hangs out the side.

Refit the plates, then the micro switches and the arm between them, and then all the re-lubricated bearings. They stick better with plenty of grease. The next step is to note where the two little humps are in the top of the housing. These are the stops that trigger the micro switches. With the top half of the housing on the bench facing up, bring the bottom section over and place it within the half with the micro switches in a position exactly 180 degrees to the cut-off humps.

When you have refitted the unit to the tower first check on your console to see if it is indicating north. If you have done it correctly it should. Now to determine which way your tower points when you lay it over.

Mine points to 125 degrees, with the reverse at 305 degrees. Set your console to the appropriate heading and then and only then fit the mast and antenna to the rotator. Up with the tower and you are back in business. The antenna should now, if all has gone according to plan, face the correct direction and lock at the right moment.

### Console Back Panel Problem

This particular model comes with a panel that does not eliminate the possibility of sudden death, or at least a severe dose of AC jitters. I'm not one for hanging on the end of an AC line, but that is what happened with mine. Perhaps there are others out there which are similar, as I doubt if mine was the only one made like it.

I discovered that mine had an enlarged opening in the back to allow the six pin plug to be fitted within the cabinet of the console. This is fine if, for some reason or other, you don't have to reach over from the front to check that the plug is secure in the socket. Nasty stuff AC; the response is immediate and the result never uncertain; I can vouch for that! You will need to make up a small plate to cover the oversized hole. It can be as large as the cord entry hole will allow and easily secured with those ever-useful self tappers.

\*8 Gregory Court, Pakenham VIC 3810  
ar

# ALARA

Sally Grattidge VK4SHE\*, ALARA Publicity Officer

## Traveller

Darlene WD5FOX, sponsored by Valda VK3DVT, flew to London in May this year to stay with Roger G3LQP and XYL Beryl. At Heckington in the Midlands she had her first eyeball with Diane G0RHL and OM John G0RHM. Darlene had tried once before to meet Diane without success. Diane was living in Kenya in 1971 when Darlene called in, only to find nobody home.

Darlene has corresponded with Diane for 26 years, talked to her by radio from the Seychelles when she was VQ9DC, on her Des Roches' DXpedition in 1973, and in South Africa where she was ZS5DC. Diane, and the windmill in her village, were mentioned in *Amateur Radio* in February this year.

While in England, Darlene also met Rita G0EIX and OM Brian at a pub on Epsom Downs. Darlene plans to visit Austria and Switzerland early October and hopes to meet up with Greta HB9ARC.

## Spreading the Word

Dot VK2DDB is giving a talk on ALARA to the Mid South Coast Club in November. She spoke to this group a few years ago on early radio ladies, but when someone recently asked her if there were any ladies in amateur radio she thought it was time for another talk.

VK2 is not as well represented as other states in ALARA; where are you ladies? Are you all rugged individualists who don't like joining organisations? Being an ALARA member is not very demanding or expensive and keeps you in touch with what other YLs are doing in Australia and overseas. Why not give it a go?

## YLs on Willis Island

By the time you read this the Willis Island DXpedition will be over, hopefully with many contacts. Three YLs took part in this adventure – Ann WA1S, Elvira IV3FSG and Noriko 7K3EOP.

## Introducing Akemi

Akemi JK6ARD is called Mei by her friends. This comes from one of the Chinese characters which sounds like the month of May. Akemi has been an amateur for nearly ten years and, since upgrading her licence, has enjoyed DX on SSB and RTTY. She also likes "friendly party type" contests, and hopes to make some contacts in the ALARA Contest in November.

Akemi's OM is Hiro JK6IPD, and her son Hiro Junior JM6EAW is fifteen years old. Her hobbies are Tea Ceremony, reading historical documents written in old style Japanese, computer work, and singing. She has been a member of ALARA since 1993 when she visited Australia and met Erika VK3EAB (sponsor) and Robyn VK3ENX.

At the 40th JLRS Convention in Tokyo, Akemi was asked to be editor of the JLRS Newsletter (English Version) for two years. She is looking forward to improved propagation between JA and VK so be sure to say "Hi" to Akemi if you hear her on the air.

## ALARA Contest

Don't forget the ALARA Contest on Saturday, 8 November (details elsewhere in *Amateur Radio*). This is the contest for YLs, and others, who don't usually like contests because all you do is swap numbers. You can do that too, as hard and fast as you like, and be rewarded by a big score; but, if you just like to chat and catch up with those YLs you

only hear once a year, that's fine.

Our Birthday net in July this year was a bit of a non-event, as several key operators were otherwise engaged, or forgot, and a few who listened and decided no-one was there didn't call so no-one knew they were there! So, let's make the Contest a fun get-together to make up for it.

## The Rhododendron Festival Award 1997

Dawn ZL2AGX

### Rules

1. The Award will run from 1 November to 16 November 1997 inclusive. It is available to all amateurs and short-wave listeners.

2. Contacts may be made on any band, any mode. Each station may be worked ONCE ONLY for each separate application for the Award.

3. New Zealand stations require 25 points from those listed below:-

- Compulsory contact with Special Event Station ZL6RFA – five points;

- Contact with Taranaki Branch Stations: New Plymouth Branch, ZL2AB; Hawera Branch 14, ZL2AWW; Rahotu Coastal Branch 32, ZL2ANN; Waitara Branch 47, ZL2TO; and Patea Branch 54, ZL2QF – three points; and

- Each additional Taranaki Station – one point.

4. Overseas stations require only six points, calculated as above, and **do not have to make a compulsory contact**.

5. Copy of log and fee to arrive before 31 January 1998 to: The Award Custodian, NZART Branch 27, C/o 45 Robe Street, New Plymouth 4601, New Zealand.

6. Fee covering certificate and return postage is \$6.00 each for ZL award applications; and \$US5.00 or fair equivalent for all overseas award applications. No stamps please!

### General

There are six different rhododendrons in this series. Each is a limited print with the kind permission of local artist Janet Marshall. The print to be used in 1997 is the third in the series, *R xanthostephanum* previously used in 1991.

ZL6RFA and Branch Stations will be operating on a roster basis during the Award period, on or about these frequencies on phone on most nights from 0700z: the Rhodo Net, 3.593 MHz; the ZL Awards Net, 3.677 MHz; and popular VHF and UHF frequencies. Any amateur frequencies may be used.

\*C/o PO Woodstock, QLD 4816

Tel: 077 788 642

Packet: VK4SHE@VK4RAT.#NQ.QLD.AUS.OC

Internet e-mail: rgratid@ocemail.com.au

ar

## VK QSL BUREAUX

The official list of VK QSL Bureaux. All are Inwards and Outwards unless otherwise stated.

VK1	GPO Box 600 CANBERRA ACT 2601
VK2	PO Box 73 TERALBA NSW 2284
VK3	40G Victory Blvd ASHBURTON VIC 3147
VK4	GPO Box 638 BRISBANE QLD 4001
VK5	PO Box 10092 Gouger St ADELAIDE SA 5000
VK6	GPO Box F319 PERTH WA 6001
VK7	GPO Box 371D HOBART TAS 7001
VK8	C/o H G Andersson VK8HA Box 619 HUMPTY DOO NT 0836
VK9/VK0	C/o Neil Penfold VK6NE 2 Moss Court KINGSLEY WA 6026

# AMSAT Australia

Bill Magnusson VK3JT\*

## National co-ordinator

Graham Ratcliff VK5AGR

Packet: VK5AGR@VK5WI

E-mail: vk5agr@amsat.org

## AMSAT Australia net:

Control station VK5AGR

Bulletin normally commences at 1000

UTC, or 0900 UTC on Sunday

evening depending on daylight

saving and propagation. Check-ins

commence 15 minutes prior to the

bulletin.

Frequencies (again depending on

propagation conditions):

Primary 7.064 MHz (usually during

summer).

Secondary 3.685 MHz (usually

during winter).

Frequencies +/- QRM.

## AMSAT Australia newsletter and

### software service

The newsletter is published monthly

by Graham VK5AGR. Subscription is

\$30 for Australia, \$35 for New

Zealand and \$40 for other countries

by AIR MAIL. It is payable to AMSAT

Australia addressed as follows:

AMSAT Australia

GPO Box 2141

Adelaide SA 5001

## Keplerian Elements

Current keps are available from the

Internet by accessing the AMSAT

FTP site, <ftp.amsat.org> and following

the sub-directories to "KEPS".

## Auto-track Accuracy

Last month a software update was announced on KO-23 by Roy W0SL. It corrected a small error in the Windows Driver for the Kansas City Tracker/Tuner. This program is used in conjunction with WiSP for ground station control when using the digital "PACSATS".

A lot of people use this system but the error probably went unnoticed by most users. I certainly had no reason to suspect any inaccuracy. I had been in the practice of checking (usually every six months or so) by over-riding the auto-track system while it was in operation, momentarily nudging the up/down, right/left buttons on the control box while watching the "S" meter. Normally the "S" meter reading would go down slightly and then back up as the auto-track took over again. This satisfied me that the system wasn't too far off line. Every now and then

the "S" meter would rise slightly but I put that down to incorrect computer time or old keps, either of which could have that effect.

After installing the upgrade I thought I'd give it a thoroughly good test under actual working conditions. You can do this by setting it up to track the Sun if you have a set of Sun "keps" in your computer. A word of warning, though! Some of these are very unreliable and need to be checked against a good astronomy program to see if they do really tell your rotators the exact position of the Sun.

I use another method which, as far as I can ascertain, is very accurate. Keplerian elements are available for all the large satellites which are visible shortly after sunset each clear night. The keps are in standard NASA format so they will work in any of the commonly used tracking programs. After making sure the computer clock was accurate to within a second or so, I set the auto-track system to track one of these satellites which happened to be visible that evening and went outside to look up along the boom of the antennas. Presto! there was COBE, right on target.

My satellite antennas, like most, are quite low so this method does not present too much of a problem except at very low satellite elevations. It enables you to check the TOTAL accuracy of your system including the amount of incremental movement, the lead or lag, and the "dead-time" of your rotator system.

There is no shortage of visible objects to track. Many such satellites and expended rockets are in orbit. I use software called SatSpy-2 to decide on which object to track. The author of SatSpy, Dave Cappellucci, maintains a database of NASA 2-line element sets running into thousands of such objects. The keps are freely available at his web site, <http://www.usa.net/acappella/> which also contains a sample version of SatSpy for downloading and evaluating. The fully functioned version is well worth registering. I reviewed it in the February 1996 column.

During some (KO-23) correspondence with Manfred XQ2FOD on this matter, he made the following suggestion which is worth passing on as an example of the use of modern technology in setting up a tracking antenna. Manfred said, "I went to a mountain that is in direct sight from my rooftop, and memorised the position in my GPS receiver. Then I returned home and asked the GPS to tell me the exact azimuth from my home to that mountaintop. I sent the rotator to that

position, at elevation zero, then climbed my roof and adjusted the antennas to point to the mountain. I adjusted the elevation with a level gauge".

He went on, "This method easily reaches two degrees accuracy, which is better than the rotator's potentiometer, and the meters, and fits very well in the 20 degree beamwidth of my UHF antenna".

Manfred also made the following important observation, "The computer time is MUCH more critical than old keps. If you have your computer time 10 seconds off, this will cause much more error than keps that are one month old, unless you are tracking something unstable like MIR".

Thanks to Manfred for these observations. It reinforces my earlier suggestion of using a program like AccuSet to keep your computer time absolutely spot-on. UO-22 users can opt to update their computer time from the time frames broadcast by this satellite every 10 seconds. It must be remembered that, in all these tests and set-up procedures, you are making one important assumption. That the main radiation lobes from your antennas are in fact in line with the booms. Don't laugh - check this out first! You may be surprised.

Please don't ask me what to do if you find (as one friend did) that the main lobe from his 2 m antenna was slewed away by something like 40 degrees. This situation is most likely caused by some physical error in construction and errors of this magnitude should not be too hard to correct. Good tracking software allows for slight slewing error correction but it's best to play safe and do what you can to ensure that your antennas are in fact radiating in the direction they are pointing!

## Long Haul on KO-23

I noticed an interesting message recently on KO-23. A station in Colombo, Sri Lanka, reported seeing uploads by two stations in Perth WA. Being an "Easterner" I have no idea if this is a common occurrence. The footprint would not cover both these areas for long but it raises the possibility of some interesting satellite DX from Perth on some of the higher satellites like the RS series. Here in the south-east we have windows to ZL, Antarctica and some of the islands to the north, but that's about it as far as the LEOs are concerned. Long live store and forward!

## Whatever Happened to Baby Jane?

I'm often reminded of the old Joan Crawford/Bette Davis classic movie when I'm asked, "Whatever happened to xxxxx?" by someone seeking to know the exact reason why a particular satellite was lost to the amateur service.

It's hard to keep up with the precise

technical details and they are not always easily understood by the layman. Usually the explanations appear soon after an incident and they are easily forgotten.

Recently, Chris Jackson G7UPN, in response to such a question, again explained the reasons for the removal of UO-14 from amateur service. "Earlier this year the secondary On-Board-Computer (OBC) on UO-14 failed after a high energy radiation hit. The primary OBC is still functioning 100%, as is the third OBC. However, neither of these computers are available for use as store and forward communications servers. It's possible that UO-14 may make its way back to the ham bands in the future".

It has been a bit more difficult to find the precise reason for RS-10's apparent demise. It fell silent in late May this year and, as far as I know, is still silent. No further explanations have been forthcoming from the control centre.

The much heralded Arsene satellite suffered a similar fate a few years ago. After a very promising start and a superb orbit it went silent and once again very little explanation was published as to the actual cause.

DOVE, DO-17, has had a chequered history of periodic problems but the controllers are always forthcoming with a reason and program of repairs. I believe it is again undergoing a software upload.

Tom Clarke's explanation of the reason for MO-30's sad demise was fully covered in this column few months ago.

As far as I know RS-16 is still silent with no imminent hope of recovery. I have not seen any explanation published as to its cause of failure.

### New Satellite from Surrey

In the June column I reported the news that Surrey University was about to add to its stable of UoSat birds. Chris Jackson G7UPN, in an article in *Oscar News* for August 1997, has described the first of a new series of UoSats. To be known as TMSAT-1, it has been built in collaboration with an organisation in Thailand as part of the University's on-going technology transfer program.

TMSAT-1 will have an amateur radio component which will take the art into the next century. Until now the fastest data rate available to the amateur radio satellite community has been 9.6 kb/s and, although this is quite fast, it is far behind the common Internet user rates of 28.8 kb/s and higher.

One of my non-ham friends keeps reminding me of this fact. He'd better duck for cover now because as well as a 9.6 kb/s downlink, TMSAT-1 will have a working downlink running at 38.4 kb/s as well as an experimental transmitter running at 76.8

kb/s. The 38.4 kb/s downlink will require a totally new approach to receiver design. It will not be possible just to add wider filters to a normal rig as in the case of 9.6 kb/s.

At present it looks as if a complete new receiver chain will need to be designed and no such device is available commercially, at least not in the amateur sphere. It seems that this puts it firmly back into the realm of the home builder, at least in the foreseeable future.

The new higher baud rates will make it possible to handle the very large files generated by the high definition cameras on board TMSAT-1. New picture file processing software will also have to be developed. The ultimate resolution of the earth-imaging system will be better than 100 metres/pixel for the narrow angle camera and 2 km/pixel for the wide angle camera. File sizes of three megabytes or more can be expected, hence the faster downlink baud rates.

This is a most exciting prospect and will amply reward those who make the effort to get an earth-station up and running for TMSAT-1. 100 metres per pixel compares more than favourably with the NOAA weather satellites when working in high resolution mode (HRPT). If all goes well we can look forward to some spectacular imaging.

### "In Case You Think Nothing's Happening" Department

Some folks seem to think new satellites grow on trees. Many take for granted the enormous amount of work that goes on behind the scenes. Take this quote from a recent AMSAT-NA news bulletin for example: "An international team of Phase 3D project workers assembled on August 18th at the Phase 3D Integration Laboratory in Orlando, Florida, USA to continue the final mechanical and electronic integration efforts on the satellite. Teams from Germany, Belgium, Slovenia, Hungary, Japan and the Czech Republic joined their American counterparts in an all-out marathon to prepare the satellite as quickly as possible for a safe and successful launch. Workers at the Orlando Integration Lab were racing to make the needed structural modifications to the satellite since it became known that Phase 3D would, during its planned Ariane 502 launch, most likely encounter environmental loads greater than those originally stated.

"Keith Baker KB1SF, AMSAT-NA Executive Vice President, reports from Orlando that these significant mechanical upgrade efforts are proceeding. "The folks here at the Lab have been burning the midnight oil over the past several weeks to make these structural changes on a work schedule where 16 to 18 hour work days have

been the norm, rather than the exception", Keith said.

"He went on to note that, "These people have done an absolutely superb job under some extremely difficult circumstances. We all owe them a tremendous debt of gratitude for their outstanding work."

"Over the last week, these round-the-clock efforts continued with the combined team's current activities installing and checking out a significant number of the remaining electronic and mechanical pieces into the satellite. Such efforts included installation and checkout of the spacecraft's momentum wheels, the RUDAK digital experiment, and the 2.4 GHz and 24 GHz transmitters, as well as a number of other transmitters, receivers and other equipment, some of which were being re-installed after having been previously removed to facilitate the structural modifications.

All the above is in addition, of course, to the unaccountable number of VOLUNTEER hours needed to design, produce and test the components of Phase 3D in the first place. How many of us will remember this when we press the button and hear our voice come back from P3D?

\*RMB 1627, Milawa VIC 3678

E-mail: vk3jt@amsat.org

ar



**AMATEUR  
TRANSCIVER  
RADIO CENTRE**

LARGEST SUPPLY OF HF/VHF/UHF  
TRANSCIVERS AT COMPETITIVE  
PRICES

**ALINCO** SYDNEY'S BEST  
ALINCO RANGE OF  
TRANSCIVERS & ACCESSORIES  
VHF UHF MOBILES HAND HELDS  
**NOW IN STOCK FOLLOWING MODELS**  
DR-150T DR-605T DR-140T DX-70TH  
DR-610T DR-605T DJ-G5TY  
DJ-X10 SCANNER  
NEW DR-130T DJ-191T DJ-S11 DJ-S41  
**LOTS MORE NOT LISTED**  
**PHONE FOR LOWEST PRICES**

 IC-756 IC-706MKII  
IC-207H IC-T7A

**KENWOOD** TS-570S TM-V7A  
TM-251

 **Cushcraft** ANTENNAS  
**AMERITRON** HF AMPLIFIERS  
**EXPAND YOUR COLLECTION TODAY**

**PHONE (02) 9896 2545**  
**141 GILBA ROAD,**  
**GIRRAWEE, NSW 2145**

# ARDF – Amateur Radio Direction Finding

Ron Graham VK4BRG\*

Here it is. A new column in *Amateur Radio*. What name should this column have?

Various names describing the activity commonly known as “fox-hunting” exist. As well as fox-hunting, some others that seem commonly used are radio sport, radio orienteering, foxceering and ARDF. My personal choice is *ARDF – Amateur Radio Direction Finding*, as it seems to best describe the actual activity, particularly to a non amateur. And these are the people to whom we often have to relate. They are the ones that, noticing our strange (to them) activities say, “hey, what are you people doing?”. We need a simple answer, one that isn’t ambiguous, and one that may be expanded on should they ask more questions. So, how about ARDF?

In choosing this name, it is my idea that, for the purposes of this column, all Amateur Direction Finding activities be grouped under this name, mainly for a matter of convenience. One can fully appreciate that various ARDF Groups around the country will retain their favourite name, one which is meaningful to them in their area and to their particular activity.

I think one of the main purposes of the column should be to inform and possibly bring together various people around this country who have an interest in ARDF. I have a strong impression that there are a number of groups who are actively engaged in, or would like to be engaged in, ARDF activities of one type or another and who are completely unaware of the existence of other groups.

To assist in publicising these various groups it is proposed to ask them to forward details of their activities, contact person, etc, and then to publish that information in this column. Further, it is thought that this information could be correlated and published annually thus giving an overall view of ARDF activity in Australia.

This would enable, amongst other things:

1. People in various areas to find existing groups;
2. If there isn’t a group, to be able to form one, hopefully via their local Club;
3. Visitors to an area to “check out” what’s happening in that area; and
4. Groups to be made aware of neighbouring groups and thus organise exchange visits, swap ideas, and arrange some friendly competition, etc.

Enlarging further on the above theme, I

think the direction that this column takes should be guided by the input from the various ARDF Groups. In fact, the long term existence of the column will need continuous input from others; details of what you are doing, the odd “interesting” ARDF related story, ideas regarding “rules” that you use, etc. Plus, of course, the new – new ideas, new techniques, details of new equipment and so on.

There does seem to be a fair bit happening ARDF-wise these days. If we can get this column running, these items can be published and, hopefully, gain momentum.

ARDF is on the agenda for the Region 3 IARU conference in Beijing during August. New “technical” rules will be discussed and, hopefully, introduced. Some ideas that these could introduce would make ARDF more interesting to both contestants and spectators, would allow the use of cheaper (more readily available equipment, eg FM), less physical endurance to suit warmer climates (existing rules originate from the colder climate of Europe), having multiple transmitters transmitting at the same time and thus provide more of a technical challenge, are just some examples. I think the idea is that existing rules will remain for the serious international competition, but concurrent competitions using the new rules will also be run. Wally VK4DO will attend (self-funded), so we will have a first hand report on his return.

JOTA isn’t far away. The use of some form or other of ARDF is definitely on the increase for JOTA. I was pleased to note that mention

**Are you reading  
someone else's  
Amateur Radio?  
Call  
03 9528 5962  
to find out how  
to get it every  
month!**

was made of “fox hunting” in the paperwork circulated to our local Sarina Scout Group from the Scout HQ. It even gave some examples regarding simple equipment. Hopefully, Scout and Guide interest in ARDF will continue to grow. We should be able to assist!

I have also been approached by FARS (Friendship Amateur Radio Society) International regarding the establishment of a FARS Australia. Briefly, FARS was formed about 10 years ago between a Group in Victoria, BC, Canada and a Group in Kabarovsk, Russia. Since then, Groups have been formed in Japan and USA. They have a strong interest in ARDF plus other amateur radio related activities like CW and contesting, although it appears to me that the actual “friendship” or social contact between Groups is about equally important as the sum of the previously mentioned activities – a nice aspect in my opinion. They have a “get together” every two years. One has just concluded in Japan with the next being scheduled at Portland, Oregon, USA in 1999. A suggestion has already been made to the effect that they would “strongly consider” the possibility of holding the year 2001 event in Australia should a Group actually be formed here.

Personally, I think it would be great to form FARS Australia, although it would mean a certain commitment on our behalf. I think, to organise and actually send a reasonable size team to the bi-annual events. Finding suitable keen CW operators may prove another challenge. Although it appears it isn’t essential that each Group take part in all activities, it would be nice to show the flag!

In closing, I would like to say that I am happy to assist in getting this column established in *Amateur Radio* magazine. The current thoughts are a column on a bi-monthly basis. It will DEFINITELY need input from others to continue. As previously mentioned, there seems to be a reasonable amount currently happening on the Australian ARDF scene. That activity will also need input from various parties if we are going to maintain, and hopefully increase, activity. Importantly, I do think ARDF could prove to be a way of introducing young people to this aspect of the hobby, and possibly onto other amateur radio related activities.

To start that input, I can be contacted via the addresses below, although e-mail is preferred.

\*PO Box 323, Sarina QLD 4737

E-mail rongraham @ magnet.com.au

Packet VK4BRG @ VK4BRG.#CQ.QLD.AUS.OC

ar

# Awards

John Kelleher VK3DP - Federal Awards Manager\*

## The Green Award

From time to time a little gem of an award appears on my desk. This one originated with Toly UT3UY, who was the leader of the original DXpedition to Libya in July 1995. It came to me via Steve VK2PS.

This award can be obtained by licensed radio amateurs and SWLs for contacts with 5A1A in July 1995. Two contacts are needed, two different modes, or two different bands. Please send your list of contacts with a fee of \$US10.00 or 18 IRCs (or equivalent) to: Anatoly Kirilenko UT3UY, PO Box 439/3, Kiev-151 252151, Ukraine.

## 605DX

A note from 605DX requests that the following VK4 stations please acknowledge contacts with him. All are SSB.

1991: VK4LR, NHJ, DMJ, DPB, AFL, JV, JDH, DBB, SAA, GBT.

1992: VK4NAD, NHM.

1993: VK4KPB.

1994: VK4AUD.

1995: VK4OJ, VK4UA.

I must admit that information was indeed scarce, to the point that I do not possess QSL or manager directions. Perhaps a short note to VK4CY may bring some results.

## Rally Australia Awards

The Redcliffe and District Radio Club Inc has responded to my plea for information on local awards. The following comes from their Awards Manager, Kevin Jones VK4AKI.

1. The object of this award is to travel around Australia by radio, making progressive contacts as you go. Valid contacts are those made on or after 1 October 1986.

2. The award is available in two grades:

(a) The BASIC award is a two colour certificate printed on parchment style card.

(b) The ENHANCED award is an etched aluminium plaque in gold on a black background. It will be engraved with the recipient's details.

3. The two grades are totally separate awards. It is not necessary to complete the Basic Award before attempting the Enhanced Award. Contacts made for one award DO NOT count toward the other.

4. Band and Mode endorsements are available. Packet contacts are valid.

5. Short-wave listeners are eligible to participate in these awards. The following rules, with the inclusion of the callsigns of both stations logged, apply.

## 6. Basic Rally Australia Award

(a) This award requires contacts with 25 cities and towns around Australia.

(b) The FIRST and also the FINAL contact must be with a Redcliffe and District Radio Club member. These contacts are deemed to the Redcliffe checkpoint regardless of the member's QTH.

(c) The following Cities are MANDATORY checkpoints: Redcliffe, Brisbane, Sydney, Canberra, Melbourne, Hobart, Adelaide, Perth, Darwin, Mount Isa, Townsville, and Redcliffe.

(d) A further two contacts in each of VK2, 3, 4, 5 and 6 with a further one contact in each of VK1, 7 and 8, made in progressive order along with the mandatory contacts.

(e) The Rally may be run in either direction, ie Redcliffe-Sydney or Redcliffe-Townsville, etc;

## 7. Enhanced Rally Award

(a) This award requires the accumulation of 1000 points from progressive contacts throughout Australia.

(b) Contact with all the mandatory checkpoints (as per the Basic Award) are required.

(c) Points are awarded for contacts with VK1 (20 points), VK2 (10), VK3 (10), VK4 (10), VK5 (10), VK6 (10), VK7 (20), and VK8 (20).

## 8. Applications:

(a) The applications for these awards should be accompanied by a certified log extract, signed by two other amateurs, showing date, time, frequency, callsign, and location of the stations worked.

(b) The fee for the Basic Award is \$5.00 or five IRCs.

(c) The fee for the Enhanced Award is \$25.00 or 25 IRCs.

(d) Applications for either of these awards go to: The Awards Manager Redcliffe Radio Club Inc, PO Box 20, Woody Point QLD 4019, Australia.

## 9. Contact Information.

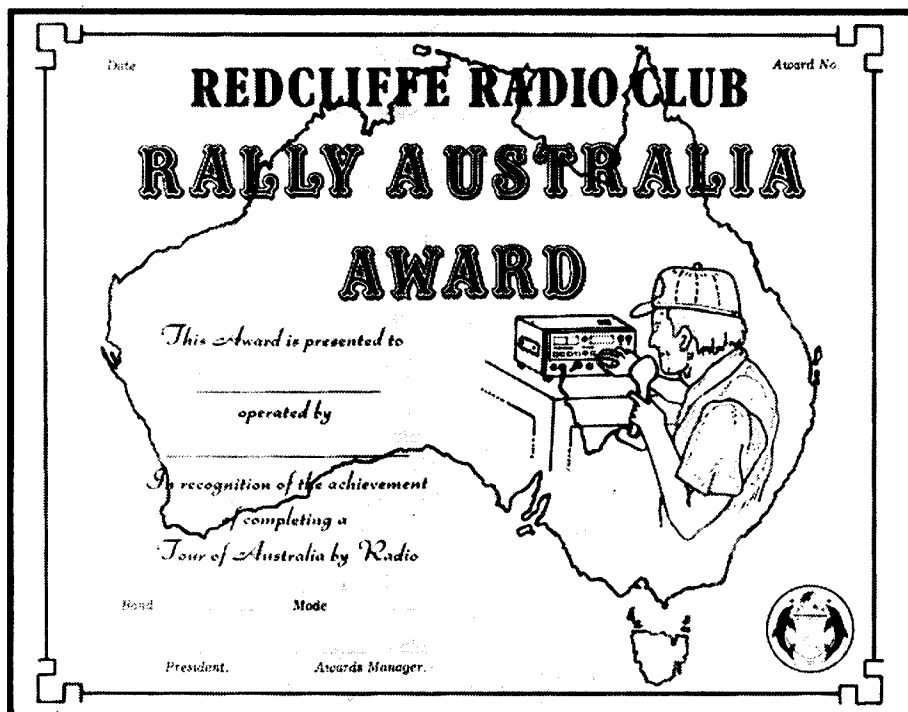
(a) Contact with a Redcliffe Radio Club member is only required for the start and finish contacts. Any licensed amateur may be worked for all other districts.

(b) The Redcliffe and Districts Radio Club conducts the Club Net every Sunday on 3.612 MHz at 1930 EAST under the callsign VK4RC. Club station VK4IZ can also be heard in most VK contests. A list of members can be obtained by sending a SASE to the Awards Manager.

## Redcliffe City Award

1. This award requires an amateur in VK or ZL to contact six Club members to qualify - VK4RC and VK4IZ count as two members.

2. Any amateur station in Region 2 or 3 (SE Asia, North or South America) requires contact with four Club members to qualify. Again VK4RC and VK4IZ count as two members.



Rally Australia Award - 261 x 212 mm.

# REDGLIFFE CITY AWARD



Awarded to .....

for radio contact with

REDGLIFFE CITY RADIO CLUB MEMBERS

Award Number .....

Mode ..... Date .....

Awards Manager .....

the same as for the two Rally Awards above.  
The packet address is:  
VK4ITM@VK4ITM.#BNE.QLD.AUS.OC

## Mongolia - The Saga

Readers may remember a reference to an award applied for by a member early in 1993. By June of that year the member had received a letter from officials of the Radio Club in Ulaan Bator that he had been awarded certificate #1. The member then followed up on this information by airmail, then registered mail, and by postcards, to no avail. He tried an alternative Box number, and went through the whole cycle again. Still no action.

A phone call from Steve Pall VK2PS (that man again) shed some light on the problem. A friend who was a journalist, and also an amateur, was going to Mongolia and Russia to write a series of travel articles. He was prepared to visit the relevant authorities in Mongolia with enquiries about the missing award.

Some months later our member received a phone call from the itinerant journalist who had possession of his award, and would he kindly collect it. In his own words our member said, "I drove from my QTH to his at just under the speed of sound".

In passing, I also tried to shake up the Mongolian people, but I have no idea whether they received my letter, as I have not yet received a reply. I possess details of three current Mongolian Awards. If, after this "saga", I have any takers I am prepared to publish this information.

\*4 Brook Crescent, Box Hill South, VIC 3128  
Phone (03) 9889 8393

3. Any amateur station in Region 1 (Europe, Asia, Africa) requires contact with three Club members to qualify. Again VK4RC and VK4IZ count as two members.

6. Fees to cover the cost of the award, \$AUS5.00 (VK/ZL/P29), \$US5.00 (Regions 2 and 3), or five IRCs (Region 1), must be included with any application.

7. The address for the awards manager is

In a bid to attract some of the older stalwarts of our hobby back to the "field day fold" it was decided to strike a compromise this year to mix the older type of activity (as of years gone by) with modern electronics activities, seminars, and bells-and-whistles trade displays, etc. The aim was to attract amateurs and their families back to events such as our country field day, complete with a well planned official dinner on the Saturday night.

As a result of diverse publicity and direct invitations sent to many of the "old-timers" who used to attend our conventions ten or twenty years ago, we were pleased to see well over 75 registered for the official dinner, which was opened by the president of the WIA (NSW Div) Geoff VK2EO. The guest

speaker was that well-known amateur direction finder expert Wally VK4DO, who made the trip with his cohort Frank VK4CAU from far northern Queensland.

It was a great night, particularly with the presence of so many old familiar faces and their wives whom we had not seen for years. Stacks of rag-chewing at all levels in a very cordial atmosphere ensured that the function went on into the very late hours. It should also be mentioned that we received a great many apologies from old-timers whose health or personal circumstances prevented them from attending.

The Sunday was the day of the field events, trade displays, seminars, flea market, hidden transmitter hunts, scrambles and talk-in hunts plus heaps and heaps of rag-chewing between

**Redcliffe City Award - 212 x 187 mm.**

3. Any amateur station in Region 1 (Europe, Asia, Africa) requires contact with three Club members to qualify. Again VK4RC and VK4IZ count as two members.

4. Band and mode endorsements are available. Packet contacts are valid. SWLs are eligible to participate.

5. Applications for this Award should be

## Club Corner

### Riverina Field Day

What a rewarding weekend it was in Wagga on 9 and 10 August. This was the bi-yearly presentation by the Wagga Amateur Radio Club of the well-known Riverina Field Days. As many will know, this annual event is alternated between Albury and Wagga and it is always well supported.

However, it has been felt that there has been a steady decline in the attendance of the older conservative amateur who is often more interested in meeting old friends and rag-chewing than studying the ultra high-tech equipment and seminars that often form a major part of modern conventions or field days. This trend of "losing the older amateur" was something the Wagga organisers decided to arrest if possible.





The trade and flea market area at the 1997 Riverina Field Day.

those that had arrived Saturday and those who swelled the attendance ranks on the Sunday.

The end-of-day closing ceremony and the presentation of prizes took place around 3 pm, to enable those who had long distances to travel sufficient time to make the return journey in a safe manner.

A great weekend and a big thank you from the Wagga Club organisers to those who attended and participated in any way. It is hoped that a similar group will make the effort to journey to Alhury next August, and then back to re-visit Wagga in 1999.

Sid Ward VK2SW

### Riverland Radio Club Inc

The Riverland Radio Club Inc held its Annual General meeting on 3 July 1997. The elected committee consists of David Wilson VK5NAP, President; Mike Mackintosh VK5CK, Vice President; Doug Tamblyn VK5GA, Secretary/Treasurer; Tony Hutchison VK5ZAI; Adrian Reimann VK5AJR; Kingsley Brauer VK5AKN; and Malcolm Gardener VK5UBT.

The President, David Wilson VK5NAP, announced in his annual report that the club enjoyed a very active and interesting year.

At the August meeting, Jim Brown from GME Electrophone gave a very interesting talk and hands-on experience of the GPS system.

In September, members are hoping for a clear night, as a sky watch night has been organised at Adrian Reimann VK5AJR's QTH.

The club has two new members who joined at the last meeting. The club meeting night is the first Thursday of each month.

Doug Tamblyn VK5GA  
Secretary

### Gold Coast Amateur Radio Society Inc

It's that time of the year again when the organisation for the Annual Gold Coast Hamfest commences.

The venue for the 20th Hamfest is again at the Albert Waterways Community Centre on the corner of Hooker Boulevard and Sunshine Boulevard.

Doors will be open to the public at 9.00 am on Saturday, 8 November 1997. Exhibits can be set up from 7.30 am.

The organisation committee wish to take this opportunity to invite you to participate in this annual event by displaying and offering for sale your goods and equipment or just promoting your club and hobby interest.

The charge for exhibitors is \$15.00 per table to cover the cost of space and the tables and chairs required. Two free entry passes will be given to each exhibitor.

If you wish to reserve a table or two, please apply to PO Box 588, Southport QLD 4215 by 8 October 1997. For any queries, please contact Rosemarie or Jim on 07 5525 1886 after 7.00 pm.

Rosemarie Scholz  
Vice President

### Coral Coast Amateur Radio Group

2100 hrs GMT 28 September 1967 - 28 September 1997 on 7.060 MHz

On 28 September 1997 the Coral Coast Group had been in operation seven days a week non stop for 30 years, having made a total of 258,320 contacts including tractor, aeronautical, marine and normal mobile contacts. During that time 43 of its members became SKs.

The instigator and net controller of the

ICOM Clearly Ahead



# "VK3LZ calling!"

More sound information from your friends at Icom.

LET YOUR MOUSE TUNE INTO THE WORLD!

Have you heard about Icom's new IC-PCR 1000? It's an amazing 'black box' that connects to your desktop PC or laptop to give you all-mode receiver capability. That's WFM, FM, AM, SSB, and CW with a frequency range of 0.01 - 1300 Mhz. The IC-PCR 1000 features a choice of three different interface screens, real-time bandscope function making it easy to find busy frequencies, and an unlimited number of memory channels.

You get all this for a much cheaper outlay than buying each radio individually, and we even supply the single aerial! We've had some unsolicited feedback from those who have already used the IC-PCR - 1000 and it has been unanimous... this is one amazing unit!

IMPORTANT DATES TO REMEMBER.

Perth Hamfest  
Sunday, November 2, '97

Daycom Icom Day  
Saturday, November 29, '97

"...73"

FreeCall 1800 338 915

290 -294 Albert Street  
Brunswick, Victoria 3056  
Tel : (03) 9387 0666  
Fax : (03) 9387 0022

ACN 006 092 575

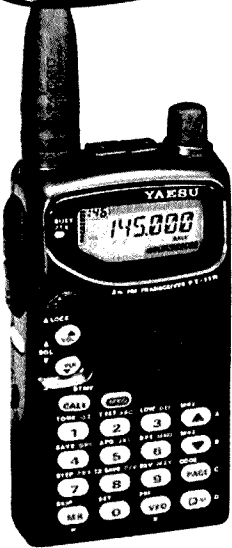
LL BROWN ADVERTISING 6182

# DICK SMITH ELECTRONICS

## Performance That Sends Out The Right Signals

Whether its transceivers, hand-helds, antennas or software, Dick Smith Electronics has everything you're looking for. At prices that communicate great value.

**SAVE \$100**



### FT-11R Micro Deluxe 2m Hand Held

One of the world's smallest 2m FM hand helds with a full-size keypad, the Yaesu FT-11R has been reduced in size but not in features. Designed to fit comfortably in your hand, it weighs just 280g.

- Large backlit LCD with full frequency readout
- 150 memories (75 in alphanumeric readout)
- Easy SET mode for customising functions
- Thumb-controlled volume and squelch
- Auto battery save, TX saver and power off
- Efficient FET RF amp with 1.5W RF output as standard, 5W with optional battery or DC adaptor
- DTMF-based selective calling and paging
- Extended 110-180MHz receiver coverage
- Naming of memory channels
- DTMF message paging with up to 6 alpha-numeric characters
- Australian version auto repeater shift
- 57 x 102 x 26mm (W.H.D.)
- With FNB-3 1 600mA/H NiCad pack, belt clip, AC charger, CA-9 charge adaptor and antenna

D 3640

**\$399**

**2 YEAR WARRANTY**

### YAESU FT-736R VHF/UHF Base Station Transceiver

Whether your interest is in talking through your local repeater, operating SSB DX or talking to the world via satellite, this high-performance multimode base station transceiver can do it all! In its standard form, the FT-736R provides 25W output on the 2m (144-148MHz) and 70cm (430-450MHz) bands in SSB, CW and FM modes. Can be expanded to cover the 6m (50-54MHz) and 23cm (1240-1300MHz) bands by installing optional modules.

- Digital control with keypad VFO frequency entry
- Efficient switch mode AC power supply
- 100 general purpose memories
- 10 full-duplex memories, 2 independent VFOs per band
- 2 full-duplex VFOs: transmit and receive frequencies can be tuned independently or synchronously for satellite operation
- Adjustable IF notch and IF shift filters
- Noise blanker and 3-speed selectable AGC
- High stability (+/- 1ppm) PLL reference oscillators
- Speech processor and VOX for SSB
- VFO or selectable channel steps on FM
- Digital input connection for packet TNCs

D 2920

**2 YEAR WARRANTY**

**\$2695**

6m module

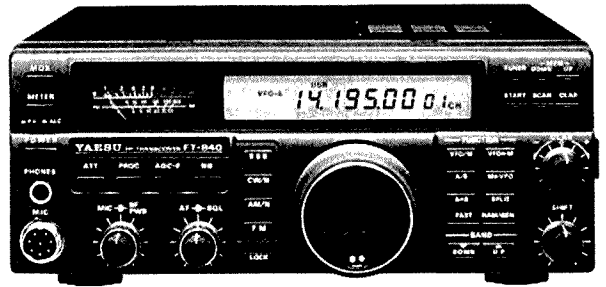
D 2921

**\$499**

23cm module

D 2922

**\$899**



### FT-840 Economical HF Mobile Transceiver

A serious HF transceiver that won't break the bank and doesn't compromise performance at home like many current micro-rigs. The Yaesu FT-840 gives you full 160m to 10m amateur band coverage with 100W PEP output on SSB/CW/AM, continuous receiver coverage (100kHz-30MHz), 100 memory channels, a large backlit LCD screen, an effective noise blanker and an uncluttered front panel. The FT-840 is simple to use, with useful features like an SSB speech processor for added audio punch, IF shift to fight interference, and Direct Digital Synthesis oscillators for cleaner transmit and improved receiver performance. Includes DC power lead and hand microphone... just connect your power supply and antenna and start having fun.

D 3275

**2 YEAR WARRANTY**

**\$1395**



**GET READY FOR THE NEW PHASE 3D SATELLITE WITH A YAESU FT-736R**

#### Specifications

- Modes: LSB/USB (J3E), CW (A1A), FM (F2D, F3E)  
 Receiver: 50, 144MHz - dual conversion, other bands triple conversion  
 Sensitivity: SSB/CW - better than 0.2uV for 12dB S+N/N;  
 FM - better than 0.35uV for 12dB SINAD  
 Size: 368 x 129 x 286mm (W.H.D.)

Offers expire 30/9/97



# DICK SMITH ELECTRONICS

*That's where you go*



# OPEN DAY!

## SATURDAY 25TH OCTOBER 1997

- **Huge savings on Ex-Demo Gear**
- **On-Air Demonstrations**
- **Plenty of On-Site Parking**
- Special prices on new and ex-demo equipment, with some items below cost!
- See Yaesu's latest dual band FM mobile, the FT-8100R. Also see the new FT-920 HF/6M base station rig on-air.
- A selection of transceiver and accessory samples at really unbelievable prices, many with warranties!
- Qualified Amateur staff for advice and assistance.
- See Yaesu's latest computer control software for handhelds and mobiles.
- Huge range of all the latest Yaesu equipment on display plus a large range of antennas and accessories.
- Bring your license with you for on-air demonstrations.
- It's under cover, so come along rain or shine!
- Light refreshments available.
- One Day Sale also running in our North Ryde Showroom, so bring the family for a fun day and savings.

## *Where do you go?*

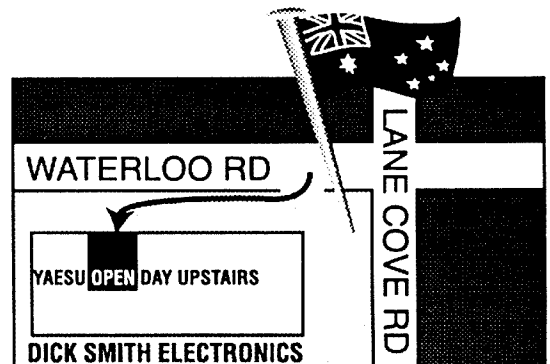
**Dick Smith Electronics**

Cnr Lane Cove & Waterloo Rds., NORTH RYDE

Ph: (02) 9937 3355

*Located in the Training Room. Directions will be signposted.*

*Plenty of free parking.*



B3117

Group is Les Bell VK4LZ. Les is located in Airlie Beach and is an extremely fit 93 years of age. Les was awarded an OBE for his efforts and services in WW II in the development and operation of radar in the RAAF.

Les Daniels VK2AKZ

### Northern Corridor Radio Group Hamfest 1997

The Northern Corridor Radio Group Hamfest 1997, to take place on Sunday, 2 November, is the Communications event of the year! It will have amateur radio, CB, Internet and related hobbies all displayed in the one location for people to look at, and to discuss the latest equipment and techniques with suppliers and friends.

There will be many live displays as well as a major raffle, homebuilt equipment contest, food, drink and a second hand equipment sale to tempt everyone.

The event will be held at the Cyril Jackson Recreation Centre in Fisher St. Bassendean, WA. It starts at 10.30 am and runs into the afternoon. Entry is \$3.

For more information, telephone Des on 08 9405 4215, fax on 08 9409 1203, e-mail to [jmcbride@omen.com.au](mailto:jmcbride@omen.com.au), or packet to vk6zj@vk6anc or vk6fja@vk6anc.

**James McBride VK6FJA**  
Secretary,

Northern Corridor Radio Group.

### RAOTC (Radio Amateur Old Timers Club)

As I write this in September, your committee is concerned that about one third of our members have not renewed their annual subscriptions which were due on 1 July.

We cannot believe that this is intentional, or that it is sending us a message apart from that we must find a more effective way to bring members' attention to the renewal date.

Arthur Evans is working on a proposal. In the meantime, it has been necessary to mail out reminders, an unwelcome expense.

We are trying hard to hold our subscription rate down to its present level of \$5.00 despite rising costs for our major expense, printing and postage of our twice yearly magazine OTN. If all the work involved in this was not entirely voluntary, we would be struggling to put out one copy each year. 'Nuff said!

**Allan Doble VK3AMD**  
ar

## Contests

Peter Nesbit VK3APN - Federal Contest Coordinator\*

### Contest Calendar Oct - Dec 97

Oct 4/5	VK/ZL/Oceania DX Contest (Phone)	(Aug 97)
Oct 5	RSGB 21/28 MHz Contest (Phone)	(Sep 97)
Oct 11/12	VK/ZL/Oceania DX Contest (CW)	(Aug 97)
Oct 18	Asia-Pacific CW Sprint	(Jan 97)
Oct 18/19	JARTS WW RTTY Contest	(Sep 97)
Oct 18/19	Worked All Germany Contest (Mixed)	(Sep 97)
Oct 19	RSGB 21/28 MHz Contest (CW)	(Sep 97)
Oct 25/26	CQ-WW DX Contest (Phone)	(Sep 97)
Nov 1/7	HA QRP Contest	
Nov 2	High Speed Club CW Contest	
Nov 8	ALARA Contest	
Nov 8/9	WAE RTTY DX Contest	(Jul 97)
Nov 8/9	OK-DX CW Contest	
Nov 15/16	IARU Region 1 160 m Contest	
Nov 22/23	CQ World-wide DX CW Contest	(Sep 97)
Dec 6/7	ARRL 160 m Contest	
Dec 13/14	ARRL 10 m Contest	
Dec 27 -		
Jan 25	Ross Hull VHF/UHF Contest	
Dec 31	ARRL Straight Key Night	

There is a list of jokes doing the rounds at the moment, which start off with "You know you're a ham when..." followed by things like "the telephone rings and you answer QRZ", or "you celebrate your wife's birthday by taking her on a romantic camping holiday, which just happens to coincide with Field Day", etc. Digging in the backyard today, I discovered a new one: "You know you're a ham when you're laying extra soil to level out the lawn, and you start worrying about the loss of antenna height" (it's true!)

Our contest managers do their best to keep entrants happy; however, leathers occasionally get ruffled, and letters appear. These range from exceedingly polite, to dark suggestions about the contest manager's sanity.

The following was received by one of our long-suffering managers recently, and I think you will agree it is a gem:

*"This note is to protest about the (...) rule in the (...) contest. I find this rule particularly objectionable and repulsive, and I demand that it be withdrawn immediately! Being a contest operator and supporter of contests, we do not need such autocratic and Hitler-like rules being promulgated in the Amateur Radio Fraternity... I have informed prospective contestants that they should ignore this infringement on their rights to enjoy a hobby which they have worked hard for, and which semi-literate morons insist on fouling up!"*

*To the author of this rule, I suggest you withdraw it in toto; or resign from the position of being associated with this contest, or better still, commit suicide! I recommend you follow all three! This great hobby does not require such rules by self-righteous upstarts!"*

As of this date, the manager is still alive. I will keep you informed of any further developments.

For information and assistance this month, thanks to VK2SRM, VK3DID, VK3DMS, HA5JJ, I2UIY, OE4BKU, OK2FD, and ZL1BVK. Until next month, good contesting!

73, Peter VK3APN

### HA-QRP 80 m CW Contest

0000z 1 November to 2400z 7 November

This international contest takes place each year during the first seven days of November, and is open only to stations running a maximum of 10 W input power. Use 3560-3600 kHz, CW only. Call "CQ TEST QRP", and exchange RST, QTH, and names. Score one point per QSO with own country, and two points per QSO with others. Stations can be contacted only once during the contest for points credit. The final score equals QSO points times DXCC countries worked. Logs must show date, time, callsign, reports, and QTH and name of station worked. Summary sheet must include first name and QTH sent during the contest, Tx input power, and Tx output device. Send logs postmarked by 21

November to: Radiotechnika Szerkesztosege, Budapest, Pf 603, H-1374 Hungary. All entrants will receive participatory certificates, and outstanding scorers will receive a free subscription to Radiotechnika magazine for one year.

### High Speed Club CW Contest

0900-1100z and 1500-1700z, Sunday, 2 November

This contest runs on the first Sunday of November each year, and is sponsored by the High Speed CW Club of Germany. (Anyone who has come across any of those QRQ rag-chews, emanating from Germany, will recognise the challenge presented by this event.)

Use 80-10 m, and exchange RST plus serial number. HSC members will send their HSC membership number. Count one point per QSO with own continent, and three per QSO with other continents. The multiplier is the total number of DXCC countries, worked separately on each band. Note that stations can be worked once per band and period.

The closing date for logs is six weeks after the contest. Send your log to: DL8WAA, Frank Steinke, Trachenbergerstrasse 49, D-01129 Dresden, Germany.

### ALARA Contest

Saturday, 8 November, 0001-2359z

This Phone/CW contest is open to amateurs and SWLs throughout the world. The object is for YLs to work anyone, whereas OMs and Clubs can work YLs only. Bands are 80-10 m, and the following frequencies are suggested: 3560-3590, 7070-7100, 14250-14280, 21170-21200, 21380-21410, and 28380-28410 kHz. Each station can be contacted twice per band - once on phone, and once on CW. No lists, nets or cross-mode contacts please.

YLs should call "CQ ALARA CONTEST" or "CQ TEST ALARA", and OMs "CQ YL". ALARA members should send RS(T), serial number, ALARA member, and name. YL non-members, OMs and Club stations will send RS(T), serial number, and name. Club stations must identify as a club station each contact, and cannot use personal callsigns during club operation.

Score five points for each QSO with an ALARA member, four points for each QSO with a YL non-member, and three points for each QSO with an OM or Club station. On CW, if either operator is a Novice, score double points. SWLs should score five points per ALARA member logged, and four points per YL non-member logged.

Logs should show date/time UTC, band, mode, callsign worked, RS(T) and serial sent and received, name of operator worked,

status of the station worked (YLALARA, YL non-member, or Club), and points. Attach a cover sheet showing full name, callsign, operator's address, claimed score, and a signed declaration "I hereby certify that I have operated in accordance with the rules and spirit of the contest". Send the log to: Mrs Marilyn Syme VK3DMS, Box 91, Irymple VIC 3498, Australia to be received by 31 December.

Certificates will be awarded for the following: top score overall; top phone only score; top VK YL CW; top VK YL Novice CW (Florence McKenzie certificate); top ALARA member in each country and VK call area; top YL non-member in each continent; top OM in each continent; top SWL in each continent; top VK Novice; top overseas YL CW; top VK club station. Trophies will be awarded to the top scoring VKYL, and top scoring DXYL.

Logs must be legible (no carbon copies please), and will not be returned. The contest manager's decision will be final, and no correspondence will be entered into.

### OK-DX CW Contest

8/9 November, 1200z Sat to 1200z Sun

This CW contest occurs in the second full weekend in November each year. Bands 160-10 m. Categories are: Single operator, single and multi-band; multi-operator, single and multi Tx; QRP, single and multi-band (max 5 W out); and SWL. Single operator stations operate max 20 hours, with minimum one hour rest periods. Multi-band stations apply "10 minute band change rule" (multi Tx stations are exempt from this rule).

Send RST plus serial; OK stations will send RST plus three letter district code. DX (VK) stations score 10 points per OK/OL/OM QSO, and one point per QSO with another country. Multipliers are the sum of DXCC countries and OK districts on each band; final score is QSO points (all bands) times multiplier from all bands.

Note rest periods in the log, and use a separate log for each band. Cross-check sheets are required for 200+ QSOs. Logs can also be submitted in ASCII on DOS disk. Entries should be postmarked by 15 December, and sent to: CSRK, Box 69, 113 27 Praha 1, Czech Republic.

### IARU Region 1 160 m CW Contest

15/16 November, 1400z Saturday to 0800z Sunday

This year, this popular European contest is being sponsored by ARI (Italy). It is a world-wide contest, and everyone can work everyone, including stations in their own country. It is scheduled for the third full weekend of November each year.

The mode is CW only. Exchange RST + two or three letter district code (state or territory for VK). Score one point per QSO, and multiply by the number of different location codes worked PLUS the number of DXCC/WAE countries worked. Send your log to: ARI Contest Manager I2UIY, PO Box 14, I-27043 Broni (PV), Italy, postmarked by 31 December. SWL entries are also welcome.

### Results of 1997 Novice Contest

Presented by Ray Milliken VK2SRM

This year, 36 contest logs were received. 33 were for section (A) phone, three for section (B) CW, and nil for section (C) SWL.

The Keith Howard Memorial Trophy was awarded to VK4NSW, the Novice with the highest score in section (A) phone, and the Clive Burns Memorial Trophy to VK5NFJ, the Novice with the highest score in section (B) CW. These perpetual trophies are held on permanent display at the Federal Office, and in each case, the winners receive an inscribed wall plaque.

#### National Winners:

Section A Novice	VK4NSW
Section A AOCP	VK4AUG
Section B Novice	VK5NFJ
Section B AOCP	VK2SPS

# = National winners

\*\* = Highest Novice score for each state (excluding national winners)

\* = Special awards.

<b>Section (A) Phone:</b>	VK3CAM	172
VK4NSW #	VK4CG	159
VK4AUG #	VK2RD	155
VK2AKL *	VK2LEE	144
VK2LTD **	VK6BIK	119
VK4WSS *	VK4OD	94
VK5MAP **	VK6MIN **	87
VK2LMA *	VK2LES	79
VK4NBC **	VK8AV	67
VK4CXG	VK5UE	67
VK4BB	VK2CW	25
VK1SAC	VK8AR	24
ZL1BVK	VK6JS	19
VK4MOJ	VK2ASK	14
VK3KQB **	VK2MGM	9
VK4CAT	<b>Section (B) CW:</b>	
VK2HV	VK5NFJ #	89
VK3JWZ	VK2SPS #	41
VK4JAE	VK4XW	22

### Results of 2nd South Pacific 160 Metre Contest

Presented by Ian Godsil VK3DID

This Contest was held in July, and was quite well patronised. Comments indicated that conditions were generally good, and that it was an enjoyable event.

# Divisional Notes

## Forward Bias - VK1 Notes

*Hugh Blemings VK1YYZ*

## Digital Signal Analysis

Some of you may recall the excellent presentation by Dave Cameron VK1DC at our July meeting on a packet radio set-up that utilised an IBM PC sound card as a modem and with some clever software to do the mod/demod, packetising and user interface.

After the meeting adjourned for coffee, Dave showed some interesting work that he had been doing on the "radio signatures" of the various packet users around town. This work uses the same radio and sound card hardware but different software to the packet system he described in his main presentation.

Digital recordings are made off air of the various packet stations and a log kept of the call signs that correspond to each recording. Fast fourier transform algorithms built into the software are used for frequency domain displays, conventional amplitude/time graphs being used for the time domain. The resultant frequency and time domain graphs of each transmission yield a visual signature of each station.

Careful review of this data has shown that each station has a slightly different centre frequency, amplitude and key up characteristic which makes each of these signatures distinct. Dave demonstrated the variations in bandwidth and amplitude between the signals of some local stations on air at the time. All present were impressed by the amount of information that can be gleaned from this simple analysis.

Building on these techniques, a group of local amateurs are studying the signatures of local repeater users. Thus far, as one would expect, many different key-up signatures have been identified. Although harder to discern with a voice signal, frequency response coupled with background noise analysis is yielding similar unique patterns to those found on packet transmissions.

Listening on the repeater input frequencies from two different locations, one in the North of Canberra, the other Southside/Tuggeranong, this group have also begun an analysis of the signatures of our local repeater "kerchunkers". A database is slowly being assembled of these different signatures and will be the basis of a future VK1 Division award.

## WICEN Activities

WICEN ACT/Monaro will be looking for volunteers to assist with the FAI Rally of Canberra which is being held on 28, 29 and 30 November this year. If you've participated before and would like to help out again this year, please contact Simon VK1AUS or Phil VK1ZPL. Simon can be reached on 2 m voice most days or on 0419 439 925. If you've not been involved in years past but would like to be, please make yourself known to Simon or Phil who will be happy to fill you in on the details. From the experience of years past, this promises to be another enjoyable weekend for all.

## Coming Events

The presentation on lightning protection, which was scheduled for our September meeting, has been shifted to the 27 October meeting. The previously promised tea and coffee will also be there. Why not join us ?

## VK2 Notes

*David Thompson VK2NH*

## Time Marches On

By the time you read this there will be less than 90 days to the beginning of 1998, and under three years to the Year 2000 Olympic Games. It is interesting to realise that the eyes of the world will be on us for the Games and, as was found out in Atlanta, amateur radio will be on show in a big way. In the coming issues of the VK2 Notes I will keep you informed of the NSW Division's actions in the preparation of amateur radio and the setting up of its image program for the big event.

## VK2 Division Broadcast Frequency

VK2WI has been providing a broadcast of Divisional news on 20 metres for some time now on Sunday mornings. The frequency we have been using has now come under review, due to changing band conditions and spectrum use. Soon, we will be putting a new 20 metre transmitter on air and so are taking the opportunity to review our broadcast frequency. The two under discussion have been 14.175 MHz, which is also used by the VK5 Division, and 14.116 MHz, which is activated by the Traveller's net later in the day.

The VK2 Division has decided to check out the frequency 14.116 MHz and, if it is suitable, move there later this year. Also, we

Although not the primary aim of the contest, it was very pleasing to see some DX contacts made outside the South Pacific region.

My sincere thanks to all those who participated, and especially to those who sent logs. Your comments, too, were valuable and will be a help for future years.

The only plea that I would make is for contestants to please read the scoring rule CAREFULLY. Only a few operators correctly calculated their scores, so my red pen was quite active!!

**Good 160ing, and see you next year.**

**73, Ian Godsil VK3DID**

CW	QSOs	Pts	Mult	Score
Call				
ZL2SQ *	38	166	15	2415
VK3IO *	27	123	12	1476
VK3APN	23	100	12	1200
VI3PES	20	91	13	1183
ZL1ALZ *	21	99	11	1089
VK5GN *	31	115	9	1035
VK3DID	18	75	10	750
VK8AV *	14	70	8	560
ZL4GU *	12	60	7	420
ZL2JR	10	47	10	329
VK6BEB *	2	4	1	4

SSB	QSOs	Pts	Mult	Score
Call				
VK5CRS *	70	312	16	4992
VK3IO *	51	216	12	2592
ZL2JR *	36	165	11	1815
ZL1BRY *	27	117	8	936
VI3PES	23	91	10	910
ZL3TX *	20	100	7	700
ZL2AWH	16	74	7	518
ZL1UE	16	62	8	496
ZL1ALZ	17	70	7	490
VK3DID	18	66	7	462
VK3APN	15	51	8	408
ZL1AGO	15	57	7	399
VK5GN	8	34	6	204
VK8AV *	7	35	5	175

\*Certificates

## Results of 1997 Waitakere Sprint

Phone:	VK4LUV	11
VK1PK	* 46 VK6JS	6
VK2XT	* 43 CW:	
VK5NFJ *	34 VK3APN	* 23
VK2LEE	31 VK8AV	* 21
VK6NU	26 VK2QF	* 20
VK5UE	18 VK5NFJ	17
VK4MOJ	15 VK3DID	14
VK4JAE	13 VK6JS	9

\*PO Box 2175, Caulfield Junction, VIC.3175  
pnesbit@melbpc.org.au

ar

would like comments from listeners on the proposed move, to make it a successful one. Just let us know during call-backs after the broadcast, fax the office or e-mail us. A full listing of frequencies for the VK2 Division news broadcast can be found on the Divisions' page.

Speaking of frequencies, the good news (for some) is that the 6 metre repeater at Dural is expected to be operational soon. Output frequency will be 53.850 MHz while the input frequency will be 52.850 MHz.

### Thredbo Disaster

The information released from the site of the Thredbo disaster makes the survival of just one person even more miraculous, I think you will agree. Dave Horsfall VK2KFU, Publicity Officer for WICEN in New South Wales sent me an e-mail. Dave told me that, while indeed, as I had reported, WICEN had not been called on to provide emergency radio communications, the body of volunteers was activated to assist Police with such things as their Disaster Victim Registration (DVR) procedures in both the registration and public enquiry aspects.

Tasks included computer entry of information from Thredbo, taking calls from the public regarding the victims, training of Police officers for these tasks, supervision of the DVR Co-ordination Centre, and liaison between the Volunteer Rescue Association operators and the Police Service. Dave tells me that some assistance was also provided to the State Emergency Service Operations Centre.

Thank you for the information, Dave. It all just confirms that we in the amateur service should be proud of the selfless contribution that WICEN makes in the times of emergency. I dips me lid to you all! Well done, folks.

### JOTA

Last month I reminded you that the Jamboree of the Air is on again this year on the weekend of 18 and 19 October 1997. Hopefully, you will be helping, but if you aren't able to assist directly with communications with a group, if you hear a JOTA station and it means you can help your fellow amateurs with a contact, do so! The training and help through contacts and knowledge imparted about the hobby is very important, how little or large. Remember how much a thrill it was for you when you made your first contacts, whether on the other side of town or, if propagation permitted, on the other side of the world.

### Affiliated Clubs Conference

Registrations are being called for the next Conference of Affiliated Clubs which will

take place on Saturday, 15 November 1997, starting at 0900 hrs local. The venue is, of course, Amateur Radio House at Parramatta.

### Post Office Box

I have been constantly reminded, prior to my writing this column, to mention that the VK2 Division has made available a post box for those amateurs to use as their postal address for amateur radio related mail. This, of course, is a service to licensed amateurs (members of the NSW Division of the WIA) who do not wish to have their personal address published by the ACA on the Internet. If you are interested, please contact the Divisional office.

### E-mail Address

Probably, by now, you know we have a change of Divisional e-mail address. If you are addressing email to the office, please do so at [vk2wi@ozemail.com.au](mailto:vk2wi@ozemail.com.au).

If you would like to contact the VK2 Division regarding your hobby, please do not hesitate to contact the office or any of the Councillors. We will be only too pleased to hear from you. If you would like to get in touch with an individual Councillor, just contact our Divisional office and it will be arranged. Our free-call phone number is 1 800 817 644 and our address can be found on page 56 of this magazine.

Next month we'll have more to report, but if you have anything you would like us to include as VK2 news, send it to me at PO Box 82, Springwood NSW 2777 or by e-mail to [dthom@penrithcity.nsw.gov.au](mailto:dthom@penrithcity.nsw.gov.au)

### VK5 Notes

Ian Hunt VK5QX

Hello to you. These notes have been taken from scripts used for recent Sunday morning broadcasts. I feel that, as many members do not hear the weekly broadcast, the content is quite appropriate for publication in *Amateur Radio* magazine. As I write there have been many things happening of note.

### A World in Turmoil

I have been looking at the news and considering what goes on in the world.

There are some items which are quite amusing, others which are certainly educational and also instances where great developments are taking place. Most unfortunately, however, we see constant reminders of man's inhumanity to man. Not the least of these is the very sad recent news surrounding the death of Diana the Princess of Wales.



Antenna Sales International

HF- VHF - UHF MOBILE ANTENNA  
HF - VHF - UHF BASE ANTENNA  
CB - MARINE - AIRCRAFT

Monoband to Multiband  
Convert Now, to the all

New!

PERTH PLUS

HF Mobile antenna

with 80-40-30-20-17-15-12-10-6-2m Included

\*\*\*

Coaxial Cables & Fittings  
HF Spring Bases, Trunk and Gutter Mounts.

Outbacker OBB "Classic"  
Outbacker "Junior plus"

Split Models  
Helical Dipoles  
Long wire Dipoles  
Baluns

Now available from .

MELBOURNE  
Daycom Communications  
Ph 03 6436444

ALICE SPRINGS.  
Farmer Electronics  
Ph 089522388

DARWIN.  
Integrated Technical Services.  
Ph 089-815411

SYDNEY.  
Andrews Communications  
Ph 02 6369060

PERTH.  
Tower Communications  
Ph 4701118

ADELAIDE  
Johnston Electronics  
Ph 08 2871061

PERTH - Model

<http://intercon.com.au/outbacker>

TERLIN AERIALS Ph +61 (08) 9455 4288  
11 McElligott Court Ph +61 (08) 9455 4289  
Canning Vale WA 6155

NEW  
INFO  
VIDEO

Send \$ 5.00 for a 15 minute informational video  
Refundable with every antenna purchase.

Upon looking at the overall picture one could be forgiven for coming to the conclusion that the world is a terrible and wicked place in which to live.

You may also wonder just what place my comments may have in material produced for the Amateur Radio Service. Let me provide what may be a grain of hope amongst all this turmoil.

Amongst items presently appearing on the Packet Radio network are many messages from amateur radio operators in different parts of the world. Almost without exception these are of a nature which express sympathy, love and concern in connection with the events and people surrounding the death of Lady Diana. There is certainly a great outpouring of feeling which clearly demonstrates the fact that there are people who really do care.

Observation makes it obvious that such is not confined to amateur radio "packet" messages. It is undoubtedly occurring on other radio modes and can certainly be seen in the media at large.

Reading of the material being transmitted reinforces the belief that within the Amateur Radio Service we have the potential to do a great deal to contribute towards the understanding of others and towards international goodwill.

Based on this consideration might I politely suggest to you that, apart from just enjoying the fun of operating and taking part generally in the activities associated with our hobby, we could just now and again stop and consider for a moment how we can do a little more towards making the world a better place. I am absolutely convinced that amateur radio has a great potential for helping others in a wide ranging fashion.

Yes, the passing of Her Royal Highness the Princess of Wales should not go unmarked, even by the South Australian Division of the Wireless Institute of Australia. It is indeed a very unhappy situation.

Despite the ways of the world being as they are there is room for optimism and that hope which comes of better values as a result of the existence amongst us of people who recognise and strive to maintain such values.

### **A Busy Weekend**

I trust that you had a enjoyable time if you entered into the Remembrance Day Contest. I was only able to listen on a spasmodic basis as I was away in the South East of the State for most of the weekend; however, it appeared that it was all going well. I did manage to make just a few contacts within the last ten minutes of the contest whilst mobile on the way back to Adelaide.

### **Advertising Our Hobby**

Over the RD Contest weekend I did manage to demonstrate and describe quite a few aspects of our hobby to my travelling companions. I enjoyed doing this and I know that they were surprised at some of the capabilities available through amateur radio. That set me to thinking that we should take every opportunity to explain and demonstrate to people as to what our hobby is about. Perhaps, as I have, you could make a resolution to do this as much as possible.

### **Thinking About Ideas and Projects**

I recently had occasion to enter into a discussion with another operator regarding possible projects which could be implemented and helped towards fruition by the VK5/VK8 Division. I would like briefly to discuss this aspect of our endeavours.

Included in the important reasons for having a Divisional organisation are the representation of the membership as well as the fostering of the hobby in various ways. I would like to refer briefly to the latter case.

There may be many ideas which members have that could be quite viable if given suitable planning and support. This is where the Division should make available its facilities and expertise. Here we also must depend on you, the member, in a number of ways.

First of all, you can come up with ideas and suggestions as to things which can be done. Next, you need to present these ideas to the Division. It would be most helpful if, before you do this, you take just a little time to work out a plan as to how your idea could be implemented. The better your planning and presentation of an idea the greater the likelihood of it being adopted.

You do not need to have great technical skills and capability to develop an idea and bring it up to this point. Once a plan is presented it is possible that we can find amongst the membership people with technical capability and skills which will allow the plan to be developed to the implementation stage.

One other most important aspect of such organisation is that, if such a plan is approved and put into motion, it is always likely that the WIA can find some means of funding the particular project. This of course comes about because we do have the financial support of members and with such a group can put to use a larger composite contribution than can be raised by just a few individuals.

This is not to say that we can always afford to provide large amounts of funding for everything that we might wish for. However, I am sure that you can readily recognise the

value of having a healthy membership figure and the resultant strength in numbers.

After all, why else would we wish to run such an organisation if it was not for the benefit of amateur radio and members as a whole.

So, to this end, I would encourage you towards two purposes. Firstly, to submit your various ideas for improvement and projects for the hobby and, secondly, to encourage others, members and non-members alike, to understand the value of a united effort where our resources are pooled for the betterment and greater enjoyment of all of us.

I trust that the material provided above will be of interest to you and that it may provide food for thought as to some of the things we might do and approaches we can adopt to making amateur radio an even better hobby.

### **"QRM" News from the Tasmanian Division**

*Robin L Harwood VK7RH*

To celebrate World Amateur Radio Day on 20 September, the Southern Branch erected a station in the grounds of Parliament House. As they were very close to the weekly Salamanca Market, many came over to see what was going on. I will include a further report in next month's column. The monthly Northern Branch meeting was held at an industrial site in Launceston where they had a lecture and demonstration on modern welding techniques. I am sure that some will be putting it into practice with the erection of beams for the summer months.

Divisional Council also met in Hobart in late September. Results will be given over VK7WI and also in the November column.

John VK7JK, our Broadcast Officer, went on the sick list in late August and we do hope that you are much better now, John. Thanks to Andrew VK7GL for stepping in as acting Broadcast Officer until John was able to resume his duties.

This month sees the annual Jamboree of the Air (JOTA). Operations will be held in each region. The Domain Activity Centre station VK7OTC will be activated. In the Northwest, Kirby VK7KC is co-ordinating activities with several special stations planned to operate over the weekend.

Meetings for this month are: Southern Branch on Wednesday, 1 October at 1930 EAST at the Domain Activity Centre; Northern Branch on Wednesday, 8 October at 1930 Tasmanian Summer Time, probably at the Australian Maritime College in Newnham (this will be confirmed over VK7WI); and North-western Branch on Tuesday, 14 October at the Penguin High School. ar



---

---

# Education Notes

Brenda M Edmonds VK3KT\* Federal Education Coordinator

---

---

Most of you know by now, I expect, that the documents for the Regulations examinations are available on the Internet. There are two major documents, the "Licence Conditions Determination" which I mentioned in my last column and the "Amateur Radio Service Information Papers", which comprises papers on "Amateur Apparatus Licence", "Amateur Examinations", "Amateurs visiting Australia" and "Amateur Regulations". For those who do not have Internet access, copies of both are available from the ACA (formerly SMA) State Offices.

These documents differ considerably from the brochures RIBs 70-72 with which we are familiar. To begin with, they are dauntingly large on photocopied A4 paper. I am worried that newcomers will find the total package very discouraging. The LCD is 25 pages. The

Information papers total 32 pages. However, the "Amateur Regulations" paper (8 pages) contains the material from RIB 72 except for the section on Emission Modes, which is covered in the LCD. The old document on Interference may also be required. So far I have had no indication of any parts which could be considered non-examinable, or whether the whole of the published material may be examined.

The "Amateur Examinations" is a historic document. It contains the first edition of any Australian Regulations examination syllabus. I would be interested to receive comments from readers on the topics included in it. My committee, whilst appreciating that a syllabus has at last been provided, is not wholly happy with the contents and emphasis, and has not as yet discussed the question distribution on the

papers to be prepared from it. We hope for some further modifications as time goes by. Readers will note that it includes reference to International agreements and some ITU regulations. This will broaden the scope of the examination considerably, but reflects the move towards parity with the European syllabus so that Australian amateurs can gain the benefits of the CEPT agreement.

There is still negotiation required with the ACA before we can finalise the draft Regulations question bank. The Examination committee is working on this. Candidates and instructors will be kept informed as developments occur.

I have asked that all the material necessary for the examination be published in brochures as previously, but have been told that this is not the intention, because of the ease of altering the material on the Net if required. The ACA Internet site can be found at <http://www.aca.gov.au> or hard copies from the State Offices will be downloaded as needed and photocopied.

\*PO Box 445, Blackburn VIC 3130

ar

---

---

# How's DX?

Stephen Pall VK2PS\*

---

---

Some of us DXers, the big guns with high towers, big multi-band and special mono-band Yagis, long-wire antenna farms, amplifiers and a host of other gadgets, are often spoilt in the pursuit of our determined goal to reach the magical 329 DXCC country status. We often tend to forget that there are others who very often, due to circumstances beyond their control, are very much restrained in their DX activities.

Ivor VK3XB phoned me the other day to tell me that he and his wife Mavis VK3KS had worked 9M600 in the Spratly Islands. It was quite an achievement for them and they were very happy for the contacts. Why? Ivor and Mavis are not your average DXers. Since February 1991 they have lived in a retirement village, where antennas, towers, Yagi beams and dipoles are strictly not allowed. This was heartbreak news to these two amateurs, both keen CW operators, with well over 300 countries to their credit in the DXCC listing.

However, as the saying goes, "if there is a will, there is a way". After many discussions and pleas, they received permission from the village management to install a random wire antenna, which is 36 feet long (about 11 metres) and is only about 16 inches (410 mm) above the ridge-line of the roof. Fortunately the roof under the tiles is insulated with aluminium foil which is an advantage.

Our DXers have worked already more

than 150 DXCC countries from the new location in the past six years with the 11 metre long piece of wire. They have several antenna tuners, each pre-tuned for a different band, which allows them instant switching between bands. CW is the favourite mode used. Incidentally, Ivor received his licence in 1934 and Mavis in 1939. This would indicate to you their age. Congratulations to both of them on their wonderful amateur spirit which overcame the difficulties.

## The Mysterious Travels of VK9XL

In the introduction to my *How's DX?* column in the June 1997 issue of *Amateur Radio*, I described some events about Vlad UA0ZDA who was granted a short-term visitor's licence in 1996 to operate from Christmas Island.

I quoted the 4 July 1996 contact, when he used the callsign VK9XL/MM when he was going to IOTA island, AS-039.

Frank VK7BC advises me now that he also had two contacts with Vlad, our "speedy" traveller. On 18 April 1996 Frank worked Vlad from Papua New Guinea as P29VXL and he gave his Stavropol address. On 4 July 1996 Frank worked R0/KC7JEF who said that he was on Komandorsk Island (IOTA AS-039) and gave his QSL Manager as W7NJ. I checked the 1996 and 1997 US Call

Books and there is no entry for the call W7NJ.

Further research by Frank discovered that the owner of the call KC7JEF is (you have guessed it!) Vladimir Y Pichelin (spelled Pchelin) 18955 SW, Blanton St Aloha, OR 97007.

So, who is and where was our "traveller" Vlad in 1996 with the Australian callsign? Was he actually on Christmas Island, Lord Howe Island, in VK6 and in VK5, and a few days later in 4K5, again on Lord Howe Island, then in Papua New Guinea and finally on Komandorsk Island (55° N - 167° E)? Was he everywhere on dry land, or maybe he was tucked away in the radio room of a Russian "tramp steamer"? And why was he using the Christmas Island callsign in various parts of Australia and on the open sea?

When I had a contact with Vlad on 4 July he used the VK9XL/MM callsign and gave a VK3 amateur as his QSL Manager. On the very same day when Frank contacted him he was already using the R0/KC7JEF callsign. Why? Will we ever find out the full, true story of this "visiting" amateur?

## Auckland Islands K8VIR/ZL9 - ZL9DX

Ed K8VIR, PO Box 480, Green Valley, AZ 85622-0480, USA was active from Auckland Island in March and April this year (see May issue of *Amateur Radio*). Not so long ago he

sent me some photographs of his activity and a pamphlet about the rules and guidelines covering the entry of tourists to these New Zealand sub-Antarctic Islands. These rules highlight the problems existing also on the Australian sub-Antarctic Islands, such as Macquarie, Heard, and McDonald, etc.

Here are some interesting points. All the New Zealand sub-Antarctic island groups are National Nature Reserves and entry is by permit only. Tourist landings are not permitted on the Bounty, Antipodes and Snares Island Groups, and unmodified or near pristine islands in the Auckland and Campbell Islands groups. Tourist groups with entry permits must be accompanied by a Department of Conservation representative. Only Auckland Island, Enderby Island and Campbell Island will be considered for permits. All animal (eg rodents, wasps) and plant(eg seeds, soil) quarantine procedures are strictly enforced with all visits. An impact management fee is charged for the permit. Even more strict rules apply on the Australian scene to Macquarie Island, Heard Island and the nearby McDonald island.

### Dominica - J77FT

The well known German DXer, Frank Turek DL7FT, PO Box 1421 14004 Berlin, Germany had a short three week DXpedition to Dominica, one of the Windward islands in the Caribbean Sea. It is a small island about 515 km north of the Venezuelan coast. It has an area of 751 square km and the population is nearing 90,000 people.

The island nation became independent in 1978 after being ruled by Great Britain since the 1700s. Roseau is the capital and the largest city. Most Dominicans have African or mixed African, British and French

ancestry. Two thirds of the inhabitants live in rural villages. Dominica is a mountainous tree covered island formed by volcanic eruptions.

After his successful activity last year in Chad as TT8FT, Frank decided to visit Dominica this year. The plan was to spend one solid week DXing and a semi relaxed two weeks with his XYL, Sigrid DL7CN, who arrived on the island one week later.

However, Frank was not prepared for the upset of many of his plans. Here are some extracts from his letter: "I wrote to the PTT in Dominica nominating my choice of callsign as J77FT for my activity. The answer was, 'yes', but the callsign will be issued on arrival only. The fee was \$US25.00. The plane landed on the northern part of the island instead of in the south. After a one and a half hour taxi-drive, which cost \$US60.00, I arrived at my \$US150.00 a day hotel. My heavy luggage, antennas, cables, and summer clothes were missing. My baggage had not arrived with me. I stood there with my ICOM IC-740 in my hand and in heavy winter clothes, because there was -20 degrees Celsius and snow on the ground when I left Berlin.

"Next day I took a taxi looking for a QTH to operate from. It was difficult, because most people did not want 'ham radio' in their vicinity. After two days of taxi-rides I found a very good place on a big rock about 150 metres above sea level, in the north, for a week only. In the meantime my luggage had caught up with me, and there was time to pick up Sigrid from the airport.

"Our problems with the QTH continued. Next day we had to move out of the cottage for four days, then back to a smaller cottage for

three days, then back again to the first cottage for the rest of our stay.

"I started operating on 24 March 1997 at 0055 UTC and EA1DSK was the first contact. I closed the station at 2012 UTC on 13 April after working KA2PFU on 10 metres. I made 10,098 QSOs with 124 countries in the SSB mode on 10, 12, 15, 17, 20, 40 and 80 metres. It was a 'big adventure' on a 'big cliff' and in the middle of the jungle which contained more than 150 kinds of birds."

### Interesting QSOs and QSL Information

\* A35MJ - Mike - 14198 - SSB - 0513 - Aug. QSL via Michael J Downs KS7D, 10538 SE 96th Ave, Portland, OR 97266, USA.

\* KG4ML - Larry - 14187 - 0128 - SSB - Aug. QSL via Larry R Minnis WB6VGI, 619 Chapelgate, Odenton, MD 1113, USA.

\* FW5IW - Paul - 7005 - CW - 0619 - Aug. QSL via Paavo Miettinen OH5UQ, Jukank 4B 16, ST-55100, Imatra, Finland.

\* ZB2AZ - Ross - 7010 - CW - 0611 - Aug. QSL via Gibraltar Amateur Radio Society, Box 292, Gibraltar.

\* P40XM - 7010 - CW - 1101 - Aug. QSL via Guenther Rehbein DL3XM, Aeussere Lepziger Str 31, D-04435, Schkeuditz, Germany.

\* 9M6HIL - Bob - 14025 - CW - 1053 - Aug. QSL via Robert W Schenck N200, POB 345, Tuckerton, NJ 08087, USA.

\* CL8VP - Juan - 7015 - CW - 0708 - Aug. QSL via CO8RCG via Cuban QSL Bureau.

\* 9M6OO - Bob - 14025 - CW - 1114 - Aug. QSL via Robert W Schenck N200, POB 345, Tuckerton, NJ 08087, USA.

\* BX0CQ - Chen - 14190 - SSB - 0756 - Aug. QSL via Sky Chen BV8BC, Box 222, Taitung, Taiwan.

\* RX1OX/FJL - Slave - 14191 - SSB - 0756 - Aug. QSL via Nikolai Pfanenstiel DL6YET, Pfarrer Muller Str 10, D-48268, Greven Reckenfeld, Germany.

\* 9A50D - Frano - 14004 - CW - 0546 - Aug. QSL via Radio Club Dubrovnik 9A1BHI, B Bogosica 14, PO Box 88, HR 20000, Dubrovnik, Europe.

\* J6/PA3EWP - 10106 - CW - 0707 - Aug. QSL via Bob Snieder PA3ERC, Van Leeuwenstraat 137, 2273 VS, Voorburg, The Netherlands.

### Future DX Activity

\* The Royal Omani Amateur Radio Society club station A47RS, celebrates its 25th anniversary from 1 October to 31 December 1997. All A4 stations will use /SJ after their suffix, eg A41XX/SJ, etc. The special event station A43XXV will be



Frank DL7FT operating as J77FT in Dominica

operating from 17 December to 21 December.

\* Mike TL8MR will be in the Central African Republic for one year. QSL via F6FNU.

\* Mike XU6WV and Harvey XU2FB were reported to be active on 20 metres between 1130 and 1430 UTC on 14192-14195 and 14226 kHz.

\* Ian, operating from Tristan da Cunha as ZD9IL, can be found on most bands. QSL manager is Edwin ZS5BBO and QSLs can be sent direct to Edwin Musto, PO Box 21 1032, Bluff, 4036, South Africa.

\* Perry 5W1PC can be found on most weekends operating SSB on 15, 17 and 20 metres. His home call is WH6XY.

\* Ray WH6ASW is now active until December from Guam as WH6AW/KH2. QSL via VK4FW.

\* Al KK5ZX will be active every third and fourth day from Johnston Island Club station during his stay, beginning 23 August. Activity will be in the CW mode but there will be some SSB also. QSL via K3SX (ex K3SME).

\* Doug W3CF and Dick K3MQH will be active from the US Virgin Islands (from Windwood) with the contest call WP2Z, 22 to 30 October. QSL W3CF/KP2 to QSL Manager KK3S. QSL K3MQH/KP2 to his home call. QSL the contest call WP2Z (for this contest only) to KK3S.

\* A group of six Swedish amateurs will be active in the CQWW CW contest on 29 to 30 November from Cuba as T48RCT.

\* If you missed the two recent Spratly Island DXpeditions, try to work a British group sponsored by the Chiltern DX Club which is practically the UK DX foundation. They intend to be active in February 1998 with the provisional callsign 9M0C.

\* Hermann DJ2BW and his XYL, Margot DL2DK, will be active from Mayotte, from 9 to 22 October as FH/DJ2BW and FH/DL2DK on all bands from 160 to 10 metres, mainly on CW and RTTY.

\* There are a number of stations at present working from Uganda. Paul 5X4F, Mario 5X1C, Joe 5X1P, Matts 5X1Z and Peter 5X1T.

\* Len VK8DK has a new QTH. He has moved to Katherine in the Northern Territory.

\* Don KH8/N5OLS will be in American Samoa until February 1999. QSL to his twin-brother John N5JA. His favourite band is 160 m.

\* Jay K0BCN will sign as V31MX from Caye Caulker, Belize from 21 to 29 October.

### From Here and There and Everywhere

\* If you have worked any of the Omani stations with the Silver Jubilee (SJ)

additional suffix, and you wish to receive an award (five points are needed), A43XXV is worth three points, A47OS/SJ two points, and all other Omani stations one point. Send your certified log copy with 10 IRCs or \$US5.00 to the Omani Award Manager, ROARS, PO Box 081 Muscat 113, Sultanate of Oman.

\* Neil VK6NE, QSL Manager for the VK9 and VK0 Bureaux, advises that presently no VK0 calls collect their Bureau cards.

\* VI3PES was a special event station celebrating the 200th anniversary of Sir Paul Edmund de Strzelecki's birthday, the Polish born explorer and scientist who, in 1840, ascended a high mountain in south-west NSW and named it Mount Kosciuszko. QSL via the VK3 QSL bureau or direct to Polonia ARC VK3CRP, PO Box 199, Chadstone Centre, VIC 3148.

\* Have you ever heard VM4AA working on the bands? Yes, it is a legitimate amateur station. The callsign was officially allocated to Mac in Runaway Bay, Queensland some years ago by the then DoTC. It was the only callsign allocated out of the VM series, a brave attempt by certain officials, and squashed immediately by the higher-ups. At least that is the explanation which I have heard many times. However, the station was real on 7 MHz at 0652 UTC on 12 August 1997 working a VK3 station in the CW mode.

\* Jim VK9NS intends to travel to the UK at the end of September/early October. There is a rumour that he might operate from Bangladesh in those months.

\* VK6NE, QSL Manager for VK9, says that only VK9LA and VK9LH are collecting their cards from the VK9 QSL Bureau. According to Neil, the following QSL Bureaux are handling cards for members

only: SARL, South Africa; DARC, Germany; URA, Andorra; REF, France; PZK, Poland; NRRL, Norway; JARL, Japan; ARAM, Monaco; ARRAME, Morocco; REP, Portugal; and EAWC, Egypt.

\* The Pakistani Amateur Radio Society (PARS) advised that the call AP2AP being used by JA8WPP and/or JA1EZM is not correct. They say no such licence has been issued by the authorities to anyone and these 'amateurs' have no permission to operate in Pakistan. Hiro JA1EZM continued to be active as AP2AP despite the message put out by PARS and says that he has a good licence. Only time will tell.

\* The Japanese station JD1/J68NQJ left Minami Torishima in late September. QSL via JA8CJY.

\* The special event station J41WCA was active from Greece, celebrating the International Amateur Athletic Federation World Championships in Athens. QSL via SV1BSX.

\* The QSL cards for FK8GM and FK5DX are going via WB2RAJ (direct).

\* If you worked 7Q7CE in Malawi, he was Eli IN3VZE who ceased operations on 25 August. QSL to home call.

\* On the weekend of 23 and 24 August you might have heard a number of GB prefixes where the three letter suffix contained a letter 'L'. These stations were from Scotland, ten of them, taking part in the Northern Lighthouse weekend activity. The amateur radio stations were established at ten lighthouses. Concurrent with this event was the lighthouse/lightship activity weekend which included similar stations at lighthouses/lightships around the world. The participants were mostly European stations.

\* Lou PA0LOU, whilst attending the



Ed K8VIR/ZL9DX putting up the antennas at the main Auckland Island hut.

IARU Region 3 conference in Beijing, used the special callsign BT1IARU from 4 to 16 September.

\* The latest international beacon to become operational is OA4B in Peru.

\* In the August issue of *Amateur Radio* on page 39, I referred to the lack of donations from VK to the VK0IR (Heard Island) effort. I mentioned that only the VK2 Division supported the expedition. Since then, I have been advised by Neil VK6NE that the VK6 Division and the Northern Corridor Radio Group (NCRG) each donated \$500 to the cause. Well done!

\* ZS45TWR is a special callsign to celebrate 45 years of Trans World Radio, a Christian Short Wave Radio operating from different areas of the world. The callsign has been activated a number of times already and will be active until the end of 1997. The QSL manager is Leon M Foot ZS4Y, POB 1561, Welkom 9460, Republic of South Africa.

\* The Willis Island VK9W team used two callsigns. VK9WY was used by the YL operators, Ann WA1S, Elvira IV3FSG and Noriko 7K3EOP. The VK9WM callsign was used by the following male operators: Bob VK4MR, Eric FK8GM, Vlad OM3CUU/VK2AED, Darryl AF7O, Bill K6KM, Doug VE5RA, and Bill VK4FW. The VK4YN callsign was reserved for the activity on Holmes Reef. QSL for all operations go to VK4FW.

\* The well known QSL Manager, Gerald (Jerry) Branson AA6BB/7 is now a silent key. For the next three months all QSL requests sent to Jerry's address will be answered by a group of volunteers.

\* Allan G0IAS advises that he is not the QSL Manager for Jim 5Z4FM. QSLs should be sent direct to Jim Stewart, PO Box 63363, Mathaiga, Nairobi, Kenya. Please do not put callsigns of any kind on the envelope, otherwise cards get 'lost'.

\* In my column in *Amateur Radio* for March 1997 there was a note about the possible eruption of the volcano Big Ben on Heard Island. The *Sydney Morning Herald* now reports that the eruption was on the nearby McDonald Islands, and was detected in March this year, although the main event must have occurred in late December or early January. Scientists apparently are now jumping for joy because the volcano on McDonald is the first one to be discovered in the southern hemisphere for at least a century. Australia now has two active volcanoes, both in the Heard Island group.

### QSLs Received

BS7H (2 m - W4FRU); CU7BA (3 w - op); 5A1A (12 m - UT3UY); VK4ALF/9 (3 w - AA6BB); - KH8/N50LS (7 m - op - Don



Ed K8VIR/ZL9DX operating from the main Auckland Island hut.

Barclay, PO Box 8, Page Pago, AS 90799, USA); EM1KA (6 m - JA2JPA).

### Thank You

As always, I am grateful for the assistance given to me by many of you. Special thanks to: VK2XH, VK2KFU, VK2TJF, VK5WO,

VK6NE, VK7BC, VK9NS, DL7FT, G0IAS, K8VIR, ROARS, and the publications *Sydney Morning Herald*, *QRZ DX*, *The DX News Sheet* and the *425 DX News*.

\*PO Box 93, Dural NSW 2158

ar

## International Amateur Radio Union Monitoring Service (IARUMS) - Intruder Watch

Gordon Loveday VK4KAL\*

### 80 m DX Window

Recently, many observations have been reported to me of intruders in the 80 m DX window, that small portion of the band used to work DX via the "Grey Line". The frequencies of so-called interference were roughly stated as 3799 to 3800 kHz. The ACA have logged a signal on 3795.125 kHz with the same technical characteristics as the reported 3799 kHz signal, ie R3BCW. Cross reference points from Darwin and Brisbane resulted in a location in North Korea.

North Korea is in our Region 3 and is entitled to use Fixed and Mobile Services between 3500-3900 kHz.

I am not familiar with mode R3BCW. It must be an updated "old mode". It does suggest that if anyone uses the DX Window they may have company!

### 7100 kHz Interference

Representations to Beijing recently about a 7100 kHz transmission have brought a reply to the effect that adjustments will be made to remove the interference. So keep checking 7100 kHz.

### Indonesian Broadcaster Interference

We are looking for a firm identification of the Indonesian broadcaster on 7098 kHz. Can anyone improve on "RRI, Republic of Indonesia"? Maybe a town or city would pinpoint it!

\*Federal Intruder Watch Co-Ordinator, Freepost No-4 Rubyvale QLD 4702 or VK4KAL@VK4UN-1

ar

---

---

# Novice Notes

Peter Parker VK1PK\*

---

---

## Antennas for the Space-Restricted

### Introduction

The trend towards smaller lot sizes and inner-city living has made it harder for many amateurs to erect antennas, particularly for the HF bands. This, along with the fear of causing interference, has driven many to confine their operating to the VHF and UHF bands and/or when away from home. This article shows that it is possible to operate successfully from a confined space. I will concentrate on antennas for two, ten and eighty metres, though it should be possible to apply the ideas given to other bands.

### Antennas for Two Metres

The helical antennas supplied with handheld transceivers often perform poorly around the house. A better antenna is usually needed. This can range from a simple ground plane or J-pole to a beam and rotator. A difficulty often faced is finding a way of routing the feedline inside without compromising security, particularly if your home is rented.

Indoor antennas can be quite effective if you are near a repeater. Provided it can be placed near a window facing the direction of interest, its performance should be acceptable. Indoor antennas can take many forms. Some experimenters have successfully used self-adhesive copper tape to build quad loops. In this case, the tape is simply stuck onto a window pane or a piece of cardboard. Little space is required; a loop for two metres is about 50 cm square, while one for 70 cm is less than 18 cm square. Depending on how the loop is fed, it may radiate either horizontal or vertical polarisation signals. More information appears in *Reference 1*.

Another option is some sort of vertical antenna. These go under various names, such as "J-poles", "Slim Jim" and the like. Normally made out of metal tubing for outdoor use, the keen experimenter should be able to use materials such as PVC tubing, coaxial cable and 300 ohm TV ribbon to make an indoor version. Performance a little over that provided by a half wave dipole should be obtainable.

Although a half-wave dipole offers less gain than the more elaborate antennas mentioned above, they are easier to build. Because vertical polarisation is most common, a simple dipole can be hung

vertically behind a curtain or in a similar inconspicuous position. Or, when outside, hang it from a tree branch for better coverage on VHF. Simple vertical antennas are particularly useful when omni-directional coverage of a local area is desired, for example during club nets or local contests. Construction details of a dipole made from coaxial cable appear elsewhere in this article.

### Antennas for Ten Metres

The existence of the 27 MHz CB band has been a real boon for the antenna experimenter active on 28 MHz. Many CB antennas can be modified to ten metres with very little work being required. For fiat dwellers, a Yagi or quad is normally out of the question, though the possibility of installing a VK2ABQ miniature beam antenna for a few decibels of gain should not be discounted (*Reference 2*).



**Fig 1 - A 27 MHz mobile whip set up for 28 MHz amateur operation.**

Those with sizeable balconies or a backyard could try a horizontal dipole. The space required is about five metres. If fed with open wire line, the dipole should also work on 21 MHz with the addition of an antenna coupling unit.

Another option is a modified fibreglass CB whip. This is effective for both local and overseas contacts and occupies very little space. Longer whips give the best performance; a 1.8 metre whip is suggested. Good height and a clear outlook are desirable (Figure 1). A ground system is important. This can either be a metal roof, gutter, railing or one or two 2.5 metre long radials. Once installed, the whip is trimmed (using a hacksaw) to make it resonant on 28 MHz. To avoid over-cutting, saw off small pieces at a time (no more than 1 cm) and check the standing wave ratio (SWR) at the antenna after each cut. If the antenna is too long, you will find that its SWR is lowest at 28.1 MHz and gradually rises towards 28.6 MHz. Continue trimming the antenna until the SWR is lowest around 28.4 MHz. It will rise either side of this frequency but should be acceptably low over the whole Novice section of 10 metres. When you've finished, you will probably have sawn 8-10 centimetres off the antenna.

### Antennas for Eighty Metres

This is a challenging band for the amateur with little space. Though a compact antenna is unlikely to yield regular DX contacts, it should be possible in almost every case to enjoy fairly regular QSOs up to about 1000 km when band conditions are quiet. There is always a trade-off between bandwidth and efficiency with small antennas. Always aim for efficiency; it is better to be heard on one frequency than to be heard on none.

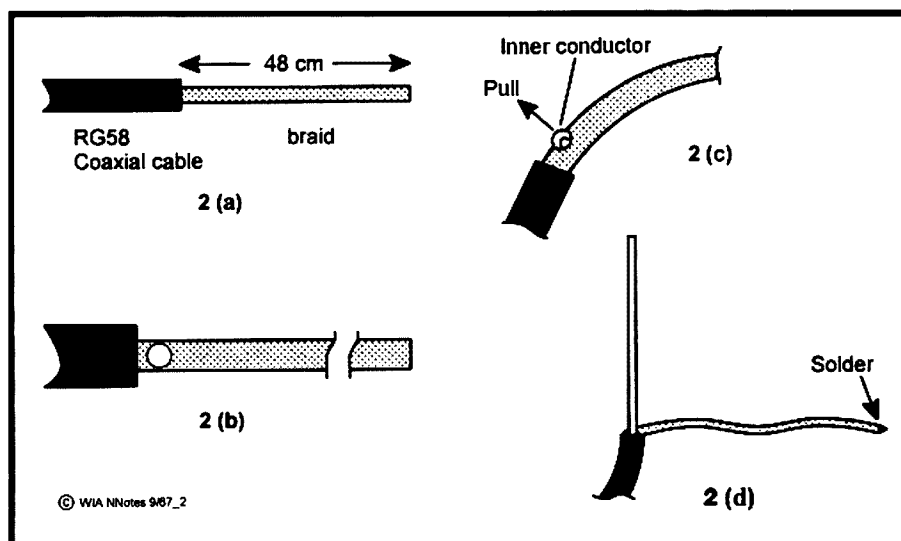
The use of 300 to 600 ohm open wire feedline (instead of 50 ohm coaxial cable) can allow a dipole cut for one band to operate on several higher frequency bands with the help of an antenna coupling unit. Of greater interest to us, however, is the behaviour of such dipoles below their normal resonant frequency. If your operating frequency is not much less than an antenna's design frequency (eg transmitting on 3.6 MHz using a tuned feeder dipole resonant at 5 MHz), such an antenna can be quite effective. Tuned feeder dipoles much shorter than this do work but are inefficient (*Reference 3*). I would suggest a dipole with a total length of at least 25 metres as a sensible minimum for efficient operation on 80 metres.

Some operators use end fed wires. An effective counterpoise is important, particularly if the wire is a quarter wavelength (20 metres) long or less. Some people use the gutters on their house for this.

However, there is a risk that poor electrical contact between lengths of guttering could act as crude rectifiers and cause interference-producing harmonics to be radiated. Half wavelength-long end fed wires exhibit high feed point impedances and are less dependent on an effective earth for correct operation.

Vertical antennas are another possibility. Again, an extensive ground system is needed for good efficiency. This greatly reduces their attractiveness to amateurs living in flats where access to any ground, let alone a good one, is difficult. People with backyards too small for a dipole may have sufficient space for a trap vertical. Several 80 metre operators known to the author have had good results with the commercially-made verticals manufactured by Andy Coman.

A rotatable dipole can be formed from two mobile whips. Such antennas have directivity and do not need extensive grounding systems. A description of such an antenna appeared in *Amateur Radio* last year (*Reference 4*). Bandwidth will be narrow, but experimentation with remotely controlled relay switching schemes, to allow a choice of



**Fig 2 - Construction of the hanging dipole for two metres.**

operating frequencies, may prove fruitful.

A magnetic loop is perhaps the smallest practical antenna for 80 metres and the only option for some. It consists of a circle or square of metal tubing brought to resonance on the operating frequency by a variable

capacitor. A single loop can cover several bands. The efficiency is lower than for larger antennas, but no ground system is needed and the antenna does not have to be very high off the ground. Loop sizes as small as 1.5 metres square are practical on eighty metres.

## Novice Plus

Helping you get more from amateur radio

### Build a Hanging Dipole for Two Metres

Described here is a simple omni-directional, vertically-polarised dipole for two metres. Made from coaxial cable, it can be rolled up and stored in a small container. It may be used as is indoors, or waterproofed for use outside. No extravagant gain claims are made; this dipole has no more gain than any other. However, it should be significantly more effective than the antenna that came with your handheld. The cost of building the project is around five to ten dollars. Allow about 20 minutes to construct and erect the antenna.

A single length of 50 ohm coaxial cable forms both the antenna element and the feedline. The antenna is made by removing a quarter wavelength of outer jacket and bending the braid back along the cable towards the transceiver to form a vertical dipole (Figs 2 and 3). This means no metal work or wiring is required (apart from attaching the BNC or PL259 plug).

#### Parts Required

The following is required to complete the project:-

- 3-4 m RG58 coaxial cable (*not critical - use longer length if height is needed or the operating position is distant from the antenna*)
- PL259 or BNC plug (*to suit transceiver*)
- small metal lug, washer or nut
- tape measure, scissors, small screwdriver, long-nosed pliers, multimeter, fishing line, soldering iron, etc.

#### Construction

1. Solder the PL259 or BNC plug to one end of the RG58 cable.
2. From the other end of the cable remove 48 cm of the black plastic outer covering to expose the braid (Fig 2 a).
3. With a small screwdriver (Phillips head is best) gently part the braid to make a small hole near where it ceases to be covered by the plastic jacket. Aim to make it about 5 mm in diameter (Fig 2 b).
4. Use either pliers or a screwdriver to pull the inner conductor out from inside the braid through the hole in the braid (Fig 2 c).
5. Fold the braid back along the cable towards the plug. Solder the end of the braid to prevent fraying (Fig 2 d).
6. Remove about 5 mm insulation from the inner conductor.
7. Solder the end of the inner conductor to a small metal lug or nut.
8. Thread fishing line through the lug or nut and hang the antenna in its desired position (Fig 3).
9. The antenna is now operational. You may wish to check the SWR and make it longer or shorter if the SWR is above about 1.5:1 at 147 MHz.

#### Erection and use

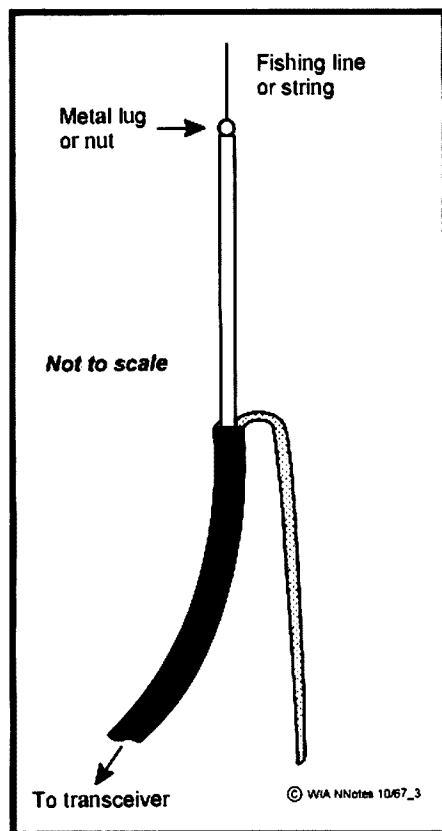
The antenna should be hung vertically for best performance. Keep it away from metal objects and have it as high as possible. Where signals are weak, hang the antenna near a window facing the repeater. If you intend to use the antenna outside, apply sealing compound to stop moisture entering the cable. Not doing this will mean poorer performance over time as cable losses increase.

although larger loops will be more efficient.

An effective magnetic loop antenna will have a thick, low-resistance element and good connections. The bandwidth will be narrow at 3.5 MHz; 10 kHz is typical. A narrow bandwidth (or "high Q") indicates that the antenna is efficient and resistive losses are low. A design that has worked well for the author will feature in December's *Novice Notes*.

## Conclusion

This article has provided a few ideas for those who may have thought that they had too little space to erect an antenna. Provided that care is exercised in the construction and adjustment of the antennas described here, all should yield acceptable results.



**Fig 3 - Hanging dipole for two metres.**

## References

1. Hawker, P. *Amateur Radio Techniques*, 7th Edition, RSGB, p 299.
2. Moxon L. *HF Antennas For All Locations*, RSGB, p 168.
3. Moxon L. *HF Antennas For All Locations*, RSGB, p 222.
4. Cook, R and Fisher, R. *Random Radiators*, *Amateur Radio*, Aug 1996 p 19.

\*7/1 Garran Place, Garran ACT 2605  
parkerp@pcug.org.au

ar

# Over to You - Members' Opinions

All letters from members will be considered for publication, but should be less than 300 words. The WIA accepts no responsibility for opinions expressed by correspondents.

## Promoting Amateur Radio

In his letter in September's *Amateur Radio* magazine, Kevin VK4AKI makes several valid points regarding the promotion of amateur radio. The letter's penultimate paragraph mentioned that there was little information on low cost amateur radio equipment (either homebrew or second hand) in communications magazines.

I hope that Kevin doesn't include *Amateur Radio* in his comments. In the last few years many construction articles on simple CW, SSB and FM equipment have appeared in *Amateur Radio*. During that period, the *Novice Notes* column also covered topics of interest to the budget-conscious amateur, including home-brewing and purchasing second-hand VHF/UHF equipment. Even non-members can freely access these latter articles via the Internet at <http://www.pcug.org.au/~parkerp/nonline.htm>.

Those interested in CW, QRP and home-brewing will probably benefit from membership of the CW Operators' QRP Club at <http://www.pcug.org.au/~parkerp/qrp.htm>. The Club's magazine, *Lo-Key*, frequently includes articles on simple homebrew transmitters and receivers. The CW Operators' QRP Club also has an innovative policy where members who promote the club by giving a potential member their *Lo-Key* have it replaced free of charge.

The above-mentioned magazines, being member-only publications, are seen by few potential amateurs. Having construction projects and articles on used equipment appear in more general magazines is therefore important. Fortunately, magazines such as *Radio and Communications* and *Silicon Chip* (see September 1996 issue for example) have featured some simple receiver projects in the last few years.

More amateurs writing articles for both *Amateur Radio* and other magazines would obviously assist these efforts further. The use of the Internet to spread information is also a promising development. Not only can we send text, photographs and schematic diagrams; sound transmission is now possible, so that the constructor could (for example) hear audio clips from a homebrew receiver before deciding whether it sounds good enough to duplicate it.

Peter Parker VK1PK  
7/1 Garran Place  
Garran ACT 2605  
parkerp@pcug.org.au

## Donation of Fluke Prize

I was happily to surprised to hear from e-mail correspondents that I had won a Fluke 12B after joining the WIA, Queensland Division.

While I've not yet seen the WIA News item on page 5 of the September *Amateur Radio* issue (*Amateur Radio* readers who subscribe to *QST* or *RadCom* will be familiar with the speed of trans-Pacific surface mail), it has been quoted as saying I'm an executive with a radio station. Tch, people will think I don't work for a living! In fact, I'm transmitter tech for TV stations WTHR and WALV-LP in Indianapolis, Indiana; officially, "Chief Operator/Senior Technician - RF", but it boils down to being the person who fixes the transmitter and other RF gadgets, and makes sure the Master Control operators keep transmitter logs up to date. Technical work of the dirty-hands sort, with only a modicum of paper shuffling.

The question is, what to do with the meter. The Fluke 12B is a very fine DVM, heavy for its size; shipping costs to the States may run close to the price of the meter! This seems an unfair burden, and probably was not anticipated in budgeting for the give-away. With that in mind, and as I already have several fine meters (including a Fluke) on the workbench, I would like to suggest the WIA locate a young VK ham of modest means who needs a DVM, and give it to him or her instead.

Lest I be accused of altruism, please bear in mind that encouraging an Australian ham to get deeper into the technology of the hobby does have an ulterior motive: one reason for my joining the WIA was the construction articles in *Amateur Radio*, and one more promising ham with decent test gear increases the odds of seeing more of them! Besides, I was once a young amateur of decidedly small budget and the OTs helped me along, so it's a debt to be repaid (and another debt, too; Ross Hull is not forgotten!).

Roberta J (Bobbi) Barmore KB9GKX

rbarmore@indy.net

ar

**Amateur radio -  
helping our  
community**

# Repeater Link

Will McGhie VK6UU\*

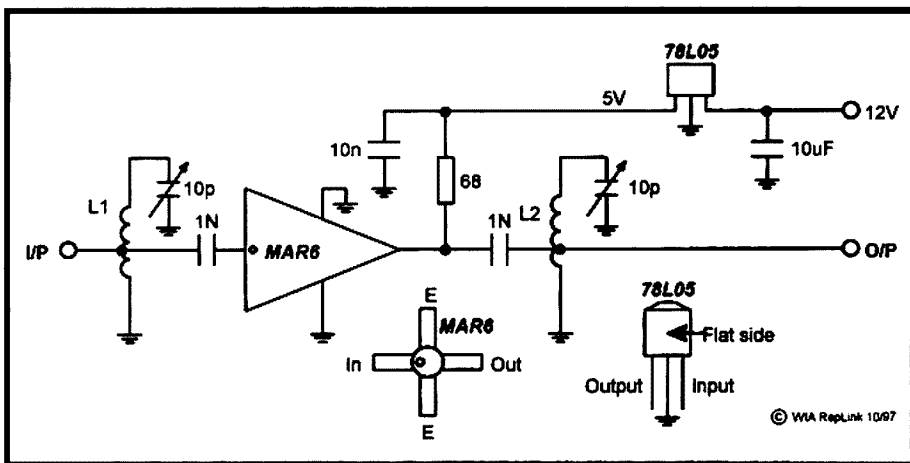


Fig 1 - Circuit diagram of the MAR6 band-pass RF pre-amplifier

## Projects

Even with limited time, I have a couple of projects under construction. One is a variable frequency two metre and 70 centimetre signal generator. The signal generator runs at one third of 146 MHz, and tunes the entire 2 m and 70 cm bands. However, the generator is not complete in terms of the circuit diagram ready for publication, and a few other loose ends.

This signal generator, after warm up, is very stable and provides signal levels on 2 m from about 50 microvolts, down into the noise. On 70 centimetres the signal level is from about 10 microvolts.

If you service a voice repeater, a signal generator is essential, but ready-made units are expensive. Some of the cheaper units advertised by a number of suppliers are of little use on VHF and above, mainly due to signal leakage. Apart from reasonable frequency stability, the next most important quality is signal leakage. It is of utmost importance that the signal from the generator only comes out of the output connector. Leakage from the generator via other means, such as the power supply lead or radiation from its container, mask the output level and make proper measurements difficult at best.

I hope to have this project ready soon, but if you would like some advance information and a circuit let me know. Getting a project from the working situation to the ready-for-publication stage, can take just as long as the time spent on the project.

## FM828 Sensitivity

The Philips FM828 is used in many voice repeaters. The units are cheap and reliable. However, the receiver has only moderate

sensitivity. Your average 828 at the 20 dB quieting point is around 0.3 to 0.4 of a microvolt. Today's receivers are at least 6 dB better than this, with some as good as 0.15 of a microvolt at the 20 dB quieting point.

A word on this 20 dB quieting point. FM receivers tend to be specified in SINAD these days, and the figure is so many microvolts for 12 dB SINAD. All SINAD means is the measured noise and distortion, the old N&D measurement. The original 20 dB quieting measurement did not measure the distortion on a test tone. It was a measurement of noise only on a non modulated carrier. As it turns out, the two measurements are about the same. The distortion measurement lowers the dB figure, so 20 dB quieting is about the same as 12 dB SINAD.

## By Ear

The 20 dB quieting point is easy to pick by ear. Lower the signal source down from a strong signal until the hiss (noise) starts to change its characteristics with the addition of crackle. Just before the start of the crackle type of noise is about the 20 dB quieting point. The noise is 20 dB down on an open mute with no RF signal. The level of microvolts being injected is the sensitivity. Having an accurately calibrated signal source is the difficult bit. Most modern commercial amateur radios on 2 m and 70 cm are around the 0.15 to 0.3 microvolt range. Compare this signal level to an FM828 to give you some idea.

## MAR6

I have tried many ways to improve the sensitivity of the FM828, from changing the front end RF transistor to one with a lower noise figure, to modifying the circuit, all with

little effect. It could be the loss in the two coupled front-end tuned circuits before the RF transistor that limits the sensitivity. These tuned circuits may be optimised for sharp selectivity rather than minimum loss.

I used a monolithic amplifier, the MAR6, in place of the existing RF transistor, and still no improvement. However, any reasonable RF pre-amp ahead of the FM828 receiver does improve the sensitivity considerably. The accompanying circuit uses the MAR6 as a bandpass RF pre-amp. This circuit is simple, and you would have seen the design many times as a broad band pre-amp without the two tuned circuits L1 and L2. These tuned circuits can be omitted and the input and output connected straight to the MAR6 via the DC blocking capacitors. However, the MAR6 has a very wide frequency response up to about 2 GHz. No need to amplify all these signals and then feed them into your FM828.

The 68 ohm resistor is important in that it sets the bias current for the MAR6. Some designs add a small RFC in series with the 68 ohm resistor.

L1 and L2 are six turns for 2 m, and three turns for 70 cm, 5 mm diameter. For 2 m, tap at about one turn, and 70 cm at half a turn. If the 10 pF trimmer capacitors don't resonate when fully meshed, add a few pF.

The 20 dB of gain and lower noise figure (2 dB) of the MAR6 will improve the FM828. It will improve your voice repeater as well, but this increased gain can cause more problems than it solves. Repeaters are struggling with overload problems as is, and the addition of more front-end gain has to be approached with caution.

Construction is on PCB material with as much ground plane as possible and good all-round RF layout. The MAR6 can be obtained from Oatley Electronics.

## 29 MHz Gateway Thoughts

There is increased interest in 29 MHz gateways now that they can be licensed. It is important that some common specifications exist in regard to the CTCSS requirements.

The 29 MHz receiver on the gateway can be open access. This means that the receiver is squelch operated. Any amateur licensed for 29 MHz can then access the gateway, simply by transmitting on the 29 MHz gateway frequency. This requires no modifications to the amateur's 29 MHz transmitter. However, if the gateway requires a CTCSS tone to access the gateway's receiver, then a CTCSS tone would have to be added to the amateur's 29 MHz transmission. Most, if not all, HF multi-band transceivers don't have CTCSS encoders built in.

This presents us with a problem. The 29 MHz gateway may well be on air but few, if



any, amateurs will be able to access it until they fit a CTCSS encoder. Not all that difficult, but difficult enough to slow the progress of use of the gateway.

So why the requirement for the CTCSS in order to access the 29 MHz gateway? There are two reasons. Firstly, 29 MHz is a noisy band with all sorts of signals. These signals will key up the gateway system and be re-broadcast out on the VHF and/or UHF repeater system the gateway is connected to. This will be very annoying to those listening on the VHF/UHF repeaters. CTCSS on the 29 MHz gateway receiver will stop this.

The second reason is to do with licensing. At this time we are not permitted to link between 29 MHz gateways. The reason for this is due to the linking regulations not permitting linking below 50 MHz. I would like to see this changed but it could take years. So, for the moment, we have to make do.

There are two ways around the problem of 29 MHz gateways linking to each other when propagation permits, and that is to use different gateway frequencies, or use CTCSS. There are three allocated band plan frequencies for 29 MHz, and they are 29.120, 29.140 and 29.160 MHz. The recommendation for the moment is for all gateways to use 29.120 MHz.

### Working

This is how it could work. All 29 MHz gateways on 29.120 MHz and requiring a 123 Hz CTCSS tone to access the gateway receiver. As the gateway 29 MHz transmitters are not encoded with 123 Hz, they can't link to one another.

From a users' point of view on 29 MHz, only one CTCSS Tx encoded tone is required, and only one frequency has to be monitored. When propagation allows, any gateway in Australia could be heard by being tuned to 29.120 MHz.

During the testing phase of the 29 MHz gateway, and to generate interest, the 29 MHz gateway receiver could run without the CTCSS requirement, but only for that initial time period. Once the interest was there, and help in installing a 123 Hz CTCSS encoder in the users' transmitters achieved, then the gateway would go to CTCSS.

### VK6 29 MHz

The 29 MHz gateway system for VK6 is ready for operation. However, there are several other projects also requiring time. Hopefully, the gateway will be on air before 1998.

*\*21 Waterloo Crescent, Lesmurdie 6076*

*Packet: VK6UU @ VK6BBR*

*E-mail: will@vale.furac.com.au*

**ar**

## Spotlight on SWLing

*Robin L Harwood VK7RH\**

The world was shocked and saddened to hear the very tragic news that Diana, Princess of Wales, was killed in a car crash in Paris on 31 August. The news reverberated around the globe in seconds with many stations hurriedly interrupting programs to announce the grim news. The BBC World Service ran continuously for 13 hours with news of Diana's death. It was a Sunday morning and everybody was completely unprepared for this event.

It was interesting observing how television completely took over coverage. Many of the reports were in fact taken off the television audio, whether CNN or the various British networks. When a major news event has previously happened, I usually tuned in to the BBC World Service to get the latest unbiased reports on the situation yet I found that on this occasion, television was very graphic and immediate in conveying the situation. Radio reports via the Beeb or other broadcasters did not have the same forceful impact that was conveyed in video form.

Throughout the week, Diana's death seemed to pre-empt all else in the print and electronic media, culminating in the final public farewell on the Saturday morning. This was broadcast over some stations live yet the best coverage on short-wave was provided by the BBC World Service, as relayed from the domestic networks, yet it did not have the same impact as television. We have to remember that there are many millions of people who do not have access to television. Short-wave radios are cheaper than satellite television receivers.

This fact has not been lost on many of the major international broadcasters who have rapidly concluded that satellite television may be out of the running in some target areas. There are regions where there are no receivers because of economic or political reasons. Some governments have actually banned private use of satellite television receivers.

There has been quite a deal of marketing hype from technical developers, particularly in Europe and to a lesser degree in the USA over various forms of digital audio broadcasting. No clear international technical standard has emerged as there are several competing systems vying for acceptance.

Major manufacturers naturally are very wary of making commitments until some universal agreement can be reached. One system known as Eureka 147 has been

developed by some European broadcasters but it is still a long way off becoming the standard for digital audio broadcasting. No receivers have yet been mass-produced because of these competing systems.

You will hear announcements from some broadcasters, such as Deutsche Welle and Radio Netherlands, that they are readily available over satellite transponders. However, the number of people accessing these are still in the hundreds. Equipment for decoding these is still expensive and these transponders are mainly for rebroadcast by domestic networks and cable operators. Programming usually is on an audio subcarrier of an existing television programme. It does appear that short-wave will continue to be around for at least a generation. There are regions and areas, which are not covered by satellite. Also, an affordable reliable receiving technology has yet to be developed, manufactured and marketed in sufficient quantities to be economically viable.

## Amateur Radio Index on Disk

**January 1968 to  
current issue.**

**IBM format 3 1/2 inch  
floppy disk.**

**Files in ASCII and  
.DBF format ready to  
import into your  
favourite  
workprocessor or  
database.**

**\$10.00**

**(includes disk and postage).**

**vk3br Communications Pty Ltd  
3 Tamar Court  
Mentone VIC 3194**

There was a recent move to have Australia's short-wave radio clubs combine to form an Australian DX Radio Federation. All clubs have found that their membership base has rapidly declined and costs to produce short-wave bulletins have increased. Bob Padula convened a meeting in early August to ascertain if there were ways and means where the clubs could co-operate and pool their dwindling resources. It looked promising at the inaugural meeting but since then only one club has indicated its willingness to continue. Bob Padula indicates that he is not going on with an

Australian DX Radio Federation because of this apathy. Fortunately, the Electronic DX Press is unaffected and will be continuing.

Yet another broadcaster is now being relayed by the BBC World Service relay at Skelton. The Sri Lankan Broadcasting Corporation in Colombo is now on from 1900 to 2100 UTC in Tamil, Sinhala and English on 5975 kHz. It has been heard here in Australia. Colombo is heard daily broadcasting to Australia on 11835 kHz from 1030 till 1130 UTC, also in English from a site within Sri Lanka (Ceylon).

Don't forget that the end of this month sees

major changes to broadcasting when Europe and North America revert to standard time. 26 October is the date scheduled for the changeover, which also is the day on which NSW, Victoria, the ACT and SA advance their clocks, Tasmania making their change on 5 October and NZ a week later.

Well, that is all for this month. Please note that I am no longer on packet and therefore will not be able to answer any messages sent via that means.

\*5 Helen Street, Newstead TAS 7250  
(03) 6344 2324

Internet e-mail: [robroy@tassie.net.au](mailto:robroy@tassie.net.au)

ar

## Pounding Brass

Stephen P Smith VK2SPS\*

In a recent issue of *Practical Wireless* I came across an advertisement on "The QRP Component Company", an overseas company selling a vast range of telegraph keys and run by Chris Pees G3TUX. Some of the keys offered by Chris include Bencher, Jones, Kent, DK1WE, Schurr and a beautifully made Swedish pump key. Further enquires can be made to Chris G3TUX at The QRP Component Company, PO Box 88, Haslemere, Surrey, GU272RF, England. Include two IRCs for return postage to receive a list of products he has to offer.

A special thanks to Drew VK5BWF for the article in relation to the "Universal Telegraph Code" which was later modified by Sir Charles Todd and adopted by the states of Victoria and New South Wales and called the "Modified Code". If any reader has further information in relation to this code, it would be greatly appreciated.

Brian VK2GCE has a few British Nato Keys left, model 5805-99591-1939 made by Price Edwards Ltd. Photos and information on these keys were featured in the December 1996 issue of *Amateur Radio* magazine on page 43. If you are interested, further enquires can be made to Brian on 02 9545 2650.

John Alcorn VK2JWA is now selling his splendid publication "Radio Telegraph and Radio Telephone Codes, Passwords and Abbreviations". The cost is \$12.00 (\$14.00 post paid in Australia). His web page is <http://hor.com.au/community/sarc/phonetic.htm> and his home address is 33 Spring St, Lismore NSW 2480. This publication was mentioned in an earlier issue of *Pounding Brass*.

On the subject of books, one that I highly recommend to all radio amateurs who are interested in telegraphy is "American

Telegraphy and Encyclopedia of the Telegraphy" by William Maver Jr. This book must be the bible of telegraphy and covers everything up to 1912. It is a hard cover reprint of the fifth edition with some 600 plus pages and 500 plus illustrations and was only recently reprinted. Some of the chapters covered include Primary Batteries, Dynamo machines used in Telegraphy, Galvanometers, Quadruplex and Duplex Repeaters, Time Telegraph Services, Burglar Alarm Telegraphy, and Fire Alarm Telegraphy.

The book contains so much information it is not possible for me to mention all of the contents in detail. The book sells for \$US34.95 plus \$US15.00 surface insured mail. The book can be purchased from

Lindsay Publications Inc, PO Box 538, Bradley, IL, USA 60915-0538 (Tel 815-935 5353); and Artifax Book, PO Box 88 Maynard, MA, 01754 USA.

Write to either of these companies for further information and a current catalogue of their out-of-print technical books. I can't supply a telephone number for the latter company, however the article appeared in the "Vail Correspondent" No 20, July 97. It's worth the money and wait for this magnificently bound book, one that will stand out in any amateur collection.

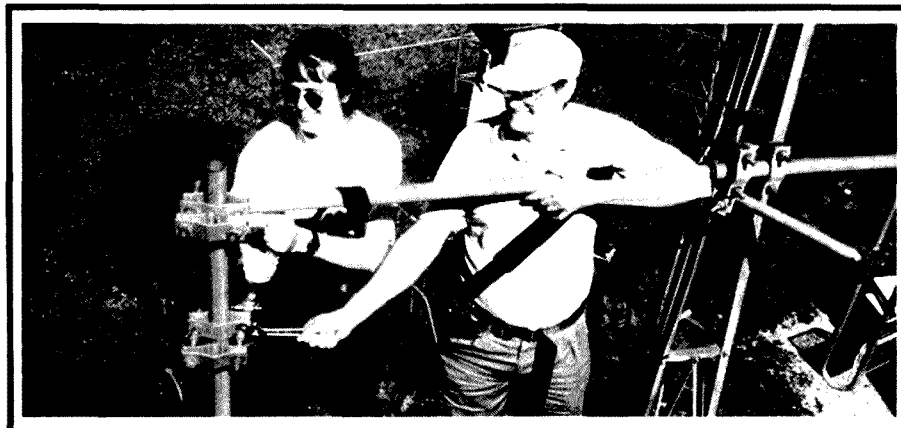
Next month, build a cassette recorder controller for use with Morse tapes (an easy circuit for beginners).

\*PO Box 361, Monu Vale NSW 2103

ar

## Amateurs in Action

Another photo from the VK1 Division antenna erecting exercise (see caption to the cover photo - page 1).



**Laeli VK2LAL and Paul VK1TEE working high off the ground on the Mt Ginini antenna array. Note the safety harnesses!**

---

---

# VHF/UHF - An Expanding World

---

---

Eric Jamieson VK5LP\*

All times are UTC.

## Six metres of 50 years ago (Part 3)

This section completes the article from the UK Six Metre Group Newsletter of October 1991, providing further insight into the establishment of six metres in an article *The History of Six* compiled by Neil Carr G0JHC from Harry School's (KA3B) *Six Metre Digest 1987*, also from an article by Brian Bower G3COJ for the UK Six Metre Group. Excerpts are worthy of inclusion on this occasion, permission having been established.

### 1947: A Year of Firsts

"With a combination of flourishing activity and the peak of Cycle 18, the year 1947 proved to be a winner in almost every respect.

"South of the border, XE1KE put Mexico on the air by operating on 50.024 MHz with 100 watts to an 829B feeding a 4 element beam at 90 feet. CE3CV in Chile was attempting to get permission for 6 metre operation. In Europe PA0UN of Eindhoven, Holland was active by special permission with 100 watts to a 4 element beam. Later PA0UM and PA0WJ followed suit.

"The big news was that Gs were given permission for 50 - 54 MHz operation for experimentation lasting until January 1, 1948. This special authorisation was later extended to April 30, 1948 and was available to anyone paying the 10 Shillings tax. Maximum power was 25 watts input.

"By late 1947 there were large amounts of activity taking place in VK-ZL and in South America, with nearly 50 active stations in Argentina alone.

"The first major event of 1947 took place on January 25th when Major W.O. Brewer (J9AAK) at Okinawa was worked by Captain Bob Mitchell (KH6DD) at Ewa, Oahu for a new distance record of 4600 miles. The QSO began at 3.13 PM Hawaiian time and lasted 27 minutes with signals as high as S-7.

"The second QSO took place at 4.33 PM with signals over S-9. At 4.48 PM, W7ACS/KH6 at Pearl Harbour took over, until 5.07 PM when signals faded out.

"Although the South Africans were not allowed 6 metre operation, ZS1T, ZS1P, ZS1AX and ZS1DJ were actively listening on 50 MHz for hopes of possible cross-band contacts. On March 26, 1947 the automatic transmissions of PA0UN were heard S9+ by ZS1P and others. On March 29th, ZS1P

worked PA0UN cross-band with S9 signals both ways during an hour long QSO.

"Seven months after the famed KH6DD - J9AAK QSO, a new distance record was set once again. This time, W7ACS/KH6 worked VK5KL in Perth[sic] Australia on August 25th at a distance of 5350 miles, breaking the old mark by 750 miles. [Actually, VK5KL was in Darwin, Northern Territory when he made the record contact. ... VK5LP]

"DX in the form of F2 propagation returned with a vengeance during October 1947, placing the 6 metre band in a frenzy.

"The South Africans finally obtained operating priveleges[sic] and put them to immediate use. On October 11th, ZS1T worked PA0UN for the first European 2-way on 50 MHz with South Africa. This contact broke the short-lived world record set two months before. The record now stood at 6000 miles. Six days later, CE1AH Chile and J9AAK Okinawa smashed the record for the third time in less than a year, with their QSO covering 10500 miles.

"The latter part of October saw many days with cross-band activity between England and the eastern portions of North America. On October 29th, PA0UN worked 2-way 50 MHz into the US for the first time. W2AMJ made the contact first at 8.14 AM EST followed shortly after by W3OR. W3OR's luck continued. November 1st saw a major opening between the East Coast and the Western areas of North America. In addition to many W6s and W7s, W3OR landed Alaska, in the form of KL7DY.

"On November 3rd an opening across the Atlantic took place, lasting for over 2 hours. The band opened at 8.10 AM EST. G5BM, G5ZT and G4NY worked a record number of US 6 metre stations via cross-band.

### The English receive permission for 50 MHz

"Special temporary licences for 6 metre work were issued by English authorities in early November of 1947. As mentioned earlier, licences for 'experimental' purposes such as these, were to expire on January 1st, 1948. They were later extended to April 30, 1948. The licences were subject to certain time and frequency limitations with 25 watts of maximum input. Stations located within London were not to operate after 1500 UTC. Hilton O'Heffernan (G5BY) received his temporary licence on November 5th, 1947.

"The January 1948 CQ Magazine reported the following: 'Having no rig on 50 MHz, Hilton grabbed a few eats and worked

until 4.30 AM to get a rig on. He then went to bed for 2 hours sleep and got up to have his first 50 MHz 2-way QSO with ZS1P, a distance of 6000 miles. Forty-five minutes later he had a QSO with W1HDQ and in another 30 minutes with a local. Within 1 hour and 15 minutes, 3 contacts and 3 continents had been worked!'

"Between November 6th and December 1st, G5BY completed 175 QSOs with 93 different stations in North America, South America, Egypt and Suez.

"Actually, Dennis Heightman (G6DH) was the first 'G' to work the US on 50 MHz. Dennis contacted W1HDQ on November 5th 1947 at 1302 GMT A QSO with W2AMJ took place at 1345 GMT. Later at 1620 GMT, G5BD worked VE1QZ for the first G - VE QSO. The month of November 1947 continued to be an excellent one for British operators. In addition to the numerous trans-Atlantic openings which took place, rare DX in the form of MD5KW (Suez) and SU1HF (Egypt) graced a few logs. G6DH was the first 'G' to work MD5KW which was being operated by Major Ken Ellis (now G5KW). This QSO took place on November 10th with MD5KW running 35 watts to an HK54, and a S27 receiver, and a 4 element beam at 35 feet.

### Transequatorial Propagation is "Discovered"

"By the fall of 1948, Mexico had as many as 15 active operators on 6 metres. Most of them ran high power levels to Yagi antennas. In Argentina, as many as 50 stations, some running as much as 300 watts, were looking towards the north for contacts. As fate would have it, the operators of both countries soon realised that a path between them existed quite often on 6 metres. On many occasions openings were intense with very solid signals. Although the mystery of 'why' was unanswered at the time, amateurs took full advantage of this propagation medium.

"On January 24th, 25th and 26th, 1949, a very severe ionospheric storm took place. The storm began at 1400 EST on the 24th and continued to 0700 EST on the 26th.

"The 6 metre band was full of Sporadic-E and Aurora. On the 25th, HC2OT in Ecuador worked W5NXM at 1800 EST followed by other W5s. HC2OT's signal was heard as far north as W0. This was the first prime evidence of TE propagation during an ionospheric disturbance. Less than a month later during another aurora session, Bill Colburn W1ELP in Massachusetts worked HC2OT via TE for the first W1 contact into South America."

Part 4 of this series next month, space permitting.

Ron VK3AFW said a message from Wal VK6KZ mentions that: "As at 14/7 the

Albany beacon on 144.465 MHz remains off the air. It is usually switched off during 'winter', whatever that means!"

## Aircraft Enhancement

Ron also reported that on 3/8, on the Sunday morning aircraft enhancement net of 144.200 SSB, the following were heard: Max VK3TMP, portable at Portarlington worked VK1BG, VK2ZRE, VK3DEM; Ian VK1BG celebrated his return after months away by working a bag of stations, Charlie VK3KLO, Gavin VK3HY, Steve VK3ZXR, (fairly new on 2 SSB, operating from Crib Point and should stir things up a bit for QSOs along the southern seaboard), Rod VK2TWR, Gordon VK2ZAB, Adrian VK2FZJ/4, (meteor bursts), Barry VK3TBM/P north of Shepparton, John VK3AJN.

Other call signs heard being worked were: Joe VK7JG, VK2BBS, VK2RO and VK3KLN.

On 2/8, Andrew VK7XR reported working Rod VK2TWR and Rob VK3DEM on 2 m and 70 cm SSB. Andrew has made some progress on his 10 GHz equipment with a new PLO now on frequency and stable.

Barry VK3TBM reports having a great time operating mobile. From 20/6 to 8/7, using his new two metre halo and MRF-240 amplifier, best contacts were:

21/7 2210 Ron VK3AFW 5x3 Coach Rd Hill, Yallourn, 110 km.

22/7 0745 Max VK3TMP 5x9 Bunyip/Pakenham, 53 km.

23/7 2225 David VK3AUU 5x3 Sydenham/Beveridge, 110/112 km.

25/7 1045 Max VK3TMP 5x9 Wandong-Bulleen, 101/55 km.

30/7 0220 David VK3AUU 5x1 10 km north of Seymour, 155 km.

30/7 2223 Ron VK3AFW 5x9-5x1 Bacchus Marsh - 5 km south of Creswick, up to 111 km.

30/7 0307 David VK3AUU 5x1 2 km south of Clunes, 205 km. 30/7 0030 David VK3AUU 5x1 Maryborough, 222 km.

1/8 0940 Bob VK3AJN 5x3 Hughes Creek Hill, 119 km.

2/8 2210 Darryl VK3KLN 5x5 Hughes Creek Hill, 114 km.

2/8 2212 Max VK3TMP/p Port Arlington 5x1 Hughes Creek Hill, 144 km.

Mixed in with these were numerous contacts with VK3s AFW, TMP, AUU, and more. Better results came when the halo was mounted 1/2 wavelength above the roof, rather than the usual 1/4 wavelength.

"I went portable on Mt Tassie between 2230 and 2310 on 9/8. While there I worked VK3XRS Bairnsdale 5x1, VK3BWT, Mallacoota 5x2, VK1BG Canberra 5x4, VK2ZAB Berowra Heights 5x2, and VK3ZXR Somerville 5x3. All when using the

five element NBS Yagi and 20 watts.

"When in Cobram I met Darryl VK3KLN; at his shack he demonstrated some of the many radio related computer programs he has, including one for scaling DL6WU Yagis. He is now on air with a 10 element! Also spoke with Len VK3BMY, who asked me to spread the word to the Melbourne VHFers that the Shepparton Club hold an SSB net on 144.1 each Wednesday night at 0930. He says anyone interested in joining in would be very welcome." [Why use the calling frequency for a net? ... VK5LP].

"Finally, I've been slowly working on my portable set-up. My current 2 m set-up uses a five element NBS Yagi with the FT-290R. The larger set-up, being built at the moment, will consist of a pair of 10 element DL6WUs on 2 m, a 15 el DL6WU on 70 cm, and either a dipole or 2 el on 6 m. 23 cm needs both antenna and transceiver/transverter! 10 GHz is on its way, in fact, it's further advanced than 23 cm! 10 GHz bits are 'on order', courtesy Alan VK3XPD."

## Microwave News

Emil W3EP in his September 1997 QST column *The World Above 50 MHz* reports a new 10 GHz ATV DX Record. He says: "Last September's column had details of a 592 km 10 GHz television contact between EA/HB9AFO and TK/F1JSR. The same pair have recently extended that distance by more than 100 km to 701 km.

"F1JSR used 110 W and a 0.6 metre dish, while HB9AFO had just 1 W into a 1 metre dish. Liaison was established on 80, 40, and 2 metres as conditions allowed. Their exploits have inspired several other French and Spanish stations to try 10 GHz operations."

## New Microwave DX Record

"Congratulations to WA6EXV and K6OW for setting a new American 24 GHz distance record of 267 km. Both stations used 100mW FM Gunn diode transmitters to two foot dishes on mountain tops in southern California. WA6EXV (DM06wl) was at Walts Point and K6OW (DM14kf) on Heaps Peak for the contact, made on the morning of 5 July. The existing record of 256 km has stood since 1992." (Thanks to the San Bernardino Microwave Society Newsletter.)

John VK3KWA from FTAC has sent a whole series of new microwave record claims which he has approved. They are:

**3300 - 3600 MHz**  
VK2 VK3XPD/2} VK5DK/4} 07/08/97 246.5 km  
VK3ZQB/2} VK5NC/4}  
**VK4 VK3XPD/2} VK5DK/4} 07/08/97 246.5 km**  
VK3ZQB/2} VK5NC/4}  
**5650 - 5850 MHz**  
VK2 VK3XPD/2} VK5DK/4} 07/08/97 246.5 km

VK3ZQB/2} VK5NC/4}  
VK4 VK3XPD/2} VK5DK/4} 07/08/97 246.5 km  
VK3ZQB/2} VK5NC/4}  
**10.0 - 10.5 GHz**  
VK2 VK3XPD/2} VK5DK/4} 07/08/97 246.5 km  
VK3ZQB/2} VK5NC/4}  
VK4 VK3XPD/2} VK5DK/4} 07/08/97 246.5 km  
VK3ZQB/2} VK5NC/4}  
**24.0 - 24.25 GHz**  
VK2 VK3ZQB/2 VK3XPD/2 07/08/97: 15.7 km  
VK4 VK3XPD/4} VK5DK/4} 07/08/97 30.0 km  
VK3ZQB/4} VK5NC/4}  
**24.0 - 24.25 GHz**  
**VK6 and national record:**  
VK6KZ/6 VK6BHT/6 19/07/97 120.6 km

So there are some good starting points for others to better the distances.

There are seven additional claims pending for microwave contacts between VK5 and VK8, so that will mean further areas of investigation for those wishing to extend the claimed distances. In regard to the latter, Alan VK3XPD writes as follows about a recent expedition he and David VK5KK made to northern SA and the Northern Territory to secure the VK5/VK8 records.

They were immediately followed by an expedition to secure similar records in VK1, VK2 and VK4 (these claims are listed above), this latter journey involving Colin VK5DK, Trevor VK5NC, Alan VK3XPD and Russell VK3ZQB. These will be the subject of further writings later.

## VK Distance Records - Old and New

Alan VK3XPD writes: "Firstly, John VK3KWA, Chairman of FTAC, provided us with information in regard to relevant microwave records. All distances are in km, a hyphen (-) has been used to indicate an existing distance record that was deemed unlikely to be extended during the expeditions, the figures in brackets indicate our 'new' record which we achieved during the expeditions.

State	VK8	VK4	VK2	VK1
70 cm	nil(171)	-	-	-
23 cm - 1.3 GHz	nil(41)	-	-	-
13 cm - 2.4 GHz	nil(171)	224	160	nil(100)
9 cm - 3.4 GHz	nil(171)	nil(245)	114(245)	nil(100)
6 cm - 5.7 GHz	nil(171)	173(245)	144(245)	67(100)
3 cm - 10 GHz	nil(171)	170(245)	218(245)	218
24 GHz	nil(59)	nil(31)	8(16.5)	nil(16.5)

"Most of the established distance records were considered by the group as suitable for extension without the benefit of 'enhanced' propagation (ie 'lift' as a result of prevailing weather conditions); however, lingering doubts remained about what was achievable for several of the longer distances. These concerns were later vindicated in the field with relatively poor signal strength reports being recorded for several contacts."

[Comment: The poor signal strength reports do not surprise me. In past years, on a number of occasions I have extensively toured the interior of Australia but only with two metres on board, finding coverage severely restricted due to what seems an unusual absorption of signals by the outback terrain, coupled with the lack of accessible high points to improve take off and so reduce the absorption. I am sure that 40 metres would be the best band to use for liaison. VK5LP.]

### The Lead-up to the Expedition

"Three weeks prior to the actual departure date, a 'get together' was arranged for a final shakedown of all the equipment. This meeting also ensured that all the necessary gear would actually fit into the cars! Colin and Trevor drove from Mt Gambier to Portland, I drove from Melbourne to Moonlight Heads (West of Cape Otway) and Russell simply trotted out to the local foreshore at Port Fairy. As expected, signal reports from Moonlight Heads over these relatively short, 'line of sight' water paths of 95 and 145 km were excellent. A few minor hiccups with several transverters were discovered but these were quickly resolved back in the shack.

"Having tested the gear and confirmed it would fit in the cars, we now waited for our respective departure dates to arrive. But one week prior to my departure I broke a bone in my left wrist, resulting in an x-ray and plaster cast, and some concerns about my ability to participate. However, I was able to continue albeit with some discomfort.

### The Expedition Begins

"Saturday, 26 July – Trevor and Colin departed Mt Gambier for Toowoomba in separate cars at 0630 local, with Trevor taking his wife and mother-in-law to Toowoomba to stay with relatives. I headed west to meet David in Adelaide for our trip to VK8. The Mt William Repeater VK3RWZ was used to arrange morning tea at Ararat with Trevor and Colin who then continued north towards Queensland. I used the Crafers repeater, VK5RAD, for liaison and directions to David's QTH at Salisbury Heights."

To be continued next month.

### From the USA

Emil Pocock W3EP in *QST's The World Above 50 MHz* for October, reports that: "Six-metre operators in every part of the country complained that there were many days without sustained openings during July, yet there was probably E-skip somewhere every day. Double-hop conditions on July 1, 5, 7, 9, 10, 16, 17, 20, and 24 made coast-to-coast contacts possible.

### 6 Meter Transatlantic

"This year's 6 metre sporadic-E

transatlantic season has been nothing like the previous three years, but finally stations from New England to Georgia got some openings in mid-July. The best days were July 10, 12, 15, 16, and 17. Doug Shepard, VE1PZ (FN85), led off the transatlantic mayhem again on July 10 with SP2SGZ at 0920 and ended with 92 QSOs. It was also the first day in 1997 that US stations (mostly limited to New England) worked Europe. The opening seemed to favour northern Europe, with many PA, OZ, DL, and SM calls in the American logs. Bob Mobile, WA1OUB (FN43), made 37 contacts, 10 of them with Sweden.

"The July 12 opening was notable for the number of Polish stations that appeared in American logs, giving several DXCC holders a new country. W1RA (FN41) and WA1OUB (FN43) were working Europeans as early as 1030. VE1PZ started off late, but his first contact of the day at 1110 was SP6GZZ and tallied 51 QSOs by the time he was done. Included in Doug's dozen countries worked that morning were OK, S5, and HB. VE1ZZ (FN84) made the unique contact of the day at 1205 with YM7PA (KN91) in Turkey, 7730 km distant. It was VE1ZZ's first Asian contact and the first Turkey to North America QSO on the band.

"The last big opening of the month on July 17 produced the strongest signals, even if the big New England DXers did not shake out any new countries during the 2-hour period. W1RA ran off 62 contest-style contacts with EI, G, GW, PA, SM, and OZ in 90 minutes. Signals reached S9 +20 dB at times. WA1OUB worked 43 Europeans, including YU1EU (KN04) for his best DX of the day. KM1E made 10 contacts, including GM, G, GW, DL, OZ, and F.

"The Hawaii-to-California duct opened in early July. Chip Margelli, K7JA (DM03), heard the 144.170 KH6HME beacon for three days before finally working Hawaii on July 8. Southern Californians made numerous 2 metre contacts that day with KH6HME and the activity was heard as far north as K6FV, in the Bay area. Nothing was

reported on the higher bands."

### VK2GJH Expedition in the Pacific

As reported previously, Jack VK2GJH started on a three-week expedition through the Gilbert and Ellis Islands on 16 July, using the calls T2D8JH, T3D8JH, and T33JH. JA1VOK reported that by the end of July, he had made 900 contacts on 6 metres into Japan, typically around 6000 km, or three sporadic E hops. In early August, he was to be on Banaba as 3D2JH.

### Internet Six News

Courtesy Geoff GJ4ICD: On 1/8 at 2145, VK3OT worked VK3ANP on 50.125 over a 500 km tropo scatter path. Steve had already worked VK1RX at 2130 on 50.125 over an 800 km tropo path with signals 539.

ZL TO VK Es: ZL3TPY had a brief QSO with VK2YO at 0140, 52/51. At the same time 46.17 and 51.67 TV carriers and VK4RGG beacon were heard.

### Closure

This month's notes have taken a long time to prepare for several reasons, details of which I need not bore you, but I seem to have made it after all!

Not much room for any further comments, except to say that our Es season is not far away. I wonder if we find a reduction in total coverage as seems to have been the case in the northern hemisphere. Does this indicate a start to the climb upwards for Cycle 23?

Closing with two thoughts for the month:

1. The young do not know enough to be prudent, and therefore they attempt the impossible – and achieve it, generation after generation, and
2. See everything, overlook a great deal, correct a little – Pope John XXIII.

73 from *The Voice by the Lake*.

\*PO Box 169, Meningie SA 5264

Fax: 08 8575 1043

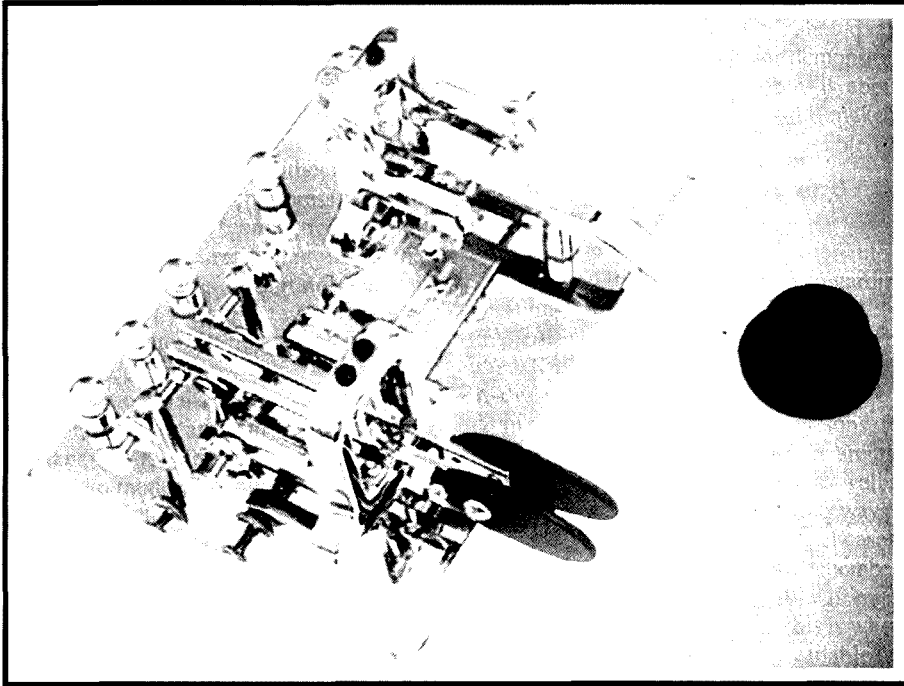
Packet: VK5LP@VK5WI.#ADL.#SA.AUS.OC

**When you buy something from one of our advertisers, tell them you read about it in the WIA Amateur Radio magazine**

# What's New

Don Jackson VK3DBB\* introduces new products of interest to radio amateurs

## Vibroplex Double Key



For those Morse enthusiasts who never know whether to use a straight keyer or an iambic key, Vibroplex has announced its "Double Key". This device combines side by side keys in the one unit, the Vibroplex straight key and the Vibrokeyer iambic keyer mounted on the one massive steel base. The unit allows the operator to instantly switch from using an electronic keyer to the more personal touch of a straight key. It comes complete with the famous Vibroplex brass logo plate and a unique serial number.

In common with all Vibroplex keys, the machined parts of the double key are made in the USA on a digital milling machine providing great accuracy, and together with careful assembly, ensures long life.

Daycom Communications Pty Ltd are the sole agents for Vibroplex in Australia, and John Day would be pleased to provide further details of this unique keyer.

## MFJ-224 2 Metre FM Analyser

The MFJ Company has released a 2 metre FM Analyser, their Model MFJ-224. With a frequency coverage of 143.5 to 148.5 MHz, the unit is capable of most types of performance measurements any discerning amateur would require.

In addition to metered functions, the MFJ-224 lets you visually analyse modulation

waveforms, and measure instantaneous-peak deviation by plugging into an oscilloscope. A headphone monitor circuit helps to tune in and easily identify signals. Amongst the



performance criteria it can handle are the following:-

- Evaluate antenna performance
- Detection of feedline faults
- Map repeater Field Strength
- Measure pre-amp gain
- Check and set deviation
- Analyse audio quality
- Band scan
- Tune transmitters and filters

It can even help track down hidden transmitters as in a fox hunt. The high resolution 60 dB RSSI display is stated to be amateur radio's most accurate S-meter.

The MFJ-224 comes in a sturdy black steel box, measuring about 95 x 48 x 190 mm, with the frequency and measurement control knobs protruding a little more. An SO-239 socket is provided for connection to your antenna system, with additional outlets for an oscilloscope and headphones.

For any amateur serious about performance in the 2 metre band, this instrument appears to be a sound investment to ensure the best results.

Contact John Day at Daycom Communications on 03 9543 6444 for further information.

## MFJ-862 VHF/UHF SWR Wattmeter



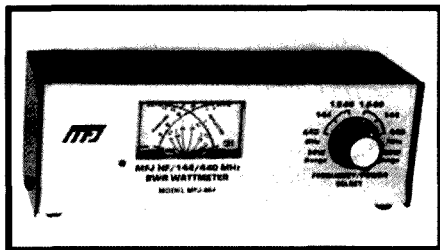
For those amateurs requiring a SWR/Wattmeter for the VHF and lower UHF bands, the MFJ Company has released a new cross-needle SWR/Wattmeter for the 2 metre and 70 cm bands. The 220 MHz band is also catered for, but this is of little interest to Australian amateurs.

The meter is a similar unit to the MFJ-864, except that there is no coverage of the HF or 6 metre bands. It has two power ranges, 300 or 60 watts forward power and one tenth of that reverse, but both have been accurately factory calibrated to 100 W and 10 W respectively. Re-calibration to your own requirements is achieved through trim-pots easily accessible through the rear of the case.

Finished in an attractive two-tone (beige and black) colour scheme in a sturdy steel case measuring 150 x 58 x 65 mm, the unit should prove a useful piece of test equipment in your shack.

For further information about the MFJ-862, contact John Day at Daycom Communications Pty Ltd on 03 9543 6444

## MFJ-864 HF/144/440 MHz SWR Wattmeter



The MFJ-864 is a cross-needle SWR Wattmeter which can be used for all amateur bands from 160 metres to 70 cm. The unit is

said to be capable of handling up to 300 W on high power and 60 W on low power in a forward direction, and one tenth of that in the reverse direction. Although the meter has been factory calibrated to 100 W and 10 W, there is provision to adjust the meter readings to your own requirements by easily accessible and clearly marked trim-pots.

As is usual with cross needle meters, one needle indicates output power, with the SWR read directly from the scale where the meter needles cross.

Two pairs of SO-239 sockets are provided, one pair for the 2 metre and 70 cm bands and the other for all frequencies up to 60 MHz, so

the one meter can be used for all bands. A circuit diagram is included in the clearly written seven page owner's manual.

Presented in a smart two tone (beige and black) steel case measuring about 185 x 65 x 60 mm, and with such a wide range of frequency coverage, the meter should prove to be a very useful accessory in your shack.

For further information about the MFJ-864, contact John Day at Daycom Communications Pty Ltd on 03 9543 6444

\*55 Ryan Road, Pakenham VIC 3810

ar

## WICEN News

David Horsfall VK2KFU\*

### Regular WICEN Column

As the activities of WICEN (in its various forms) are a major justification for the existence of amateur radio, it is hoped that this column will become a regular event; say, bi-monthly. Towards this end, I would like to solicit contributions from the other Divisions with an active (or possibly inactive) WICEN component.

I would like to collate items of WICEN interest from everywhere, and publicise them accordingly, so if nothing comes in, then all you're going to hear about is VK2 WICEN... E-mail is preferred, to [dave@geac.com.au](mailto:dave@geac.com.au), or packet radio to VK2KFU@VK2KFU.NSW.AUS.OC (but be aware of forwarding delays in the packet network).

### WICEN (NSW) Inc

#### Thredbo

Contrary to some reports, WICEN was indeed activated for the Thredbo disaster. WICEN assisted the Police with their Disaster Victim Registration (DVR) procedures, in both the registration and public enquiry aspects.

Tasks included computer entry of information from Thredbo, the taking of calls from the public regarding the victims, training of Police officers for these tasks, supervision of the DVR Co-ordination Centre, and liaison between the VRA operators and the Police Service. Some assistance was also provided to the State Emergency Operations Centre. WICEN personnel were involved day and night for the first three days of the operation.

#### AGM

The recent AGM was a popular affair, with 26 people in attendance. The meeting was preceded by an RCOs' meeting, at which Kevin Dawson VK2CKD and Malcolm Alexander VK2YVA were elected as Deputy State Co-ordinators 1 and 3 respectively.

Following this, the AGM began in earnest, and the following positions were filled: President, Dave Horsfall VK2KFU; Snr Vice President, Tony Farrow VK2TJF; Secretary, Frank Weber VK2XVJ; Treasurer, John Buxton VK2GJB; Committee, Ron Hanks VK2UR, Malcolm Alexander VK2YVA, Alan Whitmore VK2YYJ, and Richard Main VK2TPS. In the meantime, vacancies exist for Jnr Vice President and a Committee member.

The GRN demonstration (friend or foe?) attracted much interest, as did Simon Trotter's talk on RAYNET (the UK equivalent of WICEN) and the VK1 situation. Finally, the door-prizes were drawn from a hat by Simon Trotter. First prize, a \$50 gift voucher upon Dick Smith Electronics, was won by Frank Weber VK2XVJ; second prize, a \$20 gift voucher upon Dick Smith Electronics, was won by Richard Main VK2TPS; and third prize, a year's membership of WICEN, was won by Pauline Jones VK2GTB, whom we understand has decided to delay her retirement by a year. WICEN (NSW) Inc thanks Chris Ayres and Dick Smith Electronics for the generous donation of these vouchers.

#### Shahzada Horse Enduro

Finally, the recent Shahzada Horse Enduro, held in the St Albans area north-west of Sydney, sorely tested the expertise of WICEN personnel.

On Tuesday morning reports were received of a rider having fallen from her horse, and indications were that she suffered severe head injuries as well as broken bones. To cut a long story short, the Careflight helicopter, whilst perilously close to high-voltage power lines, winched her to safety. It transpired that she suffered from nothing worse than shock and severe bruising.

That afternoon, the portable repeater fell over, possibly as a result of the heavy use that

morning, and was not returned to service until a day or so later (this is a week-long event). On Wednesday, another rider fell, and severe concussion was suspected; however, it turned out that this behaviour was somewhat normal for the person involved...

If further information about WICEN (NSW) is required, please contact the acting State Co-ordinator, Alan Whitmore VK2YYJ, on 015-097-217.

\*PO Box 257, Wahroonga NSW 2076

Internet e-mail: [dave@geac.com.au](mailto:dave@geac.com.au)

Packet: VK2KFU@VK2KFU.NSW.AUS.OC

ar

## Update

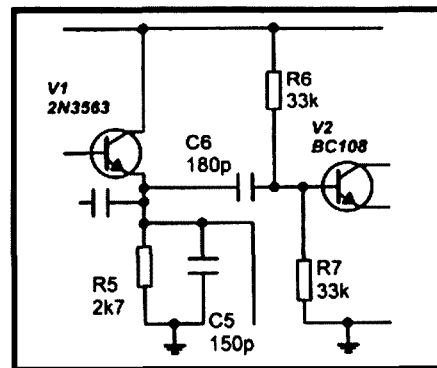


Fig 1

### An RF Inductance Meter

(Published on pages 7-9 of the June 1997 issue of *Amateur Radio magazine*)

The author of this interesting article, Lloyd Butler VK5BR, advises that in Fig 2 on page 9, the unmarked capacitor joining the emitter of V1 to the base of V2 should be labelled C6, 180 pF (Fig 1 shows the amended relevant part of the circuit diagram).

It might be a good idea to correct your copy of the June 1997 issue of *Amateur Radio* now.

ar

---

---

# Silent Keys

*Due to space demands obituaries should be no longer than 200 words.*

---

---

The WIA regrets to announce the recent passing of:-

R	BURTON	VK2EJE
R (RON)	MORRIS	VK3APM
D G	DUNN	VK3BDH
R N (ROD)	TORRINGTON	VK3TJ
E D	TREHARNE	VK5ED
C	WHALLEY	VK6KK

## **Peter Alexander VK2PA**

The amateur radio fraternity recently learned, with sorrow, of the passing of one of its widely known and highly respected members. Peter Alfred Hunt Alexander VK2PA, aged 74, who became a silent key on 14 May 1997, passing away quietly in his home, "Nandari" at Rollands Plains, near Port Macquarie.

Peter was born in Chatswood, NSW, and spent his childhood in and around Sydney. He was the youngest, and only son, in a family of six. His father, Alfred Alexander, an operator with the Pacific Cable, taught Peter the art of Morse Telegraphy, which rapidly became Peter's second language.

Gaining his AOCIP with the call VK2PA at the age of 16, Peter began a long career in communications and electronics. He left apprenticeship with AWA, in order to join the RAAF in 1941, at the age of 18. He saw active service in Papua-New Guinea, in the Milne Bay area and on Groote Island. His specialities were telegraph operating, HF-DF, VHF-DF and Radar.

During his Groote Island service he was involved in aerial surveillance work, radioing valuable information on enemy aircraft movements back to allied headquarters in Darwin. Here he lived with the local Aboriginal people gaining tolerance and respect for indigenous people of Australia and the Pacific Region.

During the war years he met and married Ina Green who was serving in the WRANS.

On discharge from the RAAF in 1945, as a Sergeant, Peter remained in the RAAF reserve for the next eight years. He and Ina moved to Port Macquarie NSW, where he established a radio repair business serving the surrounding area with general repairs and battery charging facilities for the non-electrified communities.

He was a foundation member of the Port Macquarie RSL (of which he was later to become a Director), a foundation member of the Oxley Region Amateur Radio Club and office bearer for many years. Peter also served as Secretary and Public Officer of the

Port Macquarie branch of the Air Force Association.

In January 1949, along with three other well known amateurs of the day (Col Fisher VK2ASF, Crieff Retailic VK2XO, and Doug Gill VK2SH) Peter formed the nucleus of the original group who first organised the famous Urunga Convention. As is well known, this is the longest running annual amateur event in VK land.

His other interests included astronomy. As a foundation member of the Port Macquarie Astronomical Association (and its Secretary for several years beginning in 1961-62) he was directly involved in the establishment of the still-functioning Observatory on the hill overlooking the Town Beach and Break Wall at Port Macquarie.

One of Peter's outstanding community efforts was seen in the early 50s when disastrous floods in the region severed all public communication links with the area. Peter established and controlled an emergency radio communications network through his amateur station at Hill Street, Port Macquarie to link Sydney, Brisbane, and west to Narrabri and Forbes, to carry public messages.

In 1956, Peter and his family moved to Fiji, initially to work in Suva, but some months later in Vatukoula where he worked for the next four years in the Emperor Gold Mine. He was an active amateur throughout this period under the call sign VR2CD.

A DXpedition to the Tokelau Island Group, on board "Mororo" (the refitted and renamed private yacht of the late Queen Salote of Tonga), saw Peter as part of the crew and operating team. The team headed by "Doc" Meredith, W5PQA, spent a week in the Tokelaus providing the DX hunters with some rare contacts.

Returning to Port Macquarie, Peter established Alexander's TV, a business which he successfully operated until his retirement in 1976. The business still operates under its original name, but with new owners.

Peter and Ina retired to the country, first in nearby Ballengarra, and later to the property at Rollands Plains. Peter's amateur activities at "Nandari" involved an extensive "antenna farm" with modern equipment, working various modes, but predominately his first love, CW. He would sometimes stoop to "lip flapping" (as he dubbed voice communication) but most amateurs remember Peter for his dedication to, and superior expertise in, Morse telegraphy.

Peter also held other calls throughout the years. He retained VK2PA, but also held VR2DA, ZM7DA and G3OCM.

Peter's passing ended his 58 years of



**The Oxley Region Amateur Radio Club perpetual trophy to commemorate the memory of Peter Alexander VK2PA**



progressive communications activity. His contribution to this nation's security, its communities in which he lived and served, and the fraternity we all enjoy, has been most noteworthy. His dedication and steadfast approach to the preservation of amateur standards and his vigilance in helping keep the bands free of interlopers and sloppy operating practices were well known. Over the years, he encouraged and assisted many other aspiring amateurs to gain the knowledge and expertise required to qualify for the AOCP. Amateur radio has lost another one of its champions.

To commemorate the dedication that Peter gave to amateur radio and CW, the Oxley Region Amateur Radio Club has established a perpetual trophy, known as the "Peter Alexander Golden Key Award" to be awarded each year to the top VK station in the Commonwealth Contest. Peter won the "Golden Key Award" in 1980 for his proficiency in telegraphy operating. The

perpetual trophy will remain with the ORARC and will be engraved with the top VK call and name each year. The winner will receive a personal trophy engraved accordingly.

*(Compiled by Trevor Thatcher VK2TT from an interview with Peter's family. Edited by David Pilley VK2AYD)*

### **James Jessiman VK2MLV**

It is with deep regret that I announce the passing of James Jessiman VK2MLV. He died in Wagga Base Hospital from pneumonia on Friday 25th July 1997 aged just 26.

James joined the Wagga Amateur Radio Club some five or six years ago when we ran our NAACP course from TAFE. He studied hard and received his licence soon after.

He was a quiet and unassuming fellow with a deep interest and knowledge of computers. We didn't see a lot of him after he gained his licence as his computing business began to take off but he came along whenever he could. He enjoyed all our club outings particularly Foxhunts and I am sure that it would not have been long before he would have been operating those in his own right. He was well liked by all of us.

Up until his death he held the office of Awards Manager as this was an area he felt he could contribute to within his fairly busy life. He further contributed in a big way after our photocopier became unrepairable by stepping in and offering his business machine and doing the copying and collating with his mother Robin, who also worked with him.

On many occasions we would ask James for advice on one computing matter or another and he would go out of his way to

assist. Nothing was ever too much difficulty for him nor was time of any consequence. That was just James.

This year, for all of these efforts, we awarded him the Phil Bowers Memorial Award for Outstanding Achievement. He passed away before he could be awarded it. He never knew.

To his family the members of the Wagga Radio Club extend their deepest sympathies.

Vale James.

**John Eyles VK2YW**

### **Joe Ellis VK4AGL**

The Sunshine Coast Amateur Radio Club and Amateur Radio has lost a great friend with the passing of Joe Ellis VK4AGL, on 5 May 1997.

Joe was born in Lismore on 18 April 1921, and at age 14 as VK2GL became one of the youngest amateurs in Australia. After attending the Marconi School of Wireless he qualified as a First Class Commercial Operator and went to sea as a ships radio operator. He survived two sinkings due to enemy action during the war years. He then flew with Qantas as a wireless operator for over 20 years until his retirement.

In 1975 Joe and family moved from Sydney to Burnside, Nambour, where he operated as VK4AGL. A keen DX operator, Joe kept abreast of technology and was active on all bands and modes. His helpful advice on air and ready wit will be sadly missed by all.

He is survived by his wife Jean, and sons Andrew and Matthew.

**Ron Marschke VK4GZ**

**President**

**Sunshine Coast Amateur Radio Club Inc**  
ar

## **QSP News**

### **Chinese Contact With US Spacecraft**

David Waring VK3ANP recently returned from a holiday in China. While he was there, the *China Daily*, a Government English language newspaper supplied to all tourist hotels, carried an amateur radio story on page 2 of the issue for 16 July. David sent a copy to us.

Briefly, students of the Middle School attached to Qinghua University in Beijing were able to converse as part of SAREX (Shuttle Amateur Radio Experiment) with American astronauts aboard the shuttle Columbia. Because the US and China have not yet signed an agreement permitting direct amateur communication between them, the signals were relayed via Australia. The Beijing station was BY1QH.

It is interesting to note that amateur radio can be so newsworthy as to justify several hundred words plus a photo three columns wide in a newspaper such as the *China Daily*.

## **Editor's Comment**

*Continued from page 2*

And finally, how do you write the date? Particularly when all in figures? We adhere to the British standard of day, month, year in that sequence. For example, I am writing this on 31-08-97 (the day of the death of the Princess of Wales). American custom, though, is to put the month first, so it becomes August 31 1997 or 08-31-97. And some computer programs expect (logically) that dates should be in the same sequence as other numbers, ie the most significant digit at the left, so giving 97-08-31.

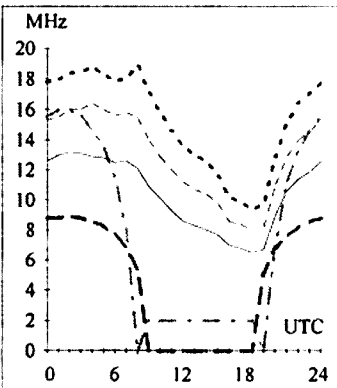
Personally I prefer to spell out the month in abbreviated form, ie 31 Aug 97, but that's another variation. Nothing's simple, is it?

On another subject, you will be pleased to see that we have two new columns this month, on ARDF and WICEN. They are managed by VK4BRG and VK2KFU, both of whom need your contributions.

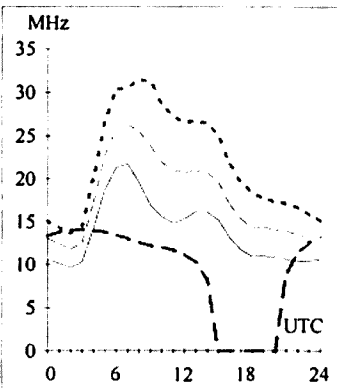
**Bill Rice VK3ABP**

**Editor**

**Adelaide-Auckland** 104  
Second 2F13-18 2E2 Short 3240 km



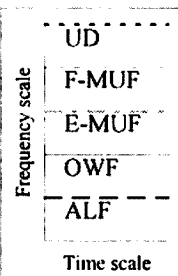
**Brisbane-Budapest** 312  
First F 0-5 Short 15469 km



# HF Predictions

Evan Jarman VK3ANI

T Index: 32



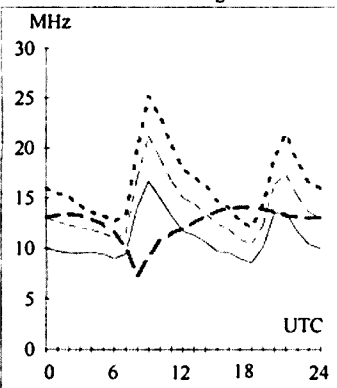
These graphs show the predicted diurnal variation of key frequencies for the nominated circuits. This also indicates a possibility of communication (percentage).

The frequencies, identified in the legend, are:-  
Upper Decile (F-layer, 10%)  
F-layer Maximum Useable Frequency (50%)  
E-layer Maximum Useable Frequency  
Optimum Working Frequency (F-layer, 90%)  
Absorption Limiting Frequency

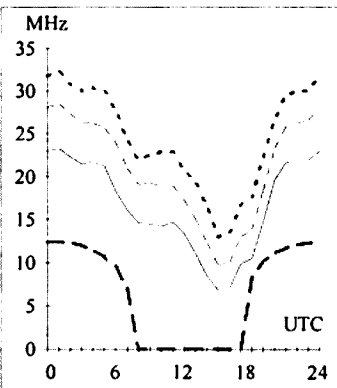
The predictions were made with the Ionospheric Prediction Service program, ASAPS V3.2. The T index used is shown above the legend. The Australian terminal azimuth, path and propagation mode are also given for each circuit.

ar

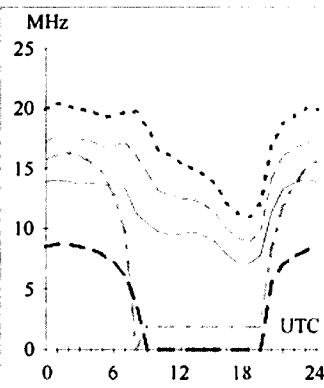
**Adelaide-London** 132  
First F 0-5 Long 23755 km



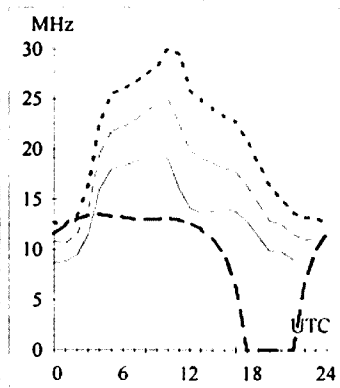
**Brisbane-Honolulu** 49  
Second 3F5-9 3E0 Short 7569 km



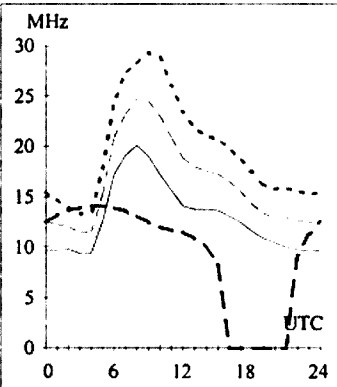
**Canberra-Honiara** 23  
Second 2F14-19 2E3 Short 3070 km



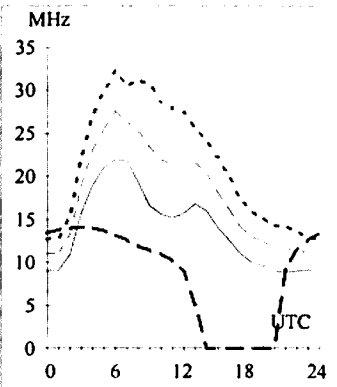
**Darwin-Capetown** 231  
Second 4F3-6 4E0 Short 11220 km



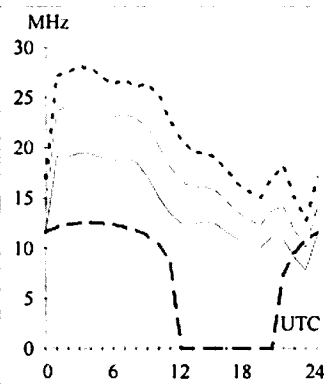
**Adelaide-London** 312  
First F 0-5 Short 16269 km



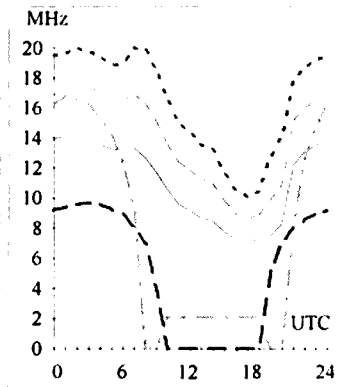
**Brisbane-Moscow** 321  
First F 0-5 Short 14071 km



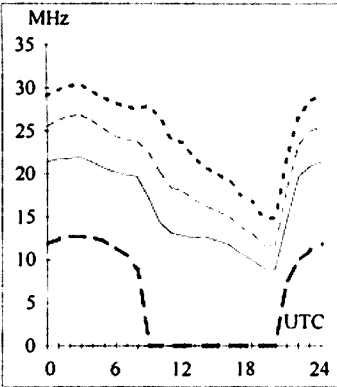
**Canberra-New Delhi** 303  
Second 4F4-9 4E0 Short 10348 km



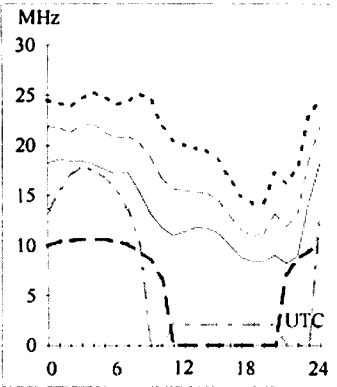
**Darwin-Christchurch** 139  
Second 3F12-16 3E1 Short 5281 km



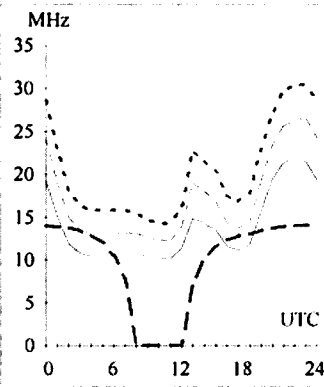
**Adelaide-Tokyo** 1  
Second 3F4-9 3E0 Short 7855 km



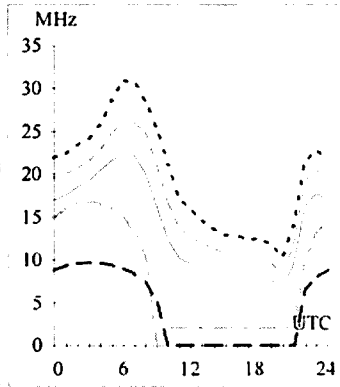
**Brisbane-Singapore** 293  
Second 3F9-14 3E0 Short 6147 km



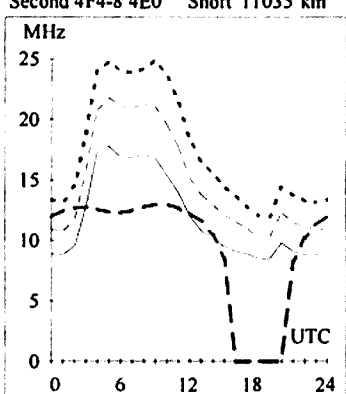
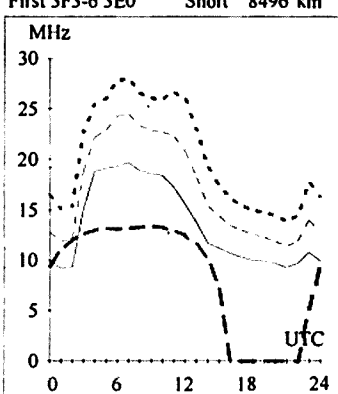
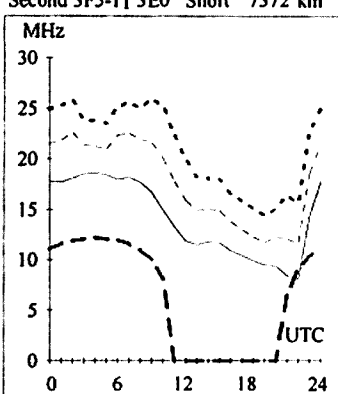
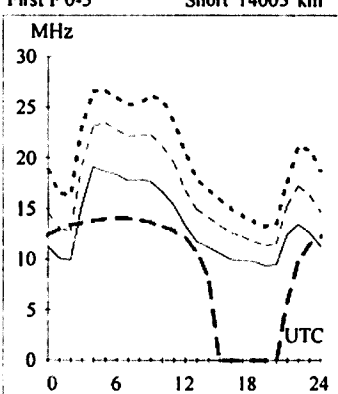
**Canberra-Washington** 70  
First F 0-5 Short 15939 km



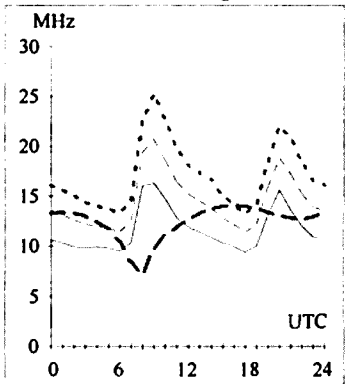
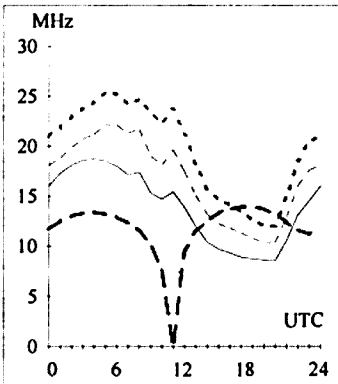
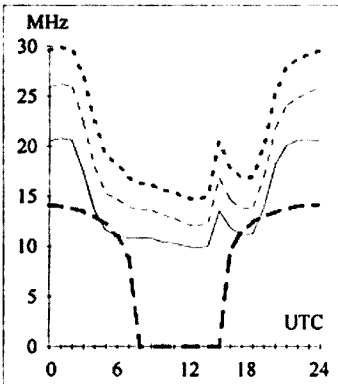
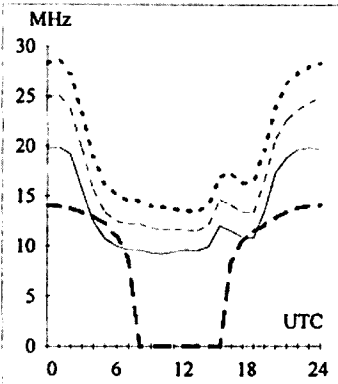
**Darwin-Osaka** 5  
Second 3F11-19 3F2 Short 5263 km



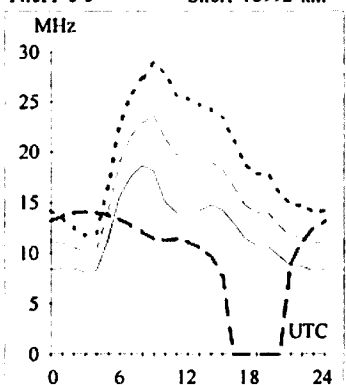
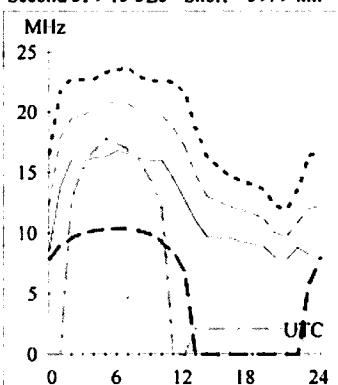
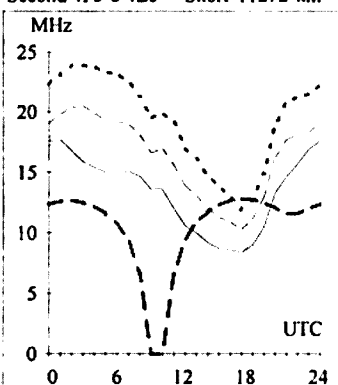
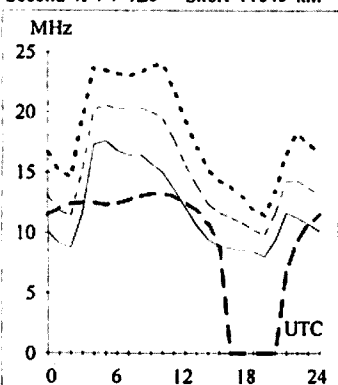
**Hobart-Amman** 283 **Melbourne-Bangkok** 312 **Perth-Harare** 257 **Sydney-Johannesburg** 230  
 First F0-5 Short 14003 km Second 3F5-11 3E0 Short 7372 km First 3F3-6 3E0 Short 8496 km Second 4F4-8 4E0 Short 11035 km



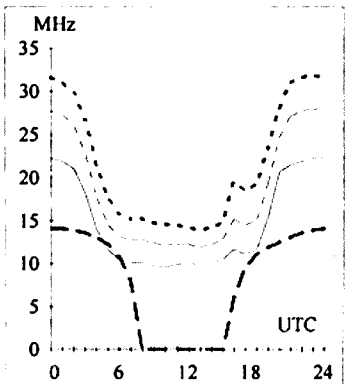
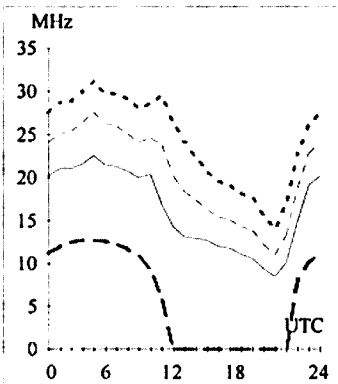
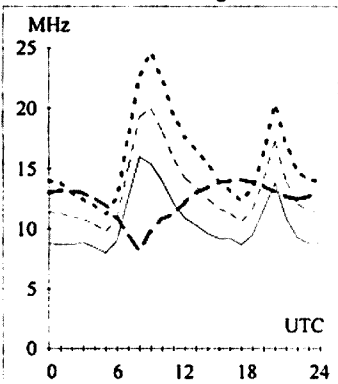
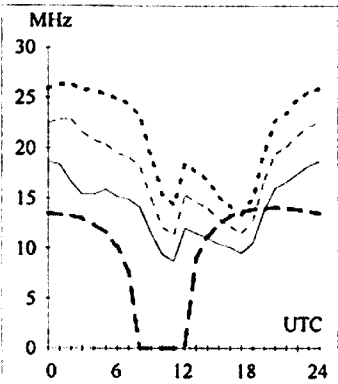
**Hobart-Calgary** 51 **Melbourne-Los Angeles** 65 **Perth-Lima** 162 **Sydney-London** 139  
 First F0-5 Short 14087 km First F0-5 Short 12772 km First F0-5 Short 14931 km First F0-5 Long 23032 km



**Hobart-Lusaka** 239 **Melbourne-Santiago** 150 **Perth-Maldives** 303 **Sydney-London** 319  
 Second 4F4-7 4E0 Short 11045 km Second 4F3-6 4E0 Short 11272 km Second 3F9-15 3E0 Short 5979 km First F0-5 Short 16992 km



**Hobart-Miami** 98 **Melbourne-Stockholm** 140 **Perth-Tokyo** 20 **Sydney-Vancouver** 45  
 First F0-5 Short 15324 km First F0-5 Long 24424 km Second 3F4-9 3E0 Short 7923 km First F0-5 Short 12502 km



# HAMADS

- Hamads may be submitted on the form on the reverse side of the *Amateur Radio* address flysheet. Please use your latest flysheet where possible.
- Please submit separate forms for **For Sale** and **Wanted** items, and be sure to include your name, address and telephone number (including STD code) if you do not use the form on the back of the *Amateur Radio* address flysheet.
- Eight lines (forty words) per issue free to all WIA members, ninth and tenth lines for name and address. Commercial rates apply for non-members.
- Deceased estates Hamads will be published in full, even if the ad is not fully radio equipment.
- WIA policy recommends that the serial number of all equipment offered for sale should be included in the Hamad.
- QTHR means the address is correct in the current WIA Call Book.
- Ordinary Hamads from members who are deemed to be in general electronics retail and wholesale distributive trades should be certified as referring only to private articles not being re-sold for merchandising purposes.
- Commercial advertising (Trade Hamads) are pre-payable at \$25.00 for four lines (twenty words), plus \$2.25 per line (or part thereof), with a minimum charge of \$25.00. Cheques are to be made out to: WIA Hamads.
- Copy should be typed or in block letters, and be received by the deadlines shown on page 1 of each issue of *Amateur Radio*, at:

Postal: 3 Tamar Court, Mentone VIC 3194  
Fax: (03) 9584 8928  
E-mail: vk3br@c031.aone.net.au

## TRADE ADS

- **AMIDON FERROMAGNETIC CORES:** For all RF applications. Send business size SASE for data/price to RJ & US Imports, PO Box 431, Kiama NSW 2533 (no enquiries at office please ... 14 Boanyo Ave Kiama). Agencies at: Webb Electronics, Albany; Assoc TV Service, Hobart; Truscotts Electronic World, Melbourne and Mildura; Alpha Tango Products, Perth; Haven Electronics, Nowra; and WIA Equipment Supplies, Adelaide.
- **WEATHER FAX programs** for IBM XT/ATs \*\*\* "RADFAXZ" \$35.00, is a high resolution short-wave weather fax, Morse and RTTY receiving program. Suitable for CGA, EGA, VGA and Hercules cards (state which). Needs SSB HF radio and RADFAX decoder. \*\*\* "SATFAX" \$45.00, is a NOAA, Meteor and GMS weather satellite picture receiving program. Needs EGA or VGA & WEATHER FAX PC card, + 137 MHz Receiver. \*\*\* "MAXISAT" \$75.00 is similar to SATFAX but needs 2 MB of expanded memory (EMS 3.6 or 4.0) and 1024 x 768 SVGA card. All programs are on 5.25" or 3.5" disks (state which) plus documentation, add \$3.00 postage. ONLY from M Delahunty, 42 Villiers St, New Farm QLD 4005. Ph 07 358 2785.
- **HAM LOG v.3.1** - Acclaimed internationally as the best IBM logging program. Review samples....AR: "Recommend it to anyone"; The Canadian Amateur: "Beyond this reviewer's ability to do it justice. I cannot find anything to improve on. A breakthrough of computer technology". ARA: "Brilliant". Simple to use with

full help, the professional HAM LOG is immensely popular (now in its 5th year), with many useful, superb features. Just \$59 (+ \$5 P & P), with a 90 page manual. Special 5 hour Internet offer. Demos, brochures available. Robin Gandevia VK2VN, 02 369 2008 BH, fax 02 369 3069. Internet address rhg@ozemail.com.au.

## FOR SALE NSW

- Deceased estate items held by the VK2 Division:  
**Kenwood TS-520S**, s/n H03-1629-04, complete with DG-5 Digital Display, s/n 730575, \$600.  
**Kenwood PS-430** power supply, \$350.  
**Kenwood TS-820** (no power cord), s/n N672629, \$450.  
**Kenwood TS-930S** (recently serviced), excellent condn, s/n 3060601, \$1300.  
**Yaesu FT-107M**, with 27 MHz marine xtals, s/n OMO80612, as new, \$600.  
**Yaesu FT-107ATU**, WARC bands, s/n D2873, as new, \$150.  
**Yaesu FT-101Z**, WARC bands, s/n 0N230962, \$500.  
**Yaesu FT-101Z**, s/n 9C020038, with dynamic mic YD-148, \$350.  
**Yaesu FRG-7**, s/n 120J310900, \$200. Many of the above checked by manufacturer; most in good to excellent condn, reasonable offers considered. WIA VK2 Office, 02 9689 2417 (1100 to 1400 Mon - Fri), fax 02 9633 1525 anytime.
- **Kenwood TS-690SAT** HF/50 MHz txcvr, \$1750 ONO.  
**Kenwood TS-440SAT** HF txcvr, \$1400 ONO. Both Kenwoods in excellent condn with all filters and manuals.  
**Kenwood TM-2550** 2 m FM 50 W txcvr, \$300.  
**Alinco DJF1T** 2 m hand-held, accessories, \$200.  
**DSP-9**, \$200.  
**TNC 320**, \$150.  
**Philips Condor 70 cm FM**, OK for 9600/1200 baud packet, \$250.  
**IBM computer**, excellent for

packet, \$100 ONO. Frank VK2EKY, QTHR, 02 9896 5859.

- **Emotator rotator** with illuminated control box; **7 m telescopic mast**, all guys and attachments, ready to install, in very good condn, \$285. Ernest VK2BED, 02 9532 0175.
- **Hy-Gain DB10/15** (10 & 15 m) 3 element trap beam, including manual, very good condn, \$185 ONO. Art VK2AS, QTHR, 02 9416 7784.
- **Yaesu FT-290R II** 2 m all mode txcvr, \$350.  
**FT-690R II** 6 m all mode txcvr, \$330.  
**FT-757GX HF** txcvr with **FC-757AT** ATU, \$850 the pair.  
**Kenwood TM2570A** 2 m 70 W mobile txcvr, \$250.  
**Yaesu FT-26** 2 m hheld, \$230.  
**Uniden UHF CB txcvr**, \$225 (10 & 6 m afterburners to 100 W, \$150 each. No reasonable offer refused. R E Taylor VK2AOE, QTHR, 02 9449 6364.
- **Yaesu FT-101E**, VGC, spare set final tubes, desk mic, hand mic, manual, \$500.  
**KW103 1 kW SWR/power meter**, \$150.  
**Yaesu FT-290R II** txcvr, PA3 car adapter/charger, MH-12 spkr/mic, unused, \$350.  
**Palomar TX200** linear amp, \$150.  
6 only **6JS6** tubes, \$50 each.  
**ATU roller inductor**, home brew, \$100.  
**Yaesu FV-901** scan VFO, \$200. Peter VK2DBI, QTHR, 02 6367 5095.

**Satfax weather satellite receiving system** including Maxisat software and Satfax interface card for PC, \$80. H H Leykam VK2HL, QTHR, 02 9971 9795.

- **Yaesu FT-757 HF** mobile txcvr, s/n 5F180131, with cradle, computer interface and manuals.  
**Yaesu FT-480** 2 m all mode mobile txcvr, s/n 2F180661, with cradle and manuals. Make an offer. David VK2CTL, 02 9234 7970 (BH).
- **Command b'cast receiver BC-946-B**, pristine condn, \$230.  
**Fluke 207-3 VLF** receiver comparator with chart recorder, GWO, \$350.  
**Lavoie AN/URM-81** VHF frequency meter, 100 - 500 MHz, \$250.  
**Price and Edwards NATO** keys, new, \$100. Brian VK2GCE, QTHR, 02 9545 2650.
- **Kenwood TS-430S** txcvr, with both manuals, serviced by Kenwood, \$900.  
**Kenwood SM-220** station monitor, bandscope, with manuals, \$350.  
**Kenwood TR-8400** UHF FM mobile, with manuals, \$300. Packing and postage extra. John VK2FUR, 02 4625 1812.
- Deceased estate VK2HH. **20-15-10 m 3 element beam antenna**, **KR400 rotator** and remote controller, connecting cable, mounted on **telescopic tower** of pipe design, fitted with hand winch and tilting base. Purchaser to dismantle. Located in Cronulla. \$550 ONO. Enquiries to George VK2UN, 02 4384 2783.

## FOR SALE VIC

- **Icom IC-707 HF** txcvr, in new condn, little used, \$1200 (list price \$2000).  
**Yaesu FT-757GX II HF** txcvr, mint condn, little used by original owner, \$950. Max VK3GMM, 03 5985 2671.
- **Yaesu High Frequency Module** (21 - 24 - 28 MHz), complete with instructions for a FT726R,

\$150. John VK3ACA. QTHR. 03 9306 2069. jadcock@melbpc.org.au.

• **Lunar Electronics 2M4-40P** 2 m linear amp, \$50. **AEA Pakratt 232 Model PK232**, complete with manuals and program, \$250. **Cushcraft ATB-34** 20-15-10 m Yagi antenna, \$200. John VK3FH, QTHR, 03 5986 1592.

• **HF linear amplifier**, GC, with extra pair new 811A valves, \$300. **German SCS Pactor**, RTTY, Amtor unit, \$300. **IC-2GXAT** 2 m hand-held, EC, \$350. **IC-2A** with two batteries, 12 V DC adapter, \$100. **Paccomm Tiny 2** packet TNC, \$150. **Transformer**, 2-3 kV, David VK3AZM, QTHR, 03 5251 3783.

• **Icom IC-735 HF** txcvr, complete with mic and mobile bracket, excellent condn in original box, s/n 36304193, \$975. Rob VK3JE, 02 6027 1077.

• Frankston South. Older style **two bedroom fibro house** for sale, well maintained, ducted heating, air conditioning throughout, land 800 m<sup>2</sup>, two street entrances, ideal for ham, includes Nally tower, TH6DXX, council approved three unit site, \$129,000 negotiable. VK3CLV, 03 9787 4915.

• **Kenwood TS-940S**, Shure 444D mic, \$2000. **Drake L4B** linear amp and PSU, \$1000. **Gem quad antenna**, 4 el, 6 bands, Ameritron remote switching, \$800. **Kenwood SW-2000** power/SWR meter, \$150. **Digital weather station**, \$300. **Yaesu world clock**, \$50. **Nally tower**, \$500. **Alinco DM130MVZ** power supply, \$200. **Kenwood mobile antenna set**, \$150. **KR250 rotator**, \$200. VK3DKC, QTHR, 03 9879 9099.

• **Kenwood TS-520S**, complete with crystals for 4 bands, mic, headphones, manual, s/n 810719, \$400. **Kenwood TM-241A** 2 m FM txcvr, complete with co-linear 5/8 Diamond ant and mast, coax, s/n 2702418, \$650. Noel VK3DPB, 03 9306 9231.

• **Icom IC-7000** wide-band receiver with handbook, covers 25-1300 MHz, all modes (AM, CW, SSB and both wide and narrow FM), excellent condn, \$900 ONO. Harold VK3AFQ, QTHR, 03 9596 2414.

• **Yaesu FT-221** 2 m txcvr, s/n 5K302182, AC/DC, power cables, manuals including WKSP manual, good condn, no further use, \$500 ONO. Max VK3AFF, QTHR, 02 6072 5217, fax 02 6072 5215.

### FOR SALE SA

• **Yaesu FT-650** all mode 6 m txcvr, 100 W out, handbook and original box, as new, \$1000. **Kenwood TS-50** HF txcvr, excellent condn, \$1000. **Yaesu FT-900** with remote kit, as new, \$1200. Gary VK5DX, 08 8370 9196 (AH), 0419 815 479 (BH).

• **Icom IC-706** mobile txcvr, HF plus 6 and 2 m, all mode, s/n 01547, immaculate condn in original carton, \$1700 ONO. John VK5KBE, QTHR, 08 8250 7259.

• Deceased estate VK5YI. **Kenwood TS-830S**, \$600. **Yaesu FT-707**, \$600. **Yaesu FC-707** ATU, \$200. **Yaesu FT-230R**, \$150. **Yaesu FT-200**, \$100. **Kenwood TR-9000**, \$400. **Hypower HL-82V** 2 m, \$150. **Tokyo Hypower HC-500A**, \$100. **20A PSU**, \$50. **Revex W502**, \$60. **KR400** rotator and mast, \$350. Mikes, switches, etc. Sell the lot for \$2000. Graeme Stretton, 088532 4757.

### FOR SALE WA

• Expressions of interest are invited for the

purchase of a large brick and tile home in a prime DX location in City Beach, WA. The antennas, mast and internal cabling goes with it. A 3 bedroom home, large kitchen, lounge/dining room, sundeck, TV/games room, large bathroom with adjacent toilet, laundry with adjoining shower are the improvements. A radio room and workshop are included underneath the residence on level with carport suitable for three cars. Antennas are duo-band 10/15 m 3 el Yagi above a mono-band 4 el Yagi on a 26 ft boom. Rotator is a current Create model with worm drive, a heavy duty unit at top of tower. The guyed tower is a 4 telescopic section, hand winched to lower from full height to 14 ft enabling service from roof height. Collins and Drake equipment not included but all cavity wall and ceiling wiring to antenna and rotator is intact (all wired with house construction in 1965). Top of the ARRL Honour Roll was achieved from this QTH. Home is Corser built and designed by Peter Overman. Present Government building controls would preclude this tower installation anywhere west or north of the City of Perth. Three phase power garden irrigation is shared with three neighbours. Jim VK6RU, QTHR, 08 9385 9664.

### FOR SALE TAS

• **Yaesu FT-230R** 25 W 2 m mobile txcvr, s/n 220103, \$250. **Icom IC2A** 1.5 W 2 m hand-held, 2 battery packs, s/n 29046, \$150. Andrew VK7XR, 0419 504 376, 03 6424 8322 (BH).

### WANTED NSW

• Plessey C45 accessories – carrier 82, tray, junction boxes J2, R, B. ARB tuning head, control box and connectors. Brian VK2GCE, QTHR, 02 9545 2650.

### WANTED VIC

• **Kingsley AR7** receiver, in any condn, but must be in green Army type case with slots for spare coils. The receiver needs only to be externally complete as it is solely required for a static Army Signals Museum display. John Stacpoole, 03 9859 4743.

• **2C39 triodes** type 7289. Roger VK3XRS, 03 5152 1163.

**Circuit for Swan 350C**. David VK3AZM, QTHR, 03 5251 3783.

• **TMK condenser checker handbook** or copy. David VK3ANP, QTHR, 03 5727 6218.

**Any information and circuit of Kyokuto VHF FM144-10SXR** txcvr, will pay all costs. Charlie VK3DCS, QTHR, 03 5331 7425.

### WANTED SA

• **Yaesu FT-726**, or 6 m module for same. Would consider mono-band txcvrs of similar vintage, eg FT-680, FT-480, TS-700, etc. Also looking for valve communications receiver, Eddystone or Collins, etc. David VK5AXW, 08 8370 1066 (BH), 08 8370 9569 (AH).

### MISCELLANEOUS

• **The WIA QSL Collection** (now Federal) requires QSLs. All types welcome, especially rare DX pictorial cards, special issue. Please contact the Hon Curator, Ken Matchett VK3TL, 4 Sunrise Hill Road, Montrose VIC 3765, tel 03 9728 5350.

ar

## WIA MORSE PRACTICE TRANSMISSIONS

VK2BWI	Nightly at 2000 local on 3550 kHz
VK2RCW	Continuous on 3699 kHz and 144.950 MHz 5 wpm, 8 wpm, 12 wpm
VK3COD	Nightly (weekdays) at 1030 UTC on 28.340 MHz and 147.425 MHz
VK3RCW	Continuous on 145.650 MHz, 5 wpm, 10 wpm
VK4WIT	Monday at 0930 UTC on 3535 kHz
VK4WCH	Wednesday at 1000 UTC on 3535 kHz
VK4AV	Thursday at 0930 UTC on 3535 kHz
VK4WIS	Sunday at 0930 UTC on 3535 kHz
VK5AWI	Nightly at 2030 local on 3550 kHz
VK5VF	Continuous on 145.650 MHz, 5 wpm to 12 wpm
VK6RCW	Continuous on 147.375 MHz, 3 wpm to 12 wpm
VK6WIA	Nightly (weekdays) at 2000 UTC on 3.555 MHz

# WIA Divisions

The WIA consists of seven autonomous State Divisions. Each member of the WIA is a member of a Division, usually in their residential State or Territory, and each Division looks after amateur radio affairs within its area.

Division Address	Officers	Weekly News Broadcasts	1997 Fees
VK1 ACT Division GPO Box 600 Canberra ACT 2601	President Hugh Blemings Secretary John Woolner Treasurer Les Davey	VK1YYZ VK1ET VK1LD 3.570 MHz LSB, 146.950 MHz FM each Sunday evening commencing at 8.00 pm local time. The broadcast text is available on packet, on Internet <a href="http://www.vk1.wia.ampr.org">aus.radio.amateur.misc</a> newsgroup, and on the VK1 Home Page <a href="http://www.vk1.wia.ampr.org">http://www.vk1.wia.ampr.org</a>	(F) \$72.00 (G) (S) \$58.00 (X) \$44.00
VK2 NSW Division 109 Wigram St Parramatta NSW (PO Box 1066 Parramatta 2124) Phone 02 9689 2417 Freecall 1800 817 644 Fax 02 9633 1525	President Geoff McGrorey-Clark Secretary Eric Fossey Treasurer Eric Van De Weyer (Office hours Mon-Fri 11.00-14.00)  Web: <a href="http://marconi.mpcpe.mq.edu.au/wia">http://marconi.mpcpe.mq.edu.au/wia</a> e-mail address: <a href="mailto:vk2wi@ozemail.com.au">vk2wi@ozemail.com.au</a> Packet BBS: VK2WI on 144.850 MHz	VK2EO VK2EFY VK2KUR From VK2WI 1.845, 3.595, 7.146*, 10.125, 14.160, 24.950, 28.320, 29.120, 52.120, 52.525, 144.150, 147.000, 438.525, 1281.750 (* morning only) with relays to some of 18.120, 21.170, 584.750 ATV sound. Many country regions relay on 2 m or 70 cm repeaters. Sunday 1000 and 1930. Highlights included in VK2AWX Newcastle news, Monday 1930 on 3.593 plus 10 m, 2 m, 70 cm, 23 cm. The broadcast text is available on the Internet newsgroup <a href="http://aus.radio.amateur.misc">aus.radio.amateur.misc</a> , and on packet radio.	(F) \$89.00 (G) (S) \$56.00 (X) \$41.00
VK3 Victorian Division 40G Victory Boulevard Ashburton VIC 3147 Phone 03 9885 9261 Fax 03 9885 9298	President Jim Linton Secretary Barry Wilton Treasurer Rob Hailey (Office hours Tue & Thur 0830-1530) Web: <a href="http://www.tbsa.com.au/~wiviav/">http://www.tbsa.com.au/~wiviav/</a>	VK3PC VK3XV VK3NC VK3BWI broadcasts on the 1st Sunday of the month, starts 10.30 am. Primary frequencies 3.615 LSB, 7.085 LSB, and FM(R)s VK3RML 146.700, VK3RMM 147.250, VK3RWG 147.225(X) and 70 cm FM(R)s VK3ROU 438.225, and VK3RMU 438.075. Major news under call VK3WI on Victorian packet BBS and WIA VIC Web Site.	(F) \$75.00 (G) (S) \$61.00 (X) \$47.00
VK4 Queensland Division GPO Box 638 Brisbane QLD 4001 Phone 074 96 47 14	President Rodger Bingham Secretary Malcolm McIntosh Treasurer Bill Sebbens e-mail address: <a href="mailto:wiaq@brisbane.dialix.com.au">wiaq@brisbane.dialix.com.au</a>	VK4HD VK4ZMM VK4XZ 1.825 MHz SSB, 3.605 MHz SSB, 7.118 MHz SSB, 14.342 MHz SSB, 28.400 MHz SSB, 29.220 MHz FM, 52.525 MHz FM, 146.700 MHz FM, 147.000 MHz FM, 438.525 MHz (Brisbane only), regional VHF/UHF repeaters at 0900 hrs Sunday. Repeated on 3.605 MHz SSB & 147.000 MHz FM, regional VHF/UHF repeaters at 1930 hrs EAST Monday. Broadcast news in text form on packet under WIAQ@VKNET.	(F) \$74.00 (G) (S) \$60.00 (X) \$46.00
VK5 South Australian Division 34 West Thebarton Rd Thebarton SA 5031 (GPO Box 1234 Adelaide SA 5001) Phone 08 8352 3428 Fax 08 8264 0463	President Ian Hunt Secretary Graham Wiseman Treasurer Joe Burford  Web: <a href="http://www.vk5wia.ampr.org/">http://www.vk5wia.ampr.org/</a>	VK5QX VK5EU VK5UJ 1827 kHz AM, 3.550 MHz LSB, 7.095 AM, 14.175 USB, 28.470 USB, 53.100 FM, 147.000 FM Adelaide, 146.700 FM Mid North, 146.800 FM Mildura, 146.825 FM Barossa Valley, 146.900 FM South East, 146.925 FM Central North, 147.825 FM Gawler, 438.425 FM Barossa Valley, 438.475 FM Adelaide North, ATV Ch 35 579.250 Adelaide. (NT) 3.555 USB, 7.065 USB, 10.125 USB, 146.700 FM, 0900 hrs Sunday. 3.585 MHz and 146.675 MHz FM Adelaide, 1930 hrs Monday.	(F) \$75.00 (G) (S) \$61.00 (X) \$47.00
VK6 West Australian Division PO Box 10 West Perth WA 6872 Phone 09 351 8873	President Wally Howse Secretary Christine Bastin Treasurer Bruce Hedland-Thomas  Web: <a href="http://www.faroc.com.au/~vk6wia">http://www.faroc.com.au/~vk6wia</a>	VK6KZ VK6ZLZ VK6OO 146.700 FM(R) Perth, at 0930 hrs Sunday, relayed on 1.825, 3.560, 7.075, 14.116, 14.175, 21.185, 29.680 FM, 50.150 and 438.525 MHz. Country relays 3.582, 147.350(R) Busselton and 146.900(R) Mt William (Bunbury). Broadcast repeated on 146.700 at 1900 hrs Sunday, relayed on 1.865, 3.563 and 438.525 MHz; country relays on 146.350 and 146.900 MHz.	(F) \$62.00 (G) (S) \$50.00 (X) \$34.00
VK7 Tasmanian Division PO Box 271 Riverside TAS 7250 Phone 03 6327 2096 Fax 03 6327 1738	President Ron Churcher Secretary Barry Hill Treasurer Mike Jenner	VK7RN VK7BE VK7FB 146.700 MHz FM (VK7RHT) at 0930 hrs Sunday relayed on 147.000 (VK7RAA), 146.725 (VK7RNE), 146.625 (VK7RMD), 3.570, 7.090, 14.130, 52.100, 144.150 (Hobart) Repeated Tues 3.590 at 1930 hrs.	(F) \$74.00 (G) (S) \$60.00 (X) \$46.00
VK8 (Northern Territory is part of the VK5 Division and relays broadcasts from VK5 as shown received on 14 or 28 MHz).			

Note: All times are local. All frequencies MHz.

**Membership Grades**  
Full (F) Pension (G)  
Needy (G) Student (S)  
Non receipt of AR (X)

Three-year membership available to (F) (G) (X) grades at fee x 3 times

## ADVERTISERS' INDEX

Andrews Communication Systems _ 3	Terlin Aerials _____ 34
Amateur Transceiver Radio _____ 23	WIA Recruitment _____ 13
Australian Electric Valve _____ 7	WIA Membership Retention _____ 9
Daycom _____ IFC	<b>Trade Hamads</b>
Dick Smith Electronics _ 28, 29, IBC	M Delahunty _____ 54
ICOM _____ OBC, 27	RJ & US Imports _____ 54
Radio and Communications _____ 4	HAMLOG - VK2VN _____ 54

### TRADE PRACTICES ACT

It is impossible for us to ensure the advertisements submitted for publication comply with the Trade Practices Act 1974. Therefore, advertisers and advertising agents will appreciate the absolute need for themselves to ensure that the provisions of the Act are complied with strictly.

### VICTORIAN CONSUMER AFFAIRS ACT

All advertisers are advised that advertisements containing only a PO Box number as the address cannot be accepted without the addition of the business address of the box-holder or seller of the goods.

# Yaesu's Done It Again



## FT-920 HF/6m Transceiver With DSP

Now there's no excuse for not taking advantage of the latest advances in Digital Signal Processing, transceiver design plus the fun of 6m operation. The stunning new Yaesu FT-920 is a high performance HF/6m multi-mode receiver that provides 100W PEP output on the 160-6m bands, incredible front-end performance based on the FT-1000MP design, and a huge array of features that make it a pleasure to use.

At first glance Yaesu's renowned Omni-Glow LCD screen is obvious, and its wide-angle view provides a wealth of information about the transceiver's operating status with multi-function metering, dual frequency displays and an Enhanced Tuning scale for DSP bandwidth, CW tuning, FM discriminator and more. Inside, the FT-920 is built around a rugged diecast unibody chassis which provides excellent heatsinking for the low distortion dual MRF255 160-6m FET power amplifier.

For more comfortable operating when weaker signals are present Yaesu's engineers dedicated themselves to enhancement of real-world signal to noise ratios, and after thousands of hours of design and testing have produced an industry-leading 33.3MIPS (millions of instructions per second) processing speed DSP in the FT-920 that provides a two-parameter noise reduction system with 32 steps of front panel adjustment. This amazing system also provides dual control DSP passband tuning, DSP auto-notch filter, an amazing new transmit Digital Speech Processor, DSP mic

equalisation, fast acting DSP VOX circuitry as well as a Contest-ready Digital Voice Recorder!

Other features include an all-band (160-6m) auto antenna tuner which also provides greater receiver band-pass protection, Direct Digital Synthesis for clean local oscillators, selectable frequency-optimised receiver front-end pre-amps, and a Shuttle Jog tuning ring for fast QSY. A Dual Watch receive system allows you to check for band openings, especially handy when monitoring 6m. Also provided are SSB/CW/FM operation (AM with optional filter), 127 memories with alphanumeric labelling, IFshift and IF noise blanker to fight interference, plus an extensive menu system for selecting most "set and forget" functions.

The FT-920 is supplied with an MH-31B8 hand mic, DC power lead and comprehensive instruction manual.

Why not call for a copy of the Yaesu 6 page FT-920 colour brochure to learn more about this efficient transceiver that's without peer in its price class.

D 3420



# \$2995

**2 YEAR WARRANTY**

*Due end Oct 97*

### PHONE FAX AND MAIL ORDERS

**PHONE:** WITHIN AUSTRALIA: 1300 366 644  
(Local Call Charge)

**FAX:** (02) 9395 1155 within Australia and  
(+612) 9395 1155 from outside Australia

**MAIL:** DICK SMITH ELECTRONICS, Direct Link Reply Paid 160,  
PO Box 321, North Ryde NSW 2113 (No Stamp Required)

*Excludes packaging and postage. All major Credit Cards accepted.  
14 Day Money Back Guaranteed if NOT completely satisfied.*

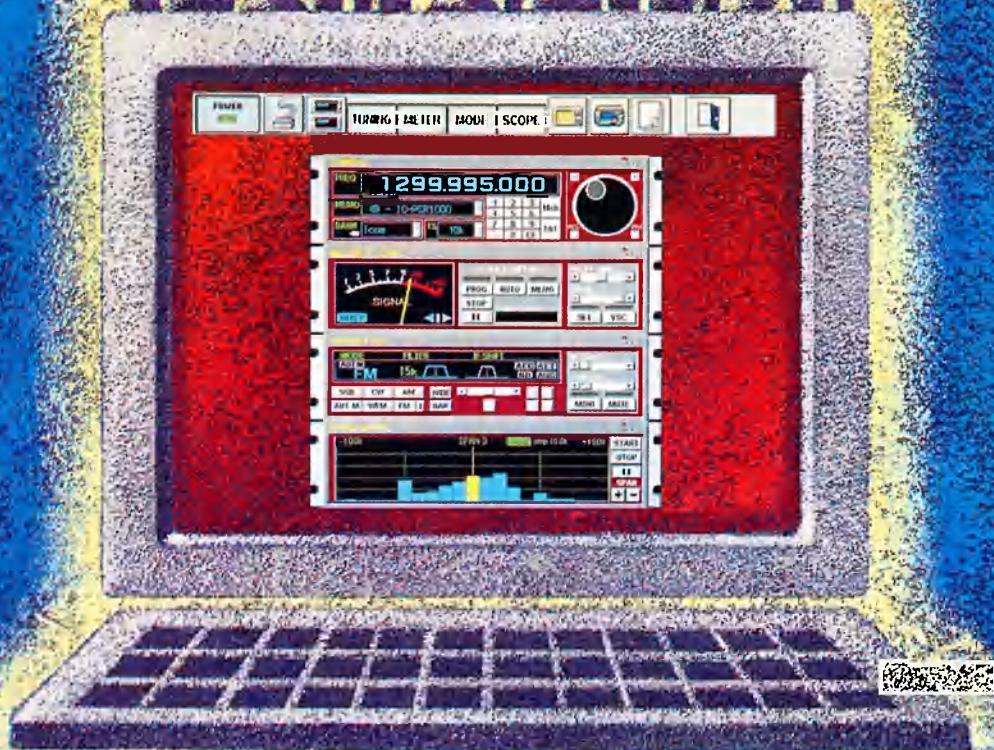


Visit our web site at  
<http://www.dse.com.au>



B 3050 col

# Let your mouse tune into the world.



The world's airwaves are now at your fingertips with the new IC-PCR 1000. This 'black box' unit delivers 3 receiver interfaces to your PC. A communications receiver; a 4 component display; and a radio screen with presets. Access the world of radio from AM or FM programming, to ham radio, aviation or marine broadcasts... all for a much cheaper outlay than buying each radio individually, and we even supply the single aerial! Hearing is believing... for the name of your nearest Icom dealer call toll free on 1800 338 915 now.

 **ICOM**  
Clearly Ahead.



# Amateur Radio

November 1997

Volume 65 No 11



*Journal of the Wireless Institute of Australia*



*Full of the latest amateur radio news, information and technical articles including...*

- Review of the Yaesu FT-920 HF & 6 m Transceiver
- Homebrew Power Meter and Attenuator Set
- Cost Effective Current-mode 1:4 and 1:1 Baluns

**Plus** *lots of other articles, news and special interest columns*

**WHAT?  
NO 1998 CALL BOOK?**

**INSTEAD, THERE'S SOMETHING DIFFERENT**

**1998**

**The Australian  
RADIOCOMMUNICATIONS  
REFERENCE GUIDE  
and  
RADIO AMATEURS' CALL BOOK**

**Revamped and refreshed 'front end' featuring:**

- new, reader-friendly layouts
- popular reference features such as Amateur Examiners, Beacon and Repeater Listings, Bandplans
- new material, including ARDF, the Internet & Amateur Radio, Digital Communications, Sources for Assistance
- better paper for improved readability

**PLUS . . .**

**More than 16,000 Call Sign listings from the Australian  
Communications Authority public licensee database**

**A NEW NAME, A NEW LOOK, A NEW PUBLICATION  
SAME OLD PRICE!**

**Cover Price: \$14.95**

**WIA Members' Price: \$13.00**

**plus postage and handling where applicable**

**AVAILABLE FROM NOVEMBER THROUGH  
YOUR WIA DIVISION**

# Amateur Radio



## Journal of the Wireless Institute of Australia

Vol 65 No 11

ISSN 0002-6859

November 1997

Amateur Radio is published by the Wireless Institute of Australia, ACN 004 920 745 as its Official Journal, on the last Friday of each month.

### Editorial

#### Editor

Bill Rice VK3ABP\*

Production Manager

Bill Roper VK3BR

Senior Technical Editor

Peter Gibson VK3AZL\*

Technical Editors

Evan Jarman VK3ANI\*

Gil Sones VK3AUI\*

Don Graham VK6HK

Contributing Editors

Ron Fisher VK3OM\*

Don Jackson VK3DBB\*

WIA News Editor

Roger Harrison VK2ZRH

Proof Readers

Allan Doble VK3AMD

Jim Payne VK3AZT

Graham Thornton VK3IY

John Tutton VK3ZC

\*Publications Committee member

### Production

Administration, Advertising, Drafting, Production

vk3br Communications Pty Ltd

3 Tamar Court, Mentone VIC 3194

Typesetting and Printing

Industrial Printing and Publishing Pty Ltd

122 Dover Street, Richmond, VIC 3121.

Mail Distribution

Mail Management Australia Pty Ltd

6 Garden Boulevard, Dingley VIC 3172

New Advertising

Eyvonne & Keith Tootell

Union Publicity Service Pty Ltd

PO Box 282, Toongabbie NSW 2146

Telephone: 1800 654 181 - 02 9831 1299

Fax: 02 9831 6161

Amateur Radio Correspondence

All contributions, correspondence, Hamads and queries concerning the content of

Amateur Radio should be sent to:

Amateur Radio

vk3br Communications Pty Ltd

3 Tamar Court, Mentone VIC 3194

E-mail: vk3br@c031.aone.net.au

Phone and Fax: 03 9584 8928

Mobile: 0418 534 168

Business Hours: 9.30 am to 3.00 pm weekdays

Amateur Radio Delivery

All correspondence and queries

concerning the delivery of

Amateur Radio should be sent to:

Amateur Radio

WIA Federal Office

PO Box 2175

Caulfield Junction VIC 3161

Registered Office:

3/105 Hawthorn Road

Caulfield North VIC 3161

Telephone: 03 9528 5962

Fax: 03 9523 8191

Business Hours: 9.30 am to 3.00 pm weekdays

Editorial and Hamads Deadlines

December 10/11/97

January 01/12/97

February 12/01/98

Receipt of Amateur Radio by Mail

The November issue will be delivered to Australia Post on Tuesday, 2 December 1997 for mailing to members.

If this magazine is not received by the 15th of the month of issue, and you are a financial member of the WIA, please check with the Post Office before contacting the registered office of the WIA. ©

© Wireless Institute of Australia 1997

### CONTENTS

#### Technical

Equipment Review - Yaesu FT-920 HF and 50 MHz All Mode Transceiver \_\_\_\_\_ 7

Ron Fisher VK3OM

A Homebrew Power Meter and Attenuator Set \_\_\_\_\_ 13

Drew Diamond VK3XU

A Cost Effective Current-mode 1:1 Balun \_\_\_\_\_ 16

Ralph Holland VK1BRH

A Cost Effective Current-mode 1:4 Balun \_\_\_\_\_ 17

Ralph Holland VK1BRH

Technical Abstracts \_\_\_\_\_ 18

Gil Sones VK3AUI

#### General

Women in Radio - Mothers and Daughters \_\_\_\_\_ 21

Christine Taylor VK5CTY

#### Columns

Advertisers' Index \_\_\_\_\_ 56

ALARA \_\_\_\_\_ 23

AMSAT Australia \_\_\_\_\_ 24

Awards \_\_\_\_\_ 25

Club Corner \_\_\_\_\_ 27

Contests \_\_\_\_\_ 27

Divisional Notes \_\_\_\_\_

VK1 Notes \_\_\_\_\_ 34

VK2 Notes \_\_\_\_\_ 34

VK3 Notes \_\_\_\_\_ 35

VK5 Notes \_\_\_\_\_ 36

VK7 Notes \_\_\_\_\_ 37

Editor's Comment \_\_\_\_\_ 2

FTAC Notes \_\_\_\_\_ 38

Hamads \_\_\_\_\_ 54

HF Predictions \_\_\_\_\_ 52

How's DX? \_\_\_\_\_ 38

Intruder Watch \_\_\_\_\_ 44

Ionospheric Update \_\_\_\_\_ 51

Over To You \_\_\_\_\_ 42

Pounding Brass \_\_\_\_\_ 43

QSP News \_\_\_\_\_ 22

Repeater Link \_\_\_\_\_ 45

Silent Keys \_\_\_\_\_ 44

Spotlight on SWLing \_\_\_\_\_ 46

Technical Correspondence \_\_\_\_\_ 55

Update \_\_\_\_\_ 47

VHF/UHF - An Expanding World \_\_\_\_\_ 48

VK QSL Bureaux \_\_\_\_\_ 35

WIA News \_\_\_\_\_ 3, 15, 23

WIA - Divisional Directory \_\_\_\_\_ 56

WIA - Federal Directory \_\_\_\_\_ 2

#### Cover

Bev VK4NBC has only held her amateur licence since 1980 but has been very active on the air. She has participated in many nets and contests, particularly Novice contests, successfully.

She has twice won the Florence McKenzie Trophy for CW contacts by Novices in the ALARA Contest. In 1996 she also had the highest overall number of contacts in the ALARA contest.

Bev is seen with the two Florence McKenzie certificates in her shack.

#### BACK ISSUES

Available direct from the WIA Federal Office, only until stocks are exhausted, at \$4.00 each (including postage within Australia) to members.

#### PHOTOSTAT COPIES

When back issues are no longer available, photocopies of articles are available to members at \$2.50 each (plus \$2.00 for each additional issue in which the article appears).

The opinions expressed in this publication do not necessarily reflect the official view of the WIA, and the WIA cannot be held responsible for incorrect information published.

# Amateur Radio Service

A radiocommunication service for the purpose of self-training, intercommunication and technical investigation carried out by amateurs, that is, by duly authorised persons interested in radio technique solely with a personal aim and without pecuniary interest.

## Wireless Institute of Australia

The world's first and oldest National Radio Society  
Founded 1910

Representing the Australian Amateur Radio Service -  
Member of the International Amateur Radio Union  
Registered Federal office of the WIA:  
3/105 Hawthorn Rd, Caulfield North, Vic 3161

All Mail to:

PO Box 2175, Caulfield Junction, VIC 3161  
Telephone: 03 9528 5962 Fax: 03 9523 8191

Business Hours: 9.30 am to 3.00 pm on weekdays

Federal Secretary  
Peter Naish VK2BPN

### FEDERAL OFFICE STAFF

June Fox	Book Keeper
Debby Johnston	Membership Secretary
Rita Trebilco VK3NRT	Examinations Officer

### COUNCIL

President	Neil Penfold	VK6NE
VK1 Federal Councillor	Richard Jenkins	VK1RJ
VK2 Federal Councillor	Michael Corbin	VK2YC
VK3 Federal Councillor	Brenda Edmonds	VK3KT
VK4 Federal Councillor	Ross Marren	VK4AMJ
VK5 Federal Councillor	Ian Watson	VK5KIA
VK6 Federal Councillor	Wally Howse	VK6KZ
VK7 Federal Councillor	Andrew Dixon	VK7GL

### EXECUTIVE

Peter Naish	VK2BPN
Rowland Bruce	VK5OU
Neil Penfold	VK6NE

### FEDERAL CO-ORDINATORS

AMSAT:	Graham Ratcliff	VK5AGR
ARDF	Wally Watkins	VK4DO
Awards:	John Kelleher	VK3DP
Contests:	Peter Nesbit	VK3APN
Education:	Brenda Edmonds	VK3KT
EMC and Standards	Roger Harrison	VK2ZRH
FTAC:	John Martin	VK3KWA
Historian:	John Edmonds	VK3AFU
IARU:	David Wardlaw	VK3ADW
Int'l Beacon Co-ord:	Roger Harrison	VK2ZRH
Intruder Watch:	Gordon Loveday	VK4KAL
ITU Conference and Study Group:	David Wardlaw	VK3ADW
Media:	Roger Harrison	VK2ZRH
QSL Manager (VK9,VK0):	Neil Penfold	VK6NE
Radio Sports:	Wally Watkins	VK4DO
Videotapes:	Bob Godfrey	VK4BOB
WICEN:	-	-

### SMA LIAISON TEAM

Roger Harrison	VK2ZRH
David Wardlaw	VK3ADW
Neil Penfold	VK6NE

# Editor's Comment

## More to be Said

There are at least two topics we have discussed recently about which more information has now come in.

First, back in June, the *Novice Notes* column on page 39 showed a polarity diagram for the low-voltage connector often used for mobile installations. It consists of a two pin plug with the pins at right angles, so defining a capital T, and a corresponding socket. The diagram (which was poorly reproduced and at least twice as big as necessary) showed polarity as positive on the crosspiece pin of the T and negative on the vertical pin. But a note on the diagram suggested that the opposite polarity was also permissible; and all that was really necessary was that all one's own equipment should conform to the same standard.

Unfortunately, there is a standard for the polarity, and it is the reverse of that shown in June. **THE TOP OF THE T IS NEGATIVE!** This standard was established by a number of emergency services including the CFA and police, and was therefore adopted by WICEN. I am indebted to Peter Mill VK3ZPP/APO who brought all this to my notice in August.

He also reminded us that we had had similar confusion about the same plugs in *Amateur Radio* back in the 1980s. After a rather tedious search I found that an article and numerous letters appeared between March and June 1985; so we should have known better, shouldn't we?

The other topic was my reference in the October editorial to the Millennium Bug. Several members of the Publications Committee are even more informed about computers than the "experts" I had talked to earlier, and they were rather less pessimistic. It now seems probable that most PCs (IBM or clones) should have no trouble in accepting the date change from 1999 to 2000, provided the software being used will allow it. The real impact of the problem will be felt mostly by larger (mainframe) computers, particularly if running obsolete software. Macintosh PCs should also be OK.

In a little over two years we will all know the answer.

Bill Rice VK3ABP

Editor

### CONTRIBUTIONS TO AMATEUR RADIO

*Amateur Radio* is a forum for WIA members' amateur radio technical experiments, experiences, opinions and news. Manuscripts with drawings and/or photos are always welcome and will be considered for possible publication. Articles on computer disk or via e-mail are especially welcome. The WIA cannot assume responsibility for loss or damage to any material. A pamphlet, "How to Write for *Amateur Radio*", is available from vk3br Communications Pty Ltd on receipt of a stamped, self addressed envelope.

## ■ WIA News

Roger Harrison VK2ZRH, Federal Media Liaison Officer

# WIA Successful at Region 3 Conference

The Wireless Institute of Australia was successful in advocating a number of actions for adoption by the Region 3 Association of the International Amateur Radio Union at its 10th Conference, held in Beijing, the capital of the Peoples Republic of China, over 8-12 September.

The Region 3 Conference also confirmed Australia's proposal to host the 11th conference in the year 2000.

Delegations from 15 Asia-Pacific countries, together with observers from Region 1 and Region 2 IARU associations, and the IARU Advisory Council, attended the 10th Region 3 Conference of the IARU, which was hosted by the Chinese Radio Sports Association (CRSA).

A five-member team attended for the Wireless Institute of Australia, headed by the WIA's IARU Liaison Officer, Dr David Wardlaw VK3ADW. The other four team members were WIA Federal President, Neil Penfold VK6NE, Brenda Edmonds VK3KT, Roger Harrison VK2ZRH and Wally Watkins VK4DO. Only David Wardlaw and Neil Penfold were funded by the WIA to attend, the other three paid their own travel and accommodation expenses.

The Conference was chaired by Chen Ping BA1HAM, Secretary of the Chinese Radio Sports Association (CRSA). The Conference President was Xu (sounds like, 'shoe') Zengwu, President of the CRSA.

Special guests attending the Conference were Mr He (sounds like, 'hay') Fuqi ('foo-chee'), Director of the Office of State Radio Regulatory Commission in China, a director of the International Telecommunications Union's Radio Communications Bureau, Robert Jones, and Ms He ('hay') Jin, a representative from the Asia-

Pacific Broadcasting Union (ABU). IARU President, Dick Baldwin W1RU, Vice President, Michael Owen VK3KI, and Secretary, Larry Price W4RA, were there as well.

A total of more than 100 people attended.

In speaking before the official opening, the Director of China's Radio Regulatory Commission, Mr Xu, stressed the importance of radio to the Chinese economy. Commenting that the Amateur and Amateur Satellite Services were comparatively undeveloped in China, he said he was pleased to see the Region 3 Conference being held in Beijing so that people could learn from one another.

He concluded by indicating the Chinese administration's support at future World Radiocommunications Conferences, not only for the Amateur Service in general, but specifically for amateurs having a 300 kHz-wide band at 7 MHz, to the delighted surprise of the Conference audience.

The Conference was officially opened by Robert Jones from the ITU, who spoke of the scale of the pending World Radiocommunications Conference, WRC-97, to be held for eight weeks from late-October through early-November, at which 1000 delegates will discuss the global administration of radiocommunications. He said amateur radio was subjected to a rapidly changing environment, with increasing pressure from other services.

Mr Jones commented on issues of concern to amateurs the world over, such as the future review of Article S.25 of the International Radio Regulations, concerning the definition of the Amateur Service and licensing qualifications, and the 7 MHz band issue, all likely to be on

the agenda of WRC-99, which is only two years away.

The Conference re-elected David Wardlaw VK3ADW as a director to the five-member board of Region 3 IARU following the retirement of director David Rankin 9V1RH/VK3QV after 24 years of service. He served variously as a director, as Chairman for a period, and also Secretary.

The other four incumbent directors were returned: Sangat Singh 9M2SS, Young Soon Park HL1IFM, Yoshiji Sekido JJ1OEY, and Fred Johnson ZL2AMJ, who was also later re-elected Chairman of directors. Keigo Komuro JA1KAB was re-appointed as Secretary.

More than 100 papers were considered by the Conference. Three working groups were formed to consider and deal with issues raised in the various papers, and to make recommendations to the delegations meeting in plenary sessions: Operations and Policy matters, Technical matter, plus Future of the Amateur Service and ITU matters.

### ALINCO DX-70TH

HF & 6M 100W  
SUPERB TRANSCEIVER \$1249

BIG RANGE OF ALINCO IN STOCK.  
FACTORY BACKED 3-YEAR WARRANTY  
NEW KENWOOD COMING... CALL US

IC-746 HF & 6M-2M 100W  
DSP, BK LCD 500H  
MFJ TUNERS & TERMINALS  
DX 1600, DX-800 LINEARS

AR-5000+3 SCANNER  
AR-8000 HAND HELD SCAN... \$950  
PALOMAR HF LINEARS... CALL

RG-213 \$149 HI-GRADE  
100M ROLL  
KENPRO, KANTRONICS, YUPITERU  
20A \$269, 50A \$599, 87A \$899

## Andrews Communication Systems

(EST. 1976 - ACN 001 968 752)

Call us now

(02) 9636 9060 or (02)  
9688 4301

SHOP 8, 41 BATHURST ST, GREYSTANES,  
N.S.W. 2145. FAX (02) 9688 1995

All 14 WIA papers submitted to the Conference were discussed and recommendations put forward were generally agreed to. The Conference expressed appreciation for the many issues of interest to Region 3 societies raised in the WIA papers. WIA recommendations accepted covered amateur examination and licensing issues, electromagnetic compatibility, amateur satellite issues, promotion of and support for the Amateur Service in Region 3, and ITU matters.

The issues raised by the IARU's Future of the Amateur Service Committee (FASC) were dealt with in the FASC-ITU matters working group, chaired by David Wardlaw VK3ADW. The recommendations of this working group, accepted by the Region 3 Conference but too lengthy to outline here, were consistent with the survey results about the definition of the Amateur Service and licence qualifications canvassed by the WIA over the past year.

In total, some 50 recommendations were considered by the Region 3 Conference plenary sessions, covering:

- important issues to be dealt with at upcoming ITU World Radiocommunications Conferences;
- the fostering of amateur radio with administrations in countries throughout region 3;
- future planning for the IARU Region 3 Association;
- issues relating to electromagnetic compatibility and standards;
- the IARU/NCDXF Beacon Project along with HF and VHF-UHF beacons in general;
- Amateur Radio Direction Finding matters; and
- Intruder Watch monitoring of the amateur bands.

At each Conference, a Finance Committee is formed and the Region 3 Association's finances and budget are considered. The Conference accepted the Finance Committee's recommendation that there be no change in member societies' level of financial subscription to the IARU Region 3 Association.

Some Conference highlights: Vietnam's national amateur society participated for the first time; the Chinese Radio Sports Association (CRSA)

supported the retention of the Hong Kong Amateur Radio Transmitters Society (HARTS) as a separate member of the IARU Region 3 Association and as a separate DXCC country since the return of Hong Kong to China on 1 July; and the signing by delegates from the 15 member societies present, together with representatives of the three regional IARU associations and the IARU

President, of a Memorandum of Understanding to pursue with their respective administrations a "Guest Amateur Radio Licence" for use during short-term, temporary, visits by amateurs from other countries "... based on the local grades, licence classification and local regulations existent in the guest country."

[Released 26/9/97]

## World Amateur Radio Day Activities

Saturday, 20 September, was World Amateur Radio Day, an opportunity to bring our hobby to the attention of the community in a positive way. As the name implies, this is a world-wide event initiated and promoted by the International Amateur Radio Union, which Australia only formally joined-in this year. Amateur radio clubs and groups in a number of states planned and put on events for 20 September, but not all came to fruition as planned, unfortunately.

The Shepparton and District Amateur Radio Club (SADARC) in Victoria planned an open day at their club rooms, conveniently located in the town's Mechanics Institute, the former library building. Club President, Jacek Szczurek, said the club publicised the event by sending out letters to schools in the area and advising the local media. A wide variety of amateur equipment was to be on-hand, he said, to highlight such amateur activities as HF and VHF/UHF, packet and amateur TV.

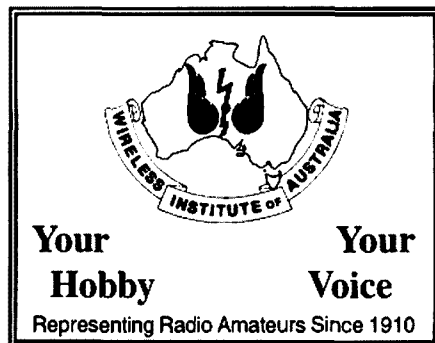
Apart from the South Side Amateur Radio Society's event at a shopping mall in suburban Woodside in Brisbane, reported in the August issue, the Tasmanian Division's Southern Branch put together a public event outside the state's parliament house.

However, the Amateur Radio Balloon Experiment (ARBE) planned by South Australian and Victorian amateurs (also reported in the August issue) was scuttled by bureaucracy in mid-August, unfortunately. WIA South Australian Division Education Co-ordinator, Tony

Van Lysdonk VK5WC, had planned to involve school students in tracking a balloon-carried payload comprising a series of environmental sensors and a 2 m FM beacon with voice-synthesised and data telemetry transmissions. In an announcement on the amateur packet radio network, Tony said, "... the project is not dead just on an indefinite hold."

The theme for the 1998 World Amateur Radio Day will be "Amateur Radio - Communicating Worldwide for Three Quarters of a Century". The International Amateur Radio Union Administrative Council decided on the theme at its meeting following the Region 3 IARU Conference in Beijing in September. The theme honours the anniversary of the first transoceanic two-way amateur communication, between France and America, in November 1923. The 1998 World Amateur Radio Day will also fall on 20 September. From the year 2000, the IARU decided that World Amateur Radio Day will occur in April, marking the anniversary month of the founding of the IARU in Paris in 1925, the *ARRL Letter* reported.

[Released 7/10/97]



# WIA at WRC-97 in Geneva

The WIA's ITU Conference Co-ordinator, Dr David Wardlaw VK3ADW, is in Geneva for the 1997 World Radiocommunications Conference, which opened on 27 October and continues through this month.

A number of threats to VHF and UHF amateur bands may emerge at the conference, arising from spectrum being sought by satellite operators who are gearing up to provide mobile telephone services via low earth orbiting (LEO) satellites. In addition, earth exploration satellites may pose a threat to the 70 cm band and spectrum for 'wind profiler' radars is to be discussed. These radars, operated at airports and air fields, are seeking spectrum around 50 MHz, 400 MHz and 1000 MHz. Their operation can affect sensitive amateur receivers in adjacent amateur bands for amateurs living nearby.

Issues for the WRC-99 agenda will be confirmed at WRC-97. Of interest to amateurs is the matter of world-wide harmonisation of the 7 MHz band to provide a 300 kHz-wide band for the Amateur Service, either from 6900-7200 kHz or 7000-7300 kHz. Discussions on spectrum for the short-wave broadcasters at WRC-97 this month could have repercussions for a decision on 7 MHz harmonisation at WRC-99, David Wardlaw told *WIA News*.

In addition, to be confirmed in Geneva this month is the matter of Article S25, about the Amateur Service, as an agenda item for WRC-99. This is the issue being pursued by the International Amateur Radio Union's 'Future of the Amateur Service Committee' (FASC). Article S25

in the International Radio Regulations defines the Amateur and Amateur-Satellite services. Bound up in this issue is the matter of whether the testing of Morse code proficiency for amateur HF band access should be retained or as a treaty obligation or left to each country's administration.

David Wardlaw will be kept busy

shuttling between the WRC's three working groups, which will be meeting in parallel.

The IARU Administrative Council, meeting in Beijing over 13-15 September following the Region 3 IARU Conference, agreed on instructions for their delegation to WRC-97, according to the *ARRL Letter*. The core delegation consists of IARU Secretary, Larry Price W4RA, IARU Vice President, Michael Owen VK3KI, and IARU Region 1 Vice President, Wojciech Nietyksza SP5FM. [Released 7/10/97]

## Lucky Victorian Fluke's August Recruitment Prize

New recruit to the Victorian Division WIA for August, Mr J D Harrison VK3FHV (no relation), has snagged the Fluke 12B digital multimeter. Meanwhile, as announced in the *Over to You* column in the October issue, June's winner, Roberta Barmore KB9GKX, has donated her prize to be given to a deserving young VK ham of modest means who needs a DVM. WIA Queensland President, Rodger Bingham VK4HD, says the Divisional Council will put on their thinking caps to see that Roberta's wishes are fulfilled.

There's a multimeter to be won every month throughout 1997 in a draw from among new WIA recruits joining in any particular month. The Fluke 12B digital multimeter is worth \$195, and the 12 prizes have been generously donated by

Philips Test & Measurement. Fluke is the world's pre-eminent manufacturer of digital test instruments and the Model 12B is from their latest range of hand-held instruments.

The Fluke 12B measures AC and DC voltage (with auto-selection above 4.5 V), resistance and capacitance from 1000 pF to 1000 µF. The instrument features a simple rotary dial, a 4000-count liquid crystal display, and diode and continuity testing. Its "continuity capture" feature indicates intermittent open and short circuits. It comes with test leads and a two-year warranty.

Every newcomer to electronics and amateur radio needs a good multimeter, and every seasoned enthusiast could always do with another one. And the chances of winning are *very* good!

Membership recruitment advertisements appear in each issue of *Amateur Radio* magazine, and in *Radio and Communications* magazine.

Membership recruitment and renewal advertisements are also on WIA Divisions' World Wide Web pages on the Internet.

[Released 7/10/97]

**Are you reading someone else's  
Amateur Radio?  
Call 03 9528 5962  
to find out how to get it every  
month!**

# Technology and Future Growth of Amateur Radio

The International Amateur Radio Union (IARU) Administrative Council has set up an *Amateur Radio Outlook Committee* which is to make general recommendations on the future growth and development of amateur radio.

The committee has been established in response to changing technology and the Internet, reports the *ARRL Letter* for 26 September. It is headed by Tom Atkins VE3CDM, President of Region 2 IARU.

The decision came from the IARU's Administrative Council meeting in Beijing over 13-15 September, following the Region 3 IARU Conference.

The Administrative Council (AC) also updated the IARU Strategic Plan for the Development of Support for Amateur Radio, the goal for 1998-99 being to

enhance support for the Amateur Service among the African nations. The AC also adopted a resolution encouraging the promotion and development of amateur radio digital technology, reviewed present and anticipated future require-

ments for radio spectrum allocations to the Amateur and Amateur-Satellite services, reviewed arrangements to participate in Africa TELECOM next year and World TELECOM in Geneva in 1999, and appointed a committee to review the IARU Monitoring System (Intruder Watch).

[Released 7/10/97.]

## UK Amateurs Get New LF Band

The UK's Radiocommunications Agency has told the Radio Society of Great Britain (RSGB) that they hope to release the 136 kHz band early next year for use by all UK Class A amateur licensees.

The 136 kHz band is an allocation available to European amateurs.

The RSGB's *GB2RS News* for 5 October, reported that the present UK-only 73 kHz band will continue in parallel with the new allocation until the end of December 1999, but no new permits for 73 kHz operation will be issued after 31 December this year. The RSGB has requested some extensions of these periods. **ar**



## Radio and Communications

INCORPORATING AMATEUR RADIO ACTION AND CB ACTION

Published by  
**ACP ACTION**,  
PO Box 119,  
Oakleigh,  
Victoria 3166  
(03) 9567 4200

Hang on, what's this? A Kenwood? Nope. It's an **ADI**, and the company's radios are now being sold in this country. If nothing else, you'll like the price — but it has plenty of other things to offer. Check it out... You can also read about one of the biggest threats to wide-tuned general coverage receive we've ever faced.

November's R&C is jam-packed with great features for amateur radio operators. Here are just a few of them...

- REVIEW: ADI AD-146. How can a new radio cost so little? It's not short on features, either.
- USA Bill to BAN scanners and amateur rigs with wide-tuned receive. This is *not* a good move...
- DXpedition report: one man took off for an Equatorial island, and actually made *lots* of contacts!
- Construction: got an old mobile radio microphone lying around? Turn it into a speaker/mic.
- Packet Radio. Is it worth another look, another visit? One enthusiastic VK5 says yes, definitely!
- As usual, we have our three DX columns, mods and more... the best stories and regulars every month!

Don't miss out — **RADIO and COMMUNICATIONS** is great reading for amateurs!  
**Check your local newsagent today!**

(PS. We also have the biggest collection of radio-oriented Classified adverts in the country. There's lots of them because they work so well. Ask your newsagent to keep a copy for you each month, or ring 1800 25 2515 for subscription details. Hurry — you might miss something!)

v3329



## ■ Equipment Review

# YAESU FT-920 HF and 50 MHz All Mode Transceiver

Reviewed by Ron Fisher VK3OM\*



The Yaesu FT-920 transceiver.

The new Yaesu FT-920 is a mid-priced transceiver which slots between the popular FT-1000MP and the FT-900. It is a fully featured rig with everything that the discerning amateur would require. At a selling price of \$2995, a full \$1000 less than the FT-1000MP, I am sure it is destined to be a very popular transceiver. It will no doubt replace the FT-990 which has been around for nearly five years now.

One of the most important new features of the FT-920 is the inclusion of the six metre band and I will be looking at its performance on this band in some detail. As I am not equipped for six metre operation, I enlisted the help of well known six metre identity John Patterson VK3ATQ to pass judgement on the FT-920's performance on the 50 MHz band.

Compared with the earlier FT-990, there are two other important differences. The first is the inclusion of full digital signal processing (DSP) for both transmit and receive; and the other is the omission of a built-in AC power supply. In view of the fact that the FT-920 is actually larger than the older FT-990, this is surprising. The FT-920 therefore

requires an external 13.8 volt DC power supply capable of supplying 22 amps. The Dick Smith D3800 would be an ideal choice and, in fact, one of these was used for all of my tests.

There is no doubt that the design of the FT-920 is based to a large extent on the highly successful FT-1000MP. Stand back a few metres and one could easily be mistaken for the other. However, the second tuning control is not for a second receiver but for the second VFO. For those who don't require a second receiver this, as I will explain later, is an excellent alternative. The second tuning control is also used for RIT/XIT and menu selection.

### FT-920 Features and Facilities

The FT-920 is a large transceiver. The front panel is the same size as the FT-1000MP and the depth of the cabinet is just 30 mm less. The overall dimensions are 410 mm wide, 135 mm high and 316 mm deep. It weighs in at 11.5 kg, somewhat less than the 15 kg of the FT-1000MP due to the omission of the AC power supply, but still hefty enough

when you need to carry it around.

The dominant feature of the front panel is the "Omni Glow" display. The bright orange background contrasts with the black lettering to produce a very readable display. This has a multitude of information to convey to the operator. I feel that it is superior to the FT-1000MP display which, under certain external lighting conditions, produced an annoying shadow effect. No doubt the FT-1000MP is more showy, but the FT-920 display is more effective.

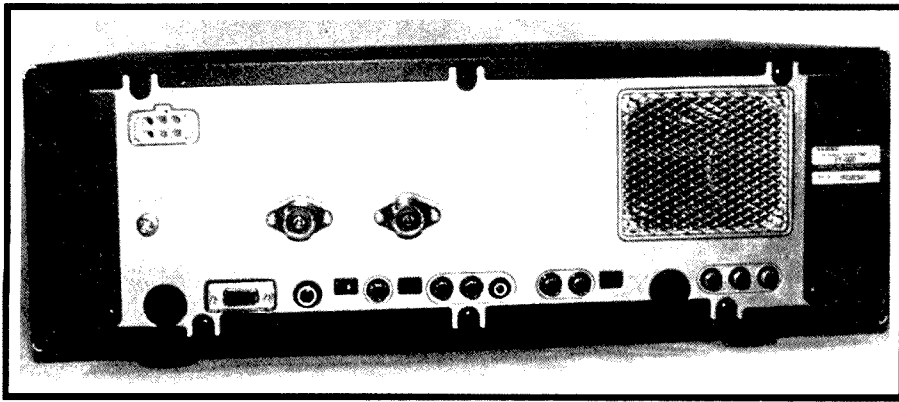
In addition to the "S" meter function, the bar-graph metering has many additional functions. These include power output, ALC, SWR, DC voltage, compression and PA current. All have a "peak hold" function which can be programmed via the menu. Up to three of the above metering functions can be viewed at the same time.

All modes of operation are provided, including FM which I note is only offered as an option in 920s sold overseas. Perhaps the only mode that is not fully catered for is AM. The only AM reception offered is through the standard SSB filter which, of course, sounds restricted. A six kHz filter is offered as an option and this should produce acceptable AM quality.

A medium selectivity CW filter (500 Hz) is available. No optional filters were included in our review transceiver. Several data modes are included with various shifts selectable.

Receiver coverage is from 100 kHz to 30 MHz, and then from 48 to 56 MHz. Unfortunately, there is no receiver coverage between 30 and 48 MHz, which will disappoint keen six metre operators who like to keep an ear on this part of the spectrum.

Transmitter coverage is confined to the various amateur bands. Each band is selectable via a dedicated "band" button and each of these buttons can recall two different frequencies. The same key pad can also be used to enter any frequency directly if required. However, the tuning controls set the FT-920 apart from other transceivers. As mentioned before, the second tuning control is for VFO B. The big difference is that while you can only transmit or receive on one of the two VFOs, they are adjustable independently at the same time.



**The rear panel of the FT-920.**

Let's say you are listening and transmitting on 14.2 MHz using VFO A and you want to check a DXpedition on 14.250 MHz. Tune VFO B to that frequency and, when ready, push the "RX" button above VFO B and there you are. With a quick push of the "RX" button above either VFO you can check either frequency. The big advantage over the old VFO A/B system is that the other VFO is fully adjustable while using the first. Perhaps not quite as good as a second receiver, but certainly way ahead of older transceivers.

The main tuning control is a delight to use with three selectable tuning steps which give 1, 10 or 100 kHz per knob revolution at tuning steps of 1, 10 or 100 Hz. Carried over from the FT-1000MP is the wonderful "shuttle-jog-tuning" system. This is the large concentric control behind the main tuning control. It is spring loaded from the centre position. As it is turned either left or right the tuning starts up or down with the scan speed increasing the further the knob is held over. Its a great way to zip up and down the band.

Naturally, the FT-920 has a built in automatic antenna tuner. It is capable of matching up to a 3:1 SWR on the HF bands and a 2:1 SWR on the six metre band, and can selected for both transmitter output and receiver input. The ATU has its own memory system with 100 channels. Tuning is very quick, usually under two seconds.

The FT-920 bristles with additional features and I will give a brief mention of some of them. The most important of these is the digital signal processing (DSP). All of the processing takes place

at audio frequencies and not, as is often the case these days, at a very low IF frequency. There are advantages and disadvantages for the audio system, but Yaesu have introduced one of the most advanced audio DSP systems available and it works very well.

There are four main DSP functions available. These are receiver noise reduction, receiver automatic notch filter, dual control receiver passband tuning which gives independent control over high and low frequency cut, and finally tailoring of the transmitted audio band pass characteristics. The DSP also has other functions which include control of the transmitter voice operation to give faster response compared to the more usual analogue systems.

The FT-920 has a built in digital voice recorder which is available to record "CQ contest" type messages. It can also

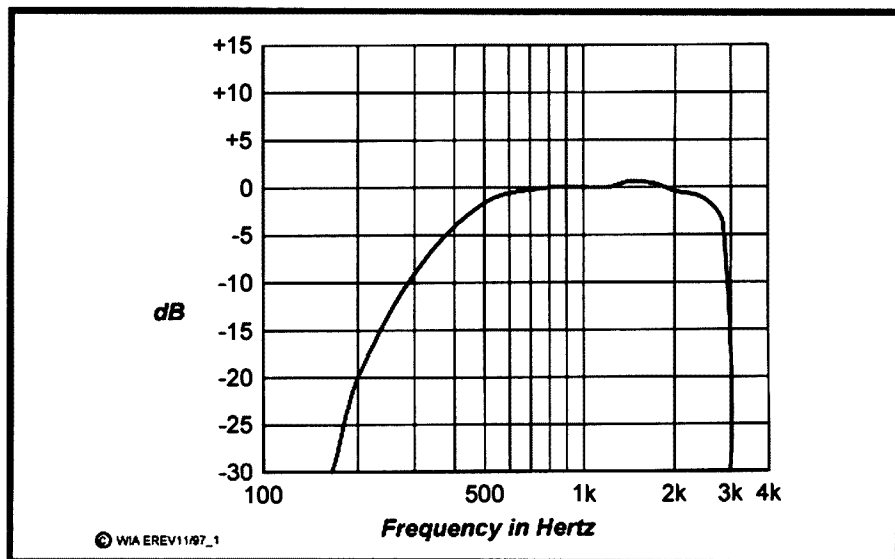
be used on receive to record incoming signals for later reference and can actually be left running continuously so that the last 16 seconds can be replayed when required.

To back up the DSP noise reduction is a fully adjustable noise blanker, and to back up the DSP passband tuning is an effective IF shift control. For the CW enthusiast, there is a built-in electronic keyer with a speed adjustment from six to 60 words per minute, plus a contest message memory system. Up to six messages can be stored, four of which can contain up to 50 characters, and two containing 20 characters.

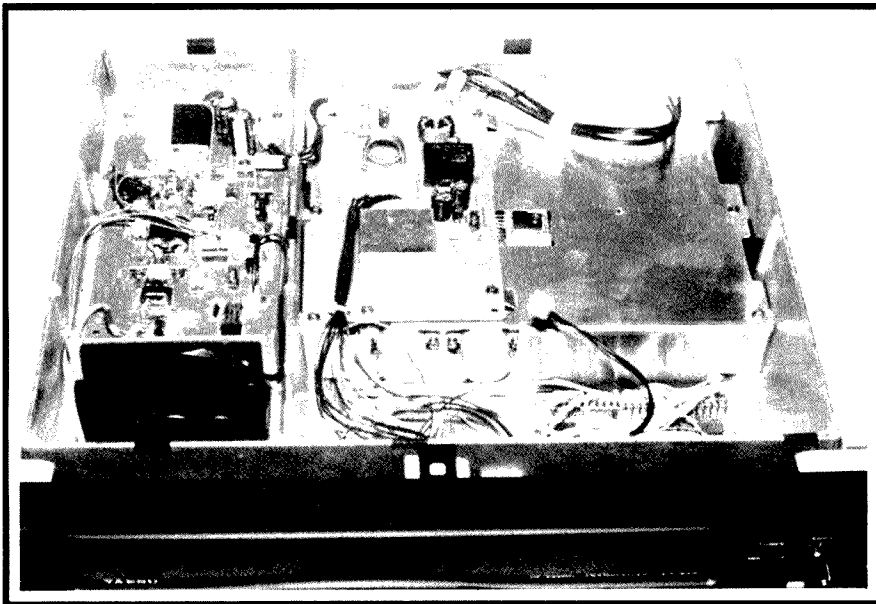
The menu contains some 73 programmable functions. Probably most of these will not require changing, but a new owner will have lots of fun going through them. Keep your instruction book handy so you can access the menu function you need quickly. Yaesu have thoughtfully included a "quick menu" facility to allow you get to the most needed items without delay.

### **FT-920 On Air**

First connect your power supply. As mentioned earlier, I used a Dick Smith D-3800 power supply for all of my on-air tests. I note that Yaesu do produce a matching external supply for the FT-920, the FP-1030A, which has a noticeable resemblance to the Dick Smith supply. I doubt that we will see the Yaesu supply in Australia as the Dick Smith organisation



**The FT-920 transmit audio response on 14.2 MHz with no compression and no ALC.**



**Top view of the FT-920 with the case removed. Note the cooling fan at the left between the front panel and the HF PA board. The ATU is beneath the metal shield to the rear right.**

seems reluctant to import Yaesu power supplies unless they happen to be part of the equipment. The FT-920 is supplied with a heavy duty DC cable fitted with two plug-in plastic automotive-type fuses. A standard six pin DC connector is used to connect to the radio.

On initial switch-on, there is a one second pause while the electronics sort themselves out before the transceiver comes to life. The "Omni Glow" display is the dominant feature, of course. The brightness of this can be set to two intensities. I preferred the brightest setting.

Received audio quality through the internal 7.5 cm speaker was excellent. So much so, that I did not find it necessary to connect an external speaker. For permanent installation, though, a forward-facing good quality speaker could be desirable. Tuning around the amateur bands I was struck with just how clean the audio sounded. The high and low cut filters are very effective and, I must admit, better than I had expected. However, they do have their limitations as, of course, they only remove the effect and not the cause. The same can be said of the notch filter which can remove an offending heterodyne like magic, but cannot eliminate the blocking effect of a close strong signal.

Compared to the FT-1000MP, the overall selectivity is wider and doesn't have the same ability to eliminate interfering signals. There was indeed a good reason for including the Collins filter in the FT-1000MP!

The DSP noise reduction control gives 32 positions of adjustment so you can fine-tune the amount required. Again, I found that for SSB reception I could not find a situation where the DSP could produce a readable signal from an audible but unreadable signal. The single position adjustable noise blanker was very effective eliminating impulse noise and, to a slightly lesser extent, power line noise.

The AGC action was very smooth with the slow decay selected. You have the choice of fast, slow or off. Yes, you can actually switch the AGC off on the FT-920. I am sure this will please many operators.

One very interesting feature of the FT-920 is the use of single control knobs. The only concentric controls are the high/low cut knobs and the shuttle jog control behind the main tuning knob. If you happen to have five thumbs on each hand (some of us do), you will appreciate this feature.

The FT-920 is supplied with a Yaesu MH-31B8 hand microphone. This rather ordinary looking microphone does seem

  
**YOUR HOBBY** **YOUR VOICE**  
 Representing Radio Amateurs - Since 1910

**RENEW**  
**YOUR MEMBERSHIP**  
**AND YOU COULD**  
**WIN**



**THIS KENWOOD TM-733A**  
**2m/70cm FM/packet rig**  
**worth \$1255**

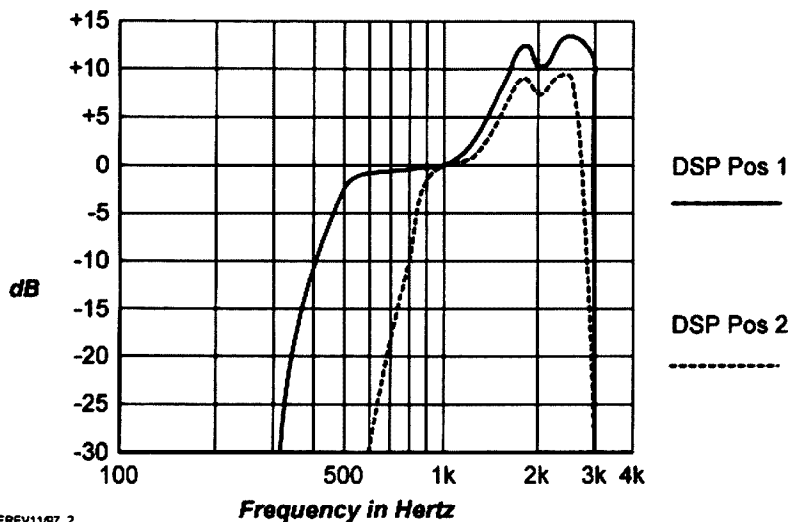
50 W on 2m 35 W on 70cm  
 Switchable 10 W/5 W RF output  
 Simultaneous VHF-UHF reception  
 Data input for 1200/9600 baud packet  
 70 multi-function memories

**All you have to do is renew**  
**your Division membership**  
**when it falls due**

**WHO'S ELIGIBLE? ● members**  
**whose renewal falls due between**  
**1/1/97 and 31/12/97 ● current**  
**members who are on a 3-year**  
**membership ● life members, and**  
**● all membership grades.**

**The prize will be awarded by means**  
**of a draw, the result to be**  
**published and the prize to be**  
**presented to the winner at the first**  
**available opportunity early in 1998.**

TM-733A prize kindly donated by  
 Kenwood Electronics Australia P/L,  
 PO Box 504, Homebush 2140.  
 Ph: (02) 9746 1888. Fax: (02) 9746 1809.



**The FT-920 transmit audio response on 14.2 MHz with DSP switched to position 1 and position 2.**

to have better than usual audio quality. The up/down buttons are on the front of the microphone and I found them rather hard to get at. In particular, if you need to use the "fast" button in conjunction with one of the other buttons, I found it required two hands, or at least a finger from each hand.

Reports on the transmitted audio were very favourable but, in general, the audio with the DSP selected was not liked. It was at this point I struck a problem. Try as I might, I could not get any sense out of the speech processor. The compression level as shown on the bar graph display would not exceed 5 dB, even with the compression control set full on. I feel this could be an isolated fault in this particular transceiver. As we will see later on, this limited the six metre performance to a very marked extent.

During the bench testing I found that the transceiver runs very very cool. The cooling fan is quiet in operation and is thermostatically controlled. At no time did the transceiver get more than lukewarm.

### FT-920 On Test

First off, the transmitter power output and current drain were measured in the CW mode with 13.8 volts DC applied to the supplied DC power cable. The following results were obtained:

Band	Power Out	Current Drain
1.8 MHz	110 watts	18.0 amps
3.6 MHz	110 watts	17.5 amps

7.1 MHz	106 watts	16.5 amps
10.1 MHz	105 watts	18.0 amps
14.2 MHz	105 watts	16.5 amps
18.1 MHz	100 watts	17.0 amps
21.1 MHz	100 watts	17.5 amps
24.5 MHz	100 watts	19.0 amps
28.5 MHz	100 watts	18.0 amps
29.5 MHz	100 watts	20.0 amps
50.5 MHz	100 watts	22.0 amps

PEP output on SSB was checked on a scope under two tone conditions and found to be exactly the same, which probably says more for the power supply than the transceiver. Minimum power output, with the RF power control backed fully off, was within a whisker of five watts on all bands, which might be a fraction high for the dedicated low power operator.

Perhaps the most interesting feature of the above measurements is the relatively high current drain at 50 MHz for 100 watts output. More on that later.

Next on the list was my usual test to estimate transmitter intermodulation distortion. This was carried out at 14.2 MHz and showed -25 dB relative to 100 watts PEP output. Some quick checks on other bands showed that, while this figure improved slightly on the lower frequency bands, it did not deteriorate to any extent on the higher bands, including six metres.

Finally, power output was checked with the automatic antenna tuner in circuit feeding a 3:1 resistive SWR. On

the lower frequency bands the loss was quite low, averaging around five watts, but on 28 and 50 MHz losses increased to around 20 watts. While this last figure might sound a lot, in practice it only amounts to a small fraction of an "S" point.

The transmitter frequency response tests, as usual, produced some interesting curves. The instruction manual describes the various positions as follows:

1. Mid and high frequency components are enhanced;
2. A high emphasis response is produced, ideal for pile-ups;
3. Both low and high emphasis is produced; and
4. A wide bandpass emulating a broadcast microphone characteristic.

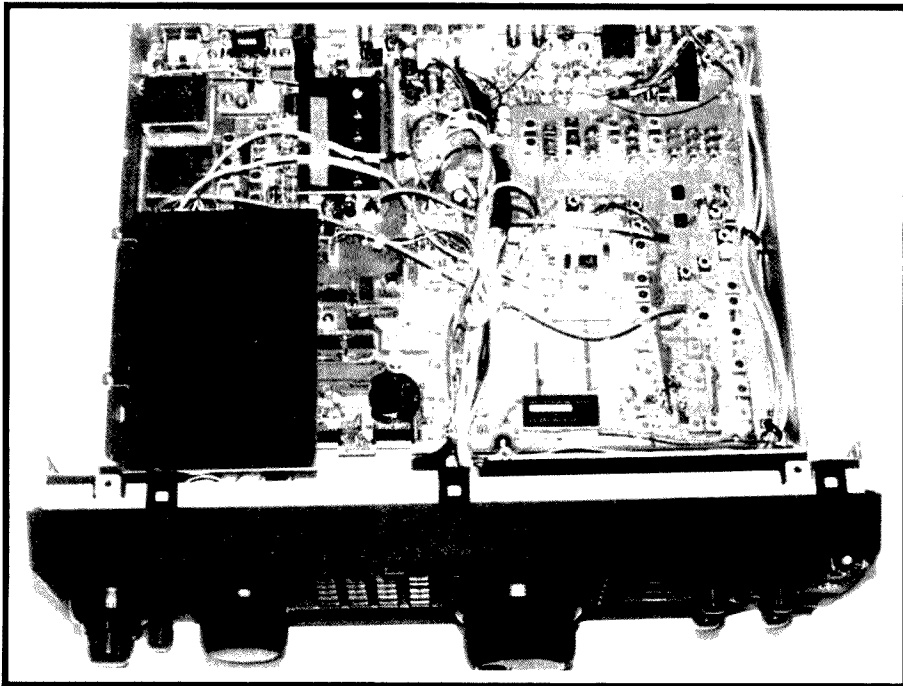
As an ex broadcast man, I cannot quite see this. In practice, use the position that gives you the best reported audio. I found that my best reports were obtained with the DSP switched off.

There are two other means of adjusting the transmit audio available to the user of the FT-920. One is via the menu system, where you can adjust the band pass relative to the filter to give slightly more or less high or low frequency response. Secondly, there is a separate adjustment for both upper and lower sideband. These are available through menu numbers U-59 and U-62.

I also note that the receiver carrier point is adjustable via the menu. An adjustment range of -300 to +500 Hz is provided for both transmit and receive. All of my tests on both transmit and receive were carried out at the default setting with no offset selected, which seemed to produce acceptable results. All SSB tests were carried out using the supplied hand microphone. I would have liked to try the FT-920 with the MD-100A8X microphone. I am sure the results would have been superb.

### Receiver Tests

The first receiver test was to check the S meter calibration. The meter is not a meter in the normally accepted sense, but a bar graph as part of the big LCD. Again I have to say that I much prefer a good old-fashioned moving coil meter which gives a much more accurate indication. But, like it or not, it seems unlikely we



**Underneath view of the FT-920 with the case removed.**

are going to see any more old-fashioned meters.

One of the problems with bar graphs is that the segments come on and off at different signal levels. However, taking all of this into account, these are the figures I recorded:

S Meter Reading	Voltage input at 50 ohms PD
S1	1.7 $\mu$ V
S3	2.0 $\mu$ V
S5	2.5 $\mu$ V
S7	7.0 $\mu$ V
S8	10.0 $\mu$ V
S9	35.0 $\mu$ V
S9+20 dB	800 $\mu$ V
S9+40 dB	.01 volt
S9+60 dB	.07 volt

These measurements were taken with the pre-amp switched on.

Each amateur band was then checked in turn to measure the signal input to give an S9 reading:

Band	Signal for S9
1.8 MHz	30 $\mu$ V
3.5 MHz	25 $\mu$ V
7.0 MHz	30 $\mu$ V
10.0 MHz	30 $\mu$ V
14.0 MHz	35 $\mu$ V
18.1 MHz	35 $\mu$ V
21.0 MHz	40 $\mu$ V
24.0 MHz	40 $\mu$ V
28.5 MHz	42 $\mu$ V
29.5 MHz	22 $\mu$ V

These figures are very consistent from band to band. They were taken with the pre-amp switched in. The pre-amp averaged about 14 dB gain although this varied slightly across the bands with slightly higher gain at the higher frequencies.

The attenuator has three positions of attenuation, 6, 12 and 18 dB, and these measured spot on. Again, could I appeal for an extra position at 24 dB to give more accurate readings of antenna gain measurements. It seems that all manufacturers have got together and chosen a maximum of 18 dB. Why?

Receiver sensitivity was measured. The measured figures easily bettered the published specification which is 0.2  $\mu$ V with pre-amp on, 10 dB S/N ratio up to 24.5 MHz and 0.13  $\mu$ V from there up to 54 MHz. My measurements were:

Band	Sensitivity, Pre-amp in
1.8 MHz	0.15 $\mu$ V
3.5 MHz	0.15 $\mu$ V
7.1 MHz	0.14 $\mu$ V
10.1 MHz	0.12 $\mu$ V
14.2 MHz	0.15 $\mu$ V
18.0 MHz	0.12 $\mu$ V
21.0 MHz	0.14 $\mu$ V
24.0 MHz	0.1 $\mu$ V
28.0 MHz	0.1 $\mu$ V
50.0 MHz	0.1 $\mu$ V

John VK3ATQ did a measurement at 14 MHz for me for noise figure and minimum discernible signal. These were a NF of 5.5 dB with the pre-amp in with an MDS of -134.5 dBm, and 10.2 dB and -129.8 dBm with the pre-amp out.

Receiver audio measurements were taken with a 4 ohm load connected to the external speaker socket. Specified audio output is 1.5 watts at 10% distortion. Our review transceiver easily exceeded this with 2.6 watts at 10% distortion. At a normal listening level of 0.5 watt, the distortion had dropped to a very creditable 0.6%.

The automatic notch filter has a measured range of 160 Hz to 3.2 kHz and is capable of reducing a heterodyne by a whopping 42 dB. Audio noise level at minimum gain was -62 dBm. Even you young fellows with acute hearing won't have any trouble with hiss or hum!

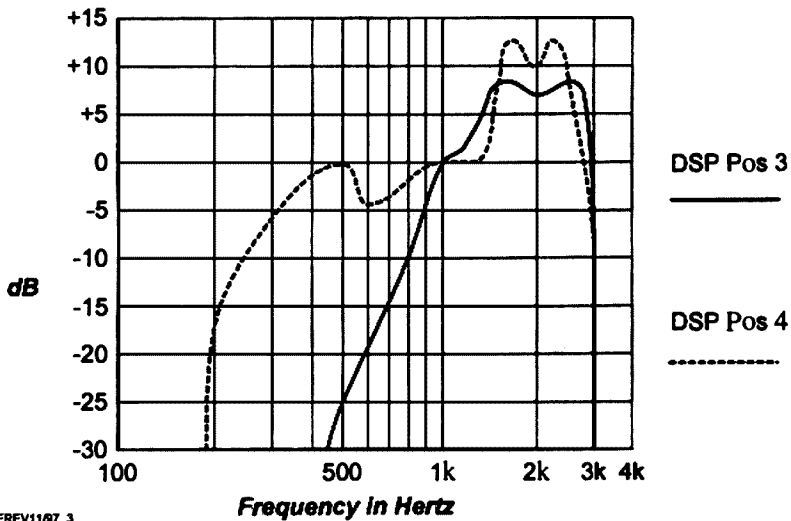
## FT-920 and Six Metres

As mentioned earlier, I turned the FT-920 over to John VK3ATQ to see how performance lined up on the six metre band. John's standard of comparison is another Yaesu, the FT-650, which he describes as a better-than-average performer.

His first complaint was the lack of general coverage between 30 and 48 MHz. Serious six metre operators like to chase the MUF past 10 metres. Noise figure measurements taken at 50.1 MHz gave 4.0 dB with the pre-amp in and 13 dB with the pre-amp out. These relate to an MDS with the 2.4 kHz band width of -136 dBm and -127 dBm respectively. The noise figure of the FT-650 at the same frequency and under the same conditions measured 2.5 dB.

John found that the transmitted audio, although of excellent quality, lacked the necessary punch to get through at tropospheric propagation limits. The FT-650 was easily readable over a 300 km path where the FT-920 was not.

As noted earlier, the final current on 50 MHz was higher than expected. John suspects that this might be due to the transmitter having an output impedance of something other than 50 ohms. Putting in the ATU to compensate for this could then upset the match to the receiver and give the slightly inferior noise figure. You might find that the receiver performs



© WAEREV1187\_3

The FT-920 transmit audio response on 14.2 MHz with DSP switched to position 3 and position 4.

better with the ATU switched out on receive.

John reported that the DSP noise reduction effect was hard to evaluate. It appeared to make very little improvement, but suggested he would like more time to evaluate this. Thanks, John, for your interesting input to this review. I am hoping that John will be able to add his comments to future reviews.

## FT-920 Instruction Manual

Actually called the "Operating Manual", it covers 94 pages and is generally well presented. Strangely, there are a few typographical errors. For instance, the page on phone patch operation is headed "Phone Pacth Operation". Well, I guess we even have a few in *Amateur Radio* from time to time.

Operating instructions are very well covered and there is even a full schematic diagram included together with details on the installation of the optional filters and the high stability master oscillator. Several pages are devoted to computer operation of the transceiver, which can be organised with very little trouble. You might be tempted to try it. As usual there is no technical information. Perhaps one day!

One thing I would like to see is a more durable cover to the manual. I have a feeling that the one on it will soon get dog eared.

## FT-920 Conclusions

I guess the first question to ask a reviewer is, would you buy one? While I have to admit that I am not in the market for a new transceiver, if I was the FT-920 would be near the top of my shopping list for the following reasons. Firstly, and most important to me, is that this rig has excellent transmitted audio quality on SSB. I admit that I have been a Kenwood enthusiast for years for this very reason. I would put the audio quality of the FT-920 right at the top of the pile along with possibly half a dozen other transceivers some of which are not necessarily new models either.

Next, the tuning ergonomics are among the best I have ever used and certainly very superior to the main transceiver I am using at home at the moment. The digital signal processing works well and, along with an excellent noise blanker, will produce readable signals under very poor conditions.

The FT-920 is really in a class by itself and the choice boils down to whether you require a second receiver or not. I don't believe that I would. The excellent two VFO system of the FT-920 would satisfy me.

Lastly, I like the look of the FT-920. I know you cannot judge a book by its cover, but I was impressed by its looks from the first time I saw it. However, there are three negative features where I

believe Yaesu missed out. The first is the omission of an internal AC power supply. Even if it was available as an option I would go along with it. The second is the non availability of a narrow SSB filter to back up the excellent DSP; also, the 500 Hz CW narrow filter might just be a bit too wide for the keen CW operator. The third is the lack of a manual notch filter. The auto notch is great but this doesn't help the CW operator.

I hear on the grape vine that there is a new Yaesu linear amplifier in the pipeline, the VL-1000. I have unearthed a few specs which you might be interested in. It covers all the HF bands and six metres. It is rated at 1 kW output (I assume PEP, and possibly CW, but maybe not FM). It has inputs for two transceivers and four switched antenna outputs, has a built-in automatic antenna tuner, and is in two units, the amplifier and a separate power supply each measuring 410 mm wide, 135 mm high and 410 mm deep. The front panel size matches the FT-920 and FT-1000MP. It will, of course, have automatic band switching when used with most current Yaesu HF transceivers.

I look forward to seeing one. Sorry, but I have no information on the price. However, with a bit of luck we should see it early to mid 1988.

Our thanks to Dick Smith Electronics for the loan of the review FT-920 transceiver. I was sorry to see it go. Dick Smith Electronics are Australian agents for Yaesu equipment. You should contact them for information on price and availability.

\*24 Sugarloaf Road, Beaconsfield Upper VIC 3808

ar

**Remember to  
leave a three  
second break  
between overs  
when using a  
repeater.**

## ■ Test Equipment

# A Homebrew Power Meter and Attenuator Set

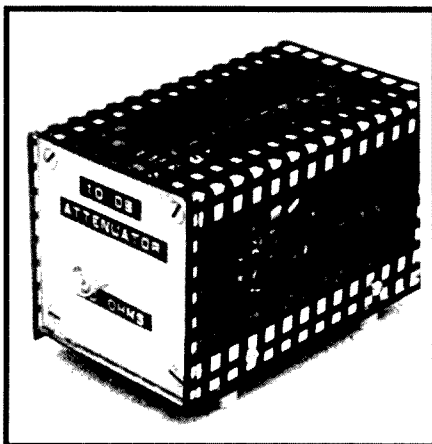
*Drew Diamond VK3XU\* provides all the information to build a useful piece of test equipment*

Radio frequency power is one of those quantities that we frequently wish to measure. The usual approach is to employ a non-inductive load resistor to absorb the RF output power from a transmitter, and somehow express the voltage developed across the load in terms of power, usually at 50 ohms.

Good non-inductive resistors have become available in recent years, which make excellent loads for moderate power transmission tests (Reference 1). However, their use is rather limited to simple power measurements. On the other hand, a more flexible method is to use a fairly sensitive power meter/load for low-power measurements and, for higher power measurements, to interpose an appropriate power attenuator between the source (transmitter) and power meter (load).

Additionally, the attenuator may find use in other applications. For example, the output waveform from a 100 W transmitter may be viewed on an oscilloscope by first passing the signal through the attenuator in order to reduce the level to a more appropriate value, without risk of overloading the 'scope input. Because the attenuator simply drops the strength of the signal, a true replica is presented on the CRT (provided of course, that the 'scope has sufficient bandwidth).

The same applies to spectrum analyser measurements where, generally, the signal must be reduced to perhaps 10 milliwatts (or by 40 dB) for a 100 W transmitter. Another use is in transverter operation, where the transceiver's HF output power must be reduced before application to the transverter.



**Photo 1 - 10 dB power attenuator.**

By having a basic power meter/load range of 12 W full-scale (fs), and a power attenuator of 10 dB, we get a second range of 120 W fs, thus a measuring set for both QRP and moderate power work is obtained. The attenuator has the following measured characteristics:

**Attenuation:** Nominally 10 dB.

**Useful Frequency**

**Range:** 1.5 to 50 MHz.

**Power Rating:** 40 W continuous, 120 W for 30 sec.

**SWR:** Less than 1.1 at HF, rising to 1.3 at 50 MHz.

The power rating needs some explanation. Wire-wound resistors are entirely unsuitable at RF due to their self-inductance. The resistors used are standard 3 W metal film types, which have satisfactorily low inductance for our purposes. When 6 W is being dissipated by a 3 W resistor in free air, the component gets pretty hot, and may even begin to discolour and smoke a little when new. However, empirically, the value remains quite stable, and no

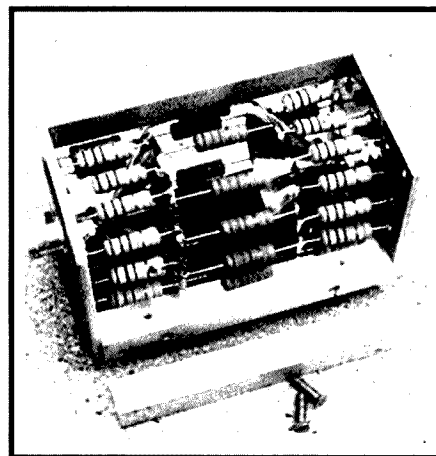
serious damage results if the overload is of short duration. Manufacturer's de-rating curves are not available, so the rating stated above has been determined experimentally.

A conventional pi configuration is used here, where (for 10 dB) about 52% of input power is dissipated in the first 91 ohm combination R1, 33% in R2, and 5% in R3, the remaining 10% reaching the load. Therefore, when (say) 100 W is applied, about 52 W must be dissipated by R1. The combined rating of R1 is only 33 W in free air, so they are somewhat overloaded. However, in practice they will withstand this overload for about 30 seconds before the components begin to show signs of stress. When the power is removed, a cool-down period of about one minute is required before power is again applied.

## Attenuator Construction

A suggested pattern is shown in Photo 1. The end plates are made from 3 mm thick sheet aluminium measuring 63 x 63 mm, connected by four 100 mm lengths of square aluminium rod. Naturally, brass would also serve, if you have it. Photo 2 shows the general idea, where one rod has been removed for clarity.

The intermediate connections are soldered to cones made from thin gauge tin-plate rescued from a Milo can. This stuff solders like a dream. Dimensions of the cones are not critical, the idea is to form a low impedance connection to the coax inner at the point of the cone, and provide an anchor for the resistors around the base of each cone.



**Photo 2 - Internal view of the attenuator (one rod removed for clarity).**



Photo 3 - Power meter/load.

If you wish to make the cones, I suggest that a cardboard template be made first, then tried for size inside the cage formed by the four connecting rods such that 3 or 4 mm clearance is obtained all round, then use the template to make your two cones from tin-plate or brass shim. If you have never made a cone before, it provides an interesting little task. Start with a circle slightly larger than required, cut a small slice out (like a pie portion), then bring the ends together. By trial and error, a cone of appropriate dimensions will be obtained.

If desired, circular intermediate connection plates should be satisfactory, and are simpler to make, although SWR at 50 MHz may be a little higher. If used, these should be connected to the coax

inner with a short length of stiff bus wire. A circle of tin-plate is also fixed to each end plate under the coax retaining nut to provide a solderable anchor point for the "earthy" ends of the 1 kilohm resistors. Thin sheet or shim metal is awkward material in which to drill holes larger than about 3 mm, so punching, or filing to size is to be preferred over ordinary drilling.

With the cones (or plates) in position, begin tacking-in (solder, sparingly) the resistors. Start with three 1 kilohms (R1) equally spaced around the perimeter, then three 680 ohms (R2) and three 1 kilohms (R3), and so on. Filling in the gaps as you go, hopefully you will finish with all 32 resistors equally spaced, or nearly so. If crowding occurs, simply unsolder and reposition as required. When all is satisfactory, go over all the tacks with extra solder.

The cover should be of perforated or drilled sheet metal so that the attenuator (which must dissipate 90% of the transmitter's power) may ventilate during use.

### Power Meter Construction

A basic full-scale power range of 12 W was chosen for two reasons. By convention, the maximum QRP power level is 5 W, which lies conveniently at exactly 0.6 on a 1 mA meter and, when used with the 10 dB attenuator, a fs range of 120 W is obtained, being the maximum permitted Australian CW

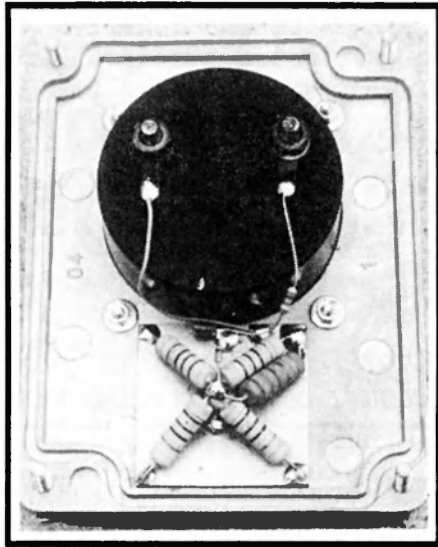


Photo 4 - Internal view of the power meter/load.

power level, and equals the sort of output to be expected from a "barefoot" transceiver.

A die-cast or other metal box is an ideal housing (Photo 3). A 40 x 40 mm square of tin-plate, brass or printed circuit board is fitted under the nut which secures the coax socket, as shown in Photo 4. Four 220 ohm 3 W metal-film resistors, and one 680 ohm are soldered between the coax inner and chassis ground with minimal lead lengths as shown. The 1N914 diode, and 10 nF ceramic capacitor should also be connected with short leads. Connections to the meter terminals may be any reasonable length required. Calibration, good to 50 MHz, of a 1 mA meter is as follows:

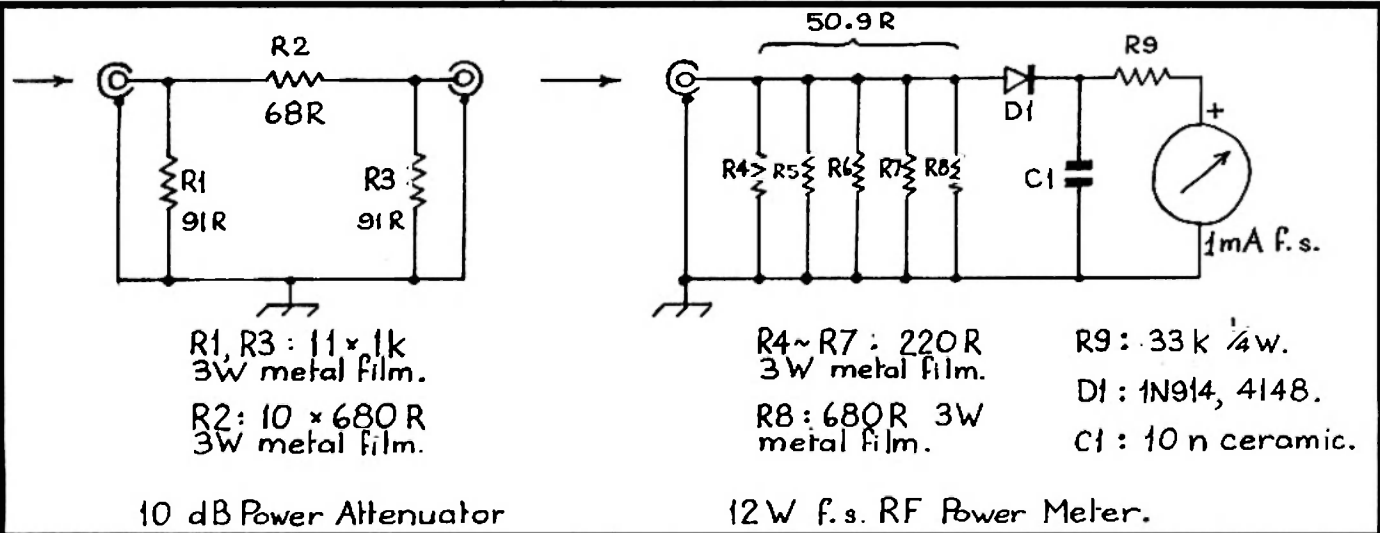


Fig 1 - Schematics of the 10 dB power attenuator (at left) and the 12 watt full-scale RF power meter.



Power	Meter
1.0 W	0.25 mA
2.0 W	0.36 mA
3.0 W	0.46 mA
4.0 W	0.53 mA
5.0 W	0.60 mA
6.0 W	0.67 mA
7.0 W	0.73 mA
8.0 W	0.79 mA
9.0 W	0.84 mA
10.0 W	0.89 mA
11.0 W	0.93 mA
12.0 W	0.98 mA

### Operation

Some typical applications have already been mentioned. To measure power levels of less than 12 W, simply connect the transmitter directly to the power meter/load input. The load is adequately rated, so there is no time restriction on your measurement.

For power measurements above 12 W, connect the attenuator, using 50 ohm cables and/or adapters to suit your set up, between transmitter and meter/load. The meter will now measure one-tenth the actual power input to the attenuator. Be aware that, in order to avoid melt-down, your measurement must take place increasingly quickly as the level is raised above 40 W, to the point where, at the 120 W CW level, you have about 30 seconds to make that measurement, and for an unprocessed SSB signal, you have about double that time.

When making oscilloscope measurements, the input connector of the 'scope should be terminated in 50 ohms in order to get meaningful results. Such a

termination could comprise an assembly similar to the power meter load, with coax connectors to suit your set-up. Or a second connector may be wired in parallel with the input connector of the meter/load for connection, via very short coax, to other high-impedance equipment, such as a 'scope input.

### Parts

The 3 W metal film resistors were purchased from Truscotts Electronic World (03 9723 3860). Similar, but rated 2 W metal films are also available from Stewart Electronics ([03] 9543 3733). The remaining components should also be available from these two, and the usual electronic component retailers. Small quantities of aluminium sheet, perforated sheet and rod are normally available from Caplan outlets.

### References and Further Reading

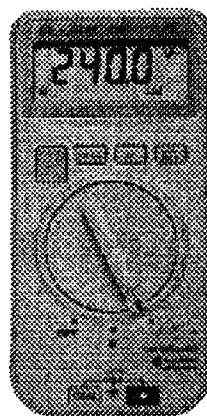
1. *Power Meter/Dummy Load (with notes on PEP); Diamond, Amateur Radio April 1993.*
2. *Test Equipment for the Radio Amateur; Smith, G4FZH, RSGB.*
3. *The VHF/UHF Manual; Jessop, G6JP, RSGB.*
4. *The VHF/UHF DX Book; White (ed), G3SEK, DIR Publishing.*
5. *"Building VHF Power Attenuators"; Wade, N1BWT, QEX April 1994.*
6. *"Build a Power Attenuator"; Basilier, WU7O, QST November 1996.*

\*45 Gatters Road, Wonga Park VIC 3115.  
ar



**YOUR HOBBY** **YOUR VOICE**  
Representing Radio Amateurs - Since 1910

**RECRUIT  
A MEMBER &  
THEY COULD  
WIN!  
THIS GREAT  
FLUKE 12B  
DIGITAL  
MULTIMETER  
WORTH \$195**



**THERE'S A WINNER  
EVERY MONTH FOR 1997  
12 PRIZES TO BE WON**

This latest hand-held DMM, from the world-leading maker of digital test instruments, has advanced features yet is simple to use. Ideal for tyro & veteran.

#### The Fluke 12B measures:

- ac and dc voltage (with auto-selection)
- resistance & capacitance (.001-1000μ)

#### The Fluke 12B features:

- 4000-count liquid crystal display
- simple rotary dial
- diode and continuity testing
- indicates intermittent opens & shorts
- 2-year warranty

**Fluke 12B prizes generously donated by Philips Test & Measurement.**

Each month's prize is awarded by way of a draw among newly recruited members each successive month and presented to the winner at the earliest opportunity following the draw.

**To sign up a new member, use the back of your AR magazine address leaflet - or clip the coupon, have them fill it out and send it now.**

**SEND TO YOUR DIVISION'S ADDRESS, SHOWN ON PAGE 56.**

✂-----  
Please send me a membership application.

NAME .....

ADDRESS .....

..... P/code .....

Call Sign (if any) ..... [AR 1-11/97]

## WIA News

### New WIA Members

The WIA bids a warm welcome to the following new members who were entered into the WIA Membership Register during the month of September 1997:

L21057 MR P HARROP  
L21058 MR A CLINKABERRY  
L21059 MR W P LECKEY  
L21060 MR E J COLLEY  
L21061 MR T A NOTT  
L21062 MR V BLAHA  
L60389 MR R G CAMPBELL-MORRISON

LF0107 MR L ZORZINO  
VK2BAN MR R PISANI  
VK2CIM MR P PRESUTTI  
VK2CSS MR G A SANGSTER  
VK2HT MR N T BOWDEN  
VK2SJM MR B HARO  
VK2ZI MR T B SAMPSON  
VK3FDH MR I DAWSON  
VK3JBI MR J CHANT  
VK3MDT MR D HASLAM  
VK7CAJ MR A J COPE  
ZL3KD MR A G F HARDING

# Antennas

# A Cost Effective Current-mode 1:1 Balun

Ralph Holland VK1BRH\* describes how to build a 1:1 balun.

## Introduction

A cost effective current-mode 1:1 balun can be constructed from a length of coax, a rod typically used for a broadcast antenna loop-stick, some electrical tape, cable ties, a length of PVC water-pipe, and some connectors. The balun is formed by winding several turns of coax on the ferrite rod.

## Principle

The operating principle is that the inner conductor and the inside of the braid act as two opposing bifilar windings with substantial inductance inserted in the outside of the braid. Differential current passes through such a transformer with little insertion loss as the opposing windings of the transformer mode effectively eliminate the winding inductance.

If you want to run an unbalanced current through the transformer then substantial inductance will be present. Thus the current balun suppresses common-mode current.

Since current flowing on the outside of the braid is referenced to ground, it must flow through the impedance resulting from the winding inductance formed by the outside of the braid and the core. This inductance will reduce the current if the impedance is high enough.

The same principle applies in the common-mode choke where two or more wires pass through a ferrite core. A typical example is seen in the ferrite chokes clamped on the monitor cable of computers.

High permeability cores can be used for current-mode baluns or common-mode chokes as there is no net magnetic field around the bifilar winding even though substantial currents are flowing.

## Construction

A ferrite rod is easier to wind and cheaper than a toroid. At 160 m I found that I needed 30 turns of RG-58C/U to ensure that I obtained equal, but opposite, current in each leg of an asymmetrically mounted dipole. To

place 30 turns you will need to wind more than one layer across the core. The turns can be held by insulation tape and by applying two cable ties on the ends of the last layer.

One end of the coax is terminated in a connector while the braid and centre conductor are split out and used as the balanced feed at the other end. You should use coax with adequate breakdown voltage to avoid damage when operating into mismatched loads.

## Housing

The balun can be housed in PVC water pipe. Cut a section large enough to make two end pieces which can be flattened with the aid of the hot air from a hair-drier or heat-gun. The circular end-sections can be cut with tin-snips. I drilled a hole for a panel-mount connector in one end and used banana connectors for the balanced feed on the other end.

The end sections should be inserted inside each end of the pipe and held in place with the PVC glue. I have found hot-melt glue adequate and easily removable. Extra protection is obtained for the ends if you leave an overhang by inserting the ends further into the pipe. My balun has survived several four-wheel-driving desert trips and is still intact and operating after five years.

## Reference

1. HF Antennas for All Locations, Les Moxon, G6XN, RSGB.

\*8 Hardy Place, Kambah 2902, ACT  
e-mail vk1brh@dynamite.com.au  
Url <http://www2.dynamite.com.au>

ar

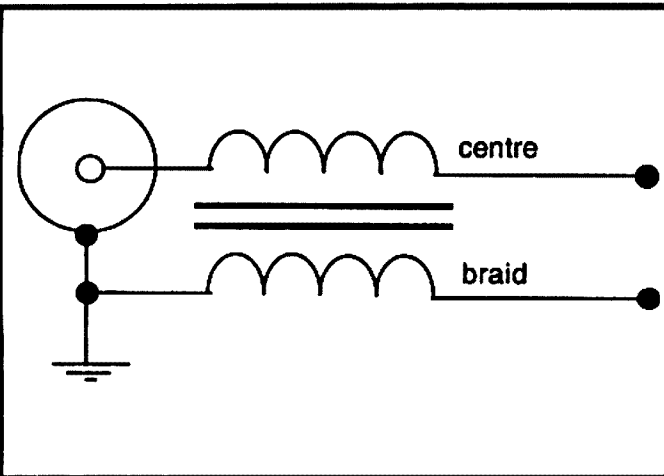


Fig 1 - Schematic of the 1:1 balun.

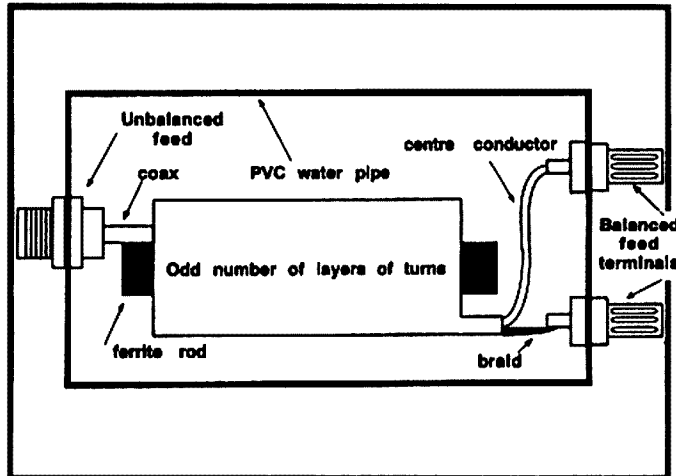


Fig 2 - Construction details for the 1:1 balun.

## ■ Antennas

# A Cost Effective Current-Mode 1:4 Balun

Ralph Holland VK1BRH\* constructs a Guanella balun.

### Introduction

A cost effective current-mode 1:4 balun can be constructed from two lengths of coax, two ferrite rods, some electrical tape, cable ties, a length of PVC water-pipe and some connectors. This form of 1:4 current-mode balun is named after G Guanella.

### Principle

The operating principle is based on the cross-connection of two current-mode baluns. On the low impedance (current) end, the transmission lines from each balun are connected in parallel, while on the high impedance (voltage) end the transmission lines are connected in series. Since the current is divided equally between the two separate baluns, the high impedance end sees half the current of the low impedance end and, since the voltages are also added in phase on the high impedance ends, the device obtains a 1:4 impedance ratio.

Only differential balanced currents are supported on the inside of the coaxes, while currents on the outside of the braid are suppressed. The symmetry of the

balanced load can be forced by grounding the centre terminal on the high impedance end (see the optional link in Figure 1).

Ideally the transmission lines should have a characteristic impedance of half the balanced load.

I have found that this balun is superior to the normally documented voltage-mode transformer or Ruthroff balun. The Guanella balun has perfect winding or transmission line symmetry with respect to the balanced load.

### Construction

It is easy to wind the coax onto the ferrite rods. Experimental data supports five turns for coverage between 3 to 30 MHz; however, if you want to operate at 1.8 MHz, I have found that about 10 to 15 turns are required. The turns can be held by insulation tape and by applying two cable ties on the ends of the last layer on each rod.

The low impedance end is terminated at a coaxial connector by taking the two centre-conductors in parallel to the centre pin and the two braids in parallel

to the ground pin. On the high impedance end the top centre-conductor and the bottom braid are connected to the load, while the top braid is connected to the bottom centre-conductor – this junction can be grounded to force symmetry in the load.

### Housing

The two balun sections can be housed in PVC water pipe. Cut a section large enough to make two end pieces which can be flattened with the aid of the heat from a hair-drier or heat-gun. The circular end-sections can be cut with tin-snips. I drilled a hole for a panel-mount connector in one end and used banana connectors for the balanced feed on the other end.

The end sections should be inserted inside each end of the pipe and held in place with the PVC pipe glue, but I have also found hot-melt glue adequate and easily removable. Extra protection is obtained for the ends if you leave an overhang by inserting the ends further into the pipe.

### References

1. *HF Antennas for All Locations*, Les Moxon, G6XN, RSGB.
2. *Transmission Line Transformers*, Jerry Sevick, W2FMI, 2nd Edition, ARRL.
3. *A Cost Effective Current-Mode 1:1 Balun*, Ralph Holland, *Amateur Radio*, November 1997, page 16.

\*8 Hardy Place, Kambah 2902, ACT  
e-mail vk1brh@dynamite.com.au  
Url <http://www2.dynamite.com.au>

ar

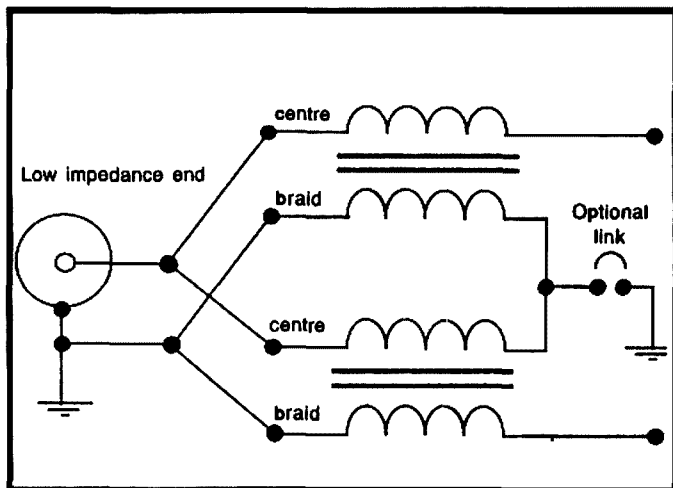


Fig 1 - Schematic of the Guanella 1:4 balun.

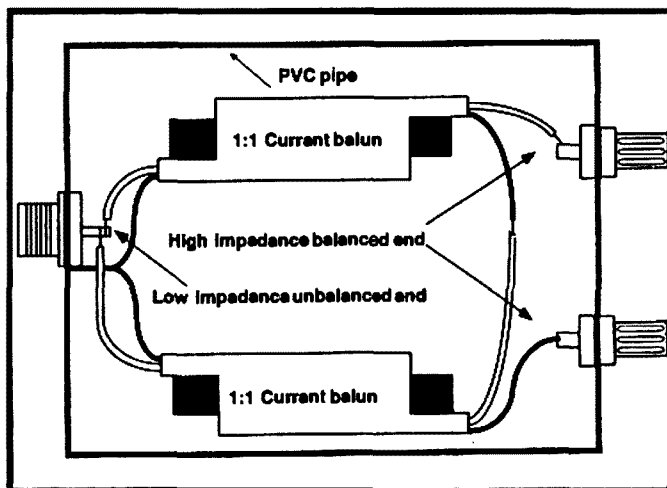


Fig 2 - Construction details for the 1:4 balun.

# Technical Abstracts

Gil Sones VK3AUI\*

## Comparison of Dual Band Hand-helds

A comparison of Dual Band Hand-helds was published in *QST*, July 1997, in which five hand-held transceivers were compared. The author was Steve Ford WB8IMY and, in addition to the features and usage data, the hand-helds were tested technically. The hand-helds tested were all purchased normally and were not special review samples. They would be representative of the sort of radio a user would

obtain over the counter. This is standard for *QST* reviews and ensures that the test samples are similar to those which a normal purchaser could expect.

The performance figures obtained are given in Table 1. Some hand-helds have AM detection when monitoring the aviation frequencies below the two metre band.

The Standard is a tiny transceiver which is powered by two AA cells. Alkaline cells are normally used but Nicads could be used if desired.

Table 1 Dual Band Handheld Transceiver Test						
		Alinco DJ-G5TH	Icom IC-T7A	Icom IC-W32A	Standard C508A	Yaesu FT-50R
Rx Sens	146 MHz	-124 (L)	-124	-124 default	-124	-124
dBm for 12 dB		-124 (R)		-123 opp		
SINAD	440 MHz	-124 (L)	-124	-125 default	-122	-124
		124 (R)		-124 opp		
Rx AM Sens	120 MHz dBm	-116	-108	-112	-118	-114
Two Tone 3rd	146 MHz	67 *	61	57	51	55
Order IMD						
Dynamic Range	440 MHz	65 *	58	58	55 *	54
dB 20 kHz Spacing						
* Noise Limited						
Adj Channel	146 MHz	63	65	64	59	51
Rejection						
20 kHz Offset	440 MHz	55	62	62	55	51
dB						
Mute Sens	146 MHz	-127	-125 AT	-125 AT	-125	-126
dBm			-121 SQ	-121 SQ		
	440 MHz	-129	-125 AT	-125 AT	-123	-131
			-121 SQ	-123 SQ		
Rx Af OP		281	259	218	99	530
mW into 8 $\Omega$ 10% Dist						
Tx Pwr Watts	146 MHz	5.5/1.2	2.5/0.6	5.5/0.5275 mW		5.7/2.7
Std Batty		/0.2		AA Alk Cells		/1/0.1
	440 MHz	5.4/1.2	2.2/0.5	5.1/0.7270 mW		5.0/2.6
		/0.2		AA Alk Cells		/0.9/0.1
Tx Pwr Watts	146 MHz	5.9	4.9	5.6	—	5.1
13.5/13.8V						
Ext Supply	440 MHz	6.5	3.5	5.4	—	5.4
Tx Rx Turnaround	146	200	110	118	140	65
Time PTT release	MHz					
to 50% Full Audio	440	200	110	140	65	
m/S S9 Sig V	MHz					
Rx Tx Turnaround	146	105	92	88	85	7
Time ("Tx Delay")	MHz					
m/S	440	110	115	92	90	12
MHz						

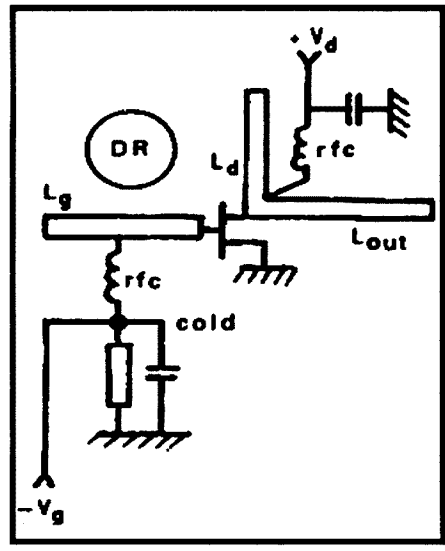


Fig 1 - DR0 with Gate side cold point.

The Yaesu and the Standard use an SMA antenna connector which means you will need an adapter to use an external antenna. The Alinco and the Icoms use a BNC antenna connector.

The figures do need some interpretation. Sensitivity is quoted in microvolts and has been converted into dBm. Sensitivity is not the sole indication of good performance. Intermodulation has a great bearing on the ability to receive signals. The disturbance experienced from adjacent services is a frequent cause of complaint.

Some hand-helds have two receivers which both cover VHF and UHF. One combination sometimes is of greater sensitivity or is preferred. This is noted as left or right, or as default and opposite in

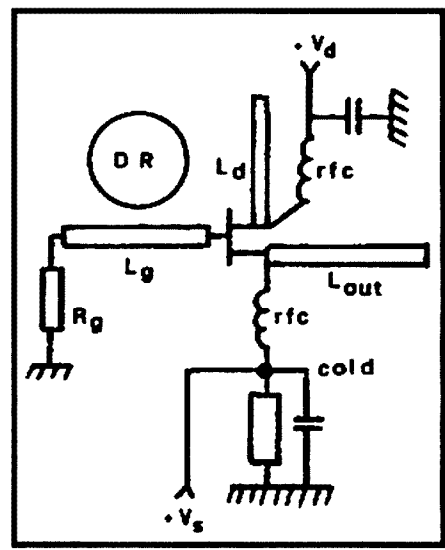


Fig 2 - DR0 with Source side cold point.

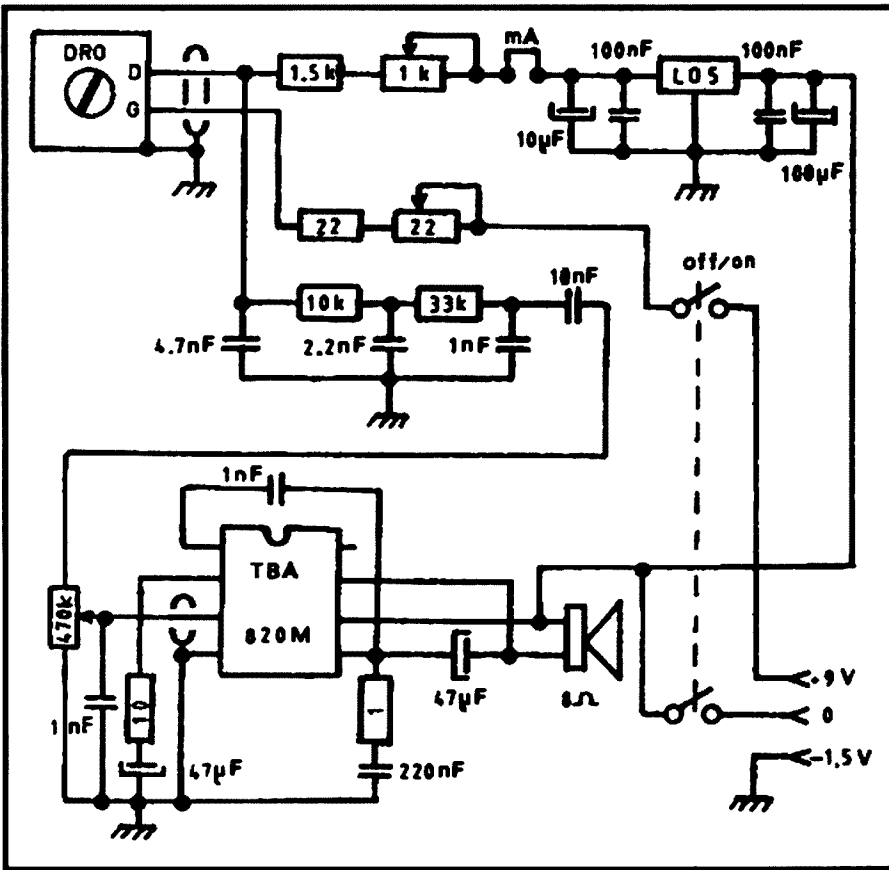


Fig 3 - 10 GHz Regenerative Receiver.

Table 1. Similarly, pre-set mutes are often used and, where alternatives are provided, these are identified by AT and SQ.

All the hand-helds tested have intermodulation performance which could be improved. The radio should be designed for operation in today's RF environment. The problem of strong signals from services in adjacent bands is not solely an Australian problem. The paging service is, however, marginally further away in some other countries.

The turnaround time gives some indication of the delay between transmit and receive. This is of importance to packet users and determines some of the TNC parameters. The major factor in these times is the settling time of the Phase Locked Loop. The PLL must stabilise before data is passed after each transition between transmit and receive.

### 10 GHz Super-Regenerative Receiver

The super-regenerative receiver is still used in many applications and it offers a simple receiver design. In VHF

Communications for January 1997, Andre Jamet F9HX describes a 10 GHz super-regenerative receiver. The design makes use of a Dielectric Stabilised Oscillator, DRO, converted to operate as a super-regenerative receiver.

A DRO is often used as the conversion oscillator in satellite TV LNBs and these can often be found surplus. This is particularly so in Europe and the UK with the many changes in satellite broadcasting. They are sometimes available here.

The DRO uses a ceramic dielectric resonator as the stabilising element. Typical circuits are shown in Figs 1 and 2. The resonator needs to be moved onto frequency for the 10 GHz band. Andre Jamet F9HX recommends moving the resonator up by abrading it with sand paper. He found it possible to move a 9.75 GHz resonator onto the 10 GHz band. After altering the frequency it is recommended to stabilise any components which have been stressed by carrying out one or two ageing cycles. An hour or so in an oven at 40 degrees C is the recommended cycle.



HF - VHF - UHF MOBILE ANTENNA  
HF - VHF - UHF BASE ANTENNA  
CB - MARINE - AIRCRAFT

Monoband to Multiband  
Convert Now, to the all  
New!

**PERTH PLUS**  
HF Mobile antenna

with 60-40-30-20-17-15-12-10-6-2m included

Also include

Coaxial Cables & fittings  
HF Spring Bases, Trunk and Gutter Mounts.

Outbacker OB8 "Classic"  
Outbacker "Junior plus"

Split Models  
Helical Dipoles  
Long wire Dipoles  
Baluns

Now available from :

**MELBOURNE**  
Daycom Communications  
Ph 03 6436444

**ALICE SPRINGS.**  
Farmer Electronics  
Ph 089522388

**DARWIN.**  
Intergrated Technical Services.  
Ph 089-815411

**SYDNEY.**  
Andrews Communications  
Ph 02 6369060

**PERTH.**  
Tower Communications  
Ph 4701118

**ADELAIDE**  
Johnston Electronics  
Ph 08 2871061

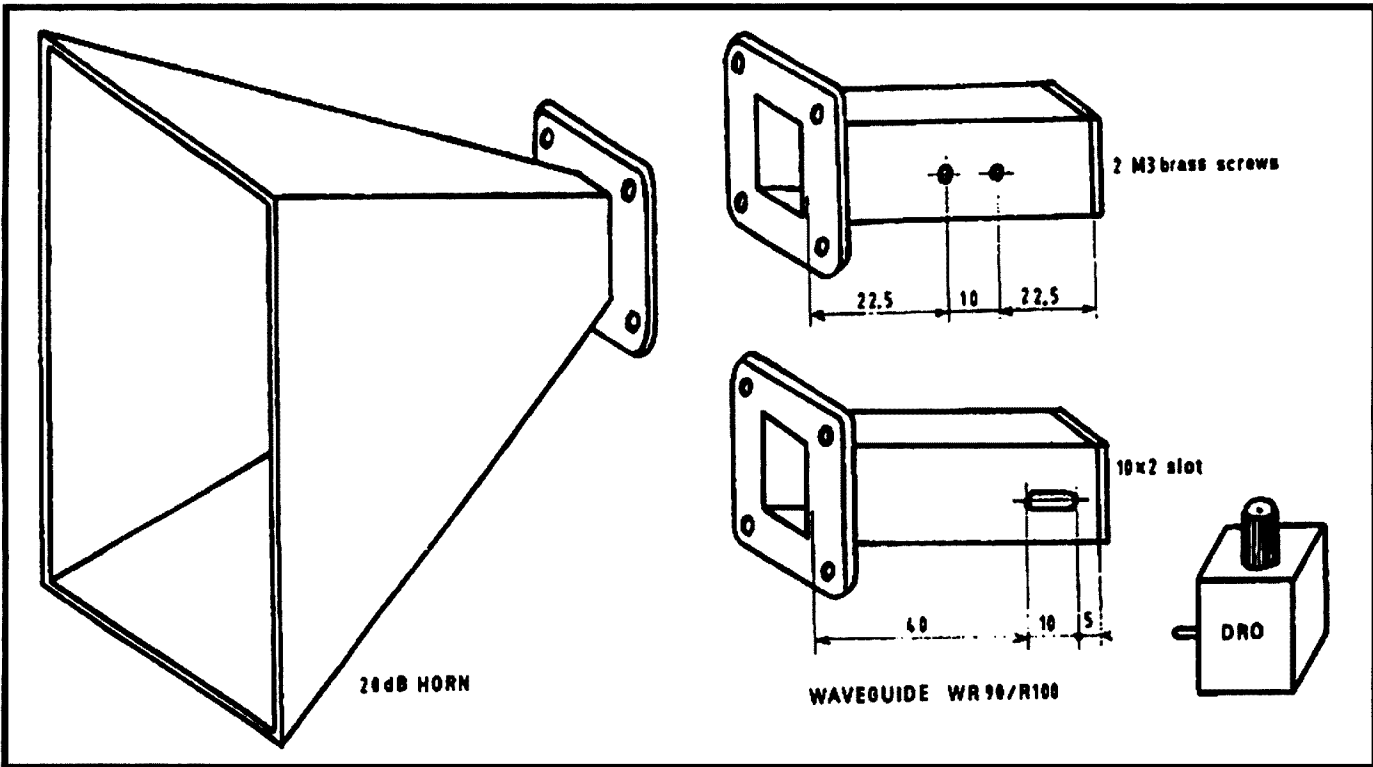
PERTH - Model

<http://intercon.com.au/outbacker>

TERLIN AERIALS Ph +61 (08) 9455 4288  
11 McElligott Court Ph +61 (08) 9455 4289  
Canning Vale WA 6155



Send \$ 5.00 for a 15 minute informational video  
Refundable with every antenna purchase.



**Fig 4 - Mechanical Design including wave-guide front and rear views.**

Converting a DRO to a self-quenching regenerator is accomplished by adding a resistor into the drain circuit to pick up the audio output and to produce the quenching oscillation. The operating point is controlled by varying Gate-Source voltage and is quite critical to obtain best super-regenerative performance. The circuit used is shown in Fig 3. The 1.5 volt negative supply was required as the DRO used needed a negative gate-source voltage.

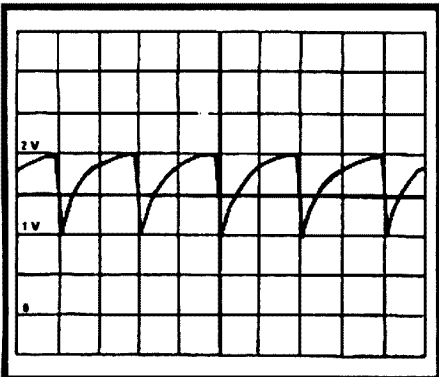
The DRO must be extracted from the LNB. This was accomplished by sawing it out. This resulted in the DRO being extracted as a small box which had been

sawn out of the LNB. The receiver construction is shown in Fig 4. The DRO is placed against a slot in the piece of wave-guide. A small piece of Teflon insulated wire removed from a scrap of coax is connected at the DRO output and is used as a coupling probe into the wave-guide. The DRO can be moved about along the slot in the wave-guide to find the optimum position. It can then be fixed in position. A couple of tuning

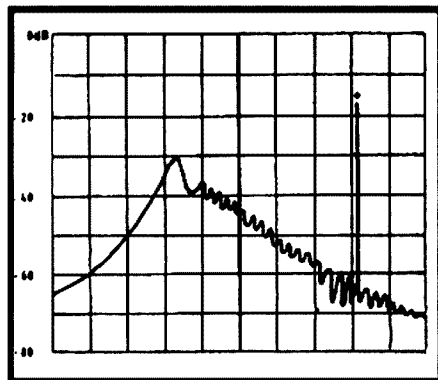
screws, as shown in Fig 4, assist with matching. A scrap of plastic biro case was glued to the head of the DRO adjusting screw to assist with tuning.

The waveform at the Drain Cold point is shown in Fig 5, showing the quenching oscillation. The super-regenerative receiver spectrum is shown in Fig 6.

*\*Clo PO Box 2175, Caulfield Junction VIC 3161*



**Fig 5 - Drain Cold Point Waveform.**



**Fig 6 - Super-regenerative Receiver Spectrum. Scan Width 2 MHz/div. Scan time 0.5 Sec/div. Bandwidth 10 kHz. Plus received signal at analyser input.**

**Help stamp out stolen equipment - always include the serial number of your equipment in your HAMAD.**

# Women in Radio – Mothers and Daughters

Christine Taylor VK5CTY\* presents another article in her series on women in amateur radio.



(l to r) Linda Luther VK5QP (ex VK4VV), Denise Robertson VK5YL, Joy Charles VK5YJ and Myrna Marnie VK5YW at the luncheon held at the Old London Tavern in July 1985 to mark the 10th anniversary of the founding of ALARA.

While most YLs take up amateur radio because their brothers or, more often, husbands are interested in the hobby, there have been a number of mother and daughter amateurs in Australia, almost from the earliest days of amateur activity.

The earliest pair were Elizabeth Hutchings VK3HM and her daughter, Marjorie Williamson VK3HQ.

Elizabeth VK3HM became involved through the interest of her son, Allan 3HL, later VK3HL. Marjorie was the first VK3 YL to transmit. She obtained her licence in 1929 and on Christmas Eve that year she exchanged Christmas Greetings with at least one station in each continent. She then sat up late into the night to make a contact with an amateur in England, just to put the icing on the cake.

She built a receiver and a transmitter in 1930 which were shown at an amateur radio exhibition in Melbourne. The antenna was a Zepp wire aerial about 50

ft (over 17 metres) high with which she could operate on 80, 40 and 20 metres.

Young Marjorie thought that two amateurs in the family were enough until one day she was invited into the shack (next door to the living room) to “listen to this music from an American station”. She donned the earphones and started twiddling the knobs. She was hooked!

She was so frustrated that she couldn't understand the Morse

Code that she set out to learn it. This was followed by the theory and eventually Marjorie sat for and passed her exam in 1932.

Mother and daughter shared the rig and made many friendships through amateur radio till they had to seal their equipment in 1939 because of WW II.

Unfortunately, Elizabeth VK3HM died suddenly in 1943 and, although Marjorie VK3HQ never set up another station, she has never regretted her interest in the hobby and never lost the friends she made.

Hebe VK2AOK obtained her licence in 1964 after encouragement from her husband Dick VK2AZG and his friends, and became very active in the DX field. She made many friends overseas and entertained many of them in her home in Sydney.

She was active within the WIA and ran a number of Nets at different times, including the South East Asia Net from Dural and a Macquarie Island Net from her home.

Hebe and Dick had two daughters and two sons who obtained licences. Jean, now VK4FUL, was in New Guinea when she passed her exam. She had the call P29OK, and also held her mother's old callsign for some time, simultaneously. The other daughter Dia became VK2YTH, John took the callsign VK2ZJD and Richard VK2BGW. Potentially there could have been six demands on the rig at once!

Brenda VK3KT (VK3 Division Federal Councillor, and Federal Education Co-ordinator) gained her licence in 1960 as a result of the activity of her husband John VK3AFU/ATG with the Rural Fire Brigades in the Victorian Wimmera area. Their two daughters, Brenda VK3QT and Vickie VK3LT, gained their licences in the 70s, along with Brenda's two sons, Charles VK3AFV and Alex VK3BQN. The whole family was licensed! In 1983, Brenda VK3QT married Paul VK3DIP, and Vickie married John VK3CU. It is expected that the next generation will proceed to gain licences in due course.



**AMATEUR  
TRANSCIVER  
RADIO CENTRE**

LARGEST SUPPLY OF HF/VHF/UHF  
TRANSCIVERS AT COMPETITIVE  
PRICES

**ALINCO** SYDNEY'S LARGEST  
RANGE OF ALINCO

TRANSCEIVERS & ACCESSORIES  
VHF UHF MOBILES HAND HELDS

**NOW IN STOCK FOLLOWING MODELS**

DR-150T DR-605T DR-140T DX-70TH  
DR-610T DR-605T DJ-G5TY

DJ-X10 SCANNER

NEW DR-130T DJ-191T DJ-S11 DJ-S41

**LOTS MORE NOT LISTED**

**ALINCO FACTORY**

**AUTHORISED DEALER**



IC-756 IC-706MKII  
IC-207H IC-77A



TS-570S TM-V7A  
TM-251



**ANTENNAS**

**AMERITRON HF AMPLIFIERS**

**EXPAND YOUR COLLECTION TODAY**

**PHONE (02) 9896 2545**

E-mail: [atrc@australia.net.au](mailto:atrc@australia.net.au)

Web Page:

<http://www.australia.net.au/~atrc>



(l to r) Norma VK2YL, Jenny VK5ANW and Marilyn VK3DMS.

Are there any instances of three generations of women operators?

There are at least three other mother and daughter combinations who came on air since the 70s when the Novice licences were introduced.

We have Jean VK2NFS and her daughter Barbara, who was very active as V85BJ from Borneo a couple of years ago, and is now quiet until she has a chance to get some aerials up in the air, as VK4GTX. Barbara entered many contests and participated in many Nets from Borneo. No doubt she will take up some of those activities once she has something up in the air again.

Norma VK2YL, who was the first President of ALARA as VK3AYL, has a double claim to fame. She is daughter of Rae VK3VUK (now VK3AYL), and daughter-in-law of Bobbie VK2PXS.

Norma obtained her licence as VK3AYL when she was still at university and wasn't much older when she became President of LARA, the forerunner of ALARA. After her marriage to Frank VK2AKG, she moved to VK2 and took the callsign VK2DJO, which she later changed to VK2YL.

Norma, Rae and Bobbie were all flown to the first ALARAMEET in Mildura piloted by Frank and his brother. Norma also holds a pilot's licence though she probably doesn't have much chance to use it now as she and Frank

have three daughters to compete with amateur radio and flying.

Joy VK5YJ is another YL who first took out a Novice call before upgrading; but she had an easier task than her daughter Joyanne did (she attended classes and her OM, Ted VK5YQ, was there to advise and encourage). Joyanne was living on the Ernabella Settlement when she decided she would try to get her licence so she could talk to her parents on the air.

She studied through the standard books on her own. When she was ready to attempt an exam she flew to Adelaide to sit for it and flew back again. Joy cannot remember how many attempts it took Joyanne, first to pass the Novice and then to upgrade, but there were a number. She holds her callsign VK5BJA with pride.

Joy's son Kim also has a licence. He took the callsign VK5KIM at first, but Ted asked him to take his old call when he knew he was very ill, so Kim is now VK5YQ. To complete the family set, Joyanne's husband Graeme now has the callsign VK5ZGE but has never used it on air.

If anyone knows of other pairs that have been missed, please accept my apologies and let me know about them.

\*16 Fairmount Avenue, Black Forest SA 5035

ar

## QSP News

### Honorary Life Membership for Murray Burford VK5ZQ

Here is a brief account of some of the history of this man, a long time member of the Wireless Institute of Australia, South Australian Division.

Apart from being an active amateur radio operator for many years, Murray has made an ongoing and constant contribution to our hobby.

He has taken an active interest in Institute affairs and previously served as a member of Council and also as a Divisional President. Murray has been involved with the weekly news broadcast since as far back as 1964 and has acted as an operator for VK5WI as well as relaying the broadcast from his own station.

Since the early 1970s, Murray has been involved in the education of new "amateurs" and is currently the instructor for the course run by the Division at the Burley Griffin Building.

Around six years ago Murray took on the production of the Divisional News Broadcast and has consistently continued to carry out this function over that period of time. I can assure you that to regularly produce the broadcast on a weekly basis over such a period is certainly no mean feat.

I am very pleased to announce that, following a suggestion received from a member and based on a recommendation from the Divisional Council, the members at the September General Meeting voted unanimously to confer upon Murray the privilege of Honorary Life Membership.

It is proposed that Murray be presented with his Honorary Life Membership Certificate and badge at the November General meeting of the Division.

On behalf of all members of the Division I have great pleasure in offering congratulations to Murray Burford VK5ZQ on his fine achievement and wish him well in his further activities in this great hobby.

Ian J Hunt VK5QX  
VK5 Division President



# ALARA

Sally Grattidge VK4SHE\*, ALARA Publicity Officer

## North Queensland Convention

The North Queensland Amateur Radio Convention was held in Townsville in September and, as usual, a number of YLs enjoyed the weekend. Seen at the Convention were Mary VK4PZ from The Caves near Rockhampton, Jocelyn VK4JJ from Bundaberg, Merrell VK4HAJ from Seaforth and Ann VK4MUM, Pat VK4MUY, Evelyn VK4EQ, Sally VK4SHE and Jeanette VK4AZL from Townsville. Also there were Eleanor, XYL of VK4ZT; Hazel, XYL of VK4CAU; Sheila, XYL of VK4IGM; Linda, XYL of VK4RB; Lyndall, XYL of VK4ZZ; Betty, XYL of VK4AGZ; Dorothy, XYL of VK4DO; Joan, XYL of VK4QF; Gay, XYL of VK4APQ; Annette, XYL of VK4CD; Dianne, XYL of VK4HAI; Noelene, XYL of VK4OB; Jeanette, XYL of VK4WJ; Sharon, XYL of VK4NEF; Teri, XYL of VK4MC; Kay, XYL of VK4ACC; Nuriti, XYL of VK4YIT; and Suzanne, Roslyn and Judy. I have a feeling this list is incomplete, so apologies to anyone I have left out.

Special guests were the operators from the Willis Island DXpedition, including three YLs, Noriko Tokura VK9WY and 7K3EOP; Elvira Simonani VK9WY, VV3FSG and VK4BES; and Ann Santos VK9WY, VK4AMS and J38AA. Your intrepid reporter had great plans to interview these ladies and get an exclusive story but, alas, did not do her homework. I discovered, when things had settled down a bit and there was time to sit down and talk, that they had not planned to stay for the whole weekend and it was too late – the birds had flown.

The Convention was held at James Cook University and opened with a meet and greet get-together, catered by the local YLs.

The ALARA table was on display, and the usual ladies home-brew with a fascinating assortment of crafts (one curious item was submitted by an amateur who has never been seen wearing a skirt – maybe we should check the rules on that...). Evelyn VK4EQ took first prize, Lyndall second prize, and Noelene third prize.

On the Saturday morning a craft session took place under the expert guidance of Dianne, daughter-in-law of Pat VK4MUY. YLs were asked to bring a plain white T shirt to decorate. After some initial hesitation, several masterpieces began to evolve, as paint, glitter, stars, moons and leaves turned boring white shirts into unique fashion items. All who took part were surprised at how easy

it is to produce something quite professional.

After lunch at the University (student style), the ladies boarded a bus driven by Bob VK4WJ, and proceeded to the Maritime Museum where Townsville's history connected with the sea was revealed. Some of the more adventurous tried on a diver's helmet which is so heavy it has to be lowered onto the shoulders by a frame resembling a guillotine. This visit was followed by afternoon tea in the garden of Judy's daughter, Jewell. This garden is one of the first in North Queensland to be in the Open Garden Scheme. Mainly palms and deliciously shady in the afternoon heat, the garden really shows how an average house block can be transformed into something special.

Saturday night was a buffet dinner at Tumberton Lodge, which is an old restored building in the Palmetum gardens. Balmy tropical breezes wafted in through open windows and doors, and no mosquitoes (wonder how they did that!). The famous "amateur hour" returned by popular request, and the local YLs' rendition of "Three Little Fishes" actually won the prize (I didn't think the others were that bad).

On Sunday morning the ladies visited the Cotters Market in Flinders Mall, where most managed to find a souvenir or two, before returning to the University for a barbecue lunch, presentations, and a relaxing chat under the trees, while the OMs squandered the family fortune at the famous auction.

## Around the Traps

Gwen VK3DYL congratulated CLARA on their 30th birthday on behalf of ALARA when she attended the CLARA GALA in

September.

"Our" Mrs Mac (Florence Mackenzie) has been in the news again in *Electronics Australia*, featured in a piece about the founders of "Wireless World"

Maria VK5BMT is an official observer of garden birds, and is busy documenting what birds visit her garden, and when and how often.

Marilyn VK3DMS and OM Geoff VK3ACZ were in Adelaide for the Stampex, and joined Jean VK5TSX, Tina VK5TMC, Jenny VK5ANW and Christine VK5CTY for an impromptu dinner.

While in VK4, Meg VK5AOV and OM David met Val VK4VR and Brian, but missed seeing Bev VK4NBC as she was visiting her OM Graham VK4BGC in hospital. Graham has not been at all well lately and we all hope he will recover soon.

Judy VK3AGC has also been in hospital. Judy, who broke her wrist a year ago shortly before setting out for Perth to go to the ALARAMEET, has had trouble with it ever since, so has returned to hospital to have it re-broken and reset. We all hope you get the improvement you are hoping for, Judy.


\*C/o PO Woodstock, QLD 4816

Tel: 077 788 642

Packet: VK4SHE@VK4RAT.#NQ.QLD.AUS.OC

Internet e-mail: rgrattid@ozemail.com.au

ar



**Your Hobby** **Your Voice**

Representing Radio Amateurs Since 1910

## WIA News

### Amateur Radio on the Space Station - Official

The American Radio Relay League (ARRL) reports that amateur radio will be an official payload on the International Space Station (ISS), construction of which is scheduled to commence in 1999, in orbit.

According to the *ARRL Letter* for 26 September, Matt Bordelon KC5BTL, at the Johnson Space Center, said ham

radio was the first payload to become official.

The ISS Payload Office is reportedly listing amateur radio onboard the space station as a transportable station in the form of hand-helds, as a site on the EXPRESS pallet, and as a permanent station on the space station's Habitation Module.

[Released 7/10/97]

# AMSAT Australia

Bill Magnusson VK3JT\*

## National co-ordinator

Graham Ratcliff VK5AGR

Packet: VK5AGR@VK5WI

E-mail: vk5agr@amsat.org

## AMSAT Australia net:

Control station VK5AGR

Bulletin normally commences at 1000

UTC, or 0900 UTC on Sunday

evening depending on daylight

saving and propagation. Check-ins

commence 15 minutes prior to the

bulletin.

Frequencies (again depending on

propagation conditions):

Primary 7.064 MHz (usually during

summer).

Secondary 3.685 MHz (usually

during winter).

Frequencies +/- QRM.

## AMSAT Australia newsletter and software service

The newsletter is published monthly

by Graham VK5AGR. Subscription is

\$30 for Australia, \$35 for New

Zealand and \$40 for other countries

by AIR MAIL. It is payable to AMSAT

Australia addressed as follows:

AMSAT Australia

GPO Box 2141

Adelaide SA 5001

## Keplerian Elements

Current keps are available from the

Internet by accessing the AMSAT

FTP site, <ftp.amsat.org> and following

the sub-directories to "KEPS".

## Some Details of the Receive Requirements for TMSAT 38k4 Downloads

Surrey University recently outlined the receiver necessary for the 38k4 baud downlink on TMSAT which is due for launch later this year. As expected, the requirements are quite a deal more stringent than for 9k6 baud and will mean more than a simple work-over of the station receiver as is the case with 9k6 baud. The following text has been abbreviated from a message as received via the Internet from Chris Jackson G7UPN/ZL2TPO. Chris is UoSAT Ground Station Manager at Surrey Satellite Technology Limited. The original message is too long to include in this column in its entirety.

### Introduction

With the launch of TMSAT-1 scheduled for later this year the radio amateur community will be able to obtain data from some of the most advanced imaging and frequency analysis payloads available to date. The

satellite's advanced imaging payload comprises three narrow angle cameras, a wide angle camera and transputer, providing the ability to generate false colour satellite imagery. This increase in payload sophistication, however, has a price, that being the immense amounts of data generated by the payload. A single uncompressed image is in the order of 3.3 Mbytes in size.

### The 38k4 Modulation Scheme

The 38k4 baud modulation scheme employed on TMSAT-1 is similar in principle to that of the existing UoSAT 9600 CPFSK modulation scheme used on previous UoSAT missions. The only alterations are pulse shape roll off factor and some of the filtering.

### Receiver Description

The differences between this and the previous 9600 baud system are:

1. All filter bandwidths require expanding to allow for the larger bandwidth received signal.

2. The crystal band pass filter needs to have a sufficiently wide bandwidth, a minimal pass band ripple, but extremely steep skirts so as to absolutely band limit the IF chain.

3. The frequency discriminator is required to be linear over its full operating range; non-linearities will cause degradation to the received signal.

The preferred line of action would be to modify the existing 9600 baud receiver and demodulator since any existing Doppler tracking and receiver control already in place for 9600 baud operation could still be used. The filter selected for the SSTL ground station is an 8-pole Butterworth crystal filter,  $BW@ -3 \text{ dB} = 65 \text{ kHz}$ , extremely steep skirts, and minimal pass band ripple. So far, no-one has reported a successful modification of existing gear using this filter. They are quite expensive but they represent the minimum requirement for successful 38k4 operation.

### G3RUH 9600 Baud FSK Modem modifications

Only the demodulator circuitry is required, and modifications are required to the receive filter and the output DAC circuitry. The receive audio is fed into the receiver filter via a small amplification stage. The signal is filtered, unscrambled and then passed onto the SSTL modem interface card for level shifting.

### Conclusions

Whilst the change from the existing 9600 baud data rate to the new 38k4 data rate will initially pose a problem, the implementation

of such a receiver will provide a reward in terms of access to the new images and faster store and forward communications. Currently, no off-the-shelf solutions exist; this, therefore, provides an excellent technical challenge in the implementation of the receiver

At the time of writing, the above sounds like a fairly expensive project. Surrey have indicated that a suitable commercial receiver is available. Once again, this would be an expensive way to go and Doppler tuning would still need to be addressed. My feeling is that this approach will appeal initially to those among us with a good grasp of communications electronics (and a pronounced sense of adventure). Perhaps some of the Gurus are already working on modifications to the existing range of amateur gear already on hand in most satellite user's shacks. This would open the project to a much wider audience. More on this one as it comes to hand. Updated information is available on the Internet at: [http://www.ee.surrey.ac.uk/CSER/UOSAT/amateurl/38k4\\_receiver\\_paper.html](http://www.ee.surrey.ac.uk/CSER/UOSAT/amateurl/38k4_receiver_paper.html)

### Worth Remembering

This is part of the text of a message from Chris G7UPN in reply to a question put to him on UO-22 recently. It's worth passing on. I hope readers will appreciate just how fortunate we are to have access to these satellites. The questioner asked, "How come private commercial companies give their satellites to amateurs?" He was referring particularly to the new TMSAT satellites.

Chris replied, "This is a similar arrangement to UO-9, UO-11, UO-14, UO-15, UO-22, KO-23, KO-25... All of these satellites are 'owned' by someone (either UoSAT, or KAIST). Generally these organisations are interested in educational aspects of space as well as developing for themselves experience with building and operating spacecraft. Mostly, these organisations are connected to universities (similar to UoSAT/SSTL being connected to the University of Surrey). The Thai company is connected to Mahanakorn University in Bangkok. They aren't exactly 'private' companies.

Amateur operators will get full access to a couple of excellent satellites in the next six months that would otherwise not be available to them. The imaging capabilities of these satellites will be better than anything else presently available on amateur radio satellites, and the 38k4 downlink will give people something new to work with". Well said, Chris.

Were it not for the fact that we have amateur radio contacts in these Universities and the heroic pioneering work of people like Prof Dr Martin Sweeting, the transponders and beacons of the satellites mentioned above would never have graced the amateur

radio bands. The best way we users can support these people who have supported us so well is to get behind the amateur organisations and, in particular, the amateur radio satellite organisations, with our membership.

## Keeping Track of the Geo-stationary Satellites

A recent article in *Wireless World* caught my attention. It described a new approach to the way commercial earth-stations keep track of geo-stationary communication satellites. It set out the major cost savings that could be achieved with the right tracking system. What's that I hear you say? "I thought geo-stationary meant NO tracking".

Well, in amateur radio terms and using amateur built antenna systems, that may be true. Commercial installations can involve dishes of maybe 10 – 20+ metres diameter and frequencies of tens of GHz. This equates to beam-widths which are measured in minutes of arc. Such dishes require the very best engineering to maintain rigidity and they need to track the satellite. Geo-stationary satellites may appear to hang in the sky but none will have a truly equatorial orbit. Neither are their orbits perfectly circular. In practice they will have a small inclination and eccentricity and consequently they will "move about a bit" to an observer. They, in fact, trace thin ellipses that drift slowly around the orbital path. Not enough to worry an amateur installation but more than enough to require the large dishes to keep them centred in the beam.

The article reviewed several systems that are in use to combat this problem, some quite costly. For the want of a simpler explanation, many of these systems use a sort of servo system where information fed back from the satellite is used to track the dish and also to keep the satellite in its allotted "window". Accurate tracking using this method is difficult to maintain, particularly at times of high ionospheric activity or when the satellite is directly in line with the sun. Power outages can also cause the system to lose lock. The article claims that tracking systems which rely on the strength of the received signal to generate the tracking error can easily be fooled by scintillation fading.

The new approach does not attempt to track by any sort of feedback. It uses a super accurate mathematical model of the satellite orbit, similar in a way to our tracking method using "keps" but orders of magnitude more accurate. It appears that the actual position of the satellite can be determined far more accurately by this method than by any sort of feedback system. The cost savings are achieved by being able to have backup systems in place at the earth-station and by being totally independent of power outages,

fading, eclipses and other natural phenomena. The tracker will always know precisely where the satellite is and be able to keep the antenna right on track.

Why bother? Commercial data is a costly commodity and cost savings are expected to top the one million dollars per year mark by using such a system. In addition, there's the customer's image of the provider's reliability and that can make the difference between a renewed contract and an ex-customer. How lucky we are not to require this order of accuracy to track our little OSCARs.

## SPUTNIK Replica

By the time you read this, the 40th anniversary SPUTNIK replica should be in

orbit. It will be known as RS-17 when it is operational after being hand launched during a space walk by a MIR Cosmonaut on or about 3 November 1997. Look for its signal around 145.820 MHz plus/minus Doppler. SPUTNIK PS-2 is a one-third scale model of the original SPUTNIK. Its transmitter will broadcast "beeps" similar to SPUTNIK-1. I described it more fully in the August 1997 column. Be quick, though, as the replica is using battery power and, like the original, has no charging capability. It has a design life of one or two months. It should stay close to MIR for some time after launch.

\*RMB 1627, Milawa VIC 3678

E-mail: vk3jt@amsat.org

ar

---

## Awards

John Kelleher VK3DP - Federal Awards Manager\*

---

### CIS Awards

On 1 January 1992, after a period of about 75 years, the USSR ceased to exist. The Commonwealth of Independent States (CIS), which is the successor that replaced the USSR, is a loose confederation of Russia, the Ukraine, Belarus and a few, but not all, of the previous countries.

The political upheaval that followed is sadly taking a serious social and economic toll on the average amateur/SWL as the move to a market-based economy has disrupted many aspects of Russian life. The freeing of the ruble from its non-convertible status to a devalued currency has not helped.

One of the bad side-effects of these historic events is some disruption to mail services. Not all mail that enters the country is delivered, especially if it comes from overseas and looks as though it might contain valuables that could be traded for ready cash, ie currency/IRCs.

The Russians know that it is happening. They have written warnings about this. They've complained to the Postal officials openly. Then what do we do about those colourful and interesting Russian awards? Here are some tips, not necessarily in order of preference.

1. Write in advance. Ask if the award is still being offered, and if the sponsor has made special arrangements with an associate in a "safer" country to receive the fees.

2. Get a supply of the European-sized letter envelopes. Foreign non-standard envelopes are too prominent.

3. Don't use colourful stamps – this may attract the wrong kind of attention.

4. We know it's expensive, but use registered mail wherever possible.

5. Wrap IRCs or currency in carbon paper cut to the exact size of the envelope.

6. If all else fails, defer your application for the award until the situation improves or is clarified.

### Canadian Ladies Amateur Radio Association Awards

General requirements. GCR accepted. Apply to Kathy Hrischenko VE3GJH, 56 Stockdale Crescent, Richmond Hill, Ontario L4C 3S9, Canada.

### CLARA Certificate

CLARA members work 12 YLs in six Canadian call areas (limit five VE3); other YL or OM operators in Canada work 10 YLs in five call areas. DX stations, including USA, work five YLs in three call areas. All bands. Contacts after 12 September 1972. Endorsements available. Fees VE and USA \$3.00; all others \$4.00.

### CLARA Ten DX Contacts Certificate

Work 10 YLs in different countries. Use an approved DX country list. Open to all YLs and OMs. Contacts after 1 January 1990. Fee is \$2.00 and a copy of your log sheet.

#### YL-DXCC

Work YLs in 100 different countries. Use an approved DX countries list. Open to all YLs and OMs. Endorsements available each additional 10 YL countries. Fees VE and USA \$3.00; all others \$4.00.

### Japan Ladies Radio Society (JLRS) Awards

General requirements. GCR list and 10 IRCs applicable for each award. Contact 26 licensed YL operators whose last letter of their callsign includes all 26 letters of the alphabet (this is called the YL Alphabet Certificate). No time limitations. Class A is for contacts with JLRS members only. Class

B for YLs anywhere in the world, including at least five Japanese YLs for operators outside Japan. Applications should be sent to: Kazuko Isiguro JE2EWW, 59-7 Wakinoshima-cho 7-chome, Tajima City, Gifu 507, Japan.

#### **YL-10 Certificate**

Requires 10 confirmed contacts with licensed YL operators world-wide, including at least one Japanese YL. Contacts after 1 January 1953. Your application goes to: Ayako Inagawa JE3LFH, 1-18-11-701 Minamihorie, Nishi-ku, Osaka 550, Japan.

#### **YL-CW Certificates**

Foreach of the following six awards, GCR list and 10 IRCs or equivalent goes to: Nobuko Nishigori JA3UPR, 2-6-11 Hirose-dai, Kaai-machi Kitakatsuragi-gun, Nara-ken 636, Japan.

#### **YL-CW-AJD**

Contact a licensed YL operator in each of the ten call areas of Japan.

#### **YL-CW-WAJA**

Contact a licensed YL in each of the 43 Prefectures.

#### **YL-CW-JCA Certificate**

Contacts with YLs in 10 different Cities in Japan. Endorsements for each group of contacts with 10 additional different cities.

#### **YL-CW-10 Certificate**

10 contacts with different licensed YLs anywhere in the world. Endorsements for each group of 10 additional contacts.

#### **YL-CW-Alphabet Certificate**

26 contacts with licensed YL operators anywhere in the world. The last letters of their call signs must represent all the 26 letters of the alphabet.

As can be seen, I had already begun to prepare this monthly report in lieu of receiving information from our YL population. Lo and behold, young Jessie Buchanan came forward with the very info I was begging for, but very close to time of publication. As a matter of interest, material for this column can be sent directly to my Call Book address, which appears each month at the end of this column.

#### **The ALARA Award**

This Award is issued by the Australian Ladies Amateur Radio Association.

1. The award is available to all licensed amateur operators and SWLs.
2. Contacts with members of ALARA since 30 June 1975 are valid for this award.
3. No band or mode limitations.
4. Contacts must be made from the same call area.
5. Requirements: VK/ZL require contacts with 10 members in five Australian States. DX stations require contacts with five members in four Australian States.

6. Stickers are available for each additional 10 (VK/ZL) or five (DX) members contacted. Special endorsements are available, eg all CW, all phone, etc.

7. Applicants must submit a complete log extract, certified by two other amateurs with their signatures appended. When an applicant is located in an isolated area with no possibility of obtaining certification, QSL cards must be forwarded for checking.

8. The fee for the award is \$AUS3.00 or four IRCs and \$AUS1.00 for additional stickers (no fee for stickers attached with the original issue of the award).

9. The address for applications is: Jessie Buchanan VK3VAN, 4 Milford Crescent, Karingal VIC 3199, Australia.

#### **NZ WARO Awards**

**General:** Contacts may be in any mode or band, with the applicant's contacts all from the same QTH. Contacts via repeaters, in WARO Nets, or Contests, are ineligible for this award. QSLs are not required. Send log list certified by one other licensed radio amateur to the Award Custodian with sufficient postage for return of the award.

**Main Award:** ZL and VK stations work 12 WARO members resident in New Zealand, DX stations work six members. Contacts should date from 1 June 1969. Endorsement seals are available to ZL and VK operators for each additional 12 stations, for DX six. Contacts with WARO DX members qualify for endorsements, but applications must contain at least three ZL contacts.

**VHF Section:** 10 VHF contacts with WARO members dating from 1 January 1979. WARO members and/or applicants may be home station, mobile or portable. Endorsements for each additional five contacts.

**SWL Section:** ZL and VK stations list 20 contacts heard with WARO members. DX list 10, dating from 1 January 1979. List full log details with call signs of both stations concerned. Endorsements for each additional 10 (five for DX) stations.

#### **NZ WARO Century Award**

1. Applications for this award must contain full log details of contacts with 100 WARO members (DX included) dating from 1 June 1987, and be signed by one other licensed amateur operator.

2. Contacts may be any mode, any band, or mixed, and from any QTH, but each YL claimed must be a financial member of WARO at the time of the contact, and may be claimed only once.

3. Contacts made via repeaters and in nets will qualify as will those made during WARO contests since 1 June 1990.

4. No QSLs required. Send list with full log details, and \$2.00 to: Award Custodian,

Eileen Bain ZL1BRX, 58 George Crescent, Buckland RD2, Pukekohe 1800, New Zealand.

Net information: 3.690 and 3.700 MHz on Mondays at 8 pm (NZ time).

#### **ARRL - YL Century Club (YLCC)**

Available to all licensed radio amateurs. Two-way communications must be established on authorised amateur bands, with stations mobile or fixed, and operated by 100 different licensed lady operators. The same YL using different call letters will NOT count. Any and all amateur bands may be used.

Contacts with YLs anywhere in the world are recognised provided only that confirmations clearly indicate the stations were operated by duly licensed women amateur radio operators.

List of claimed contacts, including the full name of the operator, alphabetically arranged by LAST name, call sign, date, band, mode, and RS(T) of each contact.

**Endorsements:** Confirmation of contacts accompanied by an alphabetical list, as described above, from stations operated by additional YLs may be submitted for credit each time 50 additional confirmations become available. Endorsements will be made to the original certificate when application is approved. Gold stickers will be awarded to applicants who have worked their additional contacts from the same country; otherwise, silver stickers will be awarded.

#### **Worked All States YL (WAS-YL)**

Available to all amateurs. Contact must be made with a duly licensed YL in each of the 50 states in the US. The District of Columbia may be counted for Maryland. There are no time or band limitations.

The call used is immaterial, provided it is licensed to the applicant. In qualifying for this certificate, it is possible to work the SAME YL in each of the 50 states.

The list of contacts must be arranged alphabetically by State, and must include the call letters, date, band, mode, RS(T), and the YL's first name.

There is no charge for these certificates, but sufficient postage for first class mail, or a stamped legal-sized envelope, must accompany the application.

Custodian for the YLCC is: Le Henderson KB6MXH, 857 Tamerack Lane, Sunnyvale CA 94086, USA.

Custodian for WAS-YL is: Richea Brigrance KU5L, RR2 Box 197, Booneville AR 72927, USA.

Time and space restrict me from mentioning more YL awards at this moment, but I promise to provide more during the coming year.

\*4 Brook Crescent, Box Hill South, VIC 3128  
Phone (03) 9889 8393

ar

# Club Corner

## Adelaide Hills Amateur Radio Society Inc

It's on again. Yes, the Adelaide Hills Amateur Radio Society Annual Buy and Sell!

**Where?** The Westbourne Park RSL Hall, 200 metres south of Big W on Goodwood Road.

**When?** Saturday, 22 November 1997. Doors open for sellers at 8.00 am, for buyers at 9.00 am, and the hall closes at 2.00 pm.

**How much?** \$10.00 per table (with one seller), \$2.00 each for extra selling staff, and \$2.00 for all buyers. Table bookings can be made by contacting Geoff Taylor VK5TY on 08 8293 5615.

**What's for sale?** Electronic equipment and parts, computer bits and pieces, hardware, books and a full range from Daycom Electronics, food, tea, coffee and cool drinks.

Geoff Taylor VK5TY

## Summerland Amateur Radio Club

The Summerland Computer Expo, sponsored by the Summerland Amateur Radio Club, will take place on Saturday, 22 November 1997 at the Lismore City Hall from 9.30 am to 4.30 pm.

There will be displays of the latest in computer technology, Bring and Buy tables for your pre-loved gear, Internet demonstrations, lucky door prizes and refreshments.

For more information, contact John on 02 6621 5217 or Graeme on 02 6685 1336. The Club's e-mail address is [sarc@nor.com.au](mailto:sarc@nor.com.au).

## The New England Amateur Radio Regional Conference Group

The Regional Conference/Field Day was held on the first Sunday of September at the Armidale Aero Club, Armidale.

Convener Roger Chubb welcomed all members who attended, with special thanks to our WIA representative. Our conferences are always well attended, but the September meeting showed an increase of 80% due to the incorporation of the 1st Bi-annual Armidale Field Day.

Congratulations to David Margery from Tamworth, who was the winner of the WIA award for "Contributions to Amateur Radio".

Matters discussed at the meeting included the next NSW WIA Conference of Clubs, the drop in WIA membership, the new

correspondence course and the North West Wormhole.

The field day was a busy hive of trash and treasure exchanges, great bargains and informative displays. Activities included a 2 metre fox hunt, a knowledge quiz and a demonstration of HF fox hunts

Our next conference has been set for the first Sunday in March, 1 March 1998. So do come along and join the fun.

## RAOTC (Radio Amateur Old Timers Club)

RAOTC members and friends in all states are reminded that daylight saving time will apply to Club broadcasts in November, December, January, February and March.

The 80, 40 and 2 metre broadcasts will take place at 2300 UTC (10 am EADST). The 20 m "north" broadcast will remain unchanged at 0100 UTC; 20 m "west" unchanged at 0200 UTC; and the evening broadcast will be on 80 m at 0930 UTC (8.30 pm EADST).

Allan Doble VK3AMD  
ar

## Contests

Peter Nesbit VK3APN - Federal Contest Coordinator\*

### Contest Calendar Nov 97 - Jan 98

Nov 1/7	HA QRP Contest	(Oct 97)
Nov 2	High Speed Club CW Contest	(Oct 97)
Nov 8	ALARA Contest	(Oct 97)
Nov 8/9	WAE RTTY DX Contest	(Jul 97)
Nov 8/9	OK-DX CW Contest	(Oct 97)
Nov 15/16	IARU Region 1 160 m Contest	(Oct 97)
Nov 29/30	CQ World-wide DX CW Contest	(Sep 97)
Dec 5/7	ARRL 160 m Contest	
Dec 13/14	ARRL 10 m Contest	
Dec 20-21	Croatian CW Contest	
Dec 27/28	Stew Perry Top Band Distance Challenge	
Dec 27 - Jan 25	Ross Hull VHF/UHF Contest	
Dec 28	RAC Canada Winter Contest	
Dec 31	ARRL Straight Key Night	
Jan 10-11	VHF/UHF Field Day Contest	
Jan 10-11	HA DX CW Contest	
Jan 23-25	CQ WW 160 m DX Contest	

In the midst of our contesting and DX chasing, it is easy to forget that once we were beginners. Some of us entered the hobby as Novices, whereas others jumped in the deep end, sometimes successfully at first try, sometimes not.

It is also easy to overlook the fact that there are some fine operators within the Novice ranks. I was reminded of this recently by an e-mail from David VK3NDS:

"I have attached a copy of a message sent to me by Bob Cox of CQ magazine, which confirms that I have the highest claimed score in the 21 MHz QRP CQ WW SSB contest 1996 (WORLD!!), which I am ecstatic about. Also, in the WPX 1996 SSB 21 MHz contest, I am #1 in VK and a certificate winner. I thought you may be interested for your column in Amateur Radio, but I also think it's nice to have some major world first-place trophies coming to Australia in the big

contests, especially for the Novices here. I am about to complete my full call theory having done my CW, but I am pleased to have these wins under the belt as a Novice.

"Here is a copy of the message, as I have not yet seen the results of these contests in Amateur Radio. Regards, David."

(From Bob Cox K3EST:)

"Dear David,

Very nice to hear from you. It appears that your high claimed score in the 1996 SSB CQ WW was very good, at #1 in the World on 21 MHz. Quite a feat from 'down under'. Here are the top claimed scores on 21 MHz QRP CQ WW SSB:

VK3NDS	21	76,380	394	21	46
Z32DR	21	31,570	233	20	62
EC1AIT	21	24,764	190	23	59
EC1AIS	21	19,000	128	20	56
UR5MTA	21	16,030	151	14	56
JR1LQK	21	110	5	5	5

# GREAT DEALS ON COMMUNICATIONS

## FT-10R 5 Watt 2m Handheld

A compact 2m hand-held with a unique clam shell design and rear-mounted NiCad battery pack that provides 5W RF output as standard through the use of a MOSFET power amplifier and extensive component miniaturisation. Built to a tough MIL-STD 810 rating for shock and vibration resistance, the FT-10R also uses gasket seals for improved weather proofing.

### Features:

- Tx 144-148MHz, Rx 140-174MHz
- RF Output: 5.0, 2.8, 1.0, 0.1W
- Dual watch facility
- Large Omni-Glow backlit display
- High efficiency speaker for super loud audio
- CTCSS encode/decode
- Auto battery save, Tx save & auto power off for longer operating times
- 12V DC socket for charging and power
- Keypad frequency entry
- 99 memories
- Digital code squelch
- Size: Just 62 x 100 x 42mm (WHD)
- Comes with FNB-41 9.6V 600mA/H NiCad, A16D version keypad, belt-clip & AC charger. D 3650

STILL JUST  
**\$399**



**2 YEAR WARRANTY**



## FT-840 Economical HF Mobile Transceiver

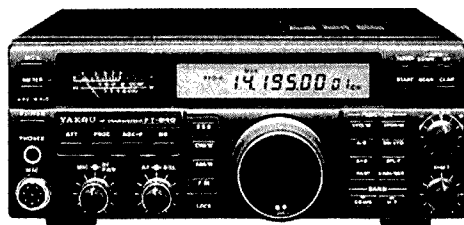
A serious HF transceiver that won't break the bank and doesn't compromise performance at home like many current micro-rigs. The Yaesu FT-840 gives you full 160m to 10m amateur band coverage (receiver 100kHz-30MHz), 100 memory channels, a large back-lit LCD screen, an effective noise blanker and an uncluttered front panel. The FT840 is simple to use, with useful features like an SSB speech processor for added audio punch, IF shift to fight interference and Direct Digital Synthesis oscillators for cleaner transmit and improved receiver performance. Includes DC power lead and hand microphone... just connect your power supply and antenna and start having fun!

D 3275

**\$1395**



**2 YEAR WARRANTY**



## Advanced Data Management Software

An advanced way to program a variety of the functions on many of the latest Yaesu handheld and mobile transceivers. Each package consists of an interface that plugs into both the serial port of your PC and connects to the transceiver via its microphone socket (for handhelds) or its packet socket (for mobiles). Also provided is easy-to-use 3.5" format PC software with pull down menus that allow for programming and naming of memory channels, selection of output power, CTCSS tones, scan and battery saver operation plus much more.

ADMS-1C for FT-10R/11/50 and 51R

D 3752

**\$79.95**  
Was \$85

ADMS-2C for FT-3000M/8000R/8500

D 3758

**\$69.95**  
Was \$85

**NEW LOW PRICES**

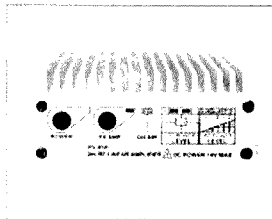


## 2m 80W RF Power Amplifier

Designed specifically for use with 2m FM handhelds, this solidly built high power 80W RF power amplifier will really give a boost to your signal when you're using a hand-held at home or in the car. It works with RF input levels of 0.5 to 5W, provides 80W output with typically just 2.5W input, and even just 1W input will still provide over 40W output. A switchable 12dB gain GaAs FET receiver pre-amp can also be selected for improved performance in quiet RF areas. The amplifier includes a large die-cast heatsink, fused DC power lead, SO-239 input/output connectors, and simple LED metering for DC supply voltage and relative RF output power. Frequency range 144-148MHz only. Requires 13.8V DC at 20A max. Size: 124 x 44 x 208mm (WHD) including protrusions.

D 2520

**\$169**  
**SAVE \$30**



**MAJOR AMATEUR STORES ARE UNDERLINED** NSW • Albury 6021 8399 • Bankstown Square 9707 4888 • Bankstown PowerHouse 9793 9677 • Blacktown 9671 7722 • Bondi Junction 9387 1444 • Brookvale 9905 0441 • Burwood 9744 7299 • Campbelltown 4627 2199 • Chatswood 9411 1955 • Chullora 9642 8922 • Gore Hill 9439 5311 • Gosford 4325 0235 • Hornsby 9477 6633 • Hurstville 9580 8622 • Kotara 4956 2092 • Liverpool 9600 9888 • Maitland 4933 7866 • Miranda 9525 2722 • Newcastle 4961 1896 • North Ryde 9937 3355 • North Sydney 66 Berry St 9964 9468 • Orange 6361 8400 • Parramatta 9689 2188 • Railway Square 9211 3777 • Penrith (02) 4732 3400 • Sydney City York St 9267 9111 • Mid City Centre 9221 0000 • Tamworth 6766 1711 • Wollongong 4228 3800 ACT • Belconnen 6253 1785 • Fyshwick 6280 4944 • Tuggeranong 6293 3399 VIC • Ballarat 5231 5433 • Bendigo 5443 0388 • Box Hill 9890 0699 • Coburg 9383 4455 • Dandenong 9794 9377 • Brighton 9592 2366 • Frankston 9783 9144 • Geelong 5223 2711 • Highpoint 9318 6300 • Knox Towerpoint 9800 3455 • Melbourne City Strand Central Arcade 9663 5320 & 246 Bourke St 9639 0396 • Niddrie 9379 7444 • Northland 9471 4823 • Richmond 9428 1614 • Ringwood 9879 5338 • Shepparton 5821 9497 • Springvale 9547 0522 • QLD • Alderley 3356 3733 • Booval 3282 6200 • Brisbane City 3229 9377 • Buranda 3391 6233 • Cairns 311 515 • Capalaba 3245 2870 • Chermerside 3359 6255 • Indooroopilly 3878 4944 • Maroochydore 5479 1800 • Mermaid Beach 5578 5600 • Rockhampton 27 9644 • Southport 5532 9033 • Toowoomba 38 4300 • Townsville 72 5722 • Underwood 3341 0844 SA • Adelaide City Pulleney St 8232 1200 • Myer Centre 8231 7777 • Elizabeth 8255 6099 • Enfield 8260 6088 • St Marys 8277 8977 • Westlakes 8235 1244 WA • Balcalta 9240 1911 • Cannington 9451 8666 • Fremantle 9335 9733 • Perth City 9481 3261 • Midland 9250 1460 • Northbridge 9328 6944 TAS • Glenorchy 6273 2176 • Hobart 6231 0800 • Launceston 6334 4555 NT • Darwin 8981 1977 • STORES IN RED ARE OPEN SUNDAYS. STORES ACROSS AUSTRALIA AND NEW ZEALAND

# GREAT DEALS ON COMMUNICATIONS

## FT-50R 2m/70cm Handheld

The Yaesu FT-50R is an amazingly compact 2m/70cm Amateur band handheld transceiver which provides MIL-STD 810 shock and vibration resistance, super wide band receiver coverage, simple menu settings for most functions and compatibility with the optional Yaesu ADMS-1C software/interface package for PC programming of many functions.

### Other features include:

- Tx 144-148MHz, 430-450MHz
- Rx 76-200, 300-540, 590-999MHz (cellular blocked)
- New FTT-12 keypad provides Digital Voice Recording, DTMF paging, CTCSS/DCS scanning and CTCSS encode/decode
- 2m/70cm RF output: 2.5, 1.0, 0.1W
- "Omni-glow" LCD screen for easier night viewing
- 112 memory channels with 4 character Alpha-numeric naming
- High speed scanning, 12V DC socket, Digital Code Squelch
- Dual watch allows monitoring of sub-band activity
- Direct FM modulation for better audio quality
- 5 battery saving systems (includes Rx and Tx Save, and Auto Off)
- Rear panel clamshell battery pack
- Supplied with FNB-40 slimline 6V 650mA/H NiCad battery pack, flexible 2m/70cm antenna and modified M-9626 AC plug pack adaptor for NiCad charging

D 3660

**\$599**



**2 YEAR WARRANTY**



## Revex W560N HF/VHF/UHF SWR/PWR Meter

Quality Revex wide-band SWR meter, offering 2 inbuilt sensors for 1.8MHz to 525MHz coverage! Provides measurement of 3 power levels (3W, 20W, 200W) and SWR. Uses an N-type socket for the VHF/UHF sensor to ensure minimal loss. Measures 120 x 80 x 85mm.

D 1375

**\$199**  
SAVE \$50

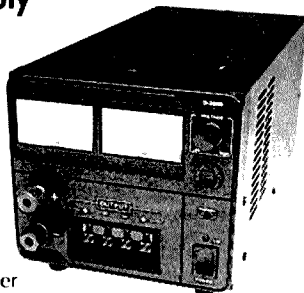


## 3-15V 25 Amp DC Power Supply

This solidly built bench top power supply provides a current of up to 25 amps ICAS at 15V, 20 amp continuous at 13.8V and lower current at lower voltages.

It also has front panel metering, plus high current banana-style and low-current output connections for extra flexibility. An internal heatsink and thermally-switched fan provides cooling without protrusions in the metal case (which measures 320 x 150 x 145mm).

Specially modified for more reliable long-term operation, it uses a rugged 50 amp bridge rectifier & trifilar transformer. Also provided is extensive overload protection through dissipation limiting circuitry for the pass transistors, a 30 amp instantaneous current limit, AC mains circuit breaker, a transformer thermal fuse & fused auxiliary secondary winding. Cat D 3800



**\$299**

Great Value!

## Rugged HF 5-Band Trap Vertical Antenna

The rugged 5BTV incorporates Hustler's exclusive trap design (25mm solid fibreglass formers, high tolerance trap covers and low loss windings) for accurate trap resonance with 1kW (PEP) power handling. Wide-band coverage is provided on the 10, 15, 20, and 40m bands (SWR typically 1.15:1 at resonance, <2:1 SWR at band edges) with 80kHz bandwidth typical on 80m at less than 2:1 SWR. An optional 30m resonator kit can be installed without affecting operation of other bands. High strength aluminium and a 4mm (wall thickness) extra heavy-duty base section guarantee optimum mechanical stability. At just 7.65m, the 5BTV can be ground mounted (with or without radials, although radials are recommended), or it can be mounted in an elevated position with a radial system. Unlike other antenna designs, the 5BTV can be fed with any length of 50 ohm coax cable.

D 4920

**\$349**

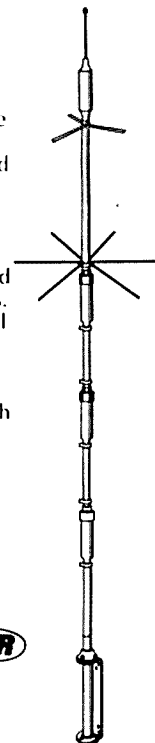


### 30m Resonator Kit

Adds 30m coverage to the 5BTV and includes all hardware.

D 4921

**\$89.95**



### PHONE FAX AND MAIL ORDERS

PHONE: WITHIN AUSTRALIA: 1300 366 644

(Local Call Charge)

FAX: (02) 9395 1155 within Australia and

(+612) 9395 1155 from outside Australia

Visit our web site at

<http://www.dse.com.au>

MAIL: DICK SMITH ELECTRONICS, Direct Link Reply Paid 160, PO Box 321,

North Ryde NSW 2113 (No Stamp Required)

Excludes packaging and postage. All major Credit Cards accepted.

14 Day Money Back Guaranteed if NOT completely satisfied. (Software excluded)



*That's where you go*

Stores across Australia and New Zealand

For the location of your nearest store call 1800 26 3922

B 3132

"In the 1996 WPX SSB Contest, the scores were:

*Low Power 21 MHz, #1 in Australia and certificate winner."*

This should shake up all those who consider it so hard to get a top world score in a major DX contest, that they don't bother trying. I know it often is very hard, especially when one is up against big signals from Europe and America but, as David shows, it can be done. Equally impressive is the fact that, despite the restrictions placed on Novices and the lack of extensive experience, David still managed to more than double the score of his nearest opponent! Well done, David, and may that inspire some of our full call operators into trying that little bit harder next contest. They might surprise themselves.

For information and assistance this month, many thanks to VK2PS, VK3DID, VK3NDS, KM9P, VE2ZP, ZL1AS (ex ZL1AAS), 9A2EU, AHARS, and ARRL. Until next month, good contesting!

73, Peter VK3APN  
pnesbit@melbpc.org.au

### Date Correction - CQ WW CW

Arrgh! It's happened again! I'm indebted to Stephen Pall VK2PS for pointing out my unforgivable error in last month's *Amateur Radio*, which showed the wrong date for the CQ WW CW Contest, of all things. Please note the correct date, which is (as always) the last full weekend of the month, and this year is 29/30 November (thanks Stephen).

### ARRL 160 m DX CW Contest

5-7 December, 2200z Friday to 1600z Sunday

The object in this contest is to work as many W/VE stations on 160 m CW as possible. Categories are: Single Operator (QRP to 5 W, Low Power to 150 W, and High Power above 150 W O/P), and Multi-operator single Tx. Exchange RST; W/VE stations will add their ARRL/CRRL Section. /MM and /AM stations should add ITU region 1, 2 or 3 as applicable. 1830-1850 kHz is recommended for intercontinental QSOs.

Score five points per QSO. The multiplier is the total number of ARRL/CRRL sections plus VE8/VY1 worked (max 77), and the final score equals QSO points x multiplier. Logs on MS-DOS disk are welcome. Send logs postmarked no later than 30 days after the end of the contest to: ARRL Contest Branch, 225 Main Street, Newington, Connecticut, CT 06111, USA. Logs can also go to the ARRL BBS at 203-665-0090, or via the Internet at [contest@arrl.org](mailto:contest@arrl.org). Certificates will be awarded to the top scoring station in each category, in each DXCC country. Note that the use of non-amateur radio means of communication during the contest (eg telephone) is not allowed for the purpose of soliciting QSOs.

### ARRL 10 m Contest (CW & Phone)

13-14 December, 0000z Saturday to 2400z Sunday

This popular ARRL contest runs on the second full weekend of December each year. The object is

to work as many stations world-wide as possible on 10 m phone, CW, or mixed. Maximum operating period is 36 hours, and listening time counts as operating time. Categories are as for the 160 m contest (see above). Send RS(T) plus serial number; W/VE will send RS(T) plus state or province. CW entrants should stay below 28.3 MHz, avoiding beacon frequencies. Stations entering the mixed mode section may work stations once on CW and once on phone.

Score two points per phone QSO, four points per two-way CW QSO, and eight points for CW QSOs with US novice or technician stations signing /N or /T (28.1 - 28.3 MHz only). Multipliers are the 50 US states plus District of Columbia (DC), plus Canadian provinces (see below), plus DXCC countries except US and Canada, plus ITU Regions (/MM and /AM QSOs only). Multipliers are counted separately on each mode. Final score is total QSO points x total multiplier. Include a dupe sheet for 500+ QSOs. Logs should be sent as for the 160 m Contest, within 30 days (see above).

### Croatian CW Contest

20-21 December, 1400z Saturday to 1400z Sunday

This contest is open to stations world-wide. Sections are single operator all band, and multi-operator all band. Use 160-10 m, CW only, and exchange RST plus ITU zone.

For each valid QSO with a 9A station, claim ten points per QSO on 160/80/40, and six points on 20/15/10. For QSOs with other continents, claim six points on 160/80/40, and three points on 20/15/10. For QSOs with own continent, including own country, claim two points on 160/80/40, and one point on 20/15/10.

Multipliers are the number of DXCC/WAE countries on each band, and the final score equals the total QSO points x the total multiplier from all bands. Forward your log, summary and dupe sheets within 30 days to: Hravatski Radio Amaterski Savez, Dalmatinska 12, 10000 Zagreb, Croatia. Logs on 3.5" disk are also welcome.

### Stow Perry Top-band Distance Challenge

27/28 December, 1500z Sat - 1500z Sun

This difficult contest is a real test of one's ability to copy weak signal information through the noise. It is for 160 m CW only. The exchange is a four character grid square (see P16 of *Amateur Radio*, December 1996 for details on how to work out your grid square). RST is optional, but if given, should be accurate.

The number of QSO points for each contact depends on the distance between the two stations, which is computed by taking the distance between the centres of the two grid squares. Count a minimum of one point per QSO, and add one extra point for each 500 km distance. For example, a QSO with a station 1750 kilometres away will count for four QSO points. No additional distance for long path is allowed. If you work a station who doesn't know their grid square, you can claim only one point for the QSO. CT, NA, and TR software will support this contest, including QSO point calculations.

The final score equals the total number of QSO points. There are no country or grid square

multipliers. Stations running five to 100 watts output can multiply their score by two, and stations running less than five watts can multiply their score by four.

Logs must be postmarked by 28 January 1998, and sent to: Bill Fisher KM9P, 1137 Charlie Ln, Lilbum, GA 30247-4203, USA. Logs on disk are also welcome in ASCII format. Alternatively, logs can be e-mailed to: [TBDC@contesting.com](mailto:TBDC@contesting.com)

Logs will be checked using computer techniques to detect busted call signs, exchanges, and not-in-log QSOs. Busted QSOs will be removed from both logs. Unique percentages will be reported in the results. All decisions by the judges are final.

### Canada Winter Contest

28 December, 0000z to 2359z Sunday

In this contest you can work anyone else for contest credit, on CW or phone, 160-2 m. You can enter as single operator single band, all band, or all band low power (100 W O/P), or multi-operator. On CW try 25 kHz up on the half hour, and on phone 1850, 3775, 7075, 7225, 14175, 21250 and 28500 kHz. Send RS(T) plus serial number; Canadians will send RS(T) plus province. (VE0 will send RS(T) plus serial no.)

Score 10 points for each QSO with a Canadian station including VE0, and two points for each non-Canadian QSO. QSOs with official Canadian RAC stations (RAC suffix) are worth 20 points. Note that CW and phone QSOs must be made in the appropriate sub-band to be valid. Multipliers are the ten Canadian provinces and two territories, and are counted once per band and mode (ie 12 on 160 m SSB, 12 on 160 m CW, 12 on 80 m SSB, etc). Multipliers are listed below. Final score equals total points x total multiplier. Send logs to: RAC, 614 Norris Court - Unit 6, Kingston, Ontario, K7P 2R9, Canada by 31 January 1998.

### Canadian Provinces & Territories

NS	Novia Scotia (VE1, CY9, CY0)
PQ	Principality of Quebec (VE2, VA2)
ON	Ontario (VE3, VA3)
MB	Manitoba (VE4)
SK	Saskatchewan (VE5)
AB	Alberta (VE6)
BC	British Columbia (VE7)
NT	North West Territories (VE8)
NB	New Brunswick (VE9)
NF	Newfoundland & Labrador (VO1, VO2)
YU	Yukon (VY1)
PE	Prince Edward Island (VY2)

### Results of 2nd South Pacific 160 m Contest (Amended)

Presented by Ian Godsil, VK3DID

The original results of this contest were forwarded in September, after which I was away for two weeks, and appeared in last month's *Amateur Radio*. Upon my return there was a letter waiting for me containing six logs which had been sent to last year's Manager, John ZL1AS (ex ZL1AAS), who himself had been overseas for several months.

After consultation with the NZART and WIA Contest Managers, it has been decided to re-issue this year's results. They appear below.

I apologise for any confusion, and for any disappointment due to a minor reshuffling of awards, but as these logs would have been received



within the deadline if ZL1AS had been at home to pass them on, it seems the fairest course of action under the circumstances.

As things stand, it is the intention to alternate Managers each year between ZL and VK, so PLEASE check carefully where to send them next year. Again my thanks for your co-operation.

73. Ian VK3DID

CW Call	QSOs	Pts	Mult	Score
ZL2SQ *	38	166	15	2415
VK6VZ *	25	119	14	1666
VK3IO *	27	123	12	1476
VK3APN	23	100	12	1200
VI3PES	20	91	13	1183
ZL1ANJ *	18	81	13	1131
ZL1ALZ	21	99	11	1089
VK5GN *	31	115	9	1035
VK3DID	18	75	10	750
VK8AV *	14	70	8	560
ZL4GU *	12	60	7	420
ZL2JR	10	47	10	329
YC0LOW *	2	10	3	30
VK6BEB	2	4	1	4
SSB				
VK5CRS *	70	312	16	4992
VK3IO *	51	216	12	2592
ZL2JR *	36	165	11	1815

ZL1ANJ *	24	102	12	1224
ZL1BRY	27	117	8	936
VI3PES	23	91	10	910
VK6VZ *	16	80	10	800
ZL3TX *	20	100	7	700
ZL2AWH	16	74	7	518
ZL1UE	16	62	8	496
ZL1ALZ	17	70	7	490
VK3DID	18	66	7	462
VK3APN	15	51	8	408
ZL1AGO	15	57	7	399
VK5GN	8	34	6	204
VK8AV *	7	35	5	175
AJ6T *	4	20	5	100

\*Certificates

### 1997 AUSTRALASIAN SPRINTS

Presented by Contest Manager AHARS

Entries for the twelfth series of the Australasian Sprints totalled eight in the CW section, and 23 in the Phone Section. The number of participants in the CW section was the fewest ever, and no logs were submitted by Novice class CW operators. The scores were generally very satisfactory, particularly in the phone section, and indicate quite good conditions on both nights. However, the main aim of the Sprints is for operators to enjoy themselves, and this appears to have happened again this year.

The Adelaide Hills Amateur Radio Society and the SA/NT Division of the WIA congratulate the WIA (ACT Division) in the CW section (Station VK1WI was again operated by Jim Miller VK1FF), and Barry Channon VK5KCX in the phone section, both being successful for the second successive year in close contests. Congratulations also to the leading scorers in the individual call areas.

Lists of the logs submitted with the scores achieved are shown below. Certificate winners are indicated by asterisks.

CW Results			
VK1WI **	28	VK5PO	64
VK1PK	12	VK5AXW	62
VK3APN *	26	VK5EN	52
VK5AFO *	14	VK5STR	42
VK5UE *	4	VK5NOS	40
VK6JS *	3	VK5RV	30
VK8AV *	22	VK5UE	28
ZL1ALZ *	24	VK5TD	23
Phone Results			
VK1WI *	42	VK6NU *	30
VK1PK	19	VK6JS	10
VK2LEE *	44	VK8AV *	42
VK3IO *	46	ZL1AGO *	36
VK4MOJ *	32	ZL1BVK	34
VK4JAE	15	ZL1ALZ	26
VK5KCX **	66	ZL3GL *	17

### Results of 1996 VK/ZL/Oceania DX Contest

Presented by John Litten ZL1AS (ZL1AAS)

PHONE	80m	40m	20m	15m	10m	Final Score							
<b>OCEANIA</b>													
DUI5AN			30820			30820							
DU7AFT				8466		8466							
V63HZ				11024		11024							
VK1NTW				60358	60358								
VK2APK		200340				200340							
VK2PS	2684					2684							
VK2VM		4640	2028	114444		212160							
VK2XT	60	5220	10710	215940	3	457758							
VK4BAY		1105	270	26350	612	58000							
VK4EET		10140	1800		29820								
VK4LAA	10					10							
VK4MZ	1440	193550	35074	113920	5832	1252728							
VK5AI		245	420			1512							
VK8AV			6204	36720	240	87248							
VK8DK		550	156			1496							
YC6PUP				35934		35934							
ZL1AIZ	64350	30030	1024	512		270111							
ZL1ANJ		22265	88	84900		206298							
ZL2AMI		40040		336		97482							
ZL2AWH	480	2090	4650	2184		39445							
ZL3TX	3800	100	1380			14363							
ZL4AV	40	405	1054	8		4532							
<b>ASIA</b>													
4L7AA		120	20			280							
EK4JJ			12	2	2	32							
EZ8CW				12		12							
JA1AAT			4	320	3	481							
JA1AAV				40		40							
JA1AB				140	3	184							
JA1GYO				374		374							
JA1HFY			8	130	6	288							
JA1MQS			1	96		119							
JA1XEM		45				45							
JE1XCZ				112	900	15	2136						
JF1KFV	40	525	152	380		4104							
JF1OPL					40	1050	25	240					4000
JG1EHF								90					90
JG1GCO								24					24
JG1UKW								132					132
JH1DVG							40	288					572
JH1NXU								8					8
JH1RMH								168					168
JH1UUT								728					728
JL7PVR/I								132					132
JQ1NGT								1024					1024
JR1BAS							136	700			9		1748
JR1BSV								18					18
JA2DLM	300	1755	532	720	63	14758							
JA2GHP						300							300
JA2GTW						30							30
JA2IZA								108		18			216
JA2YAU								672		9			1562
JR2TRC								420					420
JA3BVJ							100	128					1771
JA3LEZ								396					1771
JA3SSB								810					810
JF3EIU								4					4
JH3AKD										66			66
JH3WKE								256					256
JK2VOC							30	42					1360
JR3CVJ								90					230
JR3KAH								360					360
JA4GXS								140					140
JJ4SEU								280					280
JN4AWW							60						60
JA5BSQ								154					154
JA5OP							100	3168			4396		
JA5PEE													306
JA6QDU								306					306
JA6UBK								36					36
JA6ZLI								120		9			203
JA7BEW	90	40	63	832				80					80
JA7DAH		20		342									342
JA7YFB		175	1	132	12								910

JH7JGG	40	700	1156	12	5400	
JR7LVK			440		440	
JA8WY		120	460		1064	
JA8CJ			484		484	
JA9XBW		60			60	
JE9LLO		175	1	598	1558	
JE9REN		45		168	390	
JE9TRA				80	80	
JR9NVB		250	12	870	6	2832
JA0HYU		75			75	
JF0VCD		420	324	924	9	5508
JH1BXH/0			55	624	36	1540
JH0EPI				320		320
JIOBRB		20		168		306
7K2QOX		20	88	196		833
7N2UTO		60	9	240		742
RA0FF		1100	918	400		7683
RK0Q		1170	378	70		4788
UA0LCZ	10	175	378	168		2592
UA0SJ		200	736	272		3480
7L4IOU		440	308	576		4061
UN5F		840				840
UN6P		240	322	90		2106
UN9PQ				18		18
Asiatic Russia						
RK9JWW		80	60	40		560
RK9XWH	120	1320	900	644		11438
<b>EUROPE</b>						
Bulgaria						
LZ1LZ			20			20
LZ2TW			16			16
Czech Republic						
OK1DRQ				2		2
OK2EQ		5	9	18		98
Finland						
OH3KCB				72		72
OH6IU		45	1460	40		2646
OI6YF		5	8	42		138
Germany						
DL1DQY		5				5
DL6AKK			1			1
Italy						
IK2UCK		40	1			63
IK3OII		20	4			48
IK4SWX		270	432	110		2369
Lithuania						
LY1DR	200	455	2323	252		10492
LY3BA			152			152
Netherlands						
PA3EPN	1080		40	8		2496
Norway						
LA2IR			28			28
Spain						
EA7BA	10	30	351	8		936
Svalbard						
JW8GV		270	120			780
Sweden						
SM2DMU		315	784	24		2650
Switzerland						
HB9IK		245	220	24		1323
Russia						
U5WF		80	615	42		1650
UA6ART		5	180	2		300
UT3C		315	117			928
Ukraine						
US1I	10	720	1660	108		6669
US7IGF			1	30		44
US7IYU			1	24		36
Yugoslavia						
YU7SF			1	2		6

## SOUTH AMERICA

Peru										
OA4CPI					920		126			1995
Multiooperator:										
Oceania:										
VK4EMM1000	41625	11475	306740	7560	1015105					
<b>SWL</b>										
Asiatic Russia										
UA0-107-181	300		440		390		182			5845
Belgium										
ONL-383			45							45
Slovak Republic										
OM3-0001	40		150		420					1680
OM3-27707			210		160		8			990
Poland										
SP-0189-GD							12			12
Ukraine										
US-1-604							72		2	99
Check Logs:										
EA1CBX, SM5BBS, VI75RAAF, VK5OE, YC0LOW, ZL3GQ										

## CW RESULTS

### OCEANIA

Australia										
VK2AIC	40		200		525		180			4500
VK2APK	25850		875670		22302		9328		864	2072283
VK2AYD	52510		602880		17368		7154		585	1734486
VK2BQQ			240625						240625	
VK2DID	100		3960		169		180			11904
VK2KM	40		987480		15200		18460		2112	1872351
VK2PS	280		97745				1584		1372351	
VK2VM	83070								83070	
VK3APN	1800		342990						385670	
VK4EMM	93790		1469590		12150		25872		10032	3906396
VK4ICU			500		2052		3960		3393	37074
VK4TT					39878				39878	
VK4XA									18639	18639
VK5AGX						1120				1120
VK5GN	34170		71440		11776		7700		1020	544004
VK6IV			12375						12375	
VK8AV	72000		333900		43254		57980		8364	2233660
Indonesia										
YB2UDH			4030		10810		26208		27	121338
YB6TI							35964		35964	
Micronesia										
V63HZ						6566				6566
New Zealand										
ZL1A1H	2040		21390							38110
ZL1A1Z	158110		181700		1960		1914			937980
ZL1HV	320		28810		7632					88088
ZL2AGY			1348950							1348950
ZL2AWH	240		2280		210		144			9585
ZL2CD			193590							193590
ZL2REX	90		47150		1998					80398
ZL3GQ	112500		1419795		37026		8816			3709228
ZL4OK	13440		91060		525		4872		3	277278
ZL4OL	29140		142975		110		8			328320
ASIA										
Armenia										
EK4JJ						70				70

<b>Asiatic Russia</b>						JF0VCD	90	560	1			1212	
RA0FF	900	2080	495	864	36	20104	JH0EPI		225	25	18	728	
RA0FU	2000	2775	690	918	312	34060	JH0GHZ	300	1155	264	352	180	11220
UA0LCZ	990	1265	336	280		12188	JH0IXE		120	160	216	96	2538
<b>Israel</b>						JR0BQD	40	900		25	216	24	4228
4Z4TA		650	4			804	7L1WGY			528		528	
<b>Kazakhstan</b>						7N3SDR		100			60	18	506
UN6P	250	800	108	84		4680	7M2MEF	1495	299	690	234	10481	
<b>Japan</b>						<b>Qatar</b>							
JA1AAT			35	8		77	A71CW	40	480			800	
JA1AB		60	20	144	54	1207	<b>EUROPE</b>						
JA1HFY			9	2		20	<b>Aaland Isl</b>						
JA1HP			240	432		1344	OI0/OH3TY	160	900	30	2	2812	
JA1KI		20	12			70	<b>Bulgaria</b>						
JA1XEM	120	385	12	120		2261	LZ1LZ		100	60	72	799	
JE1ARQ		200	242	12	3	1349	LZ2TW			77	32	209	
JE1KDM		315				315	LZ4UU		675			675	
JE1XCZ		40	126	90	96	1520	<b>Czech Republic</b>						
JG1UKW					54	54	OK1AD		750			750	
JH3LCU/1	10	270	80	70	54	2231	OK1AVY		240			240	
JK1LUY			28			28	OK1DRQ		490			490	
JP1SYV	350	1350	448	576		11223	OK1FJD	10	315			440	
JA2GTW		1050				1050	OK2EQ		150	1	8	280	
JA2QVP	90	100	8	56	75	1584	OK2FEI		440	1		504	
JA2VQF			49			49	<b>Denmark</b>						
JA2XI	10	75	160			714	OZ1EUO		385	1		448	
JF2UPM	10	20	135	40		720	OZ4FF		5	2		18	
JK2VOC		300	176	84	6	2064	OZ5DX		1595			1595	
JM2RUV		5				5	OZ8SW		100			100	
JR2WLQ		75	48	144	45	1452	<b>England</b>						
JA9DDF/2	10	315	378	324	28	4865	G3GLL	40	700	16	2	1632	
JA3ARM		225	80	32		1071	G3JJZ	10	240			350	
JA3BVJ	250	600	117	352	165	7714	G3WRR		80			80	
JA3NMV/3		75	25	72		588	G5MY		520	1		594	
JF3IUC		385	264	330	180	5005	<b>Finland</b>						
JH3WKE	90	900	405	408		7240	OH1TN	320	950	187	2	5044	
JL3SBE	200	480	1	24	36	2489	OH6IU		5	54		98	
JQ3JUG				96		96	OI6YF	10	45	15		252	
JA4BAA		210	25	24		672	<b>Germany</b>						
JA4BTD					45	45	DJ0SH		200			200	
JA4ETH	10	240				350	DL1DQY		120			120	
JH4CPC	20	45				140	DL3RD			70		70	
JH4JNG	420	440	420	154	54	7527	DL5AUJ		90			90	
J14HKA	40	120		18	24	748	DL6YK	10	1035	48	18	2641	
J14SEU		385	42			806	<b>Hungary</b>						
JM4WUZ		60	96	126	3	1007	HA3LN		20			20	
JA5BSQ	900	1210		700	18	9684	HA4YG		200			200	
JA5PEE				27	27	27	HAM5AWH		200	28	2	490	
JA6BWH	250	250	6	24	12	1989	<b>Iceland</b>						
JA6TQ			49	182	180	1311	TF3DX		20			20	
JA6UBK		1080				1080	<b>Latvia</b>						
JA6PVO			20	12		66	YL2KL	10	360	130	8	1653	
JA6ZLI	10	20	2			88	<b>Lithuania</b>						
JE6AEO	630					630	LY1DR			120		120	
JE61BJ		440				440	LY2BN		630			630	
J16DMN			9	70	63	418	LY3JY		855	30	8	1680	
JA7AMK		650	99	56		2070	<b>Moldova</b>						
JA7DAH		1000	150	168		3753	ER1OA		90	25	2	333	
JA7ODY	10	1740	162	300	72	8028	<b>Norway</b>						
JA7QQQ		720				720	LA7AK	10	150			240	
JA8AJE		280	20	252		1460	<b>Portugal</b>						
JA8MXC		45	4	8		147	CT1YH	40	45			175	
JH8BDA		280	35	50		969	<b>Poland</b>						
JA9BKU		120	56	60	12	1054	SO5TW		480			480	
JA9GCI	200	385	150	216	132	6018	SP5GH		630			630	
JA9XBW		600				600	SP6CES			1	2	6	
JE9LLO		1219	130	270	24	5280	SP8BAB			36		36	
JE9REN		20				20	<b>Russia</b>						
JR9NVB	160	1210	35	140	120	6417	RA4NW	40	1375			1885	
JE0UXR	880	2730	666	736	180	25864	RU6BV			80		80	

RV1AB	20			20	WA2VQV	80			80			
UA4AGP	315	70	2	855	K3ZO	520	2940	32	7392			
UA4QGO	350	30	32	1024	K7JYE		1920		1920			
U5WF	10	1035	210	18	3942							
UA6LTI	200	2800	88	50	8401							
<b>Spain</b>					<b>Multioperator</b>							
EA1AUI	1050	30	8	1955	<b>Oceania:</b>							
EA2BNU	80	1		105	<b>Japan</b>							
EA5CKP	90	300	72	2	1504	JA1YAO	40	800	135	234	12	4704
EA5FID	225				225	JK3ZQJ	360	950	154	70	63	7140
<b>Sweden</b>					<b>Asiatic Russia</b>							
SM2DMU	10	315	120	1120	RA9ANR	160	350	4			176	2394
<b>Switzerland</b>					<b>Russia</b>							
HB9ADD	40	1740	99	8	4500	RK9JWW	240	104	154			1575
HB9DX		855	64		1751	RK0Q	40	2380	208	8		5720
HB9IK	40	1035	192	8	3875	<b>Russia</b>						
<b>Ukraine</b>					<b>RW6AWM</b>							
UR5MVZ	1170	2600	275	48	13356	RZ4AYT	10	100	16	2		410
UR6QA		1265			1265	<b>SWL</b>						
US1IDX	90				90	JA4-4665/1		5	6	198	84	816
US9QA		270			270	<b>Belgium</b>						
UT3C		350			350	ONL-383	40	200	4			558
UX7I		300	120	8	1104	<b>Slovakia</b>						
UX0HA		385			385	OM3-27707		200				200
UY0ZG		240	25	8	637	<b>Russia</b>						
<b>Yugoslavia</b>					<b>UA3-155-28</b>							
YU7SF		5	1		12	20		1				33
<b>SOUTH AMERICA</b>					<b>Check Logs:</b>							
<b>Peru</b>					<b>DL3NEO, EU2MM, LZ2AU, OZ7QB, UA6ART, UA9XS, VK3KS, VK3XB, W9YCV, ZL1ALZ, ZL2VS, ZL4GU</b>							
OA4FW		40	88		310							
<b>NORTH AMERICA</b>												
<b>USA</b>												
WA1FCN		520			520							

\*PO Box 2175, Caulfield Junction, VIC 3175  
pnesbit@melbpc.org.au

ar

## Divisional Notes

### Forward Bias – VK1 Notes

Hugh Blemings VK1YYZ

### Recent Happenings

A month of good news for the Division with, amongst other things, the donation of valuable equipment and funds for the Division and its WICEN activities, a new harmonic for one of our local operators, and rumours of a winner of the competition mentioned last month.

Mr Nick Arley kindly donated an assortment of HF gear including a TS-520S in beautiful condition, an antenna tuner, a KR-400 rotator and an Oskerblock from the estate of Richard Barnes VK2BTM. This equipment will be used to equip the Division's portable WICEN station that is presently under construction.

A donation was received from the Brindabella Motor Sport Club in recognition of the efforts of local amateurs in supporting a round of the NSW Rally Championship that was held in Canberra in May this year. Fiona McCubbin-Mee, who presented the cheque on behalf of the BMSC, was most apologetic

for the delay in its arrival; it seems she and I use the same filing system...

Our congratulations and best wishes go to Bernie VK1KIP and his XYL Karen on the arrival of Natalie – great news! Natalie arrived on 7 October at some 10 lb 1/2 oz; she and Mum are doing well.

### 1998 Committee

The time of our AGM is rapidly approaching and a number of our existing committee members will be retiring from office at the end of this term. For my part I will be seeking re-nomination and re-election to the role of President if the membership so desires.

I'd encourage our newer members to consider joining the committee and having their views incorporated into the direction of the Division in the coming year, doubly so if you don't like the present heading! The committee meets for around two hours once a month in addition to various exchanges by e-mail, packet or voice. It need not be an onerous undertaking and, indeed, we strive to be as efficient as possible in order to allow people to enjoy the hobby itself and meet

their other commitments. Give it some thought?

### Coming Events

Our November meeting will be held on the 24th at the usual Griffin Centre venue. It will be our last meeting for the year and so will be a social gathering. An assortment of warm and cold beverages, as well as snacks, will be supplied and we look forward to your attendance. Family/spouses are, of course, most welcome to attend.

The WICEN exercise to be held in conjunction with the FAI Rally of Canberra will take place on 28 to 30 November. This is an excellent opportunity to promote the hobby and your participation is welcome whether you be an old hand or newcomer to the activity.

See you at the next meeting!

### VK2 Notes

David Thompson VK2NH

### The Technology of It All

You know that I was thinking about things pretty seriously last month after I had e-mailed the VK2 Notes off to *Amateur Radio*. My computer crashed and had to be re-booted again, complete with a reload of Windows 95 and my Word documents. It was

shortly afterwards that I was reading about research involving a new computer which is being developed with a processor speed about 1,000 times that of the fastest on the present market. Interesting, considering it is said that technology in the computer field increases two-fold each year. Couple that with the introduction of new computers that you can wear, and I would tend to label it a Quantum leap, especially if it all comes packaged with a stable operating environment.

### Education on the Move

The NSW Division has been very concerned about providing the education necessary to help those who wish to enter the hobby of amateur radio. Well, soon we will have a new Novice course, supplemented by a bridging course which will take candidates to the AOC level. The Division is expecting to have the Novice course ready before the end of the year, with the AOC bridging course available early in 1998. The aim of the courses is to prepare prospective amateurs so they can be successful in the examinations and get their amateur calls. If you're interested, call the VK2 Divisional office and we will advise you of cost and times for starting the course, and how to get the study material. Be assured that the material is of a very high standard and deals with the examination curriculum nicely.

### Advance Notice for AGM

Just a quick note at this stage to let you know that a date has been set for the NSW Division AGM and election of Councillors for the next one-year term. The AGM has been set for Saturday, 18 April 1998, while nominations close at 12 noon on Saturday, 7 March 1998.

### Affiliated Clubs Conference

Last month we advised you that the Conference of Affiliated Clubs would be held at Amateur Radio House at Parramatta on Saturday, 15 November starting at 0900.

There will be a good rollup for this event and we have confirmed that a visit will be made to the conference by Mr Bill Vlies, Sydney Area Manager for the Australian Communications Authority. It will be a great privilege to have Mr Vlies address the conference. One of the ACA's field officers will attend as well. Apparently they are no longer called radio inspectors. The conference is shaping up to be something to really look forward to!

### Christmas Function

Saturday, 13 December this year is the day we all get together for a little Christmas cheer and fellowship to celebrate the end of the year and the coming holiday season. Any members of the Wireless Institute NSW Division are invited to attend. For details, phone the office.

### Dural Site Looking Good

Congratulations to the Dural team which is engaged in renovating the building and surrounds on our transmitting site to the north-west of Sydney. There is a big cleanup underway and various improvements are being made to the area. One main improvement that has been made is the upgrading of the toilet facilities. They are outside as before, but are much better, due to the new sides, back and top and now, because of the see-through roof, it has great views, especially of the stars at night.

When the little-house was inspected before the renovations, it was discovered that the outflow from the facility was slightly lower than the inlet to the septic. The Dural Officer was heard to mutter that, "*at least the situation bears out the old Australian saying 'pushing \*\*\*\* up hill'*".

### E-mail Address

This might look very similar to last month's reminder about our recent change of Divisional e-mail address. If you are addressing e-mail to the office, please do so at [vk2wi@ozemail.com.au](mailto:vk2wi@ozemail.com.au).

If you would like to contact the VK2 Division regarding your hobby, please do not hesitate to contact the office or any of the Councillors. We will be only too pleased to hear from you. If you would like to get in touch with an individual Councillor, just contact our Divisional office and it will be arranged. Our freecall phone number is 1 800 817 644 and our address can be found on the WIA Divisions' page at the back of this magazine.

### Next Month

Next month we'll have more to report, including arrangements for the holiday period, broadcast dates and times, and office opening hours; but if you have anything you would like us to include as VK2 news, send it to me at PO Box 82, Springwood NSW 2777 or by e-mail to [dthom@penrithcity.nsw.gov.au](mailto:dthom@penrithcity.nsw.gov.au)

### VK3 Notes

Barry Wilton VK3XV.

### New 10 m Beacon

The North East Radio Group intends to install a new 10 m beacon at its repeater site in Kangaroo Ground. It is proposed that the new beacon will operate under the NERG current repeater/beacon licence, VK3RMH. Transmit power will be 20 W into an omni directional, vertically polarised antenna. The operating frequency will be advised as soon as it is allocated.

### Turbo Tutorial

By the time this magazine goes to press, WIA Victoria will have conducted its 1997 "Turbo Tutorial" on the weekend of 18 and 19 October.

This highly specialised training weekend is designed to assist Novices to upgrade to full call theory and, as usual, all places were filled.

It is intended to run more of these weekend courses next year at different venues in order to provide easier access for those interested.

### Increasing Interest in VHF and UHF

There has recently been a strong resurgence in interest in RF transmission techniques in the VHF, UHF, and SHF part of the spectrum. This rise in interest is attributable, in part, to the increasing pressures associated with HF transmission interference problems and the erection of antenna masts in the metropolitan area. Six metre enthusiasts are more active as propagation improves with the new solar cycle. More members are becoming interested in EME.

## VK QSL BUREAUX

The official list of VK QSL Bureaux. All are Inwards and Outwards unless otherwise stated.

VK1	GPO Box 600 CANBERRA ACT 2601
VK2	PO Box 73 TERALBA NSW 2284
VK3	40G Victory Blvd ASHBURTON VIC 3147
VK4	GPO Box 638 BRISBANE QLD 4001
VK5	PO Box 10092 Gouger St ADELAIDE SA 5000
VK6	GPO Box F319 PERTH WA 6001
VK7	GPO Box 371D HOBART TAS 7001
VK8	C/o H G Andersson VK8HA Box 619 HUMPTY DOO NT 0836
VK9/VK0	C/o Neil Penfold VK6NE 2 Moss Court KINGSLEY WA 6026

Interest in this area is not confined to the city dwellers and activity in a number of country areas is rapidly increasing. The WIA Eastern Zone ARC is currently in the process of installing a new 1296 MHz repeater at Mt Tassie. This device will be operating on a frequency of 1273.350 MHz Tx, 1293.350 MHz Rx, under the VK3RLV callsign.

WIA Victoria is considering reviving the old VHF/UHF group (possibly under a new name) if there is sufficient interest, and is interested in hearing from any members who would like to be actively involved.

### **RF Modem Problems?**

CyNET Comms has released a radio modem for process control applications. The 405U modem has been specifically designed to use with PLCs, smart transducers and data loggers.

The units will accept RS/232 or RS/485 data connections and transmit this data by radio to a remote unit. **The transmission range is stated to be 5 or 10 km** and applications include the transmission of data between buildings, across streets, or through industrial plant.

The 405U units will operate on frequencies in the 400/500 MHz UHF band.

WIA Victoria is currently investigating any possible effects of this equipment on the 420 to 450 MHz amateur band.

### **Council Meeting**

The WIA Victoria Council met on Saturday, 20 September in an all-day meeting to discuss a number of issues and forward plan for 1998.

Agenda items included the 1998 budget, the Internet Web site and its future, VK3BWI and the loss of the Lyndhurst site, Federal finances, and a range of new membership services to be introduced.

Council noted that the WIA Victoria Web site has proved to be successful and has contributed to the recruitment of new members in recent weeks.

The dissemination of current news and information to members remains a matter of concern, and the interest and assistance of a willing and capable member is needed if we are to succeed in this area.

### **VK5 Notes**

*Ian Hunt VK5QX*

The following notes are adapted from material used in a recent VK5WI Divisional Sunday Morning News Broadcast.

### **History, Clubs and Constitutions**

A committee, basically independent of the Divisional Council, has been appointed to

look at revision of the Divisional Constitution. There are good reasons why the matter is being handled in this way and I would expect you to see why this committee should be independent in its approach.

Let me provide some background to give a historical perspective.

It was foreseen, perhaps 20 years ago, that continuing demographic and social changes would sooner or later require some State reorganisation of the WIA. Eventually we find exigencies thrust upon us when time has overtaken our planning processes.

Just how successful an organisation becomes as a result of such forced change can depend on understanding what has actually occurred. It may seem that I am speaking in riddles; however, I shall try to enlighten you.

There has been a warning of change to come in what has taken place in the Eastern States. Sydney, for example, has become a very large city and with its growth we have been able to see the effects which can occur and problems which can result.

The New South Wales Division of the WIA used to have Monthly General Meetings in the same way that we in this Division still have. As the city grew larger, people found that traffic densities increased, distances from the "outer" suburbs to any central point naturally became greater and, with these and other allied factors, people became far less enthusiastic about travelling to meetings held at a central city location.

At the same time, separate Radio Clubs began to be formed (yes, there had been some clubs existing for a while). People gradually found it far more convenient to attend their local Radio Club rather than a monthly meeting near the city centre.

A direct result of this has been the abandonment of Monthly General Meetings of the VK2 Division with a different approach needed towards ascertaining the needs and wishes of the members. Also, there is only one Annual General Meeting of the Division.

The likelihood of such a situation, as indicated above, was foreseen. It is still somewhat early to make any judgement as to just how successful any administrative changes have been in respect of the New South Wales Division.

This trend, which occurred first of all in the Sydney area, has been repeated in Melbourne and, perhaps to a lesser degree, in Brisbane. In fact only the VK1, VK5 and VK6 Divisions still hold a Monthly General Meeting.

The VK7 Division seems to present a somewhat different case with the population centres in that State being concentrated in two different locations (perhaps lessons can

be learned from the VK7 Division based on how they administer their affairs).

Here in the Adelaide area I see us approaching the above situations. More radio clubs have sprung up within the Metropolitan area and these surely must be meeting many of the needs of their local supporters. So, do we need to make changes to the way the Division operates?

Such changes would undoubtedly affect the way the Division is set up, and in turn have an impact on the desired content of the Divisional Constitution.

There are many aspects requiring attention. Amongst these is the role which the individual clubs can play and most certainly the situation of country members in the overall plan.

So, now you can see just what I was driving at when I provided the subject title above.

I do not claim this particular presentation provides a comprehensive coverage of all aspects which need to be looked at.

Any decisions made regarding organisation and constitutional changes must be made in a considered and rational manner. This means, in turn, that adequate time must be allowed for the process of consultation with members to be thorough and comprehensive.

Plenty of opportunity will be provided to allow you to have your say. Your Divisional Council does not claim to have all the answers and recognises the fact that your input and advice is needed.

I trust that bringing this to you in this way will provide an incentive towards your contribution and also some guidance as to where you, the member must, as a matter of importance, fit into what I hope will be a most active discussion.

Remember that here we are planning for the future and that it is imperative that we make the right decisions. Your guidance in a collective manner can play a major part towards seeing that we "Get It Right". Please think about it and let us know what you think.

### **Retrospective Comment**

Following release of the above material, I received comment from a correspondent in VK2 which indicated that I may have been wrong with regard to the reasons for changes which occurred in that state.

Whilst I accept his explanation as to the VK2 scenario I do remember discussion which took place during at least two Federal Conventions back in the 1960s era where the demographic problems were referred to in connection with that state. These certainly, to my mind, must have played a part in the ultimate turn of events. However, I accept correction where the comments come from someone closer to the action.

My correspondent made some very valid points which reinforce quite a few points which I have been trying to convey to you. I will deal further with these in future notes for this column.

## "QRM" News from the Tasmanian Division

Robin L Harwood VK7RH

Your Divisional Council met on 20 September and discussed several ongoing matters. We view with some concern recent developments in the Federal arena and it was decided that our Divisional President, Ron Churcher VK7RN, would attend the next Federal Council meeting, together with our Federal Councillor, Andrew Dixon VK7GL. Our alternate Federal Councillor, John Rogers VK7JK, is unavailable due to illness.

Council also decided to have new promotional material made, including membership forms and metal badges. This will probably be in co-operation with other Divisions. We also decided on a membership recruitment drive by circularising all amateurs in the state. It is to be hoped that this will, indeed, net new and renewing memberships.

Other matters raised included funding for repeaters following recent financial problems with some repeaters. Many have taken for granted these repeaters, using them without thinking that they need ongoing finance to keep operating. The problem seems to be universal as repeaters in other countries are having similar experiences. Have you supported your local repeater lately? I know that there are SYSOPS who would welcome assistance to keep these repeaters functioning.

John VK7JK is still convalescing and has to take it calmly. Andrew VK7GL has stepped in as acting broadcast officer and has done a sterling job getting the news to the rostered announcers. The weekly broadcast is aired at 2230 UTC Saturday (0930 EADT Sunday) and is repeated on Tuesday evening prior to the Tassie Devil Net at 0830 UTC on 3590 kHz.

The Northern Branch met in September at the premises of BOC Gases where modern welding techniques were demonstrated. It was a hands-on affair and I have received many favourable comments on the evening. The Northern Branch would like to thank Mr Peter Lees of BOC Gases, Peter Lyall of Lincoln Sales who went out of his way to provide the demonstration, and Lindsay Dawe who assisted the presentation. Thanks to Elwyn VK7ZEC for arranging a very successful evening.

The Southern Branch erected a station in

the grounds of Parliament House on Saturday, 20 September as part of World Amateur Radio Day. I believe that there were other demonstrations close by completely divorced from amateur radio. Hundreds of motorcycle riders had a protest demonstration over the hike in Tasmanian third party premiums. Also, there was an aboriginal land rights protest.

I do not have the exact numbers involved with the operation of VK7WI/P, but I believe it was co-ordinated by Gary VK7JGD. As I have already mentioned, Divisional Council was meeting at the same time elsewhere in the city, yet we fielded at least two enquiries from individuals who thought the station was there. We redirected them to the location and also put in a plug for amateur radio.

The Australian Maritime College was the venue for last month's Northern Branch meeting. After the business was transacted, we had a very interesting talk about the Global Maritime Distress and Search System (GMDSS), which was given by Gary Hammond VK7JAL, a senior lecturer at the AMC. We also viewed the radar set-up. Some amateurs were later trying to diagnose faults in a marine transmitter. One even suggested firing it up on 20 metres!

We now can confirm that the Divisional Annual General Meeting will be held in Launceston on Saturday, 22 March 1998. The venue will be the northern campus of the University of Tasmania. Rooms have been set aside as from 9 am, and the day will be concluded with a bistro meal in the evening. I am certain that further details will be given here later, as well as over VK7WI.

The North-western Branch will be continuing their tradition of having their annual Christmas Dinner at the Bass and Flinders Motel in Ulverstone. Highlight of the evening is the presentation of the Joan Fudge Memorial award. Bookings should be made by now with David Spicer VK7ZDJ on 0364 25 2030.

Meetings for November are as follows: Southern Branch on Wednesday, 5 November at 2000 hrs at the Domain Activity Centre; North-western Branch on Tuesday, 11 November at 1945 hrs at the Penguin High School; and Northern Branch on Wednesday, 12 November at 1930 hrs at the Alanvale campus of TAFE.

ar

**Amateur radio –  
helping our  
community**

ICOM Clearly Ahead



# "VK3LZ calling!"

More sound information from your friends at Icom.

## ACCESSORIES NEWS FLASH!

Did you know that Icom now stock SWR Bridges, HF Mobile Antennae (CAHV), and Throat Microphones (XO7). Contact your nearest dealer or Icom for details of these quality, high performance accessories.

## XMAS IS JUST AROUND THE CORNER.

If you missed us this year at Wyong, Bendigo, Moorabbin, Frankston, Mt. Gambier, Shepparton or Townsville then make sure you come along to one of our two remaining events to pick up a pre-Xmas special:

**PERTH HAMFEST**  
Sunday, November 2, '97

**DAYCOM ICOM DAY**  
Saturday, November 29, '97

# "...73"

FreeCall 1800 338 915

290 -294 Albert Street  
Brunswick, Victoria 3056  
Tel : (03) 9387 0666  
Fax : (03) 9387 0022

ACN 006 092 575

LL BROWN ADVERTISING #153

---

---

# FTAC Notes

John Martin VK3KWA, Chairman, Federal Technical Advisory Committee\*

---

---

## Six Metre Band Plan

The new 1998 Call Book will include revisions to the 6 metre band plan as discussed over the last few months.

The band segment below 50.150 MHz is recommended for international DX only, with the international calling frequency on 50.110 MHz. All other operation should be above 50.150 MHz, with a new Australian calling frequency on 50.200 MHz.

This will bring us into line with changes being made in Europe and North America, and make it possible for everyone to coexist without any conflicts. So, please spread the word: let's have a fair go for everyone. See you on 50.200!

Our two summer VHF contests, the Ross Hull Contest and the VHF-UHF Field Day, will both include 6 metres – but with an absolute ban on contest activity below 50.150 MHz.

## 160 Metre Band Plan

More comments have been received on the 160 metre band plan: from Mike VK6HD, Steve VK6VZ, and Bob VK2AVQ.

VK2AVQ suggested a DX CW segment from 1826 to 1836 kHz, and a DX SSB segment from 1837 to 1850 kHz. VK6HD and VK6VZ both agreed that the international DX CW window is from 1820 kHz to 1838 or 1840 kHz, and we should follow suit.

Both VK6HD and VK6VZ disagreed strongly with the comment that there is no European activity below about 1835 kHz. VK6VZ said that all of his European CW contacts over the last three years have been made below 1835 kHz. He supplied a log of contacts, most of which were made around 1824 kHz. VK6HD also supplied a log of DX CW contacts made between 1822 and 1827 kHz.

I can understand that 160 metre operators may disagree about the use of frequencies like 1825 kHz. But what to do when some operators say that there is no European activity below 1835 kHz, and others produce logs which say otherwise?

There is also disagreement about using the secondary allocation above 1825 kHz. Some operators do not feel that the band plan should encourage people to move out of the primary segment. On the other hand there is the point that the band below 1825 kHz is secure, and we should make more use of the higher part of the band, especially above 1850 kHz. The band is quite narrow, but we do not stand much chance of getting any

more spectrum space if we are not making effective use of what we already have.

## Call Book Data Base

At the time of writing I am finishing off the data base listings for the new Call Book. I would like to thank the following for supplying information for the update. Beacons: VK3OT, VK6HK, VK7XR.

---

---

## How's DX?

Stephen Pall VK2PS\*

---

---

The increase of the solar activity during the past months, has changed the operating habits of many DXers.

The steady rise of the 10.7 cm Solar Flux which, in turn, is a reflection on the increase of the sunspot numbers, was expected and joyfully received by many of us.

The flux index numbers in the middle of July 1997 were in the low 69, 67, 68 range. By August these figures climbed up from 71 to 92. The rise continued during September, reaching 102 on 8 September and a peak of 119 on 9 September when the Sun's activity was described as "moderate". The cyclical decline came afterwards, the flux number being 88 on 30 September.

Propagation has changed on the bands. How? On 20 metres the traditional long path propagation to Europe has returned from around 0500 UTC to about 0700 UTC. Direction has changed to short path around 1100 UTC and the 20 metre band was open sometimes even until 1500 UTC.

There is a marked improvement on 15 metres and even 10 metres is producing some good DX to the north and to the west coast of North America around 2400 UTC.

The 40 metre band is open for DX from around 0500 UTC for at least 10 hours. The propagation was excellent during the VK/ZL/O phone contest.

This is now the time to check our equipment to make sure that it functions properly when the real "big" season opens. Antennas, coax, earthing systems, CW keys, even computers, towers, masts and guy wires should be checked, not only for electronic soundness but also for physical strength and stability because the stormy and windy season is just around the corner. Like a good

Repeaters: VK1KCK, VK3XV, VK3JWZ, VK4EJR, VK6UU, VK7AX. Packet: VK1KCK, VK3AVE, VK4KWM, VK6UU, VK7AX. Apologies to anyone I may have left out of this list.

The new Call Book will include a new Packet Radio Directory, with the packet repeater list and BBS directory merged into one. A great deal of information has been sifted, but if there are any errors I would be grateful to receive the details, which can be published in this column. The same goes for the beacon and repeater lists.

\*PO Box 2175, Caulfield Junction, VIC 3161

ar

boy scout, "be prepared" for seven years of good DXing.

## Friends of Marconi

The replica of the monument celebrating the first wireless contact between the United Kingdom and Australia was unveiled at the old Marconi Caernafon Long Wave Transmitting Station in Wales, United Kingdom on 12 July 1997 (see *Amateur Radio*, July 97 issue). The presentation and unveiling was done by Jo Harris VK2KAA, Historian of the WIA NSW Division in front of a large assembly of local international and diplomatic dignitaries including press, radio and television reporters and amateurs from many neighbouring radio amateur clubs. Several descendants of the Ernst Fisk family were also in attendance.

The event was organised by the nearby Dragon Amateur Radio Club at Waunfawr near Caernafon with the assistance of many local organisations.

In Britain, the sending of the first wireless message was forgotten until interest was reviewed by the Dragon ARC staging a special event in 1993 with the callsign GB2VK celebrating the 75th anniversary of the first direct wireless message. In response, WAHRA (Wahroonga Amateur Historical Radio Association) was established and activated the special call VK2WAH. This special callsign and GB2VK have been on the air ever since on 22 September each year.

## Libya - 5A1A

Members of the "Rhein Ruhr DX Association", a group of four German operators, will be on the air from the well known club station 5A1A in Tripoli, Libya. They intend to be active from 24 November





**Jo Harris VK2KAA with Dewi E Roberts GWOABL at the Marconi monument replica unveiling ceremony.**

until 4 December. The activity will coincide with the date of the "CQ World Wide" CW DX Contest which will take place on the weekend of 29 and 30 November.

Aims of the expedition are to operate on all HF Bands including 160 m and WARC Bands, propagation permitting; to be active on CW, SSB and RTTY; and to have two stations with amplifiers on air simultaneously as often as possible.

The team consists of Andreas (Andy) Luer DJ7IK, Dieter Voss DL3KDV, Felix J Riess DL80BC, and Thomas Goetzfield DL1GGT. Internet facilities will be used to upload logs to their Web page and they will welcome comments, suggestions and information about band openings by e-mail.

The group promises a speedy QSL reply service. The QSL manager, for this operation only, is DL3KDV. Cards can be sent via the QSL Bureau or directly to: Dieter

Voss DL3KDV, Friedrichsthat 21, D-51688 Wipperfuerth, Germany.

The expedition does not require any money in exchange for a QSL Card, except the usual cost of return postage of at least one "green stamp" or one IRC.

Felix DL80BC reports, "All equipment is currently on its way to Libya. We will leave the equipment there after our operation, so that it can be used by the Libyan operators of 5A1A. All this has placed a heavy financial burden on the team so, if you can, please consider making a small donation for the cause."

Donations are welcome to assist the expedition and amateur radio in Libya, and should be sent to Felix J Riess DL80BC, PO Box 1253, D-30984 Gehrden, Germany.

The operators met the Libyan amateurs (Ali, Abubaker and Mosbach) at the German "Ham Radio Fair" in Friedrichshafen at the end of June. They also met the Austrian

members of the 5A28 team which operated the special event station from 31 August until 7 September celebrating the 28th anniversary of the Libyan Revolution. The 5A28 team was organised by the Icom Radio Club OE1XIC of Vienna, Austria and made 11,404 QSOs.

### **DXCC - 2000**

I reported some time ago that the ARRL has commissioned a special committee to evaluate the present DXCC program and to make recommendations to improve the status of the DXCC. The summer edition of *INDEXA*, the news bulletin of the International DX Association, reports that the committee has prepared an evaluation which will be presented to the ARRL Board at its January 1998 meeting.

Here are a few snippets from the interim report:

#### **A. Definition of a DXCC Country.**

#### **Clarification of Point 1. Government.**

The country in question must be a member state of the United Nations, be a member of IARU, and have an official ITU callsign allotment.

#### **Point 2. Separation by water.**

The committee recommended the use of the metric system of measuring distances. The old "miles" distance was converted into kilometres which resulted in rounding down certain distance figures. The new distances are 350 and 800 kilometres. Minimum size of DXCC country is now described as "consists of two points separated by not less than 100 metres of connected land above the high tide mark as demonstrated on a chart of sufficient scale". For the purposes of this award any island less than this size shall not be considered in the application of the water separation rules. The former 10,000 square foot area was replaced with the 100 metre straight line. This method will make it easier to determine minimum size.

#### **Point 3. Separation by another DXCC country.**

The 75 mile requirement is replaced with 100 kilometres.

#### **Point 4. Ineligible areas.**

Embassies, consulates, monuments, diplomatic missions, demilitarised zones, neutral zones, buffer zones. No change.

#### **B. The DXCC Award Structure.**

The new DXCC structure will be divided into two major categories: 1, The Mode Award Program, and 2, The Bands Award Program. There will be a number of new awards:

- a. The DXCC 2000 Championship award.
- b. The DXCC 2000 Challenge Award.
- c. Special DXCC 2000 Award (working 100 and more countries in the year 2000. No QSL cards will be required).

#### **C. Publication of Honour Rolls and other written listings, DXCC Year Book, annual lists etc.**

There will be a change in the presentation of such lists.

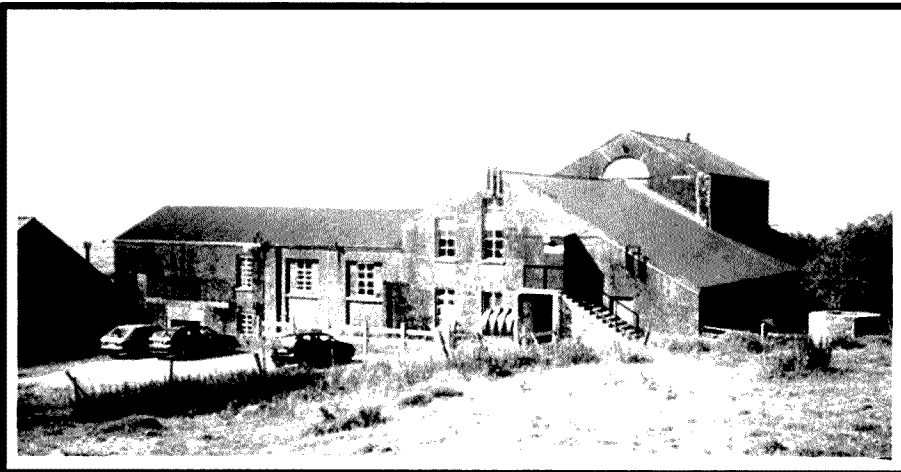
Finally, the present fee structure will be changed in such a way that at least 90% of the cost of the DXCC program will be borne by those who use the service, ie the DXers themselves and not the non-DX ARRL members.

#### **Future DX Activities**

\*YL operator Tere 8R1ASF is reported to be active from Guyana for the next two years. QSL via XE1MD.

\* Phil VR2CT (ex-VS6CT) will be active as 9M6CT from 20 October to 16 November.

\* It is rumoured that David K3LP will use the call A61AJ from 22 November to 2 December. QSL to David K3LP, formerly AA6DC.



**The old Marconi long wave transmitting station near Caernarfon, Wales.**

\* Alex W2OX, will take part in the CW section of the CQ WW Contest as V47KP. QSL via K2SB.

\* Dias CT4KO will be in Angola for at least one year using the call D2AI, starting 15 September. He is expected to operate SSB on the usual HF Bands. QSL via Antonio Pereira CT1EGH, R Guerra Junqueiro 25A, Vale de Milhacos, P-2855, Corroios, Portugal.

\* 9G5VJ will take part in the CW section of the CQ WW Contest on 29/30 November, operated by a group of British amateurs. QSLs via home calls. 9G5VJ via G4ZVJ; 9G5SW via G3VMW; and 9G5WD via G4RWD.

\* Dave AG8L will be active from the US Virgin Islands for one week in October and one week in November. During contests he will use the callsign WP2Z (QSL via KU9C). Outside the contests the call will be KP2/AG8L and QSL via KM6ON (now NN6C).

\* The intended Spanish DXpedition to Annabon Island, 3C0DX, which was postponed from May 97 to 11 October 1997, has been abandoned due to lack of visas which were not forthcoming from the relevant authorities.

\* Edin T97M will operate during the CQ WW CW Contest from the station of Abdullah using the call 9K2GS. Outside the contest he will use the call 9K2/T97M.

\* Chris SP5EXA (ex-A71CW) is now in Oman, and will be active soon as A45XR. Chris will be in Oman for five years.

\* Rick VQ9AI in Diego Garcia can be found on 14260 kHz at 1300 UTC daily. QSL to Rick Lewandoski, PO Box 367, Cascade, WI 53011-0367, USA.

\* Jim VK9NS on his way back from the UK will travel to India where he plans to operate with his call VU2JBS. He will also travel to Bangladesh where he is licensed as A21ZA. Jim hopes to visit Bhutan where,

some years ago, he was active as A51JS. He will meet the Bhutanese Ambassador to Bangladesh in Dhaka for further discussions.

\* TT6SE and TT6EB will be in Chad until 15 January 1998. QSL via F6FNU direct only.

\* Theo DJ1RL and Hans DK8FB will be active from Mayotte using the FH prefix with their home call. QSL via home calls.

\* The forthcoming CW section of the CQ WW Contest, which will take place on the weekend of the 29 and 30 November, gives the opportunity to work some of the rare ones specially activated for the contest.

\* K8DD, AC8WW and N8KR will be in the Bahamas between 25 November and 1 December using the contest call C6A/K8DD. Outside the contest they will use their individual callsigns with the C6A prefix. QSL via home calls.

\* The St Paul DXpedition, CY9DX, has been replaced with a Sable Island activity for ten days starting 24 October. They will use the call CY0DX.

\* Terje LA3EX/JW3EX will go to Jan Mayen on 10 October and will be active until March or April 1988. QSL via Terje Berg, 8099 Jan Mayen, Norway.

\* Mathias JW5NM will stay on Svalbard until mid 1988. He plans to be active on 160 metres.

\* The Geneva ITU Club station 4U1ITU will be active during the World Radio Conference 1997 from 27 October to 21 November.

\* The callsign DX1S will be used in all future contests by the Filipinas DX Society.

\* Joe K3KN will be operating as EL/K3KN until 6 or 7 November on SSB on 40 – 10 metres. He will operate from the US Embassy in Liberia. QSL via KB3U.

\* Paul WC5P will be on Christmas Island as T32BE from 19 November to 2 December. QSL via WC5P.

## Interesting QSOs and QSL Information

\* 5X1P – Joe – 14015 – CW – 0532 – Sep. QSL via Brian J Poole G3MRC, 18 Grosvenor Ave, Kidderminster, Worcs DY10 1SS, UK.

\* HZ1AB – Ron – 14005 – CW – 0438 – Aug. QSL via Leo W Fry K8PYD, 5740 North Meadows Blvd, Columbus, Ohio, 43229-4165, USA.

\* ZK1MJF – Morris – 14164 – SSB – 0516 – Oct. QSL via M J French ZL2MF, 10 Gurney Road, Belmont, Lower Hutt, 6009, New Zealand.

\* P43DJ – Dee Jay – 14164 – SSB – 0550 – Sept. QSL via Djurre Vrieswijk, PO Box 417, Aruba Island, South America.

\* SV2ASP/2 – Monk Apollo – 14191 – SSB – 0616 – Sept. QSL to Apollo Monachos, I Moni Dochiariou, GR-63087, Dafni AG Orous, Greece.

\* A71BY – Jaber – 14195 – SSB – 0629 – Sep. QSL via Jaber Bin Hamed Mohd Al Thani, PO Box 432, Doha, Qatar.

\* OY2H – Hans – 14042 – CW – 1257 – Sep. QSL via Hans Jacob Eli Egholm, Strond 93, FR-100, Torshavn, Faroe Islands, Europe.

\* 4K7DWZ – Rashad – 14254 – SSB – 1341 Sep. QSL via Box 116, Ktoprak 81031, Istanbul, Turkey.

\* 9Z4CT – Nigel – 14164 – SSB – 0514 – Sep. QSL via QSL Bureau, Trinidad and Tobago Amateur Radio Society, Box 1167, Port of Spain, Trinidad and Tobago, South America.

\* ZK1XXP – 14023 – CW – 0728 – Sep. QSL via Robert Pond WA4YBV, 9 River Cove, Portsmouth, VA, 23703, USA.

\* 9X0A – Andy – 14195 – SSB – 0455 – Sep. QSL via Andy Fyodoroff RW3AH, PO Box 899, Moscow, 127018, Russia.

\* FW5XX – Marcel – 14213 – SSB – 0515 – Sep. QSL via Marcel Dehonin ON4QM, Everest 130, B-1932, Sint Stevens Woluwe, BT Belgium.

## From Here There and Everywhere

\* The Japanese Amateur group (consisting of Atsu VK2BEX, Ken VK2IAZ, and Ken VK2IY) using the callsign VK2IOM (Island of Montague), made 1600 QSOs during a 28 hour operation using an Icom IC-756, an R-7000 vertical antenna, and an HL1K 400 W amplifier.

\* Taiwan (BV) started to use the new EX prefix.

\* Phillip 5W1AU, the well known identity on Samoa and President of the Samoan ARC, is now a silent key. He had operated the QSL Bureau on the island out of his own pocket since 1971.

\* Frank YJ8AA, reports that his planned

visit to a variety of islands in the northern part of Vanuatu is still on track, but delayed. The boat which will carry him is undergoing sea trials now.

\* Australia and New Zealand changed their clocks to daylight saving (summer time) in October. The clocks were advanced by one hour. New Zealand, Tasmania and Macquarie Island started on 6 October, the rest of Australia (except VK4 and VK6 which stayed on Standard Time) followed at the end of October. VK8 also remains on Standard Time.

\* Monk Apollo SV2ASP/2 from Mt Athos has finished the monastery's building projects. This enables him to appear more often on the bands.

\* Tom VK0TS is leaving Macquarie Island at the end of November. He does not know whether his replacement has an amateur licence or not.

\* There is still a controversy about the use of the AP2AP call sign by Hiro JA1EZM. There are about 250 licensed amateurs in Pakistan of which only 20% are active. CW activity from Pakistan is especially rare. Hiro was using the callsign of a local Pakistani amateur whilst testing a coastal radio station which he is building with JA8WPP. Only the future will tell whether the callsign was used legally or not.

\* Correction to my item "Australian Amateurs on the ARRL DXCC Honour Roll" which appeared in September *Amateur Radio*. In the Phone Section, VK5WO was omitted from the 328 group - with deletions, his number is 328/360. VK5WQ should be 328/333, not 360.

\* Eric FT5ZG on Amsterdam Island is very seldom heard. His usual operating frequency is 7006 kHz on CW. The linear sent to him by the Clipperton DX Club was not usable on arrival, due to damage in transit. Eric leaves the island in November.

\* There is a continental saying that a good priest studies until his death. One of our very experienced VK DXers was most surprised not so long ago, when a ZL Novice station started to advise him, well meaning of course, as to how to be successful in working DX stations. During the conversation the ZL amateur proudly announced that he had already worked five DX countries!

\* The February 1997 DXpedition by a German amateur group which activated the callsigns S21XZ, S21XY and S21XX, logged 12,839 QSOs representing more than 150 DXCC countries and all continents. QSL manager DL3NEO has been busy since mid-June sending out the cards.

\* The DXCC Desk announced on 3 September that they received 233 applications with 15,244 QSL cards for new



**The R-7000 vertical antenna of VK2IOM, IOTA station on Montague Island.**

awards and endorsements during the month of August.

\* The special event station GB70GBI was active early September celebrating the 70th anniversary of the inauguration of the Marconi Beam Wireless Station service to India.

\* The special event station YE8Q was active from Sulawesi (OC-146) in September. QSL via YB8QD, Box 198, Manado, 95001, Indonesia.

\* The NCDXF/IBF international beacon is now operational also from New Zealand as ZL6B on 14100, 18110, 21150, 24930 and 28200 kHz. 5Z4B is also operational on the same frequencies. Out of the planned 18 beacons in the world-wide network, 16 are now in place.

\* 9A97WPC was the special event station during the 6th World Puzzle Championship being held in Koprivnica, Croatia. QSL via the Bureau or via 9A3KQ.

\* If you worked ZD7HI on CW, do not QSL as it was a pirate. Chris, the real ZD7HI, does not operate CW.

\* Vance W5IJU intended to operate from KP5 Desecheo Island. The authorities refused his request because there are "unsafe and dangerous conditions" on the island.

\* The name of Western Samoa was changed to just Samoa in July 1997. The call prefix remains as 5W.

\* EA4DX was active from the Maldives as 8Q7XX. QSL via home address direct only.

\* The Willis Island DXpedition, VK9WY and VK9WM, made 40,265 QSOs. QSL via ODXG Willis Effort, PO Box 929, Gympie QLD 4570. The group did not land on Holmes Reef as only a very small portion of

the island is above the water at high tide. Not enough to set up a station.

\* The special event station IROMFP (Millennium for Peace) was active on 23 and 24 October and will be activated in the future every 100 days until the year 2000.

\* The Date Line DX Association had a very successful expedition to Penrhyn Island in the North Cook Group. Three stations using the call ZK1XXP operated on CW, SSB and RTTY from 20 to 27 September. They made over 12,000 QSOs. QSL route is via Robert Pond WA4YBV, 9 River Cove, Portsmouth VA 23703, USA; or to WA4YBV via the QSL Bureau.

\* The Midway-Kure DX Foundation DXpedition was active from Kure Island with the special call K7K. The seven member team was very active and was very good copy here in Sydney, practically on a 24 hour-a-day basis. QSL via Bob Johnson KF7LZ, 5627 West Hearn Road, Glendale, Arizona, 85306-4213, USA.

### QSLs Received

R1FJZ (from Boris U3AJ); FS5PL (from KF0UI, CBA); J87GU (from DL7VOG, CBA); FT5ZG (7 m - F5RQQ); KG4ML (4 w - WB6VGI); and V31JP (2 w K8JP).

### Thank You

Many thanks to my fellow amateurs whose assistance is very much appreciated. Special thanks to VK2XH, VK2DEJ, VK2KAA, VK2KFU, VK2TJF, VK5WO, VK9NS, GW0ABL, and the publications *QRZ DX*, *The DX News Sheet*, *425 DX News*, *INDEXA* and the *ARRL DXCC Desk*.

*\*PO Box 93, Dural NSW 2158*

**ar**

---

---

# Over to You – Members' Opinions

---

---

*All letters from members will be considered for publication, but should be less than 300 words. The WIA accepts no responsibility for opinions expressed by correspondents.*

---

---

## More on Federal Problems

Peter Parker's letter "Federal Problems", in the September issue of *Amateur Radio*, was superb and shows the sort of great insight that we so desperately need if we are to save the WIA and amateur radio in Australia from a slow and agonising death.

My deep concern is that Peter's letter will be allowed to pass unnoticed into the scrapheap of apathy.

**IT IS VITAL THAT THIS MUST NOT BE ALLOWED TO HAPPEN.**

Peter is spot on with his assessment of the big picture. His solution for the way ahead (he argues that the Divisions be disbanded in favour of a more unified National body), is reminiscent of the Branches system in New Zealand, which I found to be more democratic, more friendly with a distinctive "club" feel, and for which meetings were much better attended than the Divisional meetings in Australia. Any geographic area can set up a Branch if there are enough local amateurs interested enough to do so, so that Branches consist of just a few members to, for example, generally over 100 for Branch 27 in New Plymouth. And nearly everyone gets a chance to sit on the Branch committee, contribute to or edit the newsletter, teach, manage repeaters, etc.

**WE MUST CONDUCT A REFERENDUM ON THIS ISSUE.**

I suggest that a proposal to "re-invent" (with no half-measures) the WIA, be submitted to the amateur radio community in the form of a questionnaire, to be included in BOTH magazines so that the majority of amateurs can have their input on our future direction.

Peter Parker, if he agrees, would be the ideal person to formulate the draft proposal for this, and I would like to see him sent to New Zealand by the WIA as the "people's special representative", so that he could attend a provincial Branch meeting and discuss the mechanics of the system with NZART.

There is NOTHING more important than this issue to spend our money on (while there is still a little left), and nothing to be gained by lengthy consultation procedures. We just do it, or perish.

**Chris Lowe VK6BIK**  
PO Box 838  
Toodyay, WA 6566  
chrismor@avon.net.au

## VHF-UHF Contest Rules

The Rules for the two premier VHF-UHF Contests have been the subject of some discussion recently. Many competitors want some changes to the present Rules. I wish to present some views for the wider membership to comment on.

Firstly, the rules must reflect the objectives of the contest. Secondly, the rules should not, as far as possible, advantage contestants in one State over others. Thirdly, the rules should not change from one year to the next once a reasonable compromise has been reached.

Let me now turn to one of the particular contests, the VHF-UHF Field Day.

I believe the objectives for this field day include:

- encouraging activity;
- encouraging stations to venture out into the field;
- encouraging stations to operate on more than one band;
- encouraging home stations to provide field day stations with contacts; and
- encouraging operation at the higher frequencies.

If these points are accepted, then it follows that 6 m should be included as a valid band. Eliminating 6 m prevents a number of operators from going out in the field, particularly those in VK4 and VK6 where the band is more popular than 2 m. Certainly contest operation on 50.110 needs to be prevented. This can be done by not allowing point scoring contacts on that frequency or within +/-10 kHz of this frequency and disqualifying anyone found to have done so. The suggested contest calling frequency of 50.150 MHz should be used. A 40 kHz change in frequency should not cause problems for those with beams optimised on 50.110 MHz. Self policing and reporting of offenders will be required to make the avoidance of 50.110 MHz actually work. If it doesn't, then, as the sun spot count increases, there will be pressure to remove 6 m again.

As working DX is not on my list of objectives, points per km are not appropriate for scoring. One point per contact seems a good start. It encourages activity rather than just looking for the distant station. Allowing home stations to work each other also encourages activity.

To encourage multi-band operation, particularly on the higher frequencies, each band should be considered separately. That

is, the same station could be worked on each band for scoring purposes as is now done. Of course, the scores for all bands are combined after multipliers are applied.

The number of grid squares worked is presently used as a multiplier. This is OK but I suggest that the number of portable stations worked would make a better multiplier. If the number of grid squares is retained, then I hope the number of portable stations worked will also be used as a multiplier as it encourages portable operation and minimises the temptation for home stations to just work other home stations.

The separate sections for home and portable stations should be retained.

A rover station that moves to a different grid square would count as a different station but a different operator of the same equipment at the same site would not. Any operator or person associated with a multi-operation station would not be considered a different station unless more than 5 km from the multi-operator site.

To encourage operation on the higher frequencies I suggest the following band multipliers be used. Note that, because the distance covered is not part of the bonus scheme, the multiplier roughly reflects the current ease of operating on 6 and 2 m compared to the higher frequencies.

Band (MHz)	Multiplier
50	1
144	1
432	2
1296	5
2400 to 10,000	10
Higher	25

Unfortunately, the days of working 50 different calls on two metres in a six hour field day seem to have gone; so, to make it worthwhile having a 6/24 hour contest, repeat contacts after three hours should continue to be allowed for scoring purposes.

Perhaps some bonus points should be awarded for backpacker stations. I suggest a bonus equal to 10 times the number of km the station was carried be added for each band. The minimum distance should be 250 m or 50 vertical m.

I have not included any bonus points for low power as a separate field day would be appropriate for QRP; maybe others have different ideas.

The usual rules about not allowing the use of active repeaters should apply.

Now for the Ross Hull Memorial Contest. I see the objectives as:

- encouraging activity;
- encouraging stations to work DX;
- encouraging stations to operate on more than one band;

- encouraging operation at the higher frequencies;
- conducting the contest over a specified time during the Christmas- New Year period; and
- arranging the scoring so that it is not necessary to spend the entire period in the shack.

The first two objectives are met by awarding points on a distance basis. One point per 100 km is a good basic scoring rate. This differs from the existing arrangement where 6 m is penalised because it more frequently has Es openings. 2 m has some Es openings, but tropo and aircraft enhancement are easier on 2 m and up than on 6 m. The distances covered can be roughly comparable.

By allowing one contact per call per band per UTC day, additional bands used will give higher scores as per the present rules.

To encourage operation at higher frequencies, I suggest a band multiplier system based on my estimates of the difficulty of making a DX contact.

Band (MHz)	Multiplier
50	1
144	2
432	4
1296	8
2400 to 10,000	15
Higher	25

The cap on 6 m, and the discrimination of distances based on presumed likelihood of tropo Vs Es contacts, have been removed. The lower multiplier on 6 m means that, even with a big Es opening, the total band score will not be much different to what could be scored by aircraft enhancement or reasonable tropo on 2 m.

The period of the contest could remain as 0000 UTC on Boxing Day to 2359 UTC on Australia Day.

The scoring could be limited to the top 50 contacts for each band. This will not stop some operators from living in the shack, but it will make it easier for others to get a full bag and is much easier to cope with than the best seven days.

The suggested advantage of the seven days option is that it limits contacts with the same station to seven per band. Unfortunately, the best seven days is hard to decide and the tendency is to make every day a big one, just in case some good propagation occurs. The top 50 avoids this.

If it is desirable to prevent having 30 contacts with the same station, then a rule limiting the number of contacts per call per band could be added. I suggest 20 repeat contacts be the maximum. I think seven is too few and discriminates against stations

depending on whether they are in the city or the bush.

There is still the problem that stations will concentrate only on contacts of 400 km plus. This does not encourage the 25 W single Yagi station to come on, let alone compete. I therefore suggest that, in addition to the best 50 (DX) contacts, points be awarded for contacts with stations at any range, say an additional 50 contacts per band but on the basis of two points per contact regardless of distance. This will encourage the "big guns" to work the smaller and local stations without detracting from the aim of being a DX

contest. The top 50 will bring the big guns closer together and make for a tighter competition, necessitating getting every extra point possible.

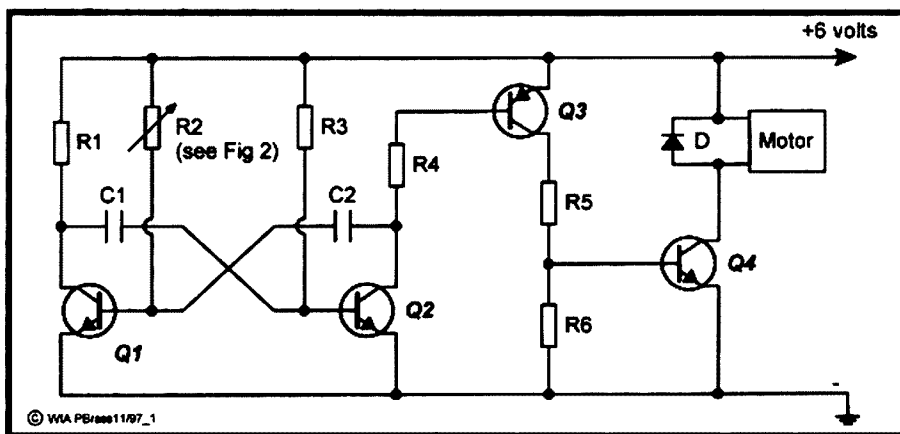
I realise that my suggestions may introduce some new problems as well as minimising others, but I hope some of the suggestions will be favourably received.

**Ron Cook VK3AFW**  
7 Dallas Avenue  
Oakleigh VIC 3166

(Although Ron's letter is longer than normally allowed, it has been published to encourage feedback to assist the Contest Manager. Ed)

## Pounding Brass

Stephen P Smith VK2SPS\*



**Fig 1 - Schematic of the audio cassette motor speed controller.**

<b>Q1, Q2</b>	<b>BC548</b>
<b>Q3</b>	<b>BC327</b>
<b>Q4</b>	<b>TIP31</b>
<b>C1</b>	<b>100 nF greencap</b>
<b>C2</b>	<b>1 nF greencap</b>
<b>R1</b>	<b>2.2 k</b>
<b>R2</b>	<b>See text and Fig 2</b>
<b>R3</b>	<b>47 k</b>
<b>R4</b>	<b>560 ohms</b>
<b>R5</b>	<b>470 ohms</b>
<b>R6</b>	<b>1 k</b>
<b>D</b>	<b>1N4002</b>

This month we take a look at a cassette motor controller which controls the playing speed of a simple portable cassette deck. Beginners should find this device easy to build and it will help them with their Morse studies and future upgrades. I would like to thank Derek O'Brien for the enclosed circuit and circuit information. I'll now take a back seat and let Derek take over and explain his motor speed control.

"Herewith the circuit diagram for the speed controller I told you about in my last letter. On reading a copy of my letter I find that I should have called the controller a

variable duty Asymmetric Multi-vibrator, the speed control being effected by varying the pulse length for which the motor is energised while the pulse frequency stays constant. This ensures adequate torque as the pulses of power are at the full voltage of the power supply.

"The circuit is quite straightforward. The time constant of the C1/R3 combination, which holds Q1 on and Q2 off, is much greater than that of the C2/R2 combination which holds Q1 off and Q2 on. R2, being variable, gives the speed control.

"When Q2 is turned on it gates Q3 on which, in turn, gates Q4 on, supplying the motor with a short burst of energy. The usual diode is there to absorb the inductive spike caused by the motor being turned off suddenly.

"I used a single pole 12 position rotary switch to provide the speed control resistances as shown in Fig 2. This gives 12 different speeds but, if it is thought that 12 speeds is excessive, all the switch positions need not be used, and the interposition resistors increased in value so their sum is the same as for 12 positions.

"When connected as in the diagram,

# International Amateur Radio Union Monitoring Service (IARUMS) - Intruder Watch

Gordon Loveday VK4KAL\*

**O**RARI, the Indonesian Amateur Radio Organisation, has requested more detailed information of the many illegal transmissions which they acknowledge originate from their country. Observers are asked to provide as much detail as possible in their reports. Names, places, organisation information, details of tasks, etc. Anything which may help to pinpoint exactly who the intruder is, or who he/she works for.

For our Region, the time to strike about intruders is now! Details of the recent Beijing conference are still fresh in the minds of those who can possibly do something about the problem. Details are also being sought about CB type operations being frequently reported in the 10 m band.

JARL, in their report to the Conference, have floated two worthwhile ideas. The first is that tapes of some intruders be swapped among Monitoring Service members. Some intruders are difficult to identify and are not heard throughout the Region. Tape swapping will probably eliminate that problem.

The second JARL idea is that long term members of the Monitoring Service should be given some form of award to recognise the dedicated service which they provide (we do this already in VK, with 37 of our Certificates of Merit being issued since 1985. FIWC). Both of these ideas have merit and the thoughts of MS co-ordinators in our region would be appreciated.

China National Radio (Radio Beijing) has been noticeably absent from monitoring reports since it was advised of the problem on 7100 kHz on 29 July this year.

In our own backyard we have, on 14.220 MHz, a news program at 2210 UTC, in English, A3E, from the BBC World Service. The signal appears to be H2 of 7.110 MHz. A check on these frequencies would be appreciated also.

My thanks to Rohan ZL1CVK, the Region 3 Co-ordinator, for most of the news.

\*Federal Intruder Watch Co-Ordinator, Freepost No 4  
Rubyvale QLD 4702 or VK4KAL@VK4UN-1  
Tel: 07 4985 4168

ar

## Silent Keys

Due to space demands obituaries should be no longer than 200 words.

The WIA regrets to announce the recent passing of:-

RM	FOREMAN	VK2DKG
B (BRUCE)	GARDINER	VK3AIE
NW	SULLIVAN	VK3CTS
T (Tom)	DOWLING	VK4OD

### Ken Beck VK4WKB

Amateur radio lost another of its old timers with the sudden passing of Ken Beck on 30 May 1997. Ken was spending a short holiday in Beijing in the company of his brother when he suffered a fatal heart attack.

Ken and his wife Lois settled in Port Macquarie when he retired from a career that, over 40 years, took him to distant islands in the Pacific region. He served in Nauru, Canton Island, Christmas Island, Fiji and Papua New Guinea, involved primarily in fuelling operations for the air transport industry. Many of the stations where Ken was stationed had poor, unreliable, and sometimes non-existent, public communica-

tions services, with the result that amateur radio played a major part in his life.

Ken held many call signs, including VR2KW, 3D2KW, T31KW, VK2WKB and lastly VK4WKB when he and Lois moved to the Sunshine Coast.

Ken will be sadly missed by his many close friends throughout Australia and the Pacific region.

Ron Marschke VK4GZ

President

Sunshine Coast Amateur Radio Club

ar

**Tell the advertiser  
you saw it  
in the  
WIA Amateur  
Radio magazine!**

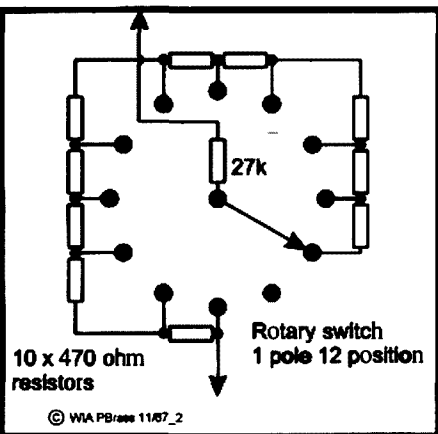


Fig 2 - Schematic of R2, the variable speed control.

rotating the switch in an anticlockwise direction gives speeds ranging from dead slow, when none of the resistors are in circuit, to full speed when the switch is open circuited. In this position, Q1 does not turn on, Q2 does not turn off, and the motor receives uninterrupted power.

"The on/off ratios for the recorder that I used may not be suitable for all makes of recorders. In fact, they were not ideal in my case; there was too great a reduction in speed between full speed and the next slower speed.

"The procedure I would recommend to set up the speeds is as follows:

1. Do not fit R2;
2. Run a tape at normal speed and time the speed of a paragraph of CW; or determine the time between two marker tones on the tape;
3. Wire a 50 k variable resistor in place of R2;
4. Adjust this resistor so that the speed is reduced to half full speed;
5. Measure this value (after disconnecting it from the controller), make up the same value with fixed resistors and wire this in series with the variable resistor;
6. Adjust the variable resistor to give a tape speed 10% lower than the maximum, if 12 positions and 10 resistors are used, or 20% lower if only six positions and five resistors are used;
7. Measure this value (after disconnecting it from the circuit) and divide it by the number of resistors used (this gives the value of the resistors wired round the rotary switch - these values should give a uniform change from full speed to half speed as the rotary switch is adjusted in an anti-clockwise direction); and
8. Wire in the rotary switch (with the resistors fitted) in series with the fixed resistor."

Thanks again, Derek, for this most informative article which, I am sure, will be of great assistance to a number of our readers.

\*PO Box 361, Mona Vale NSW 2103

ar

---

---

# Repeater Link

Will McGhie VK6UU\*

---

---

## Gateway on Air

After four years from the start of construction, and through the frustrating three year licensing phase, the Perth 29.120 MHz gateway is finally on air!

The equipment was put together over three years ago and placed on air. However, the gateway link from 29 MHz to the two metre repeater was not legal, so the gateway was turned off and the lengthy licensing process began. I learnt a lot from this process, particularly on how a relatively simple process can become bogged down. Most of the delays were of our own making. Lengthy delays in producing paper work, along with delays in delivering the paper work, added many months to what should have been a far simpler process.

Delays also with the ACA (SMA) should not have occurred to the extent they did in this licensing process. There were requests for information by the ACA that were repeated for the same information between the State and Federal sections of the ACA.

How we improve situations like this so that delays of years don't take place, I don't know, but change is needed. Perhaps we could deregulate the amateur service again.

## The Gateway

The Perth 29 MHz gateway operates on 29.120 MHz FM, to a vertical dipole spaced off a tower to give best propagation to the east of Perth. The location of the gateway is 20 kilometres east of Perth. The gateway provides access to the two metre repeater VK6RLM, which is the callsign of the gateway.

At the time of writing, the 29 MHz input is open access. No CTCSS tone is required to access the 29 MHz input and hence be re-transmitted onto the two metre repeater on 146.750 MHz. Access the other way from the two metre repeater requires an 88.5 Hz CTCSS tone by the user on his two metre transmission. This is required as not all licence grades (NAOCP and NAOLCP) are licensed to operate on 29 MHz. Even though it is the gateway system that is doing the re-transmission on 29 MHz and is controlled by the gateway, the ACA will not permit these licence grades to be re-transmitted via the gateway.

The two metre repeater is a modified FM 828. The 29 MHz equipment is a modified Yaesu FT-757. The FT-757 is running 50 watts to a vertical dipole. The local VK6WIA news is also transmitted via the 29 MHz gateway. This is done by a separate receiver on the WIA news frequency of 146.100

MHz, turning on the 29 MHz gateway transmitter when the WIA news CTCSS tone is received. All this happens automatically. The VK6 WIA news is broadcast every Sunday at 0930 and 1900 hrs West Australian time.

After a few days of operation there has been little QRM into the gateway from 29 MHz. However, in the long term I can see some form of protected access into the gateway will be required. CTCSS has the most options.

## Gateway Options

Last month's *Repeater Link* suggested some ideas on how 29 MHz gateways could operate. For the moment, all use 29.120 MHz and require CTCSS access into the gateway on 29 MHz. The two metre input also requires CTCSS access, but for a different reason which has already been discussed. Comments here are only to do with the 29 MHz input-output. Further to last month's ideas I have the following to suggest.

Rather than prevent linking between gateways (due to licence requirements) by requiring CTCSS access into the gateway by the user, reverse the requirement. Allow open access into gateways on 29 MHz but encode gateway transmitters with CTCSS, and use this gateway encoded CTCSS to prevent linking between gateways. The 29 MHz gateway receivers have a CTCSS decoder fitted, but the tone they are looking for is on other gateways, not users. As soon as a particular CTCSS tone is received from another gateway, linking is inhibited between gateways. The suggested CTCSS tone on 29 MHz gateway transmitters is 123 Hz.

A further thought is that CTCSS user access could still be used if required due to QRM, by using a different tone to that required to prevent linking between gateways. This system would then allow the maximum flexibility. Gateway linking inhibited by CTCSS, and open or CTCSS access for users. The final set-up is left to the gateway designers.

What are your thoughts on 29 MHz gateways? Now is the time to come up with a practical and inventive approach that can best utilise the gateway idea. Enhanced 29 MHz propagation is not far away due to the sun spot cycle.

## Even More

Here is even more about gateways, but a completely different idea.

As we get older, many amateurs are unable to maintain a HF station anymore. The reasons can range from reduced income due

to being on a pension, to living in a retirement village that does not allow a TH6 at 20 metres, to being unable to keep the HF beam at 20 metres serviceable. There are many more reasons, but the end result is that some amateurs in retirement have to give up their HF operation. All that is left is a two metre handheld or base rig and a modest antenna. Gone are the days of the 80 and 40 metre rag-chew nets keeping in touch with past amateur friends all round the country, and/or the odd bit of 20 metre DXing.

The silly thing is that we have a technological hobby which, by its nature, is designed to overcome, by technology, problems like this. The amateur limited to two metres or 70 centimetres FM could be "gatewayed" onto any HF band, via a station set up just for that purpose.

## Degrees

It is important to point out the intention is not to provide everything that a good amateur HF installation can provide. Having access to all HF bands on any frequency, along with all the bells and whistles that such a station provides, would be difficult and, for this idea, not required. The point is that limited access to HF is far better than none.

There could be several degrees of access. The easiest access would be a single HF SSB frequency gatewayed onto two metres. I can hear the suggestion of problems but let me run this past you.

## Simple

This is the simple single-frequency gateway on, let's say, 40 metres SSB. The biggest problem is how to re-transmit the 40 metre SSB onto two metres. How would the system know how to transmit a signal from 40 metres onto two metres without keying up on all sorts of spurious signals? No matter how good SSB mutes might be they are not good enough. The solution is simple; transmit the 40 metre single SSB frequency all the time on two metres, even when there is just 40 metre noise. The 2 metre transmitter is on transmit all the time with the audio from a single SSB frequency on 40 metres connected to it.

The user listens on two metres and hears a single 40 metre SSB frequency. So how does the amateur on two metres FM talk back if the gateway transmitter on two metres is on transmit all the time? Simple! The gateway two metre system is a normal voice repeater in which the receiver and transmitter work at the same time. Even though the gateway two metre transmitter is on constant transmit with the audio from the 40 metre frequency, the two metre voice repeater's receiver is waiting for a signal. This signal is the amateur calling in on two metres. The mute on the two metre repeater detects the incoming two metre signal and this mute logic signal turns the 40

metre SSB transmitter on, along with the amateur's audio from two metres. In operation, the incoming two metre signal has to be CTCSS encoded by the user, as only amateurs licensed for operation on a particular HF band could access the gateway. The amateur can now hear a single 40 metre SSB frequency just as if he was sitting in front of a 40 metre SSB transceiver, and called on that 40 metre SSB frequency.

Even when the amateur is calling in on two metres and, as a result, keying up the 40 metres SSB transmitter, the two metre gateway output remains on transmit. As the 40 metre transmitter is now in transmit, there is no 40 metre band signal, rather the amateur on two metres calling in is heard on the gateway's two metre output. Amateurs listening to all this on two metres hear both sides of the conversation, one from the 40 metre frequency and the other from the amateur using the two metre input. Also note, any amateurs on 40 metres listening to a QSO don't know one of the signals is being gatewayed from two metres unless told.

I may have laboured the description here a little, but I have done this so that the simple system is understood. To summarise, a normal two metre repeater is modified to be on constant transmit, with the audio coming from a single 40 metre SSB frequency and the repeater's two metre mute connected to key up the 40 metre SSB transmitter. The amateur on two metres can now hold a simple QSO with another amateur on 40 metres SSB. All this might sound complicated but it is my limitation with the English language that is the complication. In operation, the system would work with little knowledge required by the user.

### Frequency Tuning

In this simple but practical example there are no requirements for the amateur on two metres to have any extra equipment, or modify his equipment. A two metre (or 70 centimetre) FM radio is all that is required. The normal 600 kHz offset is used and the amateur now has access to a single 40 metre SSB frequency.

Now, SSB by its nature is very frequency dependent. Being slightly off frequency results in high or low pitched audio. The amateur using the gateway via two metres has no control over this. He could have, by various means but, initially to keep the system simple, he does not. A designated SSB frequency is chosen and the 40 metre transceiver is aligned so there is no frequency difference between the receive frequency and transmit frequency. Any amateur on 40 metres who appears off frequency, due to a difference between his receive and transmit frequency, would be asked to change his transmit frequency so that the audio via the gateway is correct. This is not hard and is

done now when amateurs have transceivers that have a discrepancy between receive and transmit.

What if the chosen frequency is close to another frequency already in use at the time? You have to wait until the frequency close by becomes clear. In this simple set up there are limitations, but it is the basis for more advanced systems.

### Complex

The gateway system described so far would offer a usable fun set-up that amateurs could use. Amateurs who had no access, now have limited access. Amateur bands that have less activity than 20 metres are best suited for the simple system. Remember, this gateway idea is not trying to do everything a HF station can do, just some of what it can do.

A complex gateway could offer a number of HF channels on the one band via the DTMF of the user's two metre radio. Even continuous frequency tuning would not be too difficult by using DTMF control. Changing from band to band would also be possible, and turning a HF beam, could all be built in. These ideas come later. What is needed now is a simple gateway set up to demonstrate the operation. By the time you read this, such a gateway set-up will have been tried. The system will be automatic but manned. It really is simple to set up such a system to an existing repeater.

### Dedicated

If these gateways became popular, then dedicated repeaters would be built to provide

for this activity. Existing repeaters serve a purpose as they are now and should be left as is. The HF gateway, even though it is using existing repeater technology, is different in operation.

### Clubs

What a great club project with lots of interesting technical ideas to try out. Start simple and provide a gateway, and then build on sophistication. The equipment requirements are not that great. Perhaps amateurs looking at retirement aspects with no HF operation would donate some of their HF equipment for just such a gateway.

### Licensing

This has to be mentioned as it is the most difficult problem of all. As this system is an automatic stand-alone system, it requires a licence, just like the 29 MHz gateway licence. Whether this proves difficult or not is as yet unknown. The best way is to put an application in via the WIA to the ACA and see the result. Based on past delays with the 29 MHz gateway, the most important situation to sort out is that the WIA band plan does not cater for gateways onto any HF band other than 29 MHz. Let's hope we can find a way to try this idea out before I'm in a retirement home!

\*21 Waterloo Crescent, Lesmurdie 6076  
Packet: VK6UU @ VK6BBR  
E-mail: will@vale.faroc.com.au  
ar

---

---

## Spotlight on SWLing

Robin L Harwood VK7RH\*

---

---

It was with some sadness we learnt on Saturday, 20 September, that Arthur T Cushen of Invercargill, NZ passed away after a prolonged battle with bone cancer. Arthur was a respected short-wave listener and DXer, for many decades regularly contributing a short-wave column in *Electronics Australia*. His voice was also regularly heard over Radio New Zealand and Radio Netherlands, as well as on other international broadcasters, giving listening tips. He was also an official monitor for the BBC, Radio Vatican and the VOA.

It was Arthur's column that motivated me and, I suspect, many others to listen on short-wave. Arthur's eyesight gradually deteriorated until he became totally blind. However, with the support of his wife, Ralda, Arthur kept up his prodigious work right up to the final few days of his life. It was one of the broadcasters, I think it was Kim Elliot of the VOA, who said that Arthur was "the dean

of DXers". Many fine on-air tributes were given over short-wave, including the VOA, Radio Netherlands and HCJB.

My contact with Arthur commenced in 1980 when I became the national co-ordinator of the Handicap Aid Program. Arthur was the New Zealand co-ordinator and we kept in regular communication. I was in awe of him and his accomplishments, despite his visual disability. One of my treasured possessions is a personally autographed copy of his book "World in My Ears". Vale Arthur.

The world-wide OMEGA navigation system on VLF was permanently closed as from 0300z on Tuesday, 30 September. As you may be aware, there is a huge mast located in Gippsland, Victoria that was part of this global chain. GPS satellites have superseded OMEGA, although a Russian variant of OMEGA, commonly known as ALPHA, is continuing on VLF and HF.



I noted, in last month's *Amateur Radio*, the recent death of Peter Alexander VK2PA at Port Macquarie. When I commenced on amateur radio, Peter was one of my first CW contacts. He encouraged me to persevere, as I had almost given it away, when Col VK2ASF and he just left everybody for dead. Remember their nightly QSO on 3575 kHz, which invariably ended at 45+ wpm.

I recently received the following schedule from Alaska's only short-wave broadcaster, KNLS, which is located at Anchor Point. The station is religious but others use it when KNLS programming concludes.

KNLS HF Transmission Schedule, 26 October 1997 to 28 March 1998:

0800 – 6150 kHz – English  
0900 – 6150 kHz – Russian  
1000 – 7365 kHz – Mandarin  
1100 – 6150 kHz – Russian  
1200 – 7365 kHz – Mandarin  
1300 – 7365 kHz – English  
1400 – 7355 kHz – Mandarin  
1500 – 7355 kHz – Mandarin  
1600 – 7355 kHz – Mandarin  
1700 – 7355 kHz – Russian

The English release on 6150 kHz is coming in well here but the higher channels on 25 and 31 metres were better. The 1300 release is identical and is easier to hear. QSLs are welcome but they will only confirm their own programming. Programs by others using their transmitters do not qualify, ie "Radio Free Asia".

Your report may be mailed, faxed, sent by audio recording or by e-mail. All QSLs will be returned by surface mail. To qualify, the report must include the date and time (UTC only) of the transmission, the approximate frequency, and as many program details as you can supply.

KNLS will provide only ONE QSL for each report, regardless of the number of entries. Their addresses are: Mail – PO Box 473 Anchor Point, Alaska 99556, USA; e-mail – [KNLS@aol.co](mailto:KNLS@aol.co); fax – 615 371 8791; URL – <http://www.knls.org>

Yet another international broadcaster is fighting for its survival. Radio Prague has broadcast an announcement that protests should be directed to the Ministry of Foreign Affairs in order to continue funding. Also, private operators may take it over, but without short-wave.

Radio Budapest in Hungary has reduced its output due to budgetary constraints. They are scheduled to broadcast to Australia at 0900-1000 on 15210, 17860 and 21560 kHz. On Sundays, an extra hour is heard from 1000-1100. Programming is in Hungarian at this time.

The "Voice of Free China" in Taipei will be known as "CBS-Taipei Radio International" following re-organisation of Taiwan's

external broadcasters. This will take place as from 1 January 1998. Currently it broadcasts in English to Australia on 9610 kHz from 1200 till 1300.

The BBC World Service is to broadcast a serial called "Westway" in English. Two 15-minute episodes will be aired each week as from this month. The program centres on a community health unit in Notting Hill in

West London, a multi-cultural microcosm of London's metropolis.

Well, that is all for this month. Thanks to Bob Padula and the EDXP and KNLS for assistance with this month's column.

\*5 Helen Street, Newstead TAS 7250  
(03) 6344 2324

Internet e-mail: [robroy@tassie.net.au](mailto:robroy@tassie.net.au)

ar

---

---

## Update

### Intermodulation Performance and Measurement of Intermodulation Components

(published on pages 6-12 of August 1997 issue of *Amateur Radio*)

The eagle eye of Mark Dods VK3ZR has detected errors in the two last paragraphs in column three on page 10 of the above article. Each of the instances of "mV" should read "µV". These inadvertent errors came about in the translation from the IBM platform used by *Amateur Radio* to the Macintosh platform used by the printer. It seems that all ASCII characters above 127 (the "µ" symbol is ASCII character 230) do not convert accurately. The corrected text is reproduced below:

*Our references have so far been made to levels in dBm, or decibels referred to one milliwatt. However, signal generator outputs are commonly calibrated in microvolts and millivolts with scales in multiples of 10. To convert between units, 1 µV across 50 ohms is -107 dBm. Each time the voltage is multiplied by 10, add 20 dB so that 10 µV is -87 dBm, 100 µV is -67 dBm, etc.*

*To find the signal threshold, set one signal generator to a fairly low level (say 10 µV or -87 dBm) and tune the receiver to the signal generator frequency. Adjust the attenuator so that the signal raises the audio output signal just 3 dB (1.4 times volts) above the noise level (measured with signal off). The signal threshold in dBm is equal to -87 dBm, minus the loss in dB set by the attenuator, minus 6 dB loss in the hybrid combiner.*

It would be a good idea to correct your copy of the August 1997 issue of *Amateur Radio* now.

### Simple Peak-Reading Watt-Meter

(published on pages 13-14 of August 1997 issue of *Amateur Radio*)

The author of this article, Jon Lindstad VK2WF, has requested we publish this addendum:

*"I have had an enquiry from an amateur in VK5 who has experienced a problem which could be common. He inserted a coax T-piece in the transmission line from his Tx to a dummy load and connected the watt-meter to*

*the T-piece through another length of coaxial cable. He observed different readings on the watt-meter as he changed to other ham bands. The reason for this is probably that the length of coax from the T-piece to the watt-meter acts as an open stub, causing mismatch on the transmission line.*

*"To avoid this problem, the length of coax from the T-piece to the watt-meter must be very short compared to the wavelength in question. Better still, let the signal pass through the watt-meter box (2 x PL-259) and connect the diodes directly to the inner conductor as I did in the original, but unfortunately did not emphasise in the article. My apologies."*

It would be a good idea to notate the article in your copy of the August 1997 issue of *Amateur Radio* now with a reference to this addendum.

### Random Radiators

(published on page 15 of September 1997 issue of *Amateur Radio*)

Lloyd Butler VK5BR has pointed out an error in the quote of his letter in the September 1997 *Random Radiators* column. The word "impedance" was inadvertently substituted for "resistance" near the top of column two. The third and fourth lines of text at the top of column two on page 15 should read "impedance of shunt reactance and shunt resistance. When there is no series".

It would be a good idea to correct your copy of the September 1997 issue of *Amateur Radio* now.

### Parallel Resistance

(Formula and Chart)

(published on page 11 of October 1997 issue of *Amateur Radio*)

The second equation in column one on page 11 is incorrect. Instead of  $R1=(R2 \times R_p)/(R1-R_p)$  it should read  $R1=(R2 \times R_p)/(R2-R_p)$ .

It would be a good idea to correct your copy of the October 1997 issue of *Amateur Radio* now.

We should also point out that the table for parallel resistors is equally usable for parallel inductors and series capacitors.

ar

# VHF/UHF – An Expanding World

Eric Jamieson VK5LP\*

All times are UTC.

## Five/Six Metres in Australia

In these columns, during the past three months, I have ensured that a written description is permanently recorded regarding operations on 50 MHz as they evolved following the end of World War II, during 1946/47, culminating in a world record contact between VK5KL and W7ACS/KH6 on 26 August 1947 (see August 1997 issue).

I had intended continuing from that point in further describing the VK scene as it unfolded, but since I had some information regarding pre-war operating on 56 MHz, a start will be made from there, with the other following later.

Jeff Farmer VK8GF in Alice Springs, sent me the following regarding the amateur activities of his father Max VK5GF, prepared from his father's log books of the time.

Maxwell George Farmer 1918-1991 VK5GF was first licensed on 22/1/1934. Until 30/5/1935 his operating was confined to 3.5 and 7 MHz CW and phone. Then 14 MHz took priority until March 1936 when he began using 56 MHz (five metres), in many cases operating from portable locations around Adelaide, also from Mount Lofty and Mount Barker. At the time, his rig ran 3.7 watts to a four element beam antenna. He carried out various antenna experiments and one of his favourite antennas was two half-waves in phase.

One successful five metre expedition was on 6/9/1936 when, from the top of Mount Lofty, he worked Clarry VK5KL situated on The Hummocks (with VK5HT and VK5FM), over a distance of about 75 miles, for a VK5 distance record. Using a four element beam, signals were S9 despite only 3.7 watts input.

Contacts were limited to VK5 stations, and these included VKs 5AC, 5BB, 5BD, 5BO, 5BY, 5RX, 5ES, 5FJ, 5GL, 5GM, 5HD, 5KL, 5LJ, 5ML, 5NC, 5NF, 5OB, 5OZ, 5WI, 5WX, 5YF, 5ZC, 5ZU, 5ZX and 5ZY. Most of his operating time was spent on 56 MHz, occasionally working cross-band to 7 or 14 MHz.

On 26 and 27 June 1937, Max operated portable from Rapid Bay, using 7 MHz to liaise with Adelaide stations for a 56 MHz contact, but for reasons unknown, no contact eventuated.

Not to be outdone, in December 1937 he joined forces with Ron Anderson VK5GM with a portable expedition to the summit of Mount Barker, 1680 feet ASL, to attempt a five metre contact with Frank Miller VK5BF of Murray Bridge, who journeyed to a point near Meningie, about 60 miles from Mount Barker. Forty metres was used for liaison.



A reproduction of the photo from the February 1938 issue of *Australasian Radio World*, showing VK5GF (left) and VK5GM portable on Mount Barker (see text).

Courtesy Jeff VK8GF, a page from the magazine *Australasian Radio World* for February 1938 gives a description of that portable operation, and one must admire the effort those two made to complete the expedition, lugging heavy batteries to the summit. A few extracts from that page are worthy of inclusion here.

The portable call sign was VK5GY. The five metre rig used a 6A6 as a TNT, modulated by a 42 with an input of 2.5 watts on phone (AM) and 5 watts CW. The receiver was a five-valve resistance-coupled superhet and the antenna two half-waves in phase with twisted pair feeders, mounted on a 30 foot pole which could be broken into six foot sections for carriage.

The 40 metre rig, a two stage affair of three watts input, was built inside a gramophone case along with a two valve receiver. The antenna was a half-wave Hertz hooked straight on to the tank circuit! Power for all filaments came from 6 volt accumulators. Batteries supplied high tension for the receivers, while a genemotor powered the transmitters (see photo).

VK5BF used a pair of 45 valves in push-pull, with 300 volts supplied by a bank of wet "B" batteries.

At about 4.15 pm local, VK5GY contacted VK5BF on five metres for 45 minutes with signals both ways at S8. They could stay no longer as storm clouds were gathering. It took two trips to carry all the gear to the bottom,

and they just made it before the heavens opened!

Following that trip, the next entry was on 10/2/1938 when Max worked VKs 5GB, 5LW, 5RS, 5TR, 5WK and 5ZU all at 5x9 phone.

Work commitments took over around this time and amateur activity decreased through the remainder of 1938, with a few local 56 MHz contacts to various stations. Max's last QSO prior to close down for World War II was on 14 MHz on 10/8/1939.

His next log entry: *Amateur radio station VK5GF resumes activities after an absence of seven years and one month on 11/9/1946 by working VK5GB on 50 MHz at 2000 hours local. Other contacts were to VKs 5BQ, 5CK, 5CR and 5MD. On 29/9/1946 it was noted that the band was still being called five metres. 12/10/46: VK5BQ, VK5GB and VK5RT.*

[On 15/11/46 Max made his first contact on the new band of 170 MHz with Reg VK5QR, followed by VK5KZ. Through the remainder of November and to 7/12/46 activity was limited to 170 MHz stations, which included VKs 5KZ, 5QR, 5RO, 5RQ and 5RT.]

Then it was back to 50 MHz again with mobile and portable activity having priority. On 26/12/46 at 1700 local, Max heard VK2WJ calling CQ DX but was unable to make the QSO. Again, the 3.7 watts did not have the punch required. Also heard, but didn't work, VK2AZ.

Max took up sailing and his 50 MHz rig on the 25 foot craft was 1.5 watts input to a doublet antenna 20 feet above the water.

Contacts through December/January 1947 include the usual VK5s, then on 8/1/47 he worked VK4HR. VK5 stations were now working more consistently into VK2 and VK4. Then a brief but abrupt change to try the new 166 MHz band, with many of the workings centred on mobile operation.

Max then turned to 28 MHz with brief periods on 50 and 166 MHz, but he did construct high power equipment for 28 and 50 MHz, so that in December 1947 he worked VKs 2ADT, 2AHD, 2AHF, 2NO, 2OC, 2WJ, 2ZH, 3AKM, 3HZ, 3IV, 3RR, 4AW, 7AB, 7CW and 7XL. But the VK6s still eluded him. On 21/12/47 at 1700 local he worked ZL2MF followed by ZL3LB on 23/12.

1948 was also a good year to VK2 and VK4, not only during the summer but also in June, showing his first entry into winter Es. On 11 June he made the first of many 144 MHz contacts, so by now he was firmly entrenched on the VHF bands.

In summary, VK5GF made his first QSO on 56 MHz on 22/3/36 at 1130 local time with VK5WX; 50 MHz 12/9/46 to VK5GB at 2000; 170 MHz 15/11/46 to VK5QR at 2015; first 50 MHz outside VK5 8/1/47 to VK4HR 1815; first 50 MHz outside VK 21/12/47 to ZL2MF 1700; first 144 MHz on 11/6/48 to VK5JO at 2125.

To be continued.

## The Northern Territory Expedition

### Part 2 by Alan VK3XPD

Monday, 28 July, David and I departed Adelaide in separate cars at 0830 local and headed for Marla Bore, 140 km south of the NT Border – a distance of more than 1100 km. During our journey we chatted continuously on two metres FM to relieve the monotony. We finally arrived 11 hours later and, after some discussions about who “doesn’t” snore, we agreed that a twin-share motel room was appropriate. Following tea and some discussions on suitable vantage points with a couple of “well oiled” local experts, we both retired for the night. It seemed only a matter of seconds after David’s head hit the pillow that he began to snore loudly. Unable to get to sleep, I moved out to the car!

Tuesday, 29 July, David in his Commodore, followed a “road worker” east down the Oodnadatta Track some 30 km to a vantage point that could, quote “see for 200 miles”. To his dismay, David found this site near Welbourne Hill Station was disappointing and erroneous in its description. After a few map readings the horizon at VK5KK’s end was found to be only 20 km in the desired direction, with dirt at least as high as the vantage point. The only redeeming feature of the site was the 30-foot tower, which had, of all things, a solar powered UHF CB repeater on it!

I headed north on the Stuart Highway to Mt Cavenagh, 10 km inside the NT border – a decision again based on the advice from the previous night. Disappointingly, this “mountain” turned out to be a pile of very large rocks about 50 metres above the local surroundings with no suitable access. I returned to a high point alongside the Stuart Highway and established a poor 2 m SSB liaison link with David some 170 km to the south east. The next problem was the road-noise from traffic on the highway. At that time of the morning it was so busy with cars, caravans, trucks, road-trains and tourist coaches that it became impossible to even consider setting up.

I headed across country in the Futura wagon to a “high” vantage point 5 km to the east. From here, on a rocky outcrop about 25 metres higher than my surroundings, 25 watts of two metres SSB into a five element Yagi was still poor with heavy QSB, but signals peaked at times to S3. Since there were no other high vantage points around there was little choice but to try for the QSOs from here.

Our first band was 10 GHz at 1125 local. Signal reports were 51/52 with heavy QSB. Next was 5 GHz with significantly better reports of S3 both ways. Our 3 GHz contact resulted in 51 and 41 reports – again with QSB. The 2.4 GHz contact at 1255 local was the most difficult to complete. Signal reports were 41 both ways. David actually climbed the UHF CB repeater tower and completed the 2.4 GHz contact with dish and transverter held in one hand, while holding on to the

tower with one leg locked around a tower leg, and the microphone in the other hand. The overall lack of system gain (dish gain) as the frequency decreases and yet still using the same sized dish and similar RF output power as that used on the higher frequencies, contributed to these poor results.

Next band was 1.3 GHz. Again, due to a lack of antenna gain at my end, no signals were heard at either end. The final band tried was 70 cm at 1315 local. I had FM capability, only but signals both ways were fully quieting with some slow QSB – averaging S3 to S7 but peaking higher at times. David used a 22 element K1FO with a five watt handheld! The 24 GHz band was not attempted simply because the distance was excessive for the wide-band FM gear we had – so we both packed up and moved closer together in order to complete the remaining 1.3 GHz and 24 GHz QSOs.

As daylight was quickly failing and we had a long drive back to our scheduled overnight stop at Cadney Park Roadhouse in SA, I set up 1.3 GHz at the Marryat Creek Fibre Optic Repeater station, 33 km inside SA and completed a 41 km FM contact to David who had set himself up on a “rise” about 8 km inside the NT border. Signal reports without pre-amps were S3 both ways, with some QSB. We then tried 24 GHz over the same distance without success. I moved closer to a distance of about 15 km but still no success. Eventually, I drove to David’s site in NT to verify the functionality of our gear and then drove about 5 km back into SA and we completed a successful, albeit short, 5.9 km contact with signals “full quieting”.

The lack of success experienced on these earlier attempts was attributable entirely to non line-of-sight paths. It was simply not possible to access a high vantage point that had clear uninterrupted views from inside the NT border over these larger distances to a similar point inside SA.

Having successfully established seven new distance records in VK8, we headed for Cadney Park Roadhouse some 240 km to the south, arriving at 2000 local. Next morning, after a hearty breakfast, we continued on to Port Augusta about 700 km south, but not before we checked out the impressive 6 m mesh dish (amongst eight other dishes ranging from two to four metres) set up as part of a business enterprise that sold TVRO systems from this site. Later, at 1600 local, we arrived at Port Augusta. After a brief “comfort” stop and some food, we went our separate ways – David returning to Adelaide and I continued on towards Broken Hill some 400 km to the east.

To be continued.

The full story of the Microwave Expedition is contained in a beautifully presented 14 page dossier prepared by Russell VK3ZQB, complete with graphical charts in full colour, and other relevant drawings and maps. The text was gathered together largely by Alan VK3XPD from the

experiences of those involved in the expeditions. Personally, I am at a loss to know how best to handle it!

The introduction is worthy of inclusion here.

“The surge in activity over the last 2 years on all microwave amateur bands from 2 GHz through to 24 GHz has inspired several amateurs to plan and then execute a ‘hit and run’ DX expedition across 4 states to either set ‘new’ or where possible – extend the existing VK Distance records.

“The principle aim of this exercise was to promote even greater interest in these under-utilised bands of spectrum.

“The participants were Alan Devlin – VK3XPD from Melbourne, Russell Lemke – VK3ZQB from Port Fairy, David Minchin – VK5KK from Adelaide, Trevor Niven – VK5NC and Colin Hutchesson – VK5DK, both from Mount Gambier and Les Janes from Chisholm ACT.

“Our collective achievements can be best summarised as follows. Over a three week period from late July to mid August 1997 with little or no assistance from ‘weather enhancement’ – 12 new VK Distance Records were set and, seven existing VK Distance Records were extended.

“Several of these records were actually ‘set or extended’ on more than one occasion.”

A table in the October issue indicated these new or extended records.

Having also viewed the dossier, comments from two of Australia’s well known microwave enthusiasts are relevant at this point.

From Walter Howse VK6KZ: “The story is not the records you broke and established but rather the determination and commitment of a group of dedicated people to get out and have fun and demonstrate what can be done with the microwave bands!

“The bit which is most outstanding, and has few parallels even in the USA, is the distances you covered and the time which you took to cover some of them – 1100 km in 11 hours (and on our kind of roads – no Interstate Freeways of the US!) and that having covered them, the gear was robust and worked so well.

“The USA Rovers have gear to cover lots of bands in their contests but these are mainly mountain-toppers going to pre-determined spots. What I read from your story is that you had some well researched spots but most of it was instant research and try and see how the path would work.

“I guess I have an empathy for what you have done having gone portable myself!

“Looks like I will have to “defend” my patch on the south coast if you inspire others to copy your enthusiasm! I have already passed on to two locals a copy of your article and Neil Sandford VK6BHT has been posted a copy. When he returns to the East you will have another enthusiast in the Canberra region.”

From Lyle Patison VK2ALU: “Hello

from Wollongong. Sorry that I did not have the chance to eyeball with you during your trip from Sydney to Canberra, but fully understand your need to do it direct.

"My congratulations to you and the rest of the  $\mu$ W DXpedition group for the great effort put into the exercise and also for the report on it – and, of course – the results achieved in such a short space of time.

"If this does not stir some activity on the  $\mu$ W bands down the eastern side of Australia – nothing will!

"I fully concur with the thoughts expressed on great need for much more study and correlation of results achieved over both shorter and especially, longer paths with the met conditions existing at the time, so that we can more accurately predict when appropriate conditions are likely to exist in the planning of future tests on the various microwave bands.

"I would be most interested to see something published on the 'nuts and bolts' of measurement of the variables involved and actual calculations using these variables to come up with 'benchmark' values, etc which can be used by the man in the field.

"I wonder what you guys may have come across in this regard (outside the usual Microwave Handbooks and manuals.)

"This may also allow a number of us around Australia to make a record of values which can be DIRECTLY compared over a period of time."

### Now Microwave Records

John VK3KWA from FTAC advises of the following new records:

420 – 450 MHz  
VK8 VK3XPD/8 VK5KK/8 29/07/97 167.7 km  
1240 – 1300 MHz  
VK8 VK3XPD/8 VK5KK/8 29/07/97 42.2 km  
2300 – 2450 MHz  
VK1 VK5NC/1) VK1BUC/2) 14/08/97 97.5 km  
VK5DK/1) VK3XPD/2)  
VK8 VK3XPD/8 VK5KK/8 29/07/97 167.7 km  
3300 – 3600 MHz  
VK1 VK5NC/1) VK1BUC/2) 14/08/97 97.5 km  
VK5DK/1) VK3XPD/2)  
VK8 VK3XPD/8 VK5KK/8 29/07/97 167.7 km  
5650 – 5850 MHz  
VK1 VK5NC/1) VK1BUC/2) 14/08/97 97.5 km  
VK5DK/1) VK3XPD/2)  
VK8 VK3XPD/8 VK5KK/8 29/07/97 167.7 km  
10.0 – 10.5 GHz  
VK8 VK3XPD/8 VK5KK/8 29/07/97 167.7 km  
24.0 – 24.25 GHz  
VK1 VK5NC/1) VK3XPD/2 13/08/97 17.4 km  
VK5DK/1 )  
VK2 VK3XPD/2 VK5NC/1 ) 13/08/97 17.4 km  
VK5DK/1 )  
VK8 VK3XPD/8 VK5KK/8 29/07/97 7.3 km

### Success on 3.4561 GHz

A news item from the *Official Bulletin of The West Australian VHF Group*: On Sunday 17/8 at 0700, AI VK6ZAY at Kamet and Terry VK6TRG at Wireless Hill worked 3.4561 GHz for 44 km for their first contact on this

frequency. Both had homebrew radios, Terry VK6TRG from modified VK5 kits and AI VK6ZAY with his own design homebrew.

### From the UK

Ted Collins G4UPS spent most of August on holidays in a caravan, but took his trusty TS-600, a 25 watt amplifier and a small antenna, managing to keep an eye on the bands.

Contacts were made with stations in 9A, CT, DL, EH, F, GM, HB, I, LA, OH, S5, SM and YU, so I suppose 13 countries would be considered reasonable for a period on holidays.

September was a quieter month, although Ted was somewhat annoyed to take a day off on 7 September and then find that he had missed the Libyan expedition station 5A28! I guess it has happened to all of us at some time!

### EME Contact

Dallas Taylor VK5WA advises that, on Sunday 21/9, Dave Blaschke W5UN and Graham Daubney F/G8MBI on 144.028 MHz, achieved the first single-Yagi to single-Yagi EME QSO in history.

W5UN was using an old KLM 17LBX (one of the few which survived from the destruction by tornado of his first array) and F/G8MBI was using one of Mike Stahl's 2M-8WLS. Both stations were running maximum legal power and neither employed ground gain. Success was achieved on the third schedule attempt.

Retraction: A recent note posted to MOON-NET by Mike K6MYC points out that W5UN and F/G8MBI are actually the first to complete a one-Yagi to one-Yagi EME QSO on 144 MHz. The same feat had been accomplished earlier on 50 MHz by W7HAH and SM7BAE.

In response to a query received, W5UN and F/G8MBI made their QSO on CW. No DSP was used other than narrow-band filtering. ... Ray Soifer.

### TEP Openings Around the World

There has been much stirring of TEP activity in various parts of the world, with the following being reported during September. Reports from VK3OT and *Internet Six News*. Are these the first rumblings of future F2 activity? And who said that six metres was dead? Look to the north between 0300 and 0700, especially around 48.240, 48.250 and 49.750 MHz. The signals are not strong in the lower regions of VK but they can be heard quite frequently.

1/9 1150 JA5CMO VK8VF/b 50.057 Evening TEP  
2/9 1210 JA5CMO VK8VF/b 50.057 Evening TEP  
11/9 1232 JH4JPO VK8VF/b 50.056 529  
12/9 1854 4Z5JA 7Q7RM 50.110 TEP  
12/9 0050 T14JHQ worked four LUs by TEP  
12/9 KG6UH worked three LUs – signals to S9+  
13/9 1745 4X to 7Q7 5x7 TEP  
14/9 0400 V73AT NH7R 50.110 Hawaii  
14/9 0400 V73AT KH6/K6GSS 50.110 Hawaii

14/9 0800 V73AT 49.750, 48.260 video  
16/9 1733 G0CGL 7Q7RM 50.110 First EU/7Q7 for year  
19/9 2300 WP4O 16 stations in LU, CX, PY 5x9 TEP  
19/9 1615 IK0BAL and GJ4ICD report V51VHF/b 559  
21/9 1150 JH6VXP VK8VF/b 50.056 519  
21/9 1200 VK8RH to JA6 5x9, 48.240, 48.250, 49.750 all 5x9  
21/9 1201 JH4JPO VK8RH 50.110 529  
21/9 1217 JH6VXP VK8MS 50.130 5x3  
21/9 1225 JA6QGG VK8MS 50.140 5x2  
22/9 1730 V51VHF/b to Italy 599  
23/9 1142 JH4JPO VK8VF/b 50.056 TEP 519  
23/9 1815 7Q7RM 9H5EE 5x9  
24/9 0700 Y8UU KH6HME/b KH6HI/b (info via VK4AFL)  
25/9 1240 VK8MS VR2XMT 50.140 First VK-VR2 for 1997  
25/9 1315 VK8RH to JA6 5x9, TV video 5x9  
26/9 0730 JA2IGY/b 539, heard by VK3OT, VK3ALM, VK5LP  
28/9 0600 46.172 video, then strong 49.750 video to VK3OT  
26/9 0830 VK3OT UAO-TV 49.750 First TV TEP for 1997  
26/9 1140 JH4JPO VK8VF/b 50.056 559 TEP  
26/9 1207 JH6VXP VK8MS 50.110  
26/9 1220 JH6VXP VK8RH 50.110  
28/9 2355 LU2EGQ heard XE1NVX 5x8  
29/9 0003 LU2EGQ YV4YC, 0015 WP4O, 0020 WP4LUU by TEP  
29/9 0700 open JA1,2,6 with all beacons copied in Darwin  
29/9 0800 VK8RH heard 48.2396, 48.249, 49.750 video  
25/9 YD9MEV on 145.090 5x4 FM reported by Rex VK8RH

### Beacon Status for SE NSW

Ron Cook VK3AFW passed a message from Rod Collman that the following beacons are operational from Mount Emerald near Nimmitabel in south eastern NSW: VK2RBC on 144.410 and 432.410. The 1296.410 beacon is off-air pending repairs. The beacons run 10 watts FSK to an omnidirectional horizontal antenna and are 1400 metres ASL.

### Closure

I regret that two important articles have taken most of the available space this month. A decision had to be made which way to go, so I decided to "clear the decks", so to speak, and return to more general news next month, by which time there may be some sporadic E contacts to report.

Closing with two thoughts for the month:  
1. Whoever wants to be a judge of human nature should study people's excuses, and  
2. The true test of humility is whether you can say grace before eating crow.

73 from *The Voice by the Lake*.

\*PO Box 169, Meninnie SA 5264

Fax: 08 8575 1043

Packet: VK5LP@VK5WI.#ADL.#SA.AUS.OC

E-mail: vk5lp@ozemail.com.au

ar

# Ionospheric Update

Evan Jarman VK3ANI\*

## Solar Activity

Solar activity started the quarter at low to very low levels. Activity was moderate on 29 August with a class M1.4 flare at 2332 UTC. There were a number of class C flares from the same region, considered to be the most significant region of the new solar cycle to date. Sunspot activity has markedly increased during the last quarter. Indications are that we are about to start the rapid climb phase of the new solar cycle.

The eleven year solar cycle graph is now using the more common smoothed sunspot number: smoothed over a year rather than a month. This gives the smoothed sunspot number curve its classical shape, showing the underlying trend. The T index line is monthly, showing the variation from this trend.

The SEC/NASA solar cycle panel estimation of cycle 23 is that it will peak with a smoothed sunspot number of 165 in March 2000.

## Ionospheric Activity

There was a short-wave fadeout from 2335 to 2357 UTC on 29 August associated with the class M1.4 flare. Some spread F was also observed during the local night time during July in the southern regions of Australia.

There were also short periods of depressed activity during daylight hours in northern Australia. MUFs were down by about 15-20%. These were mainly observed around Darwin. The Ionospheric Prediction Service issued nearly a dozen HF radio communications warnings during the quarter relating to this depressed activity.

## Geomagnetic Activity

The increase in geomagnetic activity on 31 July is believed to be related to a coronal hole.

While the Learmonth A index was 11, the planetary A index was 19. The planetary A index is actually an average of the observations taken around the world. The activity in the northern hemisphere was responsible for the higher average.

Activity increased to unsettled to active during 3, 13-14 and 28 August. The first being associated to the 30 July coronal mass ejection and the last two believed to be related to coronal holes.

A coronal mass ejection on 27 September is likely to be the cause of geomagnetic storm activity around 7 October.

## T index

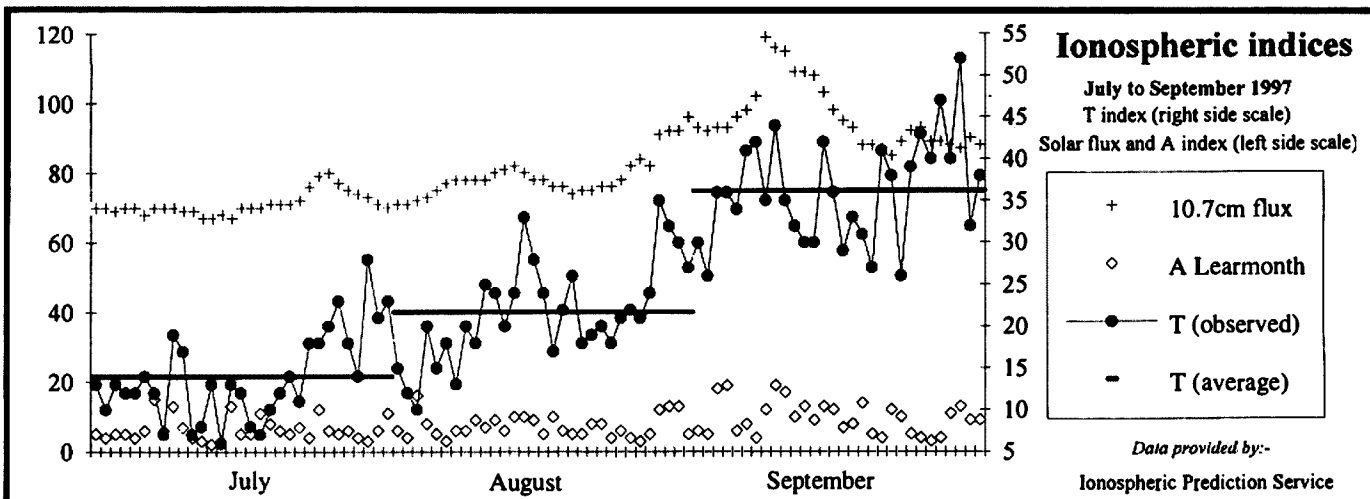
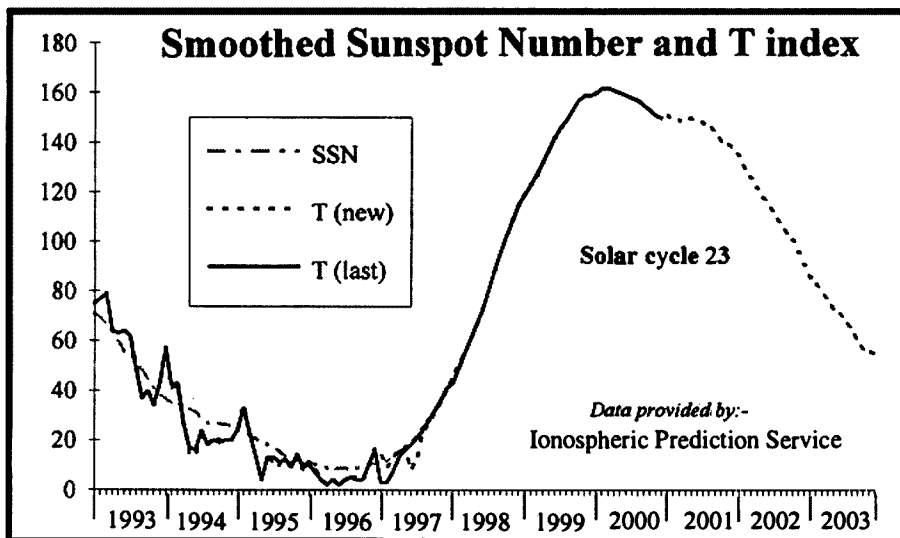
The Ionospheric Prediction Service revised the T index table during the last quarter. Values are now quoted up to the year

2006. These changes are reflected in the solar cycle graph. The revised data is displayed as T (new) and previously published values (Amateur Radio August 1997 page 51) are labelled T (last). Only values to 2003 are shown as the graph is meant to cover one solar cycle, normally eleven years.

## The Ionosphere Online

The Ionospheric Prediction Service now provides an online map of the ionosphere, accessible through their world wide web site. The map is for the Australian region and includes local HF predictions (Hourly Area Prediction charts), detail on current communications warnings and details! on HF fadeouts. The address is: [http://www.ips.gov.au/asfc/aus\\_fc/](http://www.ips.gov.au/asfc/aus_fc/) The telephone number for the recorded message, which gives both ionospheric indices and conditions has changed; the number is now 02 9213 8012.

\*C/o PO Box 2175, Caulfield Junction VIC.3161  
ar

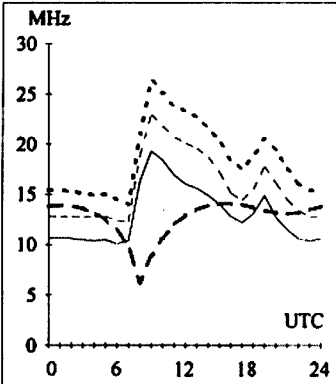
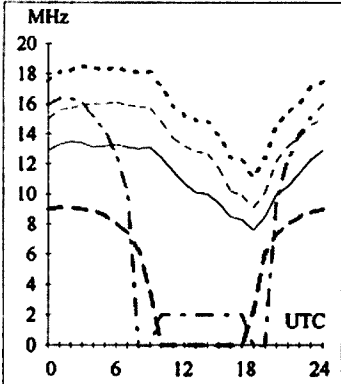


**Adelaide-Auckland** 104  
 Second 2F13-19 2E2 Short 3240 km

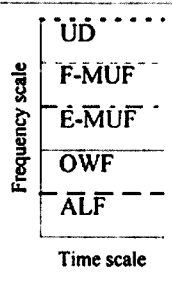
**Brisbane-London** 147  
 First F 0-5 Long 23498 km

# HF Predictions

*Evan Jarman VK3ANI*



**T Index: 35**



These graphs show the predicted diurnal variation of key frequencies for the nominated circuits. This also indicates a possibility of communication (percentage).

The frequencies, identified in the legend, are:-  
 Upper Decile (F-layer, 10%)  
 F-layer Maximum Useable Frequency (50%)  
 E-layer Maximum Useable Frequency  
 Optimum Working Frequency (F-layer, 90%)  
 Absorption Limiting Frequency

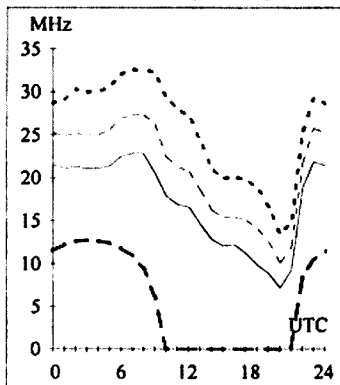
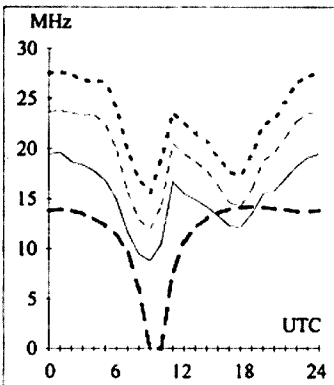
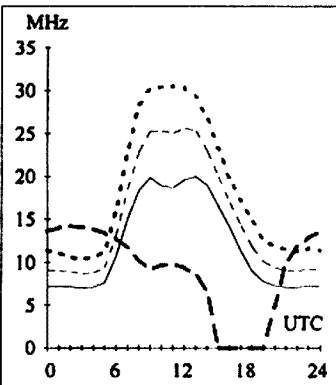
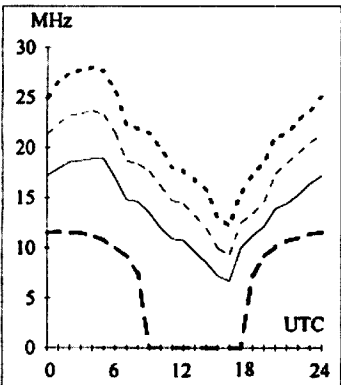
The predictions were made with the Ionospheric Prediction Service program, ASAPS V3.2. The T index used is shown above the legend. The Australian terminal azimuth, path and propagation mode are also given for each circuit.

**Adelaide-Honolulu** 57  
 Second 4F7-11 4E0 Short 9160 km

**Brisbane-London** 327  
 First F 0-5 Short 16526 km

**Canberra-Barbados** 123  
 First F 0-5 Short 16232 km

**Darwin-Osaka** 5  
 First 2F4-9 2E0 Short 5263 km

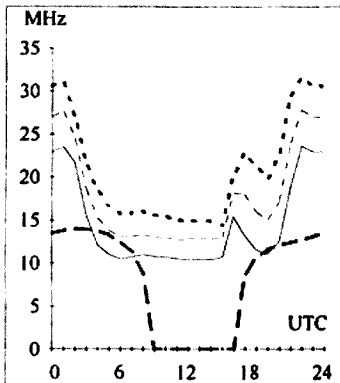
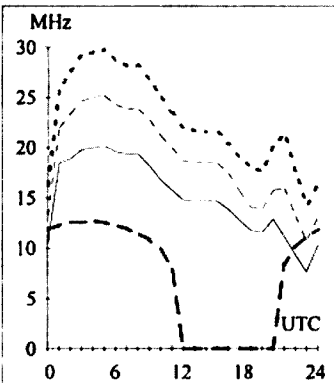
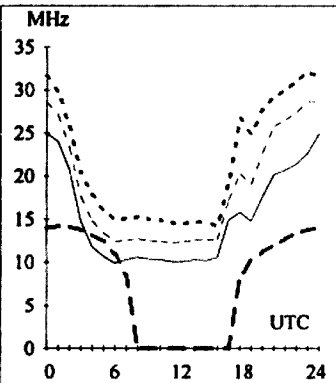
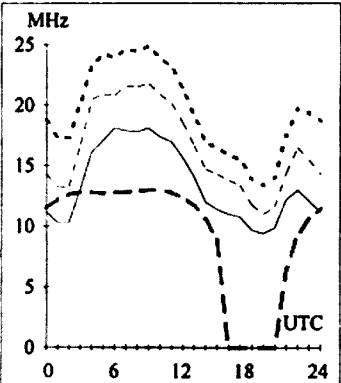


**Adelaide-Lusaka** 246  
 Second 4F4-8 4E0 Short 10788 km

**Brisbane-Seattle** 44  
 Second 4F2-5 4E0 Short 11845 km

**Canberra-New Delhi** 303  
 Second 4F4-9 4E0 Short 10348 km

**Darwin-San Francisco** 54  
 First F 0-5 Short 12316 km

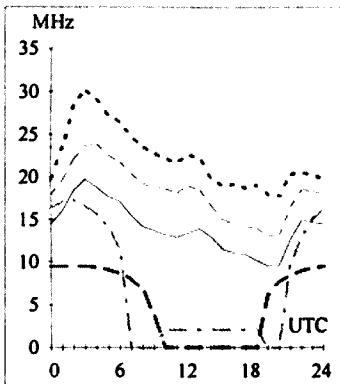
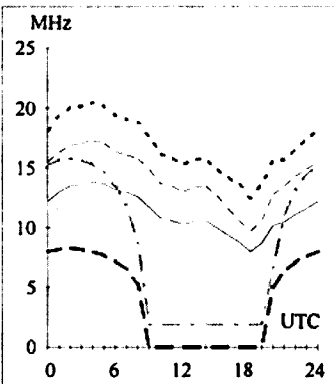
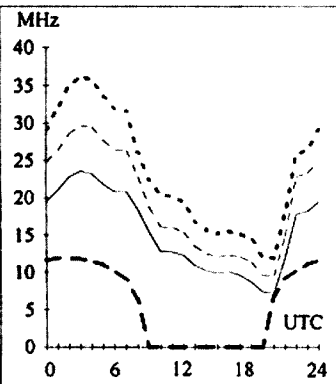
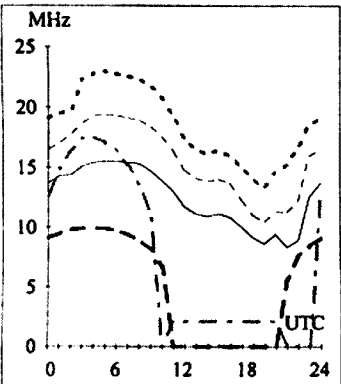


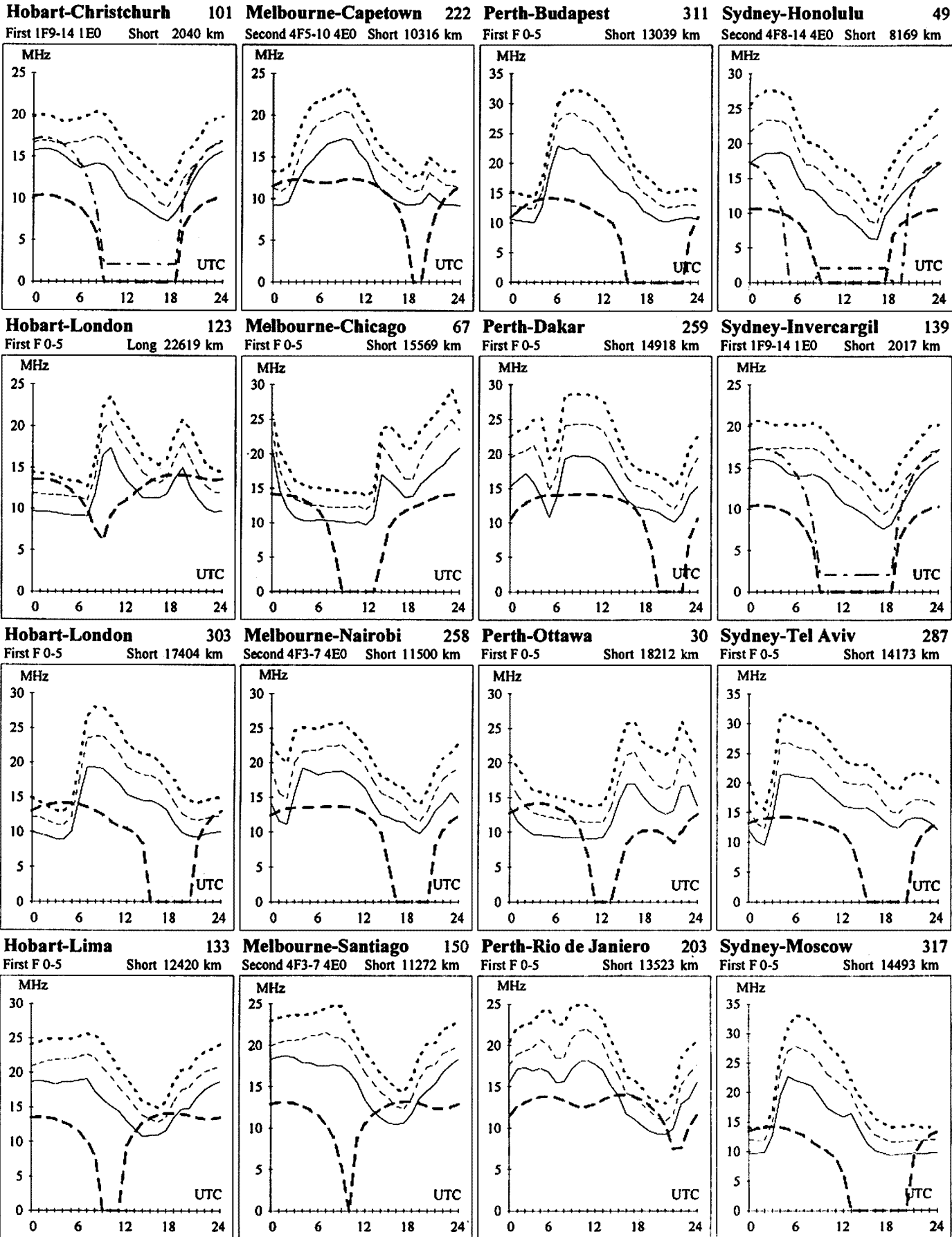
**Adelaide-Singapore** 311  
 Second 3F11-18 3E1 Short 5414 km

**Brisbane-Tokyo** 348  
 Second 3F6-10 3E0 Short 7159 km

**Canberra-Port Moresby** 355  
 Second 2F16-22 2E4 Short 2870 km

**Darwin-Suva** 103  
 Second 3F12-17 3E2 Short 5126 km





# HAMADS

- Hamads may be submitted on the form on the reverse side of the *Amateur Radio* address flysheet. Please use your latest flysheet where possible.
- Please submit separate forms for **For Sale** and **Wanted** items, and be sure to include your name, address and telephone number (including STD code) if you do not use the form on the back of the *Amateur Radio* address flysheet.
- Eight lines (forty words) per issue free to all WIA members, ninth and tenth lines for name and address. Commercial rates apply for non-members.
- Deceased estates Hamads will be published in full, even if the ad is not fully radio equipment.
- WIA policy recommends that the serial number of all equipment offered for sale should be included in the Hamad.
- QTHR means the address is correct in the current WIA Call Book.
- Ordinary Hamads from members who are deemed to be in general electronics retail and wholesale distributive trades should be certified as referring only to private articles not being re-sold for merchandising purposes.
- Commercial advertising (Trade Hamads) are pre-payable at \$25.00 for four lines (twenty words), plus \$2.25 per line (or part thereof), with a minimum charge of \$25.00. Cheques are to be made out to: WIA Hamads.
- Copy should be typed or in block letters, and be received by the deadlines shown on page 1 of each issue of *Amateur Radio*, at:

Postal: 3 Tamar Court, Mentone VIC 3194  
Fax: (03) 9584 8928  
E-mail: vk3br@c031.aone.net.au

## TRADE ADS

- **AMIDON FERROMAGNETIC CORES:** For all RF applications. Send business size SASE for data/price to RJ & US Imports, PO Box 431, Kiama NSW 2533 (no enquiries at office please ... 14 Boanyo Ave Kiama). Agencies at: Webb Electronics, Albury; Assoc TV Service, Hobart; Truscotts Electronic World, Melbourne and Mildura; Alpha Tango Products, Perth; Haven Electronics, Nowra; and WIA Equipment Supplies, Adelaide.
- **WEATHER FAX programs** for IBM XT/ATs \*\*\* "RADFAXZ" \$35.00, is a high resolution short-wave weather fax, Morse and RTTY receiving program. Suitable for CGA, EGA, VGA and Hercules cards (state which). Needs SSB HF radio and RADFAX decoder. \*\*\* "SATFAX" \$45.00, is a NOAA, Meteor and GMS weather satellite picture receiving program. Needs EGA or VGA & WEATHER FAX PC card, + 137 MHz Receiver. \*\*\* "MAXISAT" \$75.00 is similar to SATFAX but needs 2 MB of expanded memory (EMS 3.6 or 4.0) and 1024 x 768 SVGA card. All programs are on 5.25" or 3.5" disks (state which) plus documentation, add \$3.00 postage. ONLY from M Delahunty, 42 Villiers St, New Farm QLD 4005. Ph 07 358 2785.
- **HAM LOG v.3.1** - Acclaimed internationally as the best IBM logging program. Review samples....AR: "Recommend it to anyone".  
The Canadian Amateur: "Beyond this reviewer's ability to do it justice. I cannot find anything to improve on. A breakthrough of computer technology". ARA: "Brilliant". Simple to use with full help, the professional HAM LOG is immensely popular (now in its 5th year), with many useful, superb features. Just \$59 (+\$5 P & P), with a 90 page manual. Special 5 hour Internet offer. Demos, brochures available. Robin Gandevia VK2VN, 02 369 2008 BH, fax 02 369 3069. Internet address rhg@ozemail.com.au.

## FOR SALE NSW

- Cushcraft R-5 antenna, 10-12-15-17-20 metre, complete with manual, as new, \$215. 10-11 metre

Werner Wolf vertical, new, never used, \$100. Model 178 SWR/Power, Mod, FS Meter, antenna matcher, new, never used, \$100. K B Carey, VK2CWI, QTHR.

- 18 MHz monoband 3 el Yagi, excellent cond, Buyer collect, J R Thurston VK2KV, 02 4787 7003.
- TH6-DX tri-band HF beam, \$350. Yaesu FRG-7 HF receiver, \$150. Electrophone TXB-153 hand-held 2 m, \$150. DSE light duty rotator, \$100. AX-144 11 m SSB txcvr, \$175. Philips FM-92 2 m, \$150. Tony VK2BS, QTHR, 02 6642 3641 (AH), 02 6643 0243 (BH).
- Kenwood TS-520S txcvr, s/n 610946, excellent condn. complete with frequency counter, operating manuals, new spare set of final tubes, DC lead, mic. \$600. Ted VK2BTB, QTHR, 02 9644 4071.
- Yaesu FT-101Z txcvr, s/n 9H090635, as new, incl manual, original, maintenance manual, Z match (h/brew). Allan VK2PT, 02 4967 1495.
- Kenwood TS-43X HF txcvr, s/n 4111010, with SP-430 external speaker, \$700 the pair. DSE power supply, 3-15 V 25 amp, s/n 92515310, \$150. The lot \$800. Jon VK2JFE, QTHR, 02 9456 5805.
- Cushcraft tri-band Yagi, 10-15-20 m, \$110. 2m 12 element beam, \$65. Both antennas in very good condn. Ernest VK2BED, 02 9532 0175.
- Deceased estate. Kenwood TS-430S HF txcvr, both manuals, recently serviced, \$850. Kenwood TR-8400 UHF FM mobile with manual, \$250. Drake low pass filter, 1 kW, \$50. Freight extra at cost. John VK2FUR, 02 4625 1812.
- Icom IC-706 HF/6 m 2 m txcvr, remote cable, face, mounting bracket, never used mobile, mic, manual, leads, s/n 3672, can mail anywhere, \$1750. Ossie VK2RB, QTHR (QTH Tweed Heads on VK4 border), 07 5536 5951.
- HF antenna and tower: 60 ft (18 m) three-stage wind-up tower, 3 sets of guys, tumbuckles, TH6DXX antenna, Daiwa rotator, dismantled Sydney, \$900. E G Popham VK2EZQ, QTHR, 019 460 437 1900 - 2100 AEST.
- Yaesu FT-209RH handheld txcvr, 140 - 150 MHz,

5 W output, new battery, case, YH2 headset-mic for hands-free work with VOX, VGC, \$290 the lot. Bruno VK2BPO, QTHR, 02 9713 1831.

- Grundig DTR1100 digital satellite receiver, s/n 20000279, excellent working condn, with remote control and instruction manual, 1 1/2 years old, paid \$1400, will sell for \$880 ONO. Max VK2AML, 02 9797 0593.
- Icom IC-2400A, 144 and 420 MHz, 45 W, \$600. Icom IC-3200A, 144 and 420 MHz, 25 W, \$550. Both as new with manuals. Kenwood TM-201A, 144 MHz, 25 W, \$250. MFJ-484 four memory keyer with "track" key, \$200. 13.6 V 20 A PSU, ex computer, \$200. A M Dan VK2ABU, QTHR, 02 9314 6055 (BH), 02 9328 1261 (AH).

## FOR SALE VIC

- Yaesu FT-757GX, auto ATU, plus PSU, \$1100. Can be viewed in Melbourne. VK3NI, QTHR, phone Mario 02 6027 3377.
- Motorola MCX100 2 m VHF radio, 16 channel, EPROM prog complete with prog, \$120 ONO. C D Slager VK3AZE, 03 9309 4462.
- Chirside CA-33 tri-band beam, with CDE Ham II rotator system, beam disassembled with documentation and ready for transportation, \$520 ONO. Philips 815 (UHF Mk I) 50 watt base station transmitter with in-built 10 amp 13.8 volt power supply, \$100. Yaesu FT-4700RH dual band 2 m/70 cm mobile, in mint condn with box, \$840 ONO. Motorola HT220s UHF hand-helds, pair, \$50. UHF 6LD 450S Diplexer, 6 cavity type, \$100 ONO. Ian Keenan VK3AYK, QTHR, 03 9585 1123 (AH).
- Kenwood TL-922 HF linear amp, 160-10 m, 1200 watts output, new Eimac 3500Z tubes fitted recently, \$1850. Ray VK3RD, 03 9726 9222.
- Yaesu FT-707 HF txcvr, \$600. Yaesu FC-707 ATU, \$200. Yaesu FP-707 power supply, \$300. All reasonable offers considered. R W Taylor VK3XRT, QTHR, 03 9723 7802, VK3XRT@VK3ECC, [rt@rag.com.au](mailto:rt@rag.com.au)
- Motorola MCX100 2 m 16 ch radio, 30 W output, EPROM programmable, \$100. Claus VK3AZE, QTHR, 03 9309 4462.
- MFJ 9020, 20 m QRP txcvr, 4/5 watt CW, 13.8 V, \$90. James VK3AIQ, 03 5349 2382.
- Novice package, Icom IC-721 HF txcvr, AH-3 ATU, AH-2b element, IC-2300 dualband, Alinco DJ-560 dualband hand-held, \$1800. Will separate, works well, upgrading shack. F J Messemaker VK3HFM, 03 5360 8284.
- Icom IC-735 HF txcvr, complete with mic, handbook, mobile mounting bracket, in original box, EC, \$950. Yaesu FT-900 mobile txcvr, as new in box, complete with FSK900 remote kit, handbook, under warranty, \$1500. Rob VK3JE, 02 6027 1077.
- Ameritron linear amplifier, 600 W, plus peak reading SWT/Wattmeter that goes with amp. MFJ-815B linear amplifier, s/n AL81113539X. Items practically new, reason for sale is they are too heavy for an invalid person to handle, reasonable offer accepted. Antonio Lucani VK3ALA, Lot 2 Stanley Road, Stanley VIC 3747, 03 5728 6624 (any time).
- FT-101ZD, \$550. FV-101Z ext VFO, \$120. FT-101B, \$250. FT-102, SP-102, \$650. A3S 3-el tri-band, \$550. IC-2SAT, \$220. AWA F242A Dist/Analyser, \$800. IC-AT100 ATU, \$120. Leader ATU, 250 W, \$175. Star ST-700 and SR-700. Rx/Tx pair, \$300. NJZ-900 analogue phone tester, \$2300. Bird Wattmeter plug-ins, \$100 each. 10 MHz CRO,



\$150. 500 MHz frequency counter, \$150. AWA RT-80, \$40. Lee VK3GK, 7 Ester Crescent, Clayton VIC 3168.

• Icom IC-735 HF txcvr, EC, with mic, handbook, service manual, Oskeblock SWR meter, plus other extras, \$875. Alan VK3AMT, 03 9789 9106.

• Plustek 800 single sheet page-reader, HP and Twain compliant, needs Windows 3.1, black and white only, unit is a scanner/copier/fax up to A4, with all software, manuals and cables, excellent condn, \$110 ONO. Harold VK3AFQ, QTHR, 03 9596 2414.

• Yaesu MD-1B8 dynamic mic, perfect condn, up/down control, 8 pin, \$200. TET HB33 mini beam, performs well, owner upgrading, \$300. P W B Johnson VK3AJR, QTHR.

#### FOR SALE OLD

• Estate of Jim Biddle VK4QC. Yaesu FT-7B, excellent condn, complete with mic, handbook, DC lead, packed in original carton, \$400. Yaesu FT-757GXII, bought new 10 March 1992 but due to failing health only used for about a dozen QSOs, complete with mic, DC lead, handbook, packed in original carton, mint condn, \$1200. Heathkit Cantenna dummy load, 1 kW capacity, with manual, good condn, \$75. Kenwood AT-200 antenna tuner, very good condn, with manual, packed in original carton, \$125. Icom IC-02AT hand-held 2 m transmitter with HS-10SA VOX unit and hands-free headset suitable for mobile operation, all originally supplied accessories and original packing cartons, \$200. Icom IC-255A 2 m FM txcvr, with handbook, mic, mobile fittings and original packing, \$250. Quapitty new 300 ohm open wire antenna feed cable (ladder line not ribbon type), estimate between 30 and 50 metres, \$25. Contact Trevor Knight VK4NLX on 076 612 432 (AH) or 076 613 131 (BH) for further details or inspection. Prices quoted are not negotiable as the condition of these items means they are really good value.

• Kenwood TS-520S, s/n 830738, includes two spare 6146s, \$300. Matching DG5 digital display, s/n 720321, \$100. The lot, \$400. Charlie VK4BQ, QTHR, 077 794 301 or 077 788 786.

• Kenwood TS-680 with PS-50 PSU, SP-940, MC60 mic, \$1000. ATU-230, \$150. Icom IC-02A 2 m hand-held, \$250. Multi band Comantenna, \$100. All in good condn with manuals. Rod VK2BRW, Gold coast, 07 5524 3722.

• Stepped attenuator, 22 GHz, 80 dB range in 20 dB steps, SMA connectors, electrically stepped, \$30. Gary VK4AR, 07 3353 1695.

• Kenwood TS-140S, s/n 21000625, MC-80 mic, IF-10C interface, take away at \$1000. Richard VK4DIC, QTHR, 07 3264 1655.

#### FOR SALE SA

• Prime Focus 2.76 m dish, as new, solid spun heavy duty aluminium, with heavy duty, hot dipped polar mount and tripod, all mounted on a heavy duty tandem trailer with stabilisers, ideal for tropospheric work, best offer. Bob VK5UL (ex VK5BJA), QTHR, 08 8362 2251 (BH), 08 8267 5859 (AH).

• Kenwood TS-600 all mode 6 m txcvr, EC, s/n 710203, including user and workshop manuals, mic, etc, \$350 ONO. David VK5AXW, 08 8370 9569 (AH), 08 8370 1066 (BH).

#### FOR SALE WA

• Icom IC-505 all mode txcvr, 50-54 MHz, fitted with FM board, recently overhauled by Icom, complete with Dick Smith 100 W linear amp, good condn, \$675. TH3 Jnr tri-band band beam, good condn, \$200. Bruce VK6CX, 08 9810 4740 (AH), 08 9222 3616 (BH). Licensed amateurs only.

#### FOR SALE TAS

• Icom IC-736, auto ATU, 160-6 m, gen coverage receive, boxes, manuals, as new, \$2350. FL-102 Icom AM narrow filter, \$65. Commodore MPS801 printer, new, \$90. Samsung green-screen monitor, new, \$85. Com-Pakratt RS232 level converter and

program cartridge, suit C64 and C128, interfaces Commodore to PK232. Kenwood TS-690SAT 160-6 m, general coverage, \$1600. PS-5I power supply, \$275. Allen VK7AN, QTHR, 03 6327 1171 (H), 0417 354 410.

#### WANTED NSW

• Circuit for Acer 500/Multitech model MM-211 computer monitor, copying and other costs will be reimbursed. Photographic manual, "The Dufaycolor Book", to buy or borrow, needed for research into history of colour systems, costs re-imbursed. Philip VK2ZPW, QTHR, 02 9528 8070.

• 1997 International Call Book. Karl VK2GSN, 02 9773 7594 any time.

• Morse keys, especially Australian keys, Auto-Morse, Pendographs and simplex autos, top dollar paid for good condn keys. Steve VK2SPS, 02 9999 2933 after 6 pm.

• Plug-ins for Bird 43 Thruline watt-meters, elements 5C, 50C, 1000C, 50D, 1000D, 2.5K and 25K. Guy VK2BBF, QTHR, 02 4751 6726.

• Drake SSRI service info, will pay all costs. R L Murphy VK2ERM, 07 5524 2940.

• Kenwood TH-28A accessories, BT-8 battery case, PB-13 battery pack case. Noel VK2TNB, QTHR, 02 9546 3617.

#### WANTED VIC

• Power supply boxes for Wireless Sets 11 and 19, in any condn. Any front panel for No 11 set, nameplates, knobs. Original slow motion dial for R1155 receiver. Clem VK3CYD, QTHR, 03 9486

0343, clem.jarvis@rmit.edu.au.

• AR7 communications receiver, in any condn. Howard L30951, 03 9408 7597.

• Yaesu FL-7000, with handbook. Noel VK3FGN, 041 734 1464

• Yaesu FTV-250 VHF transverter. Yaesu YD-148 desk mic. Yaesu FC-101 antenna coupler. Bill VK3HX, QTHR, 03 9807 9172, fax 03 9807 9080.

#### WANTED SA

• Old valve receiver wreck, BC342, BC312, AR88, SX28, or other 1940s to 1960s model for education and restoration. Rob VK5RG, QTHR, 08 8379 1889.

• Spare CRT type T5550-2 for Tektronix type 555 CRO, must be in good working order. C Ratcliff VK5ZST, 08 8520 2988.

• Yaesu YO-901 monitorscope and/or information re same. Also valve communications receiver, Eddystone, Collins, etc. David VK5AXW, 08 8370 9569 (AH), 08 8370 1066 (BH).

• Yaesu FTDX401 instruction manual (or copy). Maurie VK5ZU, QTHR, 08 8344 3537.

#### MISCELLANEOUS

• The WIA QSL Collection (now Federal) requires QSLs. All types welcome, especially rare DX pictorial cards, special issue. Please contact the Hon Curator, Ken Matchett VK3TL, 4 Sunrise Hill Road, Montrose VIC 3765, tel 03 9728 5350.

• Summerland Computer Expo, Lismore NSW City Hall on Saturday, 22 November, commercial displays, pre-loved gear tables, Internet sessions, lucky door prizes, refreshments, sponsors SARC. Contact John on 02 6621 5217. ar

## Technical Correspondence

All technical correspondence from members will be considered for publication, but should be less than 300 words.

### Beam Gain Formula

Browsing through some old magazines I chanced upon a very interesting theory concerning the gain of a beam antenna.

It was a May 1956 edition of *CQ* and from an amateur named Robert Weinstein W2JAY. He worked for a beam manufacturer and had been searching the literature in vain for some simple method of predicting the gain of any design of beam antenna in advance of its construction.

From observed test results and published data, some hundreds in number, he claims that he discovered a simple formula involving only three factors which satisfied all of the assembled data.

The formula was: That the maximum gain obtainable from a parasitic half-wave beam antenna is given by the expression  $G_p = E + E(1+S) >$  where  $G_p$  = power gain over reference dipole,  $E$  = number of elements in beam, and  $S$  = average wavelength spacing between elements.

This formula assumes ideal conditions in that the beam is not of reduced dimensions, spacing is not reduced or increased to reduce gain, and that the beam is adjusted (particularly element spacing and lengths) for maximum gain. Also, that the SWR is intended to be 1:1 and that the antenna is mounted at reasonable effective height and

away from obstacles.

He claims that this expression has been confirmed by the published gain charts of leading antenna manufacturers and other articles.

**Example 1:** What is the power gain of a three element half-wave beam antenna with 0.1 wavelength director spacing and 0.2 wavelength reflector spacing?

From the formula,  $G_p = 3 + 3(1+0.15) > = 6.45$ . This power gain is equivalent to a gain of 8.1 dB.

**Example 2:** What is the power gain of a four element half-wave beam with a 0.1 wavelength spacing for the 1st and 2nd directors and 0.25 wavelength reflector spacing?

Compute average spacing as  $(0.1 + 0.1 + 0.5)/3 = 0.15$ . Therefore,  $G_p = 4 + 4(1.15) > = 8.6$  power gain; which is equivalent to a gain of 9.3 dB.

Certainly it does give figures which seem realistic and much more likely to be correct than some of the fancy claims that are made in this area. Seems that they had it all worked out back then and we haven't improved on it since!

Try it out and see if you agree with it.

Reg Carter VK3CAZ  
RMB N330 Ballarat VIC 3352

ar

# WIA Divisions

The WIA consists of seven autonomous State Divisions. Each member of the WIA is a member of a Division, usually in their residential State or Territory, and each Division looks after amateur radio affairs within its area.

Division	Address	Officers	Call Signs	Weekly News Broadcasts	1997 Fees
VK1	ACT Division GPO Box 600 Canberra ACT 2601	President Hugh Blemings Secretary John Woolner Treasurer Les Davey	VK1YYZ VK1JET VK1LD	3.570 MHz LSB, 146.950 MHz FM each Sunday evening commencing at 8.00 pm local time. The broadcast text is available on packet, on Internet <a href="http://www.amsat.org.au/ausradio/misc">ausradio.amsc</a> newsgroup, and on the VK1 Home Page <a href="http://www.vk1.wia.ampr.org">http://www.vk1.wia.ampr.org</a>	(F) \$72.00 (G) (S) \$56.00 (X) \$44.00
VK2	NSW Division 109 Wigram St Parramatta NSW (PO Box 1066 Parramatta 2124) Phone 02 9689 2417 Freecall 1800 817 644 Fax 02 9633 1525	President Geoff McGrorey-Clark Secretary Eric Fossey Treasurer Eric Van De Weyer (Office hours Mon-Fri 11.00-14.00)  Web: <a href="http://marconi.mpce.mq.edu.au/wia">http://marconi.mpce.mq.edu.au/wia</a> e-mail address: <a href="mailto:vk2w1@ozemail.com.au">vk2w1@ozemail.com.au</a> Packet BBS: VK2WI on 144.850 MHz	VK2EO VK2EFY VK2KUR	From VK2WI 1.845, 3.595, 7.146*, 10.125, 14.160, 24.950, 28.320, 29.120, 52.120, 52.525, 144.150, 147.000, 438.525, 1281.750 (* morning only) with relays to some of 18.120, 21.170, 584.750 ATV sound. Many country regions relay on 2 m or 70 cm repeaters. Sunday 1000 and 1930. Highlights included in VK2AWX Newcastle news, Monday 1930 on 3.593 plus 10 m, 2 m, 70 cm, 23 cm. The broadcast text is available on the Internet newsgroup <a href="http://www.amsat.org.au/ausradio/misc">aus.radio.amateur.misc</a> , and on packet radio.	(F) \$69.00 (G) (S) \$56.00 (X) \$41.00
VK3	Victorian Division 40G Victory Boulevard Ashburton VIC 3147 Phone 03 9885 9261 Fax 03 9885 9298	President Jim Linton Secretary Barry Wilton Treasurer Rob Hailey (Office hours Tue & Thur 0830-1530) Web: <a href="http://www.tbsa.com.au/~wia/vic/">http://www.tbsa.com.au/~wia/vic/</a>	VK3PC VK3XV VK3NC	VK3BWI broadcasts on the 1st Sunday of the month, starts 10.30 am. Primary frequencies 3.615 LSB, 7.085 LSB, and FM(R)s VK3RML 146.700, VK3RMM 147.250, VK3RWG 147.225, (X) and 70 cm FM(R)s VK3ROU 438.225, and VK3RMU 438.075. Major news under call VK3WI on Victorian packet BBS and WIA VIC Web Site.	(F) \$75.00 (G) (S) \$61.00 (X) \$47.00
VK4	Queensland Division GPO Box 638 Brisbane QLD 4001 Phone 07 5496 4714	President Rodger Bingham Secretary Malcolm McIntosh Treasurer Bill Sebbens e-mail address: <a href="mailto:wiaq@brisbane.dialix.com.au">wiaq@brisbane.dialix.com.au</a>	VK4HD VK4ZMM VK4XZ	1.825 MHz SSB, 3.605 MHz SSB, 7.118 MHz SSB, 14.342 MHz SSB, 28.400 MHz SSB, 29.220 MHz FM, 52.525 MHz FM, 146.700 MHz FM, 147.000 MHz FM, 438.525 MHz (Brisbane only), regional VHF/UHF repeaters at 0900 hrs Sunday. Repeated on 3.605 MHz SSB & 147.000 MHz FM, regional VHF/UHF repeaters at 1930 hrs EAST Monday. Broadcast news in text form on packet under WIAQ@VKNET.	(F) \$74.00 (G) (S) \$60.00 (X) \$46.00
VK5	South Australian Division 34 West Thebarton Rd Thebarton SA 5031 (GPO Box 1234 Adelaide SA 5001) Phone 08 8352 3428 Fax 08 8264 0463	President Ian Hunt Secretary Graham Wiseman Treasurer Joe Burford  Web: <a href="http://www.vk5wia.ampr.org/">http://www.vk5wia.ampr.org/</a>	VK5QX VK5EU VK5UJ	1827 kHz AM, 3.550 MHz LSB, 7.095 AM, 14.175 USB, 28.470 USB, 53.100 FM, 147.000 FM Adelaide, 146.700 FM Mid North, 146.800 FM Mildura, 146.825 FM Barossa Valley, 146.900 FM South East, 146.925 FM Central North, 147.825 FM Gawler, 438.425 FM Barossa Valley, 438.475 FM Adelaide North, ATV Ch 35 579.250 Adelaide. (NT) 3.555 USB, 7.065 USB, 10.125 USB, 146.700 FM, 0900 hrs Sunday. 3.585 MHz and 146.675 MHz FM Adelaide, 1930 hrs Monday.	(F) \$75.00 (G) (S) \$61.00 (X) \$47.00
VK6	West Australian Division PO Box 10 West Perth WA 6872 Phone 09 351 8873	President Wally Howse Secretary Christine Bastin Treasurer Bruce Hedland-Thomas  Web: <a href="http://www.laroc.com.au/~vk6wia">http://www.laroc.com.au/~vk6wia</a>	VK6KZ VK6ZLZ VK6OO	146.700 FM(R) Perth, at 0930 hrs Sunday, relayed on 1.825, 3.560, 7.075, 14.116, 14.175, 21.185, 29.680 FM, 50.150 and 438.525 MHz. Country relays 3.582, 147.350(R) Busselton and 146.900(R) Mt William (Bunbury). Broadcast repeated on 146.700 at 1900 hrs Sunday, relayed on 1.865, 3.563 and 438.525 MHz; country relays on 146.350 and 146.900 MHz.	(F) \$62.00 (G) (S) \$50.00 (X) \$34.00
VK7	Tasmanian Division PO Box 271 Riverside TAS 7250 Phone 03 6327 2096 Fax 03 6327 1738	President Ron Churcher Secretary Barry Hill Treasurer Mike Jenner	VK7RN VK7BE VK7FB	146.700 MHz FM (VK7RHT) at 0930 hrs Sunday relayed on 147.000 (VK7RAA), 146.725 (VK7RNE), 146.625 (VK7RMD), 3.570, 7.090, 14.130, 52.100, 144.150 (Hobart) Repeated Tues 3.590 at 1930 hrs.	(F) \$74.00 (G) (S) \$60.00 (X) \$46.00
VK8	(Northern Territory is part of the VK5 Division and relays broadcasts from VK5 as shown received on 14 or 28 MHz).				

**Membership Grades**  
 Full (F) Pension (G)  
 Needy (G) Student (S)  
 Non receipt of AR (X)

**Three-year membership available**  
 to (F) (G) (X) grades at fee x 3 times

Note: All times are local. All frequencies MHz.

## ADVERTISERS' INDEX

Amateur Transceiver Radio _____	21	WIA Recruitment _____	15
Andrews Communication Systems ___	3	WIA Membership Retention _____	9
Dick Smith Electronics ____	28, 29, IBC		
ICOM _____	OBC, 37	Trade Hamads _____	
Radio and Communications _____	6	M Delahunty _____	54
Terlin Aerials _____	19	RJ & US Imports _____	54
WIA 1998 Call Book _____	IFC	HAMLOG - VK2VN _____	54

### TRADE PRACTICES ACT

It is impossible for us to ensure the advertisements submitted for publication comply with the Trade Practices Act 1974. Therefore, advertisers and advertising agents will appreciate the absolute need for themselves to ensure that the provisions of the Act are complied with strictly.

### VICTORIAN CONSUMER AFFAIRS ACT

All advertisers are advised that advertisements containing only a PO Box number as the address cannot be accepted without the addition of the business address of the box-holder or seller of the goods.

# Yaesu's Done It Again



## FT-920 HF/6m Transceiver With DSP

Now there's no excuse for not taking advantage of the latest advances in Digital Signal Processing, transceiver design plus the fun of 6m operation. The stunning new Yaesu FT-920 is a high performance HF/6m multi-mode receiver that provides 100W PEP output on the 160-6m bands, incredible front-end performance based on the FT-1000MP design, and a huge array of features that make it a pleasure to use.

At first glance Yaesu's renowned Omni-Glow LCD screen is obvious, and its wide-angle view provides a wealth of information about the transceiver's operating status with multi-function metering, dual frequency displays and an Enhanced Tuning scale for DSP bandwidth, CW tuning, FM discriminator and more. Inside, the FT-920 is built around a rugged diecast unibody chassis which provides excellent heatsinking for the low distortion dual MRF255 160-6m FET power amplifier.

For more comfortable operating when weaker signals are present Yaesu's engineers dedicated themselves to enhancement of real-world signal to noise ratios, and after thousands of hours of design and testing have produced an industry-leading 33.3MIPS (millions of instructions per second) processing speed DSP in the FT-920 that provides a two-parameter noise reduction system with 32 steps of front panel adjustment. This amazing system also provides dual control DSP passband tuning, DSP auto-notch filter, an amazing new transmit Digital Speech Processor, DSP mic

equalisation, fast acting DSP VOX circuitry as well as a Contest-ready Digital Voice Recorder!

Other features include an all-band (160-6m) auto antenna tuner which also provides greater receiver band-pass protection, Direct Digital Synthesis for clean local oscillators, selectable frequency-optimised receiver front-end pre-amps, and a Shuttle Jog tuning ring for fast QSY. A Dual Watch receive system allows you to check for band openings, especially handy when monitoring 6m. Also provided are SSB/CW/FM operation (AM with optional filter), 127 memories with alphanumeric labelling, IF shift and IF noise blanker to fight interference, plus an extensive menu system for selecting most "set and forget" functions.

The FT-920 is supplied with an MH-31B8 hand mic, DC power lead and comprehensive instruction manual.

Why not call for a copy of the Yaesu 6 page FT-920 colour brochure to learn more about this efficient transceiver that's without peer in its price class.

D 3420



# \$2995

**2 YEAR WARRANTY**

*Due end Oct 97*

### PHONE FAX AND MAIL ORDERS

**PHONE:** WITHIN AUSTRALIA: 1300 366 644  
(Local Call Charge)

**FAX:** (02) 9395 1155 within Australia and  
(+612) 9395 1155 from outside Australia

**MAIL:** DICK SMITH ELECTRONICS, Direct Link Reply Paid 160,  
PO Box 321, North Ryde NSW 2113 (No Stamp Required)

*Excludes packaging and postage. All major Credit Cards accepted.  
14 Day Money Back Guaranteed if NOT completely satisfied.*

Visit our web site at  
<http://www.dse.com.au>

B 3050 col



# Let your mouse tune into the world.



The world's airwaves are now at your fingertips with the new IC-PCR 1000. This 'black box' unit delivers 3 receiver interfaces to your PC. A communications receiver; a 4 component display; and a radio screen with presets. Access the world of radio from AM or FM programming, to ham radio, aviation or marine broadcasts... all for a much cheaper outlay than buying each radio individually, and we even supply the single aerial! Hearing is believing... for the name of your nearest Icom dealer call toll free on **1800 338 915** now.

**ICOM**  
Clearly Ahead

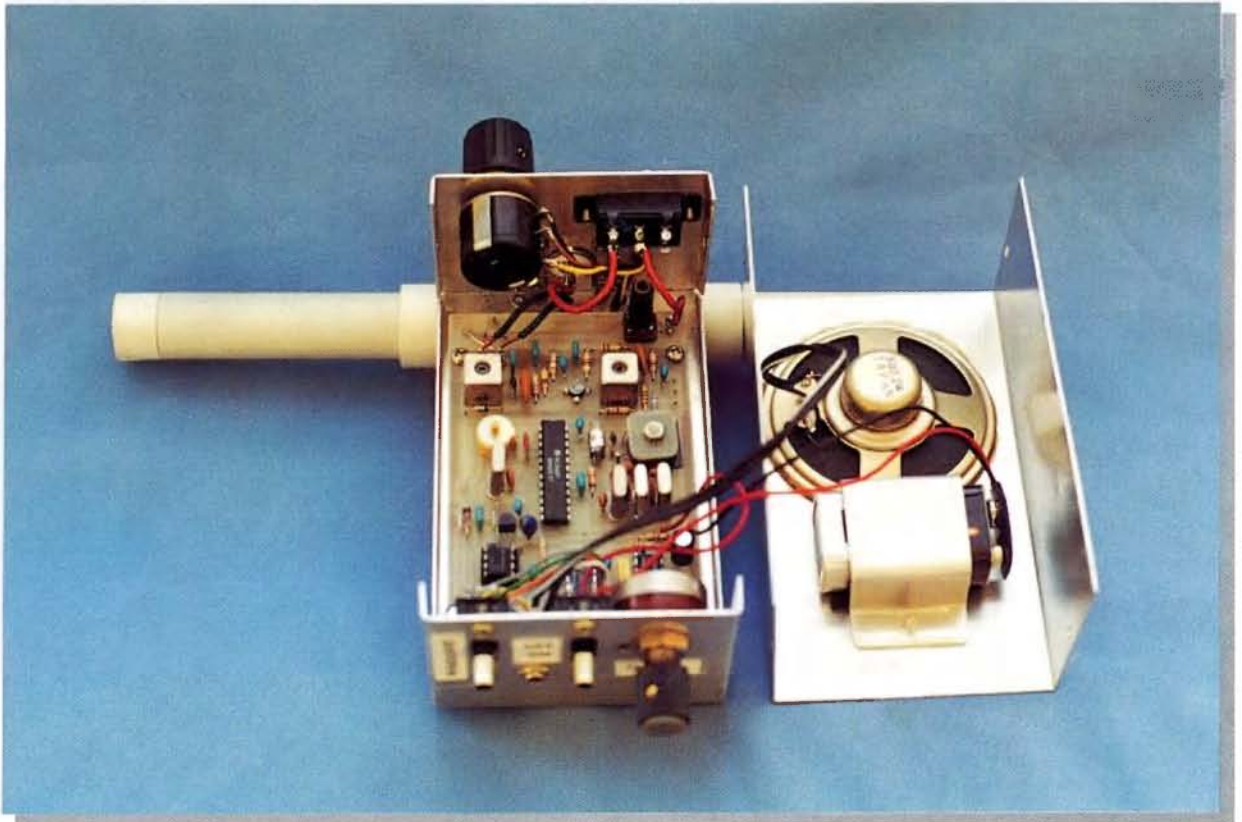
# Amateur Radio

December 1997

Volume 65 No 12



*Journal of the Wireless Institute of Australia*



*Full of the latest amateur radio news, information and technical articles including...*

- Review of PV-35R & PV-85R 2 m Power Amplifiers
- Converting the PV-35R & PV-85R for SSB Operation
- An 80 m Receiver for ARDF

**Plus** *lots of other articles, news and special interest columns*

# Yaesu FT-1000MP

## Incredible Performance, Amazing Price!



Now's your chance to pick up Yaesu's highest performance HF base transceiver, the new FT-1000MP, at a very attractive price. You'll be amazed at its incredible performance, but if you need convincing, just read what the experts have to say.

### On Operation:

"I would classify the transceiver as 'user friendly' compared to some other modern transceivers I have operated." - CQ  
 "..... we found it to be a proficient performer." - QST  
 ".....In term of ergonomics my preference is marginally for the Yaesu.....The second receiver is certainly better implemented....." - Radio Comms (UK)

### On Documentation:

"In general, Yaesu's manuals are the epitome of clear, concise, and complete documentation, and the FT-1000MP's 104 page Operating Manual is no exception." - QST

### On The Receiver:

"Its receiver is a real beauty ... its very clean and the audio is very clear and punchy ...." - Radio & Communications  
 "Measurement of second order intermodulation ... showed an average result for the IC-775DSP but the FT-1000MP was some 10dB better than any other radio measured." - Radio Comms (UK)  
 "The receiver is quiet and good at its job, and Yaesu's EDSP is icing on the cake." - QST  
 "Certainly, this receiver is designed to withstand the onslaught of very strong signals...." - CQ

### On The Transmitter:

"CW operators will be impressed with the FT-1000MP keyer." - CQ  
 "The transmitter is good as well, with a lightning fast automatic tuner built in as standard." - Radio & Communications  
 "The FT-1000MP has excellent spectral purity of the output signal." - CQ

### Digital Signal Processing:

"The EDSP filter operates smoothly and effectively in all of its modes." - CQ  
 "Having the DSP built-in means it works as well as possible - and is clearly better than most after-market add-ons." - Radio & Communications  
 "The double-whammy of crystal and mechanical filters plus DSP in the FT-1000MP is a killer combination." - QST

### Conclusions:

"... I am unable to report finding even a picky fault with the FT-1000MP." - CQ  
 "So does the inbuilt DSP say 'buy me'? In this humble scribes opinion, you bet!" - Radio & Communications  
 "The FT-1000MP offers performance and flexibility in a quality radio." - QST

Interested in more information? Why not call us for a copy of Yaesu's 12 page colour booklet, 46 page Technical Overview, or for copies of various magazine reviews. We're sure you'll soon agree that the world of HF transceivers has just taken a giant leap forward.

QST - ARRL QST (USA) Magazine review April 1996  
 CQ - CQ (USA) Magazine review April 1996  
 Radio Comms - Radio Communications (UK) magazine review January 1996  
 Radio & Communications - Radio & Communications (Aust) magazine review July 1996

Cat D-3400

# \$3995

2 YEAR WARRANTY



For further information, orders or the location of your nearest store call:

Ph: 1300 366 644 (local call charge)

Or Fax: (02) 9805 1986



# Amateur Radio



## Journal of the Wireless Institute of Australia

Vol 65 No 12

ISSN 0002-6859

December 1997

Amateur Radio is published by the Wireless Institute of Australia, ACN 004 920 745 as its Official Journal, on the last Friday of each month.

### Editorial

#### Editor

Bill Rice VK3ABP\*

#### Production Manager

Bill Roper VK3BR

#### Senior Technical Editor

Peter Gibson VK3AZL\*

#### Technical Editors

Evan Jarman VK3ANI\*

Gil Sones VK3AUI\*

Don Graham VK6HK

#### Contributing Editors

Ron Fisher VK3OM\*

Don Jackson VK3DBB\*

#### WIA News Editor

Roger Harrison VK2ZRH

#### Proof Readers

Allan Doble VK3AMD

Jim Payne VK3AZT

Graham Thornton VK3IY

John Tutton VK3ZC

\*Publications Committee member

### Production

#### Administration, Advertising, Drafting, Production

vk3br Communications Pty Ltd  
3 Tamar Court, Mentone VIC 3194

#### Typesetting and Printing

Industrial Printing and Publishing Pty Ltd  
122 Dover Street, Richmond, VIC 3121.

#### Mail Distribution

Mail Management Australia Pty Ltd  
6 Garden Boulevard, Dingley VIC 3172

#### New Advertising

Eyvonne & Keith Tootell

Union Publicity Service Pty Ltd  
PO Box 282, Toongabbie NSW 2146  
Telephone: 1800 654 181 - 02 9831 1299  
Fax: 02 9831 6161

#### Amateur Radio Correspondence

All contributions, correspondence, Hamads and queries concerning the content of

Amateur Radio should be sent to:

Amateur Radio

vk3br Communications Pty Ltd  
3 Tamar Court, Mentone VIC 3194

E-mail: vk3br@c031.aone.net.au

Phone and Fax: 03 9584 8928

Mobile: 0418 534 168

Business Hours: 9.30 am to 3.00 pm weekdays

#### Amateur Radio Delivery

All correspondence and queries concerning the delivery of

Amateur Radio should be sent to:

Amateur Radio

WIA Federal Office

PO Box 2175

Caulfield Junction VIC 3161

#### Registered Office:

3/105 Hawthorn Road

Caulfield North VIC 3161

Telephone: 03 9528 5962

Fax: 03 9523 8191

Business Hours: 9.30 am to 3.00 pm weekdays

#### Editorial and Hamads Deadlines

January 01/12/97

February 12/01/98

March 09/02/98

#### Receipt of Amateur Radio by Mail

The January issue will be delivered to Australia Post on Tuesday, 23 December 1997 for mailing to members.

If this magazine is not received by the 15th of the month of issue, and you are a financial member of the WIA, please check with the Post Office before contacting the registered office of the WIA. ©

© Wireless Institute of Australia 1997

### CONTENTS

#### Technical

Equipment Review - PV-35R and PV-85R 2 m Power Amplifiers \_\_\_\_\_ 8  
*Chas Gnaccarini VK3BRZ*

Converting the PV-35R and PV-85R 2 m Power Amplifiers for SSB Operation \_\_\_\_\_ 10  
*Chas Gnaccarini VK3BRZ*

80 m Receiver for ARDF \_\_\_\_\_ 12  
*Ian Stirling VK3MZ*

#### General

Book Review - How Radio signals Work \_\_\_\_\_ 50  
*Bill Rice VK3ABP*

#### Columns

Advertisers' Index _____	56	How's DX? _____	32
ALARA _____	16	Intruder Watch _____	38
AMSAT Australia _____	17	Morse Practice Transmissions _____	40
ARDF _____	18	Novice Notes _____	36
Awards _____	19	Over To You _____	39
Club Corner _____	20	Pounding Brass _____	45
Contests _____	22	QSLs from the WIA Collection _____	41
Divisional Notes		Repeater Link _____	42
VK1 Notes _____	26	Silent Keys _____	55
VK2 Notes _____	26	Spotlight on SWLing _____	44
VK3 Notes _____	26	Technical Correspondence _____	45
VK5 Notes _____	27	Update _____	44
VK6 Notes _____	30	VHF/UHF - An Expanding World _____	46
VK7 Notes _____	31	VK QSL Bureaux _____	55
Editor's Comment _____	2	WIA News _____	3, 21, 50, 51
Education Notes _____	35	WIA - Divisional Directory _____	56
Hamads _____	54	WIA - Federal Directory _____	2
HF Predictions _____	52	WICEN News _____	51

#### Cover

The VK3MZ 80 m ARDF receiver and directional antenna combination with the case open. Full details on how to construct this unit appear on page 12 of this issue of Amateur Radio magazine.

#### BACK ISSUES

Available direct from the WIA Federal Office, only until stocks are exhausted, at \$4.00 each (including postage within Australia) to members.

#### PHOTOSTAT COPIES

When back issues are no longer available, photocopies of articles are available to members at \$2.50 each (plus \$2.00 for each additional issue in which the article appears).

The opinions expressed in this publication do not necessarily reflect the official view of the WIA, and the WIA cannot be held responsible for incorrect information published.

## Amateur Radio Service

A radiocommunication service for the purpose of self-training, intercommunication and technical investigation carried out by amateurs, that is, by duly authorised persons interested in radio technique solely with a personal aim and without pecuniary interest.

## Wireless Institute of Australia

The world's first and oldest National Radio Society  
Founded 1910

Representing the Australian Amateur Radio Service -  
Member of the International Amateur Radio Union  
Registered Federal office of the WIA:  
3/105 Hawthorn Rd, Caulfield North, Vic 3161

All Mail to:

PO Box 2175, Caulfield Junction, VIC 3161  
Telephone: 03 9528 5962 Fax: 03 9523 8191

Business Hours: 9.30 am to 3.00 pm on weekdays

Acting Federal Secretary  
Mark Dods VK3ZR

### FEDERAL OFFICE STAFF

June Fox	Book Keeper
Debby Johnston	Membership Secretary
Rita Trebilco VK3NRT	Examinations Officer

### COUNCIL

President	Neil Penfold	VK6NE
VK1 Federal Councillor	Richard Jenkins	VK1RJ
VK2 Federal Councillor	Michael Corbin	VK2YC
VK3 Federal Councillor	Brenda Edmonds	VK3KT
VK4 Federal Councillor	Ross Marren	VK4AMJ
VK5 Federal Councillor	Ian Watson	VK5KIA
VK6 Federal Councillor	Wally Howse	VK6KZ
VK7 Federal Councillor	Andrew Dixon	VK7GL

### EXECUTIVE

Peter Naish	VK2BPN
Rowland Bruce	VK5OU
Neil Penfold	VK6NE

### FEDERAL CO-ORDINATORS

AMSAT:	Graham Ratcliff	VK5AGR
ARDF	Wally Watkins	VK4DO
Awards:	John Kelleher	VK3DP
Contests:	Peter Nesbil	VK3APN
Education:	Brenda Edmonds	VK3KT
EMC and Standards	Roger Harrison	VK2ZRH
FTAC:	John Martin	VK3KWA
Historian:	John Edmonds	VK3AFU
IARU:	David Wardlaw	VK3ADW
Int'l Beacon Co-ord:	Roger Harrison	VK2ZRH
Intruder Watch:	Gordon Loveday	VK4KAL
ITU Conference and Study Group:	David Wardlaw	VK3ADW
Media:	Roger Harrison	VK2ZRH
QSL Manager (VK9,VK0):	Neil Penfold	VK6NE
Radio Sports:	Wally Watkins	VK4DO
Videotapes:	Bob Godfrey	VK4BOB
WICEN:	-	-

### SMA LIAISON TEAM

Roger Harrison	VK2ZRH
David Wardlaw	VK3ADW
Neil Penfold	VK6NE

# Editor's Comment

## Plus, Minus, Left, Right

Over the last couple of months we have published comments about the polarity of the well-known two-pin T plug/socket as used widely for 12 volt mobile installations. As I commented last month, the standard suggested in an earlier item was reversed relative to an alleged emergency services standard. Now we find, as explained by two contributors elsewhere in this issue, that there are TWO STANDARDS, one in Victoria, one in New South Wales! Other States may have other ideas, but if T plugs are chosen there are only two possible ways to connect them, so, whichever you choose, you are right in one State and wrong in the other. This does sound like Australian politics generally, and the WIA in particular, doesn't it?

Having acquired a number of these plugs from my late brother-in-law, I decided the only way to be sure of correct polarity was to mark the positive with a dab of red nail varnish, both on the plugs and the sockets. I had acquired a little bottle of "Really Red" nail varnish some years ago, finding that it was excellent for re-colouring the port navigation light on my trailer-sailer. The original red fades in the sunlight in only a few months, yet the green starboard light has lasted for nearly 20 years! Why the difference, I wonder, for red to be so susceptible to ultra-violet, yet green unaffected?

Thinking of standards and navigation lights raises the point that red to port, green to starboard and keep to the right are universal rules for water and air traffic throughout the world. What a pity there is less agreement about road traffic, where the split is about 50-50. China, the Americas and Europe keep right, India, the UK, Japan and South-east Asia keep left. In Africa there are probably many border crossings where one is required to cross to the other side. This happened in Europe until Sweden switched from left to right some decades ago. It still happens when crossing the English Channel. Perhaps we should be glad that when we cross the River Murray it is only two-pin plug standards and similar details which change!

Christmas and New Year greetings to all.

Bill Rice VK3ABP  
Editor

### CONTRIBUTIONS TO AMATEUR RADIO

*Amateur Radio* is a forum for WIA members' amateur radio technical experiments, experiences, opinions and news. Manuscripts with drawings and/or photos are always welcome and will be considered for possible publication. Articles on computer disk or via e-mail are especially welcome. The WIA cannot assume responsibility for loss or damage to any material. A pamphlet, "How to Write for *Amateur Radio*", is available from vk3br Communications Pty Ltd on receipt of a stamped, self addressed envelope.



## ■ WIA News

Roger Harrison VK2ZRH, Federal Media Liaison Officer

# ACA Proposes Limits on RF Radiation, Calls for Submissions

The Australian Communications Authority (ACA) has proposed introducing a regulatory framework to limit people's exposure to radio frequency electromagnetic energy.

The proposed regulations would apply to all operators and users of radiocommunications equipment, as well as equipment manufacturers and suppliers, and is designed to limit RF exposure for those who use or operate RF transmitters, as well as the general public.

Amateur radio stations and equipment used by amateurs, including home stations, handheld transceivers and mobile installations, will have to comply with the RF emission limit standards set down in the Australian Standard AS 2772.1, according to the ACA's proposal.

The WIA alerted members, and the amateur radio community, to this possible development in a *WIA News* item released in the first week of September. (See *WIA News, Amateur Radio*, page 3, October 1997).

A discussion paper outlining the details of the proposal was posted on the ACA's Internet Web site ([www.aca.gov.au](http://www.aca.gov.au)) in late October. The ACA are seeking comments by Friday, 19 December. The WIA's ACA Liaison Team is formulating a submission to respond to them.

The Australian Standard on non-ionising radiation, AS 2772.1, is at present a voluntary standard. The ACA propose making it a mandatory standard. The limits set out in the standard are based on the known heating effect on biological tissue exposed to RF energy. The RF energy levels outlined in the standard have a massive safety margin below the level required to raise the temperature of biological tissue by one degree Celsius.

The ACA's proposal responds to concerns over the possible connection between exposure to electromagnetic

energy and the development of cancers, even at levels of electromagnetic radiation (EMR) well below those required to cause a measurable rise in tissue temperature. While studies conducted around the world over decades have yet to show a causal link between exposure to either specific or general EMR, the scientific community is cautioning that no one can unequivocally say that RF energy, even at comparatively low powers, does not cause cancers.

## Categories of Compliance

The ACA proposes two categories of compliance requirements to apply to equipment, with a separate two categories for operators and users. For low power devices deemed to "present a very low risk of exceeding the limits of the standard", self-declaration with a Declaration of Conformity document is proposed. For other radiocommunications equipment, the ACA proposes manufacturers and suppliers will have to provide a Declaration of Conformity based on test reports, in addition to "any other requirements that the ACA may deem necessary to confirm compliance."

The ACA is recommending that conditions would be imposed on the licences of all transmitters, which are licensed under the current Radiocommunications Act. Amateur radio licences would be included, according to the ACA's proposal, along with commercial and government broadcast transmitters, fixed and mobile radiocommunications systems, and telecommunications equipment, right through to mobile phones and CB radio equipment.

Under the current Radiocommunications Act, Class licences and Apparatus licences apply to transmitting equipment, except in the case of amateurs, where Apparatus licences are

issued to individuals who hold an appropriate Certificate of Proficiency. Spectrum licences would have conditions applied, too.

For devices and systems "whose installed performance is likely to be well within the AS 2772.1 limit", a three-tiered approach is proposed for evaluating compliance. Charts and graphs, approved by the ACA, which demonstrate performance within the exposure envelope defined by the standard is the first line of compliance conformity. The second tier is based on the use of mathematical formulas and computations related to accepted engineering standards and practices. Software computation may apply here. The third tier of compliance conformity is proposed to be based on performance evaluation from actual measurements. The latter would particularly apply to communications sites with many transmitters, according to the ACA discussion paper. This would affect beacon and repeater sites, and Division broadcast stations.

**ALINCO DX-70TH**  
HF & 6M 100W  
SUPERB TRANSCEIVER **\$1249**

BIG RANGE OF ALINCO IN STOCK.  
FACTORY BACKED 3-YEAR WARRANTY  
NEW KENWOOD COMING... CALL US  
**IC-746** HP-6M-2M 100W, DSP, BIG  
LCD, TWIN PBT, DUE SOON

**MFJ Tuners & Terminals...** CALL US  
DX-3200, DX-1600, DX-800 LINEARS

**AR-5000+3** SCANNER  
AR-8000 HAND HELD SCAN... \$950  
PALOMAR HF LINEARS... CALL  
RANGE OF SECOND-HAND  
**BIG** RADIOS, MOST IN TOP  
CONDITION WITH WARRANTY

KENPRO, KANTRONICS, YUPITERU, ETC.  
P/S 20A \$249, 50A \$599, 87A \$899.  
**DIAMOND, TIMEWAVE, JRC, KENWOOD.**

**Andrews**  
**Communications Systems**  
(EST. 1976 - ACN 001 968 752)

Call us now  
**(02) 9636 9060** or (02) 9688 4301

SHOP 8, 41 BATHURST ST, GREYSTANES,  
N.S.W. 2145. FAX (02) 9688 1995

In Australia, Standard AS 2772.2 specifies instrumentation and measurement techniques for potentially hazardous RF fields, in the near (within a wavelength) and far fields, across the 300 kHz to 100 GHz range.

A two-part article series on RF emission limits and amateur radio, written by Andrew Corney ZL2BBJ, a member of the joint Australian-NZ standards committee on non-ionising radiation, was published in the November and December 1995 issues of the NZART journal, *Break-In*. Requested in April 1996 to re-publish these topical articles in *Amateur Radio*, (the WIA has a reciprocal publishing agreement) the Publications Committee has, to date, declined any action.

### **A Global Thing**

Human exposure to electromagnetic energy has become a global concern. In the USA, the Federal Communications Commission (FCC), in a controversial move, last year adopted RF exposure limits in regard to field strengths and power density for all transmitters operating between 300 kHz and 100 GHz. For a variety of circumstances, certain equipment meeting given specifications and operational parameters was 'deemed' to comply.

While not backed by federal legislation, the FCC's move was based on the recommended exposure limits adopted by the national Council on Radiation Protection and Measurement. More recently, for handheld, or other transmitters operated close to the body, the FCC adopted guidelines for safe limits in regard to the specific absorption rate (SAR) put out by the IEEE and ANSI.

US amateurs have to meet the FCC RF exposure limits from 1 January 1998, with the technical specifications based on American Institute of Electrical and Electronics Engineers (IEEE) standards. However, US amateur stations meeting given power output levels on specified bands, according to a sliding scale, are 'deemed' to comply. But those with higher powers will have to comply by changing station equipment and antenna specifications or locations, according to advice from the American Radio Relay League (ARRL).

In Europe, the European Telecommunications Standards Institute and the European Radiocommunications Organisation (ERO) have taken an interest in the issue of RF exposure. In Japan, earlier this year, the Ministry of Posts and Telecommunications (MPT) published guidelines for human exposure to electromagnetic fields. The MPT is looking at setting up regulations for systems where estimation or measurement is well established, such as broadcast transmitters, but will leave

## **WIA Papers for the Region 3 IARU Conference, Summarised**

More than 100 individual papers were submitted to, and considered by, the International Amateur Radio Union Region 3 Association's 10th Conference, held in September in Beijing, China. The WIA submitted a total of 14 papers. Here are summaries of those papers. The authors were Dr David Wardlaw VK3ADW, Brenda Edmonds VK3KT and Roger Harrison VK2ZRH.

### **Report from the WIA**

A summary of the affairs of the WIA and significant events affecting amateur radio in Australia since the 1994 R3 Conference. Topics covered included:

- Membership decline
- Institute structure (unique in the region!)
- Liaison with the SMA (now ACA)
- Radiocommunications Act changes
- RF Hazards
- Standards
- International Liaison
- ARDF
- High Honour Received by Australian Amateur (The 1995 Australia Prize shared by Dr Ken McCracken VK2CAX)
- Publications (AR and Call Book)
- Frequency Bands
- News and Information dissemination
- Beacons and Repeaters
- Contests and Awards
- Amateur Examinations
- IARU Monitoring Service
- Satellites

In addition, there were attached annexes on call sign suffixes, the Australian band plans, and UHF/Microwave Activity in VK. A number of topics covered in this report were

mobile phones alone because they believe the procedure for estimating or measuring field strengths is unreliable.

**Correction** In the October issue, the WIA's representative on the Standards Committee on non-ionising, Dr Vince McKenna VK3AOY, was mistakenly described as a medical doctor. He's a physicist. Andrew Corney ZL2BBJ, also on the committee, was mistakenly given the title, 'Dr.' Apologies for that. [Released 11/11/97]

amplified in other WIA papers. (20 pages).

### **Harmonisation of Amateur Licence Qualifications**

The official syllabuses of a number of countries in Region 3 are already similar and closely aligned with the European CEPT syllabus. There are reciprocal agreements between administrations of some Region 3 countries. The 1994 Region 3 Conference agreed harmonisation of licences in Region 3 was "a good thing". The WIA proposed a working group to investigate harmonisation of licences throughout Region 3. (2 pages).

The Conference accepted this. Brenda Edmonds was appointed convenor.

### **ICARE – International Council for Amateur Radio in Education.**

The background to ICARE was outlined – a UK initiative which has since spread to countries in Europe, America and Africa. The object of ICARE is to encourage the introduction of amateur radio in school programs. ICARE is seen as a way to increase recruitment. The WIA proposed Region 3 become actively involved with ICARE and was willing to provide a co-ordinator. (2 pages).

The Conference left it up to individual societies.

### **Update on the WIA Exam Service**

An information paper about progress with the WIA Exam Service since 1994 (updated the 1994 Region 3 Conference paper). No proposals. (1 page).

### Further Development of the Stars\*\*\* Project in Region 3

Stars\*\*\* is the "Support of the Amateur Radio Service in IARU Region 3." The paper goes into the project's background, beginning at the 1991 Region 3 Conference in Bandung, Indonesia, as the "Promotion of Amateur Radio in Developing Countries" project. The WIA outlined eight points for consideration by the Conference and made five specific recommendations. (4 pages).

All points were discussed by a Conference working group and the recommendations on further action were adopted by the Conference.

### Diminishing Recruitment to the Amateur Service

An information paper, providing figures on candidates sitting for amateur examinations in Australia in 1992, 1994 and 1996, noting a steady decline. The WIA proposed that the Region 3 Secretariat research and publish similar data from Region 3 member societies. (2 pages).

The proposed action was accepted by the Conference.

### WICEN and Emergency Services

An information paper, outlining the role of WICEN, its structures, activities, responsibilities of co-ordinators, training, activations and its future. The paper highlighted WICEN's representation on the Australian Government's National Disaster Management Committee. (3 pages).

### Submission to the Australian Government on Establishing a New Licensing System for Australian Radio Amateurs

An information paper giving the background to the licence fee battle of 1994-95 and the lead-up to the submission for a better system of licensing for radio amateurs in Australia. The executive summary of the WIA's submission was reproduced in full. (5 pages).

The Conference specially noted this paper, to bring it to the particular attention of every Region 3 member society.

### The Amateur-Satellite Bands Contained in Footnote S5.282 to the ITU Radio Regulations

At present, the amateur satellite bands at 435 MHz, 1260 MHz, 2400 MHz and

# RENEW YOUR MEMBERSHIP - LAST CHANCE TO WIN



**This outstanding KENWOOD TM-733A dual-band 2m/70cm FM/packet rig worth \$1255**

- 50 watts on 2m ● 35 watts on 70cm
- Simultaneous dual-band VHF-UHF reception
- Data connection for 1200/9600 baud packet radio

**All you have to do is renew your Division membership when it falls due.**

### WHO'S ELIGIBLE?

- members whose renewal falls due between 1/1/97 and 31/12/97
- current members who are on a 3-year membership
- life members
- all membership grades

The prize will be awarded by means of a draw, the result to be published and the prize to be presented to the winner at the first available opportunity early in 1998.

### MORE TM-733A FEATURES

- Switchable 10 W/5 W RF output
- 12 Vdc operation
- Large, high-visibility LCD panel
- Dual-channel Rx on VHF & UHF
- Automatic band change
- Multi-scan reception functions
- 70 multi-function memories
- Selectable frequency steps
- Audible frequency identification
- Auto repeater offset on 2m
- Repeater reverse & offset switches
- Tone signalling (DTSS).

TM-733A prize kindly donated by Kenwood Electronics Australia P/L, PO Box 504, Homebush 2140. Ph: (02) 9746 1888. Fax: (02) 9746 1509.



3400 MHz have a "less than secondary" status in the international frequency allocation tables. They are mentioned by footnote only, which means spectrum planners can miss them. The WIA proposed that the IARU (that is, the international organisation which represents the three regional organisations at ITU level) take steps to have the amateur-satellite bands included in the frequency allocation table in the ITU radio regulations. (3 pages).

The Conference endorsed this proposal. This issue will be important at WRC-99.

### **Electromagnetic Compatibility (EMC) Standards in Australia.**

This paper covers the background to Australian legislation on EMC standards and its alignment with the European standards. A number of EMC problems affecting amateur radio in Australia were described. The issue of RF health hazards was specially covered – likely to be a concern for the radio amateur community across the world in future. The WIA recommended establishing a Region 3 EMC Co-ordinator. (6 pages).

The Conference adopted this proposal and the R3 Directors are to progress the matter.

### **Moves to Expand the 80 m DX Window Allocation in Australia.**

An information paper giving the background to the present 3794-3800 kHz allocation and the WIA's submission to the SMA for an allocation of 3750-3900 kHz, to be time-shared with primary users, for amateurs to use the proposed allocation outside business hours. A map was provided, showing Australia's current and proposed allocations, along with allocations in other countries around the region. (5 pages).

### **Footnotes to the Frequency Table in the ITU International Radio Regulations**

A feature of the international frequency allocation tables is the footnotes. These allow administrations to vary allocations. Some 17 footnotes affect amateur band allocations. The WIA proposed that the IARU (that is, the international organisation which represents the three regional organisations at ITU level) examine the existing footnotes and determine whether any

changes would enhance the amateur services. (6 pages).

The proposal was adopted by the Conference. This is an important point for the IARU's efforts at World Radio Conferences.

### **Developments in Radio-communications Licensing in Australia Since 1994 and the Impact on Amateur Radio**

This information paper updated a paper on the subject submitted to the 1994 Region 3 Conference in Singapore. It outlines the recent changes to the Radiocommunications Act, the "commercialisation" of the radio frequency spectrum and changes to amateur licensing.

The recent history of beacon and repeater licensing in Australia, was described, along with the huge hike in fees and the successful WIA efforts to have more equitable fees applied. The paper outlined band pressures from new services in the UHF bands, including

Multipoint Microwave Distribution Services, Low Interference Potential Devices and Wireless Local Area Networks. The paper noted that these emerging services are appearing worldwide and that they will begin to encroach on amateur activities in every region, so the Australian experience is likely to have many parallels. (9 pages).

The paper was drawn to the attention of all Region 3 member societies.

### **Reaffirmation of Invitation to Hold the 11th IARU Region 3 Conference in Australia**

This was a letter from the WIA's IARU Liaison Officer, David Wardlaw, to the Region 3 Secretary. The 9th Region 3 Conference in 1994 agreed that the 11th Conference would be held in Australia. The letter reaffirms the WIA's plans. (2 pages).

The Conference endorsed it. Australia will host the 11th Region 3 Conference in the Year 2000.

*[Released 11/11/97]*

## **1998 Call Book Out Now**

The Wireless Institute's Call Book for 1998 was published on 31 October and was generally available through state Divisions from mid-November. Sales at hamfests in Victoria and Queensland in November were reported to be brisk.

Now titled "The Australian Radio-communications Reference Guide and Radio Amateurs' Call Book," the 158-page book – larger than the 1997 edition – is selling for the same old price: \$14.95, or \$13 for WIA members. Post and packaging charges for mail order apply.

It will also be on sale through selected Dick Smith stores. Look for it – the cover's bright yellow!

Aside from the title change, there have been significant changes to the content and the layouts, in an effort to make the book more "reader friendly" and to appeal to a broader audience.

While the 1998 publication retains the broad division of reference material up front, followed by the call sign listings, this time the two sections have separate, identifying folio lines.

The reference section has been entirely "refreshed", with 15 items of entirely new material added, in addition to 14 items of popular and essential

material which have been completely updated.

New material includes:

- 6 m beacons world-wide,
- 10 m beacons and repeaters world-wide,
- NZ beacons,
- the five-band international HF beacon network,
- low frequency beacons, 200-400 kHz,
- how to attach coax plugs, correctly,
- how to get started in packet radio,
- packet wormholes explained,
- a full directory of packet radio systems,
- RS232 connections you need to know, and
- WIA World-Wide Web sites, and more.

The completely revised and updated material includes:

- the directory of nearly 500 Amateur Licence Examiners,
- the band-plans from MF (160 m) to SHF,
- Australian QSL Bureaux,
- Australian beacons and repeaters from HF to SHF,
- Australian VHF-UHF records,
- WIA broadcasts, and
- operation of amateur stations in Australia, from the ACA.

Only three items have been repeated: Australian and NZ TV channel frequencies, and the WIA affiliated clubs directory.

The WIA decided to revitalise the publication in preparation for the introduction of the call sign listings in digital form – anticipated next year – so this annual publication will have to have a new role.

This year, the call sign listings have been reproduced, unedited, from the Australian Communications Authority's public register of licensees. All the details are there, warts and all – 16,540 of them in the 100-page section.

They are listed in straight alphanumeric order, in line with international practice, rather than the 2-letter/3-letter suffix order, ranked alphabetically, as in the past. For better readability of the necessarily small typeface, the listings have been typeset in upper and lower case.

There are no suppressions of licensee details in the 1998 Call Book. The ACA has an obligation under the 1992 Radiocommunications Act to maintain a public register of all radiocommunications licensees, to which they plan to provide access by various means. For example, on their Internet web site. Because of this, and because the Call Book is no longer published under contract from the Australian Government Publishing Service (which required offering suppressions), the WIA is no longer involved in maintaining suppressions in the Call Book.

In the 58-page Reference Guide section, 90 Australian beacon frequencies are listed, 236 packet radio system frequencies, and 403 repeater system frequency pairs.

There are 210 2 m voice repeaters around Australia, and a further 110 on 70 cm.

For 6 m enthusiasts, 150 beacons around the world outside Australia are listed, along with 170 10 m beacons across the globe.

If you're interested in the low frequencies, below the AM broadcast band, 300 LF beacons between 200 kHz and 406 kHz, located around Australia and New Zealand, are listed along with their locations.

For packet radio enthusiasts – beginners and old hands alike – there's

plenty of reference material. Beginners are given a guide on where to start. For those already using packet, the technology and applications of packet wormholes are explained. The five-page Australian Packet Radio Directory lists 236 system frequencies.

If you've recently had your interest sparked in Amateur Radio Direction Finding – ARDF – the radio sport taking off in Asia, Europe and North America –

## Another NSW Recruit Scores a Fluke!

New recruit to the WIA NSW Division for September, Mr **B Haro VK2SJM** of Croydon Park in Sydney, has scored the Fluke 12B digital multimeter. He's the fourth recruit from VK2 to win a Fluke DMM.

There's a multimeter been won every month throughout 1997 in a draw from among new WIA recruits joining in any particular month. December is your last chance to join the WIA and go in the monthly draw to win a Fluke 12B digital multimeter worth \$195.

The 12 prizes for the year have been generously donated by Philips Test & Measurement. Fluke is the world's pre-eminent manufacturer of digital test instruments and the Model 12B is from their latest range of hand-held instruments. The Fluke 12B measures AC and DC voltage (with auto-selection

the ham radio activity for which you don't need an amateur licence – there's an illustrated explanation and details of who you contact to get involved.

The 1998 Australian Radiocommunications Reference Guide and Radio Amateurs' Call Book appeals to many interests. The print run is limited. Don't miss out. Order your copy now.

[Released 3/11/97, updated 11/11/97]

above 4.5 V), resistance and capacitance from 1000 pF to 1000 µF. The instrument features a simple rotary dial, a 4000-count liquid crystal display, and diode and continuity testing. Its "continuity capture" feature indicates intermittent open and short circuits. It comes with test leads and a two-year warranty.

Every newcomer to electronics and amateur radio needs a good multimeter, and every seasoned enthusiast could always do with another one. And the chances of winning are very good!

Membership recruitment advertisements have appeared in each issue of *Amateur Radio* magazine, and in *Radio and Communications* magazine throughout 1997. Membership recruitment and renewal advertisements also appear on WIA Divisions' World Wide Web pages on the Internet.

## Model Commemorative Sputnik On The Air!

The model Sputnik built as a cooperative effort between French and Russian school children was launched from the MIR spacecraft on 3 October and can be heard regularly close to 145.820 MHz as it orbits the Earth about every 94 to 97 minutes.

During the week immediately after being thrown from an airlock aboard MIR, its orbit remained very close to that of the Russian spacecraft. The 2 m beacon aboard the model Sputnik emulates the "beep-beep" of the original satellite. It can be heard on SSB or FM receivers, with only a simple dipole or ground plane antenna. It's even been logged on a handheld rig with a "rubber ducky" antenna.

The pitch of the Sputnik beacon's modulation varies according to the

satellite's internal temperature. At 50 degrees C, it's at 1361 Hz, at zero degrees, it's 1131 Hz, and at -40 degrees, it's 541 Hz, reports the *ARRL Letter* for 7 November.

The satellite was built and launched to commemorate the 40th anniversary of the launching of the first artificial earth satellite in October 1957.

Secondary school students from French Reunion Island and Naltchik in Russia built the 1:3 scale model. Reception reports can be sent to the club station at College Reydelle, FR5KJ, 103 rue de la Republique, 97489 Saint Denis Cedex, Reunion Island, or to Sergei Sambourov, PO Box 73, Kaliningrad-10 City, Moscow Area, 14070, Russia. You are asked to include a SASE and one IRC for a certificate. **ar**

## Equipment Review

# PV-35R and PV-85R 2 m Power Amplifiers

Reviewed by Chas Gnaccarani VK3BRZ\*

### Introduction

As most users of 2-metre hand-held or portable rigs know, there are times when their comparatively low power of two to three watts just won't cut the mustard. Like when you're operating from the car, for example, and your signal into a repeater is scratchy. Or perhaps you find that your packet hook-up just isn't reliable with such low power. What you wouldn't give for a little more muscle!

This pair of 2-metre "brick" power amplifiers from Dick Smith Electronics is specifically targeted at such situations. First introduced in the 1996/97 catalogue, the PV-35R 30 watt amplifier

replaces a similar unit from the previous catalogue, whilst the PV-85R 80 watt amplifier is an entirely new offering. Priced at \$129.95 and \$199 respectively (the PV-85R is on special at \$169 at present), they are an absolute steal. You couldn't even buy the parts to build them for that money.

### Description

Both amplifiers include an integral GaAsFET receive pre-amplifier which can be switched in as required, and are specified for 3 W nominal drive power (0.5 to 5 W according to the instruction sheets). They are intended for 13.8 V DC operation, the current requirements

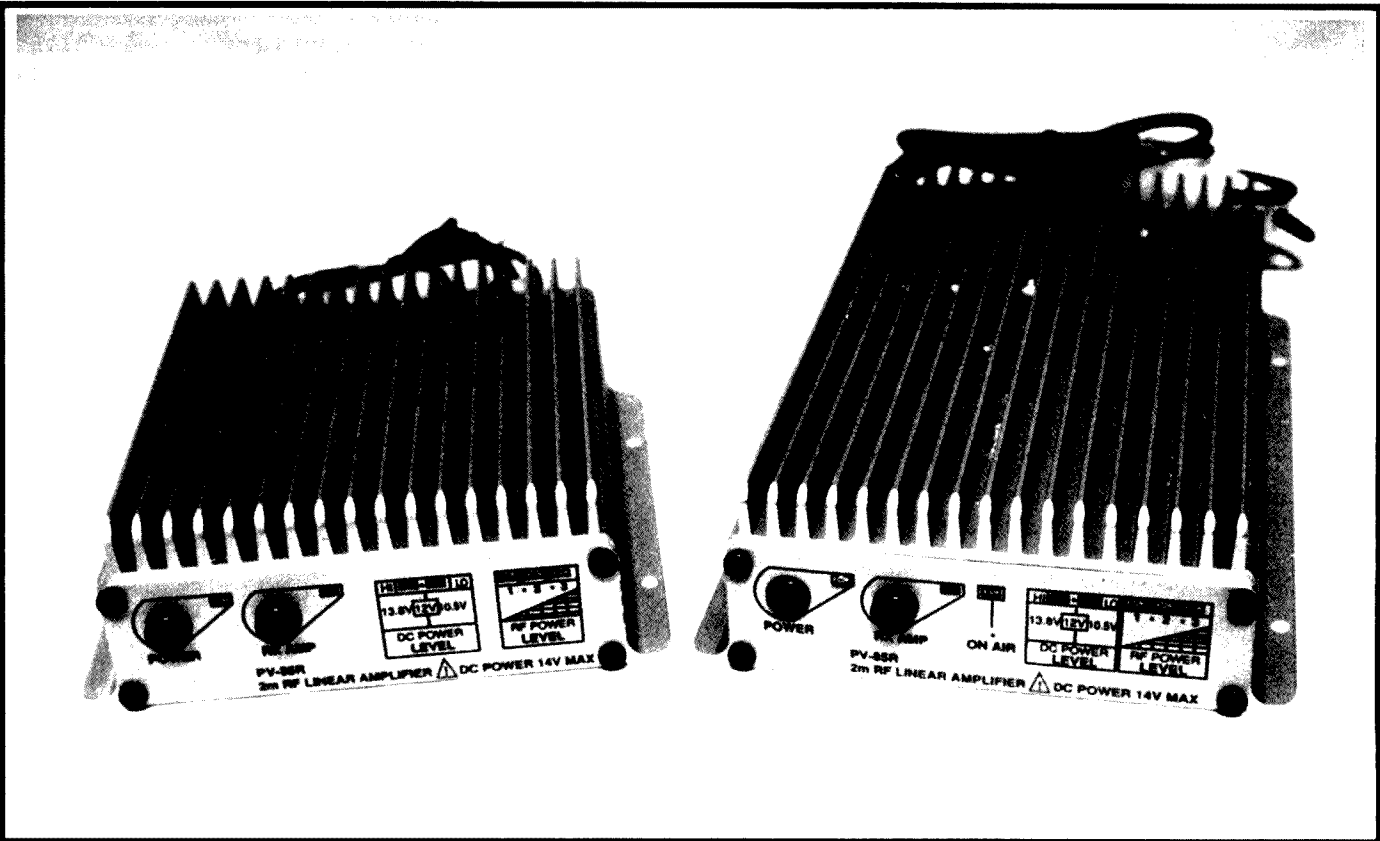
being specified as 6 A for the 30 watt unit and a hefty 20 A for the 80 watt unit.

Both amplifiers are 125 mm wide and 45 mm high, the 30 watt unit being 147 mm long, and the 80 watt unit 208 mm long, including all protrusions. Simple LED front-panel metering is provided on both units for relative RF output and quaintly, DC supply voltage.

Whilst both amplifiers are labelled on the front panel as "linear amplifiers", thus implying they are suitable for both FM and SSB, the catalogue descriptions make it plain that they are intended solely for FM operation. This is backed up by the instruction sheets as well as the label on the packaging box. Be warned: as they come, these amplifiers are **not suitable for SSB operation!**

This is for two reasons. Firstly, and more importantly, the transistors are operated in Class-C, that is without bias current. Secondly, the transmit/receive switching is actuated by the driving RF signal. Whilst this is fine for FM, there is no provision for selecting a delayed-release for SSB use.

This is a great pity. No doubt there will



be some FM operators who will want to add that extra grunt to their signal, but my experience is that it is the SSB users who are generally more serious about their station capability, and who would have purchased these amplifiers had they been suitable. For the sake of a couple of dollars' worth of components, an entire market sector is lost, especially in the case of the 80 W unit.

A glance at its circuit board revealed that it was designed as a proper linear amplifier, but the important biasing components have been left out, and part of the circuit board has been deliberately punched out, seemingly to prevent subsequent modification! Beats me!

The amplifiers are fitted with the usual SO-239 RF sockets, and you have to supply the appropriate patch-lead to go between your rig and the amplifier's input socket. You also need a 13.8 V power supply capable of delivering the current required by either amplifier if you intend using one in the shack.

## How the Bricks Stack Up

Not owning a 2 m hand-held transceiver, I chose to test these amplifiers with my Yaesu FT-290R Mk I multi-mode rig. It produces 3 W output, just as required. I suspect that many other owners of this model rig, and its successor, would be very interested in these amplifiers, but heed the warning about SSB.

Whilst the output power tests were pretty straightforward to perform, as was the pre-amp gain measurement, substantiating the manufacturer's claim of a 1.8 dB noise figure was not, as I do not have access to a noise figure meter. Instead, I elected to measure the 12 dB SINAD sensitivity of the transceiver with, and without, the pre-amp activated. As it happens, this will probably be more meaningful to FM operators.

Tests were carried out at both ends of the two metre band, and there were no significant differences in the results. The results are summarised below. The figures in brackets relate to the PV-85R, while those without brackets relate to the PV-35R.

Drive Power	Output Power	DC Supply Current
0.5 W	18 W (65 W)	4.3 A (14.5 A)
3 W	33 W (90 W)	5.5 A (17.5 A)

**Pre-amp Gain** 11 dB (10.2 dB)  
**Pre-amp Sensitivity** 0.14  $\mu$ V (0.14  $\mu$ V) for 12 dB SINAD\*  
 (\*FT-290R sensitivity without pre-amp was 0.22  $\mu$ V for 12 dB SINAD)

## Comments

Both units met their published specifications, apart from the pre-amplifier gain, which was within a dB or so of the claimed 12 dB. Frankly, this is of no concern, as the improvement in sensitivity provided by the pre-amp was very noticeable, and it is the sensitivity, rather than the outright gain, which counts. In fact, it is better to utilise the minimum gain in order to minimise front-end overload problems.

It is worth elaborating on the sensitivity of the pre-amp. My FT-290R's sensitivity is pretty average as far as 2 m rigs go. Most 2 m hand-helds would be noticeably more sensitive. If you look at the test results, you will see that the 12 dB SINAD figure came down from 0.22  $\mu$ V to 0.14  $\mu$ V, which represents an improvement of almost 4 dB. To put this in perspective, the same improvement in signal-to-noise ratio would require more than double the power at the transmitter, or replacing a  $\lambda/4$  wave whip with an extended Ringo or similar antenna. Not bad, for just a push of a button!

However, the pre-amp requires rather circumspect use in RF-hostile environments, as the additional gain might send most hand-held radios into front-end overload, especially from 148 MHz pagers. The instruction sheet warns of this possibility and, in all probability, the majority of modern hand-helds already have adequate sensitivity.

One other matter worth mentioning is the heat-sinking of the amplifiers. I didn't undertake specific tests for this, merely noting the temperature rise by touch during testing and in a few QSOs. The 30 watt unit never became more than just very warm, whereas the 80 watt unit eventually became so hot that you would not want to hold it for more than a few seconds. While its heat-sink is considerably larger than its lower-powered cousin, it should be noted that, at full output, it has to dissipate almost 160 watts of heat, compared to just 50 watts for the smaller unit. Adequate

ventilation is mandatory, especially in mobile installations. Short overs might help too!

## Do You Need One?

My perception is that many owners of hand-held radios probably also own a mobile FM rig of perhaps 25 or 50 watts output. They use their hand-helds for the purpose they were intended – handy, pocket-sized, battery-operated portable rigs. If that describes your situation, you probably don't need one of these amplifiers (but at the price, you might want one anyway!).

However, if your hand-held rig has to do service in the shack and the car as well, then the extra punch delivered by these amplifiers will give you a commanding signal. And there's something wicked about picking up a pocket-sized rig, and crunching out 80 watts!

Thanks to Dick Smith Electronics for supplying the amplifiers for the review.

\*66 Smeaton Close, Lara VIC 3212

ar



**AMATEUR  
TRANSCIVER  
RADIO CENTRE**

LARGEST SUPPLY OF HF/VHF/UHF  
TRANSCIVERS AT COMPETITIVE  
PRICES

**ALINCO** SYDNEY'S LARGEST  
RANGE OF ALINCO  
TRANSCIVERS & ACCESSORIES  
VHF UHF MOBILES HAND HELDS  
NOW IN STOCK –  
PHONE FOR BEST PRICES

**JRC** NRD-535, NRD-345 RECEIVERS  
JST-245 TRANSCIVER

LOTS MORE NOT LISTED  
ALINCO FACTORY  
AUTHORISED DEALER

**ICOM** IC-756 IC-706MKII  
IC-207H IC-T7A

**KENWOOD** TS-570S TM-V7A  
TM-251

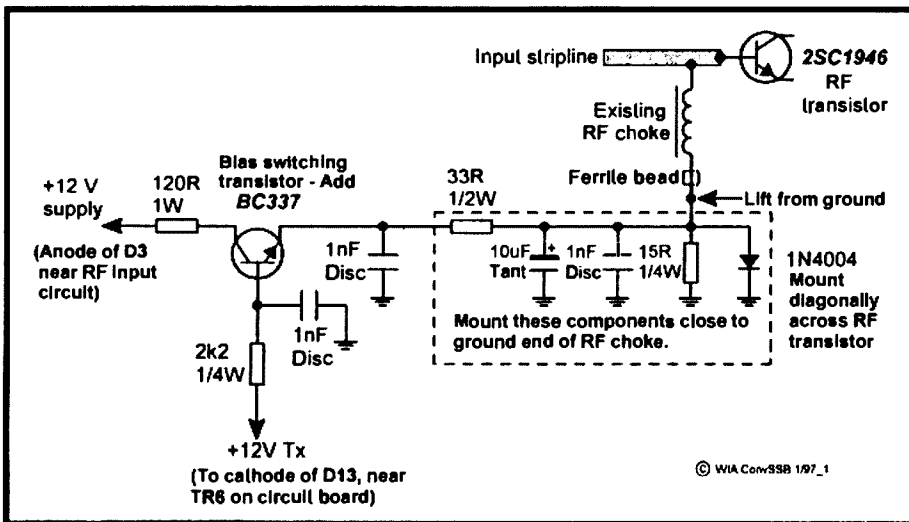
**Cushcraft** ANTENNAS  
**AMERITRON** HF AMPLIFIERS  
EXPAND YOUR COLLECTION TODAY

**PHONE (02) 9896 2545**  
E-mail: atrc@australia.net.au  
Web Page:  
<http://www.australia.net.au/~atrc>

## ■ Transmitting

# Converting the PV-35R and PV-85R 2 m Power Amplifiers for SSB Operation

Chas Gnaccarini VK3BRZ\* describes how experienced amateurs can convert these bargain amplifiers for SSB operation.



Schematic of the bias modifications to the PV-35R amplifier for use on SSB.

## Can They Be Used For SSB?

In ascertaining whether these 2 m FM power amplifiers are suitable for SSB operation, there are three important questions to be answered:

- Are the amplifier stages biased for linear operation?
- What is the maximum drive power which can be applied without driving the amplifier into distortion? and
- How is the transmit/receive switching accomplished?

I'll address each question in order.

## Biasing

For FM operation, there is no requirement for the amplifiers to be biased into conduction. However, an SSB signal must have its modulation envelope preserved, without distortion. Without appropriate bias current,

"crossover" distortion will result, manifesting itself as "splatter".

Unfortunately, these amplifiers are not biased, so on this count they are *not* suitable for SSB. It is possible for an experienced constructor to modify them and add the necessary biasing circuitry. However, some "surgery" is required, particularly in the case of the 80 watt unit, which has not one, but two stages to be modified.

Circuits of the modifications are shown in the accompanying diagrams. I respectfully suggest that, if you need more detailed information than is provided, you probably shouldn't attempt the job. You should also appreciate that the warranty will most likely be voided by the modifications.

## Drive Power

The question of maximum driving

power is rather less well defined. The output power available from any "linear" power amplifier (which includes audio amplifiers as well as RF amplifiers) depends on how much distortion you (or someone else!) are prepared to tolerate. With linear RF power amplifiers, this distortion takes the form of "splatter" into adjacent channels, which is intolerable to other band users.

So, it is vitally important to set the drive power correctly. For example, if you refer to the test results for these amplifiers, you will see that the PV-85R produced 65 W with only half a watt of drive. If it were truly linear, then one watt of drive should produce 130 W output, but you can see that, even with three watts drive, the amplifier delivered only 90 W. This is because the amplifier reaches saturation at around one watt of drive. From that point, any more drive does not result in more output.

This is of no concern for FM use, but it would result in severe distortion (again, splatter) if an SSB signal were being amplified. For SSB use, the drive power should be adjusted to a point well below saturation. I suggest that the PV-35R be driven to no more than 30 W output and the PV-85R to no more than 80 W when used for SSB.

After modification to add the biasing circuitry, the power gain of both amplifiers increases noticeably. The drive required by the PV-35R will only be about 500 mW, and the PV-85R, being a two-stage amplifier, will require no more than 200 mW to produce full output.

For use with the FT-290R transceivers, an easy way to set the drive properly is to select the low power mode and adjust its level accordingly. Refer to the rig's manual for the adjustment pot location. Be sure to remember to always select low power for SSB use, otherwise you will produce a horrendously wide signal!

Alternatively, a resistive attenuator can be placed at the base of the power transistor (not at the input socket, otherwise you attenuate the received signals too). Place a DC blocking capacitor (1000 pF disc ceramic) after the attenuator otherwise it will affect the bias. Refer to the ARRL Handbook for attenuator resistor values. The PV-35R will need about 6-7 dB of attenuation, and the PV-85R around 10-12 dB.



## Transmit/Receive Switching

Finally, we come to the matter of transmit/receive switching. Modern practice with VHF power amplifiers is to include circuitry to detect the presence of the RF driving signal and use it to switch the power amplifier into the transmit mode. This is simply for convenience, as few rigs have any connection for switching a PA these days.

This is precisely how it's done in these two amplifiers, and for FM use, where the RF drive is always present during transmission, it works fine.

SSB is another matter though. The driving waveform's amplitude is continually varying according to the speech and, during pauses between words, there is no RF present at all. This would cause the changeover relays to "chatter" as you speak. Amplifiers intended for SSB operation usually have a switch which allows you to select a delayed release, thus holding the relays in for a second or so, just enough until the next syllable. These two amplifiers are *not* equipped with this feature.

The PV-85R has provisions on the circuit board for an electrolytic capacitor to add the necessary time constant for this purpose, and it is a simple matter to add the delayed release feature. This is not the case with the PV-35R, but one can be soldered in as shown in the accompanying diagrams. If you feel confident that you understand the purpose of the modifications, and have some experience working on modern equipment, you may wish to attempt them. **Be aware, though, that such**

modifications generally void manufacturer's warranties. Also, you are responsible for any disasters you might precipitate!

## Modifying the Units

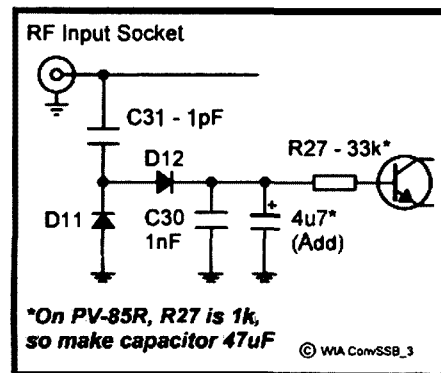
Both amplifiers were modified for SSB use, and the accompanying circuits show how this was done. The circuit board of the PV-35R is clearly marked with the component identities, so the appropriate connection points should be easily to locate.

However, this is not the case with the PV-85R, making it difficult to explain the locations of the appropriate connection points. The best bet is to locate them with a multimeter.

The additional components can be soldered in "dead bug" style. The only really critical construction is the bypassing of the ground-end of the base chokes, which should be done right at the choke, keeping the capacitor leads short. All wiring should be kept well clear of the strip-lines, to avoid the possibility of RF feedback. The diode should be mounted diagonally across the transistor case, with the body of the diode in thermal contact with the transistor's ceramic cap. Apply a little thermal-transfer compound between them.

The quiescent current for the PV-35R should be 50 to 80 mA. For the PV-85R, the driver stage should be biased to about 50 to 80 mA, and the final to about 100 to 150 mA.

Modify each stage one at a time, and measure the quiescent current, adjusting the value of the bias resistor if necessary. The bias current can easily be measured.



## Schematic of the delayed VOX release modifications to both the PV-35R and PV-85R amplifiers for use on SSB.

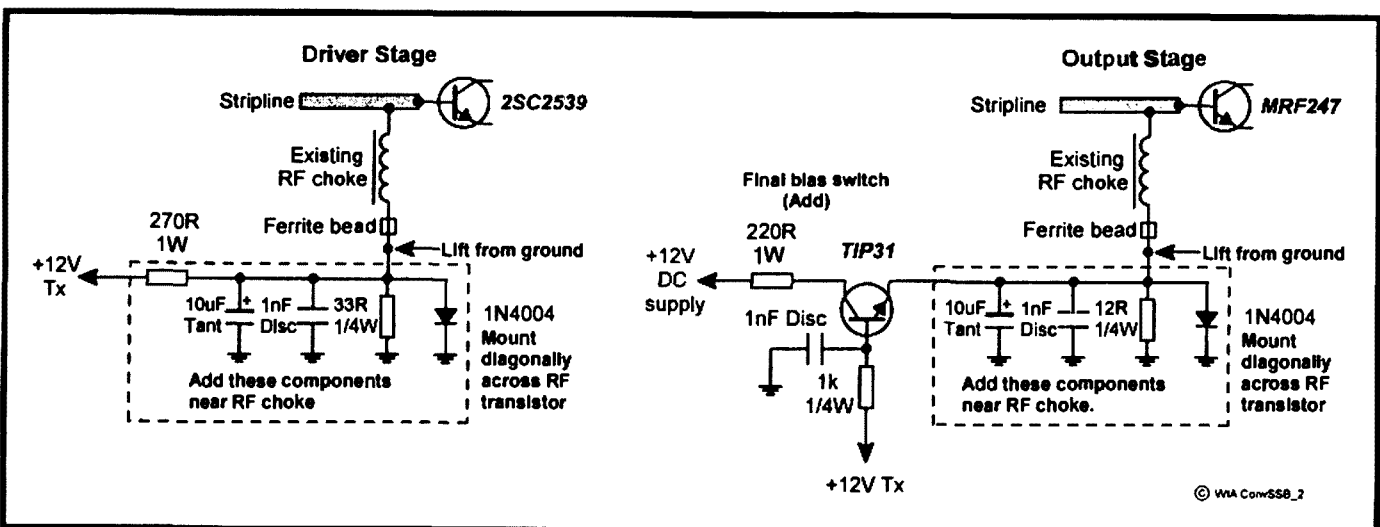
Simply connect a milli-ammeter in series with the power supply, switch the amplifier into transmit mode (do not apply any drive!) and measure the total current. Momentarily short the base of the transistor to ground, and note the reduction in total current. This is the bias current of that transistor. It's a good idea to leave a dummy load connected during this test in the unlikely event that the amplifier goes into oscillation.

After successfully adding the biasing circuits, connect a rig and dummy load to the amplifier, and tweak the input trimmer of the amplifier for maximum output. Finally, re-assemble the amplifier case, and the job is finished.

Many thanks to David VK3XLD, who assisted in developing the modifications and performing the tests, and to Dick Smith Electronics for allowing us to experiment with the amplifiers.

\*66 Smeaton Close, Lara VIC.3212

ar

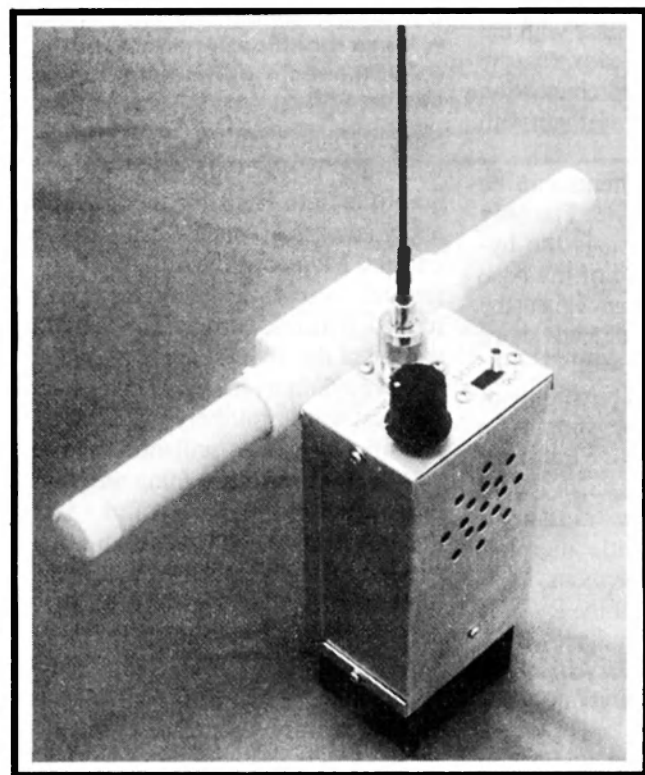


Schematic of the bias modification to the two amplifier stages in the PV-85R amplifier for use on SSB.

## ■ Receivers

# 80 m Receiver for ARDF

*Ian Stirling VK3MZ\* describes a receiver and directional antenna combination that is suitable for direction finding on the 80 m band.*



**The VK3MZ 80 m ARDF receiver.**

The receiver is a single conversion SSB receiver and the antenna is of the ferrite rod or "loop-stick" style.

The Melbourne fox-hunting group are very active in vehicle based hidden transmitter events. We are now expanding this interest into pedestrian style events (our partners and families would probably describe it as an obsession rather than an interest!). The pedestrian style fox-hunting is known as ARDF (Amateur Radio Direction Finding) and is very popular throughout the world, particularly in Japan, Korea, China and Germany.

Many of the Melbourne fox-hunting fraternity have been competing in our monthly vehicle-based fox-hunts for

fifteen or more years and feel like a new challenge. The sudden interest in ARDF was precipitated by an ARDF competition held in Townsville last year. Australia was the host nation for an international ARDF event that spanned five days and attracted competitors from many countries. A group of VK3s went to Townsville and had a fabulous time. The VK3 participants have spread the word south about what a great activity ARDF is. We have since held several ARDF style events which were well attended with up to 14 competitors taking part.

At the conclusion of the Townsville competition the VK4s offered a loan of a set of transmitting gear to the VK3s. This generous offer was quickly accepted by Mark Diggins VK3JMD. Four excellent transmitters built by Ron Graham VK4BRG were transported down to Melbourne and they have helped us get this exciting radio sporting activity off the ground in VK3.

ARDF is conducted under a strict set of international rules. The rules describe the type of transmissions, course length and protocol for competitors. The amateur bands used for ARDF are 2 m and 80 m. The 2 m band is very well established as a fox-hunting band in VK3; however, we are not very experienced at 80 m fox-hunting.

The aim of this article is to stimulate and facilitate the construction of 80 m sniffers and increase the number of people able to participate in 80 m ARDF style events.

The performance of this sniffer with the loop-stick antenna in the uni-directional mode is not unlike that of a two metre sniffer with a three element beam. However, when the antenna is switched to the bi-directional mode, very accurate DFs can be taken and this makes 80 m a very attractive band for direction finding.

### How It Works

The ferrite rod "loop-stick" antenna is switchable from a "figure of eight" pattern (bi-directional) to a cardioid pattern (uni-directional). The loop-stick and vertical sense antenna combination is based on a design in the ARRL handbook. Minor changes have been made to allow easy reproduction with locally available parts.

The receiver has one stage of RF amplification at 3.5 MHz. The signal is then converted up to an intermediate frequency of 8.00 MHz; this takes place within the MC3362. Although intended for FM applications, the Motorola MC3362 IC makes a very effective SSB receiver chip. Only the two mixers, two oscillators and varactor diodes are put to use in this receiver. The IF is selected by a simple crystal filter on the first mixer output. This is followed by a product detector which gives an audio output.

The RF amplifier associated with Q1 provides a gain of approximately 20 dB. The control voltage on gate 2 of Q1 allows this stage to also function as a signal attenuator, which is important when DFing up close to the transmitter.

The 3.5 MHz output from the RF amplifier goes to the first active mixer in the MC3362 and combines with the 4.5 MHz VFO. Potentiometer RV1 tunes the 4.5 MHz VFO by varying the bias on a pair of varactor diodes within the 3362 IC. The specified VFO tank circuit produces a tuning range of about 100 kHz and I used a ten-turn pot to allow easy tuning of sideband signals. A buffered VFO output is available from the 3362 and this is used in the tune-up procedure.

The 8.00 MHz IF component of the

# 80M RECEIVER FOR ARDF (UK3M2)

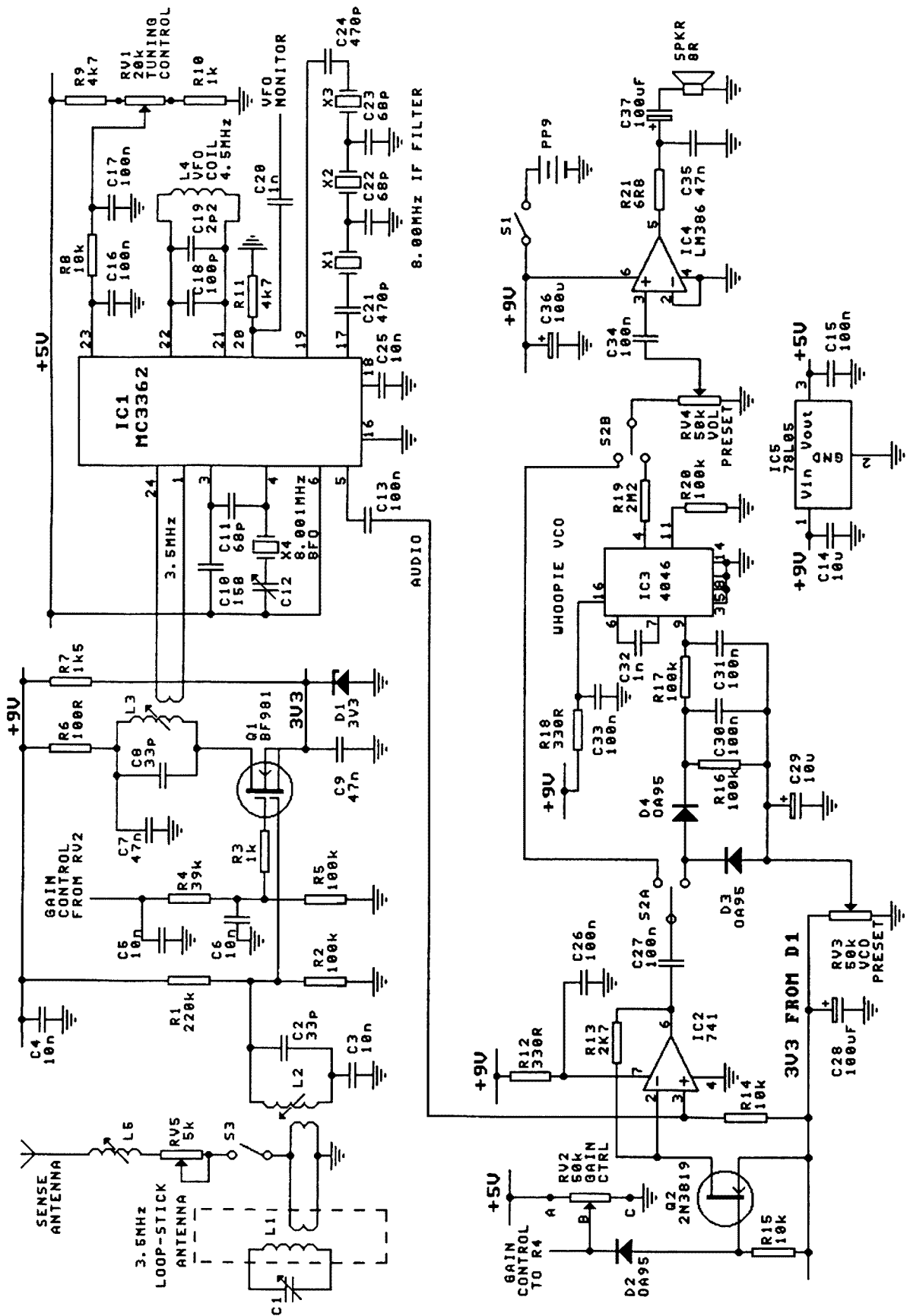


Fig 1 - Schematic of the 80 m ARDF receiver.

first mixer output is selected by the simple ladder crystal network of X1-X3. Capacitors C21 to C24 set the filter bandwidth to approximately 4 kHz when typical computer crystals are used. A fairly wide IF bandwidth has been chosen to facilitate tuning while on the run.

The 8.00 MHz IF signal passes directly to the second mixer in the MC3362 which works as a product detector and gives an audio output. There is no IF amplification. The RF amplification of Q1 and the gain of the active mixers in the 3362 provide more than adequate gain for the 80 m band. X4 sets the BFO frequency which, in this application, is tuned to the high side of the IF pass-band to allow reception of LSB signals.

The stage associated with IC2 is a gain variable audio amplifier. The gain is adjustable from about 0 to 20 dB. The RF gain of Q1 and the audio gain of IC2 are both controlled by RV2. The audio from IC2 may pass directly to the LM386 audio PA, or it can be switched to the "whoopie" VCO.

Diodes D3, D4, and the following RC network, produce a DC signal on pin 9 of IC3 which is proportional to received signal strength. The VCO in IC3 is set to operate in the audio range and produces a "whooping" sound as the antenna is pointed towards or away from the signal being tracked.

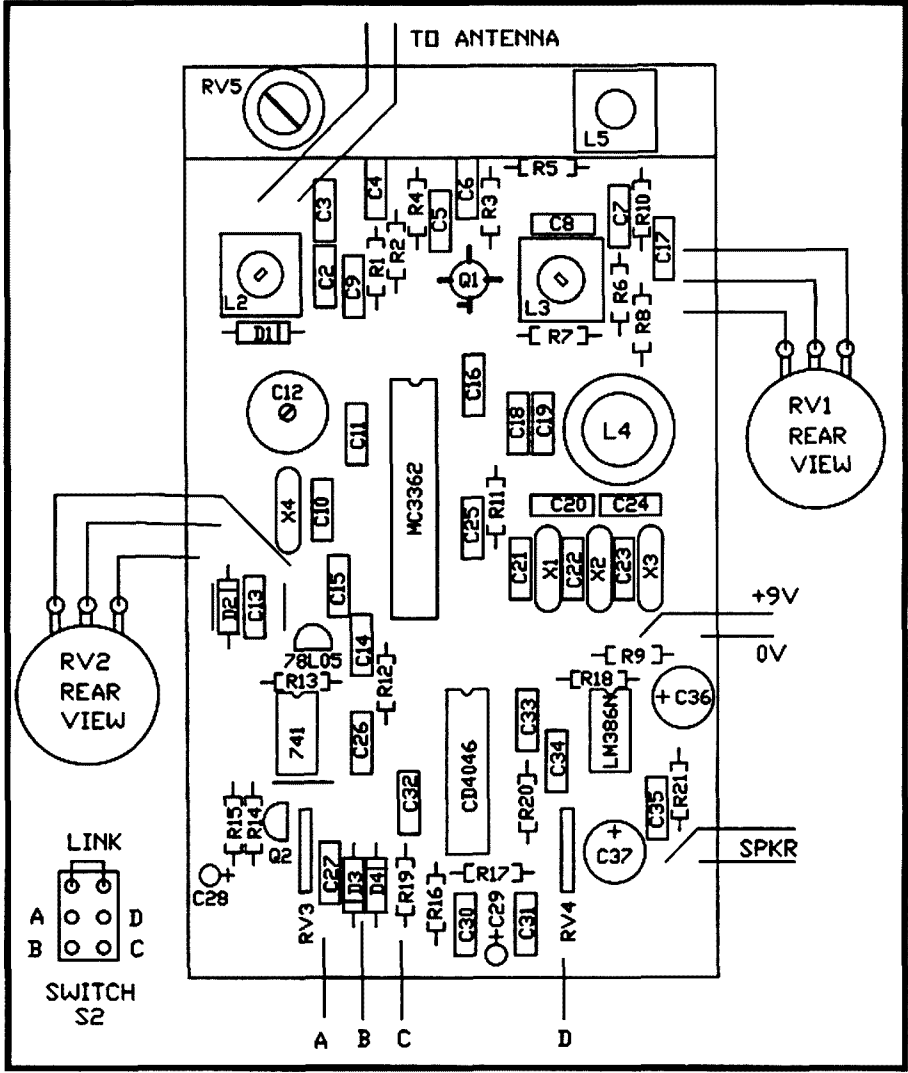
The "whoopie" mode is now widely used in ARDF and generally allows a bearing on transmitter location to be more easily discerned than by judging received audio loudness. An "S meter" could be used, however the operator would need to stop and read the meter, whereas an ear piece, together with "whoopie" mode, can be used while on the run.

**Receiver Specifications**

Single 9 V battery, current drain 50 mA. Sensitivity better than 0.2 μV. Single conversion 8 MHz IF. Bandwidth 4 kHz approx. Tuning range 100 kHz approx. Receive modes of LSB and "whoopie" signal strength.

**Construction Notes**

The circuit board is single sided, and board population and soldering is straight forward. The loop-stick antenna



**Fig 2 - Circuit board layout of the 80 m ARDF receiver.**

is made by winding 20 turns over the centre of a 10 mm diameter, 200 mm long ferrite rod. The loop-stick is housed in an electrical tee-junction box which has short lengths of conduit protruding from each end.

The antenna tuning capacitor C1 is located in the junction box cavity. The junction box is mounted directly on to the back of the metal housing box, as near as possible to the part of the box which will become the "top".

The sense antenna is a straight piece of brazing rod soldered into a PL-259 plug. An SO-239 socket is mounted on top of the metal box to provide secure but removable connection. The cardioid pattern is achieved by switching the sense antenna "in" and then adjusting RV5 and L5 for a single null. Mount RV5 on the underside of the PCB. Drill holes

on the metal box to align with RV5 and L5. This will facilitate easy adjustment of the vertical signal to achieve the cardioid pattern.

**Receiver Tune Up**

Set RV1 to the mid-position and connect a frequency counter to the VFO monitoring point on the PCB. Note that the VFO frequency is 8.00 MHz minus the desired 80m frequency (eg to tune 3.850 MHz the VFO must run at 4.150 MHz). Experiment with the values of C18 and C19 until the desired VFO frequency is achieved. For good VFO stability use only silver mica, polystyrene or NPO capacitors for the selected values of C18 and C19.

The tuning range can be reduced by increasing the value of R9. To increase the tuning range, increase the number of turns on L4 and decrease C18. The value

of the 10-turn potentiometer is not critical; any value between 10 k and 100 k will be fine. A single turn pot may be used if only a small segment of the 80 m band is required. R9 must be increased accordingly.

Use a signal generator or a strong local signal to tune L2 and L3 for maximum received signal strength. Adjust RV2 for a comfortable listening volume. Switch to "whoopie" mode and adjust RV3 so that the "whoopie" signal is a fairly low frequency purr in the absence of a received signal. When a strong signal is received, the "whoopie" tone should rise in pitch considerably.

### Antenna Tune Up

This should be done during the day to avoid sky wave effects. Run a low power signal of about 10 W and locate the receiver 0.5 to 1.0 km from the transmitter. Set the system to bi-directional mode by disconnecting the sense antenna with SW3. Peak the loopstick antenna by adjusting C1 for maximum received signal. Set RV5 and L5 to their mid-positions. Connect the vertical antenna with SW3. One of the peaks will now be larger than the other. Orientate the unit so that it is on the weaker peak. Adjustment of RV5 will now reduce this peak even further. Now adjust L5 (the effect of adjusting L5 and RV5 is to create a single null opposite a single broad peak). RV5 and L5 interact and some back and forth adjustment will be required to achieve a single null with the correct orientation.

If the null is off the front of the unit instead of the back, the position of the null may be moved 180 degrees by simply reversing the link connection from the antenna to the receiver input. For further description of the antenna set-up procedure refer to the ARRL Handbook. Look up "Direction Finding" in the index.

### Component Supplies

Drilled circuit boards, pre-wound TOKO coils for L2, L3 and some of the other hard to get components are available from the author. Write to Ian Stirling VK3MZ, 169 Glenvale Rd, Ringwood North, VIC 3134. Phone 03 9876 3643.  
E-mail I.Stirling@bhtafe.edu.au

### Parts List

Metal Box 130 x 75 x 55 mm (Dick Smith Electronics Cat H-2325). Sense antenna, 360 mm of 2 mm diameter brazing rod, trimmed during adjustment procedure.

L1 - 20 turns of 0.7 mm wire wound on ferrite aerial rod 200 mm long, 10 mm dia (DSE Cat R-5105). Spacing of one wire diameter between turns wound over centre of ferrite rod. One and a half coupling turns. Tuned to resonance by C1 shunted with a fixed 27 pF capacitor. L2, L3 - pre-wound TOKO coils, available from author.

L4 - 55 turns of 0.2 wire on AMIDON toroid T-50-49 (red mix) (Truscott's Electronic World). Secured to PCB with 3 mm nylon screw and nut with 14 x 14 mm bare PCB with a 3 mm hole used as top securing plate.

L5 - double layer of 0.2 mm wire, close wound over 12 mm of Neosid 4.8 mm former (DSE Cat R-5020). F16 slug (DSE Cat R-5025).

RV1 - 20 k 10 turn pot (or single turn pot, see text).

RV2 - 50 k linear pot.

RV3 - carbon trim-pot 50 k horizontal adjust.

RV4 - carbon trim-pot 50 k horizontal adjust.

RV5 - 5 k cermet, vertical adjust.

D1 - 3V3 Zener, 400 mW

D2, D3, D4 - OA95 etc.

Q1 - BF981 etc.

Q2 - 2N3819

IC1 - MC3362

IC2 - 741

IC3 - 4046

IC4 - LM386

IC5 - 78L05

X1, X2, X3, X4 - 8.000 MHz computer crystals.

S1, S3 - single pole double throw switch.

S2 - double pole, double throw switch.

Resistors are all 0.25 W.

R1 - 220 k

R2 - 100 k

R3 - 1 k

R4 - 39 k

R5 - 100 k

R6 - 100 R

R7 - 1k5

R8 - 10 k

R9 - 4k7

R10 - 1 k

R11 - 4k7

R12 - 330 R

R13 - 2k7

R14 - 10 k

R15 - 10 k

R16 - 100 k

R17 - 100 k

R18 - 330 R

R19 - 2M2

R20 - 100 k

R21 - 6R8

Capacitors are disk ceramic or mono-block unless otherwise specified.

C1 - 5-55 p Philips

C2 - 33 p

C3 - 10 n

C4 - 10 n

C5 - 10 n

C6 - 10 n

C7 - 47 n

C8 - 33 p

C9 - 47 n

C10 - 150 p

C11 - 68 p

C12 - 5-55 p Philips

C13 - 100 n

C14 - 10  $\mu$  tantalum

C15 - 100 n

C16 - 100 n

C17 - 100 n

C18 - 100 p polystyrene or SM

C19 - 2p2 NPO

C20 - 1 n

C21 - 470 p

C22 - 68 p

C23 - 68 p

C24 - 470 p

C25 - 10 n

C26 - 100 n

C27 - 100 n

C28 - 100  $\mu$  electro 16 V

C29 - 10  $\mu$  electro 16 V

C30 - 100 n

C31 - 100 n

C32 - 1 n

C33 - 100 n

C34 - 100 n

C35 - 47 n

C36 - 100  $\mu$  electro 16 V

C37 - 100  $\mu$  electro 16 V

\*169 Glenvale Road, Ringwood North VIC 3134

ar

**Tell the advertiser  
you saw it in the  
WIA Amateur Radio  
magazine!**

# ALARA

Sally Grattidge VK4SHE\*, ALARA Publicity Officer



**ALARA YLs at the CLARA Gala. (l to r) Elizabeth VE7YL, Lois WB3EFQ, Aola ZL1ALE, Gwen VK3DYL, Raija SM0HNV, Barbara KA3VXR, Ruth IT9ESZ, and Margaret VE3BNN.**

Christmas greetings from all the YLs of ALARA to YLs and OMs all over the world.

## CLARA Gala

This report was typed by Gwen VK3DYL at the QTH of Elizabeth VE7YL straight after breakfast! Gwen had arrived in Vancouver the night before, very late as the plane was delayed by snow storms in Calgary. She had been up north looking for polar bears in Churchill, and was very happy to have seen ten (looking forward to more details later. Gwen).

*"The Canadian YL Association (CLARA) held its 30th Birthday celebrations in Toronto over the last weekend in September. 47 YLs from eight different countries laughed and joked their way through the three days, and the hotel will probably never be the same again. In attendance were also a few OMs and a guide dog-in-training.*

*"ALARA was well represented by: Gwen VK3DYL, Elizabeth VE7YL, Lois WB3EFQ, Aola ZL1ALE, Raija SM0HNV, Barbara KA3VXR, Ruth IT9ESZ and Margaret VE3BNN.*

*"It was great to catch up with old friends (sorry, friends of long-standing!) and to meet other YLs who, in the past, had just been voices on the air or e-mail communicators.*

*Lots of new friends were made and many an e-mail address exchanged; I don't think I'll have time for any housework when I get home, but it was well worth it.*

*"And yes, Dave ZLIAMN behaved himself very well!"*

Dot VK2DDB received that message from Gwen by e-mail and took the trouble to pass it on, even though she was busy producing her first Neighbourhood Watch news-sheet at the time.

## Cough Up!

ALARA membership is due on 1 January, so don't put your November Newsletter in the drawer before removing the attached membership form, filling it in and sending it (with money) to the treasurer, Margaret Schwerin VK4AOE, PO Box 758, Dalby, QLD 4405. New members, or anyone who has already lost their form, please contact Margaret.

## Around and About

Margaret ZL3UD now lives on a 12.5 acre farmlet and has started an Alpaca stud.

Janis VE7AAP and OM Garry VE7ACM are cat lovers (funny how the world is divided into lovers and haters when it comes to cats) and have started an album of Radio Cats. As of September 1994, Janis had over 150 cats

from all over the world, all well presented and documented, but she would love to have more. If you have a Radio Cat and would like it represented in her collection, send her a photograph and some information, eg cat's name, your name and callsign, and any other interesting details. Margaret ZL3UD sponsors Janis and is collecting cats for her, so send to her at Nellavale Downs, Downs Rd, Hororata, RD2 Darfield 8172, NZ.

Joan Harris has finally obtained her licence and is operating on her OM's old callsign of VK5ZRH. Congratulations Joan, well done. Jean VK5TSK and Tina VK5TMC are still struggling with the dreaded Morse. Work commitments and fading enthusiasm make it hard going. Don't give up girls. Both plan to have full calls by the next ALARAMeet.

## Korea Ladies Amateur Radio Club

(from IARU Region 3 Magazine)  
Chae Do Sook HL1KDW

Since the 1950 Korean war the position of women in that country has gradually started to change. More women are being educated at university and are pursuing careers. As with working women all over the world, life is busy with little time for recreation, but many are joining the ranks of amateur radio operators and enjoying the rewards of friendship and communication between women from all walks of life.

Chae Do Sook has been an amateur for 10 years after being trained in the Korean Amateur Radio League to obtain a licence in 1988. She has made friends all over the world and loves to collect QSL cards.

The KLARC (Korean Ladies Amateur Radio Club) was formed in June 1984 with only 150 YLs total in Korea and 20 active YL operating members. There are now over 20,000 amateurs in Korea alone, ten percent of which are YLs.

KLARC has a YL field day once a year where information is exchanged and instruction given to beginners (some fun and friendship too, I am sure - VK4SHE). A YL journal, KLARC NEWS, is published, but is not a regular event at this time. On-air etiquette of courtesy and politeness is considered very important.

## Svalbard Polar YL 98

If you want to be in this experience of a lifetime, you must register before 31 December. Write c/o Ruth Tollefsen, PO Box 17, Tveita, N-0617, Oslo, Norway. E-mail jetpro@sn.no. Phone +47-2226 9330; or fax +47-2226 9712.

\*C/o PO Woodstock, QLD 4816

Tel: 077 788 642

Packet: VK4SHE@VK4RAT.#NQ.QLD.AUS.OC

Internet e-mail: rgrattid@ozemail.com.au

ar

# AMSAT Australia

Bill Magnusson VK3JT\*

**National co-ordinator**  
Graham Ratcliff VK5AGR  
E-mail: vk5agr@amsat.org

**AMSAT Australia net:**  
Control station VK5AGR  
Bulletin normally commences at 1000 UTC, or 0900 UTC on Sunday evening depending on daylight saving and propagation. Check-ins commence 15 minutes prior to the bulletin.

Frequencies (again depending on propagation conditions):

Primary 7.064 MHz (usually during summer).

Secondary 3.685 MHz (usually during winter).

Frequencies +/- QRM.

**AMSAT Australia newsletter and software service**

The newsletter is published monthly by Graham VK5AGR. Subscription is \$30 for Australia, \$35 for New Zealand and \$40 for other countries by AIR MAIL. It is payable to AMSAT Australia addressed as follows:

AMSAT Australia  
GPO Box 2141  
Adelaide SA 5001

**Keplerian Elements**

Current keps are available from the Internet by accessing the AMSAT FTP site, <ftp.amsat.org> and following the sub-directories to "KEPS".

## Ariane 502 Rocket Launch Success

The second flight test of the Ariane 5 launch vehicle (Ariane 502) late in October was a success, and two satellites were deployed into a geo-stationary transfer orbit. This is excellent news for all amateur satellite buffs. It augers well for an early launch of our long awaited Phase 3D high altitude satellite. AMSAT officials believe that it is still too early to know what the effect Ariane 502's now apparent success will have on the subsequent Ariane schedule, on the possible Phase 3D launch, or the vehicle on which it will ultimately ride. However, it was anticipated that a successful AR-502 flight would give ESA added flexibility in scheduling a subsequent launch for Phase 3D on a future Ariane flight.

## Phase 3D Update

The AMSAT Phase 3D spacecraft, currently nearing completion, was to have flown on the second successful flight test of

the Ariane 5 series. However, in August, ESA removed Phase 3D from the payload when it became clear that the required structural modifications to its space-frame would not be finished in time for the AR-502 launch.

The need for modifications came about as a result of ESA's discovery that launch loads on the AR-502 flight might be significantly higher than they had first anticipated. The structural modifications meant that many components already fitted to Phase 3D had to be removed and subsequently re-installed. The spacecraft is now nearing completion to the new specifications. An early re-scheduling of the launch is anticipated now that the Ariane program has resumed.

## Amateur Satellite Image Downloading and Processing

Graham VK5AGR is running a series in the *AMSAT-VK Newsletter* on this fascinating topic. The first part dealt with the image processing software developed by Colin VK5HI. It runs under Windows 95 and has heaps of goodies for satellite imaging enthusiasts. Colin has succeeded in turning a previously complex task into a very simple one by some clever programming. He has gained quite a reputation for this kind of software with several previous generations already in widespread use throughout the amateur radio satellite community.

Graham explained in detail how to configure the WiSP ground station software to automatically capture the image files and then went on to describe the versatile image processing functions of Colin's **CCD Display 97** program as well as his small DOS based program, **DISP\_ACT.EXE** which can be used to preview the large image files after partial downloading. This is a great time saver as the image files are quite large and this program allows a "sneak preview" early in the download so that uninteresting or corrupted files can be terminated without waiting for a complete download.

## MIR Update

There's no doubt that the American presence on MIR has sparked a huge increase in the popularity of the packet PMS and other MAREX operations. So much so that the PMS mailbox is often full these days. This has prompted several occasions when the system has had to be closed down. The crew are very busy. They have a full schedule of duties without having to worry about whether the PMS is full.

Amateur radio is a **RECREATIONAL** activity for them and lately the opportunity

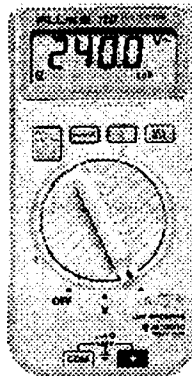


YOUR HOBBY

YOUR VOICE

Representing Radio Amateurs - Since 1910

**RECRUIT  
A MEMBER &  
THEY COULD  
WIN!  
THIS GREAT  
FLUKE 12B  
DIGITAL  
MULTIMETER  
WORTH \$195**



**THERE'S BEEN A WINNER  
EVERY MONTH FOR 1997  
LAST CHANCE TO WIN!**

This latest hand-held DMM, from the world-leading maker of digital test instruments, has advanced features yet is simple to use. Ideal for tyro & veteran.

**The Fluke 12B measures:**

- ac and dc voltage (with auto-selection)
- resistance & capacitance (.001-1000 $\mu$ )

**The Fluke 12B features:**

- 4000-count liquid crystal display
- simple rotary dial
- diode and continuity testing
- indicates intermittent opens & shorts
- 2-year warranty

**Fluke 12B prizes generously donated by Philips Test & Measurement.**

Each month's prize is awarded by way of a draw among newly recruited members each successive month and presented to the winner at the earliest opportunity following the draw.

**To sign up a new member, use the back of your AR magazine address leaflet - or clip the coupon, have them fill it out and send it now.**

**SEND TO YOUR DIVISION'S ADDRESS, SHOWN ON PAGE 56.**

Please send me a membership application.

NAME .....

ADDRESS .....

P/code .....

Call Sign (if any) ..... [AR 12/97]

for spending the hours required to read and answer all the greetings and other messages just hasn't been there. It doesn't seem all that long ago that one could look forward to having a leisurely chat with the Cosmonauts and even doing the occasional digipeat to a friend through the MIR packet station. Looks like those days are gone forever.

Perhaps when the ISS is up and running we can look forward once again to chatting to the, hopefully, more relaxed occupants during their scheduled recreation time and working through and via a more capacious digital system.

Planning for the decommissioning of MIR is already underway. One would expect that the packing up and return of the amateur radio gear is somewhere on the list over the next year or three. It will be interesting to see how long it survives. Perhaps its proven record as a backup communications system will extend its life a little longer than would otherwise be the case. At the time of writing the SAFEX 70 cm repeater is still turned off. It is not known when this experiment will be turned back on.

### **Sputnik-1 Replica Produces Good Signal**

I wonder how many people around the world have tuned in to the signal from the 40th anniversary 1/3 scale replica of Sputnik-1. Some pundits are calling it RS-17 but I have not seen any official announcement to that effect.

The most enduring memory I will have is just how strongly the signal came in. It seemed impossible that a 100-200 mW transmitter in orbit could produce such a loud signal. It bounced the "S" meter of my old Kenwood TR-7400-A FM transceiver against the stop for the entire pass on the first occasion I heard it. It conjured up memories of that day in October 1957 when I received the signal from Sputnik-1.

My friend Neil Town VK3AMK was a staff photographer with the Melbourne Herald/Sun in those days. His time exposure picture of the Sputnik-1 rocket streaking across the Melbourne night sky was produced full front page next day. The space race had begun. It grabbed the public imagination as new, spectacular announcements were made by NASA and the Russians almost daily. Few of us would have thought that only four years later we would see the first amateur radio OSCAR in orbit. Neil is still active on 80 metres and we often reminisce about those days and that event in particular.

As I was listening to the signal from the scale model Sputnik replica booming in, I turned up the volume and went outside. Sure enough, there was MIR going over, just

visible in the evening glow. The tiny Sputnik had not been released long enough to separate very far from MIR where it was "hand-launched" by Cosmonaut Pavel Vinogradov during a space-walk a day earlier. The signal was on 145.820 MHz this time; but, as I listened, I reached over to my old Eddystone S-680-X receiver and gave it a pat on the head and turned the dial to 20 MHz as I did that day 40 years earlier.

I had recorded the signal from Sputnik-1 on a Byer 66 reel-to-reel tape recorder (the Rolls Royce of recorders in its day) coupled to the line output of that receiver. The Byer "bit the dust" long ago and has been replaced by a more modern Marantz machine and the

tape has been dubbed onto a cassette which I was able to use to compare the signals. All in all a wonderful experience. Enough to bring a tear to the eye!

Thanks are due to all those involved in the project, both in France and Russia. As well as stirring our souls, their efforts and initiative have given many schools around the world the opportunity to do some very good science work. Perhaps somewhere there is a student listening to and recording the signal today who will be a scientist on board the International Space Station or beyond in another 40 years time.

\*RMB 1627, Milawa VIC 3678  
E-mail: vk3jt@amsat.org

ar

---

## **ARDF - Amateur Radio Direction Finding**

Ron Graham VK4BRG\*

---

### **JOTA and ARDF**

This is being written as plans are being made for the forthcoming JOTA. Here in Sarina we have had some ARDF activities with JOTA over the last three years and it has involved Scouts, Cubs, Guides and Brownies. I think JOTA presents a marvellous opportunity to promote ARDF activities, and thus amateur radio in general, with the Scouting and Guide movements. As well as being a great outdoor Scouting type activity, ARDF can nicely supplement the normal JOTA programmes. So, now might be the time to start planning for JOTA 1998.

Naturally, there are many ways of organising the ARDF side of JOTA. This could possibly be done by a different group of amateurs than those that do the more normal communications side of JOTA; those with a specific interest in ARDF. This would help split the workload and mean that groups of Scouts can be simultaneously involved with the regular JOTA activities plus ARDF. Equipment needed would be a low power fox plus a few sets of "sniffer" type receivers. One could even get by with just one receiver, simply demonstrate the concept of ARDF, then let individuals have some "hands on" experience. Two metres will probably be the chosen band. I hope to make some comparisons between 2 metre and 80 metre ARDF in a future column, but it appears that 80 metre equipment would be less costly.

Further to the ARDF and JOTA relationship (plus some general comments), Wally VK4DO has contributed the following thoughts: "There are several matters that require some thought and attention.

(a) For Clubs that participate in JOTA in a camp or field location, it would be an idea to introduce ARDF/foxhunting/radio sport well in advance of JOTA.

(b) Because 80 metres is far simpler to get going and a lot less costly, this is the band to start on. The ferrite rod is far superior to a beam for getting exact directions and easier to explain to beginners.

(c) By making ARDF a Club project, it could be introduced to the Scouts/Guides several months ahead of JOTA. The Club would only need two low power 80 metre transmitters and several receivers.

(d) The Club would then encourage youngsters to build their own receivers under the guidance of Club members. The Club could arrange simple competitions before JOTA, so that on the day everyone would be ready. All that is needed for this is two transmitters and have the competitors starting one at a time. The shortest time is the winner. This means less equipment is required. We are waiting on a sample 80 metre kit from China to use as a basis."

So, there are some further thoughts to add to mine. Hopefully, some more ideas will appear in the future.

### **Next Region 3 ARDF Contest**

Some more from Wally: "It has been confirmed that the next Region 3 ARDF Championship will be held in South Korea around September 1999. We are looking for a full team of 12 from Australia. In order to get young people to participate there, perhaps Clubs, through the suggested activity with JOTA, may be willing to raise funds to help sponsor or subsidise a suitable recruit.



So far there has been no offer of financial support for the Region 3 championship from the WIA Federal, or any Division."

### ARDF Activity

Over the weekends of 27/28 September and 4/5 October, I attended the Townsville Convention and the Central Highlands Clubs Fairburn Dam weekend. It is pleasing to report that there was quite a reasonable amount of ARDF activity at both events.

### Further "Fox" Development

For the last few months I have been experimenting with an MC 13175 IC. This 16 pin surface mount device is a single chip crystal controlled signal source designed for 260 to 470 MHz operation. It uses a phase locked loop (PLL) and may be modulated in a variety of ways. One application I had in mind was to try and use it as a miniature "fox" at 144 MHz.

The first consideration was to determine if it would work "down" on 144 MHz. This is satisfactory, and with an 18 MHz crystal in conjunction with the chips divide-by-eight from the signal frequency down to the PLL input, the voltage controlled oscillator (VCO) runs at 144 MHz and direct output is obtained at that frequency.

Output power was measured at two milliwatts with a three volt supply. Initial tests were satisfactory at a 200 metre range using a quarter wave wire antenna on the fox and the usual "sniffer" type receiver. The maximum range is yet to be established.

Further circuitry was developed to pulse the transmitter on for a few milli-seconds every second. This serves both to identify the device and reduce power consumption. The unit, together with two "N" size cells, is fitted into a metal box measuring 25 x 25 x 35 mm. So watch out, foxes are getting smaller!

### ARDF Groups and Contacts

As mentioned in the October column, I will endeavour to supply a list of Groups that are active in ARDF related matters plus a contact person for that Group.

I think the largest and most active would be the **Melbourne Fox Hunting Group**. This, I am informed, is made up of people from a number of clubs in the area plus other individuals, all with an interest in ARDF. For those with Internet access, they have a web page at: <http://www.ozemail.com.au/~amacl/fox/fox.html>

They also have a mailing list/reflector to which one may subscribe via their Web page, or by sending a message with *subscribe melb-fox* in the body of the message to *majordomo@planet.net.au*

For a general contact person, I suggest Mark Diggins VK3JMD (03 9558 2959; e-mail *mdiggins@netspace.net.au*). Mark

may then put you in contact with someone else who has the specific knowledge to handle your enquiry. Incidentally, Mark, plus others, will be telling us more about this Group with a major contribution to the February column.

For the **Redcliffe and District ARC**: Jason Morris VK4YOL (07 5495 3845) is the Club ARDF co-ordinator. Also, Barrie Hill VK4ZOO (073 869 1141; e-mail *barrie@ecn.net.au*), who has been involved with ARDF activities for some years now.

**Townsville ARC**. Don Terrace VK4MC (077 88 6665 [AH]; 077 25 1822 [BH];

e-mail *dterrace@ozemail.com.au*). Don is doing some good work in Townsville.

Wally VK4DO, PO Box 432, Proserpine QLD 4800 (079 47 1036; Fax 079 47 1848) is the VK plus VK4 ARDF co-ordinator.

Yours truly has set up a "web page" with a large ARDF content at: <http://www.mackay.net.au/~ron>

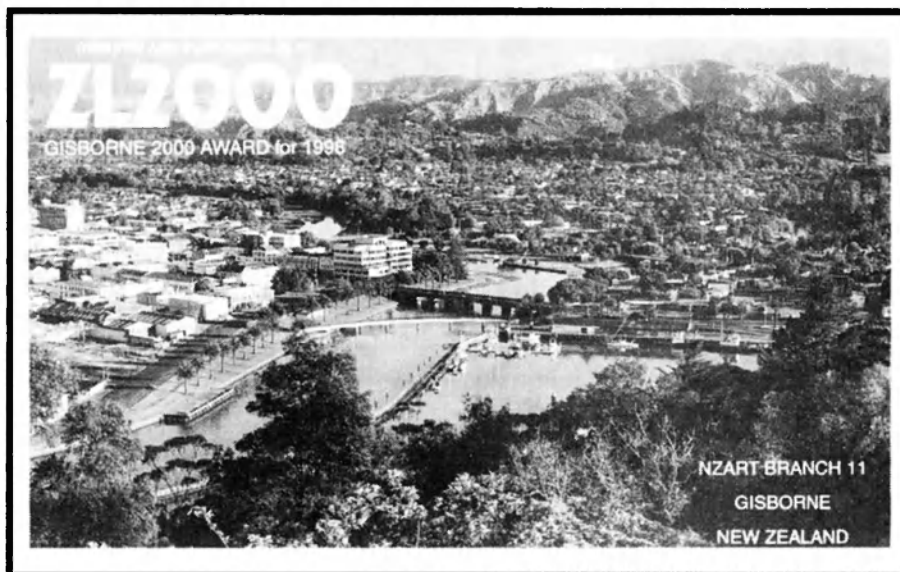
Please let me have details of a contact person if you or your Club are involved in any ARDF type activities.

\*PO Box 323, Surina QLD 4737  
E-mail *rongraham@magnet.com.au*  
Packet VK4BRG @ VK4BRG.#CQ.QLD.AUS.OC

ar

## Awards

John Kelleher VK3DP - Federal Awards Manager\*



The ZL2000 Award certificate for 1998. It is a full colour certificate measuring 297 by 210 mm.

Another year drawing to a close, and I am still asking for information on local awards. Some of the more progressive groups have come to the fore, but I am still waiting for some movement from the rest, particularly those on the list that I had reason to publish at an earlier date. Believe me, when the bands start to activate again, you will thank me for persisting.

I now know that we have an Awards Manager in VK2. What about the rest of the States? And what about two metres and above? It is downright embarrassing to have to beg for down information which will, in the end, be valuable to all and sundry!

### Israel's 50th Anniversary Award

The Israel Amateur Radio Club announces a special activity to commemorate the Jubilee of the State of Israel, and the establishment of the IARC.

The activity starts on 1 January 1998 and ends at midnight on 1 May 1998, which is Israel's 50th Independence Day. The aim is to contact as many Israel radio amateurs as possible. Contacts with Israeli stations will be counted once only, regardless of band or mode.

To honour the IARC founders, a special call sign will be used by those amateurs who belong to the founders group (Pioneers). They will use the prefix 4X50.

Special event stations will be active to commemorate Silent Keys, many of whom belonged to the founders group. These stations will use the 4X50 prefix and the Silent Key's old suffix, ending with /SK. For example 4X50BX/SK.

Each contact with an IARC member will count one point. Each contact with a Pioneer Station will count five points. The following points are required for the awards. Basic: 50

points including two Pioneer stations. Bronze: 100 points including four Pioneer stations. Silver: 150 points including six Pioneer stations. Gold: 200 points including eight Pioneer stations. Platinum: 250 points including 10 pioneer stations.

For SWLs the same rules apply, providing the log extract shows the particulars of both stations heard.

A special 50th Anniversary "Israel State Medal" will be awarded to the three highest scores in each of the IARU Regions 1, 2 and 3. Logs must be sent to the IARC Awards Manager before 30 June 1998 at PO Box 17600, Tel Aviv 61176 (please note that there was no mention of fees included in the information which I received). Tel/Fax: 972 3 534 6049. E-mail: [josepho@shani.net](mailto:josepho@shani.net)

Best 73 and shalom, from Joseph Obstfeld 4X6KJ.

### The ZL2000 Award

Now for one of those popular annual awards. The amateur fraternity is fast heading into a new century, with the year 2000 rapidly approaching. To acknowledge this event, the Gisborne Amateur Radio Club (Branch 11 NZART) have instigated an annual award UNTIL the year 2000, using the call sign ZL2000.

The award, known as the "Gisborne 2000 Award", highlights the fact that Gisborne, New Zealand is unique in being the first City in the world to greet the sunrise on a new day, and the New Year. Gisborne will be the centre of attention for much of the world during the New Year period of the year 2000.

As this is an International Award, it is therefore open to all amateur radio operators and SWLs. To achieve an annual award, only ONE contact is required with a ZL2000 station during the month of January each year, until the year 2000.

A special complimentary Award will be issued to all stations that contact a ZL2000 station for FOUR out of the possible five years of the award, up to and including the year 2000. One of these complimentary award recipients will receive a very special award in the year 2000, the details of which will be released at a later date.

The fee for the annual award in New Zealand is \$NZ5.00. For VK operators \$AUS5.00, and for the rest of the world \$NZ10.00. All correspondence and Award applications should be sent to Gisborne 2000 Award, PO Box 1017, Gisborne 3815, New Zealand.

### Rules for the ZL2000 Award

- (1) The Award will be available to all licensed amateurs and SWLs.
- (2) Only ONE contact is eligible per year

with one of the Gisborne stations using the ZL2000 callsign.

- (3) All operators using the ZL2000 call sign must be full members of the Gisborne Amateur Radio Club.
- (4) Any valid amateur frequency may be used by Phone or CW.
- (5) Contacts can only be made during January of each year.
- (6) The Award commences at 0001 hrs (NZ time) 1 January 1998 (1101 UTC 31 December 1997) and concludes 2400 hrs (NZ time) 31 January 1998 (1100 UTC 31st January 1998, and each year including the year 2000.
- (7) All valid contacts with a ZL2000 station will be sent a QSL card via the NZART QSL Bureau.
- (8) The Award for each year will be

issued on receipt of the prescribed application fee.

- (9) The application fee for the award should reach the Award Manager by 30 June of the operating year (late entries will be processed at the discretion of the ZL2000 Awards committee).
- (10) A different pictorial award will be issued each year.
- (11) Any operator or SWL collecting four awards, including the year 2000, will be issued with a complimentary award.
- (12) One amateur operator or SWL meeting the requirements of Rule 11, will be chosen to receive a special award in the year 2000.

\*4 Brook Crescent, Box Hill South, VIC 3128  
Phone (03) 9889 8393

ar

---

---

## Club Corner

---

---

### Central Coast Amateur Radio Club

The Central Coast Amateur Radio Club, a club well known for its annual Field day or Hamfest, is on the warpath. Its membership, as with most similar clubs, has diminished somewhat over the years.

The Club, after careful consideration and being sick of the doom and gloom talk and attitude in our hobby, has now appointed a "Promotion Committee" with the order "GO GET THEM".

This committee has set itself an agenda to increase membership, have radio interviews about our hobby, organise "hands-on demonstration evenings" for the public, begin an advertising campaign, and treble the number of students in the annual license courses. A tall order indeed, but already the signs are there that it is working. The committee has commenced advertisements in the Central Coast newspapers, has produced attractive brochures, and the general public has shown remarkable interest.

They have used the Limited Novice licence (no CW) as "bait", as it is felt that, after obtaining the first licence, the natural curiosity of the student will do the rest, a fact which already has been proven.

The club has taken the bit between its teeth and is getting away from the gloom attitude. The CCARC is of the opinion that, with the thousands of Cbers about, many must be sick and tired of the restrictions placed on them; this also has been proven correct.

The Club is taking the attitude of not

complaining and blaming the Internet, e-mail, CB or mobile phones for the decline of, or lack of new, interest in this great Amateur Radio Movement of ours, but is going out and doing something about it. The campaign committee strongly believes that the number of members can be doubled and the number of new student licensees can be trebled.

Optimistic? Not according to the Central Coast Amateur Radio Club.

Peter Rysdyk VK2FFA  
CCARC Promotion Committee

### The Australian Naval Amateur Radio Society (ANARS)

Established for radio amateurs and interested SWLs who have a professional Naval or Maritime background, ANARS welcomes enquiries from serving and past members of the Royal Australian Navy, Australian Merchant Navy, RANR, WRANS, RANVR, Naval Reserve Cadets and Civilian Support Staff of the RAN who have an interest in amateur radio.

Membership enquiries are also welcomed from those who have served in any foreign Navy, Merchant Navy or Naval Reserves and who are now Australian Citizens or have been granted permanent resident status in Australia.

Foreign Amateurs with similar nautical background are welcome to apply for Associate Membership of the Society.

ANARS is affiliated with the WIA, and the aims of the Society include:-

\* Encouraging the hobby of amateur radio within the RAN and the Australian Merchant Navy.

\* Bringing together all radio amateurs and interested short wave listeners with a professional naval or maritime background.

\* Co-operating with overseas naval/maritime amateur radio organisations for mutual benefit.

\* Representing the interests of Australian naval or maritime amateur radio internationally.

Active ANARS amateur operators are resident in every state, the ACT and the Northern Territory. Also included are offshore islands, New Zealand and some overseas countries.

Two "Navy Nets" are conducted each week in the Novice segment of the 80 m band on Mondays on 3532 kHz (+/- QRM) at 0930 UTC, CW mode; and Wednesdays on 3620 kHz (+/- QRM) at 0930 UTC, SSB mode.

In addition, two SSB nets are conducted every day on 7075 kHz (+/- QRM) at 0400 UTC; and on 14175 kHz (+/- QRM) at 0430 UTC. All are welcome to join the various nets.

For further information on the Society and its activities, please contact the Secretary of ANARS by writing to PO Box 482, Parramatta NSW 2124, or by phone on 02 9630 6670. Alternatively, call in to any of the "Australian Navy" nets where members will be only too pleased to assist you.

Our common bonds are the sea and radio. ANARS is Australian and proud of it!

### 50th Urunga Radio Convention

The 50th Urunga Radio convention will be held at Urunga, commencing on the morning of 11 April 1998. This convention is the first and longest continuous running radio convention in Australia. Not all, but most of the fox-hunting, and twists to fox-hunting, were devised at Urunga.

Many people have attended this convention over the years but, unfortunately, many of the early participants are now Silent Keys.

The technical advances seen in radio since the inception of the convention have, to say the least, been staggering. For example, the efficiency and power savings from the early VHF modulated oscillator transmitters and super regenerative receivers operating on two metres and powered by large 12 volt lead batteries, to the modern palm-sized transceiver covering from 50 MHz to 1 GHz on receive and 2 m and 70 cm on transmit.

Special certificates will be issued to all who attend the 50th convention. Further information can be had on the Internet; or from the committee, who are: VK2s ADA, DMS, YCJ, DGT and ZCQ; or by mail to: PO Box 8, Bellingen NSW 2454.

B J Slarke VK2ZCQ

### RAOTC

If you were licensed in 1972, or earlier, you are eligible for membership of the **Radio Amateurs Old Timers Club** of Australia. Age has no bearing on eligibility.

As at December 1997, \$12.50 will cover the joining fee of \$2.50 and membership to 30 June 1999! For this you will receive the March and September 1998, and the March 1999 issues of the club magazine *OTN*; plus, of course, the fellowship of an Australia-wide group of long time radio amateurs.

For membership application details, please contact Arthur Evans VK3VQ, Milton Crompton VK3MN or Allan Doble VK3AMD. All are QTHR.

Allan Doble VK3AMD

ar

## WIA News

### Good Publicity for Amateur Radio

The Space Pilots Club, a Toowoomba youth group interested in rocketry and space, held their annual father/son camp at Shannon Park in the countryside north of Toowoomba, over the weekend of 25-26 October.

As 'communicating' was the theme for the weekend, the Darling Downs Radio Club (DDRC) was invited to participate. The DDRC set up two HF stations, one on sideband, and the other on CW. A number of contacts were made with stations in Croatia, the United States and Antarctica (VK0ANARE).

Other displays allowed visitors to try their hand at sending Morse to a computer, and demonstrated some satellite tracking programs.

In view of the Space Pilots' interest in rocketry, one DDRC member also brought along for display a fine collection of photographs from when he worked at Woomera in its heyday.

Amateurs involved were Tom VK4BTW, Dennis VK4ADY, Keith VK4NCM, Terry VK4KTP, and Ivan VK4BIB, who also did all the hard work in co-ordinating the displays. (Thanks to Terry Walters VK4KTP, via WIAQ newsman, Graham Kemp VK4BB).

[Released 11/11/97]



HF - VHF - UHF MOBILE ANTENNA  
HF - VHF - UHF BASE ANTENNA  
CB - MARINE - AIRCRAFT

Monoband to Multiband  
Convert Now, to the all  
New!

**PERTH PLUS**

HF Mobile antenna

with 80-40-30-20-17-15-12-10-6-2m included

400-0500

Coaxial Cables & Fittings  
HF Spring Bases, Trunk and Gutter Mounts.

Outbacker OBB "Classic"  
Outbacker "Junior plus"

Split Models  
Helical Dipoles  
Long wire Dipoles  
Baluns

Now available from .

MELBOURNE  
Daycom Communications  
Ph 03 6436444

ALICE SPRINGS.  
Farmer Electronics  
Ph 089522388

DARWIN.  
Integrated Technical Services.  
Ph 089-815411

SYDNEY.  
Andrews Communications  
Ph 02 6369060

PERTH.  
Tower Communications  
Ph 4701118

ADELAIDE  
Johnston Electronics  
Ph 08 2871061

PERTH - Moor

<http://intercon.com.au/outbacker>

TERLIN AERIALS Ph +61 (08) 9455 4288  
11 McElligott Court Ph +61 (08) 9455 4289  
Canning Vale WA 6155

NEW VIDEO

Send \$ 5.00 for a 15 minute informational video  
Refundable with every antenna purchase.

# Contests

Peter Nesbit VK3APN - Federal Contest Coordinator\*

## Contest Calendar Dec 1997 - Feb 1998

Dec 5/7	ARRL 160 m Contest	(Nov 97)
Dec 13/14	ARRL 10 m Contest	(Nov 97)
Dec 20-21	Croatian CW Contest	(Nov 97)
Dec 27/28	Stew Perry 160 m Challenge	(Nov 97)
Dec 27 - Jan 25	Ross Hull VHF/UHF Contest	
Dec 28	RAC Canada Winter Contest	(Nov 97)
Dec 31	ARRL Straight Key Night	
Jan 3-4	ARRL RTTY Roundup	
Jan 9-11	Japan International DX CW (Low Band)	
Jan 10-11	VHF/UHF Field Day Contest	
Jan 17-18	HA DX CW Contest	
Jan 23-25	CQ WW 160 m DX Contest	
Jan 24-25	REF (France) CW DX Contest	
Jan 24-25	UBA (Belgium) SSB DX Contest	
Feb 7-8	YU DX Contest	
Feb 14	Asia-Pacific CW Sprint	
Feb 14-15	PACC CW/SSB DX Contest	
Feb 20-22	CQ 160 Metre SSB Contest	
Feb 21-22	RSGB 7 MHz CW Contest	
Feb 21-22	REF (France) SSB DX Contest	
Feb 21-22	UBA (Belgium) CW DX Contest	
Feb 21-22	ARRL DX CW Contest	
Feb 22	High Speed Club CW Contest	

While putting the contest calendar together this month, I noticed that next February is unusual in that it has only three full weekends. This means that, according to the published rules, there will be a total of at least six contests occurring on the weekend of 21/22 February!

No doubt the respective organisers have also noticed this clash, but whether anyone has changed the date of their contest to avoid it is anyone's guess. Over the next month I'll try to find out more information. In the meantime, please treat the listings for 21/22 February with care.

The RD Contest results have arrived, and once again VK7 takes the crown. Well done everybody!

The outcome could have been very different, however, if more stations had sent in their logs. As the RD Manager Alek VK6APK points out, the VK2 Division would have won the contest if a particular VK2, who was reasonably active on VHF, had submitted his log. However, he did not, and VK2 lost as a result.

The message is clear. If Divisions are really serious about winning (which of course they are), it is up to them to make sure that all their entrants submit logs. This is especially important considering that entrants automatically give points to other Divisions when they make contacts, at least on HF, so to not submit a log actually COSTS their Division and makes it HARDER for them to win.

The Divisions could almost tell their members that, if they don't intend to submit logs, don't enter the contest! However, nobody in his right mind wants that, so next August PLEASE enter the RD

and PLEASE submit your log. The ball is in the court of the Divisions to keep reminding their members of the necessity to send in their logs.

Finally, I want to wish everyone a very Happy Christmas.

For information this month, thanks to VK3KWA, VK4VW, VK6APK, OE4BKU, and CQ Magazine. Until next month, good contesting!  
73, Peter VK3APN

## CQ Worldwide 160 Metre DX Contest

CW: 23-25 Jan, 2200z Fri to 1600z Sun  
Phone: 20-22 Feb, 2200z Fri to 1600z Sun

The CW and Phone sections of this contest are scheduled for the last full weekend of Jan and Feb each year. The object is to contact as many stations world-wide on 160 m as possible. VK to VK contacts are permitted for contest credit. Categories are single and multi-operator. The use of packet, a spotting net, or logging assistant makes you multi-op. Suggested DX frequencies are 1830-1835; W/VEs will usually operate outside this window. Look for Japan on 1907-1912.

Exchange RS(T) plus prefix or country abbreviation (VK). W/VE will send RST plus state/province. Score two points for contacts with stations in own country, five points with stations in other countries in the same continent (continental boundary as for WAC), five points for contacts with /MM stations, and 10 points with stations in other WAC continents.

Multipliers are US states (max 48); Canadian provinces (max 13); and DXCC & WAE

countries. Maritime mobile stations no longer count as multipliers. The final score equals the total QSO points times total multiplier (US states + VE provinces + DX countries). Indicate CW or SSB on the envelope, and mail the log and paper summary sheet to: 160 Metre Contest Director, David Thompson K4JRB, 4166 Mill Stone Court, Norcross, GA 30092, USA. Mailing deadlines are 28 Feb for CW, and 31 March for SSB.

## Results of 1997 Jack Files Memorial Contest

Presented by Peter Dawson VK4VW (ex VK4EFX)

22 logs were received, all of which were well presented. Some of them included useful comments and suggestions, which will be looked at prior to next year's contest. Trophies and certificates will be posted in the next few weeks.

CW:

1	VK4EMM *	4323
2	VK3APN	2074
3	VK1WI	924
4	VK4BAZ	728
5	VK4ICU	490

Phone:

1	VK4PJK *	9520
2	VK4BAZ	8056
3	VK4AGW	7035
4	VK4MGA	6528
5	VK4MOJ	5776
6	VK4LAJ	2952
7	VK4DO	1219
8	VK1WI	714
9	VK4JAE	504
10	VK1PK	468
11	VK2LEE	385
12	VK4LUV	286
13	VK4PVH	202
14	ZL1AGO	130
15	VK5UE	126

Club:

1	VK4BAR	3017
---	--------	------

DX:

1	ZL1AGO	130
---	--------	-----

SWL:

1	L40380	9520
---	--------	------

Highest Novice Overall:

VK4PJK *	9520
----------	------

\*Denotes trophy winner. All entrants will receive a certificate of participation.

## RESULTS OF 1997 RD CONTEST

Presented by Alek Petkovic VK6APK  
VK7 Wins Again!!

For the second year running we congratulate the VK7 Division for their great effort in winning the 1997 Remembrance Day Contest. The winning margin was not as great this year as it was in 1996, but it was still a strong and well-deserved win.

It was a hard slog for all Divisions this year, as we were still very much in the doldrums as far as HF propagation was concerned. The 10 and 15 metre bands were virtually unusable this year because of the poor conditions. This was not such a worry for full call stations, as conditions on 20 and 40 were quite good. I am in full admiration of the Novices who were virtually confined to 80 m, and so were only able to operate during the hours of darkness. It was fortunate that conditions were

so good on 80, because it allowed some of them to amass some very large scores for their Division.

The standard of logs was excellent this year, making the task of checking and calculation very easy. A big disappointment, however, was the fairly low number of logs submitted compared to the number of stations who took part. In the course of checking the logs, I was quite amazed that in VK6, the return rate for both HF and VHF logs was just 58%. Also, the 42% of stations that did not submit logs were not "tail-enders" whose score would not have done much to help their Division. In VK6 for example, their points would have boosted the Divisional score by more than 30% on VHF and by 25% on HF!

It was evident that all Divisions suffered this problem to varying degrees. Perhaps the most outstanding example is that of a VK2 station, who had at least 175 points on VHF that I know of, who did not submit his log. Had he done so, VK2 Division would now be the proud holders of the title for 1997!

In 1998, think of what YOUR log means to your Division, and then send it in to be counted. It WILL make a difference.

**Divisional Scores**

The method used to determine the winning Division using "Benchmarks" and "Improvement Factors" was published with the rules on page 38 of *Amateur Radio* July 1997. Readers who wish to do their own calculations are referred to that issue of the magazine.

Table 1 shows the placing of each Division, along with their overall Improvement Factors.

**Table 1: Divisional Ladder**

1st	VK7	1.939
2nd	VK5/8	1.239
3rd	VK2	1.033
4th	VK4	0.917
5th	VK6	0.747
6th	VK3	0.503
7th	VK1	0.402

The total scores in both the HF and VHF sections are shown below in Table 2.

**Table 2: Divisional Scores**

Div'n	HF	VHF
VK1	441	68
VK2	5049	67
VK3	3183	3324
VK4	4879	410
VK5/8	3104	2229
VK6	2711	4089
VK7	2014	538

The above totals were used to calculate the Improvement Factors, which determined the winning Division. They have also been used to calculate the Benchmarks to be used for next year's contest. These Benchmarks, which are shown in Table 3, are the scores that must be surpassed by each Division in order to register an improvement. They will be published again with the rules in July 1998.

**Table 3: 1998 Benchmarks**

Div'n	HF	VHF
VK1	720	212
VK2	4523	72
VK3	4106	9602
VK4	3682	988
VK5/8	3586	1571

VK6	2897	6331
VK7	1949	277

**Individual Scores**

The individual scores for entrants are listed below. Certificate winners are denoted by an asterisk (\*), and the top Australian scores in each section by a hash (#). This year, for the first time, certificates will be issued to both the top single operator and top multi-operator stations in each division.

VK1	EA	214
HF Phone	SAY*	187
DW*	AHY	166
RN	CAT	118
SW	JK	107
2EY/1	EK	104
HF CW	XK	93
AU*	INCO/3	84
PK	ABP	80
VHF Phone	DY	68
DW*	GUS	67
HS	EX	63
RG	DVT	61
2EY/1	AMW	50
VK2	BWT	50
HF Phone	KQB	50
CAA*	MDT	50
XN*	MSL	50
CM	ADW	45
DCL	ALD	41
SHA	DBQ	41
XT	OW	39
LEE	KTO	32
XH	GMS	25
AGF	DCP	21
EP	CAM	13
LO	EST	13
BDT	CRP	11
WI	XH	1
FY	HF CW	
ALZ	APN*	238
HV	XB	160
WF	AMD	102
BQS	ANJ	100
UC	FG	96
ZM	DNG	76
KQ	KS	42
AVT	HF Open	
CF	DID*	98
DDB	VHF PHONE	
HF CW	SAA**	537
KM*#	GUS	519
OI	TBM*	449
DID	AYF	233
QF	JK	222
GS	KTO	201
PS	TFE	150
EL	XJU	141
CWS	OW	120
AZR	BGS	101
HF Open	CAM	100
BO*	DBQ	81
RJ	CAT	67
FYM	AWS	59
PH	HAY	59
VHF Phone	CRP	58
BDT*	EST	55
HV	AGH	49
VHF Open	XH	40
TJO*	GMS	27
VK3	DID	21
HF Phone	AHY	15
CB*	KK	15

BWT	5
VK4	
HF Phone	
EJ*	381
NSW	230
BAY	215
WW	164
BAF	157
BTW	110
AAH	103
KEL	73
LMB	70
ACW	61
BSH	61
AKI	54
PJ	51
DI	49
JAE	49
SJ	48
AWL	41
BRG	41
LUV	38
WJG	34
IL	30
DV	24
VY	24
IS	22
UQ	16
ADY	13
FK	11
HF CW	
LV*	256
XW	208
XY	200
LP	192
XA	132
COZ	106
RE	80
CI	78
HF Open	
EMM*	530
SM	260
GZ	189
UW	170
ZA	158
AJH	81
EV	46
BBA	23
VHF Phone	
ZBV*	119
ZA	29
PJ	25
ADY	15
JAE	14
CXG	10
VY	9
LUV	8
HBV	6
AKI	4
KEL	4
AJH	3
SJ	3
BBA	2
UQ	2
AWL	1
VHF Open	
AR*	156
VK5	
HF Phone	
GY*	256
BJM	253
BP*	251
BWH	198
UE	138

GRC	97
NN	85
XY	60
RK	39
WO	36
KCX	30
NF	27
ANW	25
EV	13
BWA	12
CTY	10
HF CW	
AGX*	134
GZ	126
HO	116
XE	84
8HA	64
BS	38
HF Open	
BRC*#	648
ATU*	320
8AV	44
VHF Phone	
BRC*	367
AKK*	301
THA	246
GRC	191
XY	140
ZKK	108
BJM	100
AJS	88
KMI	73
KCX	71
JAZ	67
EV	63
AVQ	62
TC	61
KDK	24
KIA	16
ZRH	12
VHF Open	
AR*	239
VK6	
HF Phone	
SZ*#	525
UE*	201
CSW	166
CF	150
RG	105
ANC	103
JP	102
KG	82
PX	50
AR	43
APK	36
RU	33
GGN	29
UT	29
BGN	22
HK	22
YF	22
KZ	5
FS	3
HF CW	
HQ*	238
AFW	192
AJ	126
AF	124
VZ	80
WT	40
HF Open	
JS*	77
RZ	39
FK	36

GW	31	VHF Open	
VHF Phone		CX*#	374
NU*	384	VK7	
YEI	271	HF Phone	
XV	258	CK*	307
ANC*	257	RN	291
ZDW	228	KC	187
AR	186	PC	181
FJA	160	NDO	151
RG	150	KZ	106
KG	134	JGD	86
APK	126	KV	81
JP	118	JP	72
EH	111	NGC	70
KTN	111	LS	50
FS	110	PP	47
GGA	101	SV	31
CSW	92	RM	31
MIN	91	AC	30
GGP	79	BM	25
RO	74	HX	20
UE	63	HF CW	
UT	63	RO*	248
UV	57	VHF Phone	
MCB	54	JGP*	86
KZ	50	DG	85
TS	50	HX	72
YF	50	HDM	57
KWM	40	ZBX	47
RZ	39	KV	45
WT	39	EB	34
9XZ/6	38	RM	30
GGD	33	LS	25
GGN	28	NDO	24
BJW	25	ASN	13
DY	23	SV	9
SM	20	PP	6
FK	2	RN	5

That's it for another year. I hope you enjoyed the part you played in this year's contest, and will take this opportunity to wish you a Merry Christmas and a happy and successful 1998. I will close, as usual, with some of your comments on this year's RD contest:

"Lack of propagation between VK1 and major communities in VK2 and VK3 made things difficult for VK1" ...VK1AU "A good contest. Some tactical errors lowered my score" ...VK1PK "160, 80, 40 and 20 m were open nicely. The solar flux must be improving" ...ZL3TX "It would be nice to see the results of local contests. Does the WIA have a web page site?" ...ZL2ALJ "A very enjoyable contest which I look forward to" ...ZL1ALZ "The contest was a lot of fun; activity seemed a little down on previous but then so is the DX" ...VK2QF "A real good contest, with some real good fellowship displayed by all. The spirit of amateur radio is alive and well" ...VK3CB "Enjoyed the contest once again. Did better than last year" ...VK3CAT "I have just moved house and had to unpack boxes to find my AR gear to get a station together" ...VK1NCO/3 "The level of CW competition on Saturday night was more intense than I can remember it for a long time" ...VK3APN "Enjoyed the pre-contest talk this year in VK3" ...VK3DID "A feature of this year's effort was the use of a 23 cm handheld. We had to send someone outside to climb the mast whenever a 23 cm contact was attempted" ...VK3GUS "It is a pity that this Division did not publicise this contest as hard as in previous years" VK3BGS "Could you give a certificate to the best Novice performance in each category?" ...VK4BAY "The 1st contest I have put a log in" ...VK4BAF "This is my 1st contest entered" ...VK4LMB "I enjoyed it and worked every state on a 2 metre aerial" ...VK4IS "Another good contest but fewer and fewer on the key" ...VK4LV "P2 was not heard and ZL seemed to be down on CW" ...VK4XY "My results on 15 m and 10 m were way down on last year's effort" ...VK4EMM "One of the most friendly and enjoyable RD contests" ...VK4GZ "Pity to miss beating last year's score. Main thing is that we had a lot of fun" ...VK5BRC "Very happy about the courtesy of operations this year in Adelaide" ...VK5AR "Great conditions on 80 m from VK6" ...VK6ANC "Thought my time was best spent on CW due to the double points. I also enjoyed it more" ...VK6VZ "It sure gets people back on the air again" ...VK7JGD

### Ross Hull Memorial VHF-UHF Contest: 1997 - 1998

Presented by John Martin, VK3KWA

Since the last contest, I have received a number of comments and suggestions for rule changes. Most of the ideas differ quite radically, and I have come to the conclusion that it is impossible to come up with a single set of rules which will satisfy everyone.

If I followed all of the suggestions I have received, the contest would run on weekends only and seven days a week, for a fortnight and for a month. Six metres would be dropped and retained, and scoring would be based on distance and on locator squares. Band multipliers would be reduced, increased and abolished!

So all I can do is thank everyone for their

contribution, and hope that they will not be offended if the rules haven't turned out exactly as they wished.

Certain of the rules are dictated by the aims of the contest. The major aims are:

1. To stimulate VHF/UHF activity over the summer DX season.
2. To encourage the use of narrow band modes (SSB and CW).
3. To encourage the use of higher frequency bands.
4. To reward achievement in working greater distances.

For the last few years there has been a heavy emphasis on the fourth aim. The scoring system has allowed the best equipped stations to build up large scores from a small number of contacts. Activity has declined, and people with less extravagant stations have not been able to get as many contacts as they expected.

I feel that this approach has run its course, and it is time to shift attention back to the first aim. We need more activity from a greater number of different stations, and we need a big increase in the demand for medium distance contacts.

The contest can be hard work for anyone who wishes to get a high score, and several entrants have argued strongly that the contest is too long. But I come back to the aims: we want to encourage more amateurs to flip their mode switches and tune down to the DX end of the band. There is no incentive for them to do this unless they find a reasonable level of activity over a reasonable period of time. Rather than making the contest any shorter, I would rather make it twelve months long!

This year there will be no limit on the number of contacts in the log, but there will be a limit of ten repeat contacts per station per band. This means that logs will need to contain a greater number of different call signs, and there will be a much increased demand for medium distance contacts. But with the limit of ten repeats, it will not be necessary to work everyone every day - or even every second day.

The other major change is in 6 m scoring, which has been revised to make the scoring potential more equal to that of the other bands.

The rule about contest exchanges on DX calling frequencies is unchanged. I cannot be more specific about this rule, for example by setting a limit of so many per day, or so many for the whole contest period. I would just ask entrants to please follow the spirit of this rule and not look for loopholes!

Please note also the frequency restriction on 50 MHz. This has been adopted in line with the worldwide trend to keep a small segment at 50 MHz clear for serious DX operation. There is plenty of room for everyone above 50.150 MHz.

#### Rules

The WIA maintains a perpetual trophy in honour of the late Ross Hull and his pioneering achievements in the VHF-UHF field, especially the discovery and investigation of VHF tropospheric propagation. The name of each year's contest winner is engraved on the trophy, and he/she will receive an attractive wall plaque and certificate. Certificates may also be awarded to top scorers in the various divisions of the contest. The contest is open to all amateurs.

Thanks go once again to the overseas entrants for their participation and help in making the contest the success it is. Unfortunately there are no P2 logs this year, but it is good to see the ZL entries with such high scores. A great effort considering the poor conditions on the higher bands.

#### Overseas

HF Phone	
ZL1BVK*	360
ZL3TX	248
HF CW	
ZL1ALZ*	152
ZL2ALJ	140

From the experience of this year's contest, there are a couple of issues which require attention for the 1998 contest. Firstly, I would encourage each Division to do their utmost to promote the value of submitting logs. It seems such a shame that so many people put in such a great effort, only to have those efforts wasted because their fellow entrants did not get their logs in to be counted.

The second issue concerns the operation of multi-operator stations. Rule 9 states that only one person may operate at any time. There have been reports of multi-operator stations operating on HF and VHF at the same time. This practice is almost impossible to police, and so I would recommend that this rule be amended or scrapped. In my view it does not contravene any licence conditions, and it is very much in the spirit of the contest in that it encourages participation.

I would like to hear your thoughts on both of the above issues.

**Duration:**  
0000 UTC Saturday, 27 December 1997 to 2359 UTC Sunday, 25 January 1998. In Eastern Summer Time, that is 11 am on Saturday December 27 to 11 am on Monday, 26 January.

**Sections and Awards:**

A. Multiband;  
B. Single band.  
All entrants are scored for both sections. The overall winner will be the top scorer in Section A. Awards will also be made to the top scorers in each of the following categories: 6 metres; 2 metres; 70 cm; 23 cm; 13 cm; microwaves.

**General Rules:**

Single operator only; one station callsign only. One contact per station per band per UTC day, up to a limit of ten contacts per station per band. Cross-band, repeater and satellite contacts are not permitted. A contest calling frequency of .150 on each band is recommended. Entrants must not make contest calls or exchanges on recognised DX calling frequencies unless conditions make it impractical to change frequency. On 6 m, no contest activity is permitted below 50.150 MHz. All rulings of the Contest Manager will be accepted as final.

**Penalties:**

Errors in calculation will not incur any penalty. Entrants who fail to abide by the terms of their station licences will be disqualified. Repeated abuses of calling frequencies, and any contest operation below 50.150 MHz, will lead to disqualification.

**Contest Exchange:**

RS (or RST) plus a serial number. Serial numbers need not be consecutive, but consecutive contacts must have different serial numbers.

**Scoring:**

For 2 m and above, each contact will score one point per 100 km or part thereof (ie, up to 99 km: 1 point; 100 - 199 km: 2 points, etc). On 6 m, as above for contacts up to 1999 km. Contacts of 2000 km or more will score 25 points.

The band multipliers are:

6 m	2 m	70 cm	23 cm	13 cm	Higher
x1	x4	x7	x10	x13	x16

**Logs:**

Logs must contain the following for each contact:  
- Date and UTC time.  
- Station location (if operating portable).  
- Frequency and callsign of station worked.  
- Location or Maidenhead locator of station worked (if not QTHR).  
- Reports and serial numbers sent and received.  
- Estimated distance worked and points claimed.

Separate scoring columns, or separate logs, for each band would be helpful. The Contest Manager reserves the right to correct distance estimates on the basis of computer calculation.

**Cover sheet:**

Logs must be supplied with a cover sheet containing:  
- Operator's callsign, name and address.  
- Station location (if different from the postal address).  
- A scoring table set out as the example below.  
- A signed declaration that the station has been operated in accordance with the rules and spirit of the contest, and that the contest manager's ruling will be accepted as final.

**Deadline:**

Logs must be received by Monday, 23 February 1998. Early logs would be appreciated. Post logs to: WIA Ross Hull Contest Manager, PO Box 2175, Caulfield Junction, VIC 3161.

**Sample Scoring Table:**

<b>Band</b>	<u>6m</u>	<u>2m</u>	<u>70cm</u>	<u>etc</u>
<b>Score</b>	xxxx	xxxx	xxxx	xxxx
<b>Band</b>				
<b>Multiplier</b>	<u>x1</u>	<u>x4</u>	<u>x7</u>	<u>xx</u>
<b>Total</b>	xxxxx + xxxxx + xxxxx + xxxxx = xxxxx (GRAND TOTAL)			

**Note on Calculating Distances:**

Absolute accuracy is not required. All you need to know is whether the distance is above or below the nearest multiple of 100 km. An easy method is to use a compass to draw 100 km circles around your location on a map. Better estimates can be made from six-digit Maidenhead locators, using a simple computer program published in *Amateur Radio* in December 1996. A more accurate and fully error-trapped program is available which also includes calculation of bearings and conversion between lat/long and Maidenhead locators. It is available, in IBM format only, from John Martin VK3KWA (QTHR), if you send a floppy disc (any format) in a mailing box, together with return postage.

**VHF-UHF FIELD DAY 1998**

*Presented by John Martin, VK3KWA*

The annual VHF/UHF Field Day will be run on the weekend of 10/11 January 1998. The Ross Hull Contest will be in progress at this time and all contacts can be counted for both contests.

The overall duration of the Field Day is 28 hours, but operation is for any 6 or 24 consecutive hours within this period. The reason for the extra hours is to make it possible for 6 hour entrants to operate on the Sunday without having to be set up and ready by daybreak. Please feel free to give numbers to any station that asks, even if your 6 or 24 hour period has finished!

The 6 m band was dropped last year, and there has been a strong demand for it to be reinstated. This has been done, but please note the frequency restriction: there must be no contest activity on 50.110 MHz or any other frequency below 50.150 MHz. The usual rule about DX calling frequencies on other bands still applies. A contest calling frequency of .150 on each band is suggested.

A further change is to allow contacts between home stations. Why not? The more activity the merrier.

Finally, two requests. To organisers of club stations: please don't forget to include the names and callsigns of all operators! And to all entrants: please enclose any comments and suggestions with your log.

Oh yes, now that I think of it, a third request. Head for the hills that weekend and have fun! Or stay at home if you prefer, but just get on the air and have fun.

**Duration:**

VK6 only: 0300 UTC Saturday, 10 January to 0700 UTC Sunday, 11 January. All other call areas: 0000 UTC Saturday to 0400 UTC Sunday.

**Sections and Awards:**

Entrants may submit logs for one of the following sections:

- A: Portable station, single operator, 24 hours.
- B: Portable station, single operator, 6 hours.
- C: Portable station, multiple operator, 24 hours.
- D: Home station, 24 hours.

The overall winner will be the highest all-band scorer in Section A. Awards will also be made to the highest scorer on each band in Section A, and the highest scorers in Sections B, C and D.

**General Rules:**

Operation may be from any location, or from more than one location. You may work stations within your own locator square. Operation must be for any 6 or 24 consecutive hours. Repeater, satellite and cross-band contacts are not allowed. A station is portable only if its equipment, including antennas, is transported to a location other than the normal home location of its operator.

No contest operation is allowed below 50.150 MHz. Recognised DX calling frequencies should not be used for contest exchanges or liaison.

One callsign per station, and one station per operator. If two operators set up a joint station, they may enter as a multi-operator station under a single callsign, or as separate single operator stations. Stations with more than two operators must enter section C.

**Contest Exchange:**

RS (or RST) reports, a serial number, and your four digit Maidenhead locator.

**Repeat Contacts:**

Stations may be worked again on each band after three hours. If the station is moved to a new locator square, repeat contacts may be made immediately. If the station moves back into the previous locator square, the three hour limit still applies to stations worked from that square.

**Scoring:**

For each band, score 10 points for each square in which your station operates, plus 10 points for each locator square worked, plus one point per contact. Multiply the total by the band multiplier as follows:

6 m	2 m	70 cm	23 cm	13 cm	Higher
x1	x4	x7	x10	x13	x16

Then total the scores for all bands.

**Logs:**

For each contact: UTC time, frequency, station worked, serial numbers and locator numbers exchanged, points claimed.

The front sheet should contain names and callsigns of all operators; the postal address which applies to the callsign used; station location and Maidenhead locator; section entered, the period of operation to be scored; a scoring table; and a signed declaration that the Contest Manager's decision will be accepted as final.

**Sample Scoring Table:**

<b>Band</b>	<b>QSO Pts</b>	<b>Locator Pts</b>	<b>Multiplier</b>	<b>Total</b>
2 m	120	+	280	x4 = 160
70 cm	60	+	140	x7 = 1400 etc.
<b>Overall Total</b>				<u>3000</u>

**Entrants:**

Post logs to: The Manager, VHF-UHF Field Day, PO Box 2175, Caulfield Junction VIC 3161. Logs must be received by Monday, 9 February, 1998. Early logs would be appreciated.

\*PO Box 2175, Caulfield Junction, VIC 3175

pnesbit@melbpc.org.au

ar

---

---

# Divisional Notes

---

---

## Forward Bias – VK1 Notes

*Hugh Blemings VK1YZZ*

### Season's End

The end of another year is upon us and, as always, is something of a time for reflection. For my part it's certainly been a busy one and empirical evidence suggests that the years get busier as you get older up until you retire, whereupon things get really busy and you have no free time at all...

It has been an eventful year for both the VK1 Division and for the WIA as a whole. Exercises, outings and social events have given us a full calendar and the hope is to continue this trend in 1998. As in all things your input is welcome either in the form of suggestions for events or by volunteering to organise something or present a meeting topic. Neither need be an arduous task and you may rely on support from others in anything you undertake.

### The Year Ahead

As is in years past, there will be no meeting in December as the 22nd sees us well and truly in the heart of the Christmas rush. The first meeting in 1998 will be on 19 January rather than the 26th to avoid a clash with Australia Day. This meeting will be at the Griffin centre at 8 pm as usual and will be a good opportunity to welcome in the new year with fellow amateurs. There will be a short presentation on a technical topic (as yet undetermined) as well as a selection of democratically chosen light refreshments.

The January meeting will be the last for the present committee; as noted previously there are positions available and your involvement is welcomed. The AGM will be held on 23 February. Please attend if you are able as last year we nearly missed out on a quorum due to low attendance.

In closing all that remains is for me to wish you and your families a happy Christmas and a prosperous new year.

## VK2 Notes

*David Thompson VK2NH*

### 'Tis the Season

At this time of the year it is customary to wish everyone the compliments of the season and the very best for the coming new year. I would like to do just that on behalf of the NSW Division of the Wireless Institute of Australia. As we move on toward the holiday season, just a word of warning; don't get too much RF over the break and see you back safe and well in 1998.

### Might be a Record

Recently I learnt that that we have a new amateur in the ranks who is fresh faced and smart all at the same time. Thomas Nott sat his examination at the Hornsby and District Amateur Radio Club in October and came out with flying colours. He made only two errors in the regulations, two errors in the full-call theory and flew through the 10 wpm CW examination. Congratulations Thomas and look forward to catching up with you somewhere on air.

We don't know Thomas' call yet, but I do suspect that this result might be a record for the AOCP as Thomas is only 15½ years of age. Is it a record? If you have information on other younger people who have obtained their full-call, all in one go, please let me know.

### Blue Mountains Amateur Radio Club

As you might know by now, VK2 Councillors of the WIA are in the habit of visiting affiliated clubs throughout the state of NSW. We also will be happy to visit non-affiliated clubs on invitation. On Friday night, 7 November it was my pleasure to visit the BMARC Club, which meets at the Springwood High School in the Blue Mountains. I arrived while the general part of the meeting was underway and enjoyed a chat on a technical subject which constituted part of a project the club has planned. After that it was my chance to get to know all present and chat with them about their perceptions of what both the hobby of amateur radio and the WIA should deliver to them.

As I get to visit more clubs over the coming months and I am able to talk about the visits of our Councillors to clubs in the north, south and west of the state, I will try to construct a logical sequence of subjects discussed in order of apparent importance to the amateur fraternity. Already this pattern is emerging and does question a lot of the topics which run close to the very debates which might possibly prove to be catalysts in changing the face of amateur radio. Thanks to the members of the Blue Mountains Club for your warm welcome and very stimulating discussion.

### Affiliated Clubs Conference

By the time you read this, and barring hell and high water, the Conference of Affiliated Clubs will have been held at Amateur Radio House at Parramatta. The conference was scheduled to begin on Saturday, 15 November, at 0900. In the next issue of *Amateur Radio* I will talk about some of the

issues discussed and the outcomes. The conference is an excellent way for affiliated clubs to get action on issues for the membership.

### Christmas Function

Saturday, 13 December this year is the day we all get together for a little Christmas cheer and fellowship to celebrate the end of the year and the coming holiday season. Any members of the Wireless Institute NSW Division are invited to attend. For details, phone the office.

### Office Hours Over the Holidays

The Divisional office of the VK2 Division at Parramatta will close at 2 pm on Monday, 22 December 1997 and will reopen on Monday, 12 January, 1998. The Sunday broadcasts will not go to air on Sunday, 28 December 1997 and Sunday, 4 January 1998, but will recommence on Sunday, 11 January 1998. The answering machine in the office will be checked, otherwise give your favourite Councillor a call. Just try to avoid New Year's Day until late.

### E-mail Address

This might look very similar to last months reminder about our recent change of Divisional e-mail address. If you are addressing e-mail to the office, please do so at [vk2wi@ozemail.com.au](mailto:vk2wi@ozemail.com.au).

If you would like to contact the VK2 Division regarding your hobby, please do not hesitate to contact the office or any of the Councillors. We will be only too pleased to hear from you. If you would like to get in touch with an individual Councillor, just contact our Divisional office and it will be arranged. Our free-call phone number is 1 800 817 644 and our address can be found on the WIA Divisions' page.

### Next Month

In the next column we'll have more to report, including arrangements for the holiday period, such as broadcast dates and times and office opening hours, but if you have anything you would like us to include as VK2 news, send it to me at PO Box 82, Springwood NSW 2777; or by e-mail to [dthom@penrithcity.nsw.gov.au](mailto:dthom@penrithcity.nsw.gov.au)

## VK3 Notes

*Barry Wilton VK3XV*

### Christmas Holidays

The WIA Victoria office will close on 18 December 1997, at noon, and reopen on 10 February, 1998. Membership applications received by post during this period will be processed. A recorded telephone message on the WIA Victoria office number (03 9885 9261) will provide emergency contact



information for various officers, and WICEN.

### **Sunday Broadcast**

The last broadcast from VK3BWI for 1997 will be on 7 December. This will be the last broadcast from the Lyndhurst site as the property has been sold. The Broadcast Co-ordinator, Steve Bushell is currently overseeing the construction of new equipment and arranging an alternative site. Steve expects a regular broadcast will resume on the first Sunday in February, 1998. Primary transmission will be on VHF and UHF via the repeater network, and relayed on 80 m and 40 m, if suitable volunteer members can be found to conduct the service on a regular basis.

### **WIA Victoria Web Site**

Our Web site, currently located at [www.tbsa.com.au/~wiavict/](http://www.tbsa.com.au/~wiavict/), is proving to be popular and has been directly responsible for the recruitment of a number of new members. The service will be expanded next year to include regular WIA Victoria news segments. We are in urgent need of a regular news writer and would appreciate any assistance from a member who has some journalistic ability, and preferably is conversant with HTML files. We are most appreciative of the efforts of Krystal Proctor, Keith VK3FT's daughter, for the design work and maintenance of the site.

### **New Direction for Federal WIA**

Major changes in the structure and operation of the WIA Federal office can be anticipated early in the new year. The VK2 Division have advised they will be assuming responsibility for their own membership records from January 1 and from that date will contribute less money in support of the Federal office. A precedent was established when the federal Board of Directors allowed the VK4 Division to reduce their subscription to Federal in respect of all their members by \$5.50 per head. Major changes are imminent in Victoria and it is expected all members of the Federation (Divisions) will be required to restructure, and provide a number of services which are currently the responsibility of the Federal body.

### **EMR Health Hazard**

The effect of Electro Magnetic Radiation on community health is destined to become a significant issue both politically, and with the ACA. WIA Victoria is closely monitoring investigation results in order to prepare for any possible effect on amateur transmissions from metro and other densely populated areas.

### **Outward QSL Bureau**

Some minor changes will be announced in

February. A degree of restructuring is necessary to offset a huge increase in overseas mailing charges implemented by Australia Post. The number of cards being processed is expected to increase as propagation continues to improve.

### **AR Publicity Opportunity**

World Amateur Radio Day will be celebrated in April 1998. This will provide an ideal opportunity for individual Victorian groups and clubs to co-ordinate publicity for our hobby within the community.

### **WICEN**

This summer promises to be one of extremely high fire danger. WICEN operators are well prepared to be of service to the community.

### **Christmas Greetings**

Council wishes all members a Merry Christmas and a Happy New Year.

### **VK5 Notes**

*Ian Hunt VK5QX*

### **Satellites and Reminiscing**

In these notes I refer to the launch of a commemorative satellite and tell of some of my experiences over the years. The satellite was launched "by hand" by a cosmonaut from the MIR Space Station in early November.

### **"Re-living" History!**

On Tuesday, 3 November 1997 at around 3.00 am local time I received and recorded the "beeping" signal from the commemorative satellite launched from the MIR Space Station to commemorate the launching of the first "Sputnik" (satellite) 40 years ago.

The signal was received on a frequency of 145.825 MHz. The receiving equipment comprised a Yaesu Musen FT-212RH transceiver connected to two stacked four element vertically polarised Yagis at a height of 50 feet. The satellite pass was one predicted to be (based on orbital data for MIR) one of fairly high maximum elevation of 77 degrees.

I acquired signal almost as indicated by the predictions and also saw the loss of signal accordingly. The pass lasted for a total of approximately 10 minutes and seemed rather variable as if the satellite was tumbling at a slow rate with fade-outs from time to time. To have received these signals was for me quite a thrill.

My mind kept going back to 1957 when, with a government disposals AMR300 STC general coverage receiver, I listened to the very strong signals on a frequency of 20 MHz coming from the very first "Sputnik". My

antenna was a simple 40 metre wire dipole. I was located in the Melbourne suburb of Northcote in VK3.

My wife and neighbours came crowding into the radio shack to listen to this strange and seemingly "unearthly" noise. The volume on the receiver was turned up high and the sound "broadcast" down the street for others to hear.

At the same time as receiving those signals 40 years ago, it was possible to step outside and, in the night sky, observe the eerie sight of the satellite seemingly bobbing its way across the heavens (goodness knows we have seen many other satellites since then.)

### **Past Experiences**

My mind also went back to one day at the Woomera Missile Range in the north of South Australia where, in control of an array of 16 stacked 16 element crossed Yagi antennas, I watched the signal strength display as the first, and only, satellite launched from Australian soil was "spun up" and placed into a polar orbit. This satellite was named WRESAT, having been built by the Weapons Research Establishment at Salisbury South Australia (an establishment which was part of the Defence Science and Technology Organisation).

The vehicle used to place the satellite into orbit utilised a Redstone missile as the main booster. Quite a few of these missiles were fired from Woomera as part of a re-entry physics research project known as Project Sparta. This was, of course, the type of missile used by the USA to place the first man into a sub-orbital flight.

My understanding is that the particular missile used for the WRESAT launch was regarded by the USA authorities as a "spare" which they kindly donated to WRE for this particular launch.

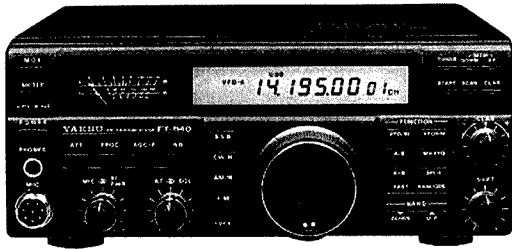
I was somewhat taken aback when I first saw one of these Redstones, particularly by the sight of what looked like large bicycle chains, which ran down the outside of the missile and were used to control the fins at the rear end of the missile for steering purposes.

The 16 Yagi array which I was operating for the WRESAT launch was originally from the Island Lagoon Satellite Tracking and Data Acquisition Network (STADAN) where I had been employed working for NASA on satellite tracking and telemetry work for a number of years.

Goodness knows just how many American satellites I had tracked using this very same array. A certain amount of the receiving equipment was also obtained from Island Lagoon, which station had been closed down following the establishment of new tracking stations in the Tidbinbilla location near Canberra, in the Australian Capital Territory.

# CHRISTMAS BARGAIN BONANZA

Get a great deal on these popular Yaesu transceivers.  
But hurry, as these specials are only available until 31st December 1997.



## FT-840 Economical HF Mobile Transceiver

A serious HF rig that doesn't compromise performance at home like many current micro-rigs. The FT-840 covers 160m to 10m with 100W PEP output on SSB/CW/AM, continuous receiver coverage (100kHz-30MHz), 100 memory channels, a large back-lit LCD screen, an effective noise blanker and an uncluttered front panel. The FT840 is simple to use, with an SSB speech processor for added audio punch, IF shift to fight interference and Direct Digital Synthesis for cleaner transmit and improved receiver performance. Includes DC power lead and hand microphone...just connect your power supply and antenna and start having fun! D 3275

**BONUS** FM Module valued at \$99.95 D 2932



**\$1395**  
2 YEAR WARRANTY

**BONUS** Remote Front Panel Kit valued at \$99.95 D 3282



**\$1895**  
2 YEAR WARRANTY

## FT-736R VHF/UHF Base Station Transceiver

Whether your interest is in talking through your local repeater, operating SSB DX, or talking to the world via satellite, this high-performance multimode base station transceiver can do it all! In its standard form, the FT-736R provides 25W output on the 2m (144-148MHz) & 70cm (430-450MHz) bands in SSB, CW, and FM modes. Can be expanded to cover the 6m (50-54MHz) & 23cm (1240-1300MHz) bands by installing optional modules.

### Features:

- Keypad frequency entry, 100 memories, selectable FM channel steps
- 2 full-duplex VFOs - transmit & receive frequencies (and modes) can be tuned independently or synchronously for satellite operation.
- Adjustable IF Notch and IF Shift filters, Noise blanker, 3-speed selectable AGC.
- Speech processor and VOX for SSB, Digital input connection for packet TNCs.
- Efficient switch-mode AC power supply. D 2920



SAVE \$400 **\$2295**

\*MAJOR AMATEUR STORES ARE UNDERLINED. NSW • Albury 6021 8399 • Bankstown Square 9707 4888 • Bankstown PowerHouse 9793 9677 • Blacktown 9671 7722 • Bondi Junction 9387 1444 • Brookvale 9905 0441 • Burwood 9744 7299 • Campbelltown 4627 2199 • Chatswood 9411 1955 • Chullora 9642 8922 • Gore Hill 9439 5311 • Gosford 4325 0235 • Hornsby 9477 6633 • Hurstville 9580 8622 • Kotara 4956 2092 • Liverpool 9600 9888 • Maitland 4933 7866 • Miranda 9525 2722 • Newcastle 4961 1896 • North Ryde 9937 3355 • North Sydney 66 Berry St 9964 9468 • Orange 6361 8400 • Parramatta 9689 2188 • Railway Square 9211 3777 • Penrith (02) 4732 3400 • Sydney City York St 9267 9111 & Mid City Centre 9221 0000 • Tamworth 6766 1711 • Wollongong 4228 3800 ACT • Belconnen 6253 1785 • Fyshwick 6280 4944 • Tuggeranong 6293 3399 VIC • Ballarat 5331 5433 • Bendigo 5443 0388 • Box Hill 9890 0699 • Coburg 9383 4455 • Dandenong 9794 9377 • Brighton 9592 2366 • Frankston 9783 9144 • Geelong 5223 2711 • Highpoint 9318 6300 • Knox Towerpoint 9800 3455 • Melbourne City Strand Central Arcade 9663 5320 & 246 Bourke St 9639 0396 • Mentone 9585 5455 • Niddrie 9379 7444 • Northland 9471 4823 • Richmond 9428 1614 • Ringwood 9879 5338 • Shepparton 5821 9497 • Springvale 9547 0522 • QLD • Alderley 3356 3733 • Booval 3282 6200 • Brisbane City 3229 9377 • Buranda 3391 6223 • Cairns 311 515 • Capalaba 3245 2870 • Chermside 3359 6255 • Indooroopilly 3878 4944 • Maroochydore 5479 1800 • Mermaid Beach 5578 5600 • Rockhampton 27 9644 • Southport 5532 9033 • Toowoomba 38 4300 • Townsville 72 5722 • Underwood 3341 0844 SA • Adelaide City Pulteney St 8232 1200 & Myer Centre 8231 7777 • Elizabeth 8255 6099 • Enfield 8260 6088 • St Marys 8277 8977 • Westlakes 8235 1244 WA • Balcatta 9240 1911 • Cannington 9451 8666 • Fremantle 9335 9733 • Perth City 9481 3261 • Midland 9250 1460 • Northbridge 9328 6944 TAS • Glenorchy 6273 2176 • Hobart 6231 0800 • Launceston 6334 4555 NT • Darwin 8981 1977

\* STORES IN RED ARE OPEN SUNDAYS. STORES ACROSS AUSTRALIA AND NEW ZEALAND

# CHRISTMAS BARGAIN BONANZA

## ST-7500 2m/70cm Mobile Antenna

A Japanese dual-band antenna with a ground-independent design and a tiltable stainless steel whip for excellent mobile results. Just 1m long, yet provides approx 3dB gain on 2m and 5.5dB gain on 70cm with a maximum power rating of 150 watts. Requires an SO-239 antenna base or SO-239 magnetic base.

D 4810

**BRAINER** SAVE \$10 **\$59<sup>95</sup>**



## ST-7800 2m/70cm High-Gain Mobile

Our best long-range 2m/70cm mobile antenna provides 4.5dB gain on 2m and 7.2dB on 70cm while only 1.5m in length. Incorporates an inbuilt tilt-over mechanism and has a maximum power rating of 150 watts. Requires an SO-239 antenna base.

D 4815

**BRAINER** **\$99<sup>95</sup>**

## High Performance 2m/70cm Base Station Antennas

Our range of Brainer base station antennas offer outstanding quality and exceptional value. They are stacked collinear types providing high gain, wide band width and a low radiation angle for extended range. The fibreglass reinforced polyester (FRP) outer tubing radome, gasket seals and stainless steel hardware provide excellent all-weather operation. They also feature comprehensive instruction sheets to make installation and set-up a breeze. Both come with a **1 YEAR WARRANTY**.

### 2m/70cm GST-1

**Freq:** 144-148MHz,  
430-450MHz  
**Gain:** 6dB on 2m,  
8dB on 70cm  
**Max. Power:** 200W  
**Length:** 2.5m  
**Connector:** SO-239 socket

D 4830

SAVE \$30 **\$169**

### 2m/70cm GST-3

**Freq:** 144-148MHz,  
430-440MHz  
**Gain:** 7.9dB on 2m,  
11.7dB (70cm)  
**Max. Power:** 200W  
**Length:** 4.4m  
**Connector:** SO-239 socket

D 4835

SAVE \$20 **\$249**

## Revex W560N HF/VHF/UHF SWR/PW Meter

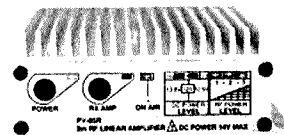
Quality wide-band SWR meter, offering 2 sensors for 1.8MHz to 525MHz coverage! Provides metering of 3 power levels (3W, 20W, 200W) and SWR. Uses an N-type socket for the VHF/UHF sensor for minimal loss. Measures 120 x 80 x 85mm. D 1375



SAVE \$50 **\$199**

## 2m 80W RF Power Amplifier

Designed for use with 2m FM handhelds, this solid 80W RF power amplifier really boosts your handheld signal at home or in the car. It works with RF levels of 0.5 to 5W, provides 80W typical output with just 2.5W input, and just 1W input will still provide over 40W output. A 12dB gain GaAs FET receiver pre-amp can also be selected for improved performance in quiet RF areas. Frequency range 144-148MHz only. Requires 13.8V DC at 20A max. Size: 124x44x208mm (WHD) inc protrusions. D 2520



SAVE \$30 **\$169**

## FT-50RD 2m/70cm Handheld

The Yaesu FT-50RD is an amazingly compact 2m/70cm Amateur band handheld transceiver which provides MIL-MIL-STD-810 shock and vibration resistance, super wideband receiver coverage, simple menu settings for most functions and compatibility with the optional Yaesu ADMS software/interface package for PC programming. Supplied with FNB-40 slimline 6V 650mAh NiCad battery pack, flexible 2m/70cm antenna and modified M-9626 AC plug pack adaptor for NiCad charging. Now includes new FTT-12 keypad for Digital Voice Recording, DTMF paging, CTCSS/DCS scanning and CTCSS encode/decode. D 3660



**BONUS** CSC-69 carry case, valued at \$19.95 D 3656



2 YEAR WARRANTY **\$599**

### PHONE FAX AND MAIL ORDERS

**PHONE:** WITHIN AUSTRALIA: 1300 366 644  
(Local Call Charge)

**FAX:** (02) 9395 1155 within Australia and  
(+612) 9395 1155 from outside Australia

Visit our web site at  
<http://www.dse.com.au>

**MAIL:** DICK SMITH ELECTRONICS, Direct Link Reply Paid 160, PO Box 321,  
North Ryde NSW 2113 (No Stamp Required)

*Excludes packaging and postage. All major Credit Cards accepted.  
14 Day Money Back Guaranteed if NOT completely satisfied. (Software excluded)*



*That's where you go*

Stores across Australia and New Zealand

For the location of your nearest store call 1800 26 3922

B 3172

So, at this early hour as I write this, I feel satisfied by my latest achievement which, to me, has more of a nostalgic and historical flavour than would be the case for many other people.

At the same time I contemplate the "march of science" and the various advances which have taken place in technology.

I do, however, wonder as to whether the world is really a better place for all this "progress". Alas, try as I may I will undoubtedly never be able to satisfactorily answer the question.

Well, I guess that is more often than not the case where nostalgia is concerned.

### Just a Nostalgic Postscript

One other item which later came to mind was the receiving of signals from the first "OSCAR" satellite. In this particular instance I was able to use the same 16 crossed Yagi array. Whilst this array was designed to operate optimally in the 136 to 137 MHz satellite band it still showed reasonable gain and directivity at 144 MHz.

I used this antenna system in conjunction with a tuneable pre-amplifier using two 7077 ceramic triodes, which was located at the base of the antenna array. The signals were then piped down low loss feed cables and received on a Collins VHF Receiver, which I believe was a URR220 unit.

A recording of the received signal was made on 1/2 inch magnetic tape using an Ampex FR100B instrumentation recorder. I believe that I still have the original 15 inch reel of tape, still in its steel can, stored away in my backyard shed.

Another interesting episode was the reception, on HF, of voice signals from the manned Russian Vostok spacecraft. The speech signals received and recorded, also on the Ampex FR100B, were in the Russian language. A person who was skilled in that language was called in by the authorities to interpret what the cosmonauts said.

(At the Island Lagoon station we were never required to receive signals from the USA manned spacecraft. There was a tracking station at a place called "Redlake" on the northern side of Woomera which was part of the US Manned Space Network. They had there an FPS16 radar which was also used from time to time for tracking vehicles launched from the Woomera Range.

The other Australian MSN tracking station was located in Western Australia at a place called Muchea.)

Reception of signals from the USSR Vostok spacecraft was by use of a Collins 237A Log Periodic Antenna which had the capability of operation from 10 to 30 MHz (a very large antenna where the supporting mast, around 300 millimetres [12 inches] in

diameter was enclosed within a tower section and the whole mast and antenna rotated). The longest element would have been nearly 15 metres (about 50 feet) long.

The receiver was another Collins unit, the R310A, which had a dial like an odometer on a motor vehicle. This receiver used a permeability tuning system where the "band" was set by positioning a large number of ferrite slugs within a set of coils. These were moved using a complicated system of gears and cams. There were 30 bands each of 1 MHz. The fine tuning across each band was achieved by a vernier system which then slowly adjusted the necessary coil slugs to cover the required range.

In the Service Manual for this receiver, which was a very comprehensive manual, there was an "exploded diagram" illustrating the gear-box and cam assembly. I distinctly remember someone at the station exclaiming with great vehemence on one occasion, "I hope to goodness that it never explodes."

### Final Comments

In the above notes I have made comment on trying to decide whether or not the world is a better place for the great developments in science and technology. I will leave it for you to try and answer that question for yourself.

In previous notes I have referred to the potential for amateur radio to contribute to better relationships between people on both a local and international basis. I do know that, if we are prepared to take the Spirit of Christmas which exists around this time of the year and allow that spirit to continue in all our dealings with others, we can make a most marked and meaningful contribution to society.

I bring to all my best wishes for a Blessed and Happy Christmas and the hope that the New Year will provide for you a time of happiness and satisfaction in all the worthy ways in which you desire. I also wish you good health as being one of the greatest blessings we can have.

### VK6 Notes

Chris Lowe VK6BIK and  
Chris Hill VK6KCH

With little time to prepare these notes prior to meeting the editorial deadline for the December issue, we will take the opportunity to introduce ourselves and provide a few personal details, along with a few general comments and VK6 information from both of us. In future you will hear from us alternately, as the task of writing the notes is to be shared.

Chris Lowe VK6BIK

My contact details are as follows: Chris Lowe VK6BIK; e-mail [chrismor@avon.net.au](mailto:chrismor@avon.net.au);

PO Box 838, Toodyay WA 6566; telephone 08 9574 4060. I also log in to VK6BBR (WIA packet BBS) when there is a "lift" on 2 metres! Since I work offshore on the Goodwyn Alpha Platform off Dampier in the North West, I cannot always respond quickly to mail received. However, e-mail can usually be forwarded to me offshore the same day, by my better half at home. I am generally away on a two week or four week cycle, and therefore am home about 50% of the time.

Amateur radio interests include HF, VHF (FM & SSB), UHF (70 cm only at this stage), EasySats and MIR, packet, and subscription to various Internet e-mail "reflectors", as they are called by hams. Unfortunately (for me, but probably fortunately for the rest of you), I dwell in an RF hole in the bush, being located at the bottom of a river valley – the locals refer to us as "The Creek Dwellers"! That said, when there is a VHF "lift" on, and I am onshore, you will certainly hear me giving the Perth and other South West repeaters a bashing.

Chris Hill VK6KCH

Chris works in the radio-communications field, and is currently pursuing a Master of Telecommunications Engineering in his spare time. Main amateur interests include VHF and UHF repeaters, packet radio and both analogue and digital satellite work. Due to time constraints, he would prefer not to receive news articles by telephone, but rather by e-mail or packet radio.

Addresses: e-mail [vk6kch@amsat.org](mailto:vk6kch@amsat.org); packet VK6KCH@VK6BBR.#PER.#WA.AUS.OC.

So, just as *Random Radiators* has "the two Rons", VK6 Notes now has "Chris and/or Chris". We look forward to your input.

Now to a few general items that may be of interest.

### WA Hamfest

The WA Hamfest, organised by the Northern Corridor Radio Group, was held at the Cyril Jackson Recreational Centre in Fisher Street, Bassendean, on Sunday, 2 November. This was the first time I (VK6BIK) have been able to attend this event, and my first impression at the car-park area was, "Wow, are there THAT many like-minded people in the State?". It was most reassuring. There can't be that many "Ham oddballs" at large amongst the "normal" population (can there?), so I came away feeling much better about what I get up to (or don't) in my time off from the drill rig.

The event itself appeared most successful, my fellow travellers from Toodyay telling me that there was a larger turnout than last year. Certainly, there wasn't much room to move in the main hall, and both the smaller and the

bigger vendors (who were well represented with support from the East) appeared to be doing a roaring trade. I know I came away with some brand new toys. Most pleurably, I met many people that I have been talking to over the air, or heard of in other ways, in the flesh for the first time. The WIA crew, especially, were there in force!

## Internet

I mentioned the Internet and e-mail reflectors. There has been a good explanation on how this works in the amateur press recently, and I can highly recommend, by way of making a start with this aspect of the hobby, interesting examples of each as follows (of course there are many more).

**Internet site:** URL is: <http://www.faroc.com.au/~vk6wia/> This is the VK6 Home Page.

**VHF e-mail reflector:** Send an e-mail message to [majordomo@marconi.mpce.mq.edu.au](mailto:majordomo@marconi.mpce.mq.edu.au) with an empty subject line, and include in the text the statement "subscribe vk-vhf". This will keep you up to date with the VK DX VHF scene, with many contributions and information from local VK6 amateurs.

## VK6RAV Repeater

Hope everyone is aware by now that we have a "new" 2 metre repeater east of the Great Divide servicing the Avon Valley area. This repeater is VK6RAV (147.275 MHz receive, 147.875 MHz transmit) located at Crow's Nest to the north-east of Northam.

The footprint seems to stretch from just north of Bunbury in the south-west, to Cunderdin in the east, and to (at least) Calingiri in the north. Jim VK6CA is the repeater manager. There are excellent colour pics, etc under "Repeaters", VK6RAV, on the above-mentioned WIA VK6 Home Page on the Internet. Many thanks to the WA Repeater Group, and to Will VK6UU for the great photography, amongst other things. Note that the best way to help out the repeater group is with your membership!

## WIA Meetings

WIA Meetings are held at the CWA building in Hay Street, West Perth.

The address is 1174 Hay Street West Perth, 3rd floor, CWA House. Meeting times are the third Tuesday of each month at 8 pm. For membership inquiries contact *the membership office* on 08 9341 3655. For general enquiries contact *the Secretary*, Christine VK6ZLZ, on 08 9351 8873; WIA, PO Box 10, West Perth WA 6872; or e-mail to [vk6wia@faroc.com.au](mailto:vk6wia@faroc.com.au)

The December meeting on 9 December is to be/was in the form of a superb *a la Carte* Xmas Dinner in the dining room on the third floor of CWA House. Sure hope you were there!

The *Broadcast Officer* is Mal VK6TVA, 08 9429 1120; fax 08 9429 8859; e-mail [vk6tva@omen.net.au](mailto:vk6tva@omen.net.au)

The *Disposals Officer* is Roy VK6XV, 08 9246 3642; e-mail [rwatkins@faroc.com.au](mailto:rwatkins@faroc.com.au)

## Other Club Meetings

The VHF Group meets on the fourth Monday in the month at 2000 hours in the Wireless Hill museum meeting room.

The WARG (WA Repeater Group) meet on the first Monday in the month at 1930 hours in the Hillview Scout Hall, corner Welshpool Road and Gibb Street. The weekly on-air net is on Sundays at 10.30 am local on 146.750 MHz and the 29.120 MHz gateway.

## "QRM" News from the Tasmanian Division

Robin L Harwood VK7RH

It has become a tradition for branches to hold an informal get-together in December in lieu of the regular monthly meeting. For example, the North-western branch will be holding a Christmas Dinner at the "Bass and Flinders Motel" in Ulverstone on 9 December. The Southern Branch will probably be holding a BBQ at the Domain Activity Centre sometime during the month. Listen over VK7WI for details. There is nothing planned at this stage in the North, so I do recommend you listen out for details.

Divisional Council met in Launceston on November 22 but, as this is being written in early November, I naturally cannot report on what happened. Further details shall be in next month's column. However, we can confirm that the Divisional Annual General Meeting will be on 22 March 1998 at the northern campus of the University of Tasmania, at Newnham.

Our Divisional secretary, VK7BE, has been touring the outback during November. I would expect that we shall be hearing all about it at a future Branch meeting, complete with pictures. I believe that he has been checking in on the Travellers Net to let everybody know where he is.

The activity during JOTA 98 from the state was varied. Operations were based in scout camps or halls throughout Tasmania. The Northern Branch stepped in at very short notice when previous arrangements fell through. Stations were operational from Longford, Summerhill, Launceston (Kings Meadows) and Exeter. The North-western Branch also had activities at various locations, including a station in a scout hut on Cradle Mountain. I believe it did snow. Not to be outdone, some East Coast amateurs erected a station on Ben Lomond, which is in the North-east and 1500 metres up.

For the first time, the scouting organisation held Jamboree on the Internet (JOTI) in conjunction with JOTA. Some of us operating at Kings Meadows noticed the Pentium set up with modem all ready to go. I was expecting RFI from that yet, surprisingly, there was none. However, when we fired up on 40, guess what happened? The strong RF flooded the modem, instantly disconnecting the Internet connection. Immediately there were howls of protest and a compromise was quickly arrived at that we would take 45-minute turns. However, it was quite apparent that the Internet Relay Chat was more popular than talking over amateur radio. I think it is certainly an indication of how much the hobby has slipped in the public's perception.

The kids certainly do know all about the intricate working of the Net and the realisation that an amateur radio licence involved quite a bit of study and examination before a licence could be obtained, did not appeal to many kids. They can talk keyboard to keyboard now in real time with someone at the opposite end of the world without heavy QRM and poor propagation. They even can talk over the Net and exchange video, without a licence. However, the Internet is not free and it can get pretty expensive, depending upon the rates charged by the Internet Service Provider. Even an explanation of packet radio did not particularly excite them either. The speeds of an Internet connection and the graphics on the web appeal to them more than packet.

Where is our hobby going now? Perhaps even five years ago, amateur radio still appealed to kids, but the novelty has well and truly worn thin by now. Communicating via radio no longer attracts them.

As you are aware, the State Government is committed to the installation of online computers in every classroom. Kids are so used to using them and the increasing use of home computing means that our hobby is really declining. The membership in our Division has reduced over this past 12 months, as has the numbers of licensed amateurs. Activity on all bands within VK7 has also dropped away.

This means that the burden of maintaining repeaters and other services, is increasingly falling on to a diminishing membership base. Costs are rising sharply and branches and your Division will have to prioritise some functions. For example the Mount Barrow repeater on 147000 has been operating for 25 years. Recent introduction of site fees plus essential maintenance of the repeater antennas and equipment has meant that the Branch must seriously consider all options. Activity on the repeater has sharply declined

although it is probably still the best repeater servicing northern Tasmania.

This sounds very pessimistic I know. We can turn it around but it depends on YOU. If you care about our hobby and don't want it to become a historical footnote, giving our precious allocations up to commercial interests, who are only too eager to snap them up, then **BECOME INVOLVED**.

There was a group formed just a few months ago here in Launceston titled "Save Our State" which briefly blossomed and then faded as a result of the apathy and reluctance

to introduce change and reform into the political and economic agenda of Tasmania. We need to **SAVE AMATEUR RADIO** from apathy and reluctance to change. This needs to be at the branch, Divisional and, yes, even at the Federal level, if our hobby is to continue in the next ten years.

I will get off my soapbox now and all that remains is to extend the best wishes of the Divisional Council for the Festive Season to you and yours and hope 1998 will see a turnaround in the hobby.

ar

As the solar Cycle 23 develops we can expect similar situations in the future.

This month is the last month of the year, and there are only a few more weeks to Christmas and a New Year. I wish all readers of this column a merry, festive Season and a prosperous and healthy New Year. See you all in 1998.

### **Many Young Ladies - RZ9MYL**

It was almost a year ago when, listening around 20 metres late at night - 1100 UTC - that I came across the Russian station RZ9MYL in Omsk, Western Siberia. The operators were YLs and I listened to a number of QSOs in German, English and French. I called in and had an interesting contact with the YL operator Nadia, who told me that she was operating from a Teachers College Club Station. The usual amateur information was exchanged and I sent my QSL card to the given address, hoping that one day a reply would come. Nothing happened.

In March this year I came across the same station again. The YL operator this time was Oksana. In response to my enquiry whether they received my QSL card for the earlier QSO, she called her supervisor, and Yuri UA9MAR came to the microphone. He greeted me like an old friend.

They had received my card for the earlier QSO and had sent me a reply card. When I told him that no card had arrived, he was embarrassed, said he was sorry, but there are sometimes problems with the mail system. He promised to try his luck again. A few months later a heavy cardboard envelope arrived from Yuri. A number of QSL cards, photographs and even a Club award arrived showing that I am No 1 VK for having had two QSOs with the station. There was also an interesting letter from Yuri. Here are some of the highlights.

Yuri UA9MAR has been on the air since 1967, and has been the Head of the "PULSAR" Radio Club attached to the Omsk Pedagogical University since 1992. He is now an Assistant Professor and is teaching his students the use of computers in their future professional activity. His wife, Valentina UA9MIL, is also at the College as a laboratory assistant and she takes part in the running of the radio club, being the Award Manager.

The Pedagogical University of Omsk is one of the largest in Siberia. There are 13 faculties. Future teachers of Physics, Mathematics, Russian Philology, Foreign Languages and other subjects study there. The largest faculty is the Faculty of Foreign Languages. About 800 students are studying German, English, French and Chinese. Ninety per cent of the foreign language students are women. The best students are

---

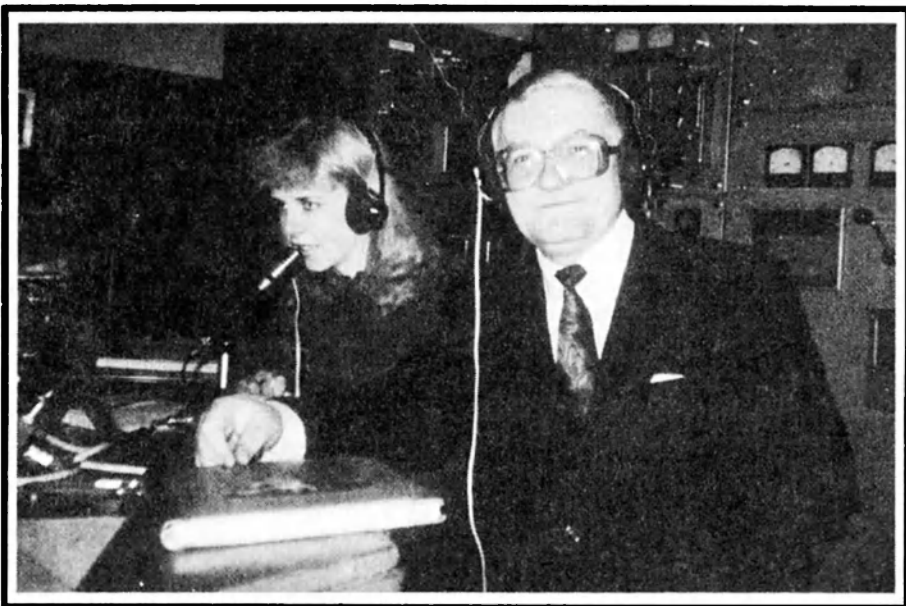
---

## **How's DX?**

*Stephen Pall VK2PS\**

---

---



**YL operator Nadia and supervisor Yuri UA9MAR at the console of Club Station Pulsar RZ9MYL in Omsk, Western Siberia.**

**P**ropagation is still a hot discussion topic among DXers. Solar flares and depressed conditions have played havoc with HF frequencies. Despite all this, there was reasonable propagation on 20 metres during the months of October and early November. The 10 cm flux was moving around the 85 average mark. On 5 November suddenly it shot up to 118 and the official report described the solar geophysical conditions as "moderate to high". It also said that a satellite proton event was in progress. This was the signal for a high intensity solar flare.

The "Sydney Morning Herald" quoted Dr Richard Thompson, solar scientist with the IFS Radio and Space Services as saying that the massive eruption on the sun at 10.49 pm local Sydney time on Thursday, 6 November

was one of the largest in at least 21 years. The explanation as to what are the consequences of such a massive energy eruption on the sun, were described thus:

- X-rays and extreme ultra-violet radiation travelling at the speed of light arrive in eight minutes, disrupting HF radio.
- Protons and electrons arrive within hours, spiralling into Earth's magnetic field, often sending false commands to satellites and causing auroras.
- Slower-moving particles from the sun's atmosphere take up to four days to arrive.
- They "shake" our magnetic field, inducing electric currents that flow into power stations causing blackouts, corrosion in long-distance pipelines, HF radio distortions and auroras.

members of the University's Amateur Radio Club "Pulsar" and use the callsign RZ9MYL.

Before 1990 there were some Government grants to assist the best students with overseas study trips but now, because of the difficult economic times, these students use amateur radio to practice their language skills.

The Club operates a Yaesu FT-747GX transceiver (donated by DJIKM), a home-built 200 watt linear amplifier, a four element cubical quad antenna for 20, 15 and 10 metres, a two element sloper for 40 metres and a 160 metre long loop antenna for 160 and 80 metres.

In Russia everybody may use the facilities of an amateur radio club, including transmitting with the club callsign, but the activity has to be supervised by the amateur chief-operator. More than 70 girls from the Foreign Languages Faculty use the club callsign. Most of them are not interested in amateur radio as such, not even in equipment or DXing, but only in talking to people in other lands to practice their language skills.

For this reason RZ9MYL is on the air constantly. However, overcrowding and shortage of equipment gives the students only 1-2 hours per week on the air. Expansion is necessary. They have obtained a room in a students hostel for the second station but they have no equipment. To assist them to furnish this second station every bit of help is welcome.

RZ9MYL is on the air every day near 14120 or 14330 kHz from 0700 to 1500 UTC. "Please call us!" says Yuri.

Yuri is on the Internet. His e-mail address is [ua9mar@pulsar.omsk.su](mailto:ua9mar@pulsar.omsk.su). His postal address is: Yuri Polushkin, President of CSC "Pulsar" Radioclub, PO Box 1742, Omsk, 644000, Russia.

### Chasing IOTA Islands

David Rankin VK3QV, well known in IARU Region 3 circles, who lives in Singapore and is active as 9VIRH, was kind enough to supply me with nine addresses of Indonesian amateurs who reside on relatively small island groups.

For those who are IOTA Island chasers, here is the information which might be useful to you:

\* OC-022 Bali Island. Ali YB9AS, PO Box 3594, Denpasar, Bali Island, 80001 Indonesia.

\* Kadek Kariana SP YC9BU, PO Box 106, Singaraja, Bali Island, 81100 Indonesia.

\* OC-088 Indonesian Kalimantan. Jar YC7JKS, PO Box 15, Banjarmasin City, CP 70001 Indonesia.

\* OC-146 Sulawesi Island. Ricky E J Welan YC8UYB, PO Box 1423, Manado, 95014 Indonesia.



**Members of the Radjo Club Pulsar. Yuri UA9MAR and his XYL Valentina UA9MIL are sitting in the middle of the front row.**

\* OC-147 Irian Jaya's Coastal Islands. Jerry Katuuk YC8BJK/9, PO Box 623, Biak Island, 98115A Indonesia.

\* OC-148 Timor Island. Ferdinand Konay YC9MKF, Irianus Rohi YC9NBR. Address for both: PO Box 1021, Kupang 85000 Indonesia.

\* OC-209 Talaud Island. Jusuf Maringka YC8TZR, PO Box 205, Lirung, 95871 Indonesia.

\* OC-210 Sangihe Island. Ronny Monoarfa YC8TXW, PO Box 166, Tahuna, 95800 Indonesia.

Please note that the YC callsign indicates a novice amateur status, and 15 metres is the band where they can be found.

Some of these island groups are so isolated that mail comes only once a week. Some times it can take quite a while for a QSL to arrive. Patience is needed. David is active on 15 metres and his postal address is: David Rankin, PO Box 14, Pasir Panjang, Singapore 911121.

### Amateur Stations in Uganda - 5X

Peter ON6TT, who is the Chairman of the Uganda Amateur Radio Society, has issued an information leaflet about the state of amateur radio in this landlocked country in East Central Africa. There are 34 licensed amateurs in Uganda (the 1997 edition of the International Callbook shows only seven entries), of which some are no longer in the country and a lot are not very interested in DX.

Uganda has a working QSL Bureau to receive cards, but there is no funding for

sending cards out of the Bureau. This is the reason why most of the DX-minded amateurs use a QSL manager. The most active Ugandan amateurs at the moment are: 5X1C, Mario, via WA1ECA; 5X1P, Joe, via G3MRC; 5X1Z, Mats, via SM7PKK; 5X1T, Peter, via ON5NT; and 5X4F, Paul, via K3SW. Mats and Joe work almost exclusively CW, Paul mixed modes and Peter almost exclusively on RTTY and SSB.

The team at work will shortly be joined by DJ1US, but Stephan does not have a 5X licence yet. The following are no longer active, having ended their contracts a while ago: 5X1R, Ake; 5X1D, Ghus (Ragge); and 5X1N, Janne. Jeff 5X1WJ is temporarily not active.

It has been noted that all these amateurs are not local residents. All of them work either for the International Red Cross, other relief agencies, or for other UN sponsored aid programs.

### Future DX Activity

\* Jacques F6HMJ will be on all bands from Mauritius as 3B8/F6HMJ from 26 November until 12 December.

\* Mats SM7PKK is in Uganda signing 5X1Z and was heard on 1833 kHz around 2100-2200 UTC.

\* Ron FP5EK is now active from St Pierre and Miquelon Islands. QSL via K1RH.

\* The planned Belize activity by a group of USA amateurs (W5), to take place at the beginning of November, was cancelled.

\* Paul KF4OOX is now on Ascension Island as ZD8V. He is on the island on a long term assignment. QSL direct via Paul L

Hutley, CSR 6310, Ascension, PO Box 4915, Patrick AFB, FL 32925, USA. Paul mentions that Dave AC4IV is also active on the island as ZD8T.

\* Dan LZ2UU will visit the Bulgarian Antarctic Base "St Kliment Ohridski" on Livingston Island in the South Shetland Group, using the callsign LZ0A.

\* 5V7BC is active from Togo. QSL via F5KPG.

\* Charles (ex-S92SS) and his XYL Leslie (ex-S92YL) will be active for the next four years as SV0KM and SV0LN from Northern Greece. QSL via PO Box 1001 (KAV), GR-67100, Xanthi, Greece.

\* Paul PA3DZM is now active from Burundi as 9U2L. QSL via PA3DMH.

\* Dias D2AI is active on all bands from Angola. QSL via CT1EGH.

\* Do you need Guatemala as a new DXCC Country? A group of Finnish operators will be active from there next year from 18 January to 5 February. Details later.

\* Joe K3KN, who was active from Liberia as EL/K3KN, now has the callsign EL2JR. QSL via KB3U.

\* R1ANF is a Russian Club station at Bellinghausen Base on King George Island. QSL via DL5EBE.

## Interesting QSOs and QSL Information

\* 4U1WB - 14213 - SSB - 1322 - Sep. QSL via KK4HD, Paul J C Van Der Eijk, 4900 Bradford Drive, Annandale, VA-22003, USA.

\* OY3JE - Jan - 14220 - SSB - 1310 - Sep. QSL via Jan Egholm, Box 3033, FR-110, Torshavn - Faroe Islands.

\* VP2MGG - Graham - 14222 - SSB - 0552 - Sep. QSL via WB2YQH, Robert E Nadolny, PO Box 73, Spring Brook, NY-14140, USA.

\* OA4CPI - Gian - 14250 - SSB - 0529 - Sep. QSL via the QSL Bureau or direct via Giannandrea Mangia Vacchi, PO Box 538, Lima 100 Peru, South America.

\* T88AA - Toshi - 14036 - CW - 1256 - Sep. QSL via JIICEL, Toshiyasu Arai, I-26-8-304, Shinsei, Kumamoto 862 Japan.

\* V63DX - 7011 - CW - 1058 - Sep. QSL via KA7HMZ, Shoji Igawa, Yokobori, Ogachi, Akita, 019-02, Japan.

\* BX0YL - 14193 - SSB - 1231 - Sep. QSL via BV4YB, Fengyuan Group Station, Box 163, Fengyuan, Taichung, Taiwan.

\* TA2LZ - Deniz - 14243 - SSB - 0644 - Sep. QSL via TA2IR, M Riza Gulen, PO Box 195, TR-81302, Kadikoy, Istanbul, Turkey.

\* K7K - 14023 - CW - 0809 - Sep. QSL via KE7LZ, Robert W Johnson, 5627 W Hearn Rd, Glendale, AZ-85306, USA.

\* 3ZOZAM - Marian - 14032 - CW - 1428 - Oct. QSL via SP8LZC, Marian

Cinkiewicz, ul Hrubieszowska 67 m 9, 22-400 Zamosc, Poland; or via the Bureau via SP8LZC.

\* 4L0CR - 14215 - SSB - 1312 - Oct. QSL via IK7JTF, Salvatore Borace, 3 Trav Corso Roma NC, I-70010, Cellamare, BA, Italy.

\* TR8SA - Chris - 14192 - SSB - 0600 - Oct. QSL via F6FNU, Antoine Baldeck, PO Box 14, F-91291, Arpajon, Cedex, France.

## From Here There and Everywhere

\* Robin DU9RG was active with the special prefix 4I9RG during November, celebrating the 65th anniversary of the Philippine Amateur Radio Association (PARA). QSL via DU9RG.

\* Klaus DJ9DX and Theo DJ1RL were active from Madagascar, then at the end of November from Mayotte signing FH/home call. QSL is acceptable via the German QSL Bureau.

\* The Administration on Nevis Island (V4) in the Caribbean has decided to secede from its Federation with St Kitts (V4) which was formed after the countries obtained their independence in 1983. A two-thirds majority vote by the islands 5000 voters will decide whether they will become fully independent. The possibility of a new DXCC country is on the horizon.

\* It was rumoured that Pitcairn Island amateurs might be using VP6 in their callsigns as the VR6 prefix belongs to the Peoples Republic of China since the hand over of Hong Kong (VR2).

\* If you worked the special prefix station OF0TA from Aland Island during the CQ WW SSB contest, it was Pekka OH2TA celebrating the 80th anniversary of the independence of Finland. QSL via OH2TA.

\* Jim VK9NS was active as VU2JBS on the low end of the CW section of the 20 metre band.

\* Yoshihiko JA2MNB was heard on the east coast of Australia on CW in the 20 metre band, operating as 3W5MNB from Vietnam. QSL to home call, JA2MNB, Yoshiko Hirano, PO Box 6, Nishiharu 481.

\* Rick (formerly KH6JEB) a well-known DXer in the Pacific, has changed his callsign to KH7RS.

\* Tariq AP2TJ reported a lot of pirates using the AP prefix operating CW on a variety of bands. The only bona-fide CW operators at present in Pakistan are: AP2HA (Hasnat, active mostly on weekends); AP2MY (Yunus, presently QRT); AP2SD (Shahid, presently QRT); AP2NK (Nasir, occasionally active); and AP2TJ (Tariq, occasionally active). Tariq says that foreigners will not be given amateur licences in Pakistan.

\* Andy 9X0A now has a QSL manager in Germany. He is Gottfried Gerth DL5WM, Obere Dorfstr 13a, D-09661, Gruenlichtenberg, Germany.

\* There is a lot of confusion with the QSL route for the \*0ANARE suffix. The VIOANARE call is used only by a small group of VK4 amateurs celebrating the 50th anniversary of the establishment of the Australian National Antarctic Research Expedition activity. QSL manager is Alan VK4AAR.

\* Tom VK0TS on Macquarie Island used the VK0ANARE callsign from 25 to 31 October. The QSL route is the same as for VK0TS, viz: Simon Trotter VK1AUS, PO Box 2063, Kambah Village, ACT 2902.

\* The ZM7A/ZL7AA team was very active from Chatham Island from 22-27 October. QSL via Lee Jennings ZL2AL, PO Box 54, Hastings, 4201, New Zealand, or via ZL2AL via the Bureau.

\* The ZK1XXP team on North Cook made 15,299 contacts comprising 6,708 SSB, 8,101 CW and 490 RTTY contacts.

\* On the occasion of the 1997 World Radiocommunication Conference WRC-97 the special call 4UIWRC was activated from 20 October to 21 November. QSL via 4U1ITU, IARC, PO Box 6, CH-1211, Geneva 20, Switzerland.

\* The Iranian QSL Bureau is located at: Director General of Telecommunications, Ministry of PTT, Dr Shariati Ave, PO Box 11365-931, 16314 Iran.

\* T32RT is Ramate Tekeaki, London Village, Christmas Island, Republic of Kiribati, Central Pacific.

\* Ray 5R8FK says that there are mail problems in Madagascar, therefore all cards should be sent to his home call, NY3N.

\* The ARRL has announced that the US has applied to the European Conference of Postal and Telecommunications Administration (CEPT) to participate in that system. If successful, the temporary activity of US amateurs in Europe and European amateurs in the US, will solve the problem of reciprocal licences.

\* Some operators are still confused how to QSL with the Libyan club station 5A1A. Abubaker (Sep 97 *Amateur Radio*) provides this information: send your QSL card only by registered mail to PO Box 74421, Tripoli, Libya. This is in your interest because there is a heavy "QRM" regarding overseas mail delivery. DO not send IRCs because they are not valid in Libya. Send two "green stamps". Abubaker says that he can confirm every contact with 5A1A including those made by the other operators or DXpeditions who used the call 5A1A, except the Austrian activity with the call 5A28 and (presumably) the



German activity from 24 November until 4 December which has DL3KDV as QSL manager.

\* The proposed St Pauls Island activity using the call CY9DX was cancelled.

\* Chuck N4BQW/KH5 was active from Palmyra from 17 to 25 October. His proposed Kingman Reef activity was cancelled due to lack of time to enable him to catch the weekly plane out from Christmas Island T32.

\* A number of new callsigns are appearing in Antarctica. ZL5PX was heard at 0800 UTC on 14245 kHz. QSL via ZL3PX. VU2JBK was also heard at 1800 UTC. Oleg UR8LV will be joining the third Ukrainian Antarctic Expedition at Vernadskogo Base (VP8).

\* George, who was operating as 5B4/G3LNS from Cyprus, now has the callsign 5B4AGC. QSL via PO Box 1344, Paphos, CY-8133, Cyprus.

\* QSL for the VK9LX Lord Howe activity goes via VK2ICV, Nick Hacko, PO Box 730, Parramatta, NSW 2124.

\* SONRA, the Society of Newfoundland

Radio Amateurs, operates the special call VO500JC, from the Club Station VO1AA in Cabot Tower in St John's, daily until 31 December 1997, celebrating the 500th anniversary of Cabot's voyage to the New World. Favourite frequencies are 14030 CW, 7030 CW and 14300 kHz SSB. Please QSL via the bureau or direct to VO1AA.

\* YIIRS is an Iraqi club station with a variety of operators. Just recently WB3CQN offered to be a QSL manager for the club and his offer was accepted.

\* Marcel FW5XX who, during his stay, gave a "rare country" to many amateurs, left Wallis Island on 17 November and returned to Belgium.

\* Ron ZL1AMO was active during early November both on SSB and CW from Rotuma Island as 3D2RW/Rotuma.

\* The other night, among the "chit-chat" nets on 40 and 80 metres, there was some discussion on the merits and de-merits of the daylight saving scheme, which introduced five different time zones on our continent. Some of the participants were totally

confused about the correct time in various capital cities. Here is a simple answer. When it is 12 noon in NSW, Tasmania, Australian Capital Territory and Victoria, it is 11:30 am in South Australia, 11.00 am in Queensland, 10.30 am in the Northern Territory and 9.00 am in Western Australia. Daylight saving began on the last Sunday in October and ends on the last Sunday in March next year.

### QSLs Received

ZB2AZ (6 w - GARS [Gibraltar Amateur Radio Society]); RIMVI (4 m - OH5NE); HV4NAC (9 m - IK0FVC); JY9QJ (4 w - DL5MBY); 9G5CW (5 m - DL2RUM); and TT8JFC (1 m - W4JZB).

### Thank You

The number of fellow amateurs who assist me to compile these notes varies from month to month. However, there is a core of the faithful to whom I must say a special thank you: VK2XH, VK2KFU, VK2TJF, ON6TT, UA9MAR, 9V1RH, and the publications *QRZ DX*, *The DX News Sheet*, *The DX News Magazine* and *425 DX News*.

\*PO Box 93, Dural NSW 2158

ar

---

## Education Notes

Brenda M Edmonds VK3KT\* Federal Education Coordinator

---

This is the first chance I have had to report on my trip to the IARU Region III Conference in Beijing in September. There was a brief report in *WIA News* in November *Amateur Radio* which most of you will have read, but there were several matters relating to education and the future of the Amateur Service which I found very interesting. One such topic was the ARDF activities. I am becoming more convinced that this would be an ideal way to start getting amateur radio into schools.

Since I returned I have tried to check changes in membership numbers of the different countries, but the various Society reports do not always specify numbers, or whether figures given are for the number of operators in the country or the number of Society members. I can state, though, that amateur radio is growing rapidly in Hong Kong, Korea, China, Bangladesh and Thailand. In many of these countries the main increase is in VHF usage, and few operators are licensed for HF. In some areas, there may be many licensed operators, but the only transmitters are club stations. On the other hand, numbers are dropping in Japan as well as in Australia. The outcome of a WIA paper on decreasing recruitment is that I have been asked to find out whether other Region III countries see this as a problem.

At the same time, I will be in touch with other societies about the development of a harmonised examination syllabus for ease of recognition of qualifications throughout Region III.

An information paper on ICARE, which was new to most of the attendees, was well received. I will be preparing a further paper for publication in the Region III News.

An important part of any Conference is the interaction between attendees outside the formal program. It was very pleasing to renew acquaintance with many of those I met in Singapore, and disappointing that some who I had expected to see did not attend. The formal receptions hosted by the Region, JARL and the host society CRSA were most enjoyable, and an ideal time to meet informally with visitors from other countries.

The formal Conference program ran for four days (8 - 12 September), with much of that time spent in working groups discussing the many papers circulated before the meeting (11 September was left free so that we could all enjoy some sightseeing - specifically a bus trip to the Great Wall. No, I will not bore you with my photographs). The meeting concluded on the afternoon of 12 September with the final Plenary Session and various presentations. A number of individuals and societies honoured David

Rankin 9V1RH/VK3QV, with speeches and gifts on his retirement as a Director of Region III.

Congratulations are due to CRSA on the efficient organisation and management of the whole week. In particular, the group of University students who acted as "liaison" were most helpful and attentive to our needs.

Personally, I found it a challenging and rewarding experience. I am glad now that I let the family persuade me to stay a few more days afterwards to see something of Beijing. For those of you concerned about WIA finances, I paid my own way, but I am sure now that it was money well spent.

\*PO Box 445, Blackburn VIC 3130

ar

**Remember to  
leave a three  
second break  
between overs  
when using a  
repeater**

# Novice Notes

Peter Parker VK1PK\*

## Antennas for the Space-Restricted (Part Two)

### A Magnetic Loop for HF

#### Introduction

October's column looked at compact antennas that amateurs use to operate from confined locations. The smallest antenna described for 80 metres was a magnetic loop. This month, we provide all the details needed to build your own.

#### Description

Able to cover all frequencies between 3.5 and about 10 MHz, the loop described here is directional, does not require a radial system, and stands just 1.8 metres tall. Most parts needed can be purchased at a hardware shop. The antenna can be put together in an afternoon and requires only hand tools to assemble. It should cost less than sixty dollars to build.

Figure 1 is the schematic diagram for the loop. Note that the element is continuous except for a gap at the top across which the variable capacitor is wired. The feedline is connected to the bottom of the loop.

Figure 2 shows the physical construction of the antenna. The loop element is 1.5 metres square and is supported on a wooden cross. To minimise losses, thick aluminium strip is used for the element. At the top of the loop is a high-voltage variable capacitor. This is used for adjusting the antenna to the operating frequency. Because of its narrow bandwidth, the tuning is very sharp and a vernier drive has been added to make tuning easier. Dimensions are not particularly critical, provided it is possible to bring the loop to resonance on all operating frequencies with the variable capacitor used.

#### Parts Needed

The following materials are required to build the antenna:

- 3 x 2 m lengths of 3x20 mm aluminium strip
- 1 x 1.8 m length of 20x44 mm pine
- 1 x 1.5 m length of square (12x12 mm) wood
- 1 x polyethylene chopping board (medium or large size)
- 1 x 150x80x4 mm piece of stiff high-voltage insulating material (eg Bakelite)
- 2 x right angle metal brackets
- 1 x 20-400 pF high voltage variable capacitor
- 1 x 6:1 vernier reduction drive (Dick Smith No P-7170)

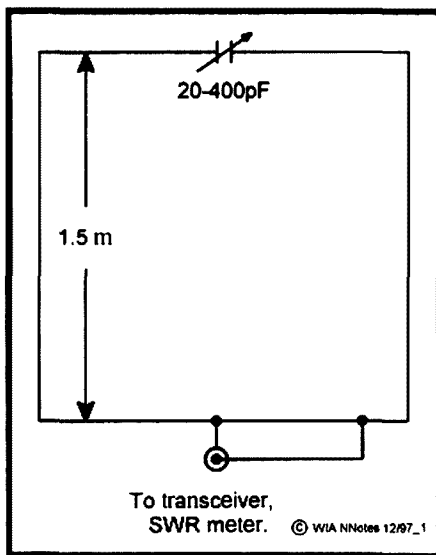


Fig 1 - Schematic Diagram of the Magnetic Loop

Small length of coaxial cable braid; RG58 coaxial cable (any length) and PL259 plug; screws, nuts and miscellaneous hardware.

Many of the above items can be bought at hardware shops. The main exception is the wide-spaced variable capacitor. These are almost unobtainable commercially, though you could try Daycom in Melbourne. Other possible sources include old high power transmitting equipment, Hamfests and deceased estates. The exact value of the variable capacitor is not particularly important, provided it is at least about 400 pF. The capacitor used in the prototype was a two gang 200 pF unit with 2 mm spacing between the plates. The gangs were connected together to provide the needed maximum capacitance.

If your attempts to obtain a suitable capacitor fail, there is always the possibility of making one. Full construction details appear in DK1NB's magnetic loop design program (details later).

#### Construction

The first step in assembling the loop is to make the wooden cross that supports the aluminium element. This is done by bolting a 1.5 m horizontal cross piece to the 1.8 m vertical section. A white polyethylene chopping board is used for the antenna's base. The two right-angled brackets are used to attach this to the vertical section.

The next step is to bend the three lengths of aluminium so that they form a 1.5 metre square loop able to fit on the frame when bolted together. As is visible in Figure 2, two

pieces are "L" shaped, while the other is bent into a shallow "U". Note that the two L-shaped pieces are about 10 cm apart at the top of the loop. These are physically joined by the bakelite insulation block that is attached to the top of the length of pine. The upper L-shaped pieces meet with the lower U-shaped piece at points 'v' and 'w'. The overlap is about 40-50 millimetres. Make the electrical connection at these points as good as possible. To achieve this, sand the aluminium at the point of contact and use two or more small bolts to hold the pieces together. Use special conductive paste if available.

The variable capacitor is mounted on a home made metal bracket so that its shaft faces downwards (see photo). To the shaft is attached a vernier reduction drive. Use either small brackets, fishing line or glue to fasten the frame of the reduction drive to the 1.8 metre vertical section. Note the thick, low-resistance conductors between the end of the loop and the tuning capacitors. Braid from a length of coaxial cable was used in the prototype. Make these connections short to minimise losses.

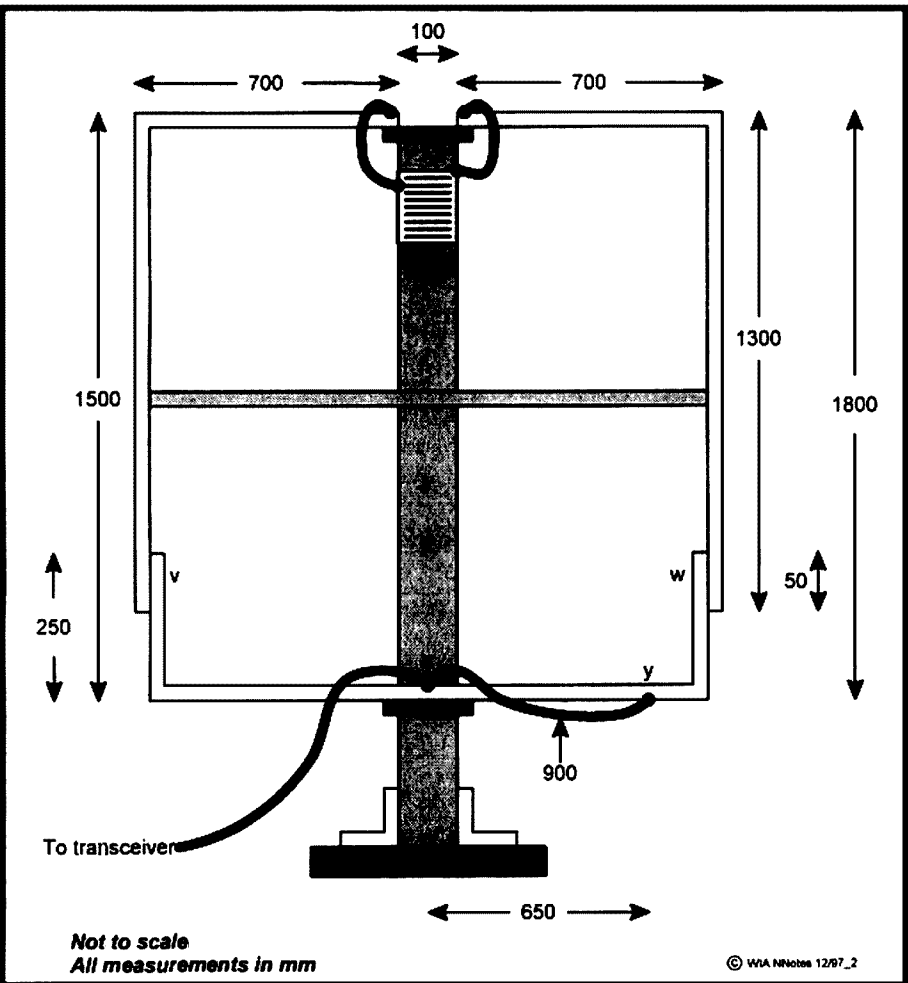
The loop is fed at the bottom. The braid of the feedline connects to the centre of the lower horizontal element (Figure 2, point 'x'). The inner conductor connects to the loop at point 'y' via a 900 mm length of coaxial cable (inner and braid soldered together). At both 'x' and 'y', a small bolt, nut and eye terminal connector are used to make connections to the aluminium element. The distance between 'x' and 'y', and the length of the coaxial cable, may both have to be varied for proper matching - this is discussed later.

#### Adjustment

The object of the adjustment process is to adjust the section between 'x' and 'y' until the antenna's feed-point impedance can be made to equal 50 ohms on the bands of interest.

The first step is to connect the antenna to an HF receiver tuned to 7 MHz. Set the receiver's RF and AF gain controls to near maximum and the antenna's capacitor to minimum capacitance (plates fully unmeshed). Then gradually increase the capacitance. Not much will happen at first, but the noise from the receiver should gradually start to increase. Further adjustment of the capacitor will result in the received noise falling. Turn the capacitor back to the position where the noise peaks. Depending on the value of your capacitor, the plates should be around a quarter meshed at this point. This test confirms that the antenna can be tuned to 7 MHz.

Repeat the process for 80 metres. This time, the noise should peak when the capacitor is near maximum capacity. If it is



**Fig 2 - Magnetic Loop - drawing**

not possible to obtain a peak, try setting the receiver to a higher frequency (4 or 5 MHz) and tune for a peak. If a peak is obtained there, but not on 3.5 MHz, it is likely that the variable capacitor's maximum capacitance is too low for eighty metres. Possible remedies include substituting a larger capacitor, connecting high voltage fixed capacitors in parallel with the variable capacitor, or making the loop larger.

Having confirmed that noise peaks can be obtained on all frequencies of interest, it is now time to ensure that the antenna's impedance is 50 ohms at these frequencies. This entails making adjustment to the antenna's feed point.

The use of a resistive antenna bridge<sup>1</sup> is recommended so that you can make antenna measurements without radiating a signal. If all you have is a conventional SWR bridge, make adjustments during the day to minimise the risk of interference to other stations.

Position the antenna near its final operating position (which should be out of other people's reach). Set your transceiver to about 3.580 MHz. Adjust the variable capacitor for maximum received noise.

Transmit a steady carrier and note the reflected power or SWR. Adjust the transmitter up and down 40 or 50 kilohertz to find the precise frequency where the SWR is lowest. Note the reading at this frequency. If you are lucky, the reflected power should be nearly zero. Otherwise, adjust the length and position of the 900 mm lead joining the feedline to point 'y' and/or the spacing between points 'x' and 'y'. You will find that there is some interaction between these adjustments and the setting of the variable capacitor. Every time a change has been made, adjust either the transmitting frequency or the antenna's variable capacitor for the point where reflected power is lowest. Repeat these procedures until reflected power is either zero or close to it.

When making these adjustments, there is a temptation to leave the transmitter keyed while making changes to the antenna or adjusting the variable capacitor. This should not be done for two reasons. The first is that the voltages at the top of the antenna element can be quite high (hundreds or even thousands of volts) even with quite low transmitting powers. The second is that the

loop is detuned when people are near it. Thus, any adjustment made when you are near the loop will not be optimum when you move away. This effect is particularly pronounced on higher frequencies, and applies to metal objects as well as humans.

Once a length and position for the 900 mm coaxial cable has been found<sup>2</sup>, along with an appropriate spacing between 'x' and 'y', all further adjustments can be done with the antenna's variable capacitor. Operating the antenna is described in the next section.

**Operation**

The Q of this antenna is very high. This means that it can only operate efficiently over a narrow frequency range (5-10 kHz typical). Almost every time you change frequency, you will have to change the setting of the variable capacitor.

As mentioned before, this is done by peaking the capacitor for maximum received noise at the desired operating frequency. If the reflected power is high, make further adjustments until it is acceptable. Again the use of a resistive-type bridge (rather than a conventional SWR meter) is preferred because of the ability to tune up without causing interference.

Note that the loop is directional, with a sharp null when the element is facing the direction of the incoming signal. This makes its behaviour different from that of full-sized quad elements, where the null is off the sides of the loop. This directivity can be useful when nulling out interference. It is also useful to remember that, when other stations report difficulty in hearing you, turning the loop may improve your signal.

**Results**

This loop has been used extensively on eighty metres. Most contacts have been made with the antenna indoors. Though performance is well down on a dipole, contacts into Western Australia and New Zealand have been made with it. The power used was twenty watts. Lower powers have been tried, but results have not been good.

Contests are always good events to test the effectiveness of new antennas. During July's hour-long 3.5 MHz Australasian CW Sprint, twelve contacts were made with the loop. This was despite the added handicap of having to retune the antenna with every significant frequency shift.

As would be expected, the loop's disadvantage when compared to full-sized antennas falls with increasing frequency. On 7 MHz for instance, the theoretical difference between the loop and a half-wave dipole is barely one S-point. Tests have confirmed the effectiveness of the loop on 40 metres, though all contacts have so far been within VK/ZL.

### Improving the Loop's Efficiency

The antenna described is capable of good results on 80, 40 and probably 30 metres<sup>1</sup>. However, it is a compromise, designed for low cost and easy construction with basic tools. Doing any of the following will increase its efficiency and/or usefulness.

1. Use copper rather than aluminium. Copper is more conductive (but more expensive) than aluminium. This means that a version of this antenna using copper rather than the specified aluminium is likely to be more efficient than the prototype. Copper water pipe (the thicker the better) should be suitable.

2. Soldering the loop element directly to the variable capacitor will also improve performance and long-term reliability, especially if the antenna is used outdoors. The reason why this wasn't done in the prototype was due to the difficulty in soldering to aluminium.

3. Use a single piece of metal for the conductor to reduce resistive losses. Where this is not possible, either solder/weld pieces together, or use conductive paste to minimise losses.

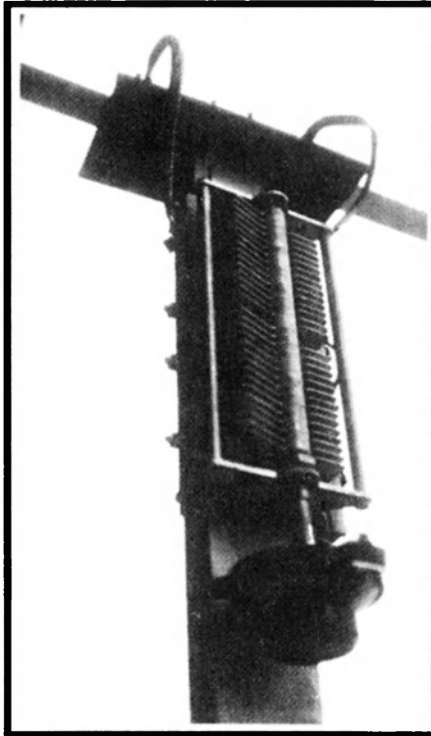
4. Make the loop a circle or octagon instead of a square. Square loops are the easiest to make, but cover less area for a given perimeter than other shapes. This lowers efficiency.

5. Make the antenna rotatable. The loop's deep nulls can be used to advantage in nulling out interference from power lines, TV sets and other stations.

6. Use a larger loop. Efficiency increases rapidly with loop size. Even a 2 or 2.5 metre square loop should be noticeably more efficient than the 1.5 metre antenna presented here. The use of magnetic loop simulation software (see elsewhere) allows one to estimate the improvement possible by making this and other changes suggested above.

7. Use more reduction on the variable capacitor to make adjustment easier. The first prototype (as shown in the photo) had only one vernier drive on the capacitor's shaft. With this arrangement, getting the antenna tuned to the desired frequency was tedious because the tuning is sharp. If you routinely change frequency, a second drive is well worth the cost, particularly if 40 and 30 metres are the main bands of interest.

To perform this modification, install the two vernier drives in tandem. If the front drive contains a 0-100 dial, you may find that the knob is limited to three turns and the back part restricted to 180 degree rotation. To overcome this, remove the knob, unscrew the 0-100 dial, and remove the C-shaped bracket that is restricting movement.



**Close-up of tuning capacitor. Note that the Bakelite insulating block, the coax braid connections to the variable capacitor and part of the aluminium element are all visible in the photo.**

### Information About Magnetic Loops

All information used in the construction of the prototype came from the following Internet sites:-

<http://ourworld.compuserve.com/homepage/csl/magloop.htm>

<http://www.gqrpclub.demon.co.uk/ants.htm>

<http://www.cdrom.com/simtel.net/msdos/hmradio.html>

Hans Joachim Kramer, DK1NB has developed a DOS computer program useful for those who design magnetic loops. Able to calculate efficiencies and bandwidths, this freeware program also contains much useful constructional advice (including pictures) to assist those who experiment with magnetic loops. This excellent program (mloop31.zip) is available from the last mentioned site on the list above.

#### Notes

<sup>1</sup>See Demaw/Hayward, *Solid State Design for the Radio Amateur*, ARRL, 1986, page 167.

<sup>2</sup>Once made, this adjustment should be close to optimum on all bands covered by the antenna; no further adjustment should be necessary.

<sup>3</sup>The antenna has not yet been used on 30 metres. However, gain should be within a few decibels of a half-wave dipole.

\*7/1 Garran Place, Garran ACT 2605  
parkep@pcug.org.au

ar

## International Amateur Radio Union Monitoring Service (IARUMS) - Intruder Watch

Gordon Loveday VK4KAL\*

The International Amateur Radio Union Monitoring System (IARUMS) is set up to record, report, and encourage the removal of non-amateur stations from amateur band allocations. Stations targeted are usually broadcast or commercial stations from other countries. Priority is not given to local "pirates". Each country appoints a Co-ordinator, who is responsible for collating reports and forwarding them to the appropriate regulatory authorities (the "Australian Communications Authority" in Australia).

Each WIA Division, apart from VK3, has a Divisional Co-ordinator to collect reports from that Division and forward them to the Federal Intruder Watch Co-ordinator. But the main strength of the service is in the individual amateurs who spend time regularly listening on the bands and identifying types of signals and stations.

More Intruder Watch listeners are always required. Volunteers who contact either their Divisional Co-ordinators or me direct will be supplied with information, log sheets and tapes to assist in identifying modes.

### Interference on 20 m

The World Service from the BBC has been heard on 14.220 MHz from 2230z until about 2345z. It appears to be the second harmonic of their 7.110 MHz transmission.

I was advised by Dave Thorne, station manager of the ACA in Hobart, that this frequency is now clear, as at 29 October. A check at my QTH (using a 15 valve GEC receiver) on 30 October showed only a very weak transmission on 7.110 MHz.

\*Federal Intruder Watch Co-ordinator, Freepost No 4 Rubyvale QLD 4702 or VK4KAL@VK4UN-1. Tel: 07 4985 4168.

ar

---

---

# Over to You – Members' Opinions

---

---

All letters from members will be considered for publication, but should be less than 300 words. The WIA accepts no responsibility for opinions expressed by correspondents.

---

---

## Contest Comments

I read with interest VK3AFW's suggestions in relation to the VHF-UHF Field Day Contest and offer my comments from the viewpoint of a 6 m DXer. I agree the rules should be consistent from one year to the next for any contest. 50 MHz was not included in 1997 because there were too many complaints arising from poor 1996 contest operating practices exhibiting a total disregard for band plans and peaceful co-existence.

The 1996 rules were quite clear and from the November 1995 issue of *Amateur Radio* I quote: "All modes and bands above 30 MHz may be used. Contest exchanges should not be made on recognised DX calling frequencies." So, what do you think happened? Incessant and irritating "CQ Contest" all day long on 50.110 MHz, that's what!

The 10 kHz guard band VK3AFW suggests around 50.110 MHz is insufficient and, in essence, some of the 6 m rules have already been defined by FTAC as published in the November "FTAC Notes" and 1998 *Call Book*. I quote in part: "All other operation should be above 50.150 MHz, with a new Australian calling frequency on 50.200 MHz."

I doubt Mr Cook's suggestion of "self policing" will work because history has shown us it hasn't before, which brings me to my next point. Why bother having rules in the first place if they are not being enforced? There are numerous stations I could name that were heard calling on a "recognised DX Call channel" and were in the final list of results. In theory these stations should have been disqualified. No one wants to play "policeman" but somebody is going to have to as the self policing by participants cannot always be relied upon.

It is laughable to think that a Yagi, particularly a home-brew one with varying degrees of tolerance, will not perform satisfactorily any more than 40 kHz up. I would hate to think how such an antenna would perform when it rains or even when it's subjected to nearby ground effect variance when it's rotated. Even an M2 2.5 WL Yagi has a usable bandwidth of 800 kHz according to the manufacturers specifications. This is definitely not a valid excuse to huddle close to 50.110 MHz.

One concern also arises and that is promoting 6 m contest operation during times of intense Es propagation increases the

likelihood of causing harmful interference to Channel 0 Television services. The acquisition of 50.050–50.200 was originally granted on a strictly non-interference basis, and remains the case today even with our revised allocation.

If we must suffer contesting on 50 MHz then please keep it strictly above 50.150 and I would suggest the following changes to the rules be implemented without further hesitation:

### General Rules:

"All modes and bands above 50.150 MHz may be used. Contest exchanges on recognised DX calling frequencies are not allowed."

In addition to this I would also like to see the following category added:

### Disqualification:

"Any station(s) found not abiding to rules of the contest shall be subject to disqualification from the contest."

I would be extremely unhappy to miss out on a DX contact that might get buried underneath a 5x9+ VK collecting numbers. This is especially so as we approach the next solar peak, whereby the instances of long haul propagation (even coming in on an Es extension) will increase. In the first weeks of January in previous years the following countries have been worked from VK3 alone: W, XE, OH, JA, SM, LA, P29, TI2 and KH6 to name a few. You would not even hear the very weak EUs underneath a contest.

To close I must sadly report that it's been almost two years on and I still haven't had the courtesy of a reply from the VHF-UHF Contest Manager, despite requesting a response. My concerns listed above were conveyed to him and I believe are still as valid today as they were then.

Adam Maurer VK3ALM  
UKSMG Country Manager  
1 Jeffrey Street  
Dandenong North VIC 3175

## Federal President Replies to Federal Finances, Federal Problems

Issues and criticisms raised in *OTY* letters from Peter Williams VK3IZ, Peter Parker VK1PK and Chris Lowe VK6BIK should not go unanswered.

Losses sustained by the WIA Federal company operations are indeed a problem. Income and expenditure have been issues addressed at length at Federal Council meetings and discussed frequently by the board of directors.

The fall in membership is highlighted by both Peters. The decline in Division membership, aggregated across the seven Divisions, is a major contributory factor in declining income for WIA Federal. But the 'blame' for this fact of life – or is it criticism of supposed inaction? – is focused, vaguely, on 'the WIA' as being a failure of the organisation. But, as Kevin Jones VK4AKI, in the September *OTY*, says: "It is us amateurs who are the WIA." Each of us, as members, are responsible for the 'membership factor'. Other factors are not directly within individual members' influence.

Consider this: if each Division member recruited one new member to their Division (or any Division!), over the next five years, there would be a net gain in aggregate membership of around 600 per year – even if the rate of non-renewals and SKs were maintained – resulting in an increase of more than 60% at the end of the five years.

The membership Recruitment and Retention campaigns, initiated and coordinated by WIA Federal over the past couple of years, have served to slow the rate of decline in aggregated Division membership. After these programs began, the annual loss fell from 362 in 1995 to 245 in 1996. That's something, but membership loss in each Division must remain a concern. A significant contributor to the percentage loss rate, and the actual numbers, comes from the smaller Divisions: ACT and Tasmania. The Divisions "more like clubs", as Peter Parker puts it. With loss rates between 10% and 20%, against loss rates under 5% in the larger Divisions, the argument that a club-based structure has inherent advantages fails in the face of the facts.

The apparent 'success' of clubs points to them meeting a need by providing services close to their 'customers'. The Queensland Division's action to 'get closer to their members' has paid off dramatically. Part of this strategy has involved taking over the administration of their membership records. As I remember, the QLD Division's Federal Councillor once said 'we have members who live closer to Manila than to Melbourne'. In 1994, before they took this (at the time, controversial) action, their membership loss rate was just under 10% for the year. In 1995, it plummeted to 1.05% and remained under 2% for 1996.

What this says is that there is most definitely a role for the Divisions, still. But the way they organise that role may need to be examined. That's an issue for each Division to sort out, not WIA Federal, or myself. The Queensland Division has one of the greatest geographic spreads in its membership. The ACT and Tasmanian Divisions are much more close-knit.

The 'model' of a more fragmented organisation comprising a collection of geographically distributed small clubs clearly has identifiable problems, and no doubt some hidden ones. The NZART has learned this, to their cost. They have posted operating losses each year for a number of years now. Likewise for the ARRL and the RSGB. The assumptions implicit in Peter Parker's argument and Chris Lowe's support of it, can thus be seen to have an inherent weakness. Change is proposed for the sake of change, rather than seeking solutions to known existing problems. Would we simply exchange one set of problems for another?

I'm not arguing in support of necessarily maintaining the present situation. WIA Federal should change in response to, or even in anticipation of, change in the world in which we operate.

Peter Williams' suggestion that WIA Federal save money "by not socialising around the region on expensive conventions", I believe, is short-sighted. There is, indeed, purpose in "costly visits to overseas societies and ITU conventions." Co-operation between the NZART and WIA Federal, initiated during so-called "costly" reciprocal visits, has led to improved licensing conditions and the clearance of interference from our bands, for example.

The ITU does not hold "conventions". That term equates to "junkets" in many people's minds. They hold conferences. Decisions made at these conferences can have significant impact on amateur radio – for better or worse. The fact that the WIA actually pays money to have a representative on the Australian delegations to World Radio Conferences, a delegate who contributes to the work of the Australian delegation alongside looking after the interests of amateur radio, counted in our favour with the Federal Government in 1995 when it came to negotiating a more reasonable licence fee than the proposed \$70+. The Ministerial Secretary didn't know that. It was a significant factor in changing the government's attitude.

The WIA doesn't pay to send a 'token' delegate to WRCs. THAT would be a waste of money. We send Dr David Wardlaw VK3ADW. His background, his continuous experience in Institute affairs, and in radiocommunications and standards administration, serves us well. So do his national and international contacts in amateur radio and in fields which impact amateur radio. His knowledge of the factors and forces shaping the future of amateur radio also serves us well. And David isn't the only person in this position. Has amateur radio gained tangible benefits? Most definitely. See "A Decade of Change", *WIA News*, pages 16-17 of *Amateur Radio*,

February 1996.

Then there are the Region 3 International Amateur Radio Union Conferences, every three years. This is the forum which discusses and plans not only regional initiatives, but the strategies to be adopted on issues to go before WRCs. Such issues affect the future of amateur radio, and these conferences legitimise policies on those issues so that the views expressed by the IARU and amateurs on delegations at WRCs have credible weight. We'd be remiss in our duty, and in derogation of the WIA Federal Constitution, if we didn't participate. Having adequate WIA presence at the Region 3 Conference in Beijing in September was considered of such importance that four Division members paid their own way, to swell our delegation's ranks.

Representation in international affairs is paid for by a \$2 component (often referred to as a levy, as a result of past history) which goes into a cumulative fund set aside for this specific purpose. While it is accounted for in the WIA Federal balance sheet, it is not part of the profit and loss accounts.

Peter Williams charges WIA Federal with spending only two lines on "policy and planning on (the) future direction of amateur radio" in the June issue of *Amateur Radio*. This is seen as one of WIA Federal's "sins of omission". This is being selective with the evidence. A reading of matters published in *WIA News* alone, over the six issues previous to June's, reveals 1000s of words on such matters. Then there was the canvassing, through a questionnaire, of members' views on proposed changes to the definition of amateur radio and the qualification of amateur operators in the International Radio Regulations. Doesn't this issue affect "our future at home"? There should be some balance, so far as is possible within both our paid and volunteer resources, between

pursuing actions on the domestic front and in the international sphere.

Many members view national and international representation as primary roles for WIA Federal. WIA Federal has managed to assemble the strongest team of representatives in these areas that the organisation has had for many years. The activities in which WIA Federal now engages, and which it is increasingly expected to engage – with responses to government and regulatory authorities' proposals coming at frequent intervals – and the tangible successes achieved, are a significant accomplishment.

Returning to WIA Federal's income and expenditure. While a number of measures have been instituted over recent years, these have necessarily been in reaction to past events. Successive Federal Councils, Federal Directors, and hardworking Federal Office staff have wrestled with these issues over recent years. The functions WIA Federal now performs, and is expected to perform – and this includes the role of the Federal Office – are somewhat different now than they were three or four years ago, let alone 30 years ago. Meeting the financial contingencies of these changes has proved a difficulty, as successive WIA Federal annual reports have admitted.

No case is made by any of the three correspondents for a different organisational model. That's a disappointment. Only assumptions or assertions are advanced that 'something' different must solve what is perceived as 'the problem', which is articulated only vaguely. Likewise, only assertions are made about the likely demise of WIA Federal. It 'ain't broke', but it is clearly recognised that it does need 'fixing'. It won't happen overnight, but it will happen.

Neil Penfold VK6NE  
WIA Federal President

## WIA MORSE PRACTICE TRANSMISSIONS

VK2BWI	Nightly at 2000 local on 3550 kHz
VK2RCW	Continuous on 3699 kHz and 144.950 MHz 5 wpm, 8 wpm, 12 wpm
VK3COD	Nightly (weekdays) at 1030 UTC on 28.340 MHz and 147.425 MHz
VK3RCW	Continuous on 145.650 MHz, 5 wpm, 10 wpm
VK4WIT	Monday at 0930 UTC on 3535 kHz
VK4WCH	Wednesday at 1000 UTC on 3535 kHz
VK4AV	Thursday at 0930 UTC on 3535 kHz
VK4WIS	Sunday at 0930 UTC on 3535 kHz
VK5AWI	Nightly at 2030 local on 3550 kHz
VK5VF	Continuous on 145.650 MHz, 5 wpm to 12 wpm
VK6RCW	Continuous on 147.375 MHz, 3 wpm to 12 wpm
VK6WIA	Nightly (weekdays) at 2000 UTC on 3.555 MHz

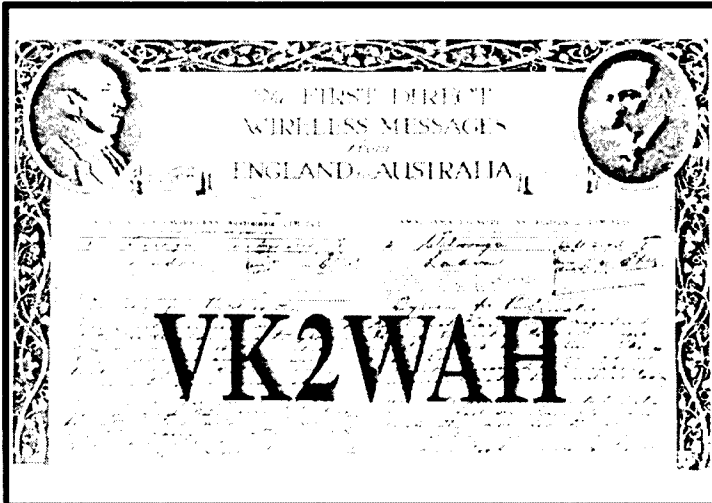
# QSLs from the WIA Collection

Ken Matchett VK3TL \* Honorary Curator WIA QSL Collection

## VK2WAH

Operating for just 24 hours on 22 September 1995, this station, activated by members of the Wahroonga Amateur Historical Radio Association, celebrated a very special event in Australia's history. This was the first direct wireless message to be sent from England to Australia. This message, sent from Carnarvon, Wales to Wahroonga, Sydney in September 1918, was transmitted by arrangement with Guglielmo Marconi and the director of his wireless telegraph station.

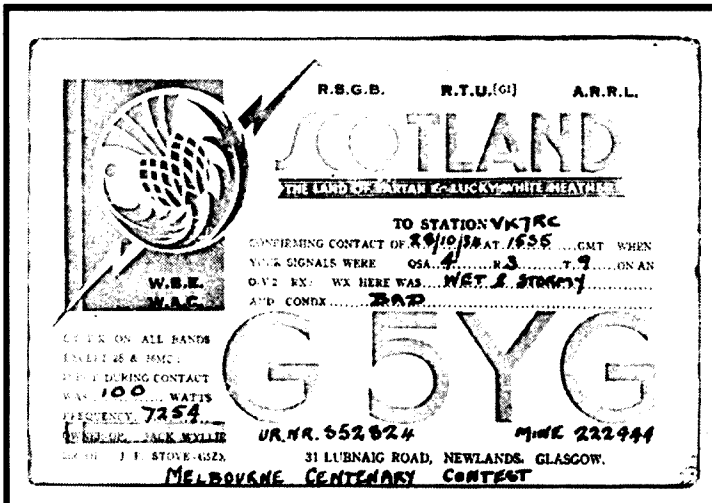
The front of the QSL shows the message from Joseph Cook, Minister for the Royal Navy, and received by Australia's Prime Minister, the Right Hon W M (Billy) Hughes. The Dragon Radio Club of Carnarvon, Wales, callsign GB2VK, celebrated the event in conjunction with the Wahroonga station VK2WAH in attempting to contact as many radio stations as possible world-wide on this special date.



## G5YG

This is a pre-war QSL from Scotland sporting the G5 prefix. The prefix G is one of the original "call letters" assigned by the International Telegraphic Union of Berne, Switzerland to Great Britain and published in the *Year Book of Wireless Telegraphy 1913*. However, in 1937 the G prefix gave way in Scotland to GM.

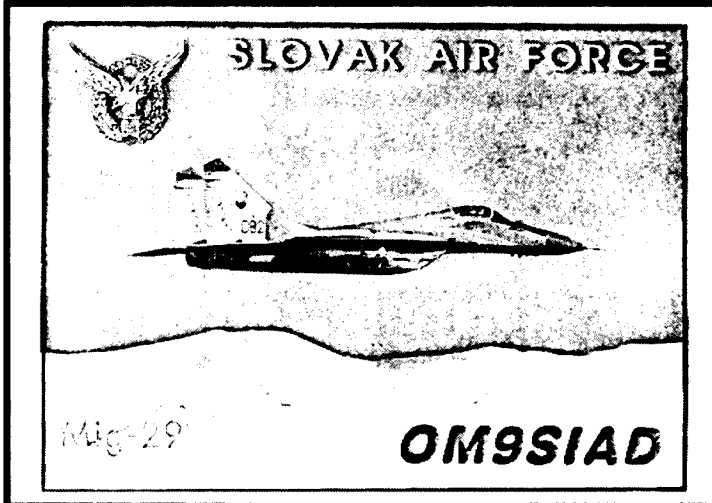
The above QSL, dated 28 October 1934, is one of the earlier Scottish QSLs. It was sent by Jack Wyllie of Glasgow to Ron Cameron VK7RC of Wynyard, Tasmania during the Melbourne Centenary Contest. Jack's transmission from "The Land of Tartan and Lucky White Heather" was crystal-controlled (CCTX) on the 40 metre band and he was receiving on a two-stage audio receiver (O-V-2).



## OM9SIAD

Slovakia was added to the DXCC listing on 1 January 1993 following the deletion of Czechoslovakia. The Constitution of the Slovak Republic was signed in 1992 and the independent state of the Slovak Republic established the next year.

The OM9SIAD QSL was a special issue QSL celebrating the 50th anniversary of the ending of the Second World War. Pictured on the QSL is a MIG 29 fighter aircraft operated by the Slovak Air Force on the occasion of the 3rd Slovak International Air Display (SIAD) held in the capital city of Bratislava.



## Thanks

The Federal Body of the WIA would like to express its thanks to the following for their kind donation of QSLs to the Collection: Bill VK2XT; Snow VK3MR; Arthur VK6ART; Ivor VK3XB; Roth VK3BG; Stan VK3TE; and Ian McLaren SWL, courtesy of Allan VK3AMD.

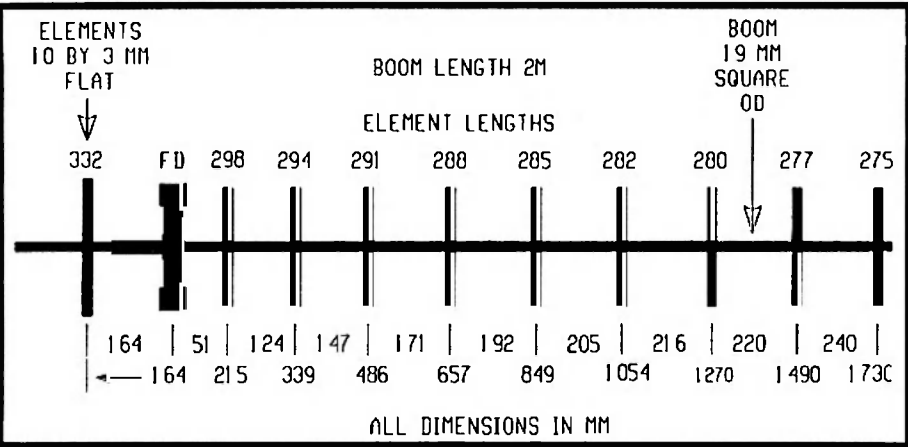
Also to the friends and relatives of the following "Silent Keys": Bruce Mann VK3BM, courtesy of Alf VK3LC; Perce Sebire VK3MX, courtesy of Stewart VK3ESD; and Fred Freeman VK3ALG, courtesy of Jack VK3SY.

\*4 Sunrise Hill Road, Montrose VIC 3765  
Tel (03) 9728 5350

ar

# Repeater Link

Will McGhie VK6UU\*



**Fig 1 - Dimensions of the 11 element 435 MHz Yagi.**  
(Drawing by VK6UU)

## Why?

I have been on seven weeks holidays and found I have less spare time than when I'm at work. Why is this so? Perhaps you take on those large jobs that you can't do while working and, as a result, there is less time?

## VHF-UHF Signal Generator

I mentioned a home brew VHF-UHF signal generator a couple of months back and promised to have it ready for publication soon. Well, soon was to be this month. The variable frequency generator was almost ready to put the finishing touches to for publication, when I ran into a problem or two. The generator had been running for several months and only needed to be accurately documented. In the process of doing this I made a minor circuit change to see what effect it would have. The end result was the oscillator did not oscillate, so I changed the modification back to the original. Would you believe, the oscillator still would not run!

Many hours were then spent trying to figure out why the oscillator would not oscillate. I did manage to solve the lack of oscillation but, in the process, discovered the circuit was unreliable. As well, I had difficulty in setting the oscillator on the correct frequency in order to achieve the required frequency tuning. The end result is that I ran out of time.

So, rather than rush the result, my intention is to present the generator next month. The signal generator is a little gem. It provides an FM signal from 140 MHz to 150 MHz and 420 MHz to 450 MHz.

## UHF Yagi

More and more UHF links are being put

into service on the 420 and 440 MHz link sub-bands. As a result, UHF beams are needed to provide gain on these link paths. Many of us have made Yagi antennas with all sorts of results. The part of the construction that I find the most difficult is the driven element. I have tried them all, but the most difficult part of the driven element is finding one that works first up with a low SWR and is 100% water proof. The design presented features a standard folded dipole but with an interesting approach to the construction of the folded dipole.

White PVC pipe is used to house the folded dipole and provide weather protection. RG-213 is forced through the inside of the pipe and the plastic right angles, ending up with both ends at the T piece. Force

is the right word, as it is a tight fit and a bit of a struggle to make it all fit together. Rather than try and describe how to do this I will leave it up to you. It is not all that hard but does take a bit of push and pull.

The total length of the RG-213 coax used as the folded dipole works out at about 650 mm. I say about because it does depend on just how the coax fits inside the plastic pipe and the gap left between the ends. Leave about 10 mm between the ends where the balun connects. The balun is connected to the braid of the RG-213; the inner of the coax is not used. The RG-213 could be replaced with any conductor, thick electrical wire for example; it is just that RG-213 fits well, can be soldered to, and is available.

What determines the overall size of the folded dipole is the 260 mm length of 15 mm diameter plastic pipe that fits into the right angle fittings. The two right angle fittings at the top and bottom are joined together by a short length of 15 mm pipe so they butt together. I trust the drawing (Fig 2) is easy to follow.

The 15 mm pipe measures 20 mm from outside to outside. I gather plastic reticulation pipe is measured from the inside. Use the thinner PVC pipe as it comes in different thicknesses. (Pipe is specified by its ID, tube by OD. Ed)

The balun, made out of RG-58, fits inside the support and is soldered to the folded dipole. This can be difficult. What I settled on was drilling a large hole in the T piece opposite the coax feed and then, through this hole, soldering the balun and coax feed onto the folded dipole. Once this is done and tested, force Silastic™ into the hole to fill the T piece as best you can. Once dry, the dipole is finished and weather proof.

The folded dipole is not critical and should



**A close-up of the folded dipole and feed.** (Photo by VK6UU)  
(Colour original inserted)



have a low SWR from 420 to 450 MHz. I found the large spacing between the two longest sides produced a wide frequency response. Fig 2 shows the folded dipole with the T piece in the same plane as the dipole. This is done for clarity but, as you can see from the photos, for mounting to the boom of the antenna, the T piece is turned 90 degrees to the folded dipole and the plastic pipe enclosing the feeder is attached to the boom with worm drive clamps (the type you use around your garden hose). (*More trademarks. Also known as Jubilee Clips. Ed*)

At the end of the plastic feed pipe attach a right angle piece to point down to prevent water entering. I used the blue PVC glue to hold the whole dipole assembly together. However, as you will discover, it is difficult to glue all the pieces together and you may be left with one that you can't. Nevertheless, what you end up with is a broad band dipole, with a low SWR, which is easy to attach to the boom of a Yagi and should keep the weather out for ever.

### The Beam

The accompanying Yagi design (Fig 1) comes from Don Graham VK6HK. The design was run through a couple of computer programs and came up with 11.5 dB gain over a dipole. I also did a physical gain measurement using accurate stepped attenuators and, would you believe, the gain measured 11.5 dB! The design is centred on 435 MHz and for 420 MHz it may be advisable to scale the design a little.

### Balun

Ever wondered how a coax balun works? How can it transform 50 ohms to 200 ohms or



The completed 11 element 435 MHz Yagi before mounting in the air.

(Colour original inserted)

(Photo by VK6UU)

75 ohms to 300 ohms? I have used these devices many times, but never really understood how they work. Well, I now know, but can I put it into words that are easily understood?

The balun is half a wavelength long at the design frequency. Think of this length of coax joined to our feed coax and then run straight out at 90 degrees. Do not bend it into the familiar U shape for the purpose of this explanation. We now have two points of interest, one where the feed coax joins the balun, and the other at the end of the balun coax. The voltage at the join between the feed coax and the balun, for example, at a given instance is one volt **positive**. At the other end of

wavelength long, it is one volt **negative**. This is important to understand: half a wavelength between points on a coax cable results in the voltage being of the opposite phase or voltage.

Now, as the voltage in our example is one volt positive at the join between the feed coax and one volt negative at the end of the coax balun, we have a difference between the ends of two volts. If we apply this to a load, such as an antenna, we have two volts instead of one volt; something for nothing? Do we have a voltage gain?

The answer is yes, but not a power gain. As the power must remain the same, but the voltage has doubled, what else has to change for this to be possible? The answer is the impedance. The impedance is now four times the impedance of the feed coax. If it was 50 ohm coax, we now have 200 ohms; and if it was 75 ohm coax, we have 300 ohms. Two volts across 200 ohms is the same power level as one volt across 50 ohms.

If you understood all this, then my writing skills are good enough; if not, then ask someone who knows how a half wave balun works and see if my explanation becomes clear.

### Correction

In a previous article on 29 MHz gateways I mentioned that there are four gateway frequencies. Subsequently, I received a phone call from John Martin of FTAC, advising the correct number of channels as three not four. They are: 29.120 MHz, 29.140 MHz and 29.160 MHz. Sorry about the extra channel I mentioned of 29.180 MHz.

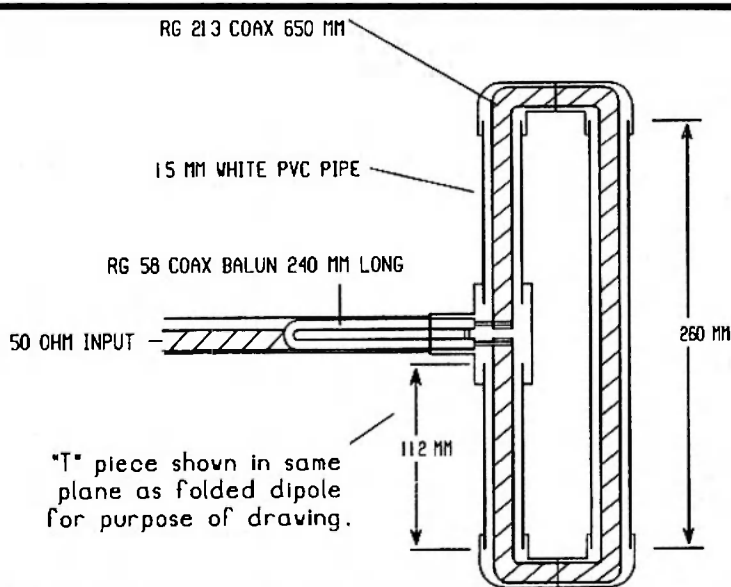
Now back to the signal generator!

\*21 Waterloo Crescent, Lesmurdie 6076

Packet: VK6UU @ VK6BBR

E-mail: will@vale.faroc.com.au

ar



Schematic of the plastic pipe folded dipole for the 11 element 435 MHz Yagi. Note that the RG-213 coax is only used as a convenient dipole; any material could be used. (Drawing by VK6UU)

---

---

# Spotlight on SWLing

Robin L Harwood VK7RH\*

---

---

Well, another year has come to a close and it has been a very interesting one at that. Several international broadcasters drastically reduced their output, including our own Radio Australia where financial cutbacks saw the demise of several language sections, namely French, Cantonese and Thai, as well as reduced programming in all remaining sections. Also, the Darwin site was put into mothballs until it could be required again. As I am writing this, a potential user has come forward for this but it is uncertain whether it will eventuate. More on this further down. The Shepparton site remains the main location for Australia's external senders, with a very small facility near Townsville serving PNG and the western Pacific.

Some international broadcasters disappeared altogether, namely Monitor Radio International and WVHA. Ironically, the latter was part of Monitor Radio and was sold to a splinter Adventist group in Florida, which got into financial difficulties. I believe that the 500 kW sender has since been sold to World Harvest Radio but has not yet been reactivated.

Other broadcasters have come pretty close to leaving short-wave as well, including Radio Canada International, Radio Prague and Radio Budapest.

The VOA and Radio France International have axed programs to Europe and Latin America. The push is continuing to move on to satellite transponders despite the fact that few receivers are around, compared to the millions of short-wave receivers.

Of course, the output from many international and domestic stations can be downloaded off the Internet in Real Audio format, yet the numbers are restricted to about 60 connections at once. Continuing congestion over the Net means that these audio feeds can easily freeze up or drop out.

Program placement via satellite to sympathetic domestic public broadcasters, or as the result of commercial arrangements, has also not been successful. Many commercial stations, particularly in Latin America, were taking advantage of these and only inserting a tiny fraction of the output, often without giving the source of the material. This, naturally, has seen the international stations reassess this policy. Another reason why short-wave will continue is the realisation that satellites are strategically vulnerable to being attacked and disabled in the event of a war.

This year has seen several competing technologies being promoted for direct audio broadcasting. However, the major

manufacturers are wary of committing themselves to any one technology because the failure to reach common standards means that the market would be fractured.

The case of AM stereo is still fresh in mind; there were four completely different systems on the market in America. Because of this failure to agree on one universal system, AM stereo quickly became moribund as no major manufacturer marketed sets in commercial quantities. True, another reason why it didn't take off was the dominance of FM; the marketplace saw to that.

Experiments have been conducted with digital broadcasting over HF. Again, two completely differing systems have been tested, one by the VOA and NASA and the other by Deutsche Telekom at Julich. The latter is promising, as it will include analogue audio next to digital. The American system would require a completely different transmitting and receiving method, although I do believe that an effort is being made to work out a compatible system. I think that the American model will probably interface with a home PC, as it will use a compression method such as MPEG, which is standard on most PCs.

Radio St Helena made its annual appearance on 26 October between 1900 and 2300 hrs. Transmitting over a disused PTP sender, rated at only 1500 watts, signals were patchy. Here, I was again unsuccessful in hearing it, although I believe that a listener in Victoria and another across the Tasman did briefly hear it. Propagation was poor to most areas; also a transmitter very near Washington DC fired up very close to the frequency of 11.092 MHz. This made it very difficult for US monitors to hear it, although some were able to hear it due to the 10 kW signal skipping over their location. Some Europeans were more fortunate despite very low levels.

I noted on the world news on SBS-TV that the Australian government was approached by the US to utilise the disused Darwin senders to broadcast to China and SE Asia over Radio Free Asia. This station is identical to RFE and Radio Liberty, which were heavily jammed throughout the Cold War. The station broadcasts in Mandarin, Korean, Vietnamese, Tibetan, Khmer and Burmese. The SBS report said that the Australian government did not want to jeopardise Australian trade with China and was likely to tactfully turn it down. As well, Radio Australia was naturally concerned that, if the proposal went ahead, its Chinese language programming would be jammed. RFA is

jammed and is not easily heard within the target area anyway. Apparently the VOA, which does also get jammed (yet not to the extent of RFA), has a larger audience.

RFA has at present senders in some CIS nations and uses senders of several US-based religious broadcasters in the Pacific and Alaska. Because of the sensitivity from the particular CIS nations, locations are not given on the official International Broadcasting Board/VOA schedule. Also, one religious station is unhappy that they are involved, namely KNLS. They also feel that their programming is compromised.

Tuning around the utility segments, I came across a broadcaster in USB on 6970 kHz. It is "Radio For Peace International" in Costa Rica. It formerly was on 7385 kHz but, as this has quickly been filled up by powerful senders, the station has chosen the lower channel. I heard it around 0905 UTC and it is easier to hear than on 7 MHz. Programming is similar to that over Radio 3CR in Melbourne on 855 kHz. In fact, I thought I was hearing a harmonic of 3CR at one time because their callsign was mentioned on several occasions. Turns out that programs produced at 3CR are broadcast over RFPI.

I wish to extend Season's Greetings to all; and don't forget that the annual yacht races will be on between Christmas and the New Year. Listen on 2 and 4 MHz.

\*5 Helen Street, Newstead TAS 7250

ar

---

---

## Update

---

---

### A Cost Effective Current-mode 1:1 Balun

(published on page 16 of November 1997 issue of *Amateur Radio*)

### A Cost Effective Current-mode 1:4 Balun

(published on page 17 of November 1997 issue of *Amateur Radio*)

Ralph Holland VK1BRH, the author of both the above articles, advises that the URL of his Web page (shown at the foot of each article) is incomplete. It should be: <http://www2.dynamite.com.au/vk1brh>

It might be a good idea to correct your copy of the November 1997 issue of *Amateur Radio* now.

### "Club Corner" - Coral Coast Amateur Radio Group

(published on page 27/30 of November 1997 issue of *Amateur Radio*)

The correct callsign of Les Daniels, the author of this contribution is VK2AKX, not VK2AKZ as published.

Please correct your copy of the November 1997 issue of *Amateur Radio* now. ar

---

---

# Pounding Brass

Stephen P Smith VK2SPS\*

---

---

I've just recently been advised of a new telegraph society that has been formed in South Africa by Roger Gould King ZS6QL called "QSQ Wireless Telegraph Society", or QSQWTS for short. The aim of the society is to promote and retain CW. The society's motto is "Less is Morse" which symbolises that you don't need hundreds of watts to successfully conduct a QSO. If there are any ex-South Africans residing here in Australia who wish to get in touch with Roger, he can be contacted at PO Box 167540, Brackendowns 1454, Republic of South Africa.

I would like to thank John VK2KV for sending me information on the new products recently released by Vibroplex. The Vibroplex Straight Key Deluxe is, by all standards, a normal hand key; however, this is the first time in nearly 100 years that Vibroplex has added a hand key to its large range of semi-autos and Iambic lines. The key comes in three models, being the Standard with a black base; the Deluxe which

has a highly polished chrome base and upper parts; and the Gold with a 24 K gold plated base with highly polished chrome upper parts.

The other new key is the Double Key combination. This consists of a straight key and Iambic paddle, or a Vibrokeyer mounted on the same base. These are two lovely keys to choose from. Both base and keys are highly polished chrome with a recommended retail price of \$US349.00 (not cheap when you convert our dollars to US!). Still, it would be nice to have one in the shack. Further enquires can be made direct to Vibroplex.

In the August 1997 issue of *Morsum Magnificat*, the official Morse magazine of Britain which covers all aspects of Morse telegraphy, past, present and future, there appeared an article which will concern collectors of telegraph instruments. Recently, a UK collector was charged import duty of 3.2% plus value added tax of 17.5% on a \$300.00 telegraph set he received from a collector in the USA. British Customs

advised the gentleman concerned that the item in question cannot be considered as a gift as he had received the set in exchange for another item. Customs considered that he had paid for the key indirectly and was therefore liable for duty.

From my own experience, items declared as gifts and under \$50.00 are free from such charges, but additional charges are payable if the value of the item is greater than \$50.00. Just be careful how you fill in your Customs Declaration Form or you can be up for a large sum of money.

If you are not already a subscriber to *Morsum Magnificat*, I highly recommend it to readers who are interested in telegraphic items, as it contains so many interesting articles and photographs.

Next month in this column, a look at Australian hand keys as used by past operators. In the following issues will appear CW Contests; Zero Beat, what does it all mean?; and Sitting for your Morse exam.

Until then, a very happy Christmas and a safe and happy New Year to all readers of this column.

\*PO Box 361, Mona Vale NSW 2103

ar

---

---

# Technical Correspondence

All technical correspondence from members will be considered for publication, but should be less than 300 words.

---

---

## T Plugs

In respect of your editorial in the November 1997 issue of *Amateur Radio*, I wish to point out a glaring error. In NSW, at least, there is a standard for those "T" connectors as used by all emergency services (and naturally WICEN NSW). **THE TOP OF THE TEE IS POSITIVE!** The mnemonic is that the vertical bar looks like an earth pin.

I could say that Australia is still a collection of autonomous states; but I won't...

David Horsfall VK2KFU  
President WICEN (NSW) Inc  
PO Box 257  
Wahroonga NSW 2076

## More on T plugs

I noted your editorial comment on the polarity of the so-called T plugs. There is, in fact, no official standard, and two "Clayton's" standards. The WICEN standard you referred to - negative to the top of the T - applies only in Victoria, and NSW uses the opposite. I do not know what is done in other states.

The polarity used in Victoria was

established by government and commercial users of radios. I am told that it was based on the idea that the top of the T resembled a minus sign, while the vertical arm of the T represented the vertical part of the plus sign. All of the surplus radios such as Vintens which made their way into amateur hands were fitted with plugs wired in this way, so this became the unofficial standard in Victoria for both WICEN and amateurs in general.

The practice in NSW was the opposite. They decided to use the vertical pin of the T as the negative pin, by analogy with the earth pin on 240 V AC plugs. This is just as logical an idea as the practice in Victoria. In fact, it probably goes one better because it is also consistent with an international guideline

used by electrical authorities, that if the connector has a RADIAL PIN, ie parallel with a line from the centre to the circumference of the plug, it is the one which should be used for the earth.

It seems unlikely that there will ever be an agreed standard which is the same in all states. But, in the lack of a standard, there is one thing we could standardise on: always buy plugs with transparent tops. That makes it easier to see which way they are wired!

John Martin VK3KWA  
Chairman FTAC  
PO Box 2175  
Caulfield Junction VIC 3161  
ar

**Are you reading someone else's  
Amateur Radio? Call 03 9528 5962  
to find out how to get it every month!**

# VHF/UHF – An Expanding World

Eric Jamieson VK5LP\*

All times are UTC.

## Change of Fax Number

Please note that my fax number has changed to 08 8575 1777 as of now. My e-mail address was missing from my last notes, but be assured it still exists as [vk5lp@ozemail.com.au](mailto:vk5lp@ozemail.com.au) and will continue to do so until otherwise noted. With this issue I commence my 29th year of writing these notes.

## Two Metres to New Zealand

Gordon McDonald VK2ZAB sent me a fax to say that he had received an NZART VHF Century Club Award, Certificate 160, for VHF contacts with more than 100 New Zealand stations. All were made using SSB. Gordon believes he may be the first VK station to achieve this feat, with all contacts in excess of 2000 km. Congratulations Gordon. I suspect that world-wide there would not be many amateurs, if any, to have made hundreds of contacts on two metres at distances in excess of 2000 km.

However, it is ironical that the significance of this achievement appears to be lost on the NZART Awards Manager, who did not note in a letter or on the award that it was for two metres. The usual VHF Century Club Award is to collect 100 points by scoring one point for contacts on six metres, three points for two metres and five points for 70 cm. This claim was for 100 contacts on two metres, not 100 points. Hopefully, the necessary endorsement can be made in the near future.

Gordon has sent me a list of 108 first contacts, each to a different station and dating from 26/01/81 to 22/01/97. All the listed contacts were made between November and February inclusive. The list shows the first contact with each station, but during the period noted hundreds of two metre contacts were made with the ZLs, and in some cases three and four contacts with the same station each season over the entire period. The contacts were spread over 18 or 19 locator squares.

Gordon said it is now almost impossible to obtain a QSL card for any contacts, even those which break a record. In 1980 the QSL rate was around 30 per cent, now virtually zero.

Gordon has also made contacts with ZL on 70 cm and 23 cm. The VK2 record for 70 cm is for a contact between VK2ZAB and ZL1AKW in 1988. A new VK2 record for 23 cm was established in January 1997 between VK2ZAB and ZL1AVZ.

## ZL News Update

30/9/97: "With the installation of a TV translator near Auckland, operating on New Zealand Channel 1 (44-51 MHz), amateurs in Auckland were notified by letter on 28 June 1997 that they were to cease operation on the 50.0-50.15 MHz band.

"Previously the NZART had received assurances from the local broadcaster that they wouldn't take up the use of Ch 1 in Auckland. ZLs have to get approval to use 6 m from the Ministry of Commerce Communications Division; it seems that some amateurs in the Auckland area may gain access to the 6 m band on a non-interference basis, following the submission of new permit applications and testing and approval by the authorities. They still have 51-53 MHz as secondary users." Information from G3FPK.

## Antarctica

Roman EM1KA, will be QRV from the Ukrainian research base at Vernadsky for another year. There is the possibility of some 6 metre operation from there. He is regularly QRV on 1827 kHz at 0400. QSL via JA2JPA.

## Six Metres is Not Dead

Don Graham VK6HK reports: "Some stirrings on 48-49 MHz here on Monday, 13 October, with video on 48249.8, 48250.3, 48251.0, 49751.03, 49749.96, 49749.7, 49750.24 and 49751.35 kHz. Bearing generally about 350 degrees. TV video carriers up to S7 but mostly S1-2, with each frequency exchanging prominence during the period. No signals on 50 MHz."

The following is an overview of six metre activity for late September and for October, practically all being by TEP mode:

27/9: 1120 JA3EGE heard VK8VF/b 50.056  
27/9: 1140 JH6VXP to VK8PN 50.110 579  
28/9: 0840 JH6WV to VK4AFL 50.110 319  
29/9: 0658 JA1RJU to VK8RH 50.110 5x9  
29/9: 0400 VK3OT heard JA7ZMA/b 599  
29/9: 0530 VK3OT 49.7498 warbly offset  
29/9: 0626 V73AT to JA1RJU 50.110 5x9  
29/9: 0640 VK4GPS Asian video 49.750 to S9  
29/9: 0730 VK3OT heard JA2IGY/b 50.0097 539  
29/9: 1044 JH4JPO heard VK8VF/b 589  
29/9: 1117 JH4JPO to VK8AN 50.110 5x3  
29/9: 1230 JA6QGG to VK8MS 50.110 5x5-9  
29/9: 1243 VR2IL to VK8MS 50.130 5x1  
30/9: 2055 LU9EO worked four KP4 stations 5x9  
30/9: 2100 WP4O heard by LU1DMA on 144 MHz  
1/10: 1115 JH4JPO heard VK8VF 50.056 599  
1/10: 1810 GJ4ICD heard by 7Q7RM  
2/10: 1246 VR2IL to VK8RH 50.110 5x9

2/10: 1300 VR2IL to VK8AN 50.120 5x5  
3/10: 2235 CO2KK to HH7PV 50.130 5x9  
3/10: 2258 AC4TO to CX, LU, HH 50.110 5x9  
4/10: 2300 WP4O to LU, CX, PY 5x9  
4/10: 0515 VK4DO and VK4TL 50.120 heard by JA3EGE  
5/10: 0435 VK4AFL to JR2NET 50.140 5x5  
5/10: 0436 JE9BHE to VK4AFL 50.140  
5/10: 0440 JA1RJU to VK4AFL 50.140  
5/10: 0442 JA1RJU to VK4DO 50.120  
5/10: 0451 JA1RJU to VK4LE 50.139  
5/10: 0530 UA0-TV 49.750 to VK3OT  
5/10: 0750 N7ET/DU7 to JR1LZK 50.085 559  
6/10: 2350 WP4O to PY5CC 50.110 5x6  
8/10: 0445 VK3OT UA0-TV 49.750 multi video  
8/10: 0610 VK3OT heard JA7ZMA/b 50.027  
8/10: 0625 VK3OT 49.752 +/- video  
8/10: 0701 V73AT to JA6YBR 50.110  
8/10: 1800 ISMXX heard by K3RRE and K1DT 50.105  
8/10: 2210 W4PO to LU and CX 5x9  
9/10: 2310 W4PO to LU 5x9 and PY5CC 5x1 50.110  
11/10: 2237 PY5CC to EH8BPX 50.110 5x5  
11/10: 2345 PY2DSC to TI5KD 50.110 5x5  
12/10: 0132 V73AT to KH6JOI 50.110  
12/10: 0415 V73AT heard JA2IGY/b, JA6YBR/b  
13/10: WP4O worked many LU and CX3ET  
13/10: GJ4ICD to EH9/IS5/IS0/SP/YU 5x9 Es  
13/10: 1230 GJ4ICD copied 5B4CY multi-hop Es  
13/10: 1656 Italy worked A22BW TEP  
13/10: PPSJ5-D to TI4JHQ, HP3XUG, V44KA, 8P6ER, KP4KIA, KP4JN.  
13/10: 2256-2350 PY to KP4, J3, WP4, PR7 2340 PY5CC worked 8P6 on 144 MHz  
14/10: 0012-0107 PY to T14, T15, ZP5, EH8  
14/10: 0102 PY5CC worked JR6HI 50.110 5x9\*  
14/10: 0330-0410 V73AT worked many JAs  
14/10: 0339 V73AT 50.110 heard by JA1RJU 599  
14/10: 0345 V73AT 50.110 heard by JH0MHE  
14/10: 0420 V73AT heard first VK video 46.17165  
15/10: 1600 TR8CA to GJ4ICD, GJ/CT/F 5x9  
15/10: LU2EGQ copied XE and YV beacons  
16/10: 2343 PY2NQ, PY5CC to WP4O 50.110 5x9  
17/10: 2150 PP1BG to CT3FT, EH8BPX, 5x9  
18/10: PY5CC worked CTIAL, CTIHB, EH1YV, first PY to Europe  
18/10: 1530 V51KC, 1725 TR8 – into Europe  
18/10: 1600 V51VHF/b heard by SM7AED  
18/10: 2300 GJ4ICD to PY5CC  
19/10: 0604 VK2QF 50.110 worked JH6VXP 559  
19/10: 2218 PY5CC to EH7, CT4; 2312 KP4, V44, 8P9HA  
2344 PY5CC to 8P6HA, 8P6ER on 144 5x1  
20/10: 0038 PP1CZ to 8P9HA, YV4DYJ, HP1XUG 5x5  
20/10: 0300 to 0700 VK5LP heard UA/BY TV 49.750 +/-  
20/10: 0620 VK3OT heard VK8RAS/b, Russian TV 5x9  
20/10: 0629 VK3OT heard JA7ZMA/b  
20/10: 0620 VK3OT heard UA0 TV 49.750 +/- strong  
20/10: 0635 VK3OT worked VK8GF 50.115  
20/10: 1700 TR8CA to GJ4ICD 5x9, also ON/PA/F  
20/10: 2120 WP4O to LU and CX9DX  
21/10: 0020 WP4O to CX, LU 5x9  
21/10: 0511 V73AT VK video again on 46.17165  
21/10: 0519 V73AT to JA1ZYK 50.110  
22/10: 1520 IK0 to V51KC  
22/10: 2150 PP1CZ and PP1BG to D44BC 50.110

23/10: 0419 VK4AFL to JA1RJU 50.140 5x6  
 23/10: 0620 JA6IMJ to VK4DO 50.110 5x9  
 23/10: 0644 JA1RJU to VK4WTN 50.110 5S9  
 23/10: 0647 JA3EGE to VK4DO 50.120, VK4 video S9  
 23/10: 0810 JA3EGE to VK4BRG 50.110 5x4  
 23/10: 0824 VK4BRG to JA3EGE  
 23/10: 0830 JA3EGE to HL1LTC 50.110 5x9  
 23/10: 1008 VK4TL to JE1BMJ 5x5  
 24/10: 0221 HL1LTC to JA1RJU 50.110  
 24/10: 0426 VK4BRG to JA1RJU 50.110  
 24/10: 9G1BJ (Ghana) worked by many I stations 5x9  
 26/10: 0009 ZP6CW to T15KD, YV4DYJ, T14JHQ, HP3XUG  
 26/10: 0428 JA3EGE reported VK video on 46.170  
 27/10: 1000-1400 G/GJ to IYU/EA/CT/S5 by Es  
 27/10: 2149 EH7KW heard ZD8VHF/b  
 28/10: 0005 PY5CC to K5LLL 50.100 579  
 28/10: 0039 LU8EWD to W5 and W6 50.130 5x7  
 29/10: 0254 JA1RJU to VK4APG 50.180 5x9  
 29/10: 0257 JL4GTO to VK4ZX 50.120 5x9  
 29/10: 0259 JL4GTO to VK4APG 50.110  
 29/10: 0255 JA1RJU to VK4AFL 50.150 5x9  
 29/10: 0300 VK3OT UA0/BY-TV 49.750 +/- TV offsets  
 29/10: 0305 JA1RJU to VK4DO 50.125 5x9  
 29/10: 0314 JL4GTO to VK4BRG 50.135 5x9  
 29/10: 0315 JA1RJU to VK4BRG 50.110 5x5  
 29/10: 0352 JL4GTO to VK4AFL 50.150 5x5  
 29/10: 2246 EA7KW heard ZD8VHF/b 539  
 30/10: 2237 PY2PA to T14JHQ  
 30/10: 2314 PY5CC KH6HI/b 579 \*\*, 2317 KP4UK 5x9

30/10: 2337 PY5DP KH6HI/b 579 \*\*  
 30/10: 2353 PY5CC to NH6YK 50.110

*\*JA to PY JMISZY received an e-mail from Peter PY5CC which said: "Yes, I worked Kenji JR6HI (Okinawa) at 0101 on 14/10 on 50.110. Signals 5x9. It was a nice surprise. No other JA or Pacific stations. Many stations from Central America and Caribbean areas."*

*\*\* These are interesting reports of KH6HI/b, as it seems too early for Southern Hemisphere Es. No other reports of such east-west propagation.*

Thanks to Six News, OH2BUA Web Cluster and VK3OT for the above table of more than 100 events. I have given rather full coverage to these openings this month to indicate that six metres is far from dead, particularly in the Northern Hemisphere, where there have been TEP openings almost on a daily basis. It seems few JA stations are presently operating on six metres and not many VKs either.

Here at VK5LP I noted video carriers around 49.750 MHz on at least 20 days during October. The one most received was on 49.7493 at a bearing of 335 degrees which is the direction of China and eastern Russia, strength usually around S2 but reaching S8 on 13/10. Generally there by 0400, but heard

as early as 0300 and continuing until about 0600/0700.

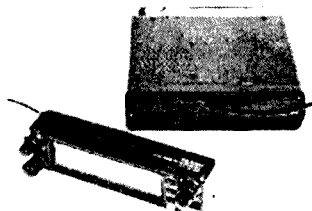
Such signals are being noted in VK2, 3, 4, 6 and 8. This is similar to the 1987/88 period when most of us did not realise the significance of the reception of such signals which led to F2 openings to Europe and the UK, also to the US, in 1989, and continuing for four years.

I would suggest that six metres should be given particular attention during the next equinox (March/April) and most certainly next September/October when it seems the possibility exists of bridging the distance to Europe in the evenings and to the US, Central America and the Caribbean in the mornings. By 1999 the openings to EU/UK will probably spread out over a longer period than the equinox, with November being important.

### News from China

Alan VK3XPD sent the following, called "BY1QH Special", which was contributed by Lars Melin SM0KAK, a member of the Tsinghua University Amateur Radio Club, Beijing, China.

BY1QH, the club station, is presently looking for stations who want to try 144 MHz DX, and are located less than 2,000 km from



# Radio and Communications

INCORPORATING AMATEUR RADIO ACTION AND CB ACTION

Published by  
**ACP ACTION**,  
 PO Box 119,  
 Oakleigh,  
 Victoria 3166  
 (03) 9567 4200

Crumbs, yet another new Yaesu VHF/UHF mobile transceiver! This time it's the FT-8100R — and it's easily the best dual-band mobile the company has produced thus far. What makes it different and better? Read our review to find out. We also investigate the most successful ever domestic marriage between computer and radio, this time from Icom.

December's R&C is jam-packed with great features for amateur radio operators. Here are just a few of them...

- REVIEW: MFJ-259 SWR Analyser and antenna resistance checker. A great aid to fixing crook antennas!
- OPINION PIECES: Two of them, from widely-different backgrounds. Where is amateur radio heading?
- SPECTRUM ANARCHY!! Our precious amateur bands are awash with pirates. Let's help stamp 'em out.
- MACQUARIE ISLAND: Tom Stokes, VKØTS, spent a year operating from a true wilderness. He reports...
- THEY DID IT WITH MIRRORS. A fascinating historical account of detecting enemy aircraft, Don't miss it!
- As usual, we have our three DX columns, mods and more... the best stories and regulars every month!

Don't miss out — **RADIO and COMMUNICATIONS** is great reading for amateurs!  
**Check your local newsagent today!**

(PS. We also have the biggest collection of radio-oriented Classified adverts in the country. There's lots of them because they work so well. Ask your newsagent to keep a copy for you each month, or ring 1800 25 2515 for subscription details. Hurry — you might miss something!)

Beijing in such DXCCs as BY, BV, VS, HL, JT, UA, and, in particular, VK6 (less than 400 km from Dampier). The Dampier area is the only location to which it would be possible to make QSOs on 144 MHz using Trans-Equatorial Propagation. Stations interested in working with BY1QH on 144 MHz need at least one Yagi (preferably horizontally or circularly polarised), the capability to work on SSB or CW, a good take-off (low horizon) in the direction of Beijing, and a minimum output power of 50 watts.

In the first leg of the ARRL EME Contest on the weekend of 18-19/10, BY1QH worked SM5FRH, SM5BSZ and SM2CEW. The QSO with SM5FRH was the first EME QSO ever from China. BY1QH also heard and identified 11 more stations during the contest. On the weekend of 25-26/10, BY1QH worked KB8RQ (first BY to North America on EME), and W5UN. Also heard was VE7BQH.

BY1QH will participate in the second leg of the ARRL EME Contest on 15-16/11. Antenna improvement is becoming urgent as it is not yet wind-proof. In addition, the club is requesting China Radio Sports Association (CRSA) to clear the much QRMed 144.000 MHz, caused by a local paging system.

Tsinghua University Amateur Radio Club is seeking any possible assistance from the international amateur radio community, such as on EME. Write to David Zhang BZ1BM at [bz1bm@wg.chnmail.com](mailto:bz1bm@wg.chnmail.com) or Lars Melin SM0KAK [lars.melin@era.ericsson.se](mailto:lars.melin@era.ericsson.se).

## Something New

This is surely a rarity. Alan Devlin VK3XPD saw the following on the Internet and thought it may interest readers of *Amateur Radio*, adding: "Some of our US cousins have a lot to learn, and the spelling is appalling too. One learns something new every day - I can't wait to try it!"

The message: Subject: Modifying FM reviecers... Date: Thu, 16 Oct 1997 11:46:56 -0500 From: "Dr. Cosmo-SYS" [drkosmo@server.iso.net](mailto:drkosmo@server.iso.net) Organization: Information Superhighway Onramp Newsgroups: [rec.radio.amateurspace](mailto:rec.radio.amateurspace)

"I heard one can do this by clipping the device to the antenna and i think the negative (-) side of the battery. i want to make it recieve differnt Freq. s and maybe transmit on them too. i know about the FCC and licenseing stuff so i will keep the power down :)

"i'm new in radio stuff so please use simple terms and maybe scematics (i can read those :> )

"thank you in advance. Dr. Cosmo-SYS"

I leave you to draw your own conclusions. Thanks Alan.

## Beacons

Ian Glanville VK3AQU advises: "Further to my last e-mail regarding the closure of VK3RA1/b. [Reported in September issue.] The beacon was shut down on the 16/9 after more than 10 years of continuous service.

"I have received an e-mail from Michael VK3TDV on behalf of Ralph VK3WRE, Eastern Zone repeater officer. accepting the offer to take over the beacon and incorporate it into their plans to establish 2 metre, 70 cm and 23 cm beacons. I am very pleased that someone is taking up the offer and will put it to good use."

Rod VK4KZR reports that the VK4RTT beacon is off air. The understanding is that the Brisbane VHF Group will reinstate it soon. More later.

Ron VK3AFW reports: "The Melbourne VK3RTG beacon on 144.430 returned to air at 0425 on 13/10. It runs seven watts to a halo in an average location at Clayton. All reports appreciated. It went off due to a high voltage transient which destroyed the power supply, although the remainder of the hardware survived."

## Meteor Scatter

Ron Cook VK3AFW sent the following report from Scott VK4JSR: "On 16/10 I spent a half hour in the shack listening to 50 MHz before departing for work. The following is a summary of what I monitored." "2031 VK7RAE/b 50.057 419 5\*.

The following are for VK3SIX/b on 50.053 MHz.

2042 549 30\*

2043 519 5

2045 419 20

2046:15 319 5

2046:45 419 10

2059 419 5

2100 519 - 559 30+

2102 419 5

2103 319 15

2105 319 5

2106 519 5

\*The final column is the ping/burn duration to the nearest 5 seconds.

"The pings were not significantly stronger than normal, as I monitor the beacons each Saturday and Sunday mornings while listening on 144.2 and 432.2 MHz, but the number of pings had increased. At all times the VK3SIX beacon was detectable, sometimes just 3 dB above my imagination!

"For your information, I was using my IC-551D with 20 dB receive pre-amp, and Timewave DSP into my temporary six element Yagi, six metres AGL."

## Balloon Launch

Alan VK3XPD reported: "Saturday 18/10 at 1300. Annunciator/Packet/Slow

Scan TV - all on 145.700 MHz sequentially. Repeater 432.975 input, 145.375 output.

"Unfortunately - "the powers that be" have limited the payload to just 1 kg therefore transmit power is a low 100 milliwatts for the Annunciator and 1 W when transmitting packet. That's all I have."

Alan also reports that the Sputnik 1/3 scale, PS-2, will be RS-17 when released, according to the sponsor's web page. Listen on 145.82 FM (145.80-145.85 for Doppler?). Date of release has again been pushed back to 3 November, during the next EVA (space walk) from MIR.

## Tropo Report

Ron VK3AFW advises that on 6/10 good conditions allowed Rod VK2TWR to work Andrew VK7XR at 1205 on two metres at 5x5. The beacon VK7RAE was 529.

Also on 6/10, at 2100, Andrew VK7XR worked Ron VK3AFW 5x9 both ways on 144.08 MHz SSB, and 5x1 both ways on 432.1 MHz SSB at 2116. Andrew was able to access many two metre repeaters along the southern part of VK3. Unfortunately, there were no other stations around to take part in these excellent conditions.

## Repeater Update

Steve VK2KFJ provides the latest information regarding six metre repeaters in VK2:

VK2RMB Sydney (Northern Beaches), 53.675 working, local activity has increased, waiting for summer DX. VK2RSN Newcastle, 53.625 working. VK2RWI Sydney (north-west), 53.850 - nearing completion, could be on air in December. VK2RTM Walcha, 53.575 - should have been on air by middle of '97, status not confirmed yet. Licence and equipment taken over by Walcha Radio Club.

## Afternoon TEP and Es Linked Up

Steve VK3OT reports: "Following the 46.240 TV report by JA1VOK of VK2QF working JH6VXP yesterday (19 October) I carefully watched the band today.

"At 0600, like clockwork, the various 49 MHz TV stations from Russia and China appeared and built up over the next 30 minutes. The difference today was that the path was skewed North West and on investigating a QSB carrier on 50.047 I heard the VK8RAS beacon keying from PG66 Alice Springs over a short Es path of 1750 km. Also noted were strong 49 TV offsets, one running raspy video with what looked like a digital test pattern on the ICR7000.

"I QSOed Jeff VK8GF on 50.115 at 0640 on SSB, both running about 80 watts and 5x5 signals.

"The new JA7ZMA beacon came in after

the VK8 beacon faded out, which is the normal extension mode as the hole into PG66 closes, and the path extends via TE afternoon mode. The beacon has three call sign sequences then FUKUSHIMA then QM07 (the grid) and a Dit Dah (I am unsure of the significance of this). Frequency is 50.027 MHz dead and best report was at 0625 519 to 539 with fast QSB.

"The TV shifted to 300 degrees and I heard Vladivostok in grid square PN briefly on 49.7499 with pronounced signature and the JA2IGY beacon 50.010 audible using DSP only at 509. I alerted VKSLP who was also copying multiple TV offsets around 49 MHz and the VK8RAS beacon."

### Portable Operation

Barry VK3TBM operated portable from Mt Tassie on 13/9. On two metres only (20 W into 5 el Yagi) he worked at 2233 VK2TWR 5x5; 2237 VK3BWT 5x3; 2242 VK3DEM 5x9; 2245 VK1BG 5x1; 2247 VK2ZAB 5x1; 2249 VK2BBF 5x2; 2252 VK1BG 5x3; 2254 VK1DO 5x2.

He returned to Mt Tassie on 27/9, but this time with 2 m and 70 cm. He had two new antennas, a recently completed 10 el DL6WU Yagi for two metres, and a 15 el DL6WU for 70 cm. This was the first opportunity to test the antennas and both worked well.

The "on air" start at 2255 meant he had missed many possible contacts but stayed on site till 2345, and managed to work (on 2 m) VK3HY 5x9, VK3DEM 5x9, VK3WRE (Ralph, Traralgon) 5x9, and VK3ZQV (Michael, Blackwarry) 5x9.

On the weekend of 11/12 October, with a camp-out in the State Forest south of Vaughn Springs in central Victoria, he had more time, so he took two 10 el DL6WUs for 2 m for a trial run together.

"I was on air at 0230 on 12/10, and listened and called till 2330 (admittedly stopping to sleep during the night). However, our favourite campsite is not well elevated; in fact, the surrounding ridges seemed to provide excellent protection from all forms of harmful RF. I heard not a cracker. I got

occasional short noises from the Mt Anakie beacon, and that was as good as it got.

"However, on the drive out I found I could easily receive the Mt Anakie beacon on the halo from a nearby ridge. While mobile, on the way home, I was fortunate to work Des VK3CY from Mt Franklin (5x9); and Alan VK3XPD while passing Gisborne. Thus, I was able to prove to my companions that my radio did, in fact, work and was more than a mere white noise generator with a fancy dial."

On 18/10, Barry went portable near the summit of Mt Hoogly, 10 km west of Mt Tassie. Using a single 10 el DL6WU on two metres, he worked: 2245 Norm VK3DUT Lakes Entrance 5x9; 2249 VK1BG 5x3; 2254 VK2ZAB 5x1; 2300 VK1DO 5x2; 2305 VK3AUU 5x9; 2325 VK3KLO 5x7; 2332 Len VK3BMY Numurkah 4-5x1; 2336 VK3DUQ/p Dromana 5x9; 2345 David VK3XDR Hallam 5x9; and 2348 Les VK3ZLS Point Lonsdale 5x5. The site wasn't ideal as his low mast was unable to clear the low eucalyptus re-growth to the north and north-east, and a pine plantation 200 m to the west affected signals to Melbourne and beyond, especially since they were wet from the drizzle that morning.

### Closure

October was certainly an interesting month. The many days of video signals around 49.750 +/- from about 335 degrees is worth noting and augers well for more TEP during March/April 1998. Our cousins in the Northern Hemisphere have certainly been given a treat with so many openings across the equator. If you want to live in a prime TEP location, then try Brazil or Puerto Rico.

Closing with two thoughts for the month:

1. A person can be so well-rounded that he isn't pointed in any direction; and
2. If mankind profits from mistakes, what a wonderful future is coming up!

73 from *The Voice by the Lake*

\*PO Box 169, Meningie SA 5264

Fax: 08 8575 1777

Packet: VK5LP@VKSWI.#ADL.#SA.AUS.OC

E-mail: vk5lp@ozemail.com.au

ar

ICOM Clearly Ahead



"VK3LZ calling!"

More sound information from your friends at Icom.

### IC-PCR 1000 CREATING HUGE INTEREST

Icom's innovative new unit is creating a stir!

Enquiries are coming from the radio types who are looking for something new, to the new technology crowd who want to expand their PC's capabilities. Lots of enthusiasts want to tune into the world via their PC, so if you are interested in this amazing unit be sure to enquire sooner rather than later as demand is strong.

### WE'LL KEEP YOU POSTED

Those in the know say that '98 promises to be a vintage year for ham fests and special events. They are growing in popularity year after year and even more will be scheduled in 1998. Keep track of all the dates you need to mark down in your diary via our column!

### COMPLIMENTS OF THE SEASON

Sincere good wishes for the coming festive season. Everyone at Icom appreciates the loyalty you give us, and we look forward to bringing you lots of innovative new products next year. Enjoy the holidays and stay safe!

"...73"

FreeCall 1800 338 915

290 -294 Albert Street  
Brunswick, Victoria 3056

Tel : (03) 9387 0666

Fax : (03) 9387 0022

ACN 006 092 575

LL BROWN ADVERTISING 6141

**Help stamp out stolen equipment - keep a record of all your equipment serial numbers in a safe place**

## BOOK REVIEW

# How Radio Signals Work

**Publisher:** McGraw Hill Australia  
**Author:** Jim Sinclair  
**Reviewed by:** Bill Rice VK3ABP  
**ISBN** 0 07 470329 3

**A** *Amateur Radio* received this book for review from McGraw Hill several months ago, and I apologise to the author and the publishers for having taken so long to look at it. I chose to review this book myself, rather than hand it over to another who may have read it sooner, because I had, on a number of occasions, met the author and I was interested to see "what he was on about"! Some decades ago he was VK5ZSJ, and later VK8ZSJ. I was a little disappointed to find that he seems to have no current licence. His former calls have belonged to others for some years.

The book begins at a very elementary level because it is intended to be intelligible to readers who have no prior knowledge of radio or propagation at all.

Having created a basic framework by use of simple analogies, it then builds on this structure, achieving eventually a coherent survey of essential theory with an absolute minimum of mathematics. It would be an ideal beginner's text for

students aiming at radio theory to amateur licence standard. It also has an excellent 18 page glossary of technical terms, the definitions therein being both precise and concise.

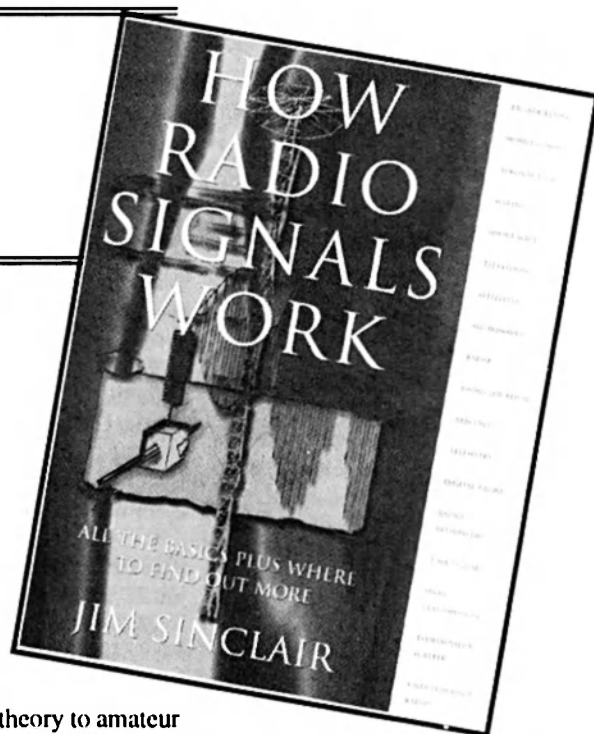
There is considerable material on propagation, but perhaps more regarding near-ground transmission paths on VHF and UHF than ionospheric propagation at HF. In this the book reflects the author's

professional experience with Telstra and its predecessors, installing TV and radio-telephone systems over outback Australia.

In conclusion, it is an excellent elementary textbook and should be available to all students beginning to learn about radio.

The recommended retail price is \$39.95.

ar



## WIA News

### New WIA Members

The WIA bids a warm welcome to the following new members who were entered into the WIA Membership Register during the month of October 1997:

L10172	MR E D ALCOTT
L21063	MR G H ARRELL
L30965	MR S B KELLY
L30966	MR M J RUDLING
L60390	MR W J HARDMAN
L60391	MR D MCLOUGHLIN
OE3WHC	PROF W HARRANTH
VK1AY	MR Y SATO
VK2AKW	MS J M KEY
VK2DA	MR M J HARDY
VK2FDX	MR C HALL
VK2FLB	MR E MILES
VK2HVS	MR B P VANDERSANDE
VK2KVH	MR V HEE
VK2TMV	MR D J BROZICEVIC
VK2VIM	MR I G MACGREGOR

VK3MRG	MR M GEORGE
VK3OC	MR J COWAN
VK3WE	MR F PAVIC
VK3XGL	MR G J LEEDER
VK3ZG	MR G CAMPBELL
VK5ZKS	MR S LIDDEN
VK6VU	MR W N NEWHAM
VK7MGW	MR R W MCCULLOCH

### Beijing Hams Crack First Two Metre Moonbounce QSOs

After many months of work, set back by equipment thefts and breakdowns, BY1QH, the club station of the Tsinghua University in Beijing, finally confirmed three, 144 MHz Earth-Moon-Earth QSOs over the night of 18-19 October with SM5FRH, SM5BSZ and SM2ECW, in Sweden. They subsequently worked KB8RQ and

W5UN, the following weekend. The contact with SM5FRH was the first EME QSO from the People's Republic of China.

BY1QH runs 200 watts output to a bay of four, nine-element Yagis. Club president David Zhang BZ1BM said the University club received a lot of technical help from Lars Melin SM0KAK, who is presently working in Beijing. The station has to battle pagers in Beijing which operate close to the 144 MHz band edge.

They are also looking to try 2 m trans-equatorial propagation (TEP) into the north-west coast of Western Australia and schedules are being established with at least one operator there.

[Released 3/11/97, updated 11/11/97]



# WICEN NEWS

David Horsfall VK2KFU\*

Here is the second of what is hoped to be a regular column about WICEN activities; as promised, unless I receive input from other Divisions then all you're going to read about is NSW news, and I can keep that up indefinitely...

## "T" Connectors

I would like to take this opportunity to clarify a point made in the editorial in November *Amateur Radio* magazine, referring to the polarity of "T" connectors. Whilst it is true that Victoria chose a particular approach, the simple fact is that there is no national standard for this connector (which is why I personally will not use them). The various emergency authorities in NSW (and presumably ACT) decided to go a particular way, and so WICEN (NSW) had no choice but to follow them, resulting in the horizontal pin being POSITIVE; the mnemonic is that the vertical pin looks like an earth pin. The best thing to do, especially for cross-border operations, would be to assume nothing, and to carry a multimeter and a polarity-changer.

## WICEN Events

The post-AGM "silly season" in NSW, where there was an exercise just about every weekend, has come to a close, so this would be a good time to describe some of the more unusual events in which WICEN (NSW) participates; what do other States do?

The weekend of the full moon towards the end of October (like Easter, it's a true "movable feast", leading to occasional conflicts with JOTA also held around that time) sees the annual **Hawkesbury Classic Paddle**, in which canoes of all shapes and sizes are paddled down the Hawkesbury River under the light of the moon; the paddlers themselves are otherwise thought to be quite sane. Naturally, their safety is paramount, and to this end WICEN deploys an extensive voice and data network, for safety communications and "due soon" messages.

Of interest is that, due to the terrain, traditional communications over the length of the course is not possible, so heavy use is made of linked repeaters (both fixed and portable). The idea is that a failure anywhere in the system will not affect the entire event, and communications into adjacent checkpoints would still be possible via simplex. To gain an idea of the importance of safety, just about every year we have a hypothermia case or two (this time it required

a helicopter evacuation), and in one year there was a drowning (thankfully not a canoeist). The participants also have to watch out for ferry cables suddenly rising out of the water (they're hard to see at night); and sadly, some idiots seem to think it's funny to throw rocks at the canoes...

Another interesting event is the annual **Bungonia Caves Rescue**, in which during a weekend various squads such as the SES, Police Rescue, VRA, etc are trained in the finer points of extracting people from caves, under the auspices of the NSW Cave Rescue Squad (who incidentally were prominent at the Thredbo disaster, and the Newcastle Earthquake).

Due to the potentially hazardous nature of these exercises (hardly a year goes by without an "authentic") again the safety of the participants is paramount, and WICEN provides a message facility, both voice and data, from the caves back to camp. This is an important exercise, as it stresses formal message-passing under realistic conditions. Notwithstanding the gravity of the event, there is still plenty of scope for experimentation, and use was made of the DVR system (Disaster Victim Registration,

used at Thredbo under WICEN supervision!) in the Sydney Police Centre, and also underground radio communications using the single-wire earth-return "Michiephone" telephone as a feedline to the surface.

## Are You Ready?

Speaking of the festive season, this is supposed to be a quiet time for WICEN (in NSW at least), but major disasters – earthquakes, floods, fires, storms; all the elementals in fact – seem to happen around now, so please keep your batteries charged and your equipment in full working order, ready for that sudden activation. How are the gas bottles for your camping stove? Do you have "long life" food and water ready to hand? What about that dodgy microphone connector you've been meaning to fix for ages? Are you ready?

## News for WICEN Column

Please send contributions for this column to [dave@geac.com.au](mailto:dave@geac.com.au) (is there anyone on the planet who \*doesn't\* have access to e-mail?), or alternatively via packet radio to [VK2KFU@VK2KFU](mailto:VK2KFU@VK2KFU), or snail-mail to PO Box 257, Wahroonga, NSW 2076.

If further information about WICEN (NSW) is required, please contact the acting State Co-ordinator, Alan Whitmore [VK2YYJ](mailto:VK2YYJ), on 015-097-217.

\*PO Box 257, Wahroonga NSW 2076  
Internet e-mail: [dave@geac.com.au](mailto:dave@geac.com.au)  
Packet: [VK2KFU@VK2KFU.NSW.AUS.OC](mailto:VK2KFU@VK2KFU.NSW.AUS.OC)  
ar

## WIA News

### ACA Upgrades Amateur Information on its Web Site

Information for amateur operators and prospective amateurs published by the Australian Communications Authority, was updated at the end of October and published on their Internet Web site at [www.aca.gov.au](http://www.aca.gov.au).

The four publications are:

- the "Amateur Licence Information Paper", covering licence grades, qualifications, examination exemptions, special call sign allocations and fees etc;
- "Amateur Examinations", covering the grades of Amateur Certificate of Proficiency, examination arrangements, theory and regulations qualifications, Morse qualifications, and syllabuses for the AOCP (full call), AOLCP (Limited),

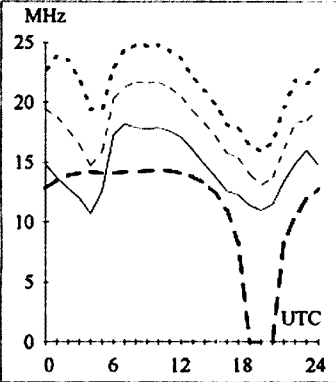
NAOCP (Novice) and NLAOCP (Novice Limited) qualifications, etc;

- "Amateur Operating Procedures", covering emission modes, interference, call sign suffixes, call-and-reply procedures, emergency procedures, the Q-code, and more; and
- "Amateurs Visiting Australia", for the information of overseas-licensed amateurs wanting to operate while visiting Australia.

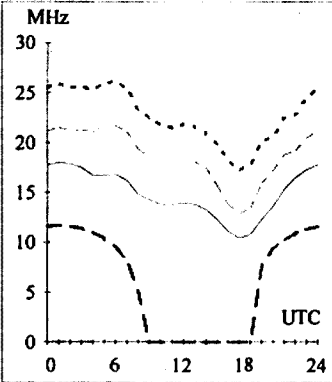
For those who don't have Internet access, copies of these papers can be obtained from the nearest ACA Area Office.

[Released 3/11/97]

**Adelaide-Accra** 242  
First F 0-5 Short 14682 km



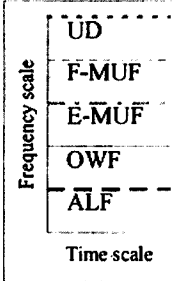
**Brisbane-Auckland** 123  
First F 7-11 Short 2289 km



# HF Predictions

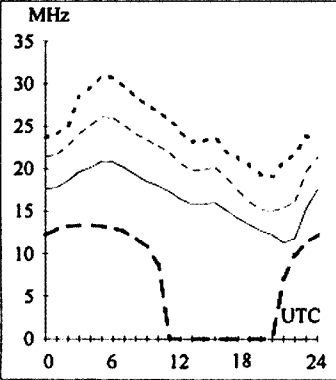
Evan Jarman VK3AN

**T Index: 41**

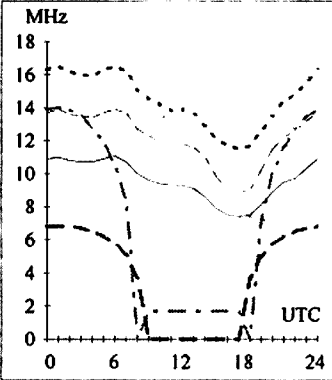


These graphs show the predicted diurnal variation of key frequencies for the nominated circuits. This also indicates a possibility of communication (percentage). The frequencies, identified in the legend, are:-  
 Upper Decile (F-layer, 10%)  
 F-layer Maximum Useable Frequency (50%)  
 E-layer Maximum Useable Frequency  
 Optimum Working Frequency (F-layer, 90%)  
 Absorption Limiting Frequency  
 The predictions were made with the Ionospheric Prediction Service program, ASAPS V3.2. The T index used is shown above the legend. The Australian terminal azimuth, path and propagation mode are also given for each circuit.

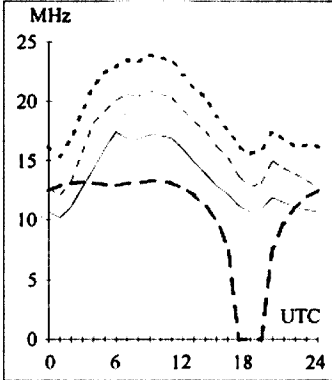
**Adelaide-Singapore** 311  
First F 4-9 Short 5414 km



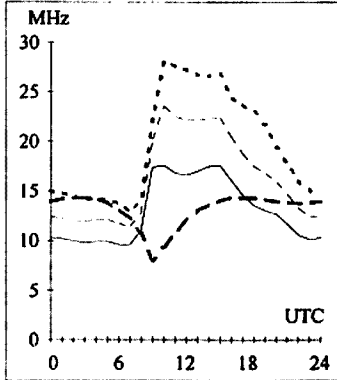
**Brisbane-Auckland** 123  
Second F 21-27 Short 2289 km



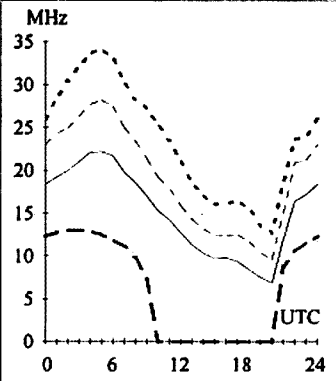
**Canberra-Pretoria** 231  
Second F 4-10 Short 10824 km



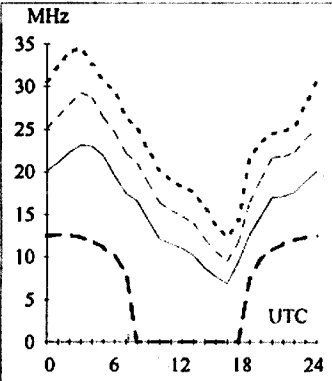
**Darwin-London** 145  
First F 0-5 Long 26170 km



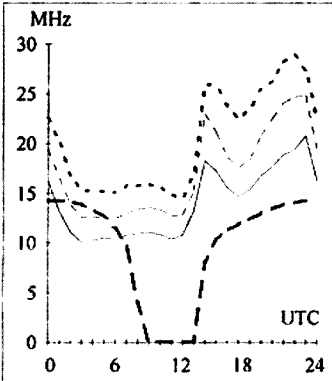
**Adelaide-Tokyo** 1  
First F 0-5 Short 7855 km



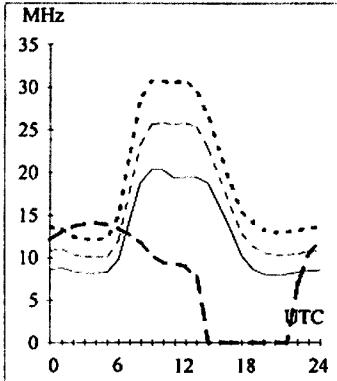
**Brisbane-Honolulu** 49  
Second F 5-10 Short 7569 km



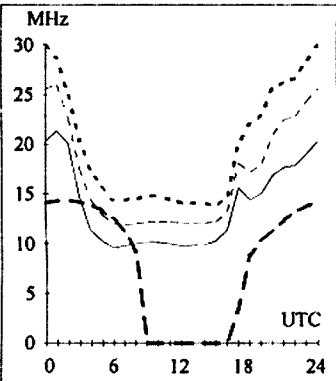
**Canberra-Washington** 70  
First F 0-5 Short 15939 km



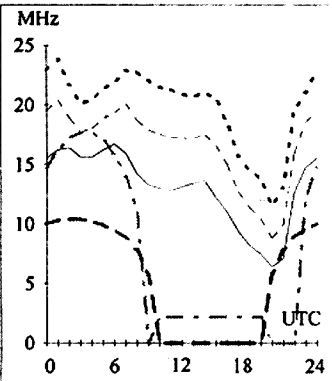
**Darwin-London** 325  
First F 0-5 Short 13854 km



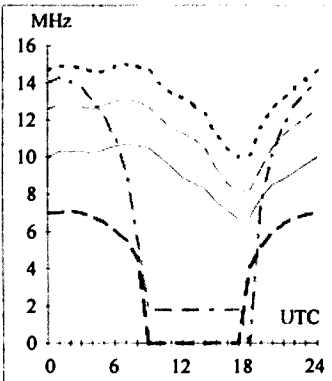
**Adelaide-Vancouver** 49  
First F 0-5 Short 13421 km



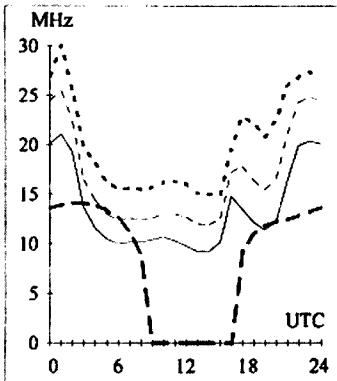
**Brisbane-Manila** 320  
Second F 9-17 Short 5813 km

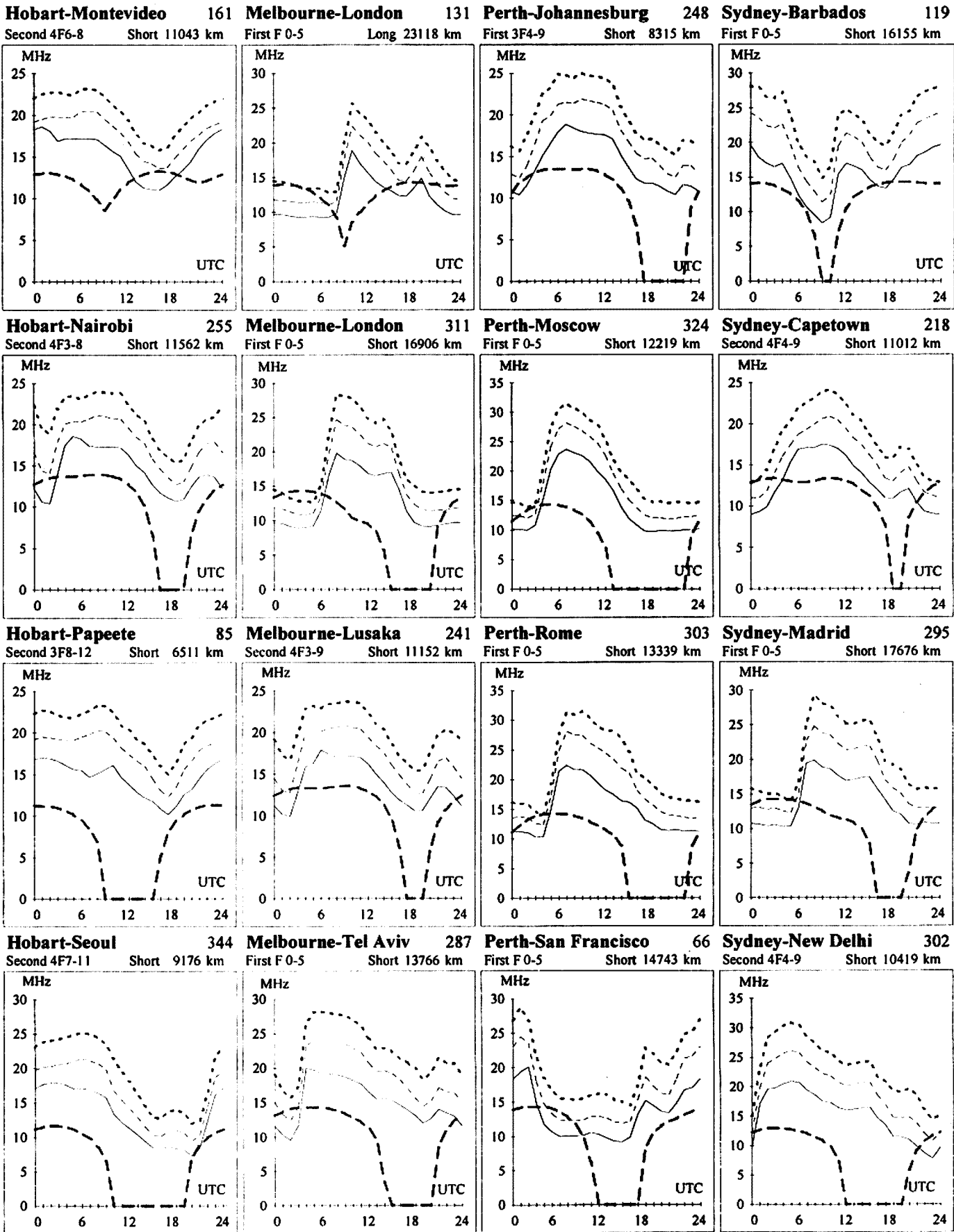


**Canberra-Wellington** 114  
Second F 20-28 Short 2325 km



**Darwin-Los Angeles** 58  
First F 0-5 Short 12693 km





# HAMADS

- Hamads may be submitted on the form on the reverse side of the *Amateur Radio* address flysheet. Please use your latest flysheet where possible.
- Please submit separate forms for **For Sale** and **Wanted** items, and be sure to include your name, address and telephone number (including STD code) if you do not use the form on the back of the *Amateur Radio* address flysheet.
- Eight lines (forty words) per issue free to all WIA members, ninth and tenth lines for name and address. Commercial rates apply for non-members.
- Deceased estates Hamads will be published in full, even if the ad is not fully radio equipment.
- WIA policy recommends that the serial number of all equipment offered for sale should be included in the Hamad.
- QTHR means the address is correct in the current WIA Call Book.
- Ordinary Hamads from members who are deemed to be in general electronics retail and wholesale distributive trades should be certified as referring only to private articles not being re-sold for merchandising purposes.
- Commercial advertising (Trade Hamads) are pre-payable at \$25.00 for four lines (twenty words), plus \$2.25 per line (or part thereof), with a minimum charge of \$25.00. Cheques are to be made out to: WIA Hamads.
- Copy should be typed or in block letters, and be received by the deadlines shown on page 1 of each issue of *Amateur Radio*, at:

Postal: 3 Tamar Court, Mentone VIC 3194  
Fax: (03) 9584 8928  
E-mail: vk3br@c031.aone.net.au

## TRADE ADS

- **AMIDON FERROMAGNETIC CORES:** For all RF applications. Send business size SASE for data/price to RJ & US Imports, PO Box 431, Kiama NSW 2533 (no enquiries at office please ... 14 Boanyo Ave Kiama). Agencies at: Webb Electronics, Albany; Assoc TV Service, Hobart; Truscotts Electronic World, Melbourne and Mildura; Alpha Tango Products, Perth; Haven Electronics, Nowra; and WIA Equipment Supplies, Adelaide.
- **WEATHER FAX programs** for IBM XT/ATs \*\*\* "RADFAXZ" \$35.00, is a high resolution short-wave weather fax, Morse and RTTY receiving program. Suitable for CGA, EGA, VGA and Hercules cards (state which). Needs SSB HF radio and RADFAX decoder. \*\*\* "SATFAX" \$45.00, is a NOAA, Meteor and GMS weather satellite picture receiving program. Needs EGA or VGA & WEATHER FAX PC card, + 137 MHz Receiver. \*\*\* "MAXISAT" \$75.00 is similar to SATFAX but needs 2 MB of expanded memory (EMS 3.6 or 4.0) and 1024 x 768 SVGA card. All programs are on 5.25" or 3.5" disks (state which) plus documentation, add \$3.00 postage. ONLY from M Delahunty, 42 Villiers St, New Farm QLD 4005. Ph 07 358 2785.
- **HAM LOG v.3.1** - Acclaimed internationally as the best IBM logging program. Review samples....AR: "Recommend it to anyone": The Canadian Amateur: "Beyond this reviewer's ability to do it justice. I cannot find anything to improve on. A breakthrough of computer technology". ARA: "Brilliant". Simple to use with full help, the professional HAM LOG is immensely popular (now in its 5th year), with many useful, superb features. Just \$59 (+ \$5 P & P), with a 90 page manual. Special 5 hour Internet offer. Demos, brochures available. Robin Gandevia VK2VN. 02 369 2008 BH, fax 02 369 3069. Internet address rhg@ozemail.com.au.
- **2 kW Antenna Tuner Kit** - includes roller inductor, 2 HV variable capacitors and turns counter, ONLY

\$US229 plus S/H. Contact Kilo-Tec, PO Box 10, Oak View, California 93022, USA.

## FOR SALE ACT

• **Yaesu FT-101ZD**, instruction manual, \$500 ONO.  
• **Hustler vertical antenna** inc 30 m resonator, \$250.  
• **Yaesu YD148** microphone. H Bromley VK1KGI, QTHR.

## FOR SALE NSW

- **HF antenna and tower:** 60 ft (18 m) three-stage wind-up tower, 3 sets of guys, turnbuckles, TH6DXX antenna, Daiwa rotator, dismantled Sydney, \$900. E G Popham VK2EZQ, QTHR, 019 460 437, 1900 - 2100 EADT.
- **Kenwood TS-430S**, FM, Y88A, access, s/n 3052300, \$900. **Yaesu FTV-707** transverter, 2 m/6 m/70 cm modules, s/n 1J020356, \$400. **Yaesu FC-707** antenna coupler, \$200. **Yaesu FC-107** antenna coupler, \$250. **FTV/FC-107** mobile bracket, \$10. **KDK FM-2016A** 2 m FM txcvr, mobile bracket, s/n 5582, \$375. All in good condn with books. Geoff VK2BGP, QTHR, 02 6743 6519.
- **Kenwood TS-940S**, approx 15 - 20 hours use, like new; brand new **SM-220** monitor and **BS-8** bandscope, new in boxes, never connected; matching **SP-940** filtered speaker; **MC-60** desk mic; all boxes and circuits, \$3250. **Icom IC-575H**, 6/10 m, 100 W, as new, \$1750. **Kenwood TS-790A** tri-band satellite txcvr, all mode, six contacts only, as brand new, \$2600. **Kenwood TS-811B** 70 cm, all mode, in excellent condn, \$1100. Two **Syntrex 2 m** mobiles, both with all NSW repeaters, 28 W, scan etc, very clean, \$250 each. **Diawa 2 m** amplifier, pre-amp, 5 W in for 90 W out, built-in fan, brand new in box, never used, mobile mount, \$450. **Kenwood TS-700SP**, all mode, 2 m, digital readout, built-in PSU, \$650. **Aron BS-635** 35 MHz double beam CRO, as new, \$350. **TECH audio generator**, \$80. **TECH signal generator**, \$80. **Dynascan USA Model E-200**, BK precision solid-state signal generator, 100 kHz - 216 MHz in seven bands, all metered etc, top

- quality generator, \$250. All items include handbooks, most with workshop manuals, original boxes. All being sold due to ill health. A Walsh VK2TBW, QTHR, 048 612 092, fax 048 611 536.
- **Icom IC-2GAT** hand-held, BP-70 battery, LC-40 carry case, wall charger, manual and circuits, boxed, mint condn, \$400 ONO. **Yaesu FV-901DM** ext VFO, excellent condn, leads, manual, original box, \$300 ONO. **Kenwood AT-230** ATU, manual, original box, very good condn, \$250. **MFJ-1700B** Tx antenna switch, boxed, excellent condn, \$95. **Icom LC-40** hand-held carry case, \$10. **KIBV DX Award Directory**, over 2240 different amateur awards, \$25. **Motrola heavy duty leather hand-held case**, \$25. Stephen VK2SPS, QTHR, 02 999 2933 (AH).
- **SCS Factor**, Amtor, **RTTY TNC** in mint condn, c/w Plusterm and MT terminal software programs, \$275 negotiable. Max VK2DT, QTHR, 02 9868 1131, fax 02 9868 4540.
- Deceased estate VK2HH, 3 el beam, 20-15-10 m, **KR400** rotator and remote controller, connecting cables, mounted on telescopic tower of pipe design, fitted with hand winch and tilting base, purchaser to dismantle, located in Cronulla, \$550 ONO. Enquiries to George VK2UN, 02 4384 2783.
- **Yaesu FL-2100B** linear amp, manual, VGC, \$1000 ONO. **Yaesu YP-150** watt meter/dummy load, VGC, \$150. **Yaesu CPU2500** 2 m txcvr, handbook, mic, VGC, \$350. **Yaesu FT-747** HF txcvr, manual, VGC, \$800. **Yaesu FV-901** scanning VFO, manual, \$200. **Yaesu 20RRH** 2 m txcvr, PA3 car adapter/charger, MH12 Spkr/Mic, unused, \$350. Peter VK2DBI, QTHR, 02 6367 5095.
- **Collectors! Collins 51J4** Rx, \$400. **Hallcrafters SX101A** Rx, \$250. 2 x **AR7** Rx, spare coils, \$150 each. **Eddystone 770R/1** 19-165 MHz, \$200. **FRG7** Rx, \$200. **Star SR200**, \$80. **Lafayette HA200**, \$100. **Trio 9R59DS**, \$80. **Bendix 221**, \$70. **Mariner 60 2-10 MHz AM** txcvr, \$50. 5 x **CB AM/SSB**, \$50 each. **Quad hub**, \$40. Receivers with documentation. Carl VK2TP, QTHR, 02 6845 1999 (BH), 02 6846 7530 (AH) fax 02 6845 1435.
- **Yaesu FT-209RH** 2 m txcvr, case, VGC, s/n 180658, battery replaced recently, \$250 ONO. Peter VK2BPO, 02 9713 1491 (AH).
- **Yaesu FR101** general coverage receiver with 6 and 2 m converters, handbook, \$450. **Tono 9000**, handbook, \$100. **8:1 balun**, 2 kW, in-built lightning arrestors, weather-proof enclosure, \$40. **HTX100** 10 m SSB txcvr, \$150. Ray VK2FW, 063 653 410.
- **Yaesu FT-107M** with DMS, s/n 0J080220, \$650. **Yaesu FC-107** ATU, s/n 0J050339, \$150. **YM-38** desk mic, \$60. **Yaesu SP-107** speaker, \$70. **Kenwood SP-180** speaker, \$65. **DMP-200** printer, dual interface, ideal for RTTY/Pac, \$100 ONO. All in absolute mint condn, original cartons, manuals, not used last nine years. W Tam-Grange VK2KS, 02 4646 1141.
- **Drake TR7A** HF txcvr, s/n 11680, hand-held mic, **PS7** PSU (s/n 10497), **R7A** general coverage rcvr (s/n 3370), matching extn spkr (slightly damaged), workshop and operating manuals, cables to interface both radios, all in good working order, \$1600 ONO. Pat VK2ABE, 02 6768 1470 (BH).
- **Kenwood TS-50S** HF txcvr, **AT-50** ATU, as new, \$1750. **Kenwood TM-2570A** 2 m FM mobile, \$150. **Uniden HR-2150** 10 m mobile, \$300. **Uniden Sundowner UHF CB** txcvr, \$225. **Yaesu FT-26** 2 m FM hand-held, \$230. **Yaesu FL-2100B** HF linear

amp. non-WARC. \$350. R E Taylor VK2AOE, QTHR, 02 9449 6364.  
 • **Yaesu FT7 HF** txcvr, Ten Tec ATU, SWR bridge, Morse key, PSU, David VK2BDT, QTHR, 02 4821 5036.

**FOR SALE VIC**

• **Yaesu FT7** txcvr, 5 bands, 25 W, 13.8 V supply required, manual, excellent condn, \$400. **Heathkit linear amplifier**, 2 x 572B tubes, full PSU has 4 voltage positions, manual. **Yaesu mobile whips**, 80, 40, 20 and 2 m with base, cable and connector, all in plastic tube with ends, \$250 the lot. George VK3DS, QTHR, 03 5332 3226.  
 • **Yaesu FL2100Z HF** (incl WARC bands) Australian legal limit linear amplifier, in excellent condition, uses 2 x 572B tubes, s/n 11070425, price without tubes \$450, price with tubes installed and tested \$700. Chris VK3KCP, 03 9629 2653.  
 • **Kenwood TS-520S** with external VFO, \$550. R Trebilco VK3NRT, QTHR, 03 9798 3248.  
 • **Yaesu FT-757GX HF** txcvr, \$750. Bert VK3DVG, 03 216 804.  
 • **Icom IC-Delta 100**, 2/70/23 FM tri-bander, remote front panel, 50/35/10 W, wide RX, 642 mems, remote control mic, VGC with orig packaging and accessories, \$1550. Bird model 4381 RF Power Analyst, ThruLine, uses standard Bird 43 elements, operates to 2.3 GHz, min/max hold, calculates SWR, mod %, return loss, FWD and REF power in PEP or dBm (this is not a toy!), \$750. Adam VK3ALM, 03 9794 7873, e-mail vk3alm@c031.aone.net.au

• **Racal RA17-L** communications receiver, manual, spare tubes, \$450. Will deliver to Melbourne. Peter VK3IZ, QTHR, 03 5156 2053, jupeter@Bigpond.com

**FOR SALE QLD**

• Deceased estate VK4OD. **Kenwood TS-830S** with AT-200 ATU, MC-50 desk mic, \$600. **Kenwood TR-2600** 2 m HT, mobile stand, MS-1 charger, four battery packs, \$150. **Mini Multi Tri-band beam**, \$300. **Crank-up mast**, 25 ft, \$75. Ron VK4GZ, QTHR, 07 5448 4063.  
 • **Icom IC-275H** all mode 100 W txcvr, new condn, ideal terrestrial satellite, \$1500. **Goldstar CRO**, 50 MHz dual channel, new condn, \$750. Peter VK4PO, QTHR, 07 3390 1129.  
 • **Complete station: Kenwood TS-530S**, s/n 1121004; **Datong ASPO-30RR & 2147/A**; **Versa Tuner MFJ946-11**; **Mizuko SX3** pre-sel; Archer high power low pass filter; Clipsal 10 A power line filter; **Emtron EP2000** SWR meter; antenna rotator; **Kenwood MC50** mic; Morse hand key; Kambrook 4-way power outlet; **EB31 tri-band dipole** 20-15-10 m; **MC35S** noise cancelling mic; all in good working order, \$850. H Cox VK4OX, 07 5497 5308.  
 • **Hills tower**, 70 ft, three section, winch up, \$900. Amateur radio equipment table, 6' 8" x 2' 8" with shelves, power points, \$120. 40 ft **Oregon pine pole** with base, \$110. **Three band 3 el Yagi** with motor and controller, \$300. Peter VK4EB, QTHR, 07 5546 6164.

**FOR SALE SA**

• **Log periodic antenna**, 8 el, MUST SELL, \$450 negotiable. **Bits and pieces**. Paul VK5MAP, QTHR, phone/fax 08 8651 2398 for list.

**FOR SALE WA**

• New comm antenna **HB-35** tri-band beam, also tilt-over tower, buyer to collect, price negotiable. Tom VK6TP, 08 9299 6741

**FOR SALE TAS**

• **Kenwood TS-820 HF** txcvr, good condn, general coverage receive, desk mic, ext speaker, service manual, \$450. Brian VK7HSB, 03 6244 4844.  
 • **Icom IC-736 HF & 6 mtr**txcvr, general coverage Rx, AC PSU, auto ATU, as new, boxes, manuals, \$2350. **Icom FL-102 AM** filter, suit IC-760, -761, -765, -775 and -775, new, \$65. Com **Pakratt**, suit C64 & C128, RS232 level conv, program cartridge, suit AEA

PK232 MBX, new, \$120. Allen VK7AN, 03 6327 1171, 0417 354 410.

**WANTED ACT**

• **VLF receivers**, Fluke 270 or other; **thermionic noise diodes and tunnel diodes** (any type). Paul VK1ZAS, 3 Redgrave Place, ACT 2611, phone/fax 02 6288 5577, e-mail paule@ise.canberra.edu.au

**WANTED NSW**

• Two valve sockets for **QQE06/40** or **QQV06/40** or 6894. Bob VK2AVQ, QTHR, 02 9878 2359.  
 • **RF probe** type 2R56075 and **HV probe** type 3R56020 for AWA VoltOhmyst, Maurie VK2OW, 02 9838 1834.  
 • **BT-8** or **PB-13** battery cases (either or both) for TH-28A. Noel VK2TNB, QTHR, 02 9546 3617  
 • **Kenwood TS-600**, details to Neville VK2QF, QTHR, 02 6373 8624, fax 02 6373 8611.  
 • **Icom IC-725 handbook** and/or operating instructions. A Ambery VK2BOG, QTHR.

**WANTED VIC**

• Power supply/modulator type **MP-28B** for TA-12 transmitter. **Rack for SCRS22 Tx/Rx**, condn not important but must have all the gubbins. Borrow manual for **Racal 9008M** modulation meter. Peter VK3IZ, QTHR, 03 5156 2053, jupeter@Bigpond.com  
 • **Q meter** or **RF RLC bridge**. All offers considered. Morris VK3DOC, 03 9824 8988.

**MISCELLANEOUS**

• **The WIA QSL Collection** (now Federal) requires **QSLs**. All types welcome, especially rare DX pictorial cards, special issue. Please contact the Hon Curator, Ken Matchett VK3TL, 4 Sunrise Hill Road, Montrose VIC 3765, tel 03 9728 5350.  
 • **Radio and Hobbies - Electronics Australia** magazines, over 40 years, most complete since 1958, some 1940's wartime copies. Free to take but no sorting please! Take all or nothing! Keith VK2AXN, QTHR, 02 9489 0304. ar

**Silent Keys**

*Due to space demands obituaries should be no longer than 200 words.*

The WIA regrets to announce the recent passing of:  
 N Burton L20992  
 C O Healey VK2COH  
 A K Burt VK2XF  
 C W Johnson VK2YJ  
 I F (Ian) Berwick VK3ALZ

**Tom Douglass Dowling VK40D**

Tom Dowling passed away in hospital at Buderim, Queensland, on 28 August 1997, at the age of 77. He was born at Corio Village in Geelong on 17 March 1920 and was educated at Geelong College. After leaving school he worked at Dalgetys. In 1940 Tom enlisted in the Army and was sent to Singapore. When Singapore fell, he spent three and a half years as a POW and worked on the notorious Burma railway.

On his return to Australia, Tom married

Nancy. They lived at Lismore, Victoria, where Tom was branch manager for Dalgetys until 1952. Then followed 22 years on his property "Glenesk" near Swan Hill. In 1973 Tom sold the property and moved to Buderim.

Tom loved sport but amateur radio was also a consuming interest. He was a staunch member of the Sunshine Coast Amateur Radio Club and a keen CW operator; he held the Ken Wilford Memorial Trophy from its inception in 1994. He taught his eldest granddaughter Emma Forbes a little about the Morse Code and, in a final tribute at his funeral service, Emma spoke for us all in saying, "73 OM dah de dah".

Tom is survived by his wife Nancy, and daughters Jen, Angela and Diane.

Ron Marschke VK4GZ ar

**VK QSL BUREAUX**

The official list of VK QSL Bureaux. All are Inwards and Outwards unless otherwise stated.

- VK1 GPO Box 600 CANBERRA ACT 2601
- VK2 PO Box 73 TERALBANSW 2284
- VK3 40G Victory Blvd ASHBURTON VIC 3147
- VK4 GPO Box 638 BRISBANE QLD 4001
- VK5 PO Box 10092 Gouger St ADELAIDE SA 5000
- VK6 GPO Box F319 PERTH WA 6001
- VK7 GPO Box 371D HOBART TAS 7001
- VK8 C/o H G Andersson VK8HA  
Box 619 HUMPTY DOO NT 0836
- VK9/VK0 C/o Neil Penfold VK6NE  
2 Moss Court KINGSLEY WA 6026

# WIA Divisions

The WIA consists of seven autonomous State Divisions. Each member of the WIA is a member of a Division, usually in their residential State or Territory, and each Division looks after amateur radio affairs within its area.

Division	Address	Officers	Call Signs	Weekly News Broadcasts	1997 Fees
VK1	ACT Division GPO Box 600 Canberra ACT 2601	President Hugh Blemings Secretary John Woolner Treasurer Les Davey	VK1YYZ VK1IET VK1LD	3.570 MHz LSB, 146.950 MHz FM each Sunday evening commencing at 8.00 pm local time. The broadcast text is available on packet, on Internet <a href="http://www.vk1.wia.ampr.org">aus.radio.amateur.misc</a> newsgroup, and on the VK1 Home Page	(F) \$72.00 (G) (S) \$58.00 (X) \$44.00
VK2	NSW Division 109 Wigram St Parramatta NSW (PO Box 1066 Parramatta 2124) Phone 02 9689 2417 Freecall 1800 817 644 Fax 02 9633 1525	President Geoff McGrorey-Clark Secretary Eric Fossey Treasurer Eric Van De Wayer (Office hours Mon-Fri 11.00-14.00)	VK2EO VK2EFY VK2KUR	From VK2WI 1.845, 3.595, 7.146*, 10.125, 14.160, 24.950, 28.320, 29.120, 52.120, 52.525, 144.150, 147.000, 438.525, 1281.750 (* morning only) with relays to some of 18.120, 21.170, 584.750 ATV sound. Many country regions relay on 2 m or 70 cm repeaters. Sunday 1000 and 1930. Highlights included in VK2AWX Newcastle news, Monday 1930 on 3.593 plus 10 m, 2 m, 70 cm, 23 cm. The broadcast text is available on the Internet newsgroup <a href="http://www.vk1.wia.ampr.org">aus.radio.amateur.misc</a> , and on packet radio.	(F) \$69.00 (G) (S) \$56.00 (X) \$41.00
VK3	Victorian Division 40G Victory Boulevard Ashburton VIC 3147 Phone 03 9885 9261 Fax 03 9885 9298	President Jim Linton Secretary Barry Wilton Treasurer Rob Hailey (Office hours Tue & Thur 0830-1530) Web: <a href="http://www.tbsa.com.au/~wivac/">http://www.tbsa.com.au/~wivac/</a>	VK3PC VK3XV VK3NC	VK3BWI broadcasts on the 1st Sunday of the month, starts 10.30 am. Primary frequencies 3.615 LSB, 7.085 LSB, and FM(R)s VK3RML 146.700, VK3RMM 147.250, VK3RWG 147.225, (X) and 70 cm FM(R)s VK3ROU 438.225, and VK3RMU 438.075. Major news under call VK3WI on Victorian packet BBS and WIA VIC Web Site.	(F) \$75.00 (G) (S) \$61.00 (X) \$47.00
VK4	Queensland Division GPO Box 638 Brisbane QLD 4001 Phone 07 5496 4714	President Rodger Bingham Secretary Peter Harding Treasurer John Presotto e-mail address: <a href="mailto:wiaq@brtsbane.dialix.com.au">wiaq@brtsbane.dialix.com.au</a> Web: <a href="http://www.wiaq.powerup.com.au">http://www.wiaq.powerup.com.au</a>	VK4HD VK4JPH VK4WX	1.825 MHz SSB, 3.605 MHz SSB, 7.118 MHz SSB, 14.342 MHz SSB, 28.400 MHz SSB, 29.220 MHz FM, 52.525 MHz FM, 146.700 MHz FM, 147.000 MHz FM, 438.525 MHz (Brisbane only), regional VHF/UHF repeaters at 0900 hrs Sunday. Repeated on 3.605 MHz SSB & 147.000 MHz FM, regional VHF/UHF repeaters at 1930 hrs EAST Monday. Broadcast news in text form on packet under WIAQ@VKNET.	(F) \$74.00 (G) (S) \$60.00 (X) \$46.00
VK5	South Australian Division 34 West Thebarton Rd Thebarton SA 5031 (GPO Box 1234 Adelaide SA 5001) Phone 08 8352 3428 Fax 08 8264 0463	President Ian Hunt Secretary Graham Wiseman Treasurer Joe Burford Web: <a href="http://www.vk5wia.ampr.org/">http://www.vk5wia.ampr.org/</a>	VK5QX VK5EU VK5UJ	1827 kHz AM, 3.550 MHz LSB, 7.095 AM, 14.175 USB, 28.470 USB, 53.100 FM, 147.000 FM Adelaide, 146.700 FM Mid North, 146.800 FM Mildura, 146.825 FM Barossa Valley, 146.900 FM South East, 146.925 FM Central North, 147.825 FM Gawler, 438.425 FM Barossa Valley, 438.475 FM Adelaide North, ATV Ch 35 579.250 Adelaide. (NT) 3.555 USB, 7.065 USB, 10.125 USB, 146.700 FM, 0900 hrs Sunday. 3.585 MHz and 146.675 MHz FM Adelaide, 1930 hrs Monday.	(F) \$75.00 (G) (S) \$61.00 (X) \$47.00
VK6	West Australian Division PO Box 10 West Perth WA 6872 Phone 09 351 8873	President Wally Howse Secretary Christine Bastin Treasurer Bruce Hedland-Thomas Web: <a href="http://www.faroc.com.au/~vk6wia">http://www.faroc.com.au/~vk6wia</a>	VK6KZ VK6ZLZ VK6OO	146.700 FM(R) Perth, at 0930 hrs Sunday, relayed on 1.825, 3.560, 7.075, 14.116, 14.175, 21.185, 29.680 FM, 50.150 and 438.525 MHz. Country relays 3.582, 147.350(F) Busseton and 146.900(R) Mt William (Bunbury). Broadcast repeated on 146.700 at 1900 hrs Sunday, relayed on 1.865, 3.563 and 438.525 MHz; country relays on 146.350 and 146.900 MHz.	(F) \$62.00 (G) (S) \$50.00 (X) \$34.00
VK7	Tasmanian Division PO Box 271 Riverside TAS 7250 Phone 03 6327 2096 Fax 03 6327 1738	President Ron Churcher Secretary Barry Hill Treasurer Mike Jenner	VK7RN VK7BE VK7FB	146.700 MHz FM (VK7RHT) at 0930 hrs Sunday relayed on 147.000 (VK7RAA), 146.725 (VK7RNE), 146.625 (VK7RMD), 3.570, 7.090, 14.130, 52.100, 144.150 (Hobart) Repeated Tues 3.590 at 1930 hrs.	(F) \$74.00 (G) (S) \$60.00 (X) \$46.00
VK8	(Northern Territory is part of the VK5 Division and relays broadcasts from VK5 as shown received on 14 or 28 MHz).			Membership Grades Full (F) Pension (G) Needy (G) Student (S) Non receipt of AR (X)	Three-year membership available to (F) (G) (X) grades at fee x 3 times

Note: All times are local. All frequencies MHz.

## ADVERTISERS' INDEX

Amateur Transceiver Radio _____	9	WIA Membership Retention _____	5
Andrews Communication Systems _____	3		
Dick Smith Electronics IFC, 28, 29, IBC		<b>Trade Hamads</b>	
ICOM _____	OBC, 49	M Delahunty _____	54
Radio and Communications _____	47	RJ & US Imports _____	54
Terlin Aerials _____	21	HAMLOG - VK2VN _____	54
WIA Recruitment _____	17	Kilo-Tec _____	54

### TRADE PRACTICES ACT

It is impossible for us to ensure the advertisements submitted for publication comply with the Trade Practices Act 1974. Therefore, advertisers and advertising agents will appreciate the absolute need for themselves to ensure that the provisions of the Act are complied with strictly.

### VICTORIAN CONSUMER AFFAIRS ACT

All advertisers are advised that advertisements containing only a PO Box number as the address cannot be accepted without the addition of the business address of the box-holder or seller of the goods.

# Yaesu's Done It Again



## FT-920 HF/6m Transceiver With DSP

Now there's no excuse for not taking advantage of the latest advances in Digital Signal Processing, transceiver design plus the fun of 6m operation. The stunning new Yaesu FT-920 is a high performance HF/6m multi-mode receiver that provides 100W PEP output on the 160-6m bands, incredible front-end performance based on the FT-1000MP design, and a huge array of features that make it a pleasure to use.

At first glance Yaesu's renowned Omni-Glow LCD screen is obvious, and its wide-angle view provides a wealth of information about the transceiver's operating status with multi-function metering, dual frequency displays and an Enhanced Tuning scale for DSP bandwidth, CW tuning, FM discriminator and more. Inside, the FT-920 is built around a rugged diecast unibody chassis which provides excellent heatsinking for the low distortion dual MRF255 160-6m FET power amplifier.

For more comfortable operating when weaker signals are present Yaesu's engineers dedicated themselves to enhancement of real-world signal to noise ratios, and after thousands of hours of design and testing have produced an industry-leading 33.3MIPS (millions of instructions per second) processing speed DSP in the FT-920 that provides a two-parameter noise reduction system with 32 steps of front panel adjustment. This amazing system also provides dual control DSP passband tuning, DSP auto-notch filter, an amazing new transmit Digital Speech Processor, DSP mic

equalisation, fast acting DSP VOX circuitry as well as a Contest-ready Digital Voice Recorder!

Other features include an all-band (160-6m) auto antenna tuner which also provides greater receiver band-pass protection, Direct Digital Synthesis for clean local oscillators, selectable frequency-optimised receiver front-end pre-amps, and a Shuttle Jog tuning ring for fast QSY. A Dual Watch receive system allows you to check for band openings, especially handy when monitoring 6m. Also provided are SSB/CW/FM operation (AM with optional filter), 127 memories with alphanumeric labelling, IF shift and IF noise blanker to fight interference, plus an extensive menu system for selecting most "set and forget" functions.

The FT-920 is supplied with an MH-31B8 hand mic, DC power lead and comprehensive instruction manual.

Why not call for a copy of the Yaesu 6 page FT-920 colour brochure to learn more about this efficient transceiver that's without peer in its price class.

D 3420



# \$2995

## 2 YEAR WARRANTY

**BONUS**  
Bonus D-3800 25A  
power supply valued at \$299  
offer expires 31/12/97

### PHONE FAX AND MAIL ORDERS

**PHONE:** WITHIN AUSTRALIA: 1300 366 644  
(Local Call Charge)

**FAX:** (02) 9395 1155 within Australia and  
(+612) 9395 1155 from outside Australia

**MAIL:** DICK SMITH ELECTRONICS, Direct Link Reply Paid 160,  
PO Box 321, North Ryde NSW 2113 (No Stamp Required)

*Excludes packaging and postage. All major Credit Cards accepted.  
14 Day Money Back Guaranteed if NOT completely satisfied.*

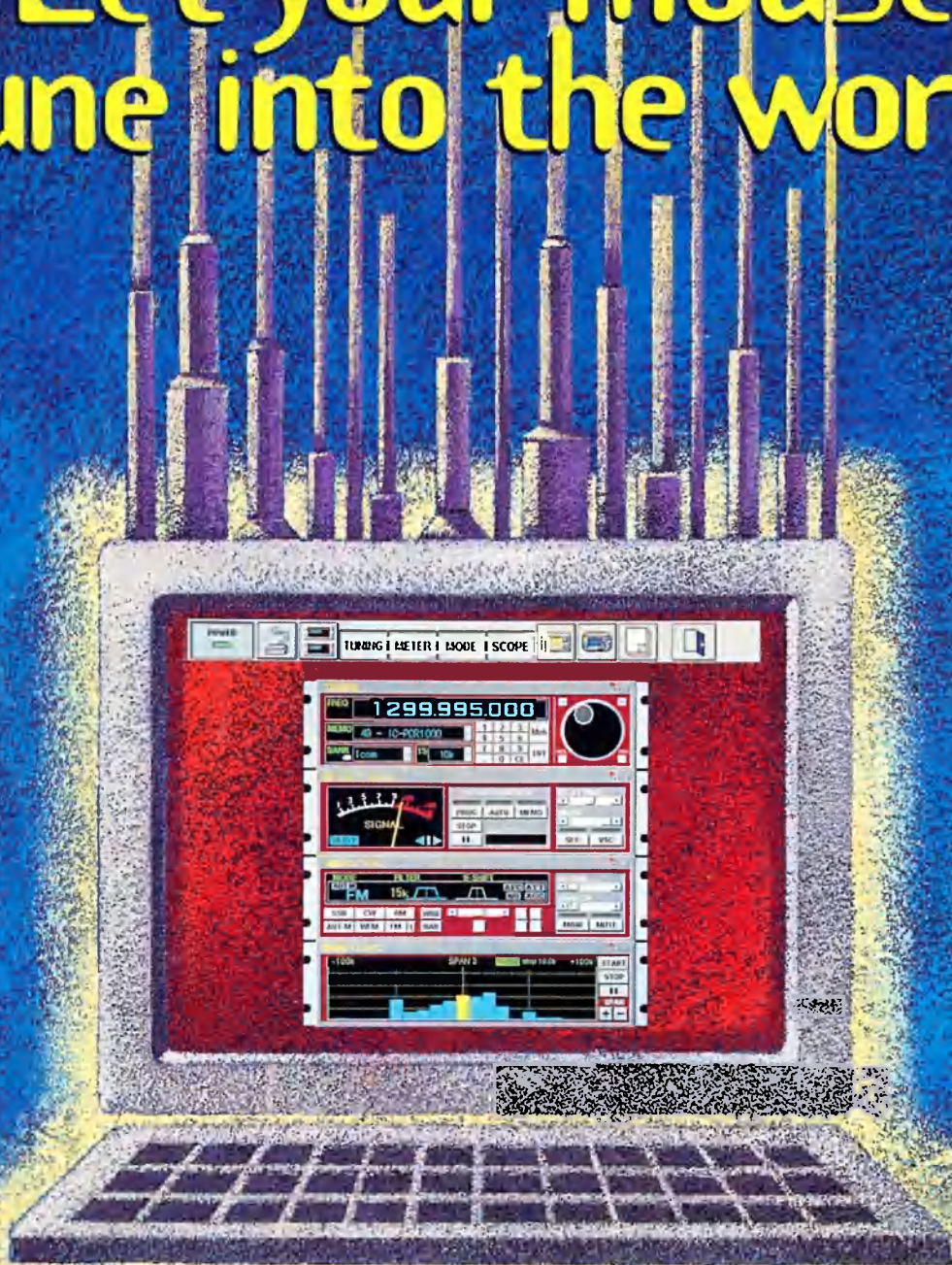


Visit our web site at  
<http://www.dse.com.au>

B 3050 col



# Let your mouse tune into the world.



The world's airwaves are now at your fingertips with the new IC-PCR 1000. This black box unit delivers 3 receiver interfaces to your PC. A communications receiver; a 4 component display; and a radio screen with presets. Access the world of radio from AM or FM programming, to ham radio, aviation or marine broadcasts... all for a much cheaper outlay than buying each radio individually, and we even supply the single aerial! Hearing is believing... for the name of your nearest Icom dealer call toll free on **1800 338 915** now.

**ICOM**  
Clearly Ahead