

"Miniwatt"

VK2ZC

DIGEST

VOL. 1 No. 5
FEBRUARY 1962

TECHNICAL AND COMMERCIAL TOPICS OF
CURRENT INTEREST TO THE ELECTRONICS INDUSTRY

CONTENTS

	Page
TRANSISTOR OPERATION AT 200 Mc/s—the AF102 in Mast-head Amplifier Design	70
A 4-VALVE 12 W PUBLIC ADDRESS AMPLIFIER	77
SPECIAL PURPOSE RESISTORS	80
TRANSISTOR DISSIPATION IN CLASS B OUTPUT STAGES	82



Published by the
Miniwatt
Electronics Division of
Philips Electrical Industries
Pty. Limited,
20 Herbert Street,
Artarmon, N.S.W.,
Australia.

MAST-HEAD AMPLIFIER
USING AF102

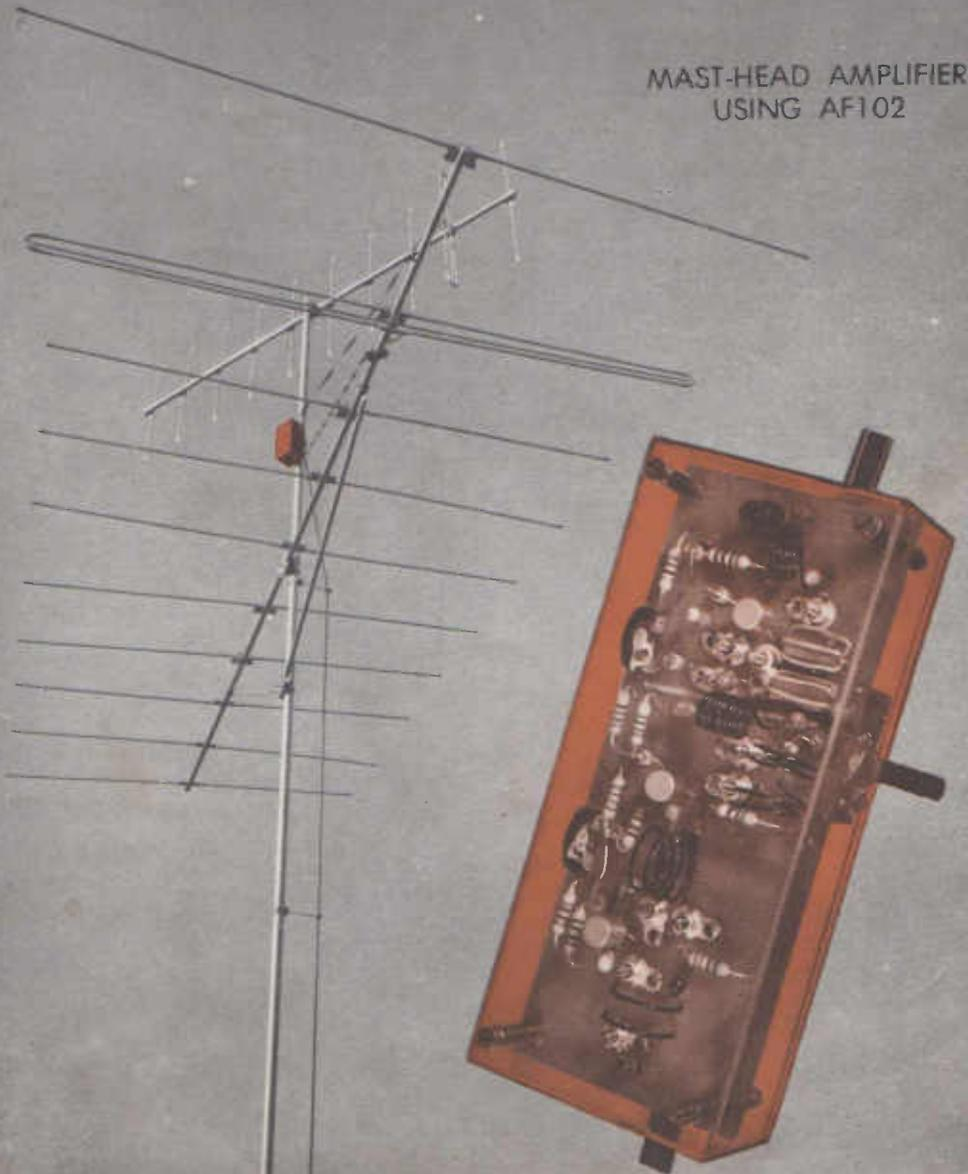

Transistor Operation at 200 Mc/s.

—the AF102 in Mast-head Amplifier Design

An experimental printed wiring assembly has been constructed in order to study the AF102 in TV mast-head amplifier applications. The results of the investigation will also be of interest to circuit designers in the Communications Field. All measurements have been standardised on a 50 Ω unbalanced basis.

A power gain of 22 dB flat has been achieved over a single lower-band channel bandwidth using a single transistor, and the same order of flat gain over three higher-band channels using a two-stage amplifier. These gain figures, obtained after a compromise with such factors as low noise factor for this particular application, are not the maximum obtainable from the AF102. Economical wide-band units are feasible, using a single stage.

The AF102 is an alloy-diffused pnp junction transistor designed for operation at frequencies in excess of 200 Mc/s. It features low intrinsic base resistance, high slope and low noise factor.

1. General Considerations in Mast-head Amplifier Design

For some years, low noise valves have been used in mast-head amplifier application in order to improve the signal-to-noise at the set terminals. Despite their excellent performance capabilities, valves have no proper place at the mast-head as they require high voltages for satisfactory operation and introduce additional cost and problems in meeting safety requirements.

On such points as long life, cost, weight and wind loading, the transistor has the advantage.

2. Extension of the Fringe Areas

The imminent installation of TV transmitters in country centres will introduce extensive new areas of fringe reception. In these regions the use of mast-head amplifiers will undoubtedly increase.

The experimental amplifiers described in this article feature a high band (Ch's. 7, 8 and 9) and a low band (Ch. 2), but the design principles may be extended to cover alternative channels.

3. Narrow-Band versus Wide-Band Units

This introduces the first design compromise. The manufacturers' ideal would be a single wide-band amplifier with acceptable performance on all channels. This concept raises serious problems of interference

MINIWATT AF102

PNP Germanium Transistor

Maximum Ratings (*Absolute Maximum*)
Collector to base voltage ($-V_{CB}$) 25 V
Collector Current ($-I_C$) 10 mA

Characteristics at $T_{amb} = 25^\circ\text{C}$ (and at $-V_{CB} = 12\text{ V}$, $I_E = 1\text{ mA}$, $f = 200\text{ Mc/s}$ unless otherwise stated)

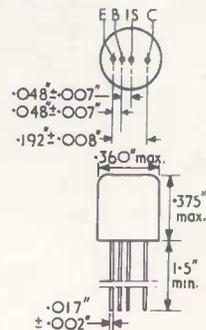

	Typical	Range min. max.	
Frequency at which $ h_{re} = 1$	f_i 180	—	— Mc/s
Intrinsic base impedance (at 2 Mc/s)	$ Z_{rb} $ 10	—	— Ω
Noise figure (with 30 Ω source resistance)	F 6	—	7.5 dB
Available power gain in typical grounded base stage (without neutralisation)	G_a 13	10	— dB
Collector cutoff current ($I_E = 0$)	$-I_{CBO}$ —	—	10 μA
Base current for $-V_{CB} = 12\text{ V}$, $-I_C = 1\text{ mA}$	$-I_B$ —	—	50 μA
Base voltage for $-V_{CB} = 12\text{ V}$, $-I_C = 1\text{ mA}$	$-V_{BE}$ —	220	360 mV
<i>Small Signal Admittance Parameters</i>			
Input conductance	g_{11b} 30	—	— mmhos
Input capacitance	C_{11b} —12	—	— pF
Forward transfer admittance (absolute value)	$ y_{21b} $ 25	—	— mmhos
Phase angle of y_{rb}	ϕ_{21b} 90	—	— deg.
Feedback admittance (absolute value)	$ y_{12b} $ 0.4	—	— mmhos
Phase angle of y_{rb}	ϕ_{12b} —90	—	— deg.
Output conductance	g_{22b} 0.3	—	— mmhos
Output capacitance	C_{22b} 1.8	—	— pF

from unwanted radiations, which in turn require a formidable range of band elimination filters and extensive field studies. The problem of phase distortion should not be discounted.

For these reasons, the amplifiers described are relatively narrow band (one to three channels width), but design methods for economical wide-band systems are indicated.

The front cover illustration shows a unit providing separate balanced inputs for horizontally and vertically polarised fringe aerials, receiving transmissions from different directions.

4. Balanced versus Unbalanced Down-Leads

In the main, unshielded 300 Ω down-lead has been used for reasons of cost, weight, ease of connection and acceptable losses. However, it has some notable disadvantages such as "salting-up" and greater susceptibility to locally radiated interference. On the other hand low-loss shielded cable avoids these disadvantages and is increasingly used in difficult situations in spite of slight additional weight and cost. Hence the mast-head units described are designed for a 75 Ω unbalanced down-lead. In addition, shielded cable provides better mechanical protection, which is particularly important as the down-lead has also to supply DC power. Also, problems of power supply polarity no longer arise. Stand-off type cable clamps shown in the cover illustration were used for convenience only. Simple means of transforming to 300 Ω balanced, if needed, are described in section 6.

5. AF102 Circuit Configuration and Operating Point

(a) *Noise Considerations.* Unless the amplifier has a low noise figure comparable with a good tuner, its main advantages will be lost and gain figures become less significant.

The noise figure of the AF102 is a function of both source conductance and susceptance as shown in Figs. 1a and 1b,⁽¹⁾ which apply for an average transistor at 200 Mc/s. The noise figure is essentially the same in common base or common emitter configuration.⁽²⁾

From Nielsen's⁽³⁾ formula for noise figure, we can approximate for the case of $h_{rb} \approx 1$ by:

$$F \approx 1 + \frac{r_{bb'}}{R_g} + \frac{r_e}{2R_g} + \frac{\left(\frac{f}{f_{cb}}\right)^2 (R_g + r_e + r_{bb'})^2}{2R_g r_e} \quad (1)$$

where F = noise factor

$r_{bb'}$ = ohmic base resistance (Ω) $\approx |Z_{rb}|$ quoted in data

R_g = source resistance (Ω)

r_e = DC emitter resistance = $\frac{kT}{qI_E} = \frac{25}{I_E}$ (mA)

f = frequency of measurement

f_{cb} = cutoff frequency in grounded base which is related to:

f_1 = frequency at which $|h_{re}| = 1$ by:
 $f_{cb} \approx (1 + 0.3)f_1$ for the AF102.

Using this formula, F (converted to dB) has been calculated for I_E of 1, 2 and 3 mA for $f = 60$ Mc/s, the results being given in Fig. 2.

This theoretical treatment shows that the optimum source conductance is in each case non-critical, and that for source conductances ranging from 5 to 17 mmho, F is less than 2 dB.

There are two points which are worth mentioning at this stage. Firstly, at 60 Mc/s the contribution of the frequency dependent noise term is not negligible, and it is this which tends to deteriorate the noise performance at low values of source conductance, especially

at higher values of I_E . However, there is a compensation arising out of the increase in f_1 with increasing I_E , which has been taken into account in plotting Fig. 2. Thus the resulting curves are virtually identical over this broad range of source conditions. Secondly, measurements have indicated noise figures slightly in excess of those predicted theoretically, and at 2 mA, $F = 2.5$ dB was obtained with an optimum source conductance of approximately 17 mmho.⁽¹⁾ The deviation of measured optimum source conductance from the 9 mmho predicted theoretically is not serious owing to the relative constancy of F .

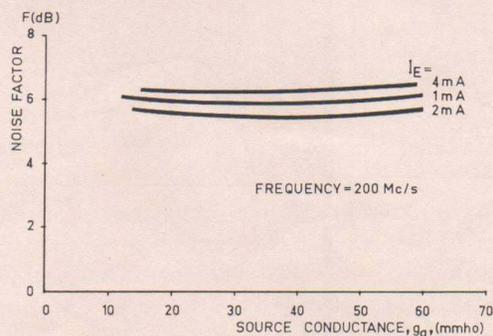

(a)

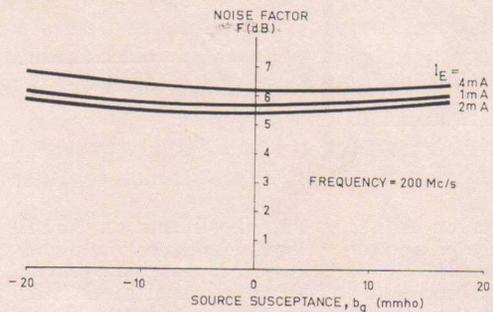

(b)

Fig. 1.—Illustrating the relative constancy of AF102 Noise Factor over a wide range of source admittance and a limited range of collector current.

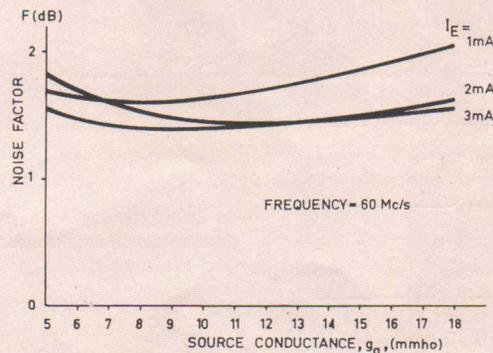

Fig. 2.—Theoretical dependence of AF102 Noise Factor on source conductance, at a frequency of 60 Mc/s—derived from Nielsen's equation.

Besides possessing a low mid-frequency noise figure, the "upper noise corner"⁽⁴⁾ for the AF102 is quite high. The upper noise corner frequency, f_A , can be derived from Equation (1) by equating the frequency-dependent term to the sum of the non-frequency-dependent terms.

$$f_A = \frac{1.3 f_1}{(R_g + r_e + r_{bb'})} \sqrt{r_e (2R_g + 2r_{bb'} + r_e)} \dots \quad (2)$$

For $R_g = 30 \Omega$, $I_E = 1 \text{ mA}$, then $f_A = 185 \text{ Mc/s}$. Measurements have in fact indicated a noise corner closer to 140 Mc/s .

It is to be noted that the improvement in f_1 with increasing I_E will tend to raise f_A . At $I_E = 3 \text{ mA}$, the theoretical figure for f_A is about 189 Mc/s .

(b) *Input Matching Considerations.* The source conductance for optimum noise figure for the transistor does not correspond to that for maximum transfer of power. Hence some degree of mismatch is desirable. As a target, one should try to keep the VSWR within about 3:1. For I_E approximately 1 mA, both g_{11b} and C_{11b} are practically constant over a 60 Mc/s to 200 Mc/s range, and the common base configuration has thus much to recommend it when broad-band inputs are contemplated. However, greater gain is obtainable if I_E is increased somewhat. The common emitter configuration, on the other hand, exhibits changes in g_{11e} of the order of 10:1 over the above range. Thus, despite other excellent features, including high gain at lower frequencies, this configuration will require some form of impedance compensation in the input circuit, if broad banding is contemplated.

Besides reducing the power transfer, excessive mismatch at the input terminals of the amplifier, if not allowed for in alignment, tend to introduce "tilt" effects in reception, the extent depending upon the degree of mismatch and the exact length of the connection between amplifier and antenna (a 1' length of 300Ω "ribbon" corresponds to about a quarter wavelength at 200 Mc/s). It is not possible to reduce these effects by means of padding at the input, as this would only deteriorate the noise performance as well as gain. With this in mind, it is recommended that the mast-head unit be aligned using an accurate "dummy aerial" which also simulates the connecting leads. This implies that for the best results the aerial and amplifier be supplied as an integrated unit. VSWR'S appreciably better than the 3:1 target figure are obtainable with careful design.

In the case of an un-neutralised stage, the input admittance will be affected to some degree by the condition of the tuned collector circuit. If this is not allowed for in design, adequate compromise between power match and noise may not be achieved. Figures 3a, 3b, 4a and 4b⁽¹⁾ indicate the effects on the input admittance of the AF102 of a double-tuned collector circuit providing approximately flat gain over a single channel width. To a reasonable degree of approximation, the curves for the input conductance and shunt capacitance (g_i and $\frac{b_i}{\omega}$ respectively) can be taken to also apply for a two-channel-width collector circuit. The theoretical input admittance is given by:

$$y_i = Y_1 - \frac{Y_{12} Y_{21}}{Y_2}$$

where $Y_1 = Y_1^\circ + y_{11}$
 $Y_2 = Y_2^\circ + y_{22}$

Y_1° and Y_2° being those lumped admittances, at input and output terminals respectively, which are external to the transistor.

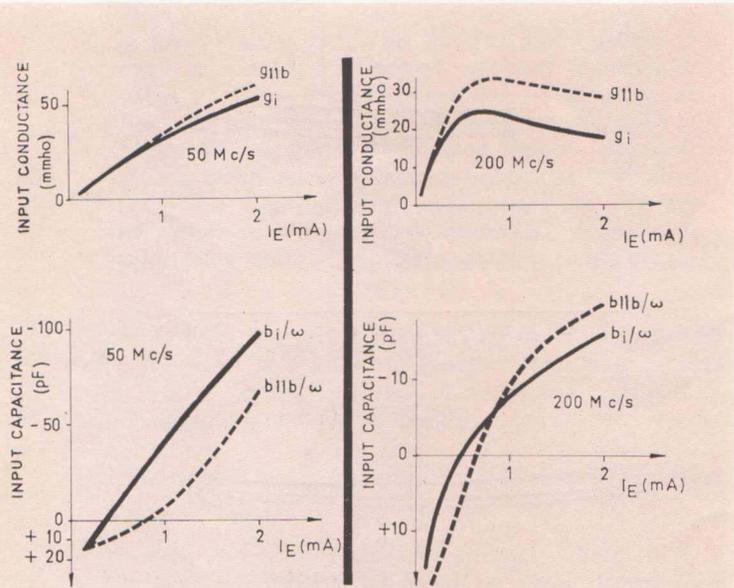

Fig. 3.—Effects on AF102 input admittance of a lower frequency tuned circuit (single channel bandwidth) loading the collector.

Fig. 4.—Effects on AF102 input admittance of a higher frequency tuned circuit (single channel bandwidth) loading the collector.

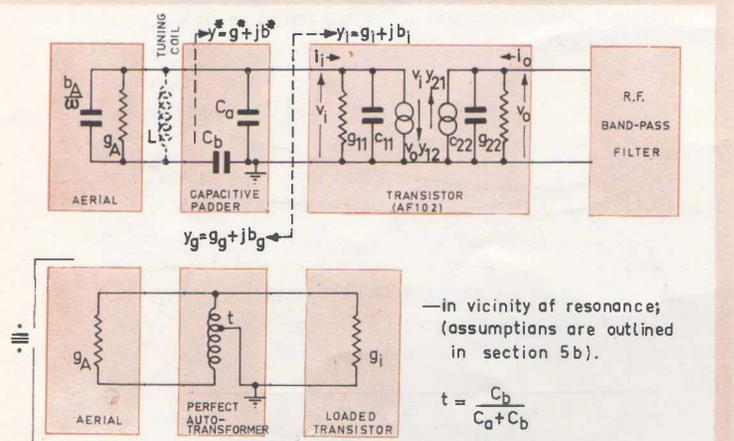

Fig. 5.—Derivation of simplified equivalent circuit, useful for estimating VSWR and source conductance, for mast-head units described.

The equivalent input arrangement made use of throughout for the experimental units is given in Fig. 5.

It can be easily shown that

$$g^* = \frac{C_b^2 g_1}{\left(\frac{g_1}{\omega}\right)^2 + \left(\frac{b_1}{\omega} + C_a + C_b\right)^2}$$

and if $C_a + C_b \gg \frac{b_1}{\omega}$, g^* is independent of b_1 .

If also $\left(\frac{g_1}{\omega}\right) \ll \left(\frac{b_1}{\omega} + C_a + C_b\right)$ then

$$g^* \approx \left(\frac{C_b}{C_a + C_b}\right)^2 g_1 = t^2 g_1$$

and the capacitive tapping arrangement would behave as a true auto-transformer, stepping down the transistor input conductance to the required level of balanced conductance.

b^* on the other hand is given by:

$$b^* = \frac{\omega C_b \left\{ \frac{g_1^2}{\omega^2} + \left(\frac{b_1}{\omega} + C_a + C_b\right) \left(\frac{b_1}{\omega} + C_a\right) \right\}}{\frac{g_1^2}{\omega^2} + \left(\frac{b_1}{\omega} + C_a + C_b\right)^2}$$

Now if $\frac{g_1}{\omega} \ll \left(\frac{b_1}{\omega} + C_a + C_b\right)$

$$\omega C_b \left(\frac{b_1}{\omega} + C_a\right)$$

$$\text{then } b^* \approx \frac{b_1}{\frac{b_1}{\omega} + C_a + C_b}$$

and if further $\frac{b_1}{\omega} \ll C_a$:

$$b^* \approx \frac{\omega C_a C_b}{(C_a + C_b)} = \omega C_a t,$$

i.e. the susceptance of the two capacitors C_a , C_b in series.

Transforming from the other direction, we arrive at

$$y_{\pi} = j\omega C_a + \frac{j\omega C_b \left(g_a - \frac{j}{\omega L} + j\omega C_A \right)}{g_a + j\omega \left(C_b - \frac{1}{\omega^2 L} + C_A \right)}$$

and for a truly resistive aerial system $C_A = 0$.

$$\therefore y_{\pi} = \frac{\omega^2 C_b^2 g_A}{g_A^2 + \omega^2 \left(C_b - \frac{1}{\omega^2 L} \right)^2} + j\omega \left\{ C_a + \frac{C_b \left(g_A^2 - \frac{1}{L} \left[C_b - \frac{1}{\omega^2 L} \right] \right)}{g_A^2 + \omega^2 \left(C_b - \frac{1}{\omega^2 L} \right)^2} \right\}$$

However, in the vicinity of resonance, the imaginary term must equal $-j\frac{b_1}{\omega}$, and so is non-zero. Also,

$$\frac{1}{\omega^2 L} \approx \frac{C_b \left(C_a + \frac{b_1}{\omega} \right)}{\left(C_a + C_b + \frac{b_1}{\omega} \right)} \approx \frac{C_a C_b}{(C_a + C_b)},$$

with previous assumptions,

$$\text{and so } g_g \approx \frac{\omega^2 C_b^2 g_A}{g_A^2 + \omega^2 \left(\frac{C_b}{C_a + C_b} \right)^2} = \frac{g_A}{\frac{g_A^2}{\omega^2 C_b^2} + \left(\frac{C_b}{C_a + C_b} \right)^2}$$

$$\text{and if } g_A \ll \omega C_b, \quad g_g = g_A \left(\frac{C_a + C_b}{C_b} \right)^2$$

i.e. $g_g = \frac{g_A}{t^2}$, as to be expected.

This analysis, together with Section 5 (a), provides the basis for a compromise between standing-wave and noise considerations. The degree to which the above assumptions hold in practice depends on two main factors. Firstly, at high frequencies, only a small total LC product is required for tuning the input circuit, and the additional tuning coil required across the input terminals may become too small to be physically realizable, if too great a total capacitance is in the circuit. Secondly, too great a capacitance will severely restrict the input circuit bandwidth.

(c) Gain, Bandwidth and Stability Considerations.

The response of a mast-head unit should be comparatively flat over any channel bandwidth. The design target was set at $\leq \frac{1}{2}$ dB total variation over a single channel.

As previously stated, the gains achieved in the following designs do not represent the maximum achievable. However, gain figures exceeding 20 dB will be quite adequate in the great majority of cases for the amplifier to serve the additional function of a distribution unit for up to about four sets. Distribution technique has been treated by Lackey⁽⁵⁾.

At higher frequencies the common base configuration is characterised by some internal positive feedback which boosts the gain. However, satisfactory stability margin can still be maintained, and the resulting interaction of the output circuit on the input circuit is still reasonably small at 200 Mc/s. Although this interaction produces a slight deterioration in VSWR, this is within acceptable limits. An idea of the degree of interaction can be obtained from Figs. 3 and 4.

For common emitter configuration, however, the internal feedback is negative, with consequent reduction in gain. A satisfactory neutralising scheme can be arrived at by considering a single element, having admittance Y_N , connected between output and input of the transistor through an idealised transformer having unity turns ratio. The y parameters of the combination become:

$$\begin{aligned} Y_{11} &= y_{11} + Y_N \\ Y_{21} &= y_{21} - Y_N \\ Y_{12} &= y_{12} - Y_N \\ Y_{22} &= y_{22} + Y_N \end{aligned}$$

The condition for perfect neutralisation being $Y_{12} = 0$, i.e. $Y_N = y_{12}$.

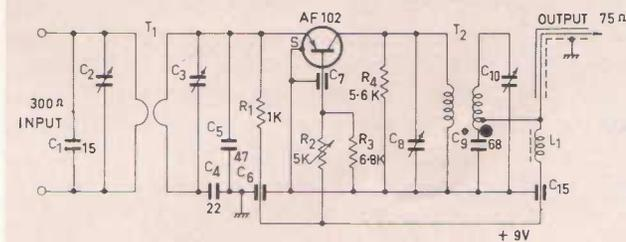

A.

A. SINGLE-STAGE HIGH-BAND CIRCUIT
(COMMON BASE)

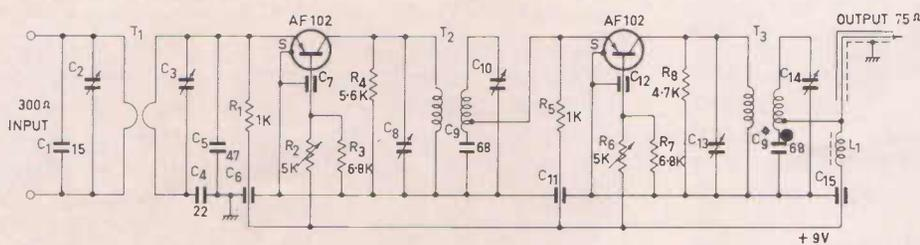

B.

B. TWO-STAGE HIGH-BAND CIRCUIT
(COMMON BASE)

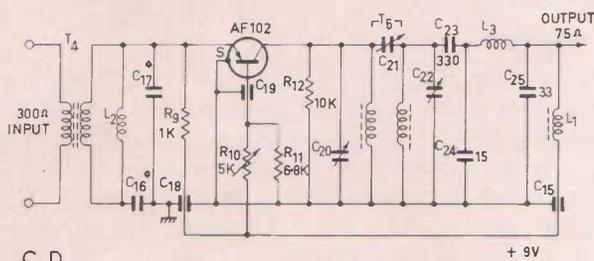

C, D.

C, D. SINGLE-STAGE LOW-BAND CIRCUITS
(COMMON BASE)

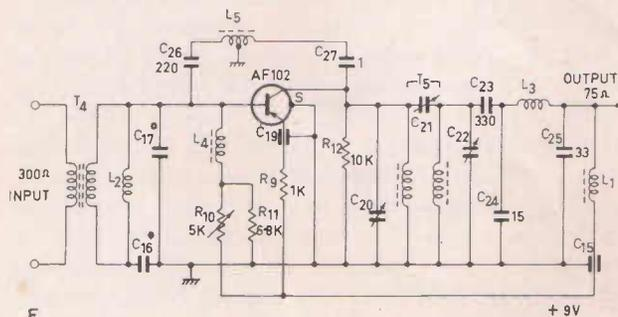

E.

E. SINGLE-STAGE LOW-BAND CIRCUIT
(COMMON EMITTER)

Any low-band circuit can be coupled, at the output, to either high-band circuit through point ● with C_{10}^* removed.

Parts List

$R_{1, 5, 9}$ 1 K
 $R_{3, 7, 11}$ 6.8 K

R_1 5.6 K
 R_5 4.7 K

R_{12} 10 K
 $R_{2, 4, 10}$ 5 K $\frac{1}{2}$ W Philips type E097AC/5K

All fixed resistors Philips insulated cracked carbon type B8 305 05B/..

$C_{1, 21}$ 15 pF
 C_4 22 pF
 C_6 47 pF
 C_{10}^* 68 pF for cct. C, 47 pF for cct. D, 100 pF for cct. E
 C_{17}^* 150 pF for cct. C, 150 pF for cct. D, 39 pF for cct. E

$C_{10, 9}^*$ 68 pF
 C_{20}^* 330 pF
 C_{25} 33 pF
 C_{20} 220 pF

$C_{0, 7, 11, 12, 15, 18, 19}$ 820 pF feed-through capacitors Philips type C309BB/R820E

$C_{2, 3, 8, 10, 13, 14, 20, 21, 22}$ ceramic trimmers (0.8 pF max. zero capacitance, 6 pF min. variation) Philips type C004EA/6E
 C_{27} Philips glass lead-in type 88018/03

All above Philips "Pin-Up" type C322 capacitors

T_1 Two hair-pin loops, 18 B & S enam. copper, $\frac{7}{16}$ " high, $\frac{1}{8}$ " across, coil separation $\frac{5}{16}$ ".

T_2 Prim. and sec. $2\frac{1}{4}$ t 18 B & S enam. copper, $\frac{5}{8}$ " former, $\approx \frac{1}{8}$ " between turns and $\approx \frac{1}{8}$ " between prim. and sec. Secondary tapped $\frac{3}{4}$ t from $C_{10, 9}^*$.

T_3 As for T_2 except $\approx \frac{1}{4}$ " spacing between prim. and sec.

T_4 Prim. and sec. 5 t each, 22 B & S enam. copper, wound bifilar through Ferroplana double bead type K5.050.06/1Z2

T_5 Prim. and sec. each $2\frac{1}{2}$ t 25 B & S polythene covered, wound through Ferroplana single bead type K5.000.81/1Z2

$L_{1, 4}$ Ferroxcube-cored choke, Philips type VK200.10/4B

L_2 4 t 18 B & S enam. copper, $\frac{5}{16}$ " former (spacing adjusted)

L_3 0.35 μ H, 8 t 18 B & S enam. copper, $\frac{5}{16}$ " former, wound close spaced.

L_5 10 t 24 B & S enam. copper, centre-tapped, wound bifilar on Ferroxcube bead type 56.390.31/4B (refer Section 6)

Output Cable Telcon type ET10M, 75 Ω cellular polythene

Fig. 6.—Circuit details of Experimental Mast-head Amplifiers.

TABLE 2—PERFORMANCE CHART OF SAMPLE AMPLIFIERS

Configuration	Input circuit 3 dB Bandwidth (Mc/s)	Total 3 dB Bandwidth (Mc/s)	Noise Figure F (dB)	Power Gain (dB)	VSWR maximum	Power Responses (linear scale)	
						Input Circuit	Overall
A. Channels 7, 8, 9 Common Base One stage $I_E = 1\frac{1}{2}$ mA	39	36	$7\frac{1}{2}$	10	$3\frac{1}{2} : 1$ Ch's. 7 & 9 5 Ch. 8		
B. Channels 7, 8, 9 Common Base Two stages $I_E = 1\frac{1}{2}, 2$ mA	39	29	$7\frac{1}{2}$	22	$3\frac{1}{2} : 1$ Ch's. 7 & 9 5 : 1 Ch. 8		
C. Channel 2 Common Base One stage $I_E = 1\frac{1}{2}$ mA	26	$13\frac{1}{2}$	$5\frac{1}{2}$	$14\frac{1}{2}$	$2\frac{1}{2} : 1$ (refer Fig. 7a)	single-tuned responses of approx. 26 Mc/s bandwidth: flat within $\frac{1}{2}$ dB over 7 Mc/s channel width	
D. Channel 2 Common Base One stage $I_E = 3$ mA	26	$13\frac{1}{2}$	$5\frac{1}{2}$	17	$3\frac{1}{2} : 1$ (refer Fig. 7b)		
E. Channel 2 Common Emitter One stage $I_E = 3$ mA	27	12	$4\frac{1}{2}$	22	$2\frac{1}{2} : 1$ (refer Fig. 7c)		

Configuration A or B can be used with C, D or E using the coupling arrangements discussed in Section 7 (a).
Markers not specified in photographs are at multiples of 10 Mc/s.

This would require a neutralising component which is in fact, a negative admittance. So that neutralising can be achieved using a positive capacitance, the transformer has to be an inverting type, i.e. Y_N becomes equal to $-y_{12e}$. In practice, some allowance must also be made for stray capacitive feedback.

Over a 3 : 1 frequency range, y_{12e} exhibits approximately a 3 : 1 change. This, with a suitable wide-band transformer (Section 6) opens the way for wide-band common emitter units.

The stability factor A (which must be appreciably greater than unity) is given by:

$$A = \frac{(g_{11} + g_e)(g_{22} + g_L)}{|y_{12}| |y_{21}|} \cdot \frac{2}{[1 + \cos(\phi_{12} + \phi_{21})]}$$

where g_L is an additional damping conductance introduced into the output circuit in order to ensure stability when the output lead is disconnected.

In the common base configuration, stability problems will be worse at higher frequencies where the total loop phase shift is approximately zero.

6. Wide-Band Transformers

Some interesting wide-band "baluns" have been developed, all of the auto-transformer type. Both primary and secondary consist of a small number of turns of 24 B & S enamelled copper wire, bifilar wound circumferentially on a small Ferroxcube double-bead, type 56 390 31/4B. Briefly they are:

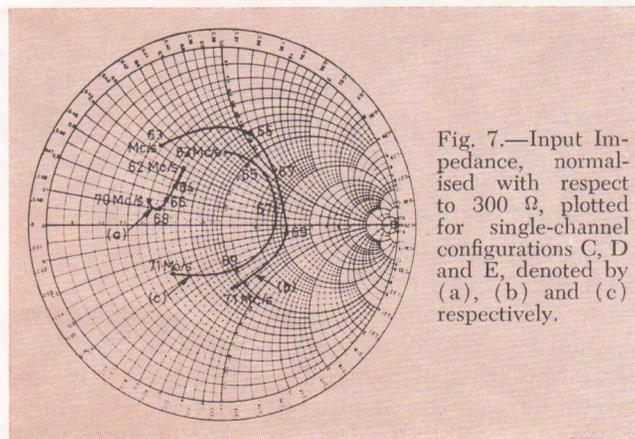

Fig. 7.—Input Impedance, normalised with respect to 300 Ω, plotted for single-channel configurations C, D and E, denoted by (a), (b) and (c) respectively.

(a) $8\frac{1}{2}$ t, centre-tapped, with additional tap $3\frac{1}{2}$ t removed from this—for noise and wide-band gain measurements on 300 Ω balanced systems using 50 Ω unbalanced equipment.

(b) 10 t centre-tapped, for (i) converting 75 Ω unbalanced output to 300 Ω balanced, should this be desired, (ii) wide-band input arrangements for mast-head units, (iii) wide-band neutralising arrangements for common emitted stages (in a 1 : 1 balanced configuration).

All units were checked, on a back-to-back basis, for insertion loss in a 50 Ω system, providing losses per unit as tabulated.

TABLE 1
INSERTION LOSSES OF BROAD-BAND AUTO-TRANSFORMERS

Freq. (Mc/s)	75 : 300 Ω "balun" (dB)	50 : 300 Ω "balun" (dB)
40	0.2	0.6
100	0.1	0.4
200	0.2	0.2
350	3	1.8

7. Experimental Amplifiers

Printed wiring technique with its low wiring capacitance, provides a high degree of reproducibility from prototype to production sample. Fibreglass board was used as most of the synthetic-resin bonded-paper boards tested had significant losses at 200 Mc/s at impedance levels as low as 300 Ω . For the $\frac{1}{16}$ " board used, the copper thickness was .001".

Experimental interchanging of transistor configuration was simple with the layout adopted.

Figure 6 shows circuit diagrams and parts list for all configurations tested.

(a) Factors common to all Configurations

All configurations possess identical bias arrangements, chosen so as to provide extremely good temperature stabilisation, to present only a small conductance across the transistor input terminals (noise considerations) and to investigate the effects of various values of I_E (5 K Ω potentiometer).

In addition they all use a capacitive tap arrangement in the input circuit in order to provide a satisfactory compromise between noise and power match. This is based on the considerations of Section 5 (b). The arrangement of the tapping capacitors also helps preserve a better degree of balance on the input line.

Each low-band configuration is provided with a wide-band π coupler section⁽⁶⁾ in the output circuit, coupling to a 75 Ω output impedance. This comprises C_{24} , C_{25} and L_3 . Where a low-band output is to be combined with that of a high-band, the former is connected, through the small tapped section of the high-band output coil to the 75 Ω line. The high-band output coil then connects to ground through the 33 pF of the low-band π coupler, coil L_3 presenting a high impedance to higher frequencies. This arrangement has proved quite satisfactory, no interaction effects being observed. VSWR at the output terminals remains within 3 : 1 over a wide range of frequency. The importance of down-lead mismatch has been dealt with by Wiemers⁽⁷⁾.

Transistor lead-lengths are cut to about $\frac{1}{2}$ ". All earth by-passing is accomplished by low inductance, broad band, ceramic feed-through type capacitors. Ferroxcube-cored chokes (grade 4B) are used for isolating DC and RF circuits.

Stability requirements (Section 5 (c)) have been met by means of resistors R_4 , R_8 and R_{12} .

(b) Specific Points concerning the Experimental Amplifiers

In Table 2 a comparison is made between each of the amplifiers constructed. However, some further specific details are as follows:

Configurations (A) and (B) possess an over-coupled double-tuned input circuit, which besides providing sufficient bandwidth for Ch's. 7, 8 and 9 also helps preserve balance on the input line. To preserve input line balance, the low-band circuits use a bifilar-wound shell type 1 : 1 transformer with isolated primary and secondary. For the low-band circuits, input circuit tuning is carried out by adjusting a small coil, L_2 .

For convenience, the inter-stage coupling in (B) is arranged on a 50 Ω basis, which approximates closely to a power match. The transformers T_2 and T_3 are both overcoupled to about the same extent.

A capacitively top coupled transformer T_5 is adopted for the single-channel low-band circuits (C), (D) and (E). The use of Ferroxcubana cores, with only a few turns of wire, both simplifies the manufacture of the coils and reduces their overall size.

Configuration (D) is approximately neutralised by means of the 1 : 1 reversing transformer L_5 and the capacitor C_{27} of approximately 1 pF, provided by a Philips glass bead lead-in.

8. Further Information

Space considerations have precluded mention of such details as power supply arrangements and measuring techniques. Advice on these, and other details, is available on request.

(This investigation was carried out in the "Miniwatt" Electronic Applications Laboratory by A. J. Erdman, assisted by N. A. Steadson.)

References

- (1) Valvo source.
- (2) J. M. Stewart—Noise Figure of Junction Transistors—*Proc. I.E.E.*, Paper 2973 E.
- (3) E. G. Nielsen—Behaviour of Noise Figure in Junction Transistors—*Proc. I.R.E.*, Vol. 45, pp. 957-963, July 1957.
- (4) H. Cooke—Letter in *Proc. I.R.E.*, March 1961, p. 648.
- (5) F. R. Lackey—Receiving Antenna and Distribution Systems for operation of Multiple Television Receivers—Paper delivered at I.R.E. Aust. Conv., March 20-25, 1961.
- (6) H. B. Yin—Calculating Bandwidths for Matching Networks—*Electronic Industries*, July 1960, pp. 70-74.
- (7) F. J. Wiemers—Einfluss der Anpassung der Empfangsantenne und des Empfangereingangs auf die Bildgüte—*Radio Mentor*, No. 4, 1961, pp. 280-285.



A 4-VALVE 12 W PUBLIC ADDRESS AMPLIFIER

Performance Specifications

Rated power output	12 W
Total harmonic distortion (at rated power output and 1 Kc/s)	2.3%
Sensitivity for rated output:	
at PU input	480 mV
at Microphone input	4.5 mV
Frequency response (measured at PU input):	
for 0.5 W output	-1 dB at 11 c/s, -3 dB at 10 Kc/s
for rated output	-3 dB at 19 c/s and 15 Kc/s
Treble cut	-10 dB at 3.5 Kc/s
Feedback	8 dB

A simple medium-power Public Address amplifier is described. It has inputs for crystal pick-ups and high-impedance microphones, and mixing facilities are provided. The basic amplifier (two 6GW8's) is ideally suitable for the incorporation of an AC107 hybrid-type transistor pre-amplifier, as previously described in "Digest". This would then also provide an inexpensive complete amplifier for use with dynamic microphones.

The amplifier described in this article is both simple and straightforward, using the pentode sections of two 6GW8 triode-pentodes in a push-pull output circuit. The initial design considerations for such an amplifier were discussed in a previous issue of the *Digest*⁽¹⁾, and are briefly:

- (i) The pentode operating conditions for Class AB with 300 V supply (page 38).
- (ii) "Arrangement (b)" for the triode section in which one triode is applied as phase splitter and the other triode as voltage amplifier (pages 38 and 39).

For applications where a sensitivity of approximately 350 mV for full rated output is sufficient, or where full rated output is not required, the basic amplifier with only two 6GW8's will be adequate (e.g. with crystal or ceramic pick-ups). Where it is desired to use a microphone, additional gain must be provided by a pre-amplifier stage. The present amplifier includes such a stage, using an EF86 pentode, and this arrangement is suitable for all high-impedance microphones commonly employed in public address service. However, if the source is a low-impedance microphone then either a step-up transformer must be added, or alternatively the

entire EF86 stage can be replaced by a hybrid type transistor pre-amplifier stage⁽²⁾, no transformer then being required. In this case it is only necessary to adjust the decoupling network (R_7 , C_4), the mixing arrangements requiring no alteration.

Provision is made for independent mixing of both microphone and PU inputs.

CIRCUIT DESCRIPTION (see Fig. 1)

Input Circuit

A simple resistive adder network has been used as mixer.

The microphone pre-amplifier stage provides a basic voltage gain of (170 \times), but this figure is reduced to about (107 \times) by the mixing network, mainly due to losses in resistor R_8 . Similarly, the basic sensitivity of the PU input is reduced by resistor R_9 . These resistors are necessary to obtain satisfactory isolation between the two inputs.

A simple treble-cut tone control R_{10} - C_5 is also included in the input circuit.

Voltage Amplifier and Phase Splitter

One triode section of the 6GW8 pair is used as voltage amplifier to produce the required drive for the output stage. Since the cathodyne phase splitter (second triode section) does not contribute to the overall gain, the voltage-amplifying stage must provide the maximum possible amplification. Miller effect becomes noticeable in this high-gain triode stage due to the high

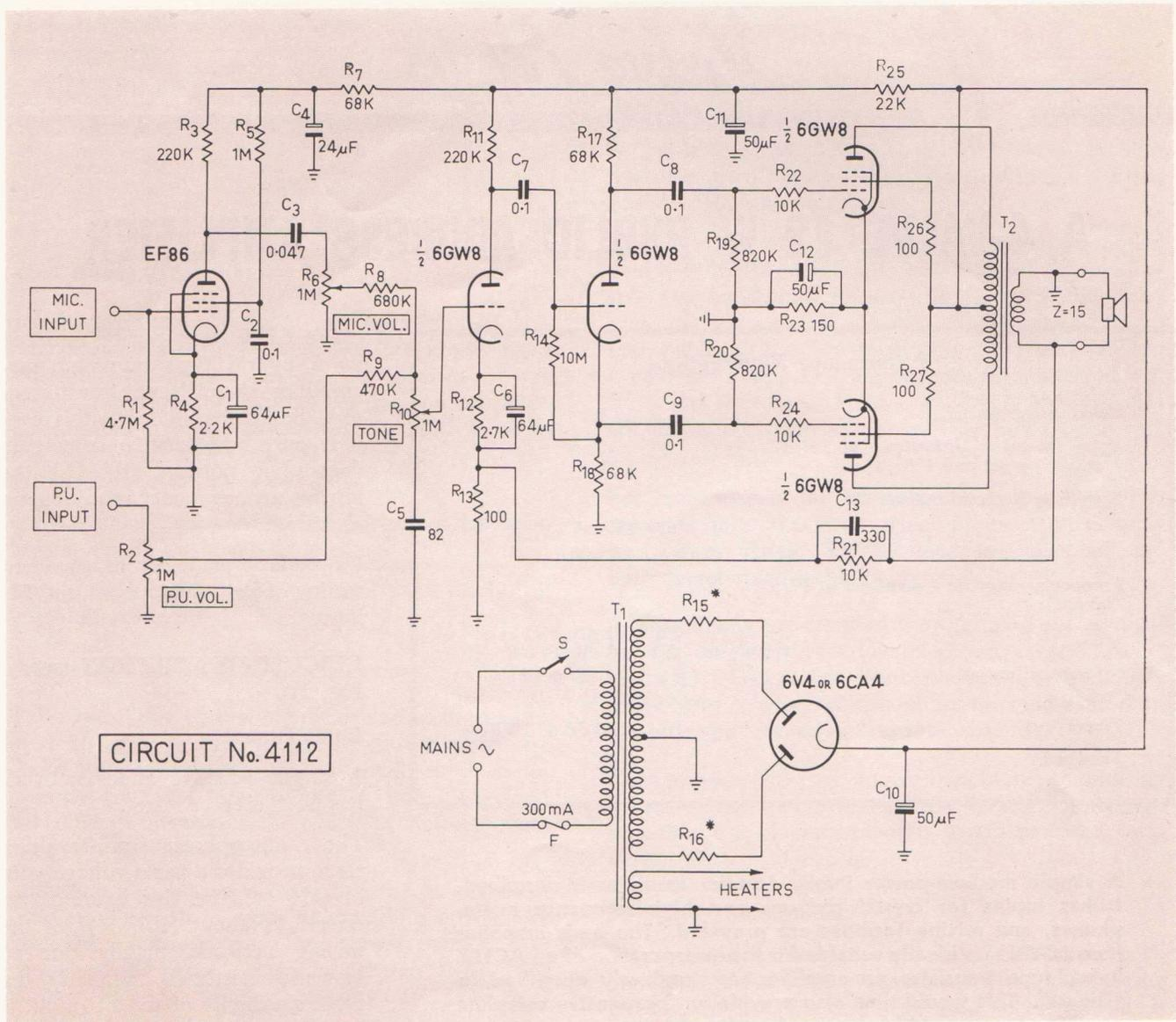

CIRCUIT No. 4112

Parts List

R ₁	4.7 M Ω	R ₅	1 M Ω	R ₁₂	2.7 K Ω	R _{17, 18}	68 K Ω, 5%
R _{2, 6, 10}	1 M Ω log.	R ₇	68 K Ω, 1 W	R _{13, 20, 27}	100 Ω	R _{19, 20}	820 K Ω
R _{3, 11}	220 K Ω	R ₈	680 K Ω	R ₁₄	10 M Ω	R _{21, 22, 24}	10 K Ω
R ₄	2.2 K Ω	R ₉	470 K Ω	*R _{15, 16}	150 Ω, 3 W, WW (for 6V4) 180 Ω, 3 W, WW (for 6CA4)	R ₂₃	150 Ω, 2 W
		R ₁₀	470 K Ω			R ₂₅	22 K Ω, 1 W

All resistors, 10%, ½ W unless otherwise stated. Use of Cracked Carbon Resistors is recommended for this amplifier (Philips series B8 305 05 (½ W) and B8 305 06 (1 W)).

C _{1, 8}	64 μF, 10 VW electrolytic (Philips type C425AL/D64)	C ₅	82 pF mica, or ceramic, 10% (Philips type C304AB/A82E)
C _{2, 7, 9, 0}	0.1 μF 400 V polyester (Philips type C296AC/A100K)	C _{10, 11}	50 μF, 350 VW electrolytic
C ₃	0.047 μF, 400 V polyester (Philips type C296AC/A47K)	C ₁₂	50 μF, 25 VW electrolytic (Philips type C425AL/F50)
C ₄	24 μF, 300 VW electrolytic	C ₁₃	330 pF mica, or ceramic, 10% (Philips type C304AH/A330E)

T ₁	Power transformer: 80 mA, 2 × 285 V, e.g., Ferguson PF170 or A & R 1885 100 mA, 2 × 285 V, e.g., Ferguson PF130 or A & R 1889	S	S.P.S.T. toggle switch
T ₂	Output transformer: 10 K plate-plate, multi-tapped secondary, 15 W, e.g., Ferguson OPM7 or A & R 2628	F	300 mA fuse
		4	Noval valve sockets (Philips ceramic type B8 700 21)

Fig. 1—Circuit details of "Miniwatt" 12 W Public Address Amplifier.

grid-circuit impedance, and it is this which limits the high-frequency response.

Output Stage

The two 6GW8 pentode sections operate in push-pull Class AB. The optimum load for 300 V supply voltage is given as $9,100 \Omega^{(1)}$. Transformers having such a primary impedance are not available as stock items from manufacturers. However, medium fidelity transformers with 8 and 10 K Ω impedance plate-plate and 15 W power rating are readily available at a reasonable price and give good results. The sample amplifier was tested with such a 10 K Ω transformer.

Feedback voltage from the output transformer secondary winding is injected into the cathode circuit of the triode voltage amplifying stage to provide approximately 8 dB of feedback. The distortion characteristic and frequency response of the amplifier are shown in Figs. 2 and 3 respectively and are quite adequate for PA service.

Power Supply

A thermionic valve rectifier is used in the power supply since it is, at the present time, cheaper than silicon diodes for the DC output current required. The HT current drawn by the amplifier varies from approximately 72 mA to 93 mA between zero-drive and full-drive conditions. As the amplifier will rarely, if ever, be driven in practice with a continuous signal for full rated output, the average HT drawn will generally not rise much above 80 to 83 mA. Under these conditions it is possible to use a 6V4 rectifier (maximum current 90 mA); alternatively a heavier duty 6CA4 could be adopted. For the same reason, it is possible to use a standard mains transformer with a secondary rating of $2 \times 285 \text{ V}$, 80 mA, particularly since the heater requirements will be considerably less than that for which it is rated. The Parts List of Fig. 1 includes suitable types with both 80 and 100 mA ratings.

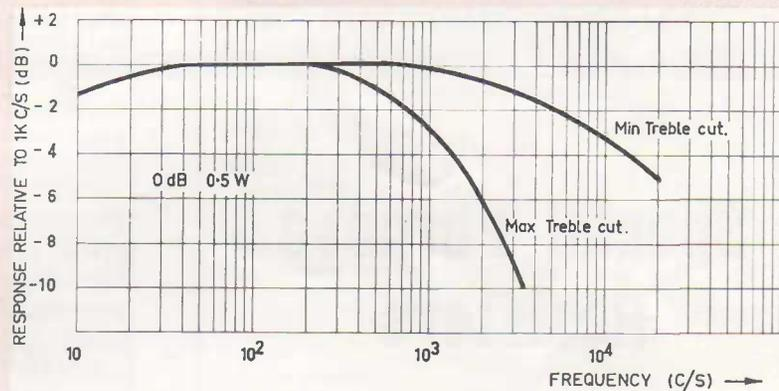

Fig. 2—Distortion characteristic at 1 Kc/s.

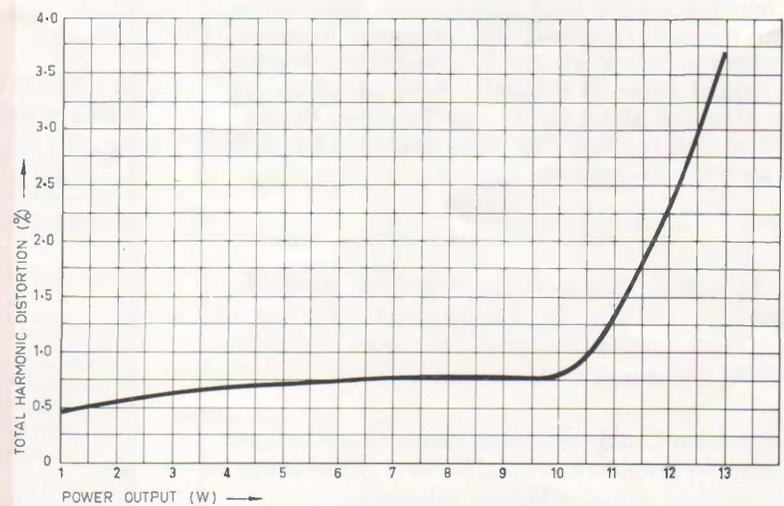

Fig. 3—Frequency response (measured at PU input) and tone control action.

The values of the current-limiting resistors R_{15} and R_{16} depend on the type of rectifier as indicated in the Parts List.

DC Voltage Analysis of Amplifier

	Voltage	Meter range
6GW8		
Pentode plate	300 V	300 V
Pentode screen	305 V	1200 V
Pentode cathode	9.8 V	12 V
Triode plate (phase splitter)	191 V	300 V
Triode cathode (phase splitter)	63 V	120 V
Triode plate (driver)	162 V	300 V
Triode cathode (driver)	1.3 V	3 V
EF86		
Plate	79 V	300 V
Screen grid	81 V	300 V

Cathode	1.5 V	3 V
C_{10}	305 V	1200 V
C_{11}	255 V	300 V
C_4	205 V	300 V

Voltage readings were taken with a 40 K Ω /V Philips voltmeter on the ranges indicated and under no-signal input conditions. All voltages were measured with respect to ground.

(This article is based on work carried out in the "Miniwatt" Electronic Applications Laboratory by P. Heins and J. Clark.)

References

1. P. Heins and J. Clark, Miniwatt "Twin Ten" Amplifier, *Miniwatt Digest*, Vol. 1, No. 3, Dec. 1961.
2. T. Davis, AC107 Low-Noise Transistor offers Advantages in Pre-Amplifier Design, *Miniwatt Digest*, Vol. 1, No. 2, Nov. 1961, p. 26.

Special Purpose Resistors

In industrial and communications equipment there is frequently a need for reliable resistors capable of meeting a more rigid performance specification than normally required for consumer products. For such purposes, Philips manufactures a number of special types of resistors, three of which are the Moulded Metal Oxide, the Precision Cracked Carbon and the Precision Wire Wound, each with its own special features.

The Moulded Metal-Oxide resistors have been designed specifically for miniaturised transistor circuits. Their special features are small dimensions, low-noise, moisture-resistance and stability.

The Precision Cracked-Carbon resistors are low-noise, high-stability resistors, available in a wide range of values in close initial selection tolerances.

The Precision Wire-Wound resistors feature very close initial selection tolerances together with a very high long-term stability.

The characteristics of each type are listed in the accompanying tables.

In addition to these three types of resistors, the Philips range includes low-reactive wire-wound resistors and vitreous-enamelled wire-wound load resistors which are not described further here, but details will be supplied on request.

Factors in Selection of a Resistor

Where resistance value is critical, the circuit designer is faced with the task of ensuring that the component he chooses will remain within an acceptable tolerance of the nominal value over a long period. In order to determine the variation in value, he must take into account such factors as temperature coefficient, long-term stability and voltage coefficient. It is only after considering all these factors that he is able to specify a type and a selection tolerance which will ensure an overall acceptable limit.

Where extreme precision is essential, the wire-wound type of resistor will be the obvious choice. In many cases requiring precision, but where the cost of the wire-wound resistor is not justified, the cracked-carbon resistor will be chosen. This applies particularly where high values, high frequencies or low noise are factors to be considered.

The metal-oxide resistor, having a better stability than the normal composition types, offers the further advantages of very small dimensions and relatively low cost.

In Fig. 1, the size of a metal-oxide resistor is compared with that of a typical carbon composition resistor also capable of dissipating 0.5 W at 70° C.

Fig. 2 shows the power derating curves for each type of resistor at higher temperatures.

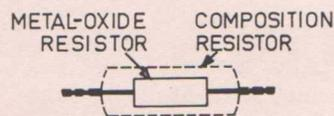

Fig. 1.—Size of a Moulded Metal-Oxide resistor compared with a conventional composition resistor. The rated dissipation of both resistors at 70° C is 0.5 W.

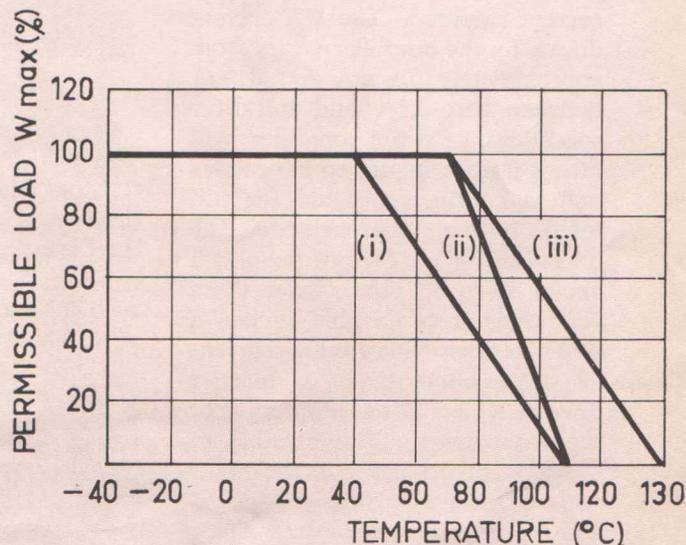

Fig. 2.—Power derating at high ambient temperatures for Philips resistors: (i) Precision Wire-Wound, (ii) Precision Cracked-Carbon, (iii) Moulded Metal-Oxide.

Type Numbers

A resistor is completely specified by a type number, the first part of which may be determined from the accompanying tables of characteristics. This is followed by a number and letter denoting the value, as shown in the following typical examples:

Description	Type Number
1 M Ω \pm 1%, 0.25 W, Cracked Carbon	E003AC/D1M
1.5 K Ω \pm 5%, 0.5 W, Metal Oxide	E004AD/B1K5
100 Ω \pm 0.25%, 1.2 W, Wire Wound	83513F/100E

(The letter E following all values below 1000 Ω indicates the decimal point.)

PRECISION WIRE WOUND RESISTORS TYPES 83510 / ... to 83524 / ...

General Characteristics

Temperature Range	-55° C to +110° C
Stability (change in R after 1000 hrs. at W_{max} at 40° C)	\pm 0.25%
Temperature Coefficient	\pm 0.0025%/C°
Tolerance	\pm 0.5% (E), \pm 1.0% (D), \pm 2.0% (C), \pm 5.0% (B) for all types, with the addition of \pm 0.25% (F) for types 83510 to 83514 (incl.). (Letter in brackets follows first five figures of type number.)
Resistance Values	R24 series (24 values per decade)

Type	Resistance (Ω)	Max. Dissipation W_{max} at 40° C (Watts)
83510 / ... 83520 / ...	1—250 251—2.55 K	0.4
83511 / ... 83521 / ...	3—670 671—6.0 K	0.6
83512 / ... 83522 / ...	6—1.34 K 1.35 K—12.1 K	0.7
83513 / ... 83523 / ...	17—3.65 K 3.66 K—33 K	1.2
83514 / ... 83524 / ...	25—6.3 K 6.31 K—37 K	1.8

PRECISION CRACKED CARBON RESISTORS TYPE E003 / ...

General Characteristics

Temperature Range	-40° C to +110° C
Stability (change in R after 1000 hrs. at W_{max})	<1.5% for values up to 91 K <2.5% for values above 91 K
Temperature coefficient	-0.02%/C° to -0.03%/C° for values up to 91 K -0.03%/C° to -0.06%/C° for values above 91 K
Voltage coefficient	<0.1%
Noise potential	<0.5 μ V/volt applied
Peak voltage	500 V for 0.125 W rating 700 V for 0.25 W rating 1000 V for 0.5 W rating 1400 V for 1.0 W rating
Resistance Values	R24 series (24 values per decade)

Resistance (Ω)	Max. Dissipation W_{max} at 70° C (Watts)	Tolerance (%)	Type
10—0.62 M	0.125	\pm 1 \pm 2 \pm 5	E003AB/D... E003AB/C... E003AB/B...
10—1.0 M	0.25	\pm 1 \pm 2 \pm 5	E003AC/D... E003AC/C... E003AC/B...
10—1.6 M	0.5	\pm 1 \pm 2 \pm 5	E003AD/D... E003AD/C... E003AD/B...
10—1.6 M	1.0	\pm 1 \pm 2 \pm 5	E003AG/D... E003AG/C... E003AG/B...

MOULDED METAL OXIDE RESISTORS TYPE E004AD/B

General Characteristics

Temperature Range	-55° C to +130° C
Stability (change in R after 1000 hrs. at W_{max} at 70° C)	< 5.0%
Temperature Coefficient	Low values +0.07%/C° max. High values -0.07%/C° max.
Voltage coefficient	< 0.1%
Noise potential	< 1 μ V/volt applied
Resistance values	R12 series (12 values per decade)

Resistance (Ω)	Max. dissipation W_{max} at 70° C (Watts)	Tolerance (%)
10—15 K	0.5	\pm 5.0



Actual size

MIL-R-11C style RC-20

TRANSISTOR DISSIPATION IN CLASS B OUTPUT STAGES

In a transistor Class B output stage, the peak instantaneous collector dissipation exceeds the average dissipation by a factor of several times. Overheating of the transistor junctions can occur at low frequencies where the period is comparable to transistor thermal time constant, and where the design is based on maximum average junction temperature rating (T_{jmax}).

A simplified design is used to illustrate the problems of low frequency operation.

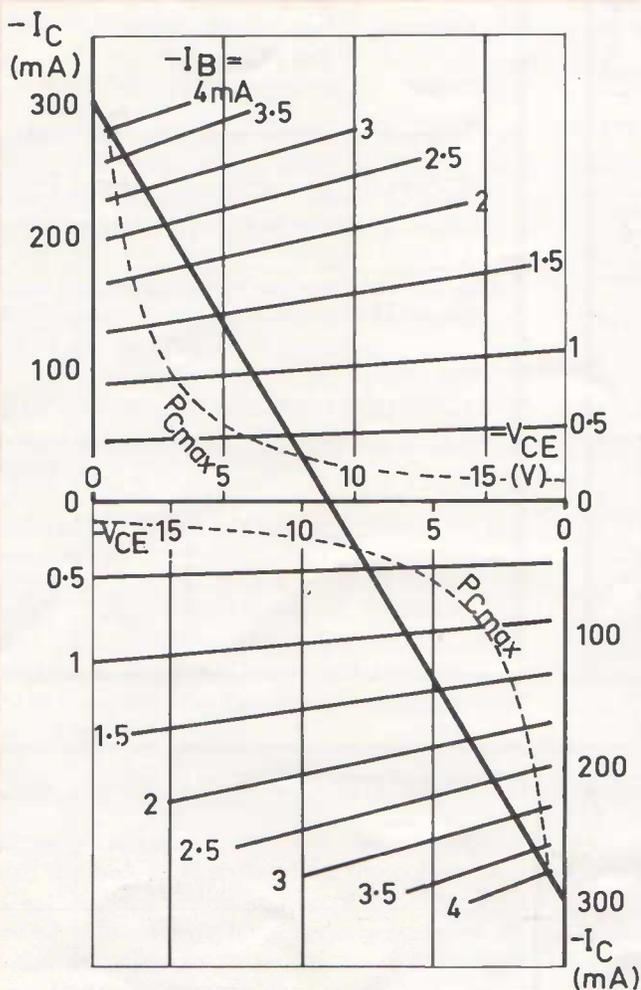

Fig. 1.—Composite characteristic for 2-OC74 in Class B push-pull.

Assume idealized transistors and output transformer (i.e. bias at $I_C = 0$, $I'_{CO} = 0$, $V_{CEK} = 0$, and lossless transformer), then the minimum load resistance R_L per transistor is given by:

$$R_L = \frac{V_{CC}^2}{\pi^2 P_{Cmax}} \quad (1)$$

where V_{CC} = supply voltage

and P_{Cmax} = maximum value of average collector dissipation per transistor.

It is important to note that P_{Cmax} occurs, not at full output, but when the power output (P_o) is given by⁽²⁾:

$$P_o = \left(\frac{4}{\pi^2}\right) P_{o_{max}} = 0.404 P_{o_{max}} \quad (2)$$

where $P_{o_{max}}$ = maximum output power (two transistors), or when

$$I_C = \left(\frac{2}{\pi}\right) I_{C_{max}} \quad (3)$$

where $I_{C_{max}}$ = maximum collector current.

There is a further design constraint arising from maximum permissible collector current, and this must be carefully checked since in many cases it is possible to satisfy the restriction of P_{Cmax} and not $I_{C_{max}}$.

Assume a situation using the 2-OC74 with $V_{CC} = 9$ V, the design aim being to obtain maximum output power.

Since I_{Cmax} is 300 mA, then R_L is limited to:

$$\frac{V_{cc}}{I_{Cmax}} = \frac{9}{300 \times 10^{-3}} = 30 \Omega \text{ minimum.}$$

Hence from Eqn. (1), $P_{Cmax} = 274$ mW.

(A curve representing P_{Cmax} is shown on the composite output characteristics Fig. 1.)

The average collector dissipation per transistor at maximum output power is given by:

$$P_c = \left(\frac{1}{\pi}\right) V_{cc} I_{Cmax} - \frac{I_{Cmax}^2 R_L}{4} \quad (4)$$

On substitution of values, $P_c = 184$ mW.

The thermal considerations are expressed by the thermal equation:

$$T_{jmax} = T_{amb} + K P_{Cmax} \quad (5)$$

where T_{jmax} and T_{amb} are the maximum junction and ambient temperatures respectively, and K = total thermal resistance (i.e. 0.09 C°/mW for a heat sink of 2 sq. in.).

A load line for the 30Ω load resistance calculated is drawn on the composite characteristics. It will be noted that the load line crosses the maximum dissipation curve; therefore during part of the cycle the instantaneous dissipation exceeds the calculated average dissipation.

Fig. 2 shows the instantaneous collector dissipation for a single transistor over a cycle, for two conditions of input signal. Curve (a) represents the case with sufficient drive for full output. As the drive is reduced, the points labelled A, B and C move towards the point O. New positions for these points are shown as A', B' and C' on curve (b). This curve represents the case of maximum value of average collector dissipation and occurs when Equation (3) is satisfied. When the drive is reduced further such that $I_c = 0.5 I_{Cmax}$, the curve exhibits a single peak at point O. For $I_c < 0.5 I_{Cmax}$, the amplitude of this peak diminishes along a vertical axis through O.

Curve (b) represents the worst case since the average dissipation is ex-

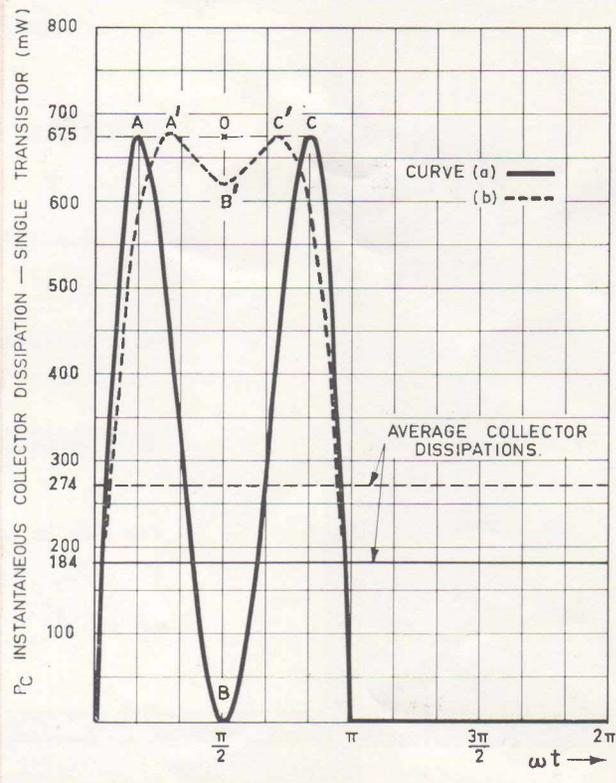

Fig. 2.—Variation of collector dissipation over one cycle (shown for single OC74 in Class B push-pull). Curve (a) at full output power (P_{omax}). Curve (b) at $P_o = 0.404 P_{omax}$.

ceeded for a longer period of the cycle than for any other condition of drive. When the period of the signal frequency is comparable to the thermal time constant (t_{ω}) of the transistor, appreciable junction temperature cycling will occur.

Usually, it will be possible to approximate the curve (b) by the first two terms of a Fourier sine expansion having the form

$$p = P + \Delta p \sin 2 \pi f t \quad (6)$$

In a given design, the resultant peak periodic junction temperature variation ΔT_j may be specified to be less than an arbitrary constant ϵ , i.e. $\Delta T_j < \epsilon$.

For convenience, this variation may be normalised with respect to $K\Delta p$, resulting in a new (dimension-

$$\text{less) constant } \epsilon', \text{ that is, } \frac{\Delta T_j}{K\Delta p} < \epsilon'.$$

In order for this condition to apply⁽³⁾,

$$f > \frac{1}{8t_{\omega}} \sqrt{\frac{1 - \epsilon'^2}{\epsilon'^2}} \quad (7)$$

Generally, for audio work, values of minimum frequency will be of the order of 10 c/s. Provided that the thermal time constant of the transistor is large compared with the period of the lowest frequency amplified, the fact that the instantaneous dissipation exceeds the average dissipation will be of little consequence.

(This information has been compiled by T. Davis of the "Miniwatt" Electronic Applications Laboratory.)

References

1. Wolfendale, E. The Junction Transistor and its Applications (First Ed.), p. 152.
2. Joyce & Clarke. Transistor Circuit Analysis (First Ed.), p. 189.
3. Valvo Technical Information, T19, July 1961.
4. Valvo Berichte, Vol. 6, No. 1, June 1960.

PHILIPS

- ELECTRONIC VALVES AND TUBES
 - SEMICONDUCTOR DEVICES
- CATHODE-RAY TUBES
 - LIGHT-SENSITIVE DEVICES
- TEMPERATURE-SENSITIVE DEVICES
 - FERRITES
- RADIATION-SENSITIVE DEVICES
 - FINE WIRES
- SPECIALIZED COMPONENTS AND DEVICES
 - SPECIALIZED MATERIALS
- TECHNICAL PUBLICATIONS

For Use in the Fields of—

ENTERTAINMENT — COMMUNICATIONS — INDUSTRY
COMMERCE — MEDICINE — SCIENTIFIC RESEARCH
AND DEFENCE



THE *Miniwatt* ELECTRONICS DIVISION

of

Philips Electrical Industries Pty. Limited

20 Herbert Street, Artarmon, N.S.W.

Phone 43 2171

Branches at—

ADELAIDE	11-13 West Terrace, Adelaide, S.A., phone 51 6051
BRISBANE	56-58 Cordelia Street, South Brisbane, Qld., phone 42 471
CANBERRA	C.B.C. Chambers, Petrie Street, Civic Centre, Canberra City, A.C.T., phone J 4498
HOBART	73 Brisbane Street, Hobart, Tas., phone 3 3038
MELBOURNE	590 Bourke Street, Melbourne, Vic., phone 60 1321
NEWCASTLE	194 Parry Street, Newcastle West, N.S.W., phone MA 5001
PERTH	672 Murray Street, Perth, W.A., phone 21 3131
SYDNEY	67 Mars Road, Lane Cove, N.S.W., phone 42 1261
WOLLONGONG	139A Prince's Highway, Fairy Meadow, N.S.W., phone 2 6055

Production Centre—

HENDON WORKS Tapley's Hill Road, Hendon, S.A., phone 4 5021

The information given in this publication does not imply a licence under any patent. Further information on the products described in this publication may be obtained on application to any of the addresses listed above.