

Friday, October 24, 1924

WIRELESS WEEKLY

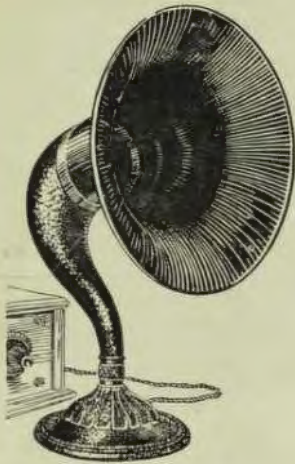

# Loud Speakers

## that give you radio as you OUGHT to hear it!



A good Loud Speaker is the ideal means of hearing radio at its best. The whole family can sit in cool comfort and listen in without the bother of adjusting earphones. Choose one of these supreme Loud Speakers for lasting satisfaction.

There is not one, but several perfect Loud Speakers from which to make your choice. United Distributors Limited hold the Australian agency for all these:

**MUSIC MASTER LOUD SPEAKER.**—This has a resonant wood amplifying bell, which neutralises all mechanical effects, and produces a remarkable volume of clear, pure tone, free from muffling or distortion—a life-like re-creation of the original. As illustrated above ..... £12

**ATLAS LOUD SPEAKER.**—The "Musician of the Air." Its scientific design, with careful fabrication and assembly, goes far to compensate for any shortcomings of broadcasting. It gives you the programmes clearly, sweetly and naturally ..... £7/10/

**SIGNAL LOUD SPEAKER.**—Of special shape and construction, as illustrated on top of Radiovox Cabinet at foot of page. Strong and sweet ..... £4/15/-

**BRANDE'S TABLE TALKER.**—"Known the world over" ..... £4/15/-

ALL RADIO DEALERS CAN SUPPLY YOU.

## United Distributors Ltd.

(Wholesale Only)

72 Clarence Street  
SYDNEY.

592 Bourke Street  
MELBOURNE.

and at Brisbane, Adelaide, Perth, Hobart,  
Wellington.

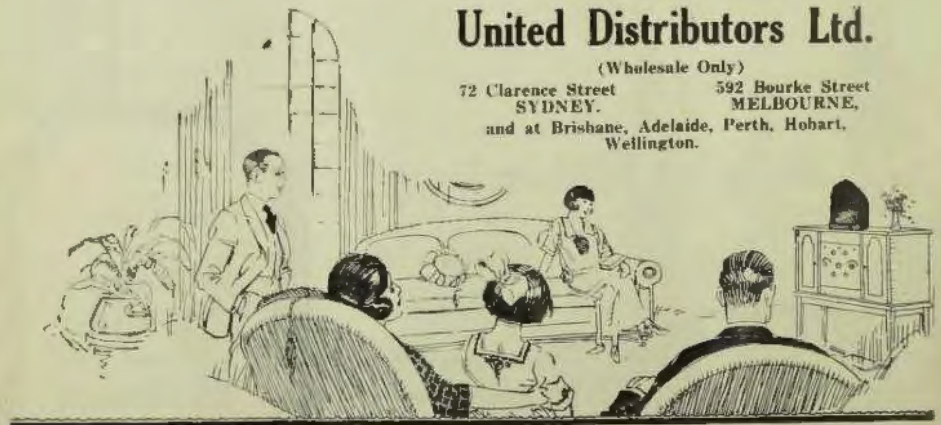

# **AT LAST!**

## **A Fixed Detector Worth While**

No more fussing about with tiresome catswhiskers

Instal a

## **“Volmax” Fixed Detector**

and listen in without interruption.

PRICE . . . . . 8/3 each

Have you seen our new model Single Valve Crystal Outfit.

The Reflex Circuit used gives the clarity of a Crystal Set, combined with a volume of a two valve outfit.

Well designed in handsome Maple Cabinet, with compartment for batteries (dry cell)

**NO ACCUMULATOR BATTERIES REQUIRED**

PRICE COMPLETE WITH ALL ACCESSORIES . . . . . £15/15/-

**WIRELESS SUPPLIES LTD.**

21 ROYAL ARCADE & 329A GEORGE STREET, SYDNEY

PHONE M3378

## You can depend *THOROUGHLY* on **Frost Guaranteed Parts**

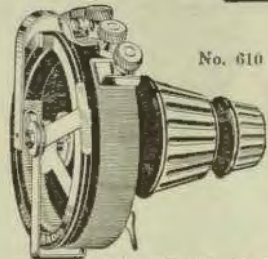

No. 610

**FROST-RADIO Bakelite Tube Control Unit.**

Called for Short: "Pot-Rheo."  
Made of maroon bakelite. Combines in one unit rheostat with vernier, and potentiometer, with two-knob control. All controls work with extreme smoothness. A valuable addition to any set.

No. 607, 6 ohms Vernier and 200 ohms Potentiometer . . . . . 17/6  
No. 610, 35 ohms Vernier Rheostat and 400 ohms Potentiometer . . . . . 17/6

**FROST-RADIO Rheostats and Potentiometers.**

Precision adjustment. Pieces of apparatus that reflect quality.  
Nos. 650-2. Maroon Bakelite 8 and 30 ohm Rheostats . . . . . 7/3  
Nos. 651-3. Same with Vernier . . . . . 9/6  
No. 654. 400 ohm Potentiometer . . . . . 9/6  
Nos. 600-2. Metal Frame 8 and 30 ohm Rheostats . . . . . 5/0  
Nos. 601-4. Same with Vernier . . . . . 7/6  
Nos. 603-5. 400 and 200 ohm Potentiometers . . . . . 5/6



**FROST FONES.**

Made with watch-like precision to respond to the extremely small electrical currents of radio reception. While remarkably sensitive, they also are sturdy enough for many years of use.

No. 101. Frost Fones, 2,000 ohm, Aluminium Head Pieces . . . . . 32/6  
No. 171. Frost Fones, 3,000 ohm, Aluminium Head Pieces . . . . . 37/6  
No. 172. Frost Fones, 3,200 ohm, Maroon Bakelite Head Pieces . . . . . 45/-

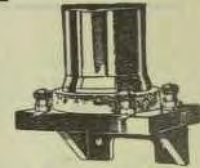

**FROST-RADIO**

No. 618

**FROST-RADIO**

Sponge Base Sockets.

No. 618. Moulded Bakelite Shock Absorber Socket for standard Base Valves . . . . . 6/3  
No. 617. Same for U.V. 100 Valves . . . . . 6/3  
No. 612. Moulded Bakelite Vacuum Tube Socket, Bakelite Panel, Maroon Finish, for U.V. 100 Valves . . . . . 5/-  
No. 107. Same for Standard Valves . . . . . 5/-  
No. 616. Compact gang of three Shock Absorber Sockets, for panel or table mounting, for U.V. 100 Valves . . . . . 24/0  
No. 619. Same for Standard Valves . . . . . 24/6

**FROST-RADIO.**

Jacks, all styles . . . . . 4/6 to 6/6  
Plugs, double & single, 4/6 & 5/-  
021. Parallel Switches . . . . . 5/-  
608. Push and Pull Battery Switches . . . . . 4/-  
400. Crystal Loose Couplers 75/-  
410. Crystal Tuning Coil Slider . . . . . 27/6

YOUR DEALER CAN SUPPLY ALL THESE!

### **UNITED DISTRIBUTORS LTD.**

(Wholesale Only)

72 CLARENCE ST., SYDNEY. 592 BOURKE ST., MELBOURNE.  
and at Adelaide, Perth, Brisbane, Hobart, Wellington.

*Murdoch's  
Efficient*

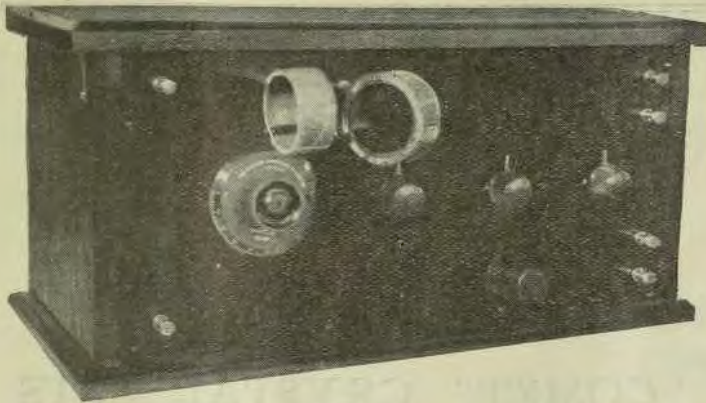

*Wireless  
Service*

## ASSEMBLE YOUR OWN VALVE SET

— UNDER THE MURDOCH SIMPLE SYSTEM —

**W**HY not make your own Set? It doubles the joy of Wireless. MURDOCH'S simple diagrams and instructions make success certain, and you have expert advice free for the asking. The only accessories required to complete the set are Valves, Batteries and Phones.

1 Valve Set . . . .	£5/5/-
2 Valve Set . . . .	£7/7/-
3 Valve Set . . . .	£9/9/-

### LATEST STOCKS TO HAND

#### VARIABLE CONDENSERS.

Made by the New York Coil Co., and is absolutely the finest Condenser sold, with Vernier Knob and Dial, .001 . . . . . 32/6  
Tunup Variable Condensers, plain .0005, 13/6  
.001, 18/6.

#### HEADPHONES

Murdoch's 2000 ohms, £1/7/6; 3000, £1/10/-  
Trimm's Dependable, 2400 ohms . . . . £1/12/6  
Baldwin's C Type, with Mica Diaphragm,  
4000 ohms . . . . . £3/15/-

#### VALVES.

A.P. Valves, Dull Emitter Type, 199 Socket  
and V.T. Socket . . . . . 25/-  
U.V. 201 A . . . . . 30/-

Skilled advice  
on all Radio  
matters given  
free

# Murdoch's

In Park Street Ltd, SYDNEY.

The World's Largest Men's & Boys' Wear Store

Kindly mention  
"Wireless  
Weekly"  
when writing.



**SENSATIONAL RADIO OFFER**  
*By* DAVID JONES'

**"COMET" CRYSTAL SETS**  
IN SILKY OAK CABINET  
**COMPLETE for 63/-**

Nothing more to buy! The "Comet" Crystal Set is complete—  
assembled—ready for installation. It comprises:— Crystal Set,  
crystal, cabinet, headphones, insulators and 100-ft. aerial wire.  
It has a receiving range of approximately 25 miles. Obtainable  
only at David Jones'. Price complete . . . . . 63/-  
Call at David Jones' Radio Department during the daily broadcast-  
ing sessions and test the "Comet" Crystal Set for yourself.

**HEADPHONES**

*at* **REMARKABLY LOW PRICES**

Extraordinary low pricing now announced by David Jones' for  
Headphones. These are highly sensitive and fully tested.  
David Jones' Special 'Phones, 2000 ohms. Pair . . . . . 21/-  
'Mello' Phones, 4000 ohms. Pair . . . . . 25/-

**WIRELESS ACCESSORIES**

Giblin Remler Honeycomb Coils for 3LO Melbourne  
200 Turns unmounted, 6/- Mounted . . . . . 10/-  
250 Turns unmounted, 6/9. Mounted . . . . . 10/9  
'Jumbo' Filament Switch. Price, each . . . . . 3/-  
Framingham Series Parallel Switch. Each . . . . . 5/6  
Fixed Condensers, all capacities. Priced from . . . . . 1/3

**DAVID JONES'**

FOR RADIO SERVICE

252 YORK STREET :: SYDNEY

ASK YOUR NEIGHBOR  
—HE KNOWS !!

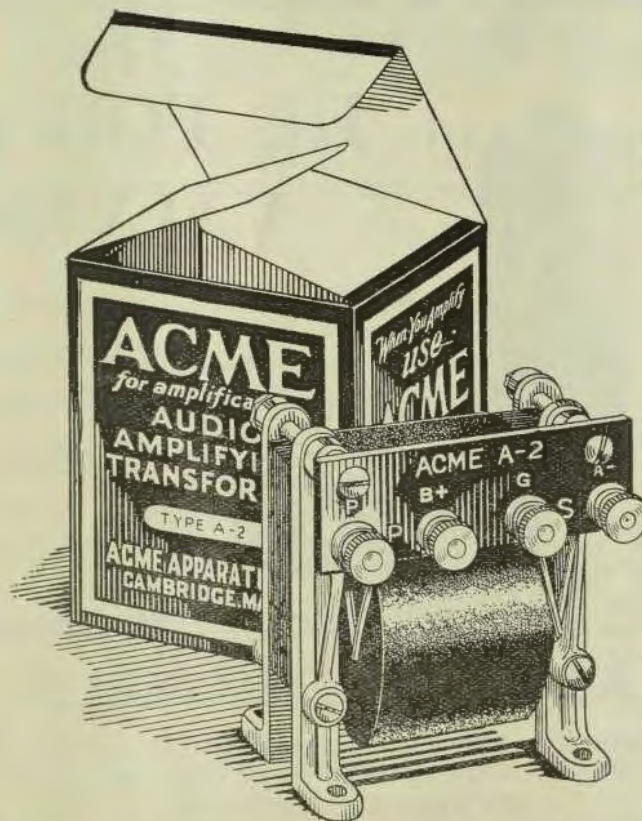

ACME A-2  
for volume

AT ALL  
GOOD  
STORES

Price  
35/-

ACME transformers are used by thousands of radio owners to get increased range and louder, clearer radio. ACME transformers give maximum amplification without distortion. Each transformer is tested and carries a guarantee tag. The name ACME is a guarantee of best results.

USE ACME TRANSFORMERS IN THE SET YOU BUILD.  
LOOK FOR THEM IN THE SET YOU BUY.

Wholesale  
Only

**P. H. CLARK LTD.**

38-44 CARRINGTON ST. SYDNEY

Phone: City 8469  
Box 914, G.P.O.

MADE BY



THE MAN WHO INVENTED BROADCASTING

30/- each



D.V.3 Filament, 3-v. .06 amp. Both types fit standard American Socket.  
D.V.2 Filament, 5-v. .25 amp.

# DE FOREST VALVES

TYPE D.V. 2.—Takes 5 volts at  $\frac{1}{4}$  amp. on Filament . . . . . 30/- each  
Plate Voltages, Detector . . 18-22 $\frac{1}{2}$  volts  
Plate Voltages, Amplifier . 60-150 volts

TYPE D.V. 3.—Takes 3 volts at .06 of an amp. on Filament . . . . . 30/- each  
Plate Voltage, 16-22 $\frac{1}{2}$  Volts, Detector  
Plate Voltage, 60-120 volts, used as an amplifier.

Both Types Fit Standard American Socket.

## RADION The SUPREME Insulation for Radio Panels.

Demand RADION — high-grade Knob and Dials, Knobs, Valve Sockets and Panels.

STOCKED BY ALL DEALERS.

(Wholesale Only)

## INTERNATIONAL RADIO COMPANY LIMITED

200 Castlereagh Street - - Sydney, N.S.W.  
Phone: MA 1387

Also at Melbourne, Adelaide, Perth, and Courtney Place, Wellington, N.Z.



# THE CLYDE STORAGE BATTERY

**THE FIRM BEHIND THE GOODS—!**

NO NEED TO PAY MORE

DANGEROUS TO PAY LESS

CAPACITY  
EFFICIENCY  
and  
SERVICE

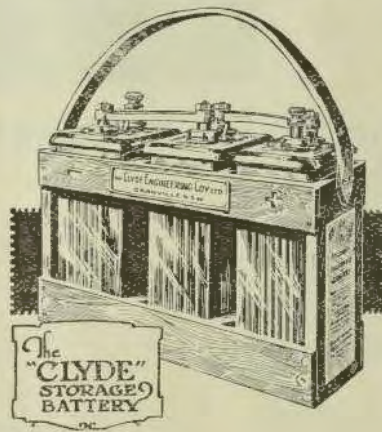

GUARANTEED  
FOR  
12 MONTHS

WE CAN DELIVER ANY QUANTITIES OF FULLY CHARGED CELLS

SPECIALISTS IN REPAIRS AND RECHARGING

**The Clyde Engineering Coy., Ltd.**

**Battery Service Station**

Goulburn St. :: Nr. Wentworth Avenue, Sydney

PHONE MA 1393

Opposite Australian General Electric Co. Ltd.

# Headphones at Cullen's

Large Stocks of Headphones, including the following—

- Peerless Headphones . . . . . 30/-
- Pico Headphones . . . . . 25/-
- Murdoch's 2000 ohms . . . . . 27/6
- Murdoch's 3000 ohms . . . . . 30/-
- Trimm's Dependable H.P. . . . . 32/6
- Western Electric H.P. . . . . 44/-



## Mr. W. L. Hamilton Joins the Cullen Organisation

Mr. W. L. Hamilton needs no introduction to radio enthusiasts generally. His articles on set construction are read eagerly; the sets he has originated are the last word in efficiency. He has been the means of converting many to radio-enthusiasm by showing them the way to better results. Now he has joined the Cullen organisation and all are invited to bring their problems and queries to him for solution. There is no charge. This is part of the service of this Store.

### MELBOURNE BROADCASTING CAN NOW BE RECEIVED

Information on tuning in to Melbourne broadcasting is offered by Mr. Hamilton. Put aside a few minutes to-day to call

*You have my word for it!*

# E.R. Cullen

## 96, Bathurst Street

Phone: City 896 and 2596

RADIO AND



ELECTRICAL STORE

# Complete Single & 2 Valve Receivers

## READY TO ASSEMBLE

Half the fascination of Radio, is in the assembling of your own Set. The two sets described here are absolutely reliable, and completely ready to assemble. We supply a working diagram and full directions, so that success is certain, and previous knowledge of wireless is unnecessary.

COMPARE OUR PRICES—SEND FOR OUR PRICE LIST OF COMPLETE RADIO STOCKS.

### SINGLE VALVE RECEIVER—READY TO ASSEMBLE

Ashcoy Polished Panel, 10 x 8 x 3/16 .. . . .	0 6 5
1 2-coil Variable H.C. Mounting ..	0 15 6
1 .001 Variable Condenser, with Dial and Knob .. . . .	1 0 0
1 6-ohm. Rheostat .. . . .	0 4 6
8 N.P. Terminals .. . . .	0 3 4
1 .00025 Grid Condenser and Leak	0 3 6
1 Valve Socket .. . . .	0 2 0
Panel Wire .. . . .	0 2 0

£2 17 3

### ACCESSORIES

4 Mounted H.C. Coils .. . . .	1 7 6
1 Detector Valve .. . . .	0 15 0
1 4-Volt. 60-amp. Accumulator complete with Case and Carrying Strap .. . . .	2 18 6
1 50-volt "B" Battery .. . . .	0 14 0
1 Pair 4,000 ohm. Head Phones ..	1 10 0

£7 5 0

PRICE COMPLETE .. . . . £10 2 3

### TWO VALVE RECEIVER — READY TO ASSEMBLE

1 Ashcoy Polished Panel, 13 x 9 x 3/16 .. . . .	0 9 0
1 2-Coil Variable H.C. Mounting ..	0 15 6
1 .001 43 Plate Variable Condenser with Dial and Knob .. . . .	1 0 0
2 6-ohm Rheostats .. . . .	0 9 0
8 N.P. Terminals .. . . .	0 3 4
1 .00025 Grid Condenser and Leak	0 3 6
2 Valve Sockets .. . . .	0 4 0
Panel Wire .. . . .	0 3 0
1 Jefferson Star Transformer .. . .	1 2 6

£4 9 10

### ACCESSORIES

4 Mounted H.C. Coils .. . . .	1 7 6
1 Detector Valve .. . . .	0 15 0
1 Amplifier Valve .. . . .	1 0 0
1 4-volt 60-amp. Accumulator complete with case and carrying strap	2 18 6
1 50-volt. "B" Battery .. . . .	0 14 0
1 pair 4,000 ohm Head Phones ..	1 10 0

£8 5 0

PRICE COMPLETE .. . . . £12 14 10

# RADIOELECTRIC

Wireless Suppliers

10 MARTIN PLACE  
(right opp. G.P.O.)  
SYDNEY

Wireless Engineers

## The Valve for Short Wave Reception



Marconi Receiving  
Valve, Type "Q X."

The construction of the Marconi "Q.X." Valve makes it pre-eminently suitable for short wave reception. The plate and grid leads are brought directly out through the sides of the glass tube, ensuring that the capacity effects in the valve are at a minimum.

The Marconi "Q.X." is a particularly sensitive detector, and is equally effective when used as an amplifier. This means greater range for your set.

This valve is the result of unremitting research and long experience in successful valve manufacture.

Experimenters who want long distance short wave reception install the "Q.X." See that you have one!

Price, 42/6

Obtainable from all Radio Dealers

**Amalgamated**  **Wireless**  
*(Australasia) Ltd.*

97 Clarence Street  
Sydney

Collins Street  
Melbourne

Radio Dealers kindly write for Trade Price List





Phones, Redfern 964 and 950.

Official Organ of the New South Wales Division of the Wireless Institute of Australia, with which is incorporated the Affiliated Radio Societies and the Australian Radio Relay League.

VOL. 1. No. 28.

Friday, October 24, 1924

CONTENTS:		Page
EDITORIAL .....		12
WIRELESS INSTITUTE .....		14
FRAME AERIALS .....		17
THE S.T.-100 WITH ONE STAGE OF H.F. ....		22
BASKET COILS .....		27
THE DESIGN OF EFFICIENT RECEIVERS .....		29
STANDARD OF EXPERIMENTAL RATING .....		34
INTERSTATE NOTES .....		36

**EDITOR:** The Editor will be glad to consider Technical and Topical Articles of interest to Australian Experimenters. All Manuscripts and Illustrations are sent at the Author's risk, and although the greatest care will be taken to return unsuitable matter (if accompanied by stamps), the Editor cannot accept responsibility for its safe return. Contributions should be addressed to the Editor, "Wireless Weekly," 33/37 Regent Street, Sydney, N.S.W.

**SUBSCRIPTION RATES** Twelve months (52 issues), 13/-, post free. Six months (26 issues), 6/6, post free. Single Copies, 3d. each, or post free, 4d.

**QUESTIONS and ANSWERS DEPT.** Except in the case of subscribers, all Technical Questions, or those entailing research work or drawings, must be accompanied by a postal note or stamps to the value of 1/-.

**ADVERTISING** Advertising Rates may be had on application to the Advertising Manager. Copy must be in the hands of the Editor by the Friday preceding each issue. If copy is not received in time, the previous week's advertisement will be repeated.

All accounts should be made payable to Publicity Press Ltd., 33/37 Regent Street, Sydney.

Agents in Great Britain: The Colonial Technical Press Ltd., Dudley House, Southampton Street, Strand, W.C. 2.

"Wireless Weekly" is full protected by copyright and nothing that appears in it may be reprinted, either wholly or in part, without special permission. The use of our articles or quotations from them for any purpose whatsoever is never authorised.

## EDITORIAL

### A UNIVERSAL LANGUAGE . . . . .

**T**HE A.R.R.L. (U.S.A.) and "Radio News" has decided to support Esperanto as the auxiliary wireless language, and for quite some time "English Wireless World" has taken the Esperantists' Association under its paternal wing, and in its columns from time to time has strongly advocated the closer linking of this international language with wireless, both amateur and broadcasting. In fact "Wireless World" was specially represented at the recent Esperantists' world conference at Geneva, as was also a Hungarian and French wireless journal. Obviously, these journals would not have troubled about representation had they not been convinced that, in its relation to wireless, Esperanto possesses a far deeper significance than is commonly realised. The A.R.R.L. does not officially recommend any matter to its members until it has found by investigation that such matter is worthy of consideration.

Some months ago we pointed out that the rapid development in amateur wireless would soon lead to the establishment of communication between Australian and foreign experimenters. Recently Bell (N.Z.) got through to California, and with a fellow experimenter in Argentine. Australians will shortly follow, and before very long communication will be opened up with amateurs in countries further afield. The problem of speech exchange will then demand attention.

As a suggestion as to whether it would not prove a worthy subject for consideration now we recommend this matter to the Wireless Institute.

### England Again.

Albury has been placed more conspicuously on the map by the success of Mr. P. Boulton (a letter from whom appears elsewhere in this issue) in receiving broadcasting from England. We also learn that an experimenter at Manly is receiving British broadcasting regularly.

As predicted by us months ago, it will not be long before the reception of British, Continental and American broadcasting stations will be an ordinary everyday occurrence.

### Sunshine After Rain.

Mr. Renshaw is no doubt fast becoming accustomed to the role of peace maker, and his visit to Queensland seems to have occurred at a psychological moment because the antagonism between the Wireless Institute and the Radio Society of Queensland was fast assuming the proportions of a deadlock.

It is to be sincerely hoped that the keynote of co-operation which was struck by Mr. Renshaw at the crowded meeting in Brisbane, will find an echo in the minds of those to whom his remarks were addressed. There is no room for party feeling or for personal enmity in the experimental movement. We look for better things from Queensland.

### THE LEICHHARDT AND DISTRICT RADIO SOCIETY

On Tuesday, October 14th, members of the Leichhardt and District Radio Society, held their 102nd general meeting at the club-room, 176 Johnston St., Annandale.

The attendance was good, and the main business of the evening was the delivery of the fifth lecture of syllabus No. 2 by Mr. W. J. Zech, who dealt with "Crystal Circuits and Their Construction." The lecture proved very interesting, and was much appreciated by those present.

At the conclusion of the lecture Mr. Zech replied to a number of questions relative to his subject, after which a vote of thanks was carried by acclamation.

Next Tuesday evening, the Society will hold its 25th monthly business evening, and on Tuesday November 11th, the 7th lecture of Syllabus No. 2 will be delivered by Mr. E. J. Fox, who will deal with the subject of "Batteries."

The Society meets every Tuesday evening at the club room, 176 Johnston St., Annandale, and inquiries from prospective members should be addressed to the Hon. Secretary, Mr. W. J. Zech, 145 Booth St., Annandale.

## SECOND ANNUAL REPORT.

During the past twelve months the fortunes of the Leichhardt and District Radio Society have remained continually favourable towards progress and advancement, and one need not travel outside its ranks to find a reason for this most satisfactory state of affairs. Whilst its membership consists of men who have the interest of the Society at heart, and are prepared at all times to work unceasingly for its benefit, we must progress.

The period under review has been a very busy one, and it is only by making a resume of the work that has been done, that one realises what a busy period it has actually been.

Commencing with the subject of membership we find that, since the first annual meeting was held twelve months ago, 40 new names have been added to the membership roll—an average of 3.3 per month.

Shortly after the first annual meeting was held, it was thought desirable to have designed and printed a letterhead suitable for the use of the Society, and thanks to the good graces of our worthy President, Mr. Kirkpatrick, we have, for nearly twelve months, been writing our correspondence on a very attractive and nicely designed letterhead.

Perhaps the most important of the Society's activities has been the delivery of lectures, both by members and non-members, and although we have had occasional visitors for this purpose, the bulk of the work in this direction has fallen upon the shoulders of the members themselves, and they have acquitted themselves well.

Lectures delivered by non-members were as follows: October 30th, 1923, "Wave Meters," by Mr. Mann, and "Esperanto: Its Relation to Radio," by Mr. J. N. Edmonds on July 15th, 1924. On April 29th of this year, the Society had the honor of a visit from Mr. Phil Renshaw, Hon. Secretary of the Wireless Institute of Australia, who addressed members in connection with a proposed affiliation of radio clubs and societies with the body of which he is Hon. Secretary.

Returning to the matter of lectures by members we find that, in all, sixteen lectures have been delivered during the past twelve months, and each and all have proved very successful. These were the outcome of two syllabuses drawn up in January of this year, and the other drafted in July on the completion of Syllabus No. 1.

During the period under review, members have been particularly fortunate in having arranged numerous visits to places of interest which were

as follows: I.C.S. lectures on wireless subjects, November 13th and 20th, 1923. P. & O. R.M.S. Mooltan, February 17th, 1924; Garden Island, February 10th, 1924, and Broadcasters (Sydney) Ltd., in February also. In addition, several visits of parties of members were made to Pennant Hills, and on August 30th, 1923, a party of members paid a visit to the Croydon Radio Club, by special invitation from that body.

Lately the subject of Morse practice has been taken more seriously by members, and now a period of at least fifteen minutes is devoted to this matter every meeting night.

Whilst the Society has been very busy from a wireless point of view, the social aspect of club life has not been neglected. On December 11th, 1923, a very pleasant social evening was spent at the club-room, and on January 19th, members conducted a very successful launch excursion on the harbour. On June 10th of this year, Mr. and Mrs. Chilton, of V.I.S., were farewelled, prior to their departure for Townsville. The function was a very pleasant one and was very well attended. During its progress a presentation of a silver-plated coffee service was made to the guests of the evening.

Other activities of the Society have been the election of three Trustees on November 6th, 1923, the appointment in January of "Wireless Weekly" as its official organ, the donation of one guinea towards the Moore Relief Fund, in March of this year, the affiliation with the Wireless Institute of Australia on May 6th, 1924, the conducting of two very successful "Sale and Exchange" evenings on May 20th and June 24th, the arrangement of "Questions and Answers" evenings on July 29th and September 23rd, 1924, and the conducting of a debate under the heading of "Dull Emitter Valves v. Accumulator heated Filament Valves" on August 19th. On September 16th, the Society held its first "Exhibition of Apparatus" and the function was very successful.

During the past twelve months the attendance of members at the Society's meetings has been very satisfactory and, generally speaking, the future is full of promise.

W. J. ZECH,  
Hon. Secretary.

Tell Your Friends about

Wireless Weekly

HEADQUARTERS  
Room 24 2<sup>nd</sup> Floor  
82 Pitt St.  
SYDNEY N.S.W.



Phil Renshaw Hon. Sec.  
Box 3120 G.P.O. Sydney  
Phone B 2235  
A.H. Perrett Publicity Officer

NEW SOUTH WALES DIVISION.

2DE.

HAVE you ever heard this call sign? Does it arouse any emotions in your breast? Most of us, no doubt, have heard somewhat of this mysterious station, and possibly its owner and operator may be known to a few. At any rate, he is now better known to Queensland experimenters than he was three weeks ago. 2DE is situated in an obscure little village known as Roseville, and its owner and operator, Mr. Phil Renshaw, is known wherever the name of wireless casts spells in this fair land of Australia. Mr. Renshaw has just returned from a trip to Queensland, and while there he has devoted practically the whole of his time to the interests of the science and the experimental movement in the northern State. It is confidently expected that the outcome of his visit will be extremely fruitful, and while there Mr. Renshaw got in touch with all the various interests, and by every means in his power has endeavoured to co-ordinate their activities in every way.

The largest, longest, and most representative meeting ever held in Queensland in connection with radio matters was held at the Y.M.C.A. Rooms in Brisbane on Friday night, October 10th. Over 100 amateurs were present at the invitation of Mr. Renshaw, and the subject under discussion was the formation of a Queensland Central Council. Mr. W. Finney, Queensland Radio Inspector, was in the chair. Various speakers addressed the meeting on behalf of the various interests, and Mr. Renshaw, who was enthusiastically received, made what is considered to be the most interesting, longest, and best delivered address ever placed before a Queensland audience of wireless enthusiasts. While, unfortunately, it cannot be denied that matters have not been running as smoothly as everyone would wish in the northern State, there is every prospect of unity in the future. The keynote of the whole trouble was struck when Mr. Renshaw stated that harmonious relationship in radio circles is vital, and this must be observed if the work is to proceed with any degree of vigour.

Organisation is essential, but it must be organisation of the right kind. The various interests must be brought together and co-ordinated, each one receiving recognition of its due importance, and great care must be taken that no one interest is given undue prominence at the expense of any other. The result of this meeting was that a very friendly feeling was established, and the following resolution, moved by Mr. Pries and seconded by Mr. Underwood, was carried after considerable discussion: "That certain persons representative of the various radio bodies be appointed to meet and discuss the all-important point of the establishment of a central body, which should be representative of all Queensland Radio Societies." This conference will meet at an early date, probably before this is in print, and it is confidently expected that much good will result. Mr. Renshaw, during his visit to the northern State, has created quite an interest in amateur experimental radio, and one of his pleasant duties was the judging of competitive exhibitions shown by the Toombul Branch at the Toombul Show.

Now that Mr. Renshaw is back in Sydney, we extend to him a very hearty welcome home, and, long before this reaches the reader's hands, no doubt his pleasant voice will be heard over the ether. Carry on the good work, 2DE.

A. H. PERRETT,  
Publicity Officer.

The new Melbourne broadcasting station, 3LO, commenced its first regular transmission by broadcasting the opera from Melbourne. Although this station has not yet the strength of 2FC, considering that it had just commenced operations the transmission was complimentary. Using five valves, Mr. P. Boulton, of Albury, was able to work a loud speaker with sufficient volume for the music and singing to be heard from a house on the opposite side of the street. No doubt, when 3LO gets properly into its stride, listeners-in will receive this station with the same strength and satisfaction as 2FC.



## THE MEANING OF "MODULATED WAVE"

**T**HE wave in space which brings us the broadcast music or voice is known as a modulated high frequency electromagnetic wave. Let us examine this rather imposing expression and see what it actually means.

The voice or music which we wish to transmit varies in frequency from about 30 cycles per second to about 400 cycles per second. An electromagnetic wave could be created at these frequencies. But it is found that it would travel only slightly further than the sound waves themselves. There would therefore be very little to be gained by changing the sound wave into an electromagnetic wave of the same frequencies.

### Distances Travelled.

It is found that a high frequency electromagnetic wave will travel to enormous distances. The term high frequency in this case means frequencies from about 30,000 cycles per second to about 3,000,000 cycles per second. It will be seen at once that these frequencies are of a different order than the voice and music frequencies. Roughly in another way 1,000 cycles of the high or radio they are 1,000 times as great, or stating the fact frequencies will occur during one cycle of the voice or audio frequency.

The modulated wave is a combination of the audio and the radio frequency. The radio frequency part of the wave is spoken of as the carrier because it is used to carry the audio frequency. The radio frequency is modulated by the audio frequency, and we ordinarily think of the audio frequencies as existing in the complete wave as a change in amplitude or intensity of the radio frequency. The successive cycles of the carrier frequency vary in intensity or strength in accordance with the audio frequency.

When we say that the wave is electro-magnetic we mean that it consists of two parts. One part is a magnetic field, exactly like that given by the familiar horse shoe magnets. The other part is an electric field, exactly like the one that can be obtained by rubbing a piece of glass with a cork, by which the glass will then pick up small bits of paper. In the wave these two fields, electric and magnetic move through space together, at the velocity of light, or 10,000 miles per second.

The process by which radio frequency is modulated at the audio frequency is relatively simple. A vacuum tube oscillator is used. As long as the plate voltage on this oscillating tube is held con-

stant, the resulting wave has constant amplitude or intensity and is not modulated. In order to modulate the wave, the plate voltage is varied up and down in accordance with the audio frequency, and the amplitude of the resulting wave in space varies in the same way.

### Components of Wave are Three.

Now it is found that this wave of changing intensity is exactly equal to the sum of three constant frequencies, that is, three frequencies whose amplitude does not change. One of these is, of course, the carrier frequency at which the transmitting tube is oscillating. The second frequency is the sum of the carried and the voice frequency, and the third is the difference between them. These sum and difference frequencies are known as the side bands. With a receiver that is sufficiently selective, we can tune to any one of these three frequencies and detect it. Remember that each of these frequencies is constant, and that it is only their sum which varies in amplitude. It is easy to see why the sum does change in intensity, because since the three frequencies are slightly different, they cannot stay in step with each other, or, as we say, in phase with each other, and will consequently tend to help each other at certain times, and at other times will act against each other, and reduce the amplitude or intensity of the combinations.

### Instantaneous Frequency Changes.

No two successive cycles of the modulated wave are alike in amplitude. But are they alike in frequency? Before we can answer this question, we must say what we mean by frequency. When this word is applied to something that repeats itself exactly time after time, it has a very definite meaning. The frequency is the number of these exactly similar cycles that occur in one second. But when the cycles are constantly changing, we can only say that the frequency at any instant is the number of cycles which would occur in one second if all the succeeding cycles were exactly like the one occurring at that instant. In a modulated wave, therefore, we must think of the frequency as constantly changing in its instantaneous value.

### Cycles Per Second.

Let us say that the carrier or radio frequency which we wish to use is 800,000 cycles per second. This corresponds roughly to a wave length of 380 metres, that is the peaks of the wave as it trav-

(Continued on Page 50.)

**WAVERLEY RADIO CLUB.**

A letter was received from the Wireless Institute at the meeting of the Waverley Club held on the 14th inst., thanking the club for its co-operation in asking transmitters to close down during broadcasting hours. Arrangements were finalised in connection with the dance set down for the 22nd inst. It was decided that as much publicity as possible be given the function, towards which £2/10/- had been donated. A committee, consisting of Messrs. Bowman, Graham, and Hurrows, was elected. Mr. D. Graham was nominated M.C. After the business had been dealt with, Mr. J. Miller delivered an interesting talk on "Biographs and Lenses." This was voted an instructive change from wireless.

**THE ORIGIN OF "SOS."**

SO many explanations have been given of the origin of wireless distress signals used by ships at sea, that recently the International Telegraph Bureau was requested to give the correct version as to why these three letters were chosen. The Director of the Bureau stated that the first suggestion for a distress signal for ships' use was made by the Italian delegates at the preliminary conference on wireless telegraphy held at Berlin in 1903, when the adoption of a universal signal, "SSRDDD," was

argued, "S" presumably being to indicate that it was a ship calling and "D" being the international designation for an urgent message. All stations and ships should be compelled to receive such calls, suspending all other communication for the time being. The other delegates agreed to the need for such a signal, but the final decision was left for the special conference later. Shortly after this suggestion was made the Marconi Co. recognised that a distress call signal was necessary, and on February 1st, 1904, the famous signal "CQD" was instituted on all ships fitted with their apparatus, "CQ" being the International Telegraph sign for "all stations," while the letter "D," as already pointed out, is the designation used for an "urgent" message.

Several countries, including the United States, adopted the "CQD," and used it until the Telegraph Conference in Berlin in 1906, when the German Government suggested that the standard distress signal for ships at sea should be "SDS." Previously German ships had used the signal "SOE," but the last letter "E" was easily dropped, as it consisted of a single "dot," and was often lost in atmospheric disturbances. Finally the famous signal "SOS" was adopted officially by the International Radio Telegraph Convention in July, 1908. The "SOS" should be signalled without spaces, and not as three separate letters.

**LIGHTNING HAZARD**

Do you know that your Fire Insurance Company is not liable unless you have a Lightning Arrester fitted to your Aerial? By using a "Control" Radio Arrester, you conform to their regulations.

Outdoor pattern "Control" Arrester is \_\_\_\_\_

Retailed by all first class Radio Stores

**at 7/6 each** (posted 9d. extra)

Or direct from the Manufacturers:—

**Electric Control & Engineering Ltd.**

CHESTER STREET  
CAMPERDOWN :: SYDNEY

(Makers of Lightning Arresters and Switchgear for Australian conditions for over 12 years)

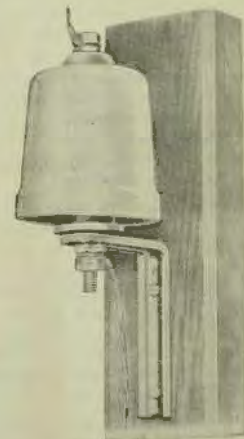

"CONTROL"

## FRAME AERIALS

**A** FRAME aerial (or loop aerial) like most other things, has its advantages and disadvantages. Its most admirable features are, first and foremost, its directional qualities which tend to minimise interference or jamming by other stations working on nearby wave lengths, a very high degree of selectivity and consequent sharpness of tuning, and compactness and portability.

Its chief disadvantage is the loss of signal strength. It should be remembered that the strength of the signals received on any frame aerial, however efficient, will only equal about 35 per cent. of the signal strength obtained from an outdoor aerial, using the same type of receiver. It is obvious, therefore, that wherever circumstances permit the use of an outdoor aerial it is, generally speaking, always better to employ this in preference to the frame.

Some experimenters prefer to use a fixed loop aerial, usually carried around the walls of the room. The very fact that it is fixed, however, is a great disadvantage.

Before proceeding with constructional details, it may be well to first explain briefly the exact difference between the outdoor and the indoor aerial. An ordinary outdoor aerial may be described as an aerial with an open end, and an indoor or frame aerial as a loop, having both ends joined to the receiver and thus closed.

If a length of thin steel strip is held out in a horizontal position, it may be made to vibrate freely. If the other end is also held it will still vibrate, although not quite so freely as before. Similarly, an outdoor aerial having a free or open end, will respond more readily to the incoming electrical vibrations than a frame aerial having no free end. Where the open end aerial will effectively operate a simple receiver the frame aerial will require a certain amount of boosting up—one or more stages of amplification—before it will perform the same duties.

The frame aerial can be made directional to any point of the compass, and in order to receive signals from any particular station one side of the frame must point in the direction of that station. It may be more clearly understood if we call the

side the "Edge." If the frame is not pointing in this direction, no signals will be heard. This fact is due to the difference in phase produced in the opposite sides of the frame. When the frame is pointing "edge on" to the transmitting station, the incoming waves will strike one edge before they reach the other, and this alternate striking or cutting results in the production of high-frequency alternating currents as in the case of an outdoor aerial.

If the frame is now rotated through an angle of 90 degrees so that it is squarely facing the

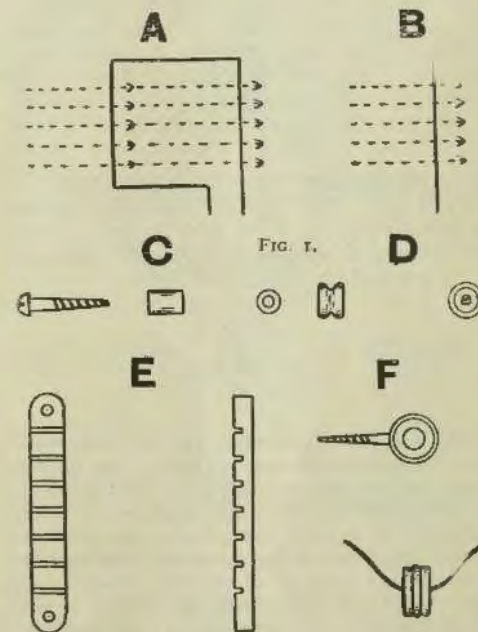

FIG. 1.

transmitting station, no signals will be heard, because the waves will then strike both sides of the frame at the same time, thus producing an equal and opposite potential which results in neutrality. This is clearly illustrated in Fig. 1, where the dotted lines represent the incoming waves. "A" shows the loop "edge on" in the correct position in

relation to the waves, and "B" shows the incorrect position.

In a very simple form the frame may consist of two pieces of  $\frac{1}{2}$  in. board, each 4ft. long by 2in. wide, screwed together in the form of a simple cross. A number of small insulated eyelets are screwed into the ends of the arms, allowing a distance of about  $\frac{1}{2}$  in. between each one. The winding may consist of 7 turns of single 16 or 18 bare or cotton-covered copper wire wound on as shown in Fig. 2, to form a continuous series of squares of decreasing size. This amount of wire will cover the wave lengths of 2BL. If desired two terminals may be attached to any convenient part of one of the arms and the ends of the winding connected to these or direct to a large capacity

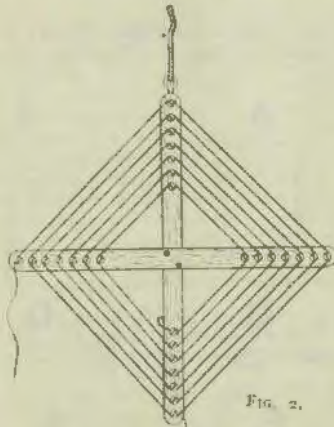

Fig. 2.

variable condenser, preferably not less than .00075 mfd. The leads to receiver are taken from the condenser terminal, this usually being the only tuning device required providing the frame is wound correctly. It is more convenient to commence the winding from one of the innermost binding posts or eyelets and wind in an outward direction. A length of flexible wire should be soldered to each end of the wiring if terminals are not provided. A suitable method of mounting it is to attach a small screw eye to the end of the top arm and suspend it by means of a piece of cord from the ceiling.

Diagrams C to F (Fig. 1) show four different types of binding posts, either of which will be found quite suitable. C is a short length of ebonite, fibre or glass tube large enough in internal

diameter to take a round-headed wood screw which secures same to the arms; D is a miniature porcelain reel type insulator, made specially for frame aerial work, which should be obtainable from almost any wireless store; E shows how a strip of  $\frac{3}{8}$  in. sheet ebonite may be slotted to take the wires—one strip being screwed to each arm; and F is the ordinary insulated eyelet or screw eye. Seventeen turns of wire, and a correspondingly extra number of binding posts will be necessary to receive 2FC. As pointed out, the wire is wound on in spiral formation.

In Fig. 3 the arrangement of the winding is somewhat modified, being wound in helix formation

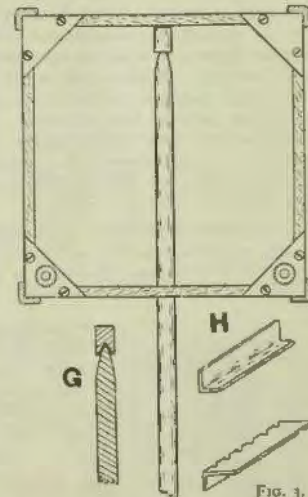

Fig. 3.

round a flat box-like frame, provided at each corner with rubber or ebonite angle pieces H, having small nicks cut as shown to form spacing beds for the wire. Thin sheet ebonite may be bent in this way if it is heated. Each side should be 3ft. 6in. long, and the width will, of course, depend on the number of turns it is proposed to wind on.

About the same number of turns as mentioned before will be found suitable for the different wave lengths. Small pieces of  $\frac{1}{8}$  in. sheet ebonite or three-ply wood are cut to a triangular shape and screwed to the corners as shown, terminals being fitted in two of these as desired. An ordinary broom handle, pointed at one end, passes through a clearance hole in the centre of the bottom of the

frame and engages a recessed bearing block secured to the inside of the top of the frame as shown. (See also sectional view G.) This arrangement provides a simple means of swivelling the frame on its own axis. The lower end of the broom handle is secured to any suitable base.

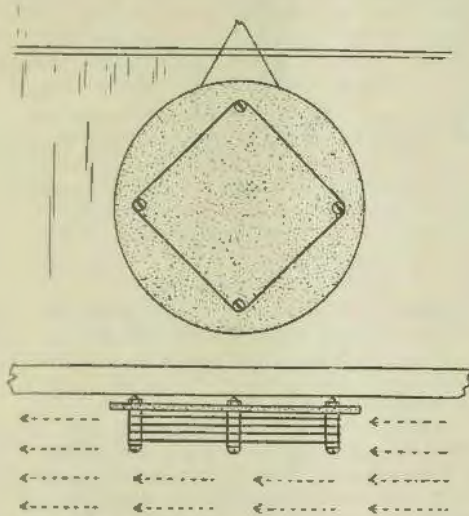

FIG. 4.

If one of the walls of the operator's room should be in a direct line with the broadcasting station, a frame aerial of this type may be wound round four insulated binding posts attached to a large disc of treated cardboard or three ply wood and hung as high up as possible on the wall as shown in Fig. 4. The lower illustration represents a top view showing the correct position of the wall and frame in relation to the incoming waves.

Fig. 5 is a modification of Fig. 3, where four arms are employed in place of the box-like frame, these being attached to a central hub and provided at the outer ends with insulated spreaders on which the wire is wound. These spreaders may consist of short lengths of round hard wood well soaked in melted paraffin wax, or of ebonite or fibre rod or tube. A selection of different types is given in Fig. 6. Diagram 1 shows a piece of round ebonite rod provided with small nicks and fitted firmly into a hole bored through the outer end of the wooden arm. This can also be made of wood and bound round with rubber tape. J. and K. shows

two ways of utilising a piece of thin sheet ebonite which is preferably fitted into a slot cut in the end of the arm. L is an ordinary bone or vulcanite comb screwed to the end of the arm, M a piece of diagonal cross section hard wood, and N a series of short lengths of insulated sleeving pushed through holes in a wooden cross piece.

The arrangement of the central hub, too, may be varied to suit individual tastes and various degrees of advancement in mechanical skill. A very simple method is to provide two hubs as shown in the sectional diagram O, and after securing the arms in their correct positions on the face of one of the hubs, clamp both hubs together as shown by means of a long 3/8in. Whitworth bolt, the protruding end of which is utilised as a manipulating device in the following manner: A distance piece, consisting of a short length of round hard wood is drilled through as indicated by the dotted lines at R and secured firmly to one end of a piece of broom handle. The bolt passes through this and is tightened up by means of another nut, which should just clear the broom handle support. The lower support S may consist of another length of broom handle having a 6in. length of round brass tubing secured to its upper end, as shown, so as to form a socket for the support attached to the frame.

Two other methods of arranging the central hub are shown at P. and Q. In diagram P, a hexagonal piece of board about 1/2in. in thickness and measuring 9in. across the points, is provided with slots in which the lower ends of the arms are se-

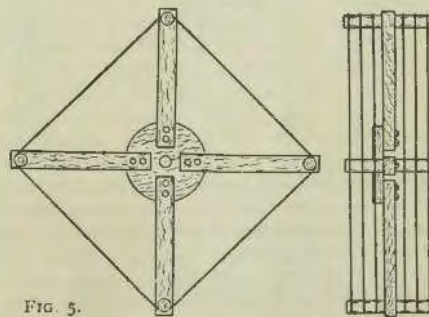

FIG. 5.

cured by means of long screws or nails as shown in part section. The hub Q is cut out from a piece of 3/4in. board and drilled in the centre of each flat as indicated by the dotted lines at Q and in the side view T. The lower ends of the arms are pro-

vided with fillets which are smeared over with a little glue and plugged into the holes.

Suitable dimensions of such an instrument would be as follows: The distance between the extreme ends of each pair of arms is 24in., and we can either arrange a small hub with long arms or a large hub with short arms. Alternately we could attach the spreaders direct to the points of the hexagonal hub, but for the sake of appearance the hub should measure 6in. across the flats.

If the arms are each cut 10in. long and the fillets made 1in. long, we get exactly 24in. between the ends of each pair when they are secured in position round the sides of the hub. Type K

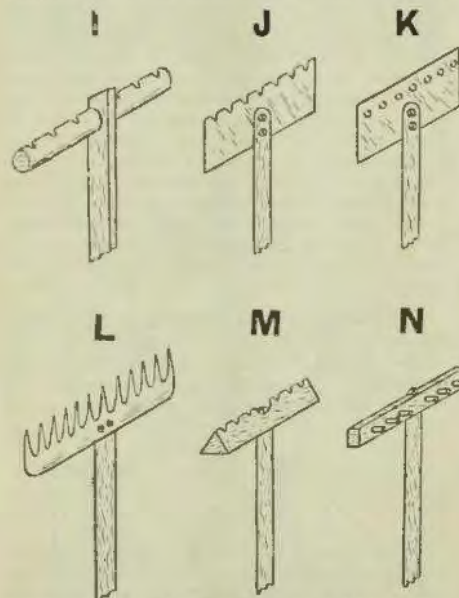

spreaders will perhaps be most suitable and these should be cut from thin sheet ebonite or fibre to a width of 2in. and a length depending on the number of turns required. Small holes are drilled along each edge (7 for 2BL or 17 for 2FC) and they are then firmly secured in saw cuts in the ends of each arm.

The position of these will, of course, be at right angles to the face of the hub. The turns of wire are now wound on, passing each turn carefully through the holes in the spreaders. The ends of the winding may be connected to two terminals suitably mounted on the hub. The method of

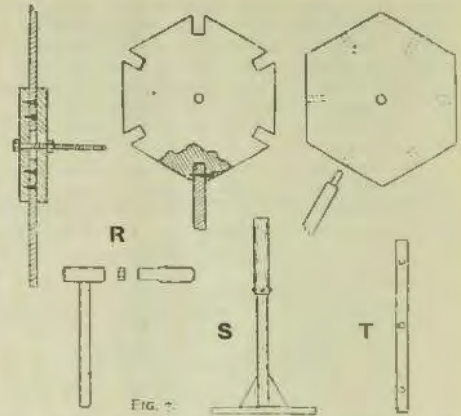

mounting may be similar to that described in Fig. 7, but no doubt other methods will suggest themselves. A telescopic stand with a thumb-screw attachment may appeal to those who are capable of undertaking the job.

There are, of course, many different circuits which would be suitable for use in conjunction with a frame aerial. The one we are chiefly concerned with here must essentially be simple and at the same time efficient, capable of being built up and

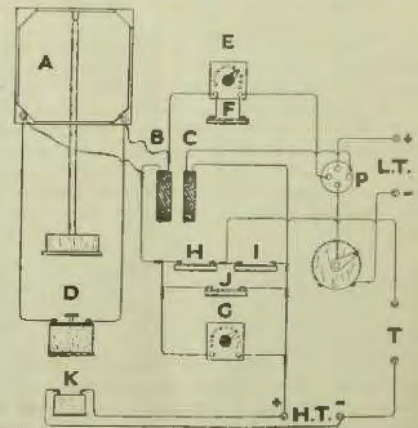

Don't take a reading of your B batteries with an ammeter. Use a voltmeter. One test with an ammeter will draw as much current from the battery as you would in a month of regular service.

operated by the average reader, and suitable as a general purpose broadcast loop receiver. The Flewelling super regenerator can be well recommended, and a pictorial diagram of this is shown.

This should meet the requirements of those enthusiasts who are content to confine their ambitions to the reception of broadcasting.

The coils B. and C. may be of any suitable type, the secondary coil C. giving about two-thirds the inductance of the primary coil B. Here is scope for experimenting with various coils.

The variable condenser D should have a capacity of .0005 mfd., and this and the filament rheostat, should be well shielded to prevent body capacity effects. E is a variable grid resistance from 1 to 1½ megohms, and G. is a similar component, being continuously variable from 1/4 to 1 megohm. H. is an ordinary mica grid condenser connected in shunt with the variable resistance E. The fixed condensers H, I, and J., each have a capacity of .006 mfd., the exact value being rather critical.

The circuit is fairly easy to operate. Adjust the resistance E. to the maximum value and vary the coupling of the two coils until a whistling noise is heard in the headphones, then vary the coupling and condenser continuously until the desired signals are heard, when it will be necessary to readjust both resistances. These are then left at the best positions while the signals are finally tuned in by making further adjustments of the coils and condenser. Sharper tuning is sometimes obtained by connecting a small vernier condenser across the terminals of the variable condenser. If the exact values of the variable resistances are known, these, of course, may be replaced by fixed resistances. K is a 2 mfd. fixed condenser connected in shunt with the high-tension battery, this being desirable, although not essential. A few experiments should be tried with telephone condensers of different values.

China is not to be counted among the backward nations of the world in the matter of radio broadcasting. To prove which, the press has accepted the modern viewpoint, and, with one of its representatives now in the field, will give to China what so many of the great dailies are providing listeners in America. The Shun Pao, first Chinese newspaper to take up broadcasting is on the air four times daily, with lectures in Chinese and musical programmes. Will we be able to pick up the weird strains from their peculiar instruments and translate them?

#### SCIENTIFIC FACTS I HAVE DISCOVERED ABOUT RADIO.

That once you have become a radio fan you are a goner.

That Grandma is just as apt to get it as Willie.

That the shortest wave is the permanent one in the head.

That the less air in a vacuum tube, and the more in an inner, the farther you will carry.

That a boy can sit up till two o'clock in the morning receiving and never utter a word of complaint.

But if his father tells him to stay up and close the furnace, then what an interference!

—Homer Croy.

#### A NEWCOMER

The Wireless Company of Newcastle, has opened up business at 59 Hunter Street. This firm are Northern Representatives of the Burgin Electric Company.

#### "STERLING" RADIO GOODS.

Still another speaker has arrived to add to the range manufacture by the Sterling Telephone and Electric Company Ltd., of London. This is catalogued "The Dinkie," and is certainly the finest small-sized loud speaker obtainable. Although standing only 13 inches high and having a flare diameter of 7 inches, the Sterling "Dinkie" gives a volume which is amazing and of wonderful purity. It weigh less than 2½lbs; and is therefore easily portable. Being listed at the low price of £3 it should find a very big demand as it is all that is needed for a room of ordinary size. The Lawrence and Hanson Electrical Co., Ltd., sole agents for the Sterling Telephone and Electric Co., Ltd., announce the very heavy forward sales from the first shipment to arrive.

#### WILES' WONDERFUL WIRELESS.

That other things besides wireless were worth while wangling was proved by a member of the Second Storymen's Union one night recently, when he effected an entrance via the back window into the head office of Mr. Harry Wiles, 60 Goulburn Street, blew open the safe, and decamped with a considerable sum of money.

## The S.T.-100 with a further Stage of High Frequency

BY "INSULATOR"

WHEN it was announced in "Wireless Weekly" that I had received K.G.O. on a loud speaker I was inundated with letters of request for the circuit I was using. Here it is, then, and once more the credit is due to Mr. John Scott Taggart. In "Modern Wireless" of June last he described this receiver. All that I have done is to build it and substitute U.V. 201a valves instead of English valves. And I'll confess to you that, although it is my own set, I have never heard its equal. People have come from near and far to hear it, and have expressed very high appreciation of its results. The volume is wonderful, and the clarity of speech is incomparable. A little humorous story will not be out of place here. One night Mrs. Insulator insisted on being taken to the pictures, and just as we were locking up, a little fellow from four or five doors down the street bailed us up with the request to put on the wireless, "as daddy has some friends at home who would like to hear it." I complied with the request, and the friends of four or five doors away heard all from my home. How's that?

The principle of dual amplification or reflexing is employed in this receiver. Quoting Mr. John Scott Taggart, he states, referring to the diagram of the

circuit (Fig. 8): "It will be seen that the aerial circuit comprises the coil L.1 and the condenser C.1, the small fixed condenser C.A.T. being included in order that constant aerial tuning may be applied. The valve V.1 acts purely as a high-frequency amplifier, the amplified oscillations being passed on, via the coil L.3, which is closely coupled to L.2 in the anode (plate) circuit of V.1 to the grid of V.2. The high frequency oscillations are further amplified by the valve V.2, and are then rectified by the crystal detector D. The rectified signals then pass through the transformer T1T2 back to the valve V.2, where they are magnified by this valve and pass on to V.3 by means of the transformer T3T4, the low frequency oscillations being thus further magnified. THE RECEIVER THUS ACTS AS A FIVE-VALVE SET, having two stages of high frequency amplification, a rectifier, and two stages of note magnification, with the difference that the rectifier is a crystal and the one valve, namely, V.2—does the work of two. A great saving in valves and current is thus effected."

I'll sharpen my pencil after that lot!

Although three valves are provided, it is not incumbent on the user to employ all at once. A

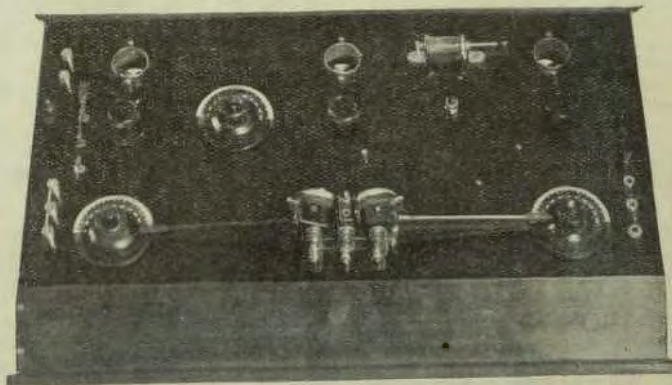

Front View of Panel.



switch, S.1, is provided to cut out the first valve and allow the two remaining valves to function. This is accomplished by bringing S.1 to X position (downward in actual use, although shown upward in Fig. 3), thereby cutting out L.1, C.1 and V.1, and permitting L.3 to become the A.T.I. (aerial tuning inductance). This is the usual S.T. 100 circuit, with the alteration that the second transformer, T3T4, has a fixed condenser from the O.P. to the O.S. to increase the purity of the reception. This condenser varies with the actual transformer employed; in my case I use one .00025 mf.

In my own set I employed the following material, and I advise you to keep to it as much as possible on account of spacing in panel drilling and mounting:—

- 1 Bakelite panel, 24 x 12 x 3/16.
- 1 Igranite 3 coil holder (assembled).
- 2 .0005 Hurst vernier condensers.
- 1 .0003 Hurst variable condenser.
- 1 Remler panel socket.
- 3 30-ohms Marco rheostats.
- 3 United standard sockets.
- 1 Marco S.P. D.T. switch.
- 2 United 5 to 1 transformers.
- 1 Foote variator.
- 1 A.W.A. crystal detector.
- 3 3-inch dials.
- 2 Vernier knobs.
- 10 Binding posts.

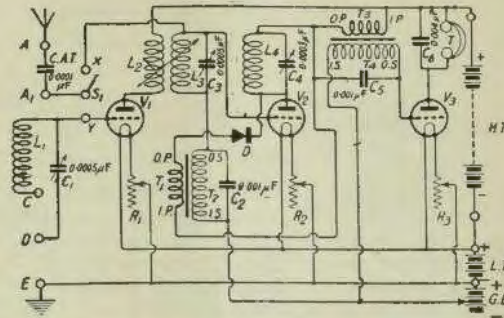

- 2 Clix sockets (for phones).
- 1 Marco jack (for loud speaker).
- 1 .0001 wetless fixed condenser (C.A.T.).
- 1 .00025 wetless fixed condenser (T.3 T.4).
- 1 .001 wetless fixed condenser (T.1 T.2).
- 1 .002 wetless fixed condenser (loud speaker).
- 6 Socket distance pieces of 3/16 brass tubing 1 inch each long.
- 6 1 1/2 x 1 1/2 nickel screws and nuts (for above).
- 4 1/2 x 1/2 nickel screws and nuts (for mounting transformers).
- 1/2 lb. No. 16 tinned copper wire (for wiring).

The Hurst condensers require a 1/4-inch hole for fixing. Space allows only for Marco rheostats, but, although United transformers are on the list, Jefferson's will be found to function admirably. It is not

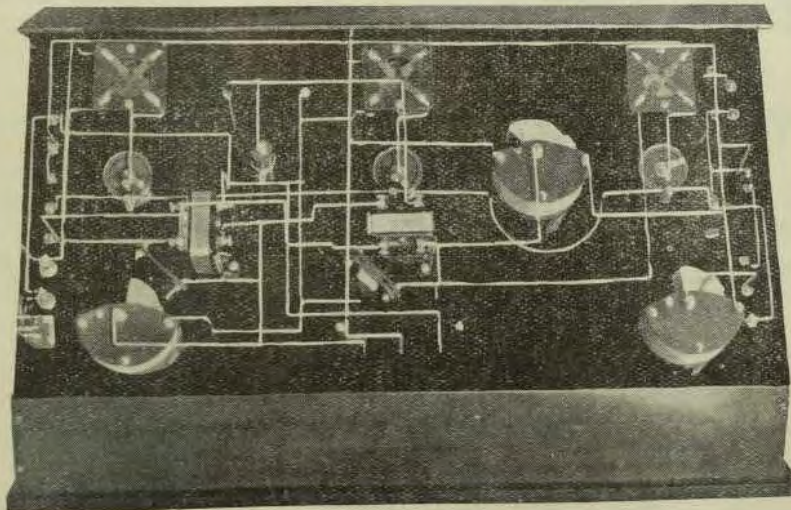

Back View of Panel.

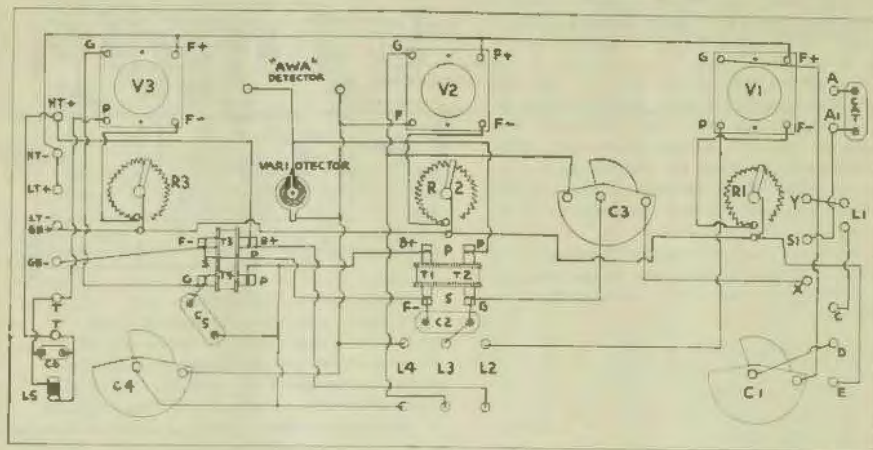

FIG 4

FIG 5.

necessary to have two detectors, but, as I had my panel drilled for the A.W.A., I have left it on. As I said before, experiment only will determine the correct value of fixed condenser to be used with the transformers.

Now, then, look at the illustrations while I take a "breather." This is getting a bit heavy; after it is over I think I'll turn out to "grass"!

Fensted your eyes? Right-oh! Gaze at Fig. 4. This is the panel drilling diagram, and you will be able to reconcile it with Fig. 1, the view of the completed set. Need I tell you to square the panel and use a centre punch for making out the holes before drilling? The large-sized holes for the valve sockets may cause you to think. I drilled mine with an extension bit, one I borrowed and have since failed to

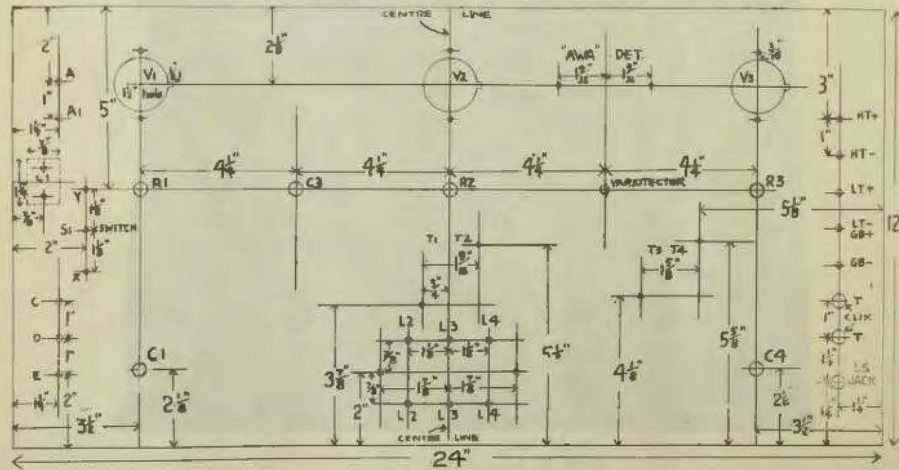

return—habit again. If you are so fortunate as to possess an extension bit, go to it; otherwise use a fretsaw, which should eliminate your trouble.

The valve sockets are mounted behind the panel, but the rim of the socket just fits flush with the front of the panel, the socket being maintained in position by two pieces of 3/16 brass tubing, each 1 inch long and having a nickel bolt 1 1/2 inches long running through the panel through the tube, and held securely behind the socket with a nut. For this purpose, in Fig. 4 you will notice above and below each socket a provision for these bolts or screws. Is that quite clear, or is it like the proverbial mud?

The Marco S.P.D.T. switch comes to you mounted on a base. Remove from base and re-assemble switch on panel. The rest of the parts are easily assembled. You will note that, instead of using four screws to mount each transformer, I only allow two screws each. Saves time!

The wiring is next, so consult Figs. 2 and 5, and you will be on the right track. The panel tri-plug has six terminals, which will be seen in Fig. 1, hence the six small holes in the middle of the bottom provided for the purpose of wiring this unit. Be careful when wiring the transformers, otherwise the rest is O.K.

Coils.—The coils I use are listed here:—

	Amateurs.	2 B.L.	2 P.C.
L.1.. .. .	19	40	150

L.2.. .. .	25	75	250
L.3.. .. .	19	40	200
L.4.. .. .	25	50	100

Batteries.—I use a 6-volt accumulator and "shove" as much as 120 volts on the plates of the valves. Grid bias, 4.5 volts.

Testing.—(Keep a bottle of aspros handy during the next few moments.) Insert coils suitable for the station you are going after. Connect your H.T+ to the top battery terminal, H.T+ to the second top, L.T+ to the third, L.T+ to the fourth; bridge the fourth and fifth—that is, don't use the grid biasing battery while testing, and plug your phones into the clip sockets. Insert the valves and join aerial to A and earth to E, shorting C and D to E. Turn up the filaments of the valves, and look to see that the switch S.1 is turned up, and that coils L.2 and L.3 are closely coupled together. L.4 should be well away from L.3.

Slowly move C.1 and C.3 together until some sort of music or speech is heard, and then turn to the crystal detector and locate your sensitive spot. This should be a matter of seconds if you follow out the directions accompanying these variotectors. The station should be now heard at surprising strength, which will be increased by bringing L.4 closer to L.3 and tuning finally on C.4. Some kick?

Perhaps you only have two valves, so insert them into the sockets V.2 and V.3 and turn switch S.1 downwards: swing coil L.2 away from L.3, and tune

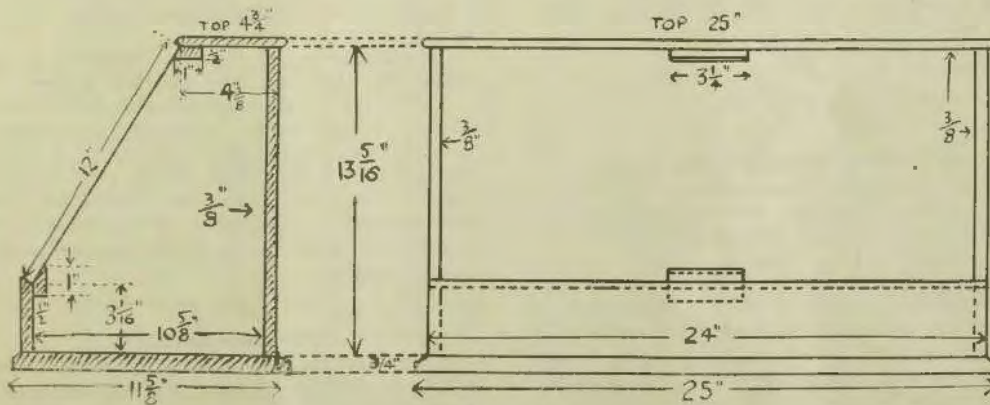

FIG. 6.

with C.3 and C.4. This is the S.T. 100 without stabilising resistance, which may be added if the low frequency oscillations are too severe. Join it to the grid of V.2 and down to the positive of the L.T. battery.

One word about the terminals on the left-hand side of the panel. When using the three valves constant aerial tuning is employed by joining aerial to A, leaving A.1 free and shorting C, D and E, and joining earth to E. Ordinary parallel tuning is obtained by joining aerial to A.1, shorting C, D and E, and joining earth to E, leaving A free. Series tuning is possible with three valves, but not with the two valves. This is obtained by joining aerial to D, earth to E, and connecting C to E, leaving both A and A.1 free.

A nice choice with the three valves. On the two-valve side, when the switch is turned down, constant aerial tuning is obtained by joining aerial to A, leaving A.1 C and D free, and connecting the earth to E. Ordinary parallel tuning is brought about by joining aerial to A.1, earth to E, and leaving A, C and D free. In both instances C.3 becomes the A.T.C., and L.3 becomes the A.T.I.

Read the previous paragraph over again, and you will understand it alright. I've got a little surprise for you. What do you think? I'm actually giving the measurements for a cabinet. See Fig. 4. Oh, yes, I have one like it—see Fig. 1. No, I didn't make it; my big "bruvver" did, and he polished it nicely. Go thou and do likewise!

The last word now. Patter about with the set. I know it is difficult to handle at first, but it soon will come to you, and I am sure you will bless me for telling you about it. Personally, I prefer this set of mine to any that I have seen, and I've seen quite a number. I am sure you will say likewise very shortly.

**Blue Prints.**—For those who desire them, I am providing blue prints of Figs. 4 and 5 for 5/6 posted. Don't forget, each is 2 feet long.

#### SOLDERED CONNECTIONS BEST.

If you must make your connections exceptionally tight on the B batteries, don't make the mistake of using a pair of pliers on the nuts. Many people follow this practice, but it should be avoided, as in nine out of ten cases some of the connections are loosened or else broken off entirely. If you must have the wires to these batteries good and tight, solder them. This can be done without trouble, providing a very hot iron is used. Don't hold the latter on the binding posts too long, as this will tend to melt the insulating material which surrounds the little screws.

#### AVOID LOOSE CONTACT.

Many condensers are designed so there is a friction contact to the moveable plates, that is, the contact is made by the shaft touching a piece of metal. This is a cheap and easy way to make a connection, but it will develop into a loose contact and dust collecting between the shaft and the contact point decreases the efficiency of the entire set. Good firm connections usually made in the form of pigtaills by wire fastened to the shaft of bearing, form a far superior contact. Scratching and grinding noises in the phones are often traced to a friction contact on a variable condenser.

Sliding and friction contacts are all loose connections and are a source of trouble. It must be remembered that most of the energy radiated by the transmitting station is lost in space. Only the smallest fraction of the current broadcast is picked up by a receiving station. A loose contact places resistance in the path of the feeble impulses passing through the receiving set and the sound is greatly decreased if not inaudible in the phones.

#### HOLDING SOLDER ON IRON.

Set builders and experimenters who have trouble with their soldering irons will find a few pence worth of sal ammoniac a good investment. It is a white powder. When the iron gets refractory about holding solder, file it clean and bright, heat it a trifle above soldering temperature. Plunge it into a solution of sal ammoniac and apply solder and resin, or use resin cored solder. Coat the point half way up the iron. Let the iron cool and then use it as before. Care in not getting it too hot will prevent burning off the "tinning," as it is called.

Porcelain is one of the best insulators for the aerial; but there are good and bad grades.

Efforts of the Hazletine Research Corporation to restrain Freed-Eisemann, neutrodyne manufacturer, from continuing manufacturing the set have resulted in Judge Ives, in the Eastern District Court of Brooklyn, N.Y., not only refusing the petition, but ordering the Hazletine Corporation to turn over to the Court all royalties paid by Freed-Eisemann, pending further hearing.

#### SWINGING AERIALS.

An aerial that is permitted to swing will produce jerky and uncertain signals. The tighter the wire is stretched the better it is for receiving clear signals. Always solder the lead-in wire from the aerial.

## BASKET COILS AND HOLDERS.

(John Rae.)

**M**OST amateurs have a liking for basket coils; they score on account of their simplicity of construction, their low self-capacity, low cost and freedom from dead-ends. Few amateurs, however, have a satisfactory mounting for these very handy coils, and the suggestions given here will, I hope, be helpful.

For those who are unacquainted with basket and spider-web coils a few remarks concerning them will not be out of place. Keep the resistance low; the wire should preferably be not finer than No. 28 gauge, because high-resistance coils will not tune sharply. As an alternative to the usual type wound on a cardboard former, a skeleton coil may be made by winding the wire around nails driven in a wooden cylindrical block as shown in Fig. 1. The coil on completion is coated with shellack or dipped in molten wax and allowed to dry. On withdrawing the nails the finished coil may be slipped off the block. Coils wound in this fashion will be more fragile and perhaps a trifle less efficient than those wound on cardboard, since the shellack or wax used to hold them together increases their self-capacity.

Whatever type of coils you may use, they can with a little ingenuity be easily adapted to the mountings described in this article. Exact dimensions are purposely omitted.

From the point of view of simplicity the holder shown in Fig. 2 has many advantages. It consists of a wooden cylinder or stout cardboard tube about a foot long and 2 inches in diameter, along which the coils are moved to vary the coupling. This tube is loosely mounted on two wooden supports about 8 inches apart, and the projecting end may be used as a rack for spare coils. The main disadvantage of most types of basket coil mountings is the difficulty in interchanging coils, and the loss of time and patience in connecting wire ends to terminals. A way out of the difficulty is illustrated in Fig. 3. Ter-

minals are provided on the baseboard to keep the permanent connections from the set, and small three-pronged clips are clamped under the terminals to take the coil leads. These can be easily cut with shears from sheet copper or brass. Reference to Figs. 2 and 3 will explain the construction of this perfectly simple coil mounting.

The next coil mount is a more precise and elaborate arrangement. Plugs and sockets are used, and interchanging coils is the work of a moment. Each coil is mounted upon a piece of  $\frac{1}{4}$  inch thick ebonite or hardwood, to the base of which two valve pins are attached, and the ends of the coil are clamped to the pins with the locknuts provided. The method of mounting will depend largely upon individual types of coil; that adopted in the original model is shown in Fig. 4. This figure also illustrates the mounting of the valve sockets on another piece of wood or ebonite. Two of these socket mountings will be required. Great care should be exercised when drilling the holes for both sockets and plugs, in each case keeping them a standard distance—say, 2 inches—apart. From Fig. 5, which shows the completed instrument, it will be seen that one of the socket mountings form the endpiece of a rectangular wooden frame about 3 inches by 12 inches; two strips of wood 12 inches by 1 inch and  $\frac{1}{4}$  inch thick form the sides, upon which the moving socket mount slides. The remaining small endpiece has a clearance hole drilled in it to take a wooden knitting needle, the business end of which is glued to the sliding socket mount. From the two sockets on the latter lengths of flex go to two terminals on the small endpiece, while at the other end two other terminals take the leads from the fixed mounting. If the written explanation is difficult to follow, reference to Fig. 5 will make the whole idea perfectly clear. The complete instrument should cost but little, and the construction of it should present no difficulties.

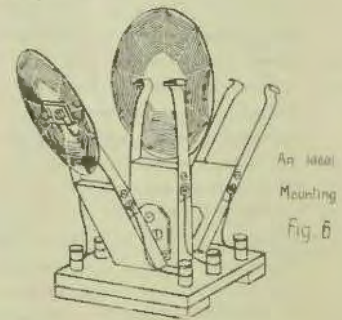
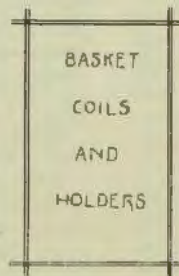
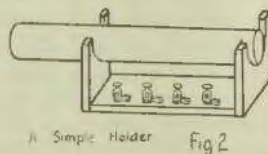
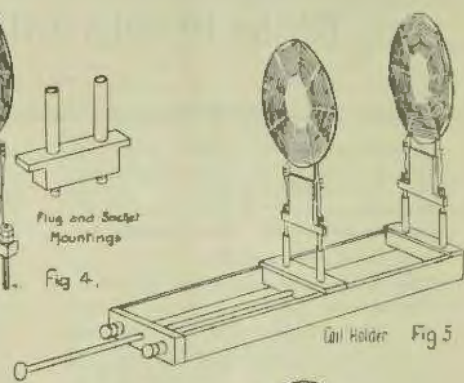
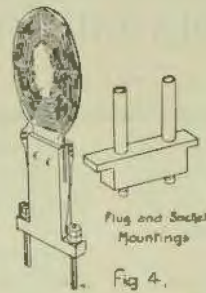
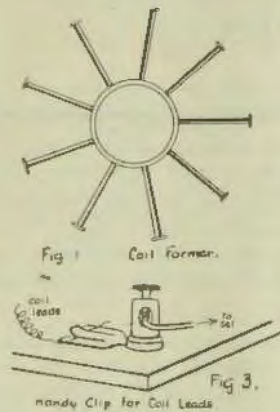

We now come to what, in the writer's opinion, is the finest basket coil mount he has ever seen. It is illustrated in Fig. 6, and will need little explanation. Three arms of  $\frac{1}{4}$  inch thick ebonite or hardwood are strongly hinged together, and the central one is fixed to a baseboard carrying six terminals, which should be well spaced so as to be easily accessible. Six stout strips of springy brass  $\frac{1}{4}$  inches by  $\frac{1}{4}$  inch are cut with shears from a sheet, and two holes are drilled in each at distances of  $\frac{1}{4}$  inch and  $\frac{1}{2}$  inch from one end. The other end is hammered over a nail into the shape of a question mark. Examine Fig. 6 and note the position of the brass strips on the edges of the arm pieces. Screw them in place with a washer on the bottom screw, and take a length of soft flex from thence to each of the terminals. Strips of wood along two of the undersides of the baseboard complete the coil holder.

To adapt the coils for the mounting, screw a piece of ebonite about  $1\frac{1}{2}$  inches by  $\frac{1}{2}$  inch to the centre of each cardboard former; mount on the ebonite two valve pins—if the cardboard is stout enough the pins may be mounted on it direct—and connect the two wire ends of the coil to the pins. The distance between the latter should be about  $\frac{1}{4}$  inch less than that between the brass strips on the holder.

To attach the coils to the holder, compress the strips with the fingers, engage the pins in the hook-shaped ends, release, and the coil is securely mounted, electrical connection being made through the supporting brass strips. If the valve pins are a little too long, saw a piece off the end.

The possession of efficient apparatus is a source of great satisfaction to most amateurs, and I think you will agree that this mounting is the goods and well worth any trouble in assembling.

## THE DESIGN OF EFFICIENT RECEIVERS

By W. A. STEWART.

IN the average receiver seen these days, there seems to me to be a lack of design, and judging by the way in which the panels of some sets are laid out, it often appears as though the constructor stood several feet off and threw the various components on to the panel. In designing a receiver, more care should be a secondary consideration, more care being taken in the prevention of interaction between components. Wiring of these components must also be considered, and all leads kept as short as possible.

Let's start from the first. Take the panel; this should be of a good insulating material, and after it has been squared up, the centres of both sides and ends should be found, and on the back two lines should be drawn with a scribe, so that they bisect each other in the centre of the panel, as shown in Fig. 1. These serve as a guide when mounting the condensers, rheostats, etc. It is usual to mount the tuning elements on the left hand end of the panel, and the rheostats, potentiometer, etc., towards the other end.

In this way if audio amplification is being resorted to, it carries on towards the right, and radio amplifiers are added to the left hand end; it will be seen that the wiring is then quite simple and is practically straight all the way. You will often find a set laid out with the tuning elements at the right hand end, the builder usually claiming that it is easier to tune with your right hand, but if a message has to be written down, it is far harder to write with your left hand. I think that taken all round the former method is the most convenient. It is usual practice to screw the panel to a baseboard, and on this baseboard, mount the transformers and valve sockets; and on a strip of bakelite or other insulating material, the terminals. It is an advantage to mount the terminals on the back of a set, as all battery leads are then kept from the front of the set and the wiring is much easier.

On the panel mount the condensers, coils, rheostats, potentiometer, variable grid leak, and jacks if they are used. Many sets have bezels, through which the valves may be seen, but I consider these unnecessary, as there is no occasion to watch the valves, and it is quite easy to look over the top of the set, or lift the lid of the cabinet, if one is used. Even if you cannot see the valves, you can easily

tell if the set is functioning properly, by the sounds heard in the phones.

With regard to the mounting of inductances, and condensers. If you want to get really efficient results, all coils should be mounted at least two inches from any other part of the set, and at the same time the leads must be kept short. You may wonder how this is to be done with honeycomb coils, but coil holders can be obtained with extension strips to keep them away from the panel. Concerning the inductances themselves, a straight wound coil is far better than any other coil and where possible should be used. Of course on the longer wave lengths, it is rather hard to build a compact straight wound coil, and honeycomb coils of the duo-lateral type can be used to advantage, but for waves below 600 metres straight wound coils should be employed. In designing inductances they should be

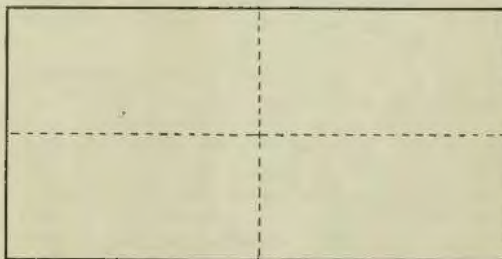

FIG 1

constructed so as to give a maximum of inductance for a minimum of resistance. Resistance is objectionable and as little of it as possible should be introduced into a circuit.

What are known as "low loss" inductances are becoming very popular, being usually wound with heavy wire and made as far as possible self supporting. When they were first introduced some people thought of using wire with a gauge of about 8 or 10, but tests prove that although the electrical resistance may be lower, eddy currents are set up between turns, and the coils of this wire are three or four times less efficient than those wound with 20 gauge wire. For the average coils 16 or 18 gauge is hard to beat. No matter how well a coil is constructed, the trouble taken will go by the board if the condenser used for tuning is a poor one.

Tuning condensers should be of the best, and should be preferably of the "low loss" type, although any condenser can be used, providing it is well built. The condenser should not be of too big a capacity, as it being better to use a small condenser, and a large inductance, as the larger the inductance the easier the tuning.

With regard to the mounting of coils, care should be taken to see that they are not mounted so as the lines of force from the coil pass through the condenser plates, as if they do the resistance of the circuit will be increased and the selectivity decreased. It is a well-known fact that a piece of metal near a tuning circuit causes losses, as strong currents are set up in the metal plate (which can be regarded as a single turn inductance), and if strong currents were flowing in the coil, the plate would get quite hot. For this reason it will be seen that coils must be kept clear of condensers, and mounted at right angles to them. On no account mount a condenser inside a coil, as there would be hardly any tuning at all. One of the best examples of neutralising reaction between coils was shown in the neutrodyne receiver where the coils were mounted at an angle of 60 degrees; in this position the coupling is practically nil. Audio frequency transformers can also be mounted this way to prevent howling.

The moving spindles of variable condensers should also be earthed to prevent body capacity effects. In the better types of condenser, the end plate is made of metal, with the spindle connected to it. This plate is then earthed as are also the mounting screws of the condenser. In a receiver of any kind all connections should be as short and as direct as possible, and where practicable very few of the wires should run close together. This is specially applicable in radio frequency amplifiers. Where two wires cross they should be well insulated and the cross should be at right angles. Thick wire of low resistance should be used for all connections, and resin should be used for a flux for all soldering. Capacity between leads and also between components should also be prevented as far as possible, as it is these small leaks which tend to cause inefficiency in a great majority of the sets. Design a receiver with a view to ease of operation, and with a view also to keeping the leads short and direct.

Keep all metal away from the tuning elements, and don't put the batteries in the same case as the set. Although it keeps the leads short, the batteries are at earth potential, and tend to introduce resistance into the circuit. Furthermore gas is being continually liberated from a battery, which

has harmful effects on the set itself. If the batteries must be in the same case, the case containing the batteries should be lined with lead.

Remember that a high-resistance circuit cannot tune sharply, and always design inductances with a view to keeping the inductance high in value and the resistance as low as possible. Large coils and small condensers, are far better than large condensers, and small coils, and for best results, only the best of gear should be used.

#### K.H.J. NOW.

As far as we can say, the first experimenter in Australia to pull in KGO on a single valve was H. Gotting, of Braemar, N.S.W. His report reached us months before most of us knew that station was on the air.

Now we heard from Mr. Gotting that he has picked up KHJ, the station of the "Times," Los Angeles, last Saturday evening on a detector and 2 audio.

Among the technical items of a small radio paper published at Apia is one reading, "After the leads have been connected to your receiver, with required tubes, batteries, etc., you will be ready for the test. If under these conditions you cannot tune in the desired station, take a low resistance lead from your aerial just above the receiver and solder it to the lake or bay. Amateurs may not know how to solder a lead to the lake as stated above, but these things are technical facts and you are not supposed to know. If this fails, try some hook-up of your own."

#### ADDITIONS TO N.S.W. TRANSMITTERS

Please add the following to the "Wireless Weekly" list:—

2 X.A.—H. K. James, 12 Rosemount Avenue, Summer Hill. Transmits C.W., I.C.W., and telephony, between 6 and 8 p.m. and from 8 p.m. to 1 a.m. Special D.X. tests can be arranged throughout the day.

Please note the following alteration: 3YN, D. J. Harkin (formerly 3KF), 41 Carlisle St., Preston, Vic. 180 metres. Transmits C.W., I.C.W. and phones between 7 p.m. and 12 p.m. Saturdays. Irregularly through the week.

#### REVISING POLARITY OF PHONES.

It is sometimes an advantage to reverse the polarity of the phones. Some phones will work much better with the current running through them in one direction.



## The Value of Well-Insulated Aerials and Earth

**T**HE listener who desires efficiency, volume, range and selectivity cannot attach too much importance to insulation of the aerial and earth. As the collector of feeble radio impulses the aerial is of supreme importance, and on a par with it, in carrying away the waves after they have been through the receiving apparatus, is the earth connection.

An analysis of radio broadcasting will very probably explain this most clearly. The wave that is sent out from a broadcasting station travels over an ever-widening area, gradually becoming weaker and weaker as it goes hundreds, perhaps thousands, of miles through more or less absorbing atmosphere and over imperfectly conducting ground.

The receiving aerial may be pictured in the mind as the "fingers of the air." To make use of this feeble impulse, the aerial must be sensitive. Once the wave strikes the wire, it begins a journey to a receiver that may be as weakening as the projection from the distant station.

### MAIN CAUSE OF WEAKENING.

The main cause of this weakening is poor insulation. A point of poor insulation is a point where there is a "leak." That is, the current is able to flow off the aerial wire and into the roof or the walls of the house. This involves a loss, which manifests itself into weaker signals.

Impulses picked up by a distant receiver are so very minute that the most effective collective device possible should be used, and every possible method of insulation be utilised in order to give them a "clear track" into the set. When an aerial is on the roof the lead-in should be held away by insulation from the sides of the buildings. The lead-in should also be run through the wall or window in a porcelain tube or like insulation.

Inside the room short leads are best, but, regardless of whether the lead is long or short, it should be insulated just as well as the wire on the outside of the house or apartment. The popular theory that inside or outside wooden, stone, or brick walls will not deduct from the efficiency of an aerial is false. The radio listener who has his lead-in tacked to the surface of a building may not think that the power is diminished, yet there is probably a loss here that is reducing his range and selectivity. Even if the wire has an insulating covering it should not be run directly against a wall. The very proximity of the

wall may cause a loss.

### EARTH WIRE NEEDS INSULATION.

After passing through the receiving instruments the signal currents flow into the earth, and here insulation is again highly important. At first sight it seems unimportant by what path the impulses get into the ground. One would think that the more paths that were provided the better. This, however, is not the case. Only one earth should be provided, and that one the best available.

The important thing about the earth connection is that it should have as low a resistance as possible. High resistance reduces the signal strength. The thing about wireless currents is that they do not follow the path of least resistance. The word resistance is here used in its technical sense of electrical resistance. They follow the easiest path to be sure, but this is not necessarily the path of least resistance. The easiest path for wireless currents is the shortest path. We can, therefore, have the following queer condition: Suppose a wireless receiving installation has two earth connections, one near the receiver and the other at some distance from it. Most of the signal current will flow into the ground through the nearer earth connection. If, therefore, the nearer earth connection happens to have a large resistance, the signal strength will be reduced. Now, if the nearer earth is removed, the current must flow through the distant connection—it has nowhere else to go, and if the resistance of this earth is low the signal strength will be greater than when there were two earths.

The practical application of all this is to be sure to support the earth wire on insulators up to the point where it is connected to the ground. Water pipes are about the best things on to which to connect the earth wire, and the connection at this point should be as positive as possible.

### CONNECTION FOR HEADSETS.

Headphones, generally speaking, operate the best when the positive side of the phone is connected to the positive side or lead of the B battery. Some phone cords are marked with a red stripe to indicate the positive cord of the phones. But if the phones aren't marked, try them connected one way and then reverse these conditions. The positive side will be indicated by the connection that gives the clearest and loudest signals.

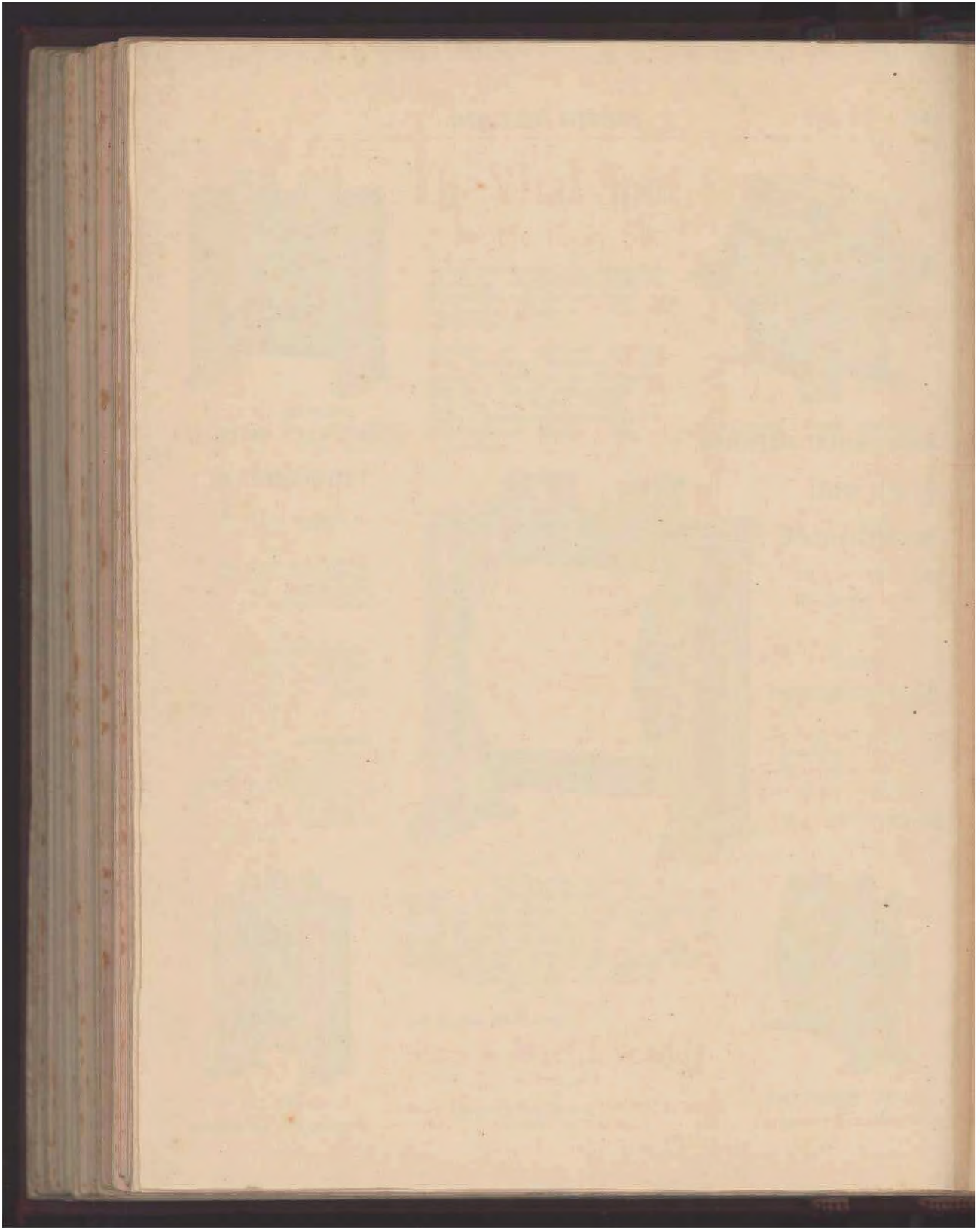

The Name to Know in Radio

# Wiles' Wonderful Wireless

58-60-62 GOULBURN ST. (1 door from Pitt St)  
384 PITT ST. (Near Goulburn Street)  
23 PITT STREET, NEAR CIRCULAR QUAY

SAME QUALITY  
SAME PRICES  
SAME SERVICE

CONSTRUCT YOUR OWN BROADCASTING RECEIVING SET WE SUPPLY COMPLETE BUILDING INSTRUCTIONS AND ADVISE WIRE BACK ORDER.

Our Special Selection of Technical Books that will increase your knowledge of the Radio Science.

The Radio Telephone, by Davis, written in that it can be understood	2/6
Construction of Another Valve System, by Douglas	2/6
How to Build Your Wireless Apparatus, by Mitchell	1/6
Practical Wireless Notes for All, by Harris	1/6
How a R.F.C. of Wireless, by Harris	1/6
Wanted for All, by Hunt-Taggart	1/6
Simplified Wireless, by Hunt-Taggart	1/6
How to Make Your Own Broadcast Receiver, by Scott-Taggart	3/6
The Complete Wireless, by Scott, Part 1	1/6
Practical Broadcasting and How to Make Them, by Cassella	1/6
How to Build Another Valve System, by Conway	2/6
Construction of Wireless Receiving Apparatus of 7 tubes	2/6
The Boy's Wireless Book	6/6
The Radio Experimenter's Handbook, by Osney, Part 1	6/6
The Radio Experimenter's Handbook, by Osney, Part 2	6/6
Practical Radio, by Williams	10/6
The Radio Demographer's Secret, giving Complete Data, Circuits and Plans—How to Build	6/6
A Radio Receiver	4/6
A Two Tube Circuit, with Full Port Amplification	4/6
Detector and Amplifying Units	4/6
The U-Higher	4/6
A Portable Receiver	4/6
The RT 100 Receiver	4/6
All About Antennae and Their Construction	4/6
The Subscription Service	3/6

**BEST QUALITY PRICES**

1/10 Bare Copper, 1933	2/9
1/10 " " "	2/9
7/12 " " "	4/6
7/20 " " "	6/6
11 Gauge Aluminium Wire, 1933	10/6
English Rhinostyle, 8 adms	1/6

**SHANNONSON**

Five, 800 ohms	2/6
Eight, 800 ohms	3/6
Murdock's, 2000 ohms	4/6
Murdock's, 5000 ohms	4/6
Zeus	4/6
Town's M. Dependable	12/6
T.M.C., 4000 ohms	2/6
Radio Signal Unit	3/6
Bismberg, Dayton	3/6
Woods Electric, 2000 ohms	4/6
Standard Lightweight	4/6
Norweg, 2000 ohms	4/6
Radio, with 500 ohms	7/6

**HONEYCOMB INDUCTANCE COILS for all Australian Broadcasting Wavelengths (Unmounted)**

35 Turns — 200/250 Metres	2/6
30 Turns — 100/125 Metres	2/6
20 Turns — 50/75 Metres	2/6

**SPECIAL ANNOUNCEMENT**  
In our price of parts for the modified RT-100 Radio Circuit, published in Wireless Weekly, October 1934, the Crystal Detector was omitted, and we are therefore including in this advertisement the complete list of parts.

75 Turns — 200/110 Metres	4/6
100 Turns — 450/425 Metres	4/6
150 Turns — 500/1000 Metres	4/6
200 Turns — 1000/2000 Metres	4/6
250 Turns — 1250/1750 Metres	4/6
Full Price for Mounting the above Plates	3/6
Mounting Screws	1/6

**Parts Required for the Modified RT-100 Radio Circuit**

Power Glass, 2 1/2 x 3 1/2	10/6
1 1/2" Condenser, with Variable	1 1/2
1 1/2" Condenser, with Variable	1 1/2
1 1/2" Plug	2/6
1 1/2" Potentiometer Handle	1/6
1 1/2" Photo Electric	1/6
1 Through Coil Detector	4/6
1 Battery Switch	1/6
1 S.T. Horn	1/6
1 S.T. Horn	1/6
1 Johnson's 31 Transformer	12/6
1 200 Ohm Condenser—Frohmanna	4/6
1 200 Ohm Condenser—Frohmanna	4/6
1 Variable Self Lock	1/6
1 Lead Wire Battery	1/6
1 Single Cabinet	21/6

The price of the circuit with the RT-100 Circuit is being marketed at the best quality.

**Our Guarantee**

It is our intention that every article in this list shall be carefully described. Therefore we guarantee everything you buy from us to be satisfactory in every detail. You will be pleased to return your money and all transportation charges you have paid.

## W. HARRY WILES

Radio and Electrical Supplies, 60-62 Goulburn-st, Sydney

Please address all communications to our Head Office, 60-62 Goulburn Street.

ESTAB. 20 YEARS

## STANDARD OF EXPERIMENTAL RATING

IS IT TOO HIGH ?

By A. BURROWS.

THE appeal which wireless has for so many has been attributed to many reasons. Some have given the honor to the fact that you never know what you're going to strike next—the "glorious uncertainty"—which generally consists of wondering how long a valve is going to last. Others attribute the universal interest of wireless to its many complications, while a few evidently misguided fans state that as a hobby it has cheapness to recommend it.

Probably, however, the real reason for the popularity of the experimental side of wireless is the fact that so little is known about it. Every experimenter, after all, is working in the dark. He knows that a certain combination of adjustments or instruments will produce a definite effect, but when it comes to even a simple explanation of why this is so, he is, as a rule, at sea.

It is only the experimenter, however, who really experiences the interest of wireless in this respect; the broadcast listener—that is, the confirmed BCL—is quite a stranger to it—in fact, he probably regards those points which are so interesting to the amateur as decided curses so far as he is concerned. Which, of course, simply goes to show that it all depends upon the point of view.

Which brings us back to the old experimenter - broadcast listener argument. Lately this question seems to be developing a new angle, for in the opinion of many experimenters the authorities show a definite desire to make things as difficult as possible for the experimental movement. Whether or not this is a fact, which seems rather doubtful, few experimenters will in any case blame the broadcast listeners for it. They are, of course, the indirect cause of many of the amateurs' more recent troubles, but they cannot be held responsible for any undue hostility on the part of the authorities.

**No Incentive.**

Things undoubtedly seem rather anyhow with Australian experimenters. Clubs generally appear to be having a stiff fight to keep their ends, up, and as a united body, experimenters, in spite of their much talked-of organisation, don't appear to be getting anywhere. Yet it cannot be denied that there must be a huge number experimentally interested in wireless at present; from the ruck of broadcast fans there must be a big proportion of

those who regard their gear in a somewhat different light from a gramophone. And surely these (unless the definition means someone on a par with Reinartz) are entitled to be called experimenters.

This languishing of the experimental movement is attributed by some to the fact that so few of those who may be skilled technicians will go to the trouble of gaining experimental licenses. This means, in other words, that to them the status of an experimenter is, to all intents and purposes, nothing. And without that standing which means so much to some there is little incentive to any sort of organisation.

On the other hand, there are those who contend that the authorities have made the gaining of an experimenter's license difficult for the express purpose of debarring as many as possible from achieving that honor. This may or may not be true; but the fact remains that there were some grows from the experimenters who attached some prestige to their name when, not so long ago, experimental licenses could be had for the asking. It would seem that the amateurs really don't know what they want but what they have to decide now is whether they shall protest against the rigid examinations and so forth, using what power they may have; or be content to let the experimental status remain exclusive and select.

There is perhaps little doubt that the difficulty (and it is almost generally agreed that the difficulty exists) in gaining experimental licenses is having some detrimental effect upon amateur work. When a man's license is endorsed as that of a broadcast listener, and when he is called a broadcast listener, it is scarcely probable that he will be as keenly interested in activities beyond his own work, as he would be if he knew that he held the standing of an experimenter. The fact that there appeared to be more life in the organised experimenters before the present regulations bears out the truth of this.

**Choking the Movement.**

It can be argued, of course, that the more accessible the licenses the less importance will be attached to the amateurs' status; that there would not be enough difference between the experimenters and the BCLs to give the former any prestige. This, to an extent is true, but there is always the happy medium. At present the authorities are erring

on the side of making the circle of experimenters too exclusive—too 'genuine,' and the general opinion is that the present interpretation of the regulations, so far as amateurs are concerned, will inevitably result in the throttling of the experimental movement, which includes the R.R.L. in Australia and anything of a worth while nature.

Whether or not the authorities are deliberately endeavouring to kill the organisation of experimenters, as alleged by some, is, of course, a very debatable point. There are quite a number of leading experimenters who are satisfied with things as they are now, and there is really little reason to think that the Government is acting in anything but good faith. It is certainly the Government's concern to see that the issue of experimental licenses doesn't reach undue proportions, but many would be willing to pay as much as their brother the BCL if they could be called by the name of experimenter. And there seems little doubt that for a man to know he is an experimenter, without bearing the name and seeing it upon his license, is not enough. A good turn would be done amateurs generally if the present high standard necessary is gaining a license were lowered to some extent.

#### ELECTRON FLOW IN THE OPERATION OF TUBES.

THE addition of a third electrode, called the "grid," between filament and plate in the vacuum tube, makes it possible to increase or decrease the current between plate and filament over wide limits. It is obvious that the electrons traveling from filament to plate must pass through the wires forming the grid. If the grid is given a potential which is negative with respect to the filament, the grid will repel the electrons, but many of them will still pass through and reach the plate, because of their high velocity, inasmuch as the positive plate potential still affects them to some extent. If the grid potential is made still more negative, the plate current will diminish until finally it may be stopped entirely.

If, however, the grid is given a positive potential instead of a negative, electrons will be attracted to the grid as well as to the plate, and more electrons will now be drawn toward the plate than would otherwise pass, so that the plate current increases. The charge on the grid partially neutralises the effect of the space charge. A limit to the magnitude of the plate current will finally be reached, when the space charge caused by the large number of negative electrons in the tube fully counteracts the influence of

the positive charges on the grid and the plate. The attainment of the limiting or saturation value of the plate current is assisted by the absorption of more electrons into the grid if its positive potential is increased. The absorption gives rise to a relatively small current in the grid circuit. The total electron flow is the sum of the plate current and the grid current. As the potential of the grid becomes more positive, more electrons will be absorbed by the grid.

The current in the plate circuit depends very markedly upon the potential of the space between plate and filament. Electrons which have just left the filament and are moving away from it give a "space charge," as it is called, to the vacuous space in the vicinity of the filament, and will limit the flow of electrons between filament and plate. The influence of this space charge may be controlled by varying the potential of the grid. If the grid is made positive, it will tend to neutralise the effect of the electron space charge which is negative, and the result will be an increase in the flow of electrons from filament to plate. If the grid is made negative, it adds to the effect of the electrons in the space and decreases the flow of electrons in the plate circuit. Thus, if the temperature of the filament is kept constant, and the potential applied to the plate is kept constant, the current in the plate circuit may be varied also by varying the potential of the grid.

#### REMEDYING TROUBLES IN VARIABLE GRID LEAKS.

Check up carefully all connections in the grid circuit, which applies equally to all other circuits of the hook-up. See that every connection is as tight as it should be, and that nothing but the very best variable grid leak is used. Some tubes may not require a grid leak at all. This can be determined only by experiment. A loud humming noise is one of the indications of trouble in the grid circuit, though the noise may also be caused by alternating currents in the house lighting system. When ticks are heard in the headphones instead of good clear signals, there is something wrong with the adjustment of the grid control.

#### WHICH PROBABLY WOULD BE PLENTY

A tenant in Sheffield has been brought into court for not paying her rent—refusing to do so until the landlord removes the aerial from the roof. However, her fears were not of lightning, but merely that this apparatus would permit said landlord to hear everything that the old lady said in her own house!

## INTERSTATE NOTES

### SOUTH AUSTRALIA.

**T**HE radio dealers in South Australia still continue to do a brisk trade. A good supply of the popular UV201A valves has been procured, but other components are still unobtainable, and manufacturers of receiving sets are having a hard job to obtain the necessary parts.

5 D.N. still delights his large audiences of listeners in every Tuesday, Thursday, and Saturday evening sharp at 8 p.m. Sets of all descriptions are tuned to his wave length, with the expectation of hearing something good, and they are never disappointed, for 5 D.N. is easily the premier station in South Australia.

Mr. E. J. Hume, the owner of Station 5 D.N., returned to Adelaide on Tuesday, having visited Melbourne and Sydney on business. While in Melbourne, Mr. Hume interviewed the Federal authorities regarding his application for a "B" class broadcasting license, and it is understood that Mr. Malone, who recognises the fact that Mr. Hume has complied with the required conditions, has given him the assurance that his license will shortly be forthcoming, and also gave him an understanding that his wave-length will be somewhere between 250 and 300 metres, so that the work of installing the new higher-powered transmitter can be proceeded with immediately.

The transmitter now in use will be kept as a standby in case of any emergency, so that this station will always be on the ether at its appointed times of transmission.

While in Melbourne, Mr. Hume, together with Mr. L. C. Jones, visited the station of Mr. Boss Hull at St. Kilda, and had the pleasure of listening to transmissions from his own station. Mr. Hull, when tuning-in, picked up a strong carrier wave and exclaimed, "Oh, this is one of the local stations!" and was surprised to hear the announcer say, "This is 5 Don N. calling." The visitors were also agreeably surprised, so strong did the music come in on the loud speaker.

#### 5 B.G. Chats with Users of Crystal Sets.

Mr. Harry Kauper, 5 B.G., is probably the most popular of the experimental transmitters here. He has invited those using crystal sets to write to him concerning their troubles and difficulties with their

sets, and his advice, given them over the radiophone, is greatly appreciated.

One night recently he was heard giving a short lecture on crystal sets with valve amplification. He mentioned that at present there are hundreds of people who are getting quite satisfactory reception on crystal sets in their well-known form of a crystal, coil and condenser.

When the local broadcasting station gets on full power, however, the crystal user, getting much stronger signals, would be looking for a means of amplifying the sounds, so that a loud speaker could be used. They would then be faced with the problem of whether they should keep their crystal set and amplify the sound by means of a valve, or go in for a straightout valve set.

Mr. Kauper recommended them to keep their crystal detectors, and make use of a valve solely for the purpose of increasing the sound to loud speaker strength. This would furnish them with a set which, they could rest assured, was not causing annoyance to their neighbours, who, next morning, they could look squarely in the eye and without any guilty feeling. With it they would get the best possible reproduction in the loud speaker, because of the fine rectifying qualities of the crystal. It would be simple to operate—anybody in the house could do it, and it would be very economical to run. Mr. Kauper went on to describe the construction of such an amplifier for those who might wish to assemble it for themselves.

#### 5 B.N. Has a Mishap.

Mr. Austin seems to be having a run of bad luck, as just recently he burnt out his power transformer. This has been renewed, and now (on Friday evening) he announces that one of his 5-watt valves has gone west.

Mr. Austin apologised to the many anxious listeners who were waiting to hear his usual Friday evening entertainment for being late in starting up, and stated that he had been out scouring the town for a new 5-watter, but that he had been unable to obtain one. He further stated that he was transmitting with two receiver tubes, and that he expected that his transmission would not be up to the usual

(Continued on Page 38.)

# HERCULES

(TRADE MARK)

## The "SPEE-DEE" Specialty Co.'s Line of High - Grade Radio Apparatus

We have much pleasure in announcing to the trade generally that we have been appointed the sole New South Wales Agents for this high-grade, yet moderately-priced, line.

We will be able to give immediate delivery on most of the following items, the balance to arrive in about four weeks' time.

Item.	List Price.	Item.	List Price.
Antenna Insulators . . . . .	each 8d.	Rheostat, 20 ohm . . . . .	each 4/-
Contact Studs . . . . .	doz. 1/-	Potentiometers, Bakelite, 200 ohm . . . . .	7/3
Switch Stops . . . . .	doz. 1/-	Vernier Dial Adjuster . . . . .	1/8
Spaghetti, 3ft. length . . . . .	9d.	No. 500 Series Paralleled Switch . . . . .	1/9
Metal Binding Posts . . . . .	each 4d.	No. 400 Switch Levers . . . . .	1/6
Small Compo. Binding Posts . . . . .	doz. 4/6	Glass Enclosed Detectors . . . . .	6/-
Medium Compo. Binding Posts . . . . .	doz. 5/-	Dials, Tapered Knob, 3 1/2 in. . . . .	3/-
Large Compo. Binding Posts . . . . .	doz. 5/3	No. 200 Switch Levers . . . . .	1/6
Soldering Lugs . . . . .	doz. 6d.	Catwhiskers . . . . .	2d.
Lettered Terminals . . . . .	each 6d.	23-Plate Vern. Cond. and Dial . . . . .	29/6
Crystal Detectors . . . . .	3/10	43-Plate Vern. Cond. and Dial . . . . .	32/-
Catwhisker Brackets . . . . .	1/3	23-Plate Variable Cond. and Dial . . . . .	20/6
Crystal Cups . . . . .	each 6d.	43-Plate Variable Cond. and Dial . . . . .	24/9
Rheostat, 6 ohm . . . . .	each 3/9	V.T. Socket, Bakelite . . . . .	4/3
Rheostat, 30 ohm . . . . .	each 4/-		

WE ARE ALSO AGENTS FOR THE WORLD-FAMOUS

## "Timmons' Adjustable Talkers"

These Loud Speakers embody a totally different principle to the usual type of Talker. They depend upon what is known as "reflected tone," which gives the most natural reproduction of Speech and Music which it is possible to achieve. List Price, £13/10/.

## BURGIN ELECTRIC CO., LTD.

WIRELESS ENGINEERS AND SUPPLIERS

Showrooms and Sales Dept.

FIRST FLOOR CALLAGHAN HOUSE, 391 GEORGE STREET, SYDNEY

(Continued from Page 36)

standard. Although only using receiving valves, Mr. Austin's transmission was received at excellent strength; his modulation was perfect. After working for a little while, Mr. Austin substituted a 5-watt tube for one of the receiving valves. This made a considerable increase in the strength of his transmission, his modulation still remaining very clear, and the listeners-in were genuinely sorry when he closed down for the night.

**Wireless on the Train.**

The wireless test which has been arranged by the S.A. Division of the Wireless Institute of Australia is to take place next Thursday evening, and promises to be a great success.

A special train, consisting of four first-class coaches, has been hired for the evening. A receiving set is to be installed in each coach, so that passengers will be in constant touch with the experimenters.

**The Opening of Braybrook Station.**

The opening of the Melbourne (Braybrook) Broadcasting Station on Monday evening is causing considerable excitement amongst listeners-in here, as this station should come in fairly strong in South Australia, being much nearer than 2 P.C. and 2 B.L., who are both able to be heard on a one-valve set. Judging by what has been heard of this new station, while testing, the transmissions will be quite up to expectations.

**LEICHARDT AND DISTRICT RADIO SOCIETY.**

Members of the Leichardt and District Radio Society had a very busy time on Oct. 7th, when the 2nd Annual Meeting was held at the club-room, 176 Johnston Street, Annandale.

The attendance was exceptionally good, and the big volume of business on hand was dealt with expeditiously and well. This included such important matters as the election of officers for the ensuing year, the adoption of the Hon. Secretary's report, and the Hon. Treasurer's report and balance sheet, the election of new members, and several other matters of more or less importance.

The Hon. Secretary's report revealed a year of steady progress and advancement, and for the edification of experimenters in general a copy of this report will appear in these columns of our next issue. Watch for it.

Next Tuesday evening the Society will hold its 103rd general meeting when an inter-club debate will be conducted, and should prove quite a success. The sixth lecture of syllabus No. 2 will be delivered on Tuesday, October 28th, by Mr. F. Thompson, who will deal with the interesting subject of "Valves."

The Society welcomes inquiries regarding the work that it is doing, and these should be addressed to the Hon. Secretary, Mr. W. J. Zech, 145 Booth St., Annandale.

**CROYDON RADIO CLUB.**

The usual weekly meeting of the Croydon Radio Club was held on Saturday, 11th October, at the clubrooms, "Rockleigh," Lang Street, Croydon, at 7.30 p.m.

After buzzer practice the question of club membership was fully discussed.

It was thought that in view of the increasing number of broadcast listeners who wished to join the club, which is primarily for experimenters, that members be graded into two classes—(a) full membership, (b) associate membership.

The following motion was finally passed:—"That all persons applying for full membership must pass a simple verbal test, failure of which entitles them to associate membership, carrying every privilege except the power to vote or hold office in the club."

Members are requested to roll up in full force on October 25th, when Mr. P. Sewell will lecture on "Electrolytic Rectifiers."

All intending members are respectfully invited to communicate with the hon. secretary, Mr. G. Maxwell-Cutts, "Garwell," Highbury Street, Croydon.

**ANOTHER CLUB STARTED.**

Established six weeks ago, the Guildford Congregational Wireless Club commenced operations with a crystal receiver, and in this short space of time, have passed on to the valve and loud speaker stage. Rules have been drawn up and the club would welcome correspondence from other societies. Secretary H. R. Hewett, Grassmere St., Guildford.

**TRANSMITTERS, NOTE!**

Mr. O. Sander (2 U.W.) left last Sunday to install a six-valve receiver for J. Asprey, of Ascot (Q.). The job will include an 80ft. mast. Sander will be up in the atmospheric region for a month, and asks us to mention that he will be very glad to listen-in to any transmissions and to forward reports.

**QUESTIONS AND ANSWERS.**

P.E. (Rockdale): Yes, you could use the variocoupler, and the tuning would be far sharper, and the results would be just as good, if not better.



OUR SPECIAL  
LINE

# Peerless Head Phones

2000 Ohms.

**30/-**

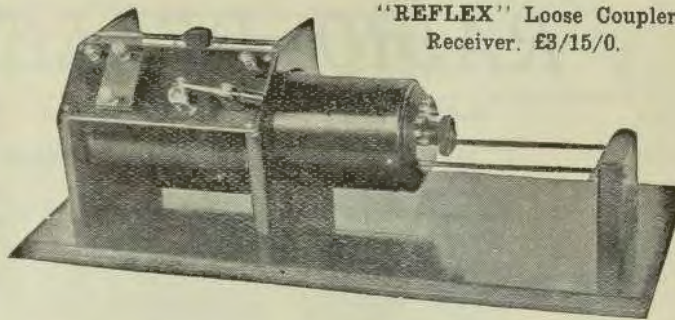

"REFLEX" Loose Coupler  
Receiver. £3/15/0.

Complete Set of Parts to make the above Set, 36/6.

Postage 1/6.

*The Vital Parts of your Set are  
Valves and Headphones*

WE SPECIALISE IN THESE TWO LINES.

FOR INSTANCE:

We make a Special Carton for sending Valves to the country. It is almost impossible for the postal people to break a valve packed in this carton.



**THE NEW PRICES OF VALVES**

PHILLIPS, D1, D2 and E. . . . .	18/6
MARCONI, R . . . . .	19/-
MULLARD . . . . .	19/-
DE FOREST RADIOTRON . . . . .	30/-



**HEADPHONES OF HIGH QUALITY  
THAT WE STOCK.**

PEERLESS, 2000 ohm . . . . .	30/-
TRIMM, 2000 ohm . . . . .	32/6
TRIMM, 3000 ohm . . . . .	45/-
RED SEAL—the Aristocrat of all Head- phones . . . . .	45/-

WE HAVE ALL OTHER BRANDS.

SEND FOR OUR PRICE LIST.

**RADIO HOUSE, 619 GEORGE STREET, SYDNEY**  
THE QUALITY RADIO STORE.

## RADIO DEALERS--

Before placing your orders, get in touch with us.

WE SUPPLY ALL PARTS FOR

### CRYSTAL SETS

SLIDERS, DETECTORS, CRYSTALS, WIRE, WOOD-WORK (Highly Finished), RODS, etc., H. T. BATTERIES, ACCUMULATORS, CONDENSERS.

OUR PRICES ARE COMPETITIVE

*Geo. Matthews & Emery*

DAKING HOUSE,

PITT ST. (opposite Railway Station),

SYDNEY.

## THE LATEST IN WIRELESS

Complete Set of Parts, to build One Valve Set, Guaranteed to work LOUD SPEAKER . . . . . £7  
(less batteries and phones)

Crystal Detectors, from 1/6                      Phones, from 25/-

Loud Speakers, from £4

THE SIRIUS Electrical and Radio Co.

No. 9 MACQUARIE PLACE

# MAXIMUM EFFICIENCY

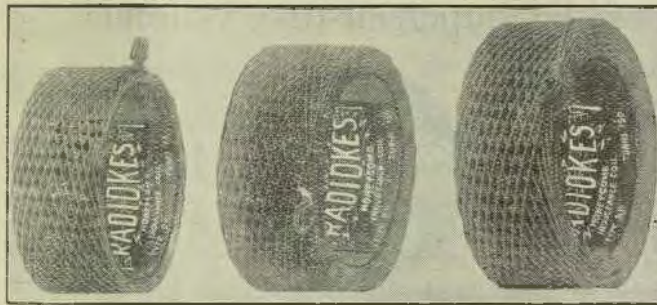

TYPE AH

TYPE DH

TYPE GH

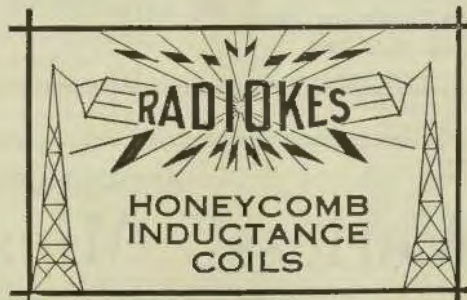

RADIOKES Coils are wound to give ample spacing, and are impregnated with special low capacity compound, ensuring maximum signal strength, maximum selectivity, maximum mechanical strength. Are not affected by damp.

Turns	Approximate Wave Length with .001 Condenser.	Wave Lengths
25	.....	60-230 Metres
35	.....	85-340
50	.....	150-500
75	.....	200-750
100	.....	280-1000
150	.....	360-1450
200	.....	470-2000
250	.....	530-2500
300	.....	700-3000
400	.....	900-4000
500	.....	1150-5200
600	.....	1350-6100
750	.....	1600-7700
1000	.....	2200-14700
1250	.....	2700-18200
1500	.....	3200-22200

Stocked by Leading Radio Dealers.

Trade Enquiries from KEITH STOKES Pty., Montana House, 27-29 King-st., Sydney

### No Valve Amplifier Needed--

AT LAST! A RELIABLE CRYSTAL!

### "J.B." Supersensitive Galena.

A product of Australia, the finest mineral producing country in the world.

A revelation in crystal reception. Volume and Clarity unexcelled.

EVERY ONE  
**A LOUD  
SPEAKER**



1/6 Ask far and insist upon having  
ONLY  
**"J.B." 1/6**

SOLD BY ALL RELIABLE DEALERS.

Sole Distributing Agent: WM. WILSON-SMITH, 296 OXFORD ST., PADDINGTON  
Telephone: Padd. 1228.

#### ANNOUNCEMENT

## "Wetless" Mica Condenser

AND DUO LATERAL COILS

Owing to the enormous demand for the above goods, the Manufacturers have been compelled to



appoint Distributing Agents, and, in future, the trade throughout Australia, will be supplied through

MADE IN AUSTRALIA

### Fox & MacGillycuddy Limited

DAILY TELEGRAPH BUILDINGS, KING STREET, SYDNEY.  
'Phone City 3062.

### Wireless Weekly

#### SUBSCRIPTION RATES.

Single Copies . . . . 3d. net  
 12 months (52 issues), 13/- post free.  
 6 months (26 issues), 6/6, post free.

All communications to be addressed to the Editor, "Wireless Weekly," 33 Regent St., Sydney.

Telephone: Redfern 964.

All advertising and other matter for insertion should be in the hands of the Editor by Friday.

All copy must be written in ink or typed, and on one side of paper only.

Advertising Rates on application.

### WIRELESS BOOKS

#### FOR THE AMATEUR

- Wireless Valves Simply Explained, Scott-Taggart, 3/6; postage 3d. extra.
- Simple Valve Receiving Sets, 2/-; postage 3d. extra.
- Practical Wireless Sets for All, Harris, 2/-; postage 3d. extra.
- Construction of Crystal Receivers, Douglass, 2/-; postage 3d. extra.
- Twelve Tested Wireless Sets, Harris, 3/6; postage 3d. extra.
- Wireless Component Parts and How to Make Them, 2/-; postage 3d. extra.
- Practical Wireless Valve Circuits, Scott-Taggart, 3/6; postage 3d. extra.
- How to Locate Trouble in your Set, 1/6; postage 2d. extra.
- How to Make Wireless Amplifiers, 9d.; postage 1d. extra.
- 100 Wireless Circuits and Connections, 9d.; postage 1/- extra.

**N.S.W. Bookstall Co. Ltd**

476 GEORGE STREET,  
 SYDNEY.

## Wireless Apparatus

New or Second-hand,  
 Bought, Sold or Exchanged

### HOWELL'S

19 Barlow Street  
 SYDNEY

PHONE : MA 1133

OPEN TILL 9.30 FRIDAY NIGHT



Masts, wood and steel, any size from 20 ft. to 200 ft.; Aerial Wire; Insulators; Spreaders; Ash and Metal Hoops, all sizes; Rigging Wire; Screws; Halyards; Anchor Pegs; Trucks, etc.; Wireless Cabinets, any design; Portable Poles and Aerials, a speciality. Flags of all Nations and designs. Prices on Application.

**E. H. BRETT & SONS LTD.**  
 LITTLE AVENUE. BALMAIN EAST  
 Phone W 1205  
 W 1005

ASK YOUR DEALER FOR OUR

*Elsie Vernier*

—2 - Coil Holder—

AT 16/-

PACIFIC ELECTRIC CO.

87 CLARENCE STREET,  
SYDNEY.

Phone B 5891

SOLE AUSTRALIAN DISTRIBUTORS

"RAMSAY" RADIO SUPPLIES

You cannot buy better : : Everything for the Amateur

Maple Baseboards . . . . .	2/9	1½-volt Dry Cell Valve, "Phillips" . . . . .	27/6
Maple Loose Coupler Ends . . . . . Set of 4	2/3	UV 199 Radiatron Valve . . . . .	30/-
Contact Stops, N.P. . . . . per doz.	1/-	Socket for UV 199 Valve . . . . .	4/-
Contact Studs, N.P. . . . . per doz.	1/-	"Modern" 4 to 1 Transformers . . . . .	25/-
N.P. Runner Rods . . . . . each	1/-	"Emmeo" 3 & 5 to 1 Transformers . . . . .	21/-
Crystal Detector Parts on Card . . . . .	2/9	Primary Tubes, Wound . . . . .	3/6
S.P. D.T. Knife Switch . . . . .	2/9	2200 Pico Head Phones . . . . .	25/-
D.P. D.T. Knife Switch . . . . .	5/-	4000 British Mel. Head Phones . . . . .	25/-
Valve Sockets, "R" Type . . . . .	2/6	4000 Brande's Superior Head Phones . . . . .	40/-
Lin. Switch Arms . . . . .	1/6	Footc Variotector . . . . .	10/-
Crystal Cups . . . . . 6d. & 9d.		All Types of Crystals from . . . . .	1/-

Write for Catalogue W16, also Catalogue on Complete Sets.

**RAMSAY SHARP & COMPANY, LIMITED**

RADIO ENGINEERS

217 GEORGE STREET, SYDNEY.

# SMITH'S SPECIALS

WATCH FOR OUR SPECIAL REDUCED LINES  
EACH WEEK

Galena Crystal .. . . . .	1/-	Pico Phones .. . . . .	25/-
Maple Base Boards .. . . . .	2/9	Brookley Mica Condensers .. . .	1/6
Set Loose Coupler Maple Wood-		201A Valves .. . . . .	30/-
work (5 pieces) .. . . . .	2/6	23 Plate Variable Condensers ..	17/-
"R" Type Sockets .. . . . .	2/-	Clix Sockets .. . . . .	7d.
$\frac{1}{4}$ inch Sliders, without rod .. . .	1/-	Radiotron Sockets .. . . . .	3/3
Dutch Detector Valves .. . . . .	15/-	UV 199 Sockets .. . . . .	3/3
Box Type Crystal Set .. . . . .	22/6		

Bakelite cut and drilled to order.

*FREE ADVICE ON BUILDING YOUR SET.*

## SMITH'S RADIO STORES

3 VICTORIA ARCADE,

OPP. HOTEL AUSTRALIA.

**WIRELESS**  
**RADIO SETS AND REQUISITES**  
 ARE OBTAINABLE AT LOWEST PRICES FROM  
**SWAINS'** 119a-123 PITT STREET, SYDNEY  
A FEW DOORS FROM THE G.P.O.

CRYSTAL OUTFITS . . From 25/- Operative within a radius of 25 miles.  
 ONE VALVE SETS . . From £5/10/- " " " up to 100 miles.  
 TWO to SIX VALVE SETS From £28/0/0 " " " 5000 miles.

IMPROVE YOUR CRYSTAL SET BY ADDING

OUR ONE VALVE AMPLIFIER—COSTING ONLY £7/7/-—READY FOR CONNECTING UP—  
 IT WILL INCREASE THE VOLUME TREMENDOUSLY—AND THE RANGE UP TO 100 MILES.  
 OR OUR TWO VALVE AMPLIFIER AT £10/10/- COMPLETE—OPERATES A LOUD SPEAKER

—WE SELL—

The Famous FROST Parts and Fittings—All Makes of Valves, Phones and Loud Speakers.

The **Sterling** Sets - Loud Speakers - and Phones. Every kind of Crystal.

JUST ARRIVED, THE FAMOUS STERLING CONDENSERS AND VARIOMETERS

All the Latest Books and Magazines on Wireless.

The United Distributors Co's. Home Assembly Sets—Spare Parts—and Fittings.

Wireless Concerts and News, daily from 12 till 5.30 p.m.

PRICE LIST FREE.

**WATCH THIS SPACE FOR OUR**  
**WEEKLY SPECIAL**

AND SAVE £ s. d.

THIS WEEK

A LOOSE COUPLER CRYSTAL RECEIVER, COMPLETE WITH  
 PHONES, AERIAL GEAR and all ACCESSORIES . . . . . 2/17/6

BEST RESULTS GUARANTEED

**RADIO-W'LESS Mfg. Co.**

307 George Street, Sydney  
Phone: B5747

**RADIO-W'LESS GALENA, 2/-**  
 —is as loud as a Single Valve.

494 Military Road, Mosman  
Phone: Y2175



**Before you  
Expend  
Money on  
Radio  
Equipment  
Consult  
Anthony  
Horderns'  
Wireless  
Experts.**

Your inspection of the big display of everything that is new in the world of Wireless, is invited.

**(Wireless -- Second Floor)**

**Anthony Hordern & Sons  
Limited,**

Brickfield Hill, Sydney

Phone City 9440. Box 2712 C.P.O.



**THEY  
HAVE A  
SPONSOR**

***Western Electric  
Head Receivers with the new  
"COMFY" PAD***

World-wide in popularity, "Western Electric" Head Receivers have a considerably increased value by the addition of a new "comfy" pad—light in weight and made of soft leather and flannel. The wearer is thus assured of the utmost comfort and ease.

**TRY A PAIR FOR COMFORT'S SAKE**  
*British-made throughout*

In the mind of the man who judges a thing by its sources "Western Electric" Head Receivers have a sponsor. The sponsor is the name "Western Electric," a name inseparably associated with telephones the world over.

Any Radio dealer will supply you with "W.E." Head Receivers. Always insist on "Western Electric."

**Have you sent your Subscription  
to Wireless Weekly yet?**

**Have No Regrets! Get Your Pair To-Day!**

**27/6**

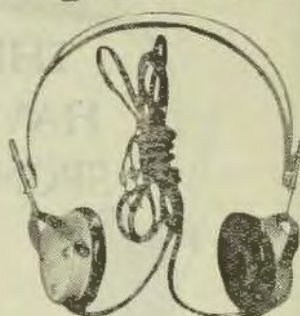

**27/6**

(4000 OHMS) **HEADPHONES** (4000 OHMS)

Made by the Ericsson Company — the world's Greatest Telephone Manufacturers.

Light and comfortable, highly sensitive, easy adjustment, robust construction, and beautifully finished.

We are so confident that you will be satisfied with these Headphones that we offer you

**MONEY BACK GUARANTEE**

We will cheerfully refund your money if you are not satisfied with them, provided phones are returned undamaged within fourteen days.

**RADIO SERVICE STORE**

Assembly Platform, Railway Station, Sydney

**"RIGHT ON THE STATION"**

# MICK SIMMONS LTD.

*Licensed Radio Dealers*

We have just received a shipment of the following lines:—

**TRANSFORMERS.**

Signal, each . . . . .	21/-
United 3½ to 1, each . . . . .	26/3
United 5 to 1, each . . . . .	26/3
All American 3 to 1, each . . . . .	30/-
All American 5 to 1, each . . . . .	32/6

**DIALS.**

Mahogany Rheostat Dials, each . . . . .	1/9
Mahogany Condenser Dials, each . . . . .	2/3
Scranton 3in. Condenser Dials, each . . . . .	2/-

**VALVES.**

U.V. 301A, each . . . . .	30/-
Phillips D1, each . . . . .	18/6
Phillips D2, each . . . . .	18/6
Phillips D4, each . . . . .	18/6
Phillips D5, each . . . . .	18/6
Ediswan, each . . . . .	17/6

Call and inspect our fine range of wireless accessories.

*Remember our motto: "Quality consistent with reasonable prices"*

*Mick Simmons Ltd.*

Headquarters: HAYMARKET, SYDNEY  
THE WORLD'S GREATEST SPORTS STORE

\_\_\_\_\_

**WHAT ARE YOU DOING!**  
about ensuring that you get Wireless Weekly delivered at your door by the postman every week? Here is a sure way. Just fill in this form and mail it to us with remittance. We will do the rest.

**SUBSCRIPTION FORM**  
Wireless Weekly,  
33/37 Regent St., Sydney.

Please forward me for..... months "Wireless Weekly for which I enclose..... plus exchange of country cheque.  
..... 192....

To the Editor,  
Signed..... Address.....  
Annual Subscription, 13/-, post free.

\_\_\_\_\_

(Continued from Page 15.)

els through space will be 380 metres, or about a quarter of a mile apart.

Let us say that the voice frequency at the instant we are considering is 1000 cycles per second. This corresponds roughly to high C on the piano. The modulated wave, then, has a nominal frequency of 800,000 and its amplitude varies up and down 1000 times per second in accordance with the voice frequency.

The side bands would be the sum and the difference of these two frequencies, that is, 801,000 cycles per second and 799,000 cycles per second; the instantaneous value of the frequency of the modulated wave will vary between these two frequencies as limits. It is seen at once that if a receiver is to respond to this modulated wave, it must not tune so sharply as to give a different intensity to the different frequencies in this band. If it amplifies the 800,000 cycle, part of the wave 100 times, when tuned to it, it must give practically the same amplification up to 801,000 cycles and down to 799,000 cycles.

Musical notes contain frequencies as high as 4,000 or 4,500 cycles per second. The receiver must, therefore, have a band of uniform response 8,000 or 9,000 cycles wide. It need not, however, have a band any wider than this. This is the limit to which the selectivity of a broadcast receiver can be carried, if we are to be able to choose between broadcasting at will.

Until the advent of the super-heterodyne receiver, nothing even approaching the degree of selectivity just described could be obtained. Thus it was that often two or three stations were heard at the same time, and it was impossible to eliminate a powerful nearby station and listen to more distant ones. In the super-heterodyne receiver, however, we can obtain this remarkable degree of sharpness of tuning. We can separate stations that differ by less than one per cent. in frequency and yet not distort the music by cutting off the side bands.

#### NEW ZEALAND AND THE PATENT SITUATION.

##### Alleged Infringement of Patent Rights.

Listeners-in throughout the Dominion are considerably perturbed over the crisis which has arisen in the wireless world, as a result of which the majority of New Zealand broadcasting stations have closed down. This step has been taken following the action of Amalgamated Wireless (Australasia) Ltd. in en-

forcing observance of what it terms its patent rights of certain apparatus.

According to information available in Wellington, the position which has arisen is under immediate consideration by the Government. A certain amount of light has been thrown on the matter (says the "New Zealand Herald") by Mr. C. H. Pearson, who addressed listeners-in from 1YB (Auckland). Mr. Pearson read a letter, received by a firm of local gramophones dealers from the Wellington solicitors for Amalgamated Wireless Ltd., intimating that broadcasting from 1YB constituted an infringement of the company's patent rights, because it necessarily involved the use of certain circuits and apparatus for which the company held exclusive patent rights in New Zealand. The letter mentioned one of the principal patents by number and name, and two others by number only. It then proceeded:—

"The only means by which you can lawfully acquire any right to use the inventions which are the subject of these patents is to make arrangements with our client for the grant of a license or licenses in that behalf. No such license has been granted, or, indeed, applied for. On the contrary, we understand that the circumstances are such that it must have been known to those in charge of the broadcasting that an infringement of our client's patents was necessarily involved. They, nevertheless, seem to have proceeded with their infringement in the idea that our client could not sustain the claims. That idea, if it existed, is entirely erroneous. Our client is prepared and intends to protect its rights by due process of law whenever they are challenged.

"We are accordingly instructed to call upon you immediately to desist from the use of all apparatus infringing the Letters Patent belonging to our client, and to inform you that our client holds you responsible in damages for all infringement committed by you or to which you are a party. The immediately important matter is the question as to whether or not you are prepared to undertake to desist from the use of infringing apparatus, and on this point we would ask you to favour us with a prompt reply. Failing a prompt and satisfactory reply, the only course open to the company will be to take action against you for an injunction and damages."

In reply, the company's solicitors were informed that 1YB was a private station controlled by Mr. C. H. Pearson, whose license debarred him from accepting or paying any remuneration for services rendered to or by the station. The company was reminded that a license to use the patent rights claimed was sought last November, but that no definite reply had

been received from the company. Mr. Pearson had no intention of using his station as a commercial one, and had the assurance of the department that his license as a private station would not be interfered with, nor would it come under the scope of the new Government regulations.

Mr. Pearson stated that he had forwarded copies of these letters to the Minister-in-Charge of Telegraphs, the Hon. J. G. Coates, and he was satisfied to leave the matter in the hands of the Government. Until he knew exactly where he stood, however, he proposed to close the station. In the meantime, he suggested, all listeners-in should send telegrams to Auckland members of Parliament protesting against any attempt to establish a monopoly of broadcasting in New Zealand.

#### WESTERN AUSTRALIA.

Our broadcasting station, 6 W.F., is now operating on increased power,  $3\frac{1}{2}$  kwts. No appreciable increase has been noted in the local area, but reports of excellent reception as far as 300 miles within the confines of the State have been made.

A very successful demonstration of wireless telephony was given by Messrs. Congdon and Grey before the Subiaco Returned Soldiers' League at their monthly meeting held at the Subiaco Council Chambers on Monday week last. A Ducon attachment was used for the aerial, and no earth. After a preliminary delay, owing to the "softening" of one of the transmitting valves at 6 W.F., which had to be replaced, music was brought in at tremendous volume, and was uncomfortably loud in the room. Two loud speakers were tried, but as the volume and clarity were improved by using one, the second one was only used as a standby.

Another concert will be given from the Queen's Hall next week, via 6 W.F. It is hoped to radiate two concerts per month from this establishment.

The military camp "season" has begun here, a week being allotted to each battalion. The battalion which has just broken canvas had amongst its youths two who saw the advantage of a wireless set o' nights. A crystal receiver was, therefore, included in the "kit," and the bedtime stories by Auntie Pat, from 6 W.F., much appreciated.

The Radio and Electrical Exhibition which has just terminated recently, and which was held in the Perth Town Hall, was a decided success from an electrical point of view. Although demonstrations of received wireless music were given nightly, that was

practically all of the wireless exhibits, save perhaps a few small components on show by the large wholesale houses. None of the local stores held stands.

The Westralian Farmers Ltd. had a broadcasting department at the Royal Show which commenced this week. Its popularity could be judged by the great crowd of visitors gathered around the instruments. Loud speaker demonstrations were given. Several other city firms held exhibits. This shows a marked interest in radio goods over last year, as the Royal Show of 1923 held no wireless exhibits whatsoever.

Westralian Farmers, 6 W.F., broadcasted their most successful concert on a recent evening, this being also a Show night, when the Queen's Hall was connected and the annual concert of the Caledonian Society broadcasted. Every Scotsman who wasn't actually at the hall contrived to be present around his radio friend's loud speaker (?). It would be interesting to learn just who is receiving 6 W.F. in Sydney, with particulars of receiver. Any reports addressed to the editor will, I am sure, be handed to me. I would thus obtain any confirmation desired.

"Farm products cost more than they used to."

"Yes," replied the farmer. "When a farmer is supposed to know the botanical name of what he's raisin', and the entomological name of the insect that eats it, and the pharmaceutical name of the chemical that will kill it, somebody's got to pay."

An old nigger wished to pick a quarrel with another nigger. Nigger No. 1 swore and stormed at Nigger No. 2, and kept on swearing and storming hoping to provoke him. Nigger No. 2 said not a word, but kept at his work. Nigger No. 1 swore and stormed more. Nigger No. 2 said not a word. Nigger No. 1 frothed still more. Nigger No. 2 still silent. Nigger No. 1 got desperate and said "Look here yo', kinky-headed, flat nosed, slab-footed nigger, I warns yo', before God don't you keep givin' me none o' your damned sileneel!"

The husband, who had a great habit of teasing his wife, was out driving with her, when they met a farmer driving a span of mules. Just as they were about to pass the farmer's rig the mules turned their heads towards the auto and brayed vociferously.

Turning to the wife, the husband remarked: "Relatives of yours, I suppose?"

"Yes," said the wife, sweetly, "by marriage."

We are Sole Agents for  
**"ASHCOY"**  
 Brand, Best British Polished  
**EBONITE PANELS**  
 for Radio Work.  
 Each packed in a sealed envelope.  
 Stocked in all the Standard Sizes for  
 Crystal and Valve Sets.  
 Edges ground true to size.

**ASK YOUR RADIO DEALER**

Full Stocks of British Ebonite Sheets,  
Rods and Tubes.

WHOLESALE ONLY  
**A. S. HARRISON & CO.**  
 5-7 Barrack Street, SYDNEY.  
 Phone B4574 P.O. Box 2591



**SIGNAL HOME ASSEMBLY SETS**

can be put together with a screw-driver and a pair of pliers in a few hours, at about half the cost of shop-assembled sets.  
 Clear diagram and full instructions.  
 1 Valve, £5/10/-; 2 Valves, £9/0/-; 3 Valves (Audio Frequency), £11/11/-; 3 Valves (Radio Frequency), £11/11/-; 4 Valves (Radio Frequency), £13/13/-

**YOUR DEALER HAS THEM!**  
**UNITED DISTRIBUTORS LTD.**  
 (Wholesale only),  
 72 CLARENCE STREET, SYDNEY.

**"PICO" HEAD PHONES**

THE STANDARD OF SATISFACTION.

"Pico Head Phones combine PERFECTLY all the essentials you seek—lightness, volume, clarity and durability. They are extremely light—indeed—negligible in weight, and most comfortable on the head. These qualities make them doubly welcome in warm weather.

**2200 OHMS RESISTANCE.**

Every set of "Pico" Head Phones is minutely tested before packing, and is accompanied by a written

**FULL GUARANTEE**

against defective workmanship or material.

**PRICE — 2 5 / -**

Ask your dealer to show you

**"PICO" HEAD PHONES.**

**UNITED DISTRIBUTORS LIMITED**  
 (Wholesale Only)

72 CLARENCE STREET — SYDNEY  
 592 BOURKE STREET — MELBOURNE



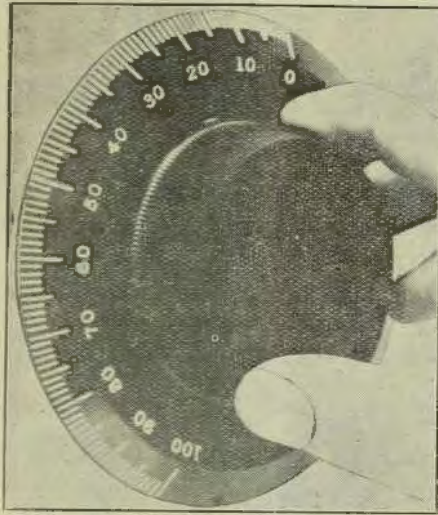

R200—4in. dials, fits 3/16in. or 1/4in. shaft.

# GILFILLAN

## *Tapered Grip Dial*

TUNE IN WITH EASE

See how quickly you can turn to any degree or fraction of a degree.

It gives you that satisfied feeling.

When better Radio Parts are made Gilfillan will make them.

*Gilfillan Radio Parts are always Just a Little Bit Better*

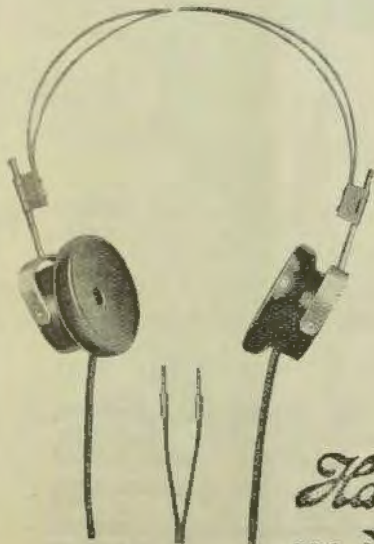

EVERY LISTENER-IN NEEDS HEADPHONES

BUY YOURS AT HARRINGTON'S LTD.

MELLO PHONES

WESTERN ELECTRIC      IMPERIA PHONES

BALDWIN PHONES

A. P. VALVES . . . . . 25/-

RADIOTRON VALVES . . . . . 30/-

PHILLIP'S VALVES . . . . . 18/6

ALL MARCO PARTS

IMPERIA SETS ————— 1 to 6 Valves

Write or Call for Particulars.

*Harringtons* <sup>LD</sup>

386 George Street, Sydney

ADELAIDE — 10 Rundle Street.  
WELLINGTON, N.Z.—42 Willis St.  
AUCKLAND, N.Z.—140 Queen St.  
MELBOURNE—266 Collins Street.  
KATOOMBA — Katoomba Street.  
BRISBANE — 98 Queen Street.

# Good News

## for Crystal Set Owners!

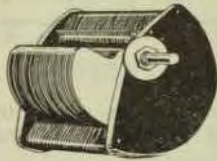

A1 Quality Condenser.  
 77a-43 Plate, .001 . . . 15/-  
 77a-23 Plate, .0005 . . . 12/-  
 77a-11 Plate, .0003, 10/-  
 55-43 Plate Vernier, complete with knob and dial . . . 25/-  
 55-23 Plate Vernier, complete with knob and dial . . . 22/6

That wonderful Crystal—N.H.M. GALENA—is now reduced. You can buy the best Crystals obtainable in Sydney from Colville-Moore. We have made special arrangements for supplies, and can quote these low prices:—

N.H.M.  
 No. 2-1/-.



N.H.H.  
 Guaranteed  
 Super Sensitive  
 1/6



Honeycomb Coils.

Coils.	Mtd.	Unmtd.
19	5/3	2/6
25	5/3	2/7
35	5/3	2/4
40	5/3	2/6
50	5/6	2/9
75	5/9	3/-
100	5/9	3/4
135	6/3	3/4
150	6/3	3/4
200	6/6	3/9
235	6/6	3/9
250	6/6	3/9

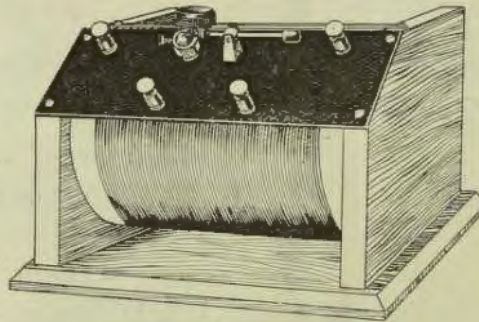

Unassembled Sets can be supplied; all parts ready drilled for assembling.

Wound primary, and complete with wiring and assembling diagrams.

PRICE is only 16/-

COL-MO Single Slide Crystal Set . . . . . 15/-  
 Complete with Phones, Aerial Wire, Insulators . . . . . 50/-

SOLE DISTRIBUTORS OF N.H.M. GALENA FOR AUSTRALASIA:

**COLVILLE-MOORE**  
 WIRELESS SUPPLIES, LIMITED.  
 10 ROWE STREET (NEXT HOTEL AUSTRALIA) SYDNEY



# MEL - O - PHONES



You cannot do better than purchase a set of **MEL-O-PHONES**. The high resistance Head Set of Reliable Construction and Good Appearance. ——— Guaranteed British Make

The price is low . . . . . 25/- per Set  
Weight only 10ozs.—4000 ohms resistance.

Wound to give maximum number of turns proportional to resistance. Stalloy Diaphragms Aluminium Head Bands. Self alignment to the ears.

Our stock of Head Phones comprise other well-known makes, all at COL-MO PRICES.

COL-MO 4000 ohms . . . . .	32/6
PICO 2000 ohms . . . . .	25/-
BRANDES 4000 ohms . . . . .	35/-
TRIMM'S DEPENDABLE 2400 ohms . . . . .	32/6
TRIMM'S PROFESSIONAL 3000 ohms . . . . .	45/-
BROWN'S ADJUSTABLE 2000 ohms . . . . .	£5/10/-
BROWN'S SUPER-SENSITIVE 4000 & 8000 ohms . . . . .	£5/15/-
WESTERN ELECTRIC 4000 & 8000 ohms . . . . .	£2/4/-

**COLVILLE-MOORE**  
**WIRELESS SUPPLIES, LIMITED.**  
 10 ROWE STREET (NEXT HOTEL AUSTRALIA) SYDNEY

Trade inquiries for MEL-O-PHONES from Mr. Keith Stokes, Montana House, King St., Sydney, Manufacturers' Representative.

Putting  
**QUALITY**  
*into*  
**RADIO**



**JEFFERSON**  
Super - Sensitive  
Amplifying  
**TRANSFORMERS**



**FOX & MacGILLYCUDDY LTD.**  
DAILY TELEGRAPH BUILDINGS, SYDNEY.  
Brisbane Agents: Wireless House, Adelaide Street, Brisbane

Friday, October 24, 1924

WIRELESS WEEKLY

Fifty-Seven

## For Your New Receiver

USE THESE FAMOUS PARTS  
Your dealer will show them to you



Framingham Vernier  
Rheostats.



Framingham Potentiometer.



Framingham "All Tube"  
Universal Rheostats.



DeVeau Gold Seal Radio  
Head Set Cat. No. 843.



Framingham Inductance  
Switch.



Framingham Series Parallel  
Switch.

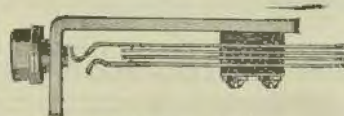

DeVeau Two-Circuit Radio  
Jack Cat. No. 25.

### WHOLESALE ONLY ANNOUNCEMENT.

AGENTS FOR—

Jefferson Elec. Mfg. Coy.  
Framingham Products.  
Premier Electric Coy.  
Molesworth Crystals.  
Deveau Goods.  
Russell Fraser Wire Coy.  
D.A. and Dutilh—Paris.  
Electrad Grid Leaks.

SOLE N.S.W. SALESMEN FOR—

Baldwin 'Phones, Loud Speakers  
and Units.

New York Coil Coy.—Condensers.

Complete Stocks of all Radio Goods.

## FOX & MacGILLYCUDDY LTD.

DAILY TELEGRAPH BUILDINGS, SYDNEY.

BRISBANE AGENTS: WIRELESS HOUSE, ADELAIDE STREET, BRISBANE.



SPECIALISING IN VALVE SETS. Our long years of experience in Radio make us first and foremost in this particular branch. IS MR. KEOGH'S AMERICAN EXPERIENCE WORTH BEING AVAILED OF? We have the Technical Knowledge. Call and See Us. "SERVICE" IS OUR WATCHWORD. We are landing a big shipment of goods on 4th October. Call and inspect.

THE HOUSE OF RADIO      503 George Street      Opposite Crystal Palace Theatre

### MY PRICES WERE ALWAYS SALE PRICES

SPECIALS THAT MAKE YU TAKE A LFL NOTIS — WHAT !!

Western Electric 4000 ohms Phones ..	38/-	6 Volt. 60 amp. C.A.V. Accumulators ..	58/-
Pico 2200 ohm Phones ..	24/-	12 Point Inductance Switches ..	5/6
Mel. 4000 Phones ..	22/6	3in. Calibrated Knob and Dial ..	1/6
Murdoch 2000 ohm 22/6, 3000 ohm ..	25/-	Framingham Parallel Switches ..	4/9
Frost 2000 ohm Phones ..	30/-	Set of Eight Engraved Terminals ..	3/6
43 Plate Plain Signal Condenser ..	16/-	3/20 Copper Aerial Wire ..	2/9
43 Plate Vernier Signal Condenser ..	26/-	Kellogg Moulded Bakelite Coupler,	
23 Plate Plain Signal Condenser ..	14/6	150-2000 ..	59/6
23 Plate Vernier Signal Condenser ..	23/6	The Echo Loud Speaker ..	84/-
Radiotron 201a Valves, including Socket	30/-		

EXTRA SPECIAL: With every Amplion Loud Spenker, I will give free, one copy of Williams' Practical Radio, value, 10/6.

### PRICE'S RADIO DEN

220 Oxford Street, Woollahra.      Waverley 451.

170a New South Head Road, Double Bay.

**HALF-YEARLY**  
**Stocktaking Sale**

**GENUINE BARGAINS**

12in. ELECTRIC BOWL FITTINGS  
from 24/- (Plain and Decorated).  
Electric Irons, Electric Toasters, Per-  
colators, Electric Trains, Electric  
Fans, Etc., Etc. Inspect our Stock of  
Electrical and Radio Appliances at

**THE**  
**Home Electric**

106a KING STREET — SYDNEY

'Phone B 5565.

**10** RADIO **10**  
 Per Bargain Sale Per  
 cent cent

Get Ready for Melbourne High Power Broad-  
 casting of 1720 Metres, and take advantage of  
 the low prices during our 10 Days' Sale.

Rheostats . . . . .	2/6	Loud Speakers . . . . .	30/-
Dials . . . . .	1/8	3 Coil Mounts . . . . .	27/6
Phones, Pieus . . . . .	25/-	Terminals . . . . .	4d.
Phones, Mellor . . . . .	24/6	Crystals . . . . .	6d.
Transformers . . . . .	25/-	Crystal Sets . . . . .	25/-
Knobs . . . . .	1/6		

Call and see our Bargains.

**The Radio Company Ltd.**

HEAD OFFICE 15 LOFTUS ST., CIRCULAR QUAY, SYDNEY

No. 1 Branch . . 15 Loftus St., Circular Quay      No. 2 Branch . . Bondi Junction

No. 3 Branch . . . . . 66 King St., City

**2.L.I.**



# GRODAN Spider Formers

6d. ————— each ————— 6d.



Continued success meets  
this cheap and effective  
tuning unit.

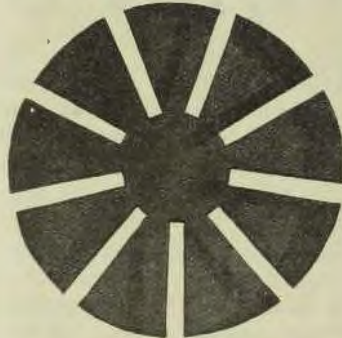

You can make your own  
set from Grodan Parts,  
for less than 10/-.

Ask for the original  
Grodan Brand.  
All Dealers, .. 6d. each



**GROSE and DANIELL**  
185a GEORGE STREET WEST  
Opp. POST OFFICE  
SYDNEY Telephone M W 1508



## FULLY GUARANTEED CRYSTAL SET

Complete in every detail, £3 15s.

Here is volume and value—a Set that comes to you absolutely  
complete and ready for use. All you have to do is to adjust  
the aerial and ground wires.

Everything needed is supplied with the

### METRO JR. Crystal Radio Receiving Set

Included in the Set are one set of head phones—which are very  
sensitive — all aerial equipment, leading wire, ground clamp,  
insulators.

It offers you the highest perfection at the lowest possible price

Your dealer has it.

## United Distributors Limited

(Wholesale Only)

72 Clarence St., Sydney.

592 Bourke St., Melbourne.

1/6—Q.S.A.

CRYSTALS

Q.S.A.—1/6

# AMERTRAN

The AmerTran audio transformer can be used in all stages of an audio amplifier with tubes capable of handling the energy and in a properly balanced circuit. Because of the great amplification of this transformer it is seldom necessary to employ more than two stages for greatest volume, and one stage with the AmerTran will, as a rule, give satisfactory results with a loud speaker when used with a good regenerative receiver or radio frequency amplification. In general it may be said that if the signals can be heard distinctly with head phones with the detector only, a loud speaker can be operated with only one stage of audio frequency, when using the AmerTran, and the results will be startling to those who have been using the ordinary type of amplifying transformer. Ratios 5 to 1 and 3½ to 1 in stock.

## Argentite Crystals

Known the  
World around  
as



the most  
Sensitive  
Known

SOLD WITH AN ABSOLUTE GUARANTEE BY THE BEST RADIO DEALERS.

Australian Distributors:—

WELBY RADIO CO., 13 Royal Arcade, Sydney



## Correspondence

October 16th, 1924.

To the Editor, "Wireless Weekly."

Dear Sir,—On Wednesday last I intended to give KGO the usual run on my four-valve set, but found that, although they came through alright, they had not the volume of previous receptions. It suddenly occurred to me that I had forgotten to throw in the aerial switch, and that actually I was working KGO on the lead-in wire only. At 8 p.m. the same night—using two stages radio, detector, and two stages audio of a six-valve set completed by me last Saturday only—2FC (Farmer's) was tuned in without any trouble, and without any aerial connection whatever, and later without any earth connection. It was found that 2FC could be tuned in at any time during the evening without any aerial or lead-in connection whatever. A loop was then brought into use, and worked a loud speaker with sufficient volume to be heard clearly all over the house. The aerial was again brought into use, but instead of being connected was held by one of the party, who joined hands with the writer, who then held the aerial terminal on the set. This made no difference to 2FC, who still came in clearly on the headphones, although the wireless wave had to pass through two persons from the aerial terminal before reaching the set. Attention was then given to the new Melbourne station 3LO. This station was picked up without any aerial connection whatever, and was just audible when used with a loop and loud speaker, the music being plainly followed about ten feet away from the loud speaker. Something freakish then happened. Although both the phones and the loud speaker were detached from the set, and no part of them nor their cords were near the set, the announcement from 2FC and also the choir items could be heard all over the room. This continued until 2FC closed down, and together with all the previous items can be verified by disinterested parties who were at the house at the time. It is the first time I have experienced audibility from a set when no phones nor speakers of any kind were used. Have you heard of or do you know of a similar happening? I also beg to report having heard the new British broadcasting station 3XXXX on October the 1st and 2nd; time—vicinity of 11 p.m. The first night a lecture was received, and the second night an item by a trio (instrumental). This station has also been heard by another station in Albury.—Yours faithfully,

P. BOULTON.

"Tenarbyn," Griffith Street, Albury.

[Mr. Boulton presents an entirely new one to us, and something which we cannot account for. Can any reader offer a theory?—Ed.]

Brunswick Street,  
Ballina, N.S.W., 12/11/24.

To the Editor, "Wireless Weekly."

Dear Sir,—Much has been written about "Experimenters" and "Amateurs" in your paper lately. It is obvious that about two dozen stations in N.S.W. constitute the total of real "experimenters." To be included in this number one needs to have a long pocket and a good banking account, for, no matter how good his knowledge of wireless or how great his ambition to succeed, he cannot do so if the cash to purchase the necessary apparatus is not forthcoming. Then, again, there is the drawback in the country of having no power supply. Phone transmitters are costly things, almost prohibitive to the average country worker. If accumulators are used they have to be taken a long way to be charged. The usual charge is 1/- per volt up this way. Of course, dry cell valves are a boon in this respect. My own accumulator has a charging rate of 2 amps. At the power-house here the lowest rate is 3 amps, and frequently they put two or three batteries in series and give the lot as much as 6 amps. Needless to say, the result is anything but satisfactory, but you have no alternative.

At the writer's station there is the usual three-coil regenerative single valve receiver and a small spark transmitter. This does not lend itself to much serious experiment, but still some interesting things can be done. Aerials, earths, and counterpoises can be tried; the frame aerial, too, can be used on nearby signals, using it as a direction finder.

Now that I have set forth the above facts, what class do you put me in? Am I an "Amateur" or a "Genuine Experimenter"? My knowledge of radio is good, as I hold a seagoing operator's ticket, served four years afloat as operator, and take a keen interest in anything pertaining to wireless. Have held an experimental license since 1913.—Yours faithfully,

FRANCIS KIMPTON,

2 B.N.

### "B" AND TORCH BATTERIES.

22½ V with wandering Plugs, 10/—City  
45 V with wandering Plugs, 20/—City  
These batteries are larger than the usual  
"B" Batteries. Reading 8 to 12 amps,  
which ensures longer life.

Manufactured by R. MATTHEWS & Sons  
Commercial Road, Leichhardt — Sydney



## VOLUME WITHOUT NOISE

The TUNATALKER is radically different in theory and construction from any horn type Loud Speaker, neat in appearance, possessing a deep, rich tone, absolutely free from distortion, it is in fact—

**THE SPEAKER OF COMBINED EXCELLENCE**  
**PRICE . . . . £8**

The Continental Radio and Electric Co. Inc. (Wholesale Only)  
GLADSTONE CHAMBERS, 90 PITT STREET, SYDNEY.  
CHAS. R. GABB & CO. WILLS & CO., PTY., LTD.  
14 Chessel St., Adelaide. 7 Quadrant, Launceston.  
Corbett, Derham & Co. Pty. Ltd. (Wholesale Only), Manufacturers, 573-85 Lonsdale-st., Melbourne



## Hearing's the thing!

The Headphones are all-important. There is only one economy possible, and that is to buy the best. The construction of

### Brown's Type "A" Headphones

is quite distinctive. The ordinary diaphragm is replaced by an iron reed, tuned to a suitable tone, to which an aluminium cone-shaped diaphragm, spun to the fineness of paper, is screwed. This diaphragm will respond to the most feeble impulses which would not affect other headphones. Broadcast vocal and instrumental music is heard at great distances with wonderful distinctness.

Wireless enthusiasts agree that "super-sensitive" is the only way to adequately describe these phones.

*"To obtain the best results from your receiving set, it is essential to use the best headphones."*

Procurable from all Radio Dealers.

Amalgamated  Wireless  
(Australasia) Ltd.

97 Clarence Street  
Sydney

Collins Street  
Melbourne



Friday, October 24, 1924

WIRELESS WEEKLY

# STERLING LOUD SPEAKERS



ARE FAITHFUL TO AN ECHO IN REPRODUCTION . . . CLEAR, MELODIOUS AND PERFECT IN TONE . . . AMPLE IN VOLUME WITHOUT A SIGN OF DISTORTION

- The Dinkie . . . . . £3
- The Baby . . . . . £4/15/-
- The Audivox . . . . . £9
- The Magnavox 14in. . . £10/10/-
- The Magnavox 18in. . . £12/10/-

Sterling { Lightweight Headphones, 4000 ohms, 44/-  
Valve Sets 2, 3, 4, or 5 Valves

**Large Stocks**

**PHILIPS VALVES**

**IMMEDIATE DELIVERY**

OBTAINABLE FROM ALL LICENSED RADIO SUPPLIERS  
STERLING TELEPHONE & ELECTRIC CO. LTD., LONDON  
AGENTS:

**The LAWRENCE & HANSON ELECTRICAL Co. Ltd**

**33 York Street, Wynyard Square, Sydney.**  
Branches : Newcastle, Melbourne, Brisbane, and throughout New Zealand.  
Telephone City 6016 (3 Lines)

Published by A. W. Watt, "Keira," Alfred St., North Sydney, for the proprietors and printers, Publicity Press, Ltd., 12/16 Regent Street, Sydney.